

PRODUCT CATALOG

2014-2015

America's premier manufacturer and distributor of year round gardening supplies™

SINCE
1995

**GROW
WITH US!**



Sunlight Supply, Inc.

National Garden Wholesale.

www.sunlightsupply.com



Sunlight Supply, Inc.

National Garden Wholesale

Specializing in the wholesale of indoor horticulture, organics and hydrogardening supplies.
Proudly offering the industry's finest selection of signature, exclusive and semi-exclusive brands.

Sun System®

AMERICA'S #1 BRAND
of horticultural lighting fixtures

sun blaze

Dependable HO & VHO
fluorescent fixtures

Our Signature Brands

GALAXY® GROW AMP

Reliable low-emission digital ballasts

DigiMax

High-tolerance lamps optimized
for today's digital ballasts

ECOPLUS

Setting the standard for water
and air management products

MOTHER EARTH

Premium growing medias
and amendments

Grower's Edge

Growing accessories for
indoor gardeners

RAINMAKER

Value priced trigger pump
battery and backpack sprayers

ULTRA SUN

PREMIUM QUALITY, VALUE PRICED
HORTICULTURAL LAMPS

Duralastics

Durable, lasting plastic grow trays and reservoirs

AgroLED®

Energy Saving LED Garden Lights

SUNFILM

Quality Reflective
Film Products for Indoor Gardening

SuperSprouter

Propagation heat mats, domes,
trays and plugs

FASTFIT

toolless assembly light
& tray stands

POWER ALL

Quality extension cords,
adapters and power strips

FRESH FILTER

Lightweight Australian granular
carbon air purification products
& accessories

TITAN® CONTROLS

Controlling your
growing environments

IDEALair

COMMERCIAL-GRADE
Premium quality equipment to cool, heat,
dehumidify & humidify your indoor garden

HydroFlow

Quality, Compatible Irrigation Solutions

Hurricane

Powerful oscillating, centrifugal
and mixed flow fans

Flo-n-Gro

Hydrogardening Bucket Systems

SUN GRIP

The Original, Patented, Lighting
& Equipment Hangers



A complete line of indoor and
outdoor growing containers



Automatic self-contained fire extinguishers

AirForce Pro

High volume commercial-grade
air pumps



Liquid measuring devices for today's grower

SHEAR PERFECTION

Affordable trimming & cutting tools

EASY CLEAN TRAYS™

Easy-to-clean quick drain
ABS grow trays

SUN HUT

Affordable indoor greenhouses

STAKE OUT

Innovative plant support bracket

HYDROTON

Expanded Clay Hydroponic Growing Media

AFTERBURNER

High output mixed flow fans

Hyperfan

Highest CFM per watt
of any fan in the industry

Spectralux

Fluorescent Horticultural Grow Lamps

Sun System® SUN WINCH

Track Mounted Motorized Lift System for Lighting Fixtures

idealH2O

Premium Water Filtration Systems

www.sunlightsupply.com

Our Exclusive Distributed Brands



80/20 SPECIAL MIX



Premium blend potting soils



Our Semi-Exclusive Distributed Brands



Our Industry Leading Distributed Brands



Intro Sections

- Table of Contents I
- Introduction & Quick Reference 1
- Index II

Lighting Sections

- Sun System Reflectors 13
- Magnetic Ballasts 25
- Electronic Ballasts 27
- Sun System Complete Systems 34
- Commercial Greenhouse Fixtures 36
- Fluorescent Lighting 38
- New Lighting Technology 41
- Lamps 43
- Lighting Components 52
- Power & Lamp Cords 54
- Light Movers & Hangers 57

Garden Accessories Sections

- Safety Equipment 62
- Nutrients & Supplements 63
- Water Treatment 118
- Pest & Disease Control 120
- Leaf Shines & Washes 130
- Growing Media 132
- Cloning & Seed Starting 147
- Grow Systems/Trays/Reservoirs 159
- Tents/Indoor Greenhouses 170
- Pumps & Irrigation Supplies 176
- Water Chillers, Heaters & Purification 197
- Environmental Controls 206
- Fans/Ventilation/Ducting & Access.. 220
- AC/Dehumidification/Humidification 232
- Air Purification 238
- Sprayers & Wands 246
- Growing Accessories 249
- Food Storage 257
- Hand Tools 259
- Reflective & Greenhouse Films 263
- pH/EC/TDS Meters & Solutions 265
- Timers & Instruments 276
- Pots & Containers 281
- Books & DVD's 290
- Preferred Suppliers 291
- Shopping List 364

National Garden Wholesale® is a division of Sunlight Supply®, Inc. Manufacturer of Sun System® brand lighting fixtures. Sun System is a registered brand name of Sunlight Supply®, Inc. Corporate office: Vancouver, WA USA. Prices and product offering subject to change without notice. Suggested retail prices will be higher in Alaska, Hawaii and Puerto Rico. Copyright 2014. Printed in Oregon State.

1, 2, 3, 4...

1 Submersible Pump - Little Giant 178
 1-ABS Submersible Pump - Little Giant 178
 1/4in SunGrip Heavy Duty Light & Equipment Hanger .57
 1/8in The Original SunGrip Light Hanger57
 1/8in White SunGrip Light Hangers57
 10 Foot Lamp Extension Cords55
 10 in - Ideal H2O De-Chlorinator System199
 10 x 20 - Mondri Propagation Trays151
 10 x 20 - Super Sprouter Propagation Trays151
 10 x 20 Double Thick Trays Super Sprouter151
 10 x 20 Propagation Tray - Mondri Black & White Premium151
 100 Pint - Ideal-Air Dehumidifier232
 100/200 Booster Pump - Ideal H2O RO199
 105 Gallon Stand Up Reservoir166
 105 Overhead Dehumidifier - Quest Dual233
 110 Overhead Dehumidifier - Quest Dual233
 12 Light 240V Controller with Dual Trigger Cords - Helios 18211, 278
 12 Watt LED Lamp - Full Spectrum41, 51
 120 & 240 Volt - Power All Extension Cords54
 120 Volt - 8ft Power Cord55
 120 Volt Ballast Timer - Apollo 456, 209-210, 276
 120 Volt Duplex Receptacle53
 13 SEER - Ideal-Air Professional Installation Mini Split AC 24,000 BTU235
 13 Seer Air Conditioners - Cooling Only235
 1382 Calibration Solution - Control Wizard274
 14 Gauge - Power All Extension Cords 120 & 240 Volt .54
 14 Gauge Power All Extension Cord w/ Circuit Breaker .54
 14 Gauge/4 Conductor Interconnector Wire for Mini Split A/C237
 1413 TDS Solution - Oakton275
 1413 uS/CM Calibration Solutions - Hanna275
 15 Minute Lighting Delay Timer - Hades 1212
 15 SEER Mini Split Inverter Heat Pumps - Heating & Cooling235
 150 Mesh Screens - Hydro Flow Fittings190
 150 Overhead Dehumidifier - Quest Dual233
 1500 Elite Submersible Pump - EcoPlus177
 1500 PPM Calibration Solutions - Hanna275
 155 Overhead Dehumidifier - Quest Dual233
 15ft - 16 Gauge Lamp Cord55
 15ft Lamp Cord - 16 gauge Socket Assembly56
 15ft Sensor Extension Cable - Titan Controls208
 16 Gauge Lamp Cord - 15ft55
 16 Gauge Power All Extension Cord w/ Circuit Breaker .54
 16 Light 240V Controller with Dual Trigger Cords - Helios 16212, 278
 16 Light 240V Controller w/ Timer - Helios 13212, 278
 1600 X-Clude Formula 2 - Whitmire121
 170 Pint Ideal-Air CG2 Dehumidifier232
 180 Pint - Ideal-Air Dehumidifier232
 2 in - Super Sprouter Heated Germination Kit147
 2 Point Detachable Lamp Cord55
 2 Room CO2 Monitor/Controller - Titan Atlas 4207
 2 Tray Seedling Heat Mat - Super Sprouter147
 2 Zone - 6 Cycle Digital Water Timer - Melnor196
 2.77 EC Conductivity Solution Sachets - BlueLab274
 2.77 EC Conductivity Standard Solution - BlueLab274
 20 in - Ideal H2O De-Chlorinator System199
 20 Pack - Agrotech Magnum Reflector19
 2000 SR Ducting - ThermoFlo229
 203 Concentrate Pesticide Soil Spray/Drench - SNS 122
 205 Overhead Dehumidifier - Quest Dual233
 209 Systemic Pest Control Concentrate - SNS122
 217 Mite Control RTU - SNS122
 217C Mite Control Concentrate - SNS122
 24 Light 240V Controller with Dual Trigger Cords - Helios 17212, 279
 24 Light 240V Controller w/ Timer - Helios 14212, 278
 24-7 Nutrient Monitor265
 24-7 Replacement Probes265
 240 & 120 Volt - Power All Extension Cords54
 240 Volt - 8ft Power Cord55

240 Volt Ballast Timer - Apollo 556, 209-210, 276
 240 Volt Digital Timer - Apollo 11210, 277
 240 Volt Duplex Receptacle53
 240 Volt Mechanical Timer - Apollo 10210, 276
 244 Fungicide RTU - SNS122
 244C Fungicide Concentrate - SNS122
 25 PSI Pressure Regulator - Hydro Flow190
 2ft x 4ft - Fast Fit Tray Stand58, 169
 3 Ply - Can-Duct Silver/Silver229
 3 Way - Pure128
 3 Way Commercial - Pure128
 3 Way Soil Meter - Bond272
 3-6ft Extension Cords with Circuit Breaker - Power All Commercial Grade - 125 Volt - 7ft Lead Cord54
 3-in-1 Garden Spray II - Safer126
 3-in-1 Multimeter - HortiStick265
 3.5 & 5 Gallon Black Plastic Bucket Lid284
 3.5 Gallon Black Plastic Buckets284
 30 Pint Ideal-Air Dehumidifier232
 30x Grower's Edge Illuminated Magnifier Loupe129
 360 Degree Aeroptic Clone Spinner181
 360 Degree Sprayer Red181
 360 Spray Bottles246
 360 Trigger Sprayer246
 3ft x 3ft - Fast Fit Tray Stand58, 169
 4 Light 120 Volt Controller w/ Timer - Helios 1210, 277
 4 Light 120 Volt Controller with Relay Trigger Cord - Helios 2210, 277
 4 Light 240V Controller with Relay Trigger Cord - Helios 4211, 277
 4 Light 240V Controller with Relay Trigger Cord - Helios 5211, 277
 4 Light 240V Controller with Timer - Helios 3210, 277
 4 Light 240V Controller w/ Trigger Cord - Helios 11211, 278
 4 Light 240V Controller with Trigger Cord & Timer - Helios 9211, 278
 4 Outlet Power Strip 125V 8ft Cord Power All Indoor55
 4 Outlet Power Strip - 125V Power All Indoor GFCl .55, 62
 4 Way Analyzer - Luster Leaf Rapitest271, 280
 4-Pot System - AutoPot168
 45 Degree Dripper Stake195
 48 Gallon Stand Up Reservoir166
 4ft x 4ft - Fast Fit Tray Stand58, 169
 4ft x 8ft - Fast Fit Tray Stand58, 169
 4KV Socket Extender Mogul Base52
 5 Gallon - Measure Master Graduated Measuring Bucket251
 5 Gallon Black Plastic Buckets284
 5-MSP Submersible Pumps - Little Giant178
 50 Amp Power Cord55
 50 Amp Power Cord - Titan Controls212
 50 Cell Tray Kit - Botanicare CocoGro Plugs152
 50 Pint Ideal-Air Dehumidifier232
 55 Gallon Barrel with Lid - Food Grade160
 55 Gallon Replacement Lid161
 SKV Socket Assembly 16 gauge56
 SKV Socket Assembly Short56
 SKV/HOR Mogul Socket52
 6 Cycle Digital Aqua Timer - Melnor196
 6 Outlet Grounded Adapter - 125 Volt Power All54
 6 Outlet Surge Strip - 125 Volt Power All Indoor Metal .55
 6 Pack Adjust-A-Wings Avenger Reflector20
 6-CIM-R Submersible Pump - Little Giant178
 6/750e DE Flex Complete Fixture - Gavita Pro31, 37
 60 Pint - Ideal-Air Dehumidifier232
 60x - Grower's Edge Illuminated Microscope129
 70 Pint Ideal-Air Dehumidifier232
 70% Neem Oil - Monterey124
 72 Cell Plug Insert Trays - Super Sprouter151
 7ft Lead Cord with 3 - 6ft Extension Cords with Circuit Breaker - Power All Commercial Grade54
 8 Light 240V Controller with Dual Trigger Cords - Helios 12211, 278
 8 Light 240V Controller with Dual Trigger Cords - Helios 6211, 277

A

A La Carte Components - Fast Fit59, 169
 A La Carte Light Rail Components - LightRail60
 A-OK Starter Plugs - Grodan132
 A/C 14 Gauge/4 Conductor Interconnector Wire237
 A/C 24,000 BTU 13 SEER - Ideal-Air Professional Installation Mini Split235
 ABS Plastic Black Reservoirs & Lids165
 AC - Samsung Max Mini Split Systems235
 AC - Samsung Max Split Linesets236
 AC Electrical Components for Splits236
 AC Fan Control Kit237
 AC Power Supply - Titan Controls Ares CO2 Generator 208
 AC SpeediChannel Split Fit Kit236
 AC Split Drain Line237
 AC Split Lineset Couplers and Flare Nuts237
 AC Split Pads and Equipment Mounts237
 AC Spray Foam Sealant236
 AC Surge Protector237
 AC Triple-D Coil Cleaner236
 AC/DE Air-Cooled Double Ended Reflector 8 in18
 Accessories - LightRail 560
 Accessories - Sun Hut174
 Accurate pH 7 & pH 8 Soil pH & Moisture Meter265
 Acid Loving - FoxFarm Happy Frog75
 Acid Plant Food - Maxsea106
 Actino-Iron104
 Actinovate Fungicide122
 Active Filters - Can-Lite240
 Adapters - Hydro Flow Garden Hose186
 Adapters - Hydro Flow GHT x Barbed186
 Adaptors GHT x NPT - Hydro Flow191
 Adjust-A-Wing DE Large Socket Kit with Cord19
 Adjust-A-Wings Avenger DE Reflector19
 Adjust-A-Wings Avenger Reflectors20
 Adjust-A-Wings Enforcer Reflectors23
 Adjust-A-Wings Large DE Super Spreader19
 Adjusta Drive Complete 4.0 - LightRail59
 Adjustable 90 Degree Elbow Ducting - Ideal-Air227
 Adjustable Differential Tempstat - Grozone TP2215
 Adjustable Drip Stakes with Cleanout - Hydro Flow 187
 Adjustable Flow Rate Water Pumps - EcoPlus176
 Adjustable Measuring Spoon - RAW83
 Adjusting Clamps - Hydro Flow187
 Aeration Frames - RediRoot282
 Aeration Liners - RediRoot281
 Aero Bucket Lid with Mesh Bottom - Botanicare284
 AeroFlo2 Replacement Parts166
 AeroFlo2 Systems - GH166
 Aeroptic Clone Spinner 360 Degree181
 Aeroponics System - GH RainForest 236 - Thirty-six 2in Site168
 Aeroponics System - GH RainForest 318 - Eighteen 3in Site168
 Aeroponics System - GH RainForest 66 - Six 6in Site 167
 After Burner High Output Mixed Flow Fans Hurricane 221
 Aggregate Plus - Sunshine Mix #4137
 AgraQuest Serenade Garden125
 AgroLED 12 Watt LED Lamp - Full Spectrum41, 51
 AgroLED Green Flashlight/Lamp by Feliz41, 51, 252
 AgroLED LED Fixtures42
 AgroLED LED/TS HO Combination Fixtures42
 AgroLED T8 LED Tubes41, 51
 AgroLED The Hangover41, 59
 Agrotech Magnum Reflector19

Agrotech Magnum Reflector - Double Ended18
 Agrotech Magnum Reflector 20 Pack19
 Air Box Stealth Edition241
 Air Conditioner - Electrical Components for Splits236
 Air Conditioner - R410A Refrigerant Refill Kit237
 Air Conditioner - Samsung Max Mini Split Systems 235
 Air Conditioner - Samsung Max Programmable Thermostat236
 Air Conditioner - Samsung Max Split System AC Linesets 236
 Air Conditioner - SpeediChannel Split Fit Kit236
 Air Conditioner - SpeediChannel Split Lineset Covers and Fittings236
 Air Conditioner - Split Lineset Couplers & Flare Nuts 237
 Air Conditioner - Split Pads & Equipment Mounts237
 Air Conditioner - Spray Foam Sealant236
 Air Conditioner 24,000 BTU 13 SEER - Ideal-Air Professional Installation Mini Split235
 Air Conditioner Digital Thermostat - LuxPro235
 Air Conditioner Dual Hose 12,000 BTU - Ideal-Air234
 Air Conditioner Split Drain Line237
 Air Conditioner Triple-D Coil Cleaner236
 Air Conditioners - Hard Start Kit237
 Air Conditioners & Dehumidifiers Surge Protector237
 Air Conditioners Fan Control Kit237
 Air Conditioners Ideal-Air Mini Split - Cooling Only 235
 Air Diffusers - EcoPlus Flexible181
 Air Filter for PowerDry 1300 & RDS10 Dehumidifiers - Quest233
 Air Filter for PowerDry 4000 & Dual Overhead Dehumidifiers - Quest233
 Air Filters - Odor-Sok241
 Air Force Pro Linear Air Pumps180
 Air King Fans - Wall Mount & Clip225
 Air King Pedestal Fans225
 Air Manifold T Style 3/8 Inch Inlet - EcoPlus180
 Air Manifold Trumpet Style 1/2 Inch Inlet - EcoPlus 180
 Air Manifolds - Plastic180
 Air Pump - EcoPlus Supreme179
 Air Pump - GH Dual Diaphragm180
 Air Pumps - Air Force Pro Linear180
 Air Pumps - EcoPlus Commercial179
 Air Pumps - EcoPlus Eco179
 Air Stone Discs - EcoPlus181
 Air Stones - EcoPlus Round181
 Air Tight Duct Collar - Ideal-Air228
 Air-Cooled Double Ended Reflector - AC/DE18
 Air-Cooled Reflectors - American17-18
 Air-Cooled Reflectors - Import20-21
 Algae Block Sleeve - Hydro-logic202
 All Purpose - FoxFarm Happy Frog75
 All Purpose Plant Food - Maxsea106
 All Purpose Scissors Model SS-330H - ARS261
 All Purpose Seabird Guano - Vital Earth's103
 All Purpose Stainless Scissors SS-330 HN-R - Zenport 261
 Aluminum Semi-Rigid Premium Flex Ducting Ideal-Air 229
 American Air-Cooled Reflectors17-18
 American Pride Dry Mix - FoxFarm73
 AmHydro Dark Energy108
 AmHydro Super Charger108
 AmHydro SuperNova Nutrient Additive108
 Aminos - Nectar For The Gods Athena's87
 Amino-Aide - Soul Synthetics79
 Analog Temp & Humidity Controller - Saturn 1213
 Analyzer 4 Way - Luster Leaf Rapitest271, 280
 Ancient Amber - Roots Organics77
 Ancient Forest - General Organics143
 Anti-Wilt Propagation & Transplant Spray - Vita Grow 156
 AP-1 Aquapro TDS Water Tester - HM Digital269
 Aphrodite's Extraction - Nectar For The Gods87
 Apollo 10 - 240 Volt Mechanical Timer210, 276
 Apollo 11 - 240 Volt Digital Timer210, 277
 Apollo 12 - Short Cycle Timer With Photocell210, 277
 Apollo 14 - 8 Outlet Power Strip with Timer210, 277
 Apollo 2 - Cycle Timer with Photocell209, 276
 Apollo 3 - Fixed Cycle Timer209, 276
 Apollo 4 Ballast Timer 120 Volt56, 209-210, 276

Apollo 5 - 240 Volt Ballast Timer 56, 209-210, 276	B.C. Grow - Technaflora 97	Basement Mix - Royal Gold 143	Black Grow Trays Styrene Plastic (OD) 165
Apollo 6 - One Outlet Mechanical Timer 209, 276	B.C. Nutrients - Technaflora 97	Basic Home Canning Funnel - Ball 257	Black Heavy Duty Saucers - Gro Pro 288
Apollo 7 - One Outlet Digital Timer 209, 276	B.t. - Monterey 124	Basket Lid 10 in - Flo-n-Gro 6.6 Gallon Gro Giant 161, 287	Black Holes Drippers 169, 196
Apollo 8 - Two Outlet Mechanical Timer 209, 276	B'Cuzz Bloom 95	Basket Liners - GH CocoTek 288	Black Lightning Powder Free Nitrile Gloves 62
Apollo 9 - Two Outlet Digital Timer 209, 276	B'Cuzz Blossom Builder 96	Bat Guano - Buried Treasure Nitro 80	Black Low Profile (LP) Reservoirs - Botanicare 163
Apple Crumble - Ona Block 242	B'Cuzz Coco 145	Bat Guano - Buried Treasure Phos 80	Black Mesh Insert - 3 Gallon Flo-n-Gro 161, 287
Apple Crumble Gel - Ona 242	B'Cuzz Growth 95	Bat Guano - FoxFarm Happy Frog High Phosphorus 75	Black Pearl - Grotek 86
Apple Crumble Mini Mist Can 242	B'Cuzz HydroMix 145	Bat Guano - Roots Organics HP2 Liquid 76	Black Plastic Bucket Lid 284
Apple Crumble Mist Can - Ona 242	B'Cuzz Root 95	Bat Guano - Roots Organics Nitro 77	Black Plastic Buckets 3.5 & 5 Gallon 284
Apple Crumble Spray - Ona 242	B'Cuzz Tabzz 95	Bat Guano - Roots Organics Phos 77	Black Plastic Pots - Gro Pro Premium Square 286
Aptus - Bloom Sensation 84	B1 Plant Formula - Grotek VitaMaxPlus 85	Bat Guano - Roots Organics Super Nitro 77	Black Power Cloner - Botanicare 153
Aptus - Root Sensation 84	B2 Professional Growing Mix - Roots Organics 141	Bat Guano - Vital Earth's High Phos 103	Black Premium Plastic Saucer 288
Aqua Heat Titanium Reservoir & Aquarium Heater 199	Back Draft Dampers - Ideal-Air 228	Bat Guano & K-Mag - Roots Organics HPK 77	Black Reservoirs - Duralastics 164
Aqua Timer - Melnor 6 Cycle Digital 196	Back to the Roots Aquafarm 190	Bat Guano 11 - 4 - 2 - Vital Earth's High Nitrogen 103	Black Reservoirs & Lids - ABS Plastic 165
Aquadue Duplo Water Timer - Claber 196	Backflow Preventor - Hydro Flow 168	Bat Guano 9 - 3 - 1 - Vital Earth's High Nitrogen 103	Black Sea Kelp - VermaPlex 106
Aquafarm - Back to the Farm 168	Backpack Sprayer - Rainmaker 246	Bat Guano Grow - Earth Juice 110	Black Smart Pots with Handles 282
Aquano Video 2 Timer - Claber 196	Bag - Botanicare Camo Grow 289	Batteries for pH/TDS Pens - Hanna 270	Black Square Plastic Pots 287
Aquaponics - Back to the Roots Aquafarm 168	Bag - Vermicrop Polyester Tea 91	Battery Powered Sprayer - Rainmaker 246	Black Square Plastic Pots - Gro Pro 286
Aquapro TDS Water Tester AP-1 - HM Digital 269	Bag Bloom - MyCO2 Mushroom 214	Battery Sprayer - 5L/1.3 Gal - Root Lowell Flo-Master 247	Black Square Pots 286
Aquashield Compost Solution - Botanicare 119	Bag Grow - MyCO2 Mushroom 214	Beastie Bloomz - FoxFarm 74	Black Square Saucer for Black Square Pots 286
Arborjet AzaSol 121	Bags - Gro Pro Grow 289	Bee Micron Trays 250	Black Trays - Botanicare Low Tide 162
Arborjet Eco-Mite 121	Bags - Grower's Edge Nylon Storage 258	Bee Pollen & Trim Tray Kit 249	Black Trays - Botanicare OD 162
Arborjet Eco-PM 121	Bags - Heavy Harvest Premium Compost Tea Brewing 250	Bembe Sweet & Dandy - Bushdoctor 73	Black Trays Inside Dimension (ID) - Duralastics 164
Ares 10 - Ten Burner CO2 Generators - Titan Controls 208	Bags - Zip-Zag 258	Bench - Botanicare 164	Black Wire Nut 53
Ares 2 - Two Burner CO2 Generators - Titan Controls 208	Bale Organic Growing Medium - GH CocoTek 143	Beneficial Insect Mail-Backs - Orcon 127	Black/White Poly Sheeting 264
Ares 4 - Four Burner CO2 Generators - Titan Controls 208	Ball Basic Home Canning Funnel 257	Berry Sweet - Botanicare 70	Blackout - Sun Hut Grow Tents 172
Ares 8 - Eight Burner CO2 Generators - Titan Controls 208	Ball Collection Elite Wide Mouth Jars 257	Bi-Carb Old Fashion Fungicide - Monterey 125	Block - Ona 243
Ares CO2 Generator AC Power Supply 208	Ball Decorative Jar - Gallon (Commemorative Jar) 257	Big & Chunky Perlite - FoxFarm 137	Block - Ona Pro 242
Ares Hose and Regulator - Titan Controls 208	Ball Quilted Crystal Jelly Jars 257	Big Bloom - FoxFarm 73	Block - Roots Organics Coco Chips 140
Ares Replacement Burners - Titan Controls 209	Ball Valves - Hydro Flow Barbed 184	Big Boy Float Valve Big - Hydro-logic 205	Block Apple Crumble - Ona 242
Armor Si - GH 66	Ball Wide Mouth Jars 257	Big Boy Garden Hose Connection Kit 205	Block Covers - Grower's Edge 134
ARS All Purpose Scissors Model SS-330H 261	Ball Wide Mouth Lids & Bands 257	Big Boy Pressure Regulator 3/4in 205	BlockBuster Reflector 6 in Air-Cooled 17
ARS Curved Scissors Model SS-320BM 262	Ballast - Eye Hortilux Gold 33	Big Boy Replacement Filters - Hydro-logic 205	BlockBuster Reflector 8 in Air-Cooled 18
ARS Harvesting Scissors SS-320BT 261	Ballast - Eye Hortilux Platinum Electronic 32	Big Boy System - Hydro-logic 205	Blood Meal - Grow More 100
ARS Sharpening Stone AC-SS240 261	Ballast - Galaxy Grow Amp Electronic 27	Big John - Little Giant 6-CIM-R Submersible Pump 178	Bloom - B'Cuzz 95
Atami Bloombastic 95	Ballast - Galaxy Grow Amp Master Blaster 1500W 27	Big Mama - Grodan Delta Gro-Blocks 133	Bloom - Cutting Edge Solutions 93
Atami Rootbastic 95	Ballast - Galaxy Legacy Electronic 28	Big Momma Bubbler Bucket - Flo-n-Gro 160	Bloom - Earth Juice 109
Athena's Aminos - Nectar For The Gods 87	Ballast - Gavita Pro Electronic 29	Big Shot Measuring Glass - Measure Master 251	Bloom - Humboldt Nutrients 112
Atlas 1 - CO2 Monitor/Controller 206	Ballast - Nanolux Digital 32	Big Swell - Soul Synthetics 79	Bloom - Soul Synthetics 79
Atlas 2 - Preset CO2 Monitor/Controller 206	Ballast - Sun System Hard Core 25	Big Up Powder - Humboldt Nutrients 115	Bloom All-In-One - RAW 81
Atlas 3 - Day/Night CO2 Monitor/Controller 206	Ballast - Sun System Hard Core 277 Volt 26	Big Worm - Roots Organics 141	Bloom Aqua - Supernatural 89
Atlas 4 - 2 Room CO2 Monitor/Controller 207	Ballast - Sun System Hard Core 480 Volt 26	Bio-Cartridges - Vermicrop Vermi T 91	Bloom Fuel - Grotek 85
Atlas 5 - Portable Handheld CO2 Temp & Humidity Monitor 207	Ballast - Sun System Harvest Pro 25	BioAg CytoPlus 94	Bloom Khaos - Nectar For The Gods 88
Atlas 7 - CO2 Controller 207	Ballast Kit - Major Brand Capacitor Ready to Grow 1000 W 52	BioAg Ful-Humix 94	Bloom Plant Food - Maxsea 106
Atlas 8 - Digital CO2 Controller with Fuzzy Logic 207	Ballast Timer 120 Volt - Titan Apollo 4 56, 209-210, 276	BioAg Ful-Power 94	Bloom Sensation 84
Atlas 9 - Digital CO2 Controller with Remote Sensor 207	Ballast Timer 240 Volt - Titan Apollo 5 56, 209-210, 276	BioAg TM-7 94	Bloom Stimulator Concentrate - HydroDynamics Green Fuse 102
Atmosphere Vortex Inline Powerfans 223	Ballasts - Fulham Racehorse T5 HO Fluorescent 52	BioBud - GH 67	Bloom Terra - Supernatural 89
Atmosphere Vortex Powerfans S-line 223	Ballasts - Fulham Workhorse T5 HO Fluorescent 52	BioChar - Mother Earth Premium 135	Bloombastic - Atami 95
Atmosphere Vortex Powerfans V-Series 223	Ballasts - Galaxy Digital Logic 28	BioCozyme - Grow More 98	Blossom Blaster - Grotek 86
Atomizer - Root Lowell Portable 247	Ballasts - Galaxy Digital Logic Dimmable 28	Biological Mosquito Control - Microbe-Lift BMC 128	Blossom Builder - B'Cuzz 96
Atomizer - Root Lowell Stationary 247	Ballasts - Gavita DigiStar e-Series Electronic 31	BioMarine - GH 68	Blow Molded - Traditional Square Pots 286
Aurora Innovations Master Pack 78	Bamboo Stakes Green - Bond 255	BioNEM Insecticide & Repellent - Safer 126	Blow Molded Nursery Pots 283
Aurora Innovations Precision Perlite 141	Bamboo Stakes Natural - Bond 255	BioPak - Vital Earth's PHC 103	Blowers - Hurricane 226
Auto Pot 4-Pot System 168	Bamboo Stakes Natural - Grower's Edge 255	BioRoot - GH 67	Blue Bucket - 4 Gallon Flo-n-Gro 161, 287
Auto Pot FlexiTank Reservoirs 168	Bamboo Stakes Natural Bulk - Grower's Edge 254	BioThrive Bloom - GH 67	Blue Bucket - 6.6 Gallon Flo-n-Gro Gro Giant 161, 287
Automated 12 Site Soil Garden - Gro-n-Dirt 160	Banana Bliss - GH Flora Nectar 65	BioThrive Grow - GH 67	Blue Daylight Metal Halide Lamps - Eye Hortilux 45
AutoPot 4-Pot System 168	Bands - Ball Wide Mouth Jars 257	BioWeed - GH 67	Blue Dripper Stake with Basket - Hydro Flow 195
AutoPot FlexiTank Reservoirs 168	Barbed Ball Valves - Hydro Flow 184	Bird Guano - Roots Organics 78	Blue Enhanced Performance Lamps - Ultra Sun MH 44
Avalanche - Grow More 98	Barbed Elbow Reducers - Hydro Flow 185	Bird's Nest - Roots Organics Coco 140	Blue Enhanced Performance Metal Halide Lamps - SolarMax 47
Avenger DE Reflector - Adjust-A-Wings 19	Barbed Fittings & Valves 1/2in - Hydro Flow (EcoPlus) 185	Bits - Mosquito 124	Blue Ice Enhanced Performance Metal Halide Lamps - Sunmaster 47
Avenger Reflector 20	Barbed Fittings & Valves 3/4in - Hydro Flow (EcoPlus) 185	Black & White Poly Film - Panda 263	Blueleaf Calibration & Conductivity Standard Solution 274
Awesome Blossoms - Technaflora 97	Barbed Fittings 1/2in - Hydro Flow 184	Black & White Poly Film - Sunfilm Panda 263	Blueleaf Calibration & Conductivity Solution Sachets 274
Axial Fans - Hurricane 226	Barbed Fittings 1/4in - Hydro Flow 183	Black & White Premium 10 x 20 Propagation Tray - Mond 151	Blueleaf Carry Case 266
Axiom Harpin Protein - RX Green Solutions 117	Barbed Fittings 1/4in - Hydro Flow (EcoPlus) 185	Black Bucket 6.6 Gallon - Flo-n-Gro 161, 287	Blueleaf Combo Meter 266
AzaMax 120	Barbed Fittings 1/8in - Hydro Flow 183	Black Casting - VermaPlex 134	Blueleaf Combo Meter Replacement pH Probe 266
AzaSol - Arborjet 121	Barbed Fittings 1in - Hydro Flow 184	Black Dripper Stake with Basket - Hydro Flow 195	Blueleaf Commercial Truncheon Meter 267
Azos - Xtreme Gardening 92, 158	Barbed Fittings 1in - Hydro Flow (EcoPlus) 185	Black Fabric Pots - Smart Pot 282	Blueleaf Connect Guardian Monitor 266
B	Barbed Fittings 3/16in - Hydro Flow 183	Black Gold Earthworm Castings 137	Blueleaf Connect Product Suite 266
B-1 Green - Technaflora Thrive Alive 97	Barbed Fittings 3/4in - Hydro Flow 184	Black Gold Just Coir Loose 137	Blueleaf Guardian Monitor 266
B-1 Red - Technaflora Thrive Alive 97	Barbed Fittings 3/8in - Hydro Flow 183	Black Gold Natural & Organic Potting Soil 137	Blueleaf Guardian Monitor Replacement pH Probe 266
B-Vitamin - RAW 81	Barbed Float Valve 1/2in - Hydro-logic 201	Black Gold Perlite 137	Blueleaf Original Truncheon Meter 267
B. Seaweed - Technaflora 97	Barbed Reducer - Hydro Flow 184	Black Gold Waterhold Cocoblend Soil 137	Blueleaf pH 4.0 Calibration Solution 274
B.C. Bloom - Technaflora 97	Barbed Straight Reducers - Hydro Flow 184	Black Gro Pro Round Fabric Pots 281	Blueleaf pH 7.0 Calibration Solution 274
B.C. Boost - Technaflora 97	Barbed Tee Reducers - Hydro Flow 185	Black Grow Trays - Botanicare ID 162	
	Barrel with Lid - Food Grade 55 Gal. 160		

Bluelab pH Meter	265	Botanicare Kind Base	68	Bulb - SunBlaster 26 Watt Compact Fluorescent	50	Carbon Filter Flanges - Can-Filters	241
Bluelab pH Pen	266	Botanicare Kind Bloom	68	Bulb Food - FoxFarm Happy Frog	76	Carbon Filters - Can-Filters	240
Bluelab pH Probe KCl Storage Solution	274	Botanicare Kind Grow	68	Bulk Grower's Edge Natural Bamboo Stakes	254	Carbon Filters - Can-Filters Can-Max	239
Bluelab ppm Pen	266	Botanicare Liquid Karma	69	Bulk Rolls - Grower's Edge Commercial Grade Trellis Netting	256	Carbon Filters - Can-Lite Active Filters	240
Bluelab Probe Care Kit for Conductivity	274	Botanicare Low Tide Black Trays	162	Bulkhead Fittings - Hydro Flow	191	Carbon Filters - Phresh	238
Bluelab Probe Care Kit pH	274	Botanicare Microgarden	163	Buried Treasure Nitro Bat Guano	80	Carbon Filters - Phresh Skinny	239
Bluelab Probe Care Kit pH & Conductivity	274	Botanicare Neoprene Inserts	154	Buried Treasure Peruvian Seabird Guano	80	Carry Case - Bluelab	266
Bluelab Soil pH Meter	266	Botanicare Original Inside Dimension (ID) White Grow Trays	162	Buried Treasure Phos Bat Guano	80	Carson Optical MagniScope	129
Bluelab Soil pH Pen	266	Botanicare Outside Dimension (OD) Black Trays	162	Buried Treasure Phos Seabird Guano	80	Carson Optical MicroMax LED Microscope	129
Bond 3 Way Soil Meter	272	Botanicare pH Up & pH Down	273	Burners - Titan Controls Ares Replacement	209	Carson Optical zOrb Digital Microscope	129
Bond 8 Pattern Watering Wand 36in	248	Botanicare Porthole Covers	163	Bush Load - GH	66	Cascade Minerals	107
Bond Clear Plastic Saucers	289	Botanicare Power Clone Rooting Gel	155	Bushdoctor Bembé Sweet & Dandy	73	Case - Bluelab	266
Bond Drop Forged Pruner Set	262	Botanicare Power Clone Rooting Solution	155	Bushdoctor Boomerang - FoxFarm	72	Case with LED Pocket Microscope - iPhone 4/4S	129
Bond Floral Shear	262	Botanicare Power Clone Black	153	Bushdoctor Coco Loco Potting Mix	136	Case with LED Pocket Microscope - iPhone 5	129
Bond Garden Net Trellis	256	Botanicare Power Cloner Domes	153	Bushdoctor Flowers Kiss - FoxFarm	72	Cat Se Cable - Titan Patch Cord	213
Bond Green Bamboo Stakes	255	Botanicare Power Cloner White	152	Bushdoctor Kangaroos - FoxFarm	73	Catalog - Sunlight Supply Products	290
Bond Machete	262	Botanicare Pure Blend Pro Bloom	69	Bushdoctor Lucky Dog K-9 Kube Growers Blend	136	Catalyst - Earth Juice	109
Bond Medium Duty Hose 5/8in x 50ft	196, 248	Botanicare Pure Blend Pro Grow	69	Bushdoctor Microbe Brew - FoxFarm	73	Caterpillar Killer for Trees, Shrubs & Vegetables Safer	126
Bond Moisture Meter	280	Botanicare Pure Blend Pro Soil	69	Bushdoctor Sledge Hammer - FoxFarm	73	CD Inline Duct Ozonator - 1 Cell Uvonair 10 in	245
Bond Natural Bamboo Stakes	255	Botanicare Pure Blend Pro Tea	69	Butterfly Hose Clamps - Hydro Flow	187	CD Inline Duct Ozonator - 1 Cell Uvonair 8 in	245
Bond Precision Tip Pruner	262	Botanicare Pure Bloom Granular	72	Butterfly Hose Clamps - Ideal-Air	230	CD Inline Duct Ozonator - 2 Cell Uvonair 10 in	245
Bond Reusable T-Markers	158, 253	Botanicare Pure Granular Grow	72	Button Emitters - Hydro Flow	189	CD Inline Duct Ozonator - 3 Cell Uvonair 12 in	245
Bond Super Steel Stakes	255	Botanicare ReadyGro	139	BX - Premier Tech Pro-Mix	142	Cell Plug Insert Trays - Super Sprouter	151
Bond TieRite Tape Gun	262	Botanicare ReadyGro Super Plugs	152	BX Biofungicide + Mycorrhizae Premier Tech Pro-Mix	142	Centrifugal Fans FG Series - Fantech	222
Bond TieRite Tape Gun Tie Tape Replacement Parts	262	Botanicare Reservoirs & Lids	163	BX with Biofungicide - Premier Tech Pro-Mix	142	Centrifugal Inline Fans - Hurricane	221
Bond Twine	253	Botanicare Root Guard Lids	288	Bypass Pruner Model Z201 - Zenport Heavy Duty	261	Ceramic Fixture - LEC 315	35, 41
Bond Twist Tie Spool	253	Botanicare Seaplex	72	Bypass Pruning Shear 8.5in Model Z103 - Zenport	261	CES - G-Rex	92
Bond Ultimate Pruning Combo Set	262	Botanicare Silica Blast	70			CES - Mag-Amped	93
Bone Meal - Grow More	100	Botanicare Slacker Aeration	139			CES - Plant Amp	94
Bonide Captain Jack's Dead Bug Brew	126	Botanicare Slacker Moisture	139			CES - Sonoma Gold Bloom	93
Bonide Pyrethrin Garden Insect Spray	127	Botanicare Sweet - Carbo Raw	69			CES - Sonoma Gold Grow	93
Bonide Systemic Insect Control	127	Botanicare Sweet - Citrus	70			CES - Sour-Dee	94
Bonide Thuricide (BT)	127	Botanicare Sweet - Grape	70			CES - Sugaree	93
Book - Gardening Indoors with Soil & Hydroponics	290	Botanicare Sweet - Original Berry	70			CES - T-Rex	92
Book - Hydroponic Basics - The Basics of Soilless Gardening Indoors	290	Botanicare Turbogarden	164			CES - Uncle John's Blend	94
Book - The Indoor Gardening Guide	290	Botanicare Vitamino	71			CES Bloom	93
Boomerang - FoxFarm Bushdoctor	72	Botanicare White Low Profile (LP) Reservoirs	163			CES Grow	93
Booster Pump - Evolution	203	Botanicare ZHO Root Inoculant	72, 155			CES Micro	93
Booster Pump - Ideal H2O RO 100/200	199	Bottles - 360 Spray	246			CG2 Dehumidifier - Ideal-Air 170 Pint	232
Booster Pump for Merlin GP	203	Bottom Draw Pump Adaptors - Hydro Flow	191			Cha Ching - FoxFarm	74
Booster Pump For Stealth	202	Bottom Draw Water Pumps - EcoPlus	176			Chain	61
Boosters - Hurricane Inline Duct	226	Bracket - Hydro-logic Evolution-RO1000	201			Checker pH Tester - Hanna	270
Boss Cocogro Cubes - Botanicare	140	Bracket for Grow Tents - Light Rail	60			Checker Replacement Electrode - Hanna	270
Boss Reflector - DE	18	Brackets - DE Commercial Reflector	36			Chiller - EcoPlus 1/10 HP	197
Botanical Plant Oil - Terpinator	116	Brackets - Ice Box	24			Chiller - EcoPlus 1/2 HP	197
Botanicare (ID) Black Grow Trays	162	Brackets - SE Commercial Reflector	36			Chiller - EcoPlus 1/4 HP	197
Botanicare Aero Bucket Lid with Mesh Bottom	284	Brackets - Vortex	223			Chillers - EcoPlus Commercial Grade Water	197
Botanicare Aquashield Compost Solution	119	Brass Tubing Insert - Hydro Flow	192			Chrome Air Manifolds T Style 3/8 Inch Inlet	180
Botanicare Bench	164	Brass Tubing Insert Punch Tool - Hydro Flow	191			Chrome Air Manifolds Trumpet Style 1/2 Inch Inlet	180
Botanicare Black Low Profile (LP) Reservoirs	163	Breakout Powder	84			Circuit Breaker - 14 Gauge Power All Extension Cord	54
Botanicare Boss Cocogro Cubes	140	Breeze Dispenser Fan - Ona	244			Circuit Breaker - 16 Gauge Power All Extension Cord	54
Botanicare Cal-Mag Plus	71	Brewer - Flo-n-Gro Big Momma	160			Circuit Breaker Cord Triple Plug Power All	54
Botanicare Camo Grow Bag	289	Brewer - Flo-n-Gro Gro Momma Bubbler Bucket	160			Citrus Sweet - Botanicare	70
Botanicare Clearex Salt Leaching Solution	71	Bricks Organic Growing Medium - GH CocoTek	142			Claber Aquaduo Duplo Water Timer	196
Botanicare Clone Machine 25 & 48	153	Bubble Maker - Hydor	180			Claber Aquano Video 2 Timer	196
Botanicare CNS17 Bloom	71	Bubbler Bucket - Flo-n-Gro Big Momma	160			Claber Faucet to Hose Connector	196
Botanicare CNS17 Grow	71	Bubbler Bucket - Flo-n-Gro Gro Momma	160			Claber Koala Indoor Faucet Connector	196
Botanicare CNS17 Ripe - Botanicare	71	Bucket - 4 Gallon Flo-n-Gro Blue	161, 287			Claber Oasis Self Watering System	168
Botanicare CocoGro Cloning Plug Refills	152	Bucket - 6.6 Gallon Flo-n-Gro Giant Blue	161, 287			Claber Spiral Hose Kit	196
Botanicare Cocogro Loose	139	Bucket 5 Gal - Measure Master Graduated Measuring	251			Clamps - Hydro Flow Butterfly Hose	187
Botanicare Cocogro Plug 50 Cell Tray Kit	152	Bucket 6.6 Gallon - Flo-n-Gro Black	161, 287			Clamps - Hydro Flow Flow Rate Adjusting	187
Botanicare Cocogro Premium Organic Soilless Media	140	Bucket Lid	284			Clamps - Hydro Flow Nylon Hose	187
Botanicare CocoRox	139	Bucket Lid - Gamma Seal	284			Clamps - Ideal-Air Butterfly	230
Botanicare Daisy Cloner	153	Bucket Lid with Mesh Bottom - Botanicare	284			Clamps - Ideal-Air Neoprene Lined Noise Reduction Supreme	230
Botanicare Dripper Stake with 3/16in dripper line	195	Bucket Lids - Gro Pro	284			Clamps - Ideal-Air Noise Reduction Classic	230
Botanicare Eazy Drain Reservoirs & Lids	163	Buckets - 3.5 & 5 Gallon Black Plastic	284			Clamps - Ideal-Air Quick Release Stainless Steel	230
Botanicare Ebb & Flow Fittings	181	Buckets & Lid - EZ Store	165, 287			Clamps - Ideal-Air Stainless Steel	230
Botanicare Fulvex	72	Bud - Botanicare Growilla	70			Classic 1000 DE Complete Fixture - Gavita Pro	30, 36
Botanicare Growilla Bud & Veg	70	Bud Blaster - Supernatural	90			Classic 128 Cutting System - EZ-Clone	154
Botanicare Horti-Trellis	256	Buddha Bloom - Roots Organics	76			Classic 16 Cutting System - EZ-Clone	153
Botanicare Humidome	163	Buddha Grow - Roots Organics	76			Classic 32 Cutting System - EZ-Clone	153
Botanicare Hydroguard	119	Budswel Dry	108			Classic 600 SE Complete Fixture - Gavita Pro	30
Botanicare Hydrolite	139	Budswel Liquid	108			Classic 64 Cutting System - EZ-Clone	153
Botanicare Hydroplex	70	Buffer Solution - Milwaukee Instruments	275			Classic Clamps - Ideal-Air Noise Reduction	230
		Bulb - GE 42 Watt Compact Fluorescent	50			Classic Series 16in Hurricane Wall Mount Fan	225

Cycle Timer with Photocell - Titan Apollo 2 209, 276
 Cyclestat with Day/Night Sensor - Grozone CY1 215
 Cyclestat with Day/Night Sensor - Grozone CY2 Short
 Period 215
 Cyclestat with Day/Night Sensor and Bargraph Display -
 Grozone CY3 Digital 215
 Cyclone Dispenser Fan - Ona 244
 CytoPlus - BioAg 94

D
 Daisy Cloner - Botanicare 153
 Dampers - Ideal-Air Back Draft 228
 Danner Mag Drive Pump 190 GPH 177
 Danner Mag Drive Pumps 250 GPH - 700 GPH 177
 Danner Mag Drive Pumps 950 - 2400 GPH 177
 Dark Energy - AmHydro 108
 Day/Night CO2 Monitor/Controller - Titan Atlas 3 206
 Day/Night Fan Controller - Mercury 3 213, 226
 Day/Night Fan Speed Control - Grozone TV1 215
 Day/Night Photocontroller - Nyx 1 213
 Day/Night Temp & Humidity Controller with Night Outlet
 Plus CO2 Integration - Kronus 4 213
 Day/Night Temp Controller - Zephyr 1 214, 226
 Day/Night Tempstat - Grozone TP1 215
 Daylight Metal Halide Lamps - Eye Hortilux Blue 45
 DE - Gavita Pro Double Ended HPS Lamps 46
 DE Boss Reflector 18
 DE Commercial Reflector with Brackets 36
 DE Complete Fixture - Gavita Pro 1000e 31, 37
 DE Complete Fixture - Gavita Pro Classic 1000 30, 36
 DE e-Series Complete Fixture - Gavita Pro 1000e 31, 37
 DE Flex Complete Fixture - Gavita Pro 6/750e 31, 37
 DE Large Socket Kit with Cord 19
 DE Reflector - Dominator XXXL 22
 DE Reflector 8 in - Double Ended AC/DE 18
 De-Chlorinator System 10 in - Ideal H2O 199
 De-Chlorinator System 20 in - Ideal H2O 199
 Dead Bug Brew - Bonide Captain Jack's 126
 Dechlorinator+ Microbe Life 119
 Decorative Jar - Gallon (Commemorative Jar) 257
 Deep Breath - Emerald Triangle 111
 Deer & Rabbit Repellent - Liquid Fence 127
 Dehumidifier - Quest PowerDry 4000 Pro 232
 Dehumidifier - 170 Pint Ideal-Air CG2 232
 Dehumidifier - 180 Pint Ideal-Air 232
 Dehumidifier - Quest Dry RDS 10 232
 Dehumidifier - Quest Dual 105 Overhead 233
 Dehumidifier - Quest Dual 110 Overhead 233
 Dehumidifier - Quest Dual 150 Overhead 233
 Dehumidifier - Quest Dual 155 Overhead 233
 Dehumidifier - Quest Dual 205 Overhead 233
 Dehumidifier - Quest PowerDry 1300 232
 Dehumidifiers - Hard Start Kit 237
 Dehumidifiers - Quest Air Filter for PowerDry 1300 and
 RDS10 233
 Dehumidifiers - Quest Air Filters for PowerDry 4000 &
 Dual Overhead 233
 Dehumidifiers - Quest Overhead Return Air Duct Collar 233
 Dehumidifiers - Quest Overhead Supply Air Duct Collars 233
 Dehumidifiers 30, 50 & 70 Pint Ideal-Air 232
 Dehumidifiers 60 & 100 Pint - Ideal-Air 232
 Dehumidifiers Surge Protector 237
 Dehumidify Controller - Eos 1 214
 Delay Timer - Hades 1 212
 Delta Gro-Blocks & Big Mama - Grodan 133
 Delta Starter Mini-Blocks - Grodan 133
 Deluxe 6.5in Fruit Scissors Model ZS105 - Zenport 261
 Deluxe Sprayer 1.3 Quart - Mondi 247
 Deluxe Sprayer 2.1 Quart - Mondi 247
 Deluxe Steel Stakes - Grower's Edge 255
 Deluxe Vaporizer - Grower's Edge 249
 Demeter's Destiny - Nectar For The Gods 87
 Destiny - Nectar For The Gods Demeter's 87
 Detachable Lamp Cord - 2 Point 55
 Detector Tubes - CO2 209
 Deuce Deuce - Humboldt Nutrients 113
 Dial-A-Temp 227
 Diamond Black - GH 68
 Diamond Fusion Lightite Film - Easygrow 264
 Diamond Nectar - GH 66
 Diaphragm Switch - Little Giant S-5LL 178
 Diatomaceous Earth Food Grade - Perma-Guard 127
 Diffusion Foil Film - Easygrow 264
 DigiMax Digital HPS Lamps 43
 DigiMax Double Ended Lamp 43
 DigiStar e-Series Electronic Ballasts - Gavita 31
 Digital Aqua Timer - Melnor 6 Cycle 196
 Digital Ballast - Nanolux 32
 Digital CO2 Controller with Fuzzy Logic - Titan Controls
 Atlas 8 207
 Atlas 9 207
 Digital CO2 Controller with Remote Sensor - Titan Controls
 Atlas 8 207
 Atlas 9 207
 Digital Complete Fixture 34
 Digital Cyclestat with Day/Night Sensor and Bargraph
 Display - Grozone CY3 215
 Digital Environmental Controller - Saturn 4 214
 Digital Environmental Controller with CO2 PPM Control -
 Saturn 6 214
 Digital Environmental Controller with CO2 Timer -
 Saturn 5 214
 Digital HPS Lamps - DigiMax 43
 Digital Humidity Controller - Eos 2 214
 Digital Logic Electronic Ballasts 28
 Digital Logic Wireless Remote Controls 29
 Digital Microscope - Carson Optical zOrb 129
 Digital Mixed Flow Fan - Hyper Fan 220
 Digital Moisture Meter - Luster Leaf Rapitest 280
 Digital Plus Soil pH Meter - Luster Leaf Rapitest 271
 Digital Programmable Thermostat - LuxPro 219
 Digital Recycle and Light Timer with High Temp. Shut-Off -
 Hades 2 212
 Digital Short Cycle Timer 219, 279
 Digital Soil pH Meter - Luster Leaf Rapitest 271
 Digital Stand Fan - Hurricane Supreme Super 8 224
 Digital Temp, Humidity & CO2 Controller - Saturn 3 213
 Digital Thermometer & Hygrometer - Grower's Edge 280
 Digital Thermostat - LuxPro 235
 Digital Thermostat - Super Sprouter Heat Mat 148
 Digital Timer - Apollo 7 209, 276
 Digital Timer - Apollo 9 209, 276
 Digital Timer - Intermatic Multi-Purpose DT620 CL 279
 Digital Timer 240 Volt - Apollo 11 210, 277
 Digital Water Timer - Melnor 2 Zone - 6 Cycle 196
 DIM1 Fan Speed Dimmer with Optional Kick Start -
 Grozone 215
 Dimmer with Optional Kick Start - Grozone DIM1 Fan
 Speed 215
 Dip 'N Grow Rooting Solution 156
 Dipstick - EC 265
 Direct Drive Pump - Little Giant PE-1 178
 Directional Sprayer - Solo 246
 Dirty Dozen Starter Kit - FoxFarm 73
 Discs Air Stones - EcoPlus 181
 Disease Control - Serenade Garden 125
 Dispenser - Ona Mist 244
 Dispenser Fan - Ona Breeze 244
 Dispenser Fan - Ona Cyclone 244
 Dispenser Fan - Ona Odor Stop 244
 Dispenser Fan - Ona Storm 244
 Dispensers 1oz - Measure Master 68, 252
 Display - Xtreme Gardening Mykoss Drops 100 gm
 Pouches 92
 Display - Xtreme Gardening Tea Brew Packs 92
 Disposable Pipettes - Measure Master 251
 Disposable Scalpel - Super Sprouter 157
 DiST 5 Replacement Probe (H173311) - Hanna 270
 DiST 5 Waterproof EC/TDS/Temperature Tester - Hanna 270
 Distribution Manifold 6 Outlet - Hydro Flow 187
 DM-1 HM Digital In-Line Dual TDS Monitor 203, 269
 Doktor Doom Spider Mite Knock Out 120
 Doktor Doom Total Release Fogger 120
 Dolomite Lime - Grow More 100
 Dome - Botanicare Humidome 163
 Dome - Super Sprouter Standard Vented Humidity 7in150
 Dome - Super Sprouter Ultra Clear Vented Germination
 Zin 150
 Domes - Super Sprouter Ultra Clear Vented Humidity Domes
 with Light Tracks 150
 Domes - Botanicare Power Cloner 153
 Domes - Mondi Propagation 4in 150
 Domes - Mondi Propagation 7 in 150
 Domes - Super Sprouter Standard 150
 Dominator XXXL 6 in Air-Cooled Reflector 20
 Dominator XXXL 8 in Air-Cooled Reflector 20
 Dominator XXXL Double Ended Reflector 22
 Dominator XXXL Non AC 22
 Don't Bug Me 120
 Double Ended - Gavita Pro Classic Complete Fixture 30, 36
 Double Ended AC/DE Reflector 8 in 18
 Double Ended Adjust-A-Wing Avenger Reflector 19
 Double Ended Adjust-A-Wing Super Spreader 19
 Double Ended Agrotech Magnum Reflector 18
 Double Ended Boss Reflector 18
 Double Ended HPS Lamps - Gavita Pro 46
 Double Ended HPS Lamps - Ushio 46
 Double Ended Lamp - DigiMax 43
 Double Ended Reflector - Dominator XXXL 22
 Double Ended Reflector - Gavita HoriStar 24
 Double Ended Socket Kit with Cord 19
 Double Ended Super Sun Reflector 18
 Double Junction pHTestr 10 - Oakton 268
 Double Junction pHTestr 30 - Oakton 268
 Double Thick Trays 10 x 20 - Super Sprouter 151
 Down - Botanicare 273
 Down - Earth Juice Natural 273
 Down - Nectar For The Gods Hades 88, 273
 Down - Technaflora 273
 Down 30% - Grow More 273
 Down Liquid & pH Down Dry - GH 273
 DPC-12000-50A-4P - Powerbox 217
 DPC-12000-D-60A-4HW - Powerbox 217
 DPC-15000-50A-4P - Powerbox 217
 DPC-15000TD-50A-4P - Powerbox 217
 DPC-4000-240V-4P - Powerbox 217
 DPC-7500-120V-4P - Powerbox 217
 DPC-7500-240V-4P - Powerbox 217
 DPC-7500-COMBO-4P - Powerbox 217
 DPC-8000-240V-4P - Powerbox 217
 Drain Line for Split Systems 237
 Dramm Rain Wand Colormark 248
 Dramm Rain Wand Touch N Flow 248
 Draw Pump Adaptors - Hydro Flow Bottom 191
 Drill Bit - Duralastics Conical Step 164
 Drip Cap 134
 Drip Hydroponic System - GH Eco Grower 168
 Drip Kit - Hydro Flow 3ft x 3ft & 4ft x 4ft 192
 Drip Kit - Hydro Flow 4ft x 8ft 192
 Drip Ring - Hydro Flow 168, 188
 Drip Stakes Poly Tubing - Hydro Flow 194
 Drip Stakes with Cleanout - Hydro Flow Adjustable 187
 Drip-n-Gro Dual Top Feed Drip System - 6 Site 159
 Drip-n-Gro Expansion Kit - 6 Site 160
 Drip-n-Gro Mesh Insert - 2 Gallon Flo-n-Gro 161, 287
 Drip-n-Gro Support - Stake Out 161
 Drifter Stake 45 Degree 195
 Drifter Stake Line - Hydro Flow 195
 Drifter Stake with 3/16in dripper line - Botanicare 195
 Drifter Stake with Basket - Black Hydro Flow 195
 Drifter Stake with Basket - Blue Hydro Flow 195
 Drippers - Black Holes 169, 196
 Drippers - Hydro Flow Multi-Stream Push-In 187
 Drippers - Raindrip 1 GPH 193
 Drippers - Raindrip 1/2 GPH 193
 Drippers - Raindrip 2 GPH 193
 Drop Forged Pruner Set - Bond 262
 Dropper - Measure Master 251
 Drop pH Down - GH 273
 Dry pH Up - GH 272
 Dry Rack - Grower's Edge Hang Time 249
 Dry Rack Enclosed w/ Zipper Opening Grower's Edge 249
 Dry Rack Partially Enclosed - Grower's Edge 249
 Dry Rack with Clips - Grower's Edge 249
 Dry RDS 10 Dehumidifier - Quest 232
 DT620 CL Digital Timer - Intermatic 279
 Dual 105 Overhead Dehumidifier - Quest 233
 Dual 110 Overhead Dehumidifier - Quest 233
 Dual 150 Overhead Dehumidifier - Quest 233
 Dual 155 Overhead Dehumidifier - Quest 233
 Dual 205 Overhead Dehumidifier - Quest 233
 Dual Arc - HPS & MH Combo Lamp - Eye Hortilux 44
 Dual Arc Tube Lamp - Ultra Sun 44
 Dual Arc Tube Lamp - Ushio 46
 Dual Diaphragm Air Pump - GH 180
 Dual Female Lamp Cord Receptacle 53
 Dual Hose Air Conditioner 12,000 BTU - Ideal-Air 234
 Dual Shut Off Garden Hose Y - Hydro Flow 188
 Dual Spectrum Fluorescent Grow Lamps - Feliz 50
 Dual TDS Monitor DM-1 - HM Digital 203, 269
 Dual Top Feed Drip System - 6 Site Drip-n-Gro 159
 Dual Zone CO2 Controller - Grozone CO2D 216
 Ducting - Can-Duct Insulated 229
 Duct - Flange Kits 227
 Duct Back Draft Dampers - Ideal-Air 228
 Duct Boosters - Hurricane 226
 Duct Collar - Air Tight - Ideal-Air 228
 Duct Collar for Overhead Dehumidifiers - Quest Return
 Air 233
 Duct Collars for Overhead Dehumidifiers - Quest Supply
 Air 233
 Duct Couplers - Ideal-Air 228
 Duct Elbow - ThermoFlo 229
 Duct Hanger Strap 230
 Duct Reducers - Ideal-Air 227
 Duct Silencers - Phresh 239
 Duct Tape - Ideal-Air Silver 231
 Duct Tape - Silver Flex 231
 Duct Wye Branch - Ideal-Air 227
 Ducting - Can-Duct Silver/Silver 3 Ply 229
 Ducting - Ideal-Air Adjustable 90 Degree Elbow 227
 Ducting - Ideal-Air Aluminum Semi-Rigid Premium
 Flex 229
 Ducting - Ideal-Air Silver Premium Insulated Flex 229
 Ducting - Ideal-Air Silver/Black 228
 Ducting - Ideal-Air Silver/Black Flex 228
 Ducting - Ideal-Air Silver/Silver Flex 228
 Ducting - Ideal-Air White/Silver Vinyl Light Tight Flex 229
 Ducting - Max-Duct Vinyl 230
 Ducting - ThermoFlo 2000 SR 229
 Ducting - ThermoFlo SR Insulated 229
 Ductless Air Conditioners Fan Control Kit 237
 Ductless Mini Split Systems - Samsung Max AC 235
 Dunks - Mosquito 124
 Duplex Receptacle Universal 53
 Duplex Receptacles 120V & 240V 53
 Duplo Water Timer - Claber 196
 Duralastics Conical Step Drill Bit 164
 Duralastics Reservoirs 164
 Duralastics Trays Black Inside Dimension (ID) 164
 Duralastics Trays White Inside Dimension (ID) 164
 Dust Shroom - Horti-Control 241
 Dust Shroom Cleaning Kit - Horti-Control 241
 Dutch Leach Tray Elbows & Caps - Grodan 166
 Dutch Leach Tray with 2 Elbows - Grodan 166
 Dutch Master Gold Zone 119
 Dyna-Gro Foliage-Pro 107
 Dyna-Gro K-L-N Concentrate 157
 Dyna-Gro Liquid Bloom 107
 Dyna-Gro Liquid Grow 107
 Dyna-Gro Mag-Pro 107
 Dyna-Gro Pro-Tekt 107
 Dyna-Gro Root-Gel 157

E
 E-Ballast - Eye Hortilux Gold 33
 e-Series Complete Fixture - Gavita Pro 1000e DE 31, 37

e-Series Complete Fixture - Gavita Pro 6/750e DE . . . 31, 37

e-Series Complete Fixture - Gavita Pro 600e SE . . . 30, 37

e-Series Electronic Ballasts - Gavita DigiStar . . . 31

e-Series Master Controllers - Gavita . . . 29, 219

e-Start Metal Halide Lamps - Eye Hortilux . . . 45

E.C. Dipstick . . . 265

Earth Juice Bat Guano Grow . . . 110

Earth Juice Bloom . . . 109

Earth Juice Catalyst . . . 109

Earth Juice Grow . . . 108

Earth Juice Hi-Brix Molasses . . . 109

Earth Juice Meta-K . . . 109

Earth Juice Microblast . . . 109

Earth Juice Natural Up & Natural Down . . . 273

Earth Juice Primal Harvest . . . 109

Earth Juice Rainbow Mix Bloom . . . 110

Earth Juice Rainbow Mix Grow . . . 110

Earth Juice Rooters Mycorrhizae Endo/Ecto Blend . . . 108

Earth Juice Sugar Peak Flowering . . . 109

Earth Juice Sugar Peak Grand Finale . . . 109

Earthworm Castings - Black Gold . . . 137

Earthworm Castings - Wiggle Worm Soil Builder . . . 142

Easy Clean Trays Outside Dimension (OD) . . . 165

Easy Pour Watering Can - Fiskars . . . 247

Easygrow Diamond Fusion Lightite Film . . . 264

Easygrow Eco Diamond Diffusion Foil Film . . . 264

Easygrow Silver/White Lightite Film . . . 264

Eazy Drain Reservoirs & Lids - Botanicare . . . 163

Ebb & Flow Expansion Kit - 6 Site Flo-n-Gro . . . 160

Ebb & Flow Fitting Kit - Hydro Flow (EcoPlus) . . . 181

Ebb & Flow Fittings - Botanicare . . . 181

Ebb & Flow Fittings - Hydro Flow (EcoPlus) . . . 183

Ebb & Flow Support - Stake Out . . . 161

Ebb & Flow System - 12 Site Flo-n-Gro . . . 159

Ebb & Flow System - 6 Site Flo-n-Gro . . . 159

Ebb & Flow System - 6 Site Gro Giant . . . 159

EC Conductivity Standard Solution - BlueLab . . . 274

EC Shake Nutrient Meter . . . 265

EC/pH/Temp Tri-Meter - Future Harvest . . . 271

EC/TDS HydroTester COM-80 - HM Digital . . . 269

EC/TDS/TEMP Combo Meter COM-100 - HM Digital . . . 268

EC/TDS/Temperature Tester - Hanna DiST 5 Waterproof . . . 270

ECM1 External Contactor Modules - Gavita . . . 29, 219

Eco Air Pumps - EcoPlus . . . 179

Eco Diamond Diffusion Foil Film - Easygrow . . . 264

Eco Grow Pots . . . 284

Eco Grower Drip Hydroponic System . . . 168

Eco-Mite - Arborjet . . . 121

Eco-PM - Arborjet . . . 121

Econo Wing Reflector . . . 23

Econo Wing Reflector XL . . . 23

EcoPlus 1/10 HP Chiller . . . 197

EcoPlus 1/2 HP Chiller . . . 197

EcoPlus 1/4 HP Chiller . . . 197

EcoPlus 1500 Elite Submersible Pump . . . 177

EcoPlus Adjustable Flow Rate Water Pumps . . . 176

EcoPlus Air Manifold T Style 3/8 Inch Inlet . . . 180

EcoPlus Air Manifold Trumpet Style 1/2 Inch Inlet . . . 180

EcoPlus Air Stone Discs . . . 181

EcoPlus Air Stones Round . . . 181

EcoPlus Axial Fans . . . 226

EcoPlus Blowers . . . 226

EcoPlus Commercial Air Pumps . . . 179

EcoPlus Commercial Grade Water Chillers . . . 197

EcoPlus Convertible Bottom Draw Water Pumps . . . 176

EcoPlus Eco Air Pumps . . . 179

EcoPlus Eco Fixed Flow Rate Submersible Pumps . . . 176

EcoPlus Flexible Air Diffusers . . . 181

EcoPlus Premio Jet Pumps . . . 176

EcoPlus Small & Large Pump Filter Bag . . . 179

EcoPlus Supreme Air Pump . . . 179

EcoPlus Titanium Reservoir & Aquarium Heaters . . . 199

EcoPlus/Hydro Flow Barbed Fittings & Valves 1/2in . . . 185

EcoPlus/Hydro Flow Barbed Fittings & Valves 3/4in . . . 185

EcoPlus/Hydro Flow Barbed Fittings 1/4in . . . 185

EcoPlus/Hydro Flow Barbed Fittings 1in . . . 185

EcoPlus/Hydro Flow Ebb & Flow Fitting Kit . . . 181

EcoPlus/Hydro Flow Ebb & Flow Fittings . . . 183

Ecotestr pH 1 - Oakton . . . 268

Ecotestr pH 2 - Oakton . . . 268

Ecotestr TDS Low - Oakton . . . 268

EL 400V Electronic Lamps - Gavita Pro Plus . . . 45

Elbow - 1:1 Ratio Evolution . . . 201

Elbow - ThermoFlo . . . 229

Elbow Ducting - Ideal-Air 90 Degree Adjustable . . . 227

Elbow for Merin GP - 2:1 Ratio . . . 204

Elbow Reducers - Hydro Flow Barbed . . . 185

Elbows - Grodan Dutch Leach . . . 166

Electrical Components for Splits . . . 236

Electronic - Gavita Pro Ballasts . . . 29

Electronic Ballast - Eye Hortilux Gold . . . 33

Electronic Ballast - Eye Hortilux Platinum . . . 32

Electronic Ballast - Galaxy Grow Amp . . . 27

Electronic Ballast - Galaxy Grow Amp Master Blaster 1500W . . . 27

Electronic Ballast - Galaxy Legacy . . . 28

Electronic Ballast - Nanolux Digital . . . 32

Electronic Ballasts - Fulham Racehorse T5 HO Fluorescent 52

Electronic Ballasts - Fulham Workhorse T5 HO Fluorescent 52

Electronic Ballasts - Galaxy Digital Logic . . . 38

Electronic Ballasts - Gavita DigiStar e-Series . . . 21

Electronic Lamps - Gavita Pro Plus EL 400V . . . 45

Elemental - Roots Organics . . . 78

Elite Wide Mouth Jars - Ball . . . 257

Emerald Mountain Mix - Roots Organics . . . 141

Emerald Triangle Crystal Burst . . . 110

Emerald Triangle Deep Breath . . . 111

Emerald Triangle G 10 . . . 111

Emerald Triangle Killer Tea . . . 110

Emerald Triangle Magnum . . . 110

Emerald Triangle Purple Maxx . . . 110

Emerald Triangle Snow Storm Ultra . . . 110

Emerald Triangle Sonic Bloom . . . 111

Emitter - Hydro Flow Multi-Flow . . . 192

Emitters - Hydro Flow In-Line Flag . . . 189

Emitters - Hydro Flow Regulated Button . . . 189

Enclosed Greenhouses - Sun Hut The Original . . . 174

Enclosed Greenhouses - The Big Easy Sun Hut . . . 171

End ALL Insect Killer - Safer . . . 125

End Cap - Hydro Flow EZ Pull . . . 186

Enhanced HPS Lamps - Gavita . . . 46

Enhanced Metal Halide Lamps - Sunmaster Red Sunrise . . . 48

Enhanced Performance HPS Lamps - GE . . . 48

Enhanced Performance HPS Lamps - Philips . . . 48

Enhanced Performance HPS Lamps - SolarMax . . . 47

Enhanced Performance HPS Lamps - Sunmaster . . . 47

Enhanced Performance HPS Lamps - Ushio . . . 46

Enhanced Performance Metal Halide Lamp - SolarMax Red . . . 47

Enhanced Performance Metal Halide Lamps - SolarMax Blue . . . 47

Enhanced Performance Metal Halide Lamps - Sunmaster . . . 47

Environmental Controller - Titan Hyperion 1 Wireless . . . 206

Environmental Digital Controller - Saturn 4 . . . 214

Environmental Digital Controller with CO2 PPM Control - Saturn 6 . . . 214

Environmental Digital Controller with CO2 Timer - Saturn 5 . . . 214

Eos 1 - Humidify/Dehumidify Controller . . . 214

Eos 2 - Digital Humidity Controller . . . 214

Epic Reflector 8 in Air-Cooled . . . 17

Epsom Salts - Monterey . . . 116

Equalizer Hot Spot Diffuser . . . 19

Equilibrium - Humboldt Nutrients . . . 115

Equipment Hanging Board - GrowLab . . . 174

Equipment Mounts for Splits . . . 237

EuroGrower - Complete System . . . 167

Europonic Fossil Fuel - Europonic . . . 101

Europonic Nitrozime - HydroDynamics . . . 102

Europonic Rockwool Conditioning Solution - HydroDynamics . . . 101

Europonic Silicate - HydroDynamics . . . 100

Evolution 8 in Air-Cooled Reflector . . . 17

Evolution RO1000 - 1000 GPD . . . 199

Evolution RO1000 - Hydro-logic TDS Inline Monitor Pro . . . 203

Evolution RO1000 - Pressure Booster Pump . . . 203

Evolution RO1000 Filters . . . 199

Evolution RO1000 Float Valve - Hydro-logic . . . 204

Evolution RO1000 QC Fittings . . . 204

Evolution RO1000 UV Sterilizer Kit . . . 202

Evolution Waste Reducer Elbow - 1:1 Ratio . . . 201

Evolution-RO1000 Wall Mount Bracket . . . 201

Excellofizz - Supernatural . . . 90

Expansion Kit - 3 Site Gro Giant . . . 160

Expansion Kit - 6 Site Drip-n-Gro . . . 160

Expansion Kit - 6 Site Flo-n-Gro Ebb & Flow . . . 160

Extender - 4KV Socket Mogul Base . . . 52

Extension Cable - Titan Controls 15ft Sensor . . . 208

Extension Cords - 10 Foot Lamp . . . 55

Extension Cords 120 & 240 Volt - Power All . . . 54

Extension Cords w/ Circuit Breaker - 14 Gauge Power All 54

Extension Cords w/ Circuit Breaker - 16 Gauge Power All 54

Extension Cords w/ Circuit Breaker - Power All Commercial Grade 125V 7ft Lead Cord w/ 3 - 6ft Extension Cords . . . 54

External Contactor Modules - Gavita ECM1 . . . 29, 219

Extinguisher - Flame Defender 2 KG . . . 62

Extra Large Perlite - Supreme . . . 134

Extraction - Nectar For The Gods Aphrodite's . . . 87

Extractor - Vermicrop Vermi T . . . 91

Extreme Gardening Azos . . . 92, 158

Extreme Gardening CalCarb . . . 91

Extreme Gardening Mykos . . . 92

Extreme Gardening Mykos Drops Pouches Display . . . 92

Extreme Gardening Mykos Drops Root Paks . . . 91

Extreme Gardening Mykos WP . . . 92

Extreme Gardening Mykostart Starter Paks Display . . . 92

Extreme Gardening Tea Brew Packs . . . 92

Extreme Gardening Tea Brew Packs Display . . . 92

Extreme Serene - Roots Organics . . . 77

Eye Dropper - Measure Master . . . 251

Eye Hortilux Blue Daylight Metal Halide Lamps . . . 45

Eye Hortilux Dual Arc - HPS & MH Combo Lamp . . . 44

Eye Hortilux e-Start Metal Halide Lamps . . . 45

Eye Hortilux Gold E-Ballast . . . 33

Eye Hortilux HPS Conversion Lamps . . . 45

Eye Hortilux Metal Halide - Standard Metal Halide Lamps . . . 44

Eye Hortilux MH Conversion Lamp . . . 45

Eye Hortilux Platinum Electronic Ballast . . . 32

Eye Hortilux Protected Metal Halide Lamp . . . 45

Eye Hortilux Super HPS - High Pressure Sodium Lamps . . . 44

EZ Pull End Cap - Hydro Flow . . . 186

EZ Store Container/Buckets & Lid . . . 165, 287

EZ-Clone 360 Sprayer . . . 154, 181

EZ-Clone Classic 128 Cutting System . . . 154

EZ-Clone Classic 16 Cutting System . . . 153

EZ-Clone Classic 32 Cutting System . . . 153

EZ-Clone Classic 64 Cutting System . . . 153

EZ-Clone Clear Rez . . . 154

EZ-Clone Neoprene Replacement Inserts . . . 154

EZ-Clone Replacement Pumps . . . 154

EZ-Clone Rooting Compound . . . 156

EZ-Clone Sprayer . . . 154, 181

F

F-D-S - Uber . . . 88

Fabric Liner - Flo-n-Gro Square . . . 161

Fabric Pot - Root Pots . . . 283

Fabric Pot - Smart Pot Transplanter . . . 283

Fabric Pots - Black Gro Pro Round . . . 281

Fabric Pots - Gro Pro Square . . . 281

Fabric Pots - RootTrapper II . . . 282

Fabric Pots - Smart Pot Black . . . 282

Fabric Pots - Smart Pot Tan . . . 282

Fabric Pots - Tan Gro Pro Round . . . 281

Fan - Classic Series 16in Hurricane . . . 225

Fan - Classic Series Hurricane 6in Clip . . . 225

Fan - Hurricane Metal Floor . . . 225

Fan - Hurricane Super 8 Digital . . . 225

Fan - Hurricane Supreme Series Oscillating Stand . . . 224

Fan - Hurricane Supreme Series Super 8 Digital Stand . . . 224

Fan - Hurricane W Stand . . . 224

Fan - Wall Mount Air King . . . 225

Fan Control Cooling Thermostat - Zephyr 4 . . . 214, 226

Fan Control Kit for Ductless Air Conditioners . . . 237

Fan Controller - Dial-A-Temp . . . 227

Fan Controller - Mercury 3 . . . 213, 226

Fan Speed Control - Grozone TV1 Day/Night . . . 215

Fan Speed Control - Grozone TV2 Multimode . . . 215

Fan Speed Controller - Ideal-Air . . . 227

Fan Speed Controller - Mercury 2 . . . 213, 226

Fan Speed Controller - Mercury 4 Multi-Function 213, 226

Fan Speed Dimmer with Optional Kick Start - Grozone DIM1 . . . 215

Fan Variable Speed Control - The Speedster . . . 227

Fans - Air King Pedestal . . . 225

Fans - Can-Fan . . . 223

Fans - Can-Fan Q-Max . . . 223

Fans - Fantech Inline Centrifugal FG Series . . . 222

Fans - Fantech Inline Mixed Flow FKD Series . . . 222

Fans - Hurricane After Burner High Output Mixed Flow . . . 221

Fans - Hurricane Axial . . . 226

Fans - Hurricane Centrifugal Inline . . . 221

Fans - Hurricane Supreme Series Wall Mount Oscillating . . . 224

Fans - Hyper Fan Digital Mixed Flow . . . 220

Fans - Hyper Fan Stealth . . . 220

Fantech Inline Centrifugal Fans FG Series . . . 222

Fantech Inline Mixed Flow Fan FKD Series . . . 222

Farm Kit - GH . . . 167

Fast Fit A La Carte Components . . . 59, 169

Fast Fit Tray Stand 2ft x 4ft . . . 58, 169

Fast Fit Tray Stand 3ft x 3ft . . . 58, 169

Fast Fit Tray Stand 4ft x 4ft . . . 58, 169

Fast Fit Tray Stand 4ft x 8ft . . . 58, 169

Fast-Gro Propagation Heating Mats . . . 148

Fat Gro-Slab - Grodan . . . 132

Faucet Connector - Claber Koala . . . 196

Faucet to Hose Connector - Claber . . . 196

Feliz AgroLED Green Flashlight/Lamp . . . 41, 51, 252

Feliz Dual Spectrum Fluorescent Grow Lamps . . . 50

Feliz Fluorescent Grow Lamps . . . 50

Female Lamp Cord Receptacle - Dual . . . 53

Female Receptacle For Lamp Cord . . . 53

Fender Grommets - Hydro Flow . . . 194

FG Series - Fantech Inline Centrifugal Fans . . . 222

Fiber Grow Greenhouse Kits - Planters' Pride . . . 149

Figure-Eight Poly Tube Clinchers - Hydro Flow . . . 188

Fill & Drain Siphon Kit - Hydro Flow . . . 183

Fill/Drain Fitting Kit - Hydro Flow . . . 183

Film - Black/White Poly Sheeting . . . 264

Film - Clear Nursery Greenhouse . . . 264

Film - Clear Tufflite UV UV Protected Greenhouse . . . 264

Film - Easygrow Diamond Fusion Lightite . . . 264

Film - Easygrow Eco Diamond Diffusion Foil . . . 264

Film - Easygrow Silver/White Lightite . . . 264

Film - Orca . . . 263

Film - Pand Black/White . . . 263

Film - Sunfilm Panda . . . 263

Film Mylar - Sunfilm . . . 263

Film Seam Tape - Orca . . . 263

Filter - Hydro-logic Pump Protector & Inlet Filter 1/2in . . . 203

Filter - Hydro-logic Pump Protector & Inlet Filter 3/8in . . . 203

Filter Bag - EcoPlus Small & Large Pump . . . 179

Filter for PowerDry 1300 and RDS10 Dehumidifiers - Quest . . . 233

Filter for PowerDry 4000 & Dual Overhead Dehumidifiers - Quest . . . 233

Filter Washer 3/4in - Hydro Flow . . . 191

Filters - Can-Filter . . . 240

Filters - Can-Filters Can-Max . . . 239

Filters - Can-Lite . . . 240

Filters - Hydro-logic Big Boy . . . 205

Filters - Hydro-logic Evolution RO1000 . . . 199

Filters - Hydro-logic PreEvolution . . . 201

Gavita Pro Classic 600 SE Complete Fixture	30, 36	GH Flora Nectar Banana Bliss	65	Gold Zone - Dutch Master	119	Gro Pro Thin Skins	281
Gavita Pro Double Ended HPS Lamps	46	GH Flora Nectar Coconut	64	Goof Plug Rack - Hydro Flow	186	Gro Terra - Supernatural	89
Gavita Pro Electronic Remote Ballasts	29	GH Flora Nectar FruittFusion	64	Graduated Measuring Bucket 5 Gal - Measure Master	251	Gro-Blocks & Big Mama - Grodan Delta	133
Gavita Pro Plus EL 400V Electronic Lamps	45	GH Flora Nectar Pineapple Rush	64	Graduated Measuring Round Containers - Measure Master	251	Gro-n-Dirt Automated 12 Site Soil Garden	160
Gavita Reflector - Hortistar 1000 DE	24	GH Flora Nectar Sugar Cane	65	Graduated Rectangle Measuring Containers - Measure Master	251	Gro-Slabs - Grodan	132
Gavita Reflector - Hortistar 600 SE	24	GH Flora Series Performance Pack	63	Grand Finale - Earth Juice Sugar Peak	109	Gro-Smart Tray Insert - Grodan	152
Gavita Reflector - TripleStar	23	GH FloraBlend	65	Granular Mycorrhizae - Plant Success	105	Gro-Wool Absorbent Granulate - Grodan	132
Gavita Reflectors	23-24	GH FloraDuo Hydroponics A	64	Granulate - Grodan	132	Grochek Combo pH/EC/TDS/TEMP Monitor - Hanna	269
Gavita TripleStar 600 Reflector	23	GH FloraDuo Hydroponics B	64	Grape Sweet - Botanicare	70	Grochek TDS Monitor - Hanna	270
GE Enhanced Performance HPS Lamps	48	GH FloraKleen	65	Gravitation #10 - Emerald Triangle G 10	111	Grochek Water Resistant pH Indicator - Hanna	269
GE Spiral Fluorescent Bulb 42 Watt	50	GH Floralicious Bloom	64	Gray Heavy Duty Reservoirs	165	Grodan Dutch Leach Tray Elbows & Caps	166
GE Starcoat T5 HO Fluorescent Lamps	50	GH Floralicious Grow	64	Gray Wire Crimp	53	Grodan Dutch Leach Tray with 2 Elbows	166
Gel - Clonex Rooting	155	GH Floralicious Plus	64	Great White Mycorrhizae - Plant Success	105	Grodan Giant Pot	286
Gel - Ona Apple Crumble	242	GH FloraNova Bloom	63	Green Bamboo Stakes - Bond	255	Grodan Gro-Smart Tray Insert	152
Gel - Ona Fresh Linen	243	GH FloraNova Grow	63	Green Drain Elbow for Merlin GP - 2:1 Ratio	204	Grodan Gro-Wool Absorbent Granulate	132
Gel - Ona Polar Crystal	243	GH FloraShield	119	Green Eye LED Cap Light	252	Grodan Maxipot	286
Gel - Ona Pro	243	GH General Organics GO Box	67	Green Eye LED Flashlight	252	Grodan Pargro Quick Drain Stonewool	133
Gel 2 Root - Planters Pride	152	GH Grommets	195	Green Eye LED Headlight	252	Grodan Rose Bucket	286
Gel Packets - Clonex Rooting	155	GH Hardwater Flora Micro	63	Green Flashlight/Lamp by Feliz - AgroLED	41, 51, 252	Grodan Stonewool A-OK Starter Plugs	132
Gel-Pak - Clearoma	241	GH KoolBloom	66	Green Fuse Bloom Stimulator Concentrate - HydroDynamics	102	Grodan Stonewool Delta Gro-Blocks & Big Mama	133
Gel2Root - Planters Pride	152	GH MaxiBloom	65	Green Fuse Growth Stimulator Concentrate - HydroDynamics	102	Grodan Stonewool Delta Starter Mini-Blocks	133
General Organics Ancient Forest	143	GH MaxiGro	65	Green Fuse Root Stimulator Concentrate - HydroDynamics	102	Grodan Stonewool Gro-Slabs	132
General Organics BioBud	67	GH RainCalibration Solutions	272	Green Harvest MH Conversion Lamps - Sunmaster	48	Grodan Stonewool Grow-Chunks	132
General Organics BioMarine	68	GH Net Cups	285	Green Lite - Roots Organics	141	Grodan Stonewool Grow-Cubes	134
General Organics BioRoot	67	GH Panda Reservoir	166	Green Premium Plastic Saucer	288	Grodan Stonewool MacroPlugs	133
General Organics BioThrive Bloom	67	GH pH Control Kit	272	Green Stay - Supernatural	90	Grommets - GH	195
General Organics BioThrive Grow	67	GH pH Down Liquid & GH pH Down Dry	273	Green T5 HO Fluorescent Grow Lamps - Spectralux	49	Grommets - Hydro Flow	195
General Organics BioWeed	67	GH pH Test Kit	272	Green Thumb - Pure	128	Grommets - Hydro Flow Fender	194
General Organics CaMg+	67	GH pH Up Liquid & pH UP Dry	272	GreenCure Fungicide	123	Grotek Black Pearl	86
General Organics Diamond Black	68	GH Power Grower - 8 Pack Kit	167	GreenFields Potting Soil - Roots Organics	140	Grotek Bloom Fuel	85
General Organics GO Box	67	GH PowerGrower Eco	167	Greenhouse Film - Clear	264	Grotek Blossom Blaster	86
General Purpose - Grow More Water Soluble	99	GH RainForest 236 - Thirty-six 2in Site Aeroponics System	168	Greenhouse Film Clear - Tufflite IV	264	Grotek Cal-Max	85
Generator - HydroGen Water Cooled CO2 MiniGen	219	GH RainForest 318 - Eighteen 3in Site Aeroponics System	168	Greenhouse Kits & Pellet Refills - Planters' Pride	149	Grotek Cal-Max	85
Generator AC Power Supply - Titan Ares CO2	208	GH RainForest 66 - Six 6in Site Aeroponics System	167	Greenhouse Thermo-Hygrometer - Mondri	150	Grotek Final Flush Regular	84
Generator Water Cooled - HydroGen Pro	219	GH Rapid Rooter	148	Greenhouses - Sun Hut Blackout	172	Grotek InstaGreen	85
Generators - Titan Controls Ares 10	208	GH RapidStart	66, 155	Greenhouses - Sun Hut Fortress	173	Grotek Monster Bloom	85
Generators - Titan Controls Ares 2	208	GH Snaature Snapstand 4ft x 4ft Tray Stand	168	Greenhouses - The Big Easy Sun Hut	171	Grotek Monster Grow	85
Generators - Titan Controls Ares 4	208	GH Snaature Snapstand Fittings	168	Greenhouses - The Original Sun Hut	174	Grotek Pro-Silicate	85
Generators - Titan Controls Ares 8	208	GH Spigot For 6-Gallon Containers	68	GreenPower Plus - Philips/Gavita EL 400V Electronic Lamps	45	Grotek Reservoirs & Lids	165
Generators Burners - Titan Ares Replacement	209	GH Subculture B	66	Greenway Nutrients - No Fungus Gnats	121	Grotek Solo-Tek Bloom	85
GentleRain Shower Head Wand - Melnor	248	GH Subculture M	66	Greenway Nutrients - No Powdery Mildew	121	Grotek Solo-Tek Grow	84
Germination Dome - Super Sprouter Standard	150	GH TNC 1/4 HP Pump	177	Greenway Nutrients - No Spider Mites	120	Grotek Vegetative Growth Booster	86
Germination Dome - Super Sprouter Ultra Clear Ventilated 2in	150	GH Vortex DC Sprayer	167	Greenway Nutrients - No Spider Mites RTU	120	Grotek VitaMaxPlus B1 Plant Formula	85
Germination Kit 2in - Super Sprouter Heated	147	GH Water Farm - Complete & Modular Systems	167	Grid Plant Supports - Link-Ups Grow Through	254	Grounded Adapter - 125 Volt Power All 6 Outlet	54
GFCI Power Strip - 4 Outlet 125V Power All Indoor	55, 62	GH Water Farm 8 Pack Circulating Upgrade Kit	167	Gro Aqua - Supernatural	89	Grow - Cutting Edge Solutions	93
GH - General Organics Ancient Forest	143	GH Water Farm 8 Pack Kit	167	Gro Giant - Flo-n-Gro Black Bucket 6.6 Gallon	161, 287	Grow - Earth Juice	108
GH - Rapid Root Mat	148	GH WaterPower 120 Pump	177	Gro Giant Blue Bucket 6.6 Gallon	161, 287	Grow - Humboldt Nutrients	112
GH AeroFlo2 Replacement Parts	166	GHT x Barbed Adapters - Hydro Flow	186	Gro Giant Drip Ring	168, 188	Grow - Soul Synthetics	79
GH AeroFlo2 Systems	166	GHT x NPT Adaptors - Hydro Flow	191	Gro Giant Ebb & Flow System - 6 Site	159	Grow All-In-One - RAW	81
GH Armor Si	66	Ginormous - Humboldt Nutrients	115	Gro Giant Expansion Kit - 3 Site	160	Grow Amp Electronic Ballasts	27
GH AzaMax	120	Glacial Rock - Vital Earth's Powdered	104	Gro Giant Mesh Basket Lid 10in - Flo-n-Gro 6.6 Gal	161, 287	Grow Amp Master Blaster 1500W Electronic Ballasts	27
GH BioBud	67	Glass Frames - Reflector Replacement	23	Gro Giant Net Pot Lids	288	Grow Bag - Botanicare Camo	289
GH BioMarine	68	Glasses - Professional UV Safety	62	Gro Pro Black Square Plastic Pots	286	Grow Bags - Gro Pro	289
GH BioRoot	67	Gloves - Black Lighting Powder Free Nitrile	62	Gro Pro Clear Plastic Saucers	288	Grow Big - FoxFarm	74
GH BioThrive Bloom	67	Gnat Nix! - Growstone	146	Gro Pro Grow Bags	289	Grow Big Hydroponic - FoxFarm	74
GH BioThrive Grow	67	Gnats - Greenway Nutrients No Fungus	121	Gro Pro Heavy Duty Black Saucers	288	Grow Film - Orca	263
GH BioWeed	67	GO BioBud	67	Gro Pro Mesh Pots/Bucket Lids	284	Grow Film Seam Tape - Orca	263
GH Bush Load	66	GO BioMarine	68	Gro Pro Net Pot Lids	288	Grow Lamps - Feliz Dual Spectrum Fluorescent	50
GH CALiMAGic	65	GO BioRoot	67	Gro Pro Net Pots	285	Grow Lamps - Feliz Fluorescent	50
GH CaMg+	67	GO BioThrive Bloom	67	Gro Pro Premium Nursery Pots - Injection Molded	283	Grow Light - Garden Bright	39
GH CocoTek Bale Organic Growing Medium	143	GO BioThrive Grow	67	Gro Pro Premium Round Mesh Bottom Pots	284	Grow Light - Super Sprouter T5 High Output	38, 150
GH CocoTek Basket Liners	288	GO BioWeed	67	Gro Pro Premium Square Black Plastic Pots	286	Grow Light - White Wing	40
GH CocoTek Bricks Organic Growing Medium	142	GO Box - General Organics	67	Gro Pro Premium White Square Pots	285	Grow Light Fixture - Sun System HPS 150	34
GH CocoTek Mats Organic Growing Medium	143	GO CaMg+	67	Gro Pro Root Master Pots	285	Grow Media - B'Cuzz HydroMix	145
GH Controller Complete & Texas Controller	167	GO Diamond Black	68	Gro Pro Round Fabric Pots - Black	281	Grow Media - Botanicare Cocogro	140
GH Covert Tank	166	GO Diamond Bloom - Cutting Edge Solutions	93	Gro Pro Round Fabric Pots - Tan	281	Grow Media - Gold Label Coco	144
GH Diamond Black	68	Gold E-Ballast - Eye Hortilux	33	Gro Pro Round Plastic Mesh Bottom Pots	284	Grow Media - Gold Label Custom 80/20	143
GH Diamond Nectar	66	Gold Grow - Cutting Edge Solutions	93	Gro Pro Square Fabric Pots	281	Grow Media - Gold Label HydroCoco 60/40	144
GH Dual Diaphragm Air Pump	180	Gold Label Coco	144	Gro Pro Square Mesh Pot	287	Grow Media - Gold Label Hydrocorn	144
GH Eco Grower Drip Hydroponic System	168	Gold Label Custom 80/20	143			Grow Media - Gold Label Hydrocorn	144
GH EuroGrower - Complete System	167	Gold Label HydroCoco 60/40	144			Grow Media - Vital Earth's Coco Lite	145
GH Farm Kit	167	Gold Label Hydrocorn	144			Grow Media - Vital Earth's Manna Mix	145
GH Flora Bloom	63	Gold Label Hydrocorn XL	144			Grow Medium - Oasis Rootcubes	149
GH Flora Gro	63					Grow Medium - Oasis Rootcubes Bulk Pack	149
GH Flora Micro	63					Grow Medium - Oasis Rootcubes Plus	149

Grow More Dolomite Lime	100	Grower's Edge Vaporizer - Commercial Grade	249	Guardian Monitor Connect - BlueLab	266	Harvest Pro Ballast	25
Grow More Fish Meal	100	Grower's Edge Vine Clips	252	Guardian Monitor Replacement pH Probe - BlueLab	266	Harvest Shears - Long, Straight Blade H300S - Zenport	261
Grow More Flower & Bloom	100	Grower's Edge Wireless Remote Sensor	280	H		Harvesting Scissors SS-320BT - ARS	261
Grow More Hawaiian Bud	98	Growers Blend - Bushdoctor Lucky Dog K-9 Kube	136	Hades 1 - 15 Minute Lighting Delay Timer	212	Hawaiian Bud - Grow More	98
Grow More Hula Bloom	98	Growilla Bud & Veg - Botanicare	70	Hades 2 - Digital Recycle and Light Timer with High Temp. Shut-Off	212	HB112C - 240 Volt Plug-In Timer	279
Grow More Kelp Meal	99	Growing Medium - GH CocoTek Bale	143	Hades Down - Nectar For The Gods	88, 273	HD Stakes - Super Steel	255
Grow More Mendocino Avalanche	98	Growing Medium - GH CocoTek Bricks	142	Hand Cleaner - Roots Organics Sap Off Soap	250	HDI Europonic Fossil Fuel	101
Grow More Mendocino Honey	98	Growing Medium - GH CocoTek Mats	143	Hand Cleaner - Sticky Bye-Bye	250	HDI Europonic Nitrozime	102
Grow More pH Down 30%	273	Growing Medium with Tray - Oasis Wedge	149	Handheld TDS Tester TDS-3 - HM Digital	269	HDI Europonic Sillwax Conditioning Solution	101
Grow More pH Up 30%	273	Growing Mix - Roots Organics B2 Professional	141	Hang Time Drying Rack - Grower's Edge	249	HDI Europonic Silicate	100
Grow More Rapid Root	156	GrowLab	175	Hangover - AgroLED	41, 59	HDI Green Fuse Bloom Stimulator Concentrate	102
Grow More Seabird Guano	100	GrowLab Equipment Hanging Board	174	Hanna 1500 PPM (Model 70442L) & 1413 uS/CM (Model HI 7031L) Calibration Solutions	275	HDI Green Fuse Growth Stimulator Concentrate	102
Grow More Seagrow All Purpose	98	GrowLab Hercules Support	174	Hanna 20ml Packet Solutions	275	HDI Green Fuse Root Stimulator Concentrate	102
Grow More Seagrow Flower & Bloom	98	Growstone Gnat Nix!	146	Hanna Batteries for pH/TDS Pens	270	HDI Ionic Bloom	101
Grow More Soil Builder Humic	98	Growstone GS-1 Hydroponic Growth Medium	146	Hanna Checker pH Tester	270	HDI Ionic Bloom Hardwater Formula	101
Grow More Triple Super Phosphate	100	Growstone GS-2 Mix This Soil Aerator	146	Hanna Checker Replacement Electrode	270	HDI Ionic Grow	101
Grow More Water Soluble 20 - 10 - 20	99	Growstone GS-3 Coco-Mix	146	Hanna Cleaning Solution	275	HDI Ionic Grow Hardwater Formula	101
Grow More Water Soluble Flower Hardener	99	Growth - B'Cuzz	95	Hanna Combo pH/EC/TDS/Temperature Tester with Low Range EC	270	HDI Ionic PK Boost	101
Grow More Water Soluble Foliage Developer	99	Growth Booster - Grotek Vegetative	86	Hanna DiST 5 Replacement Probe (HI73311)	270	HDI Ionic Tote Starter Kit	101
Grow More Water Soluble General Purpose	99	Growth Medium - Growstone GS-1 Hydroponic	146	Hanna DiST 5 Waterproof EC/TDS/Temp Tester	270	HDI Mother Plant A & B	102
Grow More Water Soluble Grow & Bloom	99	Growth Regulator - Monterey Florel	116	Hanna Grochek Combo pH/EC/TDS/Temp Monitor	270	HDI Root Riot Cubes	149
Grow More Water Soluble High Foss	99	Growth Stimulator Concentrate - HydroDynamics Green Fuse	102	Hanna Grochek TDS Monitor	270	HDI Root Riot Trays	149
Grow More Water Soluble Tomato	99	Grozone Controls CO2D Dual Zone CO2 Controller	216	Hanna Hydroponics pH Tester (HI99104)	270	Headlight - Green Eye LED	252
Grow System - Flo-n-Gro Gro-n-Dirt Automated 12 Site Soil Garden	160	Grozone Controls CO2R CO2 Controller with AUX Output and High Temp.	216	Hanna PH 4 & PH 7 Calibration Solutions	275	Heat Mat - Super Sprouter	147
Grow Tent - GrowLab	175	Grozone Controls CY1 Cyclestat w/ Day/Night Sensor	215	Hanna pH Cleaning & Calibration Solution Starter Kit	275	Heat Mat 2 Tray - Super Sprouter	147
Grow Tent Accessories - Sun Hut	174	Grozone Controls CY2 Short Period Cyclestat with Day/Night Sensor	215	Hanna pH Grochek Water Resistant pH Indicator	269	Heat Mat Digital Thermostat - Super Sprouter	148
Grow Tents - Sun Hut Blackout	172	Grozone Controls CY3 Digital Cyclestat with Day/Night Sensor and Bargraph Display	215	Hanna pH/TDS/Temperature Monitor	269	Heat Mat Thermostat - Super Sprouter	148
Grow Tents - Sun Hut Fortress	173	Grozone Controls DIM1 Fan Speed Dimmer with Optional Kick Start	215	Hanna PHEP Tester	270	Heat Pumps - Ideal-Air 15 SEER	235
Grow Tents - Sun Hut The Big Easy	171	Grozone Controls HT2 Climate Controller (Temp & RH) Single Output Bargraph Display	216	Hanna Primo TDS Tester	270	Heat Scrubber - Hydro Innovations	219
Grow Tents - Sun Hut The Original	174	Grozone Controls HTC Climate Controller (Temp, RH & CO2) Two Outputs w/ Digital Display	216	Hanna Replacement pH Probe (HI1285-6)	270	Heated Germination Kit 2 in - Super Sprouter	147
Grow Tents Hanging Bracket - Light Rail	60	Grozone Controls OSW On/Off 120V Switcher (Trigger Cord)	216	Hanna Replacement pH Probe (HI1286)	269	Heater - EcoPlus Titanium Reservoir & Aquarium	199
Grow Tray Elbows & Caps - Grodan	166	Grozone Controls OSWDN On/Off 120V Switcher (Day/Night Sensor)	216	Hanna Replacement pH Probe (HI1293)	269	Heater - Titan Controls CO2 Inline	207
Grow Tray with 2 Elbows - Grodan Dutch Leach	166	Grozone Controls SCC1 Temp, Humidity & CO2 Controller Simple One Series	216	Hanna Replacement pH Probe (HI73127)	270	Heaters - Hydor Theo	199
Grow Trays - Black Styrene Plastic (OD)	165	Grozone Controls SCO2 CO2 Controller Simple One Series	216	Hanna Storage Solution	275	Heating Mats - Fast-Gro	148
Grow Trays - Botanicare ID Black	162	Grozone Controls TP1 Day/Night Tempstat	215	Hanna Waterproof pH/EC/TDS Meter	270	Heating Products Hard Start Kit	237
Grow Trays - Botanicare ID White	162	Grozone Controls TP2 Adjustable Differential Tempstat	215	Hanna Waterproof PHEP 4 Tester With Replaceable Electrode (Model HI 98127)	270	Heating Products Surge Protector	237
Grow Trays - Botanicare Low Tide Black	162	Grozone Controls TP3 High Temp Shut-Off Tempstat	215	Happy Frog Acid Loving - FoxFarm	75	Heating/Cooling Controller - Zephyr 3	214, 226
Grow Trays - Botanicare OD Black	162	Grozone Controls TV1 Day/Night Fan Speed Control	215	Happy Frog All Purpose - FoxFarm	75	Heavy Duty Black Saucers - Gro Pro	288
Grow Trays - Duralastics Black ID	164	Grozone Controls TV2 Multimode Fan Speed Control	215	Happy Frog Bulb Food - FoxFarm	76	Heavy Duty Bypass Pruner Model Z201 - Zenport	261
Grow Trays - Duralastics White ID	164	Grozone Controls USCO2 Single Zone Ultra Simple CO2 Controller	216	Happy Frog Fruit & Flower - FoxFarm	75	Heavy Duty Container with Handles	283
Grow Trays - Easy Clean Trays Outside Dimension	165	GS-1 Hydroponic Growth Medium - Growstone	146	Happy Frog High Phosphorus Bat Guano - FoxFarm	75	Heavy Duty Light & Equipment Hangers 1/4in SunGrip	57
Grow Yo-Yo	58	GS-2 Mix This Soil Aerator - Growstone	146	Happy Frog Japanese Maple - FoxFarm	75	Heavy Duty Net Pots	285
Grow-Chunks - Grodan	132	GS-3 Coco-Mix - Growstone	146	Happy Frog Jump Start - FoxFarm	76	Heavy Duty Peel & Stick Zipper - Lite Tite	264
Grow-Cubes - Grodan	134	Guano - Budswel Dry	108	Happy Frog Premium Lawn - FoxFarm	76	Heavy Duty Reservoirs	165
Grow-N - Soul Synthetics	79	Guano - Budswel Liquid	108	Happy Frog Rose Food - FoxFarm	76	Heavy Duty Sprayer 36oz - Root Lowell Flo-Master	247
Grower's Edge Commercial Grade Trellis Netting	255	Guano - Buried Treasure Nitro Bat	80	Happy Frog Soil - FoxFarm	136	Heavy Duty Time Switch - Intermatic	279
Grower's Edge Commercial Grade Trellis Netting Bulk Rolls	256	Guano - Buried Treasure Peruvian Seabird	80	Happy Frog Soil Conditioner - FoxFarm	137	Heavy Harvest Premium Compost Tea Brewing Bags	250
Grower's Edge Deluxe Steel Stakes	255	Guano - Buried Treasure Phos Bat	80	Happy Frog Steamed Bone Meal - FoxFarm	75	Heavy-Duty Plug-In 240 Volt Timer - Intermatic	279
Grower's Edge Deluxe Vaporizer	249	Guano - Buried Treasure Phos Seabird	80	Happy Frog Tomato & Vegetable - FoxFarm	75	Heavy-Duty Plug-In Timer - Intermatic	279
Grower's Edge Dry Rack Enclosed w/ Zipper Opening	249	Guano - Grow More Seabird	100	Hard Core Ballast	25	Heavy-Duty Zip Ties - HVAC	230
Grower's Edge Dry Rack Partially Enclosed	249	Guano - Roots Organics Nitro Bat	77	Hard Core Ballast 277 Volt	26	Helios 1 - 4 Light 120 Volt Controller w/ Timer	210, 277
Grower's Edge Dry Rack with Clips	249	Guano - Roots Organics Phos Bat	77	Hard Core Ballast 480 Volt	26	Helios 10 - Pre-wired 8 Light 240V Controller with Trigger Cord & Timer	211, 278
Grower's Edge Garden Plant Tie Soft	252	Guano - Roots Organics Sea Bird	78	Hard Neoprene Inserts - EZ-Clone	154	Helios 11 - 4 Light 240V Controller w/ Trigger Cord	211, 278
Grower's Edge Hang Time - Drying Rack	249	Guano - Roots Organics Super Nitro Bat	77	Hard Start Kit for Heating and Cooling Products	237	Helios 12 - 8 Light 240V Controller with Dual Trigger Cords	211, 278
Grower's Edge Illuminated Magnifier Loupe - 30x	129	Guano - Super Tea Mix	108	Hardwater Flora Micro - GH	63	Helios 13 - 16 Light 240V Controller with Timer	212, 278
Grower's Edge Illuminated Magnifier Loupe - 40x	129	Guano - Vital Earth's All Purpose Seabird	103	Hardwater Formula Ionic Bloom - HydroDynamics	101	Helios 14 - 24 Light 240V Controller with Timer	212, 278
Grower's Edge Illuminated Microscope 30x	128	Guano - Vital Earth's High Phos Bat	103	Hardwater Formula Ionic Grow - HydroDynamics	101	Helios 15 - 8 Light 240V Controller with Timer	212, 278
Grower's Edge Illuminated Microscope 60x	129	Guano - Vital Earth's High Phos Seabird	103	Harpin Protein - RX Green Solutions Axiom	117	Helios 16 - 16 Light 240V Controller w/ Dual Triggers	212, 278
Grower's Edge Illuminated Microscope 60x - 100x	128	Guano 11 - 4 - 2 - Vital Earth's High Nitrogen Bat	103	Harvest - Nectar For The Gods Herculean	86	Helios 17 - 24 Light 240V Controller w/ Dual Triggers	212, 279
Grower's Edge iPhone 4/4S Case with LED Pocket Microscope - 60x	129	Guano 9 - 3 - 1 - Vital Earth's High Nitrogen Bat	103			Helios 18 - 12 Light 240V Controller with Dual Trigger Cords	211, 278
Grower's Edge iPhone 5 Case with LED pocket Microscope 60x	129	Guano Grow - Earth Juice	110			Helios 2 - 4 Light 120V Controller with Relay Trigger Cord	210, 277
Grower's Edge Large Display Digital Thermometer & Hygrometer	280	Guano Liquid Bloom - Vital Earth's	102			Helios 3 - 4 Light 240V Controller with Timer	210, 277
Grower's Edge Natural Bamboo Stakes	255	Guano Liquid Grow - Vital Earth's	102			Helios 4 - 4 Light 240V Controller with Relay Trigger Cord	211, 277
Grower's Edge Natural Bamboo Stakes - Bulk	254	Guardian - Connect Products	266			Helios 5 - 4 Light 240V Controller with Relay Trigger Cord	211, 277
Grower's Edge Nylon Storage Bags	258	Guardian Monitor - BlueLab	266			Helios 6 - 8 Light 240V Controller with Dual Trigger Cords	211, 277
Grower's Edge Plant Stake Labels	158, 253					Helios 7 - 8 Light 240V Controller with Timer	211, 277
Grower's Edge Soft Mesh Trellis Netting	255					Helios 8 - 8 Light 240V Controller with Dual Trigger Cords	211, 278
Grower's Edge Sun Spool	252						
Grower's Edge Thermometer/Hygrometer w/ Sensor	280						
Grower's Edge Trellis Netting	255						
Grower's Edge Twist Tie	253						

Lamps - SolarMax Blue Enhanced Performance MH 47
 Lamps - SolarMax Enhanced Performance HPS 47
 Lamps - SolarMax MH Conversion 47
 Lamps - Spectralux T5 HO Fluorescent Green 49
 Lamps - Spectralux T5 HO Fluorescent Grow 49
 Lamps - Spectralux T5 VHO Fluorescent 49
 Lamps - Spectralux T8 HO Fluorescent Grow 49
 Lamps - Standard High Pressure Sodium (HPS) 48
 Lamps - Standard Metal Halide 49
 Lamps - SunBlaster T5 HO Fluorescent 50
 Lamps - Sunmaster Blue Ice Enhanced Performance Metal Halide 47
 Lamps - Sunmaster Green Harvest MH Conversion 48
 Lamps - Sunmaster Red Sunrise Enhanced Metal Halide 48
 Lamps - Sunmaster Yellow Blossom Enhanced Performance HPS 47
 Lamps - Ultra Sun HPS 43
 Lamps - Ultra Sun Metal Halide 4,200K 44
 Lamps - Ultra Sun Metal Halide Conversion 44
 Lamps - Ultra Sun T5 HO Fluorescent 49
 Lamps - Ushio Double Ended HPS 46
 Lamps - Ushio Enhanced Performance HPS 46
 Lamps - Ushio MH Conversion 46
 Lamps - Venture Super Metal Halide Horizontal 48
 Large Display Digital Thermometer & Hygrometer - Grower's Edge 280
 Large Double Ended Super Spreader 19
 Large Titanium Scissor - Fiskars 260
 Lawn - FoxFarm Sticky Frog Premium 76
 Leafminer Traps - Sticky 123
 Leak Protector & Shut Off Valves - Hydro-logic 203
 Leak Protector Replacement Pads - Hydro-logic 203
 LEC 315 Lamps - Philips Mastercolor 34, 41, 49
 LEC 315 Light Emitting Ceramic Fixture 35, 41
 LED Cap Light - Green Eye 252
 LED Fixtures - AgroLED 42
 LED Flashlight - Green Eye 252
 LED Headlight - Green Eye 252
 LED Lamp - Full Spectrum AgroLED 12 Watt 41, 51
 LED Lamp Hanger - The Hangover 41, 59
 LED Microscope - Carson Optical MicroMax 129
 LED Tubes - AgroLED T8 41, 51
 LED/T5 HO Combination Fixtures - AgroLED 42
 Legacy Electronic Ballasts - Galaxy 28
 LEP - Gavita Pro 270e 42
 Libbey Storage Jars 257
 Lid - 55 Gallon Replacement 161
 Lid - EZ Store 165, 287
 Lid - Flo-n-Gro Clear Vented 161, 287
 Lid - For Buckets 3.5 & 5 Gallon 284
 Lid - Gamma Seal 284
 Lid 10 in - Flo-n-Gro 6.6 Gallon Mesh Basket 161, 287
 Lid Libbey Storage Jars 257
 Lid with Mesh Bottom - Botanicare Aero Bucket 284
 Lids - Ball Wide Mouth Jars 257
 Lids - ABS Plastic Black Reservoirs 165
 Lids - Botanicare 163
 Lids - Botanicare Easy Drain 163
 Lids - Botanicare Root Guard 288
 Lids - Gro Pro Mesh Pots/Bucket 284
 Lids - Gro Pro Net Pot 288
 Lids - Grotek Reservoirs 165
 Life Cloning Solution - RX Green Solutions 158
 Lift System Motorized - SunWinch 57
 Lift System Remote - SunWinch 57
 Light & Equipment Hangers 1/4in SunGrip 57
 Light 240V Controller with Dual Trigger Cords - Helios 18 211, 278
 Light Controller 16 Light 240V with Dual Trigger Cords - Helios 16 212, 278
 Light Controller 16 Light 240V w/ Timer - Helios 13 212, 278
 Light Controller 24 Light 240V with Dual Trigger Cords - Helios 17 212, 279
 Light Controller 24 Light 240V w/ Timer - Helios 14 212, 278
 Light Controller 4 Light 120 Volt w/ Timer Helios 1 210, 277
 Light Controller 4 Light 120V with Relay Trigger Cord - Helios 2 210, 277
 Light Controller 4 Light 240V with Relay Trigger Cord - Helios 4 211, 277
 Light Controller 4 Light 240V with Relay Trigger Cord - Helios 5 211, 277
 Light Controller 4 Light 240V w/ Timer - Helios 3 210, 277
 Light Controller 4 Light 240V with Trigger Cord - Helios 11 211, 278
 Light Controller 50 Amp - Hercules 2 210
 Light Controller 8 Light 240V with Dual Trigger Cords - Helios 12 211, 278
 Light Controller 8 Light 240V with Dual Trigger Cords - Helios 6 211, 277
 Light Controller 8 Light 240V with Dual Trigger Cords - Helios 8 211, 278
 Light Controller 8 Light 240V w/ Timer - Helios 15 212, 278
 Light Controller 8 Light 240V w/ Timer - Helios 7 211, 277
 Light Controller Pre-wired 4 Light 240V with Trigger Cord & Timer - Helios 9 211, 278
 Light Controller Pre-wired 8 Light 240V with Trigger Cord & Timer - Helios 10 211, 278
 Light Controller w/ Dual Trigger Cords - Helios 18 211, 278
 Light Controllers - Gavita Master 29, 219
 Light Duty Garden Wire - Luster Leaf 254
 Light Emitting Ceramic Fixture - LEC 315 35, 41
 Light Emitting Plasma Gavita Pro 270e LEP 42
 Light Hanger - Grow Yo Yo 58
 Light Hanger - LightRail 3.5 Complete Kit 59
 Light Hanger - LightRail 4.0 Adjusta Drive Complete 59
 Light Hanger - LightRail 5 Complete Kit 60
 Light Hanger - LightRail Components 60
 Light Hanger - Sun Stand 2 59
 Light Hanger - SunBlaster Universal T5 Light Strip Hanger 39, 61
 Light Hanger - SunLift 57
 Light Hanger - SunWinch Motorized Lift System 57
 Light Hanger Accessories - LightRail 5 60
 Light Hangers - 1/8in The Original SunGrip 57
 Light Hangers - 1/8in White SunGrip 57
 Light Meter - HortiCare LITEcheck 279
 Light Meter - Sun System 279
 Light Mover - LightRail 3.5 Complete Kit 59
 Light Mover - LightRail 4.0 Adjusta Drive Complete 59
 Light Mover - LightRail 5 Complete Kit 60
 Light Mover - LightRail Components 60
 Light Rail Hanging Bracket for Grow Tents 60
 Light Spreader - Super Spreader Large DE 19
 Light Spreader - Super Spreaders Medium 20
 Light Stand - SunBlaster T5 Universal 39, 60
 Light Strip Hanger T5 Universal - SunBlaster 39, 61
 Light Tight Flex Ducting White/Silver Vinyl - Ideal-Air 229
 Light Timer with High Temp. Shut-Off - Hades 2 212
 Light Track Domes - Super Sprouter Ultra Clear Vented Humidity 150
 Light Warrior Grow Medium - FoxFarm 136
 Lighting Delay Timer - Hades 1 212
 Lighting Flip Box - Lightspeed Controller FLIP 16 218
 Lighting Flip Box - Lightspeed Controller FLIP 20 218
 Lighting Flip Box - Lightspeed Controller FLIP 4 218
 Lighting Flip Box - Lightspeed Controller FLIP 8 218
 Lighting Timer & High Temp Shut-Off - Hades 3 212
 Lightite Diamond Fusion Film - Easygrow 264
 Lightite Silver/White Film - Easygrow 264
 LightRail 3.5 Complete Kit 59
 LightRail 4.0 Adjusta Drive Complete 59
 LightRail 5 Accessories 60
 LightRail 5 Complete Kit 60
 LightRail A La Carte Light Rail Components 60
 Lightspeed Controller FLIP 16 Lighting Flip Box 218
 Lightspeed Controller FLIP 20 Lighting Flip Box 218
 Lightspeed Controller FLIP 4 Lighting Flip Box 218
 Lightspeed Controller FLIP 8 Lighting Flip Box 218
 Lime - Grow More 100
 Line for Split Drain System 237
 Line For Use With Drifter Stakes - Hydro Flow 195
 Linear Air Pumps - Air Force Pro 180
 Liner - Flo-n-Gro Square Fabric 161
 Liners - RediRoot Aeration 281
 Lineset Couplers and Flare Nuts for Splits 237
 Lineset Covers and Fittings - SpeediChannel 236
 Linesets - Samsung Max Split System AC 236
 Link-Ups Grow Through Grid Plant Supports 254
 Liquid - Ona 243
 Liquid Bloom - Dyna-Gro 107
 Liquid Bloom - Vital Earth's Seabird Guano 102
 Liquid Fence Deer & Rabbit Repellent 127
 Liquid Fish - Maxicrop 111
 Liquid Formula - Clearoma 242
 Liquid Grow - Dyna-Gro 107
 Liquid Grow - Vital Earth's Seabird Guano 102
 Liquid Humate Plus - VermaPlex 107
 Liquid Karma - Botanicare 69
 Liquid KoolBloom - GH 66
 Liquid Ladybug 123
 Liquid Oxygen H2O2 118
 Liquid pH Down - GH 273
 Liquid pH Up - GH 272
 Liquid Seaweed Plus Iron - Maxicrop 111
 Liquid Yucca - VermaPlex 106
 Lite Tite Heavy Duty Peel & Stick Zipper 264
 LITEcheck Light Meter - HortiCare 279
 Little Giant 1 Submersible Pump 178
 Little Giant 1-ABS Submersible Pump 178
 Little Giant 5-MSP Submersible Pumps 178
 Little Giant 6-CIM-R Submersible Pump 178
 Little Giant NK-1 Submersible Pump 178
 Little Giant NK-2 Submersible Pump 178
 Little Giant PE-1 Submersible Direct Drive Pump 178
 Little Giant RS-5LL Diaphragm Switch 178
 Long Blade Micro Pruner Model H355L - Zenport 260
 Loose Coco Fiber - Royal Gold 143
 Loupe - 30x Illuminated Magnifier 129
 Loupe - 40x - Grower's Edge Illuminated 129
 Low Ambient Outdoor Fan Control Kit for Ductless Air Conditioners 237
 Low Flow Model - Hydro-logic Flowmaster 1/4in 203
 Low Pressure, High Flow Membrane - Stealth RO 201
 Low Profile (LP) Reservoirs - Botanicare Black 163
 Low Profile (LP) Reservoirs - Botanicare White 163
 Low Range EC Combo pH/EC/TDS/Temp Tester - Hanna 270 270
 Low Tide Black Trays - Botanicare 162
 LP Generators - Titan Controls Ares 10 208
 LP Generators - Titan Controls Ares 2 208
 LP Generators - Titan Controls Ares 4 208
 LP Generators - Titan Controls Ares 8 208
 LP Hose and Regulator - Titan Controls Ares 208
 LP Reservoirs - Botanicare Black 163
 LP Reservoirs - Botanicare White 163
 LSM-12 Flipbox - Powerbox 218
 LSM-16 Flipbox - Powerbox 218
 LSM-20 Flipbox - Powerbox 218
 LSM-8 Flipbox - Powerbox 218
 LT Black Trays - Botanicare 162
 Lucky Dog K-9 Kube Growers Blend - FoxFarm Bushdoctor 136
 Luster Leaf Colored Plant Labels 158, 253
 Luster Leaf Foam Wire Tie Strips 254
 Luster Leaf Light Duty Garden Wire 254
 Luster Leaf Link-Ups Grow Through Grid Plant Supports 254
 Luster Leaf Plant Labels 158, 253
 Luster Leaf Rapiclip Foam Wire Tie 254
 Luster Leaf Rapiclip Twist & Clips 254
 Luster Leaf Rapiclip Vinyl Stretch Tie 254
 Luster Leaf Rapitest 4 Way Analyzer 271, 280
 Luster Leaf Rapitest Digital Moisture Meter 280
 Luster Leaf Rapitest Digital Plus Soil pH Meter 271
 Luster Leaf Rapitest Digital Soil pH Meter 271
 Luster Leaf Rapitest Mini pH Tester 272
 Luster Leaf Rapitest pH Soil Tester 271
 Luster Leaf Rapitest Soil pH Meter 272
 Luster Leaf Rapitest Soil Test Kit 272
 Luster Leaf Rapitest Soil Tester 280
 Luster Leaf Soft Wire Tie Strips 253
 Luster Leaf T Label Plant Markers 158, 253
 Luster Leaf Tomato Clips 254
 LuxPro Digital Thermostat 235
 LuxPro Programmable Digital Thermostat 219

M

Machete - Bond 262
 MacroPlugs - Grodan 133
 Madness Soluble - Humboldt Nutrients Myco 114
 Mag Drive Pump 190 GPH - Danner 177
 Mag Drive Pumps 250 GPH - 700 GPH - Danner 177
 Mag Drive Pumps 950 - 2400 GPH 177
 Mag Pro - Dyna-Gro 107
 Mag-Amped - Cutting Edge Solutions 93
 Mag-Pro - Dyna-Gro 107
 Mag-Pro - Garden Culture 290
 Magic - Nectar For The Gods Medusa's 86
 MagiCal - Technaflora 96
 Magnetic Ballast - Hard Core 25
 Magnetic Ballast - Hard Core 277 Volt 26
 Magnetic Ballast - Hard Core 480 Volt 26
 Magnetic Ballast - Harvest Pro 25
 Magnifier Loupe - 30x Grower's Edge Illuminated 129
 Magnifier Loupe - 40x - Grower's Edge Illuminated 129
 MagniScope - Carson Optical 129
 Magnum - Emerald Triangle 110
 Magnum XXXL 6 in Air-Cooled Reflector 17
 Magnum XXXL 8 in Air-Cooled Reflector 17
 Mail-Backs - Orcon Beneficial Insect 127
 Mania - Nectar For The Gods Gaia 86
 Manifold 1/2 Inch Inlet - EcoPlus Trumpet Style 180
 Manifold 3/8 Inch Inlet - EcoPlus T Style 180
 Manifold 6 Outlet - Hydro Flow 187
 Manifold Triple Shut-Off - Raindrop 3 Outlet 193
 Manna Mix - Vital Earth's 145
 Marine Compost - Roots Organics 141
 Marine Cuisine - FoxFarm 73
 Martini pH55 pH/Temp Tester & Probe - Milwaukee 267
 Master A - Humboldt Nutrients 114
 Master B - Humboldt Nutrients 114
 Master Blaster 1500 Watt HPS Lamp - Ultra Sun 43
 Master Blaster Electronic Ballasts Galaxy Grow Amp 27
 Master Controllers - Gavita 29, 219
 Master Pack - Auroral Innovations 78
 Mastercolor LEC 315 Lamps - Philips 34, 41, 49
 Mat - Rapid Rooter 148
 Mats Organic Growing Medium - GH CocoTek 143
 Max Mini Split Air Conditioner Systems - Samsung 235
 Max Programmable Thermostat for Split Systems 236
 Max Split Linesets - Samsung 236
 Max-Duct Vinyl 230
 Max-Fan 223
 Maxi-Jet Water Pump 178
 MaxiBloom - GH 65
 Maxicrop Liquid Fish 111
 Maxicrop Liquid Seaweed Plus Iron 111
 Maxicrop Original 111
 Maxicrop Original Soluble Powder 111
 MaxiGro - GH 65
 Maximum Granular - Humboldt Nutrients 114
 Maxipot - Grodan 286
 Maxsea Acid Plant Food 106
 Maxsea All Purpose Plant Food 106
 Maxsea Bloom Plant Food 106
 Mayan MicroZyme - Humboldt Nutrients 114
 Measure Master Big Shot Measuring Glass 251
 Measure Master Dropper 251
 Measure Master Graduated Measuring Bucket 5 Gal 251
 Measure Master Graduated Rectangle Measuring Containers 251
 Measure Master Graduated Round Containers 251
 Measure Master Pump Dispensers 1oz 68, 252
 Measure Master Spoons 251
 Measure Master Sterile Disposable Pipettes 251

Measure Master Sure Shot Measuring Glass251

Measure Master Syringe 100cc/ml251

Measuring Bucket 5 Gallon - Measure Master251

Measuring Containers - Graduated Rectangle Measure Master251

Measuring Glass - Measure Master Big Shot251

Measuring Glass - Measure Master Sure Shot251

Measuring Spoon - RAW Adjustable83

Measuring Spoons - Measure Master251

Measuring Syringe - Measure Master251

Mechanical Timer - Apollo 6 One Outlet209, 276

Mechanical Timer - Apollo 8 Two Outlet209, 276

Mechanical Timer 240 Volt - Apollo 10210, 276

Media - Gold Label Coco144

Media - Gold Label Custom 80/20143

Media - Gold Label HydroCoco 60/40144

Media - Gold Label Hydrocorn144

Media - Vermicrop CocoNot Premium Coconut Coir Alternative144

Medium Duty Hose 5/8in x 50ft - Bond196, 248

Medusa's Magic - Nectar For The Gods86

Mega Morpheus - Nectar For The Gods87

Mega Worm - Vital Earth's145

Melnor 2 Zone - 6 Cycle Digital Water Timer196

Melnor 6 Cycle Digital Aqua Timer196

Melnor GentleRain Shower Head Wand248

Membrane - Hydro-logic Steath RO Low Pressure, High Flow201

Membrane 100 GPD - Ideal H2O199

Membrane Flush Kit For Stealth RO100/200202

Mendo Mix - Royal Gold143

Mendocino Avalanche - Grow More98

Mendocino Honey - Grow More98

Mercury 2 - Fan Speed Controller213, 226

Mercury 3 - Day/Night Fan Controller213, 226

Mercury 4 - Multi-Function Fan Speed Controller 213, 226

Merlin GP Green Drain Elbow - 2:1 Ratio204

Merlin GP Pressure Booster Pump203

Merlin GP Replacement Filters202

MERV 11 Filter - Quest PowerDry 1300 & RDS10 Dehumidifiers233

MERV 11 Filter - Quest PowerDry 4000 & Dual Overhead Dehumidifiers233

Mesh Basket Lid 10 in - Flo-n-Gro 6.6 Gallon161, 287

Mesh Bottom Pots - Gro Pro Premium Round284

Mesh Bottom Pots - Gro Pro Round Plastic284

Mesh Bottom Tray - Super Sprouter151

Mesh Insert - 2 Gallon Flo-n-Gro Drip-n-Gro161, 287

Mesh Insert - 3 Gallon Flo-n-Gro Black161, 287

Mesh Pot - Gro Pro Square287

Mesh Pots/Bucket Lids - Gro Pro284

Meta-K - Earth Juice109

Metal Floor Fan - Hurricane225

Metal Halide - 4,200K Ultra Sun Lamps44

Metal Halide - Eye Hortilux Standard MH Lamps44

Metal Halide (MH) Lamps - Standard49

Metal Halide Blue Enhanced Performance Lamps - Ultra Sun44

Metal Halide Capacitors - Replacement52

Metal Halide Conversion Lamps - SolarMax47

Metal Halide Conversion Lamps - Ultra Sun44

Metal Halide e-Start Lamps - Eye Hortilux45

Metal Halide Horizontal Lamp - Venture48

Metal Halide Lamp - Eye Hortilux Protected45

Metal Halide Lamp - SolarMax Red47

Metal Halide Lamps - Eye Hortilux Blue45

Metal Halide Lamps - SolarMax Blue Enhanced Performance47

Metal Halide Lamps - Sunmaster Blue Ice Enhanced Performance47

Metal Halide Lamps - Sunmaster Red Sunrise48

Meter - BlueLab Combo266

Meter - BlueLab pH265

Meter - BlueLab Soil pH266

Meter - EC Shake Nutrient Meter265

Meter Calibration Solutions - GH272

MH - 4,200K Ultra Sun Lamps44

MH - Standard Lamps49

MH Capacitors - Replacement52

MH Conversion Lamp - Eye Hortilux45

MH Conversion Lamps - SolarMax47

MH Conversion Lamps - Sunmaster Green Harvest48

MH Conversion Lamps - Ushio46

Micro - Cutting Edge Solutions93

Micro - Humboldt Nutrients113

Micro Blade Pruner Model H355 - Zenport260

Micro Blade Pruner Model H355C - Zenport Curved260

Micro Irrigation Valve - Hydro Flow In-Line187

Micro Pruner Model H355L - Zenport Long Blade260

Micro Shear Model H356 - Zenport260

Micro-Tip Pruning Snip - Fiskars259

Micro-Tip Pruning Snips - Fiskars260

Microbe Brew - FoxFarm Bushdoctor73

Microbe Life - Microbe-Lift BMC128

Microbe Life Dechlorinator+119

Microbe Life Photosynthesis Plus Beneficial Bacteria104

Microbe-Lift BMC - Biological Mosquito Control128

Microblast - Earth Juice109

Microgarden - Botanicare163

MicroMax LED Microscope - Carson Optical129

Micron Trays - Honey Bee250

Microscope - Carson Optical MagniScope129

Microscope - Carson Optical MicroMax LED129

Microscope - Carson Optical zOrb Digital129

Microscope 30x - Grower's Edge Illuminated128

Microscope 60x - 100x - Grower's Edge Illuminated128

Microscope 60x - Grower's Edge Illuminated129

Microscope 60x - Grower's Edge iPhone 4/4S Case with LED Pocket129

Microscope 60x - Grower's Edge iPhone5 Case with LED Pocket129

MicroZyme - Humboldt Nutrients114

Mike O'Rizey - Plant Success105

Mildew Cure - SaferGro123

Milwaukee Instruments Calibration Solutions275

Milwaukee Martini pH55 pH/Temp Tester and Probe267

Milwaukee pH Controller MC122267

Milwaukee pH Tester pH600 AQ267

Milwaukee pH/EC/TDS Combo Meter BEM802267

Milwaukee Portable pH Meter MW100268

Milwaukee Replacement pH Probe Model SE220267

Milwaukee Smart pH/EC/TDS Combination Meter MW802268

Milwaukee Waterproof TDS Tester Model T75267

Milwaukee Waterproof TDS Tester Model T76267

Mini Flow Spray Stakes - Hydro Flow188

Mini Mist Can - Ona Apple Crumble242

Mini pH Tester - Luster Leaf Rapitest272

Mini Split - R410A Refrigerant Refill Kit237

Mini Split A/C, 14 Gauge/4 Conductor Interconnector Wire237

Mini Split Air Conditioner 24,000 BTU 13 SEER - Ideal-Air Professional Installation235

Mini Split Air Conditioners 13 Seer - Cooling Only235

Mini Split Inverter Heat Pumps 15 SEER - Heating & Cooling235

Mini-Blocks - Grodan133

Mini-Bubblers - Hydro Flow189

Mini-Split Installation Tool Kit - Ideal-Air235

MiniGen Water Cooled CO2 Generator - HydroGen219

Mist - Clonex156

Mist - Ona243

Mist - Ona Apple Crumble Can242

Mist - Ona Pro242

Mist & Spray Deluxe Sprayer 1.3 Quart - Mondy247

Mist & Spray Deluxe Sprayer 2.1 Quart - Mondy247

Mist & Spray Premium Tank Sprayer 1.5 Qrt - Mondy247

Mist Can - Ona Apple Crumble Mini242

Mist Dispenser - Ona244

Mite Control Concentrate - SNS 217C122

Mite Control RTU - SNS 217122

Mix #4 - 1 Cu. Ft. Compressed - Sunshine Advanced138

Mix #4 - 2 Cu. Ft. Loose - Sunshine Advanced138

Mix #4 - 2.2 Cu. Ft. Compressed - Sunshine Advanced138

Mix #4 - 3 Cu. Ft. Compressed - Sunshine Advanced138

Mix #4 - Aggregate Plus - Sunshine137

Mix #4 Natural & Organic - Sunshine138

Mix #4 Natural & Organic w/ Mycorrhizae - Sunshine138

Mix #4 with Mycorrhizae - Sunshine138

Mixed Flow Fan - Hyper Fan Digital220

Mixed Flow Fan FKD Series - Fantech222

Mixed Flow Fans - Hurricane After Burner221

Mogul - 5KV/HOR Socket52

Mogul Base - 4KV Socket Extender52

Moisture Digital Meter - Luster Leaf Rapitest280

Moisture Meter - Accurate pH 7 & Accurate pH 8265

Moisture Meter - Bond280

Molasses - Earth Juice Hi-Brix109

Molasses - RAW Cane82

Molasses - Wholesome Sweetener Organic116

Molded Strain Relief Lamp Cord56

Momma Bubbler Bucket - Flo-n-Gro Big160

Mondi 30in Water Pump Extension With Ball Valve177

Mondi Black & White Premium 10 x 20 Propagation Tray151

Mondi Greenhouse Thermo-Hygrometer150

Mondi Mist & Spray Deluxe Sprayer 1.3 Quart247

Mondi Mist & Spray Deluxe Sprayer 2.1 Quart247

Mondi Mist & Spray Premium Tank Sprayer 1.5 Quart247

Mondi Propagation Domes 4in150

Mondi Propagation Domes 7in150

Mondi Propagation Tray Insert 55-01151

Mondi Propagation Trays 10 x 20151

Mondi Super Saucers288

Mondi Telescopic Water Wand248

Mondi Utility Sump Pump 1200x177

Mondi Utility Sump Pump 1585x177

Monitor - BlueLab Guardian266

Monitor - Hydro Innovations HydroGen CO2219

Monitoring Cards123

Monster Bloom - Grotek85

Monster Grow - Grotek85

Monterey 70% Neem Oil124

Monterey B.t.124

Monterey Bi-Carb Old Fashion Fungicide125

Monterey Epsom Salts116

Monterey Florel Brand Growth Regulator116

Monterey Foli-Cal116

Monterey Insect Spray with Spinosad124

Monterey Neem Oil RTU124

Monterey Once A Year Insect Control II125

Monterey Sluggo125

Monterey Take Down Garden Spray124

Morpheus - Nectar For The Gods Mega87

Mosquito Bits124

Mosquito Control - Microbe-Lift BMC128

Mosquito Dunks124

Mother Earth Coco135

Mother Earth Coco Covers134

Mother Earth Hydroton135

Mother Earth Perlite #3 & #4135

Mother Earth Premium BioChar135

Mother Plant A & B - HydroDynamics102

Motorized Lift System - SunWinch57

Mounting Brackets - Vortex223

Mounds for Splits237

Multi PT Testr 35 - Oakton268

Multi-Colored Grower's Edge Plant Stake Labels 158, 253192

Multi-Flow Emitter - Hydro Flow192

Multi-Function Fan Speed Controller - Mercury 4,213, 226187

Multi-Purpose DT620 CL Digital Timer - Intermatic279

Multi-Stream Push-In Drippers - Hydro Flow187

Multi-Volt Powercords - 120 & 240 Volt55

Multicolored Neoprene Inserts - Super Sprouter155

Multimeter - HortiStick 3-in-1265

Multimode Fan Speed Control - Grozone TV2215

Multiply - NPK81

Mushroom Bag Bloom - MyCO2214

Mushroom Bag Grow - MyCO2214

MVP Power Cords - 120 & 240 Volt55

Myco Madness Soluble - Humboldt Nutrients114

Myco Maximum Granular - Humboldt Nutrients114

MyCO2 Mushroom Bag Bloom214

MyCO2 Mushroom Bag Grow214

Mycorrhizae - Plant Success Granular105

Mycorrhizae - Plant Success Great White105

Mycorrhizae - Plant Success Orc Liquid105

Mycorrhizae - Plant Success Soluble105

Mycorrhizal - Pro-Mix Pur105

Mykos - Xtreme Gardening92

Mykos Drops Pouches Display - Xtreme Gardening92

Mykos Drops Root Paks - Xtreme Gardening91

Mykos WP - Xtreme Gardening92

Mylar Film - Sunfilm263

N

NanoDome Combo Kit - SunBlaster152

Nanolux Digital Ballast32

NanoTech T5 Reflectors - SunBlaster39

Natural & Organic Potting Soil - Black Gold137

Natural Bamboo Stakes - Bond255

Natural Bamboo Stakes - Grower's Edge255

Natural Bamboo Stakes Bulk - Grower's Edge254

Natural Bloom - Humboldt Nutrients112

Natural Forces - SucraShield123

Natural Grow - Humboldt Nutrients112

Natural Industries - Actinovate Fungicide122

Natural Industries Actino-Iron104

Natural Up & Natural Down - Earth Juice273

Nature's Nectar Nitrogen83

Nature's Nectar Phosphorus83

Natures Nectar Potassium83

Nectar For The Gods Aphrodite's Extraction87

Nectar For The Gods Athena's Aminas87

Nectar For The Gods Bloom Khaos88

Nectar For The Gods Demeter's Destiny87

Nectar For The Gods Gaiga Mania86

Nectar For The Gods Hades Down88, 273

Nectar For The Gods Herculean Harvest86

Nectar For The Gods Hygeia's Hydration87

Nectar For The Gods Medusa's Magic86

Nectar For The Gods Mega Morpheus87

Nectar For The Gods Olympus Up88, 273

Nectar For The Gods Pegasus Potion87

Nectar For The Gods Poseidonzyme87

Nectar For The Gods Triton's Trawl87

Nectar For The Gods Zeus Juice86

Needle Nose Shear Model H303 - Zenport261

Neem Oil - Monterey 70%124

Neem Oil RTU - Monterey124

Neoprene Inserts - Botanicare154

Neoprene Inserts - Super Sprouter Multicolored155

Neoprene Inserts - Super Sprouter Solid Color154

Neoprene Lined Noise Reduction Clamps Classic - Ideal-Air230

Neoprene Lined Noise Reduction Clamps Supreme - Ideal-Air230

Neoprene Replacement Inserts - EZ-Clone154

Neptune's Harvest Crab Shell112

Neptune's Harvest Fish & Seaweed Fertilizer112

Neptune's Harvest Fish Fertilizer111

Neptune's Harvest Kelp Meal112

Neptune's Harvest Seaweed Fertilizer112

Net Cups - GH285

Net Pot Lids - Gro Pro288

Net Pots - Gro Pro285

Net Pots - Heavy Duty285

Net Trellis - Bond256

Netting - Botanicare Horti-Trellis256

Netting - Grower's Edge Commercial Grade Trellis255

Netting Bulk Rolls - Grower's Edge Commercial Grade Trellis256

Netting Soft Mesh Trellis - Grower's Edge255

Netting Trellis - Gardener256

Netting Trellis - Grower's Edge255

Table with 2 columns: Item Name and Page Number. Includes categories like pH meters, plant supports, grow lights, and propagation equipment.

Propagation Domes - Mondri 7in 150
Propagation Domes - Super Sprouter Ultra Clear Vented Humidity Domes with Light Tracks 150
Propagation Heating Mats - Fast-Gro 148
Propagation Station - Super Sprouter 147
Propagation Tray Mondri Black & White Premium 10 x 20 151
Propagation Tray & Insert 10 x 20 Quad Thick 151
Propagation Tray Insert 55-01 - Mondri 151
Propagation Trays 10 x 20 - Mondri 151
Propagation Trays 10 x 20 - Super Sprouter 151
Propagation Trays Super Sprouter 10 x 20 Double Thick 151
Protected Metal Halide Lamp - Eye Hortilux 45
Protein - RX Green Solutions Axiom Harpin 117
ProZap Insect Guard 125
Prozyme - Humboldt Nutrients 114
Pruner - Bond Precision Tip 262
Pruner - Fiskars Softgrip Floral 260
Pruner - Zenport Heavy Duty Bypass Model Z201 261
Pruner Model H355 - Zenport Micro Blade 260
Pruner Model H355C - Zenport Curved Micro Blade 260
Pruner Model H355L - Zenport Long Blade Micro 260
Pruner Set - Bond 262
Pruning Combo Set - Bond 262
Pruning Shear 8.5in Mondri Z103 - Zenport 261
Pruning Snip Softtouch Micro-Tip - Fiskars 259
Pruning Snips - Fiskars Micro-Tip Titanium 260
PT Testr 35 - Oakton 268
Pump - EcoPlus 1500 Elite Submersible 177
Pump - GH TNC 1/4 HP 177
Pump - GH WaterPower 120 177
Pump - Ideal H2O RO 100/200 Booster 199
Pump - Little Giant 1 Submersible 178
Pump - Little Giant 1-ABS 178
Pump - Little Giant 6-CIM-R 178
Pump - Little Giant NK-1 178
Pump - Little Giant NK-2 178
Pump - Maxi-Jet 178
Pump 1200x - Mondri Utility Sump 177
Pump 1585x - Mondri Utility Sump 177
Pump 190 GPH - Danner Mag Drive 177
Pump 300 GPH - Supreme Hydroponics Sump 178
Pump Adaptors - Hydro Flow Bottom Draw 191
Pump Dispensers 1oz - Measure Master 68, 252
Pump Extension With Ball Valve - Mondri 177
Pump Filter Bag - EcoPlus Small & Large 179
Pump Protector & Inlet Filter - 1/2in Hydro-logic 203
Pump Protector & Inlet Filter - 3/8in Hydro-logic 203
Pump Sprayer Pressurized - Rainmaker 246
Pump Sprayers - Rainmaker Pressurized 246
Pumps - Air Force Pro Linear 180
Pumps - Condensate 179, 237
Pumps - EcoPlus Adjustable Flow Rate 176
Pumps - EcoPlus Convertible Bottom Draw 176
Pumps - EcoPlus Eco Fixed Flow Rate Submersible 176
Pumps - EcoPlus Premio Jet 176
Pumps - EZ-Clone Replacement 154
Pumps - Little Giant 5-MSP 178
Pumps 250 GPH - 700 GPH - Danner Mag Drive 177
Punch - Hose 193
Punch N' Cut - Hydro Flow 193
Punch Tool for Brass Tubing Insert - Hydro Flow 191
Punches - Raindrip Hole 193
Pur Mycorrhizal - Pro-Mix 105
Pura Vida Bloom - Technaflora 96
Pura Vida Grow - Technaflora 96
Pure 3 Way 128
Pure 3 Way Commercial 128
Pure Blend Pro Bloom - Botanicare 69
Pure Blend Pro Grow - Botanicare 69
Pure Blend Pro Soil - Botanicare 69
Pure Blend Tea - Botanicare 69
Pure Bloom Granular - Botanicare 72
Pure Flowers 84
Pure Granular Grow - Botanicare 72
Pure Green Thumb 128
Pure Kapow 128
Pure Kapow Commercial 128
Purple Maxx - Emerald Triangle 110
Push-In Drippers - Hydro Flow Multi-Stream 187
Push-In Fittings - Hydro Flow 185
PVC Flex Tubing - Hydro Flow 194
PVC Plastic Saucers - Gro Pro Clear 288
Pyrethrin & Insecticidal Soap Concentrate II - Safer 126
Pyrethrin Garden Insect Spray - Bonide 127
Pyryo K - Uber 88
Q
Q-Max Fans - Can-Fan 223
QC Fitting for Stealth RO & Small Boy Systems 202
QC Fittings for Evolution & Tall Blue Systems 204
QC Fittings for Evolution & Tall Boy 204
QC Fittings for Stealth RO & Tall Boy Systems 204
Quad Thick Tray & Insert 10 x 20 151
Quest Air Filter for PowerDry 1300 & RDS10 Dehumidifiers 233
Quest Air Filter for PowerDry 4000 & Dual Overhead Dehumidifiers 233
Quest Dry RDS 10 Dehumidifier 232
Quest Dual 105 Overhead Dehumidifier 233
Quest Dual 110 Overhead Dehumidifier 233
Quest Dual 150 Overhead Dehumidifier 233
Quest Dual 155 Overhead Dehumidifier 233
Quest Dual 205 Overhead Dehumidifier 233
Quest PowerDry 1300 Dehumidifier 232
Quest PowerDry 4000 Pro Dehumidifier 232
Quest Return Air Duct Collar for Overhead Dehumidifiers 233
Quest Supply Air Duct Collars for Overhead Dehumidifiers 234
Quick Connect Fitting for Small Boy 203
Quick Connect Fittings - Stealth RO & Small Boy Systems 202
Quick Connect Straight Stem - Hydro-logic 204
Quick Drain Stonewool - Grodan Pargo 133
Quick Release Stainless Steel Hose Clamps - Ideal-Air 230
Quick Start Plugs - iHort 152
Quilted Crystal Jelly Jars - Ball 257
R
R-N-A - Uber 88
R410A Refrigerant Refill Kit 237
Rabbit & Deer Repellent - Liquid Fence 127
Raccoon T5 HO Fluorescent Ballasts 52
Race Hanging Bracket for Grow Tents 60
Rain Forest Loose - Sunshine Advanced 138
Rain Wand Colormark - Dramm 248
Rain Wand Touch N Flow - Dramm 248
Rainbow Mix Bloom - Earth Juice 110
Rainbow Mix Grow - Earth Juice 110
Raindrip 1 GPH Drippers 193
Raindrip 1/2 GPH Drippers 193
Raindrip 2 GPH Drippers 193
Raindrip 3 Outlet Manifold Triple Shut-Off 193
Raindrip Hole Punches 193
Raindrip Professional Tubing Cutter 193
Raindrip Stakes 193
RainForest 236 - Thirty-six 2in Site Aeroponics System 168
RainForest 318 - Eighteen 3in Site Aeroponics System 168
RainForest 66 - Six 6in Site Aeroponics System 167
Rainmaker Backpack Sprayer 246
Rainmaker Battery Powered Sprayer 246
Rainmaker Pressurized Pump Sprayer 246
Rainmaker Pressurized Pump Sprayers 246
Rainmaker Trigger Sprayer 246
Range Extender - BlueLab Connect 266
Rapidclip Foam Wire Tie - Luster Leaf 254
Rapidclip Twist & Clips - Luster Leaf 254
Rapidclip Vinyl Stretch Tie - Luster Leaf 254
Rapid Root - Grow More 156
Rapid Rooter Mat 148
Rapid Rooter Plugs - GH 148
RapidStart - GH 66, 155
Rapitest 4 Way Analyzer - Luster Leaf 271, 280
Rapitest Digital Moisture Meter - Luster Leaf 280
Rapitest Digital Plus Soil pH Meter - Luster Leaf 281
Rapitest Digital Soil pH Meter - Luster Leaf 271
Rapitest Mini pH Tester - Luster Leaf 272
Rapitest pH Soil Tester - Luster Leaf 271
Rapitest Soil pH Meter - Luster Leaf 272
Rapitest Soil Test Kit - Luster Leaf 272
Rapitest Soil Tester - Luster Leaf 280
RAW Adjustable Measuring Spoon 83
RAW B-Vitamin 81
RAW Bloom All-In-One 81
RAW Calcium/Mag 81
RAW Cane Molasses 82
RAW Full Up 82
RAW Grow All-In-One 81
RAW Humic Acid 82
RAW Kelp 82
RAW Nitrogen 82
RAW OminA 82
RAW Phosphorus 82
RAW Potassium 82
RAW Silica 83
RAW Yucca 83
RDS 10 Dehumidifier - Quest 232
Ready to Grow 1000 Watt HPS Ballast Kit - Major Brand Capacitor 52
ReadyGro - Botanicare 139
ReadyGro Super Plugs - Botanicare 152
Receptacle - Dual Female Lamp Cord 53
Receptacle Duplex 120V & 240V 53
Receptacle For Lamp Cord - Female 53
Receptacle Universal - Duplex 53
Recharge R410A Refrigerant Refill Kit 237
Recipe For Success Kit - Technaflora 96
Rectangle Measuring Containers - Measure Master 251
Red 360 Degree Sprayer 154, 181
Red Enhanced Performance Metal Halide Lamp - SolarMax 47
Red Sunrise Enhanced Metal Halide Lamps - Sunmaster 48
RediRoot Aeration Frames 282
RediRoot Aeration Liners 281
Reducer - Hydro Flow Barbed 184
Reducers - Hydro Flow Barbed Elbow 185
Reducers - Hydro Flow Barbed Straight 184
Reducers - Hydro Flow Barbed Tee 185
Reducers - Ideal-Air Ducting 227
Refill Kit - R410A Refrigerant 237
Refill Pack - Super Sprouter Perfect Plug 148
Refills - Botanicare CocoGro Plugs 152
Reflective - Sunfilm Mylar Film 263
Reflector - AC/DE 8 in 18
Reflector - Adjust-A-Wings Avenger 20
Reflector - Adjust-A-Wings Avenger DE 19
Reflector - Adjust-A-Wings Enforcer 23
Reflector - Agrotech Magnum 19
Reflector - Agrotech Magnum 20 Pack 19
Reflector - BlockBuster 6 in 17
Reflector - BlockBuster 8 in 18
Reflector - DE Boss 18
Reflector - DE Large Socket Kit with Cord 19
Reflector - Dominator XXXL 6 in 20
Reflector - Dominator XXXL 8 in 20
Reflector - Dominator XXXL Double Ended 22
Reflector - Dominator XXXL Non AC 22
Reflector - Econo Wing 23
Reflector - Econo Wing XL 23
Reflector - Epic 8 in 17
Reflector - Evolution 8 in Air-Cooled 17
Reflector - Gavita Hortistar 1000 DE 24
Reflector - Gavita Hortistar 600 SE 24
Reflector - Gavita TripleStar 600 23
Reflector - Irradiator 22
Reflector - Irradiator 6 in 21
Reflector - Irradiator 8 in 21
Reflector - Magnum XXXL 6 in 17
Reflector - Magnum XXXL 8 in 17
Reflector - Parabolic 22
Reflector - Silver Sun 22
Reflector - Solartech Magnum 22
Reflector - Sun Star 22
Reflector - Sun Star 6 in 21
Reflector - SunGro 6 in Air-Cooled 20
Reflector - SunGro 8 in Air-Cooled 21
Reflector - Super Sun 6 in 18
Reflector - Super Sun DE 18
Reflector - Value Wing 8 Pack 23
Reflector - Vertical 19
Reflector - Yield Master 6 in 21
Reflector - Yield Master 8 in 21
Reflector Accessories 19-20, 24
Reflector Cleaning Cloth 24, 48
Reflector Hanging Hook 53, 61
Reflector Replacement Glass Frames 23
Reflector with Brackets - DE Commercial 36
Reflector with Brackets - SE Commercial 36
Reflectors - SunBlaster NanoTech T5 39
Refrigerant Refill Kit - R410A 237
Regulated Button Emitters - Hydro Flow 189
Regulator and Hose - Titan Controls Ares 208
Remote Controls - Galaxy Digital Logic 29
Remote for Lift System - SunWinch 57
Replacement - Strain Relief & Heyco 53
Replacement 360 Trigger Sprayer 246
Replacement Air Filter - Quest PowerDry 1300 & RDS10 Dehumidifiers 233
Replacement Burners - Titan Controls Ares 209
Replacement Checker Electrode - Hanna 270
Replacement EC/TDS Probe - HM Digital 268
Replacement Filter - Quest PowerDry 4000 & Dual Overhead Dehumidifiers 233
Replacement Filters - Hydro-logic Big Boy 205
Replacement Filters - Hydro-logic Merlin GP 202
Replacement Filters - Hydro-logic Small Boy 205
Replacement Filters - Hydro-logic Tall Boy 205
Replacement Filters - Ideal H2O 199
Replacement Filters Tall Blue - Hydro-logic 204
Replacement Glass Frames - Reflectors 23
Replacement High Pressure Sodium Capacitors 52
Replacement High Pressure Sodium Ignitors 52
Replacement Lid - 55 Gallon 161
Replacement Metal Halide Capacitors 52
Replacement Mounting Brackets - Vortex 223
Replacement Pads - Hydro-logic Leak Protector 203
Replacement Parts - Bond TieRite Tape Gun 262
Replacement Parts - CO2 Regulator 207
Replacement Parts - GH AeroFlo2 166
Replacement Pelletized Carbon 241
Replacement pH Probe - HM Digital 269
Replacement pH Probe (HI1285-6) 270
Replacement pH Probe (HI1286) - Hanna 269
Replacement pH Probe (HI1293) - Hanna 269
Replacement pH Probe (HI73127) - Hanna 270
Replacement pH Probe Combo Meter - BlueLab 266
Replacement pH Probe for Tri-Meter - Future Harvest 271
Replacement pH Probe Guardian Monitor - BlueLab 266
Replacement pH Probe Model SE220 - Milwaukee 267
Replacement pH Probe Nutradip - Future Harvest 271
Replacement Probe DIST 5 (HI73311) - Hanna 270
Replacement Pumps - EZ-Clone 154
Replacement Screens - Hydro Flow Poly 191
Replacement Sockets - T5 HO 53
Replacement Soil pH Probe - BlueLab 266
Replacement Titan Controls 15ft Sensor Extension Cable 208
Replacement Vent - Super Sprouter Domes w/ Light Tracks 150
Replacement Vent - Super Sprouter Standard Humidity Dome 7 in 150
Replacement White Plastic Washer 207
Reservoir - GH Panda 166
Reservoir - Stand Up 105 Gallon 166
Reservoir - Stand Up 48 Gallon 166
Reservoir & Aquarium Heater - EcoPlus Aqua Heat 199
Reservoir Cleaner - EZ-Clone Clear Rez 154
Reservoir Shut Off Valve Kit - Hydro Flow 188

Reservoirs - AutoPot FlexiTank 168
 Reservoirs - Botanicare Black LP 163
 Reservoirs - Botanicare White LP 163
 Reservoirs - Duralastics 164
 Reservoirs - Heavy Duty 165
 Reservoirs & Lids - ABS Plastic Black 165
 Reservoirs & Lids - Botanicare 163
 Reservoirs & Lids - Botanicare Eazy Drain 163
 Reservoirs & Lids - Grotek 165
 Restrictors 1:1 - Stealth RO 202
 Retail Catalog - Sunlight Supply 290
 Retail Packs - Oasis Horticultures 149
 Return Air Duct Collar for Overhead Dehumidifiers - Quest 233
 Reusable T-Markers - Bond 158, 253
 Reverse Osmosis - Evolution RO1000 - 1000 GPD 199
 Reverse Osmosis - Hydro-logic Stealth RO 100 201
 Reverse Osmosis - Hydro-logic Stealth RO 200 201
 Reverse Osmosis Filters - Stealth 201
 Reverse Osmosis System 75 GPD - Ideal H2O 198
 Reverse Osmosis Systems - Ideal H2O 198
 Ribbon Traps - Yellow Stickey 124
 Ring - Hydro Flow Drip 168, 188
 Ripe - Botanicare CNS17 71
 RO - Ideal H2O 198
 RO 100/200 Booster Pump - Ideal H2O 199
 RO System 75 GPD - Ideal H2O 198
 Rockwool A-OK Starter Plugs - Grodan 132
 Rockwool Conditioning Solution - HydroDynamics Europonic 101
 Rockwool Covers - Cube Cap 134
 Rockwool Covers - Drip Cap 134
 Rockwool Covers - Grower's Edge 134
 Rockwool Delta Gro-Blocks & Big Mama - Grodan 133
 Rockwool Delta Starter Mini-Blocks - Grodan 133
 Rockwool Gro-Slabs - Grodan 132
 Rockwool Grow-Chunks - Grodan 132
 Rockwool Grow-Cubes - Grodan 134
 Rockwool MacroPlugs - Grodan 133
 Rolls - Grower's Edge Commercial Grade Trellis Netting 256
 Root - B'Cuzz 95
 Root 66 - Technaflora 96
 Root Gel - Dyna-Gro 157
 Root Guard Lids - Botanicare 288
 Root Inoculant - Botanicare ZHO 72, 155
 Root Lowell Commercial Portable Sprayer/Atomizer 247
 Root Lowell Commercial Stationary Sprayer/Atomizer 247
 Root Lowell Flo-Master Battery Sprayer 5L/1.3 Gallon 247
 Root Lowell Flo-Master Heavy Duty Sprayer 36oz 247
 Root Lowell Flo-Master Pressurized Sprayer 40oz 247
 Root Lowell Flo-Master Sprayer 1 Gallon 247
 Root Master Pots - Gro Pro 285
 Root Paks - Xtreme Gardening Mykos Drops 91
 Root Pots 283
 Root Riot Cubes - HDI 149
 Root Riot Trays - HDI 149
 Root Sensation 84
 Root Stimulator Concentrate - HydroDynamics Green Fuse 102
 Root-Gel - Dyna-Gro 157
 Rootbastic - Atami 95
 RootBuilder II 285
 Rootburst Powder - Supernatural 90
 Rootcubes - Oasis 149
 Rootcubes Bulk Pack - Oasis 149
 Rootcubes Plus - Oasis 149
 Rootech Cloning Gel - Technaflora 157
 Rooters Mycorrhizae Endo/Ecto Blend - Earth Juice 108
 Rooting Compound - EZ-Clone 156
 Rooting Compound - Vita Grow 156
 Rooting Gel - Botanicare Power Clone 155
 Rooting Gel - Clonex 155
 Rooting Gel Packets - Clonex 155
 Rooting Solution - Botanicare Power Clone 155
 Rooting Solution - Dip 'N Grow 156
 RootMaker Containers 285
 Roots Organics Ancient Amber 77
 Roots Organics B2 Professional Growing Mix 141
 Roots Organics Big Worm 141
 Roots Organics Buddha Bloom 76
 Roots Organics Buddha Grow 76
 Roots Organics Coco Bird's Nest 140
 Roots Organics Coco Chips Block 140
 Roots Organics Coco Palms 141
 Roots Organics Compressed Coco Fiber 140
 Roots Organics Elemental 78
 Roots Organics Emerald Mountain Mix 141
 Roots Organics Extreme Serene 77
 Roots Organics Formula 707 141
 Roots Organics Green Lite 141
 Roots Organics GreenFields Potting Soil 140
 Roots Organics HP2 Liquid Bat Guano 76
 Roots Organics HPK Bat Guano & K-Mag 77
 Roots Organics Marine Compost 141
 Roots Organics Nitro Bat Guano 77
 Roots Organics Oregonium XL 77
 Roots Organics Original Potting Soil 140
 Roots Organics Phos Bat Guano 77
 Roots Organics Player Pack 78
 Roots Organics Sap Off Soap 250
 Roots Organics Sea Bird Guano 78
 Roots Organics Soilless Hydro Coco Mix 140
 Roots Organics Super Nitro Bat Guano 77
 Roots Organics Surge 77
 Roots Organics Trinity Catalyst 76
 Roots Organics Uprising Bloom 78
 Roots Organics Uprising Foundation 78
 Roots Organics Uprising Grow 78
 RootTrapper II 282
 Rose & Flower Mix - Vital Earth's 103
 Rose Bucket - Grodan 286
 Rose Food - FoxFarm Happy Frog 76
 Round Fabric Pots - Black Gro Pro 281
 Round Fabric Pots - Tan Gro Pro 281
 Round Graduated Containers - Measure Master 251
 Round Mesh Bottom Pots - Gro Pro 284
 Round Plastic Mesh Bottom Pots - Gro Pro 284
 Round Pots - Eco Grow 284
 Royal Flush - Humboldt Nutrients 115
 Royal Gold Basement Mix 143
 Royal Gold Loose Coco Fiber 143
 Royal Gold Mendo Mix 143
 Royal Gold Tupur 143
 RS45 Cable and Software - Saturn 6 214
 Rubber Grommets - Hydro Flow 195
 RX Green Solutions Axiom Harpin Protein 117
 RX Green Solutions Life Cloning Solution 158
S
 S-5LL Diaphragm Switch - Little Giant 178
 S-line - Atmosphere Vortex Powerfans 223
 S.I. (Structural Integrity) - Humboldt Nutrients 115
 Sachets - BlueLab Calibration & Conductivity Solution 274
 Safer 3-in-1 Garden Spray II 126
 Safer BioNEM Insecticide & Repellent 126
 Safer Caterpillar Killer for Trees, Shrubs & Vegetables 126
 Safer End ALL Insect Killer 125
 Safer Garden Fungicide 126
 Safer Insect Killing Soap 126
 Safer Pyrethrin & Insecticidal Soap Concentrate II 126
 Safer Yard & Garden Insect Killer 126
 SaferGro Mildew Cure 123
 SaferGro Pest Out 123
 Safety Glasses - Professional UV 62
 Salt Free - Sticky Bye-Bye 250
 Salt Leaching Solution - Botanicare Clearex 71
 Samsung Max Mini Split Air Conditioner Systems 235
 Samsung Max Programmable Thermostat for Split Systems 236
 Samsung Max Split System AC Linesets 236
 Sap Off Soap - Roots Organics 250
 Saturn 1 - Analog Temp & Humidity Controller 213
 Saturn 3 - Digital Temp, Humidity & CO2 Controller 213
 Saturn 4 - Digital Environmental Controller 214
 Saturn 5 - Digital Environmental Controller w/ CO2 Timer 214
 Saturn 6 - Digital Environmental Controller with CO2 PPM Control 214
 Saucer for Black Square Pots 286
 Saucers - Bond Clear 289
 Saucers - Gro Pro Clear Plastic 288
 Saucers - Gro Pro Heavy Duty Black 288
 Saucers - Mondii 288
 Saucers - Premium Plastic Black 288
 Saucers - Premium Plastic Green 288
 Scalpel - Super Sprouter Sterile Disposable 157
 SCC1 Temp, Humidity & CO2 Controller Simple One Series - Grozone 216
 Scissor - Fiskars Premier Large Titanium 260
 Scissor-Fix 250, 262
 Scissors - ARS All Purpose Model SS-330H 261
 Scissors - ARS Curved Model SS-320BM 261
 Scissors - Zenport 6.5in Deluxe Fruit Model ZS105 261
 Scissors - Zenport All Purpose Stainless SS-330 HN-R 261
 Scissors SS-320BT - ARS Harvest 261
 SCO2 CO2 Controller Simple One Series - Grozone 216
 Screened Wall Vents - Ideal-Air 228
 Screens - Hydro Flow Poly Replacement 191
 SE Commercial Reflector with Brackets 36
 SE Complete Fixture - Gavita Pro 600e 30, 37
 SE Complete Fixture - Gavita Pro Classic 600 30, 36
 SE e-Series Fixture - Gavita Pro 600e 30, 37
 SE220 - Milwaukee pH Probe For MW100 or BEM101 267
 Sea Bird Guano - Roots Organics 78
 Sea Cal - Humboldt Nutrients 114
 Sea Mag - Humboldt Nutrients 115
 Seabird Guano - Buried Treasure Peruvian 80
 Seabird Guano - Buried Treasure Phos 80
 Seabird Guano - Grow More 100
 Seabird Guano - Vital Earth's All Purpose 103
 Seabird Guano - Vital Earth's High Phos 103
 Seabird Guano Liquid Bloom - Vital Earth's 102
 Seabird Guano Liquid Grow - Vital Earth's 102
 Seagrow All Purpose - Grow More 98
 Seagrow Flower & Bloom - Grow More 98
 Sealant - Spray Foam 236
 Seals - Hydro Flow Uniseal 191
 Seam Tape - Orca Grow Film 263
 Seaplex 72
 Seaweed - Technaflora B 97
 Seaweed & Fish Fertilizer - Neptune's Harvest 112
 Seaweed Extract - Technaflora Soluble 97
 Seaweed Extract - Vital Earth's Soluble 103
 Seaweed Fertilizer - Neptune's Harvest 112
 Seaweed Plus Iron - Maxicrop Liquid 111
 Sediment Filter - Ideal H2O 199
 Seed Starting Blend - Organic Mechanics 146
 Seedling Heat Mat - Super Sprouter 147
 Seedling Heat Mat 2 Tray - Super Sprouter 147
 Seedling Heat Mat Digital Thermostat - Super Sprouter 148
 Seedling Heat Mat Thermostat - Super Sprouter 148
 Select-A-Watt Electronic Ballasts - Galaxy Legacy 28
 Select-A-Watt Electronic Ballasts Galaxy Grow Amp 27
 Self Watering System - Claber Oasis 168
 Semi-Rigid Aluminum Premium Flex Ducting - Ideal-Air 229
 Sensor Extension Cable - Titan Controls 218
 Sensor Temp & Humidity with Photocell - Kronus 213
 Sensor Yellow Monitoring Cards 123
 Serenade Garden Disease Control 125
 Shake Nutrient Meter - EC 265
 Sharpening Stone AC-SS240 - ARS 261
 Shear - Bond Floral 262
 Shear - Shear Perfection Titanium Curved Trimming 2in 259
 Shear - Shear Perfection Titanium Cutting 1.5 in 259
 Shear - Shear Perfection Titanium Straight Trimming 2in 259
 Shear - Shear Perfection Titanium Straight Trimming 3in 259
 Shear - Zenport 8.5in Bypass Pruning Model Z103 261
 Shear - Zenport Needle Nose Model H303 261
 Shear - Zenport Precision Micro Model H356 260
 Shear Perfection Garden Snips 259
 Shear Perfection Titanium Curved Trimming Shear 2in 259
 Shear Perfection Titanium Cutting Shear 1.5in 259
 Shear Perfection Titanium Straight Trimming Shear 2in 259
 Shear Perfection Titanium Straight Trimming Shear 3in 259
 Shears - Long, Straight Blade H3005 - Zenport 261
 Sheeting - Black/White Poly 264
 Short 5KV Socket Assembly 56
 Short Cycle Timer - Digital 219, 279
 Short Cycle Timer With Photocell - Apollo 12 210, 277
 Short Period Cyclestat with Day/Night Sensor - Grozone CY2 215
 Shortcut Snip - Fiskars 260
 Shot Measuring Glass - Measure Master 251
 Shower Head Wand - Melnor GentleRain 248
 Shut Off Valve Kit - Hydro Flow 188
 Shut Off Valves - Hydro Flow 188
 Shut Off Valves - Hydro-logic 203
 Sierra Natural Science Pest Control 122
 Silenced Fans - Q-Max 223
 Silencer - Hyper Fan Stealth 220
 Silencers for Ducting - Phresh 239
 Silica - RAW 83
 Silica Blast - Botanicare 70
 Silicate - HydroDynamics Europonic 100
 Silver Duct Tape - Ideal-Air 231
 Silver Flex Duct Tape 231
 Silver Premium Insulated Flex Ducting - Ideal-Air 229
 Silver Sun Reflectors 22
 Silver/Black Flex Ducting - Ideal-Air 228
 Silver/Silver 3 Ply - Can-Duct 229
 Silver/Silver Flex Ducting - Ideal-Air 228
 Silver/White Lightite Film - Easygrow 264
 Simple CO2 Controller - Grozone USCO2 Single Zone 216
 Simple CO2 Tubing Hanger 208
 Simple One Series - Grozone SCC1 Temp, Humidity & CO2 Controller 216
 Simple One Series - Grozone SCO2 CO2 Controller 216
 Simple Piece Spray Heads - Hydro Flow 189
 Single Zone Ultra Simple CO2 Controller Grozone USCO2 216
 Siphon Kit - Hydro Flow Fill & Drain 183
 Skinny - Phresh Filters 239
 Slacker Aeration - Botanicare 139
 Slacker Moisture - Botanicare 139
 Sledge Hammer - FoxFarm Bushdoctor 73
 Sleeve - Hydro-logic Algae Block 202
 Sluggo - Monterey 125
 SM-90 119
 Small Boy Float Valve 202
 Small Boy QC Fittings 202, 204
 Small Boy Replacement Filters - Hydro-logic 205
 Small Boy System - Hydro-logic 204
 Small Boy to Stealth RO 100 Upgrade Kit 205
 Smart pH/EC/TDS Combination Meter MW802 - Milwaukee 268
 Smart Pot - Black 282
 Smart Pot - Black with Handles 282
 Smart Pot - Tan 282
 Smart Pot Transplanter 283
 Smart Volt Power Cords 55
 Snap Stand 4ft x 4ft Tray Stand 168
 Snapstand 4ft x 4ft Tray Stand - GH Snapture 168
 Snapstand Fittings - GH 168
 Snapture Snapstand 4ft x 4ft Tray Stand 168
 Snapture Snapstand Fittings - GH 168
 Snip - Fiskars Comfort Grip Floral 259
 Snip - Fiskars Shortcut 260
 Snip - Fiskars Softtouch Micro-Tip Pruning 259
 Snips - Fiskars Micro-Tip Pruning 260
 Snips - Shear Perfection 259
 Snips Model H370 - Zenport Floral/Thread 260
 Snow Storm Ultra - Emerald Triangle 110
 SNS 203 Concentrate Pesticide Soil Spray/Drench 122
 SNS 209 Systemic Pest Control Concentrate 122
 SNS 217 Mite Control RTU 122
 SNS 217C Mite Control Concentrate 122

SNS 244 Fungicide RTU	122	Soilless Grow Media – Botanicare Cocogro	140	Spray – Ona Apple Crumble	242	Starcoat T5 HO Fluorescent Grow Lamps – GE	50
SNS 244C Fungicide Concentrate	122	Soilless Hydro Coco Mix – Roots Organics	140	Spray – Ona Fresh Linen	243	Start Kit for Heating and Cooling Products	237
Socket Assembly – 5KV Short	56	Soilless Plugs – GH Rapid Rooter	148	Spray – Ona Pro	243	Starter Cubes – Root Riot	149
Socket Assembly with 15ft Lamp Cord – 16 gauge	56	SolarMax Blue Enhanced Performance Metal Halide Lamps	47	Spray Bottles – 360	246	Starter Cubes – Root Riot Trays	149
Socket Assembly With Pigtail Strain Relief	52	SolarMax Enhanced Performance HPS Lamps	47	Spray Foam Sealant	236	Starter Kit – FoxFarm Dirty Dozen	73
Socket Extender – Mogul Base – 4KV	52	SolarMax MH Conversion Lamps	47	Spray Heads – Hydro Flow Single Piece	189	Starter Kit – Hanna pH Cleaning & Calibration Solution	275
Socket Kit with Cord – DE Large	19	SolarMax Red Enhanced Performance Metal Halide Lamp	47	Spray Stakes – Hydro Flow Mini Flow	188	Starter Kit – HydroDynamics Ionic Tote	101
Socket Mogul – 5KV/HOR	52	SolarTech Magnum Reflector	22	Spray-N-Grow	117	Starter Kit – Olivia’s Cloning	157
Socket with Power Cord or Lamp Cord	56	Solenoid with Cord Set – CO2 Regulator Parts	207	Sprayer – Clearoma	242	Starter Plugs – GH Rapid Rooter	148
Sockets – T5 HO Replacement	53	Solid Color Neoprene Inserts – Super Sprouter	154	Sprayer – EZ-Clone 360	154, 181	Starter Plugs – Super Sprouter Perfect Plug Refill Pack	148
Soft Mesh Trellis Netting – Grower’s Edge	255	Solo Directional Sprayer	246	Sprayer – GH Vortex DC	167	Stationary Sprayer/Atomizer – Root Lowell	247
Soft Neoprene Inserts – EZ-Clone	154	Solo-Tek Bloom – Grotek	85	Sprayer – Mond Mist & Spray Deluxe 1.3 Quart	247	Stealth & Small Boy Float Valve	202
Soft Plant Ties – Grower’s Edge	252	Solo-Tek Grow – Grotek	84	Sprayer – Mond Mist & Spray Deluxe 2.1 Quart	247	Stealth Edition – Air Box	241
Softgrid Floral Pruner – Fiskars	260	Soluble Mycorrhizae – Plant Success	105	Sprayer – Mond Mist & Spray Premium Tank 1.5 Qt	247	Stealth Hyper Fan	220
Softtouch Micro-Tip Pruning Snip – Fiskars	259	Soluble Powder – Maxicrop Original	111	Sprayer – Rainmaker Backpack	246	Stealth Pressure Booster Pump	202
Software – Saturn 6	214	Soluble Seaweed Extract – Technaflora	97	Sprayer – Rainmaker Battery Powered	246	Stealth Replacement Filters – Hydro-logic	201
Soil – Black Gold Natural & Organic Potting	137	Soluble Seaweed Extract – Vital Earth’s	103	Sprayer – Rainmaker Pressurized Pump	246	Stealth RO 100 – Hydro-logic	201
Soil – Black Gold Waterhold Cocoblend	137	Soluble Tri-Pack – FoxFarm	75	Sprayer – Rainmaker Trigger	246	Stealth RO 100 to Stealth RO 200 Upgrade Kit	202
Soil – Botanicare ReadyGro	139	Solution – BlueLab 2.77 EC Conductivity Standard	274	Sprayer – Root Lowell Flo-Master Battery 5L/1.3 Gal	247	Stealth RO Flow Restrictors 1:1	202
Soil – Botanicare Slacker Aeration	139	Solution – BlueLab pH 4.0 Calibration	274	Sprayer – Root Lowell Flo-Master Heavy Duty 36oz	247	Stealth RO QC Fittings	202, 204
Soil – Botanicare Slacker Moisture	139	Solution – BlueLab pH 7.0 Calibration	274	Sprayer – Root Lowell Flo-Master Pressurized 40oz	247	Stealth RO100/200 – Membrane Flush Kit	202
Soil – Bushdoctor Lucky Dog K-9 Kube Growers Blend	136	Solution – BlueLab pH Probe KCl Storage	274	Sprayer – Solo Directional	246	Stealth Ultra-Violet Sterilizer Kit	202
Soil – FoxFarm Bushdoctor Coco Loco Potting Mix	136	Solution – HM Digital pH Electrode Storage	275	Sprayer – Solo Directional	246	Steamed Bone Meal – FoxFarm Happy Frog	75
Soil – FoxFarm Happy Frog	136	Solution – HM Digital TDS Calibration	274	Sprayer – Solo Directional	246	Steath RO Low Pressure, High Flow Membrane Hydro-logic	201
Soil – FoxFarm Nutrient Trio	74	Solution – HM Digital TDS Calibration	275	Sprayer/Atomizer – Root Lowell Flo-Master	247	Steel Stakes – Bond	255
Soil – FoxFarm Ocean Forest	136	Solution – Oakton pH 4.01, pH 7.00 & 1413 TDS	275	Sprayer/Atomizer – Root Lowell Portable	247	Steel Stakes – Grower’s Edge Deluxe	255
Soil – FoxFarm Ocean Forest	136	Solution Cleaning – Hanna	275	Sprayer/Atomizer – Root Lowell Stationary	247	Stem x 1/4in Quick Connect Straight – Hydro-logic	204
Soil – FoxFarm Ocean Forest	136	Solution Packets – Hanna	275	Square Black Plastic Pots – Gro Pro Premium	286	Sterr Drill Bit – Duralastics Conical	164
Soil – General Organics Ancient Forest	143	Solution Storage – Hanna	275	Square Fabric Liner – Flo-n-Gro	161	Sterile Disposable Pipettes – Measure Master	251
Soil – Just Right Xtra Potting Mix	145	Solutions – GH Meter Calibration	272	Square Fabric Pots – Gro Pro	281	Sterile Disposable Scalpel – Super Sprouter	157
Soil – Organic Mechanics Container Blend	146	Solutions – Hanna 1500 PPM & 1413 uS/CM	275	Square Mesh Pot – Gro Pro	287	Sterilizer Kit – Hydro-logic Evolution RO1000	202
Soil – Organic Mechanics Premium Blend	146	Solutions – Hanna PH 4 & PH 7 Calibration	275	Square Plastic Pot	285	Stick-BlueLab Connect	266
Soil – Organic Mechanics Seed Starting Blend	146	Sonic Bloom – Emerald Triangle	111	Square Plastic Pots – Black	287	Stickey – Humboldt Nutrients	113
Soil – Premier Tech Pro-Mix BX	142	Solutions – Hanna PH 4 & PH 7 Calibration	275	Square Plastic Pots – Gro Pro Black	286	Sticky Bye-Bye	250
Soil – Premier Tech Pro-Mix BX Biofungicide + Mycorrhizae	142	Sonoma Gold Bloom – Cutting Edge Solutions	93	Square Pots – Black	286	Sticky Bye-Bye Sweet Orange Salt Free	250
Soil – Premier Tech Pro-Mix BX with Biofungicide	142	Sonoma Gold Grow – Cutting Edge Solutions	93	Square Pots – Blow Molded	286	Sticky Ribbon Traps	124
Soil – Premier Tech Pro-Mix HP	142	Soul Synthetics Amino-Aide	79	Square Pots – Gro Pro Premium White	285	Sticky Thrip Leafminer Traps	123
Soil – Premier Tech Pro-Mix HP Biofungicide + Mycorrhizae	142	Soul Synthetics Big Swell	79	Square Saucer for Black Square Pots	286	Sticky Whitefly Traps	123
Soil – Premier Tech Pro-Mix HP-CC Mycorrhizae	142	Soul Synthetics Bloom	79	SR Ducting – ThermoFlo 2000	229	Stone AC-SS240 – ARS Sharpening	261
Soil – Roots Organics B2 Professional Growing Mix	141	Soul Synthetics Grow	79	SR Ducting – ThermoFlo Insulated	229	Stonewool – Grodan Pargro OD	133
Soil – Roots Organics Big Worm	141	Soul Synthetics Grow-N	79	SR Insulated Ducting – ThermoFlo	229	Stonewool A-OK Starter Plugs – Grodan	132
Soil – Roots Organics CocoPalms	141	Soul Synthetics Infinity	79	Stack – NPK	81	Stonewool Covers – Cube Cap	134
Soil – Roots Organics Emerald Mountain	141	Soul Synthetics Peak	79	Stainless All Purpose Scissors SS-330 HN-R – Zenport	261	Stonewool Covers – Drip Cap	134
Soil – Roots Organics Formula 707	141	Soul Synthetics Player Pack	79	Stainless Steel Hose Clamps – Ideal-Air	230	Stonewool Covers – Grower’s Edge	134
Soil – Roots Organics Green Lite	141	Soul Synthetics Soul	79	Stainless Steel Hose Clamps – Ideal-Air Quick Release	230	Stonewool Delta Gro-Blocks & Big Mama – Grodan	133
Soil – Roots Organics GreenFields Potting	140	Sparkle – NPK	84	Stake – Hydro Flow	188	Stonewool Delta Starter Mini-Blocks – Grodan	133
Soil – Roots Organics Marine Compost	141	Spayer Head 360 Trigger	246	Stake 45 Degree – Dripper	195	Stonewool Grow-Slabs – Grodan	132
Soil – Roots Organics Original Potting	140	Spectralux Green T5 HO Fluorescent Grow Lamps	49	Stake Labels – Grower’s Edge	158, 253	Stonewool Grow-Chunks – Grodan	132
Soil – Royal Gold Basement Mix	143	Spectralux T5 HO Fluorescent Grow Lamps	49	Stake Out Ebb & Flow & Drip-n-Gro Support	161	Stonewool Grow-Cubes – Grodan	134
Soil – Royal Gold Mendo Mix	143	Spectralux T5 VHO Fluorescent Grow Lamps	49	Stake with 3/16in dripper line – Botanicare Dripper	195	Stonewool MacroPlugs – Grodan	133
Soil – Royal Gold Tupur	143	Spectralux T8 Fluorescent Grow Lamp	49	Stake with Basket – Hydro Flow Black	195	Stonewool Covers – Grodan	134
Soil – Vermicrop Organics VermiFire	144	Speed Control – Grozone TV1 Day/Night Fan	215	Stake with Basket – Hydro Flow Blue	195	Storage Bags – Grower’s Edge Nylon	258
Soil – Vermicrop VermiSoil Premium Potting	144	Speed Control – Grozone TV2 Multimode Fan	215	Stakes – Bond Super Steel	255	Storage Bags – Zip-Zag	258
Soil – Vital Earth’s O.G. Potting	145	Speed Controller – Mercury 2	213, 226	Stakes – Raindrip	193	Storage Bags – Libbey	257
Soil Aerator – Growstone GS-2 Mix	146	Speed Dimmer with Optional Kick Start – Grozone DIM1 Fan	215	Stakes Green Bamboo – Bond	255	Storage Solution – BlueLab pH Probe KCl	274
Soil Amendment – Organic Mechanics Planting Mix	146	SpeediChannel Split Fit Kit	236	Stakes Natural Bamboo – Bond	255	Storage Solution – Hanna	275
Soil Amendment – Vermicrop Vermiblend	144	SpeediChannel Split Lineset Covers and Fittings	236	Stakes Natural Bamboo – Grower’s Edge	255	Storage Solution – HM Digital	275
Soil Builder Earthworm Castings – Wiggle Worm	142	Speedster – Variable Fan Speed Control	227	Stakes Natural Bamboo Bulk – Grower’s Edge	254	Storm Dispenser Fan – Ona	244
Soil Builder Humic – Grow More	98	Spider Mite Knock Out – Doktor Doom	120	Stakes with Cleanout – Hydro Flow Adjustable Drip	187	Straight Blade H3005 – Zenport Harvest Shears Long	261
Soil Conditioner – FoxFarm Happy Frog	137	Spigot For 6-Gallon Containers	68	Stand – Fast Fit 2ft x 4ft Tray	58, 169	Straight Reducers – Hydro Flow Barbed	184
Soil Garden 5 Gallon Pots – Gro-n-Dirt	160	Spinomad – Monterey	124	Stand – Fast Fit 3ft x 3ft Tray	58, 169	Straight Trimming Shear 2in – Shear Perfection	259
Soil Meter – Bond 3 Way	272	Spiral Fluorescent Bulb 42 Watt – GE	50	Stand – Fast Fit 4ft x 4ft Tray	58, 169	Straight Trimming Shear 3in – Shear Perfection	259
Soil pH & Moisture Meter – Accurate pH 7 & pH 8	265	Spiral Hose Kit – Claber	196	Stand – Fast Fit 4ft x 8ft Tray	58, 169	Strain Relief & Heyco Replacements	53
Soil pH Meter – BlueLab	266	Split A/C, 14 Gauge/4 Conductor Interconnector Wire	237	Stand Fan – Hurricane Supreme Series Super 8	224	Strain Relief Lamp Cord	56
Soil pH Meter – Luster Leaf Rapitest	272	Split Drain Line	237	Stand Fan – Hurricane W	224	Strap – Flex Duct Hanger	230
Soil pH Meter Digital – Luster Leaf Rapitest	271	Split Electrical Components	236	Stand Fans – Air King	225	Stretch Tie Vinyl – Luster Leaf Rapiclip	254
Soil pH Meter Digital Plus – Luster Leaf Rapitest	271	Split Fit Kit – SpeediChannel	236	Stand Oscillating Fans – Hurricane Supreme Series	224	Strip Light – Sun Blaze T5 HO Fluorescent	38
Soil pH Pen – BlueLab	266	Split Lineset Couplers and Flare Nuts	237	Stand Up Reservoir 105 Gallon	166	Strip Light – SunBlaster NanoTech T5 HO Fluorescent	39
Soil pH Replacement Probe – BlueLab	266	Split Lineset Covers and Fittings – SpeediChannel	236	Stand Up Reservoir 48 Gallon	166	Strip Light – SunBlaster T5 HO Fluorescent	39
Soil pH Tester – Luster Leaf Rapitest	271	Split Linesets – Samsung Max Split System AC	236	Standard Germination Dome – Super Sprouter	150	Strip Light – Super Sprouter T5 High Output Grow Light	38, 150
Soil Sulfur	116	Split Pads and Equipment Mounts	237	Standard High Pressure Sodium (HPS) Lamps	48	Strip Light Hanger T5 Universal – SunBlaster	39, 61
Soil Sulfur Oregon Label	116	Split Systems – Samsung Max Ductless AC	236	Standard Metal Halide (MH) Lamps	49	Strip Light Jumper Cords – Sun Blaze T5	39
Soil Test Kit – Luster Leaf Rapitest	272	Split Systems – Samsung Max Programmable Thermostat	236	Standard Metal Halide Lamps – Eye Hortilux	44	Strip Light Supreme – Sun Blaze T5 HO Fluorescent	38
Soil Tester – Luster Leaf Rapitest	280	Spoon – RAW Adjustable	83	Standard Vented Humidity Dome 7 in – Super Sprouter	150	Structural Integrity (SI) – Humboldt Nutrients	115

Styrene Plastic (OD) - Black Grow Trays 165

Subculture B - GH 66

Subculture M - GH 66

Submersible Direct Drive Pump - Little Giant PE-1 178

Submersible Pump - Danner Mag Drive 190 GPH 177

Submersible Pump - EcoPlus 1500 Elite 177

Submersible Pump - Little Giant 1-ABS 178

Submersible Pump - Little Giant 6-CIM-R 178

Submersible Pump - Little Giant NK-1 178

Submersible Pump - Little Giant NK-2 178

Submersible Pumps - EcoPlus Eco Fixed Flow Rate 176

Submersible Pumps - Little Giant 5-MSP 178

Submersible Pumps - Mag Drive 950 - 2400 GPH 177

Submersible Pumps 250 GPH - 700 GPH - Danner Mag Drive 177

SuclaShield 123

Sugar Cane - GH Flora Nectar 65

Sugar Daddy - Technaflora 96

Sugar Peak Flowering - Earth Juice 109

Sugar Peak Grand Finale - Earth Juice 109

Sugaree - Cutting Edge Solutions 93

Sulfur for Soil 116

Sulfur Oregon Label 116

Sump Pump 1200x - Mondri 177

Sump Pump 1585x - Mondri 177

Sump Pump 300 GPH - Supreme Hydroponics 178

Sun Blaze T5 High Output Fluorescent Strip Light Fixtures 38 38

Sun Blaze T5 High Output Fluorescent Strip Light Supremes 38

Sun Blaze T5 HO Fluorescent Light Fixtures 38

Sun Blaze T5 Strip Light Jumper Cords 39

Sun Blaze T5 Very High Output (VHO) Fluorescent Lighting Fixtures 38

Sun Blocker Foil Bubble - Sunfilm 263

Sun Hut - Blackout Grow Tents 172

Sun Hut - Fortress Grow Tents 173

Sun Hut - The Big Easy Grow Tents 171

Sun Hut - The Original Grow Tents 174

Sun Hut Accessories 174

Sun Spool - Grower's Edge 252

Sun Stand 2 59

Sun Star 6 in Air-Cooled Reflector 21

Sun Star Reflector 22

Sun System Digital 34

Sun System Double Ended Agrotech Magnum Reflector 18 18

Sun System Garden Bright Fluorescent Grow Light 39

Sun System Hard Core 277 Volt Ballast 26

Sun System Hard Core 480 Volt Ballast 26

Sun System Hard Core Ballast 25

Sun System Harvest Pro Ballasts 25

Sun System HPS 150 Grow Light Fixture 34

Sun System LEC 315 Light Emitting Ceramic Fixture 35, 41 41

Sun System Light Meter 279

Sun System PAR Meter with Integrated Sensor 279

Sun System PAR Meter with Remote Sensor 279

Sun System Sun Stand 2 59

Sun System Trifecta 34

Sun System White Wing Fluorescent Grow Light Fixture 40

Sun Winch Motorized Lift System 57

Sun Winch Remote for Lift System 57

SunBlaster Compact Fluorescent Bulb 26 Watt 50

SunBlaster NanoDome Combo Kit 152

SunBlaster NanoTech T5 HO Fixtures 39

SunBlaster NanoTech T5 Reflectors 39

SunBlaster T5 High Output Fluorescent Strip Lights 39

SunBlaster T5 HO Fluorescent Lamps 50

SunBlaster T5 Universal Light Stand 39, 60

SunBlaster Universal T5 Light Strip Hanger 39, 61

Sunfilm Mylar Film 263

Sunfilm Panda Film 263

Sunfilm Sun Blocker Foil Bubble 263

SunGrip Heavy Duty Light & Equipment Hangers - 1/4in The Original 57

SunGrip Light Hangers - 1/8in The Original 57

SunGrip Light Hangers 1/8in White 57

SunGro 6 in Air-Cooled Reflector 20

SunGro 8 in Air-Cooled Reflector 21

SunLift - The Original 57

SunLight 125 Fluorescent Fixture 34, 40

SunLight Supply Product Catalog 290

Sunmaster Blue Ice Enhanced Performance Metal Halide Lamps 47

Sunmaster Green Harvest MH Conversion Lamps 48

Sunmaster Red Sunrise Enhanced Metal Halide Lamps 48

Sunmaster Yellow Blossom Enhanced Performance HPS Lamps 47

Sunshine Advanced Mix #4 - 1 Cu. Ft. Compressed 138

Sunshine Advanced Mix #4 - 2 Cu. Ft. Loose 138

Sunshine Advanced Mix #4 - 2.2 Cu. Ft. Compressed 138

Sunshine Advanced Mix #4 - 3 Cu. Ft. Compressed 138

Sunshine Advanced Rain Forest Loose 138

Sunshine Advanced Super Hydro Loose 139

Sunshine Advanced Ultra Coir Loose 139

Sunshine Mix #4 - Aggregate Plus 137

Sunshine Mix #4 Natural & Organic 138

Sunshine Mix #4 Natural & Organic w/ Mycorrhizae 138

Sunshine Mix #4 with Mycorrhizae 138

SunWinch Motorized Lift System 57

SunWinch Remote for Lift System 57

Super 8 Digital Stand Fan - Hurricane Supreme 224

Super 8 Digital Wall Mount Fan - Hurricane 225

Super Boost - Supernatural 89

Super Charger - AmHydro 108

Super HPS - High Pressure Sodium Lamps Eye Hortilux.44 44

Super Hydro Loose - Sunshine Advanced 139

Super Leach - Supernatural 90

Super Metal Halide Horizontal Lamp - Venture 48

Super Nitro Bat Guano - Roots Organics 77

Super Phosphate - Grow More 100

Super Saucers - Mondri 288

Super Soak - Supernatural 89

Super Spreader for Adjust-A-Wings Large DE 19

Super Spreaders - Medium 20

Super Sprouter 72 Cell Plug Insert Trays 151

Super Sprouter Double Thick Trays 10 x 20 151

Super Sprouter Heated Germination Kit 2 in 147

Super Sprouter Mesh Bottom Tray 151

Super Sprouter Multicolored Neoprene Inserts 155

Super Sprouter Perfect Plug Refill Pack 148

Super Sprouter Propagation Station 147

Super Sprouter Propagation Trays 10 x 20 151

Super Sprouter Quad Thick Tray & Insert 10 x 20 151

Super Sprouter Seedling Heat Mat 147

Super Sprouter Seedling Heat Mat - 2 Tray 147

Super Sprouter Seedling Heat Mat Digital Thermostat 148

Super Sprouter Seedling Heat Mat Thermostat 148

Super Sprouter Solid Color Neoprene Inserts 154

Super Sprouter Standard Domes 150

Super Sprouter Standard Vented Humidity Dome 7in 150

Super Sprouter Sterile Disposable Scalpel 157

Super Sprouter T5 High Output Grow Light 38, 150

Super Sprouter Ultra Clear Vented Germination Dome 2 in 150

Super Sprouter Ultra Clear Vented Humidity Domes with Light Tracks 150

Super Steel Stakes - Bond 255

Super Sun 2 Reflector 6 in Air-Cooled 18

Super Sun DE Reflector 18

Super Tea Mix 108

Superlicious - Supernatural 90

Supernatural Bloom Aqua 89

Supernatural Bloom Terra 89

Supernatural Bud Blaster 90

Supernatural Excelfoizz 90

Supernatural Green Stay 90

Supernatural Gro Aqua 89

Supernatural Gro Terra 89

Supernatural Instant Jungle 90

Supernatural Rootburst Powder 90

Supernatural Super Boost 89

Supernatural Super Leach 90

Supernatural Super Soak 89

Supernatural Superlicious 90

Supernatural Ultimate Thrive 90

SuperNova Nutrient Additive - AmHydro 108

Superthrive 117

Supply Air Duct Collars for Overhead Dehumidifiers - Quest 233

Supports - Hydro Flow 188

Supreme Air Pump - EcoPlus 179

Supreme Extra Large Perlite 134

Supreme Hurricane Oscillating Stand Fan 224

Supreme Hurricane Super 8 Digital Stand Fan 224

Supreme Hurricane Super 8 Digital Wall Mount Fan 225

Supreme Hurricane Wall Mount Oscillating Fans 224

Supreme Hydroponics Sump Pump 300 GPH 178

Sure Shot Measuring Glass - Measure Master 251

Surge - Roots Organics 77

Surge Protector for Heating and Cooling Products 237

Surge Strip - 6 Outlet 125V Power All Indoor Metal 55

Sweet - Botanicare Carbo Raw 69

Sweet - Botanicare Citrus 70

Sweet - Botanicare Grape 70

Sweet - Botanicare Original Berry 70

Sweet & Dandy - Bushdoctor Bembe 73

Sweet Orange Salt Free - Sticky Bye-Bye 250

Switcher (Day/Night Sensor) Grozone OSWDN On/Off 216 216

Switcher (Trigger Cord) - Grozone OSW On/Off 216

Swivel Fittings - Hydro Flow Compression 190

Syringe 100cc/ml - Measure Master 251

Systemic Insect Control - Bonide 127

Systemic Pest Control Concentrate - SNS 209 122

T

T Label Plant Markers - Luster Leaf 158, 253

T Style EcoPlus Air Manifolds 3/8 Inch Inlet 180

T-Markers - Bond 158, 253

T-Rex - Cutting Edge Solutions 92

T101 - 120 Volt Commercial Grade Intermatic Timer 279

T104 - 208-277 Volt Commercial Grade Intermatic Timer 279

T5 Fixture - Sun Blaze High Output Fluorescent 38

T5 Fixture - Sun Blaze Strip Light High Output Fluorescent 38 38

T5 Fixture - Sun Blaze Strip Light Supreme High Output Fluorescent 38

T5 Fixture - Sun Blaze Very High Output Fluorescent 38

T5 Fixture - SunBlaster NanoTech High Output Fluorescent 39

T5 Fixture - SunBlaster Strip Light High Output Fluorescent 39

T5 High Output Grow Light - Super Sprouter 38, 150

T5 HO Fluorescent Electronic Ballasts - Fulham Racehorse 52

T5 HO Fluorescent Electronic Ballasts - Fulham Workhorse 52

T5 HO Fluorescent Grow Lamps - GE Starcoat 50

T5 HO Fluorescent Grow Lamps - Spectralux 49

T5 HO Fluorescent Grow Lamps - Ultra Sun 49

T5 HO Fluorescent Lamps - SunBlaster 50

T5 HO Replacement Sockets 53

T5 HO/LED Combination Fixtures - AgroLED 42

T5 Light Strip Hanger Universal - SunBlaster 39, 61

T5 Reflectors - SunBlaster NanoTech 39

T5 Strip Light Jumper Cords - Sun Blaze 39

T5 Universal Light Stand - SunBlaster 39, 60

T5 VHO Fluorescent Grow Lamps - Spectralux 49

T8 HO Fluorescent Grow Lamps - Spectralux 49

T8 LED Tubes - AgroLED 41, 51

Table Top Gardener - Portable Potting Tray 250

Tabzz - B'Cuzz 95

Take Down Garden Spray - Monterey 124

Tall Blue QC Fittings 204

Tall Blue Replacement Filters - Hydro-logic 204

Tall Boy Float Valve - Hydro-logic 204

Tall Boy QC Fittings 204

Tall Boy Replacement Filters - Hydro-logic 205

Tall Boy System - Hydro-logic 205

Tan Fabric Pots - Smart Pot 282

Tan Gro Pro Round Fabric Pots 281

Tank Sprayer 1.5 Quart - Mondri 247

Tanks - CO2 208

Tape - Ideal-Air Silver Duct 231

Tape - Orca Grow Film 263

Tape - Silver Flex Duct 231

Tape Gun - Bond 262

Tape Gun Staples & Tie Tape Replacement Parts - Bond 262

Tape Gun Tie Tape Replacement Parts - Bond 262

Tarp Zip-Up 264

TDS Calibration Solution - HM Digital 274

TDS Grocheck Monitor - Hanna 270

TDS Inline Monitor Pro for Evolution R01000 203

TDS Low - Oakton Ecotestr 268

TDS Monitor DM-1 - HM Digital 203, 269

TDS Primo Tester - Hanna 270

TDS Solution - Milwaukee Instruments 275

TDS Tester Model T75 - Milwaukee 267

TDS Tester Model T76 - Milwaukee 267

TDS Tester TDS-3 - HM Digital 269

TDS Water Tester AP-1 - HM Digital 269

TDS-3 Handheld TDS Tester - HM Digital 269

Tea - Botanicare Pure Blend 69

Tea - Emerald Triangle Killer 110

Tea Bag - Vermicrop 91

Tea Brew Packs - Xtreme Gardening 92

Tea Brew Packs Display - Xtreme Gardening 92

Tea Brewer - Flo-n-Gro Big Momma 160

Tea Brewer - Flo-n-Gro Gro Momma Bubbler Bucket 160

Tea Brewing Bags - Heavy Harvest 250

Tea Brewing System - Flo-n-Brew 160

Technaflora Awesome Blossoms 97

Technaflora B. Seaweed 97

Technaflora B.C. Bloom 97

Technaflora B.C. Boost 97

Technaflora B.C. Grow 97

Technaflora MagiCal 96

Technaflora pH Up & pH Down 273

Technaflora Pura Vida Bloom 96

Technaflora Pura Vida Grow 96

Technaflora Recipe For Success Kit 96

Technaflora Root 66 96

Technaflora Rootech Cloning Gel 157

Technaflora Soluble Seaweed Extract 97

Technaflora Sugar Daddy 96

Technaflora Thrive Alive B-1 Green 97

Technaflora Thrive Alive B-1 Red 97

Tee Fitting - Hydro Flow Tub Outlet 186

Tee Reducers - Hydro Flow Barbed 185

Telescopic Water Wand - Mondri 248

Temp & Humidity Controller with Night Outlet Plus CO2 Integration - Kronus 4 213

Temp Controller Day/Night - Zephyr 1 214, 226

Temperature & Humidity Analog Controller Saturn 1 213

Temperature & Humidity Plus CO2 Integration Kronus 2 213

Temperature & Humidity Sensor w/ Photocell - Kronus 213

Temperature Dial - Dial-A-Temp 227

Temperature, Humidity & CO2 Controller Simple One Series - Grozone SCC1 216

Temperature, Humidity & CO2 Digital Controller Saturn 3 213

Tempstat - Grozone TP1 Day/Night 215

Tempstat - Grozone TP2 Adjustable Differential 215

Tempstat - Grozone TP3 High Temperature Shut-Off 215

Tent - GrowLab 175

Tent - Sun Hut Fortress 173

Tent Accessories - Sun Hut 174

Tents - Sun Hut Blackout 172

Tents - Sun Hut The Big Easy 171

Tents - Sun Hut The Original 174

Terpinator Botanical Plant Oil 116

Test Kit - CO2 209

Test Kit - Luster Leaf Rapitest Soil 272

Test Kit - Watersafe Hydroponic Water 272

Test Kit pH - GH 272

Tester - HortiCare pH 265

Tester (HI99104) - Hanna Hydroponics pH 270

Testr 35 - Oakton 268

Texas Controller - GH 167

The Basics of Soilless Gardening Indoors Book 290

Uniseals - Hydro Flow 191
 Universal Duplex Receptacle 53
 Universal Light Stand - SunBlaster T5 39, 60
 Universal T5 Light Strip Hanger - SunBlaster 39, 61
 Up - Botanicare 273
 Up - Earth Juice Natural 273
 Up - Nectar For The Gods Olympus 88, 273
 Up - Technaflora 273
 Up 30% - Grow More 273
 Up Liquid & pH Up Dry - GH 272
 Upgrade Kit - GH Water Farm 8 Pack 167
 Upgrade Kit to Convert Small Boy to Stealth RO 100 205
 Upgrade Kit- Stealth RO 100 to Stealth RO 200 202
 Uprising Bloom - Roots Organics 78
 Uprising Foundation - Roots Organics 78
 Uprising Grow - Roots Organics 78
 USCO2 Single Zone Ultra Simple CO2 Controller - Grozone216 216
 Ushio Double Ended HPS Lamps 46
 Ushio Dual Arc Tube Lamp 46
 Ushio Enhanced Performance HPS Lamps 46
 Ushio MH Conversion Lamps 46
 Utility Sump Pump 1200x - Mondri 177
 Utility Sump Pump 1585x - Mondri 177
 UV Bulb 11in - Uvonair 3000 244
 UV Bulb 14in - Uvonair 5000 244
 UV Bulb 6in - Uvonair 1000 244
 UV Inline Duct Ozonator - 2 Bulb Uvonair 8 in 244
 UV Protected Greenhouse Film Clear - Tufflite IV 264
 UV Safety Glasses 62
 UV Sterilizer Kit - Hydro-logic Evolution R01000 202
 Uvonair 10 in CD Inline Duct Ozonator - 1 Cell 245
 Uvonair 10 in CD Inline Duct Ozonator - 2 Cell 245
 Uvonair 1000 244
 Uvonair 12 in CD Inline Duct Ozonator - 3 Cell 245
 Uvonair 3000 244
 Uvonair 5000 244
 Uvonair 8 in CD Inline Duct Ozonator - 1 Cell 245
 Uvonair 8 in UV Inline Duct Ozonator - 2 Bulb 244

V

V-Series - Atmosphere Vortex Powerfans 223
 Value Wing 8 Pack 23
 Valve - Hydro Flow In-Line Micro Irrigation 187
 Valves - Hydro Flow Barbed Ball 184
 Valves - Hydro Flow Shut Off 188
 Valves 1/2in - Hydro Flow (EcoPlus) Barbed 185
 Valves 3/4in - Hydro Flow (EcoPlus) Barbed 185
 VAM - BioAg 95
 Vaporizer - Grower's Edge Deluxe 249
 Vaporizer Commercial Grade - Grower's Edge 249
 Variable Fan Speed Control - The Speedster 227
 Variable Voltage Speed Controller - Can-Fan 223
 Veg - Botanicare Growilla 70
 Vegetative Growth Booster - Grotek 86
 Velcro Plant Ties 252
 Vented - Super Sprouter Standard Humidity Dome 7 in 150
 Vented Germination Dome 2in Super Sprouter Ultra Clear150 150
 Vents - Ideal-Air Screened Wall 228
 Venture Super Metal Halide Horizontal Lamp 48
 Verde - Humboldt Nutrients 113
 VermaPlex 106
 VermaPlex Black Casting 134
 VermaPlex Black Sea Kelp 106
 VermaPlex Hydroloyzed Fish 106
 VermaPlex Liquid Humate Plus 107
 VermaPlex Liquid Yucca 106
 VermiT 5/10 Extractor - Vermicrop 91
 VermiT Bio-Cartridges - Vermicrop 91
 Vermiblend Premium Soil Amendment 144
 Vermibrix - Vermicrop 91
 Vermicrop CocoNot Premium Coconut Coir Alternative 144
 Vermicrop Organics VermiFire Premium Soil 144
 Vermicrop Polyester Tea Bag 91
 Vermicrop VermiT 5/10 Extractor 91
 Vermicrop VermiT Bio-Cartridges 91
 Vermicrop Vermiblend Premium Soil Amendment 144

Vermicrop VermiBrix 91
 Vermicrop VermiFeast 91
 Vermicrop VermiLife 91
 Vermicrop VermiSoil Premium Potting Soil 144
 Vermicrop VermiWorm 145
 VermiFeast - Vermicrop 91
 VermiFire Premium Soil - Vermicrop 144
 VermiLife - Vermicrop 91
 VermiSoil Premium Potting Soil 144
 VermiWorm - Vermicrop 145
 Vertizontal Reflector 19
 Very High Output Fluorescent Lighting Fixtures 38
 VHO Fluorescent Grow Lamps - Spectralux T5 49
 VHO Sun Blaze T5 Fluorescent Fixture 38
 Video 2 Timer - Claber Aquano 196
 Vine Clips - Grower's Edge 252
 Vinyl - Max-Duct 230
 Vinyl Light Tight Flex Ducting White/Silver - Ideal-Air 229
 Vinyl Stretch Tie - Luster Leaf Rapiclip 254
 Vinyl Tubing - Black Hydro Flow Premium 194
 Vinyl Tubing - Blue Hydro Flow Premium 194
 Vinyl Tubing - Clear Hydro Flow Premium 194
 Vinyl Tubing - White Hydro Flow Premium 194
 Vita Grow Anti-Wilt Propagation & Transplant Spray 156
 Vita Grow Rooting Compound 156
 Vital Earth's All Purpose Seabird Guano 103
 Vital Earth's Coco Lite 145
 Vital Earth's High Nitrogen Bat Guano 9 - 3 - 1 103
 Vital Earth's High Nitrogen Bat Guano 11 - 4 - 2 103
 Vital Earth's High Phos Bat Guano 103
 Vital Earth's High Phos Seabird Guano 103
 Vital Earth's Manna Mix 145
 Vital Earth's Mega Worm 145
 Vital Earth's O.G. Potting Soil 145
 Vital Earth's O.G. Seabird Guano Liquid Bloom 102
 Vital Earth's O.G. Seabird Guano Liquid Grow 102
 Vital Earth's PHC BioPak 103
 Vital Earth's Powdered Glacial Rock 104
 Vital Earth's Rose & Flower Mix 103
 Vital Earth's Soluble Seaweed Extract 103
 VitaMaxPlus B1 Plant Formula - Grotek 85
 Vitamin Institute Superthrive 117
 Vitamino - Botanicare 71
 Vortex DC Sprayer - GH 167
 Vortex Inline Powerfans - Atmosphere 223
 Vortex Powerfans S-line 223
 Vortex Powerfans V-Series - Atmosphere 223
 Vortex Replacement Mounting Brackets 223

W

W Stand Fan - Hurricane 224
 Wall Mount Air King Fans 225
 Wall Mount Bracket - Hydro-logic Evolution-R01000 201
 Wall Mount Brackets - Ice Box 24
 Wall Mount Fan - Classic Series 16in Hurricane 225
 Wall Mount Fan - Hurricane Super 8 Digital 225
 Wall Mount Oscillating Fans - Hurricane Supreme Series 224
 Wall Vents - Ideal-Air Screened 228
 Wand - Melnor GentleRain Shower Head 248
 Wand 36in Watering 8 Pattern - Bond 248
 Wand Colormark - Dramm 248
 Wand Touch N Flow - Dramm 248
 Washer - CO2 Regulator Parts 207
 Washer 3/4in - Hydro Flow Filter 191
 Waste Reducer Elbow - 1:1 Ratio Evolution 201
 Water Chiller - EcoPlus 1/10 HP 197
 Water Chiller - EcoPlus 1/2 HP 197
 Water Chiller - EcoPlus 1/4 HP 197
 Water Chillers - EcoPlus Commercial Grade 197
 Water Conditioner - Z7 119
 Water Cooled CO2 Generator - HydroGen Pro 219
 Water Cooled CO2 MiniGen Generator - HydroGen 219
 Water Farm 8 Pack Circulating Upgrade Kit 167
 Water Farm 8 Pack Kit 167
 Water Farm Complete System - GH 167
 Water Farm Modular System - GH 167

Water Filtration - Idea H2O RO 198
 Water Filtration - Ideal H2O RO System 75 GPD 198
 Water Oxygenator - HydroRush 118
 Water Pump - Danner Mag Drive Pump 190 GPH 177
 Water Pump - Maxi-Jet 178
 Water Pump Extension With Ball Valve - Mondri 177
 Water Pumps - EcoPlus Adjustable Flow Rate 176
 Water Pumps - EcoPlus Convertible Bottom Draw 176
 Water Pumps - EcoPlus Premio Jet 176
 Water Pumps - Mag Drive 950 - 2400 GPH 177
 Water Pumps 250 GPH - 700 GPH - Danner Mag Drive 177
 Water Soluble 20 - 10 - 20 - Grow More 99
 Water Soluble Flower Hardener - Grow More 99
 Water Soluble Foliage Developer - Grow More 99
 Water Soluble General Purpose - Grow More 99
 Water Soluble Grow & Bloom - Grow More 99
 Water Soluble High Foss - Grow More 99
 Water Soluble Tomato - Grow More 99
 Water Test Kit - Watersafe 272
 Water Timer - Claber Aquade Duplo 196
 Water Timer - Claber Aquano Video 2 Timer 196
 Water Timer - Melnor 2 Zone - 6 Cycle Digital 196
 Water Timer - Melnor 6 Cycle Digital 196
 Water Wand Telescopic - Mondri 178
 Water Wizard - Little Giant 5-MSP Submersible Pumps 248
 Waterhold Cocoblend Soil - Black Gold 137
 Watering Can - Fiskars 247
 Watering System - Claber Oasis 168
 Watering Wand - Dramm Rain Colormark 248
 Watering Wand - Dramm Rain Touch N Flow 248
 Watering Wand - Melnor GentleRain Shower Head 248
 Watering Wand 36in - Bond 8 Pattern 248
 WaterPower 120 Pump - GH 177
 Waterproof EC/TDS/TEMP Combo Meter COM-100 - HM Digital 268
 Waterproof pH Meter PH-200 - HM Digital 269
 Waterproof pH/EC/TDS Meter - Hanna 270
 Waterproof PHEP 4 Tester With Replaceable Electrode - Hanna 270
 Waterproof TDS Tester Model T75 - Milwaukee 267
 Waterproof TDS Tester Model T76 - Milwaukee 267
 Watersafe Hydroponics Water Test Kit 272
 Wattle Meter - Kill A Watt 280
 Wedge Growing Medium with Tray - Oasis 149
 White Grow Trays - Botanicare ID 162
 White Grower's Edge Plant Stake Labels 158, 253
 White Low Profile (LP) Reservoirs - Botanicare 163
 White Plastic Washer - CO2 Heater 207
 White Power Cloner - Botanicare 152
 White Square Pots - Gro Pro Premium 285
 White SunGrip Light Hangers 1/8in 57
 White Trays Inside Dimension (ID) - Duralastics 164
 White Widow - Humboldt Nutrients 115
 White Wing Fluorescent Grow Light Fixture 110
 White Vinyl Vinyl Light Tight Flex Ducting - Ideal-Air 229
 Whitefly Traps - Sticky 123
 Whitmire 1600 X-Clude Formula 2 121
 Whitmire Pro-Controll Plus 122
 Wholesome Sweetener Organic Molasses 116
 Wide Mouth Jars - Ball 257
 Wide Mouth Jars - Ball Collection Elite 257
 Wide Mouth Lids & Bands - Ball 257
 Wiggle Worm Soil Builder Earthworm Castings 142
 Wing - Adjust-A-Wings Avenger 20
 Wing - Adjust-A-Wings Avenger DE 19
 Wing - Econo Wing Reflector 23
 Wing - Econo Wing XL Reflector 23
 Wing - Enforcer Reflectors 23
 Wing - Value Wing 8 Pack 23
 Wing - White Wing Fluorescent Grow Light 40
 Wire Crimp - Grey 53
 Wire for Mini Split A/C, 14 Gauge/4 Conductor 237
 Wire Light Duty - Luster Leaf 254
 Wire Nut - Black 53
 Wire Tie Foam - Luster Leaf Rapiclip 254
 Wire Tie Strips Foam - Luster Leaf 254

Wire Tie Strips Soft - Luster Leaf 253
 Wireless Environmental Controller - Titan Hyperion 1 206
 Wireless Motorized Lift System - SunWinch 57
 Wireless Remote Controls - Galaxy Digital Logic 29
 Wireless Remote for Lift System - SunWinch 57
 Wireless Remote Sensor - Grower's Edge 280
 Woodstream Ultomato Plant Cage 254
 Workhorse T5 HO Fluorescent Ballasts 52
 Worm Castings - VermaPlex Black Casting 134
 Worm Castings - Vermicrop VermiWorm 145
 Worm Castings - Vital Earth's Mega Worm 145
 Worm Castings - Wiggle Worm Soil Builder 142
 Wye Branch Ducting - Ideal-Air 227

X

X-Clude Formula 2 - Whitmire 121
 XL - Gold Label Hydrocorn 144
 Xtra Potting Mix - Just Right 145
 Xtreme Gardening Azos 92, 158
 Xtreme Gardening CalCarb 91
 Xtreme Gardening Kryptomite 120
 Xtreme Gardening Mykos 92
 Xtreme Gardening Mykos Drops 100 gm Pouches Display 92
 Xtreme Gardening Mykos Drops Root Paks 91
 Xtreme Gardening Mykos WP 92
 Xtreme Gardening Tea Brew Packs 92
 Xtreme Gardening Tea Brew Packs Display 92
 XXXL Non AC - Dominator 22

Y

Y Branch Ducting - Ideal-Air 227
 Y Garden Hose Dual Shut Off - Hydro Flow 188
 Yard & Garden Insect Killer - Safer 126
 Yellow Adjustable Measuring Spoon - RAW 83
 Yellow Blossom Enhanced Performance HPS Lamps - Sunmaster 47
 Yellow Monitoring Cards 123
 Yellow Sticky Ribbon Traps 124
 Yield Master 6 in Air-Cooled Reflector 21
 Yield Master 8 in Air-Cooled Reflector 21
 Yo Yo Light Hanger 58
 Yucca - RAW 83
 Yucca - VermaPlex Liquid 106

Z

Z7 Water Conditioner 119
 Zenport 6.5in Deluxe Fruit Scissors Model ZS105 261
 Zenport 8.5in Bypass Pruning Shear Model Z103 261
 Zenport All Purpose Stainless Scissors SS-330 HN-R 261
 Zenport Curved Micro Blade Pruner Model H355C 260
 Zenport Floral/Thread Snips Model H370 260
 Zenport Harvest Shears - Long, Straight Blade H300S 261
 Zenport Heavy Duty Bypass Pruner Model Z201 261
 Zenport Long Blade Micro Pruner Model H355L 260
 Zenport Micro Blade Pruner Model H355 260
 Zenport Needle Nose Shear Model H303 261
 Zenport Precision Micro Shear Model H356 260
 Zephyr 1 - Day/Night Temp Controller 214, 226
 Zephyr 2 - High Temperature Shut-Off with Delay 212
 Zephyr 3 - Heating/Cooling Controller 214, 226
 Zephyr 4 - Cooling Thermostat - Fan Control 214, 226
 Zeus Juice - Nectar For The Gods 86
 ZHO - Botanicare Root Inoculant 72, 155
 Zip Ties - HVAC Heavy-Duty 230
 Zip-Up for Tarps 264
 Zip-Zag Bags 258
 Zipper - Lite Tite 264
 Zipper - Tarp Zip-Up 264
 Zone - Dutch Master Gold 119
 zOrb Digital Microscope - Carson Optical 129



WHO ARE WE?

Founded in 1995, Sunlight Supply/National Garden Wholesale is a family-owned business headquartered in Washington state. We are a wholesale only company specializing in the wholesale of indoor horticulture, organics and hydrogardening supplies. We have over 450 employees and operate 12 facilities in 7 states. Our products are offered to gardening enthusiasts nationwide through a network of independent retail garden stores and internet-based retail sites. We are a leading supplier to many fine indoor gardening retail stores.

WE ARE MANUFACTURERS

We are the industry's only vertically integrated manufacturer with complete sheet metal fabrication capabilities. We market our horticultural lighting fixtures under our Sun System® umbrella name. Our specialty is horticultural lighting.

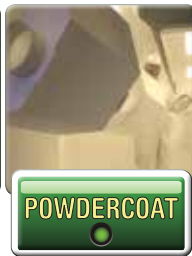
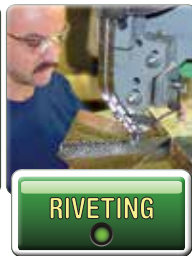
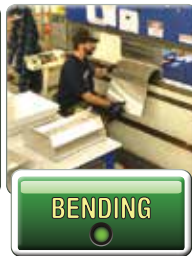

WE ARE IMPORTERS

Much of today's indoor gardening equipment is manufactured outside the U.S.A. In order to make these products available at your favorite local gardening store—our sourcing department searches worldwide to deliver our current product mix which is now sourced from 18 countries.



AUSTRALIA



BELGIUM



CANADA



CHINA



DENMARK



ENGLAND



GERMANY



INDIA



ISRAEL



ITALY

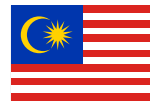

MALAYSIA



MEXICO



NETHERLANDS



NEW ZEALAND



POLAND



SOUTH KOREA



SRI LANKA



TAIWAN



WE ARE DISTRIBUTORS

Our complete product offering encompasses all product categories necessary to stock an indoor horticulture store. Our product selection is the largest and most complete in the industry. We offer over 4,600 different specialty gardening products.

National brand name products — some of these brands include:

Eye Lighting	Cutting Edge Solutions
Ushio	Grow More
Solarmax	CF Group
Grodan	Fantech
General Hydroponics	Bonide
Botanicare	Carson Optical
FoxFarm	Microbe Life
HydroDynamics	Powerbox Inc.
DutchMaster	Uvonair
Roots Organics	Bloombastic & Rootbastic
Technaflora	Nutralife
Grotek	Grow Stones
Humboldt Nutrients	Nectar of the Gods
B'Cuzz/Atami	Sierra Natural Sciences (SNS)
Black Gold/Sunshine	Neptune's Harvest
Atmosphere/Vortex	Easy Grow Lightite Films
Premier Horticulture	Vital Earth's
Bond	Orca Film
Xtreme Gardening	Grozone

We exclusively distribute many proprietary brands:

Sun System Lighting	Sun Blaze
Galaxy Legacy & Grow Amp Ballasts	AgroLED
Galaxy Master Blaster Ballasts	Fast Fit
Digital Logic Ballasts	Hurricane Fans
Phresh Filters	Hydro Flow
Titan Controls	DigiMax Lamps
EcoPlus Fans, Pumps & more	Power All
Flame Defender Fire Extinguishers	Flo-n-Gro
Ultra Sun Lamps	Duralastics
Sun Hut - Indoor Greenhouses	Easy Clean Trays
Spectralux Lamps	Grower's Edge
Mother Earth Media	Shear Perfection
Measure Master Measuring Containers	Air Force Pro
Rainmaker Sprayers	Stake Out
Gro Pro	Mother Earth
Super Sprouter Seedling Heat & Propagation Supplies	Hydroton
SunGrip Light & Equipment Hangers	Afterburner
Sun Film - Reflective & Insulated Films	Hyper Fan
Ideal-Air	

We distribute many exclusive & co-exclusive products including:

Adjust-a-Wing Reflectors	Royal Gold Growing Media	Breakout Powder	AutoPot USA
Gavita	Zenport Hand Tools	Clearoma	Botanicare - Kind
BioAg	VermaPlex	Organic Mechanics	Supernatural
Grow Lab	Fantech Fans	Scissor Fix	Azasol
Natures Nectar	Hydro Rush	oxyClone	Samsung Air Conditioners
RediRoot Pots	No Spider Mites	Gold Label 80/20	Quest Dehumidifiers
Just Right Xtra Soil	Sticky Bye Bye	Zip Zag Bags	
Feliz Compact Fluorescent Lamps	NPK/OG Distribution	MaxSea	



WE ARE A WAREHOUSING AND LOGISTICS COMPANY

We inventory our products in 9 strategic distribution center locations. The majority of our orders arrive within 24 hours to retail stores who choose to buy from us. We can drop ship on behalf of a retail store from any location. Our national presence reduces shipping times and freight expense. Multiple locations mean redundant inventory. Outages at one location can often be filled by an alternate distribution center. Sunlight occupies over 800,000 sq. ft. of manufacturing, office and warehouse space in 12 locations in 7 states.



Vancouver, WA



Livermore, CA



Denver, CO



Samoa, CA

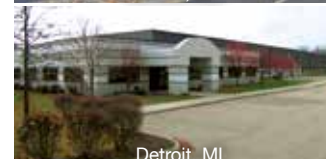

Detroit, MI



Ontario, CA



York, PA



Nashville, TN

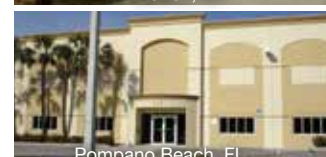

Pompano Beach, FL

The Right Environment



- Key components include relative humidity, temperature, CO₂, and air circulation/exchange
- Ideal humidity is between 40%-60%
- Some plants like higher humidity, but that can lead to problems with fungus and disease
- Ideal temperature is between 68°-75° F
- Plants need CO₂ to grow - with good air circulation and exchange, a room will naturally have between 300-400 PPM without supplemental CO₂

Choose A Method



- Ebb & Flow gardens flood and drain a tray of plants with a nutrient solution at regular intervals
- Drip gardens provide a nutrient solution to each plant through tubes & emitters (drip stakes)
- Aeroponic gardens mist an oxygenated nutrient solution directly to the roots of its plants
- NFT (Nutrient Film Technique) gardens flow a slow moving nutrient solution over the plants roots
- Organics are possible using many methods, and are often grown in container gardens

Nutrients/Fertilizers



- Liquid/Dry nutrients can be organic or synthetic
- Over or under fertilizing can cause burning, curling or yellowing of plants
- Most nutrient bottles are labeled with N-P-K (Nitrogen, Phosphorus, and Potassium)
- Additives/supplements can bolster microbial activity at the root zone, strengthen plant cell walls, increase flower sites, shorten length to harvest, increase size, flavor and aroma of fruits and flowers and more
- When used together, nutrients and supplements will help you achieve maximum results

Testing Equipment



- There are many meters available for testing solution pH, PPM, and EC
- Environmental controllers and meters are available to automate and more accurately control and maintain the temperature, humidity, CO₂ and lights
- Testing equipment for the water-nutrient solution, light, room temperature and humidity, CO₂, and air circulation is the key to a providing optimal conditions for a bountiful garden

Start With Good Water



- Water quality is essential to plant growth
- PPM (parts per million) or EC (electrical conductivity) measure salts in a solution
- Start off with a low PPM or EC and add nutrients specific to your plant variety requirements
- A Reverse Osmosis system can reduce PPM/EC
- pH (potential hydrogen) measures acidity or alkalinity in a solution on a scale of 0-14
- pH should range 5.8-6.2 in hydro and 6.0-6.8 in soil
- Nutrient "lockout" occurs in too high or low pH levels

Choose A Media



- Growing mediums act as the root anchor system
- Coco is made from the husks of a coconut, is pH stable, and provides moisture retention and aeration
- Expanded Clay pebbles provide moisture retention and aeration and are reusable if sterilized
- Rockwool stone is heated and spun into fibers then compressed, provides an excellent oxygen to water ratio, though flushing/conditioning is recommended
- Silica helps slow transpiration, provides moisture retention and aeration, and is reusable if sterilized
- Peat mixes can be altered to varying air/water ratios

Grow Lighting



- MH (Metal Halide) and HPS (High Pressure Sodium) are types of HID lights used in grow rooms
- MH lamps = Blue spectrum for vegetative
- HPS lamps = Orange/Red spectrum for flowering
- T5 lamps are high-output fluorescents with low heat/energy consumption ideal for cuttings, mother plants, and short growth cycles
- DE (Double Ended) lighting is a full spectrum HID lamp with a higher par reading than a single ended
- Plants in vegetative stage need 15-18 hrs. of light
- Plants in bloom stage need 10-12 hrs. of light

Optional Accessories



- Grow/Garden room accessories are essential for optimized growth and harvest
- Atmosphere drive devices such as fans, blowers, CO₂ emitters, and integrated timers are a grow rooms greatest accessory
- Trellising, stakes, supports, shears, and labels are useful when growing fruiting/flowering crops
- Pest and disease control may be needed and there are many organic options available
- For more information visit [SunlightSupply.com!](http://SunlightSupply.com)

HYDRO 101

A 8 STEP GUIDE TO SUCCESSFUL INDOOR HYDRO GARDENING

hydro·pon·ics

noun: the science of growing or the production of plants in nutrient rich solutions or moist inert material, instead of soil.



Hydroponic crops can use up to 90% less water than soil grown crops, when in a recirculating system.

1/4

You can plant 4 times the amount of hydroponic crops in the same area that soil crops need to grow.

x2

Hydroponic crops can grow twice as fast.



Hydroponically grown crops can be grown organically and without the use of herbicides & pesticides.



Sunlight Supply, Inc.

National Garden Wholesale.
sunlightsupply.com

INTRODUCTION & QUICK REFERENCE

WHY USE SUPPLEMENTAL LIGHTING FOR INDOOR OR GREENHOUSE GARDENING?

High intensity discharge (H.I.D.) lighting has traditionally been used only by commercial growers in large scale greenhouses. These business savvy professionals have long understood the exceptional benefits of supplemental, artificial lighting for plant growth. From stronger, healthier seed starts, into faster maturing, vigorous plants that offer much higher yields and more spectacular flowering than can be achieved without supplemental lighting. H.I.D. lighting not only supplements sunlight, but can actually replace it during long winters where sunlight is in short supply. It is very energy efficient and the cost of operating one of our light systems is comparable to using one of your kitchen appliances.

Plants need light for proper growth. The light spectrum range produced by artificial light (particularly H.I.D. light) enhances the natural light derived from the sun by many times over. The result... when combined with proper nutrients... is nothing short of AMAZING! And the best news is... this technology once

available only to the commercial market is now available to you. All this being said, what can supplemental lighting do for a home hobby grower?

- **SIGNIFICANTLY INCREASE** the health, strength, growth rate and yield of your plants.
- **SUPPLEMENT NATURAL SUNLIGHT** in your backyard greenhouse virtually eliminates seasonal & geographical restraints. In addition, by extending the "day length" with supplemental lighting, you will greatly enhance your growing success.
- **CONTAINER PLANTS** that are outdoors on decks and patios during the summer can be moved indoors during the winter under H.I.D. or high output fluorescent light allowing them to thrive year round.
- **INDOOR GARDENING** – Why settle for gardening just a few months of the year? By



using one of our light fixtures as a primary light source indoors, you can enjoy the hobby of gardening all year long!

High Intensity Discharge lighting systems have revolutionized indoor gardening in the last two decades. They are the most energy efficient grow lights available, so they produce much more light for the amount of power consumed.

LINEAR FLUORESCENTS

Traditional T12 and T8 fluorescent lighting is simply not powerful enough to light an area more than 8-10 inches below the bulb. With the recent introduction of the highly efficient T5 technology, T5 linear fluorescent fixtures can now put out a respectable 92.6 lumens per watt. T12 lamps typically put out about 30 lumens per watt. T5 fixtures are excellent for starting seeds and cuttings, but are also able to produce enough light for full term growth. Because of their minimal heat output, they can be placed very close to the plant canopy to maximize the light output.

HIGH WATTAGE SELF BALLASTED GROW LAMPS

These lamps have become quite popular in the recent past. We offer Feliz brand mogul base fluorescent lamps that put out about 70 lumens per watt. They are excellent for starting seeds or to use over a small garden area.

INCANDESCENT LAMPS

These standard household bulbs do not emit enough light, or the proper spectrum to be used by serious gardening enthusiasts. They are not very efficient, using a considerable amount of power for the light they emit. They are typically only about 15 lumens per watt.

Which Light is Right for You?

Most gardeners use at least 25 watts per square foot of garden space. You may need less if your light is used to supplement natural sunlight, or if you are growing a plant that does not require as much light (i.e. lettuce). However, many gardeners prefer to double or even triple the

recommended wattage to achieve faster growth rates. There is really no such thing as too much light, but using a big light in a small space will sometimes result in high temperatures that are difficult to control. Keep in mind that plants need periods of darkness too. Most indoor gardeners use lighting from 12 - 18 hours per day.

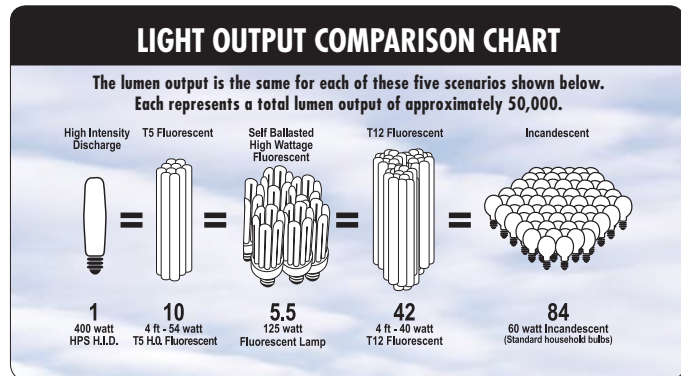

HIGH PRESSURE SODIUM (HPS) OR METAL HALIDE (MH)

If you choose H.I.D. as your source of lighting, you have another choice...HPS or MH. Sunlight Supply®, Inc. offers lights in MH and HPS. Metal Halide (MH) bulbs emit a light spectrum which appears blue-white to the human eye. This color spectrum is more conducive for vegetative growth, or starting seeds and cuttings. High Pressure Sodium (HPS) bulbs emit a spectrum which is more concentrated in red/orange light. This color is ideal for the fruiting and flowering stage of a plant's development. It is a good multi-purpose light as well.

Your style of gardening will determine which type of light is best for you. Whichever model you choose, you can be assured that your investment into the lighting technology used by the professional will be rewarded by increased, nutrition packed yields, lovelier flowers and healthier plants!

LIGHT REQUIRED FOR PHOTOSYNTHESIS

Only part of solar radiation is used by plants for photosynthesis. The photosynthetically active radiation (PAR) contains the wavelengths between 400 and 700 nanometers, and falls just within the so-called visible spectrum (380-770nm). The total visible spectrum is perceived by

us humans as white light, but with the aid of a prism, we see that the "white" light is actually separated into a spectrum of colors from violet to blue, to green, yellow, orange and red. Plants use the blue to red light as their energy source for photosynthesis.

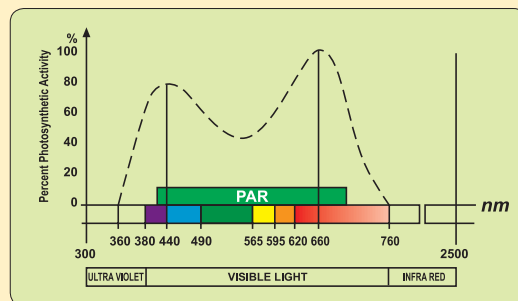

HANGING HEIGHT

A general guideline for the proper hanging height of an H.I.D. lamp would be 12" - 48" depending on wattage (see below). Make sure to check for excessive heat at the top of your plants by placing your hand (palm down) over your plants. If the top of your hand is hot, you need to move your lamp up higher. If the light source is too close to your plants, you can burn them. Remember that as your plants grow you will need to adjust the height of your lamp. Please keep in mind that the latest air-cooled reflectors, like the Super Sun® 2 allow you to place higher wattage bulbs closer to plants than was possible in the past.

When you raise the light up & away from your plants, you need to be aware of the light levels at your plants will be significantly reduced.

As light moves away from its source (the lamp) it diminishes as follows: $1/\text{Distance}^2$. For example: 1ft. = 1000 FC, 2ft. = 250 FC, 3ft. = 111 FC, 4ft. = 63 FC, 5ft. = 40 FC, & 6ft. = 28 FC.

Coverage area

A fluorescent fixture can be placed much closer to plants than an H.I.D. fixture because it produces very little heat. You should place your fluorescent lights as close to the tops of your plants as you can without excluding the outside perimeter of your garden.

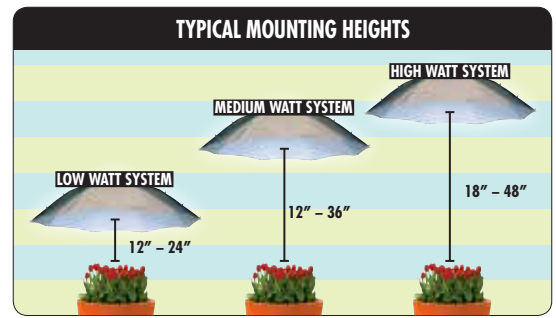

H.I.D. AVERAGE COVERAGE AREA BY WATTAGE

150/175 watts covers approx. 2' x 2' area
 250 watts cover approx. 3' x 3' area
 400 watts covers approx. 4' x 4' area
 600 watts covers approx. 6.5' x 6.5' area
 1000 watts covers approx. 8' x 8' area

NOTE: Coverage area may be reduced if
this is your primary light source.

FAQ - HORTICULTURAL LIGHTING

General Lighting Questions:

1) What is HID Lighting?

HID lighting stands for High Intensity Discharge, which is a special type of lighting that is much more intense (brighter) than other type of lighting available. An HID lighting system consists of a ballast, reflector, socket and lamp (light bulb). The ballast acts like the engine, converting and driving energy to illuminate the lamp. HID lighting options include High Pressure Sodium (HPS), Metal Halide (MH), Mercury Vapor and Low Pressure Sodium. The two typically used for plant growth are HPS and MH systems.

2) What is Color Rendering Index (CRI), Color Temperature (K) and Lumen?

Color Rendering Index is a subjective measurement of how well a lamp source renders colors. A measurement of the degree of color-shift an object undergoes when illuminated by a light source when compared to a reference source of comparable color temperature. Incandescent light is assumed to have a CRI of around 100 so it will render all colors correctly. MH only has a CRI of about 70, so only 70% of colors will be rendered correctly. HPS has a CRI of 22.

Color Temperature is not how hot the lamp is. Color temperature is the relative whiteness of a piece of tungsten steel heated to that temperature in degrees Kelvin. HPS has a warm (red) color temperature of around 2200°K as compared to MH at 4200°K, which has a cool (blue) color temperature. What is important to remember about these two terms is that CRI readings, of two sources, can only be compared if their color temperature is equal. You cannot compare the CRI of HPS (CRI=22) vs. Metal Halide (CRI=70) because the color temperatures are different (2200°K vs. 4500°K).

Lumen is a measurement of light output. It refers to the amount of light emitted by one candle that falls on one square foot of surface located at a distance of one foot from the candle. Traditionally, lumens have been the benchmark of a lamp's ability to grow plants; meaning the brighter the lamp the better the plant. However, studies have shown that a broader color spectrum lamp will perform much better than a lamp with high lumen output, especially when it comes to plant growth.

3) What is the difference between MH and HPS with regards to plant growth?

MH lamps provide more of the blue/green spectrum, which is ideal for leafy crops, and/or plants that are in a vegetative (actively growing) stage. MH lamps provide a more natural appearance in color and are typically the choice for plants that have little to no

natural light available. HPS lamps provide more yellow/orange/red spectrum, which is ideal for most plants that are actively fruiting and flowering. In addition, HPS lighting is the choice for growers looking to supplement natural sunlight. Ideally, the horticulturalist will use MH to grow their plants and HPS to fruit and flower their plants.

4) What is the difference between HID and Fluorescent lighting with regards to plant growth?

Traditionally, fluorescent lighting was used for seedlings, cuttings and plants with low light-level requirements and HID was used for established plants and plants with higher light-level requirements. Advances in fluorescent lighting technology, however, have provided more options for horticulturists. T5 fluorescent lighting is the latest in plant growth lighting. T5's high-light output combined with its low heat and energy consumption makes it an ideal light source to grow a broader array of plants.

5) What are the benefits of using T5 fluorescent lighting for plant growth?

T5 lamps provide the ideal spectrum for plant growth. Photosynthesis rates peak at 435 nm and 680 nm. A 6500K T5 lamp has a spectral distribution with relative intensity peaks at 435 nm and 615 nm. This equates to very little wasted light energy in terms of plant growth. T5 lamps promote incredible health and vigor of seedlings and cuttings. Root development is superior relative to other lighting sources. While T5 lighting is excellent for starting seeds and cuttings, it's also able to produce enough light for full term growth. Because of their minimal heat output, T5 lamps can be placed 6" - 8" above the plant canopy which maximizes photosynthetic response. Unlike conventional fluorescents, plants grown under T5 lamps do not have to be rotated to the center of the lamp. T5's slim diameter enables better photo-optic control of the emitted light, increasing efficiency in the form of even light distribution.

Environmental Impacts of T5 (at a glance):

- T5 lamps have a diameter of 5/8" - smaller is better when it comes to manufacturing, transportation and disposal.
- Reduction in raw materials and components needed for manufacturing.
- Reduction in lamp and fixture packaging materials due to relative size.
- T5 are constructed of 40% less glass than T8.
- T5 contain 30% less phosphor than T8.
- T5 contain 3mg of mercury. 70% less than T8.
- Longer lamp life means reduced maintenance cost and less going to the landfill.



FAQ - HORTICULTURAL LIGHTING

6) What are the major differences between HID ballasts and electronic ballasts?

Frequency output to the lamp and energy conversion from electricity to usable light are the biggest differences between HID ballasts and electronic ballasts. HID ballasts produce a frequency of 60 Hz. Electronic ballasts vary from manufacturer to manufacturer, but the frequency produced can be 400x that of an HID ballast. HID ballasts produce more heat than electronic ballasts, thus making electronic ballasts more energy efficient. You will not, however, save money on your electric bill by using electronic ballasts. HID lighting has been available for 60+ years, while electronic ballast (especially 400 watt and higher) is a relatively new technology.

7) Are electronic ballasts more energy efficient?

Electronic ballasts are more efficient at converting electricity into usable light. Since your power bill is based on kilowatt-hours and not efficiency, a 1000 watt electronic ballast will cost you about the same as a 1000 watt HID ballast to operate.

8) How much energy will my light use?

An average lighting system will increase your electricity cost about \$8 to \$20 per month. The exact amount depends on the wattage of the system and the number of hours operated. To calculate your cost, multiply the bulb wattage by the number of hours of operation and divide by 1000. This figure is the number of kilowatt-hours of electricity used. (Example: a 400 watt lamp running for 18 hours will use 7.2 kilowatt-hours). Check your power bill for the cost of each kilowatt-hour. Then multiply the number of kilowatt-hours used by the cost of a kilowatt-hour (K/hr) to figure the cost to run your light for that many hours.

9) Do I need special wiring in my house for my lighting system?

Lighting systems are available in a variety of voltages. The standard used by most gardeners is 120 volts / 60 Hz which plugs into a standard wall outlet. Other voltages may require special circuits and receptacles. Always contact a licensed electrician if the light you purchased has special voltage requirements and never exceed more than 75% of the rated ability of the fuse/breaker. (For example: use no more than 15 amps on a 20-amp circuit.)

10) What voltages are available for HID and Fluorescent lights?

HID systems are available in 120 volt, 208 volt, 240 volt, 277 volt and 480 volt. Fluorescent lighting varies, but most are available from 120 volt to 277 volt and 50 Hz or 60 Hz.

11) Will I save on my electric bill if I run my system with 240 volts?

No. Electric companies base your electrical bill on Wattage, not Voltage or Current. While ballasts wired for 240 volt will draw less current and run a little cooler than one wired for 120 volt, it will not save you money on your electric bill.

12) How often do I need to change my light bulb?

Most lamp manufacturers rate their lamps by "Average Life Hours" and usually claim 10,000 to 24,000 hours. These ratings are based on when the lamp will completely fail to come on. They do not factor in loss of intensity or loss of color. HID lamps lose intensity and color through normal use. This is OK if you are lighting a warehouse, but when it comes to plant growth, these losses can mean wasted electricity and poor plant performance. Serious horticulturalists recommend that you replace your lamps after 6000 hours of use. This equates to using your light 16 hours a day for one year¹³) How long should I run my lights? This depends on the type of plants and whether you have natural sunlight available to your garden. As a general rule, when you are in a vegetative stage of plant growth and you have no natural sunlight, run your lights 14-18 hours a day. If you have natural sunlight, it will vary because the sunlight may or may not be direct.

It will take a little experimenting to find the best length of time to run your lights. If you are actively fruiting and flowering, the rule is to run your lights 12 hours a day if you have no natural light.

14) How high do I need to hang my lights above my plants?

The higher the wattage the further away you want the light to be from your plants due to the amount of heat. HID lighting will be further away than a fluorescent fixture because of this. When mounting your lighting fixture take into account the type of plant and how tall the plant will grow. You want to keep the light as close as you can, but not so close to burn the plant. A simple rule is "if it is comfortable for the back of your hand, it will be a safe distance for your plants". Doing a little research on the type of plant and where it comes from will help in determining how much (or little) light your plants like. With fast growing plants, you may need to check the hanging height on a regular basis as plants that get too close to the lamp will be severely burned.

15) How big of an area will my light cover?

The size of the garden area will determine the wattage you need. If we assume that the plants will get no sunlight, a 1000 watt light will cover about 7 x 7 feet of growing area. A 600 watt will cover 6 x 6 feet, a 400 watt will cover 4 x 4 feet, and a 250 watt will cover 3 x 3 feet. These sized areas would be considered the "Primary Growing" areas. These lights will light-up larger areas, but plants placed outside of the Primary Growing area, will stretch and bend toward the light; a phenomenon called phototropism. Keep these areas of coverage in mind when using multiple fixtures. The best results occur when the areas of coverage overlap.

16) Why do I need glass to get the ETL Listing on a Metal Halide light?

Edison Testing Laboratories has stated that for a metal halide fixture to maintain its ETL Listing, that an additional tempered safety lens is required. The purpose of the glass is to prevent UV exposure in the event of an outer jacket failure.

17) Can I run a 1000 watt bulb in my 400 watt lighting system?

No! The internal components of the ballast are designed to send the correct voltage and current for the rated lamp. Mixing lamps and ballasts will result in premature failure and will void the manufacturers' warranty. Consider the size area you want your garden to be prior to making a lighting purchase. It is better to grow into a fixture than out of one.

18) Can I run a 430 watt bulb in a 400 watt lighting system?

Yes, the internal components of 400 watt and 430 watt ballasts are almost identical. You will only get 400 watts of light out of the 430 watt lamp, however.

19) Do I need to wear gloves when handling an HID light bulb?

Manufacturers do not state that gloves are required when handling their lamps. It is recommended that your hands be thoroughly washed prior to handling HID lamps though.

20) What is a conversion bulb?

A lamp that operates on the opposite ballast it was originally designed for. For example, a 940 watt conversion lamp is an HPS lamp that runs on a 1000 watt Metal Halide Ballast. There are also MH lamps that are designed to operate on HPS ballasts. These bulbs allow the grower to purchase the ballast of their choice and offer the flexibility of growing a variety of plant types by simply changing the lamp they need.

21) How do I clean the inside of my Sun System® Reflector?

Warm water and mild dish soap are the best to clean and maintain the highly reflective finish. Avoid bleach, ammonia and other harsh or abrasive cleaners.

22) How do I set up a grow light?

Scan the QR code for the complete assembly of a grow light.



QUICK REFERENCE/CONVERSIONS

Conversions

1 US gallon is equal to:

4 quarts	128 ounces	768 tsp
8 pints	3.785 liters	8.34 lbs
16 cups	256 tbsp	231 cu. in.

1 cup is equal to:

8 ounces	48 tsp	0.23 liter
½ pint	236 ml	14.4 cu. in.
16 tbsp	0.52 lbs	236 grams

1 tablespoon is equal to:

½ ounce	3 tsp	15 grams
15 ml	180 drops	0.663 cup

1 liter is equal to:

1000 ml	4.328 cups	202.88 tsp
2.164 pints	67.63 tbsp	0.264 gal
1000 grams	2.22 lbs	1.057 quarts

Measurement equivalents

3 tsp = 1 Tbsp	1 ml = 1/5 tsp
2 Tbsp = 1 fluid oz	5 ml = 1 tsp
16 Tbsp = 1 cup	15 ml = 1 Tbsp
2 cups = 1 pint (16 oz)	30 ml = 1 fluid oz
2 pints = 1 quart (32 oz)	240 ml = 1 cup
4 quarts = 1 gal (128 oz)	3840 ml = 1 gal

Common Size Conversions

n/a	3.38 ounces	100 milliliter	0.1 Liter
n/a	4 ounces	118.3 milliliter	0.118 Liter
1/2 Pint	8 ounces	237 milliliter	0.237 Liter
Pint	16 ounces	473 milliliter	0.473 Liter
Quart	32 ounces	946 milliliter	0.946 Liter
Gallon	128 ounces	3785 milliliter	3.785 Liter
2.5 Gallon	320 ounces	9464 milliliter	9.464 Liter
5 Gallon	640 ounces	18930 milliliter	18.93 Liter
6 Gallon	768 ounces	22710 milliliter	22.71 Liter

Definitions & Abbreviations

ppm = parts per million
mho = conductivity
mS = millisiemen
uS = microsiemen
tds = total dissolved solids
ec = electrical conductivity
pH = potential hydrogen

1 Siemen = 1000 mS
1 mS = 1000 uS
1 mS = 500 ppm (standard)
1 mS = 650 ppm (horticultural)
1 mg/liter = 1 ppm

C Carbon	Mn Manganese
Ca Calcium	Mo Molybdenum
Cl Chlorine	N Nitrogen
Cu Copper	Na Sodium
Fe Iron	O Oxygen
F Fluorine	P Phosphorus
H Hydrogen	S Sulfur
K Potassium	Zn Zinc

Lighting Conversion

$$1 \text{ footcandle} = \text{lumen/ft}^2$$

Watts, Amps & Volts Formula

$$\text{Amps} = \text{Wattage} \div \text{Voltage}$$

$$\text{Voltage} = \text{Wattage} \div \text{Amps}$$

AMPS are how many electrons flow past a certain point per second. VOLTAGE is a measure of how much force that each electron is under. WATTAGE is the electric power required by an appliance or device.

°F/°C TEMPERATURE CONVERSION

200° C = 392° F	100° C = 212° F	75° C = 167° F	40° C = 104° F
150° C = 302° F	95° C = 203° F	70° C = 158° F	30° C = 86° F
125° C = 257° F	90° C = 194° F	65° C = 149° F	20° C = 68° F
110° C = 230° F	85° C = 185° F	60° C = 140° F	10° C = 50° F
105° C = 221° F	80° C = 176° F	50° C = 122° F	0° C = 32° F

°F/°C TEMPERATURE FORMULA

$$^{\circ}\text{C} = (^{\circ}\text{F} - 32) \times 5/9$$

$$^{\circ}\text{F} = (^{\circ}\text{C} \times 9/5) + 32$$

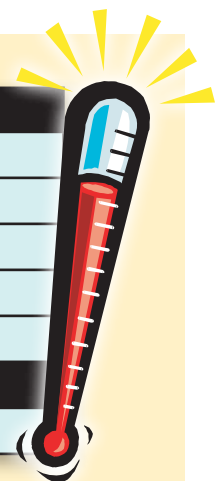



QUICK REFERENCE/CONVERSIONS

The NPK's of Growing

(N) NITROGEN

Nitrogen is essential for plant growth. Nitrogen is a part of every living cell. The two forms of nitrogen which plants take up are in the ammonia (NH₄) and nitrate (NO₃) ion forms. Most agronomic crops take up most of their nitrogen in the nitrate ion form. Plants will utilize N in the (NH₄) ion form if present and available to the plant.

Lack of nitrogen and chlorophyll means that plants cannot utilize sunlight as an energy source to carry on essential functions such as nutrient uptake. Research has proven a foliar or leaf application of nitrogen is one form of application that can supplement a plant's nitrogen requirements during

the growing cycle.

- * Nitrogen is necessary for chlorophyll synthesis and as a part of the chlorophyll molecule involved in photosynthesis.
- * Nitrogen is also a component of amino acids.
- * Nitrogen is needed for growth of plants.

From the Greek words "nitron genes" meaning "nitre" and "forming" and the Latin word "nitrum". Discovered in Scotland by Daniel Rutherford in 1772.

(P) PHOSPHORUS

Phosphate is a very important plant nutrient (macro-nutrient) needed for the plant to complete its normal production cycle. The highest level of P in young plants is found in tissue at the growing stage. As plants mature most

of the P moves into the flower and then to the seed or fruit.

- * Phosphorus is needed for photosynthesis.
- * Phosphorus is necessary for plant respiration.
- * Phosphorus is essential for energy storage and transfer.

- * Phosphorus is needed for cell division.
- * Phosphorus is necessary for cell enlargement.
- * Phosphorus is essential for several other plant processes.

From the Greek word "phosphoros" meaning "bringer of light" (an ancient name for the planet Venus?). Discovered in Germany by Hennig Brand in 1669.

(K) POTASSIUM









An important function of Potassium is its influence in efficient water use. It helps in the process of opening and closing of plant leaf pores, called the stomata. Potassium is found in cell walls which surround stomata. Adequate amounts of Potassium can increase stress conditions on plants during drought conditions. Potassium is also responsible for producing quality crops.

- * Potassium is essential for protein synthesis.
- * Potassium is important in the breakdown of carbohydrates, providing energy for plants.
- * Potassium helps to control ionic balance.
- * Potassium is important in the translocation of minerals.
- * Potassium helps plants to overcome effects of disease.



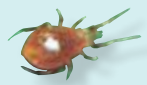







- * Potassium is essential in the fruit formation stage.
- * Potassium helps improve shelf life of fruits and vegetables.
- * Potassium is involved in the activation of more than 60 enzymes which regulate the rates of major plant growth reactions.

From the English word "potash" and the Arabic word "qali" meaning alkali ("K" comes from the Latin word "kalium"). Discovered in England by Sir Humphrey Davy in 1807.

Beneficial Insects

 Aphid Predator Aphidius sp.	 Lacewing Chrysoperla rufilabris
 Lady Beetle Hippodamia convergens	 Mealybug Destroyer Montrosieri Cryprolaemus
 Minute Pirate Bug Orius sp.	 Predatory Mite Phytoseiulus persimilis
 Trichogramma spp.	 Whitefly Parasite Encarsia formosa
 Praying Mantis Tendora aridifolia sinensis	

Destructive Insects, Mites

 Aphid	 Aphid (winged)	 Bagworm Larva	 Billbug
 Cucumber Beetle	 Cyclamen Mite	 Earwig	 Fungus Gnat (Adult)
 Fungus Gnat (Larva)	 Lacebug	 Mealybug	 Rose Chafer
 Sowbug	 Spider Mite	 Spittlebug	 Thrips
 White Fly	 White Grub		

MEASUREMENT CONVERSION CHART

This measurement conversion chart, provided by Bluelab®, is a useful tool for all hydroponic growers. It allows you to convert between common units of measure when testing your nutrient solution.

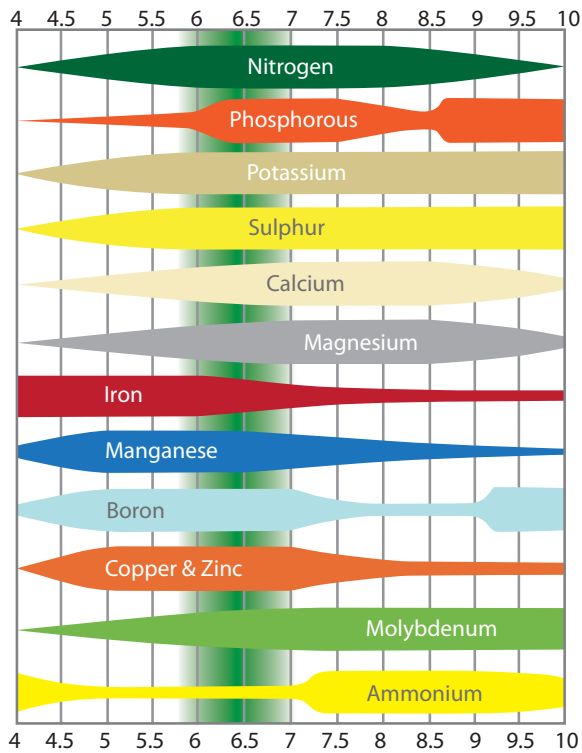

This pH Chart (right) shows the Safe Zone is between 5.8 and 6.8.

pH - Why it's important

The pH scale, from 1 to 14, measures acid-to-alkaline balance. The number 1 is the most acidic, 7 is neutral, and 14 most alkaline. Every full-point change in pH signifies a ten-fold increase or decrease in acidity or alkalinity. For example, soil or water with a pH of 5 is ten times more acidic than water or soil with a pH of 6. Water with a pH of 5 is one hundred times more acidic than water with a pH of 7. With a ten-fold difference between each point on the scale, accurate measurement and control is essential to a strong, healthy garden.

Most plants grow best in soil with a pH from 6.5 to 7. Within this range plants can properly absorb and process available nutrients most efficiently. If the pH is too low (acidic), acid salts chemically bind nutrients, and the roots are unable to absorb them. An alkaline soil with a high pH causes nutrients to become unavailable. Toxic salt buildup that limits water intake by roots also becomes a problem. Hydroponic solutions perform best in a pH range a little lower than for soil. The ideal pH range for hydroponics is from 5.8 to 6.8. Some gardeners run the pH at lower levels and report no problems with nutrient uptake. The pH of organic soil mixes is very important because it dictates the ability of specific pH-sensitive bacteria.

Measure the pH with a soil test kit, litmus paper, or electronic pH tester, all of which are available at most nurseries. When testing pH, take two or three samples and follow instructions supplied by the manufacturer "to the letter". Soil test kits measure soil pH and primary nutrient content by mixing soil with a chemical solution and comparing the color of the solution to a chart. Most of these kits are difficult for novice gardeners to achieve accurate measurements. Comparing the color of the soil/chemical mix to the color of the chart is often confusing. If you use one of these kits, make sure to buy one with good, easy-to-understand directions, and ask the sales clerk for exact recommendations on using it.

Bluelab Measurement Conversion Chart

mS/cm ² millisiemen per cm ²	EC	CF	ppm 500 (TDS) (USA)	ppm 700 (UK, CA, AUST)
0.1	0.1	1	50	70
0.2	0.2	2	100	140
0.3	0.3	3	150	210
0.4	0.4	4	200	280
0.5	0.5	5	250	350
0.6	0.6	6	300	420
0.7	0.7	7	350	490
0.8	0.8	8	400	560
0.9	0.9	9	450	630
1.0	1.0	10	500	700
1.1	1.1	11	550	770
1.2	1.2	12	600	840
1.3	1.3	13	650	910
1.4	1.4	14	700	980
1.5	1.5	15	750	1050
1.6	1.6	16	800	1120
1.7	1.7	17	850	1190
1.8	1.8	18	900	1260
1.9	1.9	19	950	1330
2.0	2.0	20	1000	1400
2.1	2.1	21	1050	1470
2.2	2.2	22	1100	1540
2.3	2.3	23	1150	1610
2.4	2.4	24	1200	1680
2.5	2.5	25	1250	1750
2.6	2.6	26	1300	1820
2.7	2.7	27	1350	1890
2.8	2.8	28	1400	1960
2.9	2.9	29	1450	2030
3.0	3.0	30	1500	2100
3.1	3.1	31	1550	2170
3.2	3.2	32	1600	2240
3.3	3.3	33	1650	2310
3.4	3.4	34	1700	2380
3.5	3.5	35	1750	2450
3.6	3.6	36	1800	2520

Container Capacities

PROD. #	POT SIZE	POT CAPACITY
724140	5"x 5"x 6.5" square pot black jumbo senior	2.8 qt. / 2.65 liter
724150	5"x 5"x 6.5" square pot white jumbo senior	2.8 qt. / 2.65 liter
724160	6"x 6"x 7" square pot black magnum	4.35 qt. / 4.1 liter
724425	5.5"x 5.5"x 6" square pot white jumbo	3.15 qt. / 3 liter
724525	Am Hydro Perfect Pot	1.75 gal. / 7 qt. / 6.6 liter
724540	1 gallon nursery pot	1 gal. / 4 qt. / 3.78 liter
724545	2 gallon nursery pot	2 gal. / 8 qt. / 7.57 liter
724550	3 gallon nursery pot	3 gal. / 12 qt. / 11.35 liter
724555	5 gallon nursery pot	5 gal. / 20 qt. / 19 liter

Pot Size	# of Pots per 3 CF Bag
4" square pot	147
1 gallon pot	21
2 gallon pot	10
3 gallon pot	7
5 gallon pot	4



GLOSSARY

Alternating Current (AC): An electric current that reverses its direction at regular occurring intervals. Homes have AC.

Acid: An acid or sour substance has a pH below 7.

Aeration: Supplying soil and roots with air or oxygen.

Aeroponics: Growing plants by misting roots suspended in air.

Alkaline: Refers to a substance with high pH; Any pH over 7 is considered alkaline.

All-Purpose (General-Purpose) Fertilizer: A balanced blend of N-P-K; All purpose fertilizer is used by most growers.

Amendment: Fortifying soil by adding organic or mineral substances in order to improve texture, nutrient content or biological activity.

Ampere (Amp): The unit used to measure the strength of an electric current.

Annual: A plant that normally completes its entire life cycle in one year or less. Tomatoes are examples of annual plants.

ANSI: American National Standards Institute requires a specific code be printed on the lamp and on the corresponding ballast. These codes must match in order for the system to operate properly.

Arc: Luminous discharge of electricity (light) between two electrodes.

Arc Tube: A quartz container for luminous gases also houses the arc in HID lights.

Auxin: Classification of plant hormones; Auxins are responsible for foliage and root elongation.

Bacteria: Very small, one-celled organisms.

Beneficial Insect: A good insect that eats bad flower and vegetable munching insects.

Biodegradable: Able to decompose or break down through natural bacterial or fungal action, substances made of organic matter are biodegradable.

Bolt: Term used to describe a plant that has gone to seed prematurely.

Bonsai: A very short or dwarfed plant.

Breaker Box: Electrical circuit box having on/off switches rather than fuses.

Breathe: Roots draw in or breathe oxygen, stomata draw in or breathe carbon dioxide.

British Thermal Unit (BTU): Amount of heat energy required to raise the temperature of one pound of water by one degree Fahrenheit.

Bud Blight: A withering condition that attacks flower buds.

Buffering: The ability of a substance to reduce shock and cushion against pH fluctuations.

Bulb: The outer glass envelope or jacket that protects the arc tube of an HID lamp.

Bulbs: Common are tulips and daffodils planted in the fall for spring blooms, or forced indoors for winter blooms.

Calyx: The pod harboring female ovule and two protruding pistils, seed pod.

Carbon Dioxide: (CO₂) A colorless, odorless, tasteless gas in the air necessary for plant life and biomass accumulation.

Carbohydrate: Neutral compound of carbon, hydrogen and oxygen. Sugar, starch and cellulose are carbohydrates.

Caustic: Capable of destroying, killing or eating away by chemical activity.

Cell: The base structural unit that plants are made of; cells contain a nucleus, that houses it's DNA.

Cellulose: A complex carbohydrate that stiffens a plants tissue.

CFM: Cubic feet per minute.

Chelate: Combining nutrients in an atomic ring that is easy for plants to absorb.

Chlorine: Chemical used to purify water.

Chloroplast: Containing chlorophyll.

Chlorosis: The condition of a sick plant with yellowing leaves due to inadequate formation of chlorophyll. Chlorosis is caused by nutrient deficiency, usually iron or imbalanced pH.

Clay: Soil made of very fine organic mineral particles. Clay is not suitable for container gardening.

Climate: The average condition of the weather in a garden room or outdoors.

Color Spectrum: The band of colors (measured in nm) emitted by a light source.

Color Temperature: The relative whiteness of a piece of tungsten steel heated to that temperature in degrees kelvin.

Color Tracer: A coloring agent added to many commercial fertilizers, so the horticulturist knows there is fertilizer in the solution.

Compaction: Soil condition that results from tightly packing soil; compacted soil allows for only marginal aeration and root penetration.

Companion Planting: Planting garlic, marigolds, etc., along with other plants to discourage insect infestation.

Compost: A mixture of decayed organic matter.

Core: The transformer in the ballast is referred to as the core in HID lighting systems.

Corms, Rhizomes and Tubers: Dormant stems planted in the fall for spring blooms, or forced indoors for winter blooms. Common varieties are dahlias and irises.

Cotyledon: Energy storage components of a seed that feed the plant before the emergence of its first true leaves.

Cross-Pollinate: Pollinating two plants having different ancestry.

Cubic Foot: Volume measurement in feet: L' x W' x H' ÷ 1728" = Cu. Ft.

Cutting: (1) Growing tip cut from a parent plant for asexual propagation (2) Clone.

Damping-Off: Disease that attacks young seedlings and cuttings causing stem to rot at base.

Direct Current (DC): An electric current that flows in only one direction.

Deplete: Exhaust soil of nutrients, making it infertile.

Desiccate: Cause to dry up. Insecticidal soap desiccates its victims.

Dioecious: Having distinct male and female organs on different plants within the same species.

Dome: The part of the HID outer bulb opposite the neck and threads.

Dome Support: The spring like brackets that mount the arc tube within the outer envelope.

Drainage: Way to empty soil of excess water: with good drainage, water passes through soil evenly.

Drip Line: A line around a plant directly under its outermost branch tips: Roots seldom grow beyond the drip line.

Drip System: A very efficient watering system that employs a main hose with small water emitters.

Dry Ice: A cold, white substance formed when carbon dioxide is compressed and cooled; dry ice changes into CO₂ gas at room temperature.

Electrode: A conductor used to establish electrical arc or contact with non-metallic part of circuit.

Elongate: Growth in length.

Envelope: Outer protective bulb or jacket of a lamp.

Equinox: The point at which the sun crosses the equator and day and night are each 12 hours long; the equinox occurs twice a year, in spring and fall.

Feed: Deliver nutrient to the plant via roots or foliage.

Female: Pistillate, ovule, seed-producing.

Ferretting: To fertilize and irrigate at the same time.

Fertilizer Burn: Over fertilization: first leaf tips burn (turn brown) then the leaves curl.

Flat: Shallow (three inch) deep container, often 18 by 24 or 10 by 20 inches with good drainage, used to start seedlings or cuttings.

Fluorescent Lamp: Electric lamp using a tube filled with fluorescent material, which has a low heat output.

Foliage: The leaves or more generally, the green part of a plant.

Foliar Feeding: Misting fertilizer solution which is absorbed by the foliage. Best to do when first turning on your lights.

Foot-Candle: The unit is defined as the amount of illumination that the surface of an imaginary 1-foot radius sphere would be receiving if there were a uniform point source of one candle in the

exact center of the sphere. The foot-candle is equal to one lumen per square foot. Foot-candle is a derived unit of illuminance from Lux. One foot-candle is equal to 10.76 lux.

Fungistat: A product that inhibits fungus keeping it in check.

Fungus: A lower plant lacking chlorophyll which may attack green plants; mold, rust, mildew.

Fuse: Electrical safety device consisting of a metal that melts and interrupts the circuit when circuit is overloaded.

Fuse Box: A box containing fuses that control electric circuits.

GPM: Gallons per minute.

Gene: Part of a chromosome that influences the development of plant; genes are inherited through sexual propagation.

Genetic Make Up: The set of genes inherited from parent plants.

Halide: Binary compound of a (halogens) with an electropositive elements.

Hermaphrodite: One plant having both male and female organs; the breeding of hermaphrodites is hard to control.

Hertz (hz): A unit of frequency that cycles one time each second: a home with 60 Hertz AC current cycles 60 times per second.

HID: High Intensity Discharge.

Honey Dew: A sticky, honey like substance secreted into foliage by aphids, scale and mealy bugs.

Hood: Lighting reflector.

HOR: The abbreviation stamped on some HID bulbs meaning they must be burned in a horizontal position.

Horizontal: Parallel to the horizon, ground or floor.

Hormone: Chemical substance that controls the growth and development of a plant. Root-inducing hormones help cuttings root.

Humidity: (relative): Ratio between the amount of moisture in the air and the greatest amount of moisture the air could hold at the same temperature.

Humus: Dark, fertile, partially decomposed plant or animal matter; humus forms the organic portion of the soil.

Hybrid: An offspring from two plants of different breeds, variety or genetic make up.

Hydrated Lime: Instantly soluble lime, used to raise pH or sweeten soil.

Hydrogen: Light or colorless, odorless gas; hydrogen combines with oxygen to form water.

Hygrometer: Instrument for measuring relative humidity in the atmosphere.

Inbred: (True Breed) Offspring of plants of the same breed or ancestry.

Inert: Chemically non-reactive; inert growing mediums make it easy to control the chemistry of the nutrient solution.

GLOSSARY

Intensity: The magnitude of the light energy per unit; intensity diminishes the farther away from the source.

Jacket: Protective outer bulb or envelope of lamp.

Kilowatt Hour: Measure of electricity used per hour; a 1000-watt HID uses one kilowatt in one hour.

Lacewing: Beneficial insects that preys on aphids.

Leach: Dissolve or wash out soluble components of soil by heavy watering.

Leaf Curl: Leaf malformation due to over-watering, over fertilization, lack of magnesium, insect or fungus damage or negative tropism.

Leaflet: Small immature leaf.

Leaves: The external part of a plant attached to branches and stems for the purpose of taking in light from the sun's energy. They do this with chloroplasts in the cells which contain chlorophyll.

LEC (Light Emitting Ceramic) metal halide: Ceramic metal halide high intensity discharge lighting is the next generation of the traditional metal halide lighting, offering longer life, improved lumen characteristics and energy savings.

LED: Light-Emitting Diode: a semiconductor diode that emits light when conducting current and is used in electronic equipment, especially for displaying readings on digital watches, calculators, lights, etc.

Leggy: Abnormally tall internode space, with sparse foliage. Leggyness of a plant is usually caused by lack of blue light or CO₂. Too much nitrogen can also cause this.

LEP (Light Emitting Plasma): Plasma, the fourth state of matter is a type of compact, long life lighting source powered by a radio frequency.

Life Cycle: A series of growth stages through which a plant must pass in its natural lifetime; the stages for an annual plant are seed, seedling, vegetative and floral.

Light Mover: A device that moves a lamp back and forth or in a circle across the ceiling of a garden room to provide more even distribution of light.

Lime: Used in the form of dolomite or hydrated lime to raise and stabilize soil pH.

Litmus Paper: Chemically sensitive paper used for testing pH.

Loam: Organic soil mixture of crumbly clay, silt and sand.

Lumen: Measurement of light output: one lumen is equal to the intensity of light emitted by one candle that falls on one square foot of surface located one foot away from one candle.

Macro Nutrient: One or all of the primary nutrients N-P-K or the secondary nutrients magnesium and calcium.

Mean: Average throughout life; HID's are rated in mean lumens.

Meristem: Tip of plants growth.

Micromol: μmol. A unit of measurement for PAR photosynthetic active radiation (a specific wavelength of light spectrum).

Micro Nutrient: Also referred to as trace elements, including S, Fe, Mn, B, Mo, Zn, and Cu.

Millimeter: Thousandth of a meter approximately .04 inch.

Moisture Meter: An electronic device that measures the exact moisture content of soil at any given point.

Monochromatic: Producing only one color; LP sodium lamps are monochromatic.

Mother Plant: The original source plant that clones or cuttings are taken from.

Mulch: A protective covering of organic compost, leaves, etc.; indoors, mulch keeps soil too moist and possible fungus could result.

Nanometer: .00000001 Meter, nm is used as a scale to measure wave lengths of light; color and light spectrums are expressed in nanometers (nm).

Necrosis: Localized death of a plant part.

Neck: Tubular glass end of the HID bulb, attached to the threads.

Nutrient: Plant food, essential elements N-P-K, secondary and trace elements fundamental to plant life.

Ohm's Power Law: A law that expresses the strength of an electric current; volts times amperes equals watts.

Organic: Made of, or derived from or related to living organisms. In agriculture organic means "natural". In chemistry organic means "a molecule or substance that contains carbon".

Ovule: A plant's egg found within the calyx, it contains all the female genes; when fertilized, an ovule will grow into a seed.

Oxygen: Tasteless, colorless element, necessary in soil to sustain plant life as well as animal life.

Parasite: Organism that lives on or in another host organism; fungus is a parasite.

Peat: Partially decomposed vegetation (usually moss) with slow decay due to extreme moisture and cold.

Perennial: A plant, such as a tree or shrub, which completes its life cycle over several years.

pH: A scale from 1 to 14 that measures the acid to alkaline balance of a growing medium (or anything); in general plants grow best in a range of 5.5 to 6.8 pH.

pH Tester: Electronic instrument or chemical used to find where soil or sater is on the pH scale.

Photometrics: The study of light, especially color.

Phosphor Coating: Internal bulb coating that diffuses light and is responsible for variations in color outputs.

Photoperiod: The relationship between the length of light and dark in a 24 hour period.

Photosynthesis: The building of chemical compounds (carbohydrates) from light energy, water and carbon dioxide.

Phototropism: The specific movement of a plant part towards a light source.

Pigment: The substance in paint or anything that absorbs light, producing (reflecting) the same color.

Pollen: Fine, dust like micro-spores containing male genes.

Power Surge: Interruption or change in intensity of electricity.

Primary Nutrients: N-P-K

Propagate: (1) Sexual: Produce a seed by breeding different male and female flowers (2) Asexual: To produce a plant by taking cuttings.

Prune: Alter the shape and growth pattern of a plant by cutting stems and shoots.

PVC Pipe: Plastic (polyvinyl chloride) pipe that is easy to work with, readily available and used to pipe water into a garden room.

Pyrethrum: Natural insecticide made from the blossoms of various chrysanthemums.

Root Bound: Roots stifled or inhibited from normal growth, by the confines of a container.

Roots: Their purpose is to anchor a plant and provide a means in which to feed and hydrate a plant.

Rejuvenate: Restore youth; a mature plant, having completed its life cycle (flowering), may be stimulated by a new 18 hour photo period, to rejuvenate or produce new vegetative growth.

Salt: Crystalline compound that results from improper pH or toxic buildup of fertilizer. Salt will burn plants, preventing them from absorbing nutrients.

Secondary Nutrients: Calcium (ca) and Magnesium (mg).

Seed Pod: A dry calyx containing a mature or maturing seed.

Short Circuit: Condition that results when wires cross and form a circuit. A short circuit will blow fuses.

Socket: Threaded, wired receptacle for a bulb.

Soluble: Able to be dissolved in water.

Spore: Seed like offspring of a fungus.

Sprout: (1) A recently germinated seed (2) Small new growth of a leaf or stem.

Square Feet (Sq Ft): Length (in feet) times width equals square feet.

Stamen: Male, pollen-producing.

Starch: Complex carbohydrate; starch is manufactured and stored in food.

Sterilize: Make sterile (super clean) by removing dirt, germs and bacteria.

Stroboscopic Effect: A quick pulsating or flashing of a lamp.

Stress: A physical or chemical factor that causes extra exertion by plants; a stressed plant will not grow as well as a non stressed plant.

Stomata: Small mouth like or nose like openings (pores) on leaf underside, responsible for transpiration and many other life functions; the millions of stomata, must be kept very clean to function properly.

Sugar: Food product of plant. Carbohydrates that contain hydrocarbon chain.

Synthesis: Production of a substance, such as chlorophyll, by uniting light energy and elements or chemical compounds.

Tap Root: The main or primary root that grows from the seed; lateral roots will branch off the tap root.

Tepid: Warm 70 to 80 degrees F (21 to 27 degrees C); always use tepid water around plants to facilitate chemical processes and ease shock.

Terminal Bud: Bud at the growing end of the main stem.

Thin: Cull or weed out weak, slow growing seedlings.

Transformer: A device in the ballast that transforms electric power from one voltage to another.

Transpire: Give off water vapor and bi-products via stomata and carbon dioxide intake at the leaves.

Trellis: Frame or netting (lattice) that trains or supports plants.

Tungsten: A heavy, hard metal with high melting point which conducts electricity well; tungsten is used for a filament in tungsten halogen and incandescent lamps.

Ultraviolet: Light with very short wave lengths, out of the visible spectrum, past the blue-violet.

Variety: Strain, phenotype.

Vent: Opening such as a window or door that allows the circulation of fresh air.

Ventilation: Circulation of fresh air, fundamental to a healthy indoor garden, an exhaust fan creates excellent ventilation.

Vertical: Up and down perpendicular to the horizontal.

Voltage: An electromotive force or potential difference expressed in volts.

Wattage: A measure of electrical power expressed in watts.

Wetting Agent: Compound that reduces the droplet size and lowers the surface tension of the water, making it wetter.

Wick: Part of a passive hydroponic system using a wick suspended in the nutrient solution, the nutrients pass up the wick and are absorbed by the medium and roots.

INTRODUCTION & QUICK REFERENCE



POWER COST ESTIMATION GUIDE Use this handy guide to figure out the cost of using various watt fixtures

POWER CONSUMPTION

On average a light system will increase your electricity cost from \$8 to \$20 per month—the exact amount depends on the size of the system and the number of hours operated. However, since these grow lights are so energy efficient, you are getting huge amounts of light (and growing power) for your money! Make sure your grow room's power circuit can handle the power draw. For safety reasons, do not exceed 75% of the rated ability of the fuse/breaker (for example: use no more than

15 amps on a 20-amp circuit). To calculate your cost, multiply the bulb wattage X hours of operation and divide by 1000. This figure is the number of kilowatt hours of electricity consumed. (Example: a 400 watt bulb running for 18 hours will use 7.2 kilowatt hours). Check your power bill for the cost of each kilowatt hour. Then multiply the number of kilowatt hours by the cost of a kilowatt hour (K/hr) to arrive at the cost per month to run the light in your area.

INTRODUCTION & QUICK REFERENCE

POWER COST ESTIMATION GUIDE PER MONTH (ASSUMES 30 DAY MONTH)												
COST PER KW/HR	4¢	6¢	8¢	10¢	12¢	14¢	16¢	18¢	20¢	22¢	24¢	26¢
HRS. PER DAY X 30 DAYS	EXAMPLE: 6 HRS X 275 WATTS* ÷ 1000 X \$.04 PER KWH X 30 DAYS = \$ 1.98											
6 HRS X 30 DAYS	\$1.98	\$2.97	\$3.96	\$4.95	\$5.94	\$6.93	\$7.92	\$8.91	\$9.90	\$10.89	\$11.88	\$12.87
8 HRS X 30 DAYS	\$2.64	\$3.96	\$5.28	\$6.60	\$7.92	\$9.24	\$10.56	\$11.88	\$13.20	\$14.52	\$15.84	\$17.16
10 HRS X 30 DAYS	\$3.30	\$4.95	\$6.60	\$8.25	\$9.90	\$11.55	\$13.20	\$14.85	\$16.50	\$18.15	\$19.80	\$21.45
12 HRS X 30 DAYS	\$3.96	\$5.94	\$7.92	\$9.90	\$11.88	\$13.86	\$15.84	\$17.82	\$19.80	\$21.78	\$23.76	\$25.74
14 HRS X 30 DAYS	\$4.62	\$6.93	\$9.24	\$11.55	\$13.86	\$16.17	\$18.48	\$20.79	\$23.10	\$25.41	\$27.72	\$30.03
16 HRS X 30 DAYS	\$5.28	\$7.92	\$10.56	\$13.20	\$15.84	\$18.48	\$21.12	\$23.76	\$26.40	\$29.04	\$31.68	\$34.32
18 HRS X 30 DAYS	\$5.94	\$8.91	\$11.88	\$14.85	\$17.82	\$20.79	\$23.76	\$26.73	\$29.70	\$32.67	\$35.64	\$38.61

*** A 250 watt lighting fixture uses 275 watts per hour. For use with Sun System® Digital.**

250 WATT LIGHTING FIXTURE

POWER COST ESTIMATION GUIDE PER MONTH (ASSUMES 30 DAY MONTH)												
COST PER KW/HR	4¢	6¢	8¢	10¢	12¢	14¢	16¢	18¢	20¢	22¢	24¢	26¢
HRS. PER DAY X 30 DAYS	EXAMPLE: 6 HRS X 468 WATTS* ÷ 1000 X \$.04 PER KWH X 30 DAYS = \$ 3.37											
6 HRS X 30 DAYS	\$3.37	\$5.05	\$6.74	\$8.42	\$10.11	\$11.79	\$13.48	\$15.16	\$16.85	\$18.53	\$20.22	\$21.90
8 HRS X 30 DAYS	\$4.49	\$6.74	\$8.99	\$11.23	\$13.48	\$15.72	\$17.97	\$20.22	\$22.46	\$24.71	\$26.96	\$29.20
10 HRS X 30 DAYS	\$5.62	\$8.42	\$11.23	\$14.04	\$16.85	\$19.66	\$22.46	\$25.27	\$28.08	\$30.89	\$33.70	\$36.50
12 HRS X 30 DAYS	\$6.74	\$10.11	\$13.48	\$16.85	\$20.22	\$23.59	\$26.96	\$30.33	\$33.70	\$37.07	\$40.44	\$43.80
14 HRS X 30 DAYS	\$7.86	\$11.79	\$15.72	\$19.66	\$23.59	\$27.52	\$31.45	\$35.38	\$39.31	\$43.24	\$47.17	\$51.11
16 HRS X 30 DAYS	\$8.99	\$13.48	\$17.97	\$22.46	\$26.96	\$31.45	\$35.94	\$40.44	\$44.93	\$49.42	\$53.91	\$58.41
18 HRS X 30 DAYS	\$10.11	\$15.16	\$20.22	\$25.27	\$30.33	\$35.38	\$40.44	\$45.49	\$50.54	\$55.60	\$60.65	\$65.71

*** A 432 watt lighting fixture uses 468 watts per hour. For use with Sun Blaze® 48.**

432 WATT LIGHTING FIXTURE

POWER COST ESTIMATION GUIDE PER MONTH (ASSUMES 30 DAY MONTH)												
COST PER KW/HR	4¢	6¢	8¢	10¢	12¢	14¢	16¢	18¢	20¢	22¢	24¢	26¢
HRS. PER DAY X 30 DAYS	EXAMPLE: 6 HRS X 680 WATTS* ÷ 1000 X \$.04 PER KWH X 30 DAYS = \$ 4.90											
6 HRS X 30 DAYS	\$4.90	\$7.34	\$9.79	\$12.24	\$14.69	\$17.14	\$19.58	\$22.03	\$24.48	\$26.93	\$29.38	\$31.82
8 HRS X 30 DAYS	\$6.53	\$9.79	\$13.06	\$16.32	\$19.58	\$22.85	\$26.11	\$29.38	\$32.64	\$35.90	\$39.17	\$42.43
10 HRS X 30 DAYS	\$8.16	\$12.24	\$16.32	\$20.40	\$24.48	\$28.56	\$32.64	\$36.72	\$40.80	\$44.88	\$48.96	\$53.04
12 HRS X 30 DAYS	\$9.79	\$14.69	\$19.58	\$24.48	\$29.38	\$34.27	\$39.17	\$44.06	\$48.96	\$53.86	\$58.75	\$63.65
14 HRS X 30 DAYS	\$11.42	\$17.14	\$22.85	\$28.56	\$34.27	\$39.98	\$45.70	\$51.41	\$57.12	\$62.83	\$68.54	\$74.26
16 HRS X 30 DAYS	\$13.06	\$19.58	\$26.11	\$32.64	\$39.17	\$45.70	\$52.22	\$58.75	\$65.28	\$71.81	\$78.34	\$84.86
18 HRS X 30 DAYS	\$14.69	\$22.03	\$29.38	\$36.72	\$44.06	\$51.41	\$58.75	\$66.10	\$73.44	\$80.78	\$88.13	\$95.47

*** A 600 watt lighting fixture uses 680 watts per hour. For use with Harvest Pro®, Hard Core, Galaxy® Digital Logic, Galaxy® Legacy.**

600 WATT LIGHTING FIXTURE

POWER COST ESTIMATION GUIDE PER MONTH (ASSUMES 30 DAY MONTH)												
COST PER KW/HR	4¢	6¢	8¢	10¢	12¢	14¢	16¢	18¢	20¢	22¢	24¢	26¢
HRS. PER DAY X 30 DAYS	EXAMPLE: 6 HRS X 1100 WATTS* ÷ 1000 X \$.04 PER KWH X 30 DAYS = \$ 7.92											
6 HRS X 30 DAYS	\$7.92	\$11.88	\$15.84	\$19.80	\$23.76	\$27.72	\$31.68	\$35.64	\$39.60	\$43.56	\$47.52	\$51.48
8 HRS X 30 DAYS	\$10.56	\$15.84	\$21.12	\$26.40	\$31.68	\$36.96	\$42.24	\$47.52	\$52.80	\$58.08	\$63.36	\$68.64
10 HRS X 30 DAYS	\$13.20	\$19.80	\$26.40	\$33.00	\$39.60	\$46.20	\$52.80	\$59.40	\$66.00	\$72.60	\$79.20	\$85.80
12 HRS X 30 DAYS	\$15.84	\$23.76	\$31.68	\$39.60	\$47.52	\$55.44	\$63.36	\$71.28	\$79.20	\$87.12	\$95.04	\$102.96
14 HRS X 30 DAYS	\$18.48	\$27.72	\$36.96	\$46.20	\$55.44	\$64.68	\$73.92	\$83.16	\$92.40	\$101.64	\$110.88	\$120.12
16 HRS X 30 DAYS	\$21.12	\$31.68	\$42.24	\$52.80	\$63.36	\$73.92	\$84.48	\$95.04	\$105.60	\$116.16	\$126.72	\$137.28
18 HRS X 30 DAYS	\$23.76	\$35.64	\$47.52	\$59.40	\$71.28	\$83.16	\$95.04	\$106.92	\$118.80	\$130.68	\$142.56	\$154.44

*** A 1000 watt lighting fixture uses 1100 watts per hour. For use with Harvest Pro®, Hard Core, Galaxy® Digital Logic, Galaxy® Legacy & Grow Amp.**

1000 WATT LIGHTING FIXTURE



Worlds Greatest TV Show featuring Sunlight Supply

industry exclusive

Most air-tight reflectors on the market!



SUN SYSTEM REFLECTORS

1 Commercial grade! Galvanized steel housing with a durable, major brand powder-coated finish.

2 Most Sun System® Reflectors include tempered glass, a built-in socket and lamp cord. Some now feature a patented detachable lamp cord.

3 These Sun System® reflectors have maximum output, uniformity and diffusion properties by using **95%** reflective German aluminum interior.

4 Completely sealed with double gaskets! Swing Stop™ retention cable keeps glass from abruptly swinging down. Captured thumb screws & closure mechanism for ease of use and excellent sealing.

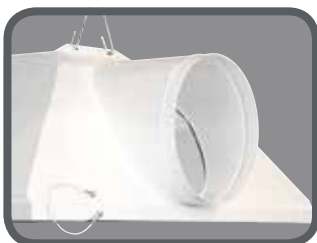

5 6" or 8" integrated air-cooled fittings allow for extremely efficient cooling. A bead ring helps to hold ducting firmly in place!

6 Fabricated and assembled in the USA with US and globally sourced parts. Every reflector gets a quality control check before packaged.

7 Sun System® Reflectors are built to last. We back our reflectors with a 5 year warranty.

8 Videos. See "How they are made" videos at www.sunlightsupply.com.

Note: Product features vary by reflector. See our reflector Quick Reference Guide in this section for specifics by reflector.

**Proudly fabricated in the USA
by American workers in our
state-of-the-art factory.**

Sunlight Supply[®], Inc. is the industry's only vertically integrated manufacturer. We use only the finest materials available to manufacture our products. Our premium quality and exacting standards have helped us build the Sun System[®] brand to what it is today. We are dedicated to providing our customers with the industry's best hobby and commercial horticultural lighting fixtures.

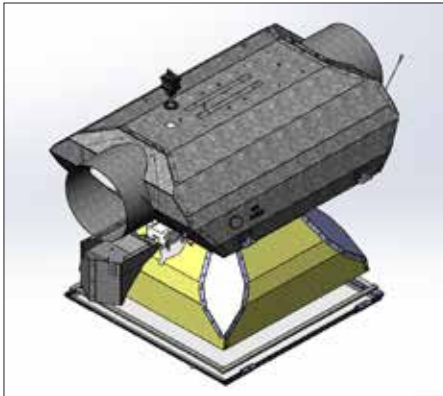

3-D C.A.D. Design

Our expertise in C.A.D. design, machine capability and tooling requirements make for prompt product design and development. Sophisticated photometric software ensures proper light dispersion.



Punching CNC

Trumpf computer numerically controlled (CNC) punch presses are used to process steel and aluminum sheet metal for reflectors and housings.

Part Bending (Braking/Forming)

12 Trumpf CNC press brakes are used to bend and form flat sheet metal. Exact tolerances of these machines ensure precision bend tolerances to within 1/10 of 1% on every angle.



Riveting and Pemming

Automatic feed riveting machines securely attach metal parts together. The Auto-Sert machine inserts Pem Bolts and Pem Nuts on various fixtures.



Powder Coating

Our reflectors and ballast housings have a powder coated finish. The electrostatic process applies powder, usually white, black, blue or green, to a part. Powder coating is far more durable and corrosion resistant than liquid paint.

The part is hung from a conveyor line entering a 5 stage wash, where heating and chemically treated water cleans the parts.

The cleaned part is dried and then enters a spray booth where the powder is applied. 8 guns shoot powder from different angles to completely cover the part. Human touch-up is done at the end of the spray booth.

The part enters a combination oven which uses infra-red and convection heat to cure the powder onto the part. Next, it enters a "cool down" area prior to handling.



The Sunlight Supply manufacturing team in Woodland, Washington. Home of Sun System!



Testing and Quality Control

All Sunlight Supply fixtures pass our 4 step testing procedure. Every fixture is test-fired twice from 2 different people. It must pass a hi-pot for grounding test, electrical leakage and a dielectric test. The overall product is reviewed for fit and finish, properly tightened fasteners, secure sockets and more.

Packaging and Shipping

A conveyor line moves assembled products from the assembly stations to the packaging area. The quality control area serves as the final product inspection point prior to the items being packaged. After being boxed, the products are placed on pallets and shipped to our distribution centers.

Assembly

Strict procedures are adhered to during the assembly of our reflectors, H.I.D. and fluorescent lighting fixtures. ETL frequently inspects our facilities to ensure compliance with their high standards.



How It's Made

To see our Manufacturing process, go to www.youtube.com and search "Sunlight Supply Manufacturing".

SUN SYSTEM® REFLECTORS MADE IN THE USA

MADE IN USA

Proudly fabricated in the USA by American workers in our state-of-the-art factory using computer controlled equipment. See www.sunlightsupply.com, click on manufacturing.

95%

Reflector is made of 95% reflective German aluminum!

LONGEVITY

Galvanized steel body is rust & corrosion resistant.

BUY THE BEST

Support the innovator in horticultural lighting. We have been the leader in new designs and technology in the industry for years.

#1

Major brand powder coated finish provides years of protection.



Our reflectors offer the ETL listed mark for proof of product compliance to North American safety standards.

AIR TIGHT

Our reflectors are the most airtight reflectors in the industry.

COMPETITOR'S CHINESE IMPORT REFLECTORS

MADE IN CHINA

Manufactured in China using antiquated stamping equipment that is NOT computer controlled. They cannot match our quality.

74-86%

Reflector is made from cheap 74-86% reflective material.

RUST

Cold rolled steel is more likely to rust & corrode.

CHEAP KNOCK-OFF

Don't be fooled by imitations - our competitors have copied our product designs and features & sent them to China to be reproduced.

BRAND X

Poor quality, inconsistent finish - compare for yourself.

NO LISTING

No proof of safety standards by outside agency testing.

LEAK AIR

Competitive reflectors are not completely sealed & leak air.

Visit www.sunlightsupply.com and click on the "Videos" tab to see how a reflector is manufactured.

Reflector Quick Reference Guide

Description	Part No.	Integrated Air Cooled Fittings	Built In Socket & Lamp Cord	Glass	Glass Part No	Glass Retention	Reflectivity	Lamp Position	Assembly Required	Fabricated In USA	Pallet Count	Reflector Weight	Reflector Dimensions Long x Wide x High
AC/DE Air Cooled Double Ended Reflector 8 in	904904	Yes - 8"	Yes	Included	640689	Hinged	95%	Horizontal	No	Yes	12	18.4	32.0" x 20.0" x 9.4"
Adjust-A-Wing Avenger Large Reflector No Cord	904550	No	Socket	N/A	N/A	N/A	95%	Horizontal	Yes	Yes	36	5.7	27.6" x 39.5" x "
Adjust-A-Wing Avenger Large Reflector w/ Cord	904540	No	Yes	N/A	N/A	N/A	95%	Horizontal	Yes	Yes	36	7.2	27.6" x 39.5" x "
Adjust-A-Wing Avenger Large Reflector w/ Cord 6/Pack	904565	No	Yes	N/A	N/A	N/A	95%	Horizontal	Yes	Yes	84	7.2	27.6" x 39.5" x "
Adjust-A-Wing Avenger Medium Reflector w/ Cord	904535	No	Yes	N/A	N/A	N/A	95%	Horizontal	Yes	Yes	72	4.7	21.7" x 27.0" x "
Adjust-A-Wing Avenger DE Reflector Large	904910	No	Yes	N/A	N/A	N/A	95%	Horizontal	Yes	Yes	36	8.4	27.6" x 39.5" x "
Adjust-A-Wing Enforcer Large	904730	No	Yes	N/A	N/A	N/A	80%	Horizontal	Yes	No	36	7.2	27.6" x 39.5" x "
Adjust-A-Wing Enforcer Medium	904735	No	Yes	N/A	N/A	N/A	80%	Horizontal	Yes	No	72	4.7	21.7" x 27.0" x "
Agrotech Magnum Double Ended Reflector	904855	No	Yes	N/A	N/A	N/A	95%	Horizontal	Yes	Yes	30	6.0	34.3" x 29.1" x 8.1"
Agrotech Magnum Reflector	904615	No	Yes	N/A	N/A	N/A	95%	Horizontal	Yes	Yes	30	5.6	34.3" x 29.1" x 8.3"
Agrotech Magnum Reflector 20/Pack	904635	No	Yes	N/A	N/A	N/A	95%	Horizontal	No	Yes	20	5.6	34.30" x 29.10" x 8.10"
Agrotech Medium Reflector	904725	No	Yes	N/A	N/A	N/A	95%	Horizontal	Yes	Yes	84	3.4	26.0" x 21.3" x 7.7"
Agrotech Medium Reflector 6/Pack	904727	No	Yes	N/A	N/A	N/A	95%	Horizontal	No	Yes	48	3.4	26.0" x 21.3" x 7.7"
BloodBuster 6 in Air Cooled Reflector	904650	Yes - 6"	Yes	Included	640796	Hinged	95%	Horizontal	No	Yes	12	23.0	25.6" x 25.6" x 9.9"
BloodBuster 8 in Air Cooled Reflector	904655	Yes - 8"	Yes	Included	640796	Hinged	95%	Horizontal	No	Yes	12	23.0	31.0" x 25.6" x 9.9"
DE Boss Reflector	904934	No	Yes	N/A	N/A	N/A	95%	Horizontal	No	Yes	24	7.3	19.8" x 19.1" x 8.6"
Dominator XXXL 6 in Air Cooled Reflector	904415	Yes - 6"	Yes	Included	640272	Hinged	86%	Horizontal	No	No	12	29.0	36.5" x 26.4" x 8.5"
Dominator XXXL 8 in Air Cooled Reflector	904420	Yes - 8"	Yes	Included	640273	Hinged	86%	Horizontal	No	No	8	36.0	39.4" x 29.9" x 9.3"
Dominator XXXL Double Ended Non AC Reflector - 3/Pack	904920	No	Yes	N/A	N/A	N/A	86%	Horizontal	No	No	12	20.0	34.8" x 29.5" x 8.8"
Dominator XXXL Non AC Reflector - 3/Pack	904442	No	Yes	N/A	N/A	N/A	86%	Horizontal	No	No	12	20.0	34.8" x 29.5" x 8.8"
Econo Wing Reflector	904465	No	Yes	N/A	N/A	N/A	86%	Horizontal	No	No	72	4.2	21.1" x 13.3" x 4.4"
Econo Wing XL	904462	No	Yes	N/A	N/A	N/A	86%	Horizontal	No	No	32	4.9	21.0" x 24.6" x 7.6"
Epic 8 in Air Cooled Reflector	904880	Yes - 8"	Yes	Included	640584	Hinged	95%	Horizontal	No	Yes	6	38.5	44.9" x 32.7" x 11.4"
Evolution 8 in Air Cooled Reflector	904930	Yes - 8"	Yes	Included	640892	Hinged	95%	Horizontal	No	Yes	12	24.85	36.5" x 25.5" x 10.6"
Irradiator 6 in Air Cooled Reflector	904865	Yes - 6"	Yes	Included	640483	Hinged	86%	Horizontal	No	No	18	18.2	27.3" x 21.3" x 9.2"
Irradiator 8 in Air Cooled Reflector	904870	Yes - 8"	Yes	Included	640483	Hinged	86%	Horizontal	No	No	24	18.5	27.9" x 21.3" x 9.2"
Irradiator Reflector	904860	No	Yes	N/A	N/A	N/A	86%	Horizontal	No	No	24	18.0	22.4" x 21.0" x 8.8"
Low Rider 6 in Reflector	904720	Yes - 6"	Yes	Included	640278	Hinged	95%	Horizontal	No	Yes	36	12.3	25" x 17.6" x 5.9"
Magnum XXXL 6 in Air Cooled Reflector	904520	Yes - 6"	Yes	Included	640281	Hinged	95%	Horizontal	No	Yes	8	26.0	36.1" x 26.5" x 9.6"
Magnum XXXL 8 in Air Cooled Reflector	904515	Yes - 8"	Yes	Included	640282	Hinged	95%	Horizontal	Yes	Yes	8	30.4	39.9" x 29.9" x 10.0"
Maximizer Reflector	904075	No	Yes	N/A	N/A	N/A	86%	Horizontal	No	No	40	5.8	21.4" x 17.0" x 7.5"
Parabolic 48 in White Reflector	904110	No	Yes	N/A	N/A	N/A	86%	Vertical	Yes	No	100	6.4	48.0" x 48.0" x 8.00"
Silver Sun Reflector	904620	No	Yes	N/A	N/A	N/A	95%	Horizontal	Yes	No	48	8.5	49.3" x 49.6" x 7.8"
Solartech Magnum Reflector	904942	No	Yes	N/A	N/A	N/A	86%	Horizontal	Yes	No	30	5.0	34.3" x 29.1" x 8.3"
Sun Star 6 in Air Cooled Reflector	904885	Yes - 6"	Yes	Included	640537	Hinged	86%	Horizontal	No	No	36	12.3	24.1" x 12.8" x 8.4"
Sun Star Reflector	904875	No	Yes	N/A	N/A	N/A	86%	Horizontal	No	No	36	7.7	20.3" x 12.5" x 8.0"
Sunmo 6 in Air Cooled Reflector	904682	Yes - 6"	Yes	Included	640274	Hinged	86%	Horizontal	No	No	12	25.65	28.0" x 25.7" x 9.8"
Sunmo 8 in Air Cooled Reflector	904684	Yes - 8"	Yes	Included	640274	Hinged	86%	Horizontal	No	Yes	12	25.65	28.8" x 25.7" x 9.8"
Super Sun 2 - 6 in Air Cooled Reflector	904300	Yes - 6"	Yes	Included	904305	Hinged	95%	Horizontal	No	Yes	20	12.5	28.0" x 13.2" x 7.8"
Super Sun DE Reflector	904906	No	Yes	N/A	N/A	N/A	95%	Horizontal	No	No	36	6.1	24.0" x 13.4" x 6.8"
Value Wing 8/Pack	904467	No	Socket	N/A	N/A	N/A	86%	Horizontal	Yes	No	240	1.9	18.6" x 14.8" x 4.8"
Vertical Reflector	904060	No	Yes	N/A	N/A	N/A	95%	Horizontal	Yes	No	48	10.1	49.3" x 49.3" x 7.8"
Yield Master 6 in Reflector	904425	Yes - 6"	Yes	Included	640271	Hinged	86%	Horizontal	No	No	24	17.1	23.9" x 22.6" x 7.4"
Yield Master 8 in Air Cooled Reflector	904665	Yes - 8"	Yes	Included	640270	Hinged	86%	Horizontal	No	Yes	12	20.1	25.0" x 24.6" x 9.6"

USA MANUFACTURED AIR-COOLED

ULTRA PREMIUM REFLECTORS

Evolution™ 8 in Air-Cooled Reflector



The patented sealed optic technology allows removal of heat generated by the lamp without cooling the lamp below proper operating temperature. 95% reflective textured German aluminum interior with 98% reflective corner inserts offer excellent uniformity, output and diffusion. Manufactured with exacting standards and double neoprene gaskets for an air tight seal. Includes tempered glass, built-in socket & 15 ft detachable lamp cord. Will not accept BT37 or larger lamps. US patent: D698987, D698628. US Patent Pending: 29/446133, 29/477993, PCTUS2014014959, 13/533189, 13/945794. Chinese Design patents pending: 201330634881.9, 201330642281.7. 5 year Warranty.

Item No.	Description	MSRP
904930	Evolution 8 in Air-Cooled Reflector	\$332.95

Sun System - the original innovators of oversized air-cooled reflectors!

Epic™ 8 in Air-Cooled Reflector



Industry's largest air-cooled reflector. Features our exclusive 98% reflective Silver German aluminum for unmatched reflectivity. Completely sealed double gasketed glass lens with the Swing Stop retention cable keeps glass from abruptly swinging down. Bolstered sealing points to ensure tight air-cooled integrity. Built in 8 inch air cooling ducts with bead ring to hold ducting securely in place. Integrated socket and new detachable 15 ft lamp cord. Galvanized steel housing with major brand powder coating. Patent No. D613900 and Patent Pending: 29/434634.



Item No.	Description	MSRP
904880	Epic 8 in Air-Cooled Reflector	\$381.95

CREATE YOUR WISH LIST BY SCANNING NOW!



PREMIUM REFLECTORS

Magnum XXXL® 6 in Air-Cooled Reflector - Generation 3



The Magnum XXXL includes tempered glass, removable frame, built-in socket & new detachable 15 ft lamp cord. Completely sealed—features double gasketed glass and hinged frame to hold glass tightly in place. 95% reflective German aluminum interior. Easy carry handles. Patent No.: D613900, D698986, D698628. Patent Pending: 29/446133, 29/457675, 29/478005, (China) ZL 2013 3058 2331.7.

Item No.	Description	MSRP
904520	Magnum XXXL 6 in Air-Cooled Reflector	\$263.95

Magnum XXXL® 8 in Air-Cooled Reflector - Generation 3



The Magnum XXXL includes tempered glass, removable frame, built-in socket & new detachable 15 ft lamp cord. Completely sealed—features double gasketed glass and frame to hold glass tightly in place. 95% reflective German aluminum interior. Easy carry handles. Patent No.: D613900, D698986, D698628. Patent Pending: 29/446133, 29/457675, 29/478005, (China) ZL 2013 3058 2331.7.

Item No.	Description	MSRP
904515	Magnum XXXL 8 in Air-Cooled Reflector	\$281.95

BlockBuster® 6 in Air-Cooled Reflector - Generation 3



The Air-Cooled BlockBuster Reflector now offers a more efficient and even light distribution. It is pre-wired with lamp cord and socket. Includes built in handles. The interior is made from 95% reflective German aluminum and is completely sealed with neoprene gaskets and hinged glass. Patent No.: D570295, D634469, D698628, D644185, 7641367. Patent Pending: 29/482993, (China) 201430019221.4.

Item No.	Description	MSRP
904650	BlockBuster 6 in Air-Cooled Reflector	\$209.95

SUN SYSTEM REFLECTORS

SUN SYSTEM REFLECTORS

BlockBuster® 8 in Air-Cooled Reflector - Generation 3

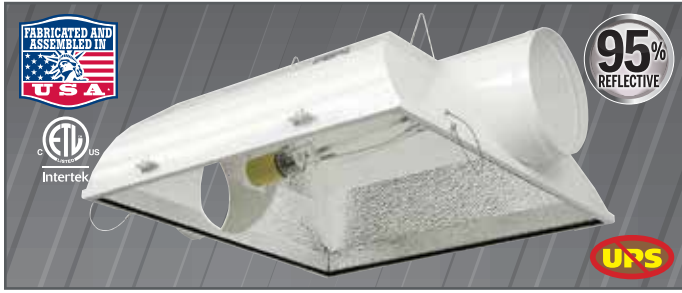

The Air-Cooled BlockBuster Reflector now offers a more efficient and even light distribution. It is pre-wired with lamp cord and socket. Includes built in handles. The interior is made from 95% reflective German aluminum and is completely sealed with neoprene gaskets and hinged glass. Patent No.: D570295, D634469, D698628, D644185, 7641367. Patent Pending: 29/482993, (China) 201430019221.4.

Item No.	Description	MSRP
904655	BlockBuster 8 in Air-Cooled Reflector	\$217.95

PERFORMANCE REFLECTOR

Super Sun® 2 Air-Cooled 6 in Reflector



The Super Sun 2 Reflector is completely sealed with neoprene gasket and hinged glass and comes with 6 inch integrated air-cooled fittings and a 95% reflective German aluminum interior for excellent output and uniformity. Patent No.: D544987, D613900, 7641367. Patent Pending: 29/446133.

Item No.	Description	MSRP
904300	Super Sun 2-6 in Air-Cooled Reflector	\$159.95

DOUBLE ENDED REFLECTORS

AC/DE™ Air-Cooled Double Ended Reflector 8 in

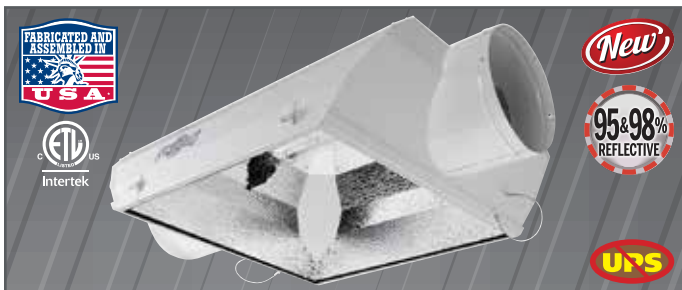

The patented sealed optic technology allows removal of heat generated by the lamp without cooling the lamp. 95% reflective textured German aluminum interior with 98% reflective corner inserts offer excellent uniformity, output and diffusion. Galvanized steel housing with durable powder coated finish. Double neoprene gaskets for an air tight seal. Hinged glass makes changing lamps and cleaning glass easy. US patent: D698987, D698628. US Patent Pending: 29/446133, 29/477993, PCTUS2014014959, 13/533189, 13/945794. Chinese Design patents pending: 201330634881.9, 201330642281.7.

Item No.	Description	MSRP
904904	AC/DE Double Ended Air-Cooled Reflector 8 in	\$381.95

USA MANUFACTURED NON AIR-COOLED

DE Boss™ Reflector



State-of-the-art, optically engineered for high performance based on proven, patented designs. Made specifically for double ended 1000 watt HPS horticultural lamps (not included). Unique double ended construction allows for maximum optical efficiency and uniformity. Deep reflector design holds the lamp heat to keep the DE lamp at optimal operating temperature. 95% reflective textured German aluminum interior with 98% reflective corner inserts offer unsurpassed uniformity, output and diffusion. Galvanized steel housing with durable powder coated finish. Detachable 15 ft lamp cord at the reflector and at ballast. 5 year Warranty.

Item No.	Description	MSRP
904934	DE Boss Reflector	\$249.95

Super Sun® DE Reflector



The Super Sun DE's compact & efficient design delivers maximum light to your growing space. 95% reflective textured German aluminum interior for excellent uniformity, output and diffusion. Galvanized steel housing with durable powder coated finish. Manufactured with exacting standards and the finest quality components.

Item No.	Description	MSRP
904906	Super Sun DE Reflector	\$181.95

Agrotech® Magnum Double Ended Reflector

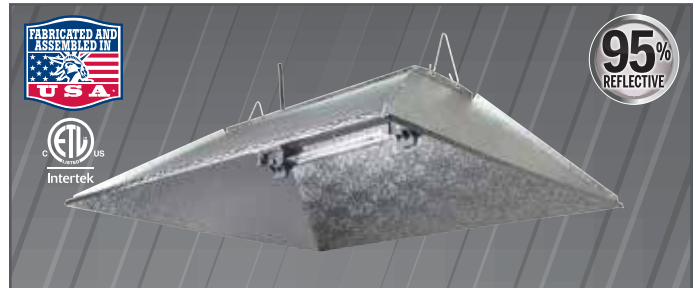

Made specifically for double ended 1000 watt HPS horticulture lamps. Unique double ended lamp construction allows for maximum optical efficiency and uniformity. 95% reflective textured German aluminum for excellent reflectivity and diffusion. Detachable 15 ft lamp cord at the reflector and at the ballast. Does not accept glass.

Item No.	Description	MSRP
904855	Agrotech Magnum Double Ended Reflector	\$181.95

Adjust-A-Wings® Avenger DE Reflector



Made specifically for double ended 1000W HPS horticulture lamps (not included). Unique double ended construction allows for maximum optical efficiency and uniformity. Full spectrum DE lamps used in this fixture focus on the red component for increased photosynthetic response. They offer improved PAR values and increased PAR/lumen maintenance (up to 90% PAR at 10,000 hrs of operation). Made with 95% reflective German aluminum.

Item No.	Description	MSRP
904910	Adjust-A-Wing Avenger DE Reflector Large	\$235.95

Large DE Socket Kit with Lamp Cord



Make your existing single ended mogul base Adjust-A-Wings Large Reflector into a double ended reflector. Simply remove your existing socket and add this new Double Ended Socket Kit with lamp cord. Includes everything to make the switch. Made specifically for double ended 1000W HPS horticulture lamps (not included).

Item No.	Description	MSRP
904914	Large Double Ended Socket Kit w/ Lamp Cord	\$89.95

SINGLE ENDED REFLECTORS

Agrotech® Magnum Reflector



Lightweight all aluminum reflector with galvanized steel back plate. Made of 95% reflective German aluminum. Comes unassembled. New detachable 15 ft lamp cord at the reflector and at the ballast. Does not accept glass.

Item No.	Description	MSRP
904615	Agrotech Magnum Reflector	\$145.95

Agrotech® Magnum Reflector 20 Pack



Lightweight all aluminum reflector with galvanized steel back plate. Made of 95% reflective German aluminum. New fully assembled reflector portion, just attach the socket assembly and your done. New detachable 15 ft lamp cord at the reflector and at the ballast. Completely assembled reflector. Sold in quantities of 20 only.

Item No.	Description	MSRP
904635	Agrotech Magnum Reflector 20/Pack	\$145.95

Verticalal® Reflector



The Verticalal Reflector operates MH and HPS lamps in the horizontal position but in an 8-sided reflector directing light downward. 95% reflective German aluminum insert for excellent output and uniformity. Pre-wired with lamp cord and adjustable socket. Does not accept BT56 lamps. US Patent No: D545994.

Item No.	Description	MSRP
904060	Verticalal Reflector	\$163.95

The Equalizer™ Hot Spot Diffuser

Simply slide this unique product over a mogul base socket on most horizontal burning reflectors to filter and disperse the intense hot spot of light directly under an HID lamp. With the hot spot diffused, you can hang reflectors closer to the plant canopy. Made of 95% reflective German aluminum.

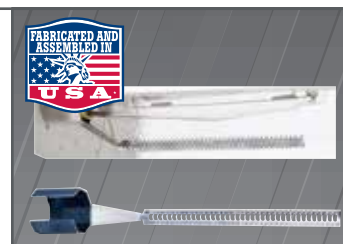

Item No.	Description	MSRP
904430	The Equalizer Hot Spot Diffuser HPS 1000	\$31.95
904435	The Equalizer Hot Spot Diffuser HPS 600/400	\$31.95
904440	The Equalizer Hot Spot Diffuser MH1000/400	\$31.95

Super Spreader® for Adjust-A-Wings® Large Double Ended

Made of 95% reflective glass coated prismatic surfaced super alloy. Creates wider, more even light spread by eliminating hot spots and shady spots. The Super-Spreader allows for closer light placement for increased power. Reduces heat at the plant level by at least 9°F and increases your yields using less lights. Compatible with Adjust-A-Wings Double Ended reflectors.

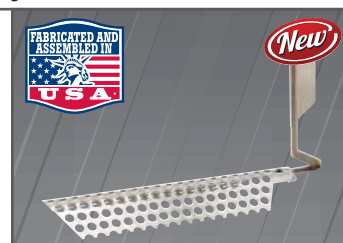

Item No.	Description	MSRP
904764	Super Spreader for AJW Large Double Ended	\$34.95

SUN SYSTEM REFLECTORS

WING REFLECTORS

Adjust-A-Wings® Avenger Reflectors



The Adjustable Light Spread allows growers to create ideal lighting conditions across all stages of plant growth for increased vitality, health & yield. Made of 95% reflective proprietary German aluminum. Increase the growing area under each lamp by up to 75%.

Item No.	Description	MSRP
904535	Adjust-A-Wing Avenger Medium Reflector w/ Cord	\$132.95
904540	Adjust-A-Wing Avenger Large Reflector w/ Cord	\$166.95
904550	Adjust-A-Wing Avenger Large Reflector No Cord	\$149.95
904555	Adjust-A-Wing Socket Assembly w/ Cord	\$41.95
904560	Adjust-A-Wing Socket Assembly No Cord	\$38.00
904565	Adjust-A-Wing Avenger Large Reflector w/ Cord 6/Pack	\$164.95
904910	Adjust-A-Wing Avenger DE Reflector Large New	\$235.95

Scan to watch these instructional videos for Adjust-A-Wings!



Assembly
Video

Setting up
Seasonal
Settings



Super Spreaders®



Super-Spreader combines common sense and innovation with advancements in reflective surface technology to produce a Super Light Spreader! The Spreader Heads are made from 95% reflective glass coated Aluminum with a prismatic micro-textured surface. By attaching the Super-Spreader accessory, the Adjust-A-Wings performance may be enhanced significantly.

Item No.	Description	MSRP
904525	Super Spreader Medium	\$29.95
904530	Super Spreader Large	\$34.95

IMPORT AIR-COOLED

PREMIUM REFLECTORS

Dominator XXXL™ 6 in Air-Cooled Reflector

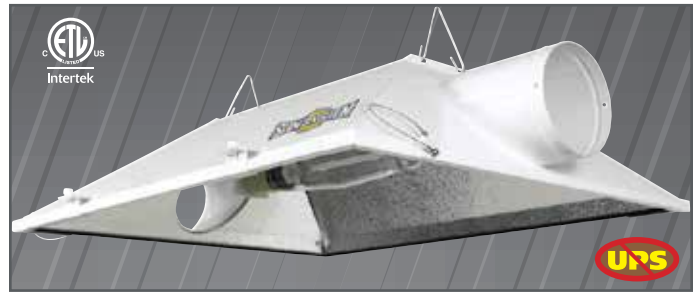

Massive size for increased coverage area and excellent uniformity. Includes tempered glass, removable frame, built-in socket & 15 ft lamp cord. Completely sealed—features gasketed glass and hinged frame to hold glass tightly in place. Powder-coated galvanized steel body. Highly reflective aluminum interior offers excellent reflectivity and diffusion. Air-cooling flanges have a bead ring to keep ducting securely in place. Patent No. D613900 and Patent Pending No: 29/434634.

Item No.	Description	MSRP
904415	Dominator XXXL 6 in Air-Cooled Reflector	\$209.95

Dominator XXXL™ 8 in Air Cooled Reflector



Massive size for increased coverage area and excellent uniformity. Includes tempered glass, removable frame, built-in socket & 15 ft lamp cord. Completely sealed—features gasketed glass and hinged frame to hold glass tightly in place. Powder-coated galvanized steel body. Highly reflective aluminum interior offers excellent reflectivity and diffusion. Air-cooling flanges have a bead ring to keep ducting securely in place. Patent No. D613900 and Patent Pending No: 29/434634.

Item No.	Description	MSRP
904420	Dominator XXXL 8 in Air-Cooled Reflector	\$227.95

SunGro™ 6 in Air-Cooled Reflector



The Air-Cooled SunGro Reflector offers a uniform, square, intense light pattern and is pre-wired with lamp cord and socket. The interior is made from highly reflective aluminum and is completely sealed with neoprene gaskets and hinged glass. US Patents: D570295 & 7641367. Patents Pending 29/370956, 29/370841 & 61/403212. 5 year Warranty.

Item No.	Description	MSRP
904682	SunGro 6 in Air-Cooled Reflector	\$149.95

Industries best overall quality imported reflectors!

SunGro™ 8 in Air-Cooled Reflector



The Air-Cooled SunGro Reflector offers a uniform, square, intense light pattern and is pre-wired with lamp cord and socket. The interior is made from highly reflective aluminum and is completely sealed with neoprene gaskets and hinged glass. US Patents: D570295 & 7641367. Patents Pending 29/370956, 29/370841 & 61/403212. 5 year Warranty.

Item No.	Description	MSRP
904684	SunGro 8 in Air-Cooled Reflector	\$159.95

PERFORMANCE REFLECTORS

Irradiator™ 6 in Air-Cooled Reflector



Completely sealed with double gasketed glass for an air-tight seal. Highly reflective aluminum interior offers excellent reflectivity and diffusion. Swing Stop retention cable keeps glass from abruptly swinging down. Captured thumb screws & closure mechanism for ease of use and excellent sealing. 6 inch integrated air-cooled fittings with bead ring. Galvanized steel housing with major brand powder-coating.

Item No.	Description	MSRP
904865	Irradiator 6 in Air-Cooled Reflector	\$145.95

Irradiator™ 8 in Air-Cooled Reflector



Completely sealed with double gasketed glass for an air-tight seal. Highly reflective aluminum interior offers excellent reflectivity and diffusion. Swing Stop retention cable keeps glass from abruptly swinging down. Captured thumb screws & closure mechanism for ease of use and excellent sealing. 8 inch integrated air-cooled fittings with bead ring. Galvanized steel housing with major brand powder-coating.

Item No.	Description	MSRP
904870	Irradiator 8 in Air-Cooled Reflector	\$154.95

Yield Master® 6 in Air-Cooled Reflector



Completely sealed featuring hinged glass and double gasket for an air-tight seal. Includes tempered glass, built-in socket and 15 ft lamp cord. Highly reflective aluminum interior for excellent output and uniformity. Air-cooling flanges have a bead ring to keep ducting securely in place. Powder-coated galvanized steel housing. Patent No.: D543652, D570295, D613900, D698628.

Item No.	Description	MSRP
904425	Yield Master 6 in Reflector	\$112.95

Yield Master® 8 in Air-Cooled Reflector



Completely sealed featuring hinged glass and double gasket for an air-tight seal. Includes tempered glass, built-in socket and 15 ft lamp cord. Highly reflective aluminum interior for excellent output and uniformity. Swing Stop retention cable keeps glass from abruptly swinging down. Powder-coated galvanized steel housing. Patent No. D644185. Patent Pending: 29/434634.

Item No.	Description	MSRP
904665	Yield Master 8 in Air-Cooled Reflector	\$121.95

Sun Star™ 6 in Air-Cooled Reflector



Completely sealed with double gasketed glass for an air-tight seal. Swing Stop retention cable keeps glass from abruptly swinging down. 6 inch integrated air-cooled fittings with bead ring. Galvanized steel housing with major brand powder-coating. Highly reflective textured aluminum. Includes socket and 15 ft lamp cord.

Item No.	Description	MSRP
904885	Sun Star 6 in Air-Cooled Reflector	\$90.95

SUN SYSTEM REFLECTORS

Scan to watch a video on how to set up a grow room!



SUN SYSTEM REFLECTORS

IMPORT NON AIR-COOLED

DOUBLE ENDED REFLECTOR

Dominator XXXL™ Double Ended Non AC Reflector - 3/Pack



Made specifically for double ended 1000 watt HPS horticultural lamps (not included). Unique double ended construction allows for maximum optical efficiency and uniformity. Full spectrum DE lamps used in this fixture focus on the red component for increased photosynthetic response. They offer improved PAR values and increased PAR/Lumen maintenance (up to 90% PAR at 10,000 hours of operation). Deep reflector design holds the lamp heat to keep the DE lamp at optimal operating temperature. Highly reflective aluminum interior offers excellent uniformity, output and diffusion. Galvanized steel housing with durable powder coated finish. Includes pre-wired sockets and 15 ft lamp cord. Sold in quantities of 3 only. 5 Year Warranty.

Item No.	Description	MSRP
904920	Dominator XXXL Double Ended Non AC Reflector - 3/Pack	\$209.95

PREMIUM HORIZONTAL REFLECTORS

Dominator XXXL™ Single Ended Non AC Reflector - 3 Pack



Massive size for increased coverage area and excellent uniformity. Powder-coated galvanized steel body. Highly reflective aluminum interior offers excellent reflectivity and diffusion. Includes unique socket assembly with 15 ft lamp cord that is attached with four wing nuts. Some assembly required. Patent No. D613900 and Patent Pending No: 29/434634. Sold in quantities of 3 only. 5 Year Warranty.

Item No.	Description	MSRP
904442	Dominator XXXL Single Ended Non AC Reflector - 3/Pack	\$162.95

Irradiator™ Reflector



Integrated socket and 15 ft lamp cord. Galvanized steel housing with major brand powder-coated finish for long lasting durability. Highly reflective aluminum reflector offers excellent diffusion properties. This is a non air-cooled hood that does not accept glass.

Item No.	Description	MSRP
904860	Irradiator Reflector	\$126.95

Sun Star™ Reflector

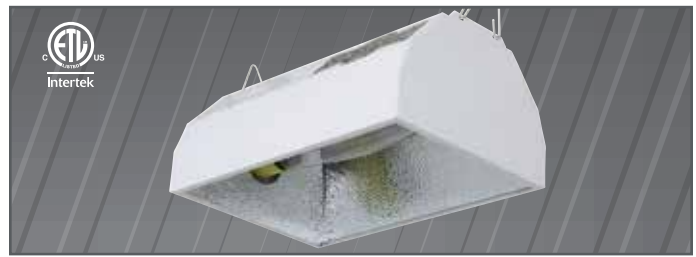

This is a great small compact hood that has an integrated socket and 15 ft lamp cord. Galvanized steel housing with major brand powder-coated finish for durability. Highly reflective textured aluminum offering excellent diffusion properties. This is a non air-cooled hood that does not accept glass.

Item No.	Description	MSRP
904875	Sun Star Reflector	\$81.95

Solartech Magnum™ Reflector

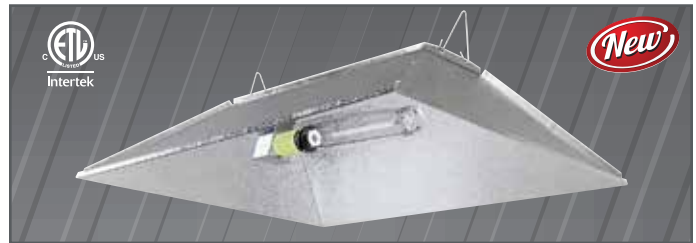

Lightweight all aluminum reflector with galvanized steel back plate. Made of highly reflective aluminum. Comes unassembled and easily sets up in minutes. Includes socket and 15 ft lamp cord. Does not accept glass. 5 year Warranty.

Item No.	Description	MSRP
904942	Solartech Magnum Reflector	\$83.95

Silver Sun® Reflector

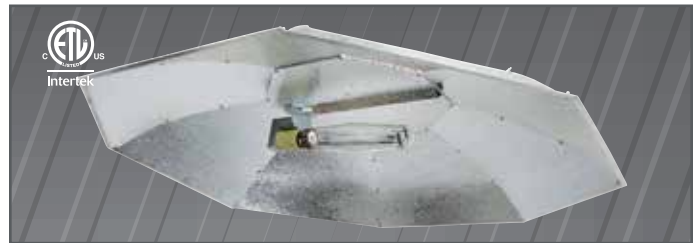

The Silver Sun combines the features of the traditional vertical and horizontal reflectors into one exceptional reflector made of highly reflective aluminum. Pre-wired with lamp cord and socket. Assembly required. US Patent No.: D545994.

Item No.	Description	MSRP
904620	Silver Sun Reflector	\$135.95

Parabolic Reflector



This reflector includes the Adjust-A-Socket mounting bracket. Socket sold separately. This exclusive adjustable bracket allows the user to raise or lower the lamp within the interior of the reflector, thus customizing light patterns. Assembly required.

Item No.	Description	MSRP
904110	Parabolic 48 in White Reflector	\$74.95
904126	Adjust A Socket Mounting Bracket Replacement	\$16.95

WING REFLECTORS

Econo Wing Reflector®



Made with highly reflective textured aluminum and a heavy duty galvanized steel mounting bracket. Corners are rounded – no sharp corners unlike competitive gull-wing type reflectors. Pre-wired with lamp cord and socket. US Patent No: D545485.

Item No.	Description	MSRP
904465	Econo Wing Reflector	\$41.95

Econo Wing Reflector® XL

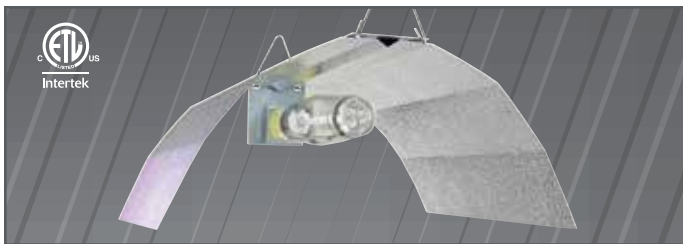

More than twice the size of a standard wing style reflector. Made with highly reflective textured aluminum for excellent output and diffusion. Light weight and easy to hang. Comes completely assembled with prewired socket and lamp cord. Superior photometric performance vs competitive wing reflectors. Heavy duty steel mounting bracket.

Item No.	Description	MSRP
904462	Econo Wing Reflector XL	\$48.95

Value Wing 8 Pack

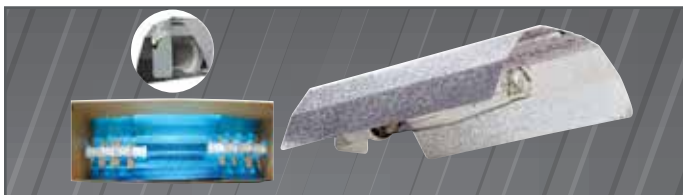

Terminal block for easy attachment of lamp cord. Socket pre-wired into reflector. Purchase 15 ft (903100) or 25 ft (903105) lamp cord separately. Sold in quantities of 8 only.

Item No.	Description	MSRP Ea
904467	Value Wing 8/Pack	\$23.95

Adjust-A-Wings® Enforcer Reflectors



Adjust-A-Wings Enforcer reflectors are made using Chinese reflective made stucco aluminum. They include a molded plastic junction box with socket, pre-wired lamp cord and all parts required for assembly. Wing and socket packaged separately.

Item No.	Description	MSRP
904730	Adjust-A-Wing Enforcer-Large	\$126.95
904735	Adjust-A-Wing Enforcer-Medium	\$92.95

REFLECTOR GLASS FRAMES

Reflector Replacement Glass Frames

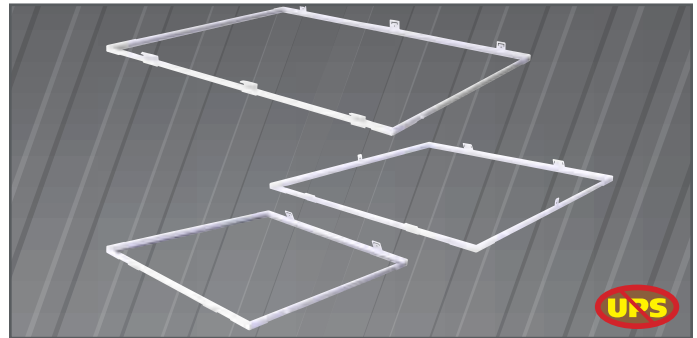

All reflector replacement glass frames are made to the same exacting standards as your original reflector glass frame. Where applicable part includes tempered glass attached to metal frame with high bond and high temperature tape.

Item No.	Description	MSRP
640584	Epic 8 in Reflector Replacement Glass Frame	\$126.95
640281	Magnum XXXL 6 in Gen 3 Replacement Glass Frame	\$108.95
640282	Magnum XXXL 8 in Gen 3 Replacement Glass Frame	\$108.95
640796	BlockBuster 6 in & 8 in Gen 3 Replacement Glass Frame	\$108.95
640278	Low Rider 6 in Replacement Glass Frame	\$90.95
640689	AC/DE 8 in Replacement Glass Frame	\$108.95
640272	Dominator 6 in & Magnum XXXL 6 in Gen 2 Replacement Glass Frame	\$108.95
640273	Dominator 8 in & Magnum XXXL 8 in Gen 2 Replacement Glass Frame	\$108.95
640274	SunGro 6 in & 8 in Blockbuster 6 in & 8 in Gen 2 Replacement Glass Frame	\$108.95
640279	Blazer 6 in Replacement Glass Frame - Side Hinge	\$90.95
640280	Blazer 8 in Replacement Glass Frame - Side Hinged	\$90.95
904305	Super Sun 2 - 6 in Replacement Glass	\$33.95
640483	Irradiator Replacement Glass Frame	\$90.95
640271	Yield Master 6 in Replacement Glass Frame	\$90.95
640270	Yield Master 8 Replacement Glass Frame	\$90.95
640537	Sun Star 6 in Replacement Glass Frame	\$72.95
640892	Evolution 8 Replacement Glass Frame	\$90.95

GAVITA REFLECTORS

Gavita TripleStar 600 Reflector

Rugged, compact design that is adjustable to 3 different positions: Wide, medium and deep. For every position the efficiency is better than 90%. The three Miro Aluminum reflector plates are replaceable.



Item No.	Description	MSRP
906005	Gavita TripleStar 600 Reflector	\$139.95
906010	Gavita TripleStar 600 Inlay Reflector Kit	\$33.95

SUN SYSTEM REFLECTORS

SUN SYSTEM REFLECTORS

Gavita HortiStar 600 SE Reflector

HortiStar 600 has 95% Miro aluminum reflector that can be replaced easily. This fixture is suitable for HPS and MH lamps 600 watt to 750 watts. The lamp cord terminal is shielded by a metal housing. Comes with 13 ft lamp cord.



Item No.	Description	MSRP
906015	Gavita HortiStar 600 SE Reflector	\$99.95
906017	Gavita HortiStar HR 96 600 SE Reflector Replacement	\$37.50

Gavita HortiStar 1000 DE Reflector

HortiStar 1000 DE has 95% Miro aluminum reflector that can be replaced easily. Specifically designed for high frequency electronic ballasts it has a connection at each side of the lamp, removing the need for a frame wire inside the lamp.



Item No.	Description	MSRP
906020	Gavita HortiStar 1000 DE Reflector Double Ended	\$124.95
906022	Gavita HortiStar 96 1000 DE Reflector Replacement	\$37.50

REFLECTOR ACCESSORIES

Lamp & Reflector Cleaning Cloth

All light bulbs need to be wiped clean of finger prints after installation. Our micro fiber lamp cleaning cloth is perfect for doing this. Removes finger prints and dust from lamps, glass, light fixtures, etc.

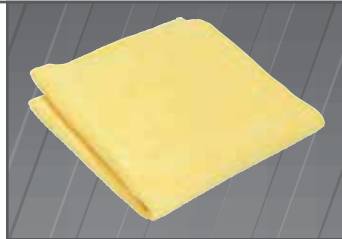

Item No.	Description	MSRP
901475	Lamp & Reflector Cleaning Cloth	\$2.69

Hydro Innovations Ice Box Wall Mount Brackets



Use to mount Ice Box to the wall or ceiling. Complete wall mount kit that includes the bracket and ducting coupler.

Item No.	Description	MSRP
904491	Hydro Innovations Ice Box 6 in Wall Mount Bracket	\$24.95
904494	Hydro Innovations Ice Box 8 in Wall Mount Bracket	\$34.95

Hydro Innovations Ice Box 6 in & 8 in



The Ice Box is a high-quality, cold water circulated heat-exchanger with housing designed to install over a 6 in or 8 in air-cooled reflector duct flange. Air is passed through the reflectors with an inline fan & then passed over the Ice Box heat exchanger.

Item No.	Description	MSRP
904490	Hydro Innovations Ice Box 6 in	\$149.95
904493	Hydro Innovations Ice Box 8 in	\$199.95



Lighting control Easy. Safe. Flexible. Sexy.

High quality green OLED display with 2 lines for full text menu, one line per channel.

Green power-on LED blinks to indicate power was interrupted.

Main and Aux output: Use both channels to control one room or separate channels to control two 12/12 rooms alternating.

Blue LEDs indicates lights on. Separate LED for Main and Aux. Blinks on wiring error/overload.

Red LEDs blink on auto-dim and high temperature shutdown. Constant on to indicate history.

5 language menu system (English, French, Spanish, German, Dutch) with full text intuitive interface.

Fast microprocessor core with battery back-up for settings and system time.



Durable aluminum housing, flush bracket to mount the controller to the wall. Scratch-proof print on front plate.

5 button intuitive control:
- Quick-key for output level
- Down in menu / change value
- Menu / enter
- Up in menu / change value
- Back in menu / cancel / reset

Sun System Harvest Pro Ballasts

Features high-quality & reliable Aerovox® brand capacitor

Featuring our exclusive **EZ CAP DOOR™** for easy capacitor replacement

DUAL UNIVERSAL LAMP CORD RECEPTACLE

400/600/1000W 120/240 Volt

ETL Intertek

Our Harvest Pro ballast with dual input voltage easily switches from 120 to 240 volt power! Simply unplug detachable 8 foot 120 volt power cord (included), turn power plate around for 240 volt power and plug in a 240 volt power cord. (240 volt power cord sold separately, Part #903082). New dual universal lamp cord receptacle is compatible with all Sun System brand reflectors as well as other branded reflectors. Louvered end plates and heat slots help cool the ballast for years of trouble-free use! Aluminum ballast enclosure is engineered to dissipate heat and keep components cool. Heavy duty handle for easy carrying or wall hanging. A barrier wall between ballast and the capacitor/ignitor helps keep the critical components cool. The capacitor and ignitor temperatures are greatly reduced by being separate from the ballast core. Lower temperatures mean better reliability & longer life. Uses high-quality and reliable Aerovox brand capacitor to ensures long lasting durability. EZ Cap Door offers easy access to the capacitor in the event it needs to be replaced. *Product No. 902449 has a 2 year

warranty. 5 Year Warranty.

Item No.	Description	Transformer Voltage	MSRP
902444	Harvest Pro Switchable 400 Watt Ballast	120/208/240/277	\$179.95
902435	Harvest Pro HPS 600 Watt Ballast	120/208/240/277	\$193.95
902441	Harvest Pro Switchable 1000 Watt Ballast	120/208/240/277	\$197.95
902452	Harvest Pro Switchable 1000 Watt Ballast 277 Volt	120/208/240/277	\$221.95
902449	Harvest Pro Switchable 1000 Watt Ballast - 480 Volt*	120/208/240/277/480	\$229.95

Sun System Hard Core Ballasts

Features high-quality & reliable Aerovox® brand capacitor

Featuring **DUAL INPUT VOLTAGE** for 120V or 240V

DUAL UNIVERSAL LAMP CORD RECEPTACLE

120/240 Volt

NEW LOWER PRICE

ETL Intertek

Exposed ballast design is compact and runs cool! Hard Core offers superior cooling capabilities while extending the longevity of the capacitor and ignitor. New dual universal lamp cord receptacle is compatible with all Sun System brand reflectors as well as other branded reflectors. Our Hard Core ballast with dual input voltage easily switches from 120 to 240 volt power! Simply unplug detachable 8 foot 120 volt power cord (included), turn power plate around for 240 volt power and plug in a 240 volt power cord. (240 volt power cord sold separately, Part #903082). Powder-coated steel housing with louvered venting and solid design helps protect internal components. Rubber feet reduce noise and vibration. Excellent ballast quality with high temp 150°C wire connections will provide years of

trouble-free operation. Removable stainless steel handles allow easy handling. 2 Year Warranty.

Item No.	Description	Transformer Voltage	MSRP
902645	Sun System Hard Core HPS 600 Watt 120/240 Volt	120/240	\$137.95
902650	Sun System Hard Core HPS/MH 1000 Watt 120/240 Volt	120/240	\$137.95

Sun System Hard Core 277 Volt Ballast



Exposed ballast design is compact and runs cool! Hard Core offers superior cooling capabilities while extending the longevity of the capacitor and ignitor. New dual universal lamp cord receptacle is compatible with all Sun System brand reflectors as well as other branded reflectors. Powder-coated steel housing with louvered venting and solid design helps protect internal components. Rubber feet reduce noise & vibration. Excellent ballast quality with high temp 150°C wire connections will provide years of trouble-free operation. Removable stainless steel handles allow easy handling. Ballast is

hardwired with an eight foot 277 volt power cord including a L7-15p twist lock plug. 2 Year Warranty.

Item No.	Description	Transformer Voltage	MSRP
902655	Sun System Hard Core Ballast HPS/MH 1000 Watt 277 Volt	120/208/240/277	\$163.95

Sun System Hard Core 480 Volt Ballast



Exposed ballast design is compact and runs cool! Hard Core™ offers superior cooling capabilities while extending the longevity of the capacitor and ignitor. New dual universal lamp cord receptacle is compatible with all Sun System® brand reflectors as well as other branded reflectors. Powder-coated steel housing with louvered venting and solid design helps protect internal components. Rubber feet reduce noise & vibration. Excellent ballast quality with high temp 150°C wire connections will provide years of trouble-free operation. Removable stainless steel handles allow easy handling. Ballast is

hardwired with an eight foot 480 volt power cord does not include plug. 2 Year Warranty.

Item No.	Description	Transformer Voltage	MSRP
902657	Sun System Hard Core Ballast HPS/MH 1000 Watt 480 Volt	120/208/240/277/480	\$177.95

Galaxy Grow Amp Electronic Ballasts

The Galaxy Grow Amp 1000 Watt ballast can operate a 1000 watt lamp at 400 watts, 600 watts, 1000 watts & Turbo Charge. The Galaxy Grow Amp 750W ballast can operate a 750 watt lamp at 600 watts & Turbo Charge a 750 watt lamp. The Galaxy Grow Amp 600 Watt ballast can operate a 600 watt lamp at 400 watts & Turbo Charge a 600 watt lamp. These ballasts will properly drive 400 Watt HPS/MH, & 600 watt HPS lamps or properly drive 400 Watt HPS/MH, 600 watt HPS & 1000 watt HPS/MH lamps. Set the desired wattage on the Select-A-Watt dial & install the correct lamp. Galaxy Grow Amp ballasts come pre-wired with a Sun System lamp cord receptacle. They are compatible with all Sun System branded reflectors. Includes a 6 foot 120 volt power cord. Purchase a 240 volt power cord separately (#903082). Specifications: extremely efficient - 99.9%; 902215 - operates 400 watt HPS/MH & 600 HPS lamps, 902235 operates 600 HPS and 750 HPS/MH lamps, 902220 operates 400, 600 and 1000 HPS/MH lamps, soft starting, extruded aluminum housing, fan cooled for superior thermal management, lightweight, very quiet and limited vibration, voltage: 120 or 240, Part No. 902225 is

240 volt only. 3 Year Warranty.

Item No.	Description	MSRP
902215	Galaxy Grow Amp 600 Watt 400/600/Turbo Charge - 120/240 Volt	\$252.95
902235	Galaxy Grow Amp 750 Watt 600/750/Turbo Charge - 120/240 Volt	\$281.95
902220	Galaxy Grow Amp 1000 Watt 400/600/1000/Turbo Charge - 120/240 Volt	\$306.95
902225	Galaxy Grow Amp 1000 Watt 400/600/1000/Turbo Charge - 240 Volt Only	\$297.95

Galaxy Grow Amp Master Blaster 1500 Watt Electronic Ballast

This Galaxy Grow Amp Master Blaster 1500 watt ballast can operate 1500 watt HPS or MH lamps. Galaxy Grow Amp ballasts come pre-wired with a Sun System lamp cord receptacle. They are compatible with all Sun System branded reflectors. Includes a 6 foot 240 volt power cord. Specifications: Voltage: 240, lightweight, soft starting, extremely efficient - 99.9%, extruded aluminum housing, fan cooled for

superior thermal management, operates 1500 HPS/MH lamps, very quiet. 2 Year Warranty.

Item No.	Description	MSRP
902230	Galaxy Grow Amp Master Blaster 1500 Watt - 240 Volt Only	\$434.95

ELECTRONIC BALLASTS

Galaxy Legacy Electronic Ballasts

GALAXY LEGACY ELECTRONIC BALLAST

Industry exclusive **SELECT-A-WATT®**
400/600/1000 Watt
+ Turbo Charge®

120V / 240V SOFT STARTING LIGHTWEIGHT 3 YEAR WARRANTY 99.9% EFFICIENT

galaxyballasts.com

Pre-programmed with a digital random start feature. It will delay 1-3 seconds each time it starts. Reduces in-rush current spikes when starting multiple ballasts at a time. These state-of-the-art ballasts are manufactured to provide today's serious grower with maximum flexibility & performance. The Galaxy Legacy is different than any other dimmable electronic ballast on the market. Lamps are only dimmable on wattages lower than the specified lamp wattage. A 1000 watt lamp can be dimmed down to 600 or 400 watt. A 600 watt lamp can be dimmed down to 400 watt but cannot be over-driven to 1000 watts. Turbo Charge is designed for 1000 watt lamps only on 902518 and 600 watt lamps only on 902517. There are three ways to use the Select-A-Watt feature: It will properly drive a 400, 600 or 1000 watt lamp to ANSI specifications. For example: Set the switch to 400 watts, insert a 400 watt lamp into your socket and the ballast will operate the 400 watt lamp. The ballast will similarly

operate 600 or 1000 watt lamps. The second option is to dim a 1000 watt lamp. Adjust the switch to 400 or 600 watts and the ballast will dim the 1000 watt lamp by 40 or 60%. The Turbo Charge feature will increase the output of a 1000 watt lamp (only) by approximately 10%. 3 Year Warranty.

Item No.	Description	MSRP
902517	Galaxy Legacy 400/600/Turbo Charge Electronic Ballast - 120/240 Volt	\$215.95
902518	Galaxy Legacy 400/600/1000/Turbo Charge Electronic Ballast - 120/240 Volt	\$270.95
902510	Galaxy Legacy 1000 Watt Electronic Ballast - 240 Volt	\$261.95

Galaxy Digital Logic Electronic Ballasts

GALAXY DIGITAL LOGIC™

Industry exclusive **New!** **400/600/1000 Watt**
+ Turbo Charge®

Thermally optimized non-air cooled aluminum housing

BUILT-IN Digital Timer
WITH 7 PRESET LIGHTING CYCLES

New Dual Universal Lamp Cord Receptacle

120V / 240V SOFT STARTING EXTREMELY RELIABLE 3 YEAR WARRANTY 99% POWER FACTOR

galaxyballasts.com

Galaxy Digital Logic™ Ballasts feature our proprietary Intelligent Control Interface™. This smart interface allows control of preprogrammed timing settings, lamp dimming, Turbo Charge™ activation, self-diagnostic feature with easily identified error codes and an hour meter to monitor the age of your lamp. This is displayed with a green LED panel on the end of the ballast. Low current, staggered ignition delay feature eliminates circuit inrush overload and protects lamp for increased lumen maintenance. Internal ballast programming will protect unit in instance of open circuit, short circuit, over/under voltage or high temperature exposure. Thermally optimized non-air cooled aluminum housing. New dual universal lamp cord receptacle is compatible with all Sun System brand reflectors as well as other branded reflectors. The optional remote control (#902234 or #902674) can be used for integrated timer

programming and operation. Control multiple units with one remote control (sold separately). 3 Year Warranty.

Item No.	Description	MSRP
902672	Galaxy Digital Logic 600 Watt Select-A-Watt 250/400/600 - Turbo Charge - 120/240 Volt	\$234.95
902232	Galaxy Digital Logic 1000 Watt Select-A-Watt 400/600/1000 - Turbo Charge - 120/240 Volt	\$289.95

Galaxy Digital Logic Wireless Remote Controls

Galaxy Digital Logic wireless remote control allows ballast configuration and setup. Preprogrammed cycle settings with digital timer integration. The Galaxy wireless remote control allows you to setup and configure your ballast(s). Sync multiple Galaxy Digital Logic Ballasts to the same schedule. Includes the Turbo Charge setting for maximum output. Easy to use LCD display.



Item No.	Description	MSRP
902674	Galaxy Digital Logic 600 Watt Remote Control	\$19.95
902234	Galaxy Digital Logic 1000 Watt Remote Control	\$19.95

Gavita ECM1 - External Contactor Modules

External Contactor Module (15A) with blue indication LED follows lights-on for main channel. Use ECMs to switch CO2, fertigation, heating etc. during lights-on or lights-off cycle. ECMs can be positioned close to the actual accessories. Cable outputs with female and male connector allow easy connection of accessories. 3 year Warranty.



Item No.	Description	MSRP
906082	Gavita ECM1 US 120 - External Contactor Module 120 Volt Plugs	\$99.50
906083	Gavita ECM1 US 240 - External Contactor Module 240 Volt Plugs	\$99.50

Gavita Master Controllers



The Gavita EL controller series currently comprises of two models: The EL1 and EL2. Both feature auto-dim, auto-shutdown, sunrise/sunset and timer. The EL1 has one output channel, while the EL2 has 2 output channels and additional outputs for External Contactor Modules and alarm contacts. 3 year Warranty.

Item No.	Description	MSRP
906080	Gavita Master Controller EL1	\$279.00
906081	Gavita Master Controller EL2	\$359.00

Gavita Pro Electronic Remote Ballasts - 240 Volt



Professional adjustable high frequency electronic ballasts. Only suitable for use with EL lamps: no acoustic resonance, up to 8% more grow light compared to traditional lamps, light maintenance after 5000 hours >95%. Microprocessor controlled with electronic safety circuit. Driver efficiency at full power is 95-96%. Gavita Pro 1000 has adjustable output to 600/660/750/825/1000/1150 watts. Sealed housing with Gore-Tex ventilation plug. Equipped with an industry standard XR505 connector

for plug and play installation with your favorite reflector. Operate at 240 volts. 3 Year Warranty.

Item No.	Description	MSRP
906030	Gavita Pro 600 Remote Ballast 240 Volt	\$279.95
906040	Gavita Pro 1000 Remote Ballast 240 Volt	\$389.95

Gavita Pro Classic Line 600 SE Complete Fixture - 240 Volt



Professional 600 watt high frequency electronic ballast. Including high efficiency Miro aluminum horticultural HortiStar HR96 reflector (96% efficiency). Only suitable for use with 600 watt EL lamp (included): No acoustic resonance, up to 8% more grow light and light maintenance after 5000 hours >95%. Microprocessor controlled. Driver efficiency >95%. Sealed housing with Gore-Tex ventilation plug. Reflector easily replaceable. Very low heat dissipation and very low weight. LED status indicator. Comes with 16 ft power cord. Operates at 240 Volts. 1 year warranty on the lamp. 3 Year Warranty.

Item No.	Description	MSRP
906045	Gavita Pro Classic 600 SE Complete Fixture 240 Volt	\$425.95

Gavita Pro Classic Line 1000 DE Complete Fixture - 240 Volt



Professional 1000 watt high frequency electronic ballast. Including high efficiency Miro aluminum horticultural HortiStar HR96 reflector (96% efficiency). Includes 1000 watt double ended EL lamp. Microprocessor controlled with electronic safety circuit. Very low heat dissipation and very low weight. Only suitable for use with 1000 watt double ended EL lamps: No acoustic resonance, more than 10% grow light compared to traditional lamps and light maintenance after 5000 hours >95%. Electronics by Gavita. Driver efficiency >95% and is adjustable to: 600/660/750/825/1150W. Sealed housing with Gore-Tex ventilation plug. Reflector easily replaceable. Comes with 16 ft power cord. Operates at 240 Volts. 1 year warranty on the lamp. 3 Year Warranty.

Item No.	Description	MSRP
906050	Gavita Pro Classic 1000 DE Complete Fixture 240 Volt	\$599.95

Gavita Pro 600e SE Complete Fixture - 120/240 Volt



The Gavita Pro 600e SE is part of the new Gavita e-series fixtures that are suitable for remote control with the Gavita Master Controllers. Equipped with a 1190 umol s-1 600W 400V electronic high frequency lamp it produces more light than any other 600W fixture. Suitable for lighting a 11 sq ft area with average 1000 umol s-1 m-2. Comes with 16 ft power cord. 1 year warranty on the lamp. 3 Year Warranty.

Item No.	Description	MSRP
906086	Gavita Pro 600e SE (300-660 Watt) 120/240 Volt	\$489.99



FASTFIT
toolless assembly light & tray stands

Check out the Fast Fit™ multiple set up options and an assembly video at www.fastfitstands.com



Gavita Pro 6/750e DE Flex Complete Fixture - 120/240 Volt



The new Gavita 6/750W 400V EL DE lamp has an efficiency of 2 $\mu\text{mol s}^{-1}$ per Watt in a wide control range of 600-825W. When necessary it can be dimmed down to 375W. Of course it is suitable for the Gavita Master Controller, eliminating the need for timers and contactors. This fixture is suitable for lighting a 15 sq ft area with 1000 $\mu\text{mol s}^{-1} \text{m}^{-2}$. Comes with 16 ft power cord. 1 year warranty on the lamp. 3 Year Warranty.

Item No.	Description	MSRP
906087	Gavita Pro 6/750e DE Flex (400-825 Watt) 120/240 Volt	\$569.99

Gavita Pro 1000e DE Complete Fixture - 120/240 Volt



The Pro 1000e DE is the new e-series flagship model. Together with the Pro 1000e DE Gavita also introduces its Pro plus 1000W Electronic lamp, with 2100 $\mu\text{mol s}^{-1}$ output. So now you have a choice of lamps as well. You can control up to 80 fixtures with a Gavita Master controller without the need for timers and contactors. The Pro 1000e can light 21 sq ft with 1000 $\mu\text{mol s}^{-1} \text{m}^{-2}$. Comes with 16 ft power cord. 1 year warranty on the lamp. 3 Year Warranty.

Item No.	Description	MSRP
906088	Gavita Pro 1000e DE (600-1150 Watt) 120/240 Volt	\$649.99

Gavita DigiStar e-Series Electronic Ballasts - 120/240 Volt



Gavita DigiStar adjustable electronic ballasts guarantee maximum lamp output regardless of a fluctuating input voltage. They operate completely silent, cool, safe and are more efficient than magnetic ballasts. The DigiStar ballasts have an adjustable output power. This feature allows you to dim and boost a lamp or to use different lamp powers with the same ballast, for example a 400W lamp for vegetative growth and 600W lamp for the flowering phase. 3 Year Warranty.

Item No.	Description	MSRP
906084	Gavita DigiStar 600e 120/240 Volt	\$249.00
906085	Gavita DigiStar 1000e 120/240 Volt	\$329.00

Nanolux Digital Ballasts - 120/240 Volt



The revolutionary Nanolux dimmable digital ballast proves that good things do come in small packages. The Nanolux uses cutting edge circuit board technology to make it 1/2 the size of traditional digital ballasts at 1/4 the weight. The Nanolux will operate HPS and MH lamps and it incorporates a random start feature, which gives each ballast a 0-15 second window to strike the lamp. This allows for a lower initial power draw when using multiple ballasts and eliminates power spikes. In addition, the Nanolux ballast is programmed with a soft start and soft dimming which helps extend lamp life. The Nanolux ballasts operate on 120 to 240 volts and utilize an LED notification system. This indicator allows the user to easily diagnose such problems as fan failure, under or over voltage, short or open

circuit protection and thermal overload protection. Customize your light output between 100%, 75% and 50%. New dual universal lamp cord receptacle is compatible with all Sun System brand reflectors as well as other branded reflectors. 3 Year Warranty.

Item No.	Description	MSRP
902750	Nanolux 1000 Watt 120/240 Volt	\$289.95
902752	Nanolux 600 Watt 120/240 Volt	\$215.95

Eye Hortilux Platinum Electronic Ballast



Engineered by experts in Lamp-Ballast compatibility to optimize Eye Hortilux lamps. Years of research & development has resulted in a product that actually works and consistently operates Metal Halide & High Pressure Sodium lamps. Clean Cool technology channels airflow to reduce dirt & dust accumulation on critical electronic components. 120 hertz, low frequency square wave form. Flicker-free steady state operation. Superior performing design - made in Japan. 120/240 dual voltage capability. Pre-wired with Sun System receptacle. Includes 120 volt power cord. Generator ready. Extended ground contact

in lamp plug for maximum safety. 5 Year Warranty.

Item No.	Description	MSRP
902580	Eye Hortilux 1000 Watt Platinum Electronic Ballast & Lamp Combo	\$659.95

Eye Hortilux Gold E-Ballasts



Designed by experts in lamp-ballast compatibility, the Eye Hortilux Gold Series e-Ballasts provide consistent, stable power to the lamp for high intensity and a quality spectrum. These ballasts feature lamp detection for safe operation (open & short circuit protection), soft start technology, silent, high frequency sine wave operation, cool operating temperature and a long range igniter (up to 70 feet). Designed to extend the life of your lamp, the Gold Series e-Ballasts operate Hortilux Super HPS, Hortilux Blue and Hortilux e-Start Metal Halide Lamps. Generator ready, flip box ready and completely sealed

against dust and moisture, these ballasts are also UL listed for fire and electrical safety. 120V cord included (240V cord may be purchased separately). 3 Year Warranty.

Item No.	Description	MSRP
902582	Eye Hortilux Gold 1000 Watt E-Ballast 120/240 Volt	\$399.95
902584	Eye Hortilux Gold 600 Watt E-Ballast 120/240 Volt	\$249.95

ELECTRONIC BALLASTS



Double DE Light

Check out our 1000 HPS Double-Ended Reflectors

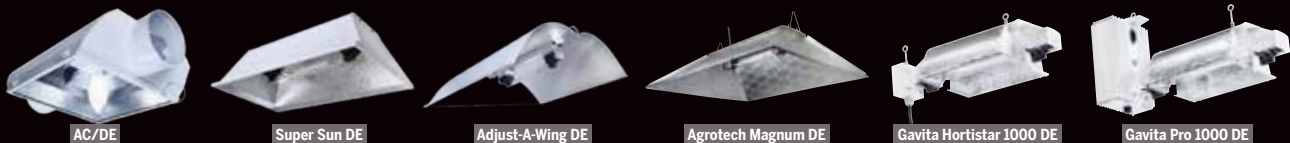

This new group of state-of-the-art reflectors and fixtures are designed specifically to accommodate Double-Ended 1000 watt HPS horticultural lamps. The AC/DE is the only air-cooled double-ended reflector on the market. These lamps feature increased PAR values as well as excellent lumen and PAR maintenance (up to 90% PAR maintenance after 10,000 hours). The full spectrum lamps focus on the red component for increased photosynthetic response. Prepare for the best crops and yields you have ever seen.



Sunlight Supply, Inc.
National Garden Wholesale.
www.sunlightsupply.com

Sun System Trifecta



Includes a magnetic ballast the Sun System Hard Core 1000 Watt Switchable 120/240 Volt Ballast, an EconoWing Reflector and an Ultra Sun 1000 HPS lamp all packaged in one box. Everything you need to get growing in one convenient box!

Item No.	Description	MSRP
906500	Trifecta	\$209.95

Sun System Digital 250/400



This state of the art digital fixture will run both 250 & 400 watt lamps. The integrated electronic ballast allows operation of both metal halide (MH) and high pressure sodium (HPS) lamps. The proprietary Smart Volt ballast operates at either 120 or 240 volts (120 volt cord included). Lightweight (only 15 lb) and easy to set up. Highly reflective aluminum insert. On/Off switch. Powder-coated steel housing is attractive and durable. 2 Year Warranty.

Item No.	Description	MSRP
900514	Sun System Digital 250/400	\$234.95

Sun System HPS 150 Grow Light Fixture



This compact easy to use light fixture will work great for any gardener. The high intensity bulb delivers an amazing 16,000 lumens and provides the output and ideal color spectrum required for successful indoor gardening. Grow herbs, flowers or fresh vegetables all year, not just in summer. 150 watt high pressure sodium bulb (mogul base) included. Highly reflective aluminum insert. Vented housing helps dissipate heat. Durable white powder-coated finish. Backlit on/off switch. 7 ft grounded 120 volt power cord. Dimensions: 15 in long x 9-1/2 in wide x 3-3/4 in high. 2 Year Warranty.

Item No.	Description	MSRP
900490	Sun System HPS 150 w/ Ultra Sun Lamp	\$85.95

SunLight™ 125 Fluorescent Fixture with Lamp



This fixture includes everything you need to get growing. It starts with a high quality 125 watt Feliz™ fluorescent 6500°K grow lamp. Add a White Wing Reflector that has a bright white powder-coated finish providing excellent reflectivity and durability. It has a sturdy steel construction for long life and a heavy duty socket assembly. Includes mogul base socket and 8 ft 120 volt power cord. Integrated mounting bracket with wire hangers for hanging the fixture. Just plug in and start growing. 1 Year Warranty.

Item No.	Description	Dimensions L x W x H	MSRP
960380	SunLight 125 Fluorescent Fixture w/ Lamp	16.5" x 11.6" x 5.1"	\$69.95

Philips Mastercolor LEC 315 Lamps

Superior color quality. Crisp white light. Very High 1.95 PPF per second light source. 3100°K or 4200°K color temperature, High 92cri, 33,000 initial lumens (105Lm/W). High 90% lumen maintenance at 8,000 hr/High 85% PPF maintenance at 20,000 hr. Unique Open Rated Lamp construction reduces radiant heat from the arc tube and is suitable for open fixture use. 1 Year Warranty.



Item No.	Description	Approx. Initial Lumens	Glass Size	MSRP
901575	Philips Master Color CDM Lamp 315 Watt Elite Agro 3100K (Full Spectrum)	33,000	T-12	\$104.95
901573	Philips Master Color CDM Lamp 315 Watt Elite MW 4200K (Blue)	33,000	T-12	\$104.95

Sun System LEC™ 315 Light Emitting Ceramic Fixture



Includes Lamp
 Philips MasterColor CDM
 Elite Agro 3100°K

Philips MasterColor CDM Elite Agro 3100°K

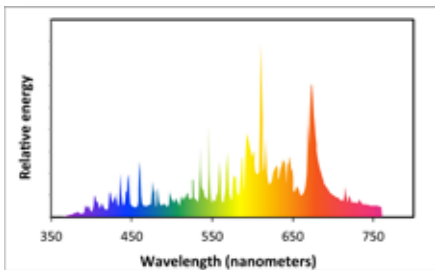

Sun System LEC 315 utilizes cutting edge Light Emitting Ceramic technology. Fixture has 98% reflective German aluminum insert and 95% reflective textured corners for excellent output, uniformity and diffusion. Highly efficient agriculturally engineered CDM-T Elite 315/930/U/O Agro Lamp (lamp included). Greatly improved full color light spectrum out of next generation ceramic lamps. Higher amounts of beneficial UV and far red spectrums increase the lamps growth power to the plants. Very high 1.95 PPF per second light source. 3100°K or 4200°K color temperature, high 92 CRI, 33,000 initial lumens (105Lm/W). Long life 20,000 hour lamp. High 90% lumen maintenance @ 8000 hr.

High 85% PPF maintenance @ 20,000 hr. Unique open rated lamp construction reduces radiant heat from the arc tube and is suitable for open fixture use. 50/60 Hz low frequency, square wave, highly efficient electronic ballast rated for 50,000 hour ballast life. LEC 315 driver incorporates built in thermal protection. One year warranty lamp. 2 Year Warranty.

Item No.	Description	MSRP
906200	Sun System LEC315 120 Volt w/ Lamp	\$599.95
906205	Sun System LEC315 240 Volt w/ Lamp	\$569.95

**THE NEW
 LOOK OF**

Sun System®



COMING SOON!



FABRICATED & ASSEMBLED IN USA
 SINGLE END-MOGUL BASE

DESIGNED IN USA
 DOUBLE-ENDED

DESIGNED IN USA
 MADE IN CHINA

SUN SYSTEM COMPLETE SYSTEMS

SE Commercial Reflector with Brackets



This is a 95% reflective German aluminum reflector with brackets built in for adding your Galaxy® Digital Logic electronic ballast (sold separately). These brackets have wing nuts that easily adjust to put the ballasts into place. A high quality mogul base socket and short lamp cord are included for easy set up. 3 year Warranty.

Item No.	Description	MSRP
904926	SE Commercial Reflector	\$129.95

DE Commercial Reflector with Brackets



This is a 95% reflective German aluminum reflector with brackets built in for adding your Galaxy® Digital Logic electronic ballast (sold separately). These brackets have wing nuts that easily adjust to put the ballasts into place. Made specifically for double ended 1000 watt HPS horticulture lamps (not included). Pre-wired lamp cord included. 3 year Warranty.

Item No.	Description	MSRP
904928	DE Commercial Reflector	\$174.95

Gavita Pro Classic Line 600 SE Complete Fixture - 240 Volt



Professional 600 watt high frequency electronic ballast. Including high efficiency Miro aluminum horticultural HortiStar HR96 reflector (96% efficiency). Only suitable for use with 600 watt EL lamp (included): No acoustic resonance, up to 8% more grow light and light maintenance after 5000 hours >95%. Microprocessor controlled. Driver efficiency >95%. Sealed housing with Gore-Tex ventilation plug. Reflector easily replaceable. Very low heat dissipation and very low weight. LED status indicator. Operates at 240 Volts. Comes with 16 ft power cord. 1 year warranty on the lamp. 3 Year Warranty.

Item No.	Description	MSRP
906045	Gavita Pro Classic 600 SE Complete Fixture 240 Volt	\$425.95

Gavita Pro Classic Line 1000 DE Complete Fixture - 240 Volt



Professional 1000 watt high frequency electronic ballast. Including high efficiency Miro aluminum horticultural HortiStar HR96 reflector (96% efficiency). Includes 1000 watt double ended EL lamp. Microprocessor controlled with electronic safety circuit. Very low heat dissipation and very low weight. Only suitable for use with 1000 watt double ended EL lamps: No acoustic resonance, more than 10% grow light compared to traditional lamps and light maintenance after 5000 hours >95%. Electronics by Gavita. Driver efficiency >95% and is adjustable to: 600/660/750/825/1150W. Sealed housing with Gore-Tex ventilation plug. Reflector easily replaceable. Operates at 240 Volts. Comes with 16 ft power cord. 1 year warranty on the lamp. 3 Year Warranty.

Item No.	Description	MSRP
906050	Gavita Pro Classic 1000 DE Complete Fixture 240 Volt	\$599.95

Gavita Pro 600e SE Complete Fixture - 120/240 Volt



The Gavita Pro 600e SE is part of the new Gavita e-series fixtures that are suitable for remote control with the Gavita Master Controllers. Equipped with a 1190 $\mu\text{mol s}^{-1}$ 600W 400V electronic high frequency lamp it produces more light than any other 600W fixture. Suitable for lighting a 11 sq ft area with average 1000 $\mu\text{mol s}^{-1} \text{m}^{-2}$. Comes with 16 ft power cord. 1 year warranty on the lamp. 3 Year Warranty.

Item No.	Description	MSRP
906086	Gavita Pro 600e SE (300-660 Watt) 120/240 Volt	\$489.99

Gavita Pro 6/750e DE Flex Complete Fixture - 120/240 Volt



The new Gavita 6/750W 400V EL DE lamp has an efficiency of 2 $\mu\text{mol s}^{-1}$ per Watt in a wide control range of 600-825W. When necessary it can be dimmed down to 375W. Of course it is suitable for the Gavita Master Controller, eliminating the need for timers and contactors. This fixture is suitable for lighting a 15 sq ft area with 1000 $\mu\text{mol s}^{-1} \text{m}^{-2}$. Comes with 16 ft power cord. 1 year warranty on the lamp. 3 Year Warranty.

Item No.	Description	MSRP
906087	Gavita Pro 6/750e DE Flex (400-825 Watt) 120/240 Volt	\$569.99

Gavita Pro 1000e DE Complete Fixture - 120/240 Volt



The Pro 1000e DE is the new e-series flagship model. Together with the Pro 1000e DE Gavita also introduces its Pro plus 1000W Electronic lamp, with 2100 $\mu\text{mol s}^{-1}$ output. So now you have a choice of lamps as well. You can control up to 80 fixtures with a Gavita Master controller without the need for timers and contactors. The Pro 1000e can light 21 sq ft with 1000 $\mu\text{mol s}^{-1} \text{m}^{-2}$. Comes with 16 ft power cord. 1 year warranty on the lamp. 3 Year Warranty.

Item No.	Description	MSRP
906088	Gavita Pro 1000e DE (600-1150 Watt) 120/240 Volt	\$649.99

Scan to go to Sunlight Supply's web site and see the latest Sun System products, instructions, videos, product specifications and much more!



Sun Blaze T5 Very High Output (VHO) Fluorescent Lighting Fixtures



White powder-coated steel housing. Wire cable hangers included with every fixture. You can choose to hang horizontally or vertically. Run on 120 volt power only. Louvered on sides for cool operation. Slots on top of fixture for convection cooling. VHO lamps offer 7,200 lumens - 95 watts each. 3000°K (red) VHO lamps can be purchased separately (#901480). One year warranty on lamps. 5 Year Warranty.

Item No.	Description	Dimensions L x W x H	MSRP
960365	Sun Blaze T5 VHO 44 - 4 ft 4 Lamp	47.0" x 12.0" x 2.5"	\$224.95
960375	Sun Blaze T5 VHO 48 - 4 ft 8 Lamp	47.0" x 22.0" x 2.5"	\$404.95

Sun Blaze T5 HO Fluorescent Light Fixtures



Wider advanced reflector design of the Sun Blaze T5 Fluorescent Fixtures offers excellent reflectivity & diffusion. 12 ft power cord & on/off switch allows for easy operation. Daisy chain feature allows multiple fixtures to be plugged in together. One year warranty on lamps. 5 Year Warranty.

Item No.	Description	Dimensions L x W x H	MSRP
960290	Sun Blaze T5 HO 22 - 2 ft 2 Lamp	23.5" x 7.25" x 2.5"	\$92.95
960295	Sun Blaze T5 HO 24 - 2 ft 4 Lamp	23.5" x 12.0" x 2.5"	\$123.95
960293	Sun Blaze T5 HO 28 - 2 ft 8 Lamp	23.5" x 22.0" x 2.5"	\$217.95
960296	Sun Blaze T5 HO 42 - 4 ft 2 Lamp	47.0" x 7.5" x 2.5"	\$115.95
960300	Sun Blaze T5 HO 44 - 4 ft 4 Lamp	47.0" x 12.0" x 2.5"	\$163.95
960302	Sun Blaze T5 HO 46 - 4 ft 6 Lamp	47.0" x 17.0" x 2.5"	\$221.95
960305	Sun Blaze T5 HO 48 - 4 ft 8 Lamp	47.0" x 22.0" x 2.5"	\$261.95

Sun Blaze T5 High Output Fluorescent Strip Light Fixtures



High output ballast for long life. Fixture Includes: 6500°K (blue) T5 HO lamp. Accommodates standard 2 ft & 4 ft replacement lamps. Power cord & 4 inch jumper cable to daisy chain multiple fixtures. 1 Year Warranty.

Item No.	Description	Dimensions L x W x H	Max Chain @ 120V	MSRP
960315	Sun Blaze T5 HO 21 - 2 ft 1 Lamp	23.8" x 1.0" x 1.75"	10	\$28.49
960320	Sun Blaze T5 HO 41 - 4 ft 1 Lamp	47.75" x 1.0" x 1.75"	5	\$33.95

Sun Blaze T5 High Output Supreme Fluorescent Strip Light Fixture with Reflector



Sun Blaze T5 High Output Fluorescent Strip Light Supremes' reflector design maximizes output and diffusion. Lightweight and easy to install, this fixture includes a 6500°K (blue) T5 HO Lamp. Mounting hardware and hanging bracket kit included. 1 Year Warranty.

Item No.	Description	Dimensions L x W x H	Max Chain @ 120V	MSRP
960345	Sun Blaze T5 HO Supreme 21 - 2 ft 1 Lamp	25.0" x 5.5" x 2.0"	10	\$39.95
960350	Sun Blaze T5 HO Supreme 41 - 4 ft 1 Lamp	48.0" x 5.5" x 2.0"	5	\$49.95

Super Sprouter T5 High Output Grow Light Fixture



This fixtures include electronic ballast, 6400°K lamp, power cord, jumper cord, hanging and flat surface mounting clips. You can run up to a maximum of 8 lights per single cord. The reflector uses nanotechnology to maximize reflection. Specifically to fit Super Sprouter Light Track Domes. 1 Year Warranty.

Item No.	Description	MSRP
726420	Super Sprouter T5 HO 18 in Grow Light Blister Pack	\$37.95

Super Sprouter
YOUR BEST START FOR SEEDS AND CUTTINGS!

Super Sprouter products can help give your plants their best start.
www.SuperSprouter.com

Sun Blaze T5 Strip Light Jumper Cords

Use the jumper cords to daisy chain two or more Sun Blaze T5 Strip Lights together. The 18 in or 4 ft jumper cord replaces the 4 in jumper cord that is included with the fixture. Allows the user to space the fixtures further apart for added flexibility.



Item No.	Description	MSRP
960325	Sun Blaze T5 Strip Light Replacement Jumper Cord 18 in	\$2.99
960330	Sun Blaze T5 Strip Light Replacement Jumper Cord 4 in	\$1.99
960335	Sun Blaze T5 Strip Light Replacement Jumper Cord 4 ft	\$4.99

SunBlaster NanoTech T5 HO Fixtures



Incorporates the Sun Blaze T5 HO fluorescent fixture and the NanoTech reflector combining them into one fixture. Includes 6400°K lamp, power cord, jumper plug with both hanging/mounting hardware. SunBlaster fixtures link together to a maximum of 8 per single power cord. The NanoTech reflector was designed using Nanotechnology to produce the ultimate in a reflective surface that can increase lumen availability by as much as 300%. 18 in fixture was designed specifically to fit into the NanoDome. 1 Year Warranty.

Item No.	Description	MSRP
904296	SunBlaster NanoTech T5 HO 21 - 2 ft 1 Lamp w/ NanoTech Reflector	\$40.50
904297	SunBlaster NanoTech T5 HO 31 - 3 ft 1 Lamp w/ NanoTech Reflector	\$44.77
904298	SunBlaster NanoTech T5 HO 41 - 4 ft 1 Lamp w/ NanoTech Reflector	\$49.30

SunBlaster T5 High Output Fluorescent Strip Light Fixtures



Built in electronic ballast provides instant starting with no flickering. Durable aluminum housing. Lasts up to 10,000 hours. Lightweight and easy to install. Fixture includes 6400°K full spectrum lamp. 1 Year Warranty.

Item No.	Description	Dimensions L x W x H	MSRP
904301	SunBlaster T5 HO 21 - 2 ft 1 Lamp	26.75" x 3.75" x 1.5"	\$27.95
904302	SunBlaster T5 HO 31 - 3 ft 1 Lamp	35.25" x 3.75" x 1.5"	\$30.45
904303	SunBlaster T5 HO 41 - 4 ft 1 Lamp	50.5" x 3.75" x 1.5"	\$32.95

SunBlaster NanoTech T5 Reflectors



SunBlaster now has a snap on reflector. The SunBlaster NanoTech T5 Reflector was engineered using Nanotechnology to create a crystal reflective layer that dramatically increases the amount of light reaching each plant.

Item No.	Description	MSRP
904313	SunBlaster NanoTech T5 Reflector 2 ft	\$16.95
904314	SunBlaster NanoTech T5 Reflector 3 ft	\$19.95
904304	SunBlaster NanoTech T5 Reflector 4 ft	\$22.95

SunBlaster T5 Universal Light Stand

For use with SunBlaster T5 fixtures. Simply attach the fixture and you are ready to grow.



Item No.	Description	MSRP
710158	SunBlaster T5 Universal Light Stand	\$35.95

SunBlaster Universal T5 Light Strip Hanger

Allows you to add up to seven T5's above your target area. Snap any size of T5 into one or all of the seven mounting banks. Made to snap into your Universal T5 Stand, hang from above, with your choice of suspension hardware or wall mount. Includes 2 SunBlaster Universal Light Strips, 2 mounting screws and 4 easy clip hangers.



Item No.	Description	MSRP
710162	SunBlaster Universal T5 Light Strip Hanger	\$10.49

Sun System Garden Bright Fluorescent Grow Light



Highly reflective textured aluminum interior. Slotted and louvered for maximum air-cooling. 8 ft 120 volt power cord. On/off switch. Completely assembled. Size: 19.75 in long x 12.25 in wide x 7.5 in tall. US Patent No: D542460. Accommodates Feliz self-ballasted compact fluorescent lamps 125 & 200 watts. 3 Year Warranty.

Item No.	Description	MSRP
960207	Sun System Garden Bright Fluorescent Grow Light	\$69.95

FLUORESCENT LIGHTING

CREATE YOUR WISH LIST BY SCANNING NOW!

FLUORESCENT LIGHTING

FLUORESCENT LIGHTING

SunLight™ 125 Fluorescent Fixture with Lamp



This fixture includes everything you need to get growing. It starts with a high quality 125 watt Feliz™ fluorescent 6500°K grow lamp. Add a White Wing Reflector that has a bright white powder-coated finish providing excellent reflectivity and durability. It has a sturdy steel construction for long life and a heavy duty socket assembly. Includes mogul base socket and 8 ft 120 volt power cord. Integrated mounting bracket with wire hangers for hanging the fixture. Just plug in and start growing. 1 Year Warranty.

Item No.	Description	Dimensions L x W x H	MSRP
960380	SunLight 125 Fluorescent Fixture w/ Lamp	16.5" x 11.6" x 5.1"	\$69.95

Sun System White Wing Fluorescent Grow Light Fixture



Bright white powder-coated finish provides excellent reflectivity. Sturdy steel construction for long life. Heavy duty socket assembly supports the weight of high wattage CFL lamps. Includes mogul base socket and 8 ft 120 volt power cord. Accommodates all Feliz compact fluorescent lamps. 3 Year Warranty.

Item No.	Description	MSRP
904293	Sun System White Wing CFL Fixture	\$54.95



These high quality T5 HO lamps are excellent for all indoor gardening applications. Use the color of your choice for the growth phase of your plants. Mix and match for a full spectrum effect. For use with T5 HO fixtures.

AVAILABLE IN THESE SIZES:

- Ultra Sun T5 24W HO Lamp
2 ft Blue 6500K
- Ultra Sun T5 54W HO Lamp
4 ft Blue 6500K
- Ultra Sun T5 24W HO Lamp
2 ft Red 3000K
- Ultra Sun T5 54W HO Lamp
4 ft Red 3000K



Exclusively distributed by Sunlight Supply



Sunlight Supply, Inc.

National Garden Wholesale.

www.sunlightsupply.com

Sun System LEC™ 315 Light Emitting Ceramic Fixture



Includes Lamp
Philips MasterColor CDM
Elite Agro 3100°K

Philips MasterColor CDM Elite Agro 3100°K



Sun System LEC 315 utilizes cutting edge Light Emitting Ceramic technology. Fixture has 98% reflective German aluminum insert and 95% reflective textured corners for excellent output, uniformity and diffusion. Highly efficient agriculturally engineered CDM-T Elite 315/930/U/O Agro Lamp (lamp included). Greatly improved full color light spectrum out of next generation ceramic lamps. Higher amounts of beneficial UV and far red spectrums increase the lamps growth power to the plants. Very high 1.95 PPF per second light source. 3100°K or 4200°K color temperature, high 92 CRI, 33,000 initial lumens (105Lm/W). Long life 20,000 hour lamp. High 90% lumen maintenance @ 8000 hr. High 85% PPF maintenance @ 20,000 hr. Unique open rated lamp construction reduces radiant heat

from the arc tube and is suitable for open fixture use. 50/60 Hz low frequency, square wave, highly efficient electronic ballast rated for 50,000 hour ballast life. LEC 315 driver incorporates built in thermal protection. One year warranty lamp. 2 Year Warranty.

Item No.	Description	MSRP
906200	Sun System LEC315 120 Volt w/ Lamp	\$599.95
906205	Sun System LEC315 240 Volt w/ Lamp	\$569.95

Philips Mastercolor LEC 315 Lamp

Superior color quality. Crisp white light. Very High 1.95 PPF per second light source. 3100°K or 4200°K color temperature, High 92cri, 33,000 initial lumens (105Lm/W). High 90% lumen maintenance at 8,000 hr/High 85% PPF maintenance at 20,000 hr. Unique Open Rated Lamp construction reduces radiant heat from the arc tube and is suitable for open fixture use. 1 Year Warranty.



Item No.	Description	Approx. Initial Lumens	Glass Size	MSRP
901575	Philips Master Color CDM Lamp 315 Watt Elite Agro 3100K (Full Spectrum)	33,000	T-12	\$104.95
901573	Philips Master Color CDM Lamp 315 Watt Elite MW 4200K (Blue)	33,000	T-12	\$104.95

AgroLED Green Flashlight/Lamp by Feliz

This unique 2-in-1 LED light system can be used either as a flashlight, a standard indoor/outdoor household lamp or both! To use it as a flashlight, just extend the handle and turn it on. To use it as a standard lamp, simply unscrew the end cap and insert it into any household light fixture with the same size standard base. 1 Year Warranty.



Item No.	Description	MSRP
960415	AgroLED 4 Watt Green Flashlight/Lamp AC/DC Rechargeable	\$29.95

AgroLED 12 Watt LED Lamp - Full Spectrum

12 watt medium base socket LED lamp. Lamp configuration is 7 Red, 3 Blue, 2 White, 1-Watt LEDs. Self-ballasted - No separate ballast required. Sturdy cast aluminum housing. Lamp lifetime is over 50,000 hours. 120 volt. 1 Year Warranty.



Item No.	Description	MSRP
901430	AgroLED 12 Watt LED Lamp	\$59.95

AgroLED T8 LED Tubes

22 watt 4 ft T8 size LED lamp. For use in AgroLED fixtures by Sun System. 120 volt. Self-ballasted - No separate ballast required. Not for retro fitting existing T8 fluorescent fixtures. Lamp lifetime is over 50,000 hours. No fragile glass. 1 Year Warranty.

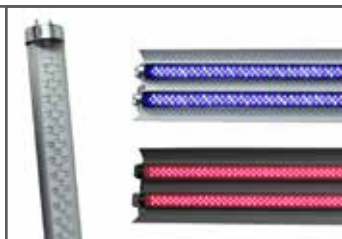

Item No.	Description	MSRP
901422	AgroLED T8 LED Tube Red	\$72.95
901418	AgroLED T8 LED Tube White/Blue	\$72.95

AgroLED The Hangover

Custom made lamp holder to accommodate AgroLED 12 watt LED lamps with medium base. Designed to be hung vertically with a Sun Grip suspension pulley (included). Maximum 12 watts. Fixture plus cord length is 10 feet. Lamp sold separately.



Item No.	Description	MSRP
960438	AgroLED The Hangover Socket & Cord	\$24.95

AgroLED LED/T5 HO Combination Fixtures



Designed to accommodate AgroLED LED Tubes (T8 size) and T5 HO lamps (sold separately). Complete flexibility to mix & match different colored lamps for desired spectrum. Housing is made of heavy-duty white steel. 1 Year Warranty.

Item No.	Description	Dimensions L x W x H	MSRP
960420	AgroLED T5 LED HO Combination Fixture 44 - 4 ft 4 Lamp	49.9" x 10.1" x 3.1"	\$129.95
960425	AgroLED T5 LED HO Combination Fixture 48 - 4 ft 8 Lamp	49.9" x 19.5" x 3.1"	\$199.95

AgroLED LED Fixtures

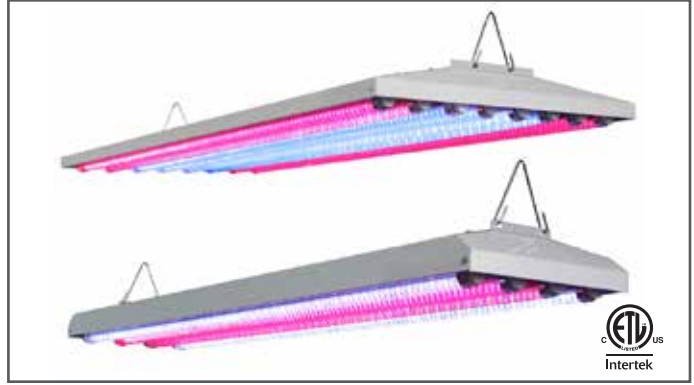

Designed to accommodate AgroLED LED Tubes - T8 size (sold separately). 44 accommodates 4 LED tubes and 48 accommodates 8 LED tubes. Complete flexibility to mix & match different colored lamps for desired spectrum. 1 Year Warranty.

Item No.	Description	Dimensions L x W x H	MSRP
960430	AgroLED T8 LED Fixture 44 - 4 ft 4 Lamp	49.9" x 10.5" x 3.1"	\$74.95
960435	AgroLED T8 LED Fixture 48 - 4 ft 8 Lamp	49.9" x 21.5" x 3.1"	\$109.95

Gavita Pro 270e LEP



The Gavita Pro 270e LEP utilizes a new emitter design that allows for a more compact fixture design, making it lighter and smaller than the Pro 300 LEP model. The Pro 270e LEP is equipped with a Master Controller input to be able to switch the fixture on and off together with your HPS e-series fixtures. Suitable for 120 - 240 Volt. Prewired with 120 V 16 ft cord with NEMA 5-15 plug. 3 Year Warranty.

Item No.	Description	MSRP
906092	Gavita Pro 270e LEP Grow US (41.02 emitter)	\$999.95
906090	Gavita Pro 270e LEP Sup US (41.01 emitter)	\$999.95

Scan to go to Sunlight Supply's web site and see the latest Sun System products, videos, product specifications and much more!



DigiMax™

Horticultural lamps optimized for today's digital ballasts

Specifically designed lamp for use with Galaxy® and other brand electronic/digital ballasts. Newly designed proprietary starter for greater reliability and increased lamp life. Next generation lamp construction for superior lumen maintenance during the lamp life cycle. Ceramic insulation plate for better insulation and performance. Robust stainless steel armature versus nickel plated steel. Far stronger and longer lasting. Green ceramic base to identify this as a digital ballast designed lamp. This high-output, balanced spectrum digital lamps are engineered specifically for plant growth and to meet the aggressive demands of both commercial and hobby growers. Embossed tin keepsake box with each lamp purchase.



ULTRA SUN™

PREMIUM QUALITY, VALUE PRICED HORTICULTURAL LAMPS



These high output, full spectrum lamps are ideal for plant growth, especially for growing fruits, vegetables, flowers and herbs. They are engineered specifically for horticulture applications. Ultra Sun™ lamps feature robust construction for superior reliability. We now offer a full line of Ultra Sun™ brand lamps including HPS, MH, Conversion lamps and Dual Arc Tube HPS/MH 1000 watt lamps. Excellent quality lamps at an economical price.

DigiMax Double Ended Lamp

Specifically designed for high frequency electronic ballasts. It has a connection at each side of the lamp, removing the need for frame wire inside the lamp. The absence of frame wire eliminates any shadows in the beam. For horizontal burning only. The jacket of this double ended lamp is made from quartz glass. Do not handle with bare hands. Oil from your hands can damage the lamp. 1 Year Warranty.



NEW LOWER PRICE

Item No.	Description	Approx. Initial Lumens	Glass Size	MSRP
901465	Digimax 1000 Watt DE - Double Ended	146,000	T-7	\$99.95

Ultra Sun Master Blaster 1500 Watt HPS Lamp

The Ultra Sun 1500 watt HPS lamp is the highest output lamp in the industry, with an amazing 206,000 initial lumens! This 2000°K temperature lamp was designed for use in our larger air-cooled hoods. These lamps are high quality, feature robust construction and have excellent reliability at an economical price. 1 Year Warranty.



Item No.	Description	Approx. Initial Lumens	Glass Size	MSRP
901692	Ultra Sun Master Blaster HPS 1500 lamp	206,000	E-25	\$149.95

Ultra Sun HPS Lamps

The Ultra Sun High Pressure Sodium (HPS) lamps have a Kelvin temperature rating of 2000°K which is ideal for the fruiting and flowering stages of plants. It is also an excellent lamp for full term plant growth. 1 Year Warranty.



Item No.	Description	Approx. Initial Lumens	Glass Size	MSRP
901523	Ultra Sun HPS 150	16,000	ED-23.5	\$18.95
901529	Ultra Sun HPS 250	29,000	ET-18	\$19.95
901528	Ultra Sun HPS 400	50,000	ET-18	\$19.95
901526	Ultra Sun HPS 600	90,000	T-15	\$59.95
901531	Ultra Sun HPS 1000	140,000	E-25	\$61.95

DigiMax Digital HPS Lamps

DigiMax high output horticultural lamps have been specifically designed for use with electronic ballasts. They are distinct in appearance with a green ceramic base and heavier duty interior components. 1 Year Warranty.



NEW LOWER PRICE

Item No.	Description	Approx. Initial Lumens	Glass Size	MSRP
901455	Digimax Digital 600 Watt HPS Lamp	92,000	T-15	\$83.95
901460	Digimax Digital 1000 Watt HPS Lamp	145,000	E-25	\$89.95

LAMPS

Ultra Sun Metal Halide Blue Enhanced Performance Lamps

The Ultra Sun Metal Halide (MH) Blue Enhanced Performance lamps offer extra emphasis in the blue and violet spectrums with Kelvin temperatures of 7,500°K and 10,000°K. These lamps are exceptional for vegetative growth. 1 Year Warranty.



Item No.	Description	Approx. Initial Lumens	Glass Size	MSRP
901534	Ultra Sun MH 400 7,500K	32,000	T-18	\$37.95
901538	Ultra Sun MH 1000 7,500K	100,000	T-120	\$61.95
901542	Ultra Sun MH 400 10,000K	32,000	T-18	\$37.95
901544	Ultra Sun MH 1000 10,000K	90,000	T-120	\$61.95

Ultra Sun Metal Halide - 4,200°K

Universal burn position. 4,200°K color temperature. Lamp has good spectral distribution. Emits the bluish and green regions of the light spectrum. Stimulates plant growth more efficiently than any other light source. 1 Year Warranty.



Item No.	Description	Approx. Initial Lumens	Glass Size	MSRP
901524	Ultra Sun MH 400/U/T-15 4200K Lamp	36,000	T-46	\$23.95
901521	Ultra Sun MH 1000/U/BT-37 4200K Lamp	86,000	BT-37	\$39.95

Ultra Sun Dual Arc Tube Lamp

The Ultra Sun Dual Arc Tube Lamp offers the best of both worlds with a 600 watt HPS and a 400 watt MH arc tube both inside one lamp jacket, operating simultaneously. This full spectrum lamp has a 3,000°K color temperature. 1 Year Warranty.



Item No.	Description	Approx. Initial Lumens	Glass Size	MSRP
901546	Ultra Sun Dual Arc HPS/MH 1000	110,000	ET-25	\$109.95

Ultra Sun Metal Halide Conversion Lamps

Ultra Sun MH Conv. Lamps are for those who have an existing HPS ballast that want to also be able to run metal halide lamps w/o purchasing a separate MH ballast. With a 6500°K temp., these lamps are great for the vegetative cycle & full term growing. 1 Year Warranty.



Item No.	Description	Approx. Initial Lumens	Glass Size	MSRP
901537	Ultra Sun MH 600 Conversion	57,000	T-25	\$97.95
901539	Ultra Sun MH 1000 Conversion	100,000	T-120	\$97.95



Eye Hortilux Super HPS - High Pressure Sodium Lamps

Provides 25% more energy in the violet, blue and green spectrum than standard High Pressure Sodium. The combination of Super HPS and the Metal Ace conversion lamp provides the optimum spectral energy levels through all stages of plant growth. 1 Year Warranty.



Item No.	Description	Approx. Initial Lumens	Glass Size	MSRP
901541	Hortilux LU250S/HTL/EN	30,500	ET-18	\$89.95
901545	Hortilux LU400S/HTL/EN	55,000	ET-18	\$94.95
901565	Hortilux LU430S/HTL/EN	58,500	ET-18	\$104.95
901570	Hortilux LU600S/HTL/EN	88,000	ET-18	\$124.95
901585	Hortilux LU1000B/HTL/EN	145,000	E-25	\$129.95

Eye Hortilux Dual Arc - HPS & MH Combo Lamp

The Eye Super Blue lamp features the extraordinary power of Super HPS and the balanced spectrum of Hortilux Blue in one bulb! The benefits of Metal Halide and High Pressure Sodium together: vigorous growth, accelerated development and hearty flowering! 1 Year Warranty.



Item No.	Description	Approx. Initial Lumens	Glass Size	MSRP
902855	Hortilux LU1000 MH/HTL/EN Super Blue Dual Arc	110,000	E-25	\$259.95

Eye Hortilux Metal Halide - Standard Metal Halide Lamps

Provides optimum spectral energy required for vegetative growth. High initial and maintained lumen output. High quality lamp for high quality plant growth. 1 Year Warranty.



Item No.	Description	Approx. Initial Lumens	Glass Size	MSRP
901721	Hortilux MH 400/HOR/HTL	39,000	BT-37	\$74.95
901722	Hortilux MH 1000 B/U/BT-37	110,000	BT-37	\$86.95

Eye Hortilux Blue Daylight Metal Halide Lamps

Revolutionizes lighting for plant growth! Exclusive Iwasaki (EYE) chemistry provides levels of red, blue and green spectral energy to optimize plant growth and yield. Designed to provide a fully balanced light spectrum that replicates natural sunlight. 1 Year Warranty.



Item No.	Description	Approx. Initial Lumens	Glass Size	MSRP
901791	Hortilux MT250D/HOR/HTL	18,000	T-15	\$124.95
901792	Hortilux MT400D/HOR/HTL	29,000	T-17	\$129.95
902852	Hortilux MP600LU/HOR/HTL Blue New	39,000	BT-37	\$149.95
901796	Hortilux MT1000D/HOR/HTL	80,000	T-120	\$239.95

Eye Hortilux e-Start Metal Halide Lamps

Hortilux e-Start Metal Halide is a new family of lamps designed for use on electronic/digital ballasts. The starting and operating characteristics of electronic/digital ballasts are different than traditional magnetic core & coil ballasts. These differences allow us to optimize lamp performance over life to improve results in your indoor garden. 1 Year Warranty.



Item No.	Description	Approx. Initial Lumens	Glass Size	MSRP
901745	Hortilux e-Start MH 250U/HTL/ES	21,500	BT- 28	\$71.95
901747	Hortilux e-Start MH 400HOR/HTL/ES	36,000	BT-37	\$76.95
901750	Hortilux e-Start MH 1000B/U/BT37/HTL/ES	120,000	BT-37	\$94.95

Eye Hortilux Metal Ace - Metal Halide Conversion Lamps

MH lamp that operates on a HPS ballast. Provides optimum spectral energy required for vegetative growth. High initial and maintained lumen output. High quality lamp for high quality plant growth. 1 Year Warranty.



Item No.	Description	Approx. Initial Lumens	Glass Size	MSRP
901840	Hortilux M400 LU/HTL	36,600	BT-37	\$99.95

Eye Hortilux Ultra Ace - High Pressure Sodium Conversion Lamps

Ultra Ace conversion lamps are HPS lamps that operate on Metal Halide systems. Transforms a one-dimensional Metal-Halide Lighting system into a complete growing system. 1 Year Warranty.



Item No.	Description	Approx. Initial Lumens	Glass Size	MSRP
901600	Hortilux NH360HTL/EN	45,000	BT-37	\$119.95
901607	Hortilux NHT940B/HTL/EN	130,000	E-25	\$199.95

Eye Hortilux Protected Metal Halide Lamp

This is the first protected metal halide lamp (MP) designed to run in a horizontal position. Protective glass safety lens NOT required when using this lamp for UL listing to apply. 1 Year Warranty.



Item No.	Description	Approx. Initial Lumens	Glass Size	MSRP
901677	Hortilux MP1000BX/U	90,000	BT-37	\$109.95

GAVITA
HOLLAND
PROFESSIONAL LIGHTING

This lamp has the highest PAR light output, improved spectrum and the best light maintenance (>95% PAR light over one year of use). Being the most efficient 1000 watt horticultural lamp available and the only lamp specifically developed for ultra high frequency electronic ballasts, this is the 1000 watt lamp of choice for Dutch professional greenhouse growers.

Gavita Pro Plus EL 400V Electronic Lamps

Gavita Pro Plus 1000W EL Double Ended 400V lamp is one of the best 1000 watt HPS lamps on the market. Specifically designed for high frequency electronic ballasts it has a connection at each side of the lamp, removing the need for a frame wire inside the lamp. For use with Gavita fixtures only. The jacket of this double ended lamp is made from quartz glass. Do not handle with bare hands. Oil from your hands can damage the lamp. Warranty applies only if these lamps are operated with a Gavita Pro series ballast. 1 Year Warranty.

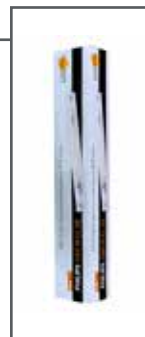

Item No.	Description	μmol	Glass Size	MSRP
906025	Gavita Pro Plus 1000 Watt 400 Volt EL DE	2,100	T-7	\$147.95
906035	Gavita Pro GPT EL 600 Watt 400 Volt E39	1,190	T-15	\$99.95

Get product data sheets, product specs, date codes, warranty information or watch a video of Eye Hortilux lamps being made here in the USA!

Gavita Enhanced HPS Lamps

Gavita Enhanced HPS lamps, suitable for DigiStar high frequency ballasts. 1 Year Warranty.



Item No.	Description	μmol	Glass Size	MSRP
902940	Gavita Enhanced HPS 400 Watt 230 Volt E39	725	T-15	\$59.95
902945	Gavita Enhanced HPS 600 Watt 230 Volt E39	1,100	T-15	\$74.95

Gavita Pro Double Ended HPS Lamps

Gavita horticultural High Pressure Sodium (HPS) lamp with high output and extreme long light maintenance. Change once a year for best results. Initial PPF: 1950 μmol s⁻¹. Light maintenance 5000 hrs: >96%. Color temperature is 2100°K and the lamp base is K12 x 30s. Suitable for High Frequency Gavita Pro 1000 Watt ballasts (Pro-line). The jacket of this double ended lamp is made from quartz glass. Do not handle with bare hands. Oil from your hands can damage the lamp. 1 Year Warranty.



Item No.	Description	μmol	Glass Size	MSRP
902955	Gavita Pro 1000 Watt 400 Volt EL DE	1,950	T-7	\$114.95
902957	Gavita Pro 6/750 Watt 400 Volt EL DE New	1,500	T-7	\$109.95



Ushio Enhanced Performance HPS Lamps

400, 600 and 1000 watt SUPER high output HPS with maximized output in both red and blue spectral range. Runs on HPS Ballast. Optimized for maximum flower yield and added blue spectrum for vegetative growth efficiency. Outperforms standard HPS bulbs. 1 Year Warranty.



Item No.	Description	Approx. Initial Lumens	Glass Size	MSRP
902900	Ushio AHS 400 Opti Red	56,000	T-15	\$75.95
902905	Ushio AHS 600 Opti Red	90,000	T-15	\$105.95
902910	Ushio AHS 1000 Opti Red	146,000	T-23	\$119.95

Ushio MH Conversion Lamps

400, 600 and 1000 watt SUPER high output MH with maximized output in both blue and red spectral range. Outperforms standard MH bulbs. Conversion bulb to operate on ANSI coded HPS ballast. Optimized for maximized branching and vegetative growth and added red spectrum for flowering efficiency. 1 Year Warranty.



Item No.	Description	Approx. Initial Lumens	Glass Size	MSRP
902915	Ushio AMH 400 Opti Blue	39,000	T-15	\$89.00
902920	Ushio AMH 600 Opti Blue	47,000	T-25	\$105.00
902925	Ushio AMH 1000 Opti Blue	109,000	T-25	\$119.95

Ushio Dual Arc Tube Lamp

It is possible for convenient & energy saving single lamp operation throughout your plant's growth cycle. High output MH & HPS burner cores enclosed in a single lamp body to achieve an enhanced full photosynthesis spectrum from a single light source! 1 Year Warranty.



Item No.	Description	Approx. Initial Lumens	Glass Size	MSRP
902860	Ushio AMS 1000 Dual Core	117,000	T-21	\$175.00

Ushio Double Ended Lamps

Super High Pressure Sodium Double Ended lamp for Plant Growth. High red and blue spectral ratios for good photosynthesis efficiency. Great lumen output for high PAR values. Robust plants through high blue light output. High red light ratio for healthy plant growth. Economic. The jacket of this double ended lamp is made from quartz glass. Do not handle with bare hands. Oil from your hands can damage the lamp. 1 Year Warranty.



Item No.	Description	μmol	Glass Size	MSRP
902912	Ushio AHS-DE 1000 Opti Red	1,950	T-7	\$129.95
902927	Ushio Double Ended Lamp - AHS-DE 1000W / PRO-PLUS New	2,100	T-7	\$159.95

You can look at or download spectral charts of most of the lamps at www.sunlightsupply.com

SolarMAX™

Manufactured in Germany by an ISO certified factory with over 40 years experience in HPS and MH lamp technology, ensuring high quality and optimized performance. Reduced lamp sizes fit most horticultural lighting fixtures. Custom tailored spectral distributions. Highest output. One year warranty.

SolarMax Enhanced Performance HPS Lamps

SolarMax lamps are specifically designed for horticultural applications. ISO certified engineering and manufacturing processes assure high quality and optimized performance. SolarMax grow lamps are designed with the grower in mind. 1 Year Warranty.



Item No.	Description	Approx. Initial Lumens	Glass Size	MSRP
902800	SolarMax Super HPS 400	55,000	T-15	\$57.95
902805	SolarMax Super HPS 600	95,000	T-15	\$82.95
902810	SolarMax Super HPS 1000	147,000	T-23	\$123.95

SolarMax Blue Enhanced Performance Metal Halide Lamps

The SolarMax Veg Metal Halide bulb delivers 30% more blue light than standard bulbs. The result is stronger roots during crucial early stages of development and more vigorous, vegetative growth throughout the plant's life. They are universal bulbs, which means that they can be burned horizontally or vertically. 1 Year Warranty.



Item No.	Description	Approx. Initial Lumens	Glass Size	MSRP
902815	SolarMax Veg MH 1000	85,000	T-25	\$122.95
902820	SolarMax Veg MH 400	32,000	T-15	\$118.95

SolarMax Red Enhanced Performance Metal Halide Lamp

SolarMax Gold are excellent for fruiting/flowering applications and because they are metal halides lamps they have enough full spectrum energy for all a plant needs from 380 to 760 nanometers. 1 Year Warranty.



Item No.	Description	Approx. Initial Lumens	Glass Size	MSRP
902840	SolarMax Gold MH 1000	100,000	T-25	\$133.95

SolarMax MH Conversion Lamps

SolarMax lamps are specifically designed for horticultural applications. SolarMax Metal Halide Conversion lamps are designed to be used in High Pressure Sodium Ballasts. 1 Year Warranty.



Item No.	Description	Approx. Initial Lumens	Glass Size	MSRP
902825	SolarMax Veg Conversion MH 1000	90,000	T-25	\$133.95
902830	SolarMax Veg Conversion MH 600	55,000	T-25	\$130.95

IF NOT THE SUN...

SUNMASTER
LIGHTING SYSTEMS FOR GREATER YIELDS

Sunmaster works with horticultural groups and major universities to further understand the specific lighting requirements for individual plants with regard to intensity and spectral output. Enhancements in lamp construction and chemical dosing are developed internally to meet varying plant needs based upon these findings. Sunmaster focuses on understanding photosynthetically active radiation to optimize light output in conjunction with growth cycles and/or plant types.

Sunmaster Yellow Blossom Enhanced Performance HPS Lamps

Yellow Blossom Lamps are High Pressure Sodium lamps designed to deliver 10% more light than standard HPS lamps. This extremely energy-efficient plant grow lamp provides more energy which is essential for optimized photosynthetic response. Compatible with electronic ballasts. Red output for stem elongation and flowering. 1 Year Warranty.



Item No.	Description	Approx. Initial Lumens	Glass Size	MSRP
901582	Sunmaster HPS SL600 U15 2.1K	90,000	T-14.5	\$90.95
901871	Sunmaster Super HPS 1000 U25 2.1K	150,000	E-25	\$102.95

Sunmaster Blue Ice Enhanced Performance Metal Halide Lamps

Blue Ice Grow Lamps emit light from 5,500°K, imitating the natural look of daylight. They are an ideal light source for the seedling and vegetative stages of plant growth, while still emitting a wide spectral distribution. Blue Ice Metal Halide Lamps surpass many other HID sources in PAR watts. Designed for optimal performance on electronic ballasts. 1 Year Warranty.



Item No.	Description	Approx. Initial Lumens	Glass Size	MSRP
901800	Sunmaster M400 U37 5.5K	30,000	BT-37	\$123.95
901802	Sunmaster M1000 U37 5.5K	80,000	BT-37	\$128.95

Sunmaster Red Sunrise Enhanced Metal Halide Lamps

Red Sunrise Grow Lamps emit balanced light similar to a 3,000°K source, making them ideal for all phases of plant growth. Its enhanced orange-red component promotes flowering, stem elongation and germination while a rich blue content assures healthy vegetative growth. Designed for optimal performance on electronic ballasts. 1 Year Warranty.



Item No.	Description	Approx. Initial Lumens	Glass Size	MSRP
901820	Sunmaster M1000 U37 3.2K	105,000	BT-37	\$114.95

Sunmaster Green Harvest MH Conversion Lamps

Green Harvest Grow Lamps emit balanced light similar to a 4,000°K source, imitating the natural white look of sunlight. Sunmaster Green Harvest Metal Halide Lamps are effective in promoting both vegetative growth and flowering. Designed for optimal performance on electronic ballasts. 1 Year Warranty.



Item No.	Description	Approx. Initial Lumens	Glass Size	MSRP
901867	Sunmaster LM1000 U37 5.5K	100,000	BT-37	\$120.95
901868	Sunmaster LM600 U25 5.5K	50,000	T-25	\$137.95

Lamp & Reflector Cleaning Cloth

All light bulbs need to be wiped clean of finger prints after installation. Our micro fiber lamp cleaning cloth is perfect for doing this. Removes finger prints and dust from lamps, glass, light fixtures, etc.



Item No.	Description	MSRP
901475	Lamp & Reflector Cleaning Cloth	\$2.69

Enhanced Performance High Pressure Sodium Lamps

GE Enhanced Performance HPS Lamps

Specially developed for greenhouses, Lucalox PSL high pressure sodium lamps offer the benefits of stable lumen and micromole maintenance and a full spectrum content that promotes photosynthesis. Photosynthesis Active Radiation (PAR, measured in micromole/sec) is essential for plant growth. The Lucalox PSL lamp has been specially developed to provide stable lumen maintenance and increased PAR output. 1 Year Warranty.



Item No.	Description	Approx. Initial Lumens	Glass Size	MSRP
901548	GE Lucalox PSL/XO HPS 400	56,500	T-15	\$61.95
901583	GE Lucalox PSL/XO HPS 600	90,000	T-17	\$81.95
901584	GE Lucalox PSL/XO HPS 750	104,000	T-15	\$99.95

Philips Enhanced Performance HPS Lamps

Ideal for growing vegetables and flowers. High lumen and growth light maintenance safeguards a constant crop quality and quantity over life. Ceramic discharge tube with PIA technology for long and reliable lifetime. 1 Year Warranty.



Item No.	Description	Approx. Initial Lumens	Glass Size	MSRP
901560	Philips Son Agro HPS C-430	53,000	ED-18	\$66.95
902811	Philips Agrolite XT HPS 1000	146,000	E-25	\$108.95

Standard High Pressure Sodium Lamps

Standard High Pressure Sodium (HPS) Lamps

High Pressure Sodium Grow Lights emit the yellow and red regions of the spectrum. High pressure sodium bulbs help stimulate flower and fruit production in plants more efficiently than other grow light sources. 1 Year Warranty.



Item No.	Description	Approx. Initial Lumens	Glass Size	MSRP
901510	GE HPS LU150 Mogul	16,000	ED-23.5	\$23.95
901515	GE HPS LU250	28,500	ET-18	\$24.95
901520	GE HPS LU 400	50,000	ET-18	\$25.95
901525	GE HPS LU600	92,000	ET-14	\$89.95
901527	Sylvania HPS LU750	105,000	BT-37	\$89.95
901530	GE HPS LU1000	140,000	E-25	\$74.95
901530-2	Sylvania HPS LU1000	140,000	E-25	\$72.95
901530-3	Philips Cermalux HPS LU1000	140,000	E-25	\$71.95

Standard Metal Halide Lamps

Venture Super Metal Halide Horizontal Lamp

This 1000 Watt Super Metal Halide bulb provides 12% more light output than a standard universal metal halide lamp. This Metal Halide lamp must be burned in a horizontal position. 1 Year Warranty.



Item No.	Description	Approx. Initial Lumens	Glass Size	MSRP
901720	Venture MS 1000/HOR/BT-37	115,000	BT-37	\$84.95

Standard Metal Halide (MH) Lamps

Metal Halide Grow lights have good spectral distribution. MH Grow Lights emit the bluish and green regions of the light spectrum. Metal Halide Grow Systems stimulate plant growth more efficiently than any other grow light source. It is best to use Metal Halide Lamps in addition to or cycled with HPS grow lights. 1 Year Warranty.



Item No.	Description	Approx. Initial Lumens	Glass Size	MSRP
901640	GE MH 250	20,800	ED-28	\$29.95
901650	GE MH 400	36,000	ED-37	\$29.95
901653	GE MH 400 Pulse Start	40,000	ED-37	\$43.95
901675	GE MH 1000/U/BT-37	110,000	BT-37	\$67.95
901675-2	Sylvania MH 1000/U/BT-37	110,000	BT-37	\$69.95
901675-3	Philips MH 1000/U/BT-37	110,000	BT-37	\$69.95

Spectralux T5 HO Fluorescent Grow Lamps



These high quality T5 HO lamps are excellent for all indoor gardening applications. Use the color of your choice for the growth phase of your plants. Mix and match for a full spectrum effect. For use with T5 HO fixtures. Do not use with VHO fixtures. 1 Year Warranty.

Item No.	Description	Approx. Initial Lumens	MSRP
901618	Spectralux T5 54 Watt HO Lamp 4 ft Blue 6500K	5,000	\$11.95
901619	Spectralux T5 54 Watt HO Lamp 4 ft Red 3000K	5,000	\$11.95
901620	Spectralux T5 24 Watt HO Lamp 2 ft Red 3000K	2,000	\$7.95
901621	Spectralux T5 24 Watt HO Lamp 2 ft Blue 6500K	2,000	\$7.95

LAMPS

Light Emitting Ceramic (LEC) Lamps

Philips Mastercolor LEC 315 Lamps

Superior color quality. Crisp white light. Very High 1.95 PPF per second light source. 3,100°K or 4,200°K color temperature, High 92cri, 33,000 initial lumens (105Lm/W). High 90% lumen maintenance at 8,000 hr/High 85% PPF maintenance at 20,000 hr. Unique Open Rated Lamp construction reduces radiant heat from the arc tube and is suitable for open fixture use. 1 Year Warranty.



Item No.	Description	Approx. Initial Lumens	Glass Size	MSRP
901575	Philips Master Color CDM Lamp 315 Watt Elite Agro 3100K (Full Spectrum)	33,000	T-12	\$104.95
901573	Philips Master Color CDM Lamp 315 Watt Elite MW 4200K (Blue)	33,000	T-12	\$104.95

Spectralux T5 VHO Fluorescent Grow Lamps

These T5 VHO (Very High Output) lamps are a brand new technology. T5 HO (High Output) lamps have an initial rating of 5,000 lumens. The new VHO lamps are 7,200 lumens. They have to be paired with a VHO fixtures such as the Sun Blaze VHO.



Item No.	Description	Approx. Initial Lumens	MSRP
901480	Spectralux T5 VHO 95 Watt 4 ft 3000K	7,200	\$15.95
901485	Spectralux T5 VHO 95 Watt 4 ft 6500K	7,200	\$15.95

Fluorescent Lamps

Ultra Sun T5 HO Fluorescent Grow Lamps



These high quality T5 HO lamps are excellent for all indoor gardening applications. Use the color of your choice for the growth phase of your plants. Mix and match for a full spectrum effect. For use with T5 HO fixtures. Do not use with VHO fixtures. 1 Year Warranty.

Item No.	Description	Approx. Initial Lumens	MSRP
901589	Ultra Sun T5 54 Watt HO Lamp 4 ft Blue 6500K	5,000	\$11.95
901592	Ultra Sun T5 54 Watt HO Lamp 4 ft Red 3000K	5,000	\$11.95
901593	Ultra Sun T5 24 Watt HO Lamp 2 ft Red 3000K	2,000	\$7.95
901594	Ultra Sun T5 24 Watt HO Lamp 2 ft Blue 6500K	2,000	\$7.95

Spectralux Green T5 HO Fluorescent Grow Lamps

These lamps illuminate green when turned on. They work great in our single lamp Sun Blaze Strip Lights or Strip Light Supremes. Only use in T5 HO fixtures, not VHO. 1 Year Warranty.

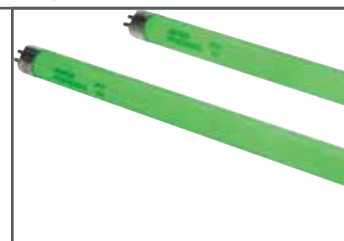

Item No.	Description	MSRP
901610	Spectralux Green T5 HO 54 Watt 4 ft	\$13.95
901612	Spectralux Green T5 HO 24 Watt 2 ft	\$11.95

Spectralux T8 Fluorescent Grow Lamp

These daylight lamps are perfect for starting seeds and cuttings. They are the ideal lamp for the Spectra Lite Fluorescent fixture (#960130). Length is 48 in. CRI-78. Horticultural spectrum. 1 Year Warranty.



Item No.	Description	Approx. Initial Lumens	MSRP
901616	Spectralux T8 32 Watt HO Lamp 4 ft Blue 6500K	2,950	\$3.29

GE Starcoat T5 HO Fluorescent Lamps

Use only these High Output (HO) lamps in Tek-Light T5, Sun Blaze, AgroLED Combination Fixture & New Wave T5 fixtures. 1 Year Warranty.

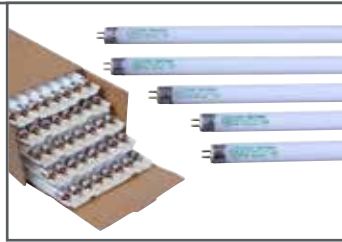

Item No.	Description	Approx. Initial Lumens	MSRP
901586	GE Starcoat T5 HO 24 Watt 2 ft 6500K	2,000	\$14.95
901591	GE Starcoat T5 HO 24 Watt 2 ft 3000K	2,000	\$14.95
901587	GE Starcoat T5 HO 54 Watt 4 ft 3000K	5,000	\$15.95
901588	GE Starcoat T5 HO 54 Watt 4 ft 6500K	5,000	\$15.95

SunBlaster T5 HO Fluorescent Lamps

High Output 6,400°K lamps simulate natural sunlight and are ideal for cuttings or vegetative growth. Some horticulturist's choose 2,700°K for budding and blooming. SunBlaster's T5 HO lamp produces a light of much greater strength than a conventional tube and, as a result, the energy input into the area being lit is much greater and the light penetration is far superior. 1 Year Warranty.



Item No.	Description	MSRP
902192	SunBlaster T5 HO 18 in 6400K Replacement Lamp New	\$7.95
901877	SunBlaster T5 HO 2 ft 6400K Replacement Lamp New	\$7.95
901881	SunBlaster T5 HO 3 ft 6400K Replacement Lamp New	\$8.49
901896	SunBlaster T5 HO 4 ft 2700K Replacement Lamp	\$9.95
901897	SunBlaster T5 HO 4 ft 6400K Replacement Lamp	\$9.95

SunBlaster Compact Fluorescent Bulb

State-of-the-art electronic, bulbs are the smallest sized full-spectrum, energy saving lights available. These 26 watt compact fluorescent bulbs fit into a variety of light fixtures. Full spectrum compact fluorescent bulbs 6400° Kelvin, provide natural color comparable to sunlight, increases visual activity and reduces eye fatigue.



Item No.	Description	MSRP
901892	SunBlaster CFL 26 Watt 6400K	\$8.95

GE Spiral Fluorescent Bulb

This 42 watt soft white compact fluorescent bulb has the light output of a standard 150 watt incandescent bulb. It puts out 2700 initial lumens & a life span of 8000 hours. It will save energy & last 10 times longer than a 150 watt soft white light bulb.



Item No.	Description	MSRP
901885	GE Compact Fluorescent 42 Watt 2700K Bulb	\$14.95

Industry exclusive

FELIZ

FELIZ LIGHT

Feliz bulbs can be use in a variety of gardening situations. The innovative part about Feliz is our internal ballast technology and its unique construction is ideal for humid conditions. Because it requires no external ballast you can simply plug it in to any ordinary household outlet as your main source of lighting or to help brighten up a dark corner.

Feliz Fluorescent Grow Lamps



Proven success in high humidity. Compatible w/ digital timers. Fits standard mogul base socket. 300w lamps not ETL listed at the time of this catalog printing. Not for use with Garden Brite or Bright Wing Fixtures. 6 Month Warranty.

Item No.	Description	MSRP
901981	Feliz Blue Fluorescent 125 Watt 6500K	\$41.95
901991	Feliz Red Fluorescent 125 Watt 2700K	\$41.95
901983	Feliz Blue Fluorescent 200 Watt 6500K	\$72.95
901993	Feliz Red Fluorescent 200 Watt 2700K	\$72.95
901984	Feliz Blue Fluorescent 250 Watt 6500K	\$90.95
901994	Feliz Red Fluorescent 250 Watt 2700K	\$90.95
901986	Feliz Blue Fluorescent 300 Watt 6500K	\$115.95
901987	Feliz Red Fluorescent 300 Watt 2700K	\$115.95

NEW LOWER PRICE

Feliz Dual Spectrum Fluorescent Grow Lamps

Proven success in high humidity. Designed for horticulture. Fits standard mogul base socket. Dual spectrum (2700°K/6500°K) for full term plant growth. 6 Month Warranty.



NEW LOWER PRICE

Item No.	Description	MSRP
901971	Feliz Dual Spectrum Fluorescent 125 Watt	\$46.95
901972	Feliz Dual Spectrum Fluorescent 200 Watt	\$77.95
901976	Feliz Dual Spectrum Fluorescent 250 Watt	\$95.95
901977	Feliz Dual Spectrum Fluorescent 300 Watt	\$121.95

AgroLED Green Flashlight/Lamp by Feliz

This unique 2-in-1 LED light system can be used either as a flashlight, a standard indoor/outdoor household lamp or both! To use it as a flashlight, just extend the handle and turn it on. To use it as a standard lamp, simply unscrew the end cap and insert it into any household light fixture with the same size standard base. 1 Year Warranty.



Item No.	Description	MSRP
960415	AgroLED 4 Watt Green Flashlight/Lamp AC/DC Rechargeable	\$29.95

AgroLED 12 Watt LED Lamp - Full Spectrum

12 watt medium base socket LED lamp. Lamp configuration is 7 Red, 3 Blue, 2 White, 1-Watt LED's. Self-ballasted - No separate ballast required. Sturdy cast aluminum housing. Lamp lifetime is over 50,000 hours. 120 volt. 1 Year Warranty.



Item No.	Description	MSRP
901430	AgroLED 12 Watt LED Lamp	\$59.95

AgroLED T8 LED Tubes

22 watt 4 ft T8 size LED lamp. For use in AgroLED fixtures by Sun System. 120 volt. Self-ballasted - No separate ballast required. Not for retrofitting existing T8 fluorescent fixtures. Lamp lifetime is over 50,000 hours. No fragile glass. 1 Year Warranty.

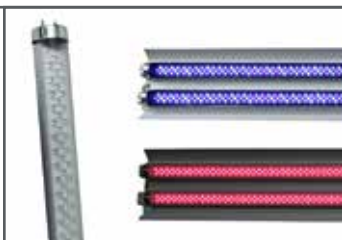

Item No.	Description	MSRP
901418	AgroLED T8 LED Tube White/Blue	\$72.95
901422	AgroLED T8 LED Tube Red	\$72.95

Follow us on Facebook and Twitter . You will get up to date information on new products, events and educational articles.







You can also find us on YouTube, Google Plus and Pinterest

LAMPS





Sunlight Supply, Inc.
National Garden Wholesale.

Bringing the gardening world to your finger tips.

www.sunlightsupply.com



Ready to Grow 1000 Watt HPS Ballast Kit - Major Brand Capacitor



Kit includes Sunlight Supply 1000 watt brand ballast, Aerovox high temperature capacitor & ignitor. Quad-tap ballast will run on 120, 208, 240 or 277 volt power. 2 Year Warranty.

Item No.	Description	MSRP
902446	Ready to Grow HPS 1000 Watt Ballast Kit	\$107.95

Replacement Metal Halide Capacitors

These major brand capacitors are rated for 100°C or 105°C temperature. The higher temperature rating means long lasting durability.



Item No.	Description	MSRP
902165	Replacement Capacitors MH 400 - 24 MFD 400 Volt	\$36.95
902170	Replacement Capacitors MH 1000 - 24 MFD 480 Volt	\$36.95

Replacement High Pressure Sodium Capacitors

These major brand capacitors are rated for 100°C or 105°C temperature. The higher temperature rating means long lasting durability.



Item No.	Description	MSRP
903000	Replacement Capacitors HPS 400 - 55 MFD 240 Volt	\$36.95
903010	Replacement Capacitors HPS 600 - 64 MFD 280 Volt (Single/Dry)	\$40.95
903015	Replacement Capacitors HPS 1000 - 26 MFD 525 Volt (Single/Wet)	\$40.95

Replacement High Pressure Sodium Ignitors

Replacement high pressure sodium ignitors for your system. Match the wattage to your system.



Item No.	Description	MSRP
200930	Replacement Ignitor CD 15 HPS 1000 (Imported)	\$23.95
200931	Replacement Ignitor CD 14 HPS 400 (Imported)	\$23.95
200933	Replacement Ignitor CD 19 HPS 600 (Imported)	\$23.95
903040	Replacement Ignitor HPS 600 (Major Brand) L1561	\$39.95
903045	Replacement Ignitor HPS 1000 (Major Brand) L1571	\$37.95

T5 HO Fluorescent Electronic Ballasts - Fulham Racehorse

Major brand electronic ballast with a small profile for easy installation. Easy push-lock wire systems. Requires grounded power cord. All ballasts are program start. Use non-shunted sockets. Has 50 in leads.

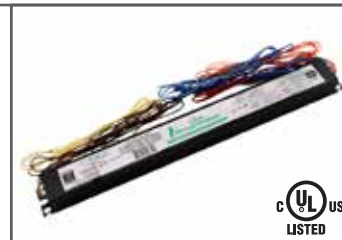

Item No.	Description	MSRP
010555	T5 HO Replacement Ballast 54 Watt 4 Lamp	\$71.95

T5 HO Fluorescent Electronic Ballasts - Fulham Workhorse

Fulham Workhorse Ballasts are reliable, high output, instant start ballasts. Easy installation. Use shunted sockets. 36 in leads.

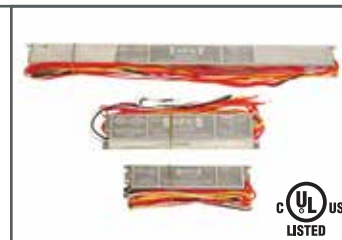

Item No.	Description	MSRP
010493	Fulham T5 HO Workhorse 5	\$34.95
010496	Fulham T5 HO Workhorse 3	\$25.95
010498	Fulham T5 HO Workhorse 7	\$60.95

Socket Mogul - 5KV/HOR

Position oriented to accept MH horizontal lamps. 5KV Socket with leads attached.

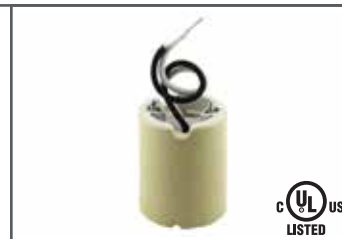

Item No.	Description	MSRP
903066	Mogul Base Socket 5KV/HOR w/ 5 in Leads	\$9.95

Socket Assembly With Pigtail Strain Relief

Our universal socket assembly is compatible with all of our reflectors and both MH & HPS lamps. We go the extra mile by offering 5KV/horizontal position oriented mogul base sockets. Includes strain relief but not lamp cord.



Item No.	Description	MSRP
903050	Socket Assembly w/ Pigtail Strain Relief	\$23.95

Socket Extender - Mogul Base - 4KV

These socket extenders are used to lengthen an existing socket in an HID lighting reflector. 600 Volt/4KV pulse rated for use with mogul base sockets and lamps up to 1500 watts. Extends socket 2-3/8 in.



Item No.	Description	MSRP
903073	Socket Extender Mogul Base 4KV	\$8.39

T5 HO Replacement Sockets

Excellent quality, reliable socket. UL listed component. Rotate lamp 90 degrees to lock in place.

*Program & rapid start ballasts require non-shunted sockets.

**Instant start ballast require shunted sockets.



Item No.	Description	MSRP
220175	T5 HO Replacement Sockets Non Shunted*	\$1.59
220177	T5 HO Replacement Sockets Shunted**	\$1.59

Female Receptacle For Lamp Cord

Replacement lamp cord receptacle for all Sun System ballasts. Donkey Ear flaps lock lamp cord in place. US Patent No: D543941.

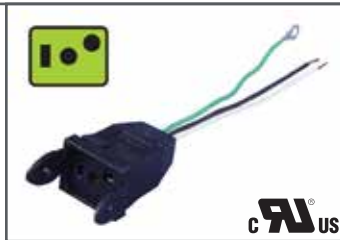

Item No.	Description	MSRP
903090	Female Receptacle 6 in	\$6.95

Dual Female Lamp Cord Receptacle

Replacement Dual lamp cord receptacle for all Sun System Magnetic ballasts. Dual receptacle is compatible with all Sun System brand reflectors as well as other brands. Includes slide plate cover.

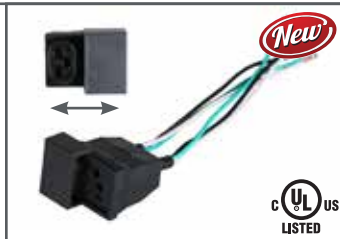

Item No.	Description	MSRP
903112	Dual Female Lamp Cord Receptacle	\$12.95

Strain Relief & Heyco Replacements

Strain relief and heyco replacements.



Item No.	Description	MSRP
270060	Strain Relief PG - 13 Pigtail	\$2.99
270090	Strain Relief 7W-2-1 Heyco	\$0.89

Duplex Receptacle Universal

This universal outlet will handle 120 or 240 volt power cords. It is 15 amp 120/240 volt with ground duplex outlet. Black nylon face.



Item No.	Description	MSRP
400025	120/240 20A-universal duplex outlet black	\$6.95

Duplex Receptacles 120V & 240V

The 120 volt 15-amp white decorator duplex electrical outlet is rated for 125 volts. It is a standard residential receptacle. The 240 volt 15-amp duplex electrical outlet is rated for 250 volts. It is off white in color.



Item No.	Description	MSRP
350591	Receptacle 120 Volt 15 Amp	\$2.49
400021	Receptacle 240 Volt 15 Amp	\$6.95

Black Wire Nut

Multi-purpose wire nut for repairs for the do it yourself person. 600 volt/150°C.



Item No.	Description	MSRP
240220	Black Wire Nut	\$0.29

Gray Wire Crimp

Closed end pre-insulated wire connector for 14-22 AWG wire. Compact design fits easily into tight locations. Wide wire range enables use on variety of applications. Slightly flared skirt protects against turned-back strands without taking up valuable space.



Item No.	Description	MSRP
240110	Wire Crimps - Gray	\$0.29

Reflector Hanging Hook

This is a universal replacement V hanging hook for Sun System reflectors and fixtures. Sold in quantities of 2 only.



Item No.	Description	MSRP Ea
430020	Reflector Hanging Hooks	\$1.29

Find all these great products at a retailer near you. Scan to find the retailer closest to you!

POWER ALL™

Quality extension cords, adapters and power strips for all your electrical needs.

Made of high quality materials. Proprietary cords feature a built in circuit breaker for added safety.

Industry exclusive



POWER & LAMP CORDS

Power All Extension Cords with 3 Outlet Power Strip 120 & 240 Volt

These are 14 gauge commercial grade extension cords featuring a three outlet power strip. These heavy duty cords come in both a 120 volt and 240 volt grounded configuration. Cords are perfect for safely adding multiple power outlets in your growing area where they are not presently available. 1 Year Warranty.



Item No.	Description	MSRP
903250	Power All 120 Volt 12 ft Extension Cord w/ 3 Outlet Power Strip - 14 Gauge	\$16.29
903255	Power All 120 Volt 25 ft Extension Cord w/ 3 Outlet Power Strip - 14 Gauge	\$21.95
903257	Power All 240 Volt 12 ft Extension Cord w/ 3 Outlet Power Strip - 14 Gauge	\$24.95
903258	Power All 240 Volt 25 ft Extension Cord w/ 3 Outlet Power Strip - 14 Gauge	\$40.95

Power All Commercial Grade Extension Cords with Circuit Breaker 125 Volt - 16 Gauge

These commercial grade extension cords incorporate a built in circuit breaker to protect you and your expensive equipment. These heavy duty cords are grounded with a molded connector. Power All cords are moisture resistant and constructed to be flexible yet durable. 16 Gauge/13A/1625 Max watts. 1 Year Warranty.



Item No.	Description	MSRP
780065	Power All Commercial Grade 125 Volt 6 ft Cord w/ Circuit Breaker -16 Gauge	\$9.95
780005	Power All Commercial Grade 125 Volt 10 ft Cord w/ Circuit Breaker -16 Gauge	\$11.95
780010	Power All Commercial Grade 125 Volt 15 ft Cord w/ Circuit Breaker -16 Gauge	\$13.95
780015	Power All Commercial Grade 125 Volt 25 ft Cord w/ Circuit Breaker -16 Gauge	\$15.95
780020	Power All Commercial Grade 125 Volt 50 ft Cord w/ Circuit Breaker -16 Gauge	\$21.95

Power All Commercial Grade 125 Volt Cords with Circuit Breaker - 14 Gauge

Ideal cord for use in your indoor/outdoor garden. These commercial grade extension cords incorporate a built in circuit breaker. These heavy duty cords are grounded with a molded connector. Cords are moisture resistant and constructed to be flexible yet durable. 14 Gauge/15A/1875 Max watts. 1 Year Warranty.



Item No.	Description	MSRP
780070	Power All Commercial Grade 125 Volt 6 ft Cord w/ Circuit Breaker -14 Gauge	\$10.95
780025	Power All Commercial Grade 125 Volt 15 ft Cord w/ Circuit Breaker -14 Gauge	\$16.95
780035	Power All Commercial Grade 125 Volt 50 ft Cord w/ Circuit Breaker -14 Gauge	\$32.95

Power All Commercial Grade 125 Volt Cord with Circuit Breaker, Triple Plug

14 gauge extension cord with a 120 volt inline receptacle located every 8 feet. Two outlets are inline and one located at the end for a max of three. Has a built in circuit breaker to help protect you and your expensive equipment. Cords are moisture resistant and constructed to be flexible yet durable. 14 Gauge/15A/1875 Max watts. 1 Year Warranty.



Item No.	Description	MSRP
780030	Power All Commercial Grade 125 Volt 25 ft Cord w/ Circuit Breaker Triple Plug (1 every 8 ft) -14 Gauge	\$29.95

Power All Commercial Grade - 125 Volt - 7 ft Lead Cord with 3 - 6 ft Extension Cords with Circuit Breaker

A 7 ft heavy duty commercial grade extension cord that splits off into 3 separate 6 ft cords, each with a female outlet. These extension cords incorporate a built in circuit breaker to help protect you and your expensive equipment. Double insulated, moisture resistant and durable with flexible molded connectors. 14 Gauge/15A/1875 Max watts. 1 Year Warranty.



Item No.	Description	MSRP
780060	Power All Commercial Grade 125 Volt -7 ft Lead Cord w/ three 6 ft Extension Cords w/ Circuit Breaker	\$27.95

Power All 6 Outlet Grounded Adapter - 125 Volt

This 6 outlet adapter turns any dual 120 volt outlet into 6 separate outlets. Includes a built in safety cover on every receptacle. This increased outlet adaptor is great for running multiple low amp accessories. 15A/1875 Max watts. 1 Year Warranty.



Item No.	Description	MSRP
780040	Power All 6 Outlet Grounded Adapter 125 Volt	\$2.95

Power All Indoor GFCI Power Strip - 4 Outlet - 125 Volt

The Power All GFCI Indoor power strip has 4 standard outlets. Each outlet is protected by a spring loaded plastic cover to prevent electrical shock, water and debris. Plugs are protected by a built in 15 amp circuit breaker with a GFCI. Cord is 6 ft unit includes a test and a reset button. 14 Gauge/15A/1875 Max watts. 1 Year Warranty.



Item No.	Description	MSRP
780045	Power All Indoor GFCI Power Strip 4 Outlet 125 Volt 6 ft Cord	\$36.95

Power All Indoor Metal Power Strip - 4 Outlet - 125 Volt - 8 ft Cord

The Power All heavy duty indoor metal power strip includes four 120 volt outlets. Each outlet is protected by a plastic cover to prevent electrical shock, water and debris. Unit includes a lighted on/off switch and built-in 15-amp circuit breaker. 14 Gauge/15A/1875 Max watts. 1 Year Warranty.



Item No.	Description	MSRP
780050	Power All Indoor Metal Power Strip 4 Outlet 125 Volt 8 ft Cord	\$12.95

Power All Indoor Metal Surge Strip - 6 Outlet - 125 Volt

The heavy duty indoor surge strip has a sturdy impact resistant metal housing with 1500 joules surge protection. Power strip has 6 horizontal outlets with built-in safety covers, 15 amp surge protection with a LED indicator and a lighted on/off switch. 14 Gauge/15A/1875 Max watts. 1 Year Warranty.



Item No.	Description	MSRP
780055	Power All Indoor Metal Surge Strip 6 Outlet 125 Volt 4 ft Cord	\$13.95

Power Cord 50 Amp

High quality power cords. Use the appropriate cord for your project.



Item No.	Description	MSRP
903198	Power Cord 50 Amp w/ Plug 6 ft 6/2 - 8/1 Gauge	\$17.95

Smart Volt Power Cords

These power cords are compatible with all ballasts that feature Smart Volt power cords. This includes Sun System Harvest Pro, Hard Core, Eye Platinum and Gold, Galaxy and Lumatek.



Item No.	Description	MSRP
903081	120 Volt Smart Volt Cord 6 ft	\$7.95
903082	240 Volt Smart Volt Cord 6 ft	\$10.95
903083	120 Volt Smart Volt Cord 20 ft	\$17.95
903084	240 Volt Smart Volt Cord 20 ft	\$20.95

MVP Power Cords - 120 & 240 Volt

MVP cords (4 prong) are compatible with Sun System 1 & 6 made before March 2009. After this date they were made with Smart Volt cords. US Patent No.: D543941.

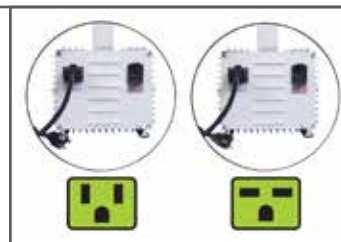

Item No.	Description	MSRP
903127	MVP Power Cord 120 Volt 8 ft	\$12.95
903132	MVP Power Cord 240 Volt 8 ft	\$14.95

Power Cords

Replacement power cords.



Item No.	Description	MSRP
903160	Power Cord 120 Volt 8 ft	\$6.95
903165	Power Cord 240 Volt 8 ft	\$13.95

Lamp Cords

Replacement lamp cords.



Item No.	Description	MSRP
903100	Lamp Cord 15 ft - 16 Gauge	\$16.95
903105	Lamp Cord 25 ft - 14 Gauge	\$39.95

Lamp Extension Cords - 10 Foot

These cords plug into the female lamp cord receptacle on a Sun System ballast then into the male plug on the lamp cord coming from the reflector. Increase the distance between their ballast and reflector by 10 feet. Match cord gauge to your existing lamp cord gauge.



Item No.	Description	MSRP
903245	10 ft Lamp Extension Cord - 16 Gauge	\$17.95
903247	10 ft Lamp Extension Cord - 14 Gauge	\$26.95

Lamp Cord - 2 Point Detachable

Replacement cord for Sun System reflectors that require the 15 ft 2 point detachable cord.



Item No.	Description	MSRP
903104	Lamp Cord 15 ft - 16 Gauge Replacement 2 Point Detachable	\$19.95

POWER & LAMP CORDS

Lamp Cord With Molded Strain Relief

Use this to replace your lamp cord on your reflectors. Length is 15 ft. US Patent No: D570295.



Item No.	Description	MSRP
903102	Lamp Cord w/ Molded Strain Relief	\$17.95

Power Cord & Lamp Cord With Socket

8 ft power cord with socket for use with mogul based self-ballasted compact fluorescent lamps.

15 ft lamp cord with socket for use with all mogul based HPS & MH lamps (ballast required).



Item No.	Description	MSRP
903063	8 ft Power Cord w/ Mogul Base Socket	\$16.95
903064	15 ft Lamp Cord w/ Mogul Base Socket	\$22.95

Socket Assembly - 5KV Short

These are shorter than our extended sockets (#903055). This is a multi-purpose socket, perfect for applications where a shorter socket is required.

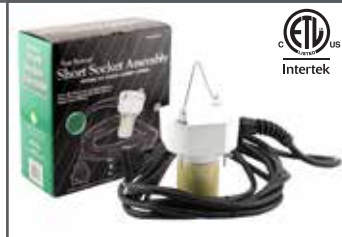

Item No.	Description	MSRP
903057	Socket Assembly - Short 5KV	\$32.95

Socket Assemblies With Lamp Cord

Use with all Sun System reflectors that do not come standard with a socket. These sockets come with the patented male lamp receptacle which is compatible with all Sun System ballasts. Flexible pigtail strain relief. 5KV mogul base socket.



Item No.	Description	MSRP
903055	Socket Assembly w/ 15 ft Lamp Cord - 16 Gauge	\$31.95
903060	Socket Assembly w/ 25 ft Lamp Cord - 14 Gauge	\$42.95

Titan Controls Apollo 4 - 120 Volt Ballast Timer

Operates magnetic or electronic ballast up to 1000 watts. 24 hour timer can be set for any lighting requirement. Compatible with digital ballasts. 10 Amps maximum/120 Volts/60 Hz./1000 Watts. 3 Year Warranty.



Item No.	Description	MSRP
734135	Titan Controls Apollo 4 - 120 Volt Ballast Timer	\$74.95

Titan Controls Apollo 5 - 240 Volt Ballast Timer

Operates magnetic or electronic ballast up to 1000 watts. 24 hour timer can be set for any lighting requirement. Compatible with digital ballasts. 10 Amps maximum/240 Volts/60 Hz./1000 Watts. 3 Year Warranty.



Item No.	Description	MSRP
734140	Titan Controls Apollo 5 - 240 Volt Ballast Timer	\$79.95

THE GROW SCENE™

Your source for the latest products, useful growing tips and hottest news in indoor gardening. Scan to sign up today!

Sun Winch Motorized Lift System

The Sun System Sun Winch is a track mounted motorized lift system for lighting fixtures. The Sun System Sun Winch lets you raise and lower your light fixtures remotely using wireless technology up to 30 feet away. The Sun Winch supports light fixtures up to 50 lb Require the Wireless Remote #710185, sold separately, to operate. 1 Year Warranty.

Sun Winch Remote for Lift System

The Sun System Sun Winch Remote for Motorized Lift System controls up to 8 Sun Winch Systems. The wireless technology provides complete and simple control that works up to 30 feet away. Battery and instructional DVD is included. 1 Year Warranty.



Item No.	Description	MSRP
710185	Sun Winch Remote for Lift System	\$29.99

SunGrip Light Hangers 1/8 in White

SunGrip Light Hangers allow you to secure items quickly & easily. SunGrip's patented system pulls tight, locks in place, & will never break, slip or rust. Heat & cold resistant. 8 ft braided polypropylene rope. Carabiner clips provide a secure hold.



Item No.	Description	MSRP
710122	SunGrip Light Hanger 1/8 in White -1/Pair	\$14.95

Item No.	Description	MSRP
710180	Sun Winch Motorized Lift System for Light Fixtures	\$99.99

SunGrip Light Hangers 1/8 in - The Original

SunGrip Light Hangers allow you to secure items quickly & easily. SunGrip's patented system pulls tight, locks in place, & will never break, slip or rust. Heat & cold resistant. 8 ft braided polypropylene rope. Carabiner clips provide a secure hold.



Item No.	Description	MSRP
710114	SunGrip Light Hanger 1/8 in - 1/Pair	\$14.95

SunGrip Heavy Duty Light & Equipment Hangers 1/4 in - The Original

SunGrip Light Hangers allow you to secure items quickly & easily. SunGrip's patented system pulls tight, locks in place & will never break, slip or rust. Heat & cold resistant. 8 ft braided polypropylene rope. Carabiner clips provide a secure hold.



Item No.	Description	MSRP
710116	SunGrip Heavy Duty Light Hanger 1/4 in	\$14.95

SunLift - The Original

SunLift is a reflector suspension system which allows you to adjust the height of a hood in one simple movement. The tension mechanism will keep the hood in place once. The support strings pull out and retract like a yo-yo. A pair of SunLifts can support up to 22 lbs Maximum extension length is 4.5 feet.



Item No.	Description	MSRP
710120	SunLift	\$13.95

Grow Yo-Yo

The Grow Yo-Yo allows the user to easily adjust the height of their reflectors as their plants grow. Also makes spraying or trimming your plants easy by being able to raise a reflector up and out of the way. Weight capacity is 22 lbs per pair.



Item No.	Description	MSRP
710129	Grow Yo-Yo 12/Box	\$10.95

Fast Fit Tray Stand 3 ft x 3 ft

Heavy duty 3 ft x 3 ft quick assembly tray stand. Absolutely no tools required. Can be assembled in 5 minutes or less. Accommodates all popular brand trays and reservoirs. Overall height is 25 in. Height from bottom bar to floor is 18 in without casters. Patent Pending 13#/136657. Tray sold separately.



Item No.	Description	MSRP
706121	Fast Fit Tray Stand 3 ft x 3 ft	\$121.95



Revolutionary toolless light & tray stands. Unique patented "no hassle" toolless design allows for a quick and simple assembly in minutes! Designed and engineered for the pieces to simply slide together. Never mess with nuts, bolts, wrenches or screw drivers again with Fast Fit™! Patent Pending 13#/136657.



Fast Fit Tray Stand 4 ft x 4 ft

Heavy duty 4 ft x 4 ft quick assembly tray stand. Absolutely no tools required. Can be assembled in 5 minutes or less. Accommodates all popular brand trays and reservoirs. Overall height is 25 in. Height from bottom bar to floor is 18 in without casters. Patent Pending 13#/136657. Tray sold separately.



Item No.	Description	MSRP
706122	Fast Fit Tray Stand 4 ft x 4 ft	\$146.95

Fast Fit Tray Stand 2 ft x 4 ft

Heavy duty 2 ft x 4 ft quick assembly tray stand. Absolutely no tools required. Can be assembled in 5 minutes or less. Accommodates all popular brand trays and reservoirs. Overall height is 25 in. Height from bottom bar to floor is 18 in without casters. Patent Pending 13#/136657. Tray sold separately.



Item No.	Description	MSRP
706120	Fast Fit Tray Stand 2 ft x 4 ft	\$99.95

Fast Fit Tray Stand 4 ft x 8 ft

Heavy duty 4 ft x 8 ft quick assembly tray stand. Absolutely no tools required. Can be assembled in 5 minutes or less. Accommodates all popular brand trays and reservoirs. Overall height is 25 in. Height from bottom bar to floor is 18 in without casters. Patent Pending 13#/136657. Tray sold separately.



Item No.	Description	MSRP
706124	Fast Fit Tray Stand 4 ft x 8 ft	\$241.95

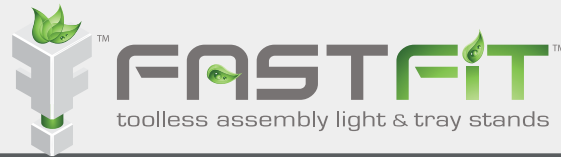



Fast Fit 2'x4' Light Stand

You will need:

- 706120—2'x4' tray stand
- 706133—4 pc caster wheels
- 706128—4' light hanging bar
- 706125—4' uprights
- 706131—Extension kit

* tray sold separately



Fast Fit 4'x4' Light Stand

You will need:

- 706122—4'x4' tray stand
- 706133—4 pc caster wheels
- 706128—4' light hanging bar
- 706125—4' uprights
- 706131—Extension kit

* tray sold separately



Fast Fit 4'x8' Light Stand

You will need:

- 706124—4'x8' tray stand
- 706134—6 pc caster wheels
- 706128—4' light hanging bar
- 706125—4' uprights
- 706131—Extension kit
- 706132—4' support bar

* tray and reflectors sold separately



Fast Fit 4'x8' Light Stand & Conversion Kit

You will need:

- 706129—8ft conversion kit
- In addition to the rest of the parts used in the regular 4'x8' Light Stand kit.

* tray sold separately

Fast Fit A La Carte Components

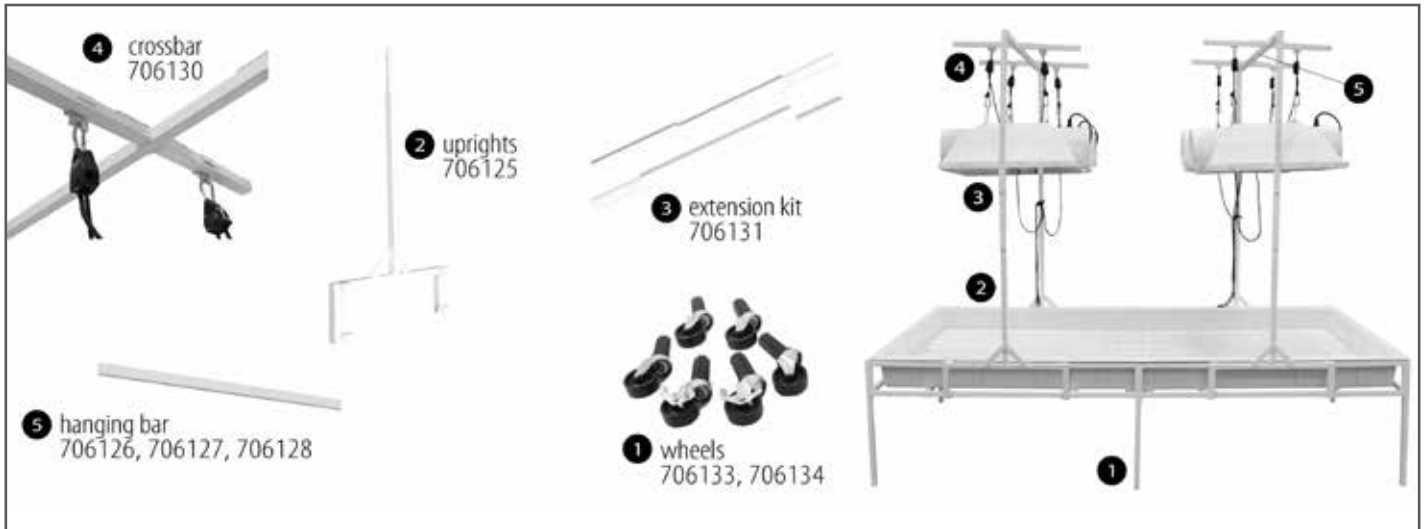

Fast Fit A La Carte Components: Castor wheels, 6 pc and 4 pc (706133, 706134). Light Stand 4 ft Uprights (706125). Extension Kit (706131). Light Stand Crossbar (706130). Sturdy hanging bar comes in 2 ft, 3 ft and 4 ft sizes (706126, 706127, 706128).



Item No.	Description	MSRP
706125	Fast Fit Light Stand Uprights 4 ft	\$91.95
706126	Fast Fit Light Hanging Bar 2 ft	\$18.95
706127	Fast Fit Light Hanging Bar 3 ft	\$16.95
706128	Fast Fit Light Hanging Bar 4 ft	\$19.95
706129	Fast Fit Conversion Kit 8 ft Hanging Bar	\$34.95
706130	Fast Fit Light Stand Crossbar	\$32.95
706131	Fast Fit Light Stand Extension Kit	\$23.95
706132	Fast Fit Tray Stand Support Bar 4 ft	\$19.95
706133	Fast Fit Castor Wheels - 4 pc	\$25.95
706134	Fast Fit Castor Wheels - 6 pc	\$30.95

Sun System Sun Stand 2

Strong sturdy construction. The stand is 60 in wide with adjustable shuttles that go from 12 in to 48 in apart in 3 in increments. Adjustable height 52 in to 88 in. Includes a pair Sunlifts to easily hang light fixtures up to 22 lbs.

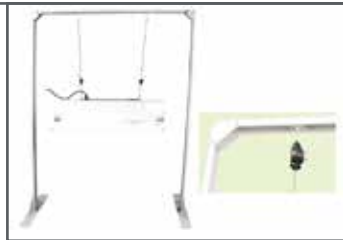

Item No.	Description	MSRP
710118	Sun Stand 2	\$99.95

LightRail 4.0 Adjusta Drive Complete

The LightRail 4 Adjusta Drive now with fully adjustable variable speed control between 6 and 10 r.p.m. and 0 to 60 second adjustable time delay for promoting even plant growth at the ends of the lamps travel. Rail and motor kit in one box - box dimensions 41 in x 6 in x 5 in.



Item No.	Description	MSRP
710057	Light Rail 4.0 Adjust A Drive 6/10 RPM	\$274.95

AgroLED The Hangover

Custom made lamp holder to accommodate AgroLED 12 watt LED lamps with medium base. Designed to be hung vertically with a Sun Grip suspension pulley (included). Maximum 12 watts. Fixture plus cord length is 10 feet. Lamp sold separately.



Item No.	Description	MSRP
960438	AgroLED The Hangover Socket & Cord	\$24.95

LightRail 3.5 Complete Kit

Rail & motor kit in one box - box dimensions: 41 in x 6 in x 5 in. Excellent for shipping or conserving space in your store.



Item No.	Description	MSRP
710135	Light Rail 3.5 Complete 10 RPM Kit	\$224.95

LightRail A La Carte Light Rail Components

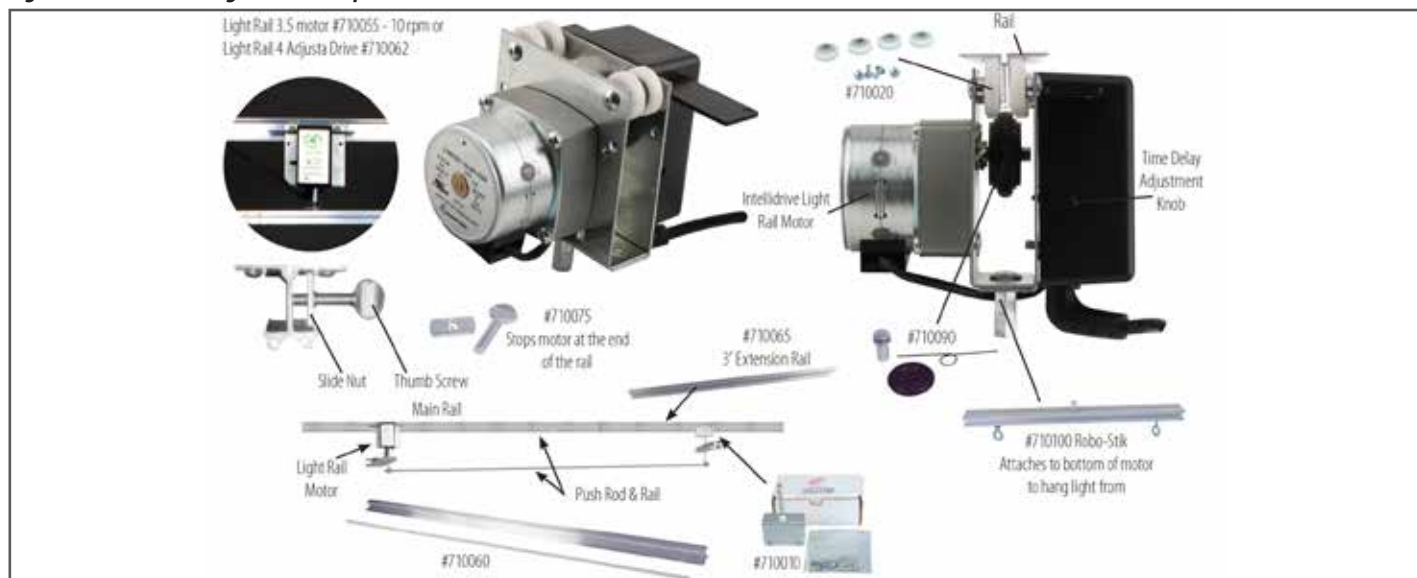

Move your lights back & forth across your growing area with a light mover. Increase your coverage area! These motors offer a 0 - 60 second time delay. 2 Year Warranty.

Item No.	Description	MSRP
LightRail 3.5 & 4.0 Motors		
710055	Light Rail 10 RPM Intellidrive Light Rail 3.5 Motor	\$204.95
710062	Light Rail 4.0 Adjusta Drive Motor Only	\$232.95
LightRail 3.5 & 4.0 Rails		
710085	Light Rail 6.5 ft Rail	\$31.95
710065	Light Rail 3 ft Extension Rail	\$12.95
710060	Light Rail 6.5 ft Rail & Threaded Push Rod	\$37.95
LightRail 3.5 & 4.0 Accessories		
710100	Light Rail Robo-Stik Lamp Stabilizing Bar	\$17.95
710090	Light Rail Drive Wheel O Ring Kit	\$4.29
710010	Light Rail Add A Lamp Hardware Only (No Rail or Rod)	\$22.49
710020	Light Rail Trolley Wheel Replacement Kit	\$5.95
710075	Light Rail Slide Nut w/ Thumb Screw	\$1.25

LightRail 5 Complete Kit

The LightRail 5 is extremely heavy-duty & functional. Great for multiple reflectors. 90+ lb capacity if properly balanced. Comes complete with a high torque 4 RPM motor, adjustable crossbar and 8 ft rail.



Item No.	Description	MSRP
710140	Light Rail 5 Complete 4 RPM Kit	\$481.95
710141	Light Rail 5 Motor Only - 4 RPM	\$332.95

Light Rail Hanging Bracket for Grow Tents

Rail Hangers are tent rail hanging brackets for hanging LightRail 3.0, 3.5 and 4.0 rails. Simply the easiest solution for hanging a LightRail in a grow tent or greenhouse. These are recommended for use with one piece rails. They are blister packed 4 per package.



Item No.	Description	MSRP
710067	Light Rail 3.0, 3.5, 4.0 Hanging Bracket for Grow Tents	\$13.95

LightRail 5 Accessories

The LightRail 5 Fore & Aft Crossbar Mounting kit for mounting crossbar, Add-A-Bar kit includes LightRail 5 trolley, crossbar, 4 foot push rod and all the hardware needed. Does not include 4 ft rail. Auxiliary rail is a 4 ft extension.



Item No.	Description	MSRP
710146	Light Rail 5 Add-A-Bar Kit	\$149.95
710147	Light Rail 5 Auxiliary Rail 4 ft	\$66.95

SunBlaster T5 Universal Light Stand

For use with SunBlaster T5 fixtures. Simply attach the fixture and you are ready to grow.



Item No.	Description	MSRP
710158	SunBlaster T5 Universal Light Stand	\$35.95

SunBlaster Universal T5 Light Strip Hanger

Allows you to add up to seven T5's above your target area. Snap any size of T5 into one or all of the seven mounting banks. Made to snap into your Universal T5 Stand, hang from above, with your choice of suspension hardware or wall mount. Includes 2 SunBlaster Universal Light Strips, 2 mounting screws and 4 easy clip hangers.



Item No.	Description	MSRP
710162	SunBlaster Universal T5 Light Strip Hanger	\$10.49

Jack Chain

Heavy duty jack chain can be used for a variety of indoor gardening applications. New design allows for individual links to be easily opened with pliers. Great for hanging reflectors, light fixtures, carbon filters and ventilation equipment.



Item No.	Description	MSRP
350205	Jack Chain 100 ft Roll	\$42.95
350210	Jack Chain 200 ft Roll	\$79.95

Reflector Hanging Hook

This is a universal replacement V hanging hook for Sun System reflectors and fixtures. Sold in quantities of 2 only.



Item No.	Description	MSRP Ea
430020	Reflector Hanging Hooks	\$1.29

Remember! The Global Garden Community Benefits Us All!

Just4Growers is an exciting, new online community for plant lovers!

- A one-stop source for indoor gardening queries
- Reliable, industry-led grower education (online and in-store)
- Stay informed with detailed practical gardening information

JOIN today!



JUST 4 GROWERS
GLOBAL GARDEN COMMUNITY

www.just4growers.com



Sun System

Sun System is the #1 brand of grow light for indoor and greenhouse gardening.



The Sunlight Supply manufacturing team in Woodland, Washington. Home of Sun System!



distributed by:
Sunlight Supply, Inc.
National Garden Wholesale.

Whether you garden as a hobby or commercially, hydroponically or in soil, indoors or outdoors, Sunlight Supply offers all of the products you need for a successful growing experience. We offer over 5,000 different products, including everything needed for indoor, organic, hydroponic, & greenhouse gardening.



AUTOMATIC FIRE EXTINGUISHERS

THE CHEAPEST INSURANCE POLICY YOU CAN BUY!

Coverage Area:
4.4 lb (2 KG) = 4' (1.24 meters diameter)

There are many electrical devices in todays indoor growing environments. Power strips, CO2 generators, heat mats, lights, light movers, reservoir heaters, fans, pumps, etc., can malfunction and cause a fire. Protect yourself, your growing environment and your home. Install a Flame Defender® today!



- Self contained – No plumbing or wiring required.
- Simply install by attaching vertically to the wall or ceiling.
- Automatic – extinguishing agent is automatically dispensed if the temperature probe on the unit reaches 155° F.
- Multi-purpose dry chemical extinguisher.
- Discharges a hemispherical spray pattern in area under sprinkler.

Visit www.sunlightsupply.com to see videos of the Flame Defender® in action or just scan the QR codes above to see them on your mobile device

Flame Defender - 2 KG

Protect yourself, your growing environment and your home. Install a Flame Defender today! Coverage area is 4 foot diameter. Product Dimensions: 5.25 in x 5.75 in x 16.25 in.



Item No.	Description	MSRP
740702	Flame Defender Extinguisher 2 kg	\$49.95

Professional UV Safety Glasses

100% UVA UVB Protection with lightweight nylon frames. Excellent for use around HPS & MH lights in grow rooms. Scratch resistant polycarbonate lens. Wrap around protection with no side shield distortion. Adjustable temple for ultimate comfort.



Item No.	Description	MSRP
708035	Professional UV Safety Glasses	\$10.95

Power All Indoor GFCI Power Strip - 4 Outlet - 125 Volt

The Power All GFCI Indoor power strip has 4 standard outlets. Each outlet is protected by a spring loaded plastic cover to prevent electrical shock, water and debris. Plugs are protected by a built in 15 amp circuit breaker with a GFCI. Cord is 6 ft unit includes a test and a reset button. 14 Gauge/15A/1875 Max watts. 1 Year



Item No.	Description	MSRP
780045	Power All Indoor GFCI Power Strip 4 Outlet 125 Volt 6 ft Cord	\$36.95

Black Lightning Powder Free Nitrile Gloves

Made to match healthy skin's natural 5.5 pH levels to ensure the most comfortable fit yet! Unique formulation reduces excess perspiration. Super strength and stretch. Textured grip. Medical quality. Latex free. Ambidextrous.



Item No.	Description	MSRP
744200	Black Lightning Powder Free Nitrile Gloves Small (100/Box)	\$18.95
744205	Black Lightning Powder Free Nitrile Gloves Medium (100/Box)	\$18.95
744210	Black Lightning Powder Free Nitrile Gloves Large (100/Box)	\$18.95
744215	Black Lightning Powder Free Nitrile Gloves X-Large (100/Box)	\$18.95



Bringing Nature and Technology Together

A leading innovator in the field of hydroponics with factories in North America and Europe. General Hydroponics is proud of its tradition of bringing nature and technology together. GH will always continue to strive for quality, simplicity, innovation and a sustainable future.

GH Flora Gro 2 - 1 - 6

Stimulates structural and vegetative growth. Builds strong roots. Provides Nitrogen, Phosphorous, Potassium and secondary minerals. Check your local Dealer Partner for availability.



Item No.	Description	MSRP
718040	GH Flora Gro Quart	\$12.50
718045	GH Flora Gro Gallon	\$31.88
718050	GH Flora Gro 2.5 Gallon	\$69.40
718055	GH Flora Gro 6 Gallon	\$140.00
718057	GH Flora Gro 15 Gallon	\$350.00
718060	GH Flora Gro 55 Gallon	\$1,283.34

GH Flora Bloom 0 - 5 - 4

Stimulates flower and fruit development. Enhances flavor, aroma and essential oils. Provides high Phosphorous, Potassium, Magnesium and Sulfur. Check your local Dealer Partner for availability.



Item No.	Description	MSRP
718010	GH Flora Bloom Quart	\$12.50
718015	GH Flora Bloom Gallon	\$31.88
718020	GH Flora Bloom 2.5 Gallon	\$69.40
718025	GH Flora Bloom 6 Gallon	\$140.00
718027	GH Flora Bloom 15 Gallon	\$350.00
718030	GH Flora Bloom 55 Gallon	\$1,283.34

GH Flora Micro 5 - 0 - 1

The foundation of the building-block system. Provides Nitrogen, Potassium, Calcium and trace elements. Combine with Flora Gro and Flora Bloom. Check your local Dealer Partner for availability.



Item No.	Description	MSRP
718120	GH Flora Micro Quart	\$15.94
718125	GH Flora Micro Gallon	\$36.58
718130	GH Flora Micro 2.5 Gallon	\$84.30
718135	GH Flora Micro 6 Gallon	\$170.00
718137	GH Flora Micro 15 Gallon	\$425.00
718140	GH Flora Micro 55 Gallon	\$1,558.34

GH Hardwater Flora Micro 5 - 0 - 1

If your tap water is over 200 ppm or contains Calcium above 70 ppm, use Flora Micro Hardwater. If your water contains 30 to 50 ppm Calcium, you can mix our original Flora Micro with Flora Micro Hardwater to create a perfect Micro blend for your plants. Check your local Dealer Partner for availability.



Item No.	Description	MSRP
718150	GH Hardwater Flora Micro Quart	\$15.94
718155	GH Hardwater Flora Micro Gallon	\$36.58
718160	GH Hardwater Flora Micro 2.5 Gallon	\$84.30
718165	GH Hardwater Flora Micro 6 Gallon	\$170.00
718166	GH Hardwater Flora Micro 15 Gallon	\$425.00

GH Flora Series Performance Pack

This box contains: 16 oz FloraMicro, FloraGro and FloraBloom, 8 oz FloraBlend and Liquid KoolBloom, 4 oz FloraKleen, 1 oz RapidStart, Floralicious Plus and pH Test Indicator.



Item No.	Description	MSRP
718145	GH Flora Series Performance Pack	\$49.99

GH FloraNova Bloom 4 - 8 - 7

FloraNova represents a breakthrough in fertilizer technology, as it gives users both the strength of a dry concentrate and the ease of a liquid. FloraNova Bloom promotes explosive flowering and fruiting. FloraNova Bloom induces phenomenal aroma, taste and colors while delivering extraordinary yields.



Item No.	Description	MSRP
718810	GH FloraNova Bloom Quart	\$27.50
718815	GH FloraNova Bloom Gallon	\$87.50
718808	GH FloraNova Bloom 2.5 Gallon	\$192.50

GH FloraNova Grow 7 - 4 - 10

FloraNova represents a breakthrough in fertilizer technology. FloraNova gives users both the strength of a dry concentrate and the ease of a liquid. Works as a specialized nutrient for rapidly growing plants during the structural and foliar growth phase.



Item No.	Description	MSRP
718800	GH FloraNova Grow Quart	\$27.50
718805	GH FloraNova Grow Gallon	\$87.50
718807	GH FloraNova Grow 2.5 Gallon	\$192.50

GH FloraDuo Hydroponics A 5-0-6

Using only two components growers can mix a large range of different nutrient blends for different kinds of plants and for phases of growth. The ratios of key ingredients, all change with different blends; each tailored to meet specialized plant needs. Check your local Dealer Partner for availability.



Item No.	Description	MSRP
726870	GH Flora Duo A Quart	\$15.00
726875	GH Flora Duo A Gallon	\$34.00
726880	GH Flora Duo A 2.5 Gallon	\$75.00
726882	GH Flora Duo A 6 Gallon	\$150.00
726883	GH Flora Duo A 15 Gallon	\$375.00

GH FloraDuo Hydroponics B 1-5-4

Using only two components, growers can mix a large range of different nutrient blends for different kinds of plants and for phases of growth. The ratios of key ingredients all change with different blends; each tailored to meet specialized plant needs. Check your local Dealer Partner for availability.



Item No.	Description	MSRP
726885	GH Flora Duo B Quart	\$15.00
726887	GH Flora Duo B Gallon	\$34.00
726890	GH Flora Duo B 2.5 Gallon	\$75.00
726895	GH Flora Duo B 6 Gallon	\$150.00
726896	GH Flora Duo B 15 Gallon	\$375.00

GH Floralicious Bloom 1-1-1

Floralicious Bloom promotes maximum flower size and fruit swelling for heavier yields. Offers phenomenal flavor and bouquet upon harvest. Leads to more coloration that is vibrant with an improved overall appearance.



Item No.	Description	MSRP
732185	GH Floralicious Bloom Quart	\$26.84
732190	GH Floralicious Bloom Gallon	\$80.50
732191	GH Floralicious Bloom 2.5 Gallon	\$184.00

GH Floralicious Grow 1-.07-0.6

Floralicious Grow enhances metabolic activities and nutrient assimilation that results in more vigorous growth. Builds the foundation of root and leaf mass needed for superior harvests. Check your local Dealer Partner for availability.



Item No.	Description	MSRP
732200	GH Floralicious Grow Quart	\$26.84
732205	GH Floralicious Grow Gallon	\$80.50
732210	GH Floralicious Grow 2.5 Gallon	\$184.00

GH Floralicious Plus 2.8-0.8-0.02

Floralicious Plus is a vegan bio plant stimulator and nutrient additive. It is everything that is Floralicious except it has been formulated to be applied in both the vegetative and regenerative or the flowering stages of growth.



Item No.	Description	MSRP
732208	GH Floralicious Plus 8 oz	\$21.84
732209	GH Floralicious Plus Pint	\$34.48
732206	GH Floralicious Plus Quart	\$60.90
732207	GH Floralicious Plus Gallon	\$212.76

GH Flora Nectar FruitnFusion 0-0-1

FloraNectar contains all natural raw cane sugar, molasses, malt syrup, select plant based esters, L-amino acids, organic acids, vitamins and essential minerals.



Item No.	Description	MSRP
732176	GH Flora Nectar FruitnFusion Quart	\$21.00
732177	GH Flora Nectar FruitnFusion Gallon	\$58.80
732178	GH Flora Nectar FruitnFusion 2.5 Gal	\$132.30
732179	GH Flora Nectar FruitnFusion 6 Gal	\$262.50

GH Flora Nectar Pineapple Rush 0-0-1

Pineapple Rush is an organic nutrient supplement designed as a sweetener for your fruits and flowers. It is made with sugars, including molasses and natural raw cane sugar. Pineapple Rush adds the essence of pineapple to the formula.



Item No.	Description	MSRP
732180	GH Flora Nectar Pineapple Quart	\$21.00
732182	GH Flora Nectar Pineapple Gallon	\$58.80

GH Flora Nectar Coconut 0-0-1

Flora Nectar Coconut ensures optimal metabolic rates during the flowering and fruiting phase when nitrogen levels have been reduced. Flora Nectar also promotes a sturdier plant structure during the vegetative phase when high levels of nitrogen are present.



Item No.	Description	MSRP
732680	GH Flora Nectar Coconut Quart	\$21.00
732685	GH Flora Nectar Coconut Gallon	\$58.80

GH Flora Nectar Banana Bliss 0-0-1



Banana Bliss is the latest addition to the GH Flora Nectar line. Banana Bliss contains all natural raw cane sugar, molasses, malt syrup, select plant based esters, L-amino acids, organic acids, polyflavonoids, vitamins & essential minerals. This unique blend of ingredients helps your plants regulate enzymes that trigger specific reactions involved in maintaining optimal metabolism. This allows your plants to achieve a balance between respiration and photosynthesis in high intensity growing environments where the rate of respiration can sometimes exceed the rate of photosynthesis.

Item No.	Description	MSRP
732196	GH Flora Nectar Banana Bliss Quart	\$21.00
732197	GH Flora Nectar Banana Bliss Gallon	\$58.80
732198	GH Flora Nectar Banana Bliss 2.5 Gallon	\$132.30
732199	GH Flora Nectar Banana Bliss 6 Gallon	\$262.50

GH Flora Nectar Sugar Cane 0-0-1

FloraNectar Sugar Cane is formulated to optimize the greatest transference of sweetness and aroma. It contains all natural raw cane sugar, molasses, malt syrup, select plant-based esters, L-amino acids, organic acids, vitamins and essential minerals.



Item No.	Description	MSRP
733500	GH Flora Nectar Sugar Cane Quart	\$21.00
733505	GH Flora Nectar Sugar Cane Gallon	\$58.80
733510	GH Flora Nectar Sugar Cane 2.5 Gallon	\$132.30
733515	GH Flora Nectar Sugar Cane 6 Gallon	\$262.50

GH FloraBlend 0.5-1-1

FloraBlend is a vegan plant booster that is made from a proprietary blend of plant materials, seaweed, rock powders & micronized leonardite. These compounds increase & promote healthy root structures & build the plant's immune system. Check your local Dealer Partner for availability.



Item No.	Description	MSRP
732211	GH FloraBlend Quart	\$12.00
732212	GH FloraBlend Gallon	\$30.00
732213	GH FloraBlend 2.5 Gallon	\$70.00
732214	GH FloraBlend 6 Gallon	\$144.00
732216	GH FloraBlend 15 Gallon	\$360.00

GH FloraKleen

FloraKleen removes fertilizer residues that can accumulate over time in hydroponic systems, growing media and potting soils. Use it monthly to purge your systems or potted plants of excess salts that can accumulate. Check your local Dealer Partner for availability.



Item No.	Description	MSRP
732915	GH Flora Kleen Quart	\$9.78
732920	GH Flora Kleen Gallon	\$23.00
732925	GH Flora Kleen 2.5 Gallon	\$54.66
732930	GH Flora Kleen 6 Gallon	\$124.20

GH CALiMAGic 1-0-0

CALiMAGic is a concentrated blend of readily available Calcium and Magnesium. It is formulated to assist fast growing plants by preventing secondary nutrient deficiencies. Check your local Dealer Partner for availability.



Item No.	Description	MSRP
733525	GH CALiMAGic Quart	\$16.20
733530	GH CALiMAGic Gallon	\$40.50
733535	GH CALiMAGic 2.5 Gallon	\$90.00
733540	GH CALiMAGic 6 Gallon	\$205.20
733531	GH CALiMAGic 15 Gallon	\$513.00

GH MaxiGro 10-5-14

MaxiGro is extremely potent, stand-alone, water-soluble, dry concentrate nutrients. MaxiGro encourages growth of seedlings and cuttings and stimulates rapid growth through the vegetative growth stage.



Item No.	Description	MSRP
718301	GH MaxiGro 2.2 lb	\$15.34
718310	GH MaxiGro 16 lb	\$118.00

GH MaxiBloom 5-15-14

This is extremely potent, stand-alone, water-soluble, dry concentrate nutrients. MaxiBloom is for the reproductive stage in fast growing annuals. MaxiBloom encourages prolific flowering and fruiting and increases yields and crop quality.



Item No.	Description	MSRP
718281	GH MaxiBloom 2.2 lb	\$15.34
718290	GH MaxiBloom 16 lb	\$118.00

GH RapidStart 1 - 0.5 - 1

RapidStart enhances your growing experience by delivering a powerful blend of premium plant extracts, amino acids and nutrients generating explosive root growth. Using RapidStart will make your plants explode!



Item No.	Description	MSRP
726850	GH RapidStart 125 ml	\$26.49
726855	GH RapidStart 275 ml	\$39.99
726860	GH RapidStart 500 ml	\$74.36
726865	GH RapidStart 1 Liter	\$143.30

GH Diamond Nectar 0 - 1 - 1

Diamond Nectar accelerates nutrient absorption where mineral foods enter the plant. It supercharges your nutrients in order to optimize the health of your plants and the quality of your crops. Check your local Dealer Partner for availability.



Item No.	Description	MSRP
732160	GH Diamond Nectar Quart	\$17.25
732165	GH Diamond Nectar Gallon	\$46.00
732170	GH Diamond Nectar 2.5 Gallon	\$92.00
732175	GH Diamond Nectar 6 Gallon	\$184.00
732174	GH Diamond Nectar 15 Gallon	\$460.00

GH KoolBloom 2 - 45 - 28

KoolBloom is a highly concentrated nutrient supplement that promotes abundant flowering and facilitates ripening in annual flowers and herbs.



Item No.	Description	MSRP
732531	GH KoolBloom 2.2 lb	\$29.40
732535	GH KoolBloom 16 lb	\$212.00

GH Liquid KoolBloom 0 - 10 - 10

Liquid KoolBloom is a bulking agent that goes way beyond other bloom boosters. Enriched with stress reducing vitamins & nutrient transporting acids, it promotes heavy production of essential oils, fantastic flavors & increases fruiting & flowering. Check your local Dealer Partner for availability.



Item No.	Description	MSRP
732537	GH Liquid KoolBloom Quart	\$21.76
732538	GH Liquid KoolBloom Gallon	\$63.50
732539	GH Liquid KoolBloom 2.5 Gallon	\$136.30
732541	GH Liquid KoolBloom 6 Gallon	\$305.50

GH Subculture M

SubCulture-M, contains a wide diversity of endo & ecto mycorrhizal fungi that colonize plant roots. These beneficial fungi form a fine network of fibrous strands that serve as an extension of plant root systems helping plants absorb water & nutrients.



Item No.	Description	MSRP
722147	GH Subculture M 75 gm	\$12.55
722149	GH Subculture M 150 gm	\$20.65
722153	GH Subculture M 300 gm	\$30.80
722157	GH Subculture M 600 gm	\$53.49

GH Subculture B 0.1 - 0.04 - 0.02

SubCulture-B is a probiotic inoculum of beneficial microorganisms that will increase the vitality and yield in all plants. In soil or hydroponics, this blend of bacteria & trichoderma fungi colonize the root zone & media to form a symbiotic relationship.



Item No.	Description	MSRP
722146	GH Subculture B 75 gm	\$21.30
722148	GH Subculture B 150 gm	\$36.10
722151	GH Subculture B 300 gm	\$62.58
722156	GH Subculture B 600 gm	\$117.73

GH Bush Load

Bush Load is a super concentrated (0.4% Paclobutrazol) plant growth regulator. Bush Load can be readily absorbed by plant roots and translocated to the active growing points. Application of Bush Load produces a long-lasting, uniform growth regulation. EPA Reg. No. 80697-3-AA-88774. Not for sale in the following states at this time: AK, LA, OK, PR.



Item No.	Description	MSRP
733550	GH Bush Load 8 oz	\$45.99
733555	GH Bush Load 16 oz	\$84.99
733560	GH Bush Load Quart	\$149.99

GH ArmorSi 0 - 0 - 4

Armor Si is suitable for all types of plants during all stages of growth. Armor Si improves plant structure and foliar development, increases yield and improves flower and fruit production. Your plants will additionally experience improved heat and cold tolerance, stress resistance, improved light absorption which leads to greater plant stature.



Item No.	Description	MSRP
732802	GH Armor Si Quart	\$15.80
732804	GH Armor Si Gallon	\$40.00
732806	GH Armor Si 2.5 Gallon	\$94.00
732808	GH Armor Si 6 Gallon	\$216.00



GH BioThrive Grow 4-3-3

BioThrive Grow is formulated to maximize vegetative growth by supplying plants with a custom diet that stimulates vigorous root and foliage development. Through proper nutrition, we create a strong frame for later flower, fruit and seed production. Check your local Dealer Partner for availability.



Item No.	Description	MSRP
726800	GH BioThrive Grow Quart	\$18.00
726802	GH BioThrive Grow Gallon	\$62.66
726804	GH BioThrive Grow 2.5 Gallon	\$133.20
726806	GH BioThrive Grow 6 Gallon	\$271.68
726807	GH BioThrive Grow 15 Gallon	\$679.20

GH BioThrive Bloom 2-4-4

Provides flowering & fruiting plants with essential nutrients, balanced for superior blooms & bountiful harvests. Specially designed to maximize flower, fruit & seed production, this formulation will give bigger, more nutritious & delicious yields. Check your local Dealer Partner for availability.



Item No.	Description	MSRP
726810	GH BioThrive Bloom Quart	\$17.84
726812	GH BioThrive Bloom Gallon	\$55.08
726814	GH BioThrive Bloom 2.5 Gallon	\$120.00
726816	GH BioThrive Bloom 6 Gallon	\$260.00
726817	GH BioThrive Bloom 15 Gallon	\$650.00
726818	GH BioThrive Bloom 55 Gallon	\$2,346.56

GH CaMg+

CaMg+ is the ideal supplement to provide a natural source of Calcium and Magnesium, critical elements in a plants growth cycle. CaMg+ is biologically catalyzed from oyster shell, dolomite lime and natural plant extracts.



Item No.	Description	MSRP
726820	GH CaMg+ Quart	\$18.12
726822	GH CaMg+ Gallon	\$58.32
726821	GH CaMg+ 2.5 Gallon	\$130.40
726823	GH CaMg+ 6 Gallon	\$272.00
726819	GH CaMg+ 15 Gallon	\$662.88
726857	GH CaMg+ 55 Gallon	\$2,399.84

GH BioRoot 1-1-1

BioRoot is a natural root growth supplement that helps plants establish healthy and vibrant root systems. It contains vitamins, enzymes, organic and humic acids that stimulate root growth. Check your local Dealer Partner for availability.



Item No.	Description	MSRP
726824	GH BioRoot Quart	\$16.98
726826	GH BioRoot Gallon	\$52.70
726825	GH BioRoot 2.5 Gallon	\$110.16
726827	GH BioRoot 6 Gallon	\$226.16

GH BioBud 0.5-0.1-1

BioBud is a powerful bloom stimulator that generates explosive flowering and massive fruit production. BioBud increases metabolic activity and mineral uptake by utilizing bio-stimulants and organic transport enhancers.



Item No.	Description	MSRP
726828	GH BioBud Quart	\$41.36
726830	GH BioBud Gallon	\$157.10
726829	GH BioBud 2.5 Gallon	\$373.04
726831	GH BioBud 6 Gallon	\$850.96

GH BioWeed 0.2-0-0.3

BioWeed is derived from a blend of cold processed seaweeds that act as a plant and soil vitality enhancer. BioWeed encourages prolific root and foliage growth as well as larger flowers and fruits. Check your local Dealer Partner for availability.



Item No.	Description	MSRP
726832	GH BioWeed Quart	\$20.22
726834	GH BioWeed Gallon	\$62.16
726833	GH BioWeed 2.5 Gallon	\$141.24
726835	GH BioWeed 6 Gallon	\$330.00
726841	GH BioWeed 15 Gallon	\$825.92

GH General Organics GO Box

General Organics now has the GO Box starter kit. The GO Box contains 16 oz BioThrive Grow and Bloom fertilizers as well as 8 oz samples of every GO liquid supplement.



Item No.	Description	MSRP
726846	GH General Organics Go Box	\$51.36



With 17 years of expertise as a leading manufacturer in the industry, Botanicare proudly offers the most comprehensive and versatile range of premium indoor and outdoor hydroponic supplies and products today. Botanicare's vision is to bring the freedom and flexibility of hydroponic and soilless growing to consumers around the world for the aspiring hobbyist, and the expert grower. Botanicare offers a complete ecosystem of premium nutrients and supplements, plastic grow trays, specialty hydroponic fittings, and turn-key grow systems to fulfill the needs of any budding hydroponicist.

GH BioMarine 2 - 3 - 1

BioMarine is a completely organic fish fertilizer that encourages rapid growth, improves color and helps increase plant's resistance to pests. BioMarine benefits all types of plants during all phases of growth, from seedling to harvest.



Item No.	Description	MSRP
726836	GH BioMarine Quart	\$16.98
726838	GH BioMarine Gallon	\$51.48
726837	GH BioMarine 2.5 Gallon	\$112.96
726839	GH BioMarine 6 Gallon	\$229.92

GH Diamond Black 0 - 0 - 1

Diamond Black is derived from 100% pure mined Leonardite, a naturally occurring form of carbon. It supports beneficial microbial activity in soils and increases micronutrient availability. Check your local Dealer Partner for availability.



Item No.	Description	MSRP
726840	GH Diamond Black Quart	\$16.98
726842	GH Diamond Black Gallon	\$52.30
726843	GH Diamond Black 2.5 Gallon	\$108.48
726844	GH Diamond Black 6 Gallon	\$220.96
726845	GH Diamond Black 15 Gallon	\$537.76

GH Spigot For 6-Gallon Containers

For use with all General Hydroponics 6 gallon containers.



Item No.	Description	MSRP
718445	GH 6 Gallon Container Spigot	\$3.50

Measure Master Pump Dispensers - 1 oz

Great for quickly measuring & dispensing your liquid plant food & supplements! One pump dispenses one ounce of liquid. 740040 is designed specifically to a one gal bottle. 740042 is designed specifically to a 2.5 gal bottle (bottles not included).



Item No.	Description	MSRP
740040	Measure Master Pump Dispenser 1 oz For Gallon Jug	\$4.69
740042	Measure Master Pump Dispenser 1 oz For 2.5 Gallon Jugs	\$7.49

Botanicare Kind Base 4 - 0 - 0

Kind Plant Nutrient System is a proprietary three part nutrient unlike any other. Kind was formulated with the calcium and magnesium separate from the trace minerals. This allows you to customize Kind to meet the specific needs of your garden, whatever Kind you grow. A fusion of science and nature, Kind provides optimal plant nutrition in perfect balance.



Item No.	Description	MSRP
733100	Botanicare Kind Base Quart	\$16.95
733105	Botanicare Kind Base Gallon	\$39.95
733110	Botanicare Kind Base 2.5 Gallon	\$89.95
733115	Botanicare Kind Base 5 Gallon	\$164.95
733120	Botanicare Kind Base 15 Gallon	\$456.00
733125	Botanicare Kind Base 55 Gallon	\$1,605.00

Botanicare Kind Grow 2 - 2 - 4

Kind Plant Nutrient System is a proprietary three part nutrient unlike any other. Kind was formulated with the calcium and magnesium separate from the trace minerals. This allows you to customize Kind to meet the specific needs of your garden, whatever Kind you grow. Kind uses high quality minerals fortified with all natural ingredients.



Item No.	Description	MSRP
733130	Botanicare Kind Grow Quart	\$16.95
733135	Botanicare Kind Grow Gallon	\$39.95
733140	Botanicare Kind Grow 2.5 Gallon	\$89.95
733145	Botanicare Kind Grow 5 Gallon	\$164.95
733150	Botanicare Kind Grow 15 Gallon	\$456.00
733155	Botanicare Kind Grow 55 Gallon	\$1,605.00

Botanicare Kind Bloom 0 - 6 - 6

Kind Plant Nutrient System is a proprietary three part nutrient unlike any other. Kind was formulated with the calcium and magnesium separate from the trace minerals. This allows you to customize Kind to meet the specific needs of your garden, whatever Kind you grow. Kind uses high quality minerals fortified with all natural ingredients.



Item No.	Description	MSRP
733160	Botanicare Kind Bloom Quart	\$16.95
733165	Botanicare Kind Bloom Gallon	\$39.95
733170	Botanicare Kind Bloom 2.5 Gallon	\$89.95
733175	Botanicare Kind Bloom 5 Gallon	\$164.95
733180	Botanicare Kind Bloom 15 Gallon	\$456.00
733185	Botanicare Kind Bloom 55 Gallon	\$1,605.00

Botanicare Pure Blend Tea

Pure Blend Tea (formerly Pure Blend Original Grow & Bloom). Pure Blend Tea combines the key elements of both Pure Blend Original Grow and Bloom, into one highly effective formula. Pure Blend Tea is enhanced and fortified with a premium blend of ultra-soluble humates, organic plant acids, trace minerals, vitamins and select amino acids. Check your local Dealer Partner for availability.



Item No.	Description	MSRP
732630	Botanicare Pure Blend Tea Quart	\$13.95
732635	Botanicare Pure Blend Tea Gallon	\$34.95
732640	Botanicare Pure Blend Tea 2.5 Gallon	\$77.95
732645	Botanicare Pure Blend Tea 5 Gallon	\$141.95
732650	Botanicare Pure Blend Tea 15 Gallon	\$399.00
732655	Botanicare Pure Blend Tea 55 Gallon	\$1,405.00

Botanicare Pure Blend Pro Soil 1-4-5

Designed specifically to be used in soil container gardens. When cultivating fruiting & flowering plants in soil, growers usually need to double or triple phosphorous levels, unlike hydroponics, thus making the 1.5-4-5 formula ideal for soil applications. Check your local Dealer Partner for availability.



Item No.	Description	MSRP
718375	Botanicare Pure Blend Pro Soil Quart	\$22.95
718380	Botanicare Pure Blend Pro Soil Gallon	\$55.95
718385	Botanicare Pure Blend Pro Soil 2.5 Gallon	\$124.50
718390	Botanicare Pure Blend Pro Soil 5 Gallon	\$226.95
718467	Botanicare Pure Blend Pro Soil 15 Gallon	\$639.00
718468	Botanicare Pure Blend Pro Soil 55 Gallon	\$2,248.00

Botanicare Pure Blend Pro Bloom Formula 2-2-5

Pure Blend Pro is a premium, one-part, natural and organic-based plant food. Pure Blend Pro is a healthy environment-friendly alternative to commercial chemical fertilizers. Use Bloom during the fruiting and flowering stage. Check your local Dealer Partner for availability.



Item No.	Description	MSRP
718450	Botanicare Pure Blend Pro Bloom Quart	\$22.95
718455	Botanicare Pure Blend Pro Bloom Gallon	\$55.95
718460	Botanicare Pure Blend Pro Bloom 2.5 Gallon	\$124.50
718465	Botanicare Pure Blend Pro Bloom 5 Gallon	\$226.95
718464	Botanicare Pure Blend Pro Bloom 15 Gallon	\$639.00
718466	Botanicare Pure Blend Pro Bloom 55 Gallon	\$2,248.00

Botanicare Liquid Karma 0.1-0.1-0.5

100% water soluble humic acid source will not cause buildup in lines, clog drippers or contribute to pH fluctuations. Liquid Karma contains metabolically active organic compounds that are absorbed immediately and act as regulatory signals, activators or catalysts to produce accelerated growth. Liquid Karma promotes increased metabolic activity produces a large amount of energy, which translates into increased growth rates. Check your local Dealer Partner for availability.



Item No.	Description	MSRP
732275	Botanicare Liquid Karma Quart	\$28.95
732280	Botanicare Liquid Karma Gallon	\$69.95
732285	Botanicare Liquid Karma 2.5 Gallon	\$157.95
732290	Botanicare Liquid Karma 5 Gallon	\$287.50
732283	Botanicare Liquid Karma 15 Gallon	\$859.95
732284	Botanicare Liquid Karma 55 Gallon	\$2,850.00

Botanicare Pure Blend Pro Grow Formula 3-2-4

Pure Blend Pro is a premium, one-part, natural and organic-based plant food. Pure Blend Pro is a healthy environment-friendly alternative to commercial chemical fertilizers. Use Grow during the vegetative growth stage. Check your local Dealer Partner for availability.



Item No.	Description	MSRP
718475	Botanicare Pure Blend Pro Grow Quart	\$22.95
718480	Botanicare Pure Blend Pro Grow Gallon	\$55.95
718485	Botanicare Pure Blend Pro Grow 2.5 Gallon	\$124.50
718490	Botanicare Pure Blend Pro Grow 5 Gallon	\$226.95
718478	Botanicare Pure Blend Pro Grow 15 Gallon	\$639.00
718479	Botanicare Pure Blend Pro Grow 55 Gallon	\$2,248.00

Botanicare Sweet - Carbo Raw

Sweet Raw is a flavorless, all natural mineral supplement that meets the metabolic demands of your plants throughout their life cycle. Sweet helps plants maintain an optimum metabolism and a proper balance between photosynthesis and respiration. Check your local Dealer Partner for availability.



Item No.	Description	MSRP
732297	Botanicare Sweet Carbo Raw Quart	\$28.95
732298	Botanicare Sweet Carbo Raw Gallon	\$69.95
732299	Botanicare Sweet Carbo Raw 2.5 Gallon	\$154.95
732302	Botanicare Sweet Carbo Raw 5 Gallon	\$282.95
732303	Botanicare Sweet Carbo Raw 55 Gallon	\$2,810.50

Botanicare Sweet - Original Berry

Sweet Berry is scientifically formulated for the bio-synthesis of crucial compounds to maintain optimal metabolism and contains: Select carbohydrates for amplified energy, increased sugar/brix content and plant bio-mass. Check your local Dealer Partner for availability.



Item No.	Description	MSRP
732291	Botanicare Sweet Berry Quart	\$28.95
732292	Botanicare Sweet Berry Gallon	\$69.95
732293	Botanicare Sweet Berry 2.5 Gallon	\$154.95
732294	Botanicare Sweet Berry 5 Gallon	\$282.95
732301	Botanicare Sweet Berry 15 Gallon	\$797.95

Botanicare Sweet - Citrus

Sweet Citrus is scientifically formulated for the bio-synthesis of crucial compounds to maintain optimal metabolism and contains: Select carbohydrates for amplified energy, increased sugar/brix content and plant bio-mass. Check your local Dealer Partner for availability.



Item No.	Description	MSRP
732266	Botanicare Sweet Citrus Quart	\$28.95
732267	Botanicare Sweet Citrus Gallon	\$69.95
732268	Botanicare Sweet Citrus 2.5 Gallon	\$154.95
732269	Botanicare Sweet Citrus 5 Gallon	\$282.95
732271	Botanicare Sweet Carbo Citrus 15 Gal	\$797.95
732272	Botanicare Sweet Carbo Citrus 55 Gal	\$2,810.50

Botanicare Sweet - Grape

Sweet Grape is scientifically formulated for the bio-synthesis of crucial compounds to maintain optimal metabolism and contains: Select carbohydrates for amplified energy, increased sugar/brix content and plant bio-mass. Check your local Dealer Partner for availability.



Item No.	Description	MSRP
732384	Botanicare Sweet Carbo Grape Quart	\$28.95
732386	Botanicare Sweet Carbo Grape Gallon	\$69.95
732388	Botanicare Sweet Carbo Grape 2.5 Gallon	\$154.95
732390	Botanicare Sweet Carbo Grape 5 Gallon	\$282.95
732391	Botanicare Sweet Carbo Grape 15 Gallon	\$797.95

Botanicare Growilla Bud 2 - 5 - 4 & Veg 5 - 4 - 2

Growilla Veg & Bud, the simple to use natural and organic plant food. This premium plant food is hand mixed in small batches to provide a wide range of organic food sources for plants and beneficial microbes. While Growilla Veg was formulated to provide the specific ratio of macro and micro nutrients that encourages lush, vigorous, vegetative growth; Growilla Bud enhances flower development, maintains soil structure and increases nutrient uptake.



Item No.	Description	MSRP
733300	Botanicare Growilla Bud 12 lb	\$62.95
733305	Botanicare Growilla Bud 25 lb	\$110.95
733310	Botanicare Growilla Veg 12 lb	\$62.95
733315	Botanicare Growilla Veg 25 lb	\$110.95

Botanicare Hydroplex 0 - 10 - 6

Hydroplex Bloom Enhancer creates larger fruits and flowers and surpasses that standard by both increasing plants' resistance to external stresses and amplifying natural enzyme, chlorophyll and essential oil production. Check your local Dealer Partner for availability.



Item No.	Description	MSRP
733090	Botanicare Hydroplex Bloom 8 oz	\$16.50
733092	Botanicare Hydroplex Bloom Quart	\$36.75
733094	Botanicare Hydroplex Bloom Gallon	\$90.95
733096	Botanicare Hydroplex Bloom 2.5 Gallon	\$197.95
733098	Botanicare Hydroplex Bloom 5 Gallon	\$379.95
734002	Botanicare Hydroplex Bloom 15 Gallon	\$1,095.25

Botanicare Silica Blast

Silicate is a beneficial nutrient supplement to be used in conjunction with a standard nutrient program. Silicate helps strengthen plant tissue helping plants flourish in adverse environmental conditions such as heat, drought and frost. Check your local Dealer Partner for availability.



Item No.	Description	MSRP
732485	Botanicare Silica Blast Quart	\$17.95
732490	Botanicare Silica Blast Gallon	\$43.50
732491	Botanicare Silica Blast 2.5 Gallon	\$96.95
732492	Botanicare Silica Blast 5 Gal	\$178.95

Botanicare Clearex Salt Leaching Solution

Clearex is an isotonic drenching solution that unlocks the ionic bond between the nutrient and the soil or soilless grow substrate, correcting the problem of nutrient salt toxicity and lockout, allowing plants to thrive again. Check your local Dealer Partner for availability.



Item No.	Description	MSRP
732605	Botanicare Clearex Quart	\$13.25
732610	Botanicare Clearex Gallon	\$32.95
732615	Botanicare Clearex 2.5 Gallon	\$71.25
732620	Botanicare Clearex 5 Gallon	\$133.50
732622	Botanicare Clearex 15 Gal	\$393.50
732621	Botanicare Clearex 55 Gal	\$1,335.00

Botanicare CNS17 Ripe 1-5-4

CNS17 Ripe was developed to maximize crop potential and quality during the final growth phase in fruiting and flowering plants. This specialty formula promotes ripening along with increased flower size, density and essential oil production. Check your local Dealer Partner for availability.



Item No.	Description	MSRP
733020	Botanicare CNS17 Ripe Quart	\$10.95
733023	Botanicare CNS17 Ripe Gallon	\$27.50
733025	Botanicare CNS17 Ripe 2.5 Gallon	\$58.50
733027	Botanicare CNS17 Ripe 5 Gallon	\$108.95
733028	Botanicare CNS17 Ripe 15 Gallon	\$304.95

Botanicare CNS17 Grow 3-1-2

CNS17 Grow contains all seventeen essential elements, making it an ideal food source for plants. Optimal ratios of nitrogen and phosphorus promote increased root development, decreased internode spacing and sturdy stalks and branches.



Item No.	Description	MSRP
733205	Botanicare CNS17 Grow Quart	\$10.95
733210	Botanicare CNS17 Grow Gallon	\$27.50
733215	Botanicare CNS17 Grow 2.5 Gallon	\$58.50
733220	Botanicare CNS17 Grow 5 Gallon	\$108.95
733225	Botanicare CNS17 Grow 15 Gallon	\$304.95
733230	Botanicare CNS17 Grow 55 Gallon	\$1,072.50

Botanicare CNS17 Bloom 2-2-3

The NPK ratio in CNS17 Bloom was designed to provide specific critical elements to support heavily fruiting and flowering crops which allows phosphorus and potassium levels to be maximized without leading to toxicity or nutrient burn.



Item No.	Description	MSRP
733240	Botanicare CNS17 Bloom Quart	\$10.95
733245	Botanicare CNS17 Bloom Gallon	\$27.50
733250	Botanicare CNS17 Bloom 2.5 Gallon	\$58.50
733255	Botanicare CNS17 Bloom 5 Gallon	\$108.95
733260	Botanicare CNS17 Bloom 15 Gallon	\$304.95
733265	Botanicare CNS17 Bloom 55 Gallon	\$1,072.50

Botanicare Cal-Mag Plus 2-0-0

Cal-Mag Plus is a highly fortified calcium, magnesium and iron plant supplement formulated to correct common deficiencies. Supplementing your preferred nutrient program with Cal-Mag Plus is strongly recommended when using reverse osmosis water and when growing in Coco Coir based medias. Check your local Dealer Partner for availability.



Item No.	Description	MSRP
732110	Botanicare Cal-Mag Plus Quart	\$19.50
732115	Botanicare Cal-Mag Plus Gallon	\$48.50
732120	Botanicare Cal-Mag Plus 2.5 Gallon	\$105.95
732125	Botanicare Cal-Mag Plus 5 Gallon	\$198.95
732124	Botanicare Cal-Mag Plus 15 Gallon	\$586.95
732126	Botanicare Cal-Mag Plus 55 Gallon	\$1,960.95

Botanicare Vitamino

Botanicare developed Vitamino to preserve balanced plant growth and optimal plant health in accelerated growth environments.



Item No.	Description	MSRP
739130	Botanicare Vitamino Quart	\$28.95
739135	Botanicare Vitamino Gallon	\$68.95
739140	Botanicare Vitamino 2.5 Gallon	\$151.50
739145	Botanicare Vitamino 5 Gallon	\$278.95

Botanicare ZHO Root Inoculant 6-0-0

ZHO is a unique and proprietary blend of beneficial Endomycorrhizal fungi, Trichoderma fungi and highly available L-Glycine amino acids. ZHO promotes rapid new root growth and improves the plants' ability to uptake water and nutrients. ZHO was specifically formulated for fruit bearing and heavy flowering plant types.



Item No.	Description	MSRP
732316	Botanicare ZHO Root Inoculant 1/4 lb	\$29.95
732318	Botanicare ZHO Root Inoculant 1 lb	\$99.95

Botanicare Fulvex

Botanicare Fulvex is an OMRI listed liquid trace mineral extract that corrects nutrient lock out conditions and amplifies nutrient uptake.



Item No.	Description	MSRP
739075	Botanicare Fulvex Quart	\$18.75
739080	Botanicare Fulvex Gallon	\$44.95
739085	Botanicare Fulvex 2.5 Gallon	\$99.95
739090	Botanicare Fulvex 5 Gallon	\$186.00

Botanicare Seaplex

Seaplex is a cold processed seaweed for foliar spraying, soil and soilless container gardens and hydroponic systems. This natural and organic supplement is packed with amino acids, enzymes, micronutrients and soil biology that encourage vigorous growth.



Item No.	Description	MSRP
739042	Botanicare SeaPlex Quart	\$21.95
739044	Botanicare SeaPlex Gallon	\$53.95

Botanicare Pure Granular Grow 6-6-5 + 8% Ca

Pure natural and organic plant food is ideal for soil container gardens, raised bed gardens, potted plants & hydroponics. Beneficial for fruits, flowers, vegetables, trees, shrubs & turf. Pure's granular formula helps prevent nutrient leaching & runoff. Check your local Dealer Partner for availability.



Item No.	Description	MSRP
739050	Botanicare Pure Granular Grow 2 lb	\$6.50
739051	Botanicare Pure Granular Grow 5 lb	\$15.95
739052	Botanicare Pure Granular Grow 12 lb	\$34.95
739054	Botanicare Pure Granular Grow 50 lb	\$65.00

Botanicare Pure Bloom Granular 1-5-4 + 6% Ca

Pure Bloom's slow release all organic granules will satisfy your fruiting and flowering plant's nutritional needs during the bloom phase of their grow cycle. Check your local Dealer Partner for availability.



Item No.	Description	MSRP
739064	Botanicare Pure Granular Bloom 2 lb	\$6.50
739066	Botanicare Pure Granular Bloom 5 lb	\$15.95
739068	Botanicare Pure Granular Bloom 12 lb	\$34.95
739070	Botanicare Pure Granular Bloom 50 lb	\$65.00



FoxFarm is a small, family-run business dedicated to producing the finest quality garden products available anywhere. Organic ingredients play a large role in our company. All formulas are handcrafted in small batches to ensure superior consistency and quality control. We offer custom blended soil mixes, natural and organic fertilizers as well as organic-based products that combine the Best of Technology with the Goodness of Nature™. We are known as the Microbrewery of Premium Plant Foods and Soil Mixes.

FoxFarm Bushdoctor Boomerang

Boomerang's microbial-based formula nourishes damaged root tissue while encouraging new root development and internodal vegetative growth. It contains solubilized organic nutrition that is immediately available to plants. Boomerang is the Comeback Formula that gives your plants a fighting chance. Not for sale in the following states at this time: FL, HI.



Item No.	Description	MSRP
732864	FoxFarm Bushdoctor Boomerang Pint	\$10.95
732865	FoxFarm Bushdoctor Boomerang Quarts	\$19.95
732867	FoxFarm Bushdoctor Boomerang Gallon	\$65.95

FoxFarm Bushdoctor Flowers Kiss

A spray-on foliar plant food is designed to be easily absorbed through stomata on the plant's leaves, like a soft rain, providing organic nutrition from the top down. It supplements micronutrients that are crucial in the early flowering phase of plant growth. Helps to alleviate stress in the transitional period between vegetative growth and flowering. Not for sale in the following states at this time: FL.



Item No.	Description	MSRP
732869	FoxFarm Bushdoctor Flower Kiss Pint	\$10.95
732870	FoxFarm Bushdoctor Flower Kiss Quart	\$19.95
732872	FoxFarm Bushdoctor Flower Kiss Gallon	\$65.95

FoxFarm Bushdoctor SledgeHammer

A unique rinse formula designed to remove excess fertilizer build up. Sledgehammer encourages water movement through soil and soilless mediums, rinsing out unwanted mineral salt residues and relieving nutrient lock up. Use in established gardens, container plantings and hydroponic systems. Not for sale in the following states at this time: FL, IL, MI, MN, MS, OK, SC, SD, WI.



Item No.	Description	MSRP
732849	FoxFarm Bushdoctor SledgeHammer Pint	\$10.95
732850	FoxFarm Bushdoctor SledgeHammer Quart	\$20.95
732852	FoxFarm Bushdoctor SledgeHammer Gallon	\$64.95

FoxFarm Bushdoctor Microbe Brew

Bush Doctor Microbe Brew is a complex blend of ingredients specially formulated to help plants achieve optimum microbial habitats at the rhizosphere or root zone environment. This concentrated brew supplies nutrition for your plants, as well as feeding the microbial colonies in the soil. Satisfy your plants' thirst by giving them the nutritional cocktail they deserve. Not for sale in the following states at this time: FL, HI, IL.



Item No.	Description	MSRP
732853	FoxFarm Bushdoctor Microbe Brew Pint	\$11.95
732854	FoxFarm Bushdoctor Microbe Brew Quart	\$24.95
732856	FoxFarm Bushdoctor Microbe Brew Gallon	\$80.95

FoxFarm Bushdoctor Kangaroots

Bush Doctor Kangaroots is a liquid root drench formulation for use on in-ground plantings, container gardens and hydroponic systems. Use Bush Doctor Kangaroots on seedlings and mature plants throughout the growing season to enhance the proliferation of root mass development. Not for sale in the following states at this time: FL, HI, IL.



Item No.	Description	MSRP
732857	FoxFarm Bushdoctor Kangaroots Pint	\$10.95
732858	FoxFarm Bushdoctor Kangaroots Quart	\$20.95
732859	FoxFarm Bushdoctor Kangaroots Gallon	\$63.95

FoxFarm BushDoctor Bembe Sweet & Dandy 0-1-3

Bembé is a liquid concentrate that is precisely designed with a complex array of natural sugars. When used as directed, Bembé can help plants achieve enhanced sweetness qualities, while providing a food source for the microbial populations at the root zone.



Item No.	Description	MSRP
732880	FoxFarm Bushdoctor Bembe Pint	\$10.95
732882	FoxFarm Bushdoctor Bembe Quart	\$18.95
732884	FoxFarm Bushdoctor Bembe Gallon	\$53.95

FoxFarm Dirty Dozen Starter Kit

Includes 9 pints of liquid plant food: One each of the BushDoctor line, Big Bloom Organic Fertilizer, Tiger Bloom Viscious Bloomer and Grow Big Soil Based Formula. Also includes three 6 oz Soluble Fertilizer: Open Sesame early ripening, Beastie Bloomz heavyweight blossoms and Cha Ching for late flowering. Not for sale in the following states at this time: FL.



Item No.	Description	MSRP
732886	FoxFarm Dirty Dozen Starter Kit	\$104.95

FoxFarm American Pride Dry Mix 9-6-6

American Pride is a blend of potent, high-test plant foods, formulated to provide an abundance of essential elements that encourage vigorous plant growth. This fertilizer contains a unique blend of exotic ingredients. Some allow for instantly available nutrition, while others deliver slowly available nitrogen over time. It is an ideal fertilizer for all types of plants and has been specially formulated for use on roses. Not for sale in the following states at this time: PA.



Item No.	Description	MSRP
718578	FoxFarm American Pride 4 lb	\$14.95

FoxFarm Marine Cuisine Seafood For Your Garden 10-7-7

A comprehensive blend of powerful plant foods combined with Pacific Northwest sea going fish, crab meal, shrimp meal, bat guano and plenty of our own earthworm castings. Contains a unique blend of ingredients. Some allow for instantly available nutrition, while others deliver slowly available nitrogen over time. It is an ideal fertilizer for flowers and vegetable gardens, ornamental trees and shrubs, fruit trees, roses, container plants and lawns. Check your local Dealer Partner for availability.



Item No.	Description	MSRP
718583	FoxFarm Marine Cuisine 4 lb	\$14.95
714311	FoxFarm Marine Cuisine Fertilizer 20 lb	\$62.95

FoxFarm Big Bloom 0.01-0.3-0.7

FoxFarm's Big Bloom is a live culture of vitamins, amino acids, natural growth hormones, enzymes and beneficial organic microbes. Our special, micro-brewed formula incorporates earthworm castings, bat guano and other high-test organic ingredients that offer a full, balanced range of nutrients.



Item No.	Description	MSRP
718519	FoxFarm Big Bloom Pint	\$7.95
718520	FoxFarm Big Bloom Quart	\$13.95
718525	FoxFarm Big Bloom Gallon	\$47.95
718530	FoxFarm Big Bloom 2.5 Gallon	\$102.95
718535	FoxFarm Big Bloom 5 Gallon	\$198.95

FoxFarm Grow Big 6-4-4

Grow Big is a fast-acting, liquid concentrate fertilizer for lush, vegetative, compact growth. Fortified with earthworm castings, Norwegian kelp and a super-concentrated micronutrient package, this special brew encourages a strong compact branching structure.



Item No.	Description	MSRP
718499	FoxFarm Grow Big Pint New	\$9.95
718500	FoxFarm Grow Big Quart	\$19.95
718505	FoxFarm Grow Big Gallon	\$59.95
718510	FoxFarm Grow Big 2.5 Gallon	\$142.95
718515	FoxFarm Grow Big 5 Gallon	\$255.95

FoxFarm Grow Big Hydroponic 3-2-6

Grow Big Hydroponic Liquid Plant Food is a potent, fast acting, liquid concentrate fertilizer specifically formulated for hydroponic use. It encourages vigorous vegetative growth. Plant size and structure are enhanced, allowing for more abundant fruit, flower and bud development.



Item No.	Description	MSRP
718539	FoxFarm Grow Big Hydroponic Pint New	\$9.95
718540	FoxFarm Gro Big Hydroponic Quart	\$20.95
718545	FoxFarm Grow Big Hydroponic Gallon	\$63.95
718550	FoxFarm Gro Big Hydroponic 2.5 Gallon	\$145.95
718555	FoxFarm Gro Big Hydroponic 5 Gallon	\$255.95

FoxFarm Nutrient Trio - Hydro

Trio pack includes Big Bloom, Grow Big and Tiger Bloom together to maximize your growing potential. A convenient 3-pack of fertilizers is a complete nutrition program. Optimizes vegetative growth, extreme flower canopy and multiple bud development. For hydroponic recirculating systems, use the FoxFarm Hydroponic Nutrient Trio.



Item No.	Description	MSRP
718577	FoxFarm Nutrient Trio - Hydro	\$57.95

FoxFarm Nutrient Trio - Soil

Trio pack includes Big Bloom, Grow Big and Tiger Bloom together to maximize your growing potential. This convenient 3-pack of fertilizers is a complete nutrition program. Optimizes vegetative growth, extreme flower canopy and multiple bud development.



Item No.	Description	MSRP
718576	FoxFarm Nutrient Trio - Soil	\$54.95

FoxFarm Tiger Bloom 2-8-4

FoxFarm Tiger Bloom is an ultra potent, high phosphorus fertilizer that also contains a good supply of nitrogen. It is formulated with a low pH to maintain stability in storage and keep micronutrients available. It encourages abundant fruit, flower and multiple bud development.



Item No.	Description	MSRP
718559	FoxFarm Tiger Bloom Pint New	\$9.95
718560	FoxFarm Tiger Bloom Quart	\$19.95
718565	FoxFarm Tiger Bloom Gallon	\$59.95
718570	FoxFarm Tiger Bloom 2.5 Gallon	\$142.95
718575	FoxFarm Tiger Bloom 5 Gallon	\$255.95

FoxFarm Open Sesame 5-45-19

Open Sesame is a pH balanced blend of extra strength nutrients specifically designed for use during early flowering and ripening in fruits, buds and flowers. Open Sesame will also enhance flower size and multiple bud development. Use in soilless mixes, organic soils, hydroponics and aeroponic systems.



Item No.	Description	MSRP
719919	FoxFarm Open Sesame Soluble 6 oz Jar New	\$13.95
719920	FoxFarm Open Sesame 1 lb	\$32.95
719925	FoxFarm Open Sesame 2 lb	\$56.95

FoxFarm Beastie Bloomz 0-50-30

Beastie Bloomz is a pH balanced blend of extra strength nutrients specially formulated to produce heavy weight fruit and maximize blossom development during the critical last weeks of flowering. Beastie Bloomz is designed to create unbelievable internal bud density.



Item No.	Description	MSRP
732758	FoxFarm Beastie Bloomz Soluble 6 oz Jar New	\$13.95
732759	FoxFarm Beastie Bloomz 1 lb	\$32.95
732760	FoxFarm Beastie Bloomz 2 lb	\$56.95

FoxFarm Cha Ching 9-50-10

Cha Ching is a pH balanced blend of extra strength nutrients specifically formulated to increase essential oils and pump out heavy resins in fruit, buds and flowers. Formulated for use during late-flowering cycles, Cha Ching contains a micronutrient pack that has all the essential elements needed to support juicy fruit.



Item No.	Description	MSRP
732748	FoxFarm Cha Ching Soluble 6 oz Jar New	\$13.95
732749	FoxFarm Cha Ching 1 lb	\$32.95
732750	FoxFarm Cha Ching 2 lb	\$56.95

FoxFarm Soluble Tri-Pack

A trio of high-octane fertilizers: Open Sesame, Beastie Bloomz and Cha Ching. Achieve bumper crop harvests by utilizing all three soluble products at first bud development.



Item No.	Description	MSRP
719930	FoxFarm Soluable Tri-Pack	\$98.95

FoxFarm Happy Frog High Phosphorus Bat Guano 0 - 5 - 0

Bat guano has been known since ancient times to be a highly beneficial organic soil amendment that has a powerful effect on all kinds of plants. Happy Frog High Phosphorus Bat Guano fertilizer is long aged and has no odor. It also contains natural bacteria and has certain properties that cannot be duplicated in a laboratory. It will deliver spectacular flowers and multiple bud development.



Item No.	Description	MSRP
720179	Happy Frog High Phosphorus Bat Guano 4 lb	\$13.95

FoxFarm Happy Frog Japanese Maple 4 - 8 - 5

Specifically formulated for use on Japanese maples, lilies, evergreens, hydrangeas, junipers, dogwoods, flowering ornamentals and other low pH feeders. A unique blend of natural fertilizers and micro-organisms that work in harmony with the soil to deliver optimum plant nutrition. Encourages brilliant reds, purples and oranges that make Japanese maples. Not for sale in the following states at this time: IL.



Item No.	Description	MSRP
720163	Happy Frog Japanese Maple Fertilizer 4 lb	\$10.95

FoxFarm Happy Frog Fruit & Flower 5 - 8 - 4

Specifically designed to supply essential nutrients for luscious fruit and flower development. This blended formula will encourage vigorous root systems, robust bud size and multiple branching. Expect brighter colors, spellbinding scents and delicious flavors, thanks to the extra boost that comes from the micronutrients and living organisms. Check your local Dealer Partner for availability. Not for sale in the following states at this time: IL.



Item No.	Description	MSRP
720161	FoxFarm Happy Frog Fruit & Flower Fertilizer 4 lb	\$10.95
714307	FoxFarm Happy Frog Fruit & Flower 18 lb	\$39.95

FoxFarm Happy Frog Tomato & Vegetable 7 - 4 - 5

Precisely designed for use on all veggies, tomato varieties, soft fruits and berries. The ratios between nitrogen, phosphorus and potassium will allow the plant to feed vigorously while producing abundant high quality fruit development. Also contains calcium which helps prevent blossom end rot and builds stronger cell walls, making plants more disease resistant. Check your local Dealer Partner for availability. Not for sale in the following states at this time: IL.



Item No.	Description	MSRP
720165	Happy Frog Tomato & Vegetable Fertilizer 4 lb	\$10.95
714309	FoxFarm Happy Frog Tomato & Vegetable 18 lb	\$39.95

FoxFarm Happy Frog Acid Loving 6 - 4 - 4

Happy Frog Acid Loving is specifically formulated for use on azaleas, rhododendrons, camellias, hydrangeas, evergreens, blueberries, raspberries, strawberries, potatoes and all other acid loving plants. Contains an additional boost of nitrogen for heavy feeding shrubs and cottonseed meal, an excellent slow release fertilizer for plants that need a low pH. Not for sale in the following states at this time: IL.



Item No.	Description	MSRP
720167	Happy Frog Acid Loving Fertilizer 4 lb	\$10.95

FoxFarm Happy Frog All Purpose 5 - 5 - 5

A ready-to-use, pH balanced blend of natural fertilizers. Some ingredients allow for instantly available nutrition, while others deliver slow-release nitrogen over time. Highly recommended for vegetable gardens, annual and perennial flower gardens, ornamental plantings and all types of container gardening. Not for sale in the following states at this time: IL.



Item No.	Description	MSRP
720169	Happy Frog All Purpose Fertilizer 4 lb	\$10.95

FoxFarm Happy Frog Steamed Bone Meal 3 - 15 - 0

Bone Meal is a wonderful food for bulbs and helps create abundant blossoms. It is super fine screened, allowing for quicker breakdown and easier absorption by plants. Provides a high level of phosphorus for all stages of plant growth and flowering. Bone meal also contains calcium, which creates strong cellular development in plants.



Item No.	Description	MSRP
720171	Happy Frog Steamed Bone Meal Fertilizer 4 lb	\$10.95

FoxFarm Happy Frog Bulb Food 3 - 8 - 8

Planting bulbs in the fall is an investment in the future. Formulated to encourage long term blooming, this fertilizer contains extra phosphorus for sustained flowering and potassium to help plants become more disease resistant. Happy Frog Bulb Food works great on tulips, daffodils, gladiolas, dahlias and all flowering plants and trees. Not for sale in the following states at this time: IL.



Item No.	Description	MSRP
720173	Happy Frog Bulb Food Fertilizer 4 lb	\$10.95

FoxFarm Happy Frog Jump Start 3 - 4 - 3

Get young transplants and seeds off to the right start. From their first day in the garden, they need the right mix of nutrients to germinate and grow. This gentle blend includes phosphorus for healthy root development and calcium, which helps buffer acidic soils and increases a plant's ability to fight off disease.



Item No.	Description	MSRP
720175	Happy Frog Jump Start Fertilizer 4 lb	\$10.95

FoxFarm Happy Frog Premium Lawn 8 - 2 - 6

A luxurious, thick, green lawn cannot exist without healthy soil. Happy Frog Premium Lawn Fertilizer contains a blend of all natural nutrients designed to be applied year round. It will gently feed your lawn and enrich your soil with beneficial microbe populations. Premium Lawn Fertilizer will balance turf grass density, giving you a thicker, more luxurious lawn. Not for sale in the following states at this time: IL.



Item No.	Description	MSRP
720177	Happy Frog Premium Lawn Fertilizer 4 lb	\$10.95

FoxFarm Happy Frog Rose Food 4 - 4 - 5

Happy Frog Rose Food is custom blended to deliver optimum nutrition for roses. The benefits of kelp meal and alfalfa meal enable roses to become horticultural beauties. This extraordinary fertilizer will create strong plants, increase the color intensity and produce prize-winning blooms. Not for sale in the following states at this time: IL.



Item No.	Description	MSRP
720181	Happy Frog Rose Food Fertilizer 4 lb	\$10.95



Aurora Innovations developed the Roots Organics product line with the goal of maximizing yields and flavors using organic ingredients. Working with a team of tissue culturist's, plant scientists, botanists and doctors they have formulated a variety of superior, organic gardening products with internationally sourced ingredients.

Roots Organics Buddha Grow 2 - 0.25 - 1.5

Buddha Grow is the finest organic ingredients specifically created to promote vigor, increase yields and enhance quality in soil grown plants during their vegetative stage.



Item No.	Description	MSRP
715175	Roots Organics Buddha Grow Quart	\$17.99
715180	Roots Organics Buddha Grow Gallon	\$49.99
715185	Roots Organics Buddha Grow 2.5 Gallon	\$109.99
715190	Roots Organics Buddha Grow 5 Gallon	\$209.99

Roots Organics Buddha Bloom 0.5 - 2 - 1

Buddha Bloom is a proprietary blend of the finest organic ingredients specifically created to promote vigor, increase yields and enhance quality in soil grown plants during their flowering stage.



Item No.	Description	MSRP
715195	Roots Organics Buddha Bloom Quart	\$17.99
715200	Roots Organics Buddha Bloom Gallon	\$49.99
715205	Roots Organics Buddha Bloom 2.5 Gallon	\$109.99
715210	Roots Organics Buddha Bloom 5 Gallon	\$209.99

Roots Organics Trinity Catalyst 0.1 - 0.5 - 0.25

This complex liquid blend of organic compounds is specifically designed for maximum effect as a plant, root and rhizosphere catalyst. This exclusive formula is a universal supplement for both growth and bloom.



Item No.	Description	MSRP
715005	Roots Organics Trinity Catalyst Quart	\$26.99
715010	Roots Organics Trinity Catalyst Gallon	\$69.99
715015	Roots Organics Trinity Catalyst 2.5 Gallon	\$159.99
715020	Roots Organics Trinity Catalyst 5 Gallon	\$299.99

Roots Organics HP2 0 - 4 - 0

This unique organic liquid bat guano is a specially extracted source of natural phosphorous specifically designed to enhance flower quality. In a liquid form, bat guano is easier to use, more concentrated, eliminates worries about dust-borne pathogens.



Item No.	Description	MSRP
715025	Roots Organics HP2 Liquid Bat Guano Quart	\$17.99
715030	Roots Organics HP2 Liquid Bat Guano Gallon	\$49.99
715035	Roots Organics HP2 Liquid Bat Guano 2.5 Gallon	\$115.99
715040	Roots Organics HP2 Liquid Bat Guano 5 Gallon	\$219.99

Roots Organics HPK 0-5-4

This organic PK liquid bloom booster is extracted from our unique natural sources of phosphorous and potassium. Bat guano, renowned as an organic source of phosphorous, is combined with Langbeinite, a natural source of potassium.



Item No.	Description	MSRP
715045	Roots Organics HPK Bat Guano & K-Mag Quart	\$19.99
715050	Roots Organics HPK Bat Guano & K-Mag Gallon	\$53.99
715055	Roots Organics HPK Bat Guano & K-Mag 2.5 Gallon	\$125.99
715060	Roots Organics HPK Bat Guano & K-Mag 5 Gallon	\$235.99

Roots Organics Ancient Amber 0.1-0-0

Humic acids are extremely effective chelating agents, facilitating the uptake of micro and macro nutrients, increasing resistance to stress and boosting overall vigor, thereby producing larger, better quality harvests.



Item No.	Description	MSRP
715065	Roots Organics Ancient Amber Quart	\$19.99
715070	Roots Organics Ancient Amber Gallon	\$49.99
715075	Roots Organics Ancient Amber 2.5 Gallon	\$99.99
715080	Roots Organics Ancient Amber 5 Gallon	\$163.99

Roots Organics Extreme Serene 0-2-2

An organic liquid kelp extract which provides a natural source of growth promoting compounds and micronutrients. Specifically designed to encourage vigorous growth, increase flower sites and increase yields.



Item No.	Description	MSRP
715085	Roots Organics Extreme Serene Quart	\$35.99
715090	Roots Organics Extreme Serene Gallon	\$99.99
715095	Roots Organics Extreme Serene 2.5 Gallon	\$235.99

Roots Organics Surge 1-1-0.5

Roots Organics Surge nutritional and microbial stimulant is designed from sustainably-harvested and enzymatically processed marine protein materials. The addition of molasses, kelp and humic acid to a powerful fish base creates a potent fusion of natural compounds to enhance the distinctive qualities and flavor of your harvest.



Item No.	Description	MSRP
715465	Roots Organics Surge Quart	\$17.99
715470	Roots Organics Surge Gallon	\$49.99
715475	Roots Organics Surge 2.5 Gallon	\$109.99
715480	Roots Organics Surge 5 Gallon	\$207.99

Roots Organics Oregonism XL

A distinctive super-soluble formulation of endo-ecto-mycorrhizae, beneficial bacteria and Trichoderma. Mycorrhizae colonize the root zone, forming a symbiosis with the plant's roots, massively increasing the size.



Item No.	Description	MSRP
715130	Roots Organics Oregonism XL 1.8 oz	\$11.95
715135	Roots Organics Oregonism XL 4 oz	\$19.95
715140	Roots Organics Oregonism XL 8 oz	\$29.95
715145	Roots Organics Oregonism XL 1 lb	\$55.95
715150	Roots Organics Oregonism XL 3 lb	\$145.95
715155	Roots Organics Oregonism XL 6 lb	\$259.95

Roots Organics Nitro Bat Guano 9-3-1

Roots Organics Nitro Bat Guano is an excellent source of nitrogen, phosphorus and calcium. Carefully processed and sifted to make it easy to work with, Roots Organics Nitro Bat Guano encourages vigorous growth and is fast acting for quick results.



Item No.	Description	MSRP
720940	Roots Organics Nitro Bat Guano 3 lb	\$14.99
720945	Roots Organics Nitro Bat Guano 9 lb	\$35.99

Roots Organics Super Nitro Bat Guano 15.5-1-1

Roots Organics Super Nitro Bat Guano is incredibly high in Nitrogen and is extracted only from select caves when the quality is at its highest. Super Nitro Bat Guano is fast acting and is so powerful it should be used carefully and sparingly.



Item No.	Description	MSRP
720960	Roots Organics Super Nitro Bat Guano 3 lb	\$29.99
720965	Roots Organics Super Nitro Bat Guano 9 lb	\$79.99

Roots Organics Phos Bat Guano 0-7-0

Roots Organics Phos Bat Guano is an excellent source of phosphorus and calcium. Carefully processed and sifted to make it easy to work with, Roots Organics Phos Bat Guano encourages vigorous flowering and fruiting.



Item No.	Description	MSRP
720980	Roots Organics Phos Bat Guano 3 lb	\$11.99
720985	Roots Organics Phos Bat Guano 9 lb	\$29.99

Roots Organics Sea Bird Guano 0 - 12 - 0

Roots Organics Seabird Guano is an excellent source of phosphate and calcium. Carefully sifted and processed to make it easy to work with, Roots Organics Seabird Guano encourages vigorous growth and is fast acting for quick results. Check your local Dealer Partner for availability.



Item No.	Description	MSRP
720930	Roots Organics Seabird Guano Granular 3 lb	\$11.99
720935	Roots Organics Seabird Guano Granular 9 lb	\$29.99
720996	Roots Organics Seabird Guano Granular 20 lb	\$53.99
720990	Roots Organics Seabird Guano Powder 3 lb	\$10.99
720995	Roots Organics Seabird Guano Powder 9 lb	\$27.99
720937	Roots Organics Seabird Guano Powder 20 lb	\$49.99
720939	Roots Organics Seabird Guano Powder 40 lb	\$61.99

Roots Organics Uprising Grow 6 - 5 - 1.5

Roots Organics Uprising Grow is a diverse blend of natural and organic ingredients specially formulated for maximum results. This formula is effective alone as an amendment or as a top dress for encouraging vigorous growth. Check your local Dealer Partner for availability.



Item No.	Description	MSRP
715440	Roots Organics Uprising Grow 3 lb	\$20.00
715441	Roots Organics Uprising Grow 9 lb	\$45.99
715442	Roots Organics Uprising Grow 20 lb	\$80.99
715443	Roots Organics Uprising Grow 40 lb	\$144.99

Roots Organics Uprising Bloom 3 - 6 - 4

Roots Organics Uprising Bloom is a diverse blend of natural and organic ingredients specially formulated for maximum results. This formula is effective alone as an amendment or as a top dress for encouraging vigorous flowering and fruiting. Check your local Dealer Partner for availability.



Item No.	Description	MSRP
715435	Roots Organics Uprising Bloom 3 lb	\$12.00
715436	Roots Organics Uprising Bloom 9 lb	\$32.99
715437	Roots Organics Uprising Bloom 20 lb	\$55.99
715438	Roots Organics Uprising Bloom 40 lb	\$96.99

Roots Organics Uprising Foundation 3 - 1 - 1

Roots Organics Uprising Foundation is a diverse blend of natural and organic ingredients specially formulated for maximum results. When used alone as an amendment or top dress, it is very effective for supplementing calcium, magnesium and iron. Check your local Dealer Partner for availability.



Item No.	Description	MSRP
715430	Roots Organics Uprising Foundation 3 lb	\$18.00
715431	Roots Organics Uprising Foundation 9 lb	\$37.99
715432	Roots Organics Uprising Foundation 20 lb	\$66.99
715433	Roots Organics Uprising Foundation 40 lb	\$117.99

Roots Organics Elemental - 20% Calcium & 4% Magnesium

Elemental contains two absolutely essential macronutrients: Calcium, an essential nutrient for plant health due to its role in cell walls, membranes and other biochemical processes; and magnesium, which is a central component of the chlorophyll molecule. Check your local Dealer Partner for availability.



Item No.	Description	MSRP
715445	Roots Organics Elemental 3 lb 20% Calcium 4% Magnesium	\$23.99
715450	Roots Organics Elemental 9 lb 20% Calcium 4% Magnesium	\$59.99
715455	Roots Organics Elemental 20 lb 20% Calcium 4% Magnesium	\$109.99
715460	Roots Organics Elemental 40 lb 20% Calcium 4% Magnesium	\$209.99

Roots Organics Player Pack

Roots Organics Player Pack includes the following: 16 oz Buddha Grow, 16 oz Buddha Bloom, 16 oz Trinity, 8 oz Extreme Serene, 8 oz Ancient Amber, 8 oz HP2, 8 oz HPK, 1.8 oz Oregonism XL. This nutrient line is designed to be used in potting soil.



Item No.	Description	MSRP
715395	Roots Organics Player Pak	\$44.99

Aurora Innovations Master Pack

Roots Organics Master Pack includes: 16 oz Buddha Grow, 16 oz Buddha Bloom, 16 oz Trinity, 8 oz Amino Aide, 8 oz Big Swell, 8 oz Ancient Amber, 8 oz Extreme Serene, 8 oz HP2, 8 oz HPK, 1.8 oz Oregonism XL. Designed to be used in potting soil.



Item No.	Description	MSRP
715400	Aurora Innovations Master Pack	\$49.99

Soul Synthetics Player Pack

Soul Synthetics Player Pack includes: 16 oz Grow, 16 oz Bloom, 16 oz Infinity, 8 oz Grow-N, 8 oz Amino Aide, 8 oz Big Swell, 8 oz Peak. This nutrient line is designed for growing in coco fiber, hydroponics and works great in soil as well.



Item No.	Description	MSRP
715390	Soul Synthetics Player Pack	\$44.99

Soul Synthetics Grow 3 - 1.25 - 1.25

Soul Synthetics Grow is a synergistic blend of highly soluble synthetic fertility components enhanced with powerful organic extracts for both maximum yields & spectacular flavor. Grow is balanced for its vegetative growth stage & pH stable.



Item No.	Description	MSRP
715250	Soul Synthetics Grow Quart	\$18.99
715255	Soul Synthetics Grow Gallon	\$53.99
715260	Soul Synthetics Grow 2.5 Gallon	\$115.99
715265	Soul Synthetics Grow 5 Gallon	\$213.99

Soul Synthetics Bloom 1.5 - 4.5 - 3

Soul Synthetics Bloom is a synergistic blend of highly soluble synthetic fertility components enhanced with powerful organic extracts for both maximum yields and spectacular flavor.



Item No.	Description	MSRP
715270	Soul Synthetics Bloom Quart	\$18.99
715275	Soul Synthetics Bloom Gallon	\$53.99
715280	Soul Synthetics Bloom 2.5 Gallon	\$115.99
715285	Soul Synthetics Bloom 5 Gallon	\$213.99

Soul Synthetics Amino-Aide 5 - 0 - 0

Amino Aide plant supercharger is a complex amino acid blend specifically formulated to increase plant vigor and yields. When used properly in conjunction with a high quality nutrient line, Amino Aid can substantially increase yields.



Item No.	Description	MSRP
715290	Soul Synthetics Amino Aide Quart	\$49.99
715295	Soul Synthetics Amino Aide Gallon	\$149.99
715300	Soul Synthetics Amino Aide 2.5 Gallon	\$349.99
715305	Soul Synthetics Amino Aide 5 Gallon	\$659.99

Soul Synthetics Grow-N 8 - 0 - 0.25

Soul Synthetics Grow-N nitrogen supplement was specifically crafted for the gardener that demands faster growth from super available high performance fertilizers. This product can be used as an additive in conjunction with any base nutrient program.



Item No.	Description	MSRP
715310	Soul Synthetics Grow-N Quart	\$21.99
715315	Soul Synthetics Grow-N Gallon	\$59.99
715320	Soul Synthetics Grow-N 2.5 Gallon	\$139.99
715325	Soul Synthetics Grow-N 5 Gallon	\$259.99

Soul Synthetics Big Swell 2 - 5 - 3

Soul Synthetics Big Swell bloom booster has been designed specifically to increase flower size, vigor, density and quality. Can be used as an additive for increased yields in conjunction with any quality base nutrient program for exceptional results.



Item No.	Description	MSRP
715330	Soul Synthetics Big Swell Quart	\$49.99
715335	Soul Synthetics Big Swell Gallon	\$149.99
715340	Soul Synthetics Big Swell 2.5 Gallon	\$349.99
715345	Soul Synthetics Big Swell 5 Gallon	\$659.99

Soul Synthetics Infinity 0.5 - 2.5 - 1.5

Soul Synthetics Infinity catalyst is a complex blend of powerful organic compounds combined with choice plant nutrition. It is specially formulated to increase vigor and prevent micronutrient deficiencies common in fast growing and heavy feeding plants.



Item No.	Description	MSRP
715350	Soul Synthetics Infinity Quart	\$28.99
715355	Soul Synthetics Infinity Gallon	\$71.99
715360	Soul Synthetics Infinity 2.5 Gallon	\$159.99
715365	Soul Synthetics Infinity 5 Gallon	\$299.99

Soul Synthetics Peak 0 - 12 - 7

Soul Synthetics Peak bloom finisher contains unique, proprietary botanical extracts as well as ample phosphorus and potassium to encourage the highest density in flowering. Peak supports the development of intense features and show quality blooms.



Item No.	Description	MSRP
715370	Soul Synthetics Peak Quart	\$25.99
715375	Soul Synthetics Peak Gallon	\$79.99
715380	Soul Synthetics Peak 2.5 Gallon	\$179.99
715385	Soul Synthetics Peak 5 Gallon	\$319.99

Buried Treasure Phos Bat Guano 0-13-0

Buried Treasure Phos Bat is a natural fertilizer from the Philippines that contains phosphorus. It can be used indoors or outdoors on vegetables, herbs, flowers, ornamentals and in hydroponic applications. Buried Treasure Guano is micronized for better solubility and delivery. Does not contain fillers. Not for sale in the following states at this time: FL, NY.



Item No.	Description	MSRP
721100	Buried Treasure Phos Bat Guano 0-13-0 2.2 lb	\$8.95
721105	Buried Treasure Phos Bat Guano 0-13-0 11 lb	\$40.95
721110	Buried Treasure Phos Bat Guano 0-13-0 40 lb	\$126.95

Buried Treasure Nitro Bat Guano 9-3-1

Malaysian Nitro Bat is a natural fertilizer that contains nitrogen, potassium and phosphorus. Plants use nitrogen to enhance leaf growth and plant vigor. It can be used indoors or outdoors on vegetables, herbs, flowers, ornamentals and in hydroponic applications. Buried Treasure Guano is micronized for better solubility and delivery. Does not contain fillers. Not for sale in the following states at this time: FL, NY.



Item No.	Description	MSRP
721130	Buried Treasure Nitro Bat Guano 9-3-1 1 lb	\$5.95
721135	Buried Treasure Nitro Bat Guano 9-3-1 5 lb	\$22.95
721140	Buried Treasure Nitro Bat Guano 9-3-1 14 lb	\$50.95

Buried Treasure Phos Seabird Guano 0-12-0

When blooming and ripening fruit, good phosphorus levels are key. Straight from Indonesia Buried Treasure Phos Seabird is a natural fertilizer that contains phosphorus. It can be used indoors or outdoors on vegetables, herbs, flowers, ornamentals and in hydroponic applications. Buried Treasure Guano is micronized for better solubility and delivery. Does not contain fillers. Not for sale in the following states at this time: FL, NY.



Item No.	Description	MSRP
721115	Buried Treasure Phos Seabird Guano 0-12-0 2.2 lb	\$7.95
721120	Buried Treasure Phos Seabird Guano 0-12-0 11 lb	\$33.95
721125	Buried Treasure Phos Seabird Guano 0-12-0 40 lb	\$70.95

Buried Treasure Peruvian Seabird Guano 12-10-3

Peruvian Seabird Guano is a natural fertilizer that contains nitrogen, potassium and phosphorus. Nitrogen derived from Seabird Guano can enhance growth and plant vigor. It can be used indoors or outdoors on vegetables, herbs, flowers, ornamentals in soil or can be used to make a tea for hydroponic applications. Buried Treasure Guano is micronized for better solubility and delivery. Does not contain fillers.



Item No.	Description	MSRP
721145	Buried Treasure Peruvian Seabird Guano 12-10-3 2.2 lb	\$7.95
721150	Buried Treasure Peruvian Seabird Guano 12-10-3 11 lb	\$36.95
721155	Buried Treasure Peruvian Seabird Guano 12-10-3 40 lb	\$116.95

Buried Treasure™

LIKE PIRATE GOLD FOR YOUR PLANTS

GUANO

Micronized for better solubility & delivery Does not contain fillers

Industry exclusive

New!

MULTIPLY



STACK



SPARKLE



Multiply

Multiply is designed to assist all nutrient regimens and feeding programs. Multiply works in conjunction with nutrient regimens and feeding programs during the vegetative stage to promote vigorous growth. Want more? Multiply then Stack. Want the best? Finish with Sparkle.



Item No.	Description	MSRP
717805	Multiply 8 oz	\$58.95
717810	Multiply Pint	\$98.95
717815	Multiply Quart	\$148.95

Stack

Stack is designed to assist all nutrient regimens and feeding programs. Stack works in conjunction with nutrient regimens and feeding programs, promoting vigorous flowering and fruit development. Want more? Multiply then Stack. Want the best? Finish with Sparkle.



Item No.	Description	MSRP
717825	Stack 8 oz	\$58.95
717830	Stack Pint	\$98.95
717832	Stack Quart	\$148.95

Sparkle

Sparkle is designed to assist all nutrient regimens and feeding programs. Sparkle works in conjunction with nutrient regimens and feeding programs during the latter stages of flowering and fruit development. Want more? Multiply then Stack. Want the best? Finish with Sparkle.



Item No.	Description	MSRP
717840	Sparkle 8 oz	\$38.95
717845	Sparkle Pint	\$68.95
717850	Sparkle Quart	\$98.95

RAW Grow All-In-One 7-4-5

RAW Grow is a tested blend of RAW soluble plant nutrients, essential elements and supplements that has been proven to be an optimal all in one horticultural fertilizer.



Item No.	Description	MSRP
717930	Raw Grow 2 oz	\$14.85
717932	Raw Grow 8 oz	\$29.85
717934	Raw Grow 2 lb	\$89.85
717936	Raw Grow 10 lb	\$248.85

RAW Bloom All-In-One 3-12-12

RAW Bloom is a tested blend of RAW soluble plant nutrients, essential elements and supplements that has been proven to be an optimal all in one horticultural fertilizer.



Item No.	Description	MSRP
717938	Raw Bloom 2 oz	\$14.85
717940	Raw Bloom 8 oz	\$29.85
717942	Raw Bloom 2 lb	\$89.85
717944	Raw Bloom 10 lb	\$248.85

RAW B-Vitamin

RAW B-Vitamin is a soluble plant supplement that is used for horticultural purposes. RAW B-Vitamin contains 1% vitamin B1. This product contains the highest concentration of fully water soluble vitamin B1 available to the home gardener. RAW B-Vitamin can be used at all stages of growth and flowering.



Item No.	Description	MSRP
717855	RAW B-Vitamin 2 oz	\$16.85
717857	RAW B-Vitamin 8 oz	\$44.85
717859	RAW B-Vitamin 2 lb	\$124.85

RAW Calcium/Mag 9-0-0

RAW Calcium/Mag is a soluble plant supplement that is used for horticultural purposes. RAW Calcium/Mag contains 15% calcium and 3% magnesium. RAW Calcium/Mag is an optimum ratio of fully water soluble calcium and magnesium.



Item No.	Description	MSRP
717861	RAW Calcium/Mag 2 oz	\$12.85
717863	RAW Calcium/Mag 8 oz	\$34.85
717865	RAW Calcium/Mag 2 lb	\$88.85



RAW Cane Molasses 0-0-1

RAW Cane Molasses is a soluble plant supplement that is used for horticultural purposes. RAW Cane Molasses is a fully water soluble powder which is highly concentrated. RAW Cane Molasses gives you all the benefits of liquid molasses without all the mess.



Item No.	Description	MSRP
717867	RAW Cane Molasses 2 oz	\$12.85
717869	RAW Cane Molasses 8 oz	\$34.85
717871	RAW Cane Molasses 2 lb	\$88.85

RAW Full Up

RAW Full Up (uptake) is a soluble plant supplement that is used for horticultural purposes. RAW Full Up (uptake) contains 10% Humic Acids derived from peat. This product is fully water soluble and may increase micronutrient uptake.



Item No.	Description	MSRP
717873	RAW Full Up 2 oz	\$18.85
717875	RAW Full Up 8 oz	\$48.85
717877	RAW Full Up 2 lb	\$138.85

RAW Humic Acid 0-0-4

RAW Humic Acid is a soluble plant supplement that is used for horticultural purposes. RAW Humic Acid contains 59% Humic Acids. This product contains the highest concentration of fully water soluble Humic Acids available to the home gardener. RAW Humic Acid can be used at all stages of growth and flowering.



Item No.	Description	MSRP
717879	RAW Humic Acid 2 oz	\$14.85
717881	RAW Humic Acid 8 oz	\$38.85
717883	RAW Humic Acid 2 lb	\$108.85

RAW Kelp 0-0-1

RAW Kelp is a soluble plant supplement that is used for horticultural purposes. RAW Kelp is 99% Kelp (*Ascophyllum Nodosum*). This product is fully water soluble and contains only 1% soluble potash which is a direct reflection of its purity.



Item No.	Description	MSRP
717885	RAW Kelp 2 oz	\$16.85
717887	RAW Kelp 8 oz	\$44.85
717889	RAW Kelp 2 lb	\$124.85

RAW Nitrogen 20-0-0

RAW Nitrogen is a soluble plant supplement that is used for horticultural purposes. RAW Nitrogen contains 20% Nitrogen. This RAW form of fully water soluble Nitrogen does not contain nitrates or urea which enables it to be applied at all stages to treat deficiencies or boost Nitrogen levels.



Item No.	Description	MSRP
717891	RAW Nitrogen 2 oz	\$9.85
717893	RAW Nitrogen 8 oz	\$28.85
717895	RAW Nitrogen 2 lb	\$78.85

RAW OminA 14-0-0

RAW ominA (essential) is a soluble plant supplement that is used for horticultural purposes. RAW ominA (essential) is derived from plant protein Hydrolysate. This product is fully water soluble which contains an essential form of vegan nitrogen that can be used at all stages.



Item No.	Description	MSRP
717897	RAW OminA 2 oz	\$18.85
717899	RAW OminA 8 oz	\$48.85
717901	RAW OminA 2 lb	\$138.85

RAW Phosphorus 9-61-0

RAW Phosphorus is a soluble plant supplement that is used for horticultural purposes. RAW Phosphorus contains 61% available Phosphate which is the highest concentration of fully water soluble Phosphorus available to the home gardener. This product is used to treat deficiencies or boost Phosphorus levels.



Item No.	Description	MSRP
717903	RAW Phosphorus 2 oz	\$9.85
717905	RAW Phosphorus 8 oz	\$28.85
717907	RAW Phosphorus 2 lb	\$78.85

RAW Potassium 0-0-50

RAW Potassium is a soluble plant supplement that is used for horticultural purposes. RAW Potassium contains 50% soluble Potash which is the highest concentration of fully water soluble Potassium available to the home gardener. This product is used to treat deficiencies or boost Potassium levels.



Item No.	Description	MSRP
717909	RAW Potassium 2 oz	\$9.85
717911	RAW Potassium 8 oz	\$28.85
717913	RAW Potassium 2 lb	\$78.85

RAW Silica 0 - 0 - 3

RAW Silica is a flowable plant supplement that is used for horticultural purposes. RAW Silica contains 45% Silicon Dioxide. This product has the highest concentration of natural Silicon Dioxide available to the home gardener. Unlike other Silica products RAW Silica is relatively pH neutral.



Item No.	Description	MSRP
717915	RAW Silica 2 oz	\$14.85
717917	RAW Silica 8 oz	\$38.85
717919	RAW Silica 2 lb	\$108.85

RAW Yucca

RAW Yucca is a wetting agent used for horticultural purposes. RAW Yucca is 100% Yucca Extract. This product is fully water soluble and can be used to supplement any nutrient program or foliar spray regimen. A wetting agent is beneficial to nutrient solutions as well as foliar spray applications and can be used at all stages of growth and flowering.



Item No.	Description	MSRP
717921	RAW Yucca 2 oz	\$28.85
717923	RAW Yucca 8 oz	\$88.85

RAW Adjustable Measuring Spoon

Small compact measuring spoon made for use with the RAW product line. Measurements of 1/4 tsp., 1/2 tsp., 3/4 tsp. and 1 tsp.



Item No.	Description	MSRP
717925	RAW Adjustable Measuring Spoon	\$3.95

Nature's Nectar™

Nature's Nectar™ is the worlds first all natural certified organic nutrient that is compatible with hydroponics, soil, coco gardening and drip irrigation. It is the leading natural organic-based nutrient in commercial food and fruit production. Nature's Nectar™ solution contains no sediment and has been manufactured to provide exceptional growth, quality and yield. Please view www.organonics.com for amazing photos, test results and detailed information for this exceptional line of products.



Nature's Nectar Nitrogen 5 - 0 - 0

Completely solubilized, instantly available source of nitrogen with no sediment. Provides nutrition for beneficial bacteria improving conditions of growing medium. Increases photosynthesis for a greener plant. Check your local Dealer Partner for availability.



Item No.	Description	MSRP
719870	Nature's Nectar Nitrogen Quart	\$17.99
719875	Nature's Nectar Nitrogen Gallon	\$49.99
719878	Nature's Nectar Nitrogen 55 Gallon	\$2,152.03

Nature's Nectar Phosphorus 0 - 4 - 0

Completely solubilized phosphorus source that also contains Calcium. Organic acid ensures phosphorus is easily absorbed. Adds size and weight to fruit and flowers. Aids in root development. Check your local Dealer Partner for availability.



Item No.	Description	MSRP
719880	Nature's Nectar Phosphorous Quart	\$17.99
719885	Nature's Nectar Phosphorous Gallon	\$49.99
719888	Nature's Nectar Phosphorous 55 Gallon	\$1,999.95

Natures Nectar Potassium 0 - 0 - 5

Fast release potassium completely solubilized. The potassium source also contains cytokinins to increase number of flower sites. Builds plant's immune system with a combination of sea kelp species. Check your local Dealer Partner for availability.



Item No.	Description	MSRP
719890	Nature's Nectar Potassium Quart	\$17.99
719895	Nature's Nectar Potassium Gallon	\$49.99
719898	Nature's Nectar Potassium 55 Gallon	\$1,999.95

Organa-Add 2 - 0 - 0

Organa-Add functions as a growth and bloom catalyst containing all necessary organic activators. Adding the product to your regimen will increase the production of essential oils improving overall quality while maximizing your yield. Organa-Add is super concentrated at 1 teaspoon for 5 gallons.



Item No.	Description	MSRP
719710	Organa-Add Quart	\$19.95
719715	Organa-Add Gallon	\$68.95

Organa-Guano 0 - 4 - 0

Natural organic flowering stimulant derived from fruit eating bats. Organa-Guano functions as a flowering catalyst containing all necessary organic activators. The completely solubilized liquid contains the highest rate of phosphorus.



Item No.	Description	MSRP
719720	Organa-Guano Quart	\$19.95
719725	Organa-Guano Gallon	\$68.95

Pure Flowers

Pure Flowers 0-30-20 has the highest nutrient levels ever achieved in a completely solubilized liquid. The unique molecular structure of a phosphite is easily absorbed through the roots and leaves. Not for sale in the following states at this time: OR, WA.



Item No.	Description	MSRP
719700	Pure Flowers Quart 0-30-20	\$28.95
719705	Pure Flowers Gallon 0-30-20	\$88.95
719702	Pure Flowers Quart 0-0-20 (WA & OR Label)	\$28.95
719707	Pure Flowers Gallon 0-0-20 (WA & OR Label)	\$88.95

Breakout Powder 0 - 35 - 23



Created by Aptus Nutrients, Breakout Powder is an amazing bloom additive. Breakout Powder pushes additional flowering in the late stages of bloom and can increase yields dramatically. The increased Phosphorus aids in the ability for a plant to process light through its leaves (Photosynthesis). Phosphorus is a key element for establishing flowers and root development as well as oil and sugar production. Potassium also plays a key role in oil and sugar production, it also develops starches and carbohydrates for cell division. Your plants deserve a break, give them Breakout Powder.

Item No.	Description	MSRP Ea
732010	Aptus Breakout Powder 100 gm	\$13.99

Bloom Sensation 0 - 19 - 22

Bloom Sensation helps your plants achieve maximum flowering development. It contains high levels of bioavailable phosphorus and potassium to feed high-yielding plants during critical blooming stages.



Item No.	Description	MSRP
731984	Bloom Sensation 250 ml	\$32.95
731986	Bloom Sensation 500 ml	\$61.95
731988	Bloom Sensation 1 Liter	\$116.95
731990	Bloom Sensation 5 Liter	\$550.95

Root Sensation

Root Sensation is designed to build vigorous roots and strong vegetative growth. It is a concentrated blend of natural acids that build soil structure and stimulate root development.



Item No.	Description	MSRP
731992	Root Sensation 250 ml	\$30.95
731994	Root Sensation 500 ml	\$58.95
731996	Root Sensation 1 Liter	\$110.95
731998	Root Sensation 5 Liter	\$522.95

GROTEK™

SCIENCE FOR PLANTS

Grotek™ is located in the heart of the rich agricultural lands surrounding the Fraser river, in Langley, British Columbia, Canada. Our ISO 9001:2008 approved facility produces consistent quality products for our clients around the world. The main focus at Grotek™ is to create innovative solutions from initial research, through to a concept and all the way to an effective product. We continue listening to and working with our worldwide partners in an effort to provide top quality specialty fertilizers to all those searching for gardening success.

Grotek Final Flush

Grotek Final Flush is a fertilizer rinse solution that acts to dissolve excess fertilizer salts that may accumulate over time as a result of regular fertilizer applications. Use to remove salts in hydroponic systems, growing media and potting soils. Available Regular and in three scents: Pina Colada, Blueberry and Strawberry.



Item No.	Description	MSRP
739600	Grotek Final Flush Reg 1 Liter	\$13.65
739605	Grotek Final Flush Reg 4 Liter	\$37.90
739610	Grotek Final Flush Pina 1 Liter	\$14.74
739615	Grotek Final Flush Pina 4 Liter	\$40.72
739620	Grotek Final Flush Straw 1 Liter	\$14.74
739625	Grotek Final Flush Straw 4 Liter	\$40.72
739630	Grotek Final Flush Blue Berry 1 Liter	\$14.74
739635	Grotek Final Flush Blue Berry 4 Liter	\$40.72

Grotek Solo-Tek Grow 6 - 3 - 7

SOLO-TEK is a stand alone soil/soilless one part nutrient system that was designed to supply essential nutrients to the plant during the vegetative and blooming/fruiting stage.



Item No.	Description	MSRP
739640	Grotek Solo-Tek Grow 1 Liter	\$26.13
739645	Grotek Solo-Tek Grow 4 Liter	\$77.34
739650	Grotek Solo-Tek Grow 10 Liter	\$172.29

Grotek Solo-Tek Bloom 3-8-8

SOLO-TEK is a stand alone soil/soilless one part nutrient system that was designed to supply essential nutrients to the plant during the vegetative and blooming/fruiting stage.

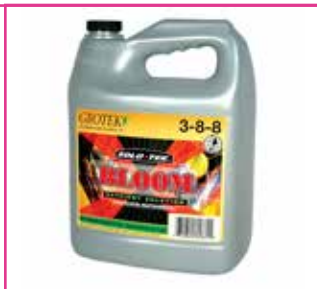

Item No.	Description	MSRP
739655	Grotek Solo-Tek Bloom 1 Liter	\$26.13
739660	Grotek Solo-Tek Bloom 4 Liter	\$77.34
739665	Grotek Solo-Tek Bloom 10 Liter	\$172.29

Grotek VitaMaxPlus B1 Plant Formula 1-1-2

VitaMax Plus is specially formulated to improve plant growth. It encourages better root development, larger buds, blooms, fruits and flowers by developing a robust plant system. Check your local Dealer Partner for availability.



Item No.	Description	MSRP
718855	Grotek VitaMaxPlus 1 Liter	\$22.79
718860	Grotek VitaMaxPlus 4 Liter	\$77.01
718862	Grotek VitaMaxPlus 10 Liter	\$152.93
718863	Grotek VitaMaxPlus 23 Liter	\$348.17

Grotek InstaGreen 3-0-0

InstaGreen is a dark greening solution, scientifically formulated to bring plants back to a lush, dark color and vigor. InstaGreen will eliminate yellow leaves in seedlings and cuttings. Check your local Dealer Partner for availability.



Item No.	Description	MSRP
718900	Grotek InstaGreen 1 Liter	\$12.46
718902	Grotek InstaGreen 4 Liter	\$33.92

Grotek Pro-Silicate 0-0-3.8

Pro-Silicate is a nutritional silicate additive containing potassium and silicon. It helps keep the plants upright, positioning the leaves correctly for maximum light exposure that ultimately leads to a high rate of photosynthesis. Check your local Dealer Partner for availability.



Item No.	Description	MSRP
718890	Grotek Pro-Silicate 1 Liter	\$13.36
718895	Grotek Pro-Silicate 4 Liter	\$37.47
718897	Grotek Pro-Silicate 10 Liter	\$92.90

Grotek Monster Grow 12-7-15

Monster Grow is a high nitrogen fuel for high performance growing that gives an added boost to your plants while they are in the vegetative stage.



Item No.	Description	MSRP
718840	Grotek Monster Grow 130 gm	\$12.77
718845	Grotek Monster Grow 500 gm	\$41.24

Grotek Monster Bloom 0-50-30

Monster Bloom is designed to increase the plant's ability to flower. It increases the essential oil content in herbs and speeds up the development of flower bud set and the total flowering phase. Check your local Dealer Partner for availability.



Item No.	Description	MSRP
718820	Grotek Monster Bloom 130 gm	\$12.77
718825	Grotek Monster Bloom 500 gm	\$41.24
718830	Grotek Monster Bloom 2.5 kg	\$193.79
718835	Grotek Monster Bloom 5 kg	\$364.29
718833	Grotek Monster Bloom 10 kg	\$684.93

Grotek Cal-Max 2-0-0

An excellent source of additional calcium, magnesium and iron, Cal-Max can be used on all plants, providing calcium, magnesium and iron for your garden. Using Cal-Max will help to eliminate leaf yellowing or flowers dropping off.



Item No.	Description	MSRP
732960	Grotek Cal-Max 1 Liter	\$12.67
732970	Grotek Cal-Max 4 Liter	\$41.11
732972	Grotek Cal-Max 10 Liter	\$99.33

Grotek Bloom Fuel 0-0-2

Bloom Fuel is a flowering supplement designed to be used alongside your regular fertilizer program. Begin adding Bloom Fuel half way through vegetative growth to encourage a flowering response.



Item No.	Description	MSRP
732765	Grotek Bloom Fuel 4 Liter	\$61.67

Grotek Vegetative Growth Booster 8 - 39 - 0

Vegetative Growth Booster is a specially formulated product for vegetative growth. Use Growth Booster to increase development in the early stages of growth. Check your local Dealer Partner for availability.



Item No.	Description	MSRP
732975	Grotek Vegetative Growth Booster 20 gm	\$15.31
732977	Grotek Vegetative Growth Booster 300 gm	\$151.71

Grotek Blossom Blaster 0 - 39 - 25

Blossom Blaster is a powerful blend of phosphorous and potassium fertilizers. It supplies the plant with a reliable source of nutrition in the area where blossoms are developing. It gives high performance in all mediums. Check your local Dealer Partner for availability.



Item No.	Description	MSRP
732980	Grotek Blossom Blaster 20 gm	\$10.98
732985	Grotek Blossom Blaster 500 gm	\$234.95
732983	Grotek Blossom Blaster 1 kg	\$403.95
732986	Grotek Blossom Blaster 2.5 kg	\$820.34

Grotek Black Pearl 1 - 1 - 2

This organic product is a blended powder that aims to build soil by replenishing nutrients. Black Pearl contains Nitrogen, Phosphorous and Potassium to support vegetative growth, larger root systems, vigorous blooming and increased drought tolerance.



Item No.	Description	MSRP
739670	Grotek Black Pearl 250 gm	\$13.78
732979	Grotek Black Pearl 1.5 kg	\$60.19



Oregon's Only Organics understands that Nectar For the Gods is not for everyone. It takes a gardener with the special passion and desire to produce the highest quality fruits and vegetables to use this line of nutrients. Nectar For the Gods will never claim the highest yielding plants or the tallest plants. But we can tell you that the flavors and the colors and the overall quality will be noticeably better.

Nectar For The Gods Medusa's Magic

Originally Oregon's Only's grow formula, Medusa's Magic packs a punch. This product goes through an enzyme digest which strips proteins from organic meals and makes them totally available to plants. But worry not, whatever is not absorbed by the plant's roots will become a microbial feast for the soil's biota.



Item No.	Description	MSRP
746256	Medusa's Magic Quart	\$15.00
746258	Medusa's Magic Gallon	\$45.00
746260	Medusa's Magic 2.5 Gallon	\$90.00
746262	Medusa's Magic 5 Gallon	\$160.00

Nectar For The Gods Gaia Mania

Derived from digested forms of soybean, feather, kelp and bone meals as well as worm castings, Gaia offers up a buffet of nutrition for your plants and microbes alike. Free from salts and nitrates, Gaia is incredibly gentle. Rich in proteins, all plants are sure to love this product.



Item No.	Description	MSRP
746232	Gaia Mania Quart	\$17.00
746234	Gaia Mania Gallon	\$50.00
746236	Gaia Mania 2.5 Gallon	\$100.00
746238	Gaia Mania 5 Gallon	\$180.00

Nectar For The Gods Zeus Juice

Zeus Juice is a blend of enzymatically digested Humic acids from BioAg's arsenal of products, blended with kelp extract. These metabolically active compounds will promote optimal nutrient availability, healthy plant cell development and profound rooting. Zeus can be used in soil and hydroponic gardens and as an effective foliar feed.



Item No.	Description	MSRP
746296	Zeus Juice Quart	\$20.00
746298	Zeus Juice Gallon	\$65.00
746300	Zeus Juice 2.5 Gallon	\$135.00
746302	Zeus Juice 5 Gallon	\$250.00

Nectar For The Gods Herculean Harvest

Rich in calcium phosphate, liquid bone meal serves two major purposes in an indoor garden: As a feed, Herculean will promote stronger cell strength, solid stems and heavier fruit; As a flush, bone meal will tie up unwanted salts and facilitate the uptake of macro nutrients.



Item No.	Description	MSRP
746240	Herculean Harvest Quart	\$12.00
746242	Herculean Harvest Gallon	\$36.00
746244	Herculean Harvest 2.5 Gallon	\$75.00
746246	Herculean Harvest 5 Gallon	\$135.00

Nectar For The Gods Athena's Aminas

The basic components of living cells are proteins, which are made up of Amino Acids. Derived from animal byproducts, Athena's is a digested hydrolysate that will benefit every stage of your plants' life from vegetative to bloom.



Item No.	Description	MSRP
746200	Athena's Aminas Quart	\$15.00
746202	Athena's Aminas Gallon	\$45.00
746204	Athena's Aminas 2.5 Gallon	\$90.00
746206	Athena's Aminas 5 Gallon	\$160.00

Nectar For The Gods Demeter's Destiny

Demeter's is a highly available form of calcium phosphate blended with amino acids. Demeter's calcium bonds with natural elements in the soil to create a microbial feast without promoting unwanted elongation. When using Demeter's, you will notice stronger plants and increased flavors and sugar production.



Item No.	Description	MSRP
746224	Demeter's Destiny Quart	\$20.00
746226	Demeter's Destiny Gallon	\$60.00
746228	Demeter's Destiny 2.5 Gallon	\$120.00
746230	Demeter's Destiny 5 Gallon	\$215.00

Nectar For The Gods Mega Morpheus

Oregon's Only's answer to phosphate rich guano tea. Derived from seabird guano, digested worm humus and mineral rich Atlantic kelp, you can't go wrong with this triple filtered, salt and grit free bloom enhancer. Like no other liquid guano, you will find the availability second to none.



Item No.	Description	MSRP
746264	Mega Morpheus Quart	\$15.00
746266	Mega Morpheus Gallon	\$45.00
746268	Mega Morpheus 2.5 Gallon	\$90.00
746270	Mega Morpheus 5 Gallon	\$160.00

Nectar For The Gods Aphrodite's Extraction

Aphrodite is the goddess of love, which is exactly how you will feel about your plants when you see the benefits. The digestion process that Aphrodite's Extraction goes through releases carbon in the form of sucrose. You can use it all of the way through or simply as a final flush.



Item No.	Description	MSRP
746208	Aphrodite's Extraction Quart	\$22.00
746210	Aphrodite's Extraction Gallon	\$60.00
746212	Aphrodite's Extraction 2.5 Gallon	\$120.00
746214	Aphrodite's Extraction 5 Gallon	\$215.00

Nectar For The Gods Hygeia's Hydration

This multipurpose supplement has many jobs in the garden. Yucca shidigera is rich in saponins which aid in the absorption of nutrients in the soil. Saponins prevent the run off of nutrients from the medium allowing more nutrition to be consumed by microbes and plants alike.



Item No.	Description	MSRP
746248	Hygeia Hydration Quart	\$15.00
746250	Hygeia Hydration Gallon	\$45.00
746252	Hygeia Hydration 2.5 Gallon	\$90.00
746254	Hygeia Hydration 5 Gallon	\$160.00

Nectar For The Gods Poseidonzyme

Nectar For The Gods' liquid kelp is rich in natural forms of potassium and is extremely gentle on plants. Poseidon works great as a foliar and root feed alike and also as an immediate food source for compost tea microbes. Use some Poseidon to increase your plants' metabolic potential and see what he can unlock.



Item No.	Description	MSRP
746272	Poseidonzyme Quart	\$22.00
746274	Poseidonzyme Gallon	\$65.00
746276	Poseidonzyme 2.5 Gallon	\$130.00
746278	Poseidonzyme 5 Gallon	\$240.00

Nectar For The Gods Triton's Trawl

For those gardeners who want the benefit of a liquid bonemeal but have issues with the farming practices of live stock, here is an alternative for them. Rich in calcium from cartilage, Triton is designed to deliver flavor, aroma and color to the finished product. It can be used alone or to enhance the effects of Herculean Harvest.



Item No.	Description	MSRP
746288	Triton's Trawl Quart	\$12.00
746290	Triton's Trawl Gallon	\$36.00
746292	Triton's Trawl 2.5 Gallon	\$75.00
746294	Triton's Trawl 5 Gallon	\$135.00

Nectar For The Gods Pegasus Potion

WOW! this stinks, but for good reason. Pegasus Potion is a nitrate free, totally available protein source of nitrogen. Nitrogen proteins are extracted from feathers and digested into their simplest, most available forms. Pegasus works great as a foliar treatment with fast results and can be used as an additive to the rest of the line.



Item No.	Description	MSRP
746280	Pegasus Potion Quart	\$15.00
746282	Pegasus Potion Gallon	\$45.00
746284	Pegasus Potion 2.5 Gallon	\$90.00
746286	Pegasus Potion 5 Gallon	\$160.00

Nectar For The Gods Bloom Khaos

Bloom Khaos is Oregon's Only's secret weapon. This patent pending product aids in the production of whatever stage your plants are in. As a foliar feed, it promotes branching and flower sites. As a water in nutrient, it promotes the uptake of calcium into fruiting bodies creating stronger, thicker and heavier fruit.



Item No.	Description	MSRP
746216	Bloom Khaos Quart	\$40.00
746218	Bloom Khaos Gallon	\$120.00
746220	Bloom Khaos 2.5 Gallon	\$240.00
746222	Bloom Khaos 5 Gallon	\$430.00

Nectar For The Gods Olympus Up

Olympus is derived from micronized limestone designed to not only raise the pH of your nutrient solution but also to buffer organic acids from healthy soil decomposition. The calcium in Olympus is also very effective at tying up salts in the medium.



Item No.	Description	MSRP
746312	Olympus Up Quart	\$14.00
746314	Olympus Up Gallon	\$40.00
746316	Olympus Up 2.5 Gallon	\$80.00
746318	Olympus Up 5 Gallon	\$135.00

Nectar For The Gods Hades Down

This blend of organic acids lowers your nutrient solution's pH. It's our pH down. Don't worry if you over shoot the down: just add some Olympus Up and see the benefits of adding more calcium.



Item No.	Description	MSRP
746304	Hades Down Quart	\$25.50
746306	Hades Down Gallon	\$80.00
746308	Hades Down 2.5 Gallon	\$160.00
746310	Hades Down 5 Gallon	\$325.00

Uber F-D-S 0-0-0.01

F-D-S utilizes next generation Active Transport Technology that literally pushes and then pulls your foliar applied elements through the leaf's Plasma Membrane and delivers them directly inside the chloroplasts of your leaves. This Active Transport method is up to 6 times more effective at delivering your foliar applied elements compared to the leading brands.



Item No.	Description	MSRP
739840	Uber F-D-S 1 Liter (0-0-0.01)	\$34.95
739845	Uber F-D-S 4 Liter (0-0-0.01)	\$99.95

Uber Pyyro K 0-3-7

A radical new PK booster based on the unique phosphorus molecule – Pyrophosphate. Pyyro K assists your plants to maximize flower building, aroma, taste and size. Pyyro K yields BIG! Up to 35% better than a regular phosphate based booster.



Item No.	Description	MSRP
739858	Uber Pyyro K 250 ml (0-3-7)	\$65.95
739860	Uber Pyyro K 1 Liter (0-3-8)	\$179.95
739865	Uber Pyyro K 4 Liter (0-3-8)	\$539.95

Uber Hi-Q 0-0-0.02

Hi-Q, Uber's state of the art new foliar spray, is designed to do what no other product has succeeded to do... maximize the quality of your favorite flowers and fruits. Hi-Q is based on natural ingredients, including 2 different forms of Vitamin C.



Item No.	Description	MSRP
739828	Uber Hi - Q 250 ml 0-0-0.02	\$75.95
739830	Uber Hi - Q 1 Liter (0-0-0.02)	\$204.95
739835	Uber Hi - Q C 4 Liter (0-0-0.02)	\$625.95

Uber R-N-A 0.01-0-0

With Uber R-N-A you will see your plants develop the perfect framework with maximal branching to support the largest yields possible. R-N-A intensifies photosynthesis which enables you to extract full value from every lumen your lighting system provides.



Item No.	Description	MSRP
739850	Uber R-N-A 1 Liter (0.01-0-0)	\$69.95
739855	Uber R-N-A 4 Liter (0.01-0-0)	\$199.95



Hygrozyme



Hygrozyme is an enzyme based product that breaks down old root mass to allow for and stimulate new growth. Bacteria free, Hygrozyme has a virtually unlimited shelf life and there is absolutely no risk of introducing living bacteria into your system.

Item No.	Description	MSRP
718975	Hygrozyme 500 ml	\$21.95
718980	Hygrozyme 1 Liter	\$36.99
718985	Hygrozyme 4 Liter	\$136.95
718990	Hygrozyme 10 Liter	\$323.95
718995	Hygrozyme 20 Liter	\$609.95

SUPERNATURAL[®] BRAND

Supernatural[®] Brand, incorporated in 1997, has developed a line of quality products that work together to provide your plants with an optimal growth environment throughout their entire life cycle. Our extensive research and development has focused on fusion and maximization of the best of foliar, solid and liquid phase growth techniques. The company's genesis lies in its founder's lifelong passion for growing beautifully clean plants of all types.



Supernatural Bloom Aqua 11 - 8 - 18

Used during the flowering stage in hydroponics to promote beautiful blooms, Bloom Aqua contains essential minerals and trace elements to support vigorous flowering. Bloom Aqua also contains 8% calcium.



Item No.	Description	MSRP
717306	Supernatural Bloom Aqua 400 gm	\$27.99
717308	Supernatural Bloom Aqua 1 kg	\$60.99
717310	Supernatural Bloom Aqua 2.26 kg	\$126.99
717312	Supernatural Bloom Aqua 10 kg	\$524.99

Supernatural Gro Aqua 11 - 6 - 16

Used during the vegetative stage in hydroponics to promote healthy plant growth, Gro Aqua contains essential macro and micro elements needed for proper plant development



Item No.	Description	MSRP
717326	Supernatural Gro Aqua 400 gm	\$27.99
717328	Supernatural Gro Aqua 1 kg	\$60.99
717330	Supernatural Gro Aqua 2.26 kg	\$126.99
717332	Supernatural Gro Aqua 10 kg	\$524.99

Supernatural Bloom Terra 15 - 31 - 14

Used during the flowering stage to promote beautiful blooms, Bloom Terra contains essential minerals and trace elements to support vigorous flowering.



Item No.	Description	MSRP
717316	Supernatural Bloom Terra 400 gm	\$27.99
717318	Supernatural Bloom Terra 1 kg	\$60.99
717320	Supernatural Bloom Terra 2.26 kg	\$126.99
717322	Supernatural Bloom Terra 10 kg	\$524.99

Supernatural Gro Terra 20 - 20 - 20

Used during the vegetative stage to promote healthy plant growth, Gro Terra contains essential macro and micro elements needed for proper plant development.



Item No.	Description	MSRP
717336	Supernatural Gro Terra 400 gm	\$27.99
717338	Supernatural Gro Terra 1 kg	\$60.99
717340	Supernatural Gro Terra 2.26 kg	\$126.99
717342	Supernatural Gro Terra 10 kg	\$524.99

Supernatural Super Boost 11 - 49 - 9

Used to promote rooting, late flowering and ripening, Super Boost uses high quality ingredients critical to plants in the late stages of the growth cycle.



Item No.	Description	MSRP
717346	Supernatural Super Boost 400 gm	\$27.99
717348	Supernatural Super Boost 1 kg	\$60.99
717350	Supernatural Super Boost 2.26 kg	\$135.99
717352	Supernatural Super Boost 10 kg	\$527.99

Supernatural Super Soak 5 - 30 - 20

Contains macro and micro nutrients essential to plant growth. It promotes the uniform spread of nutrients throughout any growth medium to enable vigorous rooting, heavy flower/fruit load and ripening. Use as directed to maximize food absorption in a stable root zone.



Item No.	Description	MSRP
717354	Supernatural Super Soak 100 gm	\$10.99
717356	Supernatural Super Soak 500 gm	\$34.99

Supernatural Excellofizz

Perfect for smaller gardens and areas with limited ventilation, Excellofizz releases optimal amounts of carbon into the growth environment. Carbon is the building block for all plants and proper absorption greatly increases plant mass and fruit load.



Item No.	Description	MSRP
717368	Supernatural Excellofizz 15/Pack	\$62.99
717370	Supernatural Excellofizz 50/Pack	\$189.99

Supernatural Rootburst Powder

With superior stem adhesion and penetrating action, Rootburst Powder is a high quality hormone formula that maintains the vibrancy of cuttings throughout the rooting phase, ensuring lush and vigorous plant growth during the vegetative stage.



Item No.	Description	MSRP
717376	Supernatural Rootburst Powder 57g	\$21.99
717378	Supernatural Rootburst Powder 170g	\$52.99

Supernatural Bud Blaster 1 - 52 - 31

Used to promote increased flower size and quality, Bud Blaster ensures a strong final ripening stage.



Item No.	Description	MSRP
717358	Supernatural Bud Blaster 100 gm	\$22.99
717360	Supernatural Bud Blaster 500 gm	\$101.99
717362	Supernatural Bud Blaster 1 kg	\$174.99
717364	Supernatural Bud Blaster 2.26 kg	\$337.99
717366	Supernatural Bud Blaster 10 kg	\$1,417.99

Supernatural Super Leach 0 - 0 - 1

Used to dissolve mineral build-up that causes nutrient deficiency, Super Leach gently flushes the growth medium to ensure a fresh nutrient profile throughout the growth cycle.



Item No.	Description	MSRP
717380	Supernatural Super Leach 160 gm	\$11.99
717382	Supernatural Super Leach 400 gm	\$25.99
717384	Supernatural Super Leach 2.26 kg	\$132.99

Supernatural Superlicious 3 - 0 - 0

Used throughout the bloom stage, Superlicious is a supplement containing chelated metals that help intensify fragrance, flavor and the production of essential oils.



Item No.	Description	MSRP
717386	Supernatural Superlicious 100 gm	\$15.99
717388	Supernatural Superlicious 500 gm	\$67.99

Supernatural Green Stay 1 - 0 - 0

Used to maintain green lower leaves needed to fuel fruit production, Green Stay helps revive and refresh plants experiencing natural stress during the flowering cycle and should be used at the first sign of stress. Green Stay aids against; calcium, magnesium and iron deficiencies.



Item No.	Description	MSRP
717390	Supernatural Green Stay 250 ml	\$13.99
717392	Supernatural Green Stay 1 Liter	\$38.99
717393	Supernatural Green Stay 4 Liter 	\$201.99

Supernatural Instant Jungle 0.081 - 0.004 - 0.02

When the correct foliar spray plant food is applied properly the result is a feedback loop. Foliar feeding increases the rate of photosynthesis which in turn increases water and nutrient uptake by the plant's vascular system. A fine mist is all that is required.



Item No.	Description	MSRP
717394	Supernatural Instant Jungle 450 ml	\$17.99
717395	Supernatural Instant Jungle 450 ml (WA & NY Label)	\$17.99

Supernatural Ultimate Thrive 5 - 0 - 2

Helping to maintain a vigorous root environment and to promote seed germination, Ultimate Thrive is a liquid macro and micro supplement used throughout the entire feeding program to aid the growth of energetic plants full of vibrant colors and heavy fruit loads.



Item No.	Description	MSRP
717396	Supernatural Ultimate Thrive 500 ml	\$33.99
717398	Supernatural Ultimate Thrive 1 Liter	\$58.99
717400	Supernatural Ultimate Thrive 4 Liter	\$178.99



In 2005 Vermicrop Organics was founded in Grass Valley, California by a small team of forward thinking gardeners. From years of growing in the Sierra foothills we've gained an appreciation for not only the fruits of our labor but the incredible environment from which they blossom. The focus of our product development is improving the horticultural industry with superior inoculates and growing mediums inspired by nature. Total dedication to the growth of our company and devotion to sustainability has brought Vermicrop to where it is today.

Vermicrop VermiLife

VermiLife is the foundation of any good compost tea. VermiWorm Premium Worm Castings are combined with Alaskan Humus at a specific ratio tested by industry leaders. We then fortify the mixture with Fossilized Kelp to increase calcium levels. Finally a proprietary method of inoculation is used to add liquid compost concentrate to the blend.



Item No.	Description	MSRP
720768	Vermicrop VermiLife 5 Gallon	\$45.99

Vermicrop VermiFeast

A mixture of premium food sources for compost tea. These food sources consist of a proprietary blend of specific simple and complex carbohydrates. Conveniently packaged and mixed specifically for compost tea.



Item No.	Description	MSRP
720770	Vermicrop VermiFeast 2 Gallon	\$99.99

Vermicrop VermiBrix

This powdered molasses alternative is easy to use, 100% soluble, all natural and GMO-free. VermiBrix has all the benefits of readily available carbs in sugar form as well as rare earth minerals. These minerals slowly release silicon and humates to help protect the plant from nutrients fluctuations and stress.



Item No.	Description	MSRP
720772	Vermicrop VermiBrix 2 Gallon	\$102.00

Vermicrop Vermi T 5/10 Extractor

This lightweight, easy to clean Bio Extractor is designed to produce a fresh microbial rich extract in 24 hours. Unlike traditional compost tea, Vermi T will maintain 100% viability for 7-10 days if properly refrigerated.



Item No.	Description	MSRP
720720	Vermi T 5/10 Extractor	\$449.99

Vermicrop Polyester Tea Bag

Introducing the Polyester Brewing Bag for compost tea home-brewers everywhere! Measuring 12 x 18 inches, this 200 micron bag is designed for proper bacterial and fungal extraction at an economical price. Made in the USA of polyester with a cotton drawstring.



Item No.	Description	MSRP
720723	Vermicrop Polyester Tea Bag	\$14.95

Vermicrop Vermi T Bio-Cartridges

This Cartridge is the key to the multiplication of a diverse microbial rich solution from your Vermi T 5/10 Extractor.



Item No.	Description	MSRP
720725	Vermi T Bio-Cartridge 5 Gallon	\$84.99
720740	Vermi T Bio-Cartridge 10 Gallon	\$149.99



Here at Reformation Technologies International (makers of the Xtreme Gardening Line), we pride ourselves in doing what every company should be doing nowadays—working with nature in a sustainable way. We wanted to step away from current notions in the gardening industry that lead people to believe high amounts of fertilizers are required to grow bountiful harvests. Rather than pumping our crops full of unnecessary nutrients, we have employed the help of the little guys underground that have been designed to find these nutrients and relay them to their host plants, while at the same time creating a healthy biosphere that allows plants to thrive.

Xtreme Gardening CalCarb

Calcium is critical to the health of your plant, contributing to the strength of cell membranes and regulation of nutrient use. Calcium is known to play a major role in the quality of many crops, including peppers, tomatoes and watermelon. It is also able to reduce the effects of heat stress in plants.



Item No.	Description	MSRP
721270	Xtreme Gardening Calcarb 6 oz	\$49.95

Xtreme Gardening Mykos Drops Root Paks 10 gm

Mykos Root Paks are great for hydroponic systems, such as deep water culture, aero and aquaponics. They grow big roots and keep the Mykos where they need to be and not clogging up your system and sprayers. Mykos works faster and inoculates stronger. May be used with any nutrient line. Check your local Dealer Partner for availability. *While supplies last.



Item No.	Description	MSRP
721240	Xtreme Gardening Mykos Drops 10 gm Paks 50/ct	\$24.95

Xtreme Gardening Mykos

Mykos is very-specific specie of Mycorrhiza that works faster and stronger. It builds root mass and increases nutrient uptake. 'Leap start' new transplants and shield roots from disease. When it comes to mycorrhizae, Mykos can't be beat. Mykos is a beneficial additive that may be used with any nutrient line. Check your local Dealer Partner for availability.



Item No.	Description	MSRP
721200	Xtreme Gardening Mykos 1 lb	\$19.95
721205	Xtreme Gardening Mykos 2.2 lb	\$29.95
721210	Xtreme Gardening Mykos 20 lb	\$199.95
721211	Xtreme Gardening Mykos 50 lb	\$459.95

Xtreme Gardening Mykos Drops 100 gm Pouches Display

Mykos Root Paks are great for hydroponic systems, such as deep water culture, aero and aquaponics. They grow big roots and keep the Mykos where they need to be and not clogging up your system and sprayers. Mykos works faster and inoculates stronger. May be used with any nutrient line. Easy to use pouches resemble the look of a candy bar. Simply tear open pouch and pour.



Item No.	Description	MSRP
721215	Xtreme Gardening Mykos Drops 100 gm Packs 60/ct Display	\$209.40

Xtreme Gardening Azos

Azos is a beneficial microbe that rapidly increases natural plant hormone production, affecting cell division, growth rates, plant and root development. Use Azos to quickly and naturally root new cuttings; water-in or add to hydroponic reservoirs to feed and fuel abundant growth. May be used with any nutrient line.



Item No.	Description	MSRP
721259	Xtreme Gardening Azos 2 oz	\$19.95
721260	Xtreme Gardening Azos 6 oz	\$29.95
721265	Xtreme Gardening Azos 12 oz	\$49.95
721268	Xtreme Gardening Azos 8 lb	\$349.95

Xtreme Gardening Mykos WP

Mykos WP can be mixed with water or added to hydroponic reservoirs. It's a very-specific species of Mycorrhiza that works faster and stronger. It builds root mass and increases nutrient uptake. Also, protects roots from disease. With more roots, you get more fruits! May be used with any nutrient line. Check your local Dealer Partner for availability.



Item No.	Description	MSRP
721220	Xtreme Gardening Mykos WP 12 oz	\$24.95
721225	Xtreme Gardening Mykos WP 2.2 lb	\$59.95
721230	Xtreme Gardening Mykos WP 15 lb	\$349.95

Xtreme Gardening Tea Brew Packs

Tea Brews are a treasure trove of beneficial organisms, brought to life through a simple brewing process, which ensure the quality of harvest you've been looking for. They rapidly break down nutrients, improve growth rates and naturally increase plant production of secondary metabolites (aroma, taste and essential oils). 90 gram tea brew packs make 3 gallons of brew. The 500 gram tea brew packs make 25 gallons of brew.



Item No.	Description	MSRP
721320	Xtreme Gardening Tea Brews 90 gm Packs 10/ct	\$49.95
721335	Xtreme Gardening Tea Brews 500 gm Packs 14/ct	\$329.95

Xtreme Gardening Tea Brew Packs Display

Tea Brews are a treasure trove of beneficial organisms, brought to life through a simple brewing process, which ensure the quality of harvest you've been looking for. They rapidly break down nutrients, improve growth rates and naturally increase plant production of secondary metabolites (aroma, taste and essential oils). Now in one use packages.



Item No.	Description	MSRP
721319	Xtreme Gardening Tea Brews 90 gm Pack 20/ct Display	\$219.95



We have our own research greenhouses that provide us with the ability to develop our specialty plant nutrients. After successful trials these nutrient formulas become Cutting Edge Solutions products and we offer them to the rest of the growing world. Our nutrients are designed to be easy to use and effective for a variety of plants. We pride ourselves on providing high quality products that we believe in.

Cutting Edge Solutions G-Rex 0 - 0 - 0.5

G-Rex is a proprietary blend of unique biologic fertilizer derived components that support root health and protection. Plant roots utilizes G-Rex to give a dose of strength that propels the plant into larger, more dramatic growth.



Item No.	Description	MSRP
715825	Cutting Edge G-Rex Quart	\$126.00
715830	Cutting Edge G-Rex Gallon	\$395.00

Cutting Edge Solutions T-Rex

T-Rex motivates your plants to get a head start during vegetating. This motivation can be seen in a more dynamic growth curve, which facilitates a greater internodal expansion. Greater expansion means more growth.



Item No.	Description	MSRP
715840	Cutting Edge T-Rex Quart	\$139.95
715845	Cutting Edge T-Rex Gallon	\$430.00

Cutting Edge Solutions Grow 2 - 1 - 6

To be used in the vegetative stage, Grow adds more nitrogen for growth and potassium to enhance the plant's photosynthetic rate and energy transfer throughout the plant. Check your local Dealer Partner for availability.



Item No.	Description	MSRP
715600	Cutting Edge Grow Quart	\$12.00
715605	Cutting Edge Grow Gallon	\$28.00
715610	Cutting Edge Grow 2.5 Gallon	\$59.00
715615	Cutting Edge Grow 6 Gallon	\$131.00
715620	Cutting Edge Grow 20 Gallon	\$380.00
715625	Cutting Edge Grow 55 Gallon	\$1,016.00

Cutting Edge Solutions Bloom 0 - 6 - 5

Bloom is a phosphorus heavy formula for enhancing flower production, as well as to encourage a plant to shift its hormonal signals from vegetative to flowering. Check your local Dealer Partner for availability.



Item No.	Description	MSRP
715630	Cutting Edge Bloom Quart	\$12.00
715635	Cutting Edge Bloom Gallon	\$28.00
715640	Cutting Edge Bloom 2.5 Gallon	\$59.00
715645	Cutting Edge Bloom 6 Gallon	\$131.00
715650	Cutting Edge Bloom 20 Gallon	\$380.00
715655	Cutting Edge Bloom 55 Gallon	\$1,016.00

Cutting Edge Solutions Micro 6 - 0 - 0

Micro is to be used throughout the entire growth cycle of a plant, regardless of vegetative or flowering cycles. Micro is highly concentrated and needs to be diluted and mixed first, before adding any other components of the CES system. Check your local Dealer Partner for availability.



Item No.	Description	MSRP
715660	Cutting Edge Micro Quart	\$14.00
715665	Cutting Edge Micro Gallon	\$33.00
715670	Cutting Edge Micro 2.5 Gallon	\$70.00
715675	Cutting Edge Micro 6 Gallon	\$161.00
715680	Cutting Edge Micro 20 Gallon	\$450.00
715685	Cutting Edge Micro 55 Gallon	\$1,203.00

Cutting Edge Solutions Mag-Amped

Mag-Amped is a pure Magnesium product, combined with an organic facilitator that helps with uptake and overall solubility. Magnesium is the basis of chlorophyll production in plants, in turn chlorophyll is a major component in photosynthesis.



Item No.	Description	MSRP
715740	Cutting Edge Mag-Amped Quart	\$29.00
715745	Cutting Edge Mag-Amped Gallon	\$87.00
715750	Cutting Edge Mag-Amped 2.5 Gallon	\$175.00
715755	Cutting Edge Mag-Amped 6 Gallon	\$350.00

Cutting Edge Solutions Sugaree

Sugaree provides an organic carbohydrate and electrolyte source to stimulate amino acid production. It's specially designed organic formulation targets increases in fruit set, retention and sugar production.



Item No.	Description	MSRP
715760	Cutting Edge Sugaree Quart	\$20.00
715765	Cutting Edge Sugaree Gallon	\$60.00
715770	Cutting Edge Sugaree 2.5 Gallon	\$122.50
715775	Cutting Edge Sugaree 6 Gallon	\$288.00

Cutting Edge Solutions Sonoma Gold Grow 1 - 4 - 4

Sonoma Gold Grow is an all-purpose organic fertilizer. Sonoma Gold is formulated for all on demand fertilizer needs during the crop cycle. Check your local Dealer Partner for availability.



Item No.	Description	MSRP
715780	Cutting Edge Sonoma Gold Grow Gallon	\$41.00
715785	Cutting Edge Sonoma Gold Grow 2.5 Gallon	\$85.00
715790	Cutting Edge Sonoma Gold Grow 6 Gallon	\$180.00
715795	Cutting Edge Sonoma Gold Grow 20 Gallon	\$530.00

Cutting Edge Solutions Sonoma Gold Bloom 0 - 6 - 6

Sonoma Gold Bloom is a formulated organic fertilizer for use during flowering and fruit set. Our Pacific Northwest sources of fish provide a local, renewable source of calcium, phosphorus and micronutrients. Check your local Dealer Partner for availability.



Item No.	Description	MSRP
715800	Cutting Edge Sonoma Gold Bloom Gallon	\$41.00
715805	Cutting Edge Sonoma Gold Bloom 2.5 Gallon	\$85.00
715810	Cutting Edge Sonoma Gold Bloom 6 Gallon	\$180.00
715815	Cutting Edge Sonoma Gold Bloom 20 Gallon	\$530.00

Cutting Edge Solutions Sour-Dee

The Sour-Dee provides organic carbohydrates and electrolytes to stimulate amino acid production and provide a superior carbohydrate source. The kind sweet and sour aroma of the organic SourDee is what you need to give your crop the characteristics that you desire. Check your local Dealer Partner for availability.



Item No.	Description	MSRP
715850	Cutting Edge Sour-Dee Quart	\$20.00
715855	Cutting Edge Sour-Dee Gallon	\$60.00
715860	Cutting Edge Sour-Dee 2.5 Gallon	\$122.50
715865	Cutting Edge Sour-Dee 6 Gallon	\$288.00
715870	Cutting Edge Sour-Dee 20 Gallon	\$860.00

Cutting Edge Solutions Uncle John's Blend 0-0-2

Uncle John's Blend (UJB), is a complexed Potassium mixture that is used primarily to enhance a plant's metabolic rate, especially for flowering plants during the blooming stage. Check your local Dealer Partner for availability.



Item No.	Description	MSRP
715715	Cutting Edge Uncle John's Blend Quart	\$29.00
715720	Cutting Edge Uncle John's Blend Gallon	\$87.00
715725	Cutting Edge Uncle John's Blend 2.5 Gallon	\$175.00
715730	Cutting Edge Uncle John's Blend 6 Gallon	\$350.00
715735	Cutting Edge Uncle John's Blend 20 Gallon	\$1,035.00

Cutting Edge Solutions Plant Amp

Plant Amp is a chelated Calcium product that also contains a proprietary organic plant stimulating ingredient. Calcium is the basis of cell wall development in a plant and the chelated Calcium in Plant Amp is extremely soluble. Check your local Dealer Partner for availability.



Item No.	Description	MSRP
715690	Cutting Edge Plant Amp Quart	\$29.00
715695	Cutting Edge Plant Amp Gallon	\$87.00
715700	Cutting Edge Plant Amp 2.5 Gallon	\$175.00
715705	Cutting Edge Plant Amp 6 Gallon	\$350.00
715710	Cutting Edge Plant Amp 20 Gallon	\$1,035.00



BioAg is a team of humic substance scientists and sustainability researchers who specialize in naturally extracted humic products for health and agriculture. In addition to providing uncompromising product integrity, we hope to educate on humic acid, to help promote industry standards and empower our customers.

BioAg Ful-Power

Ful-Power will maximize your potential. It drives nutrients and minerals into the plant and results in healthier plants and tastier produce. Ful-Power golden humic is purified by a special fermentation style extraction that increases the benefits.



Item No.	Description	MSRP
719770	BioAg Ful-Power Quart	\$19.95
719775	BioAg Ful-Power Gallon	\$49.95
719777	BioAg Ful-Power 2.5 Gallon	\$109.95
719779	BioAg Ful-Power 5 Gallon	\$179.95

BioAg Ful-Humix

It's all in the name. Ful-Humix is a cost effective amendment that adds soluble carbon to your soil. Ful-Humix should be regularly used throughout the plant life cycle, watered into greenhouse or outdoor soils.



Item No.	Description	MSRP
719740	BioAg Ful-Humix 100 gm	\$7.75
719745	BioAg Ful-Humix 300 gm	\$14.75
719747	BioAg Ful-Humix 1 kg	\$33.75

BioAg TM-7

TM-7 contains the seven micronutrients critical for plant success, plus premium concentrated humic powder for increased uptake. Use throughout the season to increase micronutrient uptake. We highly encourage adding it to your compost tea recipe.



Item No.	Description	MSRP
719750	BioAg TM-7 100 gm	\$10.75
719755	BioAg TM-7 300 gm	\$20.75
719757	BioAg TM-7 1 kg	\$54.25

BioAg CytoPlus

CytoPlus has all the benefits of seaweed and micronutrients, enhanced by BioAg's premium humic concentrate. CytoPlus stimulates soil microbial activity and increases plant growth and yield. This is a perfect additive or soil amendment to use during key growth periods.



Item No.	Description	MSRP
719760	BioAg CytoPlus 100 gm	\$10.95
719765	BioAg CytoPlus 300 gm	\$23.95
719767	BioAg CytoPlus 1 kg	\$69.00

BioAg VAM

VAM dramatically improves the surface area of your plant's root mass. Increases nutrient and water adsorbing capabilities. VAM includes 7 specially selected species of endo mycorrhizae with a heavy dose of the very aggressive Glomus intraradices.



Item No.	Description	MSRP
719730	BioAg VAM 100 gm	\$8.95
719732	BioAg VAM 300 gm	\$17.95
719734	BioAg VAM 1 kg	\$49.95
719736	BioAg VAM 5 lb	\$99.95

B'CUZZ
ATAMI™

Atami™ is a research-based organization, studying plant growth and behavior at the cellular level. We evaluate and compare the various growing media such as soil, stone-wool and coir (coco) and the effect of various stimulants. Our goal is to increase potential yields for the serious grower by analysis of the growing techniques and by increased knowledge of the plant.

Atami Bloombastic



All bloom additives in one bottle: booster, accelerator, hardener & flower enhancer. Bloombastic is highly concentrated. Bloombastic stretches the flower cell, increasing intake capacity of potassium. It creates more compact & heavier blooms.

Item No.	Description	MSRP
732489	Bloombastic 80 ml	\$31.78
732500	Bloombastic 325 ml	\$95.43
732580	Bloombastic 1.25 Liter	\$222.74
732582	Bloombastic 5.5 Liter	\$933.59

Atami Rootbastic 3 - 14 - 3

Rootbastic is a super concentrated root stimulator with a combination of high NPK bio stimulants and bio minerals which creates explosive root production. Not for sale in the following states at this time: CA.



Item No.	Description	MSRP
733400	Rootbastic 80 ml	\$43.42
733410	Rootbastic 250 ml	\$82.84
733420	Rootbastic 500 ml	\$159.98
733405	Rootbastic 80 ml (CA Label)	\$43.42
733415	Rootbastic 250 ml (CA Label)	\$82.84
733425	Rootbastic 500 ml (CA Label)	\$159.98

B'CuZZ Tabzz 0 - 12 - 15

B'CuZZ Blossom Builder Tabzz are 100% sizzling flower multipliers that ensures an explosive flower development in the flower phase. They make sure that all the strength of the plant is directed towards the flowers at the end of the growth.



Item No.	Description	MSRP Ea
732069	B'CuZZ Tabzz	\$6.87

B'CuZZ Bloom 0 - 0 - 0.7

Especially for the plant's blooming phase. B'CuZZ Bloom encourages flower cell production and increases the manufacture and transport of sugar molecules in the flowers. This will lead to big, dense flowers and great taste.



Item No.	Description	MSRP
732025	B'CuZZ Bloom Pint	\$23.34
732030	B'CuZZ Bloom Quart	\$46.68
732035	B'CuZZ Bloom Gallon	\$159.14

B'CuZZ Growth 1.0 - 0 - 0.7

B'CuZZ Growth has been developed specifically to stimulate the growth phase and it is a necessary supplement to normal nutrition. It is an all-in-one growing stimulator, containing micro-nutrients, aqua-bacteria, amino acids and proteins.



Item No.	Description	MSRP
732040	B'CuZZ Growth Pint	\$23.34
732045	B'CuZZ Growth Quart	\$46.68
732050	B'CuZZ Growth Gallon	\$159.14

B'CuZZ Root 0 - 0 - 0.7

B'CuZZ Root will initiate an explosive root production. B'CuZZ Root solutions can be best used in cloning systems and for young plants, cuttings or seedlings.



Item No.	Description	MSRP
732055	B'CuZZ Root Pint	\$23.34
732060	B'CuZZ Root Quart	\$46.68
732065	B'CuZZ Root Gallon	\$159.14

B'Cuzz Blossom Builder 0 - 9 - 19

B'Cuzz Blossom Builder liquid will increase the size and mass of flowers. Specifically created for the final weeks of the blooming phase. It works as a finisher that will lead your flowers to strong, healthy look and a beautiful attractive final weight and aroma of your flowers.



Item No.	Description	MSRP
733430	B'Cuzz Blossom Builder 3.38 oz / 100 ml	\$20.60
733435	B'Cuzz Blossom Builder 12 oz / 355 ml	\$48.95
733440	B'Cuzz Blossom Builder Quart / 946 ml	\$144.15



TECHNAFLORA PLANT PRODUCTS LTD

Technaflora Plant Products Ltd. is a proudly Canadian-owned and operated company based in Mission, British Columbia that boasts a catalogue of superior plant nutrients and additives. Unique products such as B.C. Hydroponic Nutrients™, Rootech Cloning Gel™, Thrive Alive B-1™, Awesome Blossoms™ and our famous Recipe For Success Starter Kit™ confirm the company's leadership in the specialty gardening market. Customer service along with continuing innovation and production of exceptional products are our highest priorities.

Technaflora Pura Vida Grow 6 - 4 - 3

Formulated from various plant materials, Pura Vida Grow contain sufficient organic nitrogen, phosphorous and potassium. Pura Vida Grow specifically targets the vegetative growth phase rapidly creating lush green foliage.



Item No.	Description	MSRP
726717	Pura Vida Grow 1 Liter	\$36.59
726718	Pura Vida Grow 4 Liter	\$72.53
726719	Pura Vida Grow 10 Liter	\$165.65
726720	Pura Vida Grow 20 Liter	\$292.14

Technaflora Pura Vida Bloom 2 - 6 - 6

Formulated from various plant materials, Pura Vida Bloom contain sufficient organic nitrogen, phosphorous & potassium. It is formulated to promote and maximize the flowering & fruiting performance of plants during the reproductive stage.



Item No.	Description	MSRP
726722	Pura Vida Bloom 1 Liter	\$36.59
726723	Pura Vida Bloom 4 Liter	\$72.53
726724	Pura Vida Bloom 10 Liter	\$165.70
726725	Pura Vida Bloom 20 Liter	\$292.14

Technaflora Sugar Daddy

Promotes strong plant structure. During the seedling stage, SugarDaddy rapidly accelerates sprout growth & prepares plants for transplanting. The unique combinations of ingredients in SugarDaddy are vital for all stages of plant growth and development.



Item No.	Description	MSRP
726732	Sugar Daddy 1 Liter	\$31.33
726734	Sugar Daddy 4 Liter	\$95.88
726736	Sugar Daddy 10 Liter	\$214.82
726738	Sugar Daddy 20 Liter	\$415.00

Technaflora Root 66 1 - 1 - 1

At transplanting, ROOT 66 improves the establishment of seedlings and cutting by stimulating adventitious root development. ROOT 66 can be applied to soil, soilless and hydroponic based gardening mediums.



Item No.	Description	MSRP
720691	Root 66 250 ml	\$28.74
720692	Root 66 1 Liter	\$97.73
720693	Root 66 4 Liter	\$359.36
720694	Root 66 10 Liter	\$862.48

Technaflora Recipe For Success Kit

This kit consists of B.C Bloom, B.C Boost, B.C Grow, Thrive Alive B-1 Red, Thrive Alive B-1 Green, Awesome Blossoms, Rootech Cloning Gel, MagiCal, SugarDaddy, ROOT 66 and the famous Recipe for Success mixing chart.



Item No.	Description	MSRP
726740	Recipe For Success Starter Kit	\$43.11

Technaflora MagiCal 2 - 0 - 0

MagiCal is a highly enriched formulated blend of Magnesium, Iron and Calcium that promotes vigorous and healthy plant growth for both soil and soilless gardens. Highly soluble—works in conjunction with any nutrient. Check your local Dealer Partner for availability.



Item No.	Description	MSRP
716453	MagiCal 1 Liter	\$19.83
716455	MagiCal 4 Liter	\$69.42
716456	MagiCal 10 Liter	\$165.30
716457	MagiCal 20 Liter	\$297.55

Technaflora Thrive Alive B-1 Green 1 - 1 - 1

Thrive Alive B-1 is a power packed preventative and restorative general-purpose plant tonic. It stimulates rapid and lush vegetative growth and will ensure the success of floral crops by promoting profuse flowering during blossoming.



Item No.	Description	MSRP
720630	Thrive Alive B-1 Green 250 ml	\$24.16
720635	Thrive Alive B-1 Green 500 ml	\$40.29
720640	Thrive Alive B-1 Green 1 Liter	\$60.45
720645	Thrive Alive B-1 Green 4 Liter	\$185.88

Technaflora Thrive Alive B-1 Red 1 - 1 - 1

Thrive Alive B-1 is a power packed preventative and restorative general-purpose plant tonic. It stimulates rapid and lush vegetative growth and will ensure the success of floral crops by promoting profuse flowering during blossoming. Check your local Dealer Partner for availability.



Item No.	Description	MSRP
720605	Thrive Alive B-1 Red 250 ml	\$22.41
720610	Thrive Alive B-1 Red 500 ml	\$38.05
720615	Thrive Alive B-1 Red 1 Liter	\$55.19
720620	Thrive Alive B-1 Red 4 Liter	\$169.04
720625	Thrive Alive B-1 Red 10 Liter	\$380.74
720626	Thrive Alive B-1 Red 20 Liter	\$705.51

Technaflora B. Seaweed 0 - 0 - 1

B. Seaweed is an optimal growth stimulant for all your plants. Technaflora's exceptional liquid extract is made from 100% pure, organic British Columbia kelp. B. Seaweed is ultra-concentrated and must be diluted with water.



Item No.	Description	MSRP
720685	B. Seaweed 1 Liter	\$51.50

Technaflora Awesome Blossoms 2 - 11 - 11

Awesome Blossoms is a scientifically blended superior flower stimulant designed to nurture prolific and bold blooms in all your flowering plants. Awesome Blossoms fosters explosive flower growth, promoting heavier blooms at multiple budding sites.



Item No.	Description	MSRP
720655	Awesome Blossoms 500 ml	\$22.86
720660	Awesome Blossoms 1 Liter	\$44.77
720665	Awesome Blossoms 4 Liter	\$134.37
720670	Awesome Blossoms 10 Liter	\$291.14

Technaflora B.C. Boost 3 - 0 - 2

B.C. Hydroponic Nutrients are a power-packed trio for nurturing generous vegetative crops and extraordinary floral growth. Grow & Bloom contain a full complement of micronutrients, which are bolstered by the added calcium and iron in B.C. Boost.



Item No.	Description	MSRP
720540	B.C. Boost 1 Liter	\$26.34
720545	B.C. Boost 4 Liter	\$49.25
720550	B.C. Boost 10 Liter	\$111.96
720555	B.C. Boost 20 Liter	\$197.08

Technaflora B.C. Bloom 1 - 4 - 7

B.C. Hydroponic Nutrients are a power-packed trio for nurturing generous vegetative crops and extraordinary floral growth. B.C. Bloom contain a full complement of micronutrients, which are bolstered by the added calcium and iron in B.C. Boost.



Item No.	Description	MSRP
720560	B.C. Bloom 1 Liter	\$22.37
720565	B.C. Bloom 4 Liter	\$44.77
720570	B.C. Bloom 10 Liter	\$100.77
720575	B.C. Bloom 20 Liter	\$158.68

Technaflora B.C. Grow 1 - 3 - 6

B.C. Hydroponic Nutrients are a power-packed trio for nurturing generous vegetative crops and extraordinary floral growth. B.C. Grow contain a full complement of micronutrients, which are bolstered by the added calcium and iron in B.C. Boost.



Item No.	Description	MSRP
720580	B.C. Grow 1 Liter	\$22.37
720585	B.C. Grow 4 Liter	\$44.77
720590	B.C. Grow 10 Liter	\$100.77
720595	B.C. Grow 20 Liter	\$158.68

Technaflora Soluble Seaweed Extract 1 - 1 - 16

Soluble Seaweed Extract is a concentrated, comprehensive gardener's tool in powder form. The concentrate is made from 100% pure, organic kelp. It enhanced seed germination, promotion of a healthy root system and rapid stem and shoot development.



Item No.	Description	MSRP
720680	Soluble Seaweed Extract 225 gm	\$26.86

GROW MORE

Grow More, Inc. is a manufacturer, with leading market position in a broad range of agricultural and specialty chemicals. Our goal Grow More, Inc. is to develop innovative scientific solutions for our customers – first in the form of quality products but also in the form of expertise, information, technology and advance science.

Grow More Mendocino Avalanche

Flower hardener specially developed and field tested in the Emerald Triangle of Humboldt, Mendocino and Trinity Counties in Northern California. Helps stimulate flower development in the final bloom stage, for an increase in the size and mass of flowers.



Item No.	Description	MSRP
721620	Grow More Mendocino Avalanche Quart	\$24.45
721625	Grow More Mendocino Avalanche Gallon	\$63.61

Grow More Hawaiian Bud 5 - 50 - 17

Specially formulated to supply phosphate and potash for late flowering cycle. Fortified with six trace elements plus Humic Acid and Norwegian kelp extract to help produce heavy weight flowers and buds.



Item No.	Description	MSRP
721610	Grow More Hawaiian Bud 1.5 lb	\$13.90
721615	Grow More Hawaiian Bud 25 lb	\$85.03

Grow More Hula Bloom 0 - 50 - 30

Hula Bloom is formulated to help increase flowering quality and development of blooms, while helping to increase yields. Hula Bloom provides super phosphates and minerals that are rapidly absorbed in the flowering and final ripening stages of plant growth for a superior, top quality product.



Item No.	Description	MSRP
721617	Grow More Hula Bloom 1.5 lb	\$16.95

Grow More Soil Builder Humic

Humic acids fortified with N-P-K & chelated micronutrients, provide an organic carbon that acts as substrate for beneficial soil microbes. For indoor or outdoor container plants, coco planting media or for plants that are growing in native soil. Not for sale in the following states at this time: OR.



Item No.	Description	MSRP
721680	Grow More Soil Builder - Humic 2 oz	\$4.93

Grow More BioCozyme

A 100% organic biostimulant that enhances a plants ability to absorb and utilize nutrients. Derived from natural occurring cytokinins, hormones, enzymes, vitamins, amino acids and micronutrients. Works by enhancing the plants ability to control the movement of nutrients through the stem and leaves and augments the existing enzyme functions in the plant.



Item No.	Description	MSRP
721746	Grow More BioCozyme Quart	\$13.07
721748	Grow More BioCozyme Gallon	\$31.27

Grow More Mendocino Honey

Natural organic honey plus Montmorillinite, a source of over 70 trace elements. A naturally sweet carbohydrate plus organic carbon to stimulate growth. When used in a hydroponic system, it supplies a valuable source of organic carbon & carbohydrates.



Item No.	Description	MSRP
721627	Grow More Mendocino Honey Quart	\$13.76
721630	Grow More Mendocino Honey Gallon	\$28.87
721632	Grow More Mendocino Honey 2.5 Gallon	\$71.48

Grow More Seagrow All Purpose 16 - 16 - 16

A hybrid blend of botanical seaweed extract, blood meal, organic carbon, amino acids, carbohydrates, primary N-P-K plant foods, yucca extract and micronutrients. Recommended for indoor or outdoor growing situations.



Item No.	Description	MSRP
721650	Grow More Seagrow All Purpose 1.5 lb	\$8.20
721655	Grow More Seagrow All Purpose 5 lb	\$24.62
721660	Grow More Seagrow All Purpose 25 lb	\$85.31

Grow More Seagrow Flower & Bloom 4 - 26 - 26

A hybrid blend of botanical seaweed extract, blood meal, organic carbon, amino acids, carbohydrates, primary N-P-K plant foods, yucca extract and micronutrients. Recommended for indoor or outdoor growing situations.



Item No.	Description	MSRP
721665	Grow More Seagrow Flower & Bloom 1.5 lb	\$8.20
721670	Grow More Seagrow Flower & Bloom 5 lb	\$24.11
721675	Grow More Seagrow Flower & Bloom 25 lb	\$85.91

Grow More Water Soluble Grow 20 - 6 - 16 & Bloom 9 - 21 - 12

Formulated to supply sufficient amounts of extra nutrients for high yields. Water Soluble Grow is designed for cool temperature climates, dark weather or spring time, when plants need extra vigor and growth. Water Soluble Bloom, used as a two part with Water Soluble Grow, is complete with secondary and micro nutrients. Not for sale in the following states at this time: OR.



Item No.	Description	MSRP
721705	Grow More Water Soluble Grow 25 lb	\$63.95
721710	Grow More Water Soluble Bloom 25 lb	\$63.95

Grow More Water Soluble High Foss 10 - 52 - 10

Grow More Fertilizers are formulated to supply sufficient amounts of extra nutrients for high yields. High solubility, purity and the special forms of nitrogen, phosphorus and potassium make Grow More Fertilizers the ideal product. Great for flowers or perennials, it can increase and extend bud set and flowering. Also used for root development of young plants.



Item No.	Description	MSRP
721717	Grow More Water Soluble (10-52-10) 5 lb	\$15.79
721719	Grow More Water Soluble (10-52-10) 25 lb	\$65.95

Grow More Water Soluble Tomato 5 - 11 - 26

Grow More Fertilizers are formulated to supply sufficient amounts of extra nutrients for high yields. High solubility, purity and the special forms of nitrogen, phosphorus and potassium make Grow More Fertilizers the ideal product. Special soluble non-acidifying sulfur provides increase in chlorophyll formation and availability of potassium.



Item No.	Description	MSRP
721715	Grow More Water Soluble Tomato 25 lb	\$62.94

Grow More Water Soluble 20 - 10 - 20

High solubility, purity and the special forms of nitrogen, phosphorus and potassium make Grow More Fertilizers the ideal product. 20-10-20 is fast acting in foliar sprays or liquid fertilizer injector systems, designed for cool temperature climates when plants need extra vigor and growth. Contains 60% nitrate nitrogen, 40% ammoniacal nitrogen.



Item No.	Description	MSRP
721721	Grow More Water Soluble (20-10-20) 25 lb	\$52.99

Grow More Water Soluble General Purpose 20 - 20 - 20

Grow More Fertilizers are formulated to supply sufficient amounts of extra nutrients for high yields. High solubility, purity and the special forms of nitrogen, phosphorus and potassium make Grow More Fertilizers the ideal product. Water Soluble General Purpose is an all purpose, balanced, high analysis formula for all field or greenhouse grown ornamental or agricultural crops.



Item No.	Description	MSRP
721729	Grow More Water Soluble (20-20-20) 5 lb	\$12.95
721730	Grow More Water Soluble General Purpose 25 lb	\$52.25

Grow More Water Soluble Foliage Developer 30 - 10 - 10

Grow More Fertilizers are formulated to supply sufficient amounts of extra nutrients for high yields. High solubility, purity and the special forms of nitrogen, phosphorus and potassium make Grow More Fertilizers the ideal product. A high nitrogen formula for Spring and early Summer applications, it provides an early nitrogen boost for fast, healthy plant growth.



Item No.	Description	MSRP
721735	Grow More Water Soluble (30-10-10) 5 lb	\$11.59
721740	Grow More Water Soluble (30-10-10) 25 lb	\$45.99

Grow More Water Soluble Flower Hardener 0 - 50 - 30

Grow More Fertilizers are formulated to supply sufficient amounts of extra nutrients for high yields. High solubility, purity and the special forms of nitrogen, phosphorus and potassium make Grow More Fertilizers the ideal product. Water Soluble Hardener is designed for cool temperature climates, dark weather or spring time, when plants need extra vigor and growth.



Item No.	Description	MSRP
721712	Grow More Water Soluble (0-50-30) 5 lb	\$16.49
721714	Grow More Water Soluble (0-50-30) 25 lb	\$64.99

Grow More Kelp Meal 0 - 0 - 1.5

Grow More Kelp Meal is part of the Natural Organic Fertilizers line specifically designed for your organic growing needs. Kelp meal is an excellent source of natural occurring growth enhancers. It helps plant's resistance to cold. Not for sale in the following states at this time: OR.



Item No.	Description	MSRP
721775	Grow More Kelp Meal 3 lb	\$15.95
721780	Grow More Kelp Meal 10 lb	\$40.80

Grow More Flower & Bloom 3 - 6 - 6

Low nitrogen, slow release bloom formula. For use on all flowering plants. Gentle, no burning formula, recommended for hanging baskets, all types of annual and perennial flowers. Excellent when transplanting bulbs. Not for sale in the following states at this time: OR.

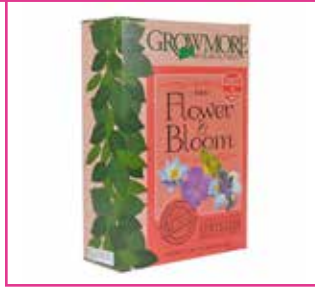

Item No.	Description	MSRP
721795	Grow More Flower & Bloom 4 lb	\$7.95
721800	Grow More Flower & Bloom 15 lb	\$22.85

Grow More Blood Meal

Combines fast release soluble nitrogen with slow release insoluble nitrogen for extended nitrogen uptake. Contains amino acids and trace amounts of phosphate.

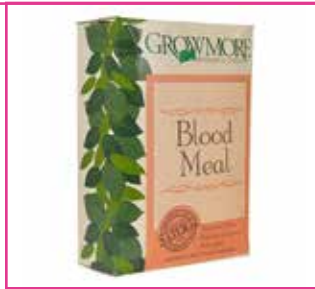

Item No.	Description	MSRP
721805	Grow More Blood Meal 3 lb	\$14.95
721810	Grow More Blood Meal 10 lb	\$25.95

Grow More Bone Meal 4 - 15 - 0

A natural source of phosphate. Readily available soluble phosphate combined with slow release insoluble phosphate. A great source of phosphate for the entire growing season.



Item No.	Description	MSRP
721815	Grow More Bone Meal 4 lb	\$8.96
721820	Grow More Bone Meal 15 lb	\$30.65

Grow More Triple Super Phosphate

Highly effective in preventing phosphate deficiencies. Works best when blended into soil environment, but can be top dressed for added phosphate needs. Not for sale in the following states at this time: OR.

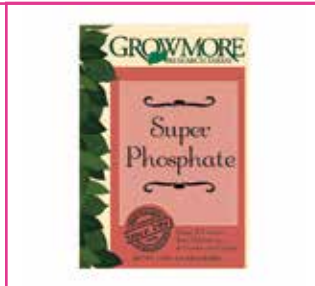

Item No.	Description	MSRP
721825	Grow More Triple Super Phosphate 4 lb	\$7.13
721830	Grow More Triple Super Phosphate 15 lb	\$23.62

Grow More Seabird Guano 10 - 10 - 1

A renewable source of quality ingredients. High in nitrogen and phosphorus. This seabird guano provides both solubility and immediately available nutrients in a slow release application. Not for sale in the following states at this time: OR.



Item No.	Description	MSRP
721750	Grow More Seabird Guano 3 lb	\$12.95

Grow More Fish Meal 4 - 0 - 0

A traditional source of nitrogen and phosphorus with a trace amount of potassium. Fish Meal will provide long lasting nutrition for your plants. Works well for compost tea blends at a tablespoon per gallon. Not for sale in the following states at this time: OR.



Item No.	Description	MSRP
721765	Grow More Fish Meal 3 lb	\$18.30

Grow More Dolomite Lime

Helps correct acidic soil environments. A great source of calcium and magnesium. Some people use the term soil sweetener. Not for sale in the following states at this time: OR.



Item No.	Description	MSRP
721845	Grow More Dolomite Lime 4 lb	\$6.60



HYDRODYNAMICS INTERNATIONAL INC

Since 1997, HydroDynamics International has been traveling the globe searching for the best horticultural products and technologies that have been proven to improve the quality and increase the yields of your favorite vegetables, herbs and flowers. Our dedicated team of horticultural professionals strive to make your crop growing adventures as successful and productive as possible, so that your efforts in turn produce flavorful and healthy herbs and produce for the body, as well as vibrant, fragrant flowers for the soul.

HydroDynamics Europonic Silicate

Europonic Silicate has 11% Silicon Dioxide, making it one of the strongest Silica products on the market. Silica helps to strengthen plants and increases resistance to environmental stresses including heat, drought and cold.



Item No.	Description	MSRP
718262	HydroDynamics Europonic Silicate Quart	\$15.95
718265	HydroDynamics Europonic Silicate Gallon	\$39.85
718267	HydroDynamics Europonic Silicate 2.5 Gallon	\$94.95
718270	HydroDynamics Europonic Silicate 5 Gallon	\$159.95

HydroDynamics Ionic Bloom 3 - 2 - 6

Ionic Bloom is for the reproductive and flowering stage of growing plants. It is enhanced with the crucial elements that support increased budding points and large, fragrant flowers. For best results use with Ionic Boost.



Item No.	Description	MSRP
718175	HydroDynamics Ionic Bloom Quart	\$18.00
718180	HydroDynamics Ionic Bloom Gallon	\$40.00
718185	HydroDynamics Ionic Bloom 2.5 Gallon	\$89.95
718190	HydroDynamics Ionic Bloom 5 Gallon	\$154.95

HydroDynamics Ionic Bloom Hardwater Formula 3 - 2 - 6

Ionic Bloom Hardwater is blended to be more acidic than standard Ionic Bloom to neutralize bicarbonates on its own. This reduces the amount of acid needed to control the pH in the reservoir & reduces possibility of acute phosphate accumulation.



Item No.	Description	MSRP
718200	HydroDynamics Ionic Bloom Hardwater Gallon	\$40.00
718205	HydroDynamics Ionic Bloom Hardwater 2.5 Gallon	\$89.95

HydroDynamics Ionic Grow 3 - 1 - 5

Specifically formulated for the green vegetative stage of growing plants. It is designed to maximize the potential for vigorous vegetative growth in green plants and during the vegetative cycle of flowering plants.



Item No.	Description	MSRP
718225	HydroDynamics Ionic Grow Quart	\$18.00
718230	HydroDynamics Ionic Grow Gallon	\$40.00
718235	HydroDynamics Ionic Grow 2.5 Gallon	\$89.95
718240	HydroDynamics Ionic Grow 5 Gallon	\$154.95

HydroDynamics Ionic Grow Hardwater Formula 3 - 1 - 5

Ionic Grow Hardwater is purposely blended to be more acidic than standard Ionic Grow. A more acidic nutrient solution will neutralise bicarbonates on its own.



Item No.	Description	MSRP
718250	HydroDynamics Ionic Grow Hardwater Gallon	\$40.00

HydroDynamics Ionic PK Boost 0 - 5 - 6

Ionic Boost delivers the key mineral elements phosphorus (P) and potassium (K) and these crucial ingredients are used in abundance by plants in their fruiting or flowering cycle.



Item No.	Description	MSRP
732255	HydroDynamics Ionic PK Boost Quart	\$18.00
732260	HydroDynamics Ionic PK Boost Gallon	\$40.00
732265	HydroDynamics Ionic PK Boost 2.5 Gallon	\$89.95

HydroDynamics Ionic Tote Starter Kit

Ionic Premium Plant Nutrients in the convenience of a triple pack. Each triple pack contains 1 quart of Ionic Grow, 1 quart of Ionic Bloom and 1 quart of Ionic Boost along product information card and feed schedule. Ionic Premium Plant Nutrients are full spectrum mineral solutions formulated through a series of chemical reactions.



Item No.	Description	MSRP
718170	HydroDynamics Ionic Starter Kit (3 Quarts)	\$49.95

HydroDynamics Europonic Rockwool Conditioning Solution

Europonic Rockwool Conditioning Solution is an advanced formulation of ingredients that stabilize rockwool for maximum nutrient utilization by the plants. Ideal for pre-conditioning rockwool and stonewool growing media products.



Item No.	Description	MSRP
732455	HydroDynamics Rockwool Conditioning Solution Quart	\$15.00
732460	HydroDynamics Rockwool Conditioning Solution Gallon	\$35.00

HydroDynamics Europonic Fossil Fuel

Fossil Fuel is created from the highest quality humic acids, which provide complex interactions with growing media to promote healthy soils and growing media which in turn helps to produce lush plant growth and expansive root systems.



Item No.	Description	MSRP
732220	HydroDynamics Europonic Fossil Fuel Quart	\$20.00
732225	HydroDynamics Europonic Fossil Fuel Gallon	\$42.00
732230	HydroDynamics Europonic Fossil Fuel 2.5 Gallon	\$100.00
732235	HydroDynamics Europonic Fossil Fuel 5 Gallon	\$160.00

HydroDynamics Europonic Nitrozime 0 - 4 - 4

Nitrozime Marine Algae Extract is a plant nutrient supplement derived exclusively from Ascophyllum Nodosum Seaweed and is 100% organic. Nitrozime enhances a plant's natural abilities with lush vegetation, earlier flowering and increased yields.



Item No.	Description	MSRP
732289	HydroDynamics Europonic Nitrozime 100 ml	\$10.00
732300	HydroDynamics Europonic Nitrozime Pint	\$40.00
732305	HydroDynamics Europonic Nitrozime Quart	\$75.00
732310	HydroDynamics Europonic Nitrozime Gallon	\$230.00

HydroDynamics Green Fuse Root Stimulator Concentrate

GreenFuse Root Stimulator is a plant biostimulator that serves as an organic catalyst. This synergy invigorates the natural root development in plants which in turn can facilitate healthier plants, larger yields and superior quality fruit and flower. GreenFuse Super Strength Concentrate has a phenomenal dilution rate of 15,000 to 1. Not for sale in the following states at this time: CA.



Item No.	Description	MSRP
732711	HydroDynamics Green Fuse ROOT Conc. 60 ml	\$50.00
732712	HydroDynamics Green Fuse ROOT Conc. 120 ml	\$80.00

HydroDynamics Green Fuse Growth Stimulator Concentrate

While not a fertilizer, GreenFuse Growth Stimulator serves as an organic catalyst that invigorates the natural growth cycle of plants which in turn can lead to healthier plants, larger yields and superior quality fruit and flower. GreenFuse Super Strength Concentrate has a phenomenal dilution rate of 15,000 to 1. Not for sale in the following states at this time: CA.



Item No.	Description	MSRP
732726	HydroDynamics Green Fuse GROW Conc. 60 ml	\$50.00
732727	HydroDynamics Green Fuse GROW Conc. 120 ml	\$80.00

HydroDynamics Green Fuse Bloom Stimulator Concentrate

GreenFuse Bloom Stimulator serves as an organic catalyst that invigorates the natural blooming cycle of plants which in turn leads to larger yields & superior quality fruits and flowers. For use in soil gardens, containers, & hydroponic gardens. GreenFuse Super Strength Concentrate has a phenomenal dilution rate of 15,000 to 1. Not for sale in the following states at this time: CA.



Item No.	Description	MSRP
732741	HydroDynamics Green Fuse BLOOM Conc. 60 ml	\$50.00
732742	HydroDynamics Green Fuse BLOOM Conc. 120 ml	\$80.00
732728	HydroDynamics Green Fuse BLOOM Conc. 300 ml	\$149.95

HydroDynamics Mother Plant A 2 - 0 - 0 & B 1 - 1 - 3

MotherPlant is a two-part nutrient formula that provides balanced nutrition for stock plants, whether grown hydroponically, in soilless mixes or soil. MotherPlant Nutrients will help your mother plants produce the most vigorous clones possible!



Item No.	Description	MSRP
732890	HydroDynamics Mother Plant A Quart	\$18.00
732891	HydroDynamics Mother Plant B Quart	\$18.00
732892	HydroDynamics Mother Plant A Gallon	\$44.95
732893	HydroDynamics Mother Plant B Gallon	\$44.95
732900	HydroDynamics Mother Plant A 2.5 Gallon	\$104.95
732902	HydroDynamics Mother Plant B 2.5 Gallon	\$104.95



Not only do we provide you with the best quality products, we also provide step-by-step instructions for how to get the most from your organic garden, developed through years of careful trial and error in our own gardens. Vital Earth's® products are used for an Eco-friendly way to improve crop production, soil health and nutrient uptake without the use of harsh chemical fertilizers and to promote a sustainable approach to agriculture.

Vital Earth's O.G. Seabird Guano Liquid Grow 4 - 3 - 4

This Vital Earth's liquid fertilizer is a special formula extracted from seabird guano, fish solubles & potassium sulfate. This unique blend is designed to give your plants nitrogen & other essential nutrients for vegetative growth.



Item No.	Description	MSRP
723320	Vital Earth's O.G. Seabird Guano Liquid Grow Quart	\$12.10
723330	Vital Earth's O.G. Seabird Guano Liquid Grow 2.5 Gallon	\$70.38
723335	Vital Earth's O.G. Seabird Guano Liquid Grow 5 Gallon	\$168.48

Vital Earth's O.G. Seabird Guano Liquid Bloom 2 - 5 - 0

This product is a special formula extracted from seabird guano, bone meal and kelp to give phosphorous and other essential nutrients to your fruiting and flowering plants. Enzymatically processed to achieve the most absorbable nutrients for your plants.



Item No.	Description	MSRP
723340	Vital Earth's O.G. Seabird Guano Liquid Bloom Quart	\$15.12
723350	Vital Earth's O.G. Seabird Guano Liquid Bloom 2.5 Gallon	\$87.98
723355	Vital Earth's O.G. Seabird Guano Liquid Bloom 5 Gallon	\$126.38

Vital Earth's Soluble Seaweed Extract 1 - 1 - 17

Vital Earth's Soluble Seaweed Extract 1-1-17 is an extract made from *Ascophyllum nodosum*, a marine plant exclusive to the North Atlantic. When used as directed, it has positive benefits to overall plant health, quality and nutrition.



Item No.	Description	MSRP
723555	Vital Earth's Soluable Seaweed Extract 3 lb	\$94.43
723560	Vital Earth's Soluable Seaweed Extract 15 lb	\$355.38

Vital Earth's PHC BioPak

Vital Earth's PHC Bio Pack is a unique, dry water soluble combination of natural humic substances, cold water kelp and a proprietary blend of beneficial bacteria.



Item No.	Description	MSRP
723485	Vital Earth's PHC Bio Pack 1 lb	\$48.79
723490	Vital Earth's PHC Bio Pack 5 lb	\$210.60

Vital Earth's High Nitrogen Bat Guano 9 - 3 - 1

First used in Peru centuries ago, bat guano continues to be in high demand for its high level of nitrogen, which is extremely helpful for the vegetative growth of plants. 100% bat guano with no additives & promotes intense growth.



Item No.	Description	MSRP
723405	Vital Earth's High Nitrogen Bat Guano 2.2 lb	\$19.57
723410	Vital Earth's High Nitrogen Bat Guano 22 lb	\$75.38

Vital Earth's High Phos Bat Guano 0 - 13 - 0

100% high phosphorous bat guano promotes intense fruiting and flowering. No additives. Known to be an effective fertilizer for centuries. Check your local Dealer Partner for availability.



Item No.	Description	MSRP
723415	Vital Earth's High Phos Bat Guano 4.4 lb	\$24.50
723420	Vital Earth's High Phos Bat Guano 22 lb	\$75.38
723425	Vital Earth's High Phos Bat Guano 44 lb	\$102.05

Vital Earth's High Nitrogen Bat Guano 11 - 4 - 2

Vital Earth's High Nitrogen Bat Guano 11 - 4 - 2 is rich in nitrogen. This special nitrogen mix promotes intense fruiting and flowering. Promotes improved crop yields.



Item No.	Description	MSRP
723460	Vital Earth's High Nitrogen Bat Guano 11-4-2 - 1.25 lb Bucket	\$17.12
723465	Vital Earth's High Nitrogen Bat Guano 11-4-2 22 lb	\$95.22

Vital Earth's Rose & Flower Mix 5 - 9 - 4

A superior blend of bat and seabird guanos for roses and all bulbs, flowering plants, trees, shrubs and vines. Designed to promote vigorous vegetative as well as flowering growth. Check your local Dealer Partner for availability.



Item No.	Description	MSRP
723385	Vital Earth's Rose & Flower Mix 44 lb	\$76.30

Vital Earth's High Phos Seabird Guano 0 - 11 - 0

This well balanced seabird guano is a perfect fertilizer to use for all your flowers, fruits, herbs and vegetables. Promotes intensive blooming and improved crop yields. All-natural organic fertilizer that is 100% guano. Check your local Dealer Partner for availability.



Item No.	Description	MSRP
723430	Vital Earth's High Phos Seabird Guano 4.4 lb	\$21.00
723435	Vital Earth's High Phos Seabird Guano 22 lb	\$47.05
723440	Vital Earth's High Phos Seabird Guano 44 lb	\$73.95

Vital Earth's All Purpose Seabird Guano 8 - 4 - 4

Vital Earth's All Purpose Seabird Guano 8 - 4 - 4 is a superior blend of 100% seabird guanos is yet another perfect fertilizer to use for all of your vegetating flowers, fruits, herbs and vegetables. Check your local Dealer Partner for availability.



Item No.	Description	MSRP
723470	Vital Earth's All Purpose Seabird Guano 4.4 lb	\$18.11
723475	Vital Earth's All Purpose Seabird Guano 22 lb	\$37.64
723480	Vital Earth's All Purpose Seabird Guano 44 lb	\$79.64

Vital Earth's Powdered Glacial Rock

This product replaces key soil elements, reversing soil depletion. An excellent source of readily available calcium, iron, magnesium & potassium plus trace elements and micronutrients. Increases phosphorus availability. Check your local Dealer Partner for availability.



Item No.	Description	MSRP
723495	Vital Earth's Powdered Glacial Rock 22 lb	\$21.79
723500	Vital Earth's Powdered Glacial Rock 44 lb	\$29.40

Actino-Iron 0-0-0

Actino-Iron is a unique granular soil additive that combines the Actinovate organic fungicide with organic iron and humates. It is used for controlling root diseases and providing long term greening. EPA Reg. No. 73314-2-AA.



Item No.	Description	MSRP
721510	Actino Iron 9 oz	\$10.59
721515	Actino Iron 3 lb	\$19.79

Microbe Life Photosynthesis Plus Beneficial Bacteria 0-0.05-0.09

Photosynthesis Plus enhances plant functions at the foliar level and the root zone in both soil and soilless substrates. Enhances photosynthesis and biological function by allowing plants to capture and utilize radiant energy more efficiently. Check your local Dealer Partner for availability. Not for sale in the following states at this time: CA, HI, MS, NM, OK, PR, SD.



Item No.	Description	MSRP
717500	Microbe Life Photosynthesis Plus Pint	\$16.95
717505	Microbe Life Photosynthesis Plus Quart	\$24.95
717510	Microbe Life Photosynthesis Plus Gallon	\$79.95
717515	Microbe Life Photosynthesis Plus 2.5 Gallon	\$179.95
717618	Microbe Life Plus-C Pint (CA Label)	\$16.95
717620	Microbe Life Plus-C Quart (CA & NM Label)	\$24.95
717625	Microbe Life Plus-C Gallon (CA & NM Label)	\$79.95
717501	Microbe Life Photosynthesis Plus-0 Pint (OR Label)	\$16.95
717506	Microbe Life Photosynthesis Plus-0 Quart (OR Label)	\$24.95
717511	Microbe Life Photosynthesis Plus-0 Gallon (OR Label)	\$79.95

WHAT IS MYCORRHIZAE ANYWAY?

A favorite research topic for the last decade has been the symbiosis between a plant root and beneficial fungus, called mycorrhizae. Mycorrhizae is the name of a widespread symbiotic (mutually beneficial) root relationship. The fungus helps the plant extract nutrients from the soil, and the plant repays the "kindness" with sugars produced by photosynthesis.

The "plant – mycorrhizae" team is perhaps nature's most successful long-term relationship. It allowed plants to move from their aquatic origins, over 460 million years ago, to the land, where they proliferate today. Mycorrhizae (myco-rise'-ee, plural form) expand plant roots, typically from 100– 1,000 fold, and can amplify nutrient and water extraction from rock itself! Who says you can't squeeze water from a rock - mycorrhizae can! And nutrients too!

The relationship is such a winner that over 90% of the world's plants form mycorrhizae in their native habitats. It is a big reason plants thrive in their native habitats without fertilizer, irrigation and pesticides. Now organic and hydroponic growers can benefit from this relationship by using National Garden Wholesale's mycorrhizal inoculants.

What are the benefits?

What does the mycorrhizal symbiosis do for the plant? One thing for sure is that mycorrhizal plants are far better than non-mycorrhizal plants at mining nutrients from the soil. The obvious result of better nutrition is better plant growth and improved yields. There are hundreds of published examples showing mycorrhizal plants growing significantly larger than non-mycorrhizal controls.

This "growth response" is only the most obvious benefit. Other benefits, while appearing unrelated to nutrition, may be caused by the improvement in phosphorus uptake. For example, plants with plenty of phosphorus are more resistant to water stress than plants low on phosphorus. Thus mycorrhizal plants have better tolerance of drought.

Many plant species are highly dependent upon mycorrhizae and thus have been difficult to work with in soilless and artificial growing media. This is primarily due to the lack of beneficial soil organisms in sterile media.

Intentional introduction of the missing beneficial microorganisms using National Garden Wholesale's mycorrhizal inoculants invariably makes the plant species easier to grow and leads to improved rooting and growth rate. Other benefits, not apparently growth related, include the ability of mycorrhizal fungi to actively promote healthier roots and improve the plant's tolerance for salts.

By Mike Amaranthus Ph.D for National Garden Wholesale®



Premium mycorrhizal inoculants

Plant Success Soluble Mycorrhizae

Plant Success Soluble is a soil drench for porous soil & contains 13 carefully selected mycorrhizal fungi, 2 trichoderma species & 17 bacterial species well-suited to a variety of soils, climates & plants. Plant enjoys improved nutrient & water uptake. Not for sale in the following states at this time: CT, HI, ID, IL, LA, MN, MS, OK, PR, SD.



Item No.	Description	MSRP
720300	Plant Success Soluble Mycorrhizae 4 oz	\$18.99

Plant Success Granular Mycorrhizae 3 - 1 - 2

Mycorrhizal granular inoculum consists of 10 carefully selected species of endomycorrhizae, ectomycorrhizae & trichoderma fungal species. Contains kelp meal, humus, vitamins & amino acids is also added to improve mycorrhizal germination & effectiveness. Not for sale in the following states at this time: HI, LA, MS, OK, PR, SD.



Item No.	Description	MSRP
720305	Plant Success Granular Mycorrhizae 1 lb	\$19.99
720307	Plant Success Granular Mycorrhizae 5 lb	\$89.99

Plant Success Orca Liquid Mycorrhizae

Orca is a highly concentrate mycorrhizal & beneficial bacteria product. Bringing together 4 highly effective endo mycorrhizal species with 11 super aggressive bacteria strains, this all-in-one inoculant is all you need when it comes to beneficials. Not for sale in the following states at this time: CT, HI, IL, LA, MN, MS, OK, PR, SD, WI.



Item No.	Description	MSRP
720350	Orca Liquid Mycorrhizae Pint	\$39.99
720355	Orca Liquid Mycorrhizae Quart	\$66.99
720360	Orca Liquid Mycorrhizae Gallon	\$234.99

Plant Success Jellyfish 2 - 2 - 6

Jellyfish root inoculant binds highly effective beneficials to your transplant roots and keeps them moist and fed in the critical establishment phase. Simply dip your roots into the blend of mycorrhizae, nitrogen fixing and beneficial bacteria, seaweed, humic acids and vitamin B1. Jellyfish will lessen transplant shock, feed your plant and ensure maximum beneficial establishment. Not for sale in the following states at this time: GA, HI, ID, IL, LA, MD, MN, MS, ND, NE, NM, NY, OK, OR, SD, WA, WI.



Item No.	Description	MSRP
720200	Plant Success Jellyfish 10 gm	\$3.99
720202	Plant Success Jellyfish 2 oz	\$17.99

Plant Success Mike O'Rizey

A beneficial soil organism inoculant that contains a diverse blend of mycorrhizal fungi that once established increase the surface area of your root system 100 - 1,000 times. This greatly increases the nutrients and water available to your plant. What results is a larger more robust plant. Not for sale in the following states at this time: CT, GA, HI, ID, IL, LA, MD, MN, MS, NC, ND, NE, NM, NY, OK, SD, UT, WI.



Item No.	Description	MSRP
720204	Plant Success Mike O'Rizey 4 oz	\$6.99
720206	Plant Success Mike O'Rizey 2 lb	\$42.99
720208	Plant Success Mike O'Rizey 5 lb	\$86.99
720210	Plant Success Mike O'Rizey 25 lb	\$390.00

Plant Success Great White Mycorrhizae

Great White is the most advance mycorrhizal product on the market today. The combination of mycorrhizae, beneficial bacteria, trichoderma and plant vitamins will give your plants a strong and developed root system. Not for sale in the following states at this time: CT, HI, IL, LA, MS, OK, PR, SD.



Item No.	Description	MSRP
720308	Great White Mycorrhizae 1 oz	\$13.99
720310	Great White Mycorrhizae 4 oz	\$39.99
720315	Great White Mycorrhizae 8 oz	\$71.99
720320	Great White Mycorrhizae Quart	\$244.99
720311	Great White Mycorrhizae 5 lb	\$495.99



Some companies use an assortment or 'cocktail' of mycorrhizae in their products. Ask for the types and the spore count and you will be directed to their supplier. The truth is that these companies often do not know much about what they are putting in their growing media products. At Premier Tech, we have been culturing endomycorrhizae for over 20 years. No other growing media company produces mycorrhizal fungi of any type.

Pro-Mix Pur Mycorrhizal

Pro-Mix Pur is an endomycorrhizal inoculant formulated on a powdered carrier. It contains Glomus intraradices, a beneficial mycorrhizal fungi which attach to and colonize root systems forming a symbiosis with plants. This vital fungus-plant alliance improves root development and plant vigor. Not for sale in the following states at this time: HI.



Item No.	Description	MSRP
713450	Premier Pro-Mix Pur-Mycorrhizal Powder 0.4 Dry Quart	\$47.99
713455	Premier Pro-Mix Pur-Mycorrhizal Granular 3.4 Dry Quart	\$47.99

NUTRIENTS & SUPPLEMENTS

MAXSEA

Maxsea combines the best of nature and technology. We blend the finest natural seaweed with important secondaries, micronutrients and the purest plant foods available. Professional growers and home gardeners alike tell us our Maxsea plant foods are the finest available anywhere. We're very proud of that.

Maxsea All Purpose Plant Food 16 - 16 - 16

Maxsea All Purpose Plant Food is designed for year round use on all plants, indoors and outdoors. A regular feeding program will promote vigorous, sturdy plants with distinct, dark, seaweed green foliage, quality blossoms and abundant fruit and vegetables. Not for sale in the following states at this time: FL.



Item No.	Description	MSRP
722250	Maxsea All Purpose Plant Food 1.5 lb	\$15.79
722255	Maxsea All Purpose Plant Food 6 lb	\$49.99
722260	Maxsea All Purpose Plant Food 20 lb	\$149.50

Maxsea Bloom Plant Food 3 - 20 - 20

Maxsea Bloom Plant Food is specially formulated to improve flowering, bud set, bud count, blossom quality, quantity and size on all flowering plants, as well as promoting abundant fruit and vegetable yields. Use Maxsea Bloom when flowering plants are beginning to set buds and continue to use throughout the blooming period. Not for sale in the following states at this time: FL.



Item No.	Description	MSRP
722265	Maxsea Bloom Plant Food 1.5 lb	\$15.79
722270	Maxsea Bloom Plant Food 6 lb	\$49.99
722275	Maxsea Bloom Plant Food 20 lb	\$149.50

Maxsea Acid Plant Food 14 - 18 - 14

Maxsea Acid Plant Food is especially formulated for all acid loving plants. Boosted with soil acidifiers and fast acting chelated iron and zinc, this formula will acidify alkaline soils and correct and prevent chlorosis. In addition to a regular feeding program for acid loving plants, this is an excellent formula to give ailing plants a boost. Check your local Dealer Partner for availability. Not for sale in the following states at this time: FL.



Item No.	Description	MSRP
722280	Maxsea Acid Plant Food 1.5 lb	\$15.79
722285	Maxsea Acid Plant Food 6 lb	\$49.99
722290	Maxsea Acid Plant Food 20 lb	\$149.50

VermaPlex®

Established in 1975, the makers of VermiPlex®, VermiTechnology Unlimited has become a leader in the vermicomposting/vermiculture industry. VermiTechnology Unlimited manufactures Pure Black Castings™ and other natural plant foods derived from worm castings. Supplying products that perform beyond consumer expectations at unbeatable prices, we have been satisfying wholesalers, distributors, retailers, growers and hobbyists throughout the United States.



VermaPlex

Apply VermaPlex as a drench or spray to your orchards & vineyards, agriculture & turf, gardens & nurseries and enjoy amazing results. For soil and soil-less gardening and needs no aeration! VermaPlex is a all natural organic specialty fertilizer that is derived entirely from 100% organic matter 1st processed by Pure Black Castings. It provides nutrients to the foliage. Check your Dealer Partner for availability.



Item No.	Description	MSRP
724200	VermaPlex Quart	\$15.95
724205	VermaPlex Gallon	\$37.95
724210	VermaPlex 2.5 Gallon	\$84.95
724212	VermaPlex 5 Gallon New!	\$164.95

VermaPlex Black Sea Kelp

Contains natural rooting hormones that improve root length, root mass and the efficiency of the root system. Black Sea Kelp stimulates root growth and beneficial microbe activity, allowing plants to absorb nutrients more efficiently. It is long lasting. 100% organic materials that is derived from sustainably-farmed seaweed. Check your Dealer Partner for availability. Not for sale in the following states at this time: OR.



Item No.	Description	MSRP
724215	VermaPlex Black Sea Kelp Quart	\$17.29
724220	VermaPlex Black Sea Kelp Gallon	\$39.95
724225	VermaPlex Black Sea Kelp 2.5 Gallon	\$93.95
724227	VermaPlex Black Sea Kelp 5 Gallon New!	\$174.95

VermaPlex Hydrolyzed Fish

Hydrolyzed Fish is a 100% organic fertilizer made from fish extracts. It's an excellent source of nitrogen, manganese, potash and essential trace elements. Hydrolyzed Fish feeds these microbes, stimulating their growth and increasing their population, making the soil healthier and more fertile. Check your Dealer Partner for availability. Not for sale in the following states at this time: OR.



Item No.	Description	MSRP
724245	VermaPlex Hydrolyzed Fish Quart	\$17.49
724250	VermaPlex Hydrolyzed Fish Gallon	\$46.49
724255	VermaPlex Hydrolyzed Fish 2.5 Gallon	\$96.29
724557	VermaPlex Hydrolyzed Fish 5 Gallon New!	\$174.95

VermaPlex Liquid Yucca

Liquid Yucca Extract is a 100% natural wetting agent derived from Yucca schidegera. Our Yucca Extract is cold-pressed for maximum biological activity. As a wetting agent, Yucca Extract can be added to almost any liquid fertilizer mix, as part of an overall fertilization program. Check your Dealer Partner for availability.



Item No.	Description	MSRP
724260	VermaPlex Liquid Yucca Quart	\$17.69
724265	VermaPlex Liquid Yucca Gallon	\$46.49
724270	VermaPlex Liquid Yucca 2.5 Gallon	\$101.95
724272	VermaPlex Liquid Yucca 5 Gallon New!	\$174.95

VermaPlex Liquid Humate Plus

Liquid Humate Plus contains naturally-occurring rooting hormones to increase root mass and root length, allowing plants to absorb nutrients more efficiently. Liquid Humate Plus feeds beneficial microbes, increasing soil fertility and stimulates root growth, allowing more efficient nutrient uptake. Contains composted organic poultry manure extract, an organic nitrogen source. Check your Dealer Partner for availability. Not for sale in the following states at this time: OR.



Item No.	Description	MSRP
724230	VermaPlex Liquid Humate Plus Quart	\$16.29
724235	VermaPlex Liquid Humate Plus Gallon	\$37.95
724240	VermaPlex Liquid Humate Plus 2.5 Gallon	\$87.95
724242	VermaPlex Liquid Humate Plus 5 Gallon New	\$164.95

Cascade Minerals

OMRI listed 100% natural volcanic basalt. A potent re-mineralizer that stays suspended within the soil allowing for optimum uptake. These minerals stimulate soil microbial activity improving function and structure. A dose of basalt minerals will greatly contribute to increased growth and vitality of plants. Check your local Dealer Partner for availability.



Item No.	Description	MSRP
715950	Cascade Minerals 10 lb	\$22.95
715955	Cascade Minerals 20 lb	\$31.95
715960	Cascade Minerals 44 lb	\$46.95

DYNA-GRO™

The Nutrition Solution®

Whether you're a hobbyist with a couple of houseplant's or a commercial grower with hundreds of acres, Dyna-Gro can provide a complete nutrition solution for your plants. Dyna-Gro Nutrition Solutions™ are "State of the art" formulas that supply all the essential minerals plants need for optimum growth. With Dyna-Gro Nutrition Solutions, you get more for your money and your plant's growth is strong and healthy.

Dyna-Gro Liquid Bloom 3 - 12 - 6

Liquid Bloom is a low nitrogen, high phosphorus complete nutrition formula specifically formulated to encourage the development of large vibrant blooms. It is ideal for roses, orchids, African violets and all other flowering plants. Check your local Dealer Partner for availability.



Item No.	Description	MSRP
719010	Dyna-Gro Liquid Bloom Quart	\$20.00
719015	Dyna-Gro Liquid Bloom Gallon	\$59.00
719017	Dyna-Gro Liquid Bloom 5 Gallon	\$275.00
719019	Dyna-Gro Liquid Bloom 15 Gallon	\$730.00

Dyna-Gro Liquid Grow 7 - 9 - 5

Liquid Grow is an all purpose complete nutrition formula used to promote both foliage and blooms. Ideal for poor, rocky soils, container grown plants and hydroponics. Excellent as a rapid cure for nutrient deficiencies. Check your local Dealer Partner for availability.



Item No.	Description	MSRP
719000	Dyna-Gro Liquid Grow Quart	\$20.00
719005	Dyna-Gro Liquid Grow Gallon	\$59.00
719007	Dyna-Gro Liquid Grow 5 Gallon	\$275.00

Dyna-Gro Pro-Tekt 0 - 0 - 3

Pro-Tekt The Silicon Solution a silicon supplement, supplies higher levels of potassium and silicon to build stronger plant walls. Pro-Tekt helps increase stem strength and leaf positioning, which improves photosynthesis. Check your local Dealer Partner for availability.



Item No.	Description	MSRP
719025	Dyna-Gro Pro-Tekt Quart	\$17.00
719030	Dyna-Gro Pro-Tekt Gallon	\$42.00
719035	Dyna-Gro Pro-Tekt 5 Gallon	\$215.00

Dyna-Gro Foliage-Pro 9 - 3 - 6

Foliage-Pro tropical foliage concentrate has the 3-1-2 NPK ratio recommended for foliage production. The 3-1-2 ratio of NPK results in greater mineral uptake by foliage plants, reducing harmful salt build-up and eliminating deficiencies. Outperforms all other fertilizers in low light environments.



Item No.	Description	MSRP
726548	Dyna-Gro Foliage-Pro Quart	\$18.95
726550	Dyna-Gro Foliage-Pro Gallon	\$55.95
726552	Dyna-Gro Foliage-Pro 5 Gallon	\$275.00

Dyna-Gro Mag-Pro 2 - 15 - 4

The high phosphorus, magnesium and sulfur content of this formula bring out color, fragrance and size in flowers, fruit and many vegetable crops. Growers using reverse osmosis, rain or deionized water benefit from the addition of Mag-Pro to their watering schedule.



Item No.	Description	MSRP
726549	Dyna-Gro Mag-Pro Quart	\$20.00
726551	Dyna-Gro Mag-Pro Gallon	\$59.00
726553	Dyna-Gro Mag-Pro 5 Gallon	\$275.00

THE GUANO COMPANY

The Guano Company produces high quality organic dry and liquid fertilizer. Made from bat guano, seabird guano, earthworm castings, soluble seaweeds, and natural compost; Super Tea Mix is great for vegetative, green growth and Budswel is designed for fruiting and flowering plants.

Budswel Dry 0 - 0.7 - 0

For fruiting and flowering plants. Easy to use! Just mix with water and broadcast lightly around roses or in flower beds. Contains earthworm castings, bat and seabird guano. Not for sale in the following states at this time: FL.



Item No.	Description	MSRP
720025	Budswel Dry 2 lb	\$25.95
720030	Budswel Dry 12 lb	\$135.95

Budswel Liquid 0.50 - 0.50 - 0.50

For fruiting and flowering plants. Easy to use! Just mix with water and broadcast lightly around roses or in flower beds. Contains earthworm castings, bat and seabird guano. Not for sale in the following states at this time: FL.



Item No.	Description	MSRP
720035	Budswel Liquid Gallon	\$41.95
720036	Budswel Liquid 5 Gallon	\$187.95

Super Tea Mix

Promotes general health and growth of houseplants and garden vegetables. This formula is ideal for seedlings - won't burn! Contains earthworm castings, bat and seabird guano.



Item No.	Description	MSRP
720040	Super Tea Dry 2 lb	\$25.95
720050	Super Tea Liquid Gallon	\$41.95

AmHydro

American Hydroponics provides state-of-the-art crop performance products and services for people to grow crops successfully, year round for pleasure and profit in any environment with an emphasis on conserving resources.

AmHydro Super Charger

Super Charger is a vitamin packed supplement consisting of a complex amalgam of vitamins, antioxidants, peptides and trace minerals. The ingredients present within Super Charger aid in the production of ATP, a form of plant energy.



Item No.	Description	MSRP
732950	Super Charger Capsules 0.35 oz	\$18.95

AmHydro Dark Energy 2 - 0 - 0

Dark Energy is a select blend of L-amino acids, specifically chosen for each of their beneficial effects on plant growth. It enhances the bloom stage of any plant by stimulating the natural production of ethylene, a flowering and ripening hormone. Check your local Dealer Partner for availability.



Item No.	Description	MSRP
732410	Dark Energy Pint	\$30.95
732415	Dark Energy Quart	\$50.95
732420	Dark Energy Gallon	\$144.95
732421	Dark Energy 2.5 Gallon	\$319.95
732422	Dark Energy 5 Gallon	\$599.95

AmHydro SuperNova Nutrient Additive 1 - 1 - 1

SuperNova is an Ascophyllum nodosum based nutrient additive, containing a wide range of macro and micro-nutrients, carbohydrates, amino acids and vitamins. The wetting agent in SuperNova makes it perfect for use as a foliar spray!



Item No.	Description	MSRP
732545	Super Nova Pint	\$26.95
732550	Super Nova Quart	\$39.95

EARTH JUICE

The Earth Juice product line now offers over 50 products for hand feeding and hydroponics. This includes liquids, granular and water-soluble powder fertilizers, beneficial microbes, fungus and pest controls and pH adjusters. Earth Juice has a host of "Good Things From the Land and Sea" that will bring the best out of every plant.

Earth Juice Rooters Mycorrhizae Endo/Ecto Blend

This special granular form, mycorrhizal blend can absorb organic forms of nutrients and promote green leaf growth, fruit and flower production while increasing drought and insect resistance.



Item No.	Description	MSRP
720325	Earth Juice Rooters Mycorrhizae 1 lb	\$13.39

Earth Juice Grow 2 - 1 - 1

Earth Juice Grow is a natural-organic liquid fertilizer that is formulated to encourage robust vegetative growth for a variety of indoor/outdoor foliage and flowering plants. Non-burning and no salt residue.



Item No.	Description	MSRP
718655	Earth Juice Grow Quart	\$13.15
718660	Earth Juice Grow Gallon	\$30.41

Earth Juice Bloom 0 - 3 - 1

A natural-organic liquid fertilizer formulated for blooming plants that will assist in the rich development of flowers, fruit and vegetables, as well as aid in the creation of essential oils, resins and fragrances.



Item No.	Description	MSRP
718680	Earth Juice Bloom Quart	\$13.15
718685	Earth Juice Bloom Gallon	\$30.41
718688	Earth Juice Bloom 2.5 Gallon	\$68.44
718695	Earth Juice Bloom 5 Gallon	\$123.15

Earth Juice Catalyst 0.03 - 0.01 - 0.10

A natural-organic molasses-kelp based liquid nutrient that aids plant growth and production. To be used as part of a complete fertilization program through all stages of plant development. Also functions as an excellent finishing formula for determinate plants.



Item No.	Description	MSRP
718705	Earth Juice Catalyst Quart	\$13.15
718710	Earth Juice Catalyst Gallon	\$30.41
718720	Earth Juice Catalyst 5 Gallon	\$123.15

Earth Juice Meta-K 0 - 0 - 5

A natural liquid potassium formulation for potassium deficient plants and those plants that require increased potassium. Recommended to apply prior to and during flowering/fruitletting to aid the plant's ability to support production.



Item No.	Description	MSRP
732835	Earth Juice Meta-K Quart	\$12.34
732840	Earth Juice Meta-K Gallon	\$28.58

Earth Juice Hi-Brix Molasses 0 - 0 - 3

Take your plants to the next level with this rare molasses. Hi-Brix MFP is a natural source of carbohydrates (sugars) and plant nutrients that has been specially tailored into liquid formulation for indoor and outdoor plants in soil and hydroponics.



Item No.	Description	MSRP
720444	Earth Juice Hi-Brix Molasses Pint	\$5.09
720446	Earth Juice Hi-Brix Molasses Gallon	\$14.49
720448	Earth Juice Hi-Brix Molasses 2.5 Gallon	\$31.49

Earth Juice Microblast

A proprietary liquid micronutrient formula designed to be used to prevent and/or correct micronutrient deficiencies. For use with Earth Juice Grow and Bloom Original Formulas as well as a variety of other liquid and dry soil and hydroponic fertilizers.



Item No.	Description	MSRP
732855	Earth Juice Microblast Quart	\$15.62
732860	Earth Juice Microblast Gallon	\$35.87

Earth Juice Sugar Peak Flowering 2 - 4 - 5

Formula is designed specifically to encourage the development of flowers, fruit and vegetables. For high production plants use the Sugar Peak Vegetative formula during growth period and at bud and flower set, switch to Sugar Peak Flowering.



Item No.	Description	MSRP
721905	Earth Juice Sugar Peak Flowering Quart	\$17.23
721910	Earth Juice Sugar Peak Flowering Gallon	\$39.64
721915	Earth Juice Sugar Peak Flowering 2.5 Gallon	\$89.18
721920	Earth Juice Sugar Peak Flowering 5 Gallon	\$160.54

Earth Juice Sugar Peak Grand Finale 0 - 6 - 4

A Finishing formula designed to help maximize the production of essential oils, resins, fragrances and yields of determinate flowering and fruiting plants.



Item No.	Description	MSRP
721930	Earth Juice Sugar Peak Grand Finale Quart	\$17.23
721935	Earth Juice Sugar Peak Grand Finale Gallon	\$39.64
721940	Earth Juice Sugar Peak Grand Finale 2.5 Gallon	\$89.18
721945	Earth Juice Sugar Peak Grand Finale 5 Gallon	\$160.54

Earth Juice Primal Harvest 0 - 12 - 1

This bloom guano has been naturally processed into a zero nitrogen and high phosphorous fertilizer that will aid in focusing the plant's energy on the production of flowers, fruit, vegetables, resins and fragrances and not on green-leafy growth.



Item No.	Description	MSRP
720222	Earth Juice Primal Harvest 5 lb	\$13.63
720225	Earth Juice Primal Harvest 20 lb	\$32.69

Earth Juice Bat Guano Grow 10-2-1

A tried and true fertilizer that has demonstrated to be a superior performing vegetative fertilizer. Very light flowing and mixes easily with most growing media.



Item No.	Description	MSRP
720263	Earth Juice Bat Guano 0.75 lb	\$5.98
720267	Earth Juice Bat Guano 3 lb	\$14.60

Earth Juice Rainbow Mix Grow 5-5-2

A finely-tuned dry-blend of natural-organic nutrients with multiple strains of beneficial Mycorrhizae plus Humic Acid, all professionally formulated for vigorous vegetative growth for a variety of indoor/outdoor plants.



Item No.	Description	MSRP
720282	Earth Juice Rainbow Mix Grow 5 lb	\$18.49
720286	Earth Juice Rainbow Mix Grow 20 lb	\$59.20

Earth Juice Rainbow Mix Bloom 1-9-2

A finely-tuned dry-blend of natural-organic ingredients with multiple strains of beneficial Mycorrhizae plus Humic Acid, all professionally formulated to encourage a profusion of flowers and abundant yields of fruit and vegetables for a variety of plants.



Item No.	Description	MSRP
720292	Earth Juice Rainbow Mix Bloom 5 lb	\$18.49
720296	Earth Juice Rainbow Mix Bloom 20 lb	\$59.20



EMERALD TRIANGLE HUMBOLDT COUNTY

Emerald Triangle, located in central Humboldt County in California, has become a major international source for hydroponics equipment and growth products. What sets Emerald Triangle apart from the rest of the industry is that our products are formulated for specific customers needs.

Emerald Triangle Killer Tea

Made from pure OMRI worm castings and the most potent seabird and bat guanos. The species of worm is critical for a high potency casting and the best by far is derived from African worms. No product on the market compares. Long shelf life, no need to aerate and no disgusting smell.



Item No.	Description	MSRP
739200	Emerald Triangle Killer Tea Gallon	\$35.95
739205	Emerald Triangle Killer Tea 2.5 Gallon	\$71.95

Emerald Triangle Snow Storm Ultra 0-0-3

The name says it all. This amino based product tricks the plant into thinking it's heat stressed. The result is intense resin, fragrance and flavor production plus the well known frosted look that growers love. Not another carbohydrate or sugar water product. Check your local Dealer Partner for availability.



Item No.	Description	MSRP
719942	Emerald Triangle Snow Storm Ultra 8 oz	\$15.95
719944	Emerald Triangle Snow Storm Ultra Quart	\$43.89
719946	Emerald Triangle Snow Storm Ultra Gallon	\$131.83
719948	Emerald Triangle Snow Storm Ultra 2.5 Gallon	\$263.67

Emerald Triangle Crystal Burst 0-15-15

One of the most potent liquid PK Boosts on the market. 50% stronger than the most popular brand yet it costs the same! Plus a healthy dose of vitamin B1 to help relieve stress caused by high performance bloom regimens.



Item No.	Description	MSRP
719650	Emerald Triangle Crystal Burst Quart	\$23.10
719655	Emerald Triangle Crystal Burst Gallon	\$69.30
719660	Emerald Triangle Crystal Burst 2.5 Gallon	\$137.50

Emerald Triangle Purple Maxx 0-0-3

Humboldt County's Own Purple Maxx is completely organic. It has been shown to improve essential oil production. Purple Maxx is an amino acid based cocktail that is a combination of organic compounds that encourages plants to stack their flowering sites closer together, producing more flowers. This additive is dye-free and incredibly versatile. Use it with soil or hydroponics growing, inside or outside.



Item No.	Description	MSRP
719905	Emerald Triangle Purple Maxx 8 oz	\$29.95
719910	Emerald Triangle Purple Maxx Quart	\$84.95
719915	Emerald Triangle Purple Maxx Gallon	\$249.95

Emerald Triangle Magnum

Magnum with Vitamin B1 is a potent magnesium supplement for preventing or treating the magnesium deficiency that often appears during bloom. Magnum will keep a plant's energy factories optimized and the B1 helps relieve the stress caused by high performance bloom formulations.



Item No.	Description	MSRP
739210	Emerald Triangle Magnum Quart	\$13.95
739215	Emerald Triangle Magnum Gallon	\$39.95
739220	Emerald Triangle Magnum 2.5 Gallon	\$79.90

Emerald Triangle Sonic Bloom 0 - 51 - 31

Sonic Bloom (Sunshine Powder) high PK booster contains 20 times the vitamin B1 of other popular boosts plus heavy doses of B2, B3, B6 that put this product in its own class. Increases the size and mass of flowers and stimulates resinous oil and fragrance production.



Item No.	Description	MSRP
719950	Emerald Triangle Sonic Bloom 1 lb	\$41.95
719955	Emerald Triangle Sonic Bloom 5 lb	\$136.95
719960	Emerald Triangle Sonic Bloom 10 lb	\$249.95

Emerald Triangle G 10 0 - 0 - 0.6

G 10 (Gravitation #10) started as our experimental substitute for Gravity but turned into something else. We've taken our original proprietary kelp extract to the next level. It's not Gravity - it's something MORE! Use with Sonic Bloom and Killer Tea for maximum finish. No PGR's.



Item No.	Description	MSRP
719665	Emerald Triangle G 10 Quart	\$58.45
719667	Emerald Triangle G 10 Gallon	\$166.00
719669	Emerald Triangle G 10 - 2.5 Gallon	\$375.00
719671	Emerald Triangle G 10 - 5 Gallon	\$667.00

Emerald Triangle Deep Breath

Veg and Pre-Bloom booster. Get CO2 like growth. Use in vegetative phase and then stop for the first 2 weeks of bloom, then pour it on while flowers finish elongating. Then switch over to G 10 for a powerful finish.



Item No.	Description	MSRP
719673	Emerald Triangle Deep Breath Quart	\$50.00
719675	Emerald Triangle Deep Breath Gallon	\$134.00
719677	Emerald Triangle Deep Breath 2.5 Gallon	\$300.00
719679	Emerald Triangle Deep Breath 5 Gallon	\$533.00

Maxicrop Liquid Fish 5 - 1 - 1

Made from fresh fish from the Atlantic Ocean and contains no chemical additives. It contains naturally occurring amino acids, as well as a huge complex of chelated minor elements (especially B vitamins). Many professional gardeners recommend the use of both Maxicrop Liquid Fish and Maxicrop Liquid Seaweed.



Maxicrop®

Item No.	Description	MSRP
718620	Maxicrop Liquid Fish Quart	\$8.50
718625	Maxicrop Liquid Fish Gallon	\$19.00

Maxicrop Liquid Seaweed Plus Iron 0.1 - 0 - 1

Contains 2% iron. It is a unique combination of pure seaweed extract with readily sequestered iron in an easy-to-use liquid form. This high iron formulated product, when sprayed directly onto foliage, or applied as a root drench will prevent yellowing (chlorosis) of leaves, especially in acid-low (calcifuge) plants.



Item No.	Description	MSRP
718615	Maxicrop Plus Iron Gallon	\$24.50

Maxicrop Original Soluble Powder 1 - 0 - 4

Natural product made from fresh Atlantic kelp. For trees, flowers, fruits and vegetables. Can be used for cuttings and rootings, outdoor plants, foliar feed, lawns, compost enhancer. Check your local Dealer Partner for availability.



Item No.	Description	MSRP
718595	Maxicrop Original Soluble Powder 10.7 oz	\$17.35

Maxicrop Original 0 - 0 - 1

Derived from seaweed. For trees, flowers, fruits and vegetables. Can be used for soaking seeds and bulbs before planting, ideal for houseplants, ideal for seedlings and cuttings. Check your local Dealer Partner for availability.



Item No.	Description	MSRP
718600	Maxicrop Original Liquid Seaweed Quart	\$9.65
718605	Maxicrop Original Liquid Seaweed Gallon	\$22.50
718592	Maxicrop Original Liquid Seaweed 2.5 Gallon	\$50.65



Neptune's Harvest is a division of Ocean Crest Seafoods Inc., Established in 1965 as a wholesale fish and seafood company. Still today, our Neptune's Harvest Organic Fertilizer gets made from fresh caught North Atlantic fish right on the docks of Gloucester, MA. Unlike a fish emulsion, our fertilizers are produced using a unique cold process "without cooking out all the good stuff". Best of all, it works great on everything that grows!

Neptune's Harvest Fish Fertilizer 2 - 4 - 1

Neptune's Harvest is an organic fertilizer made from fresh North Atlantic fish. It is made by a unique cold process that protects the vitamins, amino acids, enzymes and growth hormones. Neptune's Harvest retains the fish proteins and oils and has no unpleasant odor.



Item No.	Description	MSRP
717430	Neptune's Harvest Fish Fertilizer Quart	\$14.49
717435	Neptune's Harvest Fish Fertilizer Gallon	\$32.99

Neptune's Harvest Seaweed Fertilizer 0 - 0 - 1

Neptune's Harvest Seaweed Plant Food is an organic storehouse of over 60 naturally occurring major and minor nutrients and amino acids. It's growth promoting substances enhance plant development, color and vigor.



Item No.	Description	MSRP
717445	Neptune's Harvest Seaweed Fertilizer Quart	\$16.99
717450	Neptune's Harvest Seaweed Fertilizer Gallon	\$37.29

Neptune's Harvest Fish & Seaweed Fertilizer 2 - 3 - 1

Neptune's Harvest Organic Fish/Seaweed Blend Fertilizer gives you the best of both products with a perfect blend of fish hydrolysate and seaweed, ensuring a complete fertilization program. Growers using our fertilizer regularly have reported increased marketable yields.



Item No.	Description	MSRP
717460	Neptune's Harvest Fish & Seaweed Fertilizer Quart	\$17.49
717465	Neptune's Harvest Fish & Seaweed Fertilizer Gallon	\$43.69

Neptune's Harvest Kelp Meal 1 - 0 - 2

Neptune's Harvest Organic Kelp Meal is Ascophyllum Nodosum, which is widely recognized as one of the finest marine plants available. It is suitable for all crops and applications. Kelp Meal contains minerals, carbohydrates and amino acids.



Item No.	Description	MSRP
717475	Neptune's Harvest Kelp Meal 4 lb Bag	\$16.49
717480	Neptune's Harvest Kelp Meal 12 lb Pail	\$49.99
717485	Neptune's Harvest Kelp Meal 50 lb Bag	\$102.95

Neptune's Harvest Crab Shell 2 - 3 - 0

Neptune's Harvest Organic Crab Shell is an excellent dry organic source of NPK, Calcium and Magnesium. It will also help with nematode and fungus problems.



Item No.	Description	MSRP
717490	Neptune's Harvest Crab Shell 4 lb Bag	\$11.95
717495	Neptune's Harvest Crab Shell 50 lb Bag	\$73.95

Humboldt Nutrients is a different kind of nutrient company. We are a locally owned Humboldt County business, specializing in the world's best hydroponic, natural and organic nutrients, additives and gardening supplies. Our sole purpose is the customer and enabling our customers to take the gardening industry to the next level by providing the finest products available anywhere. We want to be known for having the finest line of products at affordable prices, with efficient distribution and outstanding customer service.



Humboldt Natural Bloom 0 - 10 - 0

Bloom Natural is an ultra-concentrated organic bloom formula designed to give your plants the large phosphorus and calcium boost needed during the flowering period. It induces an immediate flowering response in flowering plants.



Item No.	Description	MSRP
723052	Humboldt Natural Bloom Quart	\$26.32
723054	Humboldt Natural Bloom Gallon	\$93.60
723056	Humboldt Natural Bloom 2.5 Gallon	\$222.30

Humboldt Natural Grow 3 - 1 - 3

Grow Natural is a blend of soy protein powder, soft rock phosphate, potassium sulfate, organic zinc sulfate, magnesium sulfate, kelp & Alaska Peat extracts. The base ingredients will promote & facilitate the growth of beneficial bacteria & fungi.



Item No.	Description	MSRP
723044	Humboldt Natural Grow Quart	\$26.32
723046	Humboldt Natural Grow Gallon	\$93.60
723048	Humboldt Natural Grow 2.5 Gallon	\$222.30
723050	Humboldt Natural Grow 5 Gallon	\$421.20

Humboldt Nutrients Grow 2 - 1 - 6

Grow contains proprietary chelating agents that promote the availability and uptake of nutrients more efficiently than any competing three-part fertilizers.



Item No.	Description	MSRP
723000	Humboldt Nutrients Grow Quart	\$11.70
723002	Humboldt Nutrients Grow Gallon	\$29.84
723004	Humboldt Nutrients Grow 2.5 Gallon	\$65.52

Humboldt Nutrients Bloom 0 - 6 - 5

Bloom contains a proprietary, trademarked, Phosphorus booster which improves plant photosynthesis, metabolism, genetics and eventually crop quality and yield.



Item No.	Description	MSRP
723016	Humboldt Nutrients Bloom Quart	\$11.70
723018	Humboldt Nutrients Bloom Gallon	\$29.84
723020	Humboldt Nutrients Bloom 2.5 Gallon	\$65.52

Humboldt Nutrients Micro 5-0-1

Micro contains three separate chelating agents, triple insurance against nutrients falling out of solution or nutrient lock-out. Humboldt Nutrients Micro has all the micronutrients necessary to create healthy plants, strong aromas & large yields.



Item No.	Description	MSRP
723008	Humboldt Nutrients Micro Quart	\$15.80
723010	Humboldt Nutrients Micro Gallon	\$36.28
723012	Humboldt Nutrients Micro 2.5 Gallon	\$83.06

Humboldt Honey Hydro Carbs

Honey Hydro Carbs is an excellent source of carbohydrates which promotes and facilitates the growth of beneficial bacteria and fungi in your media and dramatically enhances the quality of any plant's fruit.



Item No.	Description	MSRP
723104	Humboldt Honey Hydro Carbs Quart	\$12.88
723106	Humboldt Honey Hydro Carbs Gallon	\$43.28
723108	Humboldt Honey Hydro Carbs 2.5 Gallon	\$93.60

Humboldt Honey Organic ES

Honey ES is a premium organic blend of cane molasses, yucca, quillaja, saponaria, amino acids, sea-plant extract and bentonite. The ES means Extra Strength. It increases brix levels by providing sugars to beneficial bacteria, fungi & your plants.



Item No.	Description	MSRP
723112	Humboldt Honey Organics ES Quart	\$23.40
723114	Humboldt Honey Organics ES Gallon	\$73.72
723116	Humboldt Honey Organics ES 2.5 Gallon	\$168.48

Humboldt Verde 16-1-2

It's Spanish for green. Verde creates lush, green colors and vigorous growth. It is a well-balanced growth supplement. This organically derived growth supplement increases root, stem and stalk structure, while boosting chlorophyll levels.



Item No.	Description	MSRP
723156	Humboldt Verde Quart	\$22.50
723158	Humboldt Verde Gallon	\$80.00
723162	Humboldt Verde 5 Gallon	\$360.00

Humboldt Sticky

Humboldt Sticky is a premier product that will give you phenomenal results. The state of the art binding agents present in Humboldt Sticky create a microscopic bond between your plant's leaves and your nutrient solution.



Item No.	Description	MSRP
724024	Humboldt Sticky 8 oz	\$11.10
724026	Humboldt Sticky Pint	\$18.50
724028	Humboldt Sticky Quart	\$30.00

Humboldt Deuce Deuce 0-0-22

Deuce Deuce is derived from sulfate of Potash, Pro-biotic Potassium and Ascophyllum Nodosum. Potassium aids plants in enzymatic function. It will also harden flowers.



Item No.	Description	MSRP
723168	Humboldt Deuce Deuce Quart	\$20.00
723170	Humboldt Deuce Deuce Gallon	\$70.00
723172	Humboldt Deuce Deuce 2.5 Gallon	\$165.00
723174	Humboldt Deuce Deuce 5 Gallon	\$314.00

Humboldt Nutrients Hydro Deuce 0-0-22

The high quality potassium used in our Deuce Deuce is now formulated in a lower viscosity (thickness) allowing this award winning formula to function without issue in your pumps and reservoirs.



Item No.	Description	MSRP
723234	Humboldt Hydro Deuce Quart	\$21.94
723236	Humboldt Hydro Deuce Gallon	\$76.28
723240	Humboldt Hydro Deuce 5 Gallon	\$344.20

Humboldt FlavorFul

FlavorFul contains electrolytes that stimulate and relax the plant cells, resulting in the smooth and consistent delivery of vitamins, minerals, nutrients and trace elements in soil and fertilizers.



Item No.	Description	MSRP
723076	Humboldt FlavorFul Quart	\$17.56
723078	Humboldt FlavorFul Gallon	\$58.50
723080	Humboldt FlavorFul 2.5 Gallon	\$134.56

Humboldt Nutrients Master A 4-0-3

Humboldt Nutrients Master A & B is a premium two-part amino acid-based fertilizer program designed for flowering plants. The amino acids and organic acid complexes makes all the macro and micro nutrients more available.



Item No.	Description	MSRP
723024	Humboldt Master A Quart	\$23.40
723026	Humboldt Master A Gallon	\$70.20

Humboldt Nutrients Master B 1-5-6

Humboldt Nutrients Master A & B is a premium two-part amino acid-based fertilizer program designed for flowering plants. The amino acids and organic acid complexes makes all the macro and micro nutrients more available.



Item No.	Description	MSRP
723034	Humboldt Master B Quart	\$23.40
723036	Humboldt Master B Gallon	\$70.20

Humboldt Myco Madness Soluble

Myco Madness is a bio-stimulant package that helps link the plant roots, organic matter and fertilizers of all types. Myco Madness helps plants improve nutrient and water uptake.



Item No.	Description	MSRP
723126	Humboldt Myco Madness Soluble 4 oz	\$26.00
723128	Humboldt Myco Madness Soluble 8 oz	\$50.00
723130	Humboldt Myco Madness Soluble 1 lb	\$90.00
723132	Humboldt Myco Madness Soluble 5 lb	\$400.00

Humboldt Myco Maximum Granular

Myco Maximum granular contains humic acids, organic fertilizer, 10 species of growth-enhancing mycorrhizal fungi, 19 strains of beneficial bacteria, 2 Trichoderma species, micronutrients, 11 time-released carbohydrates and 20 different amino acids.



Item No.	Description	MSRP
723134	Humboldt Myco Maximum Granular 8 oz	\$30.00
723136	Humboldt Myco Maximum Granular 1 lb	\$50.00
723138	Humboldt Myco Maximum Granular 5 lb	\$200.00

Humboldt Mayan MicroZyme

It is an organic & ecologically safe bacterial-enzymatic complex with 24 species of soil microorganisms that increases fertility while providing vital nutrients to plants & crops. It mineralizes nutrients, regulates nitrogen & builds soil organic matter. Check your local Dealer Partner for availability.



Item No.	Description	MSRP
723142	Humboldt Mayan MicroZyme 8 oz	\$32.00
723144	Humboldt Mayan MicroZyme Pint	\$55.00
723146	Humboldt Mayan MicroZyme Quart	\$96.50

Humboldt Prozyme

Prozyme is a concentrate made up of over 80 different beneficial enzymes. These enzymes will break down dead root mass, starches, carbohydrates and nutrients to make them readily available to the plant.



Item No.	Description	MSRP
723096	Humboldt Prozyme Quart	\$40.00
723098	Humboldt Prozyme Gallon	\$140.00
723100	Humboldt Prozyme 2.5 Gallon	\$340.00

Humboldt Hum-Bolt Humic

HUM-BOLT is a 8% Humic Acid which promotes high ion exchange capabilities, stimulates plant enzymes, increases beneficial organisms and acts as an organic catalyst.



Item No.	Description	MSRP
723086	Hum-Boldt Humic Quart	\$17.56
723088	Hum-Boldt Humic Gallon	\$58.50
723090	Hum-Boldt Humic 2.5 Gallon	\$134.56

Humboldt Sea Cal 2-0-0

Sea Cal is a highly concentrated growth enhancer and chelated calcium supplement that offers vital macro and micro nutrients in specific ratios during early plant development.



Item No.	Description	MSRP
723060	Humboldt Sea Cal Quart	\$34.00
723062	Humboldt Sea Cal Gallon	\$130.00
723064	Humboldt Sea Cal 2.5 Gallon	\$315.00
723066	Humboldt Sea Cal 5 Gallon	\$600.00

Humboldt Sea Mag 1-3-4

Sea Mag may be utilized for any type of vegetable, flower or herbs. Sea Mag is loaded with vital micro nutrients, plant hormones and B-vitamins. Sea Mag prevents and corrects any potential deficiencies.



Item No.	Description	MSRP
723068	Humboldt Sea Mag Quart	\$24.00
723070	Humboldt Sea Mag Gallon	\$80.00
723072	Humboldt Sea Mag 2.5 Gallon	\$190.00

Humboldt Big Up Powder 0-33-23

Big Up Powder is a premium amino chelated bloom booster. By introducing Big Up powder in the first week of flowering, you effectively flip the switch in your plant, sending it immediately into an intense flowering cycle.



Item No.	Description	MSRP
723150	Humboldt Big Up Powder 8 oz	\$30.00
723152	Humboldt Big Up Powder 1 lb	\$50.00
723154	Humboldt Big Up Powder 5 lb	\$200.00
723155	Humboldt Big Up Powder 10 lb	\$380.00

Humboldt Oneness 5-9-4

Oneness is the most advanced one part nutrient on the market. It is the perfect solution for the beginning gardener looking for experienced results. Oneness is formulated with over 30 different natural chelates.



Item No.	Description	MSRP
723178	Humboldt Oneness Quart	\$24.00
723180	Humboldt Oneness Gallon	\$85.08
723182	Humboldt Oneness 2.5 Gallon	\$195.00
723184	Humboldt Oneness 5 Gallon	\$365.00

Humboldt Nutrients Ginormous 0-6-16

Ginormous is the most advanced super-bloom booster on the market. Your vegetables and fruits will be larger, even gigantic or Ginormous with this additive.



Item No.	Description	MSRP
723186	Humboldt Ginormous Quart	\$30.00
723188	Humboldt Ginormous Gallon	\$100.00
723190	Humboldt Ginormous 2.5 Gallon	\$220.00
723192	Humboldt Ginormous 5 Gallon	\$410.00

Humboldt Nutrients Equilibrium 1-1-2

To reap a large bountiful harvest, your plants must receive the correct ratio of Ca to Mg throughout it's life cycle. Equilibrium Natural offers the ease of a one part Ca-Mg additive with the quality which has come to be associated with our products.



Item No.	Description	MSRP
723204	Humboldt Equilibrium Natural Quart	\$21.56
723206	Humboldt Equilibrium Natural Gallon	\$75.00
723208	Humboldt Equilibrium Natural 2.5 Gallon	\$178.12
723210	Humboldt Equilibrium Natural 5 Gallon	\$338.44

Humboldt Nutrients Royal Flush

Royal Flush is a salt-eliminating, finishing solution for all plants growing in soil, potting mixes, soil-less rooting media, hydroponics and other gardens. Royal Flush is applied to all of your favorite plants in the final weeks of bloom.



Item No.	Description	MSRP
723214	Humboldt Royal Flush Quart	\$14.50
723216	Humboldt Royal Flush Gallon	\$32.50

Humboldt Nutrients White Widow

White Widow is a Mycorrhizal powder containing an extremely high and diverse amount of mycological spores. With White Widow the speed and aggressiveness of your plant's root development is unprecedented.



Item No.	Description	MSRP
723222	Humboldt White Widow 1 oz	\$18.11
723224	Humboldt White Widow 2 oz	\$31.50
723226	Humboldt White Widow 4 oz	\$54.60
723228	Humboldt White Widow 8 oz	\$97.50
723230	Humboldt White Widow 1 lb	\$185.26

Humboldt Nutrients S.I. (Structural Integrity)

S.I.'s proprietary blend is formulated to instantly supply your root zone with the silicate needed to build strong, thick cell walls and cellular membranes, thus giving your plants the ability to hold heavier fruits and flowers.



Item No.	Description	MSRP
723252	Humboldt S.I. Structural Integrity Quart	\$24.00
723254	Humboldt S.I. Structural Integrity Gallon	\$85.05

Terpinator 0-0-4

Terpinator was created from years of researching naturally occurring plant compounds that are bio-osmotic potentiators. Through our patented scientific process your plants will utilize these compounds to enhance their production of Terpinoids and plant oil producing glands. These glands are brought to their maximum potential and size using Terpinator along with any nutrient program.



Item No.	Description	MSRP
749300	Terpinator 1 Liter	\$19.95
749305	Terpinator 4 Liter	\$66.95
749310	Terpinator 10 Liter	\$116.95
749315	Terpinator 24 Liter	\$266.95

Soil Sulfur

Soil Sulfur - 99.0% purity. Packaged in easy to use resealable pouch. Available in 2 lb and 4 lb pouches.



Item No.	Description	MSRP
704040	Soil Sulfur 2 lb	\$7.95
704045	Soil Sulfur 4 lb	\$12.49

Soil Sulfur Oregon Label

Soil Sulfur - 97% purity. Packaged in easy to use resealable pouch. Available in 2 lb. and 4 lb. pouches. Labeled for sale only in the state of Oregon. Not for sale in the following states at this time: AK, AL, AR, AZ, CA, CO, CT, DE, FL, GA, HI, IA, ID, IL, IN, KY, LA, MA, MD, ME, MI, MN, MO, MS, MT, NC, ND, NE, NH, NJ, NM, NV, NY, OH, OK, PA, RI, SC, SD, TN, TX, UT, VA, VT, WA, WI, WV, WY.



Item No.	Description	MSRP
704042	Soil Sulfur 2 lb (OR Label)	\$7.95
704047	Soil Sulfur 4 lb (OR Label)	\$12.49

Wholesome Sweetener Organic Molasses

Wholesome Sweeteners Fair Trade Certified Organic Molasses is a blackstrap molasses with a rich, full-bodied robust flavor that adds natural color. It is loaded with vitamins, minerals and trace elements and is a good source of iron, vitamin B6, potassium, calcium and magnesium.



Item No.	Description	MSRP
715500	Wholesome Sweetener Certified Organic Molasses Quart	\$13.95

Organic Nutrients Insect Frass 2-2-2

Insect Frass is 100% Organic plant food. Insect Frass naturally contains the nutrition plants require, beneficial micro-organisms and immediately plant-available source of Chitin. Chitin fortifies a plant causing an auto-immune response that signals a plant to produce natural toxins fending off its natural enemies.



Item No.	Description	MSRP
719460	Organic Nutrients Insect Frass 2 lb	\$26.95
719465	Organic Nutrients Insect Frass 5 lb	\$58.95
719470	Organic Nutrients Insect Frass 25 lb	\$169.95

Monterey Foli-Cal

This is a liquid calcium formulation based on 10% calcium acetate. Foli-Cal will correct calcium-deficiency disorders such as blossom end-rot on tomatoes, peppers, eggplant and bitter-pit in apples. Foli-Cal works on vegetables, tree and vine crops as well.



Item No.	Description	MSRP
704621	Monterey Foli-Cal Conc Pint	\$8.49
704622	Monterey Foli-Cal RTU Quart	\$8.99

Monterey Epsom Salts

Promotes bloom in roses and other flowering plants. Absorbed through the roots and foliage of plant. Epsom Salts is a source of Magnesium that is essential to plant development. It is required by plants to produce chlorophyll. It also helps plants absorb Phosphorus.



Item No.	Description	MSRP
704623	Monterey Epsom Salts 4 lb	\$14.99

Monterey Florel Brand Growth Regulator

This growth regulator stops the mess! Prevents fruit formation on Apple, Buckeye, Carob, Crab apple, Elm, Flowering Pear, Horse chestnut, Maple, Oak, Olive, Sour Orange, Sweet Gum/Liquidambar, Sycamore and many more. One application in the spring during full bloom, controls both leafy and dwarf mistletoe. Also used on greenhouse ornamentals. EPA Reg. No. 54705-8. Not for sale in the following states at this time: AK.



Item No.	Description	MSRP
704590	Monterey Florel Brand Growth Regulator Quart	\$27.25
704592	Monterey Florel Brand Growth Regulator Gallon	\$83.35
704594	Monterey Florel Brand Growth Regulator 2.5 Gallon	\$204.35

Vitamin Institute Superthrive

Now includes kelp which enhances SUPERthrive with nutrition from the sea. SUPERthrive World Champion activator, reviver, transplanter and grower. SUPERthrive is a non-toxic vitamin solution. Super Concentrated! 1 Tbsp per 15 Gallons! Not for sale in the following states at this time: ID.



Item No.	Description	MSRP
732810	Superthrive 2 oz	\$7.69
732815	Superthrive 4 oz	\$11.99
732820	Superthrive Pint	\$37.95
732823	Superthrive Quart	\$66.95
732825	Superthrive Gallon	\$192.95

Spray-N-Grow Coco-Wet

Add Coco-Wet to any Spray-N-Grow nutrient. Helps for better nutrient uptake. Coco-Wet is compatible with all foliar nutrients.



Item No.	Description	MSRP
732000	Coco-Wet 8 oz	\$8.95
732002	Coco-Wet Gallon	\$39.95

Spray-N-Grow

For earlier, larger, more plentiful blooms... more vibrant colors and greener plants... and larger, tastier harvests. Not a fertilizer or hormone, all-natural Spray-N-Grow is a unique, organic-based micronutrient complex.



Item No.	Description	MSRP
719050	Spray-N-Grow 8 oz	\$14.95

RX Green Solutions Axiom Harpin Protein

Axiom is derived from naturally occurring harpin proteins, proven to stimulate the plant's natural growth and defense systems. Harpin, the active ingredient, has been proven to increase plant yields and overall plant health. Use Axiom to boost overall plant growth, vigor and production and to aid in the management of disease. EPA Reg. No. 71771-3-89112. Not for sale in the following states at this time: CA.



Item No.	Description	MSRP
719496	RX Green Solutions Axiom Harpin Protein (3- .5 gm Packs)	\$9.99
719498	RX Green Solutions Axiom Harpin Protein (3- 2 gm Packs)	\$29.99
719500	RX Green Solutions Axiom Harpin Protein 2 oz Pack	\$99.99

NUTRIENTS & SUPPLEMENTS

Buried Treasure™

LIKE PIRATE GOLD FOR YOUR PLANTS

GUANO

BAT & SEABIRD

HIGH QUALITY NATURAL BAT & SEABIRD GUANO

Distributed exclusively by:

National Garden Wholesale
Sunlight Supply, Inc.
www.sunlightsupply.com

HydroRush Water Oxygenator



HydroRush is a safe and ready to use water treatment root growth stimulator. Fast growing bright white roots means better nutrient uptake for plants and faster yields. Not recommended for use after initial two weeks of bloom cycle.



#744090 ,744092 and 744094 for sale in CA only.

HydroRush™

Water Treatment for
Plants and Growing Systems
www.HydroRush.com

**Industry
exclusive**



Item No.	Description	MSRP
744075	HydroRush Water Oxygenator Quart	\$29.99
744080	HydroRush Water Oxygenator Gallon	\$89.99
744082	HydroRush Water Oxygenator 2.5 Gallon	\$199.99
744085	HydroRush Water Oxygenator 30 Gallon	\$1,999.99
744090	HydroRush Water Oxygenator Quart (CA Label) 	\$29.99
744092	HydroRush Water Oxygenator Gallon (CA Label) 	\$89.99
744094	HydroRush Water Oxygenator 2.5 Gallon (CA Label) 	\$199.99

Liquid Oxygen H2O2

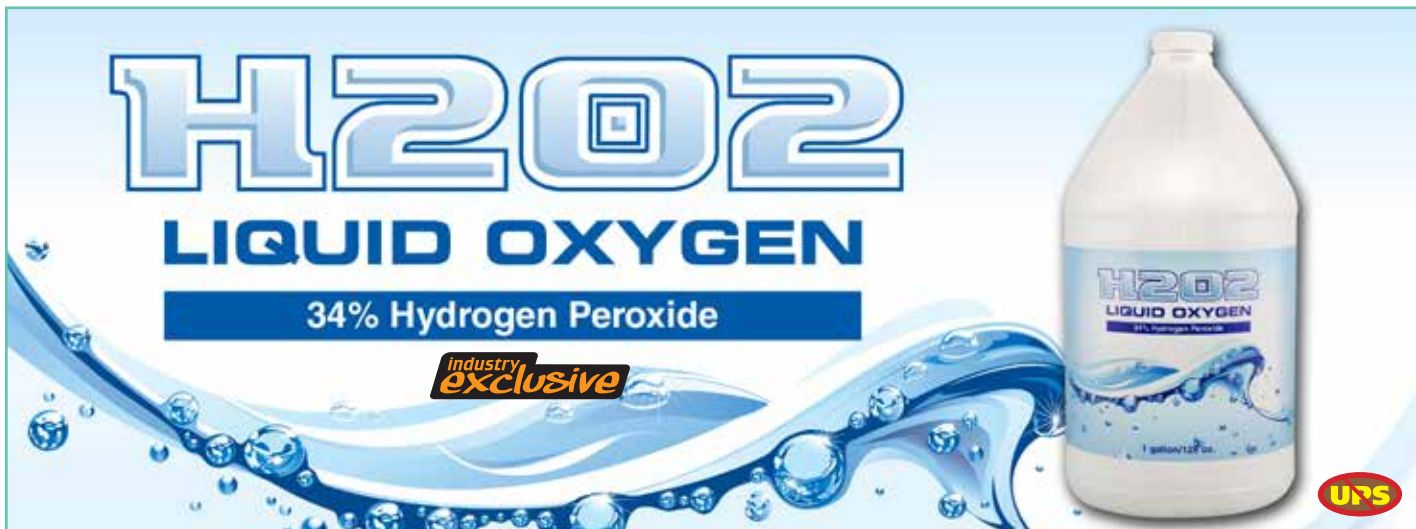



Liquid Oxygen H2O2 is composed of 34% Hydrogen Peroxide. Use with caution. Keep away from children. This product is excellent for cleaning hydroponic equipment, materials and grow areas. It is considered unlawful to sell, use or distribute this product in ways other than as claimed.

#704550 Not for sale in the following states at this time: CT, DE, IA, ID, IL, MD, MN, NE, NJ, NM, OR, PA, PR, SD, TN, VA, WI, WV, WY.

#704552 Not for sale in the following states at this time: AK, AL, AR, AZ, CA, CO, CT, FL, GA, HI, IA, ID, IL, IN, KS, KY, LA, MA, MD, ME, MI, MN, MO, MS, MT, NC, ND, NE, NH, NJ, NM, NV, NY, OH, OK, PA, PR, RI, SC, SD, TN, TX, UT, VA, VT, WA, WI, WV, WY.

#704555 Not for sale in the following states at this time: CT, DE, IA, ID, IL, MD, MN, NE, NJ, NM, OR, PA, SD, TN, VA, WI, WV, WY.

#704557 Not for sale in the following states at this time: AK, AL, AR, AZ, CA, CO, CT, DE, FL, GA, HI, IA, ID, IL, IN, KS, KY, LA, MA, MD, ME, MI, MN, MO, MS, MT, NC, ND, NE, NH, NJ, NM, NV, NY, OH, OK, PA, RI, SC, SD, TN, TX, UT, VA, VT, WA, WI, WV, WY.

Item No.	Description	MSRP
704550	H2O2 Liquid Oxygen 34% Gallon	\$32.99
704552	H2O2 Liquid Oxygen 34% Gallon (OR Label)	\$32.99
704555	H2O2 Liquid Oxygen 34% 5 Gallon 	\$129.95
704557	H2O2 Liquid Oxygen 34% 5 Gallon (OR Label) 	\$129.95

Nutrilife SM-90

The organic composition of SM-90 results in its ability to be bio-degradable and also non-toxic to humans, animals and plants. When added in small quantities directly to plant nutrient solutions, new root growth emerges.



Item No.	Description	MSRP
704490	Nutrilife SM-90 1 Liter	\$20.95
704495	Nutrilife SM-90 4 Liter	\$75.95
704496	Nutrilife SM-90 10 Liter	\$168.95
704498	Nutrilife SM-90 20 Liter	\$303.95

Z7 Water Conditioner

Z7 makes bad water great! Soil or hydro, bad water is the biggest problem facing growers today. Z7 eliminates root related problems fast! No more yellowing leaves, leaf curl, tip burn, slow growth, pH fluctuations, white mineral build up, brown slimy roots and slimy water tanks!



Item No.	Description	MSRP
704510	Z7 Water Conditioner for Soil & Hydroponics 8 oz	\$26.95
704515	Z7 Water Conditioner for Soil & Hydroponics Quart	\$72.95
704517	Z7 Water Conditioner for Soil & Hydroponics Gallon	\$185.95
704525	Z7 Water Conditioner for Soil & Hydroponics 2.5 Gallon	\$419.95
704527	Z7 Water Conditioner for Soil & Hydroponics 5 Gallon	\$779.95

GH FloraShield

Maintain healthy roots without resorting to harsh, toxic chemicals. FloraShield's unique combination of compounds can thoroughly rinse systems and plants during all phases of the life cycle.



Item No.	Description	MSRP
704030	GH FloraShield Quart	\$28.75
704035	GH FloraShield Gallon	\$80.50

Dutch Master Gold Zone 0.06 - 0 - 0.15

Zone ensures that your root system and environment are optimized so that your plants take up to 100% of what they need. Zone is specially formulated for use as a full time maintenance program outperforming everything in its class.



Item No.	Description	MSRP
719430	DutchMaster Gold Zone 1 Liter	\$26.95
719435	DutchMaster Gold Zone 5 Liter	\$93.95

Microbe Life Dechlorinator+

A full-function water conditioner that will neutralize chlorine, destroy chloramines, while adding essential electrolytes and alkalinity boosters (acid neutralizing). Formulated with R/O and UV sterilized water.

Not for sale in the following states at this time: PR.



Item No.	Description	MSRP
717673	Microbe Life Dechlorinator + Pint	\$9.95
717675	Microbe Life Dechlorinator + Quart	\$15.95
717680	Microbe Life Dechlorinator + Gallon	\$54.95
717685	Microbe Life Dechlorinator + 2.5 Gallon	\$103.95

Botanicare Hydroguard

Hydroguard's reformulation makes it even more effective than before. It's unique formula, contains an isolated form of Bacillus bacteria known as Bacillus Amyloliquefaciens. This scientifically isolated bacterium was selected for its superior ability to amplify root mass and vigor, especially in hydroponic gardening, when compared with the more common and well known Bacillus Subtilis species.



Item No.	Description	MSRP
704078	Botanicare Hydroguard Quart	\$31.00
704080	Botanicare Hydroguard Gallon	\$75.90
704082	Botanicare Hydroguard 2.5 Gallon	\$169.00
704084	Botanicare Hydroguard 5 Gallon	\$307.90

Botanicare AquaShield Compost Solution

AquaShield is useful throughout a plants life cycle in both soil gardens and hydrogardens utilizing aeroponics, deep water culture, ebb and flow and top water drip to create a natural and beneficial growing environment.



Item No.	Description	MSRP
704285	Botanicare AquaShield Quart	\$11.60
704287	Botanicare AquaShield Gallon	\$27.96
704290	Botanicare AquaShield 2.5 Gallon	\$62.36
704295	Botanicare AquaShield 5 Gallon	\$113.56

Scan now and make yourself a wish list of products to buy at a retailer near you!



AzaMax

AzaMax is a natural product with a broad spectrum of pest control. It does not use hard chemical solvents. It is an antifeedant and insect growth regulator which controls pests through starvation & growth disruption.

EPA No. 71908-1-AA-81268. Not sold in the following states at this time: PR.



Item No.	Description	MSRP
724464	AzaMax 4 oz	\$28.00
724470	AzaMax 16 oz	\$69.98
724475	AzaMax Quart	\$118.95
724477	AzaMax Gallon	\$372.99

Don't Bug Me

Don't Bug Me is a fast, effective solution for most common garden pests. Because its active ingredient is Pyrethrum, which is derived from chrysanthemum flowers, it can be applied up to the day of harvest on any fruit or vegetable.

#704085 EPA No. 1021-1705-AA-71996. Not sold in the following states at this time: NY.



Item No.	Description	MSRP
704085	FoxFarm Don't Bug Me 24 oz	\$13.95

Promis Insecticide

Promis, Aphid, Thrip and White Fly Killer **Industry exclusive** dissolved in water and applied to soil is absorbed by the roots. Once absorbed, it moves through the entire plant to protect against insects. This product also moves into and protects new growth after application. To control insects, the insecticide must distribute completely throughout the plant.

#704690 EPA No. 53883-275-89819.



Item No.	Description	MSRP
704690	Promis Insecticide Conc. Quart	\$48.95

Doktor Doom Total Release Fogger

A total release fogger for use in homeowner greenhouses, fruit and vegetable storage areas and indoor gardening areas. Used for controlling fungus gnats, spider mites, two-spotted spider mites, aphids, whiteflies, scale, mealy bugs and thrips.

#704400, 704405 EPA No. 72804-1-ZA. Not sold in the following states at this time: ND, PR.

#704410 EPA No. 72804-1. Not sold in the following states at this time: ND, PR.



Item No.	Description	MSRP
704400	Doktor Doom Fogger 3 oz	\$10.99
704405	Doktor Doom Fogger 5.5 oz	\$13.99
704410	Doktor Doom Fogger 12.5 oz	\$18.95

Doktor Doom Spider Mite Knock Out

Doktor Doom Spider Mite Knock Out is a 0.20% pyrethrin formula. Unlike soap based products which need to be applied liberally to the plant in order to drown the insects this product kills the pests on contact with just a light misting on the foliage.

#704415 EPA No. 2724-568-AA-72804. Not sold in the following states at this time: ND, PR.



Item No.	Description	MSRP
704415	Doktor Doom Spider Mite Knock Out Pint	\$15.99

Xtreme Gardening Kryptomite

Kryptomite is a 3-in-1 product: it kills mites/eggs, destroys powdery mildew and completely evaporates (no separate product to remove it!). Food-safe, non-phytotoxic. Use as a preventative or a sure-fire treatment start through harvest. The unique antioxidants inside also protect and preserve essential oils, ensuring you have the sweetest smelling flowers.

EPA No. FIFRA 25 (b)exempt.



Item No.	Description	MSRP
721380	Xtreme Gardening Kryptomite RTU Pint	\$24.95
721385	Xtreme Gardening Kryptomite RTU Gallon	\$39.95
721390	Xtreme Gardening Kryptomite RTU 2.5 Gallon	\$79.95

No Spider Mites Concentrate

Our No Spider Mites commercial **Industry exclusive** concentrate sizes are ideal for any grower with a large commercial spider mite infestation. Also works well for future preventive measures. 100% organic.



Item No.	Description	MSRP
704780	No Spider Mites Conc. Pint (Makes 5 Gal)	\$249.95
704785	No Spider Mites Conc. Quart (Makes 10 Gal)	\$395.95
704790	No Spider Mites Conc. Gallon (Makes 20 Gal)	\$649.95

No Spider Mites RTU

No Spider Mites **Industry exclusive** quickly and safely kills spider mites on plants. It is ideal for the hobbyist or commercial grower. 100% Organic. Our 16-ounce No Spider Mites size is perfect coverage to kill spider mites on up to six (6) 24 inch plants.



Item No.	Description	MSRP
704765	No Spider Mites RTU Pint	\$24.95
704770	No Spider Mites RTU Quart	\$39.95
704775	No Spider Mites RTU Gallon	\$99.95

No Powdery Mildew

No Powdery Mildew is your **industry exclusive** 100% safe & effective way to attack, control & prevent your powdery mildew outbreak immediately. It is a scientifically advanced, natural plant oil and extract technology that was developed with the most advanced nano surface technology that attacks the powdery mildew spores at the mycelium.



Item No.	Description	MSRP
739155	No Powdery Mildew Conc. Pint Dual Piston (Makes 5 Gal)	\$49.50
739160	No Powdery Mildew Conc. Quart (Makes 10 Gal)	\$89.50
739170	No Powdery Mildew Conc. Gallon Dual Piston (Makes 20 Gal)	\$159.50
739165	No Powdery Mildew RTU Quart	\$24.50

No Fungus Gnats

No Fungus Gnats is a **revolutionary, industry exclusive** 100% safe and effective organic nano particulate insect eliminator. Our patented process uses only natural plant oils and extracts in their tiniest of elemental forms which allows No Fungus Gnats advanced organic technology to eliminate all carbon based insects and their larvae anytime.



Item No.	Description	MSRP
739190	No Fungus Gnats RTU 32 oz	\$24.50
739195	No Fungus Gnats Conc Pint (Makes 5 Gal)	\$49.50

Nuke Em

This is a zero residue multi-purpose pesticide. Kills broad mites, spider mites, thrips, white fly, powdery mildew and more. Reduces mold and mildew. Meets state requirements for zero pesticide residues. OMRI listed formula comprised of 100% food grade ingredients.

Not sold in the following states at this time: IN, MS, NM, SD.



Item No.	Description	MSRP
704504	Nuke Em 8 oz	\$25.95
704506	Nuke Em Quart	\$56.96
704508	Nuke Em Gallon	\$176.95

Orange Guard Ornamental Insecticide - Concentrate

Food grade insecticide concentrate that is diluted for use. Kills and repels all known insects found on plants. Active ingredient derived from oranges.

#704300 EPA No. 61887-3-AA.



Item No.	Description	MSRP
704300	Orange Guard Gallon	\$39.95

Arborjet AzaSol

Broad Spectrum insect control derived from the Botanical Plant Neem. This patented product, is the only Neem based insecticide that is a 100% water soluble powder. AzaSol is an anti-feedant, repellent and insect growth regulator. It can be used on indoor and outdoor plants, food crops, trees, shrubs and turf and it can be applied through spray, drench, injection and more.

EPA No. 81899-4-AA. Not sold in the following states at this time: AL, AR, DC, DE, GA, IA, ID, LA, ME, MS, MT, ND, NM, OK, RI, SC, SD, UT, VT, WY.



Item No.	Description	MSRP
704980	Aza Sol Single Pack (30/Cs)	\$54.95
704985	Aza Sol Container	\$399.95

Arborjet Eco-Mite

A blend of botanical oils and extracts that provide a higher active ingredient concentration than similar products. Spray under the leaves where mites are present. Kills and repels mites and other insects. For large infestations, use on day 1, day 2 and then day 5 or 7. Then every 7-14 days after that.

EPA No. B(25) Exempt. Not sold in the following states at this time: AK, AL, AR, AZ, CT, IA, ID, KS, KY, LA, MD, ME, MS, MT, ND, NH, NM, NV, OK, PA, PR, RI, SC, SD, UT, VA, VT, WV, WY.



Item No.	Description	MSRP
704968	Arborjet Eco-Mite RTU Quart	\$22.95
704970	Arborjet Eco-Mite Quart (Makes 5 Gal)	\$78.95
704972	Arborjet Eco-Mite Gallon (Makes 20 Gal)	\$226.95

Arborjet Eco-PM

A blend of botanical oils and extracts that provide a higher active ingredient concentration than similar products. Data shows Eco-PM works better than similar products on the market. Spray on leaves and stem. Kills and repels disease. Use preventively for best results.

EPA No. B(25) Exempt. Not sold in the following states at this time: AK, AL, AR, AZ, CT, IA, ID, KS, KY, LA, MD, ME, MS, MT, ND, NH, NM, NV, OK, PA, PR, RI, SC, SD, UT, VA, VT, WV, WY.



Item No.	Description	MSRP
704974	Arborjet Eco-PM RTU Quart	\$22.95
704976	Arborjet Eco-PM Quart (Makes 5 Gal)	\$67.95
704978	Arborjet Eco-PM Gallon (Makes 20 Gal)	\$189.95

Whitmire 1600 X-Clude Formula 2

It is a microencapsulated, time release insecticide packaged in a ready-to-use aerosol canister. Effectively controls ants, aphids, beetles, fungus gnats, spider mites, mealybugs, whiteflies and more than 20 other target insects. Test spot recommended. Registered in all states.

#704568 EPA No. 499-539-AA. Not sold in the following states at this time: US Virgin Island.



Item No.	Description	MSRP
704568	1600 X-Clude Formula 2 - 20 oz	\$30.95

Whitmire Pro-Control Plus Total Release Aerosol Insecticide

Pro-Control Plus Total Release Insecticide is a ready-to-use, ultra low volume insecticide fogger that controls a wide variety of insects. Apply on bedding plants, cut flowers, flowering hanging baskets, foliage, potted flowering plants and ornamentals. Registered in all states.

EPA No. 499-462-AA.



Item No.	Description	MSRP
704595	Pro Control Plus TR 6 oz	\$11.95

Actinovate Fungicide

Actinovate microbe grows on the plant's roots & leaves, living off the plant's by-products. It attacks harmful disease causing pathogens. This natural product effectively suppresses & controls a wide range of foliar & root diseases.

EPA No. 73314-1-ZB.



Item No.	Description	MSRP
721500	Actinovate Fungicide 2 oz	\$21.09
721505	Actinovate Fungicide 18 oz	\$148.99

SNS 217 Mite Control RTU

Say good-bye to spider mites! SNS 217 and SNS 217C kills mites and their eggs. It is fully biodegradable and non toxic to animals.

#746003 Not sold in the following states at this time: AK, AR, DE, GA, IA, IN, KS, LA, MS, ND, NH, NM, OK, SC, SD, UT, WV, WY.

#746005 & 746007 Not sold in the following states at this time: AR, CT, DE, GA, IA, IN, KS, LA, MS, ND, NH, NM, OK, SC, SD, UT, WV, WY.



Item No.	Description	MSRP
746003	SNS 217 Mite Control RTU 14.5 oz	\$14.99
746005	SNS 217 Mite Control RTU Quart	\$24.99
746007	SNS 217 Mite Control RTU Gallon	\$90.00

SNS 244C Fungicide Concentrate

Kills fungus and mildew and is highly effective for the control of a broad spectrum of vegetable, fruit and ornamental plant fungal diseases.

#746074 Not sold in the following states at this time: AK, AL, AR, CT, DE, GA, IA, IN, KS, LA, MS, ND, NH, NM, OK, SC, SD, UT, WV, WY.

#746042, 746044, & 746046 Not sold in the following states at this time: AK, AL, AR, AZ, CT, DE, GA, IA, ID, IN, KS, LA, MD, MS, MT, ND, NH, NM, OH, OK, SC, SD, UT, WV, WY.



Item No.	Description	MSRP
746074	SNS 244C Fungicide Conc. 4 oz Pouch	\$8.99
746042	SNS 244C Fungicide Conc. Pint	\$24.00
746044	SNS 244C Fungicide Conc. Quart	\$40.00
746046	SNS 244C Fungicide Conc. Gallon	\$110.00

SNS 217C Mite Control Concentrate

Say good-bye to spider mites! SNS 217 and SNS 217C kills mites and their eggs. It is fully biodegradable and non toxic to animals.

Not sold in the following states at this time: AL, AR, CT, DE, GA, IA, IN, KS, LA, MS, ND, NH, NM, OK, SC, SD, UT, WV, WY.



Item No.	Description	MSRP
746072	SNS 217C Mite Control Conc. 1.5 oz Pouch	\$8.99
746010	SNS 217C Mite Control Conc. Pint	\$70.00
746015	SNS 217C Mite Control Conc. Gallon	\$350.00

SNS 244 Fungicide RTU

Kills fungus and mildew and is highly effective for the control of a broad spectrum of vegetable, fruit and ornamental plant fungal diseases.

Not sold in the following states at this time: AK, AL, AR, CT, DE, GA, IA, IN, KS, LA, MS, ND, NH, NM, OK, SC, SD, UT, WV, WY.



Item No.	Description	MSRP
746117	SNS 244 Fungicide RTU 14.5 oz	\$14.99
746025	SNS 244 Fungicide RTU Quart	\$24.99
746030	SNS 244 Fungicide RTU Gallon	\$60.00

SNS 203 Concentrate Pesticide Soil Spray/Drench

SNS 203 kills and repels fungus gnats, root aphids, thrips, shore flies and white flies. How it works: SNS 203 Concentrated Natural Pesticide active ingredients cause the pests to dehydrate and dry up the ingredients also attack fungus and algae to reduce the food source for the pests.

Not sold in the following states at this time: AK, AL, AR, CT, DE, GA, IA, IN, KS, LA, MS, ND, NH, NM, OK, SC, SD, UT, WV, WY.



Item No.	Description	MSRP
746068	SNS 203 Conc. Pesticide Soil Spray/Drench 4 oz Pouch	\$8.99
746035	SNS 203 Conc. Pesticide Soil Spray/Drench Pint	\$24.00
746040	SNS 203 Conc. Pesticide Soil Spray/Drench Gallon	\$110.00

SNS 209 Systemic Pest Control Concentrate

Safely and easily make your plants resistant to pests! SNS 209 All Natural Systemic Pest Control provides a barrier for plants to protect them against damaging insects.

Not sold in the following states at this time: AK, AL, AR, AZ, CT, DE, GA, IA, ID, IN, KS, LA, MD, ME, MS, MT, ND, NH, NM, OH, OK, PA, RI, SC, SD, UT, VA, WV, WY.



Item No.	Description	MSRP
746070	SNS 209 Systemic Pest Control Conc. 2 oz Pouch	\$8.99
746048	SNS 209 Systemic Pest Control Conc. Pint	\$24.00
746050	SNS 209 Systemic Pest Control Conc. Gallon	\$110.00

SaferGro Pest Out

Pest Out is a natural, organic miticide and insecticide that provides good control of pests, such as mites, thrips and aphids. Pest Out is a safe, long-lasting product that will protect your crops all season up to and including the day of harvest.

EPA No. FIFRA 25(b) Exempt.



Item No.	Description	MSRP
743615	SaferGro Pest Out RTU Quart	\$9.95

SaferGro Mildew Cure

Mildew Cure is a natural, organic fungicide that provides good control of powdery mildew on various crops and ornamentals. Mildew Cure is derived from garlic extracts and other essential oils, these active ingredients are food grade materials.

EPA No. FIFRA 25(b) Exempt.



Item No.	Description	MSRP
743600	SaferGro Mildew Cure Quart	\$22.95
743605	SaferGro Mildew Cure RTU Quart	\$9.95

GreenCure

GreenCure is a potassium bicarbonate-based, broad spectrum foliar fungicide that cures and prevents powdery mildew, black spot, downy mildew, botrytis blight, gray mold, anthracnose, rust and other mold, mildew and garden fungi related plant diseases. 8 oz makes approximately 16 gallons of formula.

EPA No. 70870-1-AA.



Item No.	Description	MSRP
704315	GreenCure 8 oz	\$16.95
704320	GreenCure 40 oz	\$68.95

SucraShield

SucraShield sugar-based Insecticide/Miticide/Ovicide provides fast and sure biochemical control on a wide range of soft-bodied problem pests in the greenhouse and nursery as well as fruits, nuts, mushrooms and vegetables.

EPA No. 70950-2-AA-84710. Not sold in the following states at this time: PR.



Item No.	Description	MSRP
704700	SucraShield Pint	\$32.95
704705	SucraShield Gallon	\$149.95

Liquid Ladybug

Liquid Ladybug is a bio miticide that employs organic botanical oils for controlling spider mite infestations on all indoor and outdoor plants and crops. It is designed to stop mite respiration and to rapidly evaporate away after application.



Item No.	Description	MSRP
704630	Liquid Ladybug RTU Pint	\$19.95
704635	Liquid Ladybug RTU Quart	\$34.95
704640	Liquid Ladybug RTU Gallon	\$99.95
704645	Liquid Ladybug Conc. Gallon	\$199.95

Sensor Yellow Monitoring Cards 50 Pack

Featuring superior, Posi-Trap glue, these durable, long-lasting pest monitoring and trapping cards are designed to catch a variety of pests, including winged aphids, leafminer adults, thrips, whiteflies, fungus gnat adults, shore flies, fruit flies, leafhoppers and other flying insects. The 3 in x 5 in Sensor Cards are packed in poly-bag and coated on both sides with non-drip glue that will not stick to skin.



Item No.	Description	MSRP
704560	Sensor Yellow Monitoring Cards 50/Pack	\$32.95

Sticky Whitefly Traps

The Sticky Whitefly Traps do the following things: Protect plants from whiteflies, aphids and other flying insects. Last all season, even in rain, until completely coated with insects. Non-poisonous and easy to use.



Item No.	Description	MSRP
704190	Sticky Whitefly Trap 3/Pack	\$122.95/case
704195	Sticky Whitefly Trap 5/Pack	\$6.39

Sticky Thrip Leafminer Traps

Protects plants from Thrips & Leafminers. Excellent protection for roses. Hang at plant level. Place traps every 7 ft apart or at end of each row. Lasts all season, even in rain, or until completely coated with insects or dust.



Item No.	Description	MSRP
704196	Stick Thrip Leafminer Trap 5/Pack	\$6.39

Yellow Sticky Ribbon Traps

The Yellow Ribbon Trap is a sticky, non-toxic double-sided tape that allows growers to monitor and control their flying pest infestations. The Yellow Ribbon Trap is 50 feet long by four inches wide and can be cut to any length.



Item No.	Description	MSRP
704564	Yellow Sticky Ribbon Traps - 50 ft Roll	\$21.99

Mosquito Dunks

Mosquito Dunks are formulated to release effective levels of BTI for a period of 30 days or more under typical environmental conditions. These dunks may be used in all types of containerized mosquito breeding areas.

EPA No. 6218-47-ZB.



Item No.	Description	MSRP
704650	Mosquito Dunks 2/Card	\$7.95
704655	Mosquito Dunks 6/Card	\$13.99

Mosquito Bits

The Mosquito Bits are now labeled to control Fungus Gnats in plant beds or pots! Utilizing a similar mode of action for control of mosquito larvae, the Bits, either sprinkled on the soils surface or mixed with potting soil prior to planting will kill fungus gnat larvae with the same safety and target specific control offered for mosquito larvae.

EPA No. 6218-73.



Item No.	Description	MSRP
704657	Mosquito Bits 8 oz	\$12.49
704659	Mosquito Bits 30 oz	\$18.99

Monterey Take Down Garden Spray

A ready-to-use insecticide containing natural pyrethrin plus canola oil. Use on vegetables, fruits, houseplants, ornamentals, etc. Controls aphids, beetles, mealy bugs, caterpillars, plant bugs, etc. Kills all stages of insects, including eggs.

#704603 EPA No. 67702-5-AA-54705. Not sold in the following states at this time: AR, DC, ND, SD, SD, WY.

#704604 EPA No. 67702-6-AA-54705. Not sold in the following states at this time: DC, IA, ND, OK, WY.



Item No.	Description	MSRP
704603	Take Down Garden Spray Pint	\$14.95
704604	Take Down Garden Spray RTU Quart	\$11.95

Monterey Neem Oil RTU

Ready to use (RTU) formulation for organic gardening. Has both fungicidal and insecticidal properties to control black spot, powdery mildew, spider mites, aphids, whitefly and more.

EPA No. 70051-13-AA-54705. Not sold in the following states at this time: AK, AR, DC, HI, LA, MA, ME, ND, RI, VT, WY.



Item No.	Description	MSRP
704609	Monterey Neem Oil RTU Quart	\$12.95

Monterey Insect Spray with Spinosad

For control of foliage feeding worms (caterpillars), thrips, fire ants and other listed pests in: Lawns, outdoor ornamentals, vegetables, apples, citrus and stone fruit. Contains spinosad, produced by fermentation. U.S. Patent Nos. 5,362,634 and 5,496,931.

EPA No. 62719-314-AA-54705. Not sold in the following states at this time: DC.



Item No.	Description	MSRP
704606	Insect Spray w/ Spinosad Pint	\$21.99
704607	Insect Spray w/ Spinosad Quart	\$36.99
704608	Insect Spray w/ Spinosad Gallon	\$118.99

Monterey B.t.

Ready to use (RTU) formulation for organic gardening. Has both fungicidal and insecticidal properties to control black spot, powdery mildew, spider mites, aphids, whitefly and more.

EPA No. 70051-106-54705. Not sold in the following states at this time: AK, CO, CT, DC, DE, HI, IA, ID, KY, MA, ME, MN, ND, NH, NV, NY, OH, RI, SD, VT, WV, WY.



Item No.	Description	MSRP
704596	Monterey B.t. Pint	\$12.99
704597	Monterey B.t. Gallon	\$89.99

Monterey 70% Neem Oil

A broad spectrum insecticide, miticide and fungicide that controls numerous diseases as well as insects and mites. Use on vegetables, fruit trees, ornamentals, etc. Neem is ideal for use in organic gardens.

EPA No. 70051-2-54705. Not sold in the following states at this time: LA.



Item No.	Description	MSRP
704613	Monterey 70% Neem oil Conc. Pint	\$22.99

Monterey Sluggo

Snail and slug control at its best. Sluggo contains iron phosphate and can be used around pets and wildlife. Use with vegetable gardens up until harvest and remains effective after rain or sprinkling. A pellet that breaks down into fertilizer! 1 lb covers up to 2,000 sq. ft.

#704598 EPA No. 67702-3-54705.



Item No.	Description	MSRP
704598	Monterey Sluggo 2.5 lb	\$18.99
704599	Monterey Sluggo 5 lb	\$31.99
704600	Monterey Sluggo 10 lb	\$62.99
704601	Monterey Sluggo 40 lb	\$196.99

Monterey Once A Year Insect Control II

This insecticide is used as a soil drench on ornamental trees, shrubs and certain fruit and nut trees. It controls adelgids, leaf beetles, leafhoppers, mealy bugs, scale, whiteflies, borers and many others. Gives a full year of control.

EPA No. 288-525-54705. Not sold in the following states at this time: AK, AR, DC, HI, IA, ND, NE.



Item No.	Description	MSRP
704616	Monterey Once A Year Insect Control II Quart	\$15.99
704617	Monterey Once A Year Insect Control II Gallon	\$47.99

Monterey Bi-Carb Old Fashion Fungicide

Potassium bicarbonate soluble powder for control of powdery mildew on roses, vegetables, grapes, fruit trees and ornamentals. Control powdery mildew the organic way. This is like the baking soda Grandma used.

EPA No. 54705-10. Not sold in the following states at this time: AK, AR, DC, ID, ND, NE, OK, WY.



Item No.	Description	MSRP
704618	Monterey Bi-Carb Old Fashion Fungicide 4 oz	\$10.99

ProZap Insect Guard

Kills flying and crawling insect pests including mosquitoes, flies, moths and spiders. This is long lasting, round the clock protection. Simply remove from package to activate Prozap and begin controlling action.

EPA No. 5481-533-AA-47000. Not sold in the following states at this time: CT, DC, ME, PR, RI.



Item No.	Description	MSRP
704545	ProZap Insect Guard	\$17.95

Serenade Garden Disease Control

Controls bacterial spot, powdery mildew, rust, gray mold, leaf blight, scab & more. Safe for gardeners to use as a natural, broad spectrum, effective fungicide that controls harmful diseases. Concentrate is 1 oz per gallon. Registered in all states.

#704341 EPA No. 69592-16-AA.

#704345 EPA No. 69592-12-ZA.



Item No.	Description	MSRP
704341	Serenade Garden RTU Quart	\$11.29
704345	Serenade Garden Conc. Quart	\$22.99

Tree Tanglefoot Pest Barrier

Tree Tanglefoot Pest Barrier is effective against crawling insects who must reach the tops of trees in order to feed, mate or deposit eggs. As the insects climb up over the sticky material, they become trapped without escape.



Item No.	Description	MSRP
704675	Tree Tanglefoot Pest Barrier 6 oz	\$8.99

Organocide Organic Insecticide

A nature-safe, organic spray oil effective on a wide variety of insects, mites, armored and soft scales and certain fungal diseases. It is insecticidal to the eggs, larvae, and nymphs of insects and adults of soft bodied insects. Dilution Rate: Mix 2 oz with 1 gallon of water.

EPA No. FIFRA 25(b) Exempt.



Item No.	Description	MSRP
704100	Organocide Conc. Quart	\$20.99
704102	Organocide RTU 24 oz	\$13.99

Safer End ALL Insect Killer

Kills over 45 different types of insects indoors and out. Wipes out insects & eggs with the combined killing power of pyrethrin & neem oil. Can be used up to day of harvest. For use on fruits, vegetables, flowers, trees & ornamentals.

EPA No. 59913-14-AA. Not sold in the following states at this time: PR.



Item No.	Description	MSRP
704156	Safer End All Insect Killer RTU Quart	\$11.19

Safer Yard & Garden Insect Killer

An environmentally friendly solution. Kills insects on contact, gentle on plants. Use on flowers, vegetables, shrubs and ornamentals. Use up to day of harvest. Potassium salts (insecticidal soap) weaken the insect's protective outer shell. Registered in all states.

EPA No. 59913-10-ZH.



Item No.	Description	MSRP
704105	Safer Yard & Garden Insect Killer RTU	\$10.99

Safer Insect Killing Soap

Use on houseplants, ornamental foliage plants, flowering plants and fruits and vegetables. Kills aphids, mealy bugs, spider mites and whiteflies. Check your local dealer partner for availability.

- #704115 EPA No. 42697-59-ZF.
- #704116 EPA No. 42697-60-ZB.
- #704117 EPA No. 42697-60.



Item No.	Description	MSRP
704115	Safer Insect Killing Soap w/ Seaweed Extract II RTU	\$10.99
704116	Safer Insect Killing Soap II Conc.	\$15.39
704117	Safer Insect Killing Soap II Conc. Gallon	\$79.98

Safer Garden Fungicide

Can be used on fruits, flowers, vegetables, flowering plants and ornamentals. Controls and prevents black spot, rust, leaf spot and powdery mildew on roses. Contains sulfur. Registered in all states.

- #704140 EPA No. 59913-11-ZC.
- #704141 EPA No. 42697-37-ZD.



Item No.	Description	MSRP
704140	Safer Garden Fungicide II RTU Quart	\$10.99
704141	Safer Garden Fungicide Conc. Pint	\$15.29

Safer 3-in-1 Garden Spray II

Provides three garden solutions in one: fungicide, insecticide, miticide. Its formulation kills garden insects and mites and controls fungal diseases. Registered in all states.

- #704145 EPA No. 59913-12-ZD.
- #704147 EPA No. 59913-13.



Item No.	Description	MSRP
704145	Safer 3-in-1 Garden Spray II RTU Quart	\$11.39
704147	Safer 3-in-1 Garden Spray Conc. Gallon	\$79.98

Safer BioNEEM Insecticide & Repellent

Neem Oil insect control for bedding, potted plants, trees & shrubs, lawns, yard & landscape, house plants, vegetable & fruit crops. Unique insecticide and repellent that controls over 30 common insect pests. Use on trees, shrubs, ornamentals and flowers. Registered in all states.

EPA No. 70051-6-ZA-42697.



Item No.	Description	MSRP
704150	Safer BioNeem Multi-Purpose Insecticide Conc. Pint	\$20.95

Safer Caterpillar Killer for Trees, Shrubs & Vegetables

Safer Brand Caterpillar Killer utilizes Dipel which, once ingested by the wayward caterpillar or worm, kills them within a few days. This insect killer is the most economical and natural pest control solution to caterpillars and worms on the market!

- #704155 EPA No. 42697-23-ZG.
- #704154 EPA No. 42697-23.



Item No.	Description	MSRP
704155	Safer Caterpillar Killer Conc. 8 oz	\$15.95
704154	Safer Caterpillar Killer Conc. Gallon	\$177.99

Safer Pyrethrin & Insecticidal Soap Concentrate II

Safer Brand Insecticidal Soap and Pyrethrin Concentrate can be used in your organic farm without sacrificing certification. One bottle makes 25 gals (treats up to 14,000 sq. ft.) of solution to eliminate hard and soft bodied insects on contact! Check your local dealer partner for availability.

EPA No. 59913-9. Not sold in the following states at this time: AK, HI, NM, PR.



Item No.	Description	MSRP
704138	Safer Pyrethrin & Insecticidal Soap II Conc. Gallon	\$82.99

Bonide Captain Jack's Dead Bug Brew

Captain Jack's Deadbug Brew contains Spinosad, a product first isolated from a naturally occurring soil dwelling bacterium. Use on fruits, vegetables, berries, citrus, grapes, nuts and ornamentals.

EPA No. 4-472-AA. Not sold in the following states at this time: AK, HI, PR.



Item No.	Description	MSRP
704715	Bonide Captain Jack's Dead Bug Brew RTU Quart	\$9.93
704720	Bonide Captain Jack's Dead Bug Brew Conc. Pint	\$20.29
704725	Bonide Captain Jack's Dead Bug Brew Conc. Quart	\$31.99

Bonide Thuricide (BT)

BT Kurstaki 15% is a liquid formulation of bacteria. Controls caterpillars, loopers, cabbage worms, horn worms, leaf folders and leaf rollers. One pint treats up to 10,875 sq. ft. Won't harm beneficial insects.

Not sold in the following states at this time: CA, DC, PR.



Item No.	Description	MSRP
704740	Bonide Thuricide (BT) Conc. Pint	\$18.62

Bonide Pyrethrin Garden Insect Spray

Natural Pyrethrin in a concentrated formula for economical, natural, broad spectrum garden insect control.

Not sold in the following states at this time: CA, DC, PR, SD.



Item No.	Description	MSRP
704745	Bonide Pyrethrin Garden Insect Spray Conc. 8 oz	\$15.49
704750	Bonide Pyrethrin Garden Insect Spray Conc. Pint	\$24.99

Bonide Systemic Insect Control

Economical, long lasting insect control for ornamental gardens, shrubs and trees. Use as little as 1 tablespoon/gal.

Not sold in the following states at this time: AK, CA, HI, PR.



Item No.	Description	MSRP
704760	Bonide Systemic Insect Control Conc. Pint	\$20.45

Liquid Fence Deer & Rabbit Repellent

Our eco-friendly repellent will stop deer and rabbits from eating your garden areas, flowers, shrubs, ornamental plants, trees and vines. Best of all, this easy-to-use, long-lasting spray is safe to use around your family and pets, so you can use it worry-free.

EPA No. FIFRA 25(b) Exempt. Not sold in the following states at this time: NM.



Item No.	Description	MSRP
704175	Liquid Fence Deer & Rabbit Repellent Conc. Quart	\$42.95
704185	Liquid Fence Deer & Rabbit Repellent Conc. 40 oz	\$45.95
704170	Liquid Fence Deer & Rabbit Repellent RTU 1 Gallon	\$28.95

Orcon Beneficial Insect Mail-Backs



Insects via Mail-Back gives your customers delivery of fresh live beneficial insects to home or job site. Choose from: Delphastus Pusillus, Trichogramma, Green Lacewings, Cryptolaemus, Encarsia Formosa, Predatory Mites, Ladybugs, Beneficial Nematodes or Earthworms.

Item No.	Description	MSRP
733582	Orcon Delphastus Pusillus Mail- back	\$41.99
733584	Orcon Trichogramma Mail- back	\$19.99
733586	Orcon Green Lacewig Mail- back	\$19.99
733588	Orcon Cryptolaemus Mail- back	\$41.99
733590	Orcon Encarsia Formosa Mail- back	\$41.99
733592	Orcon Predatory Mites Mail- back	\$54.99
733594	Orcon Ladybugs Mail- back	\$19.99
733596	Orcon Beneficial Nematodes Mail- back	\$33.39
733598	Orcon Earthworms Mail- back	\$19.99

Perma-Guard Diatomaceous Earth - Food Grade

Perma-Guard OMRI certified Diatomaceous Earth is the purest food grade fresh water amorphous silica diatomaceous earth available. Perma-Guard is derived from fossilized diatoms remains. Perma-Guard is OMRI certified food grade which allows it to be used on food crops through harvest and is safe for human consumption.

#704092 & 704096 Not sold in the following states at this time: AK, CT, DE, HI, KY, LA, MA, MD, ME, MS, ND, NH, NJ, PR, RI, SC, SD, VT, WV, WY.

#704094 & 704098 Not sold in the following states at this time: AK, CT, DE, HI, LA, MA, MD, ME, MS, ND, NH, NJ, PR, RI, SC, SD, VT, WV, WY.



Item No.	Description	MSRP
704092	Perma Guard Diatomaceous Earth OMRI Food Grade 2 lb	\$10.95
704094	Perma Guard Diatomaceous Earth OMRI Food Grade 5 lb	\$17.95
704096	Perma Guard Diatomaceous Earth OMRI Food Grade 10 lb	\$27.95
704098	Perma Guard Diatomaceous Earth OMRI Food Grade 50 lb	\$37.95

Microbe-Lift BMC - Biological Mosquito Control

Microbe-Lift/BMC kills developing mosquitoes before they become breeding, biting adults. It is a liquid product, so it has no adverse effect on the aesthetics of ponds and water features. Microbe-Lift/BMC can be applied to areas that can contain aquatic life, fish and plants. It can also be applied to areas used by or in contact with humans, animals, horses, livestock, pets, birds or wildlife. 2 oz treats 400 gallons for 2 years. 6 oz treats 2,000 gallons for 16 months.



EPA No. 62637-1-7466.

Item No.	Description	MSRP
717497	Microbe-Lift BMC 2 oz	\$20.99
717499	Microbe-Lift BMC 6 oz	\$26.83

Pure Kapow

Kills all leaf dwelling insects on contact as well as Mildew and molds. No beneficial foliage traits. For serious problems and infestations we recommend saturation of the leaves. Designed for use during fruit and flower but can be used in all stages of growth.

EPA No. FIFRA 25(b) Exempt.



Industry exclusive

Item No.	Description	MSRP
746400	Pure Kapow Quart	\$14.99
746402	Pure Kapow Gallon	\$38.00
746404	Pure Kapow 2.5 Gallon	\$72.00
746406	Pure Kapow 5 Gallon	\$136.99

Pure Kapow Commercial

Pure Kapow Commercial uses a specialized polarized blend of natural lemongrass and other safe botanical insecticides to suffocate mites and other pests on contact. Insects will never develop a tolerance to this formula. Kapow also kills through ingestion. In addition, it is a natural anti-fungal that helps kill and prevent mold and mildew from infecting plants. Pure Kapow Commercial is 9 to 18 times concentrated. Commercial grade non-RTU. Mix with 9-18 parts pH balanced water.



EPA No. FIFRA 25(b) Exempt.

Industry exclusive

Item No.	Description	MSRP
746408	Pure Kapow Commercial Pint	\$39.99
746410	Pure Kapow Commercial Gallon	\$239.99

Pure Green Thumb

Weekly preventative and overall plant health. Will repel bugs, keep mildew and mold off the plant and give you 30 percent more foliage growth. This product is good from rooted clone or seedling until the second week of flower or fruit. Mist the entire plant 1 time per week.

EPA No. FIFRA 25(b) Exempt.



Industry exclusive

Item No.	Description	MSRP
746424	Pure Green Thumb Quart	\$14.99
746426	Pure Green Thumb Gallon	\$38.00
746428	Pure Green Thumb 2.5 Gallon	\$72.00

Pure 3 Way Commercial

Pure 3-Way Commercial uses a specialized polarized blend of natural lemongrass and other safe botanical insecticides to suffocate mites and other leaf dwelling insects on contact. Insects will never develop a tolerance to this formula. 3-Way also kills through ingestion. In addition, it is a natural anti-fungal that helps kill and prevent mold and mildew. Commercial grade non-RTU. Mix with 9-18 parts pH balanced water.



EPA No. FIFRA 25(b) Exempt.

Industry exclusive

Item No.	Description	MSRP
746420	Pure 3 Way Commercial Pint	\$39.99
746422	Pure 3 Way Commercial Gallon	\$239.99

Pure 3 Way

Kills all leaf dwelling insects on contact as well as molds and mildew and feeds foliage. Read directions for applications. For serious problems and infestations, we recommend saturation of the leaves. We recommend rinsing 24 hours later but that is up to grower (we never do). Use up until first month of flower and fruit.



EPA No. FIFRA 25(b) Exempt.

Industry exclusive

Item No.	Description	MSRP
746412	Pure 3 Way Quart	\$14.99
746414	Pure 3 Way Gallon	\$38.00
746416	Pure 3 Way 2.5 Gallon	\$72.00
746418	Pure 3 Way 5 Gallon	\$136.99

Grower's Edge Illuminated Microscope 30x

A precision illuminated microscope with 30x magnification power. Focus can be adjusted by turning the wheel. Rotatable bulb can pinpoint the light on the object. Use to classify the type of pest invading your plants. Requires 2 AA batteries (not included).



Item No.	Description	MSRP
704477	Grower's Edge Illuminated Microscope 30x	\$18.95

Grower's Edge Illuminated Microscope 60x - 100x

A very powerful illuminated pocket microscope offers adjustable magnification from 60x - 100x. Identify even the smallest pests with this microscope. Includes batteries and protective case. Actual size of microscope is 1-1/4 inch wide by 3-1/4 inch tall.



Item No.	Description	MSRP
704478	Grower's Edge Illuminated Microscope 60x - 100x	\$18.95

Grower's Edge Illuminated Magnifier Loupe 30x

Extremely powerful 30x magnification from optical-quality double glass lenses shows ultra-fine detail. This teardrop shaped folding magnifier is compact in size. Great detail for finding the smallest of pests on your plants.



Item No.	Description	MSRP
704465	Grower's Edge Illuminated Magnifier Loupe 30x	\$12.95

Grower's Edge Illuminated Magnifier Loupe 40x

Powerful 40x lens. Unique, compact folding design with durable casing. Excellent illumination on specimen provided by two 6500K LED's. Can be used to identify plants and potential garden pests. On/off switch for the two LED lights. Batteries included.



Item No.	Description	MSRP
704467	Grower's Edge Illuminated Magnifier Loupe 40x	\$14.95

Grower's Edge Illuminated Microscope 60x

Illuminated with 3 LED lights. Focus adjusting lens barrel. Battery operated. 60x magnification. 2 light settings - high and low. On/Off switch. Includes storage case.



Item No.	Description	MSRP
704476	Grower's Edge Illuminated Microscope 60x	\$11.99

Grower's Edge iPhone 4/4S Case with LED Pocket Microscope 60x

Attach microscope to the included iPhone case to take pictures with your iPhone's built in camera. Images are stored in your iPhone's photo library. Great for record keeping and photo sharing. 60x magnification power. Compatible only with iPhone 4/4S.



Item No.	Description	MSRP
704475	Grower's Edge iPhone 4/4S Case w/ LED Pocket Microscope 60x	\$22.99

Grower's Edge iPhone 5 Case with LED pocket Microscope 60x

Attach microscope to the included iPhone case to take pictures with your iPhone's built in camera. Images are stored in your iPhone's photo library. Great for record keeping and photo sharing. 60x magnification power. Compatible only with iPhone 5.



Item No.	Description	MSRP
704473	Grower's Edge iPhone 5 Case w/ LED Pocket Microscope 60x	\$22.99

Carson Optical MagniScope

The MagniScope take two components combine to create three different optical devices... an 8 x 20mm Monocular, 3x power stand magnifier and when threaded together, a precision 30x portable Microscope.



Item No.	Description	MSRP
744010	Carson Optical MagniScope	\$71.95

Carson Optical MicroMax LED Microscope

MicroMax LED is a powerful 60-100x power Magnification Microscope with an extremely lightweight and portable design. Features a built-in LED light that provides a bright, clear image and a rubberized eyepiece for comfortable viewing. Uses 3 SG3 button cell batteries (included).



Item No.	Description	MSRP
744015	Carson Optical MicroMax LED Microscope	\$15.49

Carson Optical zOrb Digital Microscope

The zOrb is a digital microscope with an integrated camera that displays the magnified image on a computer screen. Impressive 35x magnification (14 in screen) allows you to see in great detail! Compatible with Microsoft Windows 98SE, ME, 2000, XP, XP Service Pack 3 Upgrade, Vista and MAC OSX 10.4 or later. A USB 2.0 port is required.



Item No.	Description	MSRP
744020	Carson Optical zOrb Digital Microscope	\$67.95

PEST & DISEASE CONTROL

THE NEW ONLINE GROWING COMMUNITY

www.just4growers.com



NPK Industries

Industry
exclusive

Ultimate Wash



Ultimate Wash

Over the past few years NPK Industries/OGD has received numerous requests from gardeners to remove the food coloring from Mighty Wash. We have heard these requests and created a NEW Product – Ultimate Wash with no dyes. Ultimate Wash is the next generation of plant wash and can be used up to and including the day of harvest.



Item No.	Description	MSRP
704990	Ultimate Plant Wash Quart	\$15.95
704992	Ultimate Plant Wash Gallon	\$39.95
704994	Ultimate Plant Wash 2.5 Gallon	\$74.95
704996	Ultimate Plant Wash 5 Gallon	\$143.95

Mighty Wash

Years of research have lead to the creation of this truly revolutionary plant wash. Apply it directly to the top and bottom of the leaves of your plant until the plant is fully saturated. Mighty Wash can be used throughout your plants entire growing and flowering cycle, up to and including the day of harvest.



Item No.	Description	MSRP
704800	Mighty Wash Quart	\$15.95
704805	Mighty Wash Gallon	\$39.95
704810	Mighty Wash 2.5 Gallon	\$74.95
704815	Mighty Wash 5 Gallon	\$143.95

PM Wash

PM Wash works well for cleaning plants that are subject to humid environments. PM Wash is a non-toxic plant wash that leaves your plants vibrant and healthy. PM Wash can be used throughout your plants growing and flowering cycle, up to and including the day of harvest.



Item No.	Description	MSRP
704820	PM Wash Quart	\$15.95
704825	PM Wash Gallon	\$39.95
704830	PM Wash 2.5 Gallon	\$74.95
704835	PM Wash 5 Gallon	\$143.95

Power Wash

Power Wash is a plant wash for removing unwanted residue left behind from foliar applied products. Pesticides, sticking agents, wetting agents and foliar applied nutrients can leave residue on your plants. Power Wash removes left behind residue, leaving your plants clean.



Item No.	Description	MSRP
704840	Power Wash Quart	\$13.95
704845	Power Wash Gallon	\$34.95
704850	Power Wash 2.5 Gallon	\$64.95
704855	Power Wash 5 Gallon	\$126.95

SNS 311 Plant and Vegetable Wash

Think of SNS 311 as immediate medicine for your plants or (First Aid Kit). Little sprits may help a lot of conditions. This Wash reduces oxidative stress on plants, safely removes pesticide residues and other contaminants and destroys bacteria and fungus while adding some additional vitamins.



Item No.	Description	MSRP
746076	SNS 311 Plant & Vegetable Wash 4 oz Pouch	\$8.99
746064	SNS 311 Plant & Vegetable Wash Pint	\$16.99
746066	SNS 311 Plant & Vegetable Wash Gallon	\$90.00

Dyna-Gro Pure Neem Oil Leaf Polish

Neem oil leaves a natural shine on leaves without clogging stomata that leaves need to take in carbon dioxide and release oxygen and water vapor essential to the basic functioning of the photosynthesis process.



Item No.	Description	MSRP
704425	Dyna-Gro Pure Neem Oil 8 oz	\$13.50
704430	Dyna-Gro Pure Neem Oil Quart	\$40.75

Einstein Oil

Einstein Oil uses only the finest grade, cold-pressed, wild-harvested, first extraction oil, making it the most effective neem product on the market. Mix 1/2 - 2 tsp. per quart of water and apply as a foliar spray to keep leaves and plants healthy.



Item No.	Description	MSRP
704535	Einstein Oil 4 oz	\$21.95
704540	Einstein Oil Pint	\$64.95

Earth Juice goGnats Liquid Concentrate

goGnats is a poison-free alternative for the control of soil-fungus gnats, mites, aphids, moths & other garden/hydroponic pests. goGnats liquid may be used as a plant & area spray, added to nutrient reservoirs or used as a soil drench.



Item No.	Description	MSRP
720327	GoGnats Liquid Conc. Pint	\$24.45

Want the products you see?

Scan to find a retailer near you!

LEAF SHINES & WASHES

Sun System®
SUN WINCH™

Remote Control Track Mounted Motorized Lift System for Lighting Fixtures!

- Supports light fixtures up to **50 lbs.**
- Wireless range to **30 ft.**
- Just 1 remote can control up to **8** separate lift kits – even more if you want to control rows or groups of lights *simultaneously*.



REMOTE SOLD SEPARATELY
Only 1 remote needed to control up to 8 separate Sun Winch™ Lift Kits.



Distributed exclusively by:
National Garden Wholesale®
Sunlight Supply, Inc.
www.sunlightsupply.com



NO MORE struggling to raise or lower light fixtures without smashing plants or stepping on equipment!



Expect More. Demand Grodan.

What is Grodan® stonewool?

Made from natural melted rocks blown into mineral fibers, Grodan stonewool (generically known as rockwool) has become the preferred choice for soil-less growing worldwide. Using our exclusive Delta® Technology for improved fiber structure and layering, we create perfectly uniform products that are both inert and compliant to the highest environmental & quality standards. This provides a clean medium for growing spectacular vegetables, fruits and vibrant flowers.

Experience

We were the first to develop stonewool for growing plants in 1969. And we have been perfecting it ever since.

Environmental Stewardship

Much of the new Grodan is made from used stonewool. The wool is still the same top notch quality as when we make the wool from new rocks. www.eco-label.com The European standard for earth friendly products.



Advantage for users:

- Sustainable
- Faster rate of growth
- Water management easier
- Less risk of insects
- Less labor
- Time saving
- Much easier to flush
- Less risk of salt accumulation
- Water savings
- Uniformity of evaporation
- More efficient use of space
- Recirculation possible
- Far less clean up
- Higher profitability per plant
- Better quality of yield

GROWING MEDIA

Grodan Stonewool A-OK Starter Plugs

A-OK Starter Plugs for starting seeds and rooting of cuttings prior to plugging into the larger Gro-Blocks. A-OK Starter Plugs fit in a standard 10 x 20 tray.



Item No.	Description	Plugs/		Cs	MSRP	MSRP
		Sheet	Case			
713020	Grodan A-OK 25/40 - 1 in x 1 in Plugs (200/Sheet)	200	30	6000	24	\$400.13 \$14.67
713025	Grodan A-OK 36/40 1.5 in x 1.5 in Plugs (98/Sheet)	98	30	2940	24	\$363.43 \$13.33
713030	Grodan A-OK 50/40 2 in x 2 in Plugs (50/Sheet)	50	30	1500	24	\$314.78 \$11.54

Grodan Stonewool Grow-Chunks

Light, airy & versatile. GrowChunks are about 3/4 inch square each and can be used in pots around blocks or alone. They are easily combined with other media, such as layering with coco fiber or clay pellets.



Item No.	Description	Cs	MSRP	MSRP
		lbs	Case	Each
713108	Grodan Stonewool Grow Chunks 2 cu ft	18	\$119.69	\$43.88

Grodan Stonewool Gro-Slabs

Gro-Slabs provide the final stage for growing a spectacularly large plant. Transplant your Gro-Block plant onto a slab just like professional growers. Come in clearly marked biodegradable UV resistant sleeves for comfortable handling & algae prevention.



Item No.	Description	Slabs/		MSRP	MSRP
		Case	Cs		
713001	Grodan Expert Fat Slabs 15/100 6 in x 4 in x 36 in	12	20	\$118.69	\$10.88
713005	Grodan Expert Slab 15/75 6 in x 3 in x 36 in	12	18	\$89.03	\$8.16
713010	Grodan Expert Slab 20/75 8 in x 3 in x 36 in	12	20	\$115.59	\$10.60
713015	Grodan Classic Slab 30/75 12 in x 3 in x 36 in	8	20	\$116.18	\$15.98
713018	Grodan Uni-Slab 9.5 in x 8 in x 4 in	16	5.6	\$85.60	\$5.88

Grodan Gro-Wool Absorbent Granulate

Granulated rockwool works great on its own or mixed with other loose media such as expanded clay rocks or coconut fiber. If planting in containers outdoors, Water Absorbent Granulate is the best medium of choice.



Item No.	Description	Plt Qty	Bag lbs	MSRP Cs
713090	Grodan Gro-Wool Absorbent Granulate	18	45.0	\$73.40

Grodan Stonewool Delta Gro-Blocks & Big Mama



Gro-Blocks are similar to a plant container. Need a 3 in pot? Then choose a 3 in Gro-Block. Small plants can be fully grown in our larger Gro-Blocks. Holes are perfect size for any 1.5 in starter plug. Come in packs labeled with instructions.

Item No.	Description	Blocks/ Strip	Strips/ Case	Blocks/ Case	Cs lbs	MSRP Case	MSRP Each
713050	Grodan Delta 4 - 3 in Block 3 in x 3 in x 2.5 in No Hole	8	48	384	22	\$254.46	\$5.83
713055	Grodan Delta 4 Block 3 in x 3 in x 2.5 in w/ Hole	8	48	384	21	\$254.47	\$5.83
713060	Grodan Delta 5.6 - 3 in Block 3 in x 3 in x 4 in w/ Hole	8	32	256	22	\$254.40	\$8.74
713065	Grodan Delta 6.5 - 4 in Block 4 in x 4 in x 2.5 in w/ Hole	6	36	216	22	\$198.08	\$6.05
713075	Grodan Delta 8 - 4 in Block 4 in x 4 in x 3 in w/ Hole	6	30	180	23	\$228.69	\$8.39
713080	Grodan Delta 10 - 4 in Block 4 in x 4 in x 4 in w/ Hole	6	24	144	23	\$211.31	\$9.68
713085	Grodan Delta Hugo 6 in Block 6 in x 6 in x 6 in w/ Hole	1	48	48	31	\$157.17	\$3.60
713088	Grodan Delta Big Mama Block 8 in x 8 in x 8 in	1	18	18	19	\$135.76	\$8.30

Grodan Stonewool MacroPlugs

Macroplugs are 1.5 in round with a slit that allows easy insertion of a cutting. These loose round plugs fit perfectly into the Gro-Block hole. For best results with these Macroplugs always insert them in a tray with individual cells.



Item No.	Description	Plugs/ Bag	Bags/ Case	Plugs/ Case	Cs lbs	MSRP Case	MSRP Each
713035	Grodan Macro Plug Round w/ Slit Bulk	—	—	2000	24	\$346.56	\$0.19
713038	Grodan Macro Plug Round w/ Slit (50/Bag)	50	35	1750	24	\$375.69	\$11.81

Grodan Stonewool Delta Starter Mini-Blocks

Mini-Blocks sit in a tray (flat) without support for easy starting of seeds and cuttings. These Mini-Blocks are individually wrapped in white plastic to minimize algae growth. Packed in easy tear away strips, labeled with instructions.



Item No.	Description	Blocks/ Strip	Strips/ Case	Blocks/ Case	Cs lbs	MSRP Case	MSRP Each
713040	Grodan 1.5 in Starter Mini-Blocks MM40/40 1.5 in x 1.5 in x 1.5 in (3 Strips of 15 or 45 ct)	15	50	2250	28	\$417.29	\$9.18
713045	Grodan 2 in Starter Mini-Blocks MM50/40 2 in x 2 in x 2 in (2 Strips of 12 or 24 ct)	12	60	1440	27	\$377.20	\$6.92

Grodan Pargro Quick Drain Stonewool



Pargro Quick Drain Stonewool - Better quality and drainage than other value-priced rockwool. Driest value-priced rockwool on the market.

Item No.	Description	Pcs/ Unit	Units/ Case	Cs lbs	MSRP Case	MSRP Each
713210	Grodan Pargro QD 1.5 in Plug (1372) 1.5 in x 1.5 in x 1.5 in	98	14	13	\$144.89	\$11.38
713215	Grodan Pargro QD 1.5 in Block (1170) 1.5 in x 1.5 in x 1.5 in	45	26	13	\$172.75	\$7.31
713220	Grodan Pargro QD 3 in Block (192) 3 in x 3 in x 2.5 in w/ Hole	8	24	9	\$100.00	\$4.58
713223	Grodan Pargro QD 3 in Block (192) 3 in x 3 in x 2.5 in No Hole	8	24	11	\$94.06	\$4.31
713225	Grodan Pargro QD 4 in x 2.5 in Block (216) w/ Hole	6	216	11	\$140.19	\$4.26
713230	Grodan Pargro QD 4 in x 4 in Block (72) w/ Hole	6	12	11	\$72.51	\$6.65
713235	Grodan Pargro QD 6 in x 36 in Slab	1	12	28	\$67.41	\$6.18
713250	Grodan Pargro QD Jumbo Block 6 in x 6 in x 4 in w/ Hole	1	36	11	\$78.28	\$2.39
713257	Grodan Pargro QD Biggie Block 6 in x 6 in x 6 in w/ Hole /48 Pack 	1	48	28	\$124.40	\$2.85



Get Dialed in to GROLOG™
Your free mobile app from Grodan.



Expect More. Demand Grodan.

www.grodan101.com

Grodan Stonewool Grow-Cubes

Grow-Cubes are small loose 1/2 in cubes of stonewool. Advantages are better aeration, maximum drainage so that you can hardly ever over water your plant, easy mixing with other loose media, lightweight and much cleaner than peat-based media.



Item No.	Description	Cs lbs	MSRP Case	MSRP Each
713095	Grodan Growcubes Large 2 cu ft	18	\$119.69	\$43.88
713100	Grodan Growcubes Medium 1 cu ft	20	\$148.54	\$27.23
713105	Grodan Growcubes Bulk Loose Box	22	\$97.31	\$97.31

Drip Cap

The DripCap is a patented water conservation tool & grow medium protector. It uses a new innovative dripping method, & hose holding technology.



Item No.	Description	MSRP
714867	Drip Cap 4 in	\$2.69
714873	Drip Cap 6 in	\$3.49

Cube Cap

The Cube Cap deprives the cube of its light by reflecting it back up towards the plant and away from the top of the block. The Cube Caps patented technology allows the necessary air exchange by way of its unique elevated, vented design.



Item No.	Description	MSRP
714870	Cube Cap 4 in	\$1.99
714875	Cube Cap 6 in	\$2.49

Mother Earth Coco Covers

These 100% natural coconut coir fiber covers work great for preventing algae from growing on your rockwool blocks. Also available is the 8 in coco cover with rounded corners for use with the Flo-n-Gro Ebb & Flow systems and the Drip-n-Gro system.



Item No.	Description	MSRP
714716	Mother Earth Coco Cover 4 in 1=10/Pack	\$4.49
714718	Mother Earth Coco Cover 6 in 1=10/Pack	\$5.49
714720	Mother Earth Coco Cover 8 in 1=10/Pack	\$8.29

Grower's Edge Block Covers

For blocks of rockwool and other grow media. Blocks light from media— reducing algae and pest problems. Use white side up to reflect light. Use toothpick to hold cover in place. Hole in center of cover measures 1/2 inch in diameter.



Item No.	Description	MSRP
714820	Block Covers 4 in 40/Pack	\$8.95
714822	Block Covers 6 in 40/Pack	\$15.95

Supreme Extra Large Perlite

Perlite is a naturally occurring, volcanic rock and 100% natural. When furnaced at high temperatures, Perlite pops and expands up to 15 times its original volume. The resulting, lightweight particles are made up of microscopic spheres with a porous, broken surface that promotes plant growth. This allows aeration and drainage of the root system and provides holding capacity for water and nutrients.



Item No.	Description	MSRP
713330	Supreme Extra Large Perlite 4 cu ft	\$41.95

VermaPlex Black Casting

Black Castings are the purest form of slow release natural organic plant food produced by earthworms. Derived from a proprietary process and blend of pure organics, Black Castings are raised in a controlled vermiculture feeding process and microbial enhancements, resulting in a consistent, bio-diverse, living organic fertilizer and conditioner. Check your local Dealer Partner for availability.



Industry exclusive

Item No.	Description	MSRP
724275	VermaPlex Black Casting 5 lb	\$11.95
724280	VermaPlex Black Casting 20 lb	\$29.95
724285	VermaPlex Black Casting 40 lb	\$51.95

Hydrodynamics Crop Circles

An organic potting medium made from natural coconut fibers, this medium is ideal for hydroponic and mixed media cultivation. Each Crop Circle disk expands to about five times its compressed size. Each disk fills a one gallon container. Dimensions of compressed disk 5 in diameter x 1-1/2 in thick.



Item No.	Description	MSRP
714550	Crop Circles Premium Coir Fiber	\$35.00

Industry exclusive



Premium growing media and amendments

Mother Earth Hydroton



Hydroton is a unique, lightweight expanded clay aggregate. Made in Europe, Hydroton is ecologically sustainable as it is derived from a replenishable source, clay. Clay is mined, formed into pellets and fired at high temperatures to cause the clay to expand into lightweight balls that are porous but do not float like perlite. Hydroton drains freely, is pH adjusted, free of harmful heavy metals and inert.

Item No.	Description	MSRP
714110	Mother Earth Hydroton 10 Liter	\$10.95
714115	Mother Earth Hydroton 25 Liter	\$19.95
714120	Mother Earth Hydroton 50 Liter	\$31.95

Mother Earth Perlite #3 & #4



Mother Earth Perlite is naturally occurring siliceous rock that when heated to 1600° F expands up to 20 times its original volume. The exceptional physical properties of this giant perlite make it tops in the perlite world for adding porosity to soil and soilless mixes. The #4 averages a whopping size of around 1 in and the #3 measures around 1/2 in.

Item No.	Description	MSRP
713310	Mother Earth Perlite # 3 - 4 cu ft	\$45.95
713315	Mother Earth Perlite # 4 - 4 cu ft	\$49.95

Mother Earth Coco - 100% Natural



Mother Earth Coco substrate is 100% natural. It contains the highest quality mix of coco pith and coco fiber. RHP certified for quality, Mother Earth Coco is pre-buffered and pH adjusted to neutral a 6.3-6.8. Mother Earth Coco will promote strong root growth, populate microbial activity, discourage disease and insect outbreak and release nutrients evenly. This is uncharged inert media.

Item No.	Description	MSRP
714830	Mother Earth Coco 50 Liter 1.5 cu ft	\$22.95

Mother Earth Premium BioChar



Mother Earth BioChar is a fast and easy way to boost the performance of new soil and can improve the effectiveness of compost teas and mycorrhizal products. BioChar and its use in amending soil is an age old technique. Vegetative growth is more robust than areas that were not affected by the fires. Fire creates rich deposits of carbon in the soil and this increases soil fertility and encourages microbial activity, this is the effect that BioChar is used to recreate.

Item No.	Description	MSRP
713320	Mother Earth Premium BioChar 1 cu ft	\$34.95

FoxFarm Bushdoctor Lucky Dog K-9 Kube Growers Blend

This light airy blend of peat moss and perlite is the key to every gardener's quandary. Unleash the Lucky Dog K-9 Kube and plant directly into this richly amended mix. It is loaded with beneficial microbes that expand root development to optimize nutrient availability to plants. #714290 Not for sale in the following states at this time: FL, GA, HI, IN, MO, NH.



Item No.	Description	MSRP
714290	FoxFarm Lucky Dog K-9 Kube 3.8 cu ft	\$55.95
714292	FoxFarm Lucky Dog K-9 3.8 cu ft (FL,IN,MO Label)	\$56.95

FoxFarm Bushdoctor Coco Loco Potting Mix

Coco Loco Potting Mix has the ability to hold more than its weight in water while still draining well. The coir in Coco Loco behaves like little sponges offering nutrients and water as needed by the plants. Lower humidity reduces the possibility of mold and root rot and leaving insects. #714295 Not for sale in the following states at this time: FL, GA, HI, IN, MO, NH.



Item No.	Description	MSRP
714295	FoxFarm Coco Loco Potting Mix 2 cu ft	\$19.95
714297	FoxFarm Coco Loco Potting Mix 2 cu ft (FL, IN, MO Label)	\$56.95

FoxFarm Ocean Forest Organic Potting Soil

Ocean Forest Potting Soil is perfect for containers and is ready to use right out of the bag. Nutrient rich, this mix is a powerful blend of Pacific Northwest Sea-Going fish, crab meal, shrimp meal and plenty of earthworm castings, one of nature's finest soil amendments. Ocean Forest is pH adjusted at 6.3 to 6.8 to allow for optimum fertilizer uptake. #714304 Not for sale in the following states at this time: FL, GA, IN, MO, SD.



Item No.	Description	MSRP
714304	FoxFarm Ocean Forest 12 Quart	\$8.95
714317	FoxFarm Ocean Forest 12 Quart (FL,IN, MO Label)	\$8.95

FoxFarm Ocean Forest Organic Potting Soil

Ocean Forest Potting Soil is perfect for containers and is ready to use right out of the bag. Nutrient rich, this mix is a powerful blend of Pacific Northwest Sea-Going fish, crab meal, shrimp meal and plenty of earthworm castings, one of nature's finest soil amendments. Ocean Forest is pH adjusted at 6.3 to 6.8 to allow for optimum fertilizer uptake. #714305 Not for sale in the following states at this time: FL, IN, MO, SD.



Item No.	Description	MSRP
714305	FoxFarm Ocean Forest Organic Potting Soil 1.5 cu ft	\$19.95
714315	FoxFarm Ocean Forest Organic Potting Soil 1.5 cu ft (FL,IN,MO Label)	\$20.95

FoxFarm Happy Frog Soil

Highly recommended for container gardens. Ready to use right out of the bag and is pH adjusted. Our unique mix is alive with beneficial soil microbes and mycorrhizal fungi that dramatically expand root development enabling plants to feed more aggressively. The benefits are strong plant structure, vigorous vegetative growth, with enhanced fruit and flower production. #714303 Not for sale in the following states at this time: FL, GA, HI, IN, MO, SD.



Item No.	Description	MSRP
714303	FoxFarm Happy Frog Soil 12 Quart	\$8.95
714322	FoxFarm Happy Frog Soil 12 Quart (FL,IN,MO Label)	\$8.95

FoxFarm Happy Frog Soil

Highly recommended for container gardens. Ready to use right out of the bag and is pH adjusted. Our unique mix is alive with beneficial soil microbes and mycorrhizal fungi that dramatically expand root development enabling plants to feed more aggressively. The benefits are strong plant structure, vigorous vegetative growth, with enhanced fruit and flower production. #714302 Not for sale in the following states at this time: FL, GA, HI, IN, MO, SD.



Item No.	Description	MSRP
714302	FoxFarm Happy Frog Soil 2 cu ft	\$19.95
714320	FoxFarm Happy Frog Soil 2 cu ft (FL,IN,MO Label)	\$20.95

FoxFarm Planting Mix

This premium organic planting mix has everything to get the garden off to a good start: earthworm castings, bat guano, Norwegian kelp meal, composted forest humus, sphagnum peat moss and a whole lot more. A carefully adjusted pH ensures optimum nutrient uptake. Original Planting Mix holds moisture in the soil. #714300 Not for sale in the following states at this time: FL, IL, IN, MO, SD.



Item No.	Description	MSRP
714300	FoxFarm Planting Mix 1 cu ft	\$16.95
714328	FoxFarm Planting Mix 1 cu ft (FL,IN,MO Label)	\$18.95

FoxFarm Light Warrior Grow Medium

All natural, pH balanced blend designed to promote optimal seed germination and enhance root development. Light Warrior is packed with beneficial microbes that stimulate root growth and encourage nutrient uptake. We also include plenty of earthworm castings, one of nature's finest soil amendments. #714310 Not for sale in the following states at this time: FL, GA, HI, IN, MO, SD.



Item No.	Description	MSRP
714310	FoxFarm Light Warrior Grow Medium 1 cu ft	\$21.95
714325	FoxFarm Light Warrior Grow Medium 1 cu ft (FL,IN,MO Label)	\$22.95

FoxFarm Happy Frog Soil Conditioner

Our soil conditioner is fine-screened, with generous helpings of earthworm castings, bat guano and beneficial microbes. It is inoculated with naturally occurring mycorrhizal fungi that dramatically expand root development enabling plants to feed more aggressively. Add the Soil Conditioner to existing garden soil to increase aeration, improve soil drainage and break up clay. Not for sale in the following states at this time: FL, HI, IL, IN, MO, SD.

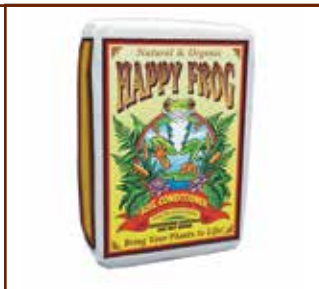

Item No.	Description	MSRP
714301	FoxFarm Happy Frog Soil Conditioner 3 cu ft	\$22.95

FoxFarm Big & Chunky Perlite

FoxFarm's Big & Chunky Perlite is perfect for aerating container plantings. Use it with our soil's to improve drainage, keep roots oxygenated and prevent plants from becoming waterlogged. Hydroponic growers know that Big & Chunky is the ultimate hydro grow medium. Use it as a stand-alone product or combine it with our Light Warrior for your cuttings and seedlings. Not for sale in the following states at this time: AR, CT, DC, DE, HI, IA, ID, IL, KS, ME, MO, NC, NH, NJ, OR, SC, SD, TN, UT, VA, WV, WY.



Item No.	Description	MSRP
714330	FoxFarm Big & Chunky Perlite 4 cu ft	\$73.95

Black Gold Natural & Organic Potting Soil

This rich, loamy mix is a premium choice for all-purpose gardening applications. Our 100% organic base consists of screened earthworm castings, Canadian sphagnum peat moss, compost and forest humus.



Item No.	Description	MSRP
714750	Black Gold Natural & Organic Potting Soil 1.5 cu ft	\$15.95

Black Gold Waterhold Cocoblend Soil

The combination of coconut fibers (coir) and Canadian sphagnum peat moss gives your outdoor container plants the advantage of water retention against constant exposure to heat, wind and sun.



Item No.	Description	MSRP
714754	Black Gold Waterhold Cocoblend Soil 2 cu ft	\$20.95

Black Gold Perlite

As a soil amendment, Perlite is used to improve aeration and drainage. Its moisture and nutrient retention capabilities and lightweight characteristics make it an excellent sterile medium for starting seeds & rooting cuttings.



Item No.	Description	MSRP
714762	Black Gold Perlite 8 Quart	\$7.95

Black Gold Just Coir Loose

This OMRI listed low salt organic material is just what the name implies, Just Coir, actually coconut coir pith. We take the highest quality coir available, rinse it to reduce salts and then reconstitute it from a compressed bale.



Item No.	Description	MSRP
714565	Black Gold Just Coir Loose 2 cu ft	\$20.95

Black Gold Earthworm Castings

This all organic soil amendment is excellent for use as a top dressing, diluted to make a rich liquid tea or mixed with soil to stimulate plant growth.



Item No.	Description	MSRP
714765	Black Gold Earthworm Castings 16 Quart	\$13.95

Sunshine Mix #4 - Aggregate Plus

Mix #4 is recommended where high air capacity and fast drainage are needed with water and salt sensitive crops or where frequent leaching is required.



Item No.	Description	MSRP
714745	Sunshine Mix #4 Aggregate Plus Bale 3.8 cu ft	\$50.95

Sunshine Mix #4 with Mycorrhizae

Sunshine Mix #4 with Mycorrhizae is an ideal choice for both indoor and outdoor gardening. Formulated with Canadian Sphagnum Peat Moss for increased moisture retention, optimum air exchange and high cation exchange capacity (CEC) plus coarse perlite for amplified root zone aeration.



Item No.	Description	MSRP
714743	Sunshine Mix #4 w/ Mycorrhizae 3.0 cu ft	\$43.95



Sunshine Advanced Mix #4 - 2.2 Cu. Ft. Compressed

Sunshine Advanced Mix #4 is meticulously formulated to meet the needs of professional growers, yet is easy to use for beginners. It contains Canadian Sphagnum peat moss, coarse perlite, coconut coir & an organic starter nutrient charge.



Item No.	Description	MSRP
714767	Sunshine Advanced Mix #4 - 2.2 cu ft Compressed	\$35.95



Sunshine Mix #4 Natural & Organic

Sunshine Mix #4 Natural & Organic contains an organic fertilizer composed of feathermeal, sulfate of potash and bonemeal. As with all organic fertilizers, the nutrients are released by decomposition through fungi and bacteria. Therefore, you may note the presence of fungal hyphae on the surface of the mix during the active decomposition phase.



Item No.	Description	MSRP
714775	Sunshine #4 Natural & Organic 3.8 cu ft Compressed Bale	\$54.95



Sunshine Advanced Mix #4 - 3 Cu. Ft. Compressed

Sunshine Advanced Mix #4 is meticulously formulated to meet the needs of professional growers, yet is easy to use for beginners. It contains Canadian Sphagnum peat moss, coarse perlite, coconut coir & an organic starter nutrient charge.

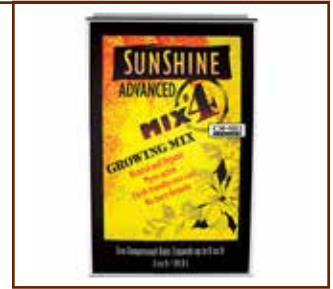

Item No.	Description	MSRP
714768	Sunshine Advanced Mix #4 - 3 cu ft Compressed	\$46.95



Sunshine Mix #4 Natural & Organic with Mycorrhizae

Sunshine Mix #4 Natural & Organic + mycorrhizae contains an organic fertilizer composed of feathermeal, sulfate of potash and bonemeal. As with all organic fertilizers, the nutrients are released by decomposition through fungi and bacteria. Therefore, you may note the presence of fungal hyphae on the surface of the mix during the active decomposition phase.



Item No.	Description	MSRP
714776	Sunshine Mix #4 Natural & Organic w/ Mycorrhizae 3.8 cu ft	\$60.95



Sunshine Advanced Mix #4 - 2 Cu. Ft. Loose

Sunshine Advanced has the dual benefits of peat moss and coconut fiber to hold water and nutrients for optimal plant growth. The increased perlite provides excellent drainage, resulting in a growing mix that is adapted for a wide range of growing conditions. Our organic nutrient pack gives just enough starter fertilizer to get your plants going.



Item No.	Description	MSRP
714785	Sunshine Advanced Mix #4 Loose 2 cu ft	\$22.95



Sunshine Advanced Mix #4 - 1 Cu. Ft. Compressed

Sunshine Advanced Mix #4 is meticulously formulated to meet the needs of professional growers, yet is easy to use for beginners. It contains Canadian Sphagnum peat moss, coarse perlite, coconut coir & an organic starter nutrient charge.



Item No.	Description	MSRP
714766	Sunshine Advanced Mix #4 - 1 cu ft Compressed	\$16.95

Sunshine Advanced Rain Forest Loose 0.06 - 0.02 - 0.05

Sunshine Advanced Rainforest Blend contains coconut fiber for nutrient and water retention. The organic nutrient pack along with humic acid, alfalfa meal and kelp meal gives a good dose of starter fertilizer to get your plants going.



Item No.	Description	MSRP
714780	Sunshine Advanced Rain Forest Loose 2 cu ft	\$22.95



Sunshine Advanced Super Hydro Loose

Sunshine Advanced Super Hydro contains high levels of perlite to provide excellent drainage. Both peat moss and compost hold and release water and nutrients for optimal plant growth. This combination results in a growing mix that is adapted for a wide range of conditions.



Item No.	Description	MSRP
714778	Sunshine Advanced Super Hydro Loose 2 cu ft	\$22.95

Sunshine Advanced Ultra Coir Loose

Sunshine Advanced Ultra Coir has the dual benefits of peat moss and coconut fiber to hold water and nutrients for optimal plant growth. The perlite provides excellent drainage, resulting in a growing mix that is suitable for most growing conditions.



Item No.	Description	MSRP
714782	Sunshine Advanced Ultra Coir Loose 2 cu ft	\$22.95

Botanicare ReadyGro

ReadyGro Aeration Formula is specifically designed for automated hydrogardens and self-watering planters with small to midsize plants. The ReadyGro Moisture Formula (1 to 2 waterings daily) is specifically designed for hand-watering, automated pots and planters with large plants.



Item No.	Description	MSRP
714800	Botanicare ReadyGro Aeration Formula 1.5 cu ft	\$25.95
714805	Botanicare ReadyGro Moisture Formula 1.5 cu ft	\$25.95

Botanicare Cocogro Loose

Cocogro is blended from 100% premium Coco Coir that has been carefully processed to our meet our rigorous specifications. Cocogro has excellent drainage properties and can be watered frequently while naturally maintaining optimum air to water ratios.



Item No.	Description	MSRP
714810	Botanicare Cocogro Loose 1.75 cu ft	\$22.95

Botanicare Slacker Aeration

Slacker, a revolutionary Coco Coir based hybrid substrate. It combines 100% High Pith Coco Fiber with carefully sourced organics, along with unique inputs such as Hydrolite and Parboiled Rice Hulls. Slacker comes pre-buffered, charged, and pH balanced so it's ready to use right out of the bag.



Item No.	Description	MSRP
714796	Botanicare Slacker Aeration 1.5 cu ft	\$33.95

Botanicare Slacker Moisture

Slacker, a revolutionary Coco Coir based hybrid substrate. It combines 100% High Pith Coco Fiber with carefully sourced organics, along with unique inputs such as Hydrolite and Parboiled Rice Hulls. Slacker comes pre-buffered, charged, and pH balanced so it's ready to use right out of the bag.



Item No.	Description	MSRP
714798	Botanicare Slacker Moisture 1.5 cu ft	\$33.95

Botanicare Hydrolite

Hydrolite is a natural, silica-based, volcanic mineral with a unique, porous, crystalline structure which allows it to hold nutrients until plants need them. Improves aeration and is highly porous. Retains nutrients and is reusable. 70% silicate and does not float. Nutrient charged to balance CEC.



Item No.	Description	MSRP
714814	Botanicare Hydrolite 4-6mm 1 cu ft	\$32.95

Botanicare CocoRox

Cocorox is a blend of Botanicare's high pith Cocogro coir fiber and Hydrolite, a silica based rock buffered with Pure Blend Pro. Formulated for use in re-circulating hydroponic systems and run to waste container gardens, this ultra-convenient grow media provides an ideal air to water ratio throughout the root zone.



Item No.	Description	MSRP
714818	Botanicare CocoRox 1.5 Cu ft	\$26.36

Botanicare Boss Cocogro Cubes

Boss is exceptional because of its multi-drain capability. It contains a coarse coir fiber mat on the bottom of the block to allow for free drainage and to keep coir fiber particles from draining out of the bag.



Item No.	Description	MSRP
720465	Botanicare Boss Cocogro 6 in Cube	\$3.95
720467	Botanicare Boss Cocogro 8 in Cube	\$4.75

Botanicare Cocogro Premium Organic Soilless Grow Media

Cocogro has a very low salt content that is available in 3/4 in double-sieved long fibers to reduce dust and give ample space within the mix. It has excellent drainage properties and can be used over a longer period of time.



Item No.	Description	MSRP
720440	Botanicare Cocogro Coir Fiber Bale 5 kg	\$16.50
720445	Botanicare Cocogro Brick Coir Fiber 650 gm	\$3.10

Roots Organics Compressed Coco Fiber

Roots Organics Coco Fiber is made from 100% pure coco fiber. This specially designed Coco Fiber has been created with increased fiber content for an ideal air to water ratio, and is perfect for mixing into your other media.



Item No.	Description	MSRP
715405	Roots Organics Compressed Coco Fiber 5 kg	\$13.95

Roots Organics Coco Chips Block

Roots Organics Coco Chips are composed of 100% pure coco fiber from coconut husks. Ideal for mixing into outdoor potting soils or into indoor container media. Add water to expand block, makes approximately 2.1 cubic feet or 16 gallons of media.



Item No.	Description	MSRP
715410	Roots Organics Coco Chips Block 4.5 kg	\$19.95

Roots Organics Coco Bird's Nest

Roots Organics Coco Bird's Nest is composed of 100% pure coco fiber from coconut husks. Roots Organics Coco Bird's Nest has been specifically designed with increased fiber content for an ideal air to water ratio.



Item No.	Description	MSRP
715415	Roots Organics Coco Birds Nest 4 kg	\$19.95

Roots Organics Soilless Hydro Coco Mix

A unique formulation of the highest quality coco fiber/Coir on the planet which is repeatedly washed for an incredibly low EC, composted for over twenty-four months, and specially blended with extra long fibers, perlite and pumice.



Item No.	Description	MSRP
715165	Roots Organics Soilless Coco Mix 1.5 cu ft	\$25.95

Roots Organics GreenFields Potting Soil

Roots Organics GreenFields potting mix was created as a super premium planting mix. It was designed with a high nitrogen content and greater water holding capacity, less perlite and pumice and specific ingredients for vigorously growing plants.



Item No.	Description	MSRP
715170	Roots Organics GreenFields Soil 1.5 cu ft	\$22.95

Roots Organics Original Potting Soil

A truly exceptional ready-to-use coco fiber-based potting soil. We begin with the highest quality coco fiber/Coir which is repeatedly washed for low EC and composted. This soil is amended with organic ingredients.



Item No.	Description	MSRP
715157	Roots Organics Potting Soil .75 cu ft	\$14.95
715160	Roots Organics Potting Soil 1.5 cu ft	\$22.95

Roots Organics Formula 707

Formula 707 is a ready to use soil created for fast growing, heavy feeding plants. It was designed with greater water holding capacity, less perlite and pumice and a light charge of nutrients for a good back bone but plenty of room for you to amend.



Item No.	Description	MSRP
715167	Roots Organics Formula 707 3 cu ft	\$39.95
715168	Roots Organics Formula 707 1.5 cu ft	\$22.95

Roots Organics Big Worm

Roots Organics Premium Worm Castings is a distinctive natural soil amendment. Our worms are carefully tended and fed an unparalleled blend of organic compost, rock dust and kelp for exceptional quality castings.



Item No.	Description	MSRP
715158	Roots Organics Big Worm 1 cu ft	\$51.95

Roots Organics CocoPalms

Roots Organics CocoPalms is made from coconut husk. CocoPalms has a near perfect natural pH level for optimum nutrient uptake and is specifically designed as the ultimate growing media for vigorous plants.



Item No.	Description	MSRP
715162	Roots Organics CocoPalms 1.5 cu ft	\$22.95

Roots Organics Green Lite

Roots Organics Green Lite growing mix is an aggressive, free draining indoor/outdoor potting mix. Green Lite is designed with more perlite and pumice to give you enhanced drainage and greater oxygen in the root zone and with specific ingredients for versatile container gardening.



Item No.	Description	MSRP
715172	Roots Organics Green Lite Soil 1.5 cu ft	\$23.95

Roots Organics Marine Compost 0.5 - 0.1 - 0.1 + Ca 3%

This is a synergistic combination of byproducts from marine life such as sustainably harvested Dungeness crab and line-caught Albacore Tuna. This powerful and sustainable compost blend is the result of a long composting period during which the marine mix is augmented with aged humus and forest materials. Our compost is great as an amendment or as top dress.



Item No.	Description	MSRP
715173	Roots Organics Marine Green Compost 1 cu ft	\$21.95

Roots Organics® Emerald Mountain Mix

Roots Organics® Emerald Mountain Potting Mix is created for the quality conscious consumer, the special breed looking for the highest levels of performance and economy. Emerald Mountain is a more economical yet well balanced organic growing media incorporating more water holding capacity while still maintaining a reliably free draining indoor and outdoor potting mix.



Item No.	Description	MSRP
715216	Roots Organics Emerald Mountain 1.5 cu ft	\$18.95

Roots Organics® B2 Professional Growing Mix

Well balanced between water holding capacity and drainage, B2 is designed for absolute consistency and control. The blend is composed of outstanding ingredients, which guarantees excellent performance as a primary media or as a foundation for any of your custom mixtures.



Item No.	Description	MSRP
715218	Roots Organics Professional Growing Mix 2 cu ft	\$22.95

Aurora Innovations Precision Perlite

Aurora Innovations' advanced sourcing and manufacturing produces only the highest quality and most consistent materials.



Item No.	Description	MSRP
715212	Aurora Innovations Precision Perlite Coarse 2 cu ft	\$15.95
715214	Aurora Innovations Precision Perlite Coarse 4 cu ft	\$27.95

Wiggle Worm Soil Builder Earthworm Castings

Earthworm Castings is an all purpose natural fertilizer that comes to you straight from nature with no alterations whatsoever. Our nightcrawlers are fed a very rich peat humus which contains a wide variety of minerals and trace elements.



Item No.	Description	MSRP
720425	Wiggle Worm Soil Builder Earth Worm Castings 15 lb	\$14.99
720430	Wiggle Worm Soil Builder Earth Worm Castings 30 lb	\$23.99

Premier Tech Pro-Mix BX Biofungicide + Mycorrhizae

Pro-Mix BX Biofungicide + Mycorrhizae is a general purpose peat-based professional growing medium suitable for a wide variety of horticultural plants and transplanting applications.



Item No.	Description	MSRP
713435	Premier Pro-Mix BX BioFungicide + Mycorrhizae 2.8 cu ft	\$25.95
713430	Premier Pro-Mix BX BioFungicide + Mycorrhizae 3.8 cu ft	\$52.95

Premier Tech Pro-Mix HP Biofungicide + Mycorrhizae

Pro-Mix HP Biofungicide + Mycorrhizae is a high porosity peat-based growing medium, ideal for water sensitive crops, rooting cutting and/or low-light growing conditions. Pro-Mix HP Biofungicide + Mycorrhizae is suitable for a wide variety of horticultural plants, especially when high air capacity and extra drainage are required.



Item No.	Description	MSRP
713445	Premier Pro-Mix HP BioFungicide + Mycorrhizae 2.8 cu ft	\$27.95
713440	Premier Pro-Mix HP BioFungicide + Mycorrhizae 3.8 cu ft	\$54.95

Premier Tech Pro-Mix HP-CC Mycorrhizae

Pro-Mix HP-CC Mycorrhizae is a lightweight, high-porosity peat-based growing medium that contains chunk coir. It ensures optimum growth, especially when high air capacity and extra drainage are required. It is ideal for water-sensitive crops, rooting cuttings and/or low-light growing conditions.



Item No.	Description	MSRP
713425	Premier Pro-Mix HP-CC Mycorrhizae 3.8 cu ft	\$50.95

Premier Tech Pro-Mix HP

Pro-Mix HP Mycorrhizae is a high porosity peat-based growing medium. This formula ensures optimum growth, especially when high air capacity and extra drainage are required.



Item No.	Description	MSRP
713405	Premier Horticulture Pro-Mix HP 3.8 cu ft	\$50.95

Premier Tech Pro-Mix BX

Pro-Mix BX Mycorrhizae is a general purpose peat-based growing medium containing a beneficial mycorrhizal inoculum (*Glomus intraradices*). These microscopic fungi attach to and colonize the root systems working in symbiosis with plants.



Item No.	Description	MSRP
713400	Premier Horticulture Pro-Mix BX 3.8 cu ft	\$48.95

Premier Tech Pro-Mix BX with Biofungicide

Pro-Mix BX Biofungicide is a general purpose peat-based growing medium compatible with a wide variety of ornamental plant species, fruit crops and most vegetable transplants that has been enriched with a biofungicide.

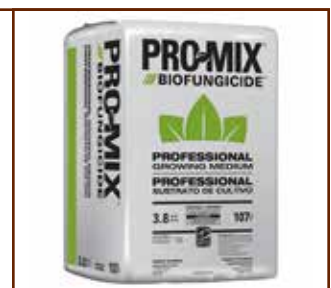

Item No.	Description	MSRP
713410	Premier Horticulture Pro-Mix BX w/ Fungicide 3.8 cu ft	\$51.95

GH CocoTek Bricks Organic Growing Medium

CocoTek is pH balanced and contains low sodium content for coir fiber. It increases water holding capacity and nutrient retention, expanding to 5 times its condensed brick size.



Item No.	Description	MSRP
714065	GH Cocotek Natural Coconut Coir Brick	\$2.38
714066	GH Cocotek Natural Mixed Brick	\$2.48

GH CocoTek Mats Organic Growing Medium

CocoTek Grow mats are made from a strong weave containing 100% organic coconut fiber and natural rubber. Roots will thrive in this natural media.



Item No.	Description	MSRP
714200	GH CocoTek Coco Mat 4 ft x 8 ft x 1/4 in	\$51.50
714201	GH CocoTek Coco Mat 4 ft x 4 ft x 1 in	\$66.52

GH CocoTek Bale Organic Growing Medium

The Natural Coir Block contains only coconut pith and fibers. Great for water holding capacity these materials also provide plenty of aeration and drainage.



Item No.	Description	MSRP
714064	GH Cocotek Bale 5 kg	\$11.95

General Organics Ancient Forest

Ancient Forest is a natural product consisting of 100% pure forest humus. It is derived from thousands of years of naturally decomposed forest litter. Also aids in the retention of water and nutrients; creating stable, long lasting soil for your garden.



Item No.	Description	MSRP
720695	General Organics Ancient Forest .5 cu ft	\$17.95

Royal Gold Basement Mix

Light charged with organic nutrients and the proper ratios of air to moisture. As each component plays an important role in the quality and consistency of the end product, proportions are measured and mixed with state of the art equipment, which insures premium quality in each bag.



Item No.	Description	MSRP
715225	Royal Gold Basement Mix 1.5 cu ft	\$25.95

Royal Gold Mendo Mix

In their laboratory and in performance tests, Royal Gold states the Mendo Mix out preformed all its competitors, for transition, growth and quality of fruit. Fortified with the highest quality ingredients, the formula is based on years of standard Humboldt soil building techniques. Established plants that have been root bound in a smaller containers transplant the best.



Item No.	Description	MSRP
715230	Royal Gold Mendo Mix 1.5 cu ft	\$25.95

Royal Gold Loose Coco Fiber

Royal Gold loose coco fiber is designed for hydroponic use; but also works well with pots and beds and all other growing techniques. We have the highest air porosity rate of any coco on the market with 40% air porosity rate.



Item No.	Description	MSRP
715235	Royal Gold Coco Mix 1.5 cu ft	\$34.95

Royal Gold Tupur

Royal Gold Tupur was developed with one idea in mind, feeding the plant as much and as often as possible! This high porosity mix allows the gardener to feed often, supplying all major NPK with any nutrient system.



Item No.	Description	MSRP
715237	Royal Gold Tupur 2 cu ft	\$25.95

Gold Label Custom 80/20

80/20 is 80% Hydrocom and 20% coco fiber with added mycorrhizae. The sodium and chloride contents are extremely low for a coco substrate. HydroCoco 80/20 is the tested and recommended growing medium for the Flo-n-Gro systems.



Item No.	Description	MSRP
713760	Gold Label Custom 80/20 Mix 50 Liter	\$35.95

Gold Label Coco

Gold Label Coco is manufactured using the fibers from the husk of the coconut. Only matured woody brown husk is used for optimal quality and stability of the substrate.



Item No.	Description	MSRP
713755	Gold Label Coco 50 Liter	\$31.95

Gold Label Hydrocorn

Gold Label Hydrocorn is manufactured using a mix of the best quality pure clay and are baked in an open furnace using high grade clean fuels, guaranteeing absence of heavy metals or other contaminants. The 8-16 mm size provides stability and the unique uneven shape of the pebble is an ideal surface for roots and beneficial bacteria.



Item No.	Description	MSRP
713750	Gold Label Hydrocorn 36 Liter	\$36.95

Gold Label Hydrocorn XL

Gold Label Hydrocorn XL is the inert hydroponic substrate of choice for professionals. The 16-25 mm size and the unique, uneven shapes of the pebbles provides better stability than even shaped round pebbles. The porous structure has a high water capacity and is suitable for both ebb/flood and top irrigation systems. Larger size won't slip through basket and liner holes.



Item No.	Description	MSRP
713752	Gold Label Hydrocorn XL 45 Liter	\$36.95

Gold Label HydroCoco 60/40

Gold Label Hydrocorn and Coco is an ideal match for high water capacity, lower watering frequency and better rooting. We utilize the 8-16 mm Hydrocorn from Gold Label and the purest Gold Label Coco to give you the perfect ebb and flood growing media which also works well in any pot based systems.



Item No.	Description	MSRP
713765	Gold Label HydroCoco 60/40 - 45 Liter	\$34.95

Vermicrop CocoNot Premium Coconut Coir Alternative

CocoNot is a natural & organic substitute for Coconut coir, peat moss & other soilless mediums & conditioners. It offers a perfect ratio of grinds & pith thus providing the plant with an exact medium structure for optimal root growth & moisture capacity.



Item No.	Description	MSRP
720395	Vermicrop CocoNot Coir Alternative 2 cu ft	\$30.95

Vermicrop VermiSoil Premium Potting Soil

Vermicrop Organics Premium Potting Soil is a rich blend of organic materials creating the best high yielding plants. Coconut Coir, Earth Worm castings, Peat Moss, Vermicrop Organics Premium Compost, Bat Guano and Mycorrhizae are some of the key elements.



Item No.	Description	MSRP
720340	Vermicrop VermiSoil Premium Potting Soil 1.5 cu ft	\$27.95

Vermicrop VermiBlend Premium Soil Amendment

VermiBlend Premium Soil Amendment has a unique blend of earthworm castings, compost, fossilized kelp, humus, rock minerals and mycorrhizae to provide ample amounts of micro nutrients, trace minerals and beneficial microbes. 1.0 - 1.5 - 0.6



Item No.	Description	MSRP
720755	Vermicrop VermiBlend Soil Amendment 1 cu ft	\$28.95

Vermicrop Organics VermiFire Premium Soil

VermiFire doesn't follow trends, it starts them. VermiFire performs above and beyond the call of duty, it is a potting soil that over achieves at every opportunity. Born from the stellar reputation of VermiSoil.



Item No.	Description	MSRP
720760	Vermicrop VermiFire 1.5 cu ft	\$28.95

Vermicrop VermiWorm

VermiWorm Premium Worm Castings are created by Red Wigglers; these are pure Eisenia Fetida castings. They are farmed organically in California by agriculturists who truly care about what they do. VermiWorms are fed a specific diet of organic matter containing no manures or chemicals.



Item No.	Description	MSRP
720765	Vermicrop VermiWorm .75 cu ft	\$39.95

Vital Earth's Mega Worm - 30L 1.3 - .0016 - .0381

Vital Earth's Mega Worm castings use only African night crawlers, raised in organic bedding with no toxic materials. Rich in nutrients, these are also rich in microbial life, which convert nutrients already available in the soil into plant-ready forms. Check your local Dealer Partner for availability.



Item No.	Description	MSRP
723305	Vital Earth's Mega Worm 30 Liter	\$60.95

Vital Earth's Manna Mix

This is our superior coconut-based planting mix. With Vital Earth's Coconut Pith, the holding capacity of the extra-long strands of coconut coir, creates the perfect water-to-air ratio for this ideal container planting mix.



Item No.	Description	MSRP
723315	Vital Earth's Manna Mix 1.5 cu ft	\$23.95

Vital Earth's Coco Lite 0.40 - 0.09 - 0.57

Clean shredded coco pith is a 100% natural growing medium that is naturally dried in the sun. When a perlite and mycorrhizal blend is added, this makes an excellent mix for growing medium for container plant growing.



Item No.	Description	MSRP
723310	Vital Earth's Coco Lite 2.0 cu ft	\$34.95

Vital Earth's O.G. Potting Soil

Vital Earth's O.G. Potting Soil is the perfect medium for growing all your fruits and vegetables. With sphagnum peat moss, which increases the holding capacity of air and water and decomposes very slowly, your plants are sure to be happy and healthy.



Item No.	Description	MSRP
723510	Vital Earth's O.G. Potting Soil 1 cu ft	\$21.95

B'cuzz Coco

B'cuzz Coco is the only coir product available through the retail hydroponics industry that undergoes a unique steaming and buffering process, resulting in an optimized, premium quality hydroponic growing medium.



Item No.	Description	MSRP
720389	B'cuzz Coco 50 Liter	\$29.95

B'cuzz HydroMix

B'cuzz Hydromix HP is a high porosity professional growing medium formulated for the serious grower. The light weight & high porosity of Hydromix provide conditions necessary to establish plant growth, especially when growing situations require high air-capacity and low water-retention media. Hydromix HP is ideal for use with water sensitive crops, propagation of plant cuttings and/or low-light conditions. Check your local Dealer Partner for availability.



Item No.	Description	MSRP
720392	B'cuzz HydroMix 3.8 cu ft	\$49.95

Just Right Xtra Potting Mix

Just Right Xtra is teaming with beneficial microbes, bacteria and fungi. This mix also contains the finest worm castings, natural organic potash and organic bone char. Just Right Xtra has a perfect pH to keep the bacteria and fungi happy and healthy! Check your local Dealer Partner for availability.



Item No.	Description	MSRP
715240	Just Right Xtra Potting Soil Mix 1.5 cu ft	\$24.95

Growstone® GS-2 Mix This Soil Aerator

Ideal aeration component of soil mixes. Its highly porous aggregates act as air pockets significantly enhancing aeration and drainage of an sphagnum peat, coco coir or composted soil-based mix. As a result, it creates the ideal environment for your plants' root systems and leads to healthy, thriving plants. 100% Recycled. 100% American made.



Item No.	Description	MSRP
714233	Growstone GS-2 Mix This Soil Aerator 1.5 cu ft	\$28.95

Growstone® GS-1 Hydroponic

It replaces strip-mined materials like clay pebbles or stonewool, reducing environmental degradation. Growstones are designed to allow for rapid moisture absorption and enhanced drainage and oxygenation.



Item No.	Description	MSRP
714231	Growstone GS-1 Hydroponic 1.5 cu ft	\$31.95

Growstone Gnat Nix!

Gnat Nix! is the only scientifically proven, environmentally friendly fungus gnat control product on the market. Trials at Kansas University have shown that used as a top dressing, Gnat Nix! is an effective physical barrier against fungus gnats. Gnat Nix! controls gnats at different points of their lifecycle, preventing adult emergence from hatching larvae and deterring females from laying eggs in the growing media.



Item No.	Description	MSRP
714240	Growstone Gnat Nix 9 Liter	\$13.99

Growstone GS-3 Coco-Mix

GS-3 coco mix combines the high porosity of Growstones with the great water holding capacity and biological benefits of high quality buffered coco coir and redwood fiber, topped with a high concentration of mycorrhizae from Xtreme Gardening (RTI).



Item No.	Description	MSRP
714242	Growstone GS-3 Coco Mix 1.5 cu ft. Bag	\$29.95

Organic Mechanics Planting Mix Soil Amendment

OMRI listed, 100% organic, peat-free and earth-friendly. Revitalize your soil with Planting Mix! It's formulated to enhance organic matter content in the root zone when planting outdoors in soil. Growers will notice improved moisture retention after adding Planting Mix to their soil. Check your local Dealer Partner for availability.



Item No.	Description	MSRP
715920	Organic Mechanics Planting Mix Soil Amendment 1 cu ft	\$13.95
715925	Organic Mechanics Planting Mix Soil Amendment 2 cu ft	\$24.95

Organic Mechanics Seed Starting Blend 0.3 - 0.1 - 0.2

Organic Mechanics Seed Starting Blend is OMRI listed, 100% organic, peat-free and earth-friendly. It contains a blend of premium ingredients designed to get seedlings off to a quick and healthy start. Use it for vegetables, herbs, annuals and perennials. Formulated for optimal seed germination, this mix provides up to 6 weeks of fertilization power! Check your local Dealer Partner for availability.



Item No.	Description	MSRP
715905	Organic Mechanics Seed Starting Blend 16 Quart	\$12.95

Organic Mechanics Container Blend Potting Soil

Organic Mechanics Container Blend Potting Soil is OMRI listed, 100% organic, peat-free and earth-friendly. It contains a blend of premium ingredients designed to grow lush plants in container gardens. Formulated to hold moisture yet have excellent drainage, growers will notice having to water less as compared to peat-based mixes. Check your local Dealer Partner for availability.



Item No.	Description	MSRP
715910	Organic Mechanics Container Blend Potting Soil 16 Quart	\$9.95
715915	Organic Mechanics Container Blend Potting Soil 2 cu ft	\$25.95

Organic Mechanics Premium Blend Potting Soil

OMRI listed, 100% organic, peat-free and earth-friendly. It contains a blend of premium ingredients designed for container gardening. Great for smaller container sizes and holding moisture under difficult (hot, dry) conditions. Formulated with exceptional moisture holding capacity, this blend has the greatest amount of compost and worm castings (as compared to Container Blend). Check your local Dealer Partner for availability.



Item No.	Description	MSRP
715935	Organic Mechanics Premium Blend Potting Soil 16 Quart	\$13.95
715940	Organic Mechanics Premium Blend Potting Soil 1 cu ft	\$19.95



Super Sprouter™

YOUR BEST START FOR SEEDS AND CUTTINGS!

Super Sprouter products can help give your plants their best start.

www.SuperSprouter.com **Industry exclusive**



CLONING & SEED STARTING

Super Sprouter Propagation Station with 7 in Dome



Everything you need to start your seedlings. This great kit includes Super Sprouter Seedling Heat Mat 10 in x 21 in, 72 site Seed Cell Plug Tray insert, 10 in x 20 in Propagation Tray and a Super Sprouter 7 in Propagation Dome with Vents. The Seedling Heat Mat is ETL listed.

Item No.	Description	MSRP
726400	Super Sprouter Propagation Station w/ 7 in Dome	\$39.95

Super Sprouter Seedling Heat Mat



Warms root area approximately 10°F - 20°F over ambient temperature to improve germination process. Helps gardeners have better success rates with seedlings and cuttings. Dimensions: 10 in x 21 in. 1 Year Warranty.

Item No.	Description	MSRP
726695	Super Sprouter Seedling Heat Mat 10 in x 21 in	\$24.95

Super Sprouter Heated Germination Kit with 2 in Dome



The Super Sprouter Heated Germination Kit is a great solution for your germination needs. The kit includes an Ultra Clear 2 inch germination dome with vents, 10 in x 20 in no hole tray, 72 site insert tray, Super Sprouter heat mat, instructions and growing tips. All that's required is your preferred growing media for germination and you are ready to grow. Heat mat is ETL listed. 1 Year Warranty.

Item No.	Description	MSRP
714152	Super Sprouter Heated Germination Kit w/ 2 in Ultra Clear Dome	\$31.95

Super Sprouter Seedling Heat Mat - 2 Tray



Mat design allows placing propagation trays end to end (instead of side by side) on this mat. These mats are 20% larger than competitive mats. This allows warming of 2 complete propagation trays to their edges. Dimensions: 12 in x 48 in. 5 ft 120 volt power cord. One mat uses 60 watts. 1 Year Warranty.

Item No.	Description	MSRP
726685	Super Sprouter 2 Tray Seedling Heat Mat Daisy-Chainable 12 in x 48 in	\$46.95

Super Sprouter Seedling Heat Mat Digital Thermostat

Easy to read digital display unit. Accurately set ideal germination temperature. Simple to use: plug mat into the thermostat & temperature probe into your soil or growing media. Temperature control range 68°F - 108°F (20°C - 42°C). Rated for maximum of 1000 watts. 6 ft power cord and probe with suction cup. 1 Year Warranty.



Item No.	Description	MSRP
726700	Super Sprouter Digital Heat Mat Thermostat	\$39.95

Super Sprouter Seedling Heat Mat Thermostat

Designed to be used with the Super Sprouter Seedling Heat Mat or any other heat mat. It's precise control allows the user to closely control mat temperature and easily dial in the ideal germination temperature. 1 Year Warranty.



Item No.	Description	MSRP
726702	Super Sprouter Seedling Heat Mat Thermostat	\$34.95

Super Sprouter Perfect Plug Tray



Pre loaded Super Sprouter Perfect Plug trays are great for seed starting and cuttings. Uses a custom peat moss blend to allow a great mixture of moisture and aeration. Pre drilled hole to foster the optimum environment for stem to media contact. Tray, insert and plugs are all included to make your cutting or seeding experience easy.

Item No.	Description	MSRP
714157	Super Sprouter Perfect Plug Custom Blend Tray 50/Count	\$23.49

Super Sprouter Perfect Plug Refill Pack

Super Sprouter Perfect Plug replacement plugs are great for seed starting and cuttings. Uses a custom peat moss blend to allow a great mixture of moisture and aeration. Pre drilled dibble to foster the optimum environment for stem to media contact. If limiting your waste plastic is important to you, use these 50 cell refill plugs to reload your Perfect Plug Tray.



Item No.	Description	MSRP
714159	Super Sprouter Perfect Plug Custom Blend Refill Pack 50/Count	\$14.99

Super Sprouter Preforma Cutting Tray with Plugs



Peat based plugs are natural and biodegradable. Makes transplanting easy. Open pore technology for optimum drainage. Excellent water-air ratio. pH balanced. Ingredients: Sphagnum, perlite and wetting agent. Not for sale in the following states at this time: GA, ID, MD, ME, NH, NJ, OK.

Item No.	Description	MSRP
714155	Super Sprouter Preforma Cutting Tray w/ Plugs	\$16.95

Fast-Gro Propagation Heating Mats

Greenhouse tests have shown that identical plants, cared for in exactly the same way, will grow up to three times faster when their roots are kept warm. Germinate seeds faster - ideal for starting seedlings! Grow plants up to 3 times faster!



Item No.	Description	MSRP
726610	Fast-Gro Heating Mat 11 in x 24 in	\$29.95
726615	Fast-Gro Heating Mat 22 in x 44 in	\$66.95

GH Rapid Rooter

Rapid Rooter plugs are all natural soilless grow plugs made of composted tree bark and organic materials. These plugs are perfect for seedlings or cuttings. Transplant plugs in soil or soilless hydrogardening applications.



Item No.	Description	MSRP
714135	GH Rapid Rooter 50/Pack Replacement Plugs	\$16.70
714140	GH Rapid Rooter 50 Cell Plug Tray	\$23.70
714150	GH Rapid Rooter Bulk Plugs	\$392.00

GH Rapid Rooter Mat

Rapid Rooter mat is a natural plant starters. It has 98 cross-cut planting sites that separate into one inch cubes for propagation cuttings and germinating seeds.



Item No.	Description	MSRP
714137	GH Rapid Rooter Mat 98	\$23.96

Planters' Pride Greenhouse Kits & Pellet Refills

Fiber Grow is made from coir, a highly renewable resource and 100% biodegradable. The coir has the capacity to absorb more water and retain it for longer periods. These all purpose kits include: pellets, tray and greenhouse dome. Pellets are universal, and fit in all Planters' Pride Fiber Grow Greenhouse Kits.



Item No.	Description	MSRP
714250	Planters Pride 20 Pellet Greenhouse Kit	\$9.99
714252	Planters Pride 20 Pellet Refill Kit	\$6.59
714255	Planters Pride 50 Pellet Greenhouse Kit	\$17.49
714257	Planters Pride 50 Pellet Refill Kit	\$13.89
714258	Planters Pride 1000 Pellet Refill Kit	\$112.95

Oasis Wedge Growing Medium with Tray

Wedge Growing Medium aids strong, fast root development of vegetative spring flowering plants. Wedge medium is ready and easy to use. Due to the unique shape of the Wedge Medium, transplanting of the rooted cuttings is made fast and easy.

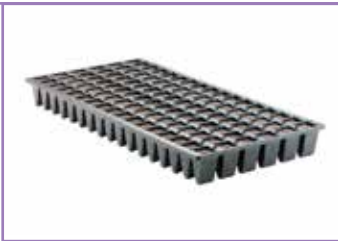

Item No.	Description	MSRP
713710	Oasis 102 Count Wedge Tray & Medium	\$9.30

Oasis Horticultures with Tray

Seed germination, simplified. The specially-engineered lower density, higher drainage foam has a unique cell structure a lot like a plant's own, making it perfect for seed germination. Its higher drainage design helps maintain an ideal air/water balance. These Horticultures come in standard 10 x 20 trays.



Item No.	Description	MSRP
713725	Oasis Horticultures 1.5 in Retail Pack w/ Tray - 50 Cells/Sheet	\$14.87

Oasis Rootcubes Bulk Pack

Rootcubes Growing Medium has multiple applications for those crops that require high water usage. This medium is designed to drain off excess water from the base of the cutting or seed, yet provide balance of air/water needed for good root development.

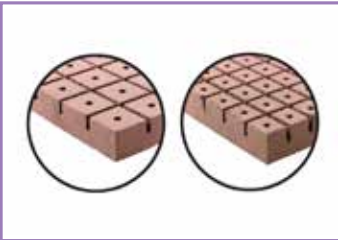

Item No.	Description	Sheets/Cs	MSRP
713700	Oasis Rootcubes 1.5 in Medium Cubes (5015) 50/Sheet	20	\$7.90
713705	Oasis Rootcubes 1.25 in Medium Cubes (5010) 104/Sheet	20	\$7.75

Oasis Rootcubes with Tray

This higher density, lower drainage foam, primarily designed for propagation of vegetative cuttings, encourages fast root development & optimal callus growth. Its finer-celled design offers greater contact with the cut end, for easier water uptake. These Rootcubes come in standard 10 x 20 trays.



Item No.	Description	MSRP
713650	Oasis Rootcubes w/Tray - 104 Cells/Sheet	\$15.99
713655	Oasis Rootcubes w/Tray - 50 Cells/Sheet	\$15.99

Oasis Rootcubes Plus with Tray

This new higher density, lower drainage foam was exclusively developed for propagation of slow-to-root vegetative cuttings. It will shave a few days off the propagation process — giving you healthy, robust plants sooner than before. Rootcubes Plus come in standard 10 x 20 trays.



Item No.	Description	MSRP
713660	Oasis Rootcubes Plus w/Tray - 104 Cells/Sheet	\$15.99
713665	Oasis Rootcubes Plus w/Tray - 50 Cells/Sheet	\$15.99

HDI Root Riot Trays

Root Riot are organic plant starter cubes for cuttings and seeds for soil or hydroponics. Includes a free Clonex Gel 15 ml packet. Made from organic material and are fully biodegradable. Root Riot will give you faster, more vigorous rooting.



Item No.	Description	MSRP
714128	Root Riot 25 Cube Tray w/ Clonex Gel	\$19.95
714130	Root Riot 50 Cube Tray w/ Clonex Gel	\$29.95

HDI Root Riot Replacement Cubes

Root Riot Organic Plant Starter Cubes are available in bags of 50 and 100 replacement cubes. Root Riot Organic Plant Starter replacement cubes are pre-moistened so they are ready to use right out of the bag.



Item No.	Description	MSRP
714129	Root Riot Replacement Cubes - 50 Cubes	\$17.95
714132	Root Riot Replacement Cubes - 100 Cubes	\$29.95

Super Sprouter T5 High Output Grow Light Fixture

This fixtures include electronic ballast, 6400K lamp, power cord, jumper cord, hanging and flat surface mounting clips. You can run up to a maximum of 8 lights per single cord. The reflector uses nanotechnology to maximize reflection. Specifically to fit Super Sprouter Light Track Domes. 1 Year Warranty.



Shown with optional dome

Item No.	Description	MSRP
726420	Super Sprouter T5 HO 18 in Grow Light Blister Pack	\$37.95

Super Sprouter Ultra Clear Vented Germination Dome 2 in

This excellent quality 2 inch Super Sprouter Ultra Clear Germination Dome fits standard 10 x 20 inch propagation flats. Use the 2 in tall dome for germinating seeds or for young clones. Two vents in the top of the dome can be opened or closed to control humidity. These are the most clear and transparent domes on the market.



Item No.	Description	MSRP
904288	Super Sprouter Ultra Clear Vented Germination Dome 2 in	\$2.59

Super Sprouter Ultra Clear Vented Humidity Domes with Light Tracks

These excellent quality 4 and 7 inch Ultra Clear Humidity Domes now have built in light tracks that accommodate the 18 inch Super Sprouter T5 HO Grow Light. The light tracks are directional to allow the light to run the length of the domes or the width of the domes, allowing two trays to run side by side. Two vents in the top of the dome can be opened or closed to control humidity.



Item No.	Description	MSRP
904289	Super Sprouter Ultra Clear Vented Humidity Dome 4 in	\$4.79
904295	Super Sprouter Ultra Clear Vented Humidity Dome 7 in w/ Light Tracks	\$5.49
726245	Super Sprouter Ultra Clear Dome Replacement Vent	\$0.69

Super Sprouter Standard Domes 2 & 4 Inch

Excellent quality Super Sprouter 2 and 4 inch tall standard domes with straight sides that allows the use of all plant sites in the propagation tray. Both domes fit snugly on standard 10 x 20 inch propagation tray.



Item No.	Description	MSRP
726215	Super Sprouter Standard Germination Dome 2 in	\$2.09
726239	Super Sprouter Standard Humidity Dome 4 in	\$4.09

Super Sprouter Standard Vented Humidity Dome 7 in

Excellent quality 7 inch tall standard humidity dome with straight sides that allows use of all plant sites in the propagation tray. The dome has two vents in the top that can be opened or closed to control humidity and has a built in handle. Fit a standard 10 x 20 inch tray. Replacement circle vents available.



Item No.	Description	MSRP
726241	Super Sprouter Standard Humidity Dome 7 in	\$4.99
726243	Super Sprouter Replacement Vent for 7 in Dome (726241)	\$0.69

Mondi Propagation Domes - 4 in

Constructed from heavy duty, high grade plastic to maximize light penetration and stand up to repeated use. Perfectly fitted for standard 10 x 20 trays, to create tight seal and reduce moisture loss.



Item No.	Description	MSRP
726130	Mondi 4 in Propagation Dome - No Vents	\$4.19
726135	Mondi 4 in Propagation Dome w/ Easy Vents	\$5.19

Mondi Propagation Domes - 7 in

A professional propagation dome for starting seeds or cuttings. Temperature and humidity controlled by two adjustable vents for better growing results. Designed to provide more cubic volume for your growing plants. Perfectly fitted for standard 10 x 20 trays.



Item No.	Description	MSRP
726140	Mondi Mini Greenhouse 7 in Propagation Dome	\$5.95
726142	Mondi Mini Greenhouse 7 in Propagation Dome w/ No Vents	\$5.95

Mondi Greenhouse Thermo-Hygrometer

This revolutionary product mounts anywhere on your Mondi Mini Greenhouse and reads the temperature and humidity inside the dome. In combination with Mondi Easy Vents, it ensures plants get the start they need with the essential real-time information. Includes battery.



Item No.	Description	MSRP
726125	Mondi Mini Greenhouse Thermo-Hygrometer	\$16.95

Super Sprouter Propagation Trays 10 x 20

10 x 20 black plastic propagation trays with and without holes.

Standard Thickness



Item No.	Description	MSRP
726165	Super Sprouter Propagation Tray 10 x 20 - No Holes	\$1.39
726167	Super Sprouter Propagation Tray 10 x 20 w/ Holes	\$1.49

Super Sprouter 72 Cell Plug Insert Trays

Fits snugly in a standard 10 x 20 propagation flat. Heavier duty than competitive inserts. Choose from round hole or square hole openings.



Item No.	Description	MSRP
726220	Super Sprouter 72 Cell Plug Tray - Square Holes	\$2.49
726410	Super Sprouter 72 Cell Germination Insert Tray - Round Holes 	\$1.65

Super Sprouter Double Thick Trays 10 x 20

Super Sprouter Double thick 10 x 20 tray is twice as thick as standard trays, ensuring it will last season after season. Don't let your hard work end up on the floor; protect your efforts by using double thick 10 x 20 tray.

Double Thick



Item No.	Description	MSRP
726294	Super Sprouter Double Thick Tray 10 x 20 - No Hole	\$2.39
726296	Super Sprouter Double Thick Tray 10 x 20 - w/ Hole	\$2.49

Mondi Propagation Trays 10 x 20

Mondi propagation trays have deep, continuous channels & level fit wide ridges prevent water pooling & provide better stability for propagation media. Super reinforced sides and lip with thick plastic and UV protection for durability & long life.



Item No.	Description	MSRP
726150	Mondi Propagation Tray 10 x 20 - No Holes	\$1.59
726155	Mondi Propagation Tray 10 x 20 - w/ Holes	\$1.59

Super Sprouter Quad Thick Tray & Insert 10 x 20

These trays are built tough. They are four times the thickness or regular 10 x 20 trays. No need to use multiple trays when one 10 x 20 tray will do the trick. The tray insert has a perforated bottom to allow for easy drainage.

Quad Thick



Item No.	Description	MSRP
726298	Super Sprouter Quad Thick 10 x 20 Tray - No Hole	\$3.89
726300	Super Sprouter Quad Thick Tray Insert	\$3.95

Mondi Black & White Premium 10 x 20 Propagation Tray

This is a clean and strong premium propagation tray made from high quality materials for durability. Interior is made of premium white plastic for increase light reflectivity. Reinforced outside shell made from recycled materials provide the strongest support to date.



Item No.	Description	MSRP
726120	Mondi Black & White Premium 10 x 20 Propagation Tray	\$4.95

Super Sprouter Mesh Bottom Tray

This mesh bottom plastic propagation tray can be inserted inside a standard 10 x 20 tray. Place your starter plugs (i.e. rockwool sheet of 98) inside the mesh bottom tray. Hand water your cuttings. The excess water will drain into the lower tray.



Item No.	Description	MSRP
726160	Super Sprouter Mesh Bottom 10 x 20 Propagation Tray	\$1.59

Mondi Propagation Tray Insert 55-01

Insert 55-01 pellet pocket tray makes pellet expansion convenient and clean with even spacing and airflow for hassle free propagation. 55 propagation pellets fit snugly while maintaining excellent drainage through the large size holes.



Item No.	Description	MSRP
726145	Mondi Propagation Tray Insert 55-01	\$1.49

SunBlaster NanoDome Combo Kit

The SunBlaster NanoDome Combo Kit includes one 18 in T5 HO SunBlaster NanoTech light fixture, a unique 7 in high dome designed to accommodate the included NanoTech fixture and a 10 x 20 tray.



Item No.	Description	MSRP
904299	SunBlaster Nano Dome Combo Kit	\$45.95

Grodan Gro-Smart Tray Insert

This durable tray has double-sided features. Use the 78-cell side to perfectly fit 1.5 in A-OK Starter plugs or round Macroplugs. Use the mesh side for sheets of A-OK's, Mini-Blocks, or Gro-Blocks. It fits in a 10 x 20 flat and keeps the Grodan elevated.



Item No.	Description	MSRP
707445	Grodan Gro-Smart Tray Insert	\$13.38

Planters' Pride Gel2Root

Contains all the necessary ingredients for your plant cuttings to begin rooting - No need to water! Gel2Root is a non-toxic rooting gel that contains everything you need to start a cutting with no hassle, no mess and no worries.



Item No.	Description	MSRP
714222	Planters Pride Gel 2 Root 6/Pack	\$19.99

iHort Quick Start Plugs

Quick start your seedlings and cuttings with the proprietary bonded Q plug. Plug dimension is 1.625 in round by 1.625 in deep. Q plugs are stabilized to create the optimum growing media, creating a stronger root system and superior lateral root development. 1500 count.



Item No.	Description	MSRP
714275	Quick Start Plugs Bulk 1.5 in x 1.5 in	\$349.95

Botanicare ReadyGro Super Plugs

A sponge like material, all natural soilless grow plugs are made of composted tree bark and organic materials. Biodynamic plugs are perfect for seedlings or cuttings. Ready Gro Super plugs are biodegradable and 100% organic. 1.5 in x 1.5 in size fits perfectly into rockwool holes. 1400 count.



Item No.	Description	MSRP
714215	Ready Gro Super Plugs	\$349.95

Botanicare CocoGro Plug 50 Cell Tray Kit

Botanicare Cocogro Cloning Plugs are the first 100% coco coir based plugs in our industry and offer an alternative to traditional peat and tree bark based rooting plugs. Developed specifically for cuttings and naturally maintain the ideal air to water ratio for accelerating rooting time and establishing vigorous clones. Get your plants started in this easy to use 50 cell plug tray.



Item No.	Description	MSRP
714208	Botanicare CocoGro Plug 50 Cell Tray Kit	\$24.50

Botanicare CocoGro Cloning Plug Refills

Botanicare Cocogro Cloning Plugs are the first 100% coco coir based plugs in our industry and offer an alternative to traditional peat and tree bark based rooting plugs. Developed specifically for cuttings and naturally maintain the ideal air to water ratio for accelerating rooting time and establishing vigorous clones.



Item No.	Description	MSRP
714210	Botanicare CocoGro Cloning Plug 50 Pack Refill	\$18.25
714212	Botanicare CocoGro Cloning Plug 100 Pack Refill	\$33.50
714214	Botanicare CocoGro Cloning Plug 500 Pack Refill	\$149.95

Botanicare Power Cloner White

Redeveloped with Botanicare Low Profile Reservoirs, these systems decrease propagation time. Includes reservoir, Humidome, recessed cord guide, neoprene inserts, high pressure sprayers, ceramic airstones, Power Clone Solution, AquaShield and ZHO.



Item No.	Description	MSRP
706178	Botanicare White Power Cloner 45 w/ Dome - 10 Gallon Reservoir	\$354.95
706186	Botanicare White Power Cloner 77 w/ Dome - 20 Gallon Reservoir	\$474.95
706187	Botanicare White Power Cloner 180 w/ Dome - 40 Gallon Reservoir	\$737.00

Botanicare Power Cloner Black

Redeveloped with Botanicare Low Profile Reservoirs, these systems decrease propagation time. Includes reservoir, recessed cord guide, neoprene inserts, high pressure sprayers, ceramic airstones, Power Clone Solution and AquaShield.



Item No.	Description	MSRP
706189	Botanicare Black Power Cloner 45 - 10 Gallon Reservoir	\$299.95
706191	Botanicare Black Power Cloner 77 - 20 Gallon Reservoir	\$379.95
706193	Botanicare Black Power Cloner 180 - 40 Gallon Reservoir 	\$581.50

Botanicare Power Cloner Domes

A tight fitting dome for use with Botanicare Power Cloners. Made from high impact, clear, ABS plastic. All domes contain humidity control vents.



Item No.	Description	MSRP
706195	Botanicare Power Cloner 45 Dome w/ Vents	\$85.95
706197	Botanicare Power Cloner 77 Dome w/ Vents	\$82.30
706199	Botanicare Power Cloner 180 Dome w/ Vents	\$128.40

Botanicare Clone Machine 25 & 48

Clone Machine 25 & 48 are improved redesign from previous Clone Machines. Made from high density polyethylene. 25 site uses just 1.5 gals and the 48 uses 6 gals of water. Both have a submersible pump and 25 or 48 - 1.5 in neoprene inserts and Power Clone Solution rooting hormone.



Item No.	Description	MSRP
706168	Botanicare Clone Machine 48	\$249.95
706172	Botanicare Clone Machine 25	\$171.95

Botanicare Daisy Cloner

A small version of the Clone Machines, this Daisy Cloner works great! It comes with a pump, net pots and root guards. It has 8 - 2 in plant sites.



Item No.	Description	MSRP
706245	Botanicare Daisy Cloner 8	\$84.95

oxyCLONE 20 Site System



The oxyCLONE 20 site cloner works on the principle of re-circulating super oxygenated water created by the oxyHEAD. The oxyHEAD draws in oxygen from the atmosphere and produces turbulence to continuously nourish your cuttings in super oxygenated water. Kit includes 2 sets of oxycerts, oxyHEAD pump; molded cover & impact resistant reservoir. Black light proof materials. 90 Day Warranty.

Item No.	Description	MSRP
706555	OxyClone 20 System	\$64.95

EZ-Clone Classic 16 Cutting System

EZ-Clone Classics have been made from fully recyclable HDPE which highly chemically resistant and extremely durable. Now has leak resistant cord outlet that allows multiple cords. Also a specially designed recessed drain that allows it to be highly protected and gives the ability to easily tip the unit for draining. Limited Lifetime Warranty.



Item No.	Description	MSRP
706420	Ez-Clone Classic 16 Cutting System	\$159.95

EZ-Clone Classic 32 Cutting System

EZ-Clone Classics have been made from fully recyclable HDPE which highly chemically resistant and extremely durable. Now has leak resistant cord outlet that allows multiple cords. Also a specially designed recessed drain that allows it to be highly protected and gives the ability to easily tip the unit for draining. Limited Lifetime Warranty. 



Item No.	Description	MSRP
706425	Ez-Clone Classic 32 Cutting System	\$249.95

EZ-Clone Classic 64 Cutting System

EZ-Clone Classics have been made from fully recyclable HDPE which highly chemically resistant and extremely durable. Now has leak resistant cord outlet that allows multiple cords. Also a specially designed recessed drain that allows it to be highly protected and gives the ability to easily tip the unit for draining. Limited Lifetime Warranty. 



Item No.	Description	MSRP
706430	Ez-Clone Classic 64 Cutting System	\$319.95



EZ-Clone Classic 128 Cutting System

EZ-Clone Classics have been made from fully recyclable HDPE which highly chemically resistant and extremely durable. Now has leak resistant cord outlet that allows multiple cords. Also a specially designed recessed drain that allows it to be highly protected and gives the ability to easily tip the unit for draining. Limited Lifetime Warranty.



Item No.	Description	MSRP
706435	Ez-Clone Classic 128 Cutting System	\$419.95

EZ-Clone Replacement Pumps

EZ-Clone ultra efficient, super high output water pumps are great for any application. The pump is smaller in physical size, creating less heat. Fully coated impellers make for a smooth and quiet operation. Limited Lifetime Warranty.



Item No.	Description	MSRP
706395	Ez-Clone Replacement Water Pump 700 GPH for 16 & 32 Units	\$69.95
706400	Ez-Clone Water Replacement Pump 800 GPH for 64 & 128 Units	\$89.95

EZ-Clone Clear Rez

Designed to help keep reservoirs, pipes, pumps, and irrigation systems free from build up during the cloning process. It is suitable for use during any stage of plant development.



Item No.	Description	MSRP
708920	Ez-Clone Clear Rez 4 oz	\$6.95
708925	Ez-Clone Clear Rez 8 oz	\$11.95
708930	Ez-Clone Clear Rez Pint	\$19.95

EZ-Clone Sprayer

Replacement sprayer for all models of EZ-Clone units.



Item No.	Description	MSRP
706392	Ez-Clone 360 Sprayer Red	\$0.70

EZ-Clone Neoprene Replacement Inserts

Custom made neoprene collars are pre-slit for easy insertion of cuttings. Available in Hard and original Soft.



Item No.	Description	MSRP Ea
706390	Ez-Clone Neoprene Insert Soft (35/Bag)	\$0.45
706391	Ez-Clone Neoprene Insert Soft (65/Bag)	\$0.45
706388	Ez-Clone Neoprene Insert Hard (35/Bag)	\$0.45
706389	Ez-Clone Neoprene Insert Hard (65/Bag)	\$0.45

Botanicare Neoprene Inserts

Black foam inserts that act as root guards.



Item No.	Description	MSRP Ea
724299	Botanicare Neoprene Insert for Power Cloners 1.7 in (25/Sheet)	\$0.53
724300	Botanicare Neoprene Insert 2 in (25/Sheet)	\$0.55
724305	Botanicare Neoprene Insert 3 in (16/Sheet)	\$0.95
724310	Botanicare Neoprene Insert 3.75 in (12/Sheet)	\$1.40

Super Sprouter Neoprene Inserts

Variety of different colors to choose from: yellow, blue, orange, green, purple, red, black and multi-color pack. Prevents cuttings and clones from moving around. Pre-slit for easy insertion with a pre-drilled hole. Color selection allows for use as identifying markers. Easy to use.



Item No.	Description	MSRP Ea
870005	Super Sprouter Neoprene Insert 2 in Yellow 100/Pack	\$0.42
870010	Super Sprouter Neoprene Insert 2 in Blue 100/Pack	\$0.42
870015	Super Sprouter Neoprene Insert 2 in Orange 100/Pack	\$0.42
870020	Super Sprouter Neoprene Insert 2 in Green 100/Pack	\$0.42
870025	Super Sprouter Neoprene Insert 2 in Purple 100/Pack	\$0.42
870030	Super Sprouter Neoprene Insert 2 in Red 100/Pack	\$0.42
870035	Super Sprouter Neoprene Insert 2 in Black 100/Pack	\$0.42

Super Sprouter Multicolored Neoprene Inserts

Variety of different colors in one multi-color pack: yellow, blue, orange, green, purple and red. Prevents cuttings and clones from moving around. Pre-slit for easy insertion with a pre-drilled hole. Color selection allows for use as identifying markers. Easy to use.



Item No.	Description	MSRP Ea
870040	Super Sprouter Neoprene Insert 2 in Multicolor 192/Pack	\$0.42

GH RapidStart 1 - 0.5 - 1

RapidStart enhances your growing experience by delivering a powerful blend of premium plant extracts, amino acids, and nutrients generating explosive root growth. Using RapidStart will make your plants explode!



Item No.	Description	MSRP
726850	GH RapidStart 125 ml	\$26.49
726855	GH RapidStart 275 ml	\$39.99
726860	GH RapidStart 500 ml	\$74.36
726865	GH RapidStart 1 Liter	\$143.30

Botanicare ZHO Root Inoculant 6 - 0 - 0

ZHO is a unique and proprietary blend of beneficial Endomycorrhizal fungi, Trichoderma fungi and highly available L-Glycine amino acids. ZHO promotes rapid new root growth and improves the plants' ability to uptake water and nutrients. ZHO was specifically formulated for fruit bearing and heavy flowering plant types.



Item No.	Description	MSRP
732316	Botanicare ZHO Root Inoculant 1/4 lb	\$29.95
732318	Botanicare ZHO Root Inoculant 1 lb	\$99.95

Botanicare Power Clone Rooting Gel 0.1 - 0.1 - 0.1

For rapid, robust roots. Get a profusion of luxuriant roots from cuttings and best of all, the main ingredients are 100% natural. Can be used with all types of rooting media.



Item No.	Description	MSRP
726050	Botanicare Power Clone Gel 2 oz	\$15.50
726055	Botanicare Power Clone Gel 4 oz	\$23.50

Botanicare Power Clone Rooting Solution 0.2 - 0.3 - 0.2

Although the Liquid Concentrate can be used as effectively as the Rooting Gel in all kinds of media, the liquid is most beneficial in aeroponic systems and for transplanting potted or bare-root plants. The powerful, all natural ingredients present in this product offer long-term protection against transplant shock.



Item No.	Description	MSRP
726065	Botanicare Power Clone Solution 4 oz	\$22.95
726070	Botanicare Power Clone Solution 8 oz	\$34.95
726075	Botanicare Power Clone Solution Pint	\$58.95
726080	Botanicare Power Clone Solution Quart	\$107.95

Clonex Clone Kit

The Clonex Clone Kit is an all-inclusive cloning kit for both beginners and experienced growers alike. It contains the items necessary to take cuttings and root them successfully. Use the included Clonex Clone Solution, Mist and Gel to help your cuttings get the necessary nutrients they need for explosive root growth.



Item No.	Description	MSRP
726020	HydroDynamics Clonex Clone Kit	\$29.95

Clonex Rooting Gel

It is a tenacious gel which will remain in contact around the stem, sealing the cut tissue and supplying the hormones needed to promote root cell development and vitamins to protect the delicate new root tissue. Clonex has a full spectrum of mineral nutrients and trace elements to nourish the young roots.



Item No.	Description	MSRP
726005	HydroDynamics Clonex Gel 100 ml	\$23.95
726010	HydroDynamics Clonex Gel 250 ml	\$49.95
726006	HydroDynamics Clonex Gel Pint	\$91.00
726007	HydroDynamics Clonex Gel Quart	\$169.00

Clonex Rooting Gel Packets

It is a tenacious gel which will remain in contact around the stem, sealing the cut tissue and supplying the hormones needed to promote root cell development and vitamins to protect the delicate new root tissue. Clonex has a full spectrum of mineral nutrients and trace elements to nourish the young roots.



Item No.	Description	MSRP
726004	HydroDynamics Clonex Gel Packets 15 ml	\$6.00

Clonex Clone Solution 1 - 0.4 - 1

Clonex Clone Solution is a clone-specific nutrient formulated using a special blend of minerals and other helpful ingredients. Clonex Clone Solution can be applied to the rooting medium and sprayed over the young clones.



Item No.	Description	MSRP
726011	HydroDynamics Clonex Clone Solution Quart	\$25.00
726012	HydroDynamics Clonex Clone Solution Gallon	\$70.00
726013	HydroDynamics Clonex Clone Solution 2.5 Gallon	\$160.00
726014	HydroDynamics Clonex Clone Solution 5 Gallon	\$300.00

Clonex Mist

Clonex Mist is a root stimulator to be used on both your mother plants and clones. It is designed to work in conjunction with Clonex Gel to produce vigorous healthy cuttings with strong roots. It is used to mist cuttings at regular intervals during the rooting process. Clonex Mist contains no hormones and is completely safe and non-toxic. Not for sale in the following states at this time: WA.



Item No.	Description	MSRP
726015	HydroDynamics Clonex Mist 100 ml	\$10.95

Vita Grow Anti-Wilt Propagation & Transplant Spray

Tests show Vita Grow Anti-Wilt surpasses all other products in its class. Sold as a concentrate, this product should be diluted and sprayed onto the leaves of cuttings or newly transplanted starts. Dilution rate is 7 parts water to 1 part concentrate.



Item No.	Description	MSRP
726500	Vita Grow Anti-Wilt Conc. 4 oz	\$9.95
726505	Vita Grow Anti-Wilt Pint	\$26.95
726510	Vita Grow Anti-Wilt Conc. Quart	\$42.95

Vita Grow Rooting Compound

A quick 3 second dip of the cutting's stem into Vita Grow RTU Rooting Compound before placing it into your favorite growing media is all you need to start the growth of healthy new roots. A great choice for aeroponic cutting/cloning machines. EPA No. 68719-2-AA.



Item No.	Description	MSRP
726515	Vita Grow Rooting Compound 4 oz	\$12.95
726520	Vita Grow Rooting Compound 8 oz	\$19.95
726525	Vita Grow Rooting Compound Pint	\$31.95

Hormex Concentrate

A vitamin, hormone concentrate and root growth stimulant. Hormex prevents transplant shock by stimulating growth of the small feeder roots, which become damaged during transplanting. Not for sale in the following states at this time: OR.



Item No.	Description	MSRP
726625	Hormex Conc. 8 oz	\$17.19
726630	Hormex Conc. Pint	\$26.89
726635	Hormex Conc. Quart	\$42.99
726634	Hormex Conc. Gallon	\$128.99

EZ-Clone Rooting Compound

Developed with cuttings in mind, EZ-Clone Rooting Compound is superior gel that aids in root development. Packed with all the essential nutrients and hormones that roots need to begin a healthy life.



Item No.	Description	MSRP
726655	EZ-Clone Rooting Compound Gel 1 oz	\$6.95
726660	EZ-Clone Rooting Compound Gel 2 oz	\$12.25
726665	EZ-Clone Rooting Compound Gel 4 oz	\$21.95
726670	EZ-Clone Rooting Compound Gel 8 oz	\$39.95

Dip 'N Grow Rooting Solution

Choice of professional plant propagators. Roots everything - from hardwoods to succulents. Cost effective solution for cuttings! EPA No. 64388-1-AA. Not for sale in the following states at this time: DC, ND, SD.



Item No.	Description	MSRP
726305	Dip 'N Grow Rooting Solution 2 oz	\$10.95
726310	Dip 'N Grow Rooting Solution Pint	\$53.95

Grow More Rapid Root

EPA registered cloning powder, 1 ounce of Rapid Root powder will treat over 1,500 cuttings. Our one dip treatment powder prevents cross contamination problem associated with liquid products. EPA No. 70908-2-AA.



Item No.	Description	MSRP
721645	Grow More Rapid Root 2 oz	\$6.21

Technaflora Rootech Cloning Gel

Rootech Cloning Gel is an exceptional recipe to promote rapid, healthy root development during vegetative propagation. At application, Rootech's unique formulation surrounds the stem so it can be used immediately. Technaflora's formulation is among the strongest cloning gels on the market. Not for sale in the following states at this time: CT.



Item No.	Description	MSRP
726704	Rootech Gel .25 oz	\$3.62
726705	Rootech Gel 2 oz	\$20.68
726710	Rootech Gel 4 oz	\$34.49
726715	Rootech Gel 8 oz	\$56.92

Humboldt Roots

Humboldt Roots is a highly concentrated organic root stimulant that expands the root zone during the critical growth stage. A large yield is directly related to a plant's metabolic rate. Humboldt Roots was specifically designed to expand the root zone which results in larger yields. Check your local Dealer Partner for availability.

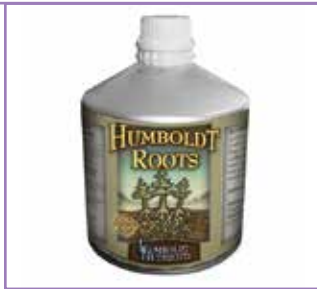

Item No.	Description	MSRP
723119	Humboldt Roots 50 ml	\$22.00
723120	Humboldt Roots 125 ml	\$42.00
723122	Humboldt Roots 250 ml	\$70.00
723124	Humboldt Roots 500 ml	\$115.00
723125	Humboldt Roots 1/2 Gallon	\$386.00

Olivia's Cloning Starter Kit

Olivia's Cloning starter kit is the complete plant cloning starter kit for hydroponic cloning that includes everything you need to get started. The Starter-Kit contains Olivia's Cloning Solution, Olivia's Cloning Gel as well as a "How To Clone a Plant" with complete instructions, tips and drawings on hydroponic cloning and a trifold pamphlet.



Item No.	Description	MSRP
726355	Olivia's Cloning Starter Kit	\$25.95

Olivia's Cloning Solution

This cloning solution is a nutrient and propagation liquid that promotes vigorous growth and rapid root development for all types of plants, flowers, fruits and vegetables. Mixing ratio is 6 oz to 1 Gallon of water.



Item No.	Description	MSRP
726345	Olivia's Clone Solution Quart	\$12.95
726350	Olivia's Clone Solution Gallon	\$37.95

Olivia's Cloning Gel

A professional strength, easy/ready to use propagation gel. Just cut, clip and grow! Stimulates root development for all types of plants. Use for all stem, leaf, softwood, semi hard & some hardwood cuttings. Seals cutting & reduces transplant shock.



Item No.	Description	MSRP
726330	Olivia's Clone Gel 2 oz	\$14.95
726335	Olivia's Clone Gel 4 oz	\$22.95
726340	Olivia's Clone Gel 8 oz	\$37.95

Dyna-Gro K-L-N Concentrate

K-L-N Concentrate is a rooting solution that contain ingredients to promote vigorous root growth in trees, foliage and flowering plants. Use it for propagating cuttings, air layering and as a transplanting drench for newly potted plants. EPA No. 87394-3. Not for sale in the following states at this time: AK, AL, AR, AZ, DE, GA, HI, IA, ID, KS, KY, LA, MA, MD, ME, MN, MO, MS, MT, ND, NE, NH, NJ, NV, OH, PR, RI, SC, SD, UT, VA, VT, WI, WV, WY.



Item No.	Description	MSRP
726530	Dyna-Gro K-L-N Conc. 8 oz	\$10.50
726535	Dyna-Gro K-L-N Conc. Quart	\$31.00
726537	Dyna-Gro K-L-N Gallon Conc.	\$103.00
726539	Dyna-Gro K-L-N 5 Gallon Conc.	\$445.00

Dyna-Gro Root-Gel

Root-Gel is a unique patented vitamin-hormone gel formulated for the propagation of cuttings. Root-Gel applies quickly, easily and thoroughly, surrounding the cutting with a viscous coating of protective nutrient gel. Root-Gel seals the cutting and functions as an artificial root system during root development. Check your local Dealer Partner for availability. EPA No. 87394-4. Not for sale in the following states at this time: AK, AL, AR, AZ, DE, GA, HI, IA, ID, IL, KS, KY, LA, MA, MD, ME, MN, MO, MS, MT, ND, NE, NH, NJ, NV, OH, OK, RI, SC, SD, TN, UT, VA, VT, WI, WV, WY.



Item No.	Description	MSRP
726540	Dyna-Gro Root-Gel 2 oz	\$12.49
726542	Dyna-Gro Root-Gel 4 oz	\$22.99
726544	Dyna-Gro Root-Gel 8 oz	\$42.99

Super Sprouter Sterile Disposable Scalpel

Use this individually wrapped sterilized scalpel for all your plant cuttings. A sterile scalpel will help prevent disease and damage to any cutting.



Item No.	Description	MSRP
728000	Super Sprouter Sterile Disposable Scalpel	\$1.95



Xtreme Gardening Azos

Azos is a beneficial microbe that rapidly increases natural plant hormone production, affecting cell division, growth rates, plant and root development. Use Azos to quickly and naturally root new cuttings; water-in or add to hydroponic reservoirs to feed and fuel abundant growth. May be used with any nutrient line.



Item No.	Description	MSRP
721259	Xtreme Gardening Azos 2 oz	\$19.95
721260	Xtreme Gardening Azos 6 oz	\$29.95
721265	Xtreme Gardening Azos 12 oz	\$49.95
721268	Xtreme Gardening Azos 8 lb	\$349.95

Clone Guard

It has been estimated that powdery mildew, mold, leaf dwelling insects and leaf dehydration account for over 50% of clone death. Clone Guard locks in water molecules from escaping from the leaves preventing the clone from wilting. It also locks out insects, powdery mildew and mold, denying them the access to the clone.



Item No.	Description	MSRP
704519	Clone Guard 4 oz	\$11.95
704521	Clone Guard Pint	\$29.95
704523	Clone Guard Quart	\$49.95

RX Green Solutions Life Cloning Solution 0.5 - 1 - 0.5

Life is a cloning solution formulated specifically to provide the nutrient inputs to assist in early root and plant development. It has a unique blend of ingredients that combine essential carbohydrates and enzymes, which promote energy metabolism and protein synthesis. Works with all growing media. Not for sale in the following states at this time: OR.



Item No.	Description	MSRP
719490	RX Green Solutions Life Cloning Solution Quart	\$19.99
719492	RX Green Solutions Life Cloning Solution Gallon	\$59.99
719494	RX Green Solutions Life Cloning Solution 2.5 Gallon	\$119.99

Bond Reusable T-Markers

These are 10 in tall plastic reusable T-Markers. Use to identify plants within your garden.



Item No.	Description	MSRP
740840	Bond Reusable T-Markers - 25/Pack	\$3.95

Grower's Edge Plant Stake Labels Multi-Colored

Use these colorful plant stake labels to mark the type of seeds that you plant. Each stake is 4 in x 5/8 in.



Item No.	Description	MSRP
801000	Grower's Edge Plant Stake Labels White - 1000/Box	\$29.95
801005	Grower's Edge Plant Stake Labels Red - 1000/Box	\$31.95
801010	Grower's Edge Plant Stake Labels Orange - 1000/Box	\$31.95
801015	Grower's Edge Plant Stake Labels Yellow - 1000/Box	\$31.95
801020	Grower's Edge Plant Stake Labels Green - 1000/Box	\$31.95
801025	Grower's Edge Plant Stake Labels Dark Blue - 1000/Box	\$31.95
801030	Grower's Edge Plant Stake Labels Lavender - 1000/Box	\$31.95

Luster Leaf Plant Labels

Choose from 4 in or 6 in durable plant stake labels. Easily label your newly planted seeds. 50 labels per package.



Item No.	Description	MSRP
741415	Luster Leaf Plant Labels 4 in	\$2.49
741425	Luster Leaf Plant Labels 6 in	\$3.19

Luster Leaf Colored Plant Labels

Choose from blue, yellow or green durable plant stake labels. Easily label your newly planted seeds on these 5 in stakes. 30 labels per package.



Item No.	Description	MSRP
741420	Luster Leaf Colored Plant Labels 5 in	\$2.99

Luster Leaf T Label Plant Markers

Label your plants or seeds with these tall T shaped plant markers. 10 T labels per package.



Item No.	Description	MSRP
741410	Luster Leaf T Label Plant Markers 8 in	\$2.09



At Flo-n-Gro®, we like to take the mystery out of growing plants hydroponically. We constantly strive to bring you the most dynamic products available in the marketplace today. Our grow systems tout simplicity and ease of use for today's growers. The innovative Flo-n-Gro® 12 Site Gro System brings you the straightforwardness you've been looking for in an ebb & flow hydroponic system. Pre-cut tubing and easy to follow instructions makes the 12 Site Gro System a 'snap' to set-up. Just add your favorite soilless grow media (Hydroton, Grodan®, etc.), and in less than one hour you're growing.

Flo-n-Gro® Ebb & Flow System - 12 Site



This Flo-n-Gro system with reservoir comes complete with twelve (12) 4 gallon grow sites and twelve (12) 3 gallon 360 degree mesh aeration inserts. Features Titan Controls Oceanus 1 - Flo-n-Gro controller. 120 Volts/60 Hz. 1 Year Warranty.

Item No.	Description	MSRP
702790	Flo-n-Gro Ebb & Flow System - 12 Site	\$624.95

Flo-n-Gro® Gro Giant Ebb & Flow System - 6 Site



The Gro Giant – Oversized Ebb & Flow Grow System is for big plants. Comes with a 55 gallon reservoir, Oceanus 2 system controller, two pumps, six food grade 6.6 gallon Gro sites, six 10 in mesh Gro inserts, fittings and irrigation tubing. All parts fit inside the 55 gallon barrel. 120 Volts/60 Hz. Patent Pending 13/200559. 1 Year Warranty.

Item No.	Description	MSRP
702811	Flo-n-Gro - Gro Giant Ebb & Flow System - 6 Site	\$649.95

Flo-n-Gro® Ebb & Flow System - 6 Site



Comes with a 55 gallon reservoir, six – food grade 4 gallon GRO sites and 6 – 3 gallon 360 degree mesh aeration inserts. It features the Oceanus 1 flood and drain digital controller and includes all the irrigation tubing, fittings, pumps and parts to set up the system. The 3/4 in fill and drain lines with exclusive tub outlet tee fittings. Can be expanded up to 24 sites using the 6 site Ebb & Flow Expansion Kit (#702785). 120 Volts/60 Hz. 1 Year Warranty.

Item No.	Description	MSRP
702806	Flo-n-Gro Ebb & Flow Gro System - 6 Site	\$519.95

Flo-n-Gro® Drip-n-Gro Dual Top Feed Drip System - 6 Site



The Drip-n-Gro top feed grow system takes hydroponic gardening techniques to a new level! This innovative bucket system comes ready to use with all the critical components pre-fabricated to allow easy set-up and get you gardening fast. The Drip-n-Gro can be expandable using the Drip-n-Gro Expansion Kit - 6 Site (available separately). 120 Volts/60 Hz. All parts fit inside the 55 gallon barrel. 1 Year Warranty.

Item No.	Description	MSRP
702792	Flo-n-Gro Drip-n-Gro Dual Top Feed Drip System w/ Reservoir - 6 Site	\$499.95

Flo-n-Gro® Ebb & Flow Expansion Kit - 6 Site

The Expansion Kit is fully compatible with the 12 Site Ebb & Flow Gro System, as well as the 6 Site Gro System. The kit comes with six (6) 4 gallon Gro sites and six (6) 3 gallon 360 degree snap in mesh aeration inserts. The kit includes 3/4 in exclusive Tub Outlet Tee Fitting and tubing to hook up to your system.



Includes Industry Exclusive Tub Outlet Tee Fittings

Item No.	Description	MSRP
702785	Titan Controls Flo-n-Gro 6 Cell Expansion Kit	\$114.95

Flo-n-Gro® Drip-n-Gro Expansion Kit - 6 Site

The Drip-n-Gro 6 site expansion kit allows easy extension of your grow system. It comes with six 4 gallon GRO sites, six 360 degree black mesh GRO inserts, irrigation tubing and all the fittings you need to easily increase your garden size. The Drip-n-Gro system can be multiplied up to 50 GRO sites. 1 Year Warranty.



Includes Industry Exclusive Tub Outlet Tee Fittings

Item No.	Description	MSRP
702793	Flo-n-Gro Top Feed 6 Site Expansion Kit	\$149.95

Flo-n-Gro® Gro Giant Expansion Kit - 3 Site

The three site expansion kit is fully compatible for use with the Gro Giant – Oversized Ebb & Flo Grow System. It comes with three huge 6.6 gallon Gro sites, three gigantic 10 inch mesh Gro inserts, irrigation tubing and fittings to easily expand your system.



New

Item No.	Description	MSRP
702812	Flo-n-Gro - Gro Giant Expansion Kit - 3 Site	\$99.95

Flo-n-Gro® Gro-n-Dirt Automated 12 Site Soil Garden - 5 Gallon Pots



Features proprietary drip ring!

New

FABRICATED AND ASSEMBLED IN USA

Have your garden ready to grow in 30 minutes or less using the Gro-n-Dirt – 12 site system. The system comes complete: 55 gallon reservoir, 12 five gallon Gro Pro cloth pots with saucers, high quality pump, Titan Controls Apollo 7 digital timer, irrigation drip rings, in-line filter, vinyl tubing and all the fittings to connect your system together. All parts fit inside the 55 gallon barrel. 120 Volts/60 Hz. 1 Year Warranty.

Item No.	Description	MSRP
702817	Flo-n-Gro Gro-n-Dirt Automated 12 Site Soil Garden - 5 Gallon Pots	\$359.95

Oceanus 1 Flo-n-Gro® Controller

The Oceanus 1 - Flo-n-Gro Controller features fully digital technology. The 24 hour timer allows you to set several watering patterns for your plants. LED lights indicate FILL and DRAIN functions. Purchase pump separately (recommend product #727085). 120 Volts/60 Hz. Patent Pending 13/200559. 1 Year Warranty.



Item No.	Description	MSRP
702780	Titan Controls Oceanus 1 Flo-n-Gro Controller	\$329.95

Flo-n-Gro® Flo-n-Brew - Compost Tea Brewing System

This compact and easy to use compost tea brewer comes with everything you need to brew. It comes with a 3 gallon tea brewer, air pump with hose, Eco 185 submersible pump, fountain kit and 2 air stones. It is 120 Volts/1 Amp/60 Hz.



Item No.	Description	MSRP
702800	Flo-n-Brew Compost Tea Brewing System	\$69.95
702798	Flo-n-Brew Fountain Head Replacement	\$2.49

Flo-n-Gro® Gro Momma Bubbler Bucket

The Gro Momma 5 gallon Bubbler Bucket system allows both the experienced and inexperienced grower to garden with ease. Kit includes: 8in mesh bucket topper, Hydroton growing media, EcoPlus air pump, 3/16 in tubing, 4 in Air Stone and expansion Tee fitting with EZ Pull End Caps.



Item No.	Description	MSRP
702804	Flo-n-Gro - Gro Momma Bubbler Bucket	\$40.95

Flo-n-Gro® Big Momma Bubbler Bucket

This oversized single site grow system can grow big plants! It offers a 6.6 gallon gro site, grow media, air pump with tubing, air stone and a 10 inch mesh insert that promotes outstanding root growth. It also comes with a grommet and tee fitting to daisy chain or easily drain the sites.



New

Item No.	Description	MSRP
702808	Flo-n-Gro Big Momma Bubbler Bucket - 6.6 Gallon	\$49.95

55 Gallon Barrel with Lid - Food Grade

This is the original reservoir barrel used in our Flo-n-Gro gardens. It is also a great multi-purpose, heavy-duty reservoir if you are building your own system. Made with food-grade plastic. Includes the lid (no holes) and clamp. Height is 36 in x Diameter of 23 in. Barrel capacity is 55 gallons and weighs 24 lb.



Item No.	Description	MSRP
707168	55 Gallon Barrel w / Lid - Food Grade	\$129.95

55 Gallon Replacement Lid

Use this lid for the 55 gallon barrel. It has no holes.



Item No.	Description	MSRP
707161	55 Gallon Replacement Lid w/ Holes	\$17.95
707166	55 Gallon Drum Ring Clamp	\$14.95

Flo-n-Gro Square Fabric Liner

This breathable fabric liner provides good drainage and aeration. Compatible only with the Ebb & Flow 6 Site System and 12 Site Gro Systems. Helps contain growing media. Fits snugly into 360 degree plastic mesh inserts. Promotes lateral root growth. Eliminates circling and misguided roots. 3 gallon size.



Item No.	Description	MSRP
724975	Flo-n-Gro Square Fabric Liner 3 Gallon	\$4.05

Flo-n-Gro Blue Bucket - 4 Gallon

The Flo-n-Gro Blue Bucket features food grade plastic, safe for you and your plants. At 4 gallon capacity. Dimensions: 9.5 in W x 9.5 in L x 13.5 in D. Compatible with the Ebb & Flow 6 & 12 Site Systems and Drip-n-Gro System. Does not include 3/4 in grommet. Use with Tub Outlet Tee Fitting #747186 sold separately. 0.835 inch hole pre-drilled in bucket.



Item No.	Description	MSRP
707635	Flo-n-Gro Blue Bucket - 4 Gallon	\$6.59

Flo-n-Gro Black Mesh Insert - 3 Gallon

This 3 gallon black mesh insert fits snugly in the Flo-n-Gro Ebb and Flow Grow System. The rigid plastic insert keeps its shape for years and the open mesh basket allows for optimal air and water flow that promotes healthy root growth for your plants.



Item No.	Description	MSRP
707640	Flo-n-Gro Black Mesh Insert	\$6.59

Flo-n-Gro Clear Vented Lid

The innovative Flo-n-Gro clear vented cover allows you to maintain the perfect humidity level for your sensitive plant starts. By adjusting the ventilation slots on the top of the cover, you can dial in your garden for optimum growth. Can be used with both 2 and 3 gallon mesh inserts.



Item No.	Description	MSRP
707645	Flo-n-Gro Clear Vented Lid	\$8.29

Drip-n-Gro Mesh Insert - 2 Gallon

This 2 gallon black mesh insert fits snugly in the Flo-n-Gro Ebb and Flow Grow System. The rigid plastic insert keeps its shape for years and the open mesh basket allows for optimal air and water flow that promotes healthy root growth for your plants.



Item No.	Description	MSRP
350800	Drip-n-Gro Short Mesh Insert	\$6.99

Flo-n-Gro Blue Bucket 6.6 Gallon

Oversized, food-grade, blue 6.6 gallon bucket. Dimensions: 14 in W x 14 in L x 12 in D - Polyethylene.



Item No.	Description	MSRP
724486	Flo-n-Gro 6.6 Gallon Blue Bucket	\$10.95

Flo-n-Gro Black Bucket 6.6 Gallon

Oversized black 6.6 gallon bucket approved for potable water. Dimensions: 14 in W x 14 in L x 12 in D - Polyethylene.



Item No.	Description	MSRP
724480	Flo-n-Gro 6.6 Gallon Black Bucket	\$9.95

Flo-n-Gro 6.6 Gallon Mesh Basket Lid 10 in

10 in wide black mesh insert basket for use with 6.6 gallon Gro Giant black bucket. Dimensions: 14-1/4 in W x 14-1/4 in H x 7-1/4 in D - Polyethylene.



Item No.	Description	MSRP
724490	Flo-n-Gro 6.6 Gallon Mesh Basket Lid 10 in	\$9.95

Stake Out Ebb & Flow & Drip-n-Gro Support

Rugged powder coated 20 gauge steel stake holder for use with Quick Stake plant holders, bamboo stakes, steel stakes and other plant supports. Securely mounts to growing site. Dual stake support design. Easy to use. Purchase your choice of plant stake separately.



Item No.	Description	MSRP
724491	Stake Out Ebb & Flow & Drip-n-Gro Support Hanger - 2/Pack	\$12.95

Stake Out Gro Giant Support - 6.6 Gallon

Rugged powder coated 20 gauge steel stake holder for use with Quick Stake plant holders, bamboo stakes, steel stakes and other plant supports. Securely mounts to growing site. Dual stake support design. Easy to use. Purchase your choice of plant stake separately.



Item No.	Description	MSRP
724493	Stake Out Gro Giant 6.6 Gallon 10 in Mesh Pot Support Hanger 2/Pack	\$12.95



Botanicare manufactures a wide variety of Trays, Reservoirs and Lids in the United States. Their plastics are made using renewable solar energy with recycled and recyclable material. "Our plastics are versatile and built to last." Botanicare offers 3 different tray lines to fit any grow space or method. The new Botanicare Low Pro Reservoirs feature true volume amounts and have been slimmed down to accommodate tighter grow spaces.

Botanicare Original Inside Dimension (ID) White Grow Trays



The ID trays now include a 7 in deep seat that accommodates larger root masses, taller pots and deeper saturation. A curved drainage grid with wider channels simplifies cleaning while newly engineered corner gussets allow for greater support. The ID trays maintain standard inside dimensions and are composed of durable white ABS plastic.

Item No.	Description	Thickness	Outside L x W x D	Capacity	MSRP
707050	Botanicare ID White 2 ft x 2 ft Grow Tray	0.187	23.5" x 23.5" x 7.5"	7.6 gal	\$61.35
707067	Botanicare ID White 2 ft x 4 ft Grow Tray	0.187	29.0" x 53.0" x 8.0"	18 gal	\$83.95
707080	Botanicare White 44 in x 24 in x 7 in Grow Tray	0.187	43.8" x 26.0" x 7.2"	17.5 gal	\$82.50
707406	Botanicare ID White 2 ft x 8 ft Grow Tray	0.187	92.5" x 24.5" x 3.8"	27 gal	\$139.95
707065	Botanicare ID White 3 ft x 3 ft Grow Tray	0.220	41.0" x 41.0" x 7.0"	36 gal	\$117.95
707225	Botanicare ID White 3 ft x 6 ft Grow Tray	0.220	77.0" x 41.0" x 7.0"	72 gal	\$189.95
707090	Botanicare ID White 4 ft x 4 ft Grow Tray	0.220	53.0" x 53.0" x 7.0"	52 gal	\$149.95
707045	Botanicare ID White 4 ft x 8 ft Grow Tray	0.240	102.5" x 53.3" x 7.0"	104 gal	\$302.95
707030	Botanicare White 42 in x 8 in x 4 in Grow Tray	0.187	42.0" x 8.0" x 4.0"	4.4 gal	\$32.95
707035	Botanicare White 44 in x 6 in x 4 in Grow Tray	0.187	44.0" x 6.0" x 4.0"	3.7 gal	\$25.95
707060	Botanicare White 22 in x 36 in x 7 in Grow Tray	0.187	36.0" x 22.0" x 7.0"	10.9 gal	\$69.50

Botanicare ID Black Grow Trays

These are the same high-quality trays as the industry standard Botanicare White Grow Trays but are now also available in black. They feature the same thickness and design as their white trays.



Item No.	Description	Thickness	Outside L x W x D	Capacity	MSRP
707061	Botanicare ID Black 2 ft x 4 ft Grow Tray	0.187	43.5" x 25.8" x 6.8"	17.5 gal	\$73.75
707066	Botanicare ID Black 3 ft x 3 ft Grow Tray	0.220	40.5" x 40.5" x 7.5"	36 gal	\$94.95
707091	Botanicare ID Black 4 ft x 4 ft Grow Tray	0.220	54.0" x 54.0" x 7.0"	72 gal	\$124.95
707237	Botanicare ID Black 3 ft x 6 ft Grow Tray	0.220	77.0" x 41.5" x 7.0"	52 gal	\$159.95
707047	Botanicare ID Black 4 ft x 8 ft Grow Tray	0.240	102.5" x 53.3" x 7.0"	104 gal	\$230.95

Botanicare Low Tide Black Trays

These newly designed trays offer a diagonal drainage grid that directs water out of the tray and sits in the same footprint as its growing space. The 3.5 in tall Low Tide trays are designed with the solution conserving gardener in mind.



Item No.	Description	Thickness	Outside L x W x D	Capacity	MSRP
707295	Botanicare LT Black 1 ft x 4 ft Tray New	0.150	48.0" x 14.3" x 4.0"	10 gal	\$34.95
707320	Botanicare LT Black 1 ft x 8 ft Tray	0.150	92.5" x 14.5" x 4.0"	19 gal	\$58.50
707300	Botanicare LT Black 2 ft x 8 ft Tray	0.150	92.0" x 24.0" x 3.8"	28.5 gal	\$89.95
707305	Botanicare LT Black 3 ft x 3 ft Tray	0.150	37.0" x 37.0" x 3.8"	15 gal	\$54.95
707310	Botanicare LT Black 4 ft x 4 ft Tray	0.150	49.0" x 49.0" x 3.8"	30 gal	\$79.95
707315	Botanicare LT Black 4 ft x 8 ft Tray	0.150	97.0" x 49.0" x 3.8"	60 gal	\$154.95

Botanicare Outside Dimension (OD) Black Trays

These trays sit in the precise footprint and fit easily into all growing tents on the market. The Botanicare OD trays, available only in black ABS plastic, are formed with an easy to clean diagonal drainage grid to direct water towards drainage fittings.



Item No.	Description	Thickness	Outside L x W x D	Capacity	MSRP
707340	Botanicare OD Black 3 ft x 3 ft Tray	0.187	36.0" x 36.0" x 6.0"	27.5 gal	\$69.95
707342	Botanicare OD Black 3 ft x 6 ft Tray	0.187	72.0" x 36.0" x 6.0"	56 gal	\$134.45
707345	Botanicare OD Black 4 ft x 4 ft Tray	0.187	48.0" x 48.0" x 6.0"	50 gal	\$99.95
707347	Botanicare OD Black 4 ft x 6 ft Tray	0.150	70.0" x 46.0" x 6.0"	75 gal	\$160.50
707350	Botanicare OD Black 4 ft x 8 ft Tray	0.187	96.0" x 48.0" x 6.0"	100 gal	\$189.50

Botanicare Reservoirs & Lids



Each reservoir works with a specially designed lid containing an access port. This access port allows for a porthole cover with a raised grip. Easy access to the reservoir without taking the entire lid off.

Item No.	Description	Outside L x W x D	MSRP
707115	Botanicare 10 Gallon Reservoir Lid	14.3" x 23.8" x 0.8"	\$36.95
707120	Botanicare 10 Gallon Reservoir	23.3" x 14.3" x 11.8"	\$57.95
707130	Botanicare 20 Gallon Reservoir Lid	26.3" x 20.0" x 1.0"	\$42.95
707135	Botanicare 20 Gallon Reservoir	26.0" x 20.0" x 11.3"	\$61.95
707140	Botanicare 25 Gallon Reservoir Lid	35.3" x 22.3" x 0.3"	\$54.95
707145	Botanicare 25 Gallon Reservoir	35.0" x 22.0" x 13.3"	\$104.25
707150	Botanicare 40 Gallon Reservoir Lid	37.3" x 29.5" x 1.0"	\$57.95
707155	Botanicare 40 Gallon Reservoir	37.0" x 29.3" x 12.0"	\$89.95
707215	Botanicare 70 Gallon Reservoir Lid	54.0" x 31.0" x 1.5"	\$95.95
707210	Botanicare 70 Gallon Reservoir	53.8" x 30.3" x 12.0"	\$185.95
707160	Botanicare 115 Gallon Reservoir Lid	51.0" x 51.0" x 1.5"	\$146.95
707165	Botanicare 115 Gallon Reservoir	50.0" x 50.0" x 14.5"	\$238.95

Botanicare Porthole Covers

For use with Botanicare reservoirs.



Item No.	Description	Outside L x W x D	MSRP
707195	Botanicare Porthole Cover (for 10, 20, 40, 70, 115 Gallon)	7.3" x 5.5" x 1.0"	\$8.95
707197	Botanicare Porthole Cover for Turbogarden (25 Gallon)	6.8" x 6.5" x 0.3"	\$9.95
707246	Botanicare Porthole Cover for Microgarden & Eazy Drain	11.5" x 5.8" x 1.0"	\$10.95

Botanicare Humidome

A clear humidome is available for one of the Botanicare trays that we offer. The dome is a heavy duty model that are a must for propagation!



Item No.	Description	Outside L x W x D	MSRP
707005	Botanicare 2 ft x 2 ft Humidome	22.0" x 22.0" x 8.0"	\$69.95

Botanicare Eazy Drain Reservoirs & Lids

Gradual interior slope to allow the solution to drain completely. Designed to be used with a bulkhead fitting and on/off valve, makes maintaining your hydroponic systems hassle free. Includes molded volume markers in gallons and liters.



Item No.	Description	Outside L x W x D	MSRP
707163	Botanicare Eazy Drain 50 Gallon Lid	41.5" x 29.5" x 1.3"	\$92.00
707164	Botanicare Eazy Drain 50 Gallon Reservoir	43.3" x 29.3" x 13.5"	\$172.95
707243	Botanicare Eazy Drain 100 Gallon Lid	81.3" x 29.5" x 1.0"	\$130.95
707244	Botanicare Eazy Drain 100 Gallon Reservoir	81.0" x 29.3" x 13.5"	\$306.95

Botanicare White Low Profile (LP) Reservoirs

Low Profile Reservoirs fit into tighter spaces but still the same volume as our current line of reservoirs. Features and benefits: Unique Cord Guide; Drainage grid with a recessed pump area; Exact volume amounts and customizable points for installation of drains and bulkhead fittings.



Item No.	Description	Outside L x W x D	MSRP
707720	Botanicare White LP 20 Gallon Reservoir	31.0" x 23.0" x 9.0"	\$73.95
707730	Botanicare White LP 20 Gallon Reservoir Lid	33.0" x 24.5" x 1.0"	\$39.95
707725	Botanicare White LP 40 Gallon Reservoir	50.0" x 30.8" x 9.5"	\$114.95
707735	Botanicare White LP 40 Gallon Reservoir Lid	50.0" x 30.8" x 1.0"	\$73.95

Botanicare Black Low Profile (LP) Reservoirs

Low Profile Reservoirs fit into tighter spaces but still the same volume as our current line of reservoirs. Features and benefits: Unique Cord Guide; Drainage grid with a recessed pump area; Exact volume amounts and customizable points for installation of drains and bulkhead fittings.



Item No.	Description	Outside L x W x D	MSRP
707700	Botanicare Black LP 20 Gallon Reservoir Bottom	31.0" x 23.0" x 9.5"	\$62.95
707710	Botanicare Black LP 20 Gallon Reservoir Lid	33.0" x 24.5" x 1.0"	\$29.95
707705	Botanicare Black LP 40 Gallon Reservoir Bottom	50.0" x 30.8" x 9.5"	\$124.25
707715	Botanicare Black LP 40 Gallon Reservoir Lid	50.0" x 30.8" x 1.0"	\$57.95
707217	Botanicare Black LP 75 Gallon Reservoir Bottom	54.5" x 44.5" x 13.3"	\$199.95
707218	Botanicare Black LP 75 Gallon Reservoir Lid	55.3" x 45.3" x 2.0"	\$136.00

Botanicare Microgarden

Provides affordable and automated method of providing your plants with optimal levels of water, nutrients and oxygen for rapid growth rates, yields, increased nutritional value, heightened fragrances and flavors. Includes: 10 gal reservoir, pump, pots, nutrients, grow substrate, timer and pH kit.



Item No.	Description	Outside L x W x D	MSRP
706610	Botanicare Microgarden Aeroponic	31.0" x 13.8" x 17.0"	\$358.95
706620	Botanicare Microgarden Ebb & Flow	31.0" x 13.8" x 17.0"	\$258.95

Botanicare Turbogarden

Experience faster growth rates, higher yields, increased nutritional value, heightened fragrances, and ease of maintenance with a fully automated Turbogarden. Includes: Pump, pots, nutrients, grow substrate, timer, 25 gal reservoir and pH kit.



Item No.	Description	Outside L x W x D	MSRP
706950	Botanicare Turbogarden Aeroponic	35.0" x 22.0" x 19.5"	\$551.95
706960	Botanicare Turbogarden Ebb & Flow	35.0" x 22.0" x 19.5"	\$366.25

Botanicare Bench

Make your tray more sturdy with a heavy duty metal bench.



Item No.	Description	MSRP
707046	4 ft x 8 ft Bench & Legs (2/Boxes)	\$303.35



Distributed exclusively by:



Sunlight Supply, Inc.
National Garden Wholesale.

Manufactured by:



Duralastic™ trays are manufactured in the USA using 25% solar energy. This line of trays have an easy clean drainage grid that allows the grower to clean their trays without the hassle of scrubbing sharp corners to remove build up. Duralastic™ trays contain a built in water level indicators to easily identify the fill level in the trays.



Duralastics Trays Black Inside Dimension (ID)

Made of black 100% recycled ABS plastic with virgin ABS cap on each side. Manufactured In the USA using 25% solar energy. Easy clean drainage grid allows the grower to clean their trays without the hassle of scrubbing sharp corners to remove build up. Built in water level indicators to easily identify the fill level in the trays.



Item No.	Description	Thickness	Outside L x W x D	MSRP
707920	Duralastics 2 ft x 4 ft ID Black Tray	0.130	54.3" x 30.3" x 7.0"	\$56.95
707915	Duralastics 3 ft x 3 ft ID Black Tray	0.130	42.8" x 42.8" x 7.0"	\$64.95
707905	Duralastics 3 ft x 6 ft ID Black Tray	0.160	43.0" x 79.0" x 7.0"	\$123.95
707910	Duralastics 4 ft x 4 ft ID Black Tray	0.160	54.3" x 54.3" x 7.0"	\$93.95
707900	Duralastics 4 ft x 8 ft ID Black Tray	0.160	54.3" x 102.5" x 7.0"	\$196.95

Duralastics Trays White Inside Dimension (ID)

Made of white 80% recycled ABS plastic with virgin ABS cap on each side. Manufactured In the USA using 25% solar energy. Easy clean drainage grid allows the grower to clean their trays without the hassle of scrubbing sharp corners to remove build up. Built in water level indicators to easily identify the fill level in the trays.



Item No.	Description	Thickness	Outside L x W x D	MSRP
707950	Duralastics 2 ft x 4 ft ID White Tray	0.130	54.3" x 30.3" x 7.0"	\$57.95
707945	Duralastics 3 ft x 3 ft ID White Tray	0.130	42.8" x 42.8" x 7.0"	\$71.95
707935	Duralastics 3 ft x 6 ft ID White Tray	0.160	43.0" x 79.0" x 7.0"	\$126.95
707940	Duralastics 4 ft x 4 ft ID White Tray	0.160	54.3" x 54.3" x 7.0"	\$107.95
707930	Duralastics 4 ft x 8 ft ID White Tray	0.160	54.3" x 102.5" x 7.0"	\$206.95

Duralastics Reservoirs



Made of black 100% recycled ABS plastic or white 80% recycled ABS plastic with virgin ABS cap on each side. Made to last at 0.160 in gauge thickness. Manufactured In the USA using 25% solar energy. Easy to clean design allows the grower to clean their reservoirs without the hassle of scrubbing sharp corners to remove build up. Built in water level indicators to easily identify the fill level in the reservoirs.

Item No.	Description	Outside L x W x D	MSRP
707925	Duralastics 75 Gallon Reservoir Black	47.3" x 47.3" x 13.0"	\$125.95
707955	Duralastics 75 Gallon Reservoir White	47.3" x 47.3" x 13.0"	\$129.95
707960	Duralastics 100 Gallon Reservoir Black	48.5" x 48.5" x 15.0"	\$173.95
707965	Duralastics 100 Gallon Reservoir White	48.5" x 48.5" x 15.0"	\$191.95

Duralastics Conical Step Drill Bit

Drill your own trays with ease with a self centering conical step drill bit! Drills holes from 1/4 in up to 1-3/8 in. Step measurement marks are etched directly on the drill bit. Titanium coated for durability and reduced friction. Drill up to 10 different sized holes with one bit!



Item No.	Description	MSRP
707202	Duralastics Conical Step Drill Bit - 1/4 in to 1-3/8 in	\$29.95

EASY CLEAN TRAYS™

Easy Clean Trays™ are uniquely designed to offer growers a simple to clean and fast draining tray at an affordable price. This new line of trays has a drain pattern to effectively remove standing water through a peaks and valley concept, evacuating water quickly to the main drainage port. Easy Clean Trays™ have a shallow channel draining network, creating an effortless cleaning process. The trays were designed with an interior edge lip, extending the growing area in the tray by supporting plants on the outer perimeter. Made with 100% recycled plastic. Manufactured in North America. One year warranty.



Easy Clean Trays Outside Dimension (OD)



Uniquely designed to offer growers a simple to clean and fast draining tray at an affordable price. These trays has a drain pattern to effectively remove standing water through a peaks and valley concept. They have a shallow channel draining network, creating an effortless cleaning process. Made with 100% recycled plastic. 1 Year Warranty.

Item No.	Description	Thickness	Outside L x W x D	MSRP
707850	Easy Clean ABS Black Tray OD 2 ft x 4 ft	0.125	48.0" x 24.0" x 8.0"	\$61.95
707853	Easy Clean ABS Black Tray OD 3 ft x 3 ft	0.125	36.0" x 36.0" x 8.0"	\$74.95
707855	Easy Clean ABS Black Tray OD 4 ft x 4 ft	0.125	48.0" x 48.0" x 8.0"	\$83.95
707860	Easy Clean ABS Black Tray OD 4 ft x 6 ft	0.125	48.0" x 72.0" x 8.0"	\$121.95
707865	Easy Clean ABS Black Tray OD 4 ft x 8 ft	0.125	48.0" x 96.0" x 8.0"	\$159.95

Black Grow Trays - Styrene Plastic (OD)

High quality trays made of styrene plastic.



Item No.	Description	Thickness	Outside L x W x D	MSRP
707170	Styrene Black Plastic 2.5 ft x 4 ft Grow Tray	0.200	48.0" x 24.0" x 7.0"	\$87.95
707175	Styrene Black Plastic 4 ft x 4 ft Grow Tray	0.200	48.0" x 48.0" x 7.0"	\$114.95
707180	Styrene Black Plastic 4 ft x 8 ft Grow Tray	0.200	96.0" x 48.0" x 8.0"	\$211.95
707190	Styrene Black Plastic 4 ft x 6 ft Grow Tray	0.200	72.0" x 48.0" x 6.0"	\$164.95

Black Reservoirs & Lids - ABS Plastic

Graduated lines indicate water level. Heavy duty thick ABS plastic.



Item No.	Description	Outside L x W x D	MSRP
707675	ABS Black Plastic 70 Gallon Reservoir	39.0" x 39.0" x 12.0"	\$109.95
707680	ABS Black Plastic 100 Gallon Reservoir	48.5" x 48.5" x 14.0"	\$157.95
707690	ABS Black Plastic 70 Gallon Reservoir Lid	43.5" x 43.5" x 1.3"	\$71.95
707695	ABS Black Plastic 100 Gallon Reservoir Lid	45.0" x 45.0" x 3.5"	\$83.95

Grotek Reservoirs and Lids

Grotek reservoirs fit under a variety of flood tables or aeroponic systems. Each unit is available with accompanying lid and includes water level indicators for ease of use.

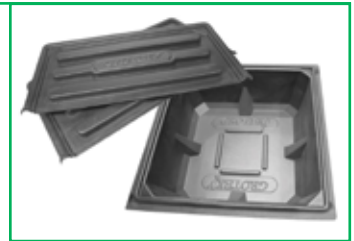

Item No.	Description	Outside L x W x D	MSRP
707230	Grotek 260 Liter (69 Gallon) Reservoir	45.0" x 45.0" x 12.0"	\$111.15
707235	Grotek 260 Liter (69 Gallon) Reservoir Lid 2/ Parts	43.0" x 43.0" x 1.0"	\$87.60
707240	Grotek 378 Liter (100 Gallon) Reservoir	51.0" x 51.0" x 13.5"	\$155.57
707245	Grotek 378 Liter (100 Gallon) Reservoir Lid 2/ Parts	49.0" x 49.0" x 1.0"	\$101.50

Heavy Duty Reservoirs

They are made with a high quality FDA approved, UV protected plastic to ensure uniform thickness and strength for maximum durability and longevity. One piece construction with rounded edges. Made in the USA. 5 Year Warranty.



Item No.	Description	Outside L x W x D	MSRP
707332	Heavy Duty Gray 55 Gallon Reservoir	51.5" x 27.5" x 13.0"	\$131.95
707335	Heavy Duty Gray 100 Gallon Reservoir	52.0" x 30.8" x 24.0"	\$166.95

EZ Store Container/Buckets 8 & 13 Gallon & Lid

Made with virgin, high density polyethylene material. These patented containers have no holes in them and can hold up to 8 or 13 gallons of liquid. EZ Stor containers are nestable, with built in hand grips. The lid is compatible with both sizes. It has a recessed fit with a tear strip and a built in handle on the front portion of the hinged lid, creating easy access without removing the lid.



Item No.	Description	Outside L x W x D	MSRP
703990	EZ Store Container/Bucket 8 Gallon	11.3" x 11.6" x 12.7"	\$14.99
703992	EZ Store Container/Bucket 13 Gallon	14.2" x 11.5" x 18.6"	\$22.99
703994	EZ Store Lid for 8 and 13 Gallon	15.8" x 0.9" x 13.2"	\$4.99

Reservoir - Stand Up - 105 Gallon

Rugged, impact and corrosion resistant, one piece seamless construction makes this tank the perfect choice for fertilizer solutions. The tank has capacity for 105 gallons and is 23 in diameter and 63 in tall. Each tank includes an 8 in threaded lid and a 2 in by 3/4 in bushing with a 3/4 in plug.



Item No.	Description	Outside L x W x D	MSRP
707169	Stand Up Reservoir 105 Gallon	23.0" x 23.0" x 63.0"	\$399.95

Reservoir - Stand Up - 48 Gallon

Foot print is only 18 in x 12 in. It is 63.5 in tall. Features standard hose threads for easy connection to a garden hose. Made from translucent FDA approved, durable plastic. Back is flat to go up against the wall. Made in the USA. 5 Year Warranty.



Item No.	Description	Outside L x W x D	MSRP
707322	Stand Up Reservoir 48 Gallon	63.5" x 18.0" x 12.0"	\$157.95

Grodan Dutch Leach Tray with 2 Elbows

Heavy duty plastic leach tray with 2 drain elbows & end caps. Designed to work with 6 in rock wool slabs, but also works well with a variety of other growing mediums.



Item No.	Description	Outside L x W x D	MSRP
707430	Dutch Leach Tray w/ Fittings	6.0" x 40.0" x 3.5"	\$16.62

Grodan Dutch Leach Tray Elbows & Caps

For use with Dutch Leach Tray.



Item No.	Description	MSRP
707435	Dutch Leach Tray Elbows	\$1.56
707440	Dutch Leach Tray Endcap	\$0.61

GH Covert Tank

Our super reinforced, portable, light weight tank is ideal for use as a hydroponic reservoir, rain barrel or for water storage. Our tanks are collapsible and are extremely compact which makes it ideal for transportation and set up in small spaces.



Item No.	Description	Outside L x W x D	MSRP
707805	GH Covert Tank Black 66 Gallon	24.0" x 24.0" x 37.5"	\$118.95

GH Panda Reservoir

The GH Panda reservoir is 40 gallons. It has a white exterior (which reflects heat) and a black interior (which discourages algae growth). It offers a small foot print and is very durable. Purchase lid separately.



Item No.	Description	Outside L x W x D	MSRP
707265	GH 40 Gallon Panda Reservoir w/ out Lid	48.0" x 24.0" x 13.0"	\$142.00
707266	GH 40 Gallon Panda Reservoir Lid w/ Cover	48.0" x 24.0" x 2.0"	\$92.00

GH AeroFlo2 Systems

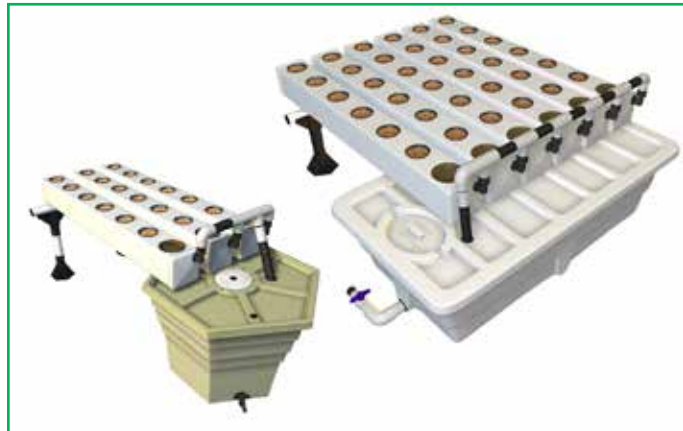

Hydroponic systems come complete with everything needed to start growing - Flora Series nutrients, clay pebbles, net cups, coco cup liners, pump (except 60 extension), support structure and manifold. AeroFlo2 super-oxygenates the nutrient solution to deliver oxygen, water and nutrient in ideal combinations.

Item No.	Description	Outside L x W x D	MSRP
706028	GH AeroFlo2 - 18 Site 2/Boxes	64.0" x 23.0" x 22.0"	\$429.00
706030	GH AeroFlo2 - 20 Site 2/Boxes	84.0" x 18.0" x 24.0"	\$421.67
706035	GH AeroFlo2 - 30 Site 2/Boxes	90.0" x 23.0" x 22.0"	\$559.98
706040	GH AeroFlo2 - 36 Site 2/Boxes	50.0" x 55.0" x 24.0"	\$937.74
706045	GH AeroFlo2 - 60 Site 2/Boxes	61.0" x 82.0" x 24.0"	\$1,173.33
706050	GH AeroFlo2 - 60 Site Extension 2/Boxes	115.0" x 82.0" x 24.0"	\$935.00

GH AeroFlo2 Replacement Parts

Replacement parts for all the AeroFlo2 systems. *Sold in case quantity only.



Item No.	Description	MSRP
706005	GH 6 ft Laser Drilled Spray Line	\$10.29
706832	GH 3 in Site Plug	\$1.07
706833	GH 4 in Site Plug	\$2.13
708325	GH Grommet 1 in	\$1.90
708330	GH Grommet 1-1/4 in	\$2.20

GH Water Farm - Complete & Modular Systems

The complete WaterFarm is designed to be a stand alone system and includes 4-gal reservoir, 2-gal growing chamber, pumping column, column support tube, drip ring, 1/2 in grommet, drain level tube, Elite 800 air pump, 9L clay pebbles and 3-part Flora Kit. The modular unit comes without a drain level tube, Elite air pump, clay pebbles or Flora kit.



Item No.	Description	Outside L x W x D	MSRP
706975	GH WaterFarm Complete	12.0" x 12.0" x 18.0"	\$65.63
706985	GH WaterFarm Module	12.0" x 12.0" x 18.0"	\$46.00

GH Farm Kit

Plumbing hardware for WaterFarm. Kit includes drip ring, pumping column, drain level tube and clip, clear air hose and grommet. Also includes the WaterFarm Module.



Item No.	Description	MSRP
706335	GH Farm Kit	\$14.30

GH Water Farm 8 Pack Circulating Upgrade Kit

The WaterFarm 8 Pack Circulating Upgrade Kit contains everything needed to reconfigure an 8 Pack and add nutrient circulation capability to an existing system. This promotes even growth and more consistent results overall.



Item No.	Description	MSRP
706976	GH WaterFarm 8/Pack Circulating Upgrade Kit	\$49.50

GH Vortex DC Sprayer

The spinning shaft of the Vortex Sprayer creates a powerful eddy that not only stirs and lifts nutrients from the reservoir, but also gently oxygenates and evenly distributes nutrients and oxygen to plant cuttings and root systems.



Item No.	Description	MSRP
706720	GH Vortex 12 Volt DC Sprayer	\$129.99

GH EuroGrower - Complete System

The heart of the EuroGrower is our custom designed 40-gallon Panda reservoir, which is more than adequate for its eight 2-gallon buckets. You can grow either numerous small plants or 1 large one. Comes complete with a 40-gallon Panda reservoir, 8 buckets, 250gph Mag-Drive 2, CocoTek bricks, clay pebbles, pH kit, Grasslin timer and 3-part Flora Series nutrients.



Item No.	Description	Outside L x W x D	MSRP
706636	GH EuroGrower 8 Complete	48.0" x 24.0" x 24.0"	\$616.66

GH Water Farm 8 Pack Kit

The WaterFarm 8-pack is 8 WaterFarm module units connected to 1 controller. These units can be arranged in a design that is suitable for any environment. The kit is powered by GH's Dual Diaphragm Air Pump & includes hardware, supplies & nutrients. Does not include clay pebbles.



Item No.	Description	Outside L x W x D	MSRP
706980	GH WaterFarm 8 Pack	79.0" x 30.0" x 15.0"	\$514.60

GH Power Grower - 8 Pack Kit

This hydroponic system features 8 of the 5.7 gal hex reservoirs with 3 gallon growing chambers, 17 gal master reservoir, 17 gal controller with float valve, tubing, fittings, drip rings and GH Flora nutrients. Does not include clay pebbles.



Item No.	Description	Outside L x W x D	MSRP
706638	GH PowerGrower 8/Pack	26.0" x 23.5" x 21.0"	\$687.48

GH Controller Complete & Texas Controller

The Controller Complete accommodates 8 farm modules. It includes a 13 gal reservoir, 8 gal controller, tubing, fittings & valve. The Texas Controller accommodates 16 farm modules 20 gal reservoir & 20 gal controller, tubing, fittings & a valve.



Item No.	Description	Outside L x W x D	MSRP
706215	GH Controller Complete	12.0" x 12.0" x 42.0"	\$134.36
706220	GH Texas Controller	24.0" x 24.0" x 42.0"	\$372.00

GH PowerGrower Eco

Complete system includes: 5.7-gal reservoir, 3-gal growing chamber, pumping column and support tube, drip ring, 1/2 in grommet, drain level tube, Elite 800 air pump, 9L clay pebbles and 3-part Flora Kit.



Item No.	Description	Outside L x W x D	MSRP
706635	GH PowerGrower Eco	15.0" x 15.0" x 15.0"	\$80.12

GH RainForest 66 - Six 6 in Site Aeroponics System

The Rainforest 66 has a Vortex Sprayer lifts and oxygenates the nutrient solution and then gently distributes it over cutting's bases or root systems. Includes: 17-Gal reservoir with lid, six - 6 in lid inserts, Vortex Sprayer, 6in plastic cups, CocoTek liners, CocoTek caps and 3-Part Flora Kit.



Item No.	Description	Outside L x W x D	MSRP
706705	RainForest 66 Aeroponic System	15.0" x 15.0" x 15.0"	\$291.50

GH RainForest 318 - Eighteen 3 in Site Aeroponics System

The RainForest 318 can accommodate up to 18 small plants from cuttings to harvest or up to ninety cuttings for rooting and transplantation using the 3 in CocoTek coconut caps included. Includes everything you need to get started even 3-Part Flora Kit.



Item No.	Description	Outside L x W x D	MSRP
706710	RainForest 318 Aeroponic System	15.0" x 15.0" x 15.0"	\$295.95

GH RainForest 236 - Thirty-six 2 in Site Aeroponics System

Growers can use the RainForest 236 to create a modestly sized nursery. Use this model to propagate cuttings or to quick-start seeds in a small footprint area. Includes everything you need to get started even 3-Part Flora Kit.



Item No.	Description	Outside L x W x D	MSRP
706715	RainForest 236 Aeroponic System	15.0" x 15.0" x 15.0"	\$291.50

GH Eco Grower Drip Hydroponic System

The Eco Grower incorporates an air driven spider drip system and uses the same revolutionary hexagonal reservoir with removable six inch lid inserts. Each lid insert will accommodate one 6 in net pot. Includes everything you need to get started even media & nutrients.



Item No.	Description	Outside L x W x D	MSRP
706721	EcoGrower Drip Hydroponic System	24.0" x 24.0" x 24.0"	\$233.75

GH Snapture Snapstand 4 ft x 4 ft Tray Stand

The custom Snapture pieces turn standard 1-1/4 in PVC pipe into tray or system stands, trellis supports, light hangers, grow tent frames and more. A versatile design to support 4 ft x 4 ft trays.



Item No.	Description	MSRP
707262	Snapture Snapstand 4 ft x 4 ft Tray Stand	\$90.00

GH Snapture Snapstand Fittings

The custom Snapture pieces turn standard 1-1/4 in PVC pipe into tray or system stands, trellis supports, light hangers, grow tent frames and more.



Item No.	Description	MSRP
707250	Snapture Snapstand Cross Fitting	\$4.79
707255	Snapture Snapstand Foot Base	\$4.79
707260	Snapture Snapstand Dovetail 90 Degree	\$3.79

Back to the Roots Aquafarm

Close Looped Ecosystem based on the sustainable method of farming known as Aquaponics. 3 Gallon AquaFarm uses waste from your pet fish to naturally fertilize the plants above. In turn, the plants clean the water for your fish. Includes everything to get started plus a coupon for a Betta fish.



Item No.	Description	MSRP
748300	Back to the Roots - Aquafarm	\$69.95

AutoPot 4-Pot System

The 4-Pot System is a gravity fed watering system which requires no power, pumps or timers to operate. It is extremely versatile and caters for gardeners and growers of all abilities guaranteeing great results. The system can easily be extended so many pots can be linked to a single reservoir.



Item No.	Description	Outside L x W x D	MSRP
707625	AutoPot 4-Pot System	15.0" x 11.0" x 24.0"	\$199.95

AutoPot FlexiTank Reservoirs

The FlexiTank Reservoir revolutionizes water storage. It requires no tools for assembly, reduces storage and shipping costs and takes minutes to assemble. Fit where other reservoirs cannot go and can be packed away and stored at the end of the season.



Item No.	Description	MSRP
708040	AutoPot 25 Gallon FlexiTank	\$79.95
708045	AutoPot 60 Gallon FlexiTank	\$107.95
708050	AutoPot 105 Gallon FlexiTank	\$179.95
708052	AutoPot 200 Gallon FlexiTank	\$259.95

Claber Oasis Self Watering System

With this Watering System you do not have to worry about watering your plants when away. The Oasis has 4 independent watering programs: 10-20-30-40 days that can be selected by simply turning the dial to water a maximum of 20 plants. Operates on one 9v battery (not included). Gravity feed. No pump. Unit dimensions is 15 in x 15 in x 15 in & 9.5 lb.



Item No.	Description	MSRP
708775	Claber Oasis Self Watering System	\$107.95

Hydro Flow Drip Ring

Pre-built ring uses four one gallon per hour cleanable emitters. The ring is constructed with 1/2 inch poly tubing. Emitters are evenly spaced to water 360 degrees around the plant. The intake fitting is a 1/2 inch barbed fitting. Ring is 10 inches in diameter.



Item No.	Description	MSRP
748420	Hydro Flow Drip Ring	\$7.49

Black Holes Drippers

Unique and innovative top feed dripper manufactured for use in hydroponics. 1/2 in and 1/4 in barb option. 1/4 in barb is compatible with standard drip emitters by plugging them into the barb (rec. 2 GPH emitter). Designed with 6 beveled emitter holes. 100% Made in the USA by 100% recycled plastic.



Item No.	Description	MSRP
748410	Black Holes Dripper 1/4 in	\$4.95
748415	Black Holes Dripper 1/2 in	\$4.95



Revolutionary toolless light & tray stands. Unique patented "no hassle" toolless design allows for a quick and simple assembly in minutes! Designed and engineered for the pieces to simply slide together. Never mess with nuts, bolts, wrenches or screw drivers again with Fast Fit™! Patent Pending 13#/136657.



Fast Fit Tray Stand 2 ft x 4 ft

Heavy duty 2 ft x 4 ft quick assembly tray stand. Absolutely no tools required. Can be assembled in 5 min. or less. Accommodates all popular brand trays and reservoirs. Height is 25 in. Height from bottom bar to floor is 18 in without casters. Tray sold separately.



Item No.	Description	MSRP
706120	Fast Fit Tray Stand 2 ft x 4 ft	\$99.95

Fast Fit Tray Stand 3 ft x 3 ft

Heavy duty 3 ft x 3 ft quick assembly tray stand. Absolutely no tools required. Can be assembled in 5 min. or less. Accommodates all popular brand trays and reservoirs. Height is 25 in. Height from bottom bar to floor is 18 in without casters. Tray sold separately.



Item No.	Description	MSRP
706121	Fast Fit Tray Stand 3 ft x 3 ft	\$121.95

Fast Fit Tray Stand 4 ft x 4 ft

Heavy duty 4 ft x 4 ft quick assembly tray stand. Absolutely no tools required. Can be assembled in 5 min. or less. Accommodates all popular brand trays and reservoirs. Height is 25 in. Height from bottom bar to floor is 18 in without casters. Tray sold separately.



Item No.	Description	MSRP
706122	Fast Fit Tray Stand 4 ft x 4 ft	\$146.95

Fast Fit Tray Stand 4 ft x 8 ft

Heavy duty 4 ft x 8 ft quick assembly tray stand. Absolutely no tools required. Can be assembled in 5 min. or less. Accommodates all popular brand trays and reservoirs. Height is 25 in. Height from bottom bar to floor is 18 in without casters. Tray sold separately.



Item No.	Description	MSRP
706124	Fast Fit Tray Stand 4 ft x 8 ft	\$241.95

Fast Fit A La Carte Components

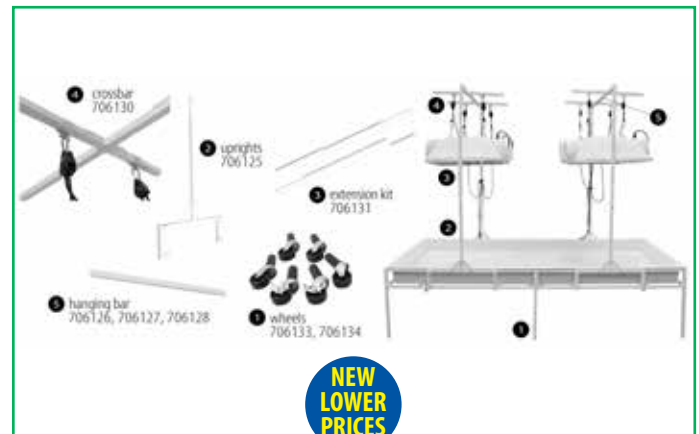

Fast Fit A La Carte Components: Castor wheels, 6 pc and 4 pc (706133, 706134). Light Stand 4 ft Uprights (706125). Extension Kit (706131). Light Stand Crossbar (706130). Sturdy hanging bar comes in 2 ft, 3 ft and 4 ft sizes (706126, 706127, 706128).

Item No.	Description	MSRP
706125	Fast Fit Light Stand Uprights 4 ft	\$91.95
706126	Fast Fit Light Hanging Bar 2 ft	\$18.95
706127	Fast Fit Light Hanging Bar 3 ft	\$16.95
706128	Fast Fit Light Hanging Bar 4 ft	\$19.95
706129	Fast Fit Conversion Kit 8 ft Hanging Bar	\$34.95
706130	Fast Fit Light Stand Crossbar	\$32.95
706131	Fast Fit Light Stand Extension Kit	\$23.95
706132	Fast Fit Tray Stand Support Bar 4 ft	\$19.95
706133	Fast Fit Caster Wheels - 4 pc	\$25.95
706134	Fast Fit Caster Wheels - 6 pc	\$30.95

Scan now to check out the newest products on our web site! Updated regularly so check frequently!



TAKE A CLOSER LOOK AT OUR COMPLETE LINE OF SUN HUTS



SUN HUT®
THE BIG EASY™
TOUGH | SELECT QUALITY
190D fabric w/ 16 mm poles

4 models to choose from!



SUN HUT®
Black Out™
PRO GRADE | PREMIUM QUALITY
210D fabric w/ 19 mm poles

10 models to choose from!



SUN HUT®
FORTRESS™
ELITE | SUPREME QUALITY
1680D fabric w/ 22 mm poles

8 models to choose from!



sun-huts.com



Larger than competitive models



Highly reflective silver interior



Quick and easy assembly



Light-tight layered tent material

Always choose Sun Hut® brand affordable enclosed greenhouses

Sun Hut® - The Big Easy™ Grow Tent

CHECK OUT OUR 3 LEVELS OF SUN HUT:

- Sun Hut® - The Big Easy: **Tough** / Select Quality
- Sun Hut® - Blackout: **Pro Grade** / Premium Quality
- Sun Hut® - Fortress: **Elite** / Supreme Quality



THE BIG EASY™

sun-huts.com



- 190D light weight and light-tight outer material
- 2 access doors in front and back
- Sturdy 16 mm/.63" Galvanized steel pole frame
- 190D silver PE removable floor liner

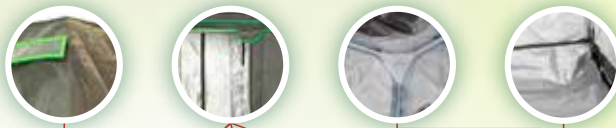

All Big Easy Grow Tents have a U Shaped Rear Door for total access to your growing space.

Model Shown: 706920 Sun Hut Big Easy 70

- Dual 10" reducing silver/black ventilation socks
- Clear viewing windows with Velcro covers
- Improved zipper for rugged & durable grow environment
- Oversized to fit most industry standard trays



The assembly of this grow tent is both quick and simple.

The Big Easy has reinforced stitching in high wear areas.

TENTS/INDOOR GREENHOUSES

Sun Hut - The Big Easy Grow Tents



Sun Hut The Big Easy Grow Tents are enclosed greenhouses that have a durable, lightweight and light-tight 190D outer material with a highly reflective interior surface. The Big Easy has reinforced stitching in high wear areas and has a new improved zipper creating a rugged and durable grow environment. All sizes have a "U" Shaped Rear Door for total access to your growing space. The frame of The Big Easy™ consists of galvanized steel poles and unique quick connect molded plastic corners. With these two features combined, the assembly of this grow tent is both quick and simple. Other features include 10 in duct ports, high and low lamp/power cord ports and a tray bottom. The 2 ft x 4 ft, 4 ft x 4 ft, and 4 ft x 8 ft models are large enough to fit the largest plastic grow trays on the market. Note: model numbers identify the approximate cubic feet. 1 Year Warranty.

Item No.	Description	Dimensions	MSRP
706915	Sun Hut Big Easy 80 - 4.3 ft x 2.8 ft x 6.5 ft	52.7" x 34.4" x 78.9"	\$178.95
706920	Sun Hut Big Easy 70 - 3.3 ft x 3.3 ft x 6.5 ft	40.2" x 40.2" x 78.9"	\$170.95
706925	Sun Hut Big Easy 145 - 4.7 ft x 4.7 ft x 6.5 ft	56.8" x 56.8" x 78.9"	\$225.95
706930	Sun Hut Big Easy 285 - 9.4 ft x 4.7 ft x 6.5 ft	56.8" x 112.8" x 78.9"	\$358.95

Always choose Sun Hut® brand affordable enclosed greenhouses

Sun Hut® - Blackout™ Grow Tent

CHECK OUT OUR 3 LEVELS OF SUN HUT:

- Sun Hut® - The Big Easy: **Tough** / Select Quality
- Sun Hut® - Blackout: **Pro Grade** / Premium Quality
- Sun Hut® - Fortress: **Elite** / Supreme Quality



sun-huts.com



210D light-tight outer material

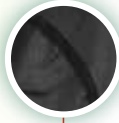

Full service easy access door/s (see chart lower right)



Sturdy 19 mm/.75" Galvanized steel pole frame

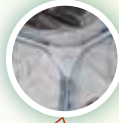

190D reflective mylar removable floor liner

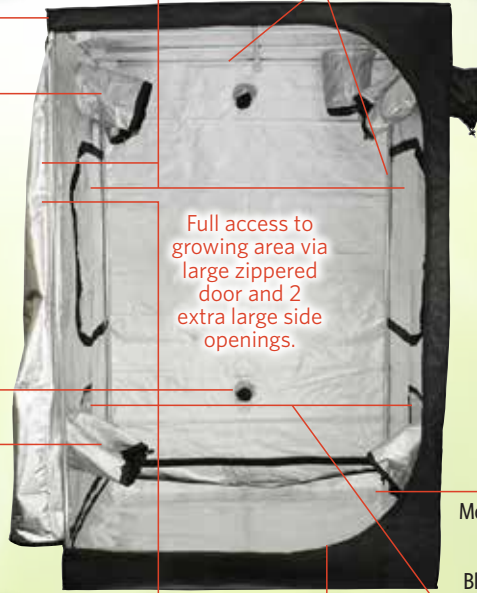

Full access to growing area via large zippered door and 2 extra large side openings.

Model Shown: 706298 Sun Hut Blackout 100



Dual sock vent and lamp/power cord ports



Clear viewing windows with Velcro covers



Heavy duty light-tight zippers



Lower vents with Micro-mesh screens & removable covers.

FRONT



SIDE



Sun Hut Blackout Tent door access configurations depend on the size of the tent.

MODEL	DOORS		
	FRONT	REAR	SIDE
706290	1	-	-
706292	1	-	-
706306	1	-	-
706294	1	-	-
706296	1	-	-
706298	1	-	2
706300	1	-	2
706308	2	2	-
706302	2	2	-
706304	2	2	-

Sun Hut - Blackout Grow Tents



The Blackout tent line offers the most complete and diverse selection of tent sizes and configurations available. These tents are constructed from 210D light tight material with a highly reflective interior surface. The frame of the tent uses heavy duty galvanized steel poles and fit securely into our reinforced polypropylene connectors. Other features include clear viewing windows, removable reflective mylar floor liner, adjustable dual sock ports for ventilation and power cords and Micro-mesh ventilation windows. Note: model numbers identify the approximate cubic feet. 1 Year Warranty.

Item No.	Description	Dimensions	MSRP
706290	Sun Hut Blackout 20 - 2.0 ft x 2.0 ft x 5.3 ft	24" x 24" x 63.6"	\$146.95
706292	Sun Hut Blackout 35 - 2.6 ft x 2.6 ft x 5.3 ft	31.6" x 31.6" x 63.6"	\$178.95
706306	Sun Hut Blackout 40 - 3.9 ft x 2.0 ft x 5.3 ft	46.5" x 24" x 63.6"	\$233.95
706294	Sun Hut Blackout 50 - 3.0 ft x 3.0 ft x 5.9 ft	36" x 36" x 70.8"	\$197.95
706296	Sun Hut Blackout 70 - 3.3 ft x 3.3 ft x 6.6 ft	39.6" x 39.6" x 79.2"	\$224.95
706298	Sun Hut Blackout 100 - 3.9 ft x 3.9 ft x 6.6 ft	46.8" x 46.8" x 79.2"	\$244.95
706300	Sun Hut Blackout 160 - 4.9 ft x 4.9 ft x 6.6 ft	58.8" x 58.8" x 79.2"	\$284.95
706308	Sun Hut Blackout 200 - 7.9 ft x 3.9 ft x 6.6 ft	94.8" x 46.8" x 79.2"	\$391.95
706302	Sun Hut Blackout 410 - 7.9 ft x 7.9 ft x 6.6 ft	94.8" x 94.8" x 79.2"	\$609.95
706304	Sun Hut Blackout 630 - 9.8 ft x 9.8 ft x 6.6 ft	117.6" x 117.6" x 79.2"	\$731.95

Always choose Sun Hut® brand affordable enclosed greenhouses

Sun Hut® Fortress™ Grow Tent

CHECK OUT OUR 3 LEVELS OF SUN HUT:

- Sun Hut® - The Big Easy:
Tough / Select Quality
- Sun Hut® - Blackout:
Pro Grade / Premium Quality
- Sun Hut® - Fortress:
Elite / Supreme Quality



sun-huts.com



1680D light-tight tent material

Full service 360° easy access doors

The industry's strongest steel frame with 22 mm poles & quick-connectors*

Highly reflective, pebbled surface is 100% safe for plants

Full 360° access to growing area via 2 large zippered doors.

Heavy duty light-tight zippers

Clear viewing windows with Velcro covers

Dual sock vent and lamp/power cord ports

Rugged 5.5" deep rubberized floor liner insert

FRONT

360° ACCESS

SIDE

Industry exclusive! Sonic welded irrigation line access holes allows reservoir to be placed outside tent.

The Sun Hut Fortress supreme quality grow tent has extra high-end features.

Maximum flexibility and superior durability.

TENTS/INDOOR GREENHOUSES

Sun Hut - Fortress Grow Tents



Sun Hut Fortress have exceptional quality with superior durability. Constructed from light tight material with a highly reflective interior surface that is 9 times thicker than popular industry tents! The frames are extremely robust and include heavy duty reinforced poly propylene connectors that fit securely into our galvanized steel poles. Rubberized waterproof floor. Includes a removable reflective floor liner, ports for ventilation and cords, two micro-mesh screened ventilation windows and many more great features. Note: model numbers identify the approximate cubic feet. 1 Year Warranty.

Item No.	Description	Dimensions	MSRP
706652	Sun Hut Fortress 45 - 2.5 ft x 2.5 ft x 7.1 ft	30.0" x 30.0" x 85.0"	\$244.95
706654	Sun Hut Fortress 90 - 3.6 ft x 3.6 ft x 7.1 ft	43.0" x 43.0" x 85.0"	\$362.95
706656	Sun Hut Fortress 85 - 2.5 ft x 4.6 ft x 7.1 ft	56.0" x 30.0" x 85.0"	\$331.95
706658	Sun Hut Fortress 150 - 4.6 ft x 4.6 ft x 7.1 ft	56.0" x 56.0" x 85.0"	\$446.95
706660	Sun Hut Fortress 245 - 5.8 ft x 5.8 ft x 7.3 ft	70.0" x 70.0" x 88.5"	\$524.95
706662	Sun Hut Fortress 310 - 4.6 ft x 9.3 ft x 7.3 ft	112.0" x 56.0" x 88.5"	\$699.95
706664	Sun Hut Fortress 470 - 8 ft x 8 ft x 7.3 ft	96.0" x 96.0" x 88.5"	\$1,159.95
706666	Sun Hut Fortress 730 - 10 ft x 10 ft x 7.3 ft	120.0" x 120.0" x 88.5"	\$1,459.95

Sun Hut - The Original Grow Tents



The Sun Hut Original Grow Tent is an affordable solution to your indoor greenhouse needs. It has a heavy duty ballistic nylon outer shell and an highly reflective interior surface. All models have full service access doors on both the front and back. The Sun Hut Original's structure consists of interlocking powder coated steel poles. Other Features include 8 in Duct Ports and Lamp/Power Cord Ports. The Sun Hut Original was designed to be used with larger sized ID trays such as Botanicare and Duralastics. Whiles supplies last. 1 Year Warranty.

Item No.	Description	Dimensions	MSRP
706800	Sun Hut 2 ft x 4 ft - The Original	24.0" x 48.0" x 84.0"	\$169.95
706805	Sun Hut 4 ft x 4 ft - The Original	48.0" x 48.0" x 84.0"	\$214.95
706810	Sun Hut 4 ft x 8 ft - The Original	48.0" x 96.0" x 84.0"	\$347.95

Sun Hut Accessories

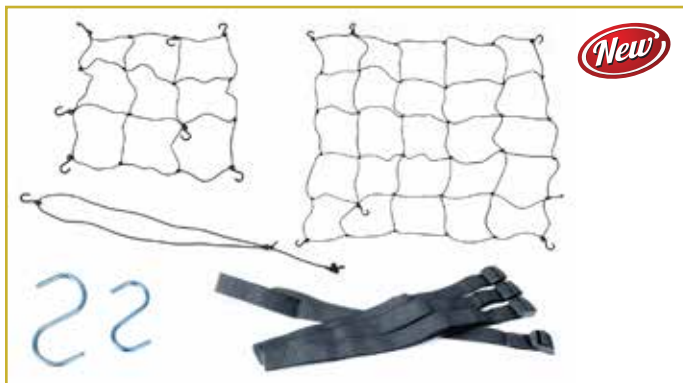

Sun Hut tent accessories includes two sizes of tent trellis made of an elastic material that conveniently hooks horizontally on the corners of the tent poles. The adjustable Elastic Support is a vertical support for your plants that can reach up to 8 feet. Nylon Straps are fully adjustable and perfect for supporting your gardening equipment. S hooks come in sizes 16 mm or 23 mm and are great for positioning wires and cords through your indoor tent.

Item No.	Description	MSRP
706590	Sun Hut Elastic Support 4/Bag	\$1.59
706592	Sun Hut Elastic Trellis 2 ft x 3.33 ft 1/Bag	\$6.99
706594	Sun Hut Elastic Trellis 4 ft x 5 ft 1/Bag	\$14.99
706596	Sun Hut Strap 2/Bag	\$0.99
706598	Sun Hut S Hook 16 mm/.63 in 5/Bag	\$0.69
706600	Sun Hut S Hook 23 mm/.90 in 5/Bag	\$0.89

GrowLab Equipment Hanging Board

The Equipment board is designed to hang a fan or equipment from the walls of the tent. It offers sufficient space of hangable space and the weight capacity 65 lb Works with all of Growlab tents excluding GL80 and smaller.



Item No.	Description	MSRP
706858	GrowLab Equipment Hanging Board 15.75 in x 78.74 in	\$55.00

GrowLab Hercules Support

Choose the Hercules Frame Support that coincides with the size of your GrowLab Portable Grow Room. Each Hercules Frame support is a complete kit which will go from floor to ceiling across the roof of the tent and back to the floor.



Item No.	Description	MSRP
706836	GrowLab Hercules Support For GrowLab 120	\$73.00
706846	GrowLab Hercules Support For GrowLab 145	\$80.00
706851	GrowLab Hercules Support For GrowLab 240	\$87.00
706856	GrowLab Hercules Support For GrowLab 290	\$118.00



The best quality, selection and sizes of indoor greenhouses you will find. Get yours today!



GrowLab



The next generation in portable grow rooms - The GrowLab Horticultural Grow Room. Here are just some of the unique and exciting features you won't find elsewhere. Clear viewing windows on all models except GL40, GL60, GL240 & GL290. Increased weight capacity with roof cross-members easily support 100 pounds. Sturdy powder coated framework helps protect against rust and gives a cleaner look; thicker than previous models. Highly reflective interior for significant increase in reflectivity for improved lighting performance. Thermally protected tent material reflects 97% of all radiant heat for superior insulation. Completely non-toxic and will not react under light and heat and no off-gassing to harm plants. Improved fabric & zippers that are thicker fabric than previous models, with the best zippers on the market. Moveable roof cross-members that easily adjust lighting and accessories; pieces snap into desired place for better functionality. Multiple intake/exhaust ports including two ports opposite each other at reflector level for air-cooling of lighting system on most models. Adjustable fan and ducting attachments so no more clamps or reducers needed! Waterproof floor features a second floor that is removable for easy cleaning between crops.

Item No.	Description	Dimensions	MSRP
706820	GrowLab 40	16" x 16" x 47"	\$110.00
706825	GrowLab 60	24" x 24" x 63"	\$147.00
706830	GrowLab 80	31" x 31" x 71"	\$179.00
706835	GrowLab 120	47" x 47" x 79"	\$245.00
706845	GrowLab 145	57" x 57" x 79"	\$285.00
706850	GrowLab 240	95" x 95" x 79"	\$612.00
706855	GrowLab 290	114" x 114" x 79"	\$733.00
706860	GrowLab 80L	59" x 31" x 79"	\$233.00
706865	GrowLab 120L	47" x 95" x 79"	\$393.00
706870	GrowLab GL100	39" x 39" x 79"	\$225.00
706880	GrowLab 145L	57" x 114" x 79"	\$450.00
706885	GrowLab Clone Lab	25" x 49" x 47"	\$295.00
706887	GrowLab Clone Lab Tall	25" x 49" x 71"	\$336.00

TENTS/INDOOR GREENHOUSES

GrowLAB Portable Grow Rooms	GL40	GL60	GL80	GL120	GL145	GL80L	GL120L	GL145L	GL240	GL290	GL CloneLAB
			standard				wide		quad		other
size assembled (ft): length x width x height	1'4" x 1'4" x 3'11"	2'0" x 2'0" x 5'3"	2'7" x 2'7" x 5'11"	3'11" x 3'11" x 6'7"	4'9" x 4'9" x 6'7"	2'7" x 4'11" x 6'7"	3'11" x 7'11" x 6'7"	4'9" x 9'6" x 6'7"	7'11" x 7'11" x 6'7"	9'6" x 9'6" x 6'7"	2'1" x 4'1" x 3'11"
size assembled (cm):	40 x 40 x 120	60 x 60 x 160	80 x 80 x 180	120 x 120 x 200	145 x 145 x 200	80 x 150 x 200	120 x 240 x 200	145 x 290 x 200	240 x 240 x 200	290 x 290 x 200	65 x 125 x 120
size packaged (ft):	2' x 0.9' x 0.4'	2.7' x 0.9' x 0.4'	3' x 1' x 0.4'	4' x 1.2' x 0.4'	4.9' x 1.2' x 0.4'	5' x 1.1' x 0.3'	4' x 1.3' x 0.5'	4.9' x 1.3' x 0.5'	4' x 1.4' x 0.6'	4.9' x 1.4' x 0.6'	4.2' x 2.3' x 0.5'
unit weight:	12 lbs	17 lbs	22 lbs	31 lbs	35 lbs	32 lbs	50 lbs	59 lbs	73 lbs	89 lbs	40 lbs
square footage:	1.7	3.9	6.9	15.5	22.6	12.9	31	45.3	62	90.5	8.7
cubic feet:	6.8	20.3	40.7	101.7	148.5	84.8	203.4	297	406.8	594	34.4
hangable weight:	100+ lbs	100+ lbs	100+ lbs	100+ lbs	100+ lbs	100+ lbs	100+ lbs	100+ lbs	100+ lbs	100+ lbs	150 lbs per shelf
viewing windows:	-	-	YES	YES	YES	YES	YES	YES	-	-	-
reducing roof port:	5"	5"	5"	8"	8"	8"	10"	10"	10"	10"	6"
reducing upper port:	-	-	-	8" left/right	8" left/right	8" left/right	8" left/right	8" left/right	8" left/right	8" left/right	-
reducing lower port:	-	5" left/right	5" left/right	8" left/right	8" left/right	8" left/right	10" left/right	10" left/right	10" left/right	10" left/right	6" left/right
reducing cable port:	4" top/bottom	4" top/bottom	4" top/bottom	4" top/bottom	4" top/bottom	4" top/bottom	4" top/bottom	4" TR/TL/BL/BR	4" TR/TL/BL/BR	4" TR/TL/BL/BR	4" top/bottom
intake flap:	2 left/right	3 left/right/back	3 left/right/back	3 left/right/back	3 left/right/back	3 left/right/back	4 left/right/back	4 left/right/back	4 left/right/back	4 left/right/back	3 left/right/back
access panels:	-	-	-	-	left, right	-	rear	rear	left, right, rear	left, right, rear	-
floor panels: (waterproof)	1	1	1	1	1	1	1	1	1	1	1
fits DryNet:	-	-	-	YES	YES	2x	2x	2x	4x	4x	-
sugg. wattage:	CFL	CFL/T5	250 - 400	400 - 600	1000	2x 400	2x 600	2x 1000	4x 600	4x 1000	T5



Fixed Flow Water Pumps • Adjustable Flow Water Pumps • Convertible Bottom Draw Pumps • Premium Italian Jet Pumps • Air Pumps • Supreme Air Pumps Commercial Air Pumps • Linear Air Pumps • Manifolds • Air Stones • Air Diffusers • Air Stone Disks



EcoPlus Eco Fixed Flow Rate Submersible Pumps



Great for everything from fountains to hydroponic systems. The pumps have an inside threaded fittings and the flow is non-adjustable. Powerful oil-free, rare earth rotor magnet. Ceramic shaft and bearing insures reliability. Strainer protects impeller from damage. Comes with a 120 volt cord. Include inlet and outlet fittings. 1 Year Warranty.

Item No.	Description	Watts	Max Height	MSRP
728490	EcoPlus Eco 66 Submersible Pump 75 GPH	5.75	2.5 ft	\$9.29
728492	EcoPlus Eco 100 Submersible Pump 100 GPH	10	3 ft	\$11.39
728495	EcoPlus Eco 132 Submersible Pump 132 GPH	28	4 ft	\$11.79
728300	EcoPlus Eco 185 Submersible Pump 158 GPH	26.5	4 ft	\$14.99
728305	EcoPlus Eco 264 Submersible Pump 290 GPH	28	6.5 ft	\$20.95
728310	EcoPlus Eco 396 Submersible Pump 396 GPH	36	6.5 ft	\$23.95
728315	EcoPlus Eco 633 Submersible Pump 594 GPH	54	7.5 ft	\$48.95
728320	EcoPlus Eco 1056 Submersible Pump 1083 GPH	89	9 ft	\$72.95
728325	EcoPlus Eco 1267 Submersible Pump 1347 GPH	192	13.5 ft	\$87.95
728330	EcoPlus Eco 1584 Submersible Pump 1638 GPH	245	12.5 ft	\$107.95
728333	EcoPlus Eco 2245 Submersible Pump 2166 GPH	246	16.5 ft	\$145.95
728335	EcoPlus Eco 3170 Submersible Pump 3170 GPH	192	13.1 ft	\$199.95
728485	EcoPlus Eco 4950 Submersible Pump 4750 GPH	250	20 ft	\$204.95
728340	EcoPlus Eco 7400 Submersible Pump 7400 GPH	550	23 ft	\$287.95

EcoPlus Premio Jet Pumps



EcoPlus Premio Jet water pumps are the original made in Italy premium water pumps. These pumps are submersible multi-use water pumps, delivering high performance with low power consumption. Premio Jet water pumps can be used externally or submerged. The pumps were designed to be silent, versatile and extremely low maintenance. 1 Year Warranty.

Item No.	Description	Watts	Max Height	MSRP
728395	EcoPlus Premio Jet 600 - 132 GPH	7.5	53.0	\$27.49
728397	EcoPlus Premio Jet 1200 - 264 GPH	20	69.0	\$35.99

EcoPlus Adjustable Flow Rate Water Pumps



This new line of adjustable water pumps offer an energy efficient magnetic ferrite rotor with a ceramic shaft, vastly improving GPH and head pressure that is needed in hydroponic systems, fountains and more. These pumps are manufactured with a built in flow regulator allowing full adjustability of your water movement. 172 GPH thru 370 GPH Models include a 6 ft 120 volt power cord. 528 GPH thru 1269 GPH models include a 15 ft 120 volt power cord. 1 Year Warranty.

Item No.	Description	Watts	Max Height	MSRP
727700	EcoPlus Adjustable Water Pump 172 GPH	9.5	4.75 ft	\$14.95
727705	EcoPlus Adjustable Water Pump 291 GPH	16	4.9 ft	\$20.95
727710	EcoPlus Adjustable Water Pump 370 GPH	24	6.9 ft	\$23.95
727715	EcoPlus Adjustable Water Pump 528 GPH	33	7.6 ft	\$37.95
727720	EcoPlus Adjustable Water Pump 655 GPH	43	8.8 ft	\$48.95
727725	EcoPlus Adjustable Water Pump 793 GPH	58	9.1 ft	\$52.95
727730	EcoPlus Adjustable Water Pump 1110 GPH	92	9.8 ft	\$72.95
727735	EcoPlus Adjustable Water Pump 1269 GPH	110	10.5 ft	\$87.95

EcoPlus Convertible Bottom Draw Water Pumps



The EcoPlus Convertible Bottom Draw Pump is the first hydroponic pump of its kind. With an interchangeable outlet fitting, this line of pumps fits almost all hydroponic applications. The bottom draw inlet allows the pump to operate in less than 1/2 inch of water. The convertible outlet offers the freedom of a horizontal or vertical water outlet. 1 Warranty.

Item No.	Description	Watts	Max Height	MSRP
727800	EcoPlus Convertible Bottom Draw Water Pump 350 GPH	27.0	7.22	\$24.95
727805	EcoPlus Convertible Bottom Draw Water Pump 550 GPH	65.0	8.86	\$49.95
727810	EcoPlus Convertible Bottom Draw Water Pump 750 GPH	75.0	10.33	\$59.95

EcoPlus 1500 Elite Submersible Pump

This heavy duty, high quality pump is the latest introduction to the EcoPlus pump family. It draws water from the bottom. 1 Year Warranty.



Item No.	Description	MSRP
728497	EcoPlus 1500 Elite Submersible Pump	\$132.95

Mondi Utility Sump Pump 1585x

A heavy duty, oil-less (water cooled) multipurpose pump suitable for water control: basement/indoor flooding, plant watering, water recirculation and more! 2 Year Warranty.



Item No.	Description	MSRP
727095	Mondi Utility Sump Pump 1585 GPH	\$124.95

Mondi Utility Sump Pump 1200x

Great for controlling water in basement/indoor flooding, plant watering, water recirculation and more! Outfitted with a 2/5 HP motor that can pump up to 1200 gallons per hour. 2 Year Warranty.



Item No.	Description	MSRP
727096	Mondi Utility Sump Pump 1200 GPH	\$127.95

Mondi 30 in Water Pump Extension With Ball Valve

Ergonomically designed extruded aluminum bend that acts like a handle for safely moving the connected pump from rain barrels or reservoirs. You no longer have to pull the pump out by the electrical cord or hose. Aluminum poles that easily connect to each other for additional height to a maximum of 42 in.



Item No.	Description	MSRP
708710	Mondi 30 in Water Pump Extension w/ Ball Valve	\$19.95

GH WaterPower 120 Pump

The WaterPower pump has been designed for ease of use. It is constructed with the highest quality workmanship and finest materials to ensure long dependable use.



Item No.	Description	MSRP
728033	GH WaterPower 120 Pump 951 GPH	\$109.98

GH TNC 1/4 HP Pump

The TNC centrifugal inline water pump moves 1250 GPH through 1 in pipe thread fittings and has a dependable ceramic/graphite seal. The TNC water pump is used in the AeroFlo2 - 60 site units.



Item No.	Description	MSRP
728115	GH TNC 1/4 HP Pump 1250 GPH	\$183.33

Danner Mag Drive Pump 190 GPH

190 GPH maximum flow with a 7 ft shut-off. 10 ft grounded power cord. Built-in adjustable flow control. 3/8 in to 1/2 in NPT. Ceramic shaft. Foam pre-filter and elbow included. 3 Year Warranty.



Item No.	Description	Max Height	MSRP
728075	Mag Drive Pump 190 GPH	7 ft	\$54.95

Danner Mag Drive Pumps 250 GPH - 700 GPH

These high quality pumps operates submerged or in-line. 10 foot grounded power cord. 1/2 in NPT. Ceramic shaft. Foam pre-filter included. 3 Year Warranty.



Item No.	Description	Max Height	MSRP
728065	Mag Drive Pump 250 GPH	7 ft	\$82.95
728070	Mag Drive Pump 350 GPH	10.5 ft	\$92.95
728060	Mag Drive Pump 500 GPH	10.5 ft	\$105.95
728072	Mag Drive Pump 700 GPH	12.5 ft	\$115.95

Danner Mag Drive Pumps 950 GPH - 2400 GPH

These high quality pumps operates submerged or in-line. 10 foot grounded power cord. 3/4 in NPT for all except 728085 which has 1 in NPT. Ceramic shaft. Foam pre-filter included. 3 Year Warranty.



Item No.	Description	Max Height	MSRP
728062	Mag Drive Pump 950 GPH	15 ft	\$148.95
728050	Mag Drive Pump 1200 GPH	15 ft	\$203.95
728080	Mag Drive Pump 1800 GPH	22 ft	\$230.95
728085	Mag Drive Pump 2400 GPH	22 ft	\$284.95

Supreme Hydroponics Sump Pump 300 GPH

Supreme Hydroponics 300 GPH Sump Pump is completely submersible. It pumps down to 1/8 in and easily attaches to a garden hose. 25 ft power cord. Shut off height 6 ft. Outlet 3/4 in GHT. Watts: 18 max. 1 Year Warranty.



Item No.	Description	MSRP
727260	Supreme Hydroponics Utility Sump Pump 300 GPH	\$48.95

Little Giant PE-1 Submersible Direct Drive Pump

Small submersible epoxy encapsulated pump for commercial, industrial and home use. Applications include hydroponic systems, water gardens, ponds, etc. 1 Year Warranty.



Item No.	Description	MSRP
727005	Little Giant PE-1 Submersible Direct Drive Pump 170 GPH	\$86.95

Little Giant 1-ABS Submersible Pump

Shallow-pan tank style designed for in-pan mounting with bottom intake with 10 ft maximum lift. Has a stainless steel shaft with 6 ft power cord with 3-prong molded plug. 1 Year Warranty.



Item No.	Description	MSRP
727010	Little Giant 1-ABS Submersible Pump 205 GPH	\$132.95

Little Giant 1 Submersible Pump

Permanently lubricated pumps for commercial, industrial and home use where liquid must be transferred or recirculated. Applications include hydroponic systems, water gardens, ponds, aquariums, etc. 1 Year Warranty.



Item No.	Description	MSRP
727015	Little Giant 1 Submersible Pump 205 GPH	\$115.95

Little Giant NK-1 Submersible Pump

Permanently lubricated pumps for commercial, industrial and home use where liquid must be transferred or recirculated. Applications include hydroponic systems, water gardens, ponds, etc. 1 Year Warranty.



Item No.	Description	MSRP
727020	Little Giant NK-1 Submersible Pump 210 GPH	\$125.95

Little Giant NK-2 Submersible Pump

Permanently lubricated pumps for commercial, industrial & home use where liquid must be transferred or recirculated. Applications include hydroponic systems, water gardens, ponds, etc. 1 Year Warranty.



Item No.	Description	MSRP
727025	Little Giant NK-2 Submersible Pump 325 GPH	\$144.95

Little Giant 5-MSP Submersible Pumps

Permanently lubricated utility pump includes garden hose adapter and removable inlet screen for easy cleaning. Lifetime oil supply. Pumps down to 1/8 in (3.2 mm). 1 Year Warranty.



Item No.	Description	MSRP
727035	Little Giant 5-MSP Submersible Pump Blue 1200 GPH	\$162.95
727050	Little Giant 5-MSPR Submersible Pump Black 1200 GPH	\$162.95

Little Giant 6-CIM-R Submersible Pump

Big John submersible sump pump for residential and light commercial use. The 6-CIM-R manual sump pumps provides efficient and reliable service. Pump features a 1-1/2 in discharge with an 18 ft maximum head. 1 Year Warranty.



Item No.	Description	MSRP
727040	Little Giant 6-CIM-R Submersible Pump 2760 GPH	\$242.95

Little Giant RS-5LL Diaphragm Switch

Can be used anytime you have a basin usage for the pump. It works by diaphragm. If the water reaches a certain level, it will shut off the pump. The pump plugs into the switch. On level: 2 in - 3 in. Off level: 0.5 in - 1.5 in when mounted to 5-MSP. For pumps up through 1/3 HP or the following pumps, 5-MSP, 6-CIM-R, NK-1 & NK-2. 18 ft cord. 1 Year Warranty.



Item No.	Description	MSRP
727045	Little Giant RS-5LL Diaphragm Switch	\$90.95

Maxi-Jet Water Pump

Energy-efficient and very durable with a sealed casing and superior internal design, it ensures that they won't overheat when ran dry, unlike most other pumps. Equipped with dual pre-filters and a simplistic design, for virtually maintenance free and long lasting. 3 Year Warranty.



Item No.	Description	MSRP
727085	Maxi-Jet 1200 Water Pump 295 GPH	\$30.99

Condensate Pumps

These pumps are used as an accessory with air conditioners and dehumidifiers. This rugged pump has 22 feet of lift. Continuous duty 140° F. Maximum inlet temperature 160° F. 2 Year Warranty.



Item No.	Description	MSRP
728130	Condensate Pump 120 Volt	\$84.95
728135	Condensate Pump 240 Volt	\$101.95

EcoPlus Small & Large Pump Filter Bag

A submersible pump is inserted into this filter bag to prevent sediment from clogging it. Use of the filter bag will prolong the life and reduce cleaning/maintenance of the pump.



Item No.	Description	MSRP
728188	EcoPlus Pump Filter Bag Small - 6.5 in x 9 in	\$9.80
728190	EcoPlus Pump Filter Bag Large - 10 in x 12.5 in	\$11.50

AIR PUMPS

EcoPlus Supreme Air Pump



The EcoPlus Supreme Air Pumps are great for providing oxygen to hydroponic systems. In hydroponic applications, the use of an air pump with an air stone will oxygenate the water and increase the uptake of nutrients by the plant. These air pumps are very quiet and built to be very durable. Low power oil-less motor. 1 Year Warranty.

Item No.	Description	PSI	Tube Size	MSRP
728290	EcoPlus Supreme Air Pump 1 Outlet 140 L/H - 3 Watt 29 GPH	1.7	3/16 in	\$12.00
728295	EcoPlus Supreme Air Pump 2 Outlet 320 L/H - 4 Watt 71 GPH	1.7	3/16 in	\$19.50
728297	EcoPlus Supreme Air Pump 4 Outlet 640 L/H - 8 Watt 143 GPH	1.7	3/16 in	\$29.90

EcoPlus Commercial Air Pumps



Widely used to provide oxygen in aquariums, fish farms and hydroponic systems. Includes chrome air manifold, ranging from four to sixteen outlets. Cylinders and pistons are made of excellent materials, making the pump strong, durable. Convenient to operate without oil or much noise. 1 Year Warranty.

Item No.	Description	PSI	Tube Size	MSRP
728450	EcoPlus Commercial Air 1 - 18 Watt Single Outlet 760 GPH	2.9	1/4 in	\$37.95
728455	EcoPlus Commercial Air 3 - 35 Watt Single Outlet 1014 GPH	3.9	3/8 in	\$59.95
728457	EcoPlus Commercial Air 5 - 80 Watt Single Outlet 1347 GPH	5.2	3/8 in	\$77.95
728459	EcoPlus Commercial Air 7 - 200 Watt Single Outlet 3804 GPH	7.0	1/2 in	\$132.95

HELPFUL HINT: Air pumps should always be placed above the water level. This prevents water from flowing back into the air pump.

EcoPlus Eco Air Pumps



Widely used in hydroponic systems. Convenient to operate without oil or much noise. Cylinders and pistons are made of excellent materials, making the pump strong and durable. Will meet many requirements of pumps with air dividers from four to twenty-two outlets. 1 Year Warranty.

Item No.	Description	PSI	Tube Size	MSRP
728350	EcoPlus Eco Air 8 Eight Outlet - 13 Watt 380 GPH	2.3	3/16 in	\$59.95
728355	EcoPlus Eco Air 4 Four Outlet - 6.5 Watt 253 GPH	2.1	3/16 in	\$27.95
728360	EcoPlus Eco Air 2 Two Outlet - 3 Watt 126 GPH	2.4	3/16 in	\$14.95
728365	EcoPlus Eco Air 1 Plus One Outlet - 2 Watt 44 GPH	2.1	3/16 in	\$9.95

HELPFUL HINT: Air pumps should always be placed above the water level. This prevents water from flowing back into the air pump.

Air Force Pro Linear Air Pumps



Commonly used to provide oxygen in aquariums, fish farms, hydroponic systems and more. Solid aluminum body for enhanced durability. Designed to minimize noise and vibration. Oil-less compressor allows for easy maintenance. No lubrication required. Use with EcoPlus Trumpet Style Air Manifolds. 2 Year Warranty.

Item No.	Description	PSI	Tube Size	MSRP
746500	Air Force Pro 15 Linear Air Pump 301 GPH	1.4		\$118.95
746505	Air Force Pro 40 Linear Air Pump 745 GPH	1.8		\$152.95
746510	Air Force Pro 60 Linear Air Pump 1078 GPH	2.1		\$184.95
746515	Air Force Pro 80 Linear Air Pump 1363 GPH	2.1		\$244.95

GH Dual Diaphragm Air Pump

This high output pump has four adjustable 1/4 in outputs that can be teed off to power up to twelve air driven hydroponics growing systems such as the WaterFarm. Also use it to reliably oxygenate their reservoir with air stones. 3 psi, 320 gph (20 L/min).



Item No.	Description	MSRP
728040	GH Dual Diaphragm Air Pump 320 GPH	\$82.84
728043	GH Dual Diaphragm Air Pump Rebuild Kit	\$19.98

Hydor Bubble Maker

Improve aeration and water movement while minimizing energy use and maintenance. Hydor Bubble Maker boasts easy setup and reliable performance.



Item No.	Description	MSRP
728532	Hydor Bubble Maker	\$21.95

AIR MANIFOLDS

Air Manifolds - Plastic

Easily diffuse air with these high quality plastic air manifolds. Barbed ends for tight fitting tubing.



Item No.	Description	Use Tube Size Inlet	Use Tube Size Outlet	MSRP
728446	4 Outlet Plastic Air Manifold	1/4 in	3/16 in	\$1.49
728447	6 Outlet Plastic Air Manifold	3/8 in	3/16 in	\$2.95
728448	8 Outlet Plastic Air Manifold	3/8 in	3/16 in	\$3.49
728449	10 Outlet Plastic Air Manifold	3/8 in	3/16 in	\$4.95

EcoPlus Air Manifold T Style 3/8 Inch Inlet

High quality chrome air manifolds. Each outlet has individually controlled valves. Barbed ends for use with tubing for a tight fit. Distributes air flow to four or more air stones or air diffusers in order to insure that equal air flow is provided to each air diffuser or air stone. Use with 3/16 inch airline product #708215.



Item No.	Description	MSRP
728460	EcoPlus Air Manifold T Style 3/8 in Inlet - 4 Valve Outlet	\$5.79
728465	EcoPlus Air Manifold T Style 3/8 in Inlet - 6 Valve Outlet	\$7.49
728470	EcoPlus Air Manifold T Style 3/8 in Inlet - 8 Valve Outlet	\$9.29

EcoPlus Air Manifold Trumpet Style 1/2 Inch Inlet

Air Manifolds allow the adjustment of air flow to four or more air stones or air diffusers in order to insure that equal air flow is provided to each air diffuser or air stone. The manifold has individual barbed valves which control the outlet of air to your air stones or diffusers. Compatible with Air Force Pro 40, 60 & 80. Use with 3/16 inch airline product #708215.



Item No.	Description	MSRP
728005	EcoPlus Air Manifold Trumpet Style 1/2 in Inlet - 4 Valve Outlet	\$6.69
728010	EcoPlus Air Manifold Trumpet Style 1/2 in Inlet - 6 Valve Outlet	\$8.39
728015	EcoPlus Air Manifold Trumpet Style 1/2 in Inlet - 12 Valve Outlet	\$13.39
728020	EcoPlus Air Manifold Trumpet Style 1/2 in Inlet - 16 Valve Outlet	\$18.29



Scan now to get the latest information on EcoPlus products! Get yours today!



EcoPlus Air Stones

These great quality Air Stones will work great for airting aquariums or reservoirs. Choose the right size for you application. Use with 3/16 inch airline product #708215.



Item No.	Description	MSRP
728405	EcoPlus Large Round Air Stone	\$4.99
728410	EcoPlus Medium Round Air Stone	\$2.95
728415	EcoPlus Small Round Air Stone	\$1.95
728420	EcoPlus 8 in Air Stone	\$1.95
728425	EcoPlus 6 in Air Stone	\$1.49
728430	EcoPlus 4 in Air Stone	\$1.29

EcoPlus Flexible Air Diffusers

These air hoses are flexible and unbreakable. They provide excellent aeration. To clean, just wipe off under running water. Use with 3/16 inch airline product #708215.



Item No.	Description	MSRP
728435	EcoPlus Flexible Air Diffuser 2 ft	\$4.79
728440	EcoPlus Flexible Air Diffuser 3 ft	\$6.39
728445	EcoPlus Flexible Air Diffuser 4 ft	\$8.19

EcoPlus Air Stone Discs

For use with EcoPlus Commercial Air Pumps. Offers maximum aeration in reservoirs. Large air stone surface area. Heavy duty construction. 1 Year Warranty.



Item No.	Description	Use Tube Size Inlet	MSRP
728416	EcoPlus Air Stone Disc 4 in	3/16 in	\$8.95
728417	EcoPlus Air Stone Disc 6 in	3/8 in	\$19.95
728418	EcoPlus Air Stone Disc 8 in	3/8 in	\$24.95

EZ-Clone 360 Sprayer

Used in high output aeroponic gardening applications. Made as a replacement in EZ-Clone systems.



Item No.	Description	MSRP
706392	EZ-Clone 360 Sprayer Red	\$0.70

Aeroponic Clone Spinner 360 Degree

A rotating 360 Degree sprayer that is ideal for rooting cuttings aeroponically. The spinner comes complete with a male thread for a secure, no leak fit. (Used in Clone Machines).



Item No.	Description	MSRP
708190	Aeroponic Clone Spinner 360	\$1.79

Float Valve

An essential part for do-it-yourselfers! This float valve assembly controls the water/nutrient solution level in your primary reservoir (controller). Comes with 1/2 in brass barbed fitting.



Item No.	Description	MSRP
708170	Float Valve w/ Barbed Fitting	\$27.95

Botanicare Ebb & Flow Fittings

Interior threads which accept 3/4 in standard pipe thread. Use as ebb and flow fittings and bulkhead fittings. Increased versatility: thread PVC pipe fittings into bulkhead fittings - ideal for use in aeroponic and drip applications. Sold in case quantities only.



Item No.	Description	MSRP
708551	Botanicare Ebb & Flow Barbed Fitting 1/2 in	\$1.80
708552	Botanicare Ebb & Flow Barbed Fitting 3/4 in	\$2.00
708558	Botanicare Ebb & Flow 1 in Barbed Fitting	\$2.10
708553	Botanicare Ebb & Flow Extension Fitting	\$0.70
708554	Botanicare Ebb & Flow Screen Fitting	\$0.65
708555	Botanicare Ebb & Flow Washer Fitting	\$0.65
708556	Botanicare Ebb & Flow Fitting Kit w/ 2 Extensions	\$6.75

Hydro Flow (EcoPlus) Ebb & Flow Fitting Kit

Kit includes: 1 - 1/2 in Tub Outlet Fitting, 1 - 3/4 in Tub Outlet Fitting, 2 - Screen Fittings and 3 - Outlet Extension Fittings. Manufactured using the finest quality materials and craftsmanship. Made with 100% virgin plastic. Hydro Flow Tub Outlet Fittings each come with 2 gaskets ensuring a water tight seal.



Item No.	Description	MSRP
708562	Hydro Flow (EcoPlus) Ebb & Flow Fitting Kit	\$6.49

Your plants could use a drink.

Industry exclusive



Quality, Compatible Irrigation Solutions

Introducing Hydro Flow™, a new line of irrigation fittings, connectors, valves, adaptors, flow restrictors, tubing and much more. This fully compatible and comprehensive line includes virtually every part needed for any indoor gardening or hydroponics application imaginable.

Our exclusive soft feel fittings use a special plastic resin that makes these fittings friendly to the hands & fingers, without sharp edges.

Visit your local Indoor Gardening Retailer and ask for Hydro Flow™ brand irrigation solutions.

www.hydro-flowproducts.com



Distributed exclusively by
National Garden Wholesale,
Sunlight Supply, Inc.
www.sunlightsupply.com



Hydro Flow (EcoPlus) Ebb & Flow Fittings

Manufactured using the finest quality materials. Made with 100% virgin plastic. Hydro Flow Tub Outlet Fittings each come with 2 gaskets ensuring a water tight seal. All pieces offered a la carte for maximum flexibility.



Item No.	Description	Bag Qty	MSRP Ea
708560	Hydro Flow (EcoPlus) Ebb & Flow Outlet Extension Fitting	10	\$0.75
708565	Hydro Flow (EcoPlus) Ebb & Flow Screen Fitting	10	\$0.75
708570	Hydro Flow (EcoPlus) Ebb & Flow Tub Outlet Fitting 1/2 in (13mm)	10	\$2.40
708575	Hydro Flow (EcoPlus) Ebb & Flow Tub Outlet Fitting 3/4 in (19mm)	10	\$2.70
708580	EcoPlus Ebb & Flow Tub Outlet Fitting 1 in (25mm)	10	\$3.10

Hydro Flow Fill & Drain Siphon Kit

The Hydro Flow Fill & Drain Siphon Kit is a non-electric siphoning pump that works perfectly for filling and draining hydroponic reservoirs at 300 Gallons or less. Creates 20 pounds of vacuum pressure. Adapts to all faucets and hoses.



Item No.	Description	MSRP
747184	Hydro Flow Fill & Drain Kit	\$19.67
742230	Hydro Flow Fill & Drain Siphon Kit	\$17.95

Hydro Flow Fill/Drain Fitting Kit

The Fill/Drain Fitting Kit includes one fill/drain fitting (custom bulkhead fitting with 1/2 in screen, nut and O-ring) and one overflow fitting (PVC tube and adapter with 1 in screen).



Item No.	Description	MSRP
706750	Hydro Flow Gray & Teal Fitting Kit Adapter	\$10.95
706751	Hydro Flow Teal Fill / Drain Fitting Adapter	\$4.19

Hydro Flow Barbed Fittings 1/8 in

These non-corrosive plastic fittings are guaranteed to provide a secure, watertight and airtight connection. These fittings offer strength and durability. Use these high quality barbed 1/8 in connectors for your irrigation or hydroponic systems.



Item No.	Description	Bag Qty	Box Qty	MSRP Ea
747000	Hydro Flow Barbed Straight 1/8 in to 1/8 in	10	—	\$0.23
747002	Hydro Flow Barbed Tee 1/8 in	10	—	\$0.37
742000	Hydro Flow Barbed Straight 1/8 in to 1/8 in - Display Box	—	500	\$0.17
742005	Hydro Flow Barbed Tee 1/8 in - Display Box	—	500	\$0.30

Hydro Flow Barbed Fittings 3/16 in

These non-corrosive plastic fittings are guaranteed to provide a secure, watertight and airtight connection. These fittings offer strength and durability. Hydro Flow 3/16 in Connectors are perfect for using with irrigation or hydroponic systems.



Item No.	Description	Bag Qty	Box Qty	MSRP Ea
747004	Hydro Flow Barbed Straight 3/16 in to 3/16 in	10	—	\$0.24
747006	Hydro Flow Barbed Elbow 3/16 in	10	—	\$0.37
747008	Hydro Flow Barbed Tee 3/16 in	10	—	\$0.37
742010	Hydro Flow Barbed Straight 3/16 in to 3/16 in - Display Box	—	500	\$0.19
742015	Hydro Flow Barbed Elbow 3/16 in - Display Box	—	500	\$0.30
742020	Hydro Flow Barbed Tee 3/16 in - Display Box	—	500	\$0.30

Hydro Flow Barbed Fittings 1/4 in

These non-corrosive plastic fittings are guaranteed to provide a secure, watertight and airtight connection. These fittings offer strength and durability. Use these high quality barbed 1/4 in connectors for your irrigation or hydroponic systems.



Item No.	Description	Bag Qty	Box Qty	MSRP Ea
747014	Hydro Flow Barbed Straight 1/4 in to 1/4 in	10	—	\$0.33
747016	Hydro Flow Barbed Elbow 1/4 in	10	—	\$0.45
747018	Hydro Flow Barbed Tee 1/4 in	10	—	\$0.45
747020	Hydro Flow Barbed Y Connector 1/4 in	10	—	\$1.36
742025	Hydro Flow Barbed Straight 1/4 in to 1/4 in - Display Box	—	500	\$0.28
742030	Hydro Flow Barbed Elbow 1/4 in - Display Box	—	500	\$0.39
742035	Hydro Flow Barbed Tee 1/4 in - Display Box	—	500	\$0.39
742040	Hydro Flow Barbed Y Connector 1/4 in - Display Box	—	250	\$1.18

Hydro Flow Barbed Fittings 3/8 in

These non-corrosive plastic fittings are guaranteed to provide a secure, watertight and airtight connection. These fittings offer strength and durability. Use these high quality 3/8 in Hydro Flow barbed connectors for your irrigation systems.



Item No.	Description	Bag Qty	Box Qty	MSRP Ea
747030	Hydro Flow Barbed Straight 3/8 in to 3/8 in	10	—	\$0.27
747032	Hydro Flow Barbed Elbow 3/8 in	10	—	\$0.38
747034	Hydro Flow Barbed Tee 3/8 in	10	—	\$0.48
747036	Hydro Flow Barbed Y Connector 3/8 in	10	—	\$1.44
742045	Hydro Flow Barbed Straight 3/8 in to 3/8 in - Display Box	—	250	\$0.22
742050	Hydro Flow Barbed Elbow 3/8 in - Display Box	—	250	\$0.33
742055	Hydro Flow Barbed Tee 3/8 in - Display Box	—	250	\$0.36
742060	Hydro Flow Barbed Y Connector 3/8 in - Display Box	—	250	\$1.25

Hydro Flow Barbed Fittings 1/2 in

These non-corrosive plastic fittings are guaranteed to provide a secure, watertight and airtight connection. These fittings offer strength and durability. Use these high quality barbed 1/2 in connectors for your irrigation or hydroponic systems.



Item No.	Description	Bag Qty	Box Qty	MSRP Ea
747046	Hydro Flow Barbed Straight 1/2 in to 1/2 in	10	—	\$0.31
747048	Hydro Flow Barbed Elbow 1/2 in	10	—	\$0.52
747050	Hydro Flow Barbed Tee 1/2 in	10	—	\$0.52
747052	Hydro Flow Barbed Y Connector 1/2 in	10	—	\$1.53
742065	Hydro Flow Barbed Straight 1/2 in to 1/2 in - Display Box	—	250	\$0.26
742070	Hydro Flow Barbed Elbow 1/2 in - Display Box	—	250	\$0.47
742075	Hydro Flow Barbed Tee 1/2 in - Display Box	—	250	\$0.47
742080	Hydro Flow Barbed Y Connector 1/2 in - Display Box	—	100	\$1.33

Hydro Flow Barbed Fittings 3/4 in

These non-corrosive plastic fittings are guaranteed to provide a secure, watertight and airtight connection. These fittings offer strength and durability. Use these high quality barbed 3/4 in connectors for your irrigation or hydroponic systems.



Item No.	Description	Bag Qty	Box Qty	MSRP Ea
747096	Hydro Flow Barbed Connector 3/4 in to 3/4 in	10	—	\$0.58
747098	Hydro Flow Barbed Elbow 3/4 in	10	—	\$0.69
747100	Hydro Flow Barbed Tee 3/4 in	10	—	\$0.69
742085	Hydro Flow Barbed Straight 3/4 in to 3/4 in - Display Box	—	100	\$0.50
742090	Hydro Flow Barbed Elbow 3/4 in - Display Box	—	100	\$0.60
742095	Hydro Flow Barbed Tee 3/4 in - Display Box	—	50	\$0.60

Hydro Flow Barbed Fittings 1 in

These non-corrosive plastic fittings are guaranteed to provide a secure, watertight and airtight connection. These fittings offer strength and durability. Use these high quality barbed 1 in connectors for your irrigation or hydroponic systems.



Item No.	Description	Bag Qty	Box Qty	MSRP Ea
747148	Hydro Flow Barbed Connector 1 in to 1 in	10	—	\$0.71
747150	Hydro Flow Barbed Elbow 1 in	10	—	\$0.85
747152	Hydro Flow Barbed Tee 1 in	10	—	\$0.77
742100	Hydro Flow Barbed Straight 1 in to 1 in - Display Box	—	50	\$0.62
742105	Hydro Flow Barbed Elbow 1 in - Display Box	—	50	\$0.75
742110	Hydro Flow Barbed Tee 1 in - Display Box	—	50	\$0.67

Hydro Flow Barbed Reducer

Use this high quality fitting to go from a 3/4 in hose or tube to a 1/2 in hose.



Item No.	Description	MSRP
708055	Hydro Flow 3/4 in to 1/2 in Barbed Reducer	\$0.99

Hydro Flow Barbed Ball Valves

These non-corrosive plastic fittings are guaranteed to provide a secure, watertight and airtight connection. These fittings offer strength and durability. These Barbed Ball Valves regulate your hydroponic irrigation systems with an easy turn of the knob.



Item No.	Description	Bag Qty	Box Qty	MSRP Ea
747058	Hydro Flow Premium Ball Valve 1/2 in Barb	10	—	\$2.20
747106	Hydro Flow Premium Ball Valve 3/4 in Barb	10	—	\$3.83
742200	Hydro Flow Barbed Ball Valve 1/2 in - Display Box	—	50	\$1.92
742205	Hydro Flow Barbed Ball Valve 3/4 in - Display Box	—	25	\$3.33

Hydro Flow Barbed Straight Reducers

These non-corrosive plastic fittings are guaranteed to provide a secure, watertight and airtight connection. These fittings offer strength and durability. Use these high quality Hydro Flow Reducers for your irrigation or hydroponic systems.



Item No.	Description	Bag Qty	Box Qty	MSRP Ea
747158	Hydro Flow Reducer Fitting 1/4 in to 3/16 in	10	—	\$0.32
747162	Hydro Flow Reducer Fitting 3/8 in to 1/4 in	10	—	\$0.25
747168	Hydro Flow Reducer Fitting 1/2 in to 3/8 in	10	—	\$0.28
747174	Hydro Flow Reducer Fitting 3/4 in to 1/2 in	10	—	\$0.45
742115	Hydro Flow Barbed Reducer 1/4 in to 3/16 in - Display Box	—	500	\$0.23
742120	Hydro Flow Barbed Reducer 3/8 in to 1/4 in - Display Box	—	250	\$0.20
742125	Hydro Flow Barbed Reducer 1/2 in to 3/8 in - Display Box	—	250	\$0.23
742130	Hydro Flow Barbed Reducer 3/4 in to 1/2 in - Display Box	—	100	\$0.40

Did you know Hydro Flow™ products are specifically designed to work in conjunction with each other to create a uniform look and fit. Scan here to get more product information.



Hydro Flow Barbed Elbow Reducers

These non-corrosive plastic fittings are guaranteed to provide a secure, watertight and airtight connection. These fittings offer strength and durability. Use the Hydro Flow Reducer Elbow for your irrigation or hydroponic systems.



Item No.	Description	Bag Qty	Box Qty	MSRP Ea
747160	Hydro Flow Barbed Reducer Elbow 1/4 in to 3/16 in	10	—	\$0.46
747170	Hydro Flow Barbed Reducer Elbow 1/2 in to 3/8 in	10	—	\$0.48
742135	Hydro Flow Barbed Reducer Elbow 1/4 in to 3/16 in - Display Box	—	500	\$0.40
742140	Hydro Flow Barbed Reducer Elbow 1/2 in to 3/8 in - Display Box	—	100	\$0.42

Hydro Flow Push-In Fittings

Hydro Flow Poly Tube Push-In Straight Fitting for both indoor and outdoor drip irrigation. The Push-In Distribution Clamp provides a tight and secure fit to 1/2 in poly tubing. The clamping ability assures that the connection will not leak or be jarred loose in its application.

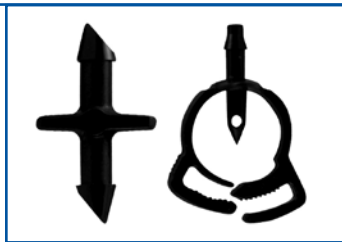

Item No.	Description	Bag Qty	Box Qty	MSRP Ea
747010	Hydro Flow 3/16 in Poly Tube Push-In-Straight Fitting	10	—	\$0.18
747192	Hydro Flow Push-In Distribution Clamp	10	—	\$0.33
742400	Hydro Flow 3/16 in Poly Tube Push-In-Straight Fitting - Display Box	—	250	\$0.11
742405	Hydro Flow Push-In Distribution Clamp - Display Box	—	200	\$0.29

Hydro Flow Barbed Tee Reducers

These non-corrosive plastic fittings are guaranteed to provide a secure, watertight and airtight connection. These fittings offer strength and durability. Use these Reducer Tees for your irrigation and hydroponic systems.



Item No.	Description	Bag Qty	Box Qty	MSRP Ea
747164	Hydro Flow Barbed Reducer Tee 3/8 in to 1/4 in	10	—	\$0.42
747166	Hydro Flow Barbed Reducer Tee 1/2 in to 1/4 in	10	—	\$0.48
747172	Hydro Flow Barbed Reducer Tee 1/2 in to 3/8 in	10	—	\$0.46
747176	Hydro Flow Barbed Reducer Tee 3/4 in to 1/2 in	10	—	\$0.67
742145	Hydro Flow Barbed Reducer Tee 3/8 in to 1/4 in - Display Box	—	250	\$0.35
742150	Hydro Flow Barbed Reducer Tee 1/2 in to 1/4 in - Display Box	—	250	\$0.42
742155	Hydro Flow Barbed Reducer Tee 1/2 in to 3/8 in - Display Box	—	250	\$0.40
742160	Hydro Flow Barbed Reducer Tee 3/4 in to 1/2 in - Display Box	—	100	\$0.58

Hydro Flow (EcoPlus) Barbed Fittings 1/4 in

Use these high quality barbed 1/4 in connectors for your irrigation systems or hydroponic systems. Feature 3 barbs for a tight fit. Bump stop assures fittings are completely and securely inserted in tubing. Made with 100% virgin plastic.



Item No.	Description	Bag Qty	MSRP Ea
708405	Hydro Flow (EcoPlus) Barbed Tee 1/4 in	10	\$0.38
708410	Hydro Flow (EcoPlus) Barbed Straight 1/4 in	10	\$0.24
708415	Hydro Flow (EcoPlus) Barbed Elbow 1/4 in	10	\$0.36

Hydro Flow (EcoPlus) Barbed Fittings & Valves 1/2 in

Use these high quality barbed 1/2 in connectors for your irrigation systems or hydroponic systems. Feature 4 barbs for a tight fit. Bump stop assures fittings are completely and securely inserted in tubing. Made with 100% virgin plastic.



Item No.	Description	Bag Qty	MSRP Ea
708420	Hydro Flow (EcoPlus) Barbed Tee 1/2 in	10	\$0.50
708425	Hydro Flow (EcoPlus) Barbed Straight 1/2 in	10	\$0.46
708430	Hydro Flow (EcoPlus) Barbed Elbow 1/2 in	10	\$0.52
708435	Hydro Flow (EcoPlus) Inline Valve 1/2 in	10	\$3.20

Hydro Flow (EcoPlus) Barbed Fittings & Valves 3/4 in

Use these high quality barbed 3/4 in connectors for your irrigation systems or hydroponic systems. Feature 4 barbs for a tight fit. Bump stop assures fittings are completely and securely inserted in tubing. Made with 100% virgin plastic.



Item No.	Description	Bag Qty	MSRP Ea
708440	Hydro Flow (EcoPlus) Barbed Tee 3/4 in	10	\$1.14
708445	Hydro Flow (EcoPlus) Barbed Straight 3/4 in	10	\$0.96
708450	Hydro Flow (EcoPlus) Barbed Elbow 3/4 in	10	\$1.04
708455	Hydro Flow (EcoPlus) Inline Valve 3/4 in	10	\$3.50

Hydro Flow (EcoPlus) Barbed Fittings 1 in

Use these high quality barbed 1 in connectors for your irrigation systems or hydroponic systems. Feature 4 barbs for a tight fit. Bump stop assures fittings are completely and securely inserted in tubing. Made with 100% virgin plastic.



Item No.	Description	Bag Qty	MSRP Ea
708460	Hydro Flow (EcoPlus) Barbed Tee 1 in	10	\$1.38
708465	Hydro Flow (EcoPlus) Barbed Straight 1 in	10	\$1.18
708470	Hydro Flow (EcoPlus) Barbed Elbow 1 in	10	\$1.30

Hydro Flow GHT x Barbed Adapters

These non-corrosive plastic fittings are guaranteed to provide a secure, watertight and airtight connection. These fittings offer strength and durability. Use these Hydro Flow Adapters with your irrigation and hydroponic systems.



Item No.	Description	Bag Qty	Box Qty	MSRP Ea
747102	Hydro Flow Garden Hose Threaded Adapter 3/4 in	10	—	\$0.50
747054	Hydro Flow 1/2 in FNPT x 1/2 in Barb	10	—	\$1.09
747104	Hydro Flow Garden Hose Cap Assembly 3/4 in	10	—	\$0.75
747056	Hydro Flow 1/2 in GHT x 1/2 in Barb	10	—	\$0.43
747260	Hydro Flow 3/4 in GHT x 1/2 in Barb	10	—	\$0.50
742165	Hydro Flow Garden Hose Threaded Adapter 3/4 in - Display Box	—	100	\$0.37
742170	Hydro Flow 1/2 in FNPT x 1/2 in Barbed - Display Box	—	100	\$0.95
742175	Hydro Flow Garden Hose Cap Assembly 3/4 in - Display Box	—	100	\$0.62
742180	Hydro Flow 1/2 in GHT x 1/2 in Barb - Display Box	—	100	\$0.33
742350	Hydro Flow 3/4 in GHT x 1/2 in Barb - Display Box	—	100	\$0.37

Hydro Flow Garden Hose Adapters

These non-corrosive plastic fittings are guaranteed to provide a secure, watertight and airtight connection. These fittings offer strength and durability. Use these fittings to connect your hose to your irrigation tubing.



Item No.	Description	Bag Qty	Box Qty	MSRP Ea
747022	Hydro Flow Garden Hose Adapter Insert 1/4 in	10	—	\$0.37
747038	Hydro Flow Garden Hose Adapter Insert 3/8 in	10	—	\$0.33
747060	Hydro Flow Garden Hose Adapter Insert 1/2 in	10	—	\$0.36
747108	Hydro Flow Garden Hose Adapter Insert 3/4 in	10	—	\$0.42
747110	Hydro Flow Garden Hose Washer 3/4 in	10	—	\$0.30
747112	Hydro Flow Garden Hose Nut 3/4 in	10	—	\$0.38
742235	Hydro Flow Garden Hose Adapter Insert 1/4 in - Display Box	—	100	\$0.25
742240	Hydro Flow Garden Hose Adapter Insert 3/8 in - Display Box	—	100	\$0.28
742245	Hydro Flow Garden Hose Adapter Insert 1/2 in - Display Box	—	100	\$0.32
742250	Hydro Flow Garden Hose Adapter Insert 3/4 in - Display Box	—	50	\$0.37
742255	Hydro Flow Garden Hose Washer 3/4 in - Display Box	—	500	\$0.21
742260	Hydro Flow Garden Hose Nut 3/4 in - Display Box	—	100	\$0.30

Hydro Flow Tub Outlet Tee Fitting

First of its kind 3/4 inch Tub Outlet Tee fitting. Constructed of high quality impact resistant Food Grade plastic. This fitting uses tapered ends to help guide the hose onto the four barb securing points.



Item No.	Description	Bag Qty	Box Qty	MSRP Ea
747186	Hydro Flow Tub Outlet Tee Fitting w/ 2 Gaskets and Nut	1	—	\$4.79
747188	Hydro Flow Tub Outlet Tee Fitting Replacement Nut	10	—	\$0.67
747190	Hydro Flow Tub Outlet Tee Fitting Replacement Gasket	10	—	\$1.00
742265	Hydro Flow Tub Outlet Tee Fitting 3/4 in - Display Box	—	25	\$4.17
742270	Hydro Flow Tub Outlet Tee Fitting Replacement Nut 3/4 in - Display Box	—	50	\$0.58
742275	Hydro Flow Tub Outlet Tee Fitting Replacement Gasket	—	—	\$0.87

Hydro Flow EZ Pull End Cap

These easy to use caps can make your do-it-yourself gardening projects much easier. The EZ Pull End Caps are made from tough, flexible vinyl. They are easy to push on and pull off, yet provide a secure, leak proof fit.



Item No.	Description	Bag Qty	Box Qty	MSRP Ea
747024	Hydro Flow EZ Pull End Cap 1/4 in	10	—	\$0.30
747044	Hydro Flow EZ Pull End Cap 3/8 in	10	—	\$0.33
747068	Hydro Flow EZ Pull End Cap 1/2 in	10	—	\$0.36
747120	Hydro Flow EZ Pull End Cap 3/4 in	10	—	\$0.45
747156	Hydro Flow EZ Pull End Cap 1 in	10	—	\$0.50
708595	Hydro Flow EZ Pull End Cap 1/4 in - Display Box	—	500	\$0.25
708596	Hydro Flow EZ Pull End Cap 3/8 in - Display Box	—	250	\$0.28
708597	Hydro Flow EZ Pull End Cap 1/2 in - Display Box	—	250	\$0.32
708598	Hydro Flow EZ Pull End Cap 3/4 in - Display Box	—	100	\$0.38
708599	Hydro Flow EZ Pull End Cap 1 in - Display Box	—	50	\$0.43

Hydro Flow Goof Plug Rack

Hydro Flow Goof Plug Rack is perfect for repairing mistake holes or when changing the configuration of poly tubing setups. 10 plugs per rack.



Item No.	Description	Bag Qty	Box Qty	MSRP Ea
747194	Hydro Flow Goof Plug Rack	10	—	\$0.90
742410	Hydro Flow Goof Plug Rack - Display Box	—	50	\$0.52

Want to view this catalog online or download one to your device. Scan now to get your electronic version now!



Hydro Flow Nylon Hose Clamps

Hydro Flow single grip hose clamps provide a superior seal on hose or tubing. As interlocking teeth are pushed together, the sealing diameter closes evenly creating a uniform clamping surface.



Item No.	Description	Bag Qty	Box Qty	MSRP Ea
747040	Hydro Flow Nylon Hose Clamp 3/8 in	10	—	\$0.75
747062	Hydro Flow Nylon Hose Clamp 1/2 in	10	—	\$0.75
747114	Hydro Flow Nylon Hose Clamp 3/4 in	10	—	\$0.92
747154	Hydro Flow Nylon Hose Clamp 1 in	10	—	\$1.11
708002	Hydro Flow Nylon Hose Clamp 3/8 in - Display Box	—	500	\$0.65
708006	Hydro Flow Nylon Hose Clamp 1/2 in - Display Box	—	500	\$0.69
708013	Hydro Flow Nylon Hose Clamp 3/4 in - Display Box	—	250	\$0.89
708017	Hydro Flow Nylon Hose Clamp 1 in - Display Box	—	250	\$0.99

Hydro Flow Flow Rate Adjusting Clamps

Single grip hose flow adjusting clamps provide a superior seal on hose or tubing. As interlocking teeth are pushed together, the sealing diameter closes evenly creating a uniform clamping surface. Large for 1/2 in tubing. Small for 1/4 in tubing.



Item No.	Description	Bag Qty	Box Qty	MSRP Ea
747180	Hydro Flow Flow Rate Adjusting Clamp Large	10	—	\$1.53
747182	Hydro Flow Flow Rate Adjusting Clamp Small	10	—	\$0.48
742215	Hydro Flow Flow Rate Adjusting Clamp Large - Display Box	—	50	\$1.33
742220	Hydro Flow Flow Rate Adjusting Clamp Small - Display Box	—	100	\$0.38

Hydro Flow Butterfly Hose Clamps

Hydro Flow Butterfly Hose Clamps make securing your hose over a fitting a breeze. Made from quality stainless steel, this hose clamps uses a butterfly style tightening tab. No screwdriver or tightening tool required. Just turn the tab to desired fit and rest assured the clamp won't stretch or slide off.



Item No.	Description	Bag Qty	Box Qty	MSRP Ea
747292	Hydro Flow Butterfly Hose Clamps 3/8 in 10/Bag	10	—	\$0.72
747294	Hydro Flow Butterfly Hose Clamps 1/2 in 10/Bag	10	—	\$0.73
747296	Hydro Flow Butterfly Hose Clamps 3/4 in 10/Bag	10	—	\$0.77
747298	Hydro Flow Butterfly Hose Clamps 1 in 10/Bag	10	—	\$0.80
742732	Hydro Flow Butterfly Hose Clamps 3/8 in Bulk - Display Box	—	100	\$0.65
742734	Hydro Flow Butterfly Hose Clamps 1/2 in Bulk - Display Box	—	100	\$0.67
742736	Hydro Flow Butterfly Hose Clamps 3/4 in Bulk - Display Box	—	100	\$0.70
742738	Hydro Flow Butterfly Hose Clamps 1 in Bulk - Display Box	—	100	\$0.73

Hydro Flow Adjustable Drip Stakes with Cleanout

Flow can be adjusted depending on the nature of use, also drip emitter can be turned off when not in use. Drip Emitters are two pieces and separate for easy cleanout.



Item No.	Description	Bag Qty	Box Qty	MSRP Ea
747196	Hydro Flow Adjustable In-Line Drip Stake w/ Cleanout 0 - 1.6 GPH	10	—	\$0.69
747198	Hydro Flow Adjustable End-Line Drip Stake w/ Cleanout 0 - 1.6 GPH	10	—	\$0.63
742415	Hydro Flow Adjustable In-Line Drip Stake w/ Cleanout- 0-1.6 GPH - Display Box	—	100	\$0.60
742420	Hydro Flow Adjustable End-Line Drip Stake w/ Cleanout- 0-1.6 GPH - Display Box	—	100	\$0.53

Hydro Flow Multi-Stream Push-In Drippers

Hydro Flow Multi-Stream Push-In Drippers allows for adjustment of flow rate and diameter of throw. Easy to regulate, increase or decrease the flow or simply turn off.



Item No.	Description	Bag Qty	Box Qty	MSRP Ea
747200	Hydro Flow 360 Degree 8 Stream Push-In Dripper	10	—	\$0.38
747202	Hydro Flow 180 Degree 5 Stream Push-In Dripper	10	—	\$0.38
742425	Hydro Flow 360 Degree 8 Stream Push-In Dripper - Display Box	—	150	\$0.33
742430	Hydro Flow 180 Degree 5 Stream Push-In Dripper - Display Box	—	150	\$0.33

Hydro Flow Distribution Manifold 6 Outlet

Hydro Flow 6 Outlet Distribution Manifold provides flexibility by distributing water to up to six sites. 2 in Poly Nipple is used for the body of the manifold. Simply push in flags to turn off desired outlets.



Item No.	Description	Bag Qty	Box Qty	MSRP Ea
747204	Hydro Flow 6 Outlet Distributor Manifold	1	—	\$4.79
742435	Hydro Flow 6 Outlet Distribution Manifold - Display Box	—	25	\$4.35

Hydro Flow In-Line Micro Irrigation Valve

Hydro Flow Micro Irrigation Valve provides options for flow rate in your drip application. Fits snugly to Hydro Flow 3/16 in tubing.



Item No.	Description	Bag Qty	Box Qty	MSRP Ea
747012	Hydro Flow In-Line Micro Irrigation Valve 3/16 in	10	—	\$0.83
742440	Hydro Flow In-Line Micro Irrigation Valve 3/16 in - Display Box	—	150	\$0.72

Hydro Flow Reservoir Shut Off Valve Kit

Hydro Flow Shut Off Valve Kit is a simple fix when you need to transport fluid from a reservoir or storage container. Simply drill a hole in your container, insert bulk head fitting, tighten the bulk head nut on the inside of your container and you are ready to distribute fluid where you need it. Another simple solution exclusively from Hydro Flow.



Item No.	Description	Bag Qty	MSRP Ea
742840	Hydro Flow Reservoir Shut Off Valve Kit	10	\$8.95

Hydro Flow Shut Off Valves

Shut Off Valves allows for connection of a 3/4 in male and 3/4 in female hose thread. 3/4 in Shut Off Valve with the swivel feature on the female end for easy install or removal. Both use a leak free ball valve to shut off flow.



Item No.	Description	Bag Qty	Box Qty	MSRP Ea
747122	Hydro Flow 3/4 in Shut Off Valve MHT x FHT	1	—	\$2.09
747124	Hydro Flow 3/4 in Shut Off Valve MHT x FHT w/ Swivel	1	—	\$2.51
742445	Hydro Flow 3/4 in Shut Off Valve MHT x FHT - Display Box	—	25	\$1.82
742450	Hydro Flow 3/4 in Shut Off Valve MHT x FHT w/ Swivel - Display Box	—	25	\$2.18

Hydro Flow Dual Shut Off Garden Hose Y

The Garden Hose Y not only splits the flow but it comes with two shut off switches to allows the user to utilize both sides or one depending on need.



Item No.	Description	Bag Qty	Box Qty	MSRP Ea
747206	Hydro Flow Garden Hose Y w/ Dual Shut Off	1	—	\$2.88
742455	Hydro Flow Garden Hose Y w/ Dual Shut Off - Display Box	—	25	\$2.50

Hydro Flow Figure-Eight Poly Tube Clinchers

Hydro Flow Figure-Eight Poly Tube Clincher is an easy and effective way to block off the end of the line. Simply run one end of the poly tubing through one side, bend back and then run back through the other side.



Item No.	Description	Bag Qty	Box Qty	MSRP Ea
747076	Hydro Flow 1/2 in Figure-Eight Poly Tube Clincher	10	—	\$0.42
747128	Hydro Flow 3/4 in Figure-Eight Poly Tube Clincher	10	—	\$0.58
742485	Hydro Flow 1/2 in Figure-Eight Poly Tube Clincher - Display Box	—	100	\$0.27
742490	Hydro Flow 3/4 in Figure-Eight Poly Tube Clincher - Display Box	—	50	\$0.44

Hydro Flow Tube Supports

Tube Clamps use a U shaped plastic clamp supported by an anchor nail to secure tubing where you want it. Support Hooks are a great way to mount tubing to buckets or trays by installing the narrow side of the hook. The tube will rest in the larger hook.



Item No.	Description	Bag Qty	Box Qty	MSRP Ea
747026	Hydro Flow Tube Support Clamp 1/4 in	10	—	\$0.20
747070	Hydro Flow Tube Support Clamp 1/2 in	10	—	\$0.38
747072	Hydro Flow Hose Support Hook 1/2 in	10	—	\$0.35
747126	Hydro Flow Hose Support Hook 3/4 in	10	—	\$0.43
742465	Hydro Flow Tube Support Clamp 1/4 in - Display Box	—	150	\$0.16
742470	Hydro Flow Hose Support Clamp 1/2 in - Display Box	—	150	\$0.26
742475	Hydro Flow Hose Support Hook- 1/2 in - Display Box	—	150	\$0.27
742480	Hydro Flow Hose Support Hook- 3/4 in - Display Box	—	100	\$0.33

Hydro Flow Holding Stake

Hydro Flow 6 in holding stake works great for securing tubing between 1/8 in-1/4 in.



Item No.	Description	Bag Qty	Box Qty	MSRP Ea
747212	Hydro Flow 6 in Holding Stake	10	—	\$0.43
742505	Hydro Flow 6 in Holding Stake - Display Box	—	100	\$0.32

Hydro Flow Mini Flow Spray Stakes

The 160 degree stake sprayers are great for irrigating containers indoors or outdoors. Side tab indicates spray direction. Recommended operating pressure is 10 - 20 PSI. At 20 PSI, you will get approximately 5 gph for #742495 and 7 gph for #742500.



Item No.	Description	Bag Qty	Box Qty	MSRP Ea
747208	Hydro Flow 160 Degree Mini Flow Spray Stake- Orange	10	—	\$0.40
747210	Hydro Flow 160 Degree Low Flow Spray Stake- Green	10	—	\$0.40
742495	Hydro Flow 160 Degree Mini Flow Spray Stake- Orange - Display Box	—	100	\$0.29
742500	Hydro Flow 160 Degree Low Flow Spray Stake- Green - Display Box	—	100	\$0.29

Hydro Flow Drip Ring

Pre-built ring uses four one gallon per hour cleanable emitters. The ring is constructed with 1/2 inch poly tubing. Emitters are evenly spaced to water 360 degrees around the plant. The intake fitting is a 1/2 inch barbed fitting. Ring is 10 inches in diameter.



Item No.	Description	MSRP
748420	Hydro Flow Drip Ring	\$7.49

Hydro Flow Mini-Bubblers

The Mini-Bubbler works perfectly for large plants or near groups of plants. Half-Circle Mini-Bubbler works perfectly for large plants or near groups of plants. Both have adjustable spray with a 0-3 ft diameter at 20 PSI.



Item No.	Description	Bag Qty	Box Qty	MSRP Ea
747214	Hydro Flow Mini-Bubbler w/ 6 in Stake Barbed Inlet	10	—	\$0.81
747216	Hydro Flow Half Circle Mini-Bubbler w/ 6 in Stake Barbed Inlet	10	—	\$0.81
742510	Hydro Flow Mini-Bubbler w/ 6 in Stake Barbed Inlet - Display Box	—	100	\$0.70
742515	Hydro Flow Half Circle Mini-Bubbler w/ 6 in Stake Barbed Inlet - Display Box	—	100	\$0.70

Hydro Flow In-Line and Push-In Flag Emitters

Hydro Flow Flag Emitters allow water to flow smoothly at the designed GPH. The flags are removable and separate easily to allow for cleaning. Works with Hydro Flow 3/16 in ID Poly Tubing.

**CLEANABLE
REUSABLE**



Item No.	Description	Bag Qty	Box Qty	MSRP Ea
747224	Hydro Flow In-Line Flag Emitter Gray 0.5 GPH	10	—	\$0.46
747226	Hydro Flow In-Line Flag Emitter Black 1 GPH	10	—	\$0.46
747228	Hydro Flow In-Line Flag Emitter Blue 2 GPH	10	—	\$0.46
747230	Hydro Flow Push-In Flag Emitter Gray 0.5 GPH	10	—	\$0.30
747232	Hydro Flow Push-In Flag Emitter Black 1 GPH	10	—	\$0.30
747234	Hydro Flow Push-In Flag Emitter Blue 2 GPH	10	—	\$0.30
747236	Hydro Flow Push-In Flag Emitter Red 3 GPH	10	—	\$0.30
742535	Hydro Flow In-Line Flag Emitter Gray 0.5 GPH - Display Box	—	150	\$0.38
742540	Hydro Flow In-Line Flag Emitter Black 1 GPH - Display Box	—	150	\$0.38
742545	Hydro Flow In-Line Flag Emitter Blue 2 GPH - Display Box	—	150	\$0.38
742550	Hydro Flow Push-In Flag Emitter Gray 0.5 GPH - Display Box	—	150	\$0.24
742555	Hydro Flow Push-In Flag Emitter Black 1 GPH - Display Box	—	150	\$0.24
742560	Hydro Flow Push-In Flag Emitter Blue 2 GPH - Display Box	—	150	\$0.24
742565	Hydro Flow Push-In Flag Emitter Red 3 GPH - Display Box	—	150	\$0.24

Hydro Flow Push In Regulated Button Emitters

Hydro Flow Push In Regulated Button Emitters can be directly inserted into 1/2 in poly tubing or connected via Hydro Flow 3/16 in ID Poly tubing. Emitter has a removable top for cleaning.

**CLEANABLE
REUSABLE**



Item No.	Description	Bag Qty	Box Qty	MSRP Ea
747218	Hydro Flow Regulated Push-In Button Emitter Yellow 0.5 GPH	10	—	\$0.43
747220	Hydro Flow Regulated Push-In Button Emitter Black 1 GPH	10	—	\$0.43
747222	Hydro Flow Regulated Push-In Button Emitter Blue 2 GPH	10	—	\$0.43
742520	Hydro Flow Regulated Push-In Button Emitter Yellow 0.5 GPH - Display Box	—	100	\$0.33
742525	Hydro Flow Regulated Push-In Button Emitter Black 1 GPH - Display Box	—	100	\$0.33
742530	Hydro Flow Regulated Push-In Button Emitter Blue 2 GPH - Display Box	—	100	\$0.33

Hydro Flow Single Piece Spray Heads

Hydro Flow Single Piece Spray Heads spray with a flat trajectory. 742570 has a 90 degree spray pattern, 742575 has a 180 degree spray pattern and 742580 has a 360 degree spray pattern.



Item No.	Description	Bag Qty	Box Qty	MSRP Ea
747238	Hydro Flow Single Piece Spray Heads 90 Degree Red/Orange	10	—	\$0.28
747240	Hydro Flow Single Piece Spray Heads 180 Degree Black	10	—	\$0.28
747242	Hydro Flow Single Piece Spray Heads 360 Degree Green	10	—	\$0.28
742570	Hydro Flow Single Piece Spray Heads 90 Degree Red/Orange - Display Box	—	250	\$0.22
742575	Hydro Flow Single Piece Spray Heads 180 Degree Black - Display Box	—	250	\$0.22
742580	Hydro Flow Single Piece Spray Heads 360 Degree Green - Display Box	—	250	\$0.22

Hydro Flow Fitting - 1/2 in Compression x 1/2 in FPT

Hydro Flow 1/2 in Compression Tee by 1/2 in FPT works as the base for the 2 in poly nipple and six outlet distribution manifold.



Item No.	Description	Bag Qty	Box Qty	MSRP Ea
747094	Hydro Flow 1/2 in Compression Tee x 1/2 in FPT	10	—	\$1.25
742700	Hydro Flow 1/2 in Compression Tee x 1/2 in FPT - Display Box	—	25	\$1.09

Hydro Flow Compression Swivel Fittings

Hydro Flow 1/2 in Compression Swivel Adapter with 3/4 in FHT allows for a secure fit to a garden hose end or spigot, supplying water to your 1/2 in poly tube.



Item No.	Description	Bag Qty	Box Qty	MSRP Ea
747086	Hydro Flow 1/2 in Compression x 3/4 in FHT Swivel Adapter	10	—	\$1.18
747088	Hydro Flow 1/2 in Compression x 3/4 in FHT Swivel Elbow	10	—	\$1.32
747090	Hydro Flow 1/2 in Compression x 3/4 in FHT Swivel Tee	10	—	\$1.32
742605	Hydro Flow 1/2 in Compression x 3/4 in FHT Swivel Adapter - Display Box	—	25	\$1.01
742610	Hydro Flow 1/2 in Compression x 3/4 in FHT Swivel Elbow - Display Box	—	25	\$1.15
742615	Hydro Flow 1/2 in Compression x 3/4 in FHT Swivel Tee - Display Box	—	25	\$1.16

Hydro Flow Compression Fittings 1/2 in

Hydro Flow 1/2 in Compression Fittings allows for a tight fit to 1/2 in poly tubing, perfect for outdoor or indoor applications.



Item No.	Description	Bag Qty	Box Qty	MSRP Ea
747078	Hydro Flow 1/2 in Compression Coupler	10	—	\$0.99
747080	Hydro Flow 1/2 in Compression Elbow	10	—	\$1.13
747082	Hydro Flow 1/2 in Compression Tee	10	—	\$1.21
747084	Hydro Flow 1/2 in Compression End Cap	10	—	\$1.13
747074	Hydro Flow 1/2 in Compression Shut Off Valve	10	—	\$2.30
742585	Hydro Flow 1/2 in Compression Coupler - Display Box	—	25	\$0.85
742590	Hydro Flow 1/2 in Compression Elbow - Display Box	—	25	\$0.98
742595	Hydro Flow 1/2 in Compression Tee - Display Box	—	25	\$1.05
742600	Hydro Flow 1/2 in Compression End Cap - Display Box	—	25	\$0.98
742460	Hydro Flow 1/2 in Compression Shut Off Valve - Display Box	—	25	\$2.00

Hydro Flow Poly Nipple

Hydro Flow 1/2 in x 2 in Poly nipple works in conjunction with the six outlet distribution manifold or can simply be used as a riser.



Item No.	Description	Bag Qty	Box Qty	MSRP Ea
747092	Hydro Flow 1/2 in NPT x 2 in Poly Nipple	10	—	\$0.52
742695	Hydro Flow 1/2 in NPT x 2 in Poly Nipple - Display Box	—	25	\$0.45

Hydro Flow 25 PSI Pressure Regulator

Hydro Flow 25 PSI Pressure Reducer is connected directly to a garden hose spigot or faucet to regulate down water line pressure to 25 PSI.



Item No.	Description	Bag Qty	Box Qty	MSRP Ea
747130	Hydro Flow 25 PSI Pressure Regulator 3/4 in FHT x 3/4 in MHT	1	—	\$5.94
742650	Hydro Flow 25 PSI Pressure Regulator 3/4 in FHT x 3/4 in MHT - Display Box	—	25	\$5.16

Hydro Flow Backflow Preventor

Hydro Flow Backflow Preventor is installed at the beginning of the irrigation line creating a siphon break which prevents water from continuing to siphon when the pump is turned off.



Item No.	Description	Bag Qty	Box Qty	MSRP Ea
747132	Hydro Flow Backflow Preventor 3/4 in FHT x 3/4 in MHT	1	—	\$3.53
742655	Hydro Flow Backflow Preventor 3/4 in FHT x 3/4 in MHT - Display Box	—	25	\$3.06

Hydro Flow Fittings with 150 Mesh Screens

These Hydro Flow fittings with 150 Mesh Screen removes particles from water, preventing clogged lines and providing a debris free watering source. Choose from the four types to meet your needs.



Item No.	Description	Bag Qty	Box Qty	MSRP Ea
747134	Hydro Flow 3/4 in Male NPT w/ 150 Mesh Screen	1	—	\$14.01
747136	Hydro Flow 3/4 in Female NHT Swivel w/ 150 Mesh	1	—	\$14.26
747140	Hydro Flow 3/4 in FHT x 3/4 in MHT In-Line Filter w/ Screen	1	—	\$6.56
747142	Hydro Flow 3/4 in FHT Swivel Tee w/ Polyester Screen	1	—	\$6.56
742660	Hydro Flow 3/4 in Male NPT w/ 150 Mesh Screen - Display Box	—	25	\$12.19
742665	Hydro Flow 3/4 in Female NHT Swivel w/ 150 Mesh Screen - Display Box	—	25	\$12.39
742675	Hydro Flow 3/4 in FHT x 3/4 in MHT In-Line Filter w/ Screen - Display Box	—	25	\$5.70
742680	Hydro Flow 3/4 in FHT Swivel Tee w/ Polyester Screen - Display Box	—	25	\$5.70

Hydro Flow Poly Replacement Screens

Hydro Flow 150 Mesh Filter Replacement Screen for 3/4 in Tee Filter, In-Line Filter and Y Filter.

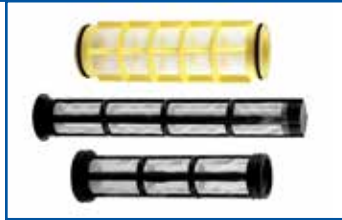

Item No.	Description	Bag Qty	Box Qty	MSRP Ea
747138	Hydro Flow Poly Y Filter Replacement Screen (150 Mesh)	1	—	\$4.85
747144	Hydro Flow Poly Replacement Screen 150 Mesh for In-Line Filter	1	—	\$4.39
747146	Hydro Flow Poly Replacement Screen 150 Mesh for 3/4 in Tee Filter	1	—	\$4.70
742670	Hydro Flow Polyester Y Filter Replacement Screen 150 mesh - Display Box	—	25	\$4.21
742685	Hydro Flow Poly Replacement Screen 150 mesh for In Line Filter - Display Box	—	25	\$3.81
742690	Hydro Flow Poly Replacement Screen 150 mesh for 3/4 in tee Filter - Display Box	—	25	\$4.08

Hydro Flow 3/4 in Filter Washer

Hydro Flow garden hose filter washer has a stainless steel 30 x 30 mesh screen to prevent particles from passing. Fits any female garden hose or garden hose fitting.



Item No.	Description	Bag Qty	Box Qty	MSRP Ea
747252	Hydro Flow 3/4 in Filter Washer 30 x 30 Mesh w/ PVC Gasket	10	—	\$0.43
747275	Hydro Flow 3/4 in Filter Washer 30 x 30 Mesh w/ PVC Gasket - Display Box	—	150	\$0.27

Hydro Flow Uniseals

Hydro Flow Uniseal is ideal for creating a secure seal in seconds for your reservoir or hydroponic system using PVC hard pipe or fittings.



Item No.	Description	Bag Qty	Box Qty	MSRP Ea
747276	Hydro Flow 1/4 in Uniseal New!	10	—	\$1.05
747278	Hydro Flow 3/8 in Uniseal New!	10	—	\$1.49
747280	Hydro Flow 1/2 in Uniseal New!	10	—	\$1.85
747282	Hydro Flow 3/4 in Uniseal New!	1	—	\$2.25
747244	Hydro Flow 1 in Uniseal	1	—	\$2.47
747246	Hydro Flow 1-1/2 in Uniseal	1	—	\$3.09
747284	Hydro Flow 2 in Uniseal New!	1	—	\$4.99
747248	Hydro Flow 3 in Uniseal	1	—	\$6.52
747250	Hydro Flow 4 in Uniseal	1	—	\$7.94
742705	Hydro Flow 1 in Uniseal - Display Box	—	25	\$2.15
742710	Hydro Flow 1-1/2 in Uniseal - Display Box	—	25	\$2.68
742715	Hydro Flow 3 in Uniseal - Display Box	—	10	\$5.67
742720	Hydro Flow 4 in Uniseal - Display Box	—	10	\$6.91

Hydro Flow Bulkhead Fittings

Designed to create a water tight seal when transferring liquid from or to a storage container/reservoir. These fittings are made from durable ABS Plastic and come with double gaskets for a secure seal as well as double female threads to incorporate fittings or filters into the bulk head. Manufactured in the U.S.A.



Item No.	Description	Bag Qty	Box Qty	MSRP Ea
747266	Hydro Flow Bulkhead Thread/Thread 1/2 in Hole Size 1-1/8 in	1	—	\$5.65
747268	Hydro Flow Bulkhead Thread/Thread 3/4 in Hole Size 1-1/2 in	1	—	\$6.48
742825	Hydro Flow Bulkhead Thread/Thread 1/2 in Hole Size 1-1/8 in - Display Box	—	25	\$4.99
742830	Hydro Flow Bulkhead Thread/Thread 3/4 in Hole Size 1-1/2 in - Display Box	—	25	\$5.59

Hydro Flow Bottom Draw Pump Adaptors

The Hydro Flow 90 Degree Bottom Draw Adaptors allow the user to draw water down close to the bottom of your hydroponic system or reservoir while using a standard submersible pump. The 1/2 in NPT diameter adaptor is compatible with EcoPlus 264 and 396 pumps. The 1 in NPT diameter adaptor is compatible with EcoPlus 633, 1056 and 1267 pumps.



Item No.	Description	MSRP
747270	Hydro Flow Bottom Draw Pump Adapter 1/2 in	\$1.42
747272	Hydro Flow Bottom Draw Pump Adapter 1 in	\$2.76

Hydro Flow Adaptors GHT x NPT

These Garden Hose Thread to National Pipe Thread adaptors are commonly used to attach, couple or extend your garden hose to pumps or other gardening accessories.



Item No.	Description	Bag Qty	Box Qty	MSRP Ea
747262	Hydro Flow Adaptor 3/4 in GHT x 1/2 in NPT	10	—	\$0.47
747264	Hydro Flow Adaptor 3/4 in GHT x 3/4 in NPT	10	—	\$0.48
742835	Hydro Flow Adaptor 3/4 in GHT x 1/2 in NPT - Display Box	—	100	\$0.40
742838	Hydro Flow Adaptor 3/4 in GHT x 3/4 in NPT - Display Box	—	100	\$0.42

Hydro Flow Punch Tool for Brass Tubing Insert

This specially designed punch tool allows you to place the brass insert directly on the punch tool and apply to the tubing in one clean motion. The brass insert receives .200 O.D. x .135 I.D. tubing to create a secure seal.



Item No.	Description	MSRP
747302	Hydro Flow Punch Tool for Brass Tubing Insert	\$14.95

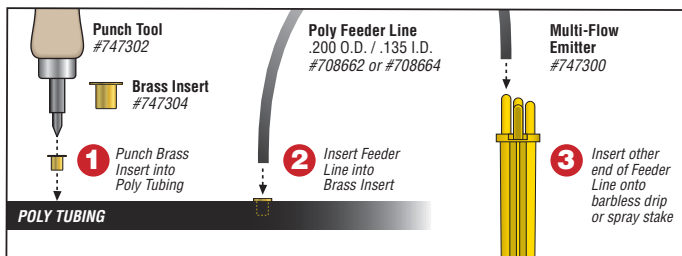

Hydro Flow Brass Tubing Insert

The brass insert replaces the need for push in fittings. Use the specialized punch tool to apply the brass insert into your poly tubing. The brass insert creates a sealed base to receive .200 O.D. x .135 I.D. tubing into the center of the brass ring for a simple and secure seal.



Item No.	Description	Bag Qty	MSRP Ea
747304	Hydro Flow Brass Tubing Insert	10	\$0.59

Hydro Flow Multi-Flow Emitter

This unique multi-position emitter stake distributes solutions using a broad fan-shaped spray. Multi-positions allows for low, medium and high spray volumes by simply changing the tubing position from one post to another. It also has a stopper post to plug. Uses .200 O.D. x .135 I.D. tubing.



Item No.	Description	Bag Qty	MSRP Ea
747300	Hydro Flow Multi-Flow Emitter	10	\$0.69

Hydro Flow 3 ft x 3 ft & 4 ft x 4 ft Drip Kit

This Hydro Flow Drip Kit is designed to simplify your irrigation set up on 3 ft x 3 ft and 4 ft x 4 ft grow tables. From reservoir to plant, this kit provides all the irrigation components required to set your garden. Hydro Flow Drip Kits are compatible with all 3 ft x 3 ft and 4 ft x 4 ft grow trays. Trays purchased separately. Kit includes pump, timer, plumbing and hardware for 12 sites.



Item No.	Description	MSRP
742800	Hydro Flow 3 x 3 & 4 x 4 Drip Kit	\$102.95

Hydro Flow 4 ft x 8 ft Drip Kit

This Hydro Flow Drip Kit is designed to simplify your irrigation set up on 4 ft x 8 ft grow tables. From reservoir to plant, this kit provides all the irrigation components required to set your garden. Hydro Flow Drip Kits are compatible with all 4 ft x 8 ft grow trays. Trays purchased separately. Kit includes plumbing and hardware for 24 sites.



Item No.	Description	MSRP
742805	Hydro Flow 4 x 8 Drip Kit	\$111.95

Hydro Flow 3 ft x 3 ft & 4 ft x 4 ft Flood and Drain Kit

This Hydro Flow Flood and Drain Kit are designed to simplify your irrigation set up on 3 ft x 3 ft and 4 ft x 4 ft flood tables. From reservoir to plant, this kit provides all the irrigation components required to set up your flood and drain tray. Trays sold separately.



Item No.	Description	MSRP
742810	Hydro Flow 3 x 3 & 4 x 4 Flood and Drain Kit	\$59.95

HydroFlow™ Example set up of Hydro Flow Kits

Complete Irrigation Kits are used in typical setups shown below (included kit parts are shown in **BLUE**).

Drip Kit

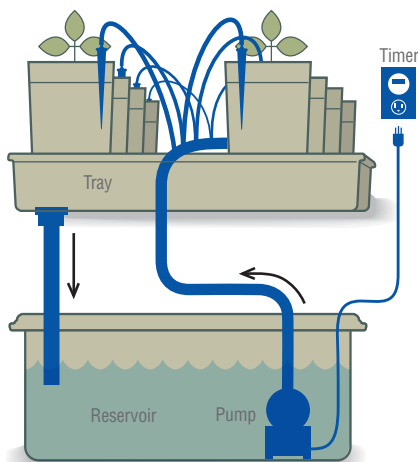

Flood & Drain Kit

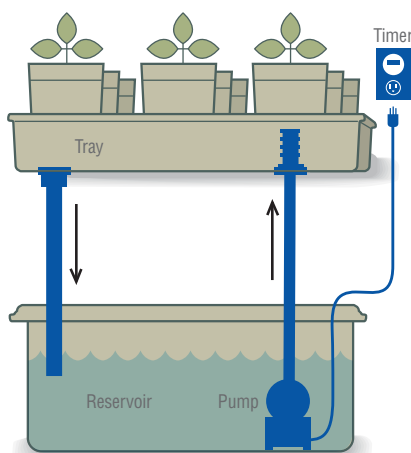

Fill & Drain Kit

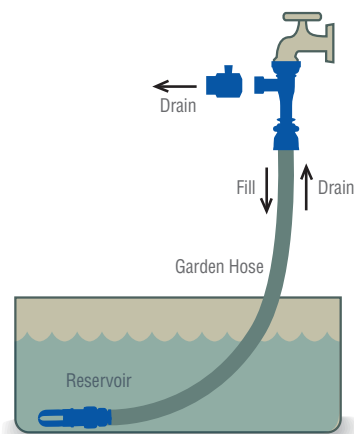

Hydro Flow 4 ft x 8 ft Flood and Drain Kit

This Hydro Flow Flood and Drain Kit are designed to simplify your irrigation set up on 4 ft x 8 ft flood tables. From reservoir to plant, this kit provides all the irrigation components required to set up your flood and drain tray. Trays sold separately.



Item No.	Description	MSRP
742815	Hydro Flow 4 x 8 Flood and Drain Kit	\$79.95

Hose Punch

Tough enough to punch a hole in thick, flexible tubing. Makes a 1/8 in hole specifically for drip lines.



Item No.	Description	MSRP
708180	Hose Punch 1/8 in	\$1.50

Raindrip 1/2 GPH Drippers

Raindrip's turbulent flow PC (pressure compensating) drippers maintain their rated flow rate for 10-60 psi inlet pressure. These drippers can be used at the end of 1/4 in tubing feeders or can be inserted directly into 1/2 in Raindrip hose.



Item No.	Description	MSRP Ea
708625	Raindrip 1/2 GPH Dripper Blister Card 10/Pack	\$0.80
708626	Raindrip 1/2 GPH Dripper Bag	\$0.52

Raindrip 1 GPH Drippers

Raindrip's turbulent flow PC (pressure compensating) drippers maintain their rated flow rate for 10-60 psi inlet pressure. These drippers can be used at the end of 1/4 in tubing feeders or can be inserted directly into 1/2 in Raindrip hose.



Item No.	Description	MSRP Ea
708630	Raindrip 1 GPH Dripper Blister Card 10/Pack	\$0.80
708631	Raindrip 1 GPH Dripper Bag	\$0.52

Raindrip 2 GPH Drippers

Raindrip's turbulent flow PC (pressure compensating) drippers maintain their rated flow rate for 10-60 psi inlet pressure. These drippers can be used at the end of 1/4 in tubing feeders or can be inserted directly into 1/2 in Raindrip hose.



Item No.	Description	MSRP Ea
708635	Raindrip 2 GPH Dripper Blister Card 10/Pack	\$0.80
708636	Raindrip 2 GPH Dripper Bag	\$0.52

Raindrip Hole Punches

Both the hole punch and professional hole punch are designed for comfortable use. They punch holes in 1/2 in, 5/8 in or 0.710 in hose to insert PC drippers or 1/4 in fittings. The black hole punch includes 10 hole plugs.



Item No.	Description	MSRP
708670	Raindrip Hole Punch Black	\$3.75
708675	Raindrip Professional Hole Punch	\$11.42

Raindrip 3 Outlet Manifold Triple Shut-Off

Converts one faucet to three separately controllable outlets. 3/4 in female hose thread inlet x 3/4 in male hose threaded outlets.



Item No.	Description	MSRP
708695	Raindrip 3 Outlet Manifold Triple Shut-Off	\$2.77

Raindrip Stakes

4 in support stakes are plastic stakes that hold 1/4 in tubing in place next to plants. 6 in support stakes are heavy duty plastic stakes that hold 1/4 in lines in place.



Item No.	Description	MSRP Ea
708640	Raindrip 4 in Support Stakes Blister Card 10/Pack	\$0.25
708645	Raindrip 6 in Support Stakes Blister Card 10/Pack	\$0.35

Raindrip Professional Tubing Cutter

The professional tubing cutter has a hardened stainless steel blade that is designed to cut all flexible plastic hose/tubing up to 1.5 in outside diameter.



Item No.	Description	MSRP
708665	Raindrip Professional Tubing Cutter	\$11.95

Hydro Flow Punch N' Cut

This lightweight all-purpose tool works as an insert, cut and hole punch tool. Can cut up to 1 inch tubing. The blade is 440° C Stainless steel and the cutter has a 4 oz polycarbonate body.



Item No.	Description	Box Qty	MSRP Ea
747178	Hydro Flow Punch N'Cut Multi-Tool	—	\$16.49
742210	Hydro Flow Punch N'Cut Multi-Tool - Display Box	10	\$14.95

Hydro Flow Poly Tubing

Professional quality food grade LDPE (Low Density Polyethylene) material. Carbon black pigment, provides an opaque tubing wall, blocking light from penetrating irrigation water. UV inhibitor protects tubing from direct sunlight. This durable tubing can be buried or used on the surface for year round water distribution. Made in the U.S.A.



Item No.	Description	MSRP
708655	Hydro Flow Poly Tubing 3/16 in ID x 1/4 in OD 50 ft Roll	\$5.69
708657	Hydro Flow Poly Tubing 3/16 in ID x 1/4 in OD 1000 ft Roll	\$63.99
708660	Hydro Flow Poly Tubing 1/2 in ID x 5/8 in OD 50 ft Roll	\$12.39
742280	Hydro Flow Poly Tubing 1/16 in ID x 1/8 in OD 50 ft Roll	\$4.19

Hydro Flow Poly Tubing for Drip Stakes

This poly tubing is designed for water or nutrient solution distribution, on drip stakes that do not have barbs on the receiving posts of the stake. Also works in conjunction with the Hydro Flow Brass Tubing Insert. Sold by the roll only.



Item No.	Description	MSRP
708662	Hydro Flow Poly Tubing .200 OD x .135 ID 50 ft	\$4.95
708664	Hydro Flow Poly Tubing .200 OD x .135 ID 1000 ft	\$82.95

Hydro Flow PVC Flex Tubing

Hydro Flow Flex PVC is a food safe compound that allows the tube to be non-rigid. The flexibility allows this tube to be easily applied to standard barbed drip stakes and push in fittings. It is soft to the touch, yet can make aggressive turns without kinking. Does not contain rubber. Sold by the roll only.



Item No.	Description	MSRP
708210	Hydro Flow Flex PVC Tubing .240 OD x .160 ID 50 ft	\$5.95
708212	Hydro Flow Flex PVC Tubing .240 OD x .160 ID 1000 ft	\$94.95

Hydro Flow Premium Vinyl Tubing - Blue

Food grade, excellent quality tubing. Made with FDA approved materials. Made in the USA.



Item No.	Description	MSRP
708260	Hydro Flow Vinyl Tubing Blue 1/2 in ID - 5/8 in OD 100 ft Roll	\$31.95

Hydro Flow Premium Vinyl Tubing - White

Food grade, excellent quality tubing. Made with FDA approved materials. Made in the USA.



Item No.	Description	MSRP
708230	Hydro Flow Vinyl Tubing White 1/2 in ID - 5/8 in OD 100 ft Roll	\$49.95
708250	Hydro Flow Vinyl Tubing White 3/4 in ID - 1 in OD 100 ft Roll	\$111.95

Hydro Flow Premium Vinyl Tubing - Clear

Food grade, excellent quality tubing. Made with FDA approved materials. Made in the USA.



Item No.	Description	MSRP
708215	Hydro Flow Vinyl Tubing Clear 3/16 in ID - 1/4 in OD 100 ft Roll	\$11.95
708222	Hydro Flow Vinyl Tubing Clear 1/4 in ID - 3/8 in OD 100 ft Roll	\$25.95
708227	Hydro Flow Vinyl Tubing Clear 3/8 in ID x 1/2 in OD 100 ft New	\$27.95

Hydro Flow Premium Vinyl Tubing - Black

Food grade, excellent quality tubing. Made with FDA approved materials. Made in the USA.



Item No.	Description	MSRP
708214	Hydro Flow Vinyl Tubing Black 1/8 in ID - 1/4 in OD 100 ft Roll	\$14.95
708220	Hydro Flow Vinyl Tubing Black 3/16 in ID - 1/4 in OD 100 ft Roll	\$16.95
708221	Hydro Flow Vinyl Tubing Black 1/4 in ID - 3/8 in OD 100 ft Roll	\$25.95
708223	Hydro Flow Vinyl Tubing Black 3/8 in ID - 1/2 in OD 100 ft Roll	\$27.95
708265	Hydro Flow Vinyl Tubing Black 1/2 in ID - 5/8 in OD 100 ft Roll	\$28.95
708245	Hydro Flow Vinyl Tubing Black 3/4 in ID - 1 in OD 100 ft Roll	\$76.95
708251	Hydro Flow Vinyl Tubing Black 1 in ID - 1.25 in OD 50 ft Roll	\$64.95

Hydro-logic Tubing

Replacement tubing for Hydro-logic products. Also can be used for a variety of other irrigation and water purification applications.



Item No.	Description	MSRP
728780	Hydro-logic Tubing White 1/2 in 25 ft Roll 10/Pack	\$14.95
728782	Hydro-logic Tubing Black 1/4 in 50 ft Roll 10/Pack	\$11.95
728784	Hydro-logic Tubing Blue 1/4 in 50 ft Roll 10/Pack	\$11.95
728786	Hydro-logic Tubing Black 3/8 in 50 ft Roll 10/Pack	\$16.95
728788	Hydro-logic Tubing Blue 3/8 in 50 ft Roll 10/Pack	\$16.95

Hydro Flow Fender Grommets

Grommets are commonly used when needing to transfer water from one container to another with tubing. Hydro Flow Fender Grommets supply additional support on the front of the grommet, keeping the grommet from pushing through. The oversized front helps to keep grommet in place, while securing the fitting with a leak free seal.



Item No.	Description	Bag Qty	Box Qty	MSRP Ea
747290	Hydro Flow Fender Grommet 3/4 in	10	—	\$1.05
708400	Hydro Flow Fender Grommet Bulk 3/4 in - Display Box	—	250	\$1.09

Hydro Flow Rubber Grommets

Choose from the 4 sizes of Hydro Flow Grommets to fit your needs.



Item No.	Description	Bag Qty	Box Qty	MSRP Ea
747042	Hydro Flow Rubber Grommet 3/8 in	10	—	\$0.46
747064	Hydro Flow Rubber Grommet 1/2 in	10	—	\$0.48
747116	Hydro Flow Rubber Grommet 3/4 in	10	—	\$1.05
747274	Hydro Flow Rubber Grommet 1 in New	10	—	\$1.19
708376	Hydro Flow Rubber Grommet 3/8 in - Display Box	—	500	\$0.48
708378	Hydro Flow Rubber Grommet 1/2 in - Display Box	—	500	\$0.50
708380	Hydro Flow Rubber Grommet 3/4 in - Display Box	—	250	\$1.09
708390	Hydro Flow Rubber Grommet Bulk 1 in - Display Box New	—	100	\$1.09

Hydro Flow Top Hat Grommets

These grommets can be used to replace old, worn top hat grommets in your hydroponic system and can be a valuable solution when building your own garden system. Top Hat grommets have a straight side wall for easy installation. When the fitting is inserted into the grommet, the wall is pushed against the whole surface to create the seal.



Item No.	Description	Bag Qty	Box Qty	MSRP Ea
747028	Hydro Flow Top Hat Grommet 1/4 in	10	—	\$0.33
747066	Hydro Flow Top Hat Grommet 1/2 in	10	—	\$0.36
747258	Hydro Flow Top Hat Grommet 5/8 in	10	—	\$0.48
747118	Hydro Flow Top Hat Grommet 3/4 in New	10	—	\$0.52
708382	Hydro Flow Top Hat Grommet Bulk 1/4 in - Display Box	—	250	\$0.28
708384	Hydro Flow Top Hat Grommet Bulk 1/2 in - Display Box	—	250	\$0.32
708386	Hydro Flow Top Hat Grommet Bulk 5/8 in - Display Box	—	250	\$0.42
742842	Hydro Flow Top Hat Grommet Bulk 3/4 in - Display Box New	—	250	\$0.45

GH Grommets

1/2 in grommet used in the reservoir drain that is used with AeroFlo 20/30. The 1 in grommet is used in the growing chamber laser sprayline on all AeroFlo systems. The 1-1/4 in grommet is used for the growing chamber drain overflow tube grommet in all AeroFlo systems.



Item No.	Description	MSRP
708325	GH Grommet 1 in	\$1.90
708330	GH Grommet 1-1/4 in	\$2.20
708320	GH Grommet 1/2 in	\$0.68
708321	GH Grommet 1/2 in	\$0.51

Dripper Stake 45 Degree

This angled dripper stake fits 1/4 in irrigation tubing and has a 45 degree angle to reduce sharp bending of the tubing, which causes clogging. It delivers a light emission of water for regular top drip irrigation.



Item No.	Description	MSRP Ea
708350	Dripper Stake 45 Degree	\$0.51

Hydro Flow Drinker Stake with Basket - Black

Made of highest quality materials. Made to be used with dripper line #708345.

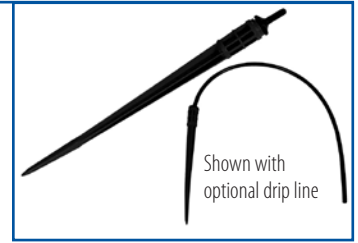

Item No.	Description	Bag Qty	MSRP Ea
747254	Hydro Flow Drinker Stake w/ Basket Black	10	\$0.48
742730	Hydro Flow Drinker Stake w/ Basket Black 100/Bag	—	\$0.48

Hydro Flow Drinker Stake with Basket - Blue

Made to be used with dripper line #708345.

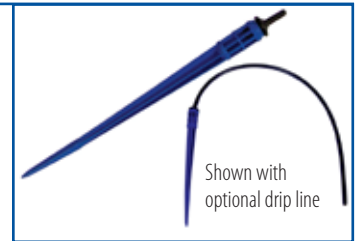

Item No.	Description	Bag Qty	MSRP Ea
747256	Hydro Flow Drinker Stake w/ Basket - Blue	10	\$0.48
708341	Hydro Flow Drinker Stake w/ Basket - Blue	—	\$0.48

Hydro Flow Poly Drinker Line

Dripper line for use with dripper stakes. Made of highest quality materials.



Item No.	Description	MSRP Ea
708345	Hydro Flow Drinker Line 3/16 in ID x 1/4 in OD - 15 in	\$0.32
742290	Hydro Flow Poly Drinker Line 3/16 in ID x 1/4 in OD - 15 in New	\$0.25

Botanicare Drinker Stake with 3/16 in dripper line

Dripper stake with 3/16 in dripper line.



Item No.	Description	MSRP
708280	Dripper Stakes with 1/8 in Drinker Line	\$0.75

Bond Medium Duty Hose 5/8 in

Solid brass couplings. Collar reduces kinking at the faucet. Crush proof couplings. Coils easily in all weather conditions. 10 Year Warranty.



Item No.	Description	MSRP
740810	Bond Medium Duty Hose 5/8 in 50 ft	\$23.49

Claber Aquano Video 2 Timer

Programmable in advance to release water up to 2 times a day, for duration ranging from 1 min to 23 hrs and 59 min. Weekly programming; water cycles run on all days of week. 15 min preset manual override allows for watering between cycles or programs interruption. Low-battery indicator; saves settings for 10 min while 9V battery (not included) is replaced. 2 Year Warranty.



Item No.	Description	MSRP
708785	Claber Aquano Video 2 Water Timer	\$71.59

Claber Aquadue Duplo Water Timer

2 independent outlets programmable in advance; watering cycles run on all days of the week. Each outlet releases water up to 3 times a day, for durations ranging from 1 min to 23 hrs and 59 min. 15 min preset manual override allows for watering between cycles or programs interruption. Low-battery indicator; saves settings for 10 min while 9V battery (not included) is replaced. 2 Year Warranty.



Item No.	Description	MSRP
708740	Claber Aquadue Duplo Water Timer	\$133.95

Claber Koala Indoor Faucet Connector

Easily attaches to an indoor straight neck faucet. Does not fit on curved neck faucet or wider than 1-1/4 inch. Rubber seal clamps on faucet preventing leaking or spraying. Lower attachment is adjustable to faucet length. Convenient quick-click coupler for fast and easy hose removal. 2 Year Warranty.



Item No.	Description	MSRP
708745	Claber Koala Indoor Faucet Connector	\$10.49

Claber Spiral Hose Kit

33-Feet hose made of thermoplastic polyurethane compound for flexibility and kink resistance. Trigger action spray nozzle with powerful jet spray ideal for cleaning up after planting. Includes nozzle aerator accessory for gentle stream spray and 3 utility faucet adaptors. Spray nozzle wall mount for no struggling with heavy hose wind-up. 2 Year Warranty.



Item No.	Description	MSRP
708750	Claber Spiral Hose Kit	\$62.95

Claber Faucet to Hose Connector

Easily connects hose to outdoor faucet. Includes one male faucet adapter and one male hose connector. Connector and adapter are simply snapped together using spring compression. Interchangeable with most polymer quick connector systems. 2 Year Warranty.



Item No.	Description	MSRP
708765	Claber Faucet to Hose Connector	\$4.09

Melnor 2 Zone - 6 Cycle Digital Water Timer

Automatically water up to 6 times per day. Water 2 areas from one faucet. Easy to program. Large LCD screen makes the entire program visible at a glance. Metal coupling nut with rubberized grip. Retains programming through battery change. Rain delay setting. 7 Year Warranty.



Item No.	Description	MSRP
708832	Melnor 2-Zone 6 Cycle Digital Water Timer	\$74.95

Melnor 6 Cycle Digital Aqua Timer

Automatically water up to 6 times per day. Easy to program. Large LCD screen makes the entire program visible at a glance. Metal coupling nut with rubberized grip. Retains programming through battery change. Rain delay setting. 7 Year Warranty.



Item No.	Description	MSRP
708834	Melnor 6 Cycle Digital Aqua Timer	\$41.56

Black Holes Drippers

Unique and innovative top feed dripper manufactured for use in hydroponics. 1/2 in and 1/4 in barb option. 1/4 in barb is compatible with standard drip emitters by plugging them into the barb (rec. 2 GPH emitter). Designed with 6 beveled emitter holes. 100% Made in the USA by 100% recycled plastic.



Item No.	Description	MSRP
748410	Black Holes Dripper 1/4 in	\$4.95
748415	Black Holes Dripper 1/2 in	\$4.95



Find all these great products at a retailer near you. Scan to find the retailer closest to you!

ECOPLUS WATER CHILLERS

KEEP YOUR COOL!

NEW LOWER PRICES



1/10 HP



1/4 HP



1/2 HP

EcoPlus 1/10 HP Chiller

Each chiller provides a high performance titanium heat exchanger for optimum performance and corrosion resistance. High quality made compressor is extremely efficient and reliable. The micro computer with digital LCD display allows for easy operation. Fittings are 1/2 inch. 120V-60Hz/264 watts/2.2 amps. Pump Size: Minimum 66 GPH/Maximum 317 GPH. Dimensions are 15.75 in W x 8.58 in D x 16.34 in H and weighs 28.7 lb. 1 Year Warranty.



Item No.	Description	MSRP
728695	EcoPlus 1/10 HP Chiller	\$379.95

EcoPlus 1/4 HP Chiller

Each chiller provides a high performance titanium heat exchanger for optimum performance and corrosion resistance. High quality made compressor is extremely efficient and reliable. The micro computer with digital LCD display allows for easy operation. Fittings are 3/4 inch. 120V-60Hz/360 watts/3 amps. Pump Size: Minimum 264 GPH/Maximum 660 GPH. Dimensions are 17.13 in W x 11.61 in D x 18.5 in H and weighs 42.5 lb. 1 Year Warranty.



Item No.	Description	MSRP
728700	EcoPlus 1/4 HP Chiller	\$524.95

EcoPlus 1/2 HP Chiller

Digital control system for accurate, stable water temperature that helps to keep your reservoir cool. Environmentally safe, freon-free R134a refrigeration system that has high energy efficiency. Will chill the water from 37-90 degrees. Max water volume of 132 gallons. Recommended pump size 317 to 793 GPH. Dimensions are 21 in W x 15.5 in D x 22 in H and weighs 52 lb. 1 Year Warranty.



Item No.	Description	MSRP
728702	EcoPlus 1/2 HP Chiller	\$944.95

Allow these units to set upright for 3 hours prior to startup.

EcoPlus Commercial Grade Water Chillers



Features a commercial-grade titanium heat exchanger for optimum performance and corrosion resistance. High-quality Japanese compressor is extremely efficient and reliable. Heavy-duty galvanized steel housing with a durable powder coated finish. Digital LCD display allows for easy operation. Remote temperature controller with a 30 ft cord allows user to monitor & adjust chiller settings, when the unit is installed in a remote location. Comes with 2 fittings to allow chiller to be plumbed with 1 inch hard PVC pipe or 1 inch flexible tubing.

Item No.	Description	MSRP
728707	EcoPlus Commercial Grade Water Chiller 1/2 HP	\$999.95
728708	EcoPlus Commercial Grade Water Chiller 1 HP	\$1,299.95
728709	EcoPlus Commercial Grade Water Chiller 1-1/2 HP	\$1,579.95
728711	EcoPlus Commercial Grade Chiller Fitting Kit	\$11.50

Hydro Innovations CoolCoil

A 12 in stainless steel coil that is designed to be used with a water-cooled system. Includes 20 ft of 3/8 in heavy duty tubing, 1/2 in and 3/8 in brass hose barb adapters, and stainless steel hose clamps.

* Requires chilled water flowing through it to operate.

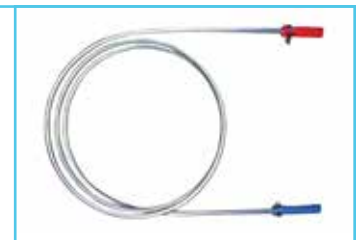

Item No.	Description	MSRP
703760	Hydro Innovations CoolCoil	\$154.95

WATER CHILLERS, HEATERS & PURIFICATION



Reverse Osmosis Water Filtration System

Industry exclusive

WATER CHILLERS, HEATERS & PURIFICATION



IDEAL H₂O™ RO SYSTEM FEATURES:

- Thin layer composite (TLC) membrane. 200 GPD RO System includes 2 membranes. 100 GPD RO System includes 1 membrane.
- Color specific LLDPE polyethylene tubing.
- 2-in-1: Adjustable flow restrictor and membrane flush valve. (detail below)
- Dual o-ring quick connect fittings for leak free operation.
- 3/8 inch quick connect inlet hose with garden hose adapter.
- Wall mountable powder coated steel bracket.
- 1.5 inch 0-100 PSI pressure gauge correctly measures water pressure in system.
- Clear ABS filter housing.
- 1 micron polyspun sediment filter.
- 5 micron coconut carbon filter.



2-in-1: Adjustable Flow Restrictor and Membrane Flush Valve



200 GPD RO System shown. 100 GPD RO System consist of same unique features and configuration, but with one RO membrane.

www.IdealH2O.net

Ideal H2O Reverse Osmosis Systems

Reverse osmosis removes the majority of all contaminants from your water. Ideal H2O Reverse Osmosis Water Filtration Systems produce up to 200 gallons per day of ultra-pure, low parts per million (PPM) water. These 3 Stage RO systems remove more than 98% of chlorine and 90% of sediment, silt and rust. Includes a poly spun sediment pre-filter and a coconut carbon pre-filter. Ideal H2O RO Systems also come with a 2 in 1 flow restrictor/membrane flush valve preinstalled. This valve allows users to periodically flush out harmful build up in the membrane, extending the membrane's life by up to 50%, all while using 25% less water than other RO systems on the market. Proudly assembled in the U.S.A. 1 Year Warranty.



Item No.	Description	MSRP
738300	Ideal H2O Premium Reverse Osmosis System - 100 GPD	\$216.95
738305	Ideal H2O Premium Reverse Osmosis System - 200 GPD	\$282.95

Ideal H2O Reverse Osmosis System 75 GPD

The Ideal H2O 75 GPD 3 Stage Reverse Osmosis Unit was designed to be light, compact and economical for today's gardening hobbyists. Utilizing a hybrid sediment/carbon filter and a full size RO membrane, this 75 GPD RO unit has the same great quality filtration as larger units in the market today. Assembled in the USA. 1 Year Warranty.



Item No.	Description	MSRP
738325	Ideal H2O Premium Reverse Osmosis System - 75 GPD	\$133.95

Scan to get more information on Ideal H2O products today!



Ideal H2O De-Chlorinator System 10 in

The Ideal H2O 10 in De-Chlorinator removes up to 99% of chlorine out of your water, as well as removing up to 90% of sediment, rust, silt and particulates down to 5 microns. Filters 60 gallons of water per hour, providing crystal clear water for your plants. 1 Year Warranty.



Item No.	Description	MSRP
738315	Ideal H2O De-Chlorinator System 10 in	\$99.95

Ideal H2O De-Chlorinator System 20 in

The Ideal H2O 20 in De-Chlorinator removes up to 99% of chlorine out of your water, as well as removing up to 90% of sediment, rust, silt and particulates down to 5 microns. Filters 120 gallons of water per hour, providing crystal clear water for your plants. 1 Year Warranty.



Item No.	Description	MSRP
738320	Ideal H2O De-Chlorinator System 20 in	\$166.95

Ideal H2O RO 100/200 Booster Pump

The Ideal H2O RO 100/200 Booster pump is designed to increase the inlet pressure of your water source. Two 3/8 in Quick Connect fittings are preinstalled for quick operation.



Item No.	Description	MSRP
738345	Ideal H2O RO 100/200 Booster Pump	\$209.95

Ideal H2O Replacement Filters



The Coconut Carbon Filter will remove sediment, chlorine, organic chemicals, etc. The Sediment Filter will remove silt, rust, sand, etc. The Ideal H2O units come with two RO membranes elements. When it is time to replace them, both must be replaced simultaneously. 1,500 gallons of RO water filter life. The Ideal H2O Hybrid Filter combines both a sediment filter and a carbon filter, removing both particulates and chemicals from the water. Works only with the Ideal H2O RO System - 75 GPD.

Item No.	Description	MSRP
738330	Ideal H2O Coconut Carbon Filter 10 in	\$13.95
738335	Ideal H2O Sediment Filter 10 in	\$8.95
738340	Ideal H2O RO Membrane 100 GPD	\$58.95
738350	Ideal H2O Coconut Carbon Filter 20 in	\$26.95
738355	Ideal H2O Sediment Filter 20 in	\$9.95
738360	Ideal H2O Hybrid Sediment/Carbon Filter	\$22.95

EcoPlus Aqua Heat Titanium Reservoir & Aquarium Heater

These easy to use heaters are very durable and reliable. The double heater tubes are fully submersible. Automatic electronic heater ideal for saltwater and freshwater. 1 Year Warranty.



Item No.	Description	MSRP
728581	EcoPlus Aqua Heat Titanium Heater 200 Watt	\$36.95
728582	EcoPlus Aqua Heat Titanium Heater 300 Watt	\$38.95

Hydor Theo Heaters

Theo aquarium heater has all the necessary features for safe and precise temperature maintenance of the water in your tank. The exclusive technology and the high quality of the components guarantee a long lasting product.



Item No.	Description	MSRP
727625	Hydor Theo Heater 200 Watt for 26-53 Gallons	\$32.95
727630	Hydor Theo Heater 300 Watt for 53-80 Gallons	\$36.95
727635	Hydor Theo Heater 400 Watt for 80-105 Gallons	\$39.95



Hydrologic Purification Systems specializes in a wide range of professional quality water purification products designed exclusively for the hydroponics and gardening industry. Our filtration systems are built from the ground up, focused on cutting edge technologies. All of our systems are easy to use and completely plug and play, requiring no plumbing knowledge.

Hydro-logic Evolution RO1000 - 1000 GPD

Achieve the highest flow rates from the most efficient RO system on the planet! Capable of producing more than 1,000 GPD or 42 gallon per hour of pure water. Remove 95%+ of all parts per million from your tap water. Can produce up to 1500 gpd at 80 psi.



Item No.	Description	MSRP
728992	Hydro-logic Evolution RO1000 High Flow System	\$789.95

Hydro-logic Evolution RO1000 Filters

The standard pre-filter included with system. For chlorine and chloramines reduction for city water. Also for well water for iron, hydrogen sulfide and heavy metals reduction. 2 needed for system.



Item No.	Description	MSRP
728772	Hydro-logic Evolution RO1000 KDF/Catalytic Carbon Pre-Filter	\$53.95
728774	Hydro-logic Evolution RO1000 Membrane Element	\$184.95

REVERSE OSMOSIS SYSTEMS

System	NGW Item Code	Product Water Flow Rate*	Reduces PPM (by 95%+)	Reduces Chlorine	Reduces Chloramines	Reduces Sediment & Dirt	Reduces Iron	Reduces Sulfur	Inlet Tubing Size	Product Tubing Size	Waste Tubing Size
Evolution-RO1000™	728992	1000 GPD/42 GPH	Y	Y	Y	Y	Low Levels	Low Levels	1/2"	3/8"	3/8"
Stealth-RO100™	728800	100 GPD/4 GPH	Y	Y	Partially	Y	Low Levels	Low Levels	3/8"	1/4"	1/4"
Stealth-RO200™	728820	200 GPD/8 GPH	Y	Y	Partially	Y	Low Levels	Low Levels	3/8"	1/4"	1/4"

DE-CHLORINATOR / SEDIMENT FILTERS

System	NGW Item Code	Product Water Flow Rate*	Reduces PPM (by 95%+)	Reduces Chlorine	Reduces Chloramines	Reduces Sediment & Dirt	Reduces Iron	Reduces Sulfur	Inlet Tubing Size	Product Tubing Size	Waste Tubing Size
Pre-Evolution™	728792	Pre-Filter only for Evolution-RO1000™	N	Y	Y	Y	Low-Med Levels	Low-Med Levels	1/2"	1/2"	None**
Big Boy™	728985	420 GPH/7 GPM	N	Y	Partially	Y	N	N	1" Port	1" Port	None**
Tall Boy™	728890	120 GPH/2 GPM	N	Y	Partially	Y	N	N	3/8"	3/8"	None**
Small Boy™	728875	60 GPH/1 GPM	N	Y	Partially	Y	N	N	1/4"	1/4"	None**

GPD = Gallons Per Day
GPH = Gallons Per Hour
GPM = Gallons Per Minute
G = Gallons

* Flow rates of RO systems are based on source water @ 60 PSI / 77°F / 500 PPM
 Minimum inlet pressure is 40 PSI / Maximum is 80 PSI

** De-chlorinator / Sediment Filters do not produce waste water

HydroLogic™
 PURIFICATION SYSTEMS

www.hydrologicsystems.com | 888.426.5644

REPLACEMENT & UPGRADE FILTERS

HydroLogic™
 PURIFICATION SYSTEMS

Part Description	NGW Item Code	Filter Replacement Schedule	Reduces PPM (by 95%+)	Reduces Chlorine	Reduces Chloramines	Reduces Sediment & Dirt	Reduces Iron	Reduces Sulfur	For Well Water	For City Water
Big Boy™ - Carbon Filter - Green - Coconut - 20"x4.5"	728950	25,000 Gallons	N	Y	Partially	N	N	N	Y	Y
Big Boy™ - Sediment Filter - Pleated - 20"x4.5"	728855	Clean regularly - Change annually	N	N	N	Y	N	N	Y	Y
Evolution-RO1000™ KDF/Carbon Pre-Filter	728772	2,000 Gallons	N	Y	Y	Y	Low Levels	Low Levels	Y	Y
Evolution-RO1000™ Membrane Element	728774	6 Months - 2 Years	Y	N	N	N	Low Levels	Low Levels	Y	Y
KDF85/Catalytic Carbon Upgrade Filter - 10"x2.5" for Stealth-RO™100/200 & Small Boy™	728975	6,000 Gallons - Small Boy 2,000 Gallons - Stealth-RO	N	Y	Y	N	Low - Med Levels	Low - Med Levels	Y	Y
KDF85/Catalytic Carbon Upgrade Filter - 20"x2.5" for Tall Boy™ & Tall Blue™	728980	15,000 Gallons - Tall Boy 6,000 Gallons - Tall Blue	N	Y	Y	N	Low - Med Levels	Low - Med Levels	Y	Y
KDF85/Catalytic Carbon Upgrade Filter - 20"x4.5" for Big Boy™	728960	50,000 Gallons	N	Y	Y	N	Low - Med Levels	Low - Med Levels	Y	Y
Pre-Evolution™ KDF/Carbon Filter - 10"x4.5"	728776	7,500 Gallons	N	Y	Y	N	Low - Med Levels	Low - Med Levels	Y	Y
Pre-Evolution™ Sediment Filter - 10"x4.5"	728778	Clean regularly - Change annually	N	N	N	Y	N	N	Y	Y
Small Boy™ Sediment Filter - 10"x2.5"	728885	3,000 Gallons (approx.)	N	N	N	Y	N	N	Y	Y
Stealth-RO™/Small Boy™ Carbon Filter - Green - Coconut - 10"x2.5"	728805	3,000 Gallons - Small Boy 1,250 Gallons - Stealth-RO	N	Y	Partially	N	N	N	Y	Y
Stealth-RO™100/200 RO Membrane Element	728815	6 Months - 2 Years	Y	N	N	N	Low Levels	Low Levels	Y	Y
Stealth-RO™100/200 RO Sediment Filter - Pleated - 10"x2.5"	728810	Clean regularly - Change annually	N	N	N	Y	N	N	Y	Y
Tall Blue™/Tall Boy™ Carbon Filter - Green - Coconut - 20"x2.5"	728865	7,500 Gallons - Tall Boy 4,500 Gallons - Tall Blue	N	Y	Partially	N	N	N	Y	Y
Tall Blue™/Tall Boy™ Sediment Filter - 20"x2.5"	728870	7,500 Gallons (approx.) - Tall Boy 4,500 Gallons (approx.) - Tall Blue	N	N	N	Y	N	N	Y	Y

www.hydrologicsystems.com | 888.426.5644

Hydro-logic Evolution-RO1000 Wall Mount Bracket

Wall mount bracket for the Evolution-RO1000. Stainless steel, heavy duty.



Item No.	Description	MSRP
741585	Hydro-logic Evolution Wall Mount Bracket	\$74.95

Hydro-logic Evolution Waste Reducer Elbow - 1:1 Ratio

Replaces standard Evolution RO1000 green drain elbow to save 50% of the drain water. Gives a 1:1 ratio. Does not reduce flow of purified water. Orange with 3/8 in QC fitting-Save more water! Included as standard equipment with Evolution RO 1000.



Item No.	Description	MSRP
738220	Hydro-logic Evolution RO1000 Water Reducer Elbow	\$19.00

Hydro-logic PreEvolution High Capacity Pre-Filter

Ensures your Evolution-RO1000 runs more efficiently. Less filter changes and maintenance - every 7,500 gallons of purified water. Cleanable sediment filter is re-usable.



Item No.	Description	MSRP
728792	Hydro-logic PreEvolution High Capacity Pre-Filter	\$279.95

Hydro-logic PreEvolution Filters

PreEvolution KDF/Catalytic Carbon Filter is the standard carbon pre-filter included with system. For high capacity chlorine and chloramines reduction for city water. Also for well water. PreEvolution Sediment Filter is the standard sediment pre-filter included with system. Pleated and cleanable filter.



Item No.	Description	MSRP
728776	Hydro-logic PreEvolution KDF/Catalytic Carbon Filter	\$89.95
728778	Hydro-logic PreEvolution Sediment Filter	\$34.95

Hydro-logic Float Valve - 1/2 in Barbed

1/2 in barbed connection. Adjustable water level and can be mounted horizontally or vertically. Allows you to fill any tank or reservoir unattended - never flood your garden again! All plastic and stainless steel materials. Better than brass and fully adjustable.



Item No.	Description	MSRP
728790	Hydro-logic Float Valve 1/2 in Barbed	\$19.00

Hydro-logic Stealth RO 100

Removes 98%+ of all contaminants in your tap water. Leading the industry in efficiency they have a 2:1 waste to product water ratio. Optional 1:1 ratio flow restrictor saves 50% more waste water. Optional high flow, low pressure, cold water membrane increases production to 200 GPD for Stealth-RO100 and 400 GPD for Stealth-RO200. Customized for gardening and hydroponics. 1 Year Warranty.



Item No.	Description	MSRP
728800	Hydro-logic Stealth RO 100	\$224.95
741570	Hydro-logic Stealth RO 100 w/ Upgraded KDF Carbon Filter	\$247.50

Hydro-logic Stealth RO 200

Removes 98%+ of all contaminants in your tap water. Leading the industry in efficiency they have a 2:1 waste to product water ratio. Optional 1:1 ratio flow restrictor saves 50% more waste water. Optional high flow, low pressure, cold water membrane available to increase production to 200 GPD for Stealth-RO100 and 400 GPD for Stealth-RO200. Customized for gardening and hydroponics. 1 Year Warranty.



Item No.	Description	MSRP
728820	Hydro-logic Stealth RO 200	\$314.95
741575	Hydro-logic Stealth RO 200 w/ Upgraded KDF Carbon Filter	\$337.50

Hydro-logic Stealth Replacement Filters

The Carbon Filter will remove sediment, chlorine, organic chemicals, etc. The Sediment Filter will remove silt, rust, sand, etc. KDF85 Filter is ideal for well water users with iron and sulfur and city water users with chloramines.



Item No.	Description	MSRP
728805	Hydro-logic Stealth & Small Boy Green Carbon Filter	\$16.50
728810	Hydro-logic Stealth Sediment Filter	\$14.50
728815	Hydro-logic Stealth Membrane Filter	\$83.00
728975	Hydro-logic Stealth KDF85 Carbon Filter	\$39.00

Hydro-logic Stealth RO Low Pressure, High Flow Membrane

Low pressure, cold water, high flow membrane for Stealth RO models. Approximately 93% PPM rejection. Replaces standard membrane. Produces up to 200 Gallons Per Day.



Item No.	Description	MSRP
738240	Hydro-logic Stealth RO Low Pressure High Flow Membrane	\$99.95

Hydro-logic Stealth RO Flow Restrictors 1:1

Replaces standard Stealth RO 100 & Stealth RO 200 flow restrictors to save 50% of the drain water. Gives a 1:1 ratio. Save more water!



Item No.	Description	MSRP
738225	Hydro-logic Stealth RO 100 Flow Restrictor	\$9.50
738230	Hydro-logic Stealth RO 200 Flow Restrictor	\$9.50

Hydro-logic Upgrade Kit- Stealth RO 100 to Stealth RO 200

This kit upgrades your Stealth RO 100 unit into a Stealth RO 200. Double the flow rate of your purified water with this simple upgrade kit.



Item No.	Description	MSRP
738205	Hydro-logic Upgrade Kit to Convert RO 100 to Stealth RO 200	\$90.00

Hydro-logic Stealth RO100/200 - Membrane Flush Kit

Power flushes Stealth-RO membrane(s). Flushes away built up scale from the membrane surface to extend membrane(s) life.

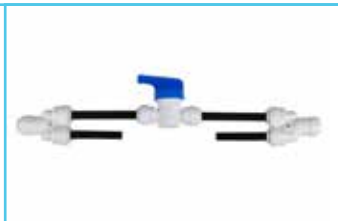

Item No.	Description	MSRP
738100	Hydro-logic Stealth RO 100/200 Flush Kit for Membrane	\$19.00

Hydro-logic QC Fitting for Stealth RO & Small Boy Systems

728937: 1/4 in Quick Connect Inline Shut Off Valve. This is used to shut off feed or outlet line to system. 728938: 1/4 in Quick Connect Union Connector. This is to connect 2 lengths of equal sized tubing together. 728939: 2 Way Splitter 1/4 in. This is a y splitter for multiple reservoirs.



Item No.	Description	MSRP
728937	Hydro-logic QC Inline Shut Off Valve 1/4 in	\$5.00
728938	Hydro-logic QC Union Connector 1/4 in	\$4.50
728939	Hydro-logic 2-Way Splitter 1/4 in	\$5.50

Hydro-logic Stealth Ultra-Violet Sterilizer Kit

Ultra Violet Sterilizer add on for either Stealth-RO units. Kills any bacteria, viruses or biological contaminants in product water. Great for well or surface water sources. 1/4 in connections and up to 1/2 gallon per minute flow rate.



Item No.	Description	MSRP
728922	Hydro-logic Stealth UV Sterilizer Kit	\$99.00

Hydro-logic Pressure Booster Pump For Stealth

This pump is designed to be installed before the Stealth-RO to boost the inlet pressure. There needs to be at least 40 psi and up to 80 psi of inlet pressure for the Stealth-RO to function properly. Wells and low pressure water sources can benefit greatly from this pump.



Item No.	Description	MSRP
728897	Hydro-logic Pressure Booster Pump for Stealth	\$209.95

Hydro-logic Stealth & Small Boy Float Valve

Use this float valve to adjust water level and can be mounted horizontally or vertically. The kit allows you to fill a reservoir or tank, unattended, to your desired water level. For use with all stealth and small boy models.



Item No.	Description	MSRP
728912	Hydro-logic Float Valve 1/4 in for Stealth	\$19.00

Hydro-logic Algae Block Sleeve

Neoprene sleeve that goes over all standard clear housings. Blocks light so no algae can grow. Easy to remove to check status of filters. Reversible blue and black. Fits Stealth RO, Small Boy and Triton.



Item No.	Description	MSRP
738235	Hydro-logic Algae Block Sleeve	\$12.95

Hydro-logic Merlin GP Replacement Filters

The Merlin-Garden Pro comes with two RO membranes elements. When it is time to replace them, both must be replaced simultaneously. 1,500 gallons of RO water filter life. The Carbon Filter is the carbon block pre-filter that will remove sediment, chlorine, organic chemicals and more. The Sediment Filter is a pre-filter that will remove silt, rust, sand, etc.



Item No.	Description	MSRP
728845	Hydro-logic Merlin GP Green Carbon Filter	\$34.95
728850	Hydro-logic Merlin GP Sediment Filter	\$25.95
728855	Hydro-logic Merlin GP Membrane	\$156.95

Hydro-logic Evolution RO1000 UV Sterilizer Kit

Ultra Violet Sterilizer add on for the Evolution RO1000 unit. Kills any bacteria, viruses, or biological contaminants in product water. Great for well or surface water sources. Includes 3/8 in QC Elbow fittings. Up to 1 gpm flow rate. Also for use with Merlin GP.



Item No.	Description	MSRP
728920	Hydro-logic Evolution RO 1000 UV Sterilizer Kit	\$99.00

Hydro-logic Flowmaster Flow Meter - 3/8 in

The Flowmaster measures how much filtered water that has gone through the system and alerts you when it's time to change filters. You can program in the filter capacity and when you reach the target number of gallons, the Flowmaster beeps.



Item No.	Description	MSRP
728905	Hydro-logic Flowmaster Flow Meter	\$59.00

Hydro-logic Flowmaster 1/4 in - Ultra Low Flow Model

Flowmaster - 1/4 in QC - gallonage & filter capacity monitor. Operates at flow rates between 0.01-0.5 GPM. Ultra low-flow model. Alerts you when it's time to change your filters. For Stealth RO or most RO systems with 1/4 in fittings.



Item No.	Description	MSRP
741580	Hydro-logic Flowmaster Low Flow Model 1/4 in	\$59.00

HM Digital In-Line Dual TDS Monitor Model DM-1

Displays TDS levels of the feed water and product water with in & out electrode probes. Auto-Off function conserves battery power. Comes equipped with Mur-lok Quick-Connect T-fittings. Installs quickly and easily. 1 Year Warranty.



Item No.	Description	MSRP
716186	HM Digital In-Line Dual TDS Monitor	\$41.95

Hydro-logic TDS Inline Monitor Pro for Evolution RO1000

Highly efficient and accurate. Auto-Off function conserves battery power. The unit shuts off automatically after 20 seconds. Dual range - measures from 0-999 ppm, with a resolution of 1 ppm. Comes factory calibrated. Comes equipped with 3/8 in & 1/2 in Quick Connect T-fittings. 3 Year Warranty.



Item No.	Description	MSRP
728900	Hydro-logic TDS Inline Monitor Pro for Evolution RO 1000	\$75.00

Hydro-logic Pressure Booster Pump - Evolution

Connects inline before system. Boosts pressure to 70 psi for ultra fast flow rates up to 1500 Gallons per day. For low pressure (below 40 psi) situations or those desiring higher flow rates. Included 24V transformer, built in high pressure switch and 1/2 in QC swivel elbow fittings.



Item No.	Description	MSRP
738210	Hydro-logic Pressure Booster Pump for Evolution	\$499.95

Hydro-logic Pressure Booster Pump for Merlin GP

It boosts the pressure up to 65 psi for Merlin-Garden Pro. The 5 diaphragm pump is a workhorse but runs quietly. Requires at least 40 psi and up to 80 psi of inlet pressure for the Merlin-Garden Pro to function properly. Comes with 120v cord and 1/2 in quick connect fittings. While supplies last.



Item No.	Description	MSRP
728895	Hydro-logic Pressure Booster Pump for Merlin GP	\$329.00

Hydro-logic Pump Protector & Inlet Filter 1/2 in

Protects booster pump from sediment and other particles. Cleanable stainless steel mesh screen. Clear housing. 1/2 in fittings included to hook directly onto inlet of pump. Mandatory for pump unless a Pre-Evolution for your Evolution-RO1000 or a Tall Blue pre-filter for your Merlin-Garden Pro. Works with all pumps with 1/2 in connections.



Item No.	Description	MSRP
741540	Hydro-logic Pump Protector & Inlet Filter 1/2 in	\$24.95

Hydro-logic Pump Protector & Inlet Filter 3/8 in

Protects booster pump from sediment and other particles. Cleanable stainless steel mesh screen. Clear housing. 3/8 in fittings included to hook directly onto inlet of pump. Mandatory for pump unless using dedicated pre-filter for your Stealth-RO or Triton-RO. Works with all pumps with 3/8 in connections.



Item No.	Description	MSRP
741545	Hydro-logic Pump Protector & Inlet Filter 3/8 in	\$19.95

Hydro-logic Leak Protector & Shut Off Valves

Installs on inlet line. If there is a leak anywhere in the system and water reaches the pad on the bottom of the leak protector the valve shuts off all incoming water preventing further damage from the leak. Pads are replaceable. Comes with 2 pads, double sided mounting tape and stainless steel mounting screws.



Item No.	Description	MSRP
741550	Hydro-logic Leak Protector & Shut Off Valve 1/4 in	\$23.95
741555	Hydro-logic Leak Protector & Shut Off Valve 3/8 in	\$24.95
741560	Hydro-logic Leak Protector & Shut Off Valve 1/2 in	\$28.95

Hydro-logic Leak Protector Replacement Pads

Pack of 2 replaceable pads for all sizes of leak protector and shut off valves.



Item No.	Description	MSRP
741565	Hydro-logic Leak Protector Replacement Pads (Set of 2)	\$7.50

Hydro-logic Green Drain Elbow for Merlin GP - 2:1 Ratio

Merlin-Garden Pro Eco Green drain elbow - 3/8 in QC replaces standard Merlin-GP black drain elbow to save 25% of the drain water. Green with 3/8 in QC fitting.



Item No.	Description	MSRP
728944	Hydro-logic Green Drain Elbow 3/8 in for Merlin GP	\$19.00

Hydro-logic Pressure Gauge with Garden Hose Connector

Pressure gauge with female garden hose connector. Allows one to measure line pressure to determine if a booster pump or pressure regulator is necessary. Diagnoses flow problems with RO filters.



Item No.	Description	MSRP
728946	Hydro-logic Pressure Gauge w/ Hose Connector	\$19.95

Hydro-logic 3/8 in Stem x 1/4 in Quick Connect Straight

The 3/8 in Stem x 1/4 in Quick Connect Straight is used and to reduce a 3/8 in quick connect fitting down to 1/4 in. This is mainly used on the Flowmaster to make it's 3/8 in fitting reduce to 1/4 in and make it compatible with the Small Boy.



Item No.	Description	MSRP
728907	Hydro-logic QC Straight 3/8 in to 1/4 in	\$3.50

Hydro-logic Quick Connect Fitting for Small Boy

This is the replacement feed valve for the Small Boy system.



Item No.	Description	MSRP
728933	Hydro-logic QC Garden Hose Connector 1/4 in	\$6.50

Hydro-logic QC Fittings for Evolution & Tall Boy

728940: 2 Way Splitter 3/8 in. 728941: 3 Way Splitter 3/8 in. Both splitters for Evolution RO1000 & Tall Boy system. 728942: 3/8 in QC Inline Shut Off Valve for Evolution RO1000 & Tall Boy system. 728943: 3/8 in QC Union Connector. Connects 2 lengths of equal sized tubing together for Evolution RO1000 & Tall Boy.



Item No.	Description	MSRP
728940	Hydro-logic QC 2-Way Splitter 3/8 in	\$5.75
728941	Hydro-logic 3-Way Splitter 3/8 in	\$12.00
728942	Hydro-logic QC Inline Shut Off Valve 3/8 in	\$6.25
728943	Hydro-logic QC Union Connector 3/8 in	\$5.00

Hydro-logic QC Fittings for Evolution & Tall Blue Systems

728932: 1/2 in Quick Connect x Garden Hose Connector - Feed Valve. A replacement feed valve for the Evolution, Merlin GP & Tall Boy. 728935: 1/2 in Quick Connect Inline Shut Off Valve to shut off feed or outlet line to Evolution & Tall Boy. 728936: 1/2 in Quick Connect Union Connector. Connect 2 lengths of equal sized tubing together for the Evolution & Tall Boy.



Item No.	Description	MSRP
728932	Hydro-logic QC Garden Hose Connector 1/2 in	\$11.00
728935	Hydro-logic QC Inline Shut Off Valve	\$8.00
728936	Hydro-logic QC Union Connector 1/2 in	\$5.50

Hydro-logic QC Fitting for Stealth RO & Tall Boy Systems

This is the replacement feed valve for the Stealth RO system as well as the Tall Boy system.



Item No.	Description	MSRP
728934	Hydro-logic QC Garden Hose Connector 3/8 in	\$6.50

Hydro-logic Tall Blue Replacement Filters

The Carbon Filter will remove sediment, chlorine, organic chemicals, etc. The Sediment Filter will remove silt, rust, sand, etc. KDF85 Filter is ideal for well water users with iron and sulfur and city water users with chloramines.



Item No.	Description	MSRP
728865	Hydro-logic Tall Green Carbon Filter 20 in	\$31.00
728870	Hydro-logic Tall Sediment Filter 20 in	\$14.00
728980	Hydro-logic Tall KDF85 Carbon Filter 20 in	\$74.95

Float Valve for Evolution RO1000 & Tall Boy

This valve comes with a 3/8 in quick connect fitting. Use this float valve to adjust water level and can be mounted horizontally or vertically. The kit allows you to fill a reservoir or tank, unattended, to your desired water level.



Item No.	Description	MSRP
728914	Hydro-logic 3/8 in Float Valve for Evolution RO 100 & Tall Boy	\$19.00

Hydro-logic Small Boy

Removes up to 99% of chlorine, 90% of sediment, rust, silt, etc. and volatile organic compounds and particulates down to 5 microns @ 1 GPM. Easily produces 60 gallons per hour of clear water and has a filter capacity of 3,000 gallons. Unit size is 11 in x 14 in and weight is 6.4 lb. 1 Year Warranty.



Item No.	Description	MSRP
728875	Hydro-logic Small Boy	\$106.95
738155	Hydro-logic Small Boy w/ KDF85 Catalytic Carbon Filter	\$129.45

Hydro-logic Small Boy Replacement Filters

The Carbon Filter will remove sediment, chlorine, organic chemicals, etc. The Sediment Filter will remove silt, rust, sand, etc. KDF85 Filter is ideal for well water users with iron and sulfur and city water users with chloramines.



Item No.	Description	MSRP
728805	Hydro-logic Stealth & Small Boy Green Carbon Filter	\$16.50
728885	Hydro-logic Small Boy Sediment Filter 10 in	\$11.00
728975	Hydro-logic Stealth KDF85 Carbon Filter	\$39.00

Upgrade Kit to Convert Small Boy to Stealth RO 100

This kit upgrades your Small Boy unit into a Stealth RO 100.



Item No.	Description	MSRP
738200	Hydro-logic Upgrade Kit to Convert Small Boy to Stealth RO 100	\$100.00

Hydro-logic Tall Boy

Removes up to 99% of chlorine, 90% of sediment, rust, silt, etc. and volatile organic compounds and particulates down to 5 microns @ 2 GPM. Easily produces 120 gals/hr of clear water and has a filter capacity of 7,500 gals. Great as a high capacity pre-filter for Stealth RO units. Unit size is 11 in x 24 in and weight is 11 lb. 1 Year Warranty.



Item No.	Description	MSRP
728890	Hydro-logic Tall Boy	\$183.95
738165	Hydro-logic Tall Boy w/ KDF85 Catalytic Carbon Filter	\$221.95

Hydro-logic Tall Boy Replacement Filters

The Carbon Filter will remove sediment, chlorine, organic chemicals, etc. The Sediment Filter will remove silt, rust, sand, etc. KDF85 Filter is ideal for well water users with iron and sulfur and city water users with chloramines.



Item No.	Description	MSRP
728865	Hydro-logic Tall Green Carbon Filter 20 in	\$31.00
728870	Hydro-logic Tall Sediment Filter 20 in	\$14.00
728980	Hydro-logic Tall KDF85 Carbon Filter 20 in	\$74.95

Hydro-logic Big Boy

Big Boy extra high capacity de-chlorinator and sediment filter. High flow rate of 7 gallons per minute or 420 gallons per hour. Whole house filter or stand alone (*with optional garden hose connection kit). It has a 25,000 gallon capacity. Removes 99% of chlorine and 95%+ of sediment. 1 Year Warranty.



Item No.	Description	MSRP
728985	Hydro-logic Big Boy	\$438.95
738150	Hydro-logic Big Boy w/ KDF85 Catalytic Carbon Filter	\$505.00

Hydro-logic Big Boy Replacement Filters

The Carbon Filter will remove sediment, chlorine, organic chemicals, etc. The Sediment Filter will remove silt, rust, sand, etc. KDF85 Filter is ideal for well water users with iron and sulfur and city water users with chloramines.



Item No.	Description	MSRP
728950	Hydro-logic Big Boy Carbon Filter	\$77.95
728955	Hydro-logic Big Boy Sediment Filter	\$56.95
728960	Hydro-logic Big Boy KDF85 Carbon Filter	\$127.95

Hydro-logic Big Boy Float Valve Big

Heavy duty float valve with 3/4 in male pipe thread and bulk head fitting. Adjustable water level and bulk head fitting. Up to 20 GM flow rates. Use this float for the Big Boy or garden hose.



Item No.	Description	MSRP
728945	Hydro-logic Float Valve for Big Boy	\$67.00

Hydro-logic Big Boy Garden Hose Connection Kit

Female garden hose thread inlet and male garden hose thread outlet. To hook Big Boy up to garden hose.



Item No.	Description	MSRP
728930	Hydro-logic Big Boy Garden Hose Connection Kit	\$18.00

Hydro-logic Pressure Regulator 3/4 in for Big Boy

Brass pressure regulator. 3/4 in female pipe thread ports. Adjustable from 20-80 PSI. Compatible with Big Boy and other applications where you need to limit high pressure.



Item No.	Description	MSRP
741595	Hydro-logic Big Boy Pressure Regulator 3/4 in	\$139.95

Hydro-logic Tubing

Replacement tubing for Hydro-logic products. Also can be used for a variety of other irrigation and water purification applications.



Item No.	Description	MSRP
728780	Hydro-logic Tubing White 1/2 in 25 ft Roll 10/Pack	\$14.95
728782	Hydro-logic Tubing Black 1/4 in 50 ft Roll 10/Pack	\$11.95
728784	Hydro-logic Tubing Blue 1/4 in 50 ft Roll 10/Pack	\$11.95
728786	Hydro-logic Tubing Black 3/8 in 50 ft Roll 10/Pack	\$16.95
728788	Hydro-logic Tubing Blue 3/8 in 50 ft Roll 10/Pack	\$16.95



Industry **exclusive**

HYPERION™ 1

Wireless • Simple • Complete Control

Monitor & control the base unit from up to 150 feet away with the included remote control.



CO₂ • Lighting • Temperature • Humidity

Check out our new product selector at: www.titancontrols.net



ENVIRONMENTAL CONTROLS



WIRELESS CONTROLLER

Titan Controls Hyperion 1 Wireless Environmental Controller

Get complete control of your grow room from up to 150 feet away without wires with the Hyperion 1 Wireless/Environmental/Lighting controller! Monitor & control the CO₂, temperature and humidity during the day & night periods. Includes a high temp shut-off, 15 min cool down with pre-set and custom lighting schedules. 15 Amps/120 Volts/ 60 Hz. 3 Year Warranty.



Item No.	Description	MSRP
702620	Titan Controls Hyperion 1 Wireless Environmental Controller	\$899.95

CO₂ DEVICES

Titan Controls Atlas 1 - CO₂ Monitor/Controller

Digital control board delivers precision CO₂ control. Maximize your CO₂ production while minimizing CO₂ or LP consumption. 50 parts per million (PPM) deadband/hysteresis built into set point. Adds CO₂ only during daylight period using the controllers integrated photocell. 15 Amps maximum/120 Volt/60 Hz. 3 Year Warranty.



Item No.	Description	MSRP
702615	Titan Controls Atlas 1 - CO ₂ Monitor/Controller	\$599.95

Titan Controls Atlas 2 - Preset CO₂ Monitor/Controller

Preset CO₂ control at 1500 PPM. Built-in self calibration feature. Simply plug in your CO₂ generator or regulator and you are ready to go. Built-in photocell allows CO₂ enrichment only during daylight hours. 5 Amps maximum/120 Volts/60 Hz. 3 Year Warranty.



Item No.	Description	MSRP
702618	Titan Controls Atlas 2 - Preset CO ₂ Monitor/Controller	\$299.95

Titan Controls Atlas 3 - Day/Night CO₂ Monitor/Controller

Controls and monitors CO₂ from 0 to 5000 parts per million (PPM). CO₂ enrichment or CO₂ exhaust features. Easy to set-up and operate. Plastic enclosure resists dust, rust and moisture. 5 Amps maximum/120 Volts/60 Hz. 3 Year Warranty.



Item No.	Description	MSRP
702608	Titan Controls Atlas 3 - Day/Night CO ₂ Monitor/Controller	\$495.95

Titan Controls Atlas 4 - 2 Room CO2 Monitor/Controller

Controls and monitors CO2 in (2) two rooms from 0 to 5000 parts per million (PPM). Two (2) remote room sensors with 25 ft cables (included). Integrated 24 hour data logging feature. Plastic enclosure resists dust, rust and moisture. 10 Amps maximum/120 Volts/60 Hz. 3 Year Warranty.



Item No.	Description	MSRP
702610	Titan Controls Atlas 4 - 2 Room CO2 Monitor/Controller	\$865.95

Titan Controls Atlas 5 - Portable Handheld CO2, Temp & Humidity Monitor

A portable monitor that measures Carbon Dioxide (CO2), Temp and Humidity. CO2 Range: 0 PPM to 9,999 PPM. Temp Range: 14°F to 140°F. Humidity Range: 0.1% to 99.0%. Runs off 4 AA batteries (included). 1 Year Warranty.



Item No.	Description	MSRP
702611	Titan Controls Atlas 5 - Portable Handheld CO2 Temperature/ Humidity Monitor	\$299.95

Titan Controls Atlas 7 - CO2 Controller

Select CO2 PPM levels at 1000 PPM, 1250 PPM or 1500 PPM. Integrated photocell. Built-in calibration feature. Single button control. Plastic enclosure resists dust, rust and moisture. 5 Amps maximum/120 Volts/60 Hz. 1 Year Warranty.



Item No.	Description	MSRP
702614	Titan Controls Atlas 7 - CO2 Controller	\$266.95

Titan Controls Atlas 8 - Digital CO2 Controller with Fuzzy Logic

A digital CO2 monitor and controller. Once the CO2 level has reached your desired set point it will disable the CO2 device. Features a photocell to ensure daytime only dosing of CO2. This controller comes with a 15 ft remote sensor. It also features fuzzy logic programming. The CO2 min/max can also be viewed on the LCD. 15 Amps maximum/120 Volts/60 Hz. 3 Year Warranty.



Item No.	Description	MSRP
702853	Titan Controls Atlas 8 - Digital CO2 Controller w/ Fuzzy Logic	\$531.95

Titan Controls Atlas 9 - Digital CO2 Controller with Remote Sensor

Digital CO2 controller with knobs to adjust your PPM set point and dead-band to operate your CO2 regulator or CO2 generator. It has a 15 ft remote sensor that includes the photocell and CO2 sniffer. Uses green plant friendly LED's to indicate the current PPM (Parts Per Million) level's. 15 Amps maximum/120 Volts/60 Hz. 3 Year Warranty.



Item No.	Description	MSRP
702854	Titan Controls Atlas 9 - CO2 Controller w/ Remote Sensor	\$299.95

Titan Controls CO2 Regulator

Compatible with Titan Controls CO2 Controllers or other 120 Volt controllers and timers. Precision accuracy flow meter - 0.5 to 15 SCF/ hour. Features heavy-duty solenoid valve. Includes two plastic tank washers and 12 ft of CO2 dispensing line. 1 Amp/120 Volts/60Hz. 1 Year Warranty.



Item No.	Description	MSRP
702710	Titan Controls CO2 Regulator	\$114.95

CO2 Regulator Replacement Parts

Replacement parts for Titan Controls CO2 Regulators. The white plastic washers are replacements for the Titan CO2 Regulator or the Titan CO2 Inline Heater. 1 Year Warranty.



Item No.	Description	MSRP
702712	Titan Controls CO2 Regulator Replacement Plastic Washer	\$0.99
702714	Titan Controls CO2 Regulator Replacement Outer Tube - Old Style	\$9.99
702716	Titan Controls CO2 Regulator Replacement Solenoid w/ Cord Set	\$49.99
702882	Titan Controls CO2 Regulator Replacement Plastic Tube - New Style	\$9.99

Titan Controls CO2 Rain System

This CO2 Rain System includes 25 ft of laser drilled 1/8 in tubing, 6 eye hooks, 1/8 in plastic T fitting and instructions. Additional 100 ft roll of tubing is also available.



Item No.	Description	MSRP
702711	Titan Controls CO2 Rain System w/ 25 ft Tubing	\$18.95
702713	Titan Controls CO2 Rain Tubing Only 100 ft Roll	\$39.95

Titan Controls CO2 Inline Heater

The CO2 Heater is installed between the CO2 cylinder valve and the regulator and warms the gas stream for increased flow rates without regulator freeze-up. Manufactured in USA. Not for use on GFI protected circuits. 1 Amp/120 Volts/60 Hz. 1 Year Warranty.



Item No.	Description	MSRP
702715	Titan Controls CO2 Inline Heater 120 Volt	\$169.95
702712	Titan Controls CO2 Regulator Replacement Plastic Washer	\$0.99

Having trouble figuring out what product you need? Scan here for the Titan Controls Product Selector Guide.



CO2 Tanks

Cylinders are made from exclusive aluminum alloy specially optimized by metallurgists to improve its durability, fracture toughness and resistance to tearing and cracking. CO2 tanks are shipped empty and do not contain CO2. UPS ground only with an additional oversize charge, as required.



Item No.	Description	MSRP
703360	CO2 Tank Aluminum 20 lb	\$199.95
703365	CO2 Tank Aluminum 50 lb	\$524.95

Simple CO2 Tubing Hanger

Simple CO2 is an inexpensive, easy and effective method for arranging CO2 tubing. Simple CO2 is an innovative product that allows for the CO2 to be evenly dispersed directly above the plant canopy. By releasing the CO2 from this optimal location, Simple CO2 is the only product that ensures 100% of the CO2 is released above the plant canopy.



Industry exclusive

Item No.	Description	MSRP
702170	Simple CO2 Tubing Hanger	\$2.49

Titan Controls Ares 2 - Two Burner CO2 Generators

Ares Series CO2 generators comes with everything you need to get your CO2 system started. Includes: CO2 Generator, AC power supply, hanging chain, ceiling hook, appropriate hose and regulator. Ares Series CO2 generators come in a variety of sizes from a small 2 burner model to a large adjustable 2 to 10 burner model. All you need to provide is a gas source! 1.5 Amps/120 Volts/60 Hz. 3 Year Warranty.



Item No.	Description	MSRP
702857	Titan Controls Ares 2 - Two Burner LP CO2 Generator	\$337.95
702858	Titan Controls Ares 2 - Two Burner NG CO2 Generator	\$337.95

Titan Controls Ares 4 - Four Burner CO2 Generators

Ares Series CO2 generators comes with everything you need to get your CO2 system started. Includes: CO2 Generator, AC power supply, hanging chain, ceiling hook, appropriate hose and regulator. Ares Series CO2 generators come in a variety of sizes from a small 2 burner model to a large adjustable 2 to 10 burner model. All you need to provide is a gas source! 1.5 Amps/120 Volts/60 Hz. 3 Year Warranty.



Item No.	Description	MSRP
702861	Titan Controls Ares 4 - Four Burner LP CO2 Generator	\$376.95
702862	Titan Controls Ares 4 - Four Burner NG CO2 Generator	\$376.95
702863	Titan Controls Ares 4 - High Altitude Four Burner LP CO2 Generator New	\$376.95

Titan Controls Ares 8 - Eight Burner CO2 Generators

Ares Series CO2 generators comes with everything you need to get your CO2 system started. Includes: CO2 Generator, AC power supply, hanging chain, ceiling hook, appropriate hose and regulator. Ares Series CO2 generators come in a variety of sizes from a small 2 burner model to a large adjustable 2 to 10 burner model. All you need to provide is a gas source! 1.5 Amps/120 Volts/60 Hz. 3 Year Warranty.



Item No.	Description	MSRP
702865	Titan Controls Ares 8 - Eight Burner LP CO2 Generator	\$466.95
702866	Titan Controls Ares 8 - Eight Burner NG CO2 Generator	\$466.95
702867	Titan Controls Ares 8 - High Altitude Eight Burner LP CO2 Generator New	\$466.95

Titan Controls Ares 10 - Ten Burner CO2 Generators

Ares Series CO2 generators comes with everything you need to get your CO2 system started. Includes: CO2 Generator, AC power supply, hanging chain, ceiling hook, appropriate hose and regulator. Switchable from 2, 6, or 10 burners. All you need to provide is a gas source! 1.5 Amps/120 Volts/60 Hz. 3 Year Warranty.



Item No.	Description	MSRP
702869	Titan Controls Ares 10 - Ten Burner LP CO2 Generator	\$578.95
702870	Titan Controls Ares 10 - Ten Burner NG CO2 Generator	\$578.95

Titan Controls Ares Hose and Regulator

LP and NG hose and regulator replacement parts. Made specifically for to work with Titan Controls Ares CO2 generators.



Item No.	Description	MSRP
702490	Titan Controls Ares Series LP Hose & Regulator	\$49.95
702491	Titan Controls Ares Series NG Hose & Regulator	\$57.95

Titan Controls Ares CO2 Generator AC Power Supply

A/C Power Supply replacement part. Made specifically for to work with Titan Controls Ares CO2 generators. UL approved power supply.



Item No.	Description	MSRP
702493	Titan Controls Ares Series CO2 Generator AC Power Supply	\$29.95

Titan Controls 15 ft Sensor Extension Cable

Titan Controls replacement 15 foot Sensor Extension Cable. This cable works with the Saturn 6 and the Atlas 8 products.



Item No.	Description	MSRP
702492	Titan Controls 15 ft Sensor Extension Cable	\$16.95

Titan Controls Ares Replacement Burners

LP and NG replacement burners. Made specifically for to work with Titan Controls Ares CO2 generators.



Item No.	Description	MSRP
702495	Titan Controls Ares Series LP Replacement Burner	\$11.95
702496	Titan Controls Ares Series NG Replacement Burner	\$11.95

CO2 Test Kit

Product 702305 includes: 1 - 100cc syringe, 2 - test tubes and instructions. Product 702300 has a range: 300 - 5000 ppm, Sample Volume: 100 ml, Sample Time: 2 min., Color: White to Purple. Box contains 10 tests.



Item No.	Description	MSRP
702305	CO2 Test Kit	\$20.95
702300	CO2 Detector Tubes	\$45.95

TIMING

Titan Controls Apollo 2 - Cycle Timer with Photocell

Controls timed equipment during daytime only, nighttime only or both. 10 seconds to 20 minutes ON TIME. 1 minute to 12 hours OFF TIME. Use to time fans, pumps or CO2. Plastic enclosure protects internal components. 15 Amps maximum/120 Volts/60 Hz. 3 Year Warranty.



Item No.	Description	MSRP
702740	Titan Controls Apollo 2 - Cycle Timer w/ Photocell	\$87.95

Titan Controls Apollo 3 - Fixed Cycle Timer

1 minute ON TIME & 4 minute OFF TIME. Timing is preset - requires no user adjustments. Ideal for aeroponic, ebb & flow or misting applications. Excellent for NFT - Nutrient Film Technique-systems. 10 Amps maximum/120 Volts/60 Hz. 3 Year Warranty.



Item No.	Description	MSRP
702635	Titan Controls Apollo 3 - Fixed Cycle Timer	\$72.95

Titan Controls Apollo 4 - 120 Volt Ballast Timer

Operates magnetic or electronic ballast up to 1000 watts. IEC 320 power input cord set attaches to any ballast. 24 hour timer can be set for any lighting requirement your plants require. Compatible with digital ballasts. 10 Amps maximum/120 Volts/60 Hz./1000 Watts. 3 Year Warranty.



Item No.	Description	MSRP
734135	Titan Controls Apollo 4 - 120 Volt Ballast Timer	\$74.95

Titan Controls Apollo 5 - 240 Volt Ballast Timer

Operates magnetic or electronic ballast up to 1000 watts. IEC 320 power input cord set attaches to any ballast. 24 hour timer can be set for any lighting requirement your plants require. Compatible with digital ballasts. 10 Amps maximum/240 Volts/60 Hz./1000 Watts. 3 Year Warranty.



Item No.	Description	MSRP
734140	Titan Controls Apollo 5 - 240 Volt Ballast Timer	\$79.95

Titan Controls Apollo 6 - One Outlet Mechanical Timer

24 hour timer is the perfect timing solution for your hydro systems. One (1) outlet. 15 minute intervals. Heavy duty construction. Easy to use & simple to operate. Plastic enclosure resists dust, rust and moisture. Do not use with digital ballasts. 15 Amps maximum/120 Volts/60 Hz. 1 Year Warranty.



Item No.	Description	MSRP
734110	Titan Controls Apollo 6 - One Outlet Mechanical Timer	\$10.95

Titan Controls Apollo 7 - One Outlet Digital Timer

24 hr digital timer is the perfect timing solution for your hydro systems. It's easy to set to run your pumps, fans, etc. One (1) outlet with 1 minute intervals. Battery back-up feature saves settings if power goes out. Do not use with digital ballasts. 15 Amps maximum/120 Volts/60 Hz. HINT: If not working properly, plug in for 5 minutes & press the reset button. Generally fixes the problem. 1 Year Warranty.



Item No.	Description	MSRP
734112	Titan Controls Apollo 7 - One Outlet Digital Timer	\$16.95

Titan Controls Apollo 8 - Two Outlet Mechanical Timer

24 hr timer is the perfect timing solution for your hydro systems. Two (2) outlets. 15 minute intervals. Heavy duty construction. Plastic enclosure resists dust, rust and moisture. Do not use with digital ballasts. 15 Amps maximum/120 Volts/60 Hz. 1 Year Warranty.



Item No.	Description	MSRP
734100	Titan Controls Apollo 8 - Two Outlet Mechanical Timer	\$12.95

Titan Controls Apollo 9 - Two Outlet Digital Timer

24 hr digital timer is the perfect timing solution for your hydro systems. Two (2) outlets with 1 minute intervals. Battery back-up feature saves settings if power goes out. Not for use with digital ballasts. 15 Amps maximum/120 Volts/60 Hz. HINT: If not functioning properly, plug in for 5 minutes and press the reset button. This generally fixes any problem. 1 Year Warranty.



Item No.	Description	MSRP
734105	Titan Controls Apollo 9 - Two Outlet Digital Timer	\$17.95

Titan Controls Apollo 10 - 240 Volt Mechanical Timer

240 Volt/24 hr timer is the perfect timing solution for your hydroponic systems. One (1) outlet with 15 minute intervals. Not for use with digital ballasts. 10 Amps maximum/240 Volts/60 Hz. 1 Year Warranty.



Item No.	Description	MSRP
734145	Titan Controls Apollo 10 - 240 Volt Mechanical Timer	\$14.95

Titan Controls Apollo 11 - 240 Volt Digital Timer

One (1) outlet. 1 minute intervals and run up to 20 schedules per day. Battery back-up feature saves settings in case of power failure. Daylight savings mode to accommodate time change. Do not use with digital ballasts. 10 Amps maximum/240 Volts/60 Hz. 1 Year Warranty.



Item No.	Description	MSRP
734155	Titan Controls Apollo 11 - 240 Volt Digital Timer	\$20.95

Titan Controls Apollo 14 - 8 Outlet Power Strip with Timer

8 outlets - 4 timed/4 constant. 24 hr mechanical programmable timer with 15 min intervals. All outlets surge protected up to 1000 joules. Circuit breaker switch for safety. 5 ft power cord set. Not for use with digital ballasts. 15 Amps maximum/120 Volts/60 Hz. 1 Year Warranty.



Item No.	Description	MSRP
734150	Titan Controls Apollo 14 - 8 Outlet Power Strip w/ Timer	\$25.95

Titan Controls Apollo 12 - Short Cycle Timer With Photocell

Controls timed equipment during daytime only, nighttime only or both. 5 sec to 30 min ON TIME. 5 sec to 60 min OFF TIME. Precise short cycle timing of CO₂, pumps or fans. 15 Amps maximum/120 Volts/60 Hz./1/3 HP. 3 Year Warranty.



Item No.	Description	MSRP
702745	Titan Controls Apollo 12 - Short Cycle Timer w/ Photocell	\$87.95



POWER



Titan Controls Hercules 2 - 50 Amp - High Amperage Controller

A trigger operated controller that allows you to operate up to 50 Amps of lights, heating or air conditioning by wiring 120 or 240 Volt power through the Power Input & connecting your lights, heater or A/C to the Power Output. 50 Amps maximum/120 or 240 Volt/60 Hz. 3 Year Warranty.



Item No.	Description	MSRP
702770	Titan Controls Hercules 2 - 50 Amp Controller	\$194.95



LIGHTING CONTROLS



Titan Controls Apollo 4 - 120 Volt Ballast Timer

Operates magnetic or electronic ballast up to 1000 watts. IEC 320 power input cord set attaches to any ballast. 24 hour timer can be set for any lighting requirement your plants require. Compatible with digital ballasts. 10 Amps maximum/120 Volts/60 Hz./1000 Watts. 3 Year Warranty.



Item No.	Description	MSRP
734135	Titan Controls Apollo 4 - 120 Volt Ballast Timer	\$74.95

Titan Controls Apollo 5 - 240 Volt Ballast Timer

Operates magnetic or electronic ballast up to 1000 watts. IEC 320 power input cord set attaches to any ballast. 24 hour timer can be set for any lighting requirement your plants require. Compatible with digital ballasts. 10 Amps maximum/240 Volts/60 Hz./1000 Watts. 3 Year Warranty.



Item No.	Description	MSRP
734140	Titan Controls Apollo 5 - 240 Volt Ballast Timer	\$79.95

Titan Controls Helios 1 - 4 Light 120 Volt Controller with Timer

Runs 4 HID lights at 120 Volts - Maximum 4000 Watts. The only lighting controllers featuring industrial-grade ballast rated relays. 24 hr timer with 15 minute non-detachable setting tabs. 4 NEMA 5-20 outlets. 50 Amps input power/40 Amps output power/120 Volts/60 Hz./4000 watts. Patent No. D66,252. 3 Year Warranty.

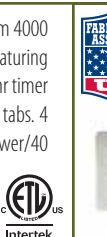

Item No.	Description	MSRP
702660	Titan Controls Helios 1 - 4 Light 120 Volt Controller w/ Timer	\$224.95

Titan Controls Helios 2 - 4 Light 120V Controller with Relay Trigger Cord

Runs 4 HID lights at 120Volts - Maximum 4000 Watts. The only lighting controllers featuring industrial-grade ballast rated relays. Plug relay trigger cord set into 24 hr wall timer. 4 NEMA 5-20 outlets. 50 Amps input power/40 Amps output power/120 Volts/60 Hz./4000 watts. 3 Year Warranty.

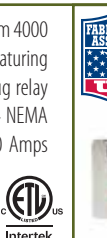

Item No.	Description	MSRP
702665	Titan Controls Helios 2 - 4 Light 120 Volt Controller w/ Relay Trigger Cord	\$199.95

Titan Controls Helios 3 - 4 Light 240V Controller with Timer

Runs 4 HID lights at 240Volts - Maximum 4000 Watts. The only lighting controllers featuring industrial-grade ballast rated relays. 120 Volt accessory timed outlet to activate in-line fans to cool your lamps. Universal outlets allow total flexibility. 30 Amps input power/20 Amps output power/240 Volts/60 Hz./4000 watts. 3 Year Warranty.



Item No.	Description	MSRP
702670	Titan Controls Helios 3 - 4 Light 240 Volt Controller w/ Timer	\$224.95

Titan Controls Helios 4 - 4 Light 240V Controller with Relay Trigger Cord

Runs 4 HID lights at 240 Volts – Maximum 4000 Watts. The only lighting controllers featuring industrial-grade ballast rated relays. 120 Volt accessory timed outlet to activate in-line fans to cool your lamps. Plug relay trigger cord set into 24 hr wall timer. 30 Amps input power/20 Amps output power/240 Volts/60 Hz./4000 watts. 3 Year Warranty.



Item No.	Description	MSRP
702675	Titan Controls Helios 4 - 4 Light Controller w/ Relay Trigger Cord	\$199.95

Titan Controls Helios 5 - 4 Light 240V Controller with Relay Trigger Cord

Runs 4 HID lights at 240 Volts. Plug relay trigger cord set into 24 hr wall timer. The only lighting controllers featuring industrial-grade ballast rated relays. 120 Volt timed accessory outlet (max 2 Amps) for light mover or fan. 30 Amps input power/40 Amps output power/240 Volts/60 Hz./4000 Watts. 3 Year Warranty.



Item No.	Description	MSRP
702671	Titan Controls Helios 5 - 4 Light 240 Volt Controller w/ Relay Trigger Cord	\$207.95

Titan Controls Helios 6 - 8 Light 240V Controller with Dual Trigger Cords

Runs 8 HID lights at 240 volts. The only lighting controllers featuring 2 industrial-grade ballast rated relays. Plug relay trigger cord set into 24 hr wall timer. Removable back panel makes controller easy to wire into your power system. 50 Amps input power/40 Amps output power/240 Volts/60 Hz./8000 Watts. 3 Year Warranty.



Item No.	Description	MSRP
702672	Titan Controls Helios 6 - 8 Light 240 Volt Controller w/ Dual Trigger Cords	\$274.95

Titan Controls Helios 7 - 8 Light 240V Controller with Timer

Runs 8 HID lights at 240 volts. The only lighting controllers featuring industrial-grade ballast rated relays. 24 hr timer with 15 min non-detachable setting tabs. Universal outlets will accept a 120 Volt or 240 Volt ballast cord set. 50 Amps input power/40 Amps output power/240 Volts/60 Hz./8000 Watts. 3 Year Warranty.



Item No.	Description	MSRP
702676	Titan Controls Helios 7 - 8 Light 240 Volt Controller w/ Timer	\$289.95

Titan Controls Helios 8 - 8 Light 240V Controller with Dual Trigger Cords

Runs 8 HID lights at 240 Volts. The only lighting controllers featuring industrial-grade ballast rated relays. Dual trigger cord sets allow the operator to run two separate light timing schedules. 50 Amps input power/40 Amps output power/240 Volts/60 Hz./8000 Watts. 3 Year Warranty.



Item No.	Description	MSRP
702677	Titan Controls Helios 8 - 8 Light 240 Volt Controller w/ Dual Trigger Cords	\$267.95

Titan Controls Helios 9 - Pre-wired 4 Light 240V Controller with Trigger Cord & Timer

Runs 4 HID lights at 240 Volts. The only lighting controllers featuring industrial-grade ballast rated relays. Circuit breakers built right into the controller! Plug relay trigger cord into 24 hour wall timer (included)! 30 Amps input power/20 Amps output power/240 Volts/60 Hz./4000 Watts. 3 Year Warranty.



Item No.	Description	MSRP
702678	Titan Controls Helios 9 - Pre-Wired 4 Light 240 Volt Controller w/ Trigger Cord & Timer	\$299.95

Titan Controls Helios 10 - Pre-wired 8 Light 240V Controller with Trigger Cord & Timer

Runs 8 HID lights at 240 Volts. The only lighting controllers featuring industrial-grade ballast rated relays. Circuit breakers built right into the controller! Plug relay trigger cord into 24 hour wall timer (included)! 50 Amps input power/40 Amps output power/240 Volts/60 Hz./8000 Watts. 3 Year Warranty.



Item No.	Description	MSRP
702679	Titan Controls Helios 10 - Pre-Wired 8 Light 240 Volt Controller w/ Trigger Cord & Timer	\$399.95

Titan Controls Helios 11 - 4 Light 240V Controller with Trigger Cord

Runs 4 HID lights at 240 Volts. The only lighting controllers featuring industrial-grade ballast rated relays. Plug relay trigger cord into 24 hour wall timer to run your lights. Universal outlets allow total flexibility. 30 Amps input power/20 Amps output power/240 Volts/60Hz./4000 Watts. 3 Year Warranty.



Item No.	Description	MSRP
702820	Titan Controls Helios 11 - 4 Light 240 Volt Controller w/ Trigger Cord	\$149.95

Titan Controls Helios 12 - 8 Light 240V Controller with Dual Trigger Cords

Runs 8 HID lights at 240 Volts. The only lighting controllers featuring 2 industrial-grade ballast rated relays. Plug dual relay trigger cord set into 24 hr wall timers to run your lights. Universal outlets allow total flexibility. 50 Amps input power/40 Amps output power/240 Volts/60 Hz./8000 Watts. 3 Year Warranty.



Item No.	Description	MSRP
702825	Titan Controls Helios 12 - 8 Light 240 Volt Controller w/ Dual Trigger Cords	\$234.95

Titan Controls Helios 18 - 12 Light 240V Controller with Dual Trigger Cords

Runs 12 HID lights at 240 Volts. The only lighting controllers featuring industrial-grade ballast rated relays. 2 trigger cords allow the operator to run 2 separate light schedules. Removable front panel makes controller easy to wire. Universal outlets will accept either 120 or 240 Volt power cords. 80 Amps input power/60 Amps output power/240 Volts/60 Hz./12,000 Watts. 3 Year Warranty.



Item No.	Description	MSRP
702843	Titan Controls Helios 18 - 12 Light 240 Volt Controller w/ Dual Trigger Cords	\$449.95

Titan Controls Helios 13 - 16 Light 240V Controller with Timer

Runs 16 HID lights at 240 Volts. The only lighting controllers featuring industrial-grade ballast rated relays. Premium quality timer with battery back-up. 100 Amps input power/80 Amps output power/240 Volts/60 Hz./16,000 Watts. 3 Year Warranty.



Item No.	Description	MSRP
702828	Titan Controls Helios 13 - 16 Light Controller w/ Timer	\$899.95

Titan Controls Helios 14 - 24 Light 240V Controller with Timer

Runs 24 HID lights at 240 Volts. The only lighting controllers featuring industrial-grade ballast rated relays. Premium quality timer with battery back-up. 150 Amps input power/120 Amps output power/220 Volts/60 Hz./24,000 Watts. 3 Year Warranty.



Item No.	Description	MSRP
702832	Titan Controls Helios 14 - 24 Light Controller w/ Timer	\$1,199.95

Titan Controls Helios 15 - 8 Light 240V Controller with Timer

Runs 8 HID lights at 240 Volts. The only lighting controllers featuring industrial-grade ballast rated relays. Reliable 24 hr timer built into the controller. NEMA 6-15 UL listed power outlets. 50 Amps input power/40 Amps output power/240 Volts/60 Hz./8000 Watts. 3 Year Warranty.



Item No.	Description	MSRP
702775	Titan Controls Helios 15 - 8 Light Controller w/ Timer	\$299.99

Titan Controls Helios 16 - 16 Light 240V Controller with Dual Trigger Cords

Runs 16 HID lights at 240 Volts. The only lighting controllers featuring industrial-grade ballast rated relays. 2 trigger cord sets activate lighting controller via external timers. Sequenced lighting delays for each light bank. 100 Amps input power/80 Amps output power/240 Volts/60 Hz./16,000 Watts. 3 Year Warranty.



Item No.	Description	MSRP
702835	Titan Controls Helios 16 - 16 Light 240 Volt Controller w/ Dual Trigger Cords	\$899.95

Titan Controls Helios 17 - 24 Light 240V Controller with Dual Trigger Cords

Runs 24 HID lights at 240 Volts. The only lighting controllers featuring industrial-grade ballast rated relays. 2 trigger cord sets activate lighting controller via external timers. Sequenced lighting delays for each light bank. All duplex outlets have circuit breaker protection. 150 Amps input power/120 Amps output power/240 Volts/60 Hz./24,000 Watts. 3 Year Warranty.



Item No.	Description	MSRP
702840	Titan Controls Helios 17 - 24 Light 240 Volt Controller w/ Dual Trigger Cords	\$1,199.95

Titan Controls Hades 1 - 15 Minute Lighting Delay Timer

Plug the 120 Volt relay trigger cord into the controller and you're protected. This timer makes lighting control safe and simple! Protects your lights from Hot Starts due to power failure. Pre-set 15 minute delay. 15 Amps maximum/120 Volts/60 Hz. 3 Year Warranty.



Item No.	Description	MSRP
702690	Titan Controls Hades 1 - 15 Minute Lighting Delay Timer	\$79.95

Titan Controls Hades 2 - Digital Recycle and Light Timer with High Temp. Shut-Off

Controls up to two light banks via your lighting controller trigger cords, has a high temperature shut-off function to turn off your grow lights and also a hot start protection function to allow your lights to cool before re-striking. Day only, night only or 24 hour mode. This controller has a 3 ft remote sensor. 15 Amps maximum/120 Volts/60 Hz. 3 Year Warranty.



Item No.	Description	MSRP
702856	Titan Controls Hades 2 - Digital Recycle and Light Timer w/ High Temp Shut-Off	\$187.95

Titan Controls Hades 3 - Lighting Timer & High Temp Shut-Off

All in one digital lighting timer for use with trigger cord activated lighting systems! Set the preferred lighting schedule for a 24 hour period, then dial in the high temp limit. It even comes with a battery back-up and a 20 minute delay to avoid hot starts. Plastic enclosure protects from rust, dust and moisture. 6 foot temperature probe is accurate to within 2°F. 120 Volts/ 15 Amps/ 60 Hz. 1 Year Warranty.



Item No.	Description	MSRP
702621	Titan Controls Hades 3 - Lighting Timer w/ High Temp Shut Off	\$124.95

Titan Controls Zephyr 2 - High Temperature Shut-Off with Delay

Controller turns off your lights if temperature exceeds set point. Built-in 0 - 30 minute Hot Start delay with HOLD feature. 6 foot temperature probe is accurate to within 2°F. 15 Amps maximum/120 Volts/60 Hz. 3 Year Warranty.



Item No.	Description	MSRP
702750	Titan Controls Zephyr 2 - High Temp Shut Off	\$87.95

Titan Controls 50 Amp Power Cord

High quality power cords. Use the appropriate cord for your project.



Item No.	Description	MSRP
903198	Power Cord 50 Amp w/ Plug 6 ft 6/2 - 8/1 Gauge	\$17.95

VENTILATION CONTROLS

Titan Controls Mercury 2 - Fan Speed Controller

Adjusts fan speed from 10% - 100%. Fire-up feature extends life of your fan. Easy to operate. Plastic enclosure protects internal components from dust, rust and moisture. 6 Amps maximum/120 Volts/60 Hz. 1 Year Warranty.



Item No.	Description	MSRP
702753	Titan Controls Mercury 2 - Fan Speed Controller	\$75.95

Titan Controls Mercury 3 - Day/Night Fan Controller

Automatically increases or decreases fan speed based on controller set points. Adjustable deadband range to meet garden requirements. Temp control range is 55°F to 95°F. 6 foot temp probe is accurate to within 2°F. 6 Amps maximum/120 Volts/60 Hz. 3 Year Warranty.



Item No.	Description	MSRP
702755	Titan Controls Mercury 3 - Day/Night Fan Controller	\$116.95

Titan Controls Mercury 4 - Multi-Function Fan Speed Controller

Select minimum fan idle speed between 25% & 60% of fan rating. Enables the user to activate/deactivate low temperature safety feature. Temp control range is 55°F to 95°F. 6 foot temp probe is accurate to within 2°F. 6 Amps maximum/120 Volts/60 Hz. 3 Year Warranty.



Item No.	Description	MSRP
702760	Titan Controls Mercury 4 - Multi Function Fan Speed Controller	\$116.95

Titan Controls Nyx 1 - Day/Night Photocontroller

Activate your lamp cooling fan, light mover or night exhaust fan with this straightforward, easy to use controller. Goes from DAY to NIGHT mode with a flip of the switch. 15 Amps maximum/120 Volts/60 Hz. 3 Year Warranty.



Item No.	Description	MSRP
702625	Titan Controls NYX 1 - Day/Night Photocontroller	\$114.95

Titan Controls Kronus 2 - Temperature & Humidity Plus CO2 Integration

Controls exhaust equipment to maintain temperature & humidity set points. Integrated CO2 outlet can activate/deactivate CO2 Controller (Atlas 1) during daytime hours based on temperature & humidity settings. Features programmable delay. 15 Amps maximum/120 Volts/60 Hz. 3 Year Warranty.



Item No.	Description	MSRP
702645	Titan Controls Kronus 2 - Temperature & Humidity Controller	\$349.95

Titan Controls Kronus 4 - Day/Night Temp & Humidity Controller with Night Outlet Plus CO2 Integration

Independent temperature and humidity outlets to control two different devices (i.e fan and dehumidifier). Now featuring programmable delay. Integrated CO2 outlet can activate/deactivate CO2 Controller (Atlas 1) during daytime hours based on temperature settings. 15 Amps/120 Volts maximum/60 Hz. 3 Year Warranty.



Item No.	Description	MSRP
702655	Titan Controls Kronus 4 - Temperature & Humidity Controller w/ Night Outlet	\$399.95

Titan Controls Temperature & Humidity Sensor with Photocell

Remote sensor is specifically designed for the Kronus 2 & 4 controllers. Provides a digitally based signal that reacts quickly to changing temperature and humidity levels in your garden. May be located up to 50 ft from the controller.



Item No.	Description	MSRP
310645	Titan Controls Temperature & Humidity Sensor w/ Photocell	\$99.95

Titan Controls Patch Cord

For use with Titan Controls Kronus models. Cat 5e cables. RJ-45 plugs. Booted connection to avoid corrosion.



Item No.	Description	MSRP
351630	Titan Controls Patch Cord 50 ft	\$18.95

TEMPERATURE & HUMIDITY

Titan Controls Saturn 1 - Analog Temperature & Humidity Controller

Precision temp and humidity control for your plants. Resettable circuit breaker protects your garden. Temp control range = 40°F to 100°F. Humidity control range = 20% to 80%. 15 Amps maximum/120 Volts/60 Hz. 3 Year Warranty.



Item No.	Description	MSRP
702636	Titan Controls Saturn 1 - Temperature & Humidity Controller	\$154.95

Titan Controls Saturn 3 - Digital Temperature, Humidity & CO2 Controller

Temperature control (Day & Night) from 55°F to 95°F. Humidity control (Day & Night) from 20% to 80%. Built-in CO2 sensor and CO2 calibration features. Auxiliary heating and cooling options. 12 Amps maximum/120 Volts/60 Hz. 3 Year Warranty.



Item No.	Description	MSRP
702657	Titan Controls Saturn 3 - Digital Temperature, Humidity & CO2 Controller	\$662.95
702658	Titan Controls Saturn 3 - Auxiliary Output - 1 Unit	\$64.95
702659	Titan Controls Saturn 3 - Auxiliary Output - 2 Units	\$116.95

Titan Controls Saturn 4 - Digital Environmental Controller

The Saturn 4 is a basic environmental controller. Will operate a CO2 controller, fan, dehumidifier and a night only device to keep your garden flourishing. Comes with a 15 ft remote sensor and a photocell for nighttime control. 15 Amps maximum/120 Volts/60 Hz. 3 Year Warranty.



Item No.	Description	MSRP
702850	Titan Controls Saturn 4 - Digital Environmental Controller	\$184.95

Titan Controls Saturn 5 - Digital Environmental Controller with CO2 Timer

Digitally based environmental controller featuring a short cycle timer for CO2 enrichment. It uses a 15 ft remote sensor to operate your temp, humidity, CO2 system & night time gear. Has a LCD display & color coded push buttons for easy programming. Offers min/max data-logging capabilities for temp. & humidity. 15 Amps maximum/120 Volts/60 Hz. 3 Year Warranty.



Item No.	Description	MSRP
702851	Titan Controls Saturn 5 - Digital Environmental Controller w/ CO2 Timer	\$227.95

Titan Controls Saturn 6 - Digital Environmental Controller with CO2 PPM Control

Control of your temperature (day & night), humidity and CO2 PPM levels with digital accuracy. Comes with a 15 ft remote sensor which also features a photocell. LCD display and push buttons allow you to easily change the settings. Has min/max data logging capabilities. 15 Amps maximum/120 Volts/60 Hz. 3 Year Warranty.



Item No.	Description	MSRP
702852	Titan Controls Saturn 6 - Digital Environmental Controller w/ CO2 PPM Control	\$599.95
702494	Titan Controls Saturn 6 RS45 Cable & Software	\$71.95

Titan Controls Eos 1 - Humidify/Dehumidify Controller

Precise humidity control with a 20%-90% range. Change from humidification to dehumidification with a flip of a switch. Controls a humidifier, dehumidifier or fan. Grounded piggy-back cord. 15 Amps maximum/120 Volts/60 Hz. 3 Year Warranty.



Item No.	Description	MSRP
702605	Titan Controls Eos 1 - Humidify/Dehumidify Controller	\$126.95

Titan Controls Eos 2 - Digital Humidity Controller

The Eos 2 is a simple to use digital humidity controller. It can be used to either humidify or dehumidify your growing environment. The knobs allow you to easily set day and night humidity levels. A range of 20% to 90% covers the sweet spot for your plants! 15 Amps maximum/120 Volts/60 Hz. 3 Year Warranty.



Item No.	Description	MSRP
702855	Titan Controls Eos 2 - Digital Humidity Controller	\$91.95

Titan Controls Zephyr 1 - Day/Night Temp Controller

Temperature control range is 55°F to 95°F. Controls cooling or heating equipment. Day and night settings keep temperature within 4°F of set point. 6 ft temp probe is accurate to within 2°F. 15 Amps/120 Volts/60 Hz. 3 Year Warranty.



Item No.	Description	MSRP
702630	Titan Controls Zephyr 1 - Day/Night Temp Controller	\$87.95

Titan Controls Zephyr 3 - Heating/Cooling Controller

Precise temp control of your cooling and heating equipment. 40°F to 100°F gives the operator a great range of settings. Change from Heating to Cooling with just a flip of the switch. Discrete green power light indicates operation of equipment. Built in 4°F split differential. 15 Amps maximum/120 Volts/60 Hz. 3 Year Warranty.



Item No.	Description	MSRP
702845	Titan Control Zephyr 3 - Cooling/Heating Controller	\$84.95

Titan Controls Zephyr 4 - Cooling Thermostat - Fan Control

Easy to use - plug fan into receptacle, then plug control into 120 volt power supply. Set thermostat to the temperature you want the fan to come on at and that's it! 1 Year Warranty.



Item No.	Description	MSRP
736167	Titan Controls Zephyr 4 - Cooling Thermostat Fan Control	\$79.95

MyCO2 Mushroom Bag - Bloom

MyCO2 - Mycelium Derived Carbon Dioxide are CO2 bags perfected. MyCO2 has the patent pending customer activation technology, postponing the CO2 cultivation until you get it home and are ready to use it. Use during the flowering stage.



Item No.	Description	MSRP
749400	MyCO2 Mushroom Bag - Bloom	\$34.95

MyCO2 Mushroom Bag - Grow

MyCO2 - Mycelium Derived Carbon Dioxide are CO2 bags perfected. MyCO2 has the patent pending customer activation technology, postponing the CO2 cultivation until you get it home and are ready to use it. Use during the veg stage.



Item No.	Description	MSRP
749405	MyCO2 Mushroom Bag - Grow	\$34.95

GROZONE CONTROL



At Grozone Control, we think that making sure tools are available for you is the right thing to help you grow greener, smarter and more efficient.

Grozone Control TP1 Day/Night Tempstat

Controls cooling or heating equipment according to a daytime or nighttime setpoint. 6 foot cord with temperature sensor precise to 2°F/1°C. Can power 120V equipment up to 15 amps. Typical control differential 2°F/1°C. 3 year Warranty.



Item No.	Description	MSRP
780100	Grozone Control TP1 Day/Night Tempstat	\$87.95

Grozone Control TP2 Adjustable Differential Tempstat

Controls cooling or heating equipment according to a setpoint and an adjustable differential from 4°F to 20°F/2°C to 11°C. 6 foot cord with temperature sensor precise to 2°F/1°C. Can power 120V equipment up to 15 amps. 3 year Warranty.



Item No.	Description	MSRP
780101	Grozone Control TP2 Adjustable Differential Tempstat	\$87.95

Grozone Control TP3 High Temperature Shut-Off Tempstat

Automatically shuts down lighting and/or other equipment when a high temperature setpoint is reached. 6 foot cord with temperature sensor precise to 2°F/1°C. Can power 120V equipment up to 15 amps. 3 year Warranty.



Item No.	Description	MSRP
780102	Grozone Control TP3 High Temperature Shut-Off Tempstat	\$87.95

Grozone Control CY1 Cyclestat with Day/Night Sensor

Controls any 120V equipment such as pumps or fans on a periodic repeat cycle. The ON duration spans from 10 sec to 20 minutes. The OFF duration spans from 1 minutes to 12 hours. The unit can function day and night or during day time only. 3 year Warranty.



Item No.	Description	MSRP
780103	Grozone Control CY1 Cyclestat with Day/Night Sensor	\$87.95

Grozone Control CY2 Short Period Cyclestat with Day/Night Sensor

Controls any 120V equipment such as pumps or fans on a periodic repeat cycle. The ON duration spans from 5 sec to 30 minutes. The OFF duration spans from 5 sec to 60 minutes. The unit can function day and night or during day time only. 3 year Warranty.



Item No.	Description	MSRP
780104	Grozone Control CY2 Short Period Cyclestat w/ Day/Night Sensor	\$87.95

Grozone Control CY3 Digital Cyclestat with Day/Night Sensor and Bargraph Display

Controls any 120V equipment such as pumps or fans on a periodic repeat cycle. Features day and night distinct cycles. Displays time countdown on bargraph readout. The ON duration spans from 5 sec to 60 minutes. The OFF duration spans from 1 minutes to 12 hours. 3 year Warranty.



Item No.	Description	MSRP
780105	Grozone Control CY3 Digital Cyclestat with Day/Night Sensor & Bargraph Display	\$170.95

Grozone Control TV1 Day/Night Fan Speed Control

Automatically slows down or speeds up centrifugal fans to respect user selected temperature day and night setpoints. TV1 will yield a variation below 2°F/1°C. 6 foot cord with temperature sensor precise to 2°F/1°C. Can drive single phase 120 V induction motor type fans up to 750 Watts. 3 year Warranty.



Item No.	Description	MSRP
780106	Grozone Control TV1 Day/Night Fan Speed Control	\$116.95

Grozone Control TV2 Multimode Fan Speed Control

Automatically slows down or speeds up centrifugal fans to respect user selected temperature setpoints. Enables the user to select the minimum fan speed (Idle Speed) between 25% and 60% of full power in 5% steps. 6 foot cord with temperature sensor precise to 2°F/1°C. Can drive single phase 120 V induction motor type fans up to 750 Watts. 3 year Warranty.



Item No.	Description	MSRP
780107	Grozone Control TV2 Multimode Fan Speed Control	\$116.95

Grozone Control DIM1 Fan Speed Dimmer with Optional Kick Start

Manual setting to slow down centrifugal fan speed between 10% and 100% of full power. Enables the user to activate/deactivate a 'Kick start' at power up or power failure return, to improve larger fan start-up. Can drive single phase 120 V induction motor type fans up to 750 Watts. 3 year Warranty.



Item No.	Description	MSRP
780108	Grozone Control DIM1 Fan Speed Dimmer w/ Optional Kick Start	\$75.95

Grozone Control OSW On/Off 120V Switcher (Trigger Cord)

Can turn on or shut off any piece of equipment by mean of a low-current 120V sense cord. On/Off switching functions (upper/lower receptacles) in one single module for increased flexibility. 3 year Warranty.



Item No.	Description	MSRP
780109	Grozone Control OSW On/Off 120 Volt Switcher (Trigger Cord)	\$69.95

Grozone Control OSWDN On/Off 120V Switcher (Day/Night Sensor)

The new OSWDN 120V switcher can turn on or shut off your equipment according to the day/night condition instead of the trigger cord voltage. The OSWDN photocell sensitivity can also be adjusted to modify the Day/Night threshold level for dark days or clear nights conditions. 3 year Warranty.



Item No.	Description	MSRP
780110	Grozone Control OSWDN On/Off 120 Volt Switcher (Day/Night Sensor)	\$87.95

Grozone Control SC02 0-5000 PPM CO2 Controller "Simple One Series"

This easy to use CO2 controller determines precisely when to activate and shut-off CO2 generators to maintain user-defined LOW and HIGH CO2 values in the grow room. The unit can deactivate CO2 enrichment during the night cycle and perform CO2 evacuation as well. The CO2 sensor is located in the controller box. 3 year Warranty.



Item No.	Description	MSRP
780111	Grozone Control SC02 0-5000 PPM CO2 Controller - Simple One Series	\$496.95

Grozone Control CO2R 0-5000 PPM CO2 Controller with AUX Output and High Temp

This easy to use CO2 controller determines precisely when to activate and shut-off CO2 generators to maintain user-defined LOW and HIGH CO2 values in the grow room. The unit can deactivate CO2 enrichment during the night cycle and perform CO2 evacuation as well. NEW: the CO2R now includes a High Temperature Shut Off. 3 year Warranty.



Item No.	Description	MSRP
780112	Grozone Control CO2R 0-5000 PPM CO2 Controller w/ AUX Output & High Temp	\$559.95

Grozone Control CO2D 0-5000 PPM Dual Zone CO2 Controller

Controls the CO2 levels in two zones simultaneously. Review performance by reading through the integrated 24-hour data logger. Special operating mode to operate two zones with only one CO2 generator. Zone remote sensors include 25 ft cables. Affordable alternative when operating multiple zones. 3 year Warranty.



Item No.	Description	MSRP
780113	Grozone Control CO2D 0-5000 PPM Dual Zone CO2 Controller	\$865.95

Grozone Control USCO2 0-2000 PPM Single Zone Ultra Simple CO2 Controller

No bells and whistles, just connect your CO2 generator and you're set! This is Grozone's beginner solution for growers looking for affordable and easy-to-use CO2 controller. User can select one among five preset CO2 control values. User can select one among five preset Elevation values. 3-LED Display shows ambient CO2 value. Day/Night detection to turn off CO2 enrichment during the night. 3 year Warranty.



Item No.	Description	MSRP
780114	Grozone Control USCO2 0-2000 PPM Single Zone Ultra Simple CO2 Controller	\$266.95

Grozone Control HTC Climate Controller (Temp, rH and CO2) Two Outputs with Digital Display

Remote sensor provides higher precision and reliability. Performs any two of the following control functions: heating, cooling, humidifying, dehumidifying, cooling and dehumidifying, hourly ventilation. Review performance by reading through the integrated 24-hour data logger. Incorporates fail-safe values for each output in case of sensor problem. 3 year Warranty.



Item No.	Description	MSRP
780115	Grozone Control HTC Climate Controller (Temp, RH, & CO2) Two Outputs w/ Digital Display	\$662.95

Grozone Control SCC1 Temperature, Humidity and CO2 Controller "Simple One Series"

An easy-to-use alternate solution to HTC Climate Controller: just connect your fan, your dehumidifier or humidifier, your CO2 generator, set the knobs and you're ready! Two built-in LVC1 to control high power HVAC Systems. Also includes these smart features: Empty CO2 tank detection, Automatic competing equipment detection and high temp and low temp limits. 3 year Warranty.



Item No.	Description	MSRP
780116	Grozone Control SCC1 Temperature, Humidity, & CO2 Controller - Simple One Series	\$662.95

Grozone Control HT2 Climate Controller (Temp and rH) Single Output Bargraph Display

Day and night temperature settings: 48°F to 104°F. Day and night humidity settings: 10% to 100%. User can select one among five operating modes. User-set low-temperature limit. Remote sensor with 25 ft cable (included). Bargraph display. 15 Amps Output. 3 year Warranty.



Item No.	Description	MSRP
780117	Grozone Control HT2 Climate Controller (Temp & RH) Single Output Bargraph Display	\$218.95



We are your #1 source for cost-effective solutions that allow you to safely and easily install 240-volt power in your hydroponics garden for running your high-wattage grow lights. Designed and built in California, Powerbox is a name you can rely on. Our controllers have been independently tested and listed by ETL.

Powerbox DPC-4000-240V-4P

The DPC-4000-240V is a versatile 240 Volt lighting controller that can effortlessly run up to four 1,000 watt lights. This model connects to a 3 or 4-wire 240 Volt service and in many cases, you can plug right into an existing dryer-type outlet. 5 Year Warranty.



Item No.	Description	MSRP
702915	Powerbox DPC-4000-240 Volt -4P	\$245.00

Powerbox DPC-7500-120V-4P

This lighting controller connects to a 4-wire 240 Volt service but provides six 120 Volt outlets (5-15r) that allow you to run up to 60 amps at 120 Volts. Usually, you can plug this unit right into an existing dryer-type outlet (14-30r). 5 ft main power cord – plug & play (14-30p). 5 Year Warranty.



Item No.	Description	MSRP
702930	Powerbox DPC-7500-120 Volt -4P	\$379.00

Powerbox DPC-7500-240V-4P

A versatile 240V lighting controller that can effortlessly run up to six 1000 Watt lights. Connects to a 3 or 4-wire 240 Volt service and in many cases, you can plug right into an existing dryer-type outlet. 5 ft main power cord, plug & play (10-30p or 14-30p). 5 Year Warranty.



Item No.	Description	MSRP
702920	Powerbox DPC-7500-240 Volt -4P	\$356.00

Powerbox DPC-7500-COMBO-4P

A versatile 240V lighting controller that provides four 240 Volt outlets and two 120V outlets. Connects to a 4-wire 240 Volt service and in many cases, you can plug right into an existing dryer-type outlet. 5 ft main power cord - plug & play (14-30p). 5 Year Warranty.



Item No.	Description	MSRP
702925	Powerbox DPC-7500-COMBO-4P	\$369.00

Powerbox DPC-8000-240V-4P

A 240 Volt lighting controller, you can control up to eight 1000 watt lights from one timer. Eight NEMA type 6-15 240 Volt outlet receptacles. 4 ft main power cord - Plug & play NEMA 14-50P, 4-Prong Plug. 5 Year Warranty.



Item No.	Description	MSRP
702935	Powerbox DPC-8000-240 Volt -4P	\$397.00

Powerbox DPC-12000

Can run up to ten 1000 watt lights, plus 120 Volt accessories - safely and reliably. 50 Amp or 60 Amp main capacity. Detachable trigger cord can override the built-in timer. Ten timed 240 Volt outlets (6-15r) and five 120 Volt outlets (5-15r). Plug & play (14-50p) or hardwire. 5 Year Warranty.



Item No.	Description	MSRP
702940	Powerbox DPC-12000-50A-4P (Plug & Play)	\$779.00
702945	Powerbox DPC-12000-60A-4HW (Hardwire)	\$789.00

Powerbox DPC-12000-D-60A-4HW

Runs up to twelve 1000 watt lights at 240 Volts. This is a dual trigger cord model with no built-in timer. Outlets are separated into 2 banks - each bank has six 240V outlets (6-15r) and three 120V outlets (5-15r). 30 Amp, 50 Amp or 60 Amp main capacity. 5 Year Warranty.



Item No.	Description	MSRP
702950	Powerbox DPC-12000-D-60A-4HW	\$819.00

Powerbox DPC-15000

Runs up to ten 1000 watt lights, plus 120 Volt accessories - safely and reliably. 50 Amp or 60 Amp main capacity. Ten timed 240 Volt outlets (6-15r) and five 120 Volt outlets (5-15r). Plug & play (14-50P) or hardwire. Built-in AUBE digital timer with battery backup. 5 Year Warranty.



Item No.	Description	MSRP
702955	Powerbox DPC-15000-50A-4P (Plug & Play)	\$799.00
702960	Powerbox DPC-15000-60A-4HW (Hardwire)	\$819.00

Powerbox DPC-15000TD

Powers ten 1000 watt lights at 240 Volts, plus it has a special feature to protect the life of your bulbs during power failures. Dial-in a delay of 1 to 10 minutes before your lights will restart when power is restored. Ten timed 240 Volt outlets (6-15r) and five 120 Volt outlets (5-15r) with built-in digital timer with battery backup. 5 Year Warranty.



Item No.	Description	MSRP
702965	Powerbox DPC-15000TD-50A-4P (Plug & Play)	\$899.00
702970	Powerbox DPC-15000TD-60A-4HW (Hardwire)	\$929.00

ENVIRONMENTAL CONTROLS

Powerbox OG Flipbox

The Flipbox is an individual light switching module that allows an individual ballast to run two separate lights - one at a time - by switching back and forth between each light, at a user-specified interval. Voltage independent - works with 120 Volt and 240 Volt ballasts. Fits Sunlight Supply style ballasts. 5 Year Warranty.



Item No.	Description	MSRP
702975	Powerbox OG Flipbox	\$167.00

Powerbox LSM-8 Flipbox

A 4 ballast, 8 light Flipbox that allows you to run 8 lights from 4 ballasts. Convenient single unit with built-in timer. Voltage independent - works with 120 Volt and 240 Volt ballasts. Fits Sunlight Supply style ballasts. 5 Year Warranty.



Item No.	Description	MSRP
702980	Powerbox LSM-8 Flipbox	\$549.00

Powerbox LSM-12 Flipbox

A 6 ballast, 12 light Flipbox that allows you to run 12 lights from 6 ballasts. The Flipbox LSM-12 has a built-in digital timer with battery backup. Voltage independent - works with 120 Volt and 240 Volt ballasts. Fits Sunlight Supply style ballasts. 5 Year Warranty.



Item No.	Description	MSRP
702985	Powerbox LSM-12 Flipbox	\$749.00

Powerbox LSM-16 Flipbox

A 8 ballast, 16 light Flipbox that allows you to run 16 lights from 8 ballasts. Convenient single unit with built-in timer. Voltage independent - works with 120-volt and 240-volt ballasts. Fits Sunlight Supply style ballasts. 5 Year Warranty.



Item No.	Description	MSRP
702990	Powerbox LSM-16 Flipbox	\$949.00

Powerbox LSM-20 Flipbox

A 10 ballast, 20 light Flipbox that allows you to run 20 lights from 10 ballasts. Paired with a DPC-15000 and 10 electronic ballasts, you can run 20 lights from just 50 Amps at 240 Volts. Voltage independent - works with 120 Volt and 240 Volt ballasts. Fits Sunlight Supply style ballasts. 5 Year Warranty.



Item No.	Description	MSRP
702995	Powerbox LSM-20 Flipbox	\$1,149.00

LIGHTSPEED FLIP

Lightspeed Controller FLIP 4 Lighting Flip Box

Lightspeed Flip 4 Lighting Controller powered by Allen Bradley. Automated 2 ballasts, 4 lights switching unit, allows you to run 4 lights from 2 ballasts. Works with any ballasts plugged into any voltage. Heavy duty Lightspeed construction, these units are built to last! Can be used with any 120V timer. 1 year Warranty.



Item No.	Description	MSRP
706100	Lightspeed Controller FLIP 4 Lighting Flip Box	\$286.95

Lightspeed Controller FLIP 8 Lighting Flip Box

Lightspeed Flip 8 Lighting Controller powered by Allen Bradley. Automated 4 ballast, 8 light switching unit, allows you to run 8 lights from 4 ballasts. Works with ballasts plugged into any voltage. Heavy duty Lightspeed construction, these units are built to last! Can be used with any 120V timer. 1 year Warranty.



Item No.	Description	MSRP
706101	Lightspeed Controller FLIP 8 Lighting Flip Box	\$475.95

Lightspeed Controller FLIP 16 Lighting Flip Box

Lightspeed Flip 16 Lighting Controller powered by Allen Bradley. Automated 8 ballast, 16 light switching unit, allows you to run 16 lights from 8 ballasts. Works with ballasts plugged into any voltage. Heavy duty Lightspeed construction, these units are built to last! Can be used with any 120V timer. 1 year Warranty.



Item No.	Description	MSRP
706102	Lightspeed Controller FLIP 16 Lighting Flip Box	\$858.95

Lightspeed Controller FLIP 20 Lighting Flip Box

Lightspeed Flip 20 Lighting Controller powered by Allen Bradley. Automated 10 ballast, 20 light switching unit, allows you to run 20 lights from 10 ballasts. Works with ballasts plugged into any voltage. Heavy duty Lightspeed construction, these units are built to last! Can be used with any 120V timer. 1 year Warranty.



Item No.	Description	MSRP
706103	Lightspeed Controller FLIP 20 Lighting Flip Box	\$1,079.95



Hydro Innovations is a young, dynamic company started and owned by an experienced indoor gardener. As our name implies, we believe that there are a lot of “thinking out of the box” innovations that can be made to improve indoor gardening, primarily in the area of heat control, which is our focus.

Hydro Innovations Ice Cap Heat Scrubber

This accessory for the HydroGEN and HydroGEN PRO uses a heat exchanger and a fan to cool the last little bit of heat left over in the CO2 produced by the generators. Adding the Ice Cap can take the water cooling efficiency from 86% to 98%!



Item No.	Description	MSRP
703751	Hydro Innovations Ice Cap Heat Scrubber	\$146.00

HydroGen Pro Water Cooled CO2 Generator

The HydroGEN PRO is the world's first and only water cooled CO2 generator. Water cooling can remove 86% of the heat produced by burning propane and has many features not available in any other CO2 generator on the market. The optional valve (used in place of a pump) is designed to be installed in a pressurized water line and to be controlled by your CO2 monitor. 1 Year Warranty.



Item No.	Description	MSRP
703740	HydroGen Pro Water Cooled CO2 Generator LP	\$429.95
703745	HydroGen Pro Water Valve	\$85.95
703750	HydroGen Pro LP to NG Conversion Kit	\$79.95

HydroGen Water Cooled CO2 MiniGen Generator

A propane fueled CO2 generator that comes with a removable heat exchanger that allows you to use the MiniGEN with or without water cooling. Designed for use in small gardens (10 ft x 10 ft or less). 1,250 BTU/hr burner is operated by an electronic ignition with no standing pilot light.



Item No.	Description	MSRP
703755	HydroGen Water Cooled CO2 MiniGen Generator LP	\$354.95

Hydro Innovations HydroGen CO2 Monitor

Calibrated and maintenance free, the HydroGen CO2 Monitor utilizes top quality SenseAir brand CO2 detection technology. Will work with any CO2 generator or bottle regulator. Programmed to turn on at 1300 ppm and off at 1500 ppm. 120 Volt switched piggyback cord.



Item No.	Description	MSRP
703746	Hydro Innovations HydroGen CO2 Monitor	\$364.95

LuxPro Programmable Digital Thermostat

Programmable outlet thermostat allows control any 120V device up to 15 amps. Use with a fan or air conditioner for cooling. Also may be used with a space heater for heating. 12 hr clock only. 2 G13A size 1.5V batteries included (for clock only). Battery free memory storage. 5 min. short cycle protection. Time & temp. alternate in display. 3 Year Warranty.



Item No.	Description	MSRP
734130	Luxpro Programmable Digital Thermostat	\$74.95

Digital Short Cycle Timer

Controls any device to be turned on and off at precise intervals. It has a large digital LCD display. ON or OFF times are 10 sec and 24 hrs respectively. A photo sensor with user controlled day/night/both button, allows users to select the photo period. A built in backup battery. 120 Volts/15 Amps/60 Hz. 1 Year Warranty.



Item No.	Description	MSRP
734170	Digital Short Cycle Timer	\$49.95

Gavita Master Controllers

The Gavita EL controller series currently comprises of two models: The EL1 and EL2. Both feature auto-dim, auto-shutdown, sunrise/sunset and timer. The EL1 has one output channel, while the EL2 has 2 output channels and additional outputs for External Contactor Modules and alarm contacts. 3 year Warranty.



Item No.	Description	MSRP
906080	Gavita Master Controller EL1	\$279.00
906081	Gavita Master Controller EL2	\$359.00

Gavita ECM1 - External Contactor Modules

External Contactor Module (15A) with blue indication LED follows lights-on for main channel. Use ECMs to switch CO2, fertigation, heating etc. during lights-on or lights-off cycle. ECMs can be positioned close to the actual accessories. Cable outputs with female and male connector allow easy connection of accessories. 3 year Warranty.



Item No.	Description	MSRP
906082	Gavita ECM1 US 120 - External Contactor Module 120 Volt Plugs	\$99.50
906083	Gavita ECM1 US 240 - External Contactor Module 240 Volt Plugs	\$99.50

Follow us on Facebook and Twitter. You will get up to date information on new products, events and educational articles.



You can also find us on YouTube, Google Plus and Pinterest



Hyperfan™

Industry exclusive **5 YEAR WARRANTY** **PHRESH**

Hyper Fan™ Features:

- Laminar Flow Fan Blade & Stator Technology creates optimal airflow similar in technology to an airplane propeller. The result is very high CFMs and exceptional static pressure performance.
- Hyperfans deliver the highest CFM's per watt of any fan in the industry.
- State-of-the-art digitally controlled DC powered Electronically Commutated Motor (ECM) is extremely quiet, long lasting and very reliable. Best of all, this unique technology uses about half the power as traditional fans.
- The included speed controller can adjust fan speed from 30% to 100%. It is detachable from the fan and independent from the power cord.
- Lightweight aluminum housing is one-third the weight of comparable steel bodied fans. They are compact and easy to install.
- Universal mounting positions – can be mounted in any position allowing maximum flexibility during installation.
- Heavy-duty 6/8/10 mm bearings, versus commonly used 4 mm bearings, ensure smoother operation and increased longevity of the fan.

www.Hyper-Fans.com

Hyper Fan

Best in its' class - delivering the highest CFM's per watt of any fan in the industry. Hyper Fan's develop higher static pressures and higher airflows than any other mixed flow fans in the market. They are the answer to a unified environmental solution for your garden. Every fan includes a detachable, fully-adjustable speed control. 5 Year Warranty.

Item No.	Description	Amps	Watts	MSRP
701400	Hyper Fan 6 in Digital Mixed Flow Fan 315 CFM	0.50	35	\$196.95
701405	Hyper Fan 8 in Digital Mixed Flow Fan 710 CFM	1.00	75	\$242.95
701410	Hyper Fan 10 in Digital Mixed Flow Fan 1065 CFM	2.10	170	\$306.95



Hyperfan Stealth™

HIGHEST SOUND REDUCTION OF ANY SILENCED FAN ON THE MARKET!

5 YEAR WARRANTY

6" | 315cfm | 35watts
8" | 710cfm | 75watts
10" | 1065cfm | 170watts

www.Hyper-Fans.com **Industry exclusive**

INTRODUCING THE NEW ULTIMATE SOUND REDUCING COMBO!
 STATE-OF-THE-ART DIGITALLY CONTROLLED MIXED FLOW HYPER FAN™

NOISE REDUCING, ACOUSTIC FOAM LINED DUCT SILENCER!

75% REDUCTION IN SOUND!



Hyper Fan Stealth

Hyper Fan's Laminar Flow Fan Blade & Stator Technology create optimal airflow similar in design to an airplane jet engine. The result is very high CFM's and exceptional static pressure performance. The Hyper Fan Stealth delivers the highest CFM's per watt of any silenced fan in the industry. A speed controller and integrated mounting brackets are included. 5 Year Warranty.

Item No.	Description	Amps	Watts	MSRP
701420	Hyper Fan Stealth 6 in 315 CFM	0.50	35	\$282.95
701425	Hyper Fan Stealth 8 in 710 CFM	1.00	75	\$349.95
701430	Hyper Fan Stealth 10 in 1065 CFM	2.10	170	\$449.95

extremely quiet | very compact size | proven aerodynamic performance | easy to install | maximum efficiency | lightweight sealed housing | lower monthly costs | extremely quiet

Hurricane *New*
AFTER BURNER™
High Output Mixed Flow Fans

Industry exclusive FIVE YEAR WARRANTY

NEW LOWER PRICE

hurricane-fans.com

ETL Intertek

Hurricane After Burner High Output Mixed Flow Fans

After Burner High Output Mixed Flow Fans offer superior performance and outstanding efficiency. The powerful motor and injection molded plastic blade create forceful CFM's while withstanding heavy amounts of static pressure. With a foam cushioned mounting bracket, the After Burners operate with less noise than traditional inline fans. Installation is very simple and each fan comes pre-wired with a 7 foot 120 volt power cord. 5 Year Warranty.

Item No.	Description	Amps	Watts	MSRP
736130	Hurricane After Burner Inline Fan 6 in 335 CFM	0.60	69	\$163.95
736135	Hurricane After Burner Inline Fan 8 in 660 CFM	1.50	161	\$199.95
736140	Hurricane After Burner Inline Fan 10 in 1000 CFM	1.70	197	\$254.95

high performance | mounting brackets included | quiet operation | extremely reliable | quality steel housing | easy installation | powder coated finish | high performance | quiet operation | extremely reliable | quality steel housing | easy installation | powder coated finish

Hurricane™
COMMERCIAL-GRADE INLINE FANS

Industry exclusive FIVE YEAR WARRANTY

www.hurricane-fans.com

ETL Intertek

Hurricane Centrifugal Inline Fans

Commercial grade, high performance fans have housings made of steel with a durable powder coated finish. Made with quality UL components for quiet operation. Include mounting brackets with easy to follow instructions. Come with an 8 ft 120V power cord. 5 Year Warranty.

Item No.	Description	Amps	MSRP
736570	Hurricane Inline Fan 4 in 171 CFM	1.00	\$104.95
736575	Hurricane Inline Fan 6 in 435 CFM	1.00	\$129.95
736580	Hurricane Inline Fan 8 in 745 CFM	1.70	\$169.95
736585	Hurricane Inline Fan 10 in 780 CFM	2.10	\$219.95
736590	Hurricane Inline Fan 12 in 1060 CFM	3.10	\$259.95

FANS/VENTILATION/DUCTING & ACCESSORIES

Fantech Inline Mixed Flow Fan FKD Series

Fantech FKD direct drive, mixed flow centrifugal fans blend the high flow of axial fans with the higher pressure, non-overloading characteristics of backward curved impellers. Automatic reset thermal overload protection and sealed ball bearings. External terminal box with prewired electrical strip. 100% speed controllable. Check your Dealer Partner for availability. 3 Year Warranty.



Item No.	Description	Amps	Watts	MSRP
736105	Fantech Indoor Inline Mixed Flow 8 in Fan FKD 8XL 837 CFM	2.99	318	\$594.95
736290	Fantech Indoor Inline Mixed Flow 10 in Fan FKD 10XL 1267 CFM	4.48	485	\$686.95
736120	Fantech Indoor Inline Mixed Flow 12 in Fan FKD 12XL 2013 CFM	4.70	467	\$866.95
736124	Fantech Indoor Inline Mixed Flow 14 in Fan FKD 14XL 2621 CFM	6.40	716	\$1,470.95

Fantech Inline Centrifugal Fans FG Series

Airtight galvanized shell housing is perfect for commercial applications. Powered by ebm-papst external rotor motorized impeller for excellent heat dissipation. Permanently lubricated sealed ball bearings. Automatic reset thermal overload protection. 100% speed controllable. Rated for airstream temperatures up to 140°F. Power cord and strain relief included, but not wired in. 5 Year Warranty.



Item No.	Description	Amps	Watts	MSRP
736405	Fantech Indoor Inline 6 in Centrifugal Fan FG 6XL 483 CFM	1.48	153	\$247.95
736415	Fantech Indoor Inline 8 in Centrifugal Fan FG 8XL 502 CFM	1.45	142	\$274.95
736090	Fantech Indoor Inline 10 in Centrifugal Fan FG 10XL 589 CFM	1.96	196	\$302.95
736100	Fantech Indoor Inline 12 in Centrifugal Fan FG 12XL 940 CFM	3.01	301	\$391.95



FG SERIES

THE INDUSTRY STANDARD FOR INLINE DUCT FANS JUST GOT BETTER!

The company that invented the circular duct fan more than thirty years ago, now introduces new improved inline fans that are **virtually airtight**. New production processes eliminate manufacturing variances to ensure tight tolerances for optimal performance of every fan. Galvanized steel housings meet code requirements for both residential and commercial applications. High quality ebm-papst motors ensure long life and dependable performance.

Simplified Installation:

The FG Series features new longer duct connections for easier installation. Fans are prewired and include bracket for mounting to wall or ceiling.

Straight-through airflow allows fans to be installed at any angle at any point along the ductwork.

FKD SERIES

ROUND INLINE MIXED FLOW CENTRIFUGAL FANS

Fantech FKD direct drive, mixed flow centrifugal fans blend the high flow of axial fans with the higher pressure, non-overloading characteristics of backward curved impellers. An excellent choice for exhaust or supply applications where quieter performance and easy installation are important. Perfect for commercial and institutional structures such as offices, hospitals, beauty salons, veterinary clinics as well as residential applications such as kitchen range hood exhaust.

FKD straight-through inline design fans are available in a wide range of sizes for easy installation in duct sizes from 8" to 20". Fans can be mounted at any angle at any point along the duct work. Motors are capable of operating in airstream temperatures up to 140°F. Motor bearings are permanently sealed, self lubricating ball type.



Industry exclusive



Look for the Energy Star Rated Models in Performance Data Chart on back page



Fantech, Inc. certifies that the models shown herein are licensed to bear the AMCA Seal. The ratings are based on tests and procedures performed in accordance with AMCA Publication 211 and comply with the requirements of the AMCA Certified Ratings Program.



THREE YEAR WARRANTY



Fantech Inc. and Systemair Inc. certify that the FKD Series shown herein is licensed to bear the AMCA Seal. The ratings shown are based on tests and procedures performed in accordance with AMCA Publication 211 and AMCA Publication 311 and comply with the requirements of the AMCA Certified Ratings Program.



www.fantech.net

Atmosphere Vortex Inline Powerfans

Speed controllable and balanced motors with permanently lubricated ball bearings ensure vibration-free operation. The Vortex Powerfan comes with a 6 ft power cord, ready to plug in, installed by the manufacturer. 10 Year Warranty.



Item No.	Description	MSRP
736700	Vortex Inline Fan 4 in 175 CFM	\$168.95
736705	Vortex Inline Fan 6 in 452 CFM	\$215.95
736710	Vortex Inline Fan 8 in 747 CFM	\$270.95
736715	Vortex Inline Fan 10 in 790 CFM	\$290.95
736720	Vortex Inline Fan 12 in 1140 CFM	\$412.95

Atmosphere Vortex Powerfans S-line

A revolutionary series of fans that combine energy efficiency, ultra-quiet operations and a collection of advanced technologies that deliver unparalleled performances. Extremely energy efficient AC brushless motor powers the patented mixed-flow dual impellers. Built with double insulated walls, noise is reduced to levels that were previously thought to be unattainable. 10 Year Warranty.



Item No.	Description	MSRP
736708	Vortex S Line S-600 6 in Fan 347 CFM	\$209.99
736712	Vortex S Line S-800 8 in Fan 728 CFM	\$254.99

Atmosphere Vortex Powerfans V-Series

This fan is powered by a permanently lubricated & balanced external rotor motor equipped with a mixed-flow impeller. This impeller is a cross between axial & centrifugal design allowing more air volume. It operates at lower RPM making them quieter. Power cord kit NOT included in V-16XL Series. 3 Year Warranty.



Item No.	Description	MSRP
736690	Vortex V-12XL Inline Fan 12 in 2050 CFM	\$864.95
736691	Vortex V-14XL Inline Fan 14 in 2905 CFM	\$1,399.95
736698	Vortex V-16XL Inline Fan 16 in 4515 CFM	\$2,289.95

Vortex Replacement Mounting Brackets

Made from galvanized steel, the mounting brackets are available for all sizes of Vortex Powerfans. They are made to be mounted in all positions either horizontally or vertically. For use with Vortex Power Fans, but not the V-Series Fans.

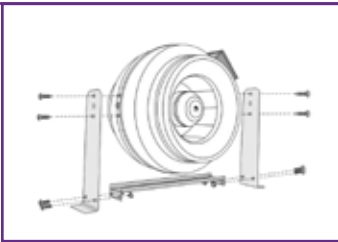

Item No.	Description	MSRP
736706	Vortex Mounting Bracket 4 in	\$11.50
736704	Vortex Mounting Bracket 6 in, 8 in & 10 in	\$14.95
736701	Vortex Mounting Bracket 12 in	\$16.95

Can-Fan Speed Controller - Variable Voltage

This Can-Fan variable voltage speed controller is for all 120 volt, 60 hz. fans with less than 7.5 amps drawn. This product provides smooth sinusoidal wave, so there is no growl at running speed.



Item No.	Description	MSRP
736872	Speed Controller Variable Voltage	\$299.98

Can-Fan Inline Fans

Can-Fan bring its innovation to market and sets a new standard for performance. The outstanding performance of our fans set them apart from the competition. Each fan comes pre-wired with an 8 ft - 120 volt power cord. 5 Year Warranty.



Item No.	Description	Amps	Watts	MSRP
736780	Can-Fan S 4 in 120 CFM	0.69	68	\$131.03
736785	Can-Fan RS 4 in HO 155 CFM	1.15	78	\$155.55
736790	Can-Fan S 6 in 269 CFM	0.69	82	\$146.57
736795	Can-Fan RS 6 in HO 392 CFM	1.15	138	\$186.66
736800	Can-Fan S 8 in 483 CFM	1.16	139	\$164.34
736805	Can-Fan RS 8 in HO 722 CFM	2.36	283	\$246.51
736810	Can-Fan RS 10 in HO 763 CFM	2.36	283	\$266.65
736815	Can-Fan RS 12 in HO 975 CFM	3.04	365	\$328.68

Can-Fan Max-Fan

Can-Fan bring its innovation to market and sets a new standard for performance. The Max-Fan is more powerful and efficient fan that takes less energy to run. 6 in - 14 in come pre-wired with an 8 ft - 120 volt power cord. 16 in come with an 8 ft whip (240 Volt). 5 Year Warranty.



Item No.	Description	Amps	Watts	MSRP
736820	Can-Fan Max Fan 6 in 334 CFM	0.70	75	\$197.77
736825	Can-Fan Max Fan 8 in 675 CFM	1.50	179	\$242.06
736745	Can-Fan Max Fan 8 in HO 932 CFM 3 Speed New	1.85	213	\$388.64
736830	Can-Fan Max Fan 10 in 1019 CFM	1.90	228	\$306.73
736835	Can-Fan Max Fan 12 in 1709 CFM	4.10	489	\$479.69
736840	Can-Fan Max Fan 14 in 1700 CFM	2.10	253	\$763.95
736842	Can-Fan Max Fan 16 in 240 Volt 2460 CFM	1.50	347	\$1,254.74

Can-Fan Q-Max Fans

The Q-Max Fan is the quiet line of fans from Can-Fan. Available in 10 in or 12 in sizes, the Q-Max is a ready to hang, true CFM silenced Max-Fan. The integrated Max-Fan with acoustic foam liner offers maximum sound absorption. The 10 in model is equipped with 3-speeds.



Item No.	Description	Amps	Watts	MSRP
736750	Can-Fan Q-Max 10 in 1019 CFM	1.95	231	\$508.56
736755	Can-Fan Q-Max 12 in 1709 CFM	4.50	489	\$592.95

Hurricane Oscillating Fans - Supreme Series

Industry exclusive



Hurricane™

Now ETL listed!

New look coming soon. Same great quality fan!



These excellent quality wall mount fans feature 3 speeds with a speed control knob and cord. They can oscillate 90 degrees or be locked in place. The fan head can also be rotated up and down for more directional control. Both are very quiet and efficient. 1 Year Warranty.

Item No.	Description	MSRP
736505	Hurricane (EcoPlus) Wall Mount Fan 16 in - Now ETL Listed	\$46.95
736506	Hurricane (EcoPlus) Wall Mount Fan 18 in - Now ETL Listed	\$66.95

Hurricane Stand Oscillating Fan - Supreme Series

The stand fan has 3-speed controls and a powder coated steel grill. The blade is chemical resistant polypropylene. 90 degrees oscillation or can be locked in non-oscillating position. Fan height is adjustable from 41 in to 55 in. 1 Year Warranty.



Item No.	Description	MSRP
736507	Hurricane (EcoPlus) Stand Fan 16 in	\$61.95

Hurricane W Stand Fan

Produces random air movement by operating in a 'W' pattern with both up/down and side to side operation. 3 speed settings and 2 oscillation settings. Powder coated steel grill. Adjustable height and tilt. 1 Year Warranty.



Item No.	Description	MSRP
736535	Hurricane W Stand Fan 16 in	\$66.95

Hurricane Super 8 Digital Stand Fan 16 in

Hurricane™

Super 8

16" Digital Stand Fan

Industry exclusive



Easy-to-use Multifunctional LCD Display

New!

The Hurricane™ Super 8 produces a figure 8 pattern for better and more uniform air circulation.

- 3 speed settings.
- 3 oscillation settings.
- 8 hour timer.
- Includes remote control.
- Powder coated steel grill.
- Adjustable height and tilt.

Ideal for home, greenhouses, garages, workshops and other areas where a heavy-duty portable stand fan can be used.





The Hurricane Super 8 produces a figure 8 pattern for better and more uniform air circulation. It has 3 speed settings and 3 oscillation settings. Super 8 has an 8 hour timer with a remote control. Powder coated steel grill. Adjustable height and tilt. Easy-to-use multifunctional LCD display. 1 Year Warranty.

Item No.	Description	MSRP
736540	Hurricane Super 8 Digital Stand Fan 16 in	\$86.95

Hurricane Super 8 Digital Wall Mount Fan 16 in

Hurricane™
Super 8
Programmable
Oscillating Wall Fan

easy-to-use remote control | figure 8 air pattern | programmable control | quiet operation | reliable metal gear construction

industry exclusive

ETL Intertek

Remote control allows the Hurricane Super 8 fan to be programmed easily

Supreme Series

QR Code

New!

The Hurricane™ Super 8 fan produces a figure 8 pattern for better and more uniform air circulation.

Program precise fan movement patterns to fit any application.

Hurricane Super 8 Programmable Oscillating Wall Mount Fan produces a figure 8 pattern for better and more uniform air circulation. This fan has reliable metal gear construction which makes for whisper quiet operation. Remote control makes for easy operation. 1 Year Warranty.

Item No.	Description	MSRP
736565	Hurricane Super 8 Digital Wall Mount Fan 16 in	\$83.95

Hurricane 16 in Wall Mount Fan - Classic Series

Classic series 16 inch wall mount oscillating fan. This fan has 3 speed settings controlled by a turn switch. The fan has a 90 degree oscillation motion. There are two convenient pull cords for speed and oscillation control. It has a durable steel neck support with a 60 inch power cord. 1 Year Warranty.



Item No.	Description	Amps	Watts	MSRP
736503	Hurricane Classic Wall Mount Oscillating Fan 16 in	0.50	60	\$39.95

Hurricane Metal Floor Fan

Hurricane 20 in High Velocity Floor Fan is ideal for home, greenhouses, garages, workshops and other areas where a heavy-duty portable stand fan can be used. 3 speed settings. Tilting fan head with permanently attached adjustment handles. Individually balanced blades with heavy-duty steel grill. 1 Year Warranty.



Item No.	Description	MSRP
736530	Hurricane Metal Floor Fan 20 in	\$67.95

Hurricane 6 in Clip Fan - Classic Series

Easily mounts wherever needed. Strong clamp holds fan in place during use. Two speed operation. Adjustable tilt mechanism. 120 volt five foot power cord. 1 Year Warranty.



Item No.	Description	Amps	Watts	MSRP
736520	Hurricane 6 in Clip Fan	0.25	30	\$19.95

Air King
 Ventilation Products®

Air King Fans

Clip on fan has impact resistant plastic grills with chemical resistant polypropylene blade, 2-speed and 1/300 HP motor. The 12 in, 16 in and 18 in fans oscillate 90 degree or can be locked in non-oscillating position and have 3-speeds. They also have powder coated steel front grill with impact resistant plastic rear grill. 1 Year Warranty.



Item No.	Description	MSRP
736735	Air King Clip On Fan 6 in	\$33.95
736725	Air King Wall Mount Fan 12 in	\$74.99
736730	Air King Wall Mount Fan 16 in	\$84.99
736740	Air King Wall Mount Fan 18 in	\$99.95

Air King Pedestal Fans

Fans feature a 3-speed 1/20 HP motor with rear mounted rotary controls and a 7 ft white power cord. The grills are constructed of a powder coated steel front grill with an impact resistant plastic rear grill. 16 in Fan height is adjustable from 36 in to 52 in. 18 in Fan height is adjustable from 37 in to 53.75 in.



Item No.	Description	MSRP
736731	Air King Pedestal Fan 16 in	\$69.99
736741	Air King Pedestal Fan 18 in	\$71.99

Hurricane Blowers

Quiet, powerful and dependable – made with industrial grade quality. Intake flange adapters built right into fan, no need to purchase hose adapters separately. Attractive gray powder coated steel housing. 10 ft grounded power cord pre wired into each unit. 1 Year Warranty.



Item No.	Description	MSRP
736620	Hurricane Blower 180 CFM	\$97.95
736625	Hurricane Blower 265 CFM	\$105.95
736630	Hurricane Blower 465 CFM	\$117.95

Hurricane Inline Duct Boosters

Perfect for boosting air flow in long runs of ducting. Come wired with junction box, strain relief and power cord. Fluted on both ends to receive ducting. 1 Year Warranty.



Item No.	Description	MSRP
736650	Hurricane Inline Duct Booster 4 in 70 CFM	\$46.95
736655	Hurricane Inline Duct Booster 6 in 160 CFM	\$52.95
736660	Hurricane Inline Duct Booster 8 in 370 CFM	\$58.95

Hurricane Axial Fans

Hurricane Axial Fans can be used in any application where ventilation/air movement is required. They are very reliable and will provide years of trouble-free use. Includes detachable power cord. 1 Year Warranty.



Item No.	Description	Amps	Watts	MSRP
736875	Hurricane Axial Fan 3.25 in 25 CFM	0.07	5	\$30.95
736880	Hurricane Axial Fan 4.5 in 112 CFM	0.23	24	\$30.95
736885	Hurricane Axial Fan 6 in 235 CFM	0.25	28	\$65.95
736890	Hurricane Axial Fan 8 in 647 CFM	1.00	102	\$99.95
736895	Hurricane Axial Fan 10 in 806 CFM	0.62	67	\$99.95
736913	Axial Fan Replacement Power Cord 6 ft			\$6.95

Titan Controls Mercury 2 - Fan Speed Controller

Adjusts fan speed from 10% - 100%. Fire-up feature extends life of your fan. Easy to operate. Plastic enclosure protects internal components from dust and moisture. 6 Amps maximum/120 Volts/60 Hz. 1 Year Warranty.



Item No.	Description	MSRP
702753	Titan Controls Mercury 2 - Fan Speed Controller	\$75.95

Titan Controls Mercury 3 - Day/Night Fan Controller

Automatically increases or decreases fan speed based on controller set points. Allows user to adjust deadband range to meet garden requirements. Temperature control range is 55°F to 95°F. 6 ft temp probe is accurate to within 2°F. 6 Amps maximum/120 Volts/60 Hz. 3 Year Warranty.



Item No.	Description	MSRP
702755	Titan Controls Mercury 3 - Day/Night Fan Controller	\$116.95

Titan Controls Mercury 4 - Multi-Function Fan Speed Controller

Allows user to select minimum fan idle speed between 25% & 60% of fan rating. Enables the user to activate/deactivate low temp safety feature. Temp control range is 55°F to 95°F. 6 ft temp probe is accurate to within 2°F. 6 Amps maximum/120 Volts/60 Hz. 3 Year Warranty.



Item No.	Description	MSRP
702760	Titan Controls Mercury 4 - Multi Function Fan Speed Controller	\$116.95

Titan Controls Zephyr 1 - Day/Night Temperature Controller

Temp control range is 55°F to 95°F. Controls cooling or heating equipment. Day and night settings keep temperature within 4°F of set point. 6 ft temp probe is accurate to within 2°F. 15 Amps maximum/120 Volts/60 Hz. 3 Year Warranty.



Item No.	Description	MSRP
702630	Titan Controls Zephyr 1 - Day/Night Temp Controller	\$87.95

Titan Controls Zephyr 3 - Heating/Cooling Controller

Precise temp control of your cooling and heating equipment. 40°F to 100°F gives the operator a great range of settings. Change from Heating to Cooling with just a flip of the switch. Discrete green power light indicates operation of equipment. Built in 4°F split differential. 15 Amps maximum/120 Volts/60 Hz. 3 Year Warranty.



Item No.	Description	MSRP
702845	Titan Control Zephyr 3 - Cooling/Heating Controller	\$84.95

Titan Controls Zephyr 4 - Cooling Thermostat Fan Control

Easy to use - plug fan into control piggyback power receptacle, then plug control into 120 volt power supply. Set thermostat to the temperature you want the fan to come on at and that's it! 1 Year Warranty.



Item No.	Description	MSRP
736167	Titan Controls Zephyr 4 - Cooling Thermostat Fan Control	\$79.95

Ideal-Air Fan Speed Controller

Works with AC/DC brush-type motors 15 amps or less. Three adjustable switch settings: full, variable and off. When switch is set to variable, adjustable knob controls fan speed. 6 ft - 120 volt power cord and up to 15 amps. Will not work with soft or slow-start motors. 1 Year Warranty.



Item No.	Description	MSRP
700515	Ideal-Air Fan Speed Controller	\$27.95

Speedster Variable Fan Speed Control

The Speedster is great multi purpose speed control. Three settings include off, on (full) and variable. Simply use the dial to increase or decrease fan motor speed. 120 volt/15 amps. 90 Day Warranty.



Item No.	Description	MSRP
736617	Speedster Variable Speed Control	\$29.95

Dial-A-Temp

A plug-in style speed control specifically designed for controlling fans or blowers. Contains an On/Off line switch with variable speed control from low to high. It operates from 115 VAC 50/60 Hz with a maximum rating of 300 Watts (2.5 amps) @ 25°C/77°F. 1 Year Warranty.



Item No.	Description	MSRP
736618	Dial A Temp Speed Control	\$31.95

Flange Kits

These flange kits are used to vent air through a wall or ceiling. Mount the flange kit to the wall or ceiling, then attach your duct work to the flange. Also for use with Sun Huts.

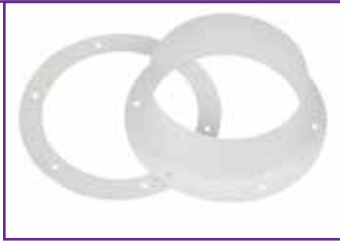

Item No.	Description	MSRP
736355	Flange Kit 4 in	\$8.95
736357	Flange Kit 6 in	\$9.95
736359	Flange Kit 8 in	\$10.95

IDEALair COMMERCIAL-GRADE **industry exclusive**

Premium quality ducting supplies to connect cooling equipment to your indoor garden. www.ideal-air.com

Ideal-Air Adjustable 90 Degree Elbow Ducting

Strengthening beads ensure a stiffer, round elbow and a better seal. All elbows come standard with one end crimped. Ideal-Air adjustable elbows are used to make turns in round pipe and flexible duct through 90 degrees.



Item No.	Description	MSRP
750100	Ideal-Air Adjustable 90 Degree Elbow 4 in	\$3.49
750105	Ideal-Air Adjustable 90 Degree Elbow 6 in	\$4.99
750110	Ideal-Air Adjustable 90 Degree Elbow 8 in	\$6.99
750115	Ideal-Air Adjustable 90 Degree Elbow 10 in	\$9.99
750120	Ideal-Air Adjustable 90 Degree Elbow 12 in	\$16.99

Ideal-Air Wye Branch

Our heavy-duty Wye Branches are made of a thick gauge galvanized steel. We have improved the design for easier use and more secure duct connections. We offer a variety of sizes and configurations for all your ducting and HVAC needs.



Item No.	Description	MSRP
736185	Ideal-Air Wye Branch 4 in x 4 in x 4 in	\$15.79
736189	Ideal-Air Wye Branch 6 in x 4 in x 4 in	\$16.69
736190	Ideal-Air Wye Branch 6 in x 6 in x 6 in	\$17.99
736195	Ideal-Air Wye Branch 8 in x 6 in x 6 in	\$19.19
736200	Ideal-Air Wye Branch 8 in x 8 in x 8 in	\$21.39
736320	Ideal-Air Wye Branch 10 in x 6 in x 6 in	\$21.99
736205	Ideal-Air Wye Branch 10 in x 8 in x 8 in	\$22.39
736325	Ideal-Air Wye Branch 12 in x 8 in x 8 in	\$30.59
736217	Ideal-Air Wye Branch 12 in x 10 in x 10 in	\$30.99
736216	Ideal-Air Wye Branch 12 in x 12 in x 12 in	\$30.99

Ideal-Air Duct Reducers

Our heavy-duty Duct Reducers are made of a thick gauge galvanized steel. We have improved the design for easier use and more secure duct connections. We offer a variety of sizes for all your HVAC and ducting needs.



Item No.	Description	MSRP
736210	Ideal-Air Duct Reducer 6 in - 4 in	\$7.19
736211	Ideal-Air Duct Reducer 8 in - 6 in	\$9.49
736310	Ideal-Air Duct Reducer 10 in - 6 in	\$12.69
736212	Ideal-Air Duct Reducer 10 in - 8 in	\$12.69
736315	Ideal-Air Duct Reducer 12 in - 8 in	\$14.29
736213	Ideal-Air Duct Reducer 12 in - 10 in	\$14.29
736214	Ideal-Air Duct Reducer 14 in - 12 in	\$17.99

Ideal-Air Duct Couplers

Quick and easy solution for connecting flex ducting. Crimped on both ends with strengthening bead for secure connection. Made from galvanized steel.



Item No.	Description	MSRP
736416	Ideal-Air Duct Coupler 4 in	\$3.79
736418	Ideal-Air Duct Coupler 6 in	\$4.59
736420	Ideal-Air Duct Coupler 8 in	\$5.59
736422	Ideal-Air Duct Coupler 10 in	\$7.59
736424	Ideal-Air Duct Coupler 12 in	\$8.59
736426	Ideal-Air Duct Coupler 14 in	\$10.59
736428	Ideal-Air Duct Coupler 16 in	\$13.59

Ideal-Air Duct Collar Air Tight

For connecting your ducting to your wall, floor or ceiling opening. 1.5 in galvanized steel mounting flange with adhesive gasket.



Item No.	Description	MSRP
736456	Ideal-Air Duct Collar Air Tight 4 in	\$6.99
736458	Ideal-Air Duct Collar Air Tight 6 in	\$8.99
736460	Ideal-Air Duct Collar Air Tight 8 in	\$10.99
736462	Ideal-Air Duct Collar Air Tight 10 in	\$13.99
736464	Ideal-Air Duct Collar Air Tight 12 in	\$16.99
736466	Ideal-Air Duct Collar Air Tight 14 in	\$19.99
736468	Ideal-Air Duct Collar Air Tight 16 in	\$23.99

Ideal-Air Back Draft Dampers

These are excellent quality back draft dampers. They are made from heavy-gauge galvanized steel with heavy duty springs. They use both an embossed bead & rubber gasket to help keep ducting securely in place.



Item No.	Description	MSRP
736980	Ideal-Air Back Draft Damper 4 in	\$17.95
736982	Ideal-Air Back Draft Damper 6 in	\$19.95
736984	Ideal-Air Back Draft Damper 8 in	\$29.95
736986	Ideal-Air Back Draft Damper 10 in	\$39.95
736988	Ideal-Air Back Draft Damper 12 in	\$49.95
736989	Ideal-Air Back Draft Damper 14 in	\$59.95

Ideal-Air Screened Wall Vents

For bringing in fresh air or exhausting stale air. Made of galvanized sheet metal. Screened opening to help keep the pests out.



Item No.	Description	MSRP
736380	Ideal-Air Screened Wall Vent 4 in	\$15.95
736382	Ideal-Air Screened Wall Vent 6 in	\$17.95
736384	Ideal-Air Screened Wall Vent 8 in	\$20.95
736386	Ideal-Air Screened Wall Vent 10 in	\$25.95
736388	Ideal-Air Screened Wall Vent 12 in	\$34.95

Ideal-Air Silver/Black Flex Ducting

Has a silver exterior and black inner core. 25 ft length silver/black ducting. Commercial grade. Black inner core helps reduce light transfer. Made with heavy duty materials.



Item No.	Description	MSRP
736971	Ideal-Air Silver/Black Flex Ducting 4 in x 25 ft	\$18.29
736972	Ideal-Air Silver/Black Flex Ducting 6 in x 25 ft	\$22.95
736973	Ideal-Air Silver/Black Flex Ducting 8 in x 25 ft	\$28.29
736974	Ideal-Air Silver/Black Flex Ducting 10 in x 25 ft	\$36.95
736975	Ideal-Air Silver/Black Flex Ducting 12 in x 25 ft	\$48.29
736976	Ideal-Air Silver/Black Flex Ducting 14 in x 25 ft	\$53.29

Ideal-Air Silver/Silver Flex Ducting

These Class 1 aluminum flexible air ducts are made from tough, puncture resistant 3 ply aluminum foil laminate and contain a high density, corrosion resistant wire helix in the duct wall for support.



Item No.	Description	MSRP
904165	Ideal-Air Silver/Silver Flex Ducting 4 in x 25 ft	\$13.95
904170	Ideal-Air Silver/Silver Flex Ducting 6 in x 25 ft	\$17.39
904175	Ideal-Air Silver/Silver Flex Ducting 8 in x 25 ft	\$22.95
904180	Ideal-Air Silver/Silver Flex Ducting 10 in x 25 ft	\$29.95
904183	Ideal-Air Silver/Silver Flex Ducting 14 in x 25 ft	\$48.29
904185	Ideal-Air Silver/Silver Flex Ducting 12 in x 25 ft	\$36.49



Scan now to figure out the amount of BTU's you need for your room size.



Ideal-Air Silver Premium Insulated Flex Ducting

This premium Ideal-Air ducting has been developed to minimize heat gain or loss resulting from the temperature difference between the air flowing in the duct and the surrounding air.



Item No.	Description	MSRP
738700	Ideal-Air Silver Insulated Flex Ducting 4 in x 25 ft	\$34.99
738702	Ideal-Air Silver Insulated Flex Ducting 6 in x 25 ft	\$52.99
738704	Ideal-Air Silver Insulated Flex Ducting 8 in x 25 ft	\$66.99
738706	Ideal-Air Silver Insulated Flex Ducting 10 in x 25 ft	\$82.99
738708	Ideal-Air Silver Insulated Flex Ducting 12 in x 25 ft	\$102.99
738710	Ideal-Air Silver Insulated Flex Ducting 14 in x 25 ft	\$127.99

Ideal-Air Aluminum Semi-Rigid Premium Flex Ducting

Idea-Air Semi Rigid Flexible Ducting is a commercial grade, high heat, aluminum laminated flex duct that will help hold its shape when bent reducing or eliminating the need for rigid elbows. The high strength comes from a high tensile steel wire helix.



Item No.	Description	MSRP
738724	Ideal-Air Aluminum Semi-Rigid Premium Flex Ducting 4 in x 25 ft	\$27.99
738726	Ideal-Air Aluminum Semi-Rigid Premium Flex Ducting 6 in x 25 ft	\$36.99
738728	Ideal-Air Aluminum Semi-Rigid Premium Flex Ducting 8 in x 25 ft	\$44.99
738730	Ideal-Air Aluminum Semi-Rigid Premium Flex Ducting 10 in x 25 ft	\$54.99
738732	Ideal-Air Aluminum Semi-Rigid Premium Flex Ducting 12 in x 25 ft	\$59.99

Ideal-Air White/Silver Vinyl Light Tight Flex Ducting

The Ideal-Air light tight flexible ducting has a heavy duty laminated aluminum inner core with an encapsulated high tensile steel wire helix. The outer core is covered with a UV resistant light tight white PVC jacket.



Item No.	Description	MSRP
738712	Ideal-Air White/Silver Vinyl Light Tight Flex Ducting 4 in x 25 ft	\$21.99
738714	Ideal-Air White/Silver Vinyl Light Tight Flex Ducting 6 in x 25 ft	\$32.99
738716	Ideal-Air White/Silver Vinyl Light Tight Flex Ducting 8 in x 25 ft	\$44.99
738718	Ideal-Air White/Silver Vinyl Light Tight Flex Ducting 10 in x 25 ft	\$56.99
738720	Ideal-Air White/Silver Vinyl Light Tight Flex Ducting 12 in x 25 ft	\$67.99
738722	Ideal-Air White/Silver Vinyl Light Tight Flex Ducting 14 in x 25 ft	\$81.99

ThermoFlo Elbow

ThermoFlo Elbow is a radius forming brace for flexible ducts that's engineered to improve the airflow and efficiency of your grow room ventilation system. It saves energy by eliminating kinks and shapes flexible ducts into efficient 90-degree elbows.



Item No.	Description	MSRP
736979	ThermoFlo Elbow	\$5.95

ThermoFlo 2000 SR Ducting

The 2000 SR Series Ducting is specifically engineered to handle unconditioned air. It can withstand high heat, high humidity and excessive CFM's without any duct failure or fatigue.



Item No.	Description	MSRP
736915	ThermoFlo SR Ducting 4 in x 25 ft	\$28.95
736920	ThermoFlo SR Ducting 6 in x 25 ft	\$40.95
736925	ThermoFlo SR Ducting 8 in x 25 ft	\$51.95
736930	ThermoFlo SR Ducting 10 in x 25 ft	\$65.95
736935	ThermoFlo SR Ducting 12 in x 25 ft	\$81.95
736940	ThermoFlo SR Ducting 14 in x 25 ft	\$100.95
736942	ThermoFlo SR Ducting 16 in x 25 ft	\$125.95

ThermoFlo SR Insulated Ducting

This insulated ducting is manufactured tough for consumers' and installers' peace of mind. A heavy duty fire retardant black polyethylene vapor barrier adds extra durability. The insulation reduces noise, heat loss and condensation.



Item No.	Description	MSRP
736950	ThermoFlo SR Insulated Ducting 4 in x 25 ft	\$50.95
736955	ThermoFlo SR Insulated Ducting 6 in x 25 ft	\$70.95
736960	ThermoFlo SR Insulated Ducting 8 in x 25 ft	\$91.95
736965	ThermoFlo SR Insulated Ducting 10 in x 25 ft	\$111.95
736970	ThermoFlo SR Insulated Ducting 12 in x 25 ft	\$133.95

Can-Duct Silver/Silver 3 Ply

Can-Duct Silver/Silver 3-ply offers a triple foil laminate grade casing complete with 2 clamps.



Item No.	Description	MSRP
738605	Can-Fan Silver/Silver 3 Ply Ducting 6 in x 25 ft	\$26.66
738610	Can-Fan Silver/Silver 3 Ply Ducting 8 in x 25 ft	\$33.32
738615	Can-Fan Silver/Silver 3 Ply Ducting 10 in x 25 ft	\$44.43
738620	Can-Fan Silver/Silver 3 Ply Ducting 12 in x 25 ft	\$55.53

Can-Duct Insulated

Can-Duct Insulated has a 3-ply layer with an additional layer of R4.2 insulation. These 25 ft lengths come complete with 2 clamps for ease of installation.



Item No.	Description	MSRP
738665	Can-Fan Insulated Ducting 6 in x 25 ft	\$62.20
738670	Can-Fan Insulated Ducting 8 in x 25 ft	\$77.74
738675	Can-Fan Insulated Ducting 10 in x 25 ft	\$99.96

Max-Duct Vinyl

Max-Duct vinyl has triple foil laminate with very durable white PVC with UV inhibitor coating. Includes 2 clamps for easy installation.



Item No.	Description	MSRP
738630	Can-Fan Max Vinyl Ducting 4 in x 25 ft	\$24.43
738635	Can-Fan Max Vinyl Ducting 6 in x 25 ft	\$37.76
738640	Can-Fan Max Vinyl Ducting 8 in x 25 ft	\$51.09
738645	Can-Fan Max Vinyl Ducting 10 in x 25 ft	\$64.42
738650	Can-Fan Max Vinyl Ducting 12 in x 25 ft	\$77.74

HVAC Heavy-Duty Zip Ties

No more dealing with hose clamps! Commercial grade HVAC zip ties are simple to use and feature a locking mechanism for a firm hold. Made from thick, heavy duty natural colored nylon. The 36 in tie can fit up to 10 in ducting and the 48 in tie can fit up to 14 in ducting.



Item No.	Description	MSRP
380100	HVAC Heavy-Duty Zip Tie 36 in 50/Pack (1ea = Pack 50)	\$18.95
380105	HVAC Heavy-Duty Zip Tie 48 in 50/Pack (1ea = Pack 50)	\$36.95

Ideal-Air Stainless Steel Hose Clamps

These stainless steel hose clamps are perfect for attaching flexible ducting to air cooled hoods, exhaust fans, filters and silencers.



Item No.	Description	MSRP
380031	Ideal-Air Stainless Steel Hose Clamps 2/Pack 4 in	\$1.95
380051	Ideal-Air Stainless Steel Hose Clamps 2/Pack 6 in	\$2.95
380061	Ideal-Air Stainless Steel Hose Clamps 2/Pack 8 in	\$4.95
380071	Ideal-Air Stainless Steel Hose Clamps 2/Pack 10 in	\$5.95
380081	Ideal-Air Stainless Steel Hose Clamps 2/Pack 12 in	\$7.95
380085	Ideal-Air Stainless Steel Hose Clamps 2/Pack 14 in	\$9.95
380086	Ideal-Air Stainless Steel Hose Clamps 2/Pack 16 in	\$11.95

Ideal-Air Butterfly Hose Clamps

These Ideal-Air Butterfly Hose Clamps make for quick and each attachment of ducting to collar fittings. Made of heavy-duty stainless steel. Unique butterfly shaped screw head easily twists for hand tightening without tools. Conveniently packaged 2 per bag.



Item No.	Description	MSRP
380130	Ideal-Air Butterfly Hose Clamp 2/Pack 4 in	\$2.29
380132	Ideal-Air Butterfly Hose Clamp 2/Pack 6 in	\$3.29
380134	Ideal-Air Butterfly Hose Clamp 2/Pack 8 in	\$5.29
380136	Ideal-Air Butterfly Hose Clamp 2/Pack 10 in	\$6.39
380138	Ideal-Air Butterfly Hose Clamp 2/Pack 12 in	\$8.39

Ideal-Air Quick Release Stainless Steel Hose Clamps

Quick release stainless steel hose clamps. Just release the tension on the screw and flip up to instantly release the clamp. Allows for easy removal of the clamp for quicker flex duct removal when cleaning the glass in your air cooled fixture.



Item No.	Description	MSRP
380120	Ideal-Air Quick Release Stainless Steel Hose Clamps 2/Pack 4 in	\$2.95
380122	Ideal-Air Quick Release Stainless Steel Hose Clamps 2/Pack 6 in	\$3.95
380124	Ideal-Air Quick Release Stainless Steel Hose Clamps 2/Pack 8 in	\$5.95
380126	Ideal-Air Quick Release Stainless Steel Hose Clamps 2/Pack 10 in	\$6.95
380128	Ideal-Air Quick Release Stainless Steel Hose Clamps 2/Pack 12 in	\$8.95

Ideal-Air Noise Reduction Clamps - Classic

2-3/8 inch wide galvanized steel clamps are used with fans, silencers, reflectors, carbon filters and ducting. The neoprene lining makes for a tight, vibration free fit. Two Philips head screws for tightening.



Item No.	Description	MSRP
380037	Ideal-Air Noise Reduction Clamp 6 in Standard	\$4.19
380039	Ideal-Air Noise Reduction Clamp 8 in Standard	\$4.89
380041	Ideal-Air Noise Reduction Clamp 10 in Standard	\$5.89
380043	Ideal-Air Noise Reduction Clamp 12 in Standard	\$6.99

Ideal-Air Noise Reduction Clamps - Supreme

2-3/8 in wide clamps are used with fans, silencers, reflectors, carbon filters and ducting. The neoprene lining helps to make for an air-tight, vibration free fit. The top quality durable powder-coated finish helps prevent rust and dust. Individually boxed.



Item No.	Description	MSRP
380092	Ideal-Air Noise Reduction Clamp Supreme 4 in	\$10.95
380094	Ideal-Air Noise Reduction Clamp Supreme 6 in	\$10.95
380096	Ideal-Air Noise Reduction Clamp Supreme 8 in	\$11.95
380097	Ideal-Air Noise Reduction Clamp Supreme 10 in	\$14.49
380098	Ideal-Air Noise Reduction Clamp Supreme 12 in	\$17.29
380150	Ideal-Air Noise Reduction Clamp Supreme 14 in	\$22.95

Flex Duct Hanger Strap

Cambridge's 1.75 in Support Webbing registers a remarkable tensile strength of up to 440 lb. Nylon webbing duct support strap. Use to hang HVAC duct. 440 lb average tensile strength. 1.75 in x 50 foot roll.



Item No.	Description	MSRP
700960	Flex Duct Hanger Strap	\$2.99

Ideal-Air Silver Duct Tape

2 in x 50 yard roll of heavy duty silver duct tape. General contractors duct tape of choice. Aggressive natural rubber adhesives for high performance applications.



Item No.	Description	MSRP
904196	Ideal-Air Silver Duct Tape 2 x 50 yd	\$8.99

Silver Flex Duct Tape

A 2 mil, heavy duty, high strength aluminum foil coated with a specially formulated pressure sensitive acrylic adhesive system. Will not leave behind messy adhesive residue. Use it to make your ducting to fixture connections air tight.



Item No.	Description	MSRP
904161	Silver Flex Duct Tape 5 yd	\$3.95
904162	Silver Flex Duct Tape 120 yd	\$19.95



Hyperfan™

IS YOUR FAN
CHOKING UNDER PRESSURE?
OURS WON'T!
TWICE THE CFM'S PER WATT
VERSUS OTHER FANS!



6 inch | **8 inch** | **10 inch**

315 cfm | 710 cfm | 1065 cfm

Mixed Flow Fans

- Laminar Flow Fan Blade & Stator Technology creates optimal airflow similar in technology to a modern jet engine. The result is very high CFM's and exceptional static pressure performance.
- Hyper Fans™ deliver the highest CFM's per watt of any fan in the industry.
- State-of-the-art digitally controlled DC powered Electronically Commutated Motor (ECM) is extremely quiet, long lasting and very reliable. Best of all, this unique technology uses about half the power as traditional fans.
- The included speed controller can adjust fan speed from 35% to 100%. It is detachable from the fan and independent from the power cord.
- Lightweight aluminum housing is one-third the weight of comparable steel bodied fans. They are compact and easy to install.

ANOTHER QUALITY PRODUCT BY:





Exclusively distributed by:
National Garden Wholesale,
Sunlight Supply Inc.
www.SunlightSupply.com



www.Hyper-Fans.com

Industry **exclusive**

IDEALair™ DEHUMIDIFIERS



We offer a complete line of dehumidifiers for every application. From small hobby growers to large scale commercial operations, we have a dehumidifier to suit your needs. www.ideal-air.com

AC/HUMIDIFICATION/DEHUMIDIFICATION

Ideal-Air Dehumidifiers 30, 50 & 70 Pint

Rated at 30, 50 & 70 pints per day at 86°F/80% RH. Quick maintenance with easy carbon filter access that is removable and washable. Low temperature defrosting. Easy to move with built in handles and wheels. Easy to use LED display panel. Removable water tank with an automatic shutoff when reservoir is full. Can be plumbed for permanent drainage. 1 Year Warranty.



Item No.	Description	MSRP
700830	Ideal-Air Dehumidifier 30 Pint	\$214.95
700826	Ideal-Air Dehumidifier 50 Pint 	\$299.99
700828	Ideal-Air Dehumidifier 70 Pint 	\$349.99

Ideal-Air Dehumidifiers 60 & 100 Pint

Automatic restart allows unit to be used with humidity controllers. Built-in defrost system is designed for operation down to 45°F. Automatic shut off when tank is full. Refrigerant: R410A. 60 Pint unit: H2O removal: (24hrs) 60 pints (86°F, 80% R.H.); Power: 6.6 Amps/700 Watts; Supply Voltage: 115V-1 Phase-60Hz. 100 Pint unit: H2O removal:(24hrs) 100 pints (86°F, 80% R.H.); Power: 9.4 Amps/1080 Watts; Supply Voltage: 115V-1 Phase-60Hz. 1 Year Warranty.



Item No.	Description	MSRP
700895	Ideal-Air Dehumidifier 60 Pint	\$549.95
700896	Ideal-Air Dehumidifier 100 Pint	\$789.95

Ideal-Air Commercial Grade 2 Dehumidifier - 170 Pint

Rated at 170 pints per day at 86°F/80% RH and 100 pints per day at AHAM standard conditions (80°F/60% RH) 9.5 amps/115V. Easy filter access that is removable and washable. Space saving and stackable up to 2 high. Easy to use digital display panel with temp & humidity readings. Built-in heavy duty condensate pump and quick connecting hose. 1 Year Warranty.



Item No.	Description	MSRP
700899	Ideal-Air CG2 Dehumidifier 170 Pint	\$1,449.95

Ideal-Air Portable Dehumidifier - 180 Pint

Automatic restart allows unit to be used with humidity controllers. Easy to use digital display with temp and humidity readings, removable washable filter, 1 speed fan motor, powder coated metal casing for long life & a heavy duty compressor. Set upright on their feet for 3 hrs prior to use. 180 Pint unit: Temp. Range: 45°F-100°F; H2O removal: (24 hrs) 180 pints (86°F, 80% R.H.); Power: 12 Amps/1350 Watts; Supply Voltage: 110V-1 Phase-60Hz; Refrigerant: R410A. 1 Year Warranty.



Item No.	Description	MSRP
700897	Ideal-Air Commercial Grade Dehumidifier 180 Pint	\$1,195.95

Quest PowerDry 1300 Dehumidifier

Dehumidifies 64 pints/day @ 80°F/60%RH and only uses 5.0 amps. Made of quality components and is protected by a heavy duty ROTO case. Includes a pleated filter. The Merv 7 filtration of the 1300 is designed to capture mold, spores, pollen and dust. Weighs 79 lb with 12 in wheels, retractable handle and a 20 ft 120V power cord. Small footprint at 17 in x 20 in. Includes an internal pump with 33 ft detachable hose. Warranty and Support: Provided by Quest. 1 Year Warranty.



Industry **exclusive**

Item No.	Description	MSRP
700822	Quest PowerDry 1300 Dehumidifier	\$1,511.95

Quest Dry RDS 10 Dehumidifier

Dehumidifies 80 pints/day @ 80°F/60%RH at just 5.4 amps. Has improved performance over the PowerDry 1300, while only drawing 4/10ths of an amp more current. Comes with a pleated filter. The Merv 7 filtration is designed to capture mold, spores, pollen and dust. Small footprint at 20 in x 20 in with 12 in wheels, retractable handle and 20 ft 120V power cord. Has flexible controls. Includes an internal pump with 33 ft detachable hose. Has a heavy duty ROTO case. Warranty and Support: Provided by Quest. 1 Year Warranty.



Industry **exclusive**

Item No.	Description	MSRP
700823	Quest Dry RDS 10 Dehumidifier	\$1,942.95

Quest PowerDry 4000 Pro Dehumidifier

Dehumidifies 176 pints/day @ 80°F/60%RH that uses only 10 amps. This is the perfect solution for large, high grade growers. Has over 22 gallons (176 pints) of capacity. Comes equipped with a solid-state control panel with an onboard humidistat located on the panel. This gives the ability to set the unit at a particular humidity level (between 20-70%RH). Protected by a heavy duty Stainless Steel shell. Includes a filter that has Merv 11 filtration. Small footprint at 20 in x 23 in with 12 in wheels, retractable handle and 25 ft 120V power cord. Includes an internal pump with 33 ft detachable hose. This unit is ductable for intake and exhaust. Warranty and Support: Provided by Quest. 1 Year Warranty.



Industry **exclusive**

Item No.	Description	MSRP
700824	Quest PowerDry 4000 Pro Dehumidifier	\$3,149.95

QUEST WARRANTY

Warranty: 1 year parts and labor. 5 year compressor and refrigerant system. Warranty and Support: Provided by Quest. Call 1-866-933-7486 or go to www.questhydro.com for more info. Retailers and Sunlight Supply have no role in warranty.

Quest Dual 205 Overhead Dehumidifier

Quest Dual 205 was designed to be placed overhead and out of the way, but can also be placed at ground level for plug and play operation. The Dual 205 was designed to be powerful yet energy efficient. It performs at over 5.7 pints per kWh. The Quest Duals' horizontal configuration, dual outlet design and insulated cabinet for quieter operation enables exceptional performance in almost any application. MERV-11 filtration is standard on these units, capturing particles down to 1 micron in size. Made in the USA. 1 Year Warranty.



Industry exclusive

Item No.	Description	MSRP
700821	Quest Dual 205 Overhead Dehumidifier	\$3,042.00

Quest Dual 105 Overhead Dehumidifier

Quest Dual 105 was designed to be placed overhead and out of the way, but can also be placed at ground level for plug and play operation. It was designed to be the most energy efficient dehumidifier at over 8.8 pints per kWh. The Quest Duals' horizontal configuration and insulated cabinet for quieter operation. Optional condensate pump and ducting kits provide the ultimate in flexibility. MERV-11 filtration is standard, capturing particles down to 1 micron. Made in the USA. 1 Year Warranty.



Industry exclusive

Item No.	Description	MSRP
700819	Quest Dual 105 Overhead Dehumidifier	\$2,072.95

Quest Dual 110 Overhead Dehumidifier

Quest Dual 110 was designed to be placed overhead and out of the way, but can also be placed at ground level for plug and play operation. It provides improved value while still offering solid performance and energy efficiency at over 5.8 pints per kWh. Optional condensate pump and ducting kits provide the ultimate in flexibility. Comes with a replaceable MERV-8 filter. Made in the USA. 1 Year Warranty.



Industry exclusive

Item No.	Description	MSRP
700817	Quest Dual 110 Overhead Dehumidifier	\$1,499.95

Quest Dual 150 Overhead Dehumidifier

Quest Dual 150 was designed to be placed overhead and out of the way, but can also be placed at ground level for plug and play operation. It provides improved value while still offering solid performance and energy efficiency at over 4.9 pints per kWh. Optional condensate pump and ducting kits provide the ultimate in flexibility. Comes with a replaceable MERV-8 filter. Made in the USA. 1 Year Warranty.



Industry exclusive

Item No.	Description	MSRP
700816	Quest Dual 150 Overhead Dehumidifier	\$1,799.95

Quest Dual 155 Overhead Dehumidifier

Quest Dual 155 was designed to be placed overhead and out of the way, but can also be placed at ground level for plug and play operation. It performs at 7.3 pints per kilowatt-hour and very energy efficient. The Quest Duals' horizontal configuration and insulated cabinet for quieter operation enable their exceptional performance. Optional condensate pump and ducting kits provide the ultimate in flexibility. MERV-11 filtration is standard, capturing particles down to 1 micron. Made in the USA. 1 Year Warranty.



Industry exclusive

Item No.	Description	MSRP
700818	Quest Dual 155 Overhead Dehumidifier	\$2,072.95

Quest Supply Air Duct Collars for Overhead Dehumidifiers

This accessory allows a limited amount of ductwork to be attached to the air outlet on Quest Dual dehumidifiers.



This allows the dehumidifier to be located outside of the indoor garden. Be sure to also purchase the return/intake air attachment (part #310786) to attach ductwork to the air intake and pull moist air out of the garden.



Item No.	Description	MSRP
310784	Quest Supply Air Duct Collar for Overhead Style Dehumidifier	\$59.95

Quest Return Air Duct Collar for Overhead Dehumidifiers

This accessory allows a limited amount of ductwork to be attached to the intake on Quest Dual dehumidifiers.



This allows the dehumidifier to be located outside of the indoor garden. Be sure to also purchase the supply air attachment (part #310784) to attach ductwork to the air outlet and send dry air back into the garden.



Item No.	Description	MSRP
310786	Quest Return Air Duct Collar for Overhead Style Dehumidifier	\$88.95

Quest Air Filter for PowerDry 1300 and RDS10 Dehumidifiers

Replacement MERV 11 filter for the Quest Portable Dehumidifiers PowerDry 1300 and RDS10. Captures particles (including mold spores) down to 1 micron in size.



Item No.	Description	MSRP
310788	Quest Air Filter 12 in x 12 in x 1 in for PowerDry 1300 & RDS10	\$7.95

Quest Air Filter for PowerDry 4000 & Dual Overhead Dehumidifiers

Replacement MERV 11 filter for the Quest PowerDry 4000 Portable Dehumidifier and the Dual 105, 155 and 205 Overhead Dehumidifiers. Captures particles (including mold spores) down to 1 micron in size.



Item No.	Description	MSRP
310790	Quest Air Filter 16 in x 20 in x 2 in for PowerDry 4000 & Dual Overhead Model	\$12.95

HUMIDIFIER

Humidifier - Commercial Grade

Features a multi-directional fogging head. Size is 12.2 in x 12.2 in in diameter. Coverage is from 160-320 sq ft. Maximum output is 0.4 GPH. Industrial-grade motor for years of use. Connects directly to your water supply with your own hookup (uses 1/4 in tubing). Operates at 62 dBA. 110 volts/60 hz/0.9 amps. 1 Year Warranty.



Item No.	Description	MSRP
700860	Humidifier Commercial Grade (48/Pkt)	\$299.95

AIR CONDITIONERS

Ideal-Air Dual Hose Air Conditioner 12,000 BTU

High performance flexible dual hose design. Heavy duty compressor and 3-speed fan motor. Auto restart function. LED Display with remote control thermostat. Supply voltage: 115 Volt - 60 Hz. Power: 11.9 Amps/1340 Watts. 1 Year Warranty.



Item No.	Description	MSRP
700820	Ideal-Air Dual Hose Air Conditioner 12,000 BTU	\$499.95

Ideal-Air™ now offers both *Do-It-Yourself* and *Professionally Installed* Mini-Split Air Conditioners & Heat Pumps

Do-It-Yourself Mini Splits

- Refrigerant lines are flexible stainless steel tube—easy to handle.
- Quick-connect fittings attach refrigerant lines to outdoor unit—easy and doesn't require special tools.
- System is pre-charged with refrigerant—Do-it-Yourself ready!
- Electrical wire already connected to the indoor unit and is labeled and prepared for easy connection to the outdoor unit.

Professional Installation Mini Splits

- Refrigerant lines are copper tube with foam insulation—easy to kink.
- Flare fittings must be made on the copper tube at the indoor and outdoor units—difficult and requires special tools.
- Requires special tools and knowledge to “charge” the system with refrigerant.
- Electrical interconnector must be trimmed and connected to the indoor and outdoor unit—difficult and easily mis-wired.

Do-It-Yourself Air Conditioners & Heat Pumps

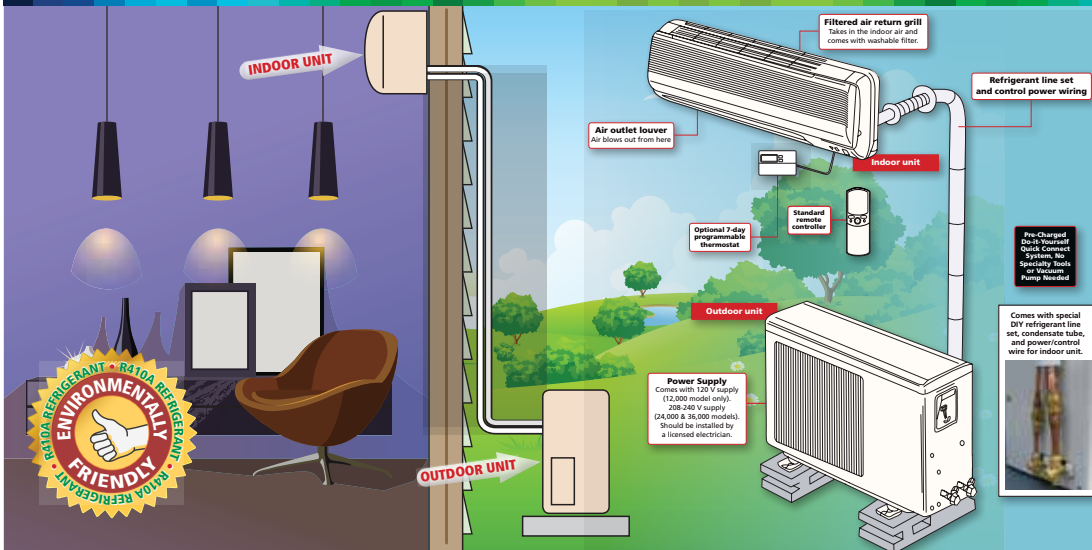

Available in both standard efficiency (13 SEER) as COOLING ONLY and in high efficiency (15 SEER) with both HEATING AND COOLING & with inverter technology (variable BTU output). Choose from: 12,000 BTU, 24,000 BTU and 36,000 BTU.

IDEALair
www.ideal-air.com

Ideal-Air™ Recommended Air Conditioning BTU Calculator

Ton's to BTU Conversion

Ton's of Air Conditioning	Equal to BTU's of Cooling
1 Ton	12,000
2 Ton's	24,000
3 Ton's	36,000

Visit www.ideal-air.com for more information.

Seasonal Energy Efficiency Rating (S.E.E.R.)

13 S.E.E.R. is the minimum efficiency level allowed. The higher the S.E.E.R. level the lower the energy use. Most air conditioners are 13 to 15 S.E.E.R.

Scan for electronic BTU Calculator:



Ideal-Air Mini Split Air Conditioners 13 Seer - COOLING ONLY

Flexible stainless steel 23 ft pre-charged line set with quick connect fittings to allow for easy Do It Yourself installation. No technician required. Now with optional Day/Night mode. Product No. 700485 features: Cooling Power/Capacity: 8.9 amps/1,180 watts/12,000 BTU. dB Rating: Indoor 38dB, Outdoor 49dB. Requires 120 volt dedicated 15 amp circuit. Product No. 700490 features: Cooling Power/Capacity: 10 Amps/2,200 watts/24,000 BTU. dB Rating: Indoor 32 dB, Outdoor 4 5dB. Requires 240 volt dedicated 15 amp circuit. Product No. 700495 features: Cooling Power/Capacity: 14 Amps/3,000 watts/36,000 BTU. dB Rating: Indoor 40 dB, Outdoor 50 dB. Requires 240 volt dedicated 20 amp circuit. 1 Year Warranty.



Item No.	Description	MSRP
700485	Ideal-Air Mini Split Air Conditioner 12,000 BTU 13 Seer	\$1,320.95
700490	Ideal-Air Mini Split Air Conditioner 24,000 BTU 13 Seer	\$2,229.95
700495	Ideal-Air Mini Split Air Conditioner 36,000 BTU 13 Seer	\$2,999.95
700520	LuxPro Digital Thermostat	\$59.95

Ideal-Air Mini Split Inverter Heat Pumps 15 Seer - HEATING & COOLING

Can be used with the optional programmable thermostat with up to 4 temperature settings each day. Flexible stainless steel 23 ft pre-charged line set with quick connect fittings to allow for easy Do It Yourself installation. No technician required. Product No. 700500 features: Amp range: 2 to 14 amps. dB Rating: Indoor 32 dB, Outdoor 45 dB. Requires 120 volt dedicated 15 amp circuit. Product No. 700505 features: Amp range: 6 to 14 amps. dB Rating: Indoor 35 dB, Outdoor 45 dB. Requires 240 volt dedicated 15 amp circuit. Product No. 700510 features: Amp range: 8 to 20 amps. dB Rating: Indoor 42 dB, Outdoor 52 dB. Requires 240 volt dedicated 20 amp circuit. 1 Year Warranty.



Item No.	Description	MSRP
700500	Ideal-Air Mini Split Heat Pump 12,000 BTU 15 Seer	\$1,849.95
700505	Ideal-Air Mini Split Heat Pump 24,000 BTU 15 Seer	\$2,785.95
700510	Ideal-Air Mini Split Heat Pump 36,000 BTU 15 Seer	\$3,335.95
700520	LuxPro Digital Thermostat	\$59.95

Ideal-Air Professional Installation Mini Split Air Conditioner 24,000 BTU 13 SEER

This version of the Ideal Air mini split comes without the flexible lineset. Uses insulated cooper tube refrigerant lines. Offers cooling only in standard 13 SEER efficiency. Note: This product requires professional installation. All warranty related diagnosis and repair to be performed by qualified HVAC Technician. See limited warranty statement at www.ideal-air.com. Uses 240 Volt power and requires a dedicated 20 Amp circuit. All Ideal-Air air conditioners need surge protection, see part #700522.



Cooling Power/Capacity: 10 amps/2,200 watts/24,000 BTU. dB Rating: Indoor 32 dB, Outdoor 45 dB. Designed for cooling with outside temperatures ranging from 49° F to 105° F. Use outside of these temperatures is not recommended and IS NOT COVERED UNDER WARRANTY. 1 year Warranty.

Item No.	Description	MSRP
700492	Ideal-Air Professional Installation Mini Split Air Conditioner 24000 BTU 13 SEER	\$1,299.95

LuxPro Digital Thermostat

Easy to use digital programmable thermostat that features separate weekday and weekend programs for heating and cooling systems. 4 periods per day. Contractor grade. Default temperature program, ranges 46° F to 90° F. For use with Ideal-Air Mini Split units. 3 Year Warranty.



Item No.	Description	MSRP
700520	LuxPro Digital Thermostat	\$59.95

Ideal-Air Mini-Split Installation Tool Kit

This is a single kit that provides all the special mini split installation tools you will need to install. Kit includes torque wrench set, R410A flare tool, tube cutter, reamer, Allen tool set, R410A gauge and hoses and a vacuum pump. Be sure to follow the manufacturer installation instructions for proper installation. 30 days Warranty.



Item No.	Description	MSRP
700580	Ideal-Air Mini Split Installation Tool Kit	\$299.95

SAMSUNG WARRANTY

Samsung makes the highest quality ductless A/Cs available. Their warranty is 5 years for the compressor, 3 years for other parts and they offer 120 days of limited labor for "out-of-the-box" issues. Retailers and Sunlight Supply have no role in warranty. All warranty service must be provided by a qualified HVAC Technician who is hired by the end-user. This Technician should contact Samsung directly for technical support and replacement parts see <http://quietside.com/samsung.html> for more info.

Samsung Max Mini Split Air Conditioner Systems

Samsung's MAX line of Mini Split Air Conditioners provide both heating and cooling. These units combine stylish looks with robust performance and world-class reliability. The Smart Inverter compressor offers varying ranges of heating and cooling capacity. This saves money and offers better temperature control. These units use R410A refrigerant and R410A flare connections. Hand-held controller included. (Optional wall mounted programmable thermostat may be purchased separately). Samsung Limited Warranty: Requires professional HVAC Technician to fulfill warranty. NOTE: These products require professional installation. All warranty issues are handled directly through Samsung and require a professional HVAC Technician to perform all warranty related work. This product cannot be returned to a retail store or to Sunlight Supply. All repairs and warranty related services are handled on site by a professional HVAC Technician.



Refrigerant linesets are offered separately and should be installed by a qualified HVAC Technician. 3 Year Warranty.

Item No.	Description	MSRP
700550	Samsung MAX 12,000 BTU Mini Split Air Conditioner System	\$1,859.95
700554	Samsung MAX 24,000 BTU Mini Split Air Conditioner System	\$2,869.95
700558	Samsung MAX 36,000 BTU Mini Split Air Conditioner System	\$4,219.95

Samsung Max Programmable Thermostat for Split Systems

Optional programmable thermostat for the Samsung Max Mini-Split systems. Features ON/OFF, Operating Mode, Fan Speed, Airflow, Temp Setting buttons. Error display. Filter replacement alarm reset and sleep mode. Built-in room temperature sensor. Wireless remote control restriction. Weekly schedule setting and vacation dates settings. Temperature range setting. 1 Year Warranty.



New

Item No.	Description	MSRP
700578	Samsung Max Programmable Thermostat for Split Systems	\$299.95

Samsung Max Split System AC Linesets

Linesets and interconnecting wires for Samsung Max and Vivace Split Systems. These parts are needed for a Samsung Split installation. Match the BTU and the length that you need.



New

Item No.	Description	MSRP
700570	Samsung Max Lineset 25 ft Interconnecting Wires for 12,000 BTU	\$192.95
700572	Samsung Max Lineset 25 ft Interconnecting Wires for 24,000/36,000 BTU	\$228.95
700574	Samsung Max Lineset 50 ft Interconnecting Wires for 12,000 BTU	\$342.95
700576	Samsung Max Lineset 50 ft Interconnecting Wires for 24,000/36,000 BTU	\$428.95

SpeediChannel Split Fit Kit

This convenient kit includes most of the common fittings needed for standard installation of SpeediChannel Lineset Covers. Kit Includes: 1 Wall Penetration Fitting, 1 Long Bend 90 degree Fitting, 1 Coupler Fitting, 1 Inside Turn Fitting, 10 SpeediClips and 10 Zip Ties.



New

Item No.	Description	MSRP
728140	SpeediChannel Fit Kit 4 in (w/ Elbow, Coupler, Penetration, Inside Turn Fittings)	\$73.95

Electrical Components for Splits

These four parts are essential for installing an electrical circuit to the outdoor unit of a mini split system. All products are UL listed and intended for outdoor use. The electrical whip (728156) is an all-in-one product that runs from the outdoor unit to the electrical disconnect box. The electrical disconnect box (728162) provides a way to cut power to the outdoor unit for servicing (required by code). The electrical conduit or "Liquid Tite" (728160) is flexible and is used to run wire along the outside of a building from the electrical panel to the disconnect box. The connector fittings (728160) are used to connect the conduit to the disconnect box.



New

Item No.	Description	MSRP
728156	Electrical Whip Ultra 1/2 x 6 ft	\$18.30
728158	Electrical Conduit Liquid Tite 1/2 x 100 ft	\$83.95
728160	Connector Fitting for Liquid Tite Conduit 1/2 in Screw On	\$1.49
728162	Electrical Disconnect Box 30 Amp Fuseable	\$22.95

SpeediChannel Split Lineset Covers and Fittings



New

The SpeediChannel Lineset Cover Systems are used to conceal split linesets, drain lines and control cables when they cannot be installed inside of the wall. Offered A La Carte for total customization. Flat backed to fit neatly against the installation surface and can be painted so that you can color match the cover to your wall.

Item No.	Description	MSRP
728106	SpeediChannel 4 in Union Coupling Fitting	\$9.95
728108	SpeediChannel 4 in Line Set Cover 2 Pcs-front/back	\$45.95
728110	SpeediChannel 4 in End Cap	\$7.75
728112	SpeediClip 11 in CT 10/Pack	\$6.59
728114	SpeediChannel 4 in Dect End Fitting	\$11.95
728122	SpeediChannel 4 in 90 degree Inside-turn Elbow Fitting	\$25.39
728124	SpeediChannel 4 in 90 degree Outside-turn Elbow Fitting	\$25.39
728126	SpeediChannel 4 in 90 degree Flat Bend Fitting	\$24.95
728128	SpeediChannel 4 in 45 degree Flat Bend Fitting	\$24.95
728136	SpeediChannel 4 in Flex Joint Fitting	\$18.50
728138	SpeediChannel 4 in Flat Wall Escutcheon Fitting	\$8.25
728142	Roof (Jack) Penetration Inlet 5 in	\$171.95
728144	SpeediChannel 4 in 90 degree Long Radius Flat Bend Fitting	\$19.95
728148	Soffit Fitting 4 in	\$22.95
728150	SpeediChannel 4 in T-Joint Fitting	\$51.95
728152	SpeediChannel 4 in Wall Penetration Fitting	\$24.95
728154	SpeediChannel 4 in Wall Escutcheon Fitting	\$8.25

Spray Foam Sealant

Expanding Foam. A ready-to-use, multi-purpose, polyurethane foam that is triple expanding when in contact with air. The expanding action fills holes, cracks and gaps more completely than standard caulks. It has excellent insulating properties and superb adhesion to virtually all building materials.

UL LISTED



New

Item No.	Description	MSRP
728102	Spray Foam Sealant 12 oz can	\$9.35

Triple-D Coil Cleaner - RTU

Triple-D is a triple active synergistic detergent cleaner formulated to remove a broad range of soils with minimal time and effort. Triple-D cleans condensers, evaporators and filters in HVAC-R systems and eliminates the need for steam cleaning, scrubbing or soaking.



New

Item No.	Description	MSRP
728182	Coil Cleaner Triple D Quart	\$12.95

Split Drain Line

Use this drain line with 25 ft and 50 ft split linesets. Line is 5/8 in inside diameter and 20 ft in length.



Item No.	Description	MSRP
728120	Drain Line (Flexible) for Mini-Split 5/8 in ID	\$72.95

Split Lineset Couplers and Flare Nuts

Used for coupling two mini-split linesets. Requires one coupler and two flare nuts per connection. Choose coupler and flare nut size based on lineset diameter.



Item No.	Description	MSRP
728164	Short Forged Flare Nut Brass 5/8 in	\$2.50
728166	Short Forged Flare Nut Brass 1/4 in	\$0.89
728168	Short Forged Flare Nut Brass 3/8 in	\$1.19
728170	Short Forged Flare Nut Brass 1/2 in	\$1.69
728172	Flare Union Coupler for 5/8 in Lineset	\$4.25
728174	Flare Union Coupler for 1/4 in Lineset	\$0.89
728176	Flare Union Coupler for 3/8 in Lineset	\$2.25
728178	Flare Union Coupler for 1/2 in Lineset	\$2.39

Split Pads and Equipment Mounts

These Wall Brackets are used for supporting condensing units. This wall mount bracket features a cross bar that is attached to a wall and two L-shaped brackets. Block Lifts are used as mounting bases when condensing units must be bolted down. Furnished complete with mounting bolts. Maximum load capacity is 900 pounds. Plastic and Foam & Cement Equipment Pads are a 2 in thick equipment pad is the industry standard used across a variety of applications.



Item No.	Description	MSRP
728104	Wall Bracket for Ductless Split System	\$64.95
728145	Block Lift for Ductless Split System 14 in 2/Pack	\$17.95
728146	Block Lift for Ductless Split System 17 in 2/Pack	\$19.95
728180	Equipment Pad 24 x 36 x 2 (Plastic) for Mini Split System	\$42.95
728184	Equipment Pad 16 x 36 (Foam & Cement) for Mini Split Systems	\$27.95
728186	Equipment Pad 24 x 36 (Foam & Cement) for Mini Split Systems	\$44.95

Surge Protector for Heating and Cooling Products

Protects electronics in lighting, air conditioners, pumps, generators and more. Works on single-phase products to protect against lightning power surges and equipment voltage surges; 24,000 amps/240 joules protection; 120-240 VAC. 1 Year Warranty.



Item No.	Description	MSRP
700522	Surge Protector for Heating & Cooling Products	\$33.95

Low Ambient Outdoor Fan Control Kit for Ductless Air Conditioners

Allows air conditioners and dehumidifiers to operate in colder conditions. Head pressure control of outdoor unit fan motor speed, 120-480 VAC; Eliminates overshoots common to on/off and pressure switch controls. Helps prevent evaporator freeze-ups, low pressure cut-outs and liquid-slugged compressors in low ambient conditions. 1 Year Warranty.



Item No.	Description	MSRP
700524	Low Ambient Outdoor Fan Control Kit for Ideal-Air 13 SEER & Coaire Ductless A/C	\$229.95

Hard Start Kit for Heating and Cooling Products

Helps electrical motors in fans, air conditioners and dehumidifiers to start more reliably when under load. Combines the award-winning, high powered relay output design with advanced patented circuitry for the most precise and reliable hard start kit on the market! Rated for 1/12 to 5 HP applications. Multi-voltage operation - 115 or 230 VAC motors. 145-175 µF @ 330V. 1 Year Warranty.



Item No.	Description	MSRP
700526	Hard Start Kit for Heating & Cooling Products	\$59.95

Interconnector Wire for Mini Split A/C, 14 Gauge/4 Conductor

Baro-Split Compact 600 cable consists of UL listed THHN soft drawn annealed solid copper to provide power and control for your mini-split installations. The continuous sheath provides watertight protection and it is covered with a PVC outer jacket for outdoor use or direct burial. Baro-Split cable is UL approved and meets or exceeds the requirements of NEC Article 330.



Item No.	Description	MSRP
728100	Interconnector Wire for Mini Split A/Cs, 250 ft Roll, 14 Gauge/4 Conductor, Solid Wire	\$299.95

R410A Refrigerant Refill Kit

Easy to use, do it yourself check and recharge kit for R410A systems. 1.8 lb canister comes with hose, gauge and 5/16 in adapter. Features easy to use color based gauge scale for help in proper charging. For R410a systems only. Great for topping off systems when low. Consult technical documents of your system to prevent over-charging.



Item No.	Description	MSRP
700512	R410A Refrigerant Refill Kit (Includes Canister, Hose for 5/16 in Connection and Gauge)	\$89.95

Condensate Pumps

These pumps are used as an accessory with air conditioners and dehumidifiers and are suitable for use with condensate from high efficiency condensing furnaces and boilers which produce acidic condensate. This rugged pump has 22 ft of lift, compared to the typical 20 ft. 2 Year Warranty.



Item No.	Description	MSRP
728130	Condensate Pump 120 Volt	\$84.95
728135	Condensate Pump 240 Volt	\$101.95



Introducing the new look from Phresh® Filter.



Phresh Filters

ALL PHRESH FILTERS COME INDIVIDUALLY BOXED WITH A PRE-FILTER AND A FLANGE.

**Half the weight
Last twice as long
Moves high CFM's**

Industry exclusive

Aluminum tops and bases for reduced weight. Half the weight of other filters. 46mm (1.8in) RC-48 activated, certified virgin carbon bed. Machine packed carbon means more carbon and less movement. Cone shaped internal base for optimum air flow. Sealed, bagged, boxed and labeled directly after being manufactured for optimum life span, handling and presentation. 51% open air custom mesh. Unique Anti Air Bypass System. Large selection of sizes available to fit any application. Flange & pre-filter included. 4 in x 8 in to 8 in x 24 in sizes only can be sent via UPS.



Scan to learn about Phresh Filters.
www.phreshfilter.com



Item No.	Description	Carbon Filter		Dimensions	MSRP
		lbs	lbs		
701000	Phresh Filter 4 in x 8 in 150 CFM	2.6	3.8	7.25" x 7.25" x 8.0"	\$104.95
701003	Phresh Filter 4 in x 12 in 200 CFM	4.3	6.3	7.25" x 7.25" x 12.25"	\$111.95
701004	Phresh Filter Lo-Pro 4 in x 20 in 125 CFM	2.9	5.1	5.3" x 5.3" x 20.0"	\$82.95
701005	Phresh Filter 6 in x 16 in 400 CFM	9	12.6	9.5" x 9.5" x 16.0"	\$171.95
701010	Phresh Filter 6 in x 24 in 550 CFM	14.1	16.5	9.5" x 9.5" x 24.0"	\$194.95
701015	Phresh Filter 8 in x 24 in 750 CFM	17.7	21.1	10.5" x 10.5" x 24.0"	\$207.95
701018	Phresh Filter 8 in x 39 in 950 CFM	30.6	37.4	10.5" x 10.5" x 39.5"	\$271.95
701020	Phresh Filter 10 in x 24 in 850 CFM	21	25.9	13.5" x 13.5" x 24.0"	\$229.95
701025	Phresh Filter 10 in x 39 in 1400 CFM	36.4	41.9	13.5" x 13.5" x 39.5"	\$304.95
701028	Phresh Filter 12 in x 24 in 950 CFM	18.9	27.5	15.5" x 15.5" x 23.6"	\$279.95
701030	Phresh Filter 12 in x 39 in 1700 CFM	42.6	53.5	15.5" x 15.5" x 39.5"	\$364.95
701033	Phresh Filter 12 in x 48 in 2200 CFM	40.1	55.2	15.5" x 15.5" x 47.2"	\$407.95
701035	Phresh Filter 14 in x 39 in 2100 CFM	48.3	60.9	17.5" x 17.5" x 39.5"	\$407.95
701040	Phresh Filter 14 in x 48 in 2500 CFM	58.6	72.1	17.5" x 17.5" x 48.0"	\$462.95
701045	Phresh Filter XL 14 in x 50 in 3800 CFM	75.3	97.0	19.0" x 19.0" x 50.5"	\$547.95

Phresh Skinny Filters



Unique inverted filter bed offers the best filtration in the industry on a budget. Phresh Skinny Filter contains 100% Pro-4/8 Australian carbon for the maximum possible air filtration. Thinner in diameter and up to half the weight of other competing filters. Small and light enough for easy single person installation. The expected lifespan of a Phresh Skinny targets 9 months but up to a very respectable 1 year when used in an optimal climate. That's up to 66% longer than other budget filter brands. 1 Year Warranty.

Item No.	Description	MSRP
701300	Phresh Skinny 6 in x 24 in 300 CFM	\$124.95
701305	Phresh Skinny 8 in x 32 in 500 CFM	\$199.95
701310	Phresh Skinny 10 in x 35 in 650 CFM	\$239.95
701315	Phresh Skinny 12 in x 39 in 900 CFM	\$309.95

Phresh Inline Filters



Phresh Inline Filters are state of the art carbon filters that practically scour the air to clean it of dust, foreign particulates, organic compounds and odors. Phresh Inline Filters are twice as light and last twice as long. Phresh In-Line Filters are perfect for the following applications: Grow tents, cupboards and cabinets.

Item No.	Description	MSRP
701175	Phresh Inline Filter 6 in 500 CFM	\$231.95
701180	Phresh Inline Filter 8 in 750 CFM	\$297.95
701185	Phresh Inline Filter 10 in 850 CFM	\$347.95
701190	Phresh Inline Filter 12 in 950 CFM	\$429.95

Can-Filters Can-Max Filter

For max air flow use Max-Filter 2500 CFM. Constructed with light weight aluminum (over 40% perforated) and high capacity carbon with an outside diameter of 20 in (over 17 sq/ft) of surface area.



Item No.	Description	MSRP
700600	Can-Max Filter w/out Flange 2500 CFM	\$426.65

Phresh Intake Filters



Removes 99.9% of bugs, molds, pollen and dust. Use for intake filtering, scrubbing and low intensity exhaust filtering. Ultra light filters use advanced nano carbon felt technology. Maintains 90% of air flow.

Item No.	Description	MSRP
701255	Phresh Intake Filter 4 in x 6 in 140 CFM	\$57.95
701260	Phresh Intake Filter 6 in x 8 in 270 CFM	\$67.95
701265	Phresh Intake Filter 6 in x 12 in 450 CFM	\$84.95
701270	Phresh Intake Filter 8 in x 12 in 460 CFM	\$97.95
701275	Phresh Intake Filter 8 in x 16 in 750 CFM	\$121.95
701280	Phresh Intake Filter 10 in x 12 in 700 CFM	\$122.95
701285	Phresh Intake Filter 10 in x 16 in 1000 CFM	\$152.95
701290	Phresh Intake Filter 12 in x 16 in 1060 CFM	\$169.95
701295	Phresh Intake Filter 12 in x 20 in 1200 CFM	\$222.95

Phresh Duct Silencers

Sound reducing acoustic foam decreases fan noise by up to 50%. Use with fans in conjunction with carbon filters, light systems and more. Durable and light weight aluminum body. Compact size is easy to install. Attach a Phresh Silencer to the intake or exhaust side of an inline fan.



Item No.	Description	MSRP
701200	Phresh Duct Silencer 4 in x 12 in	\$66.95
701205	Phresh Duct Silencer 6 in x 18 in	\$102.95
701210	Phresh Duct Silencer 8 in x 24 in	\$122.95
701215	Phresh Duct Silencer 10 in x 30 in	\$164.95
701220	Phresh Duct Silencer 12 in x 36 in	\$207.95
701225	Phresh Duct Silencer 14 in x 39 in	\$247.95

Pre-Packaged Can-Filter & Can-Fan Combos

These pre-packaged combos are great for UPS shipping. Everything you need in one packaged set.



Item No.	Description	MSRP
700763	Can-Filter Pre Packaged Can 33 w/ Can-Fan 6 in 270 CFM	\$282.04

Can-Lite Active Filters



These filters use 10% more virgin activated Australian RC light weight granular carbon. The bed depth is 2 in. Up to 2.5 years of life expectancy. All filters include a low resistance pre-filter. Each filter is shrink wrapped, boxed and labeled for ease of use.

Item No.	Description	Flange	Carbon Filter		Dimensions	MSRP
			lbs	lbs		
700589	Can-Lite Filter 4 in 250 CFM	4 in	6.6	9.0	4.0" x 4.0" x 15.0"	\$115.48
700590	Can-Lite Filter 6 in 600 CFM	6 in	14.2	20.0	10.0" x 10.0" x 24.0"	\$182.10
700591	Can-Lite Filter 8 in 1000 CFM	8 in	31.6	42.0	12.0" x 12.0" x 40.0"	\$264.27
700592	Can-Lite Filter 10 in 1500 CFM	10 in	35.4	48.0	14.0" x 14.0" x 40.0"	\$286.48
700593	Can-Lite Filter 12 in 1800 CFM	12 in	43.2	58.0	16.0" x 16.0" x 40.0"	\$342.00
700594	Can-Lite Filter 14 in 2200 CFM	14 in	50.4	68.0	18.0" x 18.0" x 40.0"	\$379.75

Can-Filters



Can-Filters provides one of nature's best odor control materials, activated carbon. Can CKV-4 (carbon type) is specially developed for this purpose. A high quality pre-filter wrapped around main body housing, helps to prevent clogging.

Item No.	Description	Flange	Carbon Filter		Dimensions	MSRP
			lbs	lbs		
700644	Can-Filter 150 w/ out Flange 1260 CFM	12 in	123	156.0	16.5" x 16.5" x 60.0"	\$421.95
700639	Can-Filter 125 w/ out Flange 1110 CFM	10 in	103	129.0	16.5" x 16.5" x 49.0"	\$366.43
700634	Can-Filter 100 w/ out Flange 840 CFM	8 in	82	103.0	16.5" x 16.5" x 39.5"	\$322.01
700629	Can-Filter 75 w/ out Flange 600 CFM	8 in	62	79.0	16.5" x 16.5" x 29.5"	\$277.60
700619	Can-Filter 66 w/ out Flange 412 CFM	6 in	42	44.0	12.0" x 12.0" x 26.0"	\$188.77
700614	Can-Filter 50 w/ out Flange 420 CFM	6 in	31	55.0	16.5" x 16.5" x 19.7"	\$222.08
700609	Can-Filter 33 w/ out Flange 200 CFM	6 in	16	25.0	12.0" x 12.0" x 13.0"	\$133.25
700595	Can-Filter 1500 w/ out Flange 35 CFM	4 in	2.5	5.5	5.5" x 5.5" x 10.0"	\$51.11
700599	Can-Filter 2600 w/ out Flange 94 CFM	4 in	5.3	9.0	5.5" x 5.5" x 18.0"	\$66.66
700604	Can-Filter 9000 w/ out Flange 118 CFM	5 in	7	12.0	5.5" x 5.5" x 25.0"	\$75.55



THE CLEANEST AIR AROUND

The Phresh® Size Selector
Choosing The Right Size Phresh® Filter



Can-Filters Flanges

The flange is used to connect the Can-Filter to the ducting or Can-Fan, this is for airflow out of the ventilated area.



Item No.	Description	MSRP
700670	Can-Filter Flange 2600/9000 4 in	\$8.89
700675	Can-Filter Flange 6 in	\$14.44
700680	Can-Filter Flange 8 in	\$15.55
700685	Can-Filter Flange 10 in	\$16.67
700690	Can-Filter Flange 12 in	\$21.11
700692	Can-Filter Flange 14 in (For Std & Max Fan)	\$29.00

Air Box Stealth Edition



We call it Stealth for a reason! Obliterate bad air and odors once and for all! A new generation in air purification. Easy to install, easy to use, easy to maintain. The Stealth Air box uses 100% premium virgin coconut charcoal, uses 100% of the filter surface area and are a 100% air tight with continuous worry-free operation. 1 Year Warranty.

Item No.	Description	MSRP
706105	Air Box 2 Stealth Edition 800 CFM 6 in	\$365.95
706106	Air Box 3 Stealth Edition 1200 CFM 8 in	\$472.95

Odor-Sok Air Filters

Constructed using microscopic activated carbon filaments & fibers. Air flows evenly across the carbon accelerating absorption. Faster adsorption rates mean smaller filter equipment & up to 30x less carbon in use for the same result over a 1 yr period.



Item No.	Description	MSRP
700800	Odor-Sok 4 in x 12 in 190 CFM	\$37.95
700805	Odor-Sok 6 in x 16 in 380 CFM	\$61.95

Horti-Control Dust Shroom Cleaning Kit

This kit includes biodegradable cleaner and a can of biodegradable plant based oil which contains rosemary & cedar oil. When your Dust Shroom is dirty, just spray the cleaner on, rinse it with warm water, allow it to dry & re-coat it with the oil.



Item No.	Description	MSRP
700990	Horti-Control Dust Shroom Cleaning Kit	\$19.95

Horti-Control Dust Shroom

This revolutionary filter will keep your air cooled reflectors, inline fans, ice boxes and ducting dust free. It will also keep mold, mildew, pests and bacteria out of your garden!



Item No.	Description	MSRP
700965	Horti-Control Dust Shroom 4 in	\$109.00
700970	Horti-Control Dust Shroom 6 in	\$119.00
700975	Horti-Control Dust Shroom 8 in	\$129.00
700980	Horti-Control Dust Shroom 10 in	\$219.00
700985	Horti-Control Dust Shroom 12 in	\$239.00

Replacement Carbon

Use to refill any carbon filter. This is high quality virgin activated coconut carbon. It comes bulk in a box and inside a plastic bag.



Item No.	Description	MSRP
700070	Replacement Pelletized Carbon 16 lb	\$82.95
700080	Replacement Pelletized Carbon 35 lb	\$159.95



Industry exclusive

Clearoma® is the ultimate odor control and odor removal product. With a secret, scientifically designed blend of natural odor control organics, essential oils, natural aldehydes, esters and ketones with vapor reducing properties, Clearoma® will remove everything obnoxious odors from grow spaces, houses, clothes, cars and more!

Clearoma Gel-Pak

Clearoma products are widely used to eliminate offensive odors. Clearoma eliminates all organic odors, while replacing them with a subtle fresh scent, which dissipates as the smell is eliminated. Perfect odor control anywhere. Refill with liquid Clearoma. Simply open the container to let the polymer inside release the aromatic vapors to control unwanted odors. Works 24 hours a day.



Item No.	Description	MSRP
700144	Clearoma Gel-Pak 8 oz	\$10.95
700146	Clearoma Gel-Pak Quart	\$16.95
700148	Clearoma Gel-Pak Gallon	\$38.95

Clearoma Sprayer

Clearoma products are widely used to eliminate offensive odors. Clearoma eliminates all organic odors, while replacing them with a subtle fresh scent, which dissipates as the smell is eliminated. Perfect odor control anywhere. One spray eliminates lingering, unwanted odors instantly.



Item No.	Description	MSRP
700136	Clearoma Sprayer 1 oz	\$3.95
700138	Clearoma Sprayer 4 oz	\$5.95

Clearoma Liquid Formula

Clearoma products are widely used to eliminate offensive odors. Clearoma eliminates all organic odors, while replacing them with a subtle fresh scent, which dissipates as the smell is eliminated. Convenient ready to use liquid. Ideal for refilling sprayers and Gel-Pak.



Item No.	Description	MSRP
700140	Clearoma Liquid Formula Quart	\$14.95
700142	Clearoma Liquid Formula Gallon	\$34.95



ONA Odor Neutralizing Agent has been solving problematic odors with great success since it arrived on the market in 1995. Formulated from essential oils, it will tackle the most difficult odors and literally eliminate them - no masking - no coverup - just neutralization and elimination. The odors are gone. This reputation for effectiveness has caused hydroponic gardeners around the world to use it successfully and they keep coming back for more.

Ona Apple Crumble Spray

So good, you have to try it! Use Ona Apple Crumble spray anywhere unwanted odors are present. Simply spray into the air as needed. Ideal for eliminating smoke, pet and garbage odors. 1 Year Warranty.



Item No.	Description	MSRP
700419	Ona Apple Crumble Spray 250 ml	\$9.95

Ona Apple Crumble Gel

Eliminate odors safely and permanently with Ona Gel. The proven industrial strength odor neutralizing ability of Ona Gel has now been combined with a new exciting scent, Apple Crumble! Available in all size gel containers. It is non-toxic, environmentally friendly and safe to use around people, pets and plants. 1 Year Warranty.



Item No.	Description	MSRP
700440	Ona Apple Crumble 1 Liter Gel	\$17.95
700442	Ona Apple Crumble 4 Liter Gel Pail	\$39.95
700444	Ona Apple Crumble 4 Liter Gel Jar	\$39.95
700446	Ona Apple Crumble 20 Liter Gel	\$167.95

Ona Apple Crumble Mist Can

Experience the power of Ona with a new blast of scent, Apple Crumble! Use our Mist Can with Ona Mist Dispenser to maximize your odor control and leave the air smelling great! 1 Year Warranty.



Item No.	Description	MSRP
700383	Ona Apple Crumble Mist Can 6 oz	\$11.95

Ona Apple Crumble Mini Mist Can

The all new Ona Apple Crumble Mini Mist Can combines our proven industrial strength formula with a convenient and portable mist can. Use for immediate odor control at home or on the road.



Item No.	Description	MSRP
700381	Ona Apple Crumble Mini Mist Can 1.3 oz	\$4.99

Ona Block Apple Crumble

Introducing the new scent of the all new Ona Black Label Series. The Black Label series uses the same unique formula as our other proven scents, with a pleasant new twist. Perfect for around the house to neutralize odors.



Item No.	Description	MSRP
700332	Ona Block Apple Crumble 6 oz	\$8.99

Ona Pro Block

Unpleasant odors are gone - quickly and easily. The best part is that the active ingredients in the ONA Blocks are plant based, and therefore safe to use around people, plants and pets.



Item No.	Description	MSRP
700327	Ona Pro Block 6 oz	\$8.95

Ona Pro Mist

It is virtually odorless and leaves only a fresh smell - like after a summer rain. Ona Pro is plant-based and safe to use around people, plants and pets. The Ona Mist aerosol is designed to only spray a short burst into the air. It is so powerful, that's all you need!



Item No.	Description	MSRP
700386	Ona Pro Mist 6 oz	\$11.95

Ona Pro Gel

Ona Pro Gel is as close to odorless. Although it has a slight scent when sniffed in the container, the final result when working on powerful odors is simply a clean, fresh smell - period.



Item No.	Description	MSRP
700400	Ona Pro Gel Quart	\$17.95
700405	Ona Pro Gel Gallon Pail	\$39.95
700410	Ona Pro Gel Gallon Jar	\$39.95
700415	Ona Pro Gel 5 Gallon	\$167.95
700420	Ona Pro Gel 7.5 Gallon	\$199.00

Ona Pro Spray

Would you like the air in your home or office to smell fresh and clean? Then use the Ona Pro Spray! It leaves nothing behind to indicate that any odors were present.



Item No.	Description	MSRP
700421	Ona Pro Spray 8 oz	\$9.95

Ona Spray - Fresh Linen

Would you like the air in your home or office to smell fresh and clean? Then use the Ona Spray now in Fresh Linen scent! It leaves nothing behind to indicate that any odors were present. It is all you will ever need.



Item No.	Description	MSRP
700425	Ona Spray Fresh Linen 8 oz	\$9.95

Ona Liquid

Ona Liquid can be added to commercial misting systems, humidifiers or simply sprayed freely into the air. Ona Liquid is water based and can easily be diluted for safe & effective washing of odor saturated garments.



Item No.	Description	MSRP
700300	Ona Liquid Polar Crystal Quart	\$17.95
700305	Ona Liquid Fresh Linen Quart	\$17.95
700310	Ona Liquid Polar Crystal Gallon	\$39.95
700315	Ona Liquid Fresh Linen Gallon	\$39.95

Ona Block

Ideal for small areas such as closets, foyers, attics, cars, gym bags, boats, kitchens, garbage cans, cupboards or vents. Simply remove the cap, or punch several small holes in the cap and place in desired location. Measures 3 x 3 in and will fit in most places.



Item No.	Description	MSRP
700320	Ona Block Polar Crystal 6 oz	\$8.95
700325	Ona Block Fresh Linen 6 oz	\$8.95

Ona Mist

Ona is very powerful and will help take out odors in garages, restaurants, bathrooms, hotel rooms, kitchens, smoking rooms or any place in your home or small business facility.



Item No.	Description	MSRP
700380	Ona Mist Polar Crystal 6 oz	\$11.95
700385	Ona Mist Fresh Linen 6 oz	\$11.95

Ona Gel - Polar Crystal

The Ona Gel is our most popular product. The Ona odor neutralizing agents are released in a controlled manner so that every drop of this excellent product is fully optimized.



Item No.	Description	MSRP
700330	Ona Gel Polar Crystal Quart	\$17.95
700340	Ona Gel Polar Crystal Gallon Pail	\$39.95
700350	Ona Gel Polar Crystal Gallon Jar	\$39.95

Ona Gel - Fresh Linen

The Ona Gel is our most popular product. The Ona odor neutralizing agents are released in a controlled manner so that every drop of this excellent product is fully optimized.



Item No.	Description	MSRP
700335	Ona Gel Fresh Linen Quart	\$17.95
700345	Ona Gel Fresh Linen Gallon Pail	\$39.95
700355	Ona Gel Fresh Linen Gallon Jar	\$39.95
700365	Ona Gel Fresh Linen 5 Gallon	\$167.95

Ona Mist Dispenser

Has an electronic eye that senses light levels. Set it to only spray in the dark (low light) or during the day (or when lights are normally on). The third option allows you to set it to spray 24 hrs a day. The spray is metered out in three adjustable time intervals - 7.5 min, 15 min or 30 min. 1 Year Warranty.



Item No.	Description	MSRP
700390	Ona Mist Auto Dispenser	\$24.95

Ona Cyclone Dispenser Fan

This portable fan runs very quietly and effectively. Loaded with a 20 liter pail of Ona Gel, it will provide high volume, high capacity distribution. Using less power than a light bulb, the Ona Cyclone provides delivers up to 5,000 square feet. 1 Year Warranty.



Item No.	Description	MSRP
700396	Ona Cyclone Dispenser Fan	\$139.95

Ona Breeze Dispenser Fan

Redesigned to be lighter and uses less power and fits on either the Ona Gel Pail or Ona Gel Jar (both 4 liters, 1 US Gal). This makes the Ona Breeze excellent value for the dispensation of Ona Gel. The Ona Breeze provides a room up to 1,500 square feet. 1 Year Warranty.



Item No.	Description	MSRP
700395	Ona Breeze Dispenser Fan 35 CFM	\$59.95

Ona Odor Stop Dispenser Fan

A dispenser fan for medium duty application. It has a high volume of airflow combined with a profile that can be conveniently placed anywhere. A maximum airflow of 225 CFM. It provides distribution for a room up to 10,000 sq. ft. 1 Year Warranty.



Item No.	Description	MSRP
700397	Ona Odor Stop Dispenser Fan 225 CFM	\$299.95

Ona Storm Dispenser Fan

Ideal for larger facilities such as schools, gymnasiums and office buildings. With its adjustable airflow control, it evenly distributes Ona for areas up to 10,000 sq. ft. (1,100 sq. meters). Designed to be used with Ona Gel 5 gal size. 225 CFM. 1 Year Warranty.



Item No.	Description	MSRP
700398	Ona Storm Dispenser Fan 225 CFM	\$399.95

uvonair®

Ozone Environmental Technologies has been manufacturing Commercial/Industrial Uvonair Ozonators since 1994. All Uvonair products are manufactured in Canada, using only the highest quality components available on the market today. Featuring both Corona Discharge and Ultra Violet Ozonators. Engineered, built and guaranteed by Ozone Environmental Technologies, with years of ozone generation experience.

Uvonair 1000

It attacks and neutralizes odors at the source. Ozone by ultraviolet light. It eliminates odor, mold, bacteria, smoke, etc. Easy to use with no maintenance required. For areas up to 1000 cubic ft. Warning: For commercial use only in unoccupied areas. 1 Year Warranty.



Item No.	Description	MSRP
741000	Uvonair 1000	\$245.95
741015	UV Bulb 6 in (For Uvonair 1000)	\$64.95

Uvonair 3000

It attacks and neutralizes odors at the source. It eliminates odor, mold, bacteria, smoke, etc. Easy to use with no maintenance required. For areas up to 3000 cubic ft. Warning: For commercial use only in unoccupied areas. 1 Year Warranty.



Item No.	Description	MSRP
741005	Uvonair 3000	\$255.95
741020	UV Bulb 11 in (For Uvonair 3000)	\$64.95

Uvonair 5000

It attacks and neutralizes odors at the source. It eliminates odor, mold, bacteria, smoke, etc. Easy to use with no maintenance required. For areas up to 5000 cubic ft. Warning: For commercial use only in unoccupied areas. 1 Year Warranty.



Item No.	Description	MSRP
741010	Uvonair 5000	\$271.95
741025	UV Bulb 14 in (For Uvonair 5000)	\$82.95

Uvonair 8 in UV Inline Duct Ozonator - 2 Bulb

Ozone safely alters the molecular structure of offensive micro-organisms, to eliminate odor. An economical system that produces ozone using special ultra violet light bulbs. Ideal for rooms up to 5000-10000 cu.ft. (150-300 m3). Warning: For commercial use only in unoccupied areas. 6 month warranty on bulb. 1 Year Warranty.



Item No.	Description	MSRP
741035	Uvonair UV Inline Duct Booster Ozonator 8 in - 2 Bulb	\$370.50
741030	UV Bulb High Output 6 in (For Uvonair Inline 8 in)	\$67.95

Uvonair 8 in CD Inline Duct Ozonator - 1 Cell

Ozone safely alters the molecular structure of offensive micro-organisms, to eliminate odor. Will treat all odors being exhausted by an 8 in (20 cm) ventilation system under most circumstances for rooms up to 20,000 cu.ft. Warning: For commercial use only in unoccupied areas. 1 Year Warranty.



Item No.	Description	MSRP
741040	Uvonair CD Inline Duct Ozonator 8 in - 1 Cell	\$562.95

Uvonair 10 in CD Inline Duct Ozonator - 2 Cell

Will treat all odors being exhausted by a 10 in (25 cm) ventilation system under most circumstances. The CD-1000-2 is intended for a room size of 40,000 cu. ft. Warning: For commercial use only in unoccupied areas. 1 Year Warranty.



Item No.	Description	MSRP
741050	Uvonair CD Inline Duct Ozonator 10 in - 2 Cell	\$729.95

Uvonair 10 in CD Inline Duct Ozonator - 1 Cell

Will treat all odors being exhausted by a 10 in (25 cm) ventilation system under most circumstances. The CD-1000-1 is intended for a room size of 20,000 cu. ft. Warning: For commercial use only in unoccupied areas. 1 Year Warranty.



Item No.	Description	MSRP
741045	Uvonair CD Inline Duct Ozonator 10 in - 1 Cell	\$619.95

Uvonair 12 in CD Inline Duct Ozonator - 3 Cell

Will treat all odors being exhausted by a 12 in (30 cm) ventilation system under most circumstances. Intended for rooms up to 100,000 cu. ft. (3000 m3). Warning: For commercial use only in unoccupied areas. 1 Year Warranty.



Item No.	Description	MSRP
741055	Uvonair CD Inline Duct Ozonator 12 in - 3 Cell	\$889.95

AIR PURIFICATION

**Remember, if it doesn't say "Pro-4/8™ Carbon"
...then it's not a Phresh® Filter.**

Phresh® Filter is the ONLY carbon filter in the industry that contains Pro-4/8™ triple activated and certified Australian virgin carbon.



www.phreshfilter.com



Exclusively distributed by:
National Garden Wholesale.
Sunlight Supply, Inc.
www.SunlightSupply.com





Rainmaker™ offers a full line of quality, multi-purpose sprayers at an affordable price. These sprayers are constructed with a high-quality translucent polyethylene material. With minimal maintenance they can last for years. Our diverse selection ranges from small to large liquid capacities. The line includes handheld sprayers, pump sprayers, wheeled cart/backpack sprayers and even electric sprayers. These sprayers work great for a variety of home and garden applications.

Industry exclusive

SPRAYERS & WANDS

Rainmaker Pressurized Pump Sprayer

This is a heavy duty, refillable pump sprayer. It features an adjustable brass spray nozzle. Capacity is 64 oz/1.9 Liters. Use to apply most pest/disease control products, foliar sprays or cleaning agents.



Item No.	Description	MSRP
708500	Rainmaker Pressurized Spray Bottle Gallon/1.9 Liter	\$9.49

Rainmaker Trigger Sprayer

This 32 oz spray bottle has an adjustable nozzle and translucent bottle to easily see liquid levels. It can be used for a variety of home and garden applications.



Item No.	Description	MSRP
708502	Rainmaker Spray Bottle 32 oz	\$2.39

Rainmaker Battery Powered Sprayer

All purpose sprayer ideal for herbicides, pesticides, liquid fertilizers and many home applications! Unit is powered by a rechargeable battery. Has a pull cart or simply take the sprayer off its carriage and wear like a backpack. Includes four interchangeable sprayer nozzles for different applications. Trigger with a lock-on option can be engaged for a continuous spraying. This sprayer has an integrated filter included and a 4 ft hose. 1 Year Warranty.



Item No.	Description	MSRP
708900	Rainmaker 5 Gallon Battery Powered Sprayer	\$199.95

Rainmaker Backpack Sprayer

All purpose sprayer ideal for herbicides, pesticides, liquid fertilizers and many home applications! Includes four interchangeable sprayer nozzles for different applications. Trigger with a lock-on option can be engaged for a continuous spraying. Padded shoulder straps for added comfort. Integrated filter included and a 4 ft hose. 1 Year Warranty.



Item No.	Description	MSRP
708902	Rainmaker 4 Gallon (16 Liter) Backpack Sprayer	\$39.95

Rainmaker Pressurized Pump Sprayers



All purpose sprayer ideal for herbicides, pesticides, liquid fertilizers and many home applications! Funnel top opening makes for easy filling. Trigger with a lock-on option can be engaged for a continuous spraying. Translucent polyethylene for durability and easy viewing of liquid levels. Carry with the grip handle or use the included shoulder strap. Includes a pressure relieve valve and a 4 ft hose. 1 Year Warranty.

Item No.	Description	MSRP
708904	Rainmaker 1 Gallon (4 Liter) Pump Sprayer	\$17.95
708906	Rainmaker 2 Gallon (8 Liter) Pump Sprayer	\$25.95
708908	Rainmaker 3 Gallon (11 Liter) Pump Sprayer	\$29.95

Solo Directional Sprayer

Solo's handheld sprayer is a one-hand pressure sprayer with a telescoping wand that is adjustable from 12 in to 23 in for comfortable ground level spraying without bending. The nozzle is fully adjustable from direct jet to fine mist. Locking trigger reduces user fatigue. A built-in shield provides added control if spraying in breezy conditions.



Item No.	Description	MSRP
708590	Solo Directional Sprayer w/ Extendable Wand 2 Liter	\$26.95

360 Spray Bottles

The 360 sprayer is equipped with a nozzle that rotates a full 360 degrees and holds that position to spray in any direction. By simply turning the nozzle, you eliminate the need to tilt the bottle.



Item No.	Description	MSRP
708585	360 Spray Bottle 8 oz	\$3.49
708586	360 Spray Bottle 16 oz	\$3.69
708587	360 Spray Bottle 24 oz	\$3.99
708588	360 Spray Bottle 32 oz	\$4.29

360 Trigger Sprayer

The 360 trigger sprayer with 9.25 inch dip tube can be used to replace current trigger sprayers. The 360 trigger sprayer comes assembled to fit 32 oz bottles or the dip tube can be cut to a desired height to fit smaller bottles. Sprayer is equipped with a nozzle that rotates a full 360 degrees and holds that position to spray in any direction. Does not include bottle.



Item No.	Description	MSRP
708583	360 Trigger Sprayer w/ 9.25 in Dip Tube	\$2.49

Root Lowell Commercial Portable Sprayer/Atomizer

This industrial grade atomizer can spray a wide variety of foliar feed products as well as pest and disease control products. This portable unit is meant to be carried around by the user as the liquid is dispensed. 2 gal capacity. Adjustable flow 1.5 to 14 GPH. Particle size: (micron) 22-46.



Item No.	Description	MSRP
708540	Root Lowell Commercial Portable Sprayer/Atomizer (1026B)	\$302.95

Root Lowell Commercial Stationary Sprayer/Atomizer

This industrial grade atomizer can spray a wide variety of foliar feed products as well as pest and disease control products. It is placed in a stationary location and is used to fog a greenhouse or confined gardening area. 2 gal capacity. Adjustable flow 1.5 to 5.3 GPH. Particle size: (micron) less than 50.



Item No.	Description	MSRP
708545	Root Lowell Commercial Stationary Sprayer/Atomizer (1952B)	\$239.95

Root Lowell Flo-Master Battery Sprayer 5 L/1.3 Gallon

No pumping needed. Uses 4 D batteries (included). One set of batteries will spray approximately 18 gallons of liquid. Telescoping wand extends from 16 in to 35 in. Adjustable nozzle with padded shoulder strap.



Item No.	Description	MSRP
708537	Root Lowell Flo-Master Battery Powered Sprayer 5 Liter/1.3 Gallon	\$49.95

Root Lowell Flo-Master Heavy Duty Sprayer 36 oz

36 oz heavy duty trigger sprayer has nozzle that adjusts from fine mist to straight stream. Cushioned comfort grip minimizes user fatigue and rear support tab provides grip for greater comfort.



Item No.	Description	MSRP
708532	Root Lowell Flo-Master Heavy Duty Trigger Sprayer 36 oz	\$6.59

Root Lowell Flo-Master Pressurized Sprayer 40 oz

40 oz capacity. Compact version of standard compressed air sprayers. Adjustable poly nozzle which can spray a fine mist. Durable poly construction. 360 degree spraying capability allows spraying in any direction, including upside down.



Item No.	Description	MSRP
708534	Root Lowell Flo-Master Pressurized Pump Sprayer 40 oz	\$8.99

Root Lowell Flo-Master Sprayer 1 Gallon

Root Lowell 1 Gallon Flo-Master Pump Sprayer features funnel top with pour spout, durable poly construction, corrosion resistant poly wand & adjustable nozzle and poly flow control with lock-on feature. 1 Year Warranty.



Item No.	Description	MSRP
708538	Root Lowell Flo-Master Pump Sprayer 1 Gallon	\$19.59

Mondi Mist & Spray Deluxe Sprayer 1.3 Quart

Superior quality, small capacity tank sprayer designed for use in the garden or home. Brass nozzles adjust spray from fine mist to gently shower. This sprayer features an extra long nozzle and extension. 2 Year Warranty.



Item No.	Description	MSRP
708715	Mondi Mist & Spray Deluxe Sprayer 1.3 Quart/1.2 Liter	\$17.49

Mondi Mist & Spray Premium Tank Sprayer 1.5 Quart

A superior quality, small capacity tank sprayer designed for use in the garden or home. Equipped with a swivel nozzle that adjusts from a jet stream to a fine mist spray. Packaged with a bonus 6 in extension nozzle for harder to reach areas. 2 Year Warranty.



Item No.	Description	MSRP
708725	Mondi Mist & Spray Premium Tank Sprayer 1.5 Quart/1.4 Liter	\$11.49

Mondi Mist & Spray Deluxe Sprayer 2.1 Quart

Superior quality, small capacity tank sprayer designed for use in the garden or home. Brass nozzles adjust spray from fine mist to gently shower. Features an extended brass head, extra long nozzle and extension. 2 Year Warranty.



Item No.	Description	MSRP
708720	Mondi Mist & Spray Deluxe Sprayer 2.1 Quart/2 Liter	\$18.95

Fiskars Easy Pour Watering Can

It holds 2.6 gals yet is easy to carry and pour. Dual handles accommodate multiple hand positions. The spout rotates for adjustable flow control, from a gentle shower to a steady stream. The filling hole is located on the side so the handles don't get in the way.



Item No.	Description	MSRP
708825	Fiskars Easy Pour Watering Can 2.6 Gallon	\$26.95

SPRAYERS & WANDS

SPRAYERS & WANDS

Melnor GentleRain Shower Head Wand

Shower head for gentle watering. Flow-control allows you to adjust flow without going back to faucet. 30 inch in length. Cushion grip with trigger control. 7 Year Warranty.



Item No.	Description	MSRP
708803	Melnor GentleRain Shower Head Watering Wand	\$14.95

Mondi Telescopic Water Wand

A soft showering head that is gentle on plants and flowers. An extendable wand that reaches from 36 in to 52 in. Adjustable flow control on the handle with shaped soft grips for comfort. Includes premium Viton high quality seals and mesh filter. Lifetime Warranty.



Item No.	Description	MSRP
708711	Mondi Telescopic Water Wand	\$21.95

Dramm Rain Wand Colormark

The Rain Wand is ideal for watering flowerbeds, gardens and shrubs. Colormark models include a 30 in Anodized aluminum extension handle, 8 in foam grip and brass water shut-off valve. Fingertip shut-off valve reduces overall water consumption. Made in the USA. Lifetime Warranty.



Item No.	Description	MSRP
708810	Dramm Rain Wand Colormark 30 in	\$39.99

Bond 8 Pattern Watering Wand 36 in

Aluminum tube expandable to 36 in. This nozzle comes with 8 selectable patterns; jet, cone, shower, full, flat, mist, soaker and angled. Tilt head.



Item No.	Description	MSRP
740815	Bond 8 Pattern Watering Wand 36 in	\$23.49

Dramm Rain Wand Touch N Flow

The Dramm Rain Wand is ideal for watering flowerbeds, gardens and shrubs. Touch N Flow Sunrise models have an anodized aluminum extension handle, lever activated water shut-off, color matched Water Breaker nozzle. Lifetime Warranty.



Item No.	Description	MSRP
708815	Dramm Rain Wand Touch N Flow Sunrise 30 in	\$28.99

Bond Medium Duty Hose 5/8 in x 50 ft

Solid brass couplings. Collar reduces kinking at the faucet. Crush proof couplings. Coils easily in all weather conditions. 10 Year Warranty.



Item No.	Description	MSRP
740810	Bond Medium Duty Hose 5/8 in 50 ft	\$23.49

Are you enjoying your 2014-15 Product Catalog?
Did you know you can view or download the PDF version on our web site?

Just go to www.sunlightsupply.com and download your own electronic version today!

Look for us on Facebook, Twitter, Pinterest, Instagram, Google Plus and YouTube.



Grower's Edge
www.growers-edge.net

Top quality gardening accessories products. Vaporizers • Plant Ties • Drying Racks • Bamboo Stakes • Steel Stakes • Trellis Netting - Bagged • Trellis Netting - Bulk Rolls • Plant Supports • Storage Bags • Labels and many more great products to make gardening easier.



Grower's Edge Dry Rack with Clips

Use to easily dry flowers and herbs featuring snap together clips to quickly add or remove shelves. Topless tiers allow for 360 degree access to contents. Snap together buckles to quickly add or remove shelves. Durable polyester netting. Wire frames to make shelves rigid and sturdy. Each level contains an adjustable center strap for added weight support. 6 tiers.



Item No.	Description	MSRP
728730	Grower's Edge Dry Rack w/ Clips 3 ft	\$43.95
728735	Grower's Edge Dry Rack w/ Clips 2 ft	\$37.95

Grower's Edge Dry Rack Enclosed with Zipper Opening

Use to easily dry flowers and herbs. Zipper allows for each level to be completely enclosed. Gently maneuver, shake and flip without losing contents. Durable polyester netting. Wire frames to make shelves rigid and sturdy. Each level contains an adjustable center strap for added weight support. 8 tiers.



Item No.	Description	MSRP
728740	Grower's Edge Dry Rack Enclosed w/ Zipper Opening - 3 ft	\$48.95
728745	Grower's Edge Dry Rack Enclosed w/ Zipper Opening - 2 ft	\$32.95

Grower's Edge Dry Rack Partially Enclosed

Use to easily dry flowers and herbs. Each tier is partially enclosed with a front reach through entrance to access contents. Durable polyester netting. Wire frames to make shelves rigid and sturdy. Each level contains an adjustable center strap for added weight support. 8 tiers.



Item No.	Description	MSRP
728750	Grower's Edge Dry Rack Enclosed Partially - 3 ft	\$39.95
728752	Grower's Edge Dry Rack Partially Enclosed - 2 ft	\$27.95

Honey Bee Pollen & Trim Tray Kit

The Honey Bee Pollen Collection & Trimming Tray is two helpful products in one. Finally gardeners have a feather-light laptop trimming surface that will separate flower pollen while manicuring. Our trays feature a comfortable nonslip base, 150 micron stainless steel screen and a pollen application brush. 100 micron white & 200 micron black stainless steel



Industry exclusive screens can be purchased separately. 1 Year Warranty.

Item No.	Description	MSRP
725470	Honey Bee Pollen & Trim Tray Kit	\$49.99

Grower's Edge Vaporizer Commercial Grade

Stainless steel housing is very durable & will not rust. Aluminum cup maintains ideal temperature for vaporization. Holes in base allow natural convection action & unrestricted air movement. 5 ft grounded power cord. Suspend with jack chain at least 3 ft away from any combustible surface. Use only with properly registered materials. Follow all safety and licensing guidelines where applicable.



Item No.	Description	MSRP
740650	Grower's Edge Vaporizer Commercial Grade	\$99.95
740655	Grower's Edge Vaporizer Replacement Cup	\$14.95

Grower's Edge Deluxe Vaporizer

Features a high quality aluminum body. Traditional electric heating element for reliable and consistent operation. Adjustable position of vaporizing cup allows control of temperature. Uses only 150 watts to maintain vaporizing temperature. Includes 6 foot power cord, vaporizing cup and wire hanger.



Item No.	Description	MSRP
704050	Grower's Edge Deluxe Vaporizer	\$127.95
704051	Vaporizer Replacement Power Cord	\$14.95
704060	Vaporizer Cup	\$14.95

Grower's Edge Hang Time - Drying Rack

Use to easily dry flowers and herbs. Carabiner clip to make hanging simple. Durable polyester netting. Wire frames to make shelves rigid and sturdy. Snap together buckles to quickly add or remove shelves.



Item No.	Description	MSRP
728765	Grower's Edge Hang Time Drying Rack 24 in Medium	\$42.95
728766	Grower's Edge Hang Time Drying Rack 32 in Large	\$52.95

Honey Bee Micron Trays

These micron screens features the top tray design. The Micron Trays will fit onto the Honey Bee Base Tray, or under the Yellow 150 Micron Screen on the base Tray. Choose from the finest screen at 100 micron, a standard screen at 150 micron or the widest screen at 200 micron stainless steel screen. Made for sifting pollen off manicured flowers. 1 Year Warranty.



Industry exclusive

Item No.	Description	MSRP
725475	Honey Bee Tray Top 100 Micron	\$33.99
725480	Honey Bee Tray Top 150 Micron	\$33.99
725485	Honey Bee Tray Top 200 Micron	\$33.99

Heavy Harvest Premium Compost Tea Brewing Bags

Heavy Harvest Compost Tea Bags will allow you to achieve the healthiest biological production possible! Finally a compost tea brewing bag with commercial durability, that is easy to clean and engineered for multiple operations, providing growers brewing flexibility. These bags can be used in any type of compost brewer. Small dimensions: 9.25 inches x 13 inches and



Industry exclusive

Large 17.75 inches x 25 inches. 1 Year Warranty.

Item No.	Description	MSRP
725490	Heavy Harvest Premium Compost Tea Brewing Bag Small	\$19.99
725495	Heavy Harvest Premium Compost Tea Brewing Bag Large	\$29.99

Sticky Bye-Bye

Sticky Bye-Bye is an all-natural salt scrub solvent. This product is especially loved by gardeners with sticky fingers and tools. Remove tree sap from your car, sticker residue, gum from hair, scrub kitchen pots, pans, counter tops & bathrooms.



Item No.	Description	MSRP
704435	Sticky Bye-Bye 8 oz	\$10.99
704445	Sticky Bye-Bye Pint	\$16.99

Sticky Bye-Bye Sweet Orange Salt Free

Sticky Bye Bye is now available in a salt free concentrate. All natural yet truly effective citrus solvent for any sticky job in the home or garden. Can be used to remove permanent marker, duct tape/adhesive residues and more! Especially good for gardeners who deal with tree sap and other plant resins.



Item No.	Description	MSRP
704447	Sticky Bye-Bye Sweet Orange Salt Free 4 oz	\$10.25
704449	Sticky Bye-Bye Sweet Orange Salt Free 8 oz	\$16.99

Itchy Bye-Bye

Overexposure to plants can often cause allergies. Itchy Bye-Bye is an all natural topical spray made to relieve and prevent the gardener's itches. Made with an organic comprehensive formula that has been around for ten years.



Item No.	Description	MSRP
704440	Itchy Bye-Bye 2 oz	\$17.99

Roots Organics Sap Off Soap

A unique and powerful hand and tool cleaning soap. Made from all natural and yet gentle ingredients Sap Off Soap works quickly to cut resins, oils, sap and even inks or certain stains from many surfaces including skin, all tools, containers and counter tops.



Item No.	Description	MSRP
740180	Roots Organics Sap Off Soap 4 oz	\$9.99
740185	Roots Organics Sap Off Soap 8 oz	\$15.99
740190	Roots Organics Sap Off Soap Pint	\$23.99

Scissor-Fix

Our SoftEdge cleaning media is a high tech spin off from the aerospace industry. Scissors stay cleaner longer! One handed cleaning! Increased Efficiency with every cleaning. Conditions with every cleaning. Will not dull or rust your scissors.



Item No.	Description	MSRP
704455	Scissor Fix	\$18.95

Table Top Gardener - Portable Potting Tray

This Potting Tray is perfect for seedlings, repotting and transplanting. Keeps soil, fertilizer and water contained. Cut-away front creates comfortable working angle. Convenient shelf keeps garden tools, planter pots and gloves within easy reach. Easy-grip handles for portability. Measures 23-1/2 in x 21 in x 6 in. Made in the USA.



Item No.	Description	MSRP
725190	Table Top Gardener - Portable Potting Tray	\$16.95

Scan to find a retailer near you that carry these products.





Measure Master offers a varied line of high quality, precision measuring devices designed for use with both liquids and solids.



Industry exclusive

www.measuremaster.net

Measure Master Big Shot Measuring Glass

General purpose measuring pint glass. Graduation measurements include teaspoon, tablespoon, ounces and milliliters. Clear glass for easy and accurate measuring. Rated PG-13.



Item No.	Description	MSRP
740625	Measure Master Big Shot Measuring Glass 16 oz	\$6.99

Measure Master Sure Shot Measuring Glass

General purpose measuring shot glass. Graduation measurements include teaspoon, tablespoon, ounces and milliliters. Clear glass for easy and accurate measuring.



Item No.	Description	MSRP
740615	Measure Master Sure Shot Measuring Glass 1.5 oz	\$3.59

Measure Master Graduated Rectangle Measuring Containers

General purpose measuring cups. Chemically resistant polypropylene measurers. U.S. and metric graduations. Translucent for easy and accurate measuring.



Item No.	Description	MSRP
740600	Measure Master Graduated Rectangle Container 8 oz/250 ml	\$2.95
740605	Measure Master Graduated Rectangle Container 16 oz/500 ml	\$4.95
740607	Measure Master Graduated Rectangle Container 32 oz/1000 ml	\$7.49
740609	Measure Master Graduated Rectangle Container 64 oz/2000 ml	\$9.49

Measure Master Spoons

General purpose measuring spoons. Four attached spoons in increments of 1 Tablespoon, 1 teaspoon, 1/2 teaspoon, 1/4 teaspoon.



Item No.	Description	MSRP
740640	Measure Master Spoons	\$2.59

Measure Master Graduated Round Containers

All-purpose Measure Master Graduated Containers feature easy to read U.S. ounce and metric milliliter graduations. Measure Master Graduated Containers are made from an impact resistant and translucent plastic for durability and clear view of liquid levels.



Item No.	Description	MSRP
740320	Measure Master Graduated Round Container 8 oz / 250 ml	\$2.95
740322	Measure Master Graduated Round Container 16 oz / 500 ml	\$4.95
740324	Measure Master Graduated Round Container 32 oz / 1000 ml	\$7.49
740326	Measure Master Graduated Round Container 64 oz / 2000 ml	\$9.49

Measure Master Sterile Disposable Pipettes

Measure Master Pipettes will work well whenever there is a need for quick, safe transfer of liquids. Packaged individually in sterile packets, these disposable pipettes fit almost all needs for liquid transfer.



Item No.	Description	MSRP Ea
749600	Measure Master Sterile Disposable Pipette 3 ml	\$0.18
749605	Measure Master Sterile Disposable Pipette 5 ml	\$0.24

Measure Master Dropper

Manufactured with food grade materials, the Measure Master 5 ml Dropper features both milliliter and teaspoon measuring increments.



Item No.	Description	MSRP
740052	Measure Master Dropper 1 tsp / 5 ml	\$1.99

Measure Master Syringe 100 cc/ml

The Measure Master 100 ml/cc syringe is a clean and accurate alternative to pouring liquids into a measuring cup or spoon. The heavy duty plastic design features easy to read graduations in both metric (5 ml) and U.S. (1/2 oz) increments.



Item No.	Description	MSRP
740610	Measure Master Syringe 100cc	\$5.49

Measure Master Graduated Measuring Bucket 5 Gallon

A food grade 5 gallon semi-transparent white plastic bucket. This is a multipurpose container that has measuring increments printed on the pail in quarts, gallons and liters for easy measuring and mixing. Holds 5 gallon of dry or wet material and comes with a comfort grip handle for easy carrying.



Item No.	Description	MSRP
740050	Measure Master Graduated Measuring Bucket 5 Gallon	\$9.95

GROWING ACCESSORIES

Measure Master Pump Dispensers 1 oz

Great for quickly measuring & dispensing your liquid plant food & supplements! One pump dispenses one ounce of liquid. 740040 is designed specifically to a one gal bottle. 740042 is designed specifically to a 2.5 gal bottle (bottles not included).



Item No.	Description	MSRP
740040	Measure Master Pump Dispenser 1 oz For Gallon Jug	\$4.69
740042	Measure Master Pump Dispenser 1 oz For 2.5 Gallon Jugs	\$7.49

Green Eye LED Headlight

The lightweight, compact Green Eye Headlight easily adjusts with its elastic band and tilting light mount. The settings are 4 lamps, 8 lamps, all lamps and flashing. Water resistant. Allows hands-free tasking. Uses three AAA batteries (not included).



Item No.	Description	MSRP
708027	Green Eye LED Headlight	\$14.95

Green Eye LED Cap Light

Ideal for viewing plants at night without disturbing their growth cycle. The lightweight, compact Cap Light easily attaches to hat brims. Made for rugged treatment and powered with 2 lithium coin batteries for up to 96 hours use.



Item No.	Description	MSRP
708028	Green Eye LED Caplight	\$9.95

Green Eye LED Flashlight

Ideal for viewing plants at night without disturbing their growth cycle. Lightweight and water-resistant. Each high-intensity LED green bulb lasts over 100,000+ hours. Uses three AAA batteries (not included).



Item No.	Description	MSRP
708029	Green Eye LED Flashlight	\$12.95

AgroLED Green Flashlight/Lamp by Feliz

This unique 2-in-1 LED light system can be used either as a flashlight, a standard indoor/outdoor household lamp or both! To use it as a flashlight, just extend the handle and turn it on. To use it as a standard lamp, simply unscrew the end cap and insert it into any household light fixture with the same size standard base. 1 Year **Industry Exclusive** Warranty.



Item No.	Description	MSRP
960415	AgroLED 4 Watt Green Flashlight/Lamp AC/DC Rechargeable	\$29.95

Velcro Plant Ties

Plant Ties are an easy way to train vines or support plants. No knots required. The plant ties are adjustable, UV resistant and durable. Plant ties wrap around your plant and back onto themselves for a secure self-gripping hold.



Item No.	Description	MSRP
740080	Velcro Plant Ties - 45 ft x 1/2 in Roll	\$3.49

Grower's Edge Vine Clips

These plastic clips work great to support your plants while they grow. Simply attach the clip around the vine and then to a support.



Item No.	Description	MSRP Ea
740045	Grower's Edge Vine Clip	\$0.14

Nie-Co-Rol - The Original

Supports plants easily with up to 60 inches of retractable line. Heavy duty plastic housing. Made in Holland.



Item No.	Description	MSRP Ea
740075	Nie-Co-Rol	\$1.99

Grower's Edge Sun Spool

Support plants easily. Features a convenient hook and a non-removable stopper. 60 in of retractable line. Durable plastic housing.



Item No.	Description	MSRP Ea
740150	Grower's Edge Sun Spool 10/Bag	\$1.49

Grower's Edge Garden Plant Tie Soft

Soft foam, flexible garden plant tie. Use to attach plants to bamboo or wire support racks without damaging your plants. 5 mm in diameter by 16 feet long.



Item No.	Description	MSRP
800060	Grower's Edge Garden Plant Tie 5mm 16 ft	\$2.59

Grower's Edge Twist Tie

Ideal for tying plants, vegetables and vines to stakes and trellises. Plastic coated for gardening. 164 foot roll with built-in cutting tool.



Item No.	Description	MSRP
800055	Grower's Edge Twist Tie Dispenser w/ Cutter - 164 ft	\$3.59

Grower's Edge Plant Stake Labels Multi-Colored

Use these colorful plant stake labels to mark the type of seeds that you plant. Each stake is 4 in x 5/8 in. Choose your favorite color.



Item No.	Description	MSRP
801000	Grower's Edge Plant Stake Labels White - 1000/Box	\$29.95
801005	Grower's Edge Plant Stake Labels Red - 1000/Box	\$31.95
801010	Grower's Edge Plant Stake Labels Orange - 1000/Box	\$31.95
801015	Grower's Edge Plant Stake Labels Yellow - 1000/Box	\$31.95
801020	Grower's Edge Plant Stake Labels Green - 1000/Box	\$31.95
801025	Grower's Edge Plant Stake Labels Dark Blue - 1000/Box	\$31.95
801030	Grower's Edge Plant Stake Labels Lavender - 1000/Box	\$31.95

Bond Twist Tie Spool

Comes on a spool with a built-in cutter. Twist tie is ideal for tying up plants, vegetables and vines. Plastic coated for gardening. Cut to any length using the built in easy cutter.



Item No.	Description	MSRP
740855	Bond Twist Tie Spool - 160 ft	\$3.99

Bond Twine

This garden twine in green or natural is a roll of 200 ft of 2-ply soft garden twine. Jute Twine is made from natural fiber and is biodegradable. Can be used for countless jobs around the garden.



Item No.	Description	MSRP
740830	Bond Natural Twine 200 ft	\$3.95
740835	Bond Green Twine 200 ft	\$3.49

Bond Reusable T-Markers

These are 10 inch tall plastic reusable T-Markers. Use to identify plants within your garden.



Item No.	Description	MSRP
740840	Bond Reusable T-Markers - 25/Pack	\$3.95

Luster Leaf Plant Labels

Choose from 4 in or 6 in durable plant stake labels. Easily label your newly planted seeds. 50 labels per package.



Item No.	Description	MSRP
741415	Luster Leaf Plant Labels 4 in	\$2.49
741425	Luster Leaf Plant Labels 6 in	\$3.19

Luster Leaf Colored Plant Labels

Choose from blue, yellow or green durable plant stake labels. Easily label your newly planted seeds on these 5 in stakes. 30 labels per package.



Item No.	Description	MSRP
741420	Luster Leaf Colored Plant Labels 5 in	\$2.99

Luster Leaf T Label Plant Markers

Label your plants or seeds with these tall T shaped plant markers. 10 T labels per package.



Item No.	Description	MSRP
741410	Luster Leaf T Label Plant Markers 8 in	\$2.09

Luster Leaf Soft Wire Tie Strips

Use these light duty soft wire ties to hold up plants up. Easily bends and shapes to your desired needs. Light Duty, pre-cut 8 in pieces of multipurpose PVC/TPR (polyvinyl chloride/thermoplastic rubber) 5 mm cushioned 0.8 mm galvanized wire.



Item No.	Description	MSRP
741400	Luster Leaf Soft Wire Tie Strips	\$4.29

Luster Leaf Foam Wire Tie Strips

Gently tie up your plants with these foam cover wire ties. Bend and twist as needed. 8 in pieces of 7 mm foam wrapped 1 mm garden wire.



Item No.	Description	MSRP
741405	Luster Leaf Foam Wire Tie Strips	\$4.29

Luster Leaf Rapiclip Twist & Clips

Rapiclip Twist & Clips are excellent for gardeners to stake and support plants. Twist & Clips are simple to use. Just overlap the hooked ends of the clips, twist slightly and you're done.



Item No.	Description	MSRP
741430	Luster Leaf Rapiclip Twist & Clips	\$1.99

Luster Leaf Tomato Clips

Luster Leaf Tomato Clips help keep your tomato vines supported and growing tall.



Item No.	Description	MSRP
741480	Luster Leaf Tomato Clips	\$2.35

Luster Leaf Light Duty Garden Wire

Luster Leaf Light Duty Garden Wire is great for yard and garden applications. Sturdy and durable to ensure your garden plants get the support they need. 164 ft/50 meter roll.



Item No.	Description	MSRP
741485	Luster Leaf Light Duty Garden Wire	\$3.75

Luster Leaf Rapiclip Foam Wire Tie

Rapiclip Foam Wire Tie is ideal for tying plants, vegetables and vines to stakes and trellises. The foam wrapped wire helps to minimize damage to plants. 32.5 ft length x 7 mm thickness.



Item No.	Description	MSRP
741435	Luster Leaf Rapiclip Foam Wire Tie	\$6.95

Luster Leaf Rapiclip Vinyl Stretch Tie

Rapiclip Vinyl Stretch Tie is great for fastening, training and support of your plants. Heavy-duty vinyl expands with the growth of the plants. Not affected by hot or cold temperatures. Comes in two sizes 0.5 in thick x 150 ft long and 1 in thick x 150 ft long.



Item No.	Description	MSRP
741440	Luster Leaf Rapiclip Vinyl Stretch Tie 0.5 in	\$2.79
741445	Luster Leaf Rapiclip Vinyl Stretch Tie 1.0 in	\$4.49

Luster Leaf Link-Ups Grow Through Grid Plant Supports

The vinyl coated steel supports are made to last any conditions. Easily hook together to allow plants to grow through the support. At the end of the season simply unhook and fold up for storage. The size of the medium support is 16 in wide x 24 in tall legs. The size of the large support is 20 in wide x 30 in tall legs.

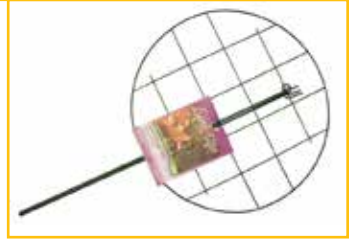

Item No.	Description	MSRP
741450	Luster Leaf Link-Ups Medium Grow Through Grid Pant Support	\$7.29
741455	Luster Leaf Link-Ups Large Grow Through Grid Pant Support	\$8.99

Woodstream Ultomato Plant Cage

Each cage is comprised of three 5 ft heavy-duty Sturdy Stakes and nine fully-adjustable support clips for continuous support throughout the plant's growth. The stakes of this cage have a strong steel core and tough, thick green plastic coating.



Item No.	Description	MSRP
740675	Woodstream Ultomato Plant Cage	\$9.95

Grower's Edge Natural Bamboo Stakes - Bulk

Grower's Edge Natural Bamboo Stakes are all natural, strong, lightweight, inexpensive, weather well and last several seasons in the garden. Use these stakes as plant stakes and markers or as supports for potted plants. 8 ft, 10 ft and 12 ft stakes cannot be shipped UPS or FedEx ground. Check your local Dealer Partner for availability.



Item No.	Description	MSRP
740745	Grower's Edge Natural Bamboo 2 ft Bulk	\$11.95
740750	Grower's Edge Natural Bamboo 3 ft Bulk	\$17.95
740755	Grower's Edge Natural Bamboo 4 ft Bulk	\$16.95
740760	Grower's Edge Natural Bamboo 6 ft Bulk	\$22.95
740765	Grower's Edge Natural Bamboo 8 ft Bulk	\$68.95
740770	Grower's Edge Natural Bamboo 10 ft Bulk	\$83.95
740775	Grower's Edge Natural Bamboo 12 ft Bulk	\$69.95

Grower's Edge Deluxe Steel Stakes

Grower's Edge Deluxe Steel Stakes are ideal for all your heavy-duty plant supporting needs. The steel core is coated with green plastic to make them weather and rust proof. They won't split, deteriorate or rot like bamboo stakes can.



Item No.	Description	MSRP Ea
740392	Grower's Edge Deluxe Steel Stake 2 ft	\$0.93
740394	Grower's Edge Deluxe Steel Stake 3 ft	\$1.02
740396	Grower's Edge Deluxe Steel Stake 4 ft	\$1.25
740398	Grower's Edge Deluxe Steel Stake 6 ft	\$2.25

Grower's Edge Natural Bamboo Stakes

Grower's Edge Natural Bamboo Stakes are all natural, strong, lightweight, inexpensive, weather well and last several seasons in the garden. Use these stakes as plant stakes and markers, or as supports for potted plants. 8 ft stakes cannot be shipped UPS ground.



Item No.	Description	MSRP
740720	Grower's Edge Natural Bamboo 2 ft	\$2.25
740725	Grower's Edge Natural Bamboo 3 ft	\$3.49
740730	Grower's Edge Natural Bamboo 4 ft	\$4.49
740735	Grower's Edge Natural Bamboo 6 ft	\$4.19
740740	Grower's Edge Natural Bamboo 8 ft	\$8.39

Bond Natural Bamboo Stakes

Bamboo stakes are all natural, strong, lightweight, inexpensive, weather well and last several seasons in the garden. Use these stakes as plant stakes and markers or as supports for potted plants. 8 ft stakes cannot be shipped ground.



Item No.	Description	MSRP
740945	Bond Natural Bamboo Stakes 2 ft	\$2.49
740950	Bond Natural Bamboo Stakes 3 ft	\$4.19
740955	Bond Natural Bamboo Stakes 4 ft	\$4.99
740960	Bond Natural Bamboo HD Stakes 6 ft	\$4.29
740965	Bond Natural Bamboo HD Stakes 8 ft	\$19.99

Bond Green Bamboo Stakes

Dyed green to blend in with the plants. Bamboo stakes are all natural, strong, lightweight, inexpensive, weather well and last several seasons in the garden. Use these stakes as plant stakes and markers or as supports for potted plants.



Item No.	Description	MSRP
740925	Bond Green Bamboo Stakes 2 ft	\$2.49
740930	Bond Green Bamboo Stakes 3 ft	\$4.19
740935	Bond Green Bamboo Stakes 4 ft	\$4.99
740940	Bond Green Bamboo Stakes 6 ft	\$4.29

Bond Super Steel Stakes

Green plastic coated plant stakes with a steel core. Rustproof with water tight closures on both ends, won't rot or split. Lightweight for indoor or outdoor use. 8 ft stakes cannot be shipped UPS or FedEx ground.



Item No.	Description	MSRP Ea
740890	Bond Super Steel Stake 2 ft	\$0.99
740895	Bond Super Steel Stake 3 ft	\$1.09
740900	Bond Super Steel Stake 4 ft	\$1.39
740910	Bond Super Steel Stake 6 ft	\$2.29
740920	Bond Super Steel HD Stake 8 ft	\$6.99

Grower's Edge Trellis Netting

Provides versatile plant support. Professional quality. Tangle-free. 6 in square reach through holes. Durable plastic allows multiple uses. Install horizontally or vertically.



Item No.	Description	MSRP
740095	Grower's Edge Green Trellis Netting 6 ft x 5 ft	\$6.29
740100	Grower's Edge Green Trellis Netting 6 ft x 10 ft	\$11.95
740105	Grower's Edge Green Trellis Netting 6 ft x 25 ft	\$21.95

Grower's Edge Soft Mesh Trellis Netting

Soft, non-abrasive mesh gently protects stems, vines and foliage. Ideal for guiding and supporting vine, flowering and vegetable plants. Nylon mesh is durable and long lasting. 6 in square reach through holes. Install vertically or horizontally depending on your gardening application.



Item No.	Description	MSRP
740110	Grower's Edge Soft Mesh Trellis Netting 5 ft x 15 ft	\$6.75
740115	Grower's Edge Soft Mesh Trellis Netting 5 ft x 30 ft	\$9.95
740120	Grower's Edge Soft Mesh Trellis Netting 5 ft x 60 ft	\$18.25

Grower's Edge Commercial Grade Trellis Netting

Grower's Edge Commercial Grade Trellis Netting is a strong, versatile polypropylene mesh specially designed for more efficient and economical cultivation of vegetables, fruits and flowers. It is easy to handle, simple to install and will not tangle. 6 inch x 6 inch reach through holes.



Item No.	Description	MSRP
740192	Grower's Edge Commercial Grade Trellis Netting 4 ft x 8 ft	\$5.59
740194	Grower's Edge Commercial Grade Trellis Netting 4 ft x 16 ft	\$9.79
740196	Grower's Edge Commercial Grade Trellis Netting 4 ft x 50 ft	\$21.79
740198	Grower's Edge Commercial Grade Trellis Netting 4 ft x 100 ft	\$34.49
740160	Grower's Edge Commercial Grade Trellis Netting 36 in x 328 ft	\$70.99
740164	Grower's Edge Commercial Grade Trellis Netting 48 in x 328 ft	\$77.99
740168	Grower's Edge Commercial Grade Trellis Netting 79 in x 328 ft	\$108.99

GROWING ACCESSORIES

GROWING ACCESSORIES

Grower's Edge Commercial Grade Trellis Netting Bulk Rolls

Grower's Edge Commercial Grade Trellis Netting is a strong, versatile polypropylene mesh specially designed for more efficient and economical cultivation of vegetables, fruits and flowers. It is easy to handle, simple to install and will not tangle. 6 inch x 6 inch reach through holes. Rolls cannot be shipped UPS or FedEx ground.



Item No.	Description	MSRP
740162	Grower's Edge Commercial Grade Trellis Netting 36 in x 3280 ft - Bulk Roll	\$346.99
740166	Grower's Edge Commercial Grade Trellis Netting 48 in x 3280 ft - Bulk Roll	\$444.99
740170	Grower's Edge Commercial Grade Trellis Netting 79 in x 3280 ft - Bulk Roll	\$754.99

Bond Garden Net Trellis

Ideal for guiding growing plants. Use garden net trellis to support vine flower and vegetable plants. Attaches to stakes or poles to create a sturdy structure for plants to climb. An easy way to keep your plants neat. 5.5 in square mesh.



Item No.	Description	MSRP
740845	Bond Garden Net Trellis	\$5.95

Gardeneer Trellis Netting

Heavy-duty nylon netting is ideal for growing tomatoes, peas and all vine crops. 7 inch reach through mesh.



Item No.	Description	MSRP
740580	Gardeneer Trellis Netting 5 ft x 15 ft	\$11.99
740585	Gardeneer Trellis Netting 5 ft x 30 ft	\$17.99

Botanicare Horti-Trellis

Hortitrellis is a professional plant support trellis for horizontal or vertical applications. It's made of pliable plastic for multiple uses, and unlike string net trellis, it will not tangle. The Hortitrellis is 48 in wide with 6 in squares. Use vertically w/support stakes.



Item No.	Description	MSRP
740000	Botanicare Horti-Trellis 4 ft x 8 ft	\$5.35
740005	Botanicare Horti-Trellis 4 ft x 16 ft	\$9.35
740010	Botanicare Horti-Trellis 4 ft x 50 ft	\$20.85
740015	Botanicare Horti-Trellis 4 ft x 100 ft	\$33.35

The Gardener's Hollow Leg

The Gardener's Hollow Leg is the debris and harvesting bag you wear. It's a fabric sack attached to a belt that is worn while you are working in the garden. The belt will hold your clipper and clipper-holster (not included). There's even a Velcro-closed pocket for your cell phone or iPod!



Item No.	Description	MSRP
748010	The Gardener's Hollow Leg	\$30.99

The Gardener's Hollow Leg Jr.

It's a fabric sack made of water-resistant, recycled polyester that is attached to a belt that you wear while harvesting produce or doing a multitude of home and garden tasks. The belt expands from 25 in to 52 in when the included extension strap is attached.



Item No.	Description	MSRP
748015	The Gardener's Hollow Leg Jr.	\$25.99



Buy American!

We are able to deliver the highest quality reflectors, lighting fixtures, lighting and environmental controls in the industry at a competitive price and still be made in the USA.

www.sunlightsupply.com

Libbey Storage Jars

Libbey glass jars are made to preserve the contents, resist scratching, corrosion and are BPA free. Each jar has a heavy base to prevent tipping. Use a press and seal lid to seal in the freshness of the contents. Choose from two sizes. Lids are sold separately.



Item No.	Description	MSRP Jar Ea
748250	Libbey Storage Jar 12.5 oz	\$2.39
748255	Libbey Storage Jar 20.5 oz	\$2.89
748260	Libbey Storage Jar Press and Seal Lid - 12.5 oz and 20 oz	\$1.29

Ball Wide Mouth Jars

Ball Wide Mouth Glass Preserving Jars are ideal for fresh preserving apple and grape juices. Our famous glass jars and closures go beyond fresh preserving to help you with serving, creative decor and gift giving. Pack includes Ball Wide Mouth Glass Jars, Ball Wide Mouth Lids with Bands and step by step instructions.



Item No.	Description	MSRP Jar Ea
748115	Ball Jars Wide Mouth Pint	\$1.26
748120	Ball Jars Wide Mouth Pint & Half	\$1.69
748125	Ball Jars Wide Mouth Quart	\$1.45
748130	Ball Jars Wide Mouth Half Gallon	\$2.55

Ball Quilted Crystal Jelly Jars

Ball Regular Mouth Quilted Crystal Jelly Jars are ideal for fresh preserving recipes such as jams, jellies, sauces, mustards and flavored vinegars. The Quilted Crystal design adds a decorative touch to these multi-purpose jars—also use them for serving, creative decor and gift-giving.



Item No.	Description	MSRP Jar Ea
748135	Ball Jars Quilted Crystal Jelly 4 oz	\$1.03
748140	Ball Jars Quilted Crystal Jelly 8 oz	\$1.16
748145	Ball Jars Quilted Crystal Jelly 12 oz	\$1.43

Ball Collection Elite Wide Mouth Jars

Ball Collection Elite Brushed Silver Wide Mouth Jars capture your creativity. Perfect for sharing, this jar has a contemporary style that is ideal for creative preserving and storing. Elegant enough to take your fruit dressings, veggie and fruit salsa, luscious pie fillings and colorful fruit syrups from the kitchen to the table, these uniquely shaped jars hold endless imagination.



Item No.	Description	MSRP Jar Ea
748150	Ball Jars Collection Elite Wide Mouth Half Pint 4/Pack	\$1.68
748155	Ball Jars Collection Elite Wide Mouth Pint 4/Pack	\$1.84

Ball Decorative Jar

Features: Easy push-down storage lid allows you to store items effortlessly One gallon size is perfect for dry storage, crafting and decoration – not for home canning use. Appearance replicates the charm of yester-year and it brings classic Americana style to your home.



Item No.	Description	MSRP Jar Ea
748160	Ball Jars Decorative 1 Gallon Commemorative Jar	\$18.08

Ball Wide Mouth Lids & Bands

Ball Wide Mouth Lids with Bands for preserving fit all regular mouth glass preserving jars. Seal in the freshness and enjoy freshly made foods tonight or tomorrow. Lids are for one-time use only. Bands can be reused. Includes 12 lids with bands.



Item No.	Description	MSRP Jar Ea
748165	Ball Jars Wide Mouth Lids & Bands 12/Pack	\$0.72

Ball Wide Mouth Lids

Ball Wide Mouth Lids for preserving fit all wide mouth glass preserving jars. Seal in the freshness and enjoy freshly made foods tonight or tomorrow. Lids are for one-time use only. Includes 12 lids.



Item No.	Description	MSRP Jar Ea
748170	Ball Jars Wide Mouth Lids 12/Pack	\$0.40

Ball Basic Home Canning Funnel

This Ball wide-mouth funnel is heat resistant to help you safely and easily fill jars to the appropriate headspace. It is designed to fit regular-mouth and wide-mouth jars. The blue translucent plastic lets you see the exact level of the food while filling the jar. Dishwasher safe on top rack.



Item No.	Description	MSRP Jar Ea
748175	Ball Jars Basic Home Canning Funnel	\$2.05

Follow us on Facebook and Twitter . You will get up to date information on new products, events and educational articles.



You can also find us on YouTube, Google Plus and Pinterest

Grower's Edge Nylon Storage Bags

Grower's Edge Nylon Storage Bags are the thickest and most durable bags on the market today. With a 1 mil thickness, these bags seal in the freshness and odors of your favorite foods. The storage bags are 19 in x 23.5 in and can hold up to 34 pounds of food. Manufactured to have multiple uses, these bags can handle extreme heat (up to 450 degrees) and can be frozen as well. Proudly made in the USA.



Item No.	Description	MSRP
744300	Grower's Edge Nylon Storage Bag - 1 mil 19 in x 23.5 in - 5/Pack	\$8.50
744305	Grower's Edge Nylon Storage Bag - 1 mil 19 in x 23.5 in - 10/Pack	\$14.95
744310	Grower's Edge Nylon Storage Bag - 1 mil 19 in x 23.5 in - 25/Pack	\$31.95

Zip-Zag Bags

Zip-Zag have taken the term resealable to a whole new level. Their patented dual lock zipper seal and quality manufacturing process ensures that all bags are 100% odor free with virtually no oxygen exchange. As an example the Zip-Zag bags have an oxygen transfer rate of 450 times less than any other zipper locking bag on the market!



Item No.	Description	MSRP
748210	Zip-Zag Bags 10.75 in x 11 in 10/Box	\$7.99
748215	Zip-Zag Bags 10.75 in x 11 in 50/Box	\$38.99
748220	Zip-Zag Bags 10.75 in x 11 in 150/Box	\$104.99
748225	Zip-Zag Bags 17 in x 17 in 10/Box	\$14.99
748230	Zip-Zag Bags 17 in x 17 in 50/Box	\$61.99
748235	Zip-Zag Bags 17 in x 17 in 150/Box	\$169.99

FOOD STORAGE

Super Sprouter™

Your best start for seeds and cuttings!



- Heat Mats
- Heat Mat Thermostats
- Neoprene Inserts
- Germination & Propagation Kits
- Plug Trays & Refills
- Domes and Trays



**VIGOROUS
ROOTS
STRONGER
PLANTS**

www.SuperSprouter.com



Industry exclusive



SHEAR PERFECTION™



www.shear-perfection.net

TITANIUM COATED • PRECISION CUTS

Shear Perfection Titanium Straight Trimming Shear - 2 in

The titanium coated stainless steel blade will stay sharp during multiple uses and is very easy to clean. This shear includes a comfort grip handle with spring loaded action for less fatigue on your hands. Storage is simple with an easy-lock mechanism. For right or left handed use.



Item No.	Description	MSRP
800350	Shear Perfection Straight Trimming Shear 2 in	\$6.95

Shear Perfection Titanium Curved Trimming Shear - 2 in

This shear allows users to fine tune their plants. The titanium coated stainless steel blade will stay sharp during multiple uses and is very easy to clean. This shear includes a comfort grip handle with spring loaded action for less fatigue on your hands. Storage is simple with an easy-lock mechanism. For right or left handed use.



Item No.	Description	MSRP
800355	Shear Perfection Curved Trimming Shear 2 in	\$6.95

Shear Perfection Titanium Cutting Shear - 1.5 in

A heavy duty shear used for thicker branches and stocks. The titanium coated stainless steel blade will stay sharp during multiple uses and is very easy to clean. Includes a comfort grip handle with spring loaded action for less fatigue. Storage is simple with an easy-lock mechanism. For right or left handed use.



Item No.	Description	MSRP
800360	Shear Perfection Cutting Shear 1.5 in	\$6.95

Shear Perfection Titanium Straight Trimming Shear - 3 in

Extra long titanium coated stainless steel blades, gives gardeners massive coverage of their plants. The titanium coated stainless steel blade will stay sharp during multiple uses and is very easy to clean. Includes a comfort grip handle with spring loaded action for less fatigue. Storage is simple with an easy-lock mechanism. For right or left handed use.



Item No.	Description	MSRP
800365	Shear Perfection Straight Trimming Shear 3 in	\$7.95

Shear Perfection Titanium Garden Snips

An all purpose snip that offers a full range of trimming possibilities. The titanium coated stainless steel blade will stay sharp during multiple uses and is very easy to clean. Includes a comfort grip handle with spring loaded action for less fatigue. Storage is simple with an easy-lock mechanism. For right or left handed use.



Item No.	Description	MSRP
800370	Shear Perfection Garden Snips	\$3.95

FISKARS®

Offering a wide variety of snips and shears to make gardening activities like precision pruning, snipping herbs and vegetables and other detailed cutting tasks easier and more enjoyable than ever. Many include special features like serrated blades to grip while you cut, Softgrip® handles for enhanced comfort, spring-action design to reduce the effort needed to cut and more.

Fiskars Softtouch Micro-Tip Pruning Snip

Super sharp, Micro-Tip blades give you top-of-the-line precision and control. Fully hardened stainless steel blades holds sharp edge longer. Comfortable Softgrip handles reduce stress and are non-slip for safety. Right or left-handed use. Lifetime Warranty.



Item No.	Description	MSRP
800015	Fiskars Softtouch Micro-Tip Pruning Snips	\$14.95

Fiskars Comfort Grip Floral Snip 9638

Comfort Grip loop handles improve control, ease fatigue. Super sharp, Micro-Tip blades give you top-of-the-line precision and control. Comfortable Softgrip handles reduce stress and are non-slip for safety. Right or left-handed use. Lifetime Warranty.



Item No.	Description	MSRP
800020	Fiskars Comfort Grip Floral Snips	\$21.95

Fiskars Shortcut Snip

Fingertip control for small, detailed cuttings. Ideal for intricate houseplant cuttings. Right or left-handed use. Fully hardened stainless steel blades holds sharp edge longer. Lifetime Warranty.



Item No.	Description	MSRP
800025	Fiskars Shortcut Snips	\$8.95

Fiskars Micro-Tip Pruning Snips

Makes deadheading, trimming and shaping plants easy. Easy Action design opens the blades after cutting. Stainless-steel blades have a precision-ground edge that stays sharp longer. Includes a handle with Softgrip touchpoints for a comfortable grip. Lifetime Warranty.



Item No.	Description	MSRP
800030	Fiskars Micro Tip Blades Pruning Snip 2/Pack	\$31.95

Fiskars Premier Large Titanium Scissor

Spring-action design gently opens blades after each cut to reduce hand strain. High-grade stainless steel blades offer a lasting sharp edge. Titanium blade coating is three times harder than steel and resists wear, scratches and corrosion. Ergonomic Softgrip handle is sculpted to fit your hand, maximizing cutting control, sensitivity and comfort. Lifetime Warranty.



Item No.	Description	MSRP
800035	Fiskars Premier Large Titanium Scissors	\$31.95

Fiskars Softgrip Floral Pruner

Our Softgrip Floral Pruner is designed to make deadheading flowers, cutting stems and removing thorns quick, easy and safe. The fully hardened, precision-ground steel blade stays sharp, and a low-friction coating makes every cut even easier. The stem stripper quickly and safely removes thorns.



Item No.	Description	MSRP
800040	Fiskars Softgrip Floral Pruner	\$11.95

Zenport Floral/Thread Snips Model H370

These excellent quality snips offer stainless steel cutting blades and durable ABS plastic handles. They are perfect for fine clipping, including taking cuttings, removing dead foliage, etc. Also used for thread cutting.



Item No.	Description	MSRP
800705	Zenport Floral/Thread Snips H370	\$5.29

Zenport Precision Micro Shear Model H356

The compact bypass shear offers smooth and precise action. Stainless steel curved blade and heavy duty plastic handle. Overall length is 6 in.



Item No.	Description	MSRP
800677	Zenport Precision Micro Shear H356	\$11.95

Zenport Micro Blade Pruner Model H355

Micro Blade Pruners have straight stainless steel blades. The handles have comfortable rubberized sides that improve gripping power. The pruning shear tips are narrow so they fit into small spaces. Length 6-5/8 in.



Item No.	Description	MSRP
800675	Zenport Micro Blade Pruner H355	\$12.49

Zenport Curved Micro Blade Pruner Model H355C

Curved Micro Blade Pruners have curved tip stainless steel blades to prevent rusting and are easy to sterilize. The handles have comfortable rubberized sides that improve gripping power.



Item No.	Description	MSRP
800676	Zenport Curved Micro Blade Pruner H355C	\$12.59

Zenport Long Blade Micro Pruner Model H355L

Micro Blade Pruners have long, straight, stainless steel blades to prevent rusting and are easy to sterilize. The handles have comfortable rubberized sides. The pruning shear tips fit into dense foliage or hard to reach foliage. Overall length is 7.5 in.



Item No.	Description	MSRP
800095	Zenport Long Blade Micro Blade Pruner H355L	\$13.69

Industry exclusive

Zenport INDUSTRIES

Quality Hand Tools Perfect For Every Job

We have the right tool for you.

Zenport Needle Nose Shear Model H303

Lightweight, needle nose shear with a wishbone spring. The blades are made of carbon steel.



Item No.	Description	MSRP
800255	Zenport Needle Nose Shear H303	\$10.79

Zenport Harvest Shears Long, Straight Blade H300S

Features cutlery grade, polished stainless steel blades. Ideal for cutting flowers and vegetables. Easy to sterilize.



Item No.	Description	MSRP
800240	Zenport Stainless Harvest Shear H300S	\$12.79

Zenport 8.5in Bypass Pruning Shear Model Z103

Euro design that is the choice of many professionals, but at a price that makes this the best choice for harvest and pruning labor crews. Tough, replaceable, carbon steel blade. Length: 8.5 in.



Item No.	Description	MSRP
800110	Zenport 8.5 in Bypass Pruning Shear Z103	\$11.29

Zenport Heavy Duty Bypass Pruner Model Z201

Easily cuts limbs up to 1 in diameter. This tool features a replaceable, non-stick, carbon steel blade, a self-cleaning sap groove and a resilient shock absorbing bumper. Blade tension is adjustable. Length: 9.2 in.



Item No.	Description	MSRP
800155	Zenport Heavy Duty Bypass Pruner Z201	\$16.29

Zenport 6.5in Deluxe Fruit Scissors Model ZS105

Tough horticulture scissors, designed for seasons of rigorous use. Length: 6.5 in.



Item No.	Description	MSRP
800430	Zenport Deluxe Fruit Scissors ZS105 (12Cs)	\$13.29

Zenport All Purpose Stainless Scissors SS-330 HN-R

7 in Stainless steel all-purpose scissors. Great for kitchen, garden, craft applications. Soft grips.



Item No.	Description	MSRP
800445	Zenport All Purpose Stainless Scissors SS-340HN-R	\$12.29



Since 1876, ARS Corporation has been defining the state of the art for pruning tools. The tools are sharp, engineered to hold their edge longer, lightweight, well-balanced, and durable. ARS tools are designed for continued professional use with minimal maintenance required.

ARS Harvesting Scissors SS-320BT

The slim blades are razor sharp and make it possible to pick fruit and remove culls in even the most crowded situations. Very popular for propagation. Soft bow grips fit any hand, reduce fatigue and can be used by lefties. Precision ground, Marquench hardened carbon steel blade. Super sharp blades are engineered to stay that way longer. Hard chrome plated carbon steel blades for rust/sap resistance and increased hardness.



Item No.	Description	MSRP
801254	ARS Harvesting Scissors	\$23.95

ARS Sharpening Stone AC-SS240

The AC-SS240 is a sharpening stone designed by ARS. Made of hard stone, this stone is ideally shaped for pruners, scissors and hedge shears. It is hard enough to sharpen ARS high carbon tool steel blades. Perfectly shaped to sharpen blades easily.



Item No.	Description	MSRP
801256	ARS Sharpening Stone	\$15.49

ARS All Purpose Scissors Model SS-330H

These softbow scissors are a quick snipper for bonsai, small plants, flower stems, tape, string and even electric wire. High carbon steel blades are hard chrome plated and marquench hardened to stay sharp longer than normal blades.



Item No.	Description	MSRP
801250	ARS All Purpose Scissors SS-330H	\$24.79

ARS Curved Scissors Model SS-320BM

ARS Curved Scissor blades are razor sharp and make it possible to pick fruit and remove culls in even the most crowded situations. Soft bow grips fit any hand, reduce fatigue and can be used by lefties. Blades made of carbon steel. Length: 6 in.



Item No.	Description	MSRP
801252	ARS Curved Tip Scissors SS-320BM	\$24.19

Bond Drop Forged Pruner Set

The drop forged pruner set includes a curved blade pruner and a straight blade pruner. Heavy duty spring with comfort cushion grip. Easily taken apart for sharpening or cleaning. Blades made with high carbon steel. 5 Year Warranty.



Item No.	Description	MSRP
801350	Bond Drop Forged Pruner Set	\$19.99

Bond Ultimate Pruning Combo Set

The Ultimate Pruning Combo Set includes: one 24 inch bypass lopper, one 8 inch bypass pruner and one 8-1/2 inch wave edge hedge shear. Use the bypass lopper for pruning live growth to promote new and structured growth. The lopper has light oval steel handles that provide leverage to slice through branches. The hedge shears are for pruning bushes and hedges. The shears have lightweight tubular steel handles. The bypass pruner is for pruning flowers and other garden plants. Cuts with clean scissor-like action. 10 Year Warranty.



Item No.	Description	MSRP
801355	Bond Ultimate Pruning Combo Set	\$29.99

Bond TieRite Tape Gun

Ties plants with a simple squeeze. For plants, vine and small trees. Use Tape Gun with Machine Staples, Blades and Tie Tape. Each item not included and sold separately.



Item No.	Description	MSRP
801380	Bond TieRite Tape Gun	\$79.99

Bond TieRite Tape Gun Replacement Parts

Replacement Bond tie tape. Secure plants and vines for use with Bond TieRite Tape Gun.



Item No.	Description	MSRP
801390	Bond TieRite Tape Gun Tie Tape - 1/2 in X 200 ft, 6 ml	\$2.49

Scissor-Fix

Our SoftEdge cleaning media is a high tech spin off from the aerospace industry. Scissors stay cleaner longer! One handed cleaning! Increased Efficiency with every cleaning. Conditions with every cleaning. Will not dull or rust your scissors.



Item No.	Description	MSRP
704455	Scissor Fix	\$18.95



Making quality tools since 1946

Bond Precision Tip Pruner

Perfect for precision pruning and thinning. Ideal for Bonsai, house plants or herb gardens. Features an ambidextrous lock.



Item No.	Description	MSRP
740800	Bond Precision Tip Pruner	\$7.95

Bond Floral Shear

Non-stick coated blades. Consumer friendly touch and try packaging. Alloy steel blades.



Item No.	Description	MSRP
740805	Bond Floral Shear	\$9.95

Bond Machete

The Bond Machete is made of high-carbon tempered steel with a serrated top edge for cutting heavy brush and undergrowth. Machete measures 22 in long and has a molded grip. Includes canvas sheath.



Item No.	Description	MSRP
801310	Bond Machete w/ Molded Grip 22 in	\$17.95



Panda Brand Film



Sunfilm Mylar Film

Used in indoor gardens to reflect the light back onto the plants. This film can be tacked or taped directly to a flat surface. Both sides are metallized for optimum reflectivity. Neatly wound on 2 in cores. Excellent, consistent quality. Now comes in 54 inch width.

Now 54" Wide



Item No.	Description	MSRP
730015	Sunfilm Mylar Film 1 mil - 54 in x 25 ft Roll	\$14.69
730020	Sunfilm Mylar Film 1 mil - 54 in x 50 ft Roll	\$27.99
730025	Sunfilm Mylar Film 1 mil - 54 in x 100 ft Roll	\$50.39
730030	Sunfilm Mylar Film 2 mil - 54 in x 25 ft Roll	\$22.70
730035	Sunfilm Mylar Film 2 mil - 54 in x 50 ft Roll	\$43.20
730040	Sunfilm Mylar Film 2 mil - 54 in x 100 ft Roll	\$77.80

Sunfilm Sun Blocker Foil Bubble

Sun Blocker Foil Bubble is a barrier bubble film laminated between 2 layers of foil. Helps to manage heating problems associated with indoor gardening, conserves energy, reflects up to 97% of all radiant heat and inhibits the growth of fungi or bacteria.



Item No.	Description	MSRP
730140	Sun Blocker Foil Bubble Film 4 ft x 50 ft Roll	\$116.95
730145	Sun Blocker Foil Bubble Film 4 ft x 100 ft Roll	\$216.95

Sunfilm Panda Film

Waterproof poly film that is black on one side and white on the other can be used for growing areas. Sunfilm Panda Film works well as a reflective film (reflects 90% of the light back to the growing area) or as a room partition. This is a very heavy duty 5.5 mil film for a variety of uses. Individually packaged.



Item No.	Description	MSRP
730085	Sunfilm Black & White Panda Film 10 ft x 10 ft Folded	\$12.95
730070	Sunfilm Black & White Panda Film 10 ft x 25 ft Folded	\$30.80
730075	Sunfilm Black & White Panda Film 10 ft x 50 ft Roll	\$56.10
730080	Sunfilm Black & White Panda Film 10 ft x 100 ft Roll	\$100.50

Panda Film Black & White Poly Film

It is a heavy-duty waterproof poly film that is black on one side and white on the other. Works well as a reflective film (reflects 90% of the light back into the growing area) or as a room partition. This is a very heavy duty film at a thickness of 5.5 - 6 mil.



Item No.	Description	Roll lbs	MSRP
730090	Panda Black & White Poly Film 10 ft x 25 ft Roll	6.7	\$27.95
730095	Panda Black & White Poly Film 10 ft x 50 ft Roll	13.0	\$52.95
730100	Panda Black & White Poly Film 10 ft x 100 ft Roll	34.0	\$92.95



Orca Grow Film

ORCA grow film is 94% reflective across the full visible spectrum and provides 99% diffusion. It is 100% light-tight, thermally reflecting, waterproof, and will not yellow from UV light. 11 mil thick and is recyclable and Eco-Friendly, it contains no halogens, plasticizers or VOCs.



Item No.	Description	Roll lbs	MSRP
730155	Orca Grow Film 54 in x 25 ft Roll	7.6	\$61.99
730160	Orca Grow Film 54 in x 50 ft Roll	11.4	\$119.99
730165	Orca Grow Film 54 in x 100 ft Roll	18.8	\$232.99

Orca Grow Film Seam Tape

ORCA Grow Film seam tape. Highly reflective and diffuse, plastic microfiber seam tape. Finish off your indoor garden with a professional look. 12 mil thick.



Item No.	Description	MSRP
730170	Orca Grow Film Seam Tape 3 in x 75 ft	\$28.69

REFLECTIVE & GREENHOUSE FILMS



Easygrow Diamond Fusion Lightite Film

Easygrow Diamond Fusion Lightite Film has a diffused pattern to spread light more evenly. Produced to help eliminate grow room hot spots. 100% light. PET coated to protect against corrosion and wear with membrane memory to reduce creasing effect.



Item No.	Description	Roll lbs	MSRP
730103	Easygrow Lightite Diamond Fusion Film 4.1 ft x 25 ft Roll	3.1	\$37.95
730105	Easygrow Lightite Diamond Fusion Film 4.1 ft x 50 ft Roll	6.2	\$69.95
730110	Easygrow Lightite Diamond Fusion Film 4.1 ft x 100 ft Roll	11.4	\$129.95

Easygrow Silver/White Lightite Film

A yield increasing spectrum enhanced silver reflector, applied to a gloss white - triple layered grow sheet. Lightite silver white grow sheet offers optimum light return and 100% Light tight capability. PET coated to protect against corrosion & wear.



Item No.	Description	Roll lbs	MSRP
730120	Easygrow Lightite Silver/White Film 4.1 ft x 100 ft Roll	12.4	\$110.95

Easygrow Eco Diamond Diffusion Foil Film

Diamond diffusion pattern to spread light more evenly. Produced to help eliminate grow room hot spots. Membrane Memory to dramatically reduce creasing effect & PET coated to protect against corrosion & wear. This product is not light tight.



Item No.	Description	Roll lbs	MSRP
730115	Easygrow Eco Diamond Diffusion Foil Film 4.1 ft x 50 ft Roll	3.6	\$51.95

Tarp Zip-Up

Tarp Zip-Up peel and stick zipper system. Creates easy access into tarp or poly enclosures. Easy installation. Opens from either side. Hundreds of different applications. Great for containing dust, moisture and pests.



Item No.	Description	MSRP
730200	Tarp Zip-Up	\$12.29

Lite Tite Heavy Duty Peel & Stick Zipper

Black Tear Proof Tape Designed for use with ordinary construction vapor barrier. This adhesive-backed zipper is perfect for creating a simple, resealable access doorway. The 84 in long, heavy-duty, water proof #5 zipper is sewn to a 950-denier high-density polyethylene backing that has a permanent high-tack acrylic adhesive.



Item No.	Description	MSRP
730215	Lite Tite Heavy Duty Peel & Stick Zipper	\$14.95

Black/White Poly Sheeting - Commercial Sizes

The 5 mil thickness polyethylene film offers excellent protection for heavy weight applications and has outstanding puncture, scuff and scrape resistance. The white surface reflects the light striking it and sends the light back to the plants. The black surface helps block the light from getting to the ground which keeps the weed growth down and the soil warm.



Item No.	Description	MSRP
748526	Black/White Poly Sheeting Commercial Size - 5 mil 24 ft x 100 ft	\$258.95
748528	Black/White Poly Sheeting Commercial Size - 5 mil 32 ft x 100 ft	\$345.95
748532	Black/White Poly Sheeting Commercial Size - 5 mil 40 ft x 100 ft	\$431.95
748536	Black/White Poly Sheeting Commercial Size - 5 mil 50 ft x 100 ft	\$539.95
748538	Black/White Poly Sheeting Commercial Size - 5 mil 50 ft x 150 ft	\$809.95

Nursery Greenhouse Film - Clear

This Nursery Greenhouse Film will cover all your needs whether the it is for a single season or full year. This is a tri-layer polyethylene film for maximum protection and ease of installation. Offers high clarity to allow the most light possible. 6 mil thickness for strength.



Item No.	Description	MSRP
748502	Nursery Clear 6 mil 1 yr Greenhouse Film 20 ft x 100 ft	\$243.95
748504	Nursery Clear 6 mil 1 yr Greenhouse Film 24 ft x 100 ft	\$292.95
748506	Nursery Clear 6 mil 1 yr Greenhouse Film 32 ft x 100 ft	\$390.95
748508	Nursery Clear 6 mil 1 yr Greenhouse Film 40 ft x 100 ft	\$487.95

Tufflite IV UV Protected Greenhouse Film - Clear

These Greenhouse Films covers all your needs whether it is for single season, full year or 4 year protection. Tufflite brand Greenhouse Film is a tri-layer polyethylene film for maximum protection and ease of installation. All Tufflite products offer high clarity to allow the most light possible. This film is UV protected and has a 6 mil thickness for strength.



Item No.	Description	MSRP
748514	Tufflite IV 6 mil 4 yr UV Protected Greenhouse Film 20 ft x 100 ft	\$402.95
748516	Tufflite IV 6 mil 4 yr UV Protected Greenhouse Film 24 ft x 100 ft	\$483.95
748518	Tufflite IV 6 mil 4 yr UV Protected Greenhouse Film 32 ft x 100 ft	\$644.95
748520	Tufflite IV 6 mil 4 yr UV Protected Greenhouse Film 40 ft x 100 ft	\$806.95
748522	Tufflite IV 6 mil 4 yr UV Protected Greenhouse Film 48 ft x 100 ft	\$967.95

EC SHAKE

EC Shake Nutrient Meter

Powered by a magnet instead of a battery! Use a gentle shaking action to generate power. Provides a quick & accurate reading of the EC. Green LED display. Factory calibrated. Automatic temperature compensation. Automatic on/off function. Waterproof. 1 Year Warranty.



Item No.	Description	MSRP
716010	EC Shake Nutrient Meter	\$89.95

HORTICARE

HortiCare pH Tester

Trans Instruments HortiCare pH check tester is specially designed with advanced features to ensure fast and accurate pH test, for the commercial as well as home growers. Operating Range: 0 to 14.0 pH; Resolution: 0.1 pH; Accuracy: ±0.2 pH; Battery: 4 x 1.5V Button Cell (LR44).



Item No.	Description	MSRP
716020	HortiCare pH Tester	\$75.95

HortiCare Nutrient Check PPM

Trans Instruments HortiCare Nutrient concentration check tester is specially designed with advanced features to ensure fast and accurate concentration test, for the commercial as well as home growers. Operating Range: 0 to 1,990ppm; Display Resolution: 10ppm; Accuracy: ±5% full scale; Calibration Point: 990ppm (KCl); Battery: 4 x 1.5V Button Cell (LR44 equiv.).



Item No.	Description	MSRP
716021	HortiCare Nutrient Check PPM	\$79.95

HortiStick 3-in-1 Multimeter

The HortiStick 3-in-1 combines the measurement of the three most crucial parameters needed for a successful harvest: pH, Conductivity & Temperature. Simple & easy to use. Rugged & water resistant. Features: pH Range: 0-14.0, ppm Range: 0-1990, Temp range: 0-50°C; pH Resolution: 0.1pH, ppm Resolution: 10ppm, Temp. Resolution: 0.1°C; pH Accuracy: ±0.2, ppm Accuracy: ±5% F.S., Temp. Accuracy 0.5°C. 1 Year Warranty.



Item No.	Description	MSRP
716023	HortiStick 3-in-1 Multimeter	\$199.95
716024	HortiStick Replacement Probe	\$116.95

CWP INSTRUMENTS

E.C. Dipstick

Has the 4 most popular scales: EC, CF, 500:1 ppm, and 700:1 ppm! Operates on 3 common inexpensive AA alkaline batteries. Measures in PPM, EC and CF scales. There is no calibration required. It calibrates itself each time you replace the batteries. The EC Dipstick is waterproof to one meter. 2 Year Warranty.



Item No.	Description	MSRP
716570	E.C Dipstick	\$87.95

24-7 Nutrient Monitor

The 24-7 Nutrient Monitor is a great all around meter for constant monitoring. It measures PPM, pH and Temp. Comes with solution. 120 volt AC current to low voltage DC power supply. 1 Year Warranty.



Item No.	Description	MSRP
716572	24-7 Nutrient Monitor	\$216.95
716573	24-7 pH Replacement Probe	\$59.95
716579	24-7 PPM Replacement Probe	\$59.95

Accurate pH 7 & Accurate pH 8

The Accurate pH 7 utilizes the electronic ground field effect of the earth on two dissimilar metals. No batteries are required. This meter comes with a cleaning pad. The Accurate pH 8 is a professional pH and Moisture Meter with 12 in Probe. This meter can measure pH and moisture at depths up to 12 inches. No batteries are required. This meter comes with a cleaning pad. 6 Month Warranty.



Item No.	Description	MSRP
716575	Accurate pH 7 Soil pH & Moisture Meter	\$66.95
716578	Accurate pH 8 Soil pH & Moisture Meter	\$77.95

BLUELAB

Bluelab pH Meter

Supplied with double junction Bluelab pH probe, 20 ml solution sachets and batteries. Range: 0.0 – 14.0 pH. Resolution: 0.1 pH. Accuracy @ 25°C: ±0.1 pH. Power Source: 2 x AAA batteries included. Features: auto turn off, low battery indicator, over range and under range indicators, portable. 5 Year Warranty.



Item No.	Description	MSRP
716340	Bluelab pH Meter	\$210.00

Bluelab Soil pH Meter

Measures the pH level of soil, media or substrates. Comes with a Soil pH Probe, Digger/Auger, pH 4.0 and pH 7.0 calibration solutions, plus a helpful Quick Start guide. Features: simple push button calibration, auto turn off function, large easy to read LCD, low battery indicator, lightweight and portable. 5 Year Warranty.



Item No.	Description	MSRP
716190	Bluelab Soil pH Meter	\$240.00
716192	Bluelab Soil pH Replacement Probe	\$110.00

Bluelab Soil pH Pen

This clever Soil pH Pen will help you manage the success of soil grown crops. The soil pH pen provides a pH and temperature reading of soils and media, so you know that the right nutrients will be made available to your plants. It will also measure solutions too. 1 Year Warranty.



Item No.	Description	MSRP
716438	Bluelab Soil pH Pen	\$184.95

Bluelab pH Pen

Measures pH and temperature. Selectable units for temperature in °C & °F. It has a backlit LCD display with double junction probe (not replaceable). Successful calibration indicator. It has a hold function & low battery warning. Fully waterproof with auto off function. 1 Year Warranty.



Item No.	Description	MSRP
716480	Bluelab pH Pen	\$112.50

Bluelab ppm Pen

Measures conductivity and temperature. Selectable units for conductivity and temperature. It has a backlit LCD display with low battery warning. This pen is fully waterproof that has a successful calibration indicator. Auto off function and hold function. 1 Year Warranty.



Item No.	Description	MSRP
716482	Bluelab PPM Pen	\$94.00

Bluelab Connect Guardian Monitor

The Bluelab Guardian Monitor Connect is not only a constant indicator of the desired levels of pH, conductivity and temperature of your nutrient solution, it also data logs these critical parameters to your computer for you. You can access the data via the cloud from a remote mobile device or computer to check for extreme variances to ensure these critical parameters are hitting the mark for crop success.



Item No.	Description	MSRP
716484	Bluelab Guardian Connect	\$498.00

Bluelab Connect Product Suite

The Bluelab Guardian Monitor Connect, Bluelab Connect Stick, Bluelab Connect Range Extender and Bluelab Connect Software. The Bluelab Guardian Monitor Connect can connect wirelessly to a computer at the grow site via the Bluelab Connect Stick, which enables the data logging of pH, Conductivity and Temperature to the FREE Bluelab Connect Software, downloadable online.



Item No.	Description	MSRP
716486	Bluelab Connect Stick	\$151.70
716488	Bluelab Connect Range Extender	\$164.00

Bluelab Guardian Monitor

Large easy to read, plant safe green LED adjustable brightness displays. Selectable values for conductivity and temperature. Simple push button pH calibration system. No calibration required for conductivity and temperature. Water resistant design. 2 Year Warranty.



Item No.	Description	MSRP
716336	Bluelab Guardian Monitor	\$364.00
716445	Bluelab Replacement pH Probe	\$81.95

Bluelab Combo Meter

A portable conductivity, pH and temperature meter all in one! Display options available in degrees C & F, EC, CF, ppm 500 and ppm 700. Simple push button pH calibration to pH 7, pH 4 and/or pH 10. Auto turn off function. Low battery indicator. Supplied with 2 x AAA batteries, replaceable double junction pH probe and solution sachets. 5 Year Warranty.



Item No.	Description	MSRP
716441	Bluelab Combo Meter	\$308.00
716445	Bluelab Replacement pH Probe	\$81.95

Bluelab Carry Case

Provides a custom fit so you can use and read your Bluelab Meter right from the carry case. A firm outer casing offers impact reduction for your Meter. There are two pockets in the top of the case especially made for meter probes. Ideal for use with the following Bluelab Meters: Bluelab Combo Meter, pH Meter, Soil pH Meter, pH & ppm Pens. Meter not included with case.



Item No.	Description	MSRP
716440	Bluelab Carry Case	\$24.95

Find the newest products at Sunlight Supply by scanning now.



Bluelab Original Truncheon Meter

Tough, high quality with fully waterproof design. Daylight readable blue LEDs. Powered by three AA batteries. EC (0.2 - 3.6), CF (2 - 36) and ppm scales (TDS and 700 scale). Fully waterproof design. No calibration required. Auto sense on & off. No external switches or adjustable buttons. Meter length: 40.7 cm or 16-1/32 in. 5 Year Warranty.



Item No.	Description	MSRP
716050	Bluelab Original Truncheon Meter	\$140.00

Bluelab Commercial Truncheon Meter

With a conductivity range right up to 6.0 EC (60 CF, 3000ppm x 500 & 4200ppm x 700), it will never leave you short. Designed for hydroponic crops that require a higher than normal EC or ppm requirement during their growing cycle. Its super tough, fully waterproof, has no on/off buttons & does not need calibrating. Battery life minimum 1 year. Meter length: 40.7 cm or 16-1/32 in. 5 Year Warranty.



Item No.	Description	MSRP
716049	Bluelab Commercial Truncheon Meter	\$140.00

MILWAUKEE

Milwaukee Instruments Martini pH55 pH/Temp Tester and Probe

This is a waterproof pH tester with large dual-level LCD that displays pH and temperature (°C or °F). The large display shows readings in an extended range from 2 to 16 pH and simultaneously shows temperature from 5°C to 105°C or 23°F to 221°F. Complete with a temperature probe for faster and more precise temperature measurement, this tester compensates automatically for temperature. 2 Year Warranty.



Item No.	Description	MSRP
716798	Milwaukee Martini pH55 - pH/Temp Tester	\$80.95
716799	Milwaukee Martini pH55 - pH/Temp Probe	\$51.95

Milwaukee Instruments Waterproof TDS Tester Model T75

Waterproof TDS tester with automatic temperature compensation and 1 point manual calibration range: 0.0 to 1999 ppm (mg/L), replaceable MA73075 probe. 2 Year Warranty.



Item No.	Description	MSRP
716605	Milwaukee T75 Waterproof TDS Tester	\$85.95
716606	Milwaukee Replacement Probe for T75 (MA73075)	\$78.95

Milwaukee Instruments Waterproof TDS Tester Model T76

Waterproof TDS tester with automatic temperature compensation and 1 point manual calibration range: 0.0 to 1999 ppm (mg/L), replaceable MA73075 probe. 2 Year Warranty.



Item No.	Description	MSRP
716610	Milwaukee T76 Waterproof TDS Tester	\$85.95

Milwaukee Instruments pH Tester Model pH600 AQ

Milwaukee's most affordable pH tester, range: 0.0 to 14.0 pH, with one point manual calibration, and accuracy of ±0.1 pH. Battery Life: 700 hours. Calibration solution sold separately. 30 Day Warranty.



Item No.	Description	MSRP
716642	Milwaukee pH Meter pH600 AQ	\$33.95

Milwaukee Replacement pH Probe Model SE220

pH Probe with Double Junction. Comes with 1 meter cable, soaker bottle for storage and is KCL3.5 gel filled, hard epoxy shell, BNC connector & is for all general pH use. Replacement for all MW & old style SM pH units. NOTE: This probe replaces the old MA911B/1.



Item No.	Description	MSRP
716666	Milwaukee Replacement Probe SE220 (MA911B)	\$60.95

Milwaukee Instruments pH/EC/TDS Combo Meter - BEM802

Range: 0.00 - 14.00 pH, 0 - 4000 ppm, 0.00 - 6.00 mS/cm, Accuracy: ±0.20 pH and ±2% full scale for EC & TDS, comes with SE600 combo probe, 110 volt power supply, unit mounting kit, a 20 ml Sachet of calibration solution of pH 7.01, 1500 ppm and 1413 µS/cm. Converts to a 9 volt battery for use as a portable field meter (9 volt battery included). 2 Year Warranty.



Item No.	Description	MSRP
716678	Milwaukee pH/EC/TDS Combo Meter	\$270.95

Milwaukee Instruments pH Controller - MC122

Range: 0.0 to 14.0, 2 point manual calibration and Accuracy: ±0.2 pH. Set Point Range: 5.5 to 9.5 pH, LED visual alarm active & power plug socket for dosing turned on when reading is higher or lower user selected set point. Supplied with 12V DC power adapter, double junction pH probe, 20 ml pH 7.01 solution and screwdriver. 2 Year Warranty.



Item No.	Description	MSRP
716690	Milwaukee pH Controller	\$197.95

Milwaukee Instruments Portable pH Meter Model MW100

100% larger and easier to read LED Display and long battery life. pH meter, range: 0.0 to 14.0, 2 point manual calibration, and Accuracy: ± 0.2 pH. Supplied with a SE220 double junction pH electrode, 9V battery, 20 ml pH 7.01 packet buffer solution and screwdriver for calibration. 2 Year Warranty.



Item No.	Description	MSRP
716665	Milwaukee MW100 Portable pH Meter	\$115.95

Milwaukee Instruments Smart pH/EC/TDS Combination Meter Model MW802

It calibrates manually in pH, EC & TDS. Range: 0.00 to 14.00 pH, 0 - 4000 ppm, 0.00 - 6.00 mS/cm, accuracy of ± 0.20 pH & $\pm 2\%$ full scale for EC & TDS. Comes with a combination electrode, 9V battery, 20ml packets of pH 7.01, 1500 ppm & 1413 μ S/cm. 2 Year Warranty.



Item No.	Description	MSRP
716615	Milwaukee MW802 Smart pH/EC/TDS/ Combination Meter	\$249.95
716617	Milwaukee SE600 Replacement Probe for MW802	\$112.95

OAKTON

Oakton Multi PT Testr 35

One pocket sized meter for pH, TDS and temperature! Advanced features include auto-shutoff, user-adjustable temperature coefficient, self-adjusting TDS and low-battery indicator. Up to 5 point pH calibration with NIST or USA auto buffer recognition. 1 Year Warranty.



Item No.	Description	MSRP
716108	Oakton Multi PT Testr 35 - PH/TDS/Temp	\$192.95

Oakton EcoTestr pH 1

Economical, pocket sized meter. Waterproof, dust proof housing that floats. Easy to use; push-button calibration with auto buffer recognition. HOLD function, and error messages. Range: 0.0 to 14.0 pH. Power: four 1.5 Volt button cell batteries (included). 1 Year Warranty.



Item No.	Description	MSRP
716104	Oakton Waterproof EcoTestr pH 1	\$70.95

Oakton EcoTestr pH 2

Automatic temperature compensation. Waterproof, dust proof housing that floats. Range: 0.0 to 14.0 pH. Low-cost pocket sized meter. Push-button calibration, HOLD function, and error messages. Power: four 1.5 Volt button cell batteries (included). 2 Year Warranty.



Item No.	Description	MSRP
716106	Oakton Waterproof EcoTestr pH 2	\$88.95

Oakton EcoTestr TDS Low

The stainless steel electrodes are both rugged and chemical resistant, for use in a variety of applications. Other features include ATC, hold function and it is completely waterproof. Range: 0-1990 ppm, Resolution: 10 ppm, Accuracy: 1% full scale and Conversion Factor: 0.4 to 1. 1 Year Warranty.



Item No.	Description	MSRP
716115	Oakton Waterproof EcoTestr TDS Low	\$85.95

Oakton Double Junction pHTestr 10

Replaceable double junction electrode. Features ATC, push-button three-point calibration, microprocessor-based, auto buffer recognition, hold function, auto-off, error messages and it is certifiable to IP67 standards. The pH range is 1.0 to 15.0 pH. 1 Year Warranty.



Item No.	Description	MSRP
716046	Oakton Waterproof pHTestr 10	\$136.95
716047	Oakton Replacement Electrode pH 10/20/30	\$99.95

Oakton Double Junction pHTestr 30

It features high ± 0.01 pH accuracy, simultaneous pH and temperature (C) display, pH range - 1.0 to 15.0 pH, three point push-button calibration, double junction electrode. Certifiable to IP67 standards - waterproof and dust proof housing floats. Has replaceable sensor and automatic temperature compensation. 1 Year Warranty.



Item No.	Description	MSRP
716048	Oakton Waterproof pHTestr 30	\$165.95
716047	Oakton Replacement Electrode pH 10/20/30	\$99.95

HM DIGITAL

HM Digital Waterproof EC/TDS/TEMP Combo Meter Model COM-100

Measures EC, TDS and temperature. Three different calibration options (KCl, 442TM, NaCl), each with its own non-linear conversion factor. ATC using three temperature coefficients. Measurement Range: 0-9990 μ S; 0-8560 ppm. Auto-off, data-hold functions and low-battery indicator. 1 Year Warranty.



Item No.	Description	MSRP
716160	HM Waterproof EC/TDS/Temp Combo Meter	\$76.95
716175	HM Digital Replacement Probe for EC/TDS	\$31.95

HM Digital EC/TDS HydroTester Model COM-80

The COM-80 is an economically priced, reliable EC/TDS meter that is ideal for testing applications such as hydroponics & gardening, pools & spas, aquariums & reef tanks, water ionizers, drinking water and more. Measures electrical conductivity (EC), total dissolved solids (TDS). Excellent for nutrient testing. Four scales: EC: μS , mS; TDS: ppm, ppt. 1 Year Warranty.



Item No.	Description	MSRP
716145	HM Digital Water Resistant Ec/TDS Meter w/ Temperature in C/F Hydrotester (Model COM-80)	\$47.95

HM Digital Waterproof pH Meter Model PH-200

Measures pH and Temperature. Auto-ranging three point calibration. pH buffer 4 solution is in a sponge embedded in a clear cap. Measurement Range: 0-14 pH with a waterproof housing. Comes factory calibrated. Includes a cap, batteries, lanyard and pH 7.0 buffer. 1 Year Warranty.



Item No.	Description	MSRP
716165	HM Digital Waterproof pH Meter	\$99.95
716180	HM Digital Replacement Probe for pH	\$41.95

HM Digital pH Meter Model PH-80

Resolution: pH 0.1 pH, 0.00 - 14.0 pH. Accurate to ± 0.1 pH. Hold button and auto shut-off. Automatic Calibration: Auto-ranging to 4, 7 or 10 pH. Low battery indicator. Clear cap to notice moisture (or lack of) on probe. Glass encased reference electrode. Batteries included. 1 Year Warranty.



Item No.	Description	MSRP
716155	HM Digital pH 80 Meter	\$62.95

HM Digital Handheld TDS Tester Model TDS-3

Ideal for commercial use. Highly efficient and accurate due to its advanced microprocessor technology. Measurement Range: 0-9990 ppm. Display: large and easy-to-read LCD screen with built-in digital thermometer. 1 Year Warranty.



Item No.	Description	MSRP
716187	HM Digital Handheld TDS-3 Tester	\$36.95

HM Digital Aquapro TDS Water Tester Model AP-1

Measures total dissolved solids (TDS) and temperature. Automatic Temperature Compensation (ATC). Water-resistant housing. Measurement Range: 0-5000 ppm. Digital Calibration (push button). Auto-off function, data-hold function and low-battery indicator. Factory calibrated. 1 Year Warranty.



Item No.	Description	MSRP
716188	HM Digital Aquapro TDS Water Tester	\$42.95

HM Digital In-Line Dual TDS Monitor Model DM-1

Displays TDS levels of the feed water and product water with in & out electrode probes. Highly efficient and accurate with microprocessor technology. Auto-Off function conserves battery power. Dual Range 0-9990 ppm. Factory Calibrated. Equipped with Quick-Connect T-fittings. 1 Year Warranty.



Item No.	Description	MSRP
716186	HM Digital In-Line Dual TDS Monitor	\$41.95

HANNA INSTRUMENTS

Hanna Grochek Combo pH/EC/TDS/TEMP Monitor (Model HI 991404)

The Combo meter is designed for continuous, high accuracy pH, EC/TDS and temperature measurements. These microprocessor indicators continuously monitor the three most important nutrient parameters in hydroponics. 2 Year Warranty.



Item No.	Description	MSRP
716800	Hanna Grochek Combo pH/EC/TDS/Temp Monitor (HI 991404)	\$249.95
716801	Hanna Replacement pH Probe (HI 1293)	\$121.95

Hanna pH Grochek Water Resistant pH Indicator (Model HI 981401N)

Water-resistant & features a molded eye which allows installation above the sample area. Accurate measurements can be verified with one or two point calibrations. Comes with a 12 Volt DC power supply. Electrode is interchangeable & the connector is well-protected. The meter is supplied with a stainless steel probe. 1 Year Warranty.



Item No.	Description	MSRP
716805	Hanna pH Indicator w/ Electrode (HI 981401N)	\$130.95
716806	Hanna Replacement pH Probe (HI 1286)	\$63.95

Hanna pH/TDS/Temperature Monitor (Model HI 981504/7)

Designed for continuous monitoring of pH, TDS and temperature, it is simple to install and can be placed above the sample to be tested. pH, TDS and temperature measurements are simultaneously displayed on three backlit LCDs which can be easily viewed at a distance. This means no more switching between parameters. 6 Month Warranty.



Item No.	Description	MSRP
716810	Hanna pH/TDS/Temp Monitor (HI 981504/7)	\$274.95
716806	Hanna Replacement pH Probe (HI 1286)	\$63.95

Hanna Grochek TDS Monitor (Model HI 983301N)

Housings and cable connections have been sealed against vapor and humidity. 12 volt DC power supply included, mean no low battery failures. Locate the meter above the sample to be monitored or take it with you for spot checking. Measurements with 0.7 TDS conversion factor or a 0.5 conversion factor. 1 Year Warranty.



Item No.	Description	MSRP
716870	Hanna GroCheck TDS Monitor (HI 983301N)	\$114.95

Hanna Combo pH/EC/TDS/Temperature Tester with Low Range EC (Model HI 98129)

The waterproof Combo (it even floats) has a large easy-to-read, dual-level LCD and automatic shut-off. pH and EC/TDS readings are automatically compensated for the effects of temperature (ATC). Has a replaceable pH electrode cartridge with an extendable cloth junction. 1 Year Warranty.



Item No.	Description	MSRP
716820	Hanna Combo Waterproof pH/EC/TDS/Temp (HI 98129)	\$194.95
716831	Hanna Replacement pH Probe (HI 73127)	\$68.95

Hanna DiST 5 Waterproof (Low Range) EC/TDS/Temperature Tester (Model HI 98311)

The DiST 5 includes features such as a replaceable graphite electrode, adjustable TDS ratio, temp. in °C or °F, automatic temp. compensation (ATC) with adjustable β, battery level indicator, stability indicator, automatic shut-off & automatic calibrating all in a floating, waterproof casing. This 3-in-1 tester is unmatched in EC/TDS/Temp. measurements! 1 Year Warranty.



Item No.	Description	MSRP
716825	Hanna DiST 5 Waterproof EC/TDS Temperature Tester (HI 98311)	\$127.95

Hanna Hydroponics pH Tester (HI99104)

Ideal pocket tester designed with a 0.01 pH resolution and two point manual calibration through easy to reach trimmers, it immediately displays pH variations to reflect the smallest change in the sample. It has a long and slim stem. Supplied with a rugged, plastic body electrode with a screw connector. Long battery life with common 1.5V batteries. 2 Year Warranty.



Item No.	Description	MSRP
716809	Hanna Hydroponics pH Tester (HI99104)	\$44.95

Hanna Waterproof PHEP 4 Tester With Replaceable Electrode (Model HI 98127)

Efficient two button operation with a temperature in °C or °F. Include features such as a dual-level LCD, battery level indicator, replaceable pH electrode cartridge, instability indicator, automatic shut-off and automatic calibration all in a floating, waterproof casing. 1 Year Warranty.



Item No.	Description	MSRP
716830	Hanna PHEP 4 Waterproof Meter (HI 98127)	\$110.95
716831	Hanna Replacement pH Probe (HI 73127)	\$68.95

Hanna Waterproof pH/EC/TDS Meter (Model HI 9813-6)

Versatile, water resistant multiparameter portable meter specifically designed for agricultural applications such as hydroponics, greenhouses, farming & nurseries. Designed for simplicity of use in taking pH, mS/cm, ppm & temperature in the C scale measurements. Comes with the HI 1285 series pH/EC/TDS/ temp. probe. 2 Year Warranty.



Item No.	Description	MSRP
716814	Hanna Water Resistant pH/EC/TDS Meter (HI 9813-6)	\$267.95
716816	Hanna Replacement pH Probe (HI 1285-6)	\$137.50

Hanna PHEP Tester (Model HI 98107)

pHep feature a rugged & ergonomically enhanced casing that fits comfortably in your hand and a larger LCD which makes it easier to read. Has a non-clogging fiber junction that will last much longer. Simply pull out 1-2 mm (1/8 in) of the junction fiber to completely renew the junction. Range of 0.0 to 14.0 pH and an Accuracy of ±0.1 pH. 1 Year Warranty.



Item No.	Description	MSRP
716840	Hanna PHEP Tester (HI 98107)	\$62.95

Hanna Primo TDS Tester

Provides a fast and dependable way to measure the total dissolved solids in your water samples. Primo TDS uses a single button at the top of the meter. Press it once and the meter is powered and ready for use. Press and hold the button for a few seconds and Primo automatically enters calibration mode. 1 Year Warranty.



Item No.	Description	MSRP
716833	Hanna Primo TDS Tester	\$46.95

Hanna Checker pH Tester (HI 98103)

The Checker supplies fast and accurate readings from 0.00 to 14.00 pH with a resolution of 0.01 pH. This compact tester features a large easy-to-read LCD and a simple to perform 2-point calibration. The pH electrode of the Checker can be replaced. 3000 hours of battery life. 1 Year Warranty.



Item No.	Description	MSRP
716435	Hanna Checker pH Tester (HI 98103)	\$45.95
716436	Hanna Checker Replacement Electrode (HI 1270)	\$29.95

Hanna Batteries for pH/TDS Pens (Model HI 740026-P)

Hanna Batteries for pH/TDS Pens. 12 per pack.



Item No.	Description	MSRP
716865	Hanna Batteries for pH/TDS Pens 12/Pack	\$23.50

FUTURE HARVEST DEVELOPMENT

Future Harvest Nutradip Nutrient Meter

It is a continuous monitoring meter with automatic temperature compensation and dc power built in for portability. Lightweight, portable and splash resistant. Wall mount or hand held - AC & DC powered. Easy to read plant friendly display. Temperature compensated Food Grade Probe. 1 Year Warranty.



Item No.	Description	MSRP
716350	Future Harvest Nutradip Nutrient Meter PPM Dual Power AC DC	\$99.95
716355	Future Harvest Nutradip Nutrient Meter EC Dual Power AC DC	\$99.95

Future Harvest Nutradip pH Meter

Nutradip pH Meter is a continuous monitoring pH meter with automatic temperature compensation and DC power built in for portability. High quality pH probe, plant friendly display and lightweight. 1 Year Warranty.



Item No.	Description	MSRP
716360	Future Harvest Nutradip pH Meter Dual Power AC DC	\$99.95

Future Harvest Nutradip pH Replacement Probe

Nutradip pH Probes are the reliable way to measure acidity in your nutrient solution. The pH Probe is a continuous monitoring pH meter with automatic temperature compensation and dc power built in for portability. 1 Year Warranty.



Item No.	Description	MSRP
716365	Future Harvest Nutradip pH Replacement Probe	\$64.95

Future Harvest Tri-Meter (EC/pH/Temp)

This meter gives you the ability to monitor pH level, Nutrient Levels in EC and Nutrient Temperature. This continuous monitoring system requires no batteries, just plug it in to an AC wall receptacle and the meter will remain in a calibrated mode for months. 2 Year Warranty.



Item No.	Description	MSRP
716310	FHD Tri-Meter Continuous Monitor (EC/pH/Temp)	\$232.95

Future Harvest Tri-Meter (PPM/pH/Temp)

This meter gives you the ability to monitor pH level, Nutrient Levels in EC and Nutrient Temperature. This continuous monitoring system requires no batteries, just plug it in to an AC wall receptacle and the meter will remain in a calibrated mode for months. 1 Year Warranty.



Item No.	Description	MSRP
716315	Future Harvest Tri-Meter Continuous Monitor # 202 (PPM/pH/Temp)	\$232.95

Future Harvest Tri-Meter pH Replacement Probe

Replacement probe for the Tri-Meters or the pH Meter. 6 Month Warranty.



Item No.	Description	MSRP
716320	Future Harvest Replacement Tri-Meter pH Probe - 3 ft Cable	\$66.95

LUSTER LEAF

Luster Leaf Rapitest Digital Soil pH Meter

You can choose plants with the same pH preferences, avoid those that will not do well in your soil. By testing your soil, you determine the soil condition so that you can adjust pH more accurately, effectively and economically. Determines soil acidity/alkalinity. Batteries included. 1 Year Warranty.



Item No.	Description	MSRP
716910	Rapitest Digital Soil pH Meter	\$14.95

Luster Leaf Rapitest Digital Plus Soil pH Meter

The Rapitest Digital Plus Soil pH Meter is programmed with plant pH preferences for over 400 fruits, vegetables, grasses and landscape plants. Measures the acidity or alkalinity of your soil. All results are displayed on the digital LCD screen, ranging from 3.5 to 9.0. Stores your own list of favorite plants. 90 Day Warranty.



Item No.	Description	MSRP
716915	Rapitest Digital Plus Soil pH Meter	\$29.95

Luster Leaf Rapitest 4 Way Analyzer Model 1880

Measures four different levels for fertilizer, light, moisture and pH. Includes instructions and guides for all four measuring levels. 1 Year Warranty.



Item No.	Description	MSRP
716752	Luster Leaf Rapitest 4 Way Analyzer	\$35.95

Luster Leaf Rapitest pH Soil Tester 1612

Kit includes: color comparator, 10 pH test capsules, complete instructions for adjusting soil pH and pH preferences list for over 450 plants for the home, yard and garden.



Item No.	Description	MSRP
716755	Rapitest pH Soil Tester	\$5.95

Luster Leaf Rapitest Soil Test Kit Model 1601

Kit includes: 4 color comparators, 40 test capsules, 10 each for pH, N, P and K, complete instructions for adjusting soil pH, fertilization guidelines and pH preferences list for over 450 plants for the home, yard and garden.



Item No.	Description	MSRP
716756	Rapitest Soil Test pH N,P,K	\$18.49

Luster Leaf Rapitest Soil pH Meter Model 1840

Instantly tells you how acid or alkaline your soil is. Check which plants suit your garden. Enables you to alter soil condition. Includes pH preferences for over 400 plants. 1 Year Warranty.



Item No.	Description	MSRP
716750	Rapitest Soil pH Meter	\$22.95

Luster Leaf Rapitest Mini pH Tester Model 1815

Tests the acidity of soil. Check which plants suit your soil. Enables you to alter soil conditions. Use for fruits, flowers, shrubs and vegetables. No batteries required.



Item No.	Description	MSRP
716753	Rapitest Mini pH Tester	\$8.95

Bond 3 Way Soil Meter

Measures moisture content of soil. Lets you know to water. Helps you determine if plant is getting adequate light. Helps you control pH level in soil. No batteries need. For indoor or outdoor use. 1 Year Warranty.



Item No.	Description	MSRP
740865	Bond 3 Way Soil Meter	\$9.95

WATERSAFE TEST KIT

Watersafe Hydroponics Water Test Kit

The Watersafe test kit contains everything you need to find out simply and accurately if your source water contains excessive levels of six common contaminants that inhibits growth. This kit tests for bacteria, pesticides, chlorine, hardness, pH and iron. This is a do it yourself kit that give you results on the spot. 15 Months Warranty.



Item No.	Description	MSRP
748290	Watersafe Hydroponics Water Test Kit	\$19.95

TESTING, CALIBRATION & ADJUSTMENT PRODUCTS

GH pH Test Kit

General Hydroponics pH Test Kits make pH testing easy. Simply fill a test-tube halfway with nutrient, add a few drops of pH Test Indicator and observe the coloration of the liquid in the test vial.



Item No.	Description	MSRP
722145	GH pH Test Kit 1 oz	\$7.54

GH pH Control Kit

General Hydroponics pH Control Kit contains 8 oz pH UP, 8 oz pH DOWN, 1 oz indicator and vial.



Item No.	Description	MSRP
722080	GH pH Control Kit	\$17.20

GH Meter Calibration Solutions

General Hydroponics uses the highest quality reference solutions, allowing growers to calibrate many popular brands of PH, EC and TDS meters (NaCl scale or the 442 scale).



Item No.	Description	MSRP
722005	GH 1500 PPM Reference Solution 8 oz	\$8.20
722015	GH pH 4.01 Calibration Solution 8 oz	\$7.54
722020	GH pH 4.01 Calibration Solution Quart	\$21.50
722030	GH pH 7.01 Calibration Solution 8 oz	\$7.54
722035	GH pH 7.01 Calibration Solution Quart	\$21.50

GH pH UP Liquid & pH UP Dry

This Base solution is formulated using Potassium Hydroxide and Potassium Carbonate. Add a little at a time when your nutrient pH is too low in order to raise the pH to the proper level.



Item No.	Description	MSRP
722090	GH pH Up Liquid Quart	\$10.76
722095	GH pH Up Liquid Gallon	\$26.90
722105	GH pH Up Dry 2.2 lb	\$15.00

GH pH Down Liquid & GH pH Down Dry

The Acid formulation uses food grade Phosphoric acid to lower the pH to the proper level.



Item No.	Description	MSRP
722120	GH pH Down Liquid Quart	\$10.76
722125	GH pH Down Liquid Gallon	\$26.90
722130	GH pH Down Dry 2.2 lb	\$10.76

Botanicare pH Up & pH Down

With plants, nutrient availability can be affected by soil or solution pH. pH levels outside recommended ranges can lead to nutrient lockout and nutrient deficiencies resulting in stunted growth and poor appearance. Control pH levels, minimize problems and maximize your plants' full potential with Botanicare's pH Up and pH Down solutions.



Item No.	Description	MSRP
722180	Botanicare pH Up Quart	\$11.95
722185	Botanicare pH Up Gallon	\$27.95
722190	Botanicare pH Down Quart	\$11.95
722195	Botanicare pH Down Gallon	\$27.95

Technaflora pH Up & pH Down

Technaflora's pH Up and pH Down enable the gardener to moderate and maintain optimum pH levels. Both pH-balancing aids are manufactured using the highest-quality ingredients: potassium hydroxide to raise pH and nitric acid to lower pH.



Item No.	Description	MSRP
716461	Technaflora pH Up 1 Liter	\$13.42
716462	Technaflora pH Up 4 Liter	\$26.86
716464	Technaflora pH Down 1 Liter	\$13.42
716465	Technaflora pH Down 4 Liter	\$26.86

Grow More pH Up 30%

Convenient ready to use liquids, concentrated, fast acting, high purity food grade ingredients. Use pH Up to raise pH of nutrient solution with potassium hydroxide.



Item No.	Description	MSRP
721860	Grow More pH Up 30% Quart	\$8.34
721865	Grow More pH Up 30% Gallon	\$22.24

Grow More pH Down 30%

Convenient ready to use liquids, concentrated, fast acting, high purity food grade ingredients. Use pH Down to lower pH of nutrient solution with phosphoric acid.



Item No.	Description	MSRP
721870	Grow More pH Down 30% Quart	\$8.34
721875	Grow More pH Down 30% Gallon	\$22.24

Earth Juice Natural UP & Natural DOWN

pH adjusting crystals that will, once and for all, eliminate the hassles and worries of spilling, splashing and dealing with harsh liquid pH adjusters. Use to adjust the pH of fertilizer and plant micronutrient foliar solutions.



Item No.	Description	MSRP
722155	Earth Juice Natural Up 2 lb	\$19.99
722160	Earth Juice Natural Up 10 lb	\$70.10
722162	Earth Juice Natural Up 30 lb	\$202.19
722173	Earth Juice Natural Down 1.6 lb	\$17.95

Nectar For The Gods Hades Down

This blend of organic acids lowers your nutrient solution's pH. It's our pH down. Don't worry if you over shoot the down: just add some Olympus Up and see the benefits of adding more calcium.



Item No.	Description	MSRP
746304	Hades Down Quart	\$25.50
746306	Hades Down Gallon	\$80.00
746308	Hades Down 2.5 Gallon	\$160.00
746310	Hades Down 5 Gallon	\$325.00

Nectar For The Gods Olympus Up

Olympus is derived from micronized limestone designed to not only raise the pH of your nutrient solution but also to buffer organic acids from healthy soil decomposition. The calcium in Olympus is also very effective at tying up salts in the medium.



Item No.	Description	MSRP
746312	Olympus Up Quart	\$14.00
746314	Olympus Up Gallon	\$40.00
746316	Olympus Up 2.5 Gallon	\$80.00
746318	Olympus Up 5 Gallon	\$135.00

Control Wizard 1382 Calibration Solution

Control Wizard Products 1382 Conductivity Standard. Use to calibrate all meters that use the 1 EC to 500 ppm water standard.



Item No.	Description	MSRP
716574	Control Wizard 1382 Calibration Solution 4 oz	\$5.95

Bluelab Probe Care Kit for Conductivity Probes

The instrument is only as accurate as the probe is clean. If the probe is contaminated or dirty, it affects the accuracy of the reading displayed. Conductivity kit contents: instructions, 500 ml 2.77 EC solution, plastic cup, conductivity probe cleaner, chamois (probe cleaning instrument).



Item No.	Description	MSRP
716052	Bluelab Nutrient Probe Care Kit Conductivity	\$11.90

Bluelab Probe Care Kit pH & Conductivity

Everything you need to clean, hydrate and calibrate pH probes as well as clean and test conductivity (ppm/EC) probes. Includes instructions, 20ml single-use Bluelab Solution Sachets, 2 each of: pH 7.0 & pH 4.0, KCl, 2.77 EC, 3x plastic cups, pH Probe Cleaner, Conductivity Probe Cleaner, Toothbrush and Chamois.



Item No.	Description	MSRP
716448	Bluelab Probe Care pH & Conductivity	\$22.95

Bluelab Probe Care Kit pH

Everything you need to clean, hydrate and calibrate pH probes. Probe cleaning and correctly storing pH probes ensures you get the most accurate readings possible and will maximize the life of a probe. The probe surface is where the instrument takes the reading of the solution or soil/media. If the probe face is dirty or contaminated, the readings may be inaccurate.



Item No.	Description	MSRP
716053	Bluelab Probe Care Kit - pH	\$16.50

Bluelab Calibration Solution 20 ml Sachets

pH instruments are calibrated to pH 7.0 first (buffer) then to pH 4.0 (slope). Bluelab's EC/CF equipment does not need calibrating as they are all factory calibrated. The CF 27.7 (EC 2.77) solution is used as a reference or checking solution to ensure you have adequately cleaned the EC/CF probe.



Item No.	Description	MSRP
732894	Bluelab pH 7.0 Calibration Solution 20 ml Sachets	\$1.80
732903	Bluelab pH 4.0 Calibration Solution 20 ml Sachets	\$1.80
732904	Bluelab 2.77EC Conductivity Solution 20 ml Sachets	\$1.80

Bluelab pH Probe KCl Storage Solution

Bluelab pH Probe KCl Storage Solution is made specifically for use with Bluelab pH products. It is designed to increase response time and maximize the life of Bluelab pH pens and pH probes. For best results, use the KCl solution to store the pH pen/probe after use and hydrate monthly.



Item No.	Description	MSRP
716056	Bluelab pH Probe KCl Storage Solution 100 ml	\$11.95

Bluelab pH 7.0 Calibration Solution

pH measuring equipment must be cleaned and calibrated regularly to ensure they are giving the user accurate readings. pH instruments are calibrated to pH 7.0 first (buffer) then to pH 4.0 (slope).



Item No.	Description	MSRP
732895	Bluelab pH 7.0 Calibration Solution 250 ml	\$8.15
732896	Bluelab pH 7.0 Calibration Solution 500 ml	\$11.00

Bluelab pH 4.0 Calibration Solution

pH measuring equipment must be cleaned and calibrated regularly to ensure they are giving the user accurate readings. pH instruments are calibrated to pH 7.0 first (buffer) then to pH 4.0 (slope).



Item No.	Description	MSRP
732897	Bluelab pH 4.0 Calibration Solution 250 ml	\$8.15
732898	Bluelab pH 4.0 Calibration Solution 500 ml	\$11.00

Bluelab 2.77 EC Conductivity Standard Solution

The EC2.77 solution is used as a reference or checking solution to ensure you have adequately cleaned the EC/ppm probe.



Item No.	Description	MSRP
732899	Bluelab 2.77EC Conductivity Solution 250 ml	\$8.15
732901	Bluelab 2.77EC Conductivity Solution 500 ml	\$11.00

HM Digital TDS Calibration Solution

For optimal performance, re-calibrate your meters periodically or if testing TDS or conductivity levels in wide or different ranges. NaCl calibration solution. Comes in lightweight HDPE plastic bottles. Sealed with a coated foam liner.



Item No.	Description	MSRP
716170	HM Digital 1000 PPM Calibration Solution	\$6.50

HM Digital pH Electrode Storage Solution

For use with HM Digital's PH-200 and PH-80 (as well as other brands of pH meters). Always make sure your sensor is kept in an electrode storage solution. If dry, refill the pH meter cap with the PH-STOR storage solution. The sponge should be moist (not soaking wet).



Item No.	Description	MSRP
716150	HM Digital pH Electrode Storage Solution (10/Cs)	\$7.95

Oakton pH 4.01, pH 7.00 & 1413 TDS Solution

Solutions made specifically for Oakton meters and testers. All Oakton Conductivity/TDS calibration solutions are cross checked using different test methods, premixed and ready to use. NIST traceable materials. ±1% accuracy at 25°C.



Item No.	Description	MSRP
716110	Oakton Calibration pH 4.01 500 ml	\$20.95
716112	Oakton Calibration pH 7.01 500 ml	\$20.95
716114	Oakton Calibration 1413 TDS 500 ml	\$18.95

Milwaukee Instruments Calibration Solutions

Milwaukee standard calibration solutions are available in 220 ml bottles and 20 ml sachets. The 220 ml leak-proof bottles and are recommended for lab application. Sachets are sealed against light and air and are ideal for on-the-spot calibration. Simply open, insert the tester or electrode into the sachet and calibrate.



Item No.	Description	MSRP
716301	Milwaukee M10004B - 20 ml Packet 4.01 Buffer Solution	\$1.07
722305	Milwaukee MA9007 - 220 ml Packet 7.01 Buffer Solution	\$11.49
716306	Milwaukee M10007B - 20 ml Packet 7.01 Buffer Solution	\$1.07
722346	Milwaukee M10442B - 20 ml Packet 1500ppm Solution	\$1.07

Hanna 20 ml Packet Solutions

Hanna 20 ml Packet Solutions are prepared according to precise formulas and are standardized with a pH meter calibrated according to the NIST standards. The 20 ml sachets are single-dose and are ready to use.



Item No.	Description	MSRP
716875	Hanna pH 4.01 Calibration Solution 20 ml	\$1.32
716876	Hanna pH 7.01 Calibration Solution 20 ml	\$1.32
716877	Hanna pH 10.01 Calibration Solution 20 ml	\$1.32
716878	Hanna Cleaning Solution 20 ml	\$1.65
716879	Hanna 1382 PPM TDS Solution 20 ml	\$1.32
716880	Hanna 1500PPM TDS Solution	\$1.32

Hanna pH 4.01 (HI 7004L) & pH 7.01 (HI 7007L) Calibration Solutions

Hanna buffer solutions are prepared according to precise formulas and are standardized with a pH meter calibrated according to the NIST standards. All pH 4.01 solutions show batch number, expiration date and the correlation table between pH and temperature. pH 7.01 is the most widely used among all buffer solutions.



Item No.	Description	MSRP
716845	Hanna pH 4 Calibration Solution Pint	\$18.75
716850	Hanna pH 7 Calibration Solution Pint	\$19.29

Hanna 1500 PPM (Model 70442L) & 1413 uS/CM (Model HI 7031L) Calibration Solutions

TDS solution are produced with high-quality potassium chloride in various concentrations. They are standardized using a conductivity meter calibrated with NIST potassium chloride. The 1413 µS/cm solution is the one best suited for general use.



Item No.	Description	MSRP
716855	Hanna 1500PPM Calibration Solution Pint	\$20.49
716860	Hanna 1413uS/CM Calibration Solution Pint	\$20.49

Hanna Storage Solution (Model HI70300L)

To minimize clogging and ensure fast response time, always keep the glass bulb and the junction of your pH electrode moist. Store the electrode with a few drops of HI 70300 storage or pH 7.01 buffer solution in the protective cap.



Item No.	Description	MSRP
716468	Hanna Storage Solution Pint	\$16.50

Hanna Cleaning Solution (Model HI7061L)

Clean the liquid junction of your electrodes once a day or at least once a week to prevent clogging and to maintain accuracy. Immerse the electrode in the proper cleaning solution for about 5 minutes. The cleaning solutions are available in 20 ml sachets and 500 ml bottles, both standard and FDA types.



Item No.	Description	MSRP
716470	Hanna Cleaning Solution Pint	\$17.75

Hanna pH Cleaning & Calibration Solution Starter Kit (Model HIPHKIT)

Single-dose sachets are quick and easy to use. Each sealed, light tight sachets holds just the right amount of solution. Kit Includes: (5) pH 4.01 buffer solution sachets, (5) pH 7.01 buffer solution sachets and (5) General cleaning solution sachets.



Item No.	Description	MSRP
716472	Hanna 4.01, 7.01, and Cleaning Solution	\$20.00

industry exclusive



TITAN[®] CONTROLS

WWW.TITANCONTROLS.NET

The industry's widest and best selection of environmental control products.



Titan Controls Apollo 2 - Cycle Timer with Photocell

Controls timed equipment during daytime only, nighttime only or both. 10 seconds to 20 minutes ON TIME. 1 minute to 12 hours OFF TIME. Use to time fans, pumps or CO₂. Plastic enclosure protects internal components. 15 Amps maximum/120 Volts/60 Hz. 3 Year Warranty.



Item No.	Description	MSRP
702740	Titan Controls Apollo 2 - Cycle Timer w/ Photocell	\$87.95

Titan Controls Apollo 3 - Fixed Cycle Timer

1 minute ON TIME & 4 minute OFF TIME. Timing is preset – requires no user adjustments. Ideal for aeroponic, ebb & flow or misting applications. Excellent for NFT – Nutrient Film Technique systems. 10 Amps maximum/120 Volts/60 Hz. 3 Year Warranty.



Item No.	Description	MSRP
702635	Titan Controls Apollo 3 - Fixed Cycle Timer	\$72.95

Titan Controls Apollo 4 - 120 Volt Ballast Timer

Operates magnetic or electronic ballast up to 1000 watts. IEC 320 power input cord set attaches to any ballast. 24 hour timer can be set for any lighting requirement your plants require. Compatible with digital ballasts. 10 Amps maximum/120 Volts/60 Hz./1000 Watts. 3 Year Warranty.



Item No.	Description	MSRP
734135	Titan Controls Apollo 4 - 120 Volt Ballast Timer	\$74.95

Titan Controls Apollo 5 - 240 Volt Ballast Timer

Operates magnetic or electronic ballast up to 1000 watts. IEC 320 power input cord set attaches to any ballast. 24 hour timer can be set for any lighting requirement your plants require. Compatible with digital ballasts. 10 Amps maximum/240 Volts/60 Hz./1000 Watts. 3 Year Warranty.



Item No.	Description	MSRP
734140	Titan Controls Apollo 5 - 240 Volt Ballast Timer	\$79.95

Titan Controls Apollo 6 - One Outlet Mechanical Timer

24 hour timer is the perfect timing solution for your hydro systems. One (1) outlet. 15 minute intervals. Heavy duty construction. Easy to use & simple to operate. Plastic enclosure resists dust, rust and moisture. Do not use with digital ballasts. 15 Amps maximum/120 Volts/60 Hz. 1 Year Warranty.



Item No.	Description	MSRP
734110	Titan Controls Apollo 6 - One Outlet Mechanical Timer	\$10.95

Titan Controls Apollo 7 - One Outlet Digital Timer

24 hr digital timer is the perfect timing solution for your hydro systems. It's easy to set to run your pumps, fans, etc. One (1) outlet with 1 minute intervals. Battery back-up feature saves settings if power goes out. Do not use with digital ballasts. 15 Amps maximum/120 Volts/60 Hz. HINT: If not working properly, plug in for 5 minutes & press the reset button. Generally fixes the problem. 1 Year Warranty.



Item No.	Description	MSRP
734112	Titan Controls Apollo 7 - One Outlet Digital Timer	\$16.95

Titan Controls Apollo 8 - Two Outlet Mechanical Timer

24 hr timer is the perfect timing solution for your hydro systems. Two (2) outlets. 15 minute intervals. Heavy duty construction. Plastic enclosure resists dust, rust and moisture. Do not use with digital ballasts. 15 Amps maximum/120 Volts/60 Hz. 1 Year Warranty.



Item No.	Description	MSRP
734100	Titan Controls Apollo 8 - Two Outlet Mechanical Timer	\$12.95

Titan Controls Apollo 9 - Two Outlet Digital Timer

24 hr digital timer is the perfect timing solution for your hydro systems. Two (2) outlets with 1 minute intervals. Battery back-up feature saves settings if power goes out. Not for use with digital ballasts. 15 Amps maximum/120 Volts/60 Hz. HINT: If not functioning properly, plug in for 5 minutes and press the reset button. This generally fixes any problem. 1 Year Warranty.



Item No.	Description	MSRP
734105	Titan Controls Apollo 9 - Two Outlet Digital Timer	\$17.95

Titan Controls Apollo 10 - 240 Volt Mechanical Timer

240 Volt/24 hr timer is the perfect timing solution for your hydroponic systems. One (1) outlet with 15 minute intervals. Not for use with digital ballasts. 10 Amps maximum/240 Volts/60 Hz. 1 Year Warranty.



Item No.	Description	MSRP
734145	Titan Controls Apollo 10 - 240 Volt Mechanical Timer	\$14.95

Titan Controls Apollo 11 - 240 Volt Digital Timer

One (1) outlet. 1 minute intervals and run up to 20 schedules per day. Battery back-up feature saves settings in case of power failure. Daylight savings mode to accommodate time change. Do not use with digital ballasts. 10 Amps maximum/240 Volts/60 Hz. 1 Year Warranty.



Item No.	Description	MSRP
734155	Titan Controls Apollo 11 - 240 Volt Digital Timer	\$20.95

Titan Controls Apollo 12 - Short Cycle Timer With Photocell

Controls timed equipment during daytime only, nighttime only or both. 5 sec to 30 min ON TIME. 5 sec to 60 min OFF TIME. Precise short cycle timing of CO2, pumps or fans. 15 Amps maximum/120 Volts/60 Hz./1/3 HP. 3 Year Warranty.



Item No.	Description	MSRP
702745	Titan Controls Apollo 12 - Short Cycle Timer w/ Photocell	\$87.95

Titan Controls Apollo 14 - 8 Outlet Power Strip with Timer

8 outlets - 4 timed/4 constant. 24 hr programmable mechanical timer with 15 min intervals. All outlets surge protected up to 1000 joules. Circuit breaker switch for safety. 5 ft power cord set. Not for use with digital ballasts. 15 Amps maximum/120 Volts/60 Hz. 1 Year Warranty.



Item No.	Description	MSRP
734150	Titan Controls Apollo 14 - 8 Outlet Power Strip w/Timer	\$25.95

Titan Controls Helios 1 - 4 Light 120 Volt Controller with Timer

Runs 4 HID lights at 120 Volts - Maximum 4000 Watts. The only lighting controllers featuring industrial-grade ballast rated relays. 24 hr timer with 15 minute non-detachable setting tabs. 4 NEMA 5-20 outlets. 50 Amps input power/40 Amps output power/120 Volts/60 Hz./4000 watts. 3 Year Warranty.



Item No.	Description	MSRP
702660	Titan Controls Helios 1 - 4 Light 120 Volt Controller w/ Timer	\$224.95

Titan Controls Helios 2 - 4 Light 120V Controller with Relay Trigger Cord

Runs 4 HID lights at 120 Volts - Maximum 4000 Watts. The only lighting controllers featuring industrial-grade ballast rated relays. Plug relay trigger cord set into 24 hr wall timer. 4 NEMA 5-20 outlets. 50 Amps input power/40 Amps output power/120 Volts/60 Hz./4000 watts. 3 Year Warranty.



Item No.	Description	MSRP
702665	Titan Controls Helios 2 - 4 Light 120 Volt Controller w/ Relay Trigger Cord	\$199.95

Titan Controls Helios 3 - 4 Light 240V Controller with Timer

Runs 4 HID lights at 240 Volts - Maximum 4000 Watts. The only lighting controllers featuring industrial-grade ballast rated relays. 120 Volt accessory timed outlet to activate in-line fans to cool your lamps. Universal outlets allow total flexibility. 30 Amps input power/20 Amps output power/240 Volts/60 Hz./4000 watts. 3 Year Warranty.



Item No.	Description	MSRP
702670	Titan Controls Helios 3 - 4 Light 240 Volt Controller w/ Timer	\$224.95

Titan Controls Helios 4 - 4 Light 240V Controller with Relay Trigger Cord

Runs 4 HID lights at 240 Volts - Maximum 4000 Watts. The only lighting controllers featuring industrial-grade ballast rated relays. 120 Volt accessory timed outlet (max 2 Amps) to activate in-line fans to cool your lamps. Plug relay trigger cord set into 24 hr wall timer. 30 Amps input power/20 Amps output power/240 Volts/60 Hz./4000 watts. 3 Year Warranty.



Item No.	Description	MSRP
702675	Titan Controls Helios 4 - 4 Light Controller w/ Relay Trigger Cord	\$199.95

Titan Controls Helios 5 - 4 Light 240V Controller with Relay Trigger Cord

Runs 4 HID lights at 240 Volts. Plug relay trigger cord set into 24 hr wall timer. The only lighting controllers featuring industrial-grade ballast rated relays. 120 Volt timed accessory outlet (max 2 Amps) for light mover or fan. 30 Amps input power/40 Amps output power/240 Volts/60 Hz./4000 Watts. 3 Year Warranty.



Item No.	Description	MSRP
702671	Titan Controls Helios 5 - 4 Light 240 Volt Controller w/ Relay Trigger Cord	\$207.95

Titan Controls Helios 6 - 8 Light 240V Controller with Dual Trigger Cords

Runs 8 HID lights at 240 volts. The only lighting controllers featuring 2 industrial-grade ballast rated relays. Plug relay trigger cord set into 24 hr wall timer. Removable back panel makes controller easy to wire into your power system. 50 Amps input power/40 Amps output power/240 Volts/60 Hz./8000 Watts. 3 Year Warranty.



Item No.	Description	MSRP
702672	Titan Controls Helios 6 - 8 Light 240 Volt Controller w/ Dual Trigger Cords	\$274.95

Titan Controls Helios 7 - 8 Light 240V Controller with Timer

Runs 8 HID lights at 240 volts. The only lighting controllers featuring industrial-grade ballast rated relays. 24 hr timer with 15 min non-detachable setting tabs. Universal outlets will accept a 120 Volt or 240 Volt ballast cord set. 50 Amps input power/40 Amps output power/240 Volts/60 Hz./8000 Watts. 3 Year Warranty.



Item No.	Description	MSRP
702676	Titan Controls Helios 7 - 8 Light 240 Volt Controller w/ Timer	\$289.95

Titan Controls Helios 8 - 8 Light 240V Controller with Dual Trigger Cords

Runs 8 HID lights at 240 Volts. The only lighting controllers featuring industrial-grade ballast rated relays. Dual trigger cord sets allow the operator to run two separate light timing schedules. 50 Amps input power/40 Amps output power/240 Volts/60 Hz./8000 Watts. 3 Year Warranty.



Item No.	Description	MSRP
702677	Titan Controls Helios 8 - 8 Light 240 Volt Controller w/ Dual Trigger Cords	\$267.95

Titan Controls Helios 9 - Pre-wired 4 Light 240V Controller with Trigger Cord & Timer

Runs 4 HID lights at 240 Volts. The only lighting controllers featuring industrial-grade ballast rated relays. Circuit breakers built right into the controller! Plug relay trigger cord into 24 hour wall timer (included)! 30 Amps input power/20 Amps output power/240 Volts/60 Hz./4000 Watts. 3 Year Warranty.



Item No.	Description	MSRP
702678	Titan Controls Helios 9 - Pre-Wired 4 Light 240 Volt Controller w/ Trigger Cord & Timer	\$299.95

Titan Controls Helios 10 - Pre-wired 8 Light 240V Controller with Trigger Cord & Timer

Runs 8 HID lights at 240 Volts. The only lighting controllers featuring industrial-grade ballast rated relays. Circuit breakers built right into the controller! Plug relay trigger cord into 24 hour wall timer (included)! 50 Amps input power/40 Amps output power/240 Volts/60 Hz./8000 Watts. 3 Year Warranty.



Item No.	Description	MSRP
702679	Titan Controls Helios 10 - Pre-Wired 8 Light 240 Volt Controller w/ Trigger Cord & Timer	\$399.95

Titan Controls Helios 11 - 4 Light 240V Controller with Trigger Cord

Runs 4 HID lights at 240 Volts. The only lighting controllers featuring industrial-grade ballast rated relays. Plug relay trigger cord into 24 hour wall timer to run your lights. Universal outlets allow total flexibility. 30 Amps input power/20 Amps output power/240 Volts/60Hz./4000 Watts. 3 Year Warranty.



Item No.	Description	MSRP
702820	Titan Controls Helios 11 - 4 Light 240 Volt Controller w/ Trigger Cord	\$149.95

Titan Controls Helios 12 - 8 Light 240V Controller with Dual Trigger Cords

Runs 8 HID lights at 240 Volts. The only lighting controllers featuring 2 industrial-grade ballast rated relays. Plug dual relay trigger cord set into 24 hr wall timers to run your lights. Universal outlets allow total flexibility. 50 Amps input power/40 Amps output power/240 Volts/60 Hz./8000 Watts. 3 Year Warranty.



Item No.	Description	MSRP
702825	Titan Controls Helios 12 - 8 Light 240 Volt Controller w/ Dual Trigger Cords	\$234.95

Titan Controls Helios 18 - 12 Light 240V Controller with Dual Trigger Cords

Runs 12 HID lights at 240 Volts. The only lighting controllers featuring industrial-grade ballast rated relays. 2 trigger cords allow the operator to run 2 separate light schedules. Removable front panel makes controller easy to wire. Universal outlets will accept either 120 or 240 Volt power cords. 80 Amps input power/60 Amps output power/240 Volts/60 Hz./12,000 Watts. 3 Year Warranty.



Item No.	Description	MSRP
702843	Titan Controls Helios 18 - 12 Light 240 Volt Controller w/ Dual Trigger Cords	\$449.95

Titan Controls Helios 13 - 16 Light 240V Controller with Timer

Runs 16 HID lights at 240 Volts. The only lighting controllers featuring industrial-grade ballast rated relays. Premium quality timer with battery back-up. 100 Amps input power/80 Amps output power/240 Volts/60 Hz./16,000 Watts. 3 Year Warranty.



Item No.	Description	MSRP
702828	Titan Controls Helios 13 - 16 Light Controller w/ Timer	\$899.95

Titan Controls Helios 14 - 24 Light 240V Controller with Timer

Runs 24 HID lights at 240 Volts. The only lighting controllers featuring industrial-grade ballast rated relays. Premium quality timer with battery back-up. 150 Amps input power/120 Amps output power/220 Volts/60 Hz./24,000 Watts. 3 Year Warranty.



Item No.	Description	MSRP
702832	Titan Controls Helios 14 - 24 Light Controller w/ Timer	\$1,199.95

Titan Controls Helios 15 - 8 Light 240V Controller with Timer

Runs 8 HID lights at 240 Volts. The only lighting controllers featuring industrial-grade ballast rated relays. Reliable 24 hr timer built into the controller. NEMA 6-15 UL listed power outlets. 50 Amps input power/40 Amps output power/240 Volts/60 Hz./8000 Watts. 3 Year Warranty.



Item No.	Description	MSRP
702775	Titan Controls Helios 15 - 8 Light Controller w/ Timer	\$299.99

Titan Controls Helios 16 - 16 Light 240V Controller with Dual Trigger Cords

Runs 16 HID lights at 240 Volts. The only lighting controllers featuring industrial-grade ballast rated relays. 2 trigger cord sets activate lighting controller via external timers. Sequenced lighting delays for each light bank. 100 Amps input power/80 Amps output power/240 Volts/60 Hz./16,000 Watts. 3 Year Warranty.



Item No.	Description	MSRP
702835	Titan Controls Helios 16 - 16 Light 240 Volt Controller w/ Dual Trigger Cords	\$899.95

Titan Controls Helios 17 - 24 Light 240V Controller with Dual Trigger Cords

Runs 24 HID lights at 240 Volts. The only lighting controllers featuring industrial-grade ballast rated relays. 2 trigger cord sets activate lighting controller via external timers. Sequenced lighting delays for each light bank. Duplex outlets have circuit breaker protection. 150 Amps input power/120 Amps output power/240 Volts/60 Hz./24,000 Watts. 3 Year Warranty.



Item No.	Description	MSRP
702840	Titan Controls Helios 17 - 24 Light 240 Volt Controller w/ Dual Trigger Cords	\$1,199.95

Digital Short Cycle Timer

Controls any device to be turned on and off at precise intervals. It has a large digital LCD display. ON or OFF times are 10 sec and 24 hrs respectively. A photo sensor with user controlled day/night/both button, allows users to select the photo period. A built in backup battery. 120 Volts/15 Amps/60 Hz. 1 Year Warranty.



Item No.	Description	MSRP
734170	Digital Short Cycle Timer	\$49.95

Intermatic Multi-Purpose DT620 CL Digital Timer

Turns lights and appliances on and off automatically. Easy set up and operation. Auto adjusts to sunrise/sunset time for dusk/dawn setting. Automatic Daylight Saving Time option. Variable ON/OFF setting option for added security. 1 Year Warranty.



Item No.	Description	MSRP
734046	Intermatic 2 Outlet Digital Timer DT620CL 120 Volt	\$39.95

Intermatic Heavy-Duty Plug-In Timer

This heavy duty, grounded timer is ideal for automatically controlling personal computers, heaters, heavy-duty appliances and HID lighting fixtures. It plugs directly into a wall outlet. TN311C - 1750W/120VAC/15 Amp/1 HP. HB111C Receptacle. 1 Year Warranty.



Item No.	Description	MSRP
734015	Intermatic TN311C Heavy Duty Timer 120 Volt	\$17.49

Intermatic Heavy-Duty Plug-In 240 Volt Timer

Automatically controls 240 volt heaters, heavy-duty appliances and lamps. 3,750 watt capacity. Plugs directly into wall outlet. 2 ON/2 OFF settings per day. 3-prong 220-240 volt grounded plug and receptacle. Manual override ON/OFF switch. HB112C Receptacle. 1 Year Warranty.



Item No.	Description	MSRP
734020	Intermatic HB112C Heavy Duty Timer 240 Volt	\$21.95

Intermatic Heavy Duty Time Switch

Heavy duty lockable metal enclosure. Tamper proof design. 1/2 in & 3/4 in knock outs. T101 - 120 volt/AC/60 Hz/Single pole/Single throw/40 amp. T104 - 208 to 277 volt/AC/60 Hz/Double pole/Single throw/40 amp. 1 Year Warranty.



Item No.	Description	MSRP
734030	Intermatic T101 Commercial Grade Timer 120 Volt	\$82.95
734035	Intermatic T104 Commercial Grade Timer 240/277 Volt	\$89.95

Light Meter - Sun System

Premium quality. 5 digit display. Measures in foot candles & lux. Automatic power off. Automatic zero when power on. Range: Up to 4,000 fc & 40,000 lux. Batteries included.



Item No.	Description	MSRP
716097	Sun System Light Meter	\$99.95

PAR Meter with Integrated Sensor - Sun System

Sun System PAR Meter comes with an integrated sensor to measure photosynthetic active radiation (PAR). Use inside with Sun System grow lights or outside with natural sunlight. Simple and easy to use. Compact size with integrated sensor. 1 Year Warranty.



Item No.	Description	MSRP
748200	Sun System PAR Meter w/ Integrated Sensor	\$349.95

PAR Meter with Remote Sensor - Sun System

Sun System PAR Meter with remote sensor measures photosynthetically active radiation (PAR). Use inside with Sun System grow lights or outside with natural sunlight. Simple and easy to use. Compact size with remote sensor. 1 Year Warranty.



Item No.	Description	MSRP
748205	Sun System PAR Meter w/ Remote Sensor	\$449.95

Light Meter - HortiCare LITEcheck

HortiCare LITEcheck checks the light intensity which is important for proper plant growth. The control of light intensity allows grower to achieve the desired growth in plants. Operation Range: 0 to 5,000 foot candle. Resolution: 10 foot candle. Accuracy: ±8% (full scale). Battery: 4 x 1.5V Button Cell (Alkaline A76 or equiv.).



Item No.	Description	MSRP
716022	HortiCare LITEcheck Meter	\$79.95

Grower's Edge Large Display Digital Thermometer & Hygrometer

Measures indoor/outdoor temperature & indoor humidity. Stores the Min./Max. values of the indoor/outdoor temperature and indoor humidity. Switch between C and F. Clock function with alarm and a 12/24 hour mode switch. 8 minutes snooze function. Waterproof temperature probe. Comes with 1 AAA alkaline battery. 1 Year Warranty.



Item No.	Description	MSRP
716560	Grower's Edge Large Display Thermometer / Hygrometer	\$19.95

Grower's Edge Thermometer/Hygrometer with Sensor

Large screen digital readout. Wireless sensor transmits up to 50 feet. Expandable to accept 2 additional sensors. Waterproof casing is chemical and UV resistant. Displays degrees in F or C. 2 AA batteries included.



Item No.	Description	MSRP
716555	Grower's Edge Digital Thermometer / Hygrometer w/ Remote Sensor	\$39.95
716557	Grower's Edge Wireless Remote Sensor	\$22.95

Kill A Watt

Measures electrical consumption accurately within 0.2% and is ETL approved. Features large LCD screen which displays 8 critical units of measurements. Enables you to cost forecast. 6 Month Warranty.



Item No.	Description	MSRP
716450	Kill A Watt Meter	\$39.95

Luster Leaf Rapitest Soil Tester

10 color coded tests: 4 for pH, 2 each for nitrogen, phosphorus and potash.



Item No.	Description	MSRP
716917	Luster Leaf Rapitest Soil Tester	\$5.99

Luster Leaf Rapitest 4 Way Analyzer Model 1880

Measures four different levels for fertilizer, light, moisture and pH. Includes instructions and guides for all four measuring levels. 1 Year Warranty.



Item No.	Description	MSRP
716752	Luster Leaf Rapitest 4 Way Analyzer	\$35.95

Luster Leaf Rapitest Digital Moisture Meter

The Rapitest Digital Moisture Meter tests for moisture at the roots - where it matters - you no longer risk over watering a healthy plant just because the soil near the surface is dry or under-watering because it appears moist. 1 Year Warranty.



Item No.	Description	MSRP
716900	Luster Leaf Rapitest Digital Moisture Meter	\$13.49

Bond Moisture Meter

Measures moisture content of soil. Lets you know when to water. No batteries needed. For indoor or outdoor use. 1 Year Warranty.



Item No.	Description	MSRP
740860	Bond Moisture Meter	\$6.95



Shop for the best brand on the market today

Sun System!

Scan now to see all the Sun System brand products!

Check out our 1000 HPS Double-Ended Reflectors

AC/DE

Super Sun DE

Adjust-A-Wing DE

Agrotech Magnum DE

Gavita Hortistar 1000 DE

Gavita Pro 1000 DE

This new group of state-of-the-art reflectors and fixtures are designed specifically to accommodate Double-Ended 1000 watt HPS horticultural lamps. The AC/DE is the only air-cooled double-ended reflector on the market. These lamps feature increased PAR values as well as excellent lumen and PAR maintenance (up to 90% PAR maintenance after 10,000 hours). The full spectrum lamps focus on the red component for increased photosynthetic response. Prepare for the best crops and yields you have ever seen.



Sunlight Supply, Inc.
National Garden Wholesaler.
www.sunlightsupply.com



Gro Pro Round Fabric Pots - Black

Gro Pro Round Fabric Pots feature breathable fabric allowing for faster plant growth through better access to oxygen. Air-flow prunes the root structure for a healthier and happier plant.



Item No.	Description	Vol (Gal)	Cu. Ft.	MSRP
725800	Gro Pro Round Fabric Pot 1 Gallon	1.3	0.18	\$1.57
725805	Gro Pro Round Fabric Pot 2 Gallon	1.5	0.20	\$2.00
725810	Gro Pro Round Fabric Pot 3 Gallon	3.9	0.52	\$2.48
725815	Gro Pro Round Fabric Pot 5 Gallon	6.8	0.91	\$3.19
725820	Gro Pro Round Fabric Pot 7 Gallon	8	1.1	\$4.17
725825	Gro Pro Round Fabric Pot 10 Gallon	13.4	1.8	\$4.76
725830	Gro Pro Round Fabric Pot 15 Gallon	19.1	2.5	\$5.95
725835	Gro Pro Round Fabric Pot 20 Gallon	22.5	3.0	\$7.14
725840	Gro Pro Round Fabric Pot 30 Gallon	36.8	4.9	\$9.52
725845	Gro Pro Round Fabric Pot 45 Gallon	44.6	5.9	\$12.71
725850	Gro Pro Round Fabric Pot 65 Gallon	62.6	8.4	\$17.21
725855	Gro Pro Round Fabric Pot 100 Gallon	98.2	13.1	\$22.45
725860	Gro Pro Round Fabric Pot 150 Gallon	154.7	20.7	\$29.95
725865	Gro Pro Round Fabric Pot 200 Gallon	204.1	27.3	\$34.52
725870	Gro Pro Round Fabric Pot 300 Gallon	293.9	39.3	\$42.86
725875	Gro Pro Round Fabric Pot 400 Gallon	400	53.5	\$52.38

Gro Pro Square Fabric Pots - Black

Gro Pro Square Fabric Pots have breathable fabric for drainage and aeration. They eliminate circling, misguided roots, promote lateral root development and vigorous plant growth. Also great for maintaining a consistent substrate temperature.



Item No.	Description	MSRP
724950	Gro Pro Square Fabric Pot 1 Gallon	\$3.29
724955	Gro Pro Square Fabric Pot 3 Gallon	\$4.36
724960	Gro Pro Square Fabric Pot 5 Gallon	\$5.99
724965	Gro Pro Square Fabric Pot 7 Gallon	\$7.35
724970	Gro Pro Square Fabric Pot 10 Gallon	\$8.96
724985	Gro Pro Square Fabric Pot 20 Gallon	\$11.76
724990	Gro Pro Square Fabric Pot 30 Gallon	\$14.93
724995	Gro Pro Square Fabric Pot 100 Gallon	\$32.62
724975	Flo-n-Gro Square Fabric Liner 3 Gallon	\$4.05

Gro Pro Round Fabric Pots - Tan

The Gro Pro Tan Round Fabric Pots are the same great quality as the black now in tan color. They are constructed from high quality non woven fabric. This fabric provides great support, while allowing air to travel into the root system. Feature breathable fabric allowing for faster plant growth through better access to oxygen.



Item No.	Description	Vol (Gal)	Cu. Ft.	MSRP
725920	Gro Pro 1 Gallon Round Fabric Pot-Tan	1.36	0.183	\$1.63
725925	Gro Pro 2 Gallon Round Fabric Pot-Tan	1.52	0.204	\$2.08
725930	Gro Pro 3 Gallon Round Fabric Pot-Tan	3.92	0.525	\$2.57
725935	Gro Pro 5 Gallon Round Fabric Pot-Tan	6.80	0.91	\$3.32
725940	Gro Pro 7 Gallon Round Fabric Pot-Tan	8	1.07	\$4.33
725945	Gro Pro 10 Gallon Round Fabric Pot-Tan	13.46	1.8	\$4.95
725950	Gro Pro 15 Gallon Round Fabric Pot-Tan	19.07	2.55	\$6.19
725955	Gro Pro 20 Gallon Round Fabric Pot-Tan	22.51	3.01	\$7.42
725960	Gro Pro 30 Gallon Round Fabric Pot-Tan	36.8	4.92	\$9.90
725965	Gro Pro 45 Gallon Round Fabric Pot-Tan	44.65	5.97	\$13.21
725970	Gro Pro 65 Gallon Round Fabric Pot-Tan	62.68	8.38	\$17.89
725975	Gro Pro 100 Gallon Round Fabric Pot-Tan	98.22	13.13	\$23.33
725980	Gro Pro 150 Gallon Round Fabric Pot-Tan	154.7	20.68	\$31.13
725985	Gro Pro 200 Gallon Round Fabric Pot-Tan	204.1	27.28	\$35.88
725990	Gro Pro 300 Gallon Round Fabric Pot-Tan	293.9	39.29	\$44.54
725995	Gro Pro 400 Gallon Round Fabric Pot-Tan	399.98	53.47	\$54.44

Gro Pro Thin Skins

Gro Pro Thin Skins are made from high quality recyclable UV protected plastic.



Item No.	Description	MSRP
724870	Gro Pro Thin Skins 1 Gallon	\$0.39
724872	Gro Pro Thin Skins 2 Gallon	\$0.71
724874	Gro Pro Thin Skins 3 Gallon	\$0.99
724876	Gro Pro Thin Skins 5 Gallon	\$1.18
724878	Gro Pro Thin Skins 7 Gallon	\$1.80
724880	Gro Pro Thin Skins 10 Gallon	\$2.71
724882	Gro Pro Thin Skins 15 Gallon	\$3.62

RediRoot Aeration Liners

RediRoot Aeration Liners are constructed of high quality non woven fabric. This fabric provides great support, while allowing air to travel into the root system. RediRoot Liners have sturdy handles, making lifting and transporting a breeze.



Item No.	Description	MSRP
724886	RediRoot Aeration Liner 5 Gallon	\$3.27
724887	RediRoot Aeration Liner 7 Gallon	\$4.18

RediRoot Aeration Frames

The RediRoots Aeration Frame is a heavy duty plastic frame with engineered air entry points to introduce oxygen to the root zone. It also provides air pruning of the roots, giving you strong lateral root growth, while reducing thin spiraling roots.



Item No.	Description	MSRP
724891	RediRoot Aeration Container 5 Gallon	\$5.09
724892	RediRoot Aeration Container 7 Gallon	\$7.44

RootTrapper II

Root wrapping in containers is a serious problem. In some cases, wrapped roots can actually kill plants. Root-tip-trapping is another non-chemical method of pruning roots. The RootTrapper II works by utilizing a unique fabric; much like using velcro on the root tips. When the root tip grows into the fabric it gets stuck (or trapped) at which point the root is forced to branch. These bags can prune up to 100 root tips in just 1 square inch of fabric!



Item No.	Description	MSRP
724839	Root Trapper II 5 Gallon	\$7.55
724840	Root Trapper II 7 Gallon	\$8.85
724841	Root Trapper II 10 Gallon	\$10.50
724842	Root Trapper II 15 Gallon	\$12.67
724844	Root Trapper II 45 Gallon	\$33.85

Smart Pot - Tan

We have color! The Tan Smart Pot provides a decorative aspect to the Smart Pot. The qualities that make the regular Smart Pot work are still the same!



Item No.	Description	Vol (Gal)	Cu. Ft.	MSRP
725700	Smart Pot Tan 1 Gallon	0.9	0.13	\$3.99
725705	Smart Pot Tan 2 Gallon	1.5	0.20	\$4.49
725710	Smart Pot Tan 3 Gallon	2.5	0.34	\$5.49
725715	Smart Pot Tan 5 Gallon	4.6	0.62	\$6.49
725720	Smart Pot Tan 7 Gallon	6.3	0.84	\$7.49
725725	Smart Pot Tan 10 Gallon	10.0	1.33	\$9.95
725730	Smart Pot Tan 15 Gallon	14.8	1.98	\$11.95
725735	Smart Pot Tan 20 Gallon	21.0	2.8	\$13.95
725740	Smart Pot Tan 25 Gallon	23.2	3.1	\$14.95
725745	Smart Pot Tan 30 Gallon	30.4	4.0	\$16.95
725750	Smart Pot Tan 45 Gallon	40.6	5.9	\$19.95
725755	Smart Pot Tan 65 Gallon	60.9	8.3	\$24.95
725760	Smart Pot Tan 100 Gallon	95.7	13.1	\$32.95
725765	Smart Pot Tan 150 Gallon	151.5	20.2	\$43.95
725770	Smart Pot Tan 200 Gallon	199.8	27.2	\$52.95
725775	Smart Pot Tan 300 Gallon	293.8	39.2	\$70.95
725780	Smart Pot Tan 400 Gallon	399.8	53.4	\$80.95

Smart Pot - Black with Handles

These soft growing containers allow more air to reach the growing medium and roots, improving drainage and keeping the root system from overheating on hot days. These pots are aeration containers allowing the air to prune the plant root structure. Easy handling with built in handles.



Item No.	Description	Vol (Gal)	Cu. Ft.	MSRP
724710	Smart Pot Black 3 Gallon w/ handles	2.6	0.35	\$5.95
724715	Smart Pot Black 5 Gallon w/ handles	4.7	0.62	\$6.95
724720	Smart Pot Black 7 Gallon w/ handles	6	0.83	\$7.95
724725	Smart Pot Black 10 Gallon w/ handles	10	1.35	\$9.95
724730	Smart Pot Black 15 Gallon w/ handles	14.9	1.99	\$12.95
724736	Smart Pot Black 20 Gallon w/ handles	21	2.80	\$14.95

Smart Pot - Black

These soft growing containers allow more air to reach the growing medium and roots, improving drainage and keeping the root system from overheating on hot days. These pots are aeration containers allowing the air to prune the plant root structure. Check your local dealer partner for availability.



Item No.	Description	Vol (Gal)	Cu. Ft.	MSRP
724700	Smart Pot Black 1 Gallon	0.9	0.13	\$2.19
724705	Smart Pot Black 2 Gallon	1.5	0.20	\$2.39
724708	Smart Pot Black 3 Gallon New!	2.5	0.34	\$4.95
724713	Smart Pot Black 5 Gallon New!	4.6	0.62	\$5.95
724718	Smart Pot Black 7 Gallon New!	6.3	0.84	\$6.95
724723	Smart Pot Black 10 Gallon New!	10.0	1.31	\$8.95
724728	Smart Pot Black 15 Gallon New!	14.8	1.9	\$9.95
724735	Smart Pot Black 20 Gallon	21.0	2.8	\$11.95
724740	Smart Pot Black 25 Gallon	23.2	3.1	\$12.95
724745	Smart Pot Black 30 Gallon	30.4	4.0	\$14.95
724750	Smart Pot Black 45 Gallon	40.6	5.9	\$18.95
724755	Smart Pot Black 65 Gallon	60.9	8.3	\$22.95
724760	Smart Pot Black 100 Gallon	95.7	13.1	\$29.95
724763	Smart Pot Black 150 Gallon	151.5	20.2	\$39.95
724765	Smart Pot Black 200 Gallon	199.8	27.2	\$49.95
724766	Smart Pot Black 300 Gallon	293.8	39.2	\$69.95
724767	Smart Pot Black 400 Gallon	399.8	53.4	\$79.95
724769	Smart Pot Liner Black 4 ft x 4 ft x 12 in	148	19.79	\$39.95
724771	Smart Pot Black 500 Gallon	496	66.3	\$84.95
724772	Smart Pot Black 600 Gallon	603	80.6	\$89.95
724773	Smart Pot Black 700 Gallon	705	94.3	\$107.95
724774	Smart Pot Black 800 Gallon	799	106	\$116.95
724775	Smart Pot Black 900 Gallon	899	120	\$131.95
724776	Smart Pot Black 1000 Gallon	1005	134	\$143.95

Smart Pot Transplanter

The Smart Transplanter is a re-usable Smart Pot that has been specially designed to make transplanting easy. The Smart Transplanter has an opening on the sidewall that allows the gardener to peel off the Transplanter with ease. Because the fabric overlaps itself, it is able to hold most mediums and mixes without any problems. 6 in base by 6 in height.



Item No.	Description	MSRP Ea
724698	Smart Pot Transplanter 1 Gallon 100/Pack	\$2.19

Root Pots

Root Pots last for multiple seasons of gardening and will generally begin to break down after about 3 to 5 years. They are designed to allow roots to breathe. Root Pots can be used with drip lines or hydroponic flood trays. Made from 100% recycled material. Root Pots are both reusable and biodegradable.



Item No.	Description	W x H inches	MSRP
728841	Root Pot 1 Gallon	6 x 7.5	\$1.55
728842	Root Pot 2 Gallon	8.5 x 8.5	\$1.95
728844	Root Pot 3 Gallon	9 x 8	\$2.42
728846	Root Pot 5 Gallon	11 x 10.25	\$3.10
728848	Root Pot 7 Gallon	13.875 x 12	\$4.00
728851	Root Pot 10 Gallon	16 x 12	\$4.60
728852	Root Pot 15 Gallon	17 x 15	\$5.75
728854	Root Pot 20 Gallon	18.875 x 15.875	\$7.00
728856	Root Pot 25 Gallon	21 x 16.5	\$7.99
728858	Root Pot 30 Gallon	24 x 16.5	\$9.25
728861	Root Pot 45 Gallon	27 x 18	\$12.25
728862	Root Pot 65 Gallon	32 x 18	\$16.75
728864	Root Pot 100 Gallon	38 x 20	\$21.50
728866	Root Pot 150 Gallon	45 x 22	\$28.95
728868	Root Pot 200 Gallon	50 x 24	\$32.50
728871	Root Pot 250 Gallon	55 x 24	\$34.99
728872	Root Pot 300 Gallon	60 x 24	\$39.99
728874	Root Pot 400 Gallon	70 x 24	\$49.99
728876	Root Pot 500 Gallon	80 x 24	\$69.00
728878	Root Pot 600 Gallon	80 x 24	\$79.99

Nursery Pots - Thermoformed

The thermoforming process of these pots creates a thin wall nursery container of exceptional quality, which deliver several advantages over competitors' products including uniformity, durability, stackability and cost-effectiveness.



Item No.	Description	MSRP
725500	Thermoformed Nursery Pot 1 Gallon	\$0.52
725505	Thermoformed Nursery Pot 2 Gallon	\$1.23
725510	Thermoformed Nursery Pot 3 Gallon	\$1.73
725515	Thermoformed Nursery Pot 5 Gallon	\$2.27

Nursery Pots - Blow Molded

These traditional blow molded nursery pots offer quality at an economical price. They are engineered for strength, even in the large sizes. The integrated rim allows for convenient handling of large plants or trees.



Item No.	Description	MSRP
725520	Blow Molded Nursery Pot 7 Gallon	\$3.39
725525	Blow Molded Nursery Pot 10 Gallon	\$6.99
725530	Blow Molded Nursery Pot 15 Gallon	\$8.99
725535	Blow Molded Nursery Pot 20 Gallon	\$12.49
725540	Blow Molded Nursery Pot 25 Gallon	\$13.99

Gro Pro Premium Nursery Pots - Injection Molded

Gro Pro Premium Nursery Pots are the best quality pots on the market! These injection molded pots have impact modified plastic added for extra strength and durability. They are much thicker and more durable than traditional blow molded nursery pots. BPA free.



Item No.	Description	MSRP
724800	Gro Pro Premium Nursery Pot 1 Gallon	\$0.48
724805	Gro Pro Premium Nursery Pot 2 Gallon	\$1.11
724810	Gro Pro Premium Nursery Pot 3 Gallon	\$1.99
724815	Gro Pro Premium Nursery Pot 5 Gallon	\$2.49
724816	Gro Pro Medium Duty Tall Nursery Pot 5 Gallon	\$2.39
724820	Gro Pro Premium Nursery Pot 7 Gallon	\$5.10
724825	Gro Pro Premium Nursery Pot 10 Gallon	\$5.95
724830	Gro Pro Premium Nursery Pot 15 Gallon	\$7.85
724835	Gro Pro Premium Nursery Pot 20 Gallon	\$11.55
724808	Gro Pro Premium Nursery Pot 25 Gallon	\$15.99

Heavy Duty Container with Handles

These heavy duty pots are made with recycled Polyethylene (PE) plastic. The best feature is the built in lateral handles for an easy carrying.



Item No.	Description	MSRP
725460	Heavy Duty Container w/ handles 20 Gallon	\$10.59
725465	Heavy Duty Container w/ handles 40 Gallon	\$24.83

A growing container for every need!

Ask for the best at a retailer near you. Check out the complete selection at www.sunlightsupply.com



Plant Warrior Pots

Plant Warrior growing containers provide added oxygen to the soil environment. Patent pending design allows oxygen to be drawn through the bottom of the container promoting healthy, strong roots. Sturdy injection molded containers. Reusable and easy to clean.



Item No.	Description	MSRP
724790	Plant Warrior Pot 1 Gallon	\$0.99
724792	Plant Warrior Pot 2 Gallon	\$1.99
724794	Plant Warrior Pot 3 Gallon	\$2.49
724795	Plant Warrior Pot 5 Gallon	\$3.29

Gro Pro Premium Round Mesh Bottom Pots

Durable, thick black plastic with hole pattern that offers excellent drainage. Heavy duty injection molded design.



Item No.	Description	MSRP
724625	Premium Black Mesh Pot 6 in	\$1.45
724630	Premium Black Mesh Pot 8 in	\$2.70
724635	Premium Black Mesh Pot 10 in	\$3.20
724640	Premium Black Mesh Pot 12 in	\$5.50

Gro Pro Round Plastic Mesh Bottom Pots

Excellent multipurpose pots made of hard black plastic. Works well for all indoor or outdoor applications.



Item No.	Description	MSRP
724100	Black Plastic Mesh Bottom Pot 6 in	\$1.35
724105	Black Plastic Mesh Bottom Pot 8 in	\$2.50
724115	Black Plastic Mesh Bottom Pot 10 in	\$2.85
724120	Black Plastic Mesh Bottom Pot 12 in	\$4.95

Gro Pro Mesh Pots/ Bucket Lids

These heavy duty 6 in, 8 in & 10 in plastic pots are designed specifically to snugly fit on standard 3.5 and 5 gallon buckets. They are mesh on the sides and bottom for maximum aeration. They work great in all hydroponic applications. Much better quality than competitive bucket lids.



Item No.	Description	MSRP
724529	Gro Pro Mesh Pot/Bucket Lid 6 in	\$4.58
724530	Gro Pro Mesh Pot/Bucket Lid 8 in	\$4.58
724535	Gro Pro Mesh Pot/Bucket Lid 10 in	\$5.10

Botanicare Aero Bucket Lid with Mesh Bottom

Fits on the top of standard 3.5 and 5 gallon buckets.



Item No.	Description	MSRP
724110	Aero Bucket Lid w/ Mesh Bottom 10 in	\$5.50

Black Plastic Buckets - 3.5 & 5 Gallon

These premium quality, black plastic buckets can be used for a variety of gardening applications. Many growers use these as containers to grow their plants in. You can even place the 3.5 gallon bucket inside the 5 gallon bucket to build your own hydroponic growing system.



Item No.	Description	MSRP
724379	Black Plastic Bucket 3.5 Gallon	\$6.99
724380	Black Plastic Bucket 5 Gallon	\$7.99

Gamma Seal Bucket Lid

Transform standard 3.5 & 5 gallon buckets into airtight, water proof, leak proof, pest-proof storage containers with this Gamma Seal Lid. Simply snap the universal adaptor ring onto your bucket and spin-on the removable, threaded lid. Can be used for dry or liquid storage. Made from high density polyethylene. FDA approved food grade plastic. BPA free. Approximately 12 in diameter.



Item No.	Description	MSRP
740780	Gamma Seal Lid for 3.5 and 5 Gallon Buckets	\$10.95

Bucket Lid

Made for use with standard 3.5 and 5 gallon buckets.



Item No.	Description	MSRP
724381	Bucket Lid - Flat for 3.5 & 5 Gallon Buckets	\$3.39

Eco Grow Pots

Eco Grow Pots are the only growing system that has the capacity & versatility to grow all varieties of vegetables, herbs, ornamental foliage, fruits and custom plantation. Scientifically proven to grow plants 50% faster, cutting water & energy usage to 50% with maximum crop yields.



Item No.	Description	MSRP
746105	Eco Grow Pot 8 in 2 Gallon	\$7.69
746115	Eco Grow Pot 12 in 5 Gallon	\$12.79
746120	Eco Grow Pot 14 in 7 Gallon	\$16.69

GH Net Cups

Made for use in a variety of different hydroponic or aeroponic systems. Works great with Hydroton.



Item No.	Description	MSRP
724365	GH Net Cup 2 in (100/Bag)	\$0.29
724370	GH Net Cup 3 in (100/Bag)	\$0.54
724375	GH Net Cup 6 in (50/Bag)	\$1.94

RootMaker Containers

RootMaker containers do not allow the roots to wrap, instead, they direct the roots to air holes where they can't escape and the roots can get air pruned. This process is repeated with the branching roots to create a healthy, fibrous root system.



Item No.	Description	MSRP
724780	RootMaker Container 1 Gallon	\$2.06
724781	RootMaker Container 3 Gallon	\$6.30
724782	RootMaker Container 5 Gallon	\$9.44

Gro Pro Root Master Pots

These unique pots allow proper root training & air pruning with strategically placed ventilation channels. They prevent spiraling & root burrowing which causes plant instability. Using these great pots will increase the overall health of plant's root structure, allow for greater stability when transplanting & increase nutrient & water uptake.



Item No.	Description	MSRP
744795	Gro Pro Root Master Pot 6 in	\$1.37
744797	Gro Pro Root Master Pot 7 in New	\$1.49
744800	Gro Pro Root Master Pot 8 in	\$1.95
744805	Gro Pro Root Master Pot 10 in	\$3.50
744810	Gro Pro Root Master Pot 12 in	\$5.95
744815	Gro Pro Root Master Pot 14 in	\$7.95
744820	Gro Pro Root Master Pot 16 in	\$9.95

Heavy Duty Net Pots

Super heavy duty, designed to be re-used. Wider hole spacing for better root aeration. Made with recycled plastic in Humboldt County.



Item No.	Description	MSRP
724429	Heavy Duty Net Pot 3 in	\$1.09
724430	Heavy Duty Net Pot 5.5 in	\$2.15
724435	Heavy Duty Net Pot 8 in	\$3.79

Gro Pro Net Pots

Excellent quality net pots are thicker and more heavy-duty than most on the market. They offer a wider rim for better support. Smaller mesh allows the grower to use virtually all types of grow media.



Item No.	Description	MSRP
724500	Gro Pro Net Pot 2 in (100/Bag)	\$0.20
724505	Gro Pro Net Pot 3 in (100/Bag)	\$0.42
724510	Gro Pro Net Pot 3.75 in (100/Bag)	\$0.56
724515	Gro Pro Net Pot 5 in (30/Bag)	\$1.12
724520	Gro Pro Net Pot 6 in (30/Bag)	\$1.28

RootBuilder II

The Root Builder II design allows roots to reach the container wall to find the air holes immediately. The downward protrusions make the root virtually impossible to escape root tip pruning. They also create shade, keeping the root system much cooler.



Item No.	Description	MSRP
724783	RootBuilder II 1 Gallon	\$5.40
724784	RootBuilder II 2 Gallon	\$6.80
724786	RootBuilder II 3 Gallon	\$10.48
724787	RootBuilder II High Five 5-7 Gallon	\$13.43
724788	RootBuilder II 18 in x 100 ft Roll	\$454.12
724789	RootBuilder II Base-Knit/Vinyl 48 in Diameter	\$20.49

Square Plastic Pot

Nice quality pots made from a slightly thinner material than other pots we offer. Great for a variety of hydroponic and soil applications.



Item No.	Description	MSRP
724425	Square Plastic Pot 5.5 in x 5.5 in x 6 in	\$0.59

Gro Pro Premium White Pots

These high quality pots can be used for a variety of indoor or outdoor gardening applications. Injection molded heavy duty plastic pots.



Item No.	Description	MSRP
724590	Gro Pro Premium White Square Pot 6 in x 6 in x 8 in	\$1.49
724592	Gro Pro Premium White Square Pot 7 in x 7 in x 9 in	\$2.49
724594	Gro Pro Premium White Square Pot 9 in x 9 in 10.5 in	\$4.29

POTS & CONTAINERS

Gro Pro Premium Square Black Plastic Pots

Premium Square Black Plastic Pots are durable, thick black plastic. They feature injection molding, a heavy duty design, good grip for easy handling and stand off feet for better drainage.



Item No.	Description	MSRP
724645	Gro Pro Premium Black Square Pot 6 in x 6 in x 8 in	\$1.49
724650	Gro Pro Premium Black Square Pot 7 in x 7 in x 9 in	\$2.49
724655	Gro Pro Premium Black Square Pot 9 in x 9 in x 10.5 in	\$4.29
724660	Gro Pro Premium Black Square Pot 8 in x 8 in x 7.5 in	\$3.69

Perfect Pot

The Perfect Pot is durable and flexible, designed for use with large plants, for soil and hydro growers alike. Dimensions: 8.5 in x 8.5 in x 7.5 in.



Item No.	Description	MSRP
724525	Perfect Pot	\$5.99

Black Square Pots

The new square shape with the textured exterior and patterned design at the top stands out from the rest of the pots. Made from copolymeric polypropylene that is stabilized to handle the UV rays.



Item No.	Description	MSRP
725400	Black Square Pot 1/2 Gallon	\$0.74
725405	Black Square Pot 1 Gallon	\$1.21
725410	Black Square Pot 1.5 Gallon	\$1.72
725415	Black Square Pot 2 Gallon	\$2.15
725420	Black Square Pot 5 Gallon	\$3.63
725425	Black Square Pot 8 Gallon	\$6.11

Black Square Saucer for Black Square Pots

These saucers are made to work with the Black Square pots. Made from the same copolymeric polypropylene that is stabilized to handle the UV rays. Match your saucer size to the pot size to pair them up for a beautiful combination.



Item No.	Description	MSRP
725430	Black Square Saucer for 1/2 Gallon Pot	\$0.33
725435	Black Square Saucer for 1 Gallon Pot	\$0.56
725440	Black Square Saucer for 1.5 Gallon Pot	\$0.65
725445	Black Square Saucer for 2 Gallon Pot	\$0.82
725450	Black Square Saucer for 5 Gallon Pot	\$1.21
725455	Black Square Saucer for 8 Gallon Pot	\$2.56

Grodan Giant Pot

This large, durable Dutch pot can be used for a variety of gardening applications. 16 drain holes for excellent drainage. Great for use with all types of growing media. Made with heavy duty plastic. Thicker than standard pots. Dimensions: 12 in x 12 in (top) x 8.5 in x 8.5 in (bottom) x 12 in tall. Capacity: 4.75 gallons.



Item No.	Description	MSRP
724395	Giant Pot Black 12 in x 8.5 in x 12 in	\$6.57

Grodan Rose Bucket

Rose bucket is another quality Dutch container that works great with one Hugo block, Growcubes, Granulate, coconut fiber or other loose media. Four bottom and side holes for excellent drainage. Dimensions: 7.6 in x 7.6 in x 9.7 tall. Capacity: 1.7 gallons.



Item No.	Description	MSRP
724385	Rose Bucket Black 7.6 in x 7.6 in x 9.7 in	\$4.16

Grodan Maxipot

This excellent quality Dutch container hold two Hugo's or can be used for any loose media. Four bottom and four side holes for excellent drainage. Thicker than standard pots. Dimensions: 9.6 in x 9.6 in x 11.5 tall. Capacity: 3.1 gallons.



Item No.	Description	MSRP
724390	Maxipot Black 9.6 in x 9.6 in x 11.5 in	\$5.23

Gro Pro Black Plastic Pots

These pots are durable and versatile. They are injection molded containers manufactured with high-grade polypropylene.



Item No.	Description	MSRP
724042	Black Plastic Pot 3.5 in x 3.5 in x 3 in	\$0.43
724044	Black Plastic Pot 4 in x 4 in x 3.5 in	\$0.45
724046	Black Plastic Pot 5.5 in x 5.5 in x 5.75 in	\$1.08

Traditional Square Pots - Blow Molded

Economical blow-molded plastic pots. Flexible and smooth for easy plant removal and transplanting.



Item No.	Description	MSRP
724032	Square Plastic Pot Black 3.5 in	\$0.27
724034	Square Plastic Pot Black 4 in	\$0.30

Black Square Plastic Pots

Reusable injection molded strength and durability. Bi-level drainage holes for excellent drainage. Smooth exterior resists salt and dirt. Tag slot is a great feature on our Jumbo, Senior and Magnum square pots. For hydroponic or soil use.



Item No.	Description	MSRP
724135	Black Square Pot (Jumbo) 5 in x 5 in x 5 in	\$1.19
724140	Black Square Pot (Jumbo Senior) 5 in x 5 in x 6.5 in	\$1.19
724160	Black Square Pot (Magnum) 6 in x 6 in x 7 in	\$1.45

Gro Pro Square Mesh Pot

This large mesh pot is perfect to hold plants in ebb and flow tables. The large base keeps the plant upright. The mesh on the sides and bottom allow for maximum aeration to the roots.



Item No.	Description	MSRP
724438	Gro Pro Square Mesh Pot 9 in x 9 in x 5-1/4 in	\$1.49

Flo-n-Gro Blue Bucket - 4 Gallon

The Flo-n-Gro Blue Bucket features food grade plastic, safe for you and your plants. At 4 gallon capacity. Dimensions: 9.5 in W x 9.5 in L x 13.5 in D. Compatible with the Ebb & Flow 6 Site System, 12 Site Gro Systems and Drip-n-Gro System. Does not include 3/4 in grommet. Use with Tub Outlet Tee Fitting #747186 sold separately. 0.835 inch hole pre-drilled in bucket.



Item No.	Description	MSRP
707635	Flo-n-Gro Blue Bucket - 4 Gallon	\$6.59

Flo-n-Gro Black Mesh Insert - 3 Gallon

This 3 gallon black mesh insert fits snugly in the Flo-n-Gro Ebb and Flow Grow System. The rigid plastic insert keeps its shape for years and the open mesh basket allows for optimal air and water flow that promotes healthy root growth for your plants.



Item No.	Description	MSRP
707640	Flo-n-Gro Black Mesh Insert	\$6.59

Flo-n-Gro Clear Vented Lid

The innovative Flo-n-Gro clear vented cover allows you to maintain the perfect humidity level for your sensitive plant starts. By adjusting the ventilation slots on the top of the cover, you can dial in your garden for optimum growth. Can be used with both 2 and 3 gallon mesh inserts.



Item No.	Description	MSRP
707645	Flo-n-Gro Clear Vented Lid	\$8.29

Flo-n-Gro Drip-n-Gro Mesh Insert - 2 Gallon

This 2 gallon black mesh insert fits snugly in the Flo-n-Gro Drip-n-Gro System. The rigid plastic insert keeps its shape for years and the open mesh basket allows for optimal air and water flow that promotes healthy root growth for your plants.



Item No.	Description	MSRP
350800	Drip-n-Gro Short Mesh Insert	\$6.99

Flo-n-Gro Blue Bucket 6.6 Gallon

Oversized, food-grade, blue 6.6 gallon bucket. Dimensions: 14 in W x 14 in L x 12 in D – Polyethylene.



Item No.	Description	MSRP
724486	Flo-n-Gro 6.6 Gallon Blue Bucket	\$10.95

Flo-n-Gro Black Bucket 6.6 Gallon

Oversized black 6.6 gallon bucket approved for potable water. Dimensions: 14 in W x 14 in L x 12 in D – Polyethylene.



Item No.	Description	MSRP
724480	Flo-n-Gro 6.6 Gallon Black Bucket	\$9.95

Flo-n-Gro 6.6 Gallon Mesh Basket Lid 10 in

10 in wide black mesh insert basket for use with 6.6 gallon Gro Giant black bucket. Dimensions: 14-1/4 in W x 14-1/4 in H x 7-1/4 in D – Polyethylene.



Item No.	Description	MSRP
724490	Flo-n-Gro 6.6 Gallon Mesh Basket Lid 10 in	\$9.95

EZ Store Container/Buckets 8 & 13 Gallon & Lid

Made with virgin, high density polyethylene material. These patented containers have no holes in them and can hold up to 8 or 13 gallons of liquid. EZ Stor containers are nestable, with built in hand grips. The lid is compatible with both sizes. It has a recessed fit with a tear strip and a built in handle on the front portion of the hinged lid, creating easy access without removing the lid.



Item No.	Description	MSRP
703990	EZ Store Container/Bucket 8 Gallon	\$14.99
703992	EZ Store Container/Bucket 13 Gallon	\$22.99
703994	EZ Store Lid for 8 and 13 Gallon	\$4.99

Botanicare Root Guard Lids

Protect plant roots from debris, heat and light and reduce algae growth on media. Fit on top of net pots and around base of plant.



Item No.	Description	MSRP
724325	Botanicare Root Guard Lid 3 in	\$0.50
724335	Botanicare Root Guard Lid 3.75 in	\$0.60
724355	Botanicare Root Guard Lid 6 in	\$1.45

Gro Pro Net Pot Lids

These durable white lids are designed specifically to fit net pots.



Item No.	Description	MSRP Ea
724600	Gro Pro Net Pot Lid 2 in (10/Bag)	\$0.42
724605	Gro Pro Net Pot Lid 3 in (10/Bag)	\$0.62
724610	Gro Pro Net Pot Lid 3.75 in (10/Bag)	\$0.78
724615	Gro Pro Net Pot Lid 5 in (10/Bag)	\$1.44
724620	Gro Pro Net Pot Lid 6 in (10/Bag)	\$1.80

GH CocoTek Basket Liners

Perfect for aeroponic systems which use net baskets and loose growing mediums. This excellent CocoTek product is designed to sit inside 2 in, 3 in and 6 in plastic baskets and prevent media from falling through.



Item No.	Description	MSRP Ea
714025	GH CocoTek Basket Liner 3 in (20/Bag)	\$0.68
714040	GH CocoTek Basket Liner 6 in (10/Bag)	\$1.08
714045	GH CocoTek Basket Liner 8 in (10/Bag)	\$3.20

Mondi Super Saucers

Ergonomic easy-grip edges allow you to grab and carry the saucer with pot from any side. Protects your carpet, tile, wood and metal shelves from moisture and dirt. Manufactured in high quality plastic. Ideal for potted plants that draw up water from below.



Item No.	Description	MSRP
724439	Mondi Super Saucer 6 in	\$0.66
724441	Mondi Super Saucer 8 in	\$0.96
724443	Mondi Super Saucer 10 in	\$1.48
724444	Mondi Super Saucer 12 in	\$1.99
724446	Mondi Super Saucer 14 in	\$2.79

Gro Pro Heavy Duty Black Saucers

Durable, hard plastic. Washable and reusable. Many sizes to fit your needs.



Item No.	Description	Top Dim	Bottom Dim	MSRP
724930	Gro Pro Heavy Duty Black Saucer - 6 in	6	5	\$0.53
724932	Gro Pro Heavy Duty Black Saucer - 8 in	8	7	\$0.96
724934	Gro Pro Heavy Duty Black Saucer - 10 in	10	9	\$1.18
724936	Gro Pro Heavy Duty Black Saucer - 12 in	12	10.5	\$1.39
724938	Gro Pro Heavy Duty Black Saucer - 14 in	14	12.6	\$2.35
724940	Gro Pro Heavy Duty Black Saucer - 16 in	16	14.5	\$2.76
724942	Gro Pro Heavy Duty Black Saucer - 18 in	18	17	\$5.89
724944	Gro Pro Heavy Duty Black Saucer - 20 in New	20	17.7	\$8.09
724946	Gro Pro Heavy Duty Black Saucer - 25 in New	25	22	\$14.59

Premium Plastic Saucers

Durable, hard plastic that is washable and reusable. New bigger sizes to accommodate larger nursery pots. Color - dark green, except 18 in, 20 in & 25 in which are black. Made in the USA.



Item No.	Description	Top Dim	Bottom Dim	MSRP
724900	Green Premium Plastic Saucer 6 in	6	5	\$0.63
724905	Green Premium Plastic Saucer 8 in	8	7.8	\$0.95
724910	Green Premium Plastic Saucer 10 in	10	8.8	\$1.35
724915	Green Premium Plastic Saucer 12 in	12	10.3	\$1.79
724920	Green Premium Plastic Saucer 14 in	14	12.3	\$2.59
724925	Green Premium Plastic Saucer 16 in	16	14.3	\$3.09
724927	Black Premium Plastic Saucer 18 in	18	16	\$5.93
724928	Black Premium Plastic Saucer 20 in	20	18	\$8.70
724929	Black Premium Plastic Saucer 25 in	25	22	\$15.51

Gro Pro Clear Plastic Saucers

Clear PVC Plastic Saucers for under your potted plants. Choose the size that will work with your pot.



Item No.	Description	Nursery Pot	Top Dim	Bottom Dim	MSRP
724665	Gro Pro Clear Plastic Saucer 6 in	1 Gallon	7.5	6	\$0.44
724670	Gro Pro Clear Plastic Saucer 8 in	2 Gallon	9.5	8	\$0.74
724675	Gro Pro Clear Plastic Saucer 10 in	3, 5 Gallon	11.5	10	\$1.18
724680	Gro Pro Clear Plastic Saucer 12 in	3, 5 Gallon	13.8	12	\$1.79
724685	Gro Pro Clear Plastic Saucer 14 in	7 Gallon	15	13.8	\$1.99
724690	Gro Pro Clear Plastic Saucer 16 in	10, 15 Gallon	17.5	16	\$3.09
724695	Gro Pro Clear Plastic Saucer 18 in	20 Gallon	19.5	17.8	\$3.99

Bond Clear Plastic Saucers

Protection for your carpets and floors. Place under pots to catch leaking water. Use with plants and flowers to keep water where you want it without staining surfaces. Interior ridges keeps plant out of water to keep plant roots healthy. 100% recyclable plastic is waterproof and strong.



Item No.	Description	Top Dim	Bottom Dim	MSRP Ea
740974	Bond Clear Plastic Saucer 8 in (25/Bag)	8	6.8	\$0.36
740976	Bond Clear Plastic Saucer 10 in (25/Bag)	10	8.8	\$0.56
740978	Bond Clear Plastic Saucer 12 in (25/Bag)	12	10.8	\$0.90
740980	Bond Clear Plastic Saucer 14 in (25/Bag)	14	12.8	\$1.08
740982	Bond Clear Plastic Saucer 16 in (25/Bag)	16	14.5	\$1.67
740984	Bond Clear Plastic Saucer 21 in (25/Bag)	21	19.5	\$3.21

Botanicare Camo Grow Bag - 30 Gallon

Sturdy 6 mil plastic bag with pre-punched drain holes and great digital camo print. Fill with preferred media. Plant right in the bag.



Item No.	Description	MSRP
740072	Botanicare Camo Grow Bag 30 Gallon	\$5.75

Gro Pro Grow Bags

Pre-packaged in quantities of 25 grow bags for easy handling. Durable & excellent quality bags. Holes in the bottom allow proper drainage. Use your favorite media and plant right in the bag.



Item No.	Description	MSRP Ea
724400	Gro Pro Grow Bags 1 Gallon 25/Pack	\$0.18
724402	Gro Pro Grow Bags 2 Gallon 25/Pack	\$0.26
724405	Gro Pro Grow Bags 3 Gallon 25/Pack	\$0.30
724410	Gro Pro Grow Bags 5 Gallon 25/Pack	\$0.42
724412	Gro Pro Grow Bags 7 Gallon 25/Pack	\$0.48
724415	Gro Pro Grow Bags 10 Gallon 25/Pack	\$0.66
724418	Gro Pro Grow Bags 20 Gallon 25/Pack	\$1.16
724420	Gro Pro Grow Bags 30 Gallon 25/Pack	\$1.78



CHECK IT OUT!

We Specialize in Indoor Horticulture, Organics & Hydrogardening Supplies.

<p>Sun System America's #1 Brand of Horticultural Lighting Fixtures</p> <p>Established in 1995, Sun System brand grow lights are high performance lighting fixtures for serious growers. Our state of the art designs, quality materials, 95% reflective Gorham aluminum interiors, airtight reflectors are often imitated but never duplicated. Made in the USA.</p>	<p>IDEALAIR COMMERCIAL GRADE</p> <p>Premium Quality Equipment to Cool, Heat, Humidify & Dehumidify Your Indoor Garden.</p> <p>We specialize in products for the Do-It-Yourself person. These products are available exclusively at fine indoor garden centers. Please visit your favorite retailer and ask for Ideal-Air™.</p>	<p>GALAXY GROW AMP</p> <p>Reliable Low-Emission Digital Ballasts</p> <p>Galaxy® state-of-the-art ballasts manufactured to provide today's serious growers with maximum flexibility and performance.</p>	<p>TITAN CONTROLS</p> <p>Controlling Your Growing Environment</p> <p>Titan Controls® offers environmental controls, precision timers, lighting controllers and CO2 equipment. We build durable quality products with the best components available in the marketplace today.</p>	<p>ULTRA SUN</p> <p>Premium Quality Value Priced Horticultural Lamps</p> <p>Ultra Sun™ offers a complete line of HPS, MH blue enhanced, dual arc tube and metal halide conversion lamps.</p>	<p>FASTFIT</p> <p>toolless assembly light & tray stands</p> <p>Fast Fit® offers four tray stand setups to fit your needs as well as assorted add-on options available for many configurations and uses. Unique patented "no hassle" toolless design allows for a quick and simple assembly.</p>
<p>PHRESH FILTER</p> <p>Lightweight Australian Granular Carbon Air Purification Products & Accessories.</p> <p>Phresh® Filters, Intake Filters, Inline Filters, Duct Silencers and HyperFan Fans are available in a variety of different sizes designed to suit any application.</p>	<p>DigiMax</p> <p>Horticultural Lamps Optimized for Today's Digital Ballasts</p> <p>DigiMax® 600W HPS, 1000W HPS and Double-ended 1000W HPS lamps are engineered & constructed to withstand the acoustic resonance and harmonic distortion of today's digital ballasts. Robust stainless steel armature, ceramic insulation plate and proprietary starter.</p>	<p>Hydro Flow</p> <p>Quality, Compatible Irrigation Solutions</p> <p>Hydro Flow® has irrigation fittings, connectors, valves, adaptors, flow restrictors, tubing and more for any indoor gardening or hydroponics application imaginable.</p> <p>Our exclusive soft feel fittings are easy on your hands & fingers, without sharp edges.</p>	<p>GRO PRO</p> <p>A Complete Line of Indoor & Outdoor Growing Containers</p> <p>Gro Pro® containers and accessories offer variety and flexibility for hobbyist and commercial growers.</p>	<p>Duralastics</p> <p>Durable, lasting plastic grow trays and reservoirs</p> <p>Durable, lasting plastic trays and reservoirs. High quality ABS plastic. Made in the USA using 25% solar energy.</p>	<p>Sunlight Supply® has been servicing the gardening community since 1995. Whether you are a hobby or commercial grower, garden indoors or out, we have every product needed to fit your gardening style and budget.</p> <p>Sunlight Supply, Inc. National Garden Wholesale.</p> <p>Specializing in the Wholesale of Indoor Horticulture, Organics and Hydrogardening Supplies. www.sunlightsupply.com</p>

Sunlight Supply Product Catalog

Comprehensive listings of products for all you year round gardening needs. Includes all products from the National Garden Wholesale/Sunlight Supply to take home as you leave a participating retail store.



Item No.	Description	MSRP
092235	NGW Retail Catalog	\$4.99

Garden Culture Magazine

Published quarterly and dedicated to the art of growing. We bring together the very best information on technology, techniques and the nature of plants to help gardeners produce the very best crops in their gardens. Garden Culture is full of expert advice for both indoor and outdoor growing and provides readers with a useful resource that will increase their enjoyment and production in the garden.



Item No.	Description	MSRP
800935	Garden Culture Magazine	\$4.99

The Indoor Gardening Guide

A comprehensive reference which covers all the topics needed to better understand the principles of gardening, both indoor and out. Contains detailed information on subjects ranging from growing methods, hydroponic systems, nutrients and additives, lighting and lighting accessories, fans and filters, CO2, environment, pests and diseases as well as all the different mediums available to gardeners today.



Item No.	Description	MSRP
800910	The Indoor Gardening Guide	\$12.99

Gardening Indoors with Soil & Hydroponics by George F. Van Patten

This Fifth Edition of this book is expanded and completely rewritten with all new information. More than 670 full color photos, drawings, charts and graphs illustrate every detail of this authoritative easy-to-understand book.



Item No.	Description	MSRP
800978	Gardening Indoors w/ Soil & Hydroponics	\$24.95

Hydroponic Basics - The Basics of Soilless Gardening Indoors by George F. Van Patten

This simple, little book is packed with information on hydroponic gardening. The graphic color, layout, and design helps guide a hydroponic gardener through basic plant science and environment to purchasing a garden and appropriate supplies. Soft cover – 80 pages.

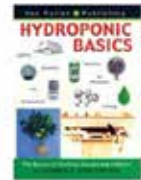

Item No.	Description	MSRP
800980	Hydroponic Basics - Soilless Gardening Indoors	\$5.99

You can find the latest new products, find a retail near you, watch videos, make a wish list, find clearance products, and more all on our web site just scan now to start!

THE GROW SCENE™

Your source for the latest products, useful growing tips and hottest news in indoor gardening. Scan to sign up today!

DO YOU WANT RESULTS?

FEWER PROBLEMS?

USE

HYGROZYME™

START to FINISH

CLEAN SYSTEMS EQUALS BETTER RESULTS

CLEANER

COMPLEX ENZYMATIC FORMULA
COMPATIBLE WITH H₂O₂

MEANER

HIGHLY CONCENTRATED ENZYME POWER

GREENER™

BPA FREE BOTTLES
COMPATIBLE WITH ALL FERTILIZER PROGRAMS

DON'T BE FOOLED BY FERTILIZERS
PRETENDING TO BE ENZYMES

PLANTS DON'T LIE - IT WORKS!™

GUARANTEED RESULTS, FANTASTIC PERFORMANCE

HYGROZYME GLOBAL

FOR TECHNICAL SUPPORT AND INFORMATION PLEASE CALL **1.877.727.9419**



HYGROZYME.COM

LIKE NO OTHER ENZYME IN THE WORLD™

SIPCO INDUSTRIES LTD. • MADE IN CANADA



SOLD AS GROZYME IN CANADA

COPYRIGHT 2013 B.DelMar Hygrozyme Global Distribution Ltd





GROWILLA™

Natural and Organic plant food

- Natural & Organic
- Simple to use, all-in-one Veg and Bud formulas
- No fillers



Introducing Growilla Veg & Bud. Developed for farmers by farmers.

This simple to use, natural and organic plant food is mixed in small batches. Its potent combination of seabird and bat guanos, earthworm castings, fish meal, and other natural inputs provides a wide range of organic food sources for plants and beneficial microbes.

Available in 12 lb and 25 lb pails.

Got questions? We've got answers. Visit botanicare.com to learn more.   



NEW YEAR. NEW LOOK. AVAILABLE NOW.



PURE BLEND[®] PRO

Natural & organic based
User-friendly one-part formulas
Enhances soil condition
Completely water soluble

KIND[™]

Optimal blend of minerals & organics
Easily adaptable to specific plant needs
Developed for fast flowering annuals
Compatible with any grow medium

CNS17[®]

Economical & high yielding
Fully chelated mineral formulas
Super concentrated
Excels in DWC, aeroponic,
and NFT systems

Check out issue #2 of the BOTANICARE[®] GROW GUIDE- The NPK issue.
Download now at botanicare.com. Available at your nearest hydro store.





Grow like the Professionals

CHOOSE GRODAN ROCKWOOL TO ACHIEVE
MAXIMUM YIELDS USING MINIMAL MEDIA

*Serious growers demand an inert, clean, uniform media they can trust.
Shouldn't you demand the same?*



Get Dialed in
to GROLOG™
Your free mobile
app from Grodan.



www.grodan101.com



grodan®

Expect More. Demand Grodan.

GROW BIG



Why bring the dirt inside?

HELP YOUR CUSTOMERS TAKE IT TO THE NEXT LEVEL
BY SIMPLY RECOMMENDING
WHAT THE PROFESSIONALS USE.



www.grodan101.com



grodan[®]

Expect More. Demand Grodan.

PRO-MIX®

NOTHING SAYS GROWING MEDIA BETTER™

PREFERRED SUPPLIERS

THE ONLY MYCORRHIZAE YOU SHOULD WANT!

GET HIGHER YIELDS WITH THE SAME MYCORRHIZAE FOUND IN PRO-MIX® HP MYCORRHIZAE™ IN A EXCEPTIONAL QUALITY AND HIGH PERFORMANCE MYCORRHIZAL INOCULANT : PRO-MIX® PUR™

GRANULAR



POWDER

THE MOST ADVANCED BIO-ADDED GROWING MEDIA

LOOK AND ASK FOR THE ONLY GROWING MEDIA THAT COMBINE DISEASE SUPPRESSION AND GROWTH ENHANCEMENT.



CONNECT TO PRO-MIX®

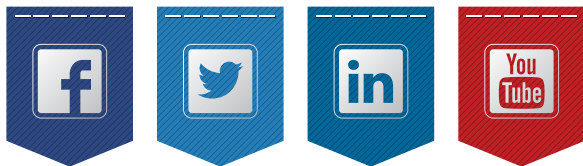

Like. Share. Tweet.



PRO-MIX® A UNIQUE CHUNK COIR GROWING MEDIUM
HP-CC
 MYCORRHIZAE™



- Provides high air porosity and good water holding properties
- Chunk coir provides coarse structure similar to bark without the added weight
- Contains MYCORRHIZAE™, which improves the overall growth of plants and increases flower/fruit yields

PROVEN RESULTS†

BEGONIA

+39% SHOOT DRY WEIGHT

CYCLAMEN

+67% SHOOT DRY WEIGHT



† Results obtained from independent plant growth trials. Individual growth results may vary to a degree. Additional results and details are available.

Nothing says high performance and cost savings like PRO-MIX® HP-CC MYCORRHIZAE™.

Premier Tech Horticulture proudly offers leading edge growing media for greenhouse growers seeking outstanding results.



TO LEARN MORE



VISIT US AT
PTHORTICULTURE.COM

1 800 667-5366

PRO-MIX® is a registered trademark of Premier Tech Ltd. or its affiliated companies © Premier Tech Ltd. 2013. All rights reserved.



Developed to be the best performing grow mixes on the market.



Grow with Confidence

Trust OMRI® Listed Sunshine Advanced to fire-up growth for all your plants. Each product is meticulously formulated to meet the needs of professionals, yet they're so easy to use that even beginning gardeners achieve success. Whether you've got tomatoes in containers on your deck or an entire herb garden indoors under lights, Sunshine Advanced will help you grow a bountiful harvest naturally and organically.

sunshineadvanced.com

Sunshine® Advanced Mix #4



- Sunshine Advanced #4 Growing Mix is recommended for indoor growing
 - This myco-active mix retains moisture while providing improved root aeration and drainage
 - OMRI® Listed
- Available Sizes:
 2 CF Loosefill Bag (70/pallet),
 3.0 CF Compressed Bale (expands to up to 6 CF),
 1.0 CF Bale , 2.2 CF Bale

Ingredients:

Canadian Sphagnum peat moss, perlite, coir, dolomite lime, gypsum, organic fertilizer, proprietary blend endomycorrhizae and organic wetting agent

Sunshine® Mix #4 with Mycorrhizae



- For indoor growing!
 - Contains a higher amount of horticultural perlite for plants that prefer greater air porosity
 - Our classic #4 boosted with endomycorrhizae
 - Low phosphorus fertilizer included to better support mycorrhizae establishment and growth
- Available Sizes:
 3.0 CF compressed bales (expands to up to 6 CF) (35/pallet)

Ingredients:

Canadian Sphagnum peat moss, perlite, dolomite lime, low phosphorus fertilizer, proprietary blend endomycorrhizae and wetting agent



From the same company that brings you **BlackGold**®

Sunshine® Advanced Rainforest Blend



- Offering optimal water retention and porosity, this blend is a myco-active medium ideal for growing many herbs and vegetables
 - It contains starter organic fertilizer, along with humic acid, kelp meal and alfalfa meal, for an initial boost; start your own feeding program 14 days after planting or seedling emergence
- Available Sizes:
 2 CF (70/pallet)

Ingredients:

Bark, coir, perlite, compost, earthworm castings, organic fertilizer includes, proprietary blend endomycorrhizae and organic wetting agent

Sunshine® Advanced Super Hydro



- Formulated to provide exceptional drainage and root aeration, this lightweight, myco-active mix is recommended for growing outdoor foliage crops, vegetables, and herbs
 - It contains starter organic fertilizer, for an initial boost; start your own feeding program 14 days after planting or seedling emergence
- Available Sizes:
 2 CF (70/pallet)

Ingredients:

Perlite, Canadian Sphagnum peat moss, compost, bark, earthworm castings, organic fertilizer includes, proprietary blend endomycorrhizae and organic wetting agent

Sunshine® Advanced Ultra Coir



- Modeled after our professional coir-based mixes
 - It is specifically designed for growing foliage crops, vegetables, herbs and other consumable crops. It is suitable for both indoor and outdoor growing but is most recommended for indoor use for crops requiring a lot of water
 - OMRI® Listed
- Available Sizes:
 2 CF (70/pallet)

Ingredients:

Canadian Sphagnum peat moss, perlite, dolomite lime, low phosphorus fertilizer, proprietary blend endomycorrhizae and wetting agent

* Sunshine Advanced, Sunshine and Sun Gro are registered trademarks of Sun Gro Horticulture Canada Ltd. * Black Gold is a registered trademark of ODIN Enterprises II, LLC and used under license.

WHATEVER YOU
GROW...



GROW
WITH EXTREME
CONFIDENCE

GET \$4 OFF
YOUR COUPON!
www.sunshineadvanced.com

Let's talk and gro together.

sunagro
HORTICULTURE
www.sunagro.com



I GOT 99
PROBLEMS

BUT ODOR



AIN'T ONE



canfilters.com

SOME PEOPLE COPY WE INNOVATE

Stronger, Quieter, 3 Speed Control and True Performance.



PRO SERIES

canfilters.com

PREFERRED SUPPLIERS

MAX 6"

PRO SERIES
420 CFM*

EZ Mount
69 Watts

MAX 8"

PRO SERIES
863 CFM*

EZ Mount
186 Watts

MAX 14"

PRO SERIES
2270 CFM*

3.5 Amps
349 Watts

MAX 16"

PRO SERIES
2299 CFM*

3.5 Amps
349 Watts



Performance certified is for installation type D - Ducted inlet, Ducted outlet. Performance ratings do not include the effects of appurtenances (accessories). * Static Pressure at 0 W.G.

PREMIUM MICROBIAL INOCULANTS

Great White



- Mycorrhizae
- Beneficial Bacteria
- Trichoderma
- Glycine
- B1
- Plant Vitamins

Great White is the most complete mycorrhizal inoculant available. Just dust it on the roots and you're done. The original and still the best.



Orca

- Mycorrhizae
- Beneficial Bacteria

The Cleanest and easiest mycorrhizal product. Simply dilute a small amount of this concentrated blend into water and apply to plants.



Jellyfish

- Mycorrhizae
- Beneficial Bacteria
- Trichoderma
- Seaweed
- Humic Acids
- Glycine
- B1

Jellyfish coats transplants in a living blend of beneficials and fungi. It bonds to the roots ensuring maximum colonization while keeping roots moist during transplant.



www.plant-success.com



Pure ORGANIC Endo Mycorrhizae



4 oz Display



4 oz



2 lb



5 lb



www.plant-success.com



Hyperfan™



6" 315cfm | 8" 710cfm | 10" 1065cfm



www.Hyper-Fans.com



Hyper Fan™ Features:

- Laminar Flow Fan Blade & Stator Technology creates optimal airflow similar in technology to an airplane propeller. The result is very high CFMs and exceptional static pressure performance.
- Highest CFM's per watt of any fan in the industry.
- State-of-the-art digitally controlled DC powered Electronically Commutated Motor (ECM) is extremely quiet, long lasting and very reliable. Best of all, this unique technology uses about half the power as traditional fans.
- The included speed controller can adjust fan speed from 35% to 100%. It is detachable from the fan and independent from the power cord.
- Lightweight aluminum housing is one-third the weight of comparable steel bodied fans. They are compact and easy to install.
- Universal mounting positions – can be mounted in any position allowing maximum flexibility during installation.
- Heavy-duty 6/8/10 mm bearings ensure smoother operation and increased longevity of the fan.

Exclusively distributed by:



National Garden Wholesale®
Sunlight Supply, Inc.

www.SunlightSupply.com



Hyperfan Stealth™

THE ULTIMATE SOUND REDUCING COMBO!

STATE-OF-THE-ART DIGITALLY CONTROLLED
MIXED FLOW HYPER FAN™



NOISE REDUCING, ACOUSTIC FOAM
LINED DUCT SILENCER!

6" | 8" | 10"

- High CFM output and linear airflow
- Exceptional static pressure performance
- Half the power consumption per CFM
- Durable and light weight aluminum housing
- Combination of extended length body and denser sound absorbing acoustic foam
- Included, fully-adjustable speed controller
- Convenient hanging brackets
- Compact size is easy to install

HIGHEST SOUND REDUCTION
OF ANY SILENCED FAN ON THE MARKET!

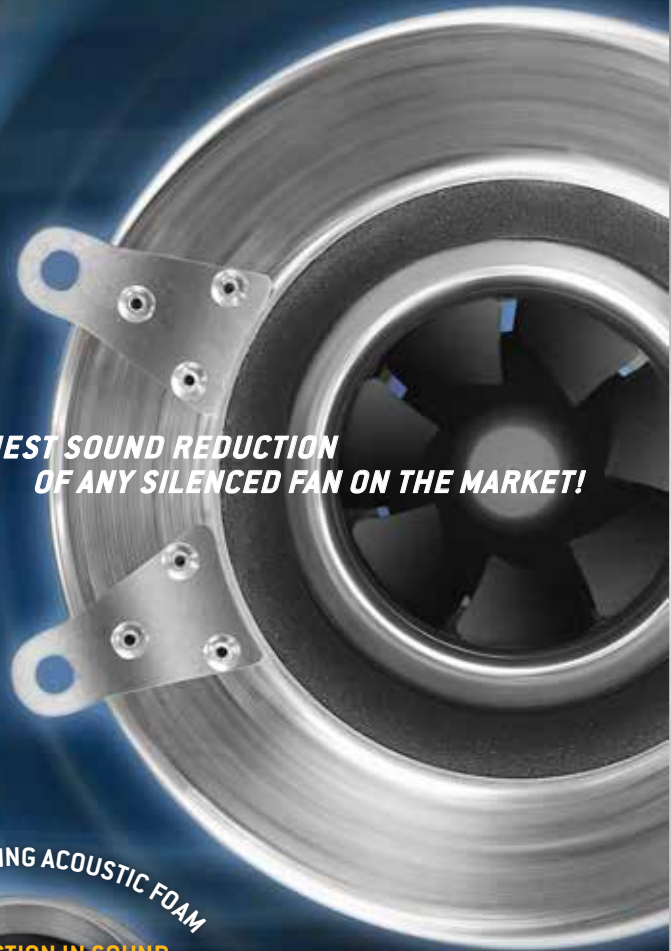

SOUND ABSORBING ACOUSTIC FOAM

15 dB REDUCTION IN SOUND =
75% REDUCTION IN SOUND!

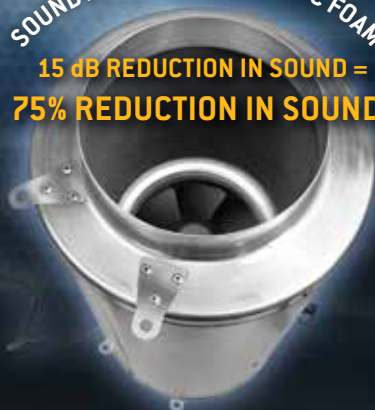

www.Hyper-Fans.com



PREFERRED SUPPLIERS

Exclusively distributed by:



National Garden Wholesale.
Sunlight Supply, Inc.

www.SunlightSupply.com

Adjust-A-Wings®

Adjust-A-Wings® Avenger Double Ended Reflector



- Made specifically for double ended 1000 watt HPS horticulture lamps (not included).
- Unique double ended construction allows for maximum optical efficiency and uniformity.
- Full spectrum DE lamps used in this fixture focus on red component for increased photosynthetic response.
- Improved PAR values & increased PAR/lumen maintenance (up to 90% PAR at 10,000 hours of operation).
- 95% reflective, glass coated German aluminum. The reflective surface is resistant to corrosion and will not dull or tarnish under normal operating conditions.

Adjust-A-Wings® Avenger MH & HPS Reflectors



- 95% reflective, glass coated German aluminum. The reflective surface is resistant to corrosion, and will not dull or tarnish under normal operating conditions.
- Twice the power and efficiency of most other reflectors.
- Easily customize your light spread and pattern to create ideal lighting conditions for your specific space and crop.

The "Adjustable Light Spread" allows growers to create ideal lighting conditions across all stages of plant growth for increased vitality, health and yield.

Adjust-A-Wings® Enforcer MH & HPS Reflectors

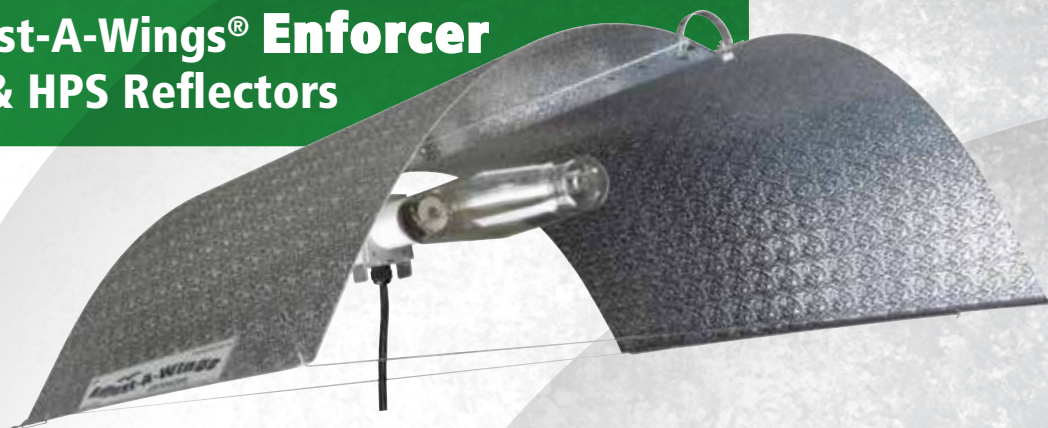

Adjust-A-Wings Enforcer series reflectors are made using Chinese reflective made stucco aluminum. Includes a molded plastic junction box with socket, pre-wired lamp cord and all parts required for assembly.

INCREASE YIELD! REDUCE HEAT! SAVE POWER!

Increase the growing area under each lamp by up to 75%. / Increase yield per lamp up to 50%.
Sold in 17 countries across 4 continents. / The "reflectors of choice" for many of the world's top growers!
Medium Dimensions: 21.7"L x 22.5 to 27"W / Large Dimensions: 27.6"L x 34.5 to 39.5"W

NUMEROUS OPTIONS TO CHOOSE FROM!

Adjust-A-Wings® Avenger Double Ended Reflector
904910 Adjust-A-Wings Avenger Double Ended Large Reflector

Adjust-A-Wings® Avenger Reflectors
904540 Adjust-A-Wings Avenger Large Reflector w/ Cord
904565 Adjust-A-Wings Avenger Large Reflector w/ Cord-6/Pk
904550 Adjust-A-Wings Avenger Large Reflector No Cord
904535 Adjust-A-Wings Avenger Medium Reflector w/ Cord

Adjust-A-Wings® Enforcer Reflectors
904730 Adjust-A-Wings Enforcer-Large
904735 Adjust-A-Wings Enforcer-Medium

DON'T FORGET TO USE SUPER SPREADERS®!
Super Spreaders create even light and more diffused light. The result is more harmonious.

Adjust-A-Wings® Super Spreaders®
904764 Super Spreader for Adjust-A-Wings Avenger Double Ended Large Reflector
904530 Super Spreader for Adjust-A-Wings Large Avenger or Enforcer Reflectors
904525 Super Spreader for Adjust-A-Wings Medium Avenger or Enforcer Reflectors



Sunlight Supply, Inc.

National Garden Wholesale.

Manufactured by Sunlight Supply®, Inc. under license from Hygro International Pty Ltd
www.sunlightsupply.com www.adjustawings.com www.super-spreader.com

EYE **HORTILUX**TM
only the sun can do it better

Grow Lamps & Ballasts



www.eyehortilux.com

BUSH DOCTOR



**Aqua
Supremo™**

**Coconut
Coir**

COCO·LOCO™

TRIPLE WASHED

◀ LOW SALT CONTENT ▶



www.FoxFarmFertilizer.com

Call us at 800-4FOXFARM

Lighting control

Easy. Safe. Flexible. Sexy.



- Replaces switchboard completely and eliminates inrush
- Central lighting control: switch, dim and boost 80 ballasts
- Control one room or 2 rooms 12/12 alternating
- Auto-dim on high temperature
- Auto shutdown on emergency temperature with alarm interface
- Sunrise / sunset
- Also switches 2x15 amps accessories (heating, fertigation, Co₂ etc)
- For DigiStar e-series, Pro 270 LEP and Pro-line e-series HPS ballasts

Gavita Master Controllers

www.gavita-holland.com

Sunlight Supply, Inc.
National Garden Wholesale
360-883-8846
SunlightSupply.com



GAVITA
PROFESSIONAL LIGHTING

HOLLAND

LUCKY DOG™

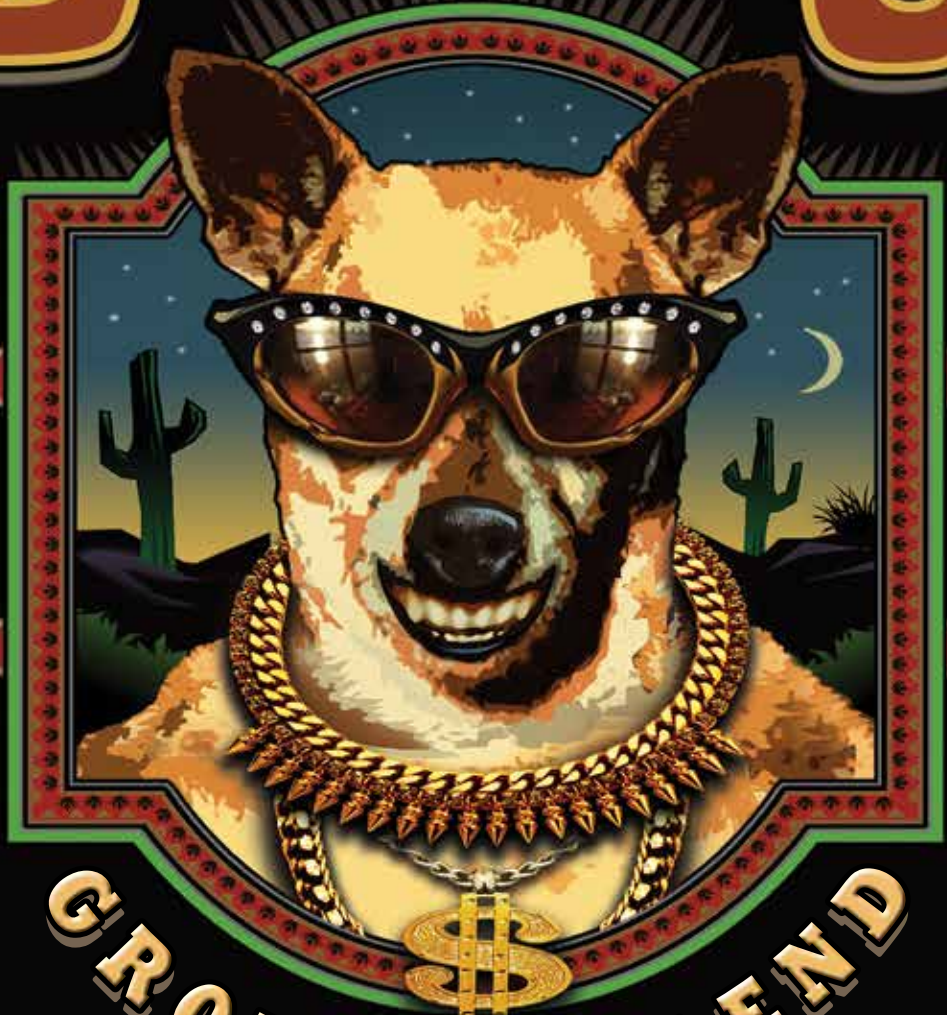

GROWERS BLEND

K-9 KUBE™

www.FoxFarmFertilizer.com

Call us at 800-4 FOXFARM



S-600
347 CFM
 4.9 CFM PER WATT

S-800
728 CFM
 3.14 CFM PER WATT

TO FIND OUT WHAT SEPARATES THE S-LINE FROM OTHER FANS, YOU HAVE TO GET INSIDE IT.

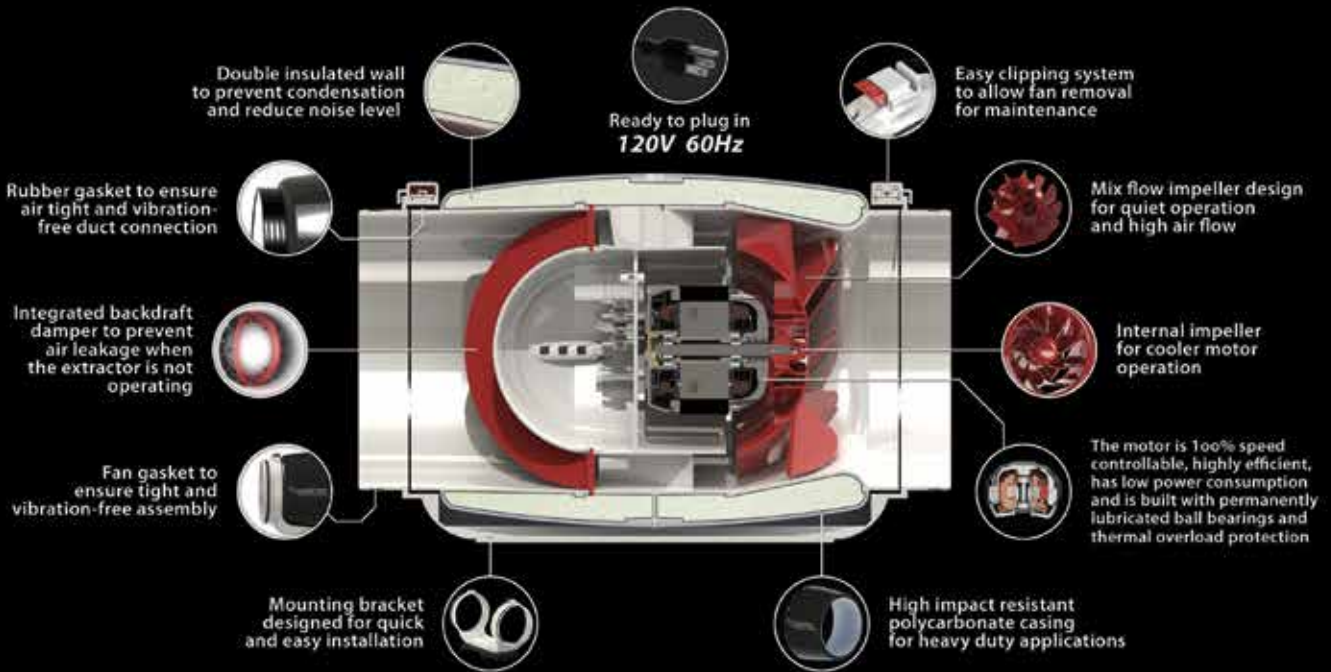

VORTEX
 POWERFANS *S-line*

WHERE INNOVATION IS A STANDARD

WWW.ATMOSPHERE.COM



Defense system for your plants.



**NEXT
GENERATION
NEEM.**

AzaSol™
Water Soluble Bio-Insecticide from Neem

Eco-Mite+™
Botanical Insecticide Miticide

Eco-PM™
Botanical Fungicide

The New Eco-Line Products

- Kills & repels pests
- Environmentally safe
- Great for hydroponics, landscapes & nurseries
- Foliar spray
- EPA 25b product
- Available in ready to use bottles and concentrate
- Available for use on food crops



Try it now. FREE Samples:
arborjet.com/ecosamples

ARBORJET®
Revolutionary Plant Health Solutions

PREFERRED SUPPLIERS

THE TRUSTED PUMP OF INDUSTRY PROFESSIONALS.

Supreme[®] HYDROPONICS



Shown with Venturi
Aerating Attachment

A PRODUCT OF



**PROVEN. TRUSTED.
ENGINEERED TO LAST.**



[dannermfg](http://dannermfg.com)

www.dannermfg.com

“Delivering **Humboldt Quality** to your **Garden**”

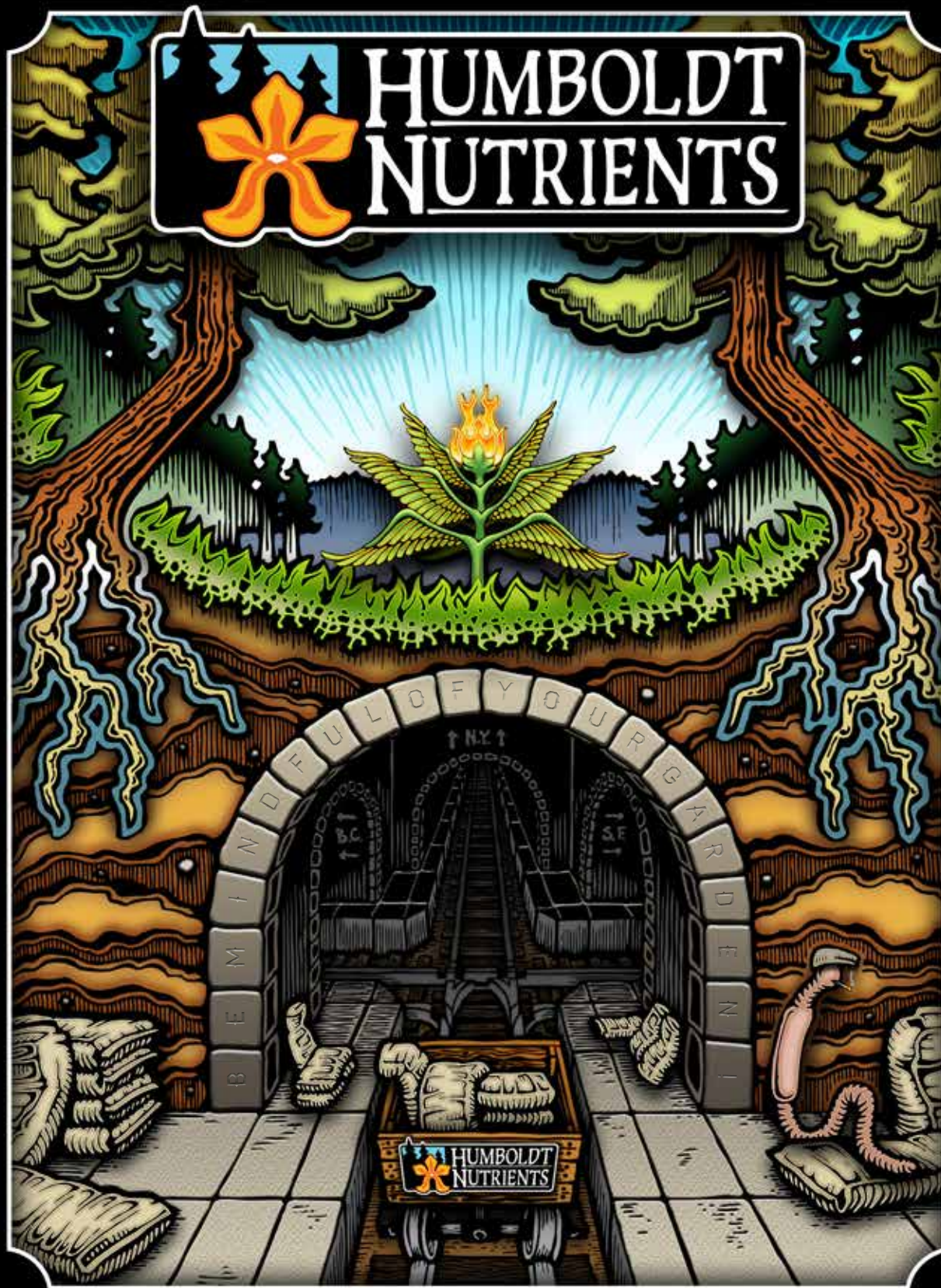

PREFERRED SUPPLIERS

www.humboldtnutrients.com

888.420.7770

SUNMASTER®

LIGHTING SYSTEMS FOR GREATER YIELDS

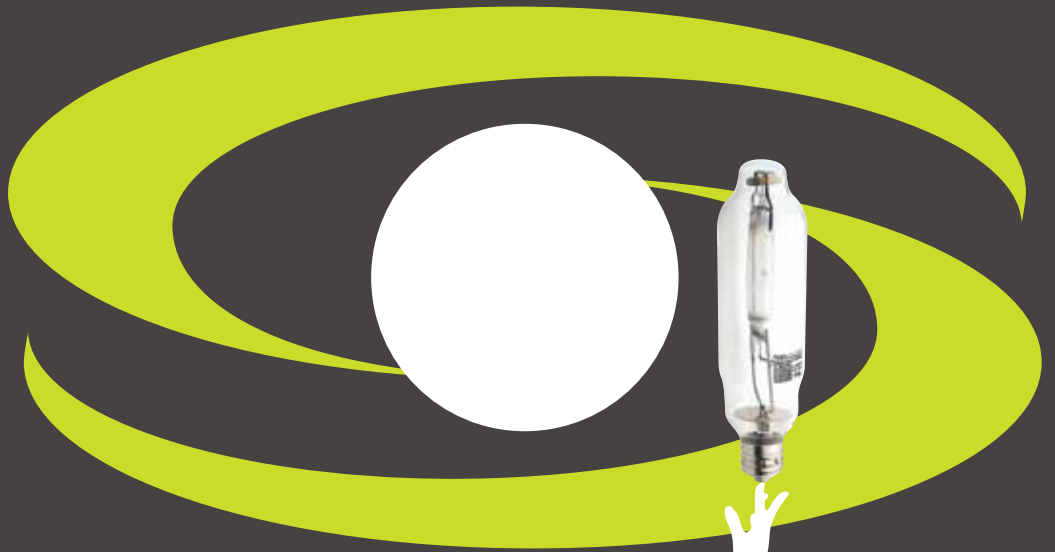

EXCELLENCE DELIVERED



*Look for Sunmaster
Products in this Catalog!*

More PAR Watts

Quality - Integrity - Science - Service

Tailored light for nutritional spectral solutions

From a lighting leader in the Horticulture industry

Technologically innovative solutions designed in the US & Canada

FOLLOW US



SunmasterGrowLamps.com

© 2013 Venture Lighting International, Inc. Sunmaster is a registered trademark of Venture Lighting International.

SUN-0165ASS1_v5-1213

MAX

MINI SPLIT AIR CONDITIONER

- *Up to 20 SEER*
- *Low noise levels*
- *Smart Inverter compressor*
- *Up to 36,000 Btu/h capacity*
- *Low ambient cooling as standard option*
- *Flexible installation, up to 164ft line set length*

The MAX is a feature packed mini split, offering world class performance and unparalleled reliability. With capacities up to 36,000 BTU, the MAX can cool large areas with ease, while using the least energy possible. Low noise levels, low ambient cooling, long line set lengths, and optional programmable thermostat allow the MAX to be used in almost any setting.

Give your garden the MAX.



optional
thermostat



standard
remote control

SAMSUNG

5 Reasons for LightRail®

- 1 Reduce shadow patterns for better yields.
- 2 Eliminate hot spots.
- 3 Save energy & money.
- 4 Solidly built in the USA - 26 years strong.
- 5 Hands down the best light mover on earth.

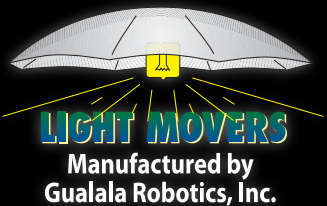
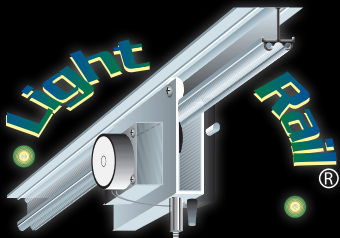
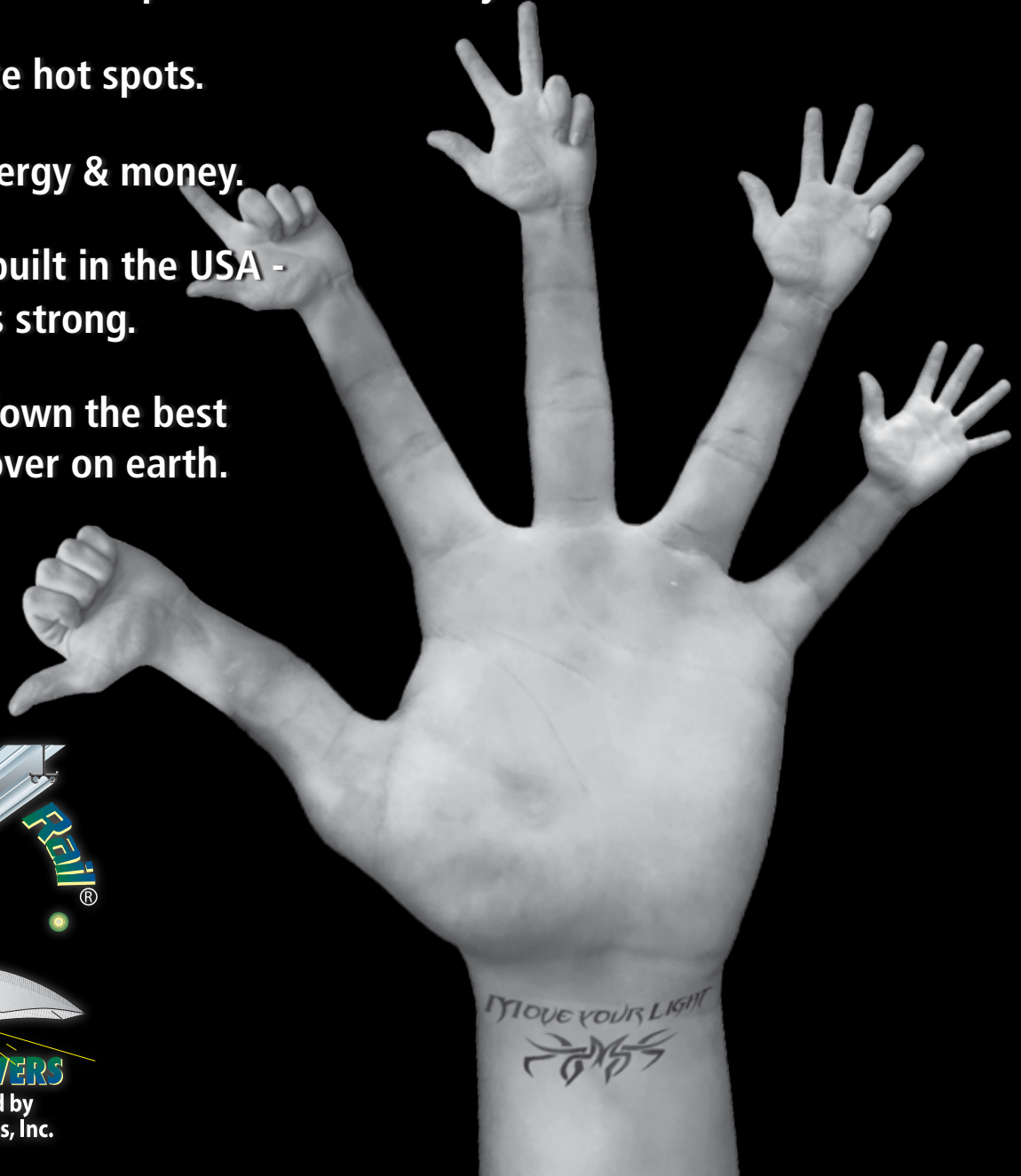

Orders: Sunlight Supply 888.929.2649 | Product Info: LightRail3.com



patented
Aeration Container

**NOT
MADE
IN CHINA**

PREFERRED SUPPLIERS



www.SmartPots.com



No Ducting Failures, No Complaints, Just Satisfaction!



When you invest in ThermoFlo Ducting your investment **REALLY PAYS OFF ...**

ThermoFlo 2000SR

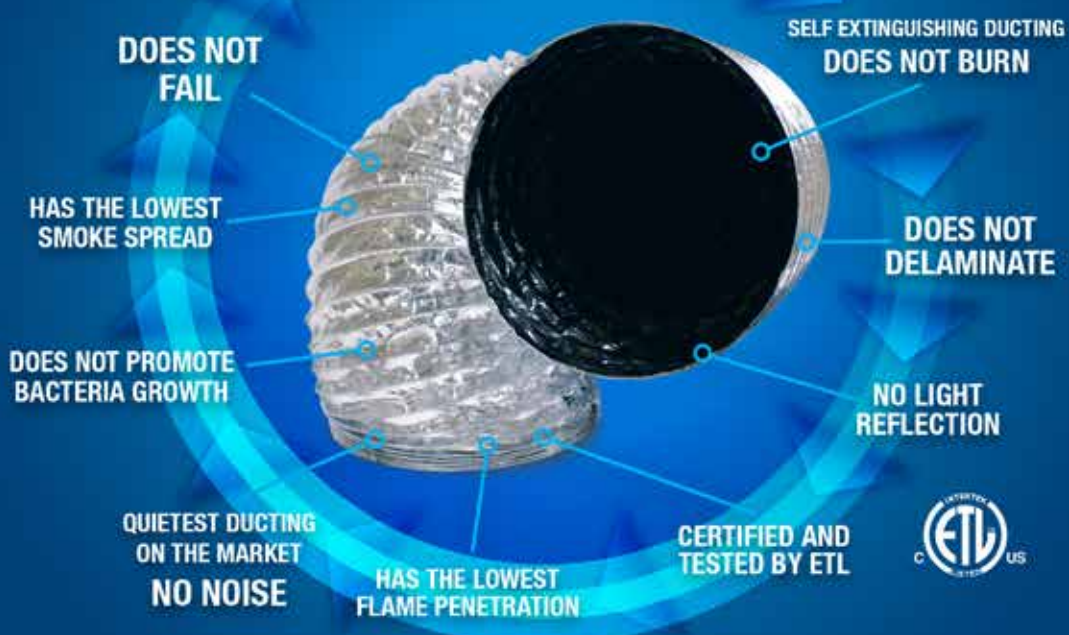

- Superior North American proprietary technology and design.
- Made in North America - Keeping American Suppliers working.
- Engineered to work in the harshes conditions.
- We only use the Best American Made raw materials.
- Exceeds all testing limits set by testing agencies - Guaranteed!
- Strictest quality controls to ensure there are NO DEFECTS.
- Most technologically advanced machinery in the world.
- Certified and tested to exceed the highest USA standards.



1.866.321.1020
www.thermoflotech.com



ROYAL GOLD

Made In Humboldt



PREFERRED SUPPLIERS



royalgoldcoco.com

Manage crop health and productivity the easy way.



Everything you need, nothing you don't.

Bluelab have a range of tough, dependable hand-held meters, wall-mounted monitors and controllers, and accessories. Our innovative products are perfect for home use right through to commercial applications. You can easily manage pH, conductivity and temperature in solutions, soils and media.

Optimize crop success with Bluelab products, simply.

Probe cable length: 2meters / 6.65 feet



www.getbluelab.com



Plant Nutrition Science

The superior way to supply all the minerals plants need for exceptional growth in easy-to-use solutions.



Foliage-Pro® 9-3-6 is a complete nutrition formula with the 3-1-2 N-P-K ratio recommended for foliage production. This ratio promotes greater mineral uptake by foliage plants, reducing harmful salt build-up and eliminating deficiencies. Used by growers and interiorscapers to maintain healthy, controlled growth on foliage plants and trees.

FOLIAGE-PRO ANALYSIS

Total Nitrogen (N)	9.0%*	Chlorine (Cl)	0.006%
2.9% Ammoniacal (NH ₄)		Cobalt (Co)	0.0005%*
6.1% Nitrate (NO ₃)		Copper (Cu)	0.05%*
Phosphorus (P ₂ O ₅)	3.0%*	Iron (Fe)	0.1%*
Potassium (K ₂ O)	6.0%*	Manganese (Mn)	0.05%*
Calcium (Ca)	2.0%*	Molybdenum (Mo)	0.0009%*
Magnesium (Mg)	0.5%*	Nickel (Ni)	0.0001%
Sulfur (S)	0.05%	Sodium (Na)	0.05%*
Boron (B)	0.01%	Zinc (Zn)	0.05%*



Grow™ 7-9-5 is an all purpose complete nutrition formula used to promote both foliage and blooms. Ideal for poor, rocky soils, container grown plants and hydroponics. Excellent as a rapid cure for nutrient deficiencies. If you are looking for a single formula to use all of the time on all of your plants, this is the one.

GROW ANALYSIS

Total Nitrogen (N)	7.0%*	Chlorine (Cl)	0.1%*
2.6% Ammoniacal (NH ₄)		Cobalt (Co)	0.0015%*
4.4% Nitrate (NO ₃)		Copper (Cu)	0.05%*
Phosphorus (P ₂ O ₅)	9.0%*	Iron (Fe)	0.1%*
Potassium (K ₂ O)	5.0%*	Manganese (Mn)	0.05%*
Calcium (Ca)	2.0%*	Molybdenum (Mo)	0.0009%*
Magnesium (Mg)	0.5%*	Nickel (Ni)	0.0001%
Sulfur (S)	0.05%	Sodium (Na)	0.1%*
Boron (B)	0.02%*	Zinc (Zn)	0.05%*



Bloom™ 3-12-6 complete nutrition formula is specifically formulated to encourage the development of large vibrant blooms. Ideal for roses, orchids, african violets and all other flowering plants. Bloom supplies a high ratio of nitrate to ammoniacal nitrogen needed to avoid stem elongation in flowering plants and vegetables. Apply before flower buds appear to help initiate flowering.

BLOOM ANALYSIS

Total Nitrogen (N)	3.0%*	Chlorine (Cl)	0.1%*
0.7% Ammoniacal (NH ₄)		Cobalt (Co)	0.0015%*
2.3% Nitrate (NO ₃)		Copper (Cu)	0.05%*
Phosphorus (P ₂ O ₅)	12.0%*	Iron (Fe)	0.1%*
Potassium (K ₂ O)	6.0%*	Manganese (Mn)	0.05%*
Calcium (Ca)	2.0%*	Molybdenum (Mo)	0.0009%*
Magnesium (Mg)	0.5%*	Nickel (Ni)	0.0001%
Sulfur (S)	0.09%	Sodium (Na)	0.1%*
Boron (B)	0.02%*	Zinc (Zn)	0.05%*

Nutrients marked with an asterisk () are guaranteed in all states. The other minerals are at concentration levels which are ideal to achieve optimum crop growth but may be below levels to satisfy the labeling requirements of some state fertilizer laws.

Pro-Tekt® 0-0-3 The Silicon Solution® supplies higher levels of silicon and potassium to help plants build stronger cell walls. Stronger cell walls make a plant less susceptible to piercing-sucking insects and invading fungi. Additional benefits include increased stem strength and leaf positioning, which improves photosynthesis; increased heat, drought and cold tolerance, plus longer lasting leaves and blooms. Recommended for all plants.



PRO-TEKT ANALYSIS

Potassium (K ₂ O)	3.7%*
Silicon (SiO ₂)	7.8%

Mag-Pro™ 2-15-4 is a super concentrated blossom booster designed to help plants initiate flowering. Mag-Pro brings out color, fragrance, and size in flowers, fruit and many vegetable crops. This nutritional supplement should always be used with a Dyna-Gro complete nutrition formula.



MAG-PRO ANALYSIS

Total Nitrogen (N)	2.0%*
1.1% Ammoniacal (NH ₄)	
0.9% Nitrate (NO ₃)	
Phosphorus (P ₂ O ₅)	15.0%*
Potassium (K ₂ O)	4.0%*
Magnesium (Mg)	2.0%*
Sulfur (S)	1.5%*

K-L-N Concentrate™ is a rooting solution containing both IBA and NAA hormones to promote vigorous root growth in trees, foliage and flowering plants. Use it for propagating cuttings, air layering and as a transplanting drench for newly potted plants.



Drench, dip or mist your plants to stimulate new root growth. Growers highly recommend K-L-N to increase production of cuttings.

K-L-N ACTIVE INGREDIENTS

Indole 3-butyric acid	0.07%
1-Naphthaleneacetic acid	0.10%

Root-Gel® is a unique gel used to promote root formation in the propagation of cuttings. It contains both IBA and NAA hormones in a water soluble form, plus just the right amount of essential minerals to get cuttings off to a great start.



ROOT-GEL ACTIVE INGREDIENTS

Indole 3-butyric acid	0.216%
1-Naphthaleneacetic acid	0.027%

WWW.DYNA-GRO.COM
800-DYNA-GRO

ATAMI
NATURALLY INNOVATING

ATAMI... THE COMPLETE NUTRITION HOUSE



BeuzZ
PRODUCTS



Dynamic Duo
1250ml Bloombastic
50ml Rootbastic



BLOOMBASTIC



ROOTBASTIC



wilmaTM
THE BEST RESULTS FROM A POT



NO PLANT GROWTH REGULATORS

BeuzZ
PRODUCTS

World Class Products Produce World Class Results!

INFO@T-NOU.COM • WWW.ATAMI.COM



MY111113

SUPERNATURAL[®] BRAND



SUPERNATURAL[®] BRAND 4 X 8 TERRAPONIC[®] AIR TABLE[®] WITH BUILT IN RESERVOIR DURABILITY TEST

LESS LABOR, MORE LEISURE, RECORD HOLDING RESULTS!

TERRAPONICS[®] IS - THE IDEAL FUSION OF HYDROPONICS AND CLEAN EARTH[®] ELEMENTS.

YOU WILL NEVER SWITCH BACK

Watch The Instructional Videos@ totallyterraponic.com





EASYGROW LTD
Horticultural Wholesale

INCREASED REFLECTION

Available in Flat or Diamond Pressed for Light Diffusion



Heat Source Using Alternative Reflective Sheeting

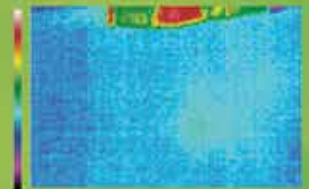

Same bulb with lightite Foil



Food Grade Material

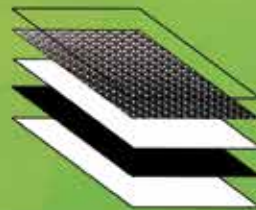

5 layered

Available in 25ft, 50ft & 100ft lengths

Our premium quality horticultural film helps to bounce light and energy back into the grow room whilst also preventing any light energy escaping. This allows for lower energy costs and increased yields. Our lightite range is over 5ml thick and provides a complete blackout



+44 1472 346 900 | www.easy-grow.co.uk
sales@easy-grow.co.uk | [facebook.com/easygrow](https://www.facebook.com/easygrow)



UK Manufactured

IT'S WHATS
INSIDE
THAT
COUNTS

WE PUT MORE
THOUGHT IN
TO OUR NUTRIENTS
SO YOU GET MORE
GROWTH OUT

GROTEK™
SCIENCE FOR PLANTS

www.grotek.net

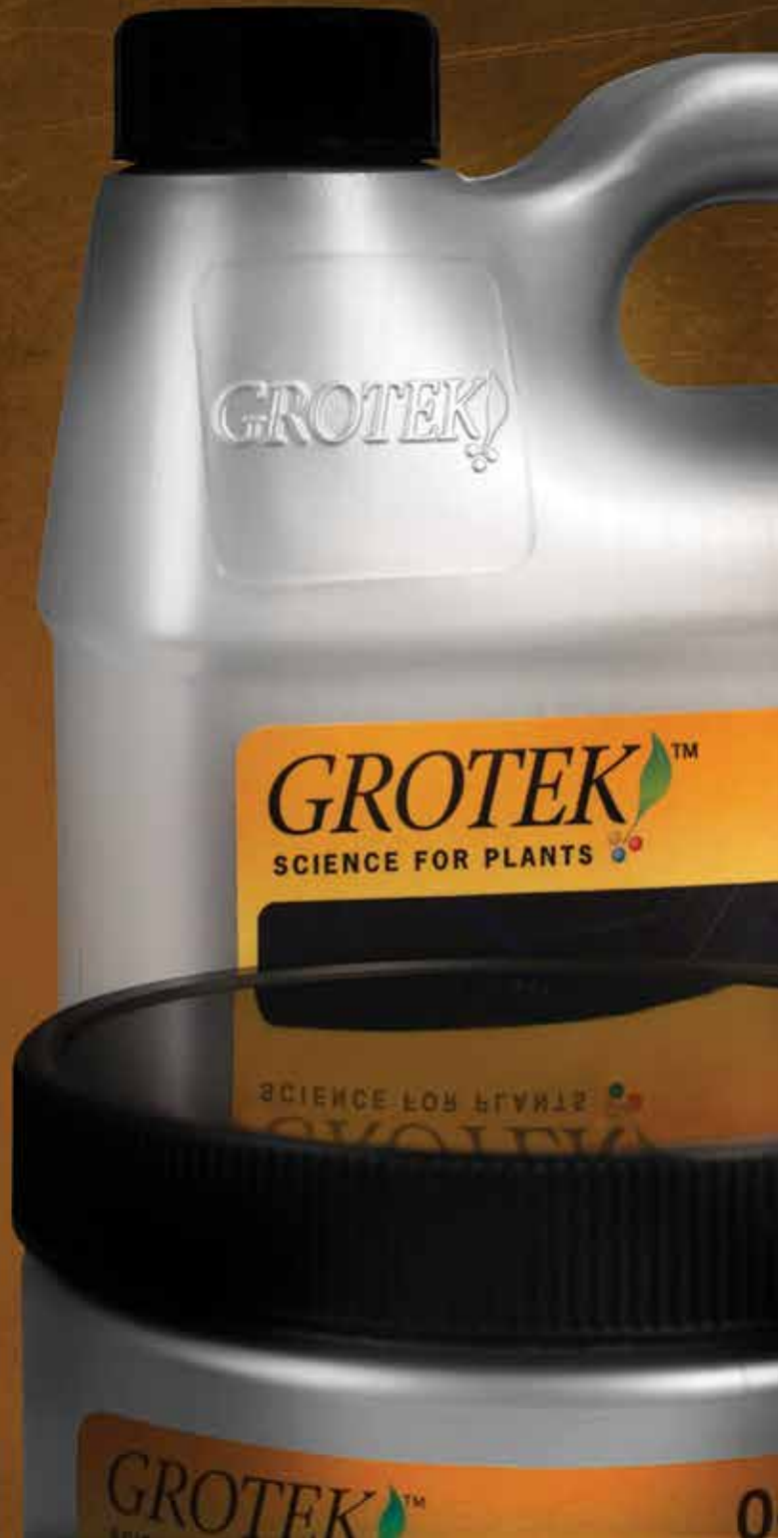

PREFERRED SUPPLIERS



Growstone®

100% Recycled. 100% American Made.

We're Growing a Revolution!

REVOLUTIONIZE YOUR SALES WITH GROWSTONE'S SUSTAINABLE PRODUCTS.

Announcing GS-3 Coco Mix & Gnat Nix!



GS-3 Coco Mix

Ready-to-Use, Ultra-clean Soilless Blend

We sourced the finest coco fiber and blended it with our 100% recycled, 100% American made Growstones. What we created is a mix that can't be matched.

- Designed for frequent feedings
- Super aerated root-zone
- Releases silica
- Prevents overwatering & root rot
- Enriched with Xtreme® Mykos nutrients
- Available in 42 liter bag



Gnat Nix!

Chemical-free Fungus Gnat Control

The only scientifically-proven, chemical-free fungus gnat control product on the market. Made in the USA from 100% recycled glass.

- Non-toxic, chemical free
- Long-lasting top dressing
- Effective under dry or moist conditions
- Great indoors – outdoors
- Available in 9 liter bag

Join the Growing Revolution

WITH ALL OF GROWSTONE'S REVOLUTIONARY PRODUCTS

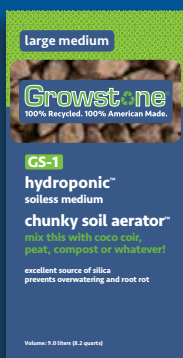

Like us on [facebook.com/growstone](https://www.facebook.com/growstone)

[growstone.com](https://www.growstone.com)

GROW MORE®

Water Soluble Fertilizers For Professional Grower

Grow More first began manufacturing water soluble fertilizer in 1973, producing top quality innovative formulations and ingredients for a global market. Distributed in 35 countries worldwide and backed-up by our own in-house laboratory. Our formulas help growers produce higher yields with larger flowers and more evening ripening, improve overall aromatics, taste and essential oils of many herbs including Thyme, Basil, Oregano, Rosemary and others.



HAWAIIAN BUD: 5-50-17

MOST POPULAR FORMULAS:

0-50-30	4-26-26	30-10-10
16-16-16	20-20-20	10-55-10

Organic Based Bio-Stimulants & Additives

Developed to enhance any indoor or outdoor nutrient programs

Native Soil
Soilless Growing Media
Container Gardens
Hydroponics System

MENDOCINO AVALANCHE FLOWER HARDENER:

- Registered in California and 25 other States.
- Helps stimulate flower development in final bloom stage.
- Helps increase size and mass of flower.
- Helps increase post harvest shelf life.

MENDOCINO HONEY:

- Increases brix content of fruit and flower.
- Improves aroma and taste.
- Provides a source of organic carbon.
- High purity, natural sweet carbohydrate.

BIO-COZYME:

- Contains many naturally occurring organic compounds to help support an active root system.
- Promotes more robust plants with shorter flowering period.
- Helps augment enzyme function and metabolism for quality yields.

SEAWEED EXTRACT:

- Organic registration with California Department of Food and Agriculture.
- Helps improve overall yields and quality of fast growing flowers, fruits, vegetables.
- Contains over 56 trace elements plus naturally occurring growth promoting compound.



Manufactured By

GROW MORE®

5600 New Century Drive, Gardena, CA 90248
www.growmore.com



CLONEX®

EPA Registered



CLONEX® Rooting Gel | CLONEX® Clone Solution | CLONEX® Mist | CLONEX® Clone Kit

CLONEX® MIST

SPRAY IT ON THE LEAVES OF MOTHER PLANTS* AND CLONES!

Ready to Use

Generates Quicker, More Vigorous and Healthy Clones

Non-Toxic

Root Stimulator for Clones

Contains No Synthetic Hormones

Combination of Minerals, Amino Acids, and Natural Additives



Four Easy Steps:



*Spray mother/donor plant a few days before taking cuttings



Make a sharp diagonal cut below a leaf node



Dip cutting into Clonex Rooting Compound then straight into cube



Spray with Clonex Mist before placing into propagator

2013
New World Record
2,032 lbs



PREFERRED SUPPLIERS

DO YOU HAVE BIG PLANS FOR 2014?



Made in the U.S.A.

www.xtreme-gardening.com



GROW LIKE A BOSS with



Container Blend Potting Soil

- Perfect blend for fast growing annuals, perennials, woody plants, and herbs!
- Excellent drainage properties, yet holds moisture well.
- Ready to use: Just add your favorite fertilizer at planting time!



Seed Starting Blend

- Use for all types of seeds!
- Water Less! SSB holds moisture well so you can water less often
- Provides 4-6 weeks of fertilization power

Planting Mix Compost Blend

- Incredible amendment that revitalizes your soil
- Adds vital organic matter to enhance the root zone
- Ideal blend for Raised Bed gardens

Premium Blend Potting Soil

- Our most moisture retentive blend, made with a ridiculous amount of worm castings
- When watering frequently, cut up to 50% with Rice Hulls or Perlite to achieve desired drainage

Yo, we're The Organic Mechanics, your Organic Potting Soil provider from da East Coast. That's right, our soils are made in PA! We've been making premium, organic, professional grade potting soils & soil amendments for 8 years now, with consistently amazing results. Plus, we have 20 years of science behind our products, so you'll be growing like a boss in no time! Oh, and you can start fertilizing from Day 1, so there's no time to waste. Try our Container Blend, Planting Mix Compost Blend, Seed Starting Blend, and Premium Blend to see for yourself!

Our products are:

- OMRI-Listed Organic
- Peat-Free
- Made & Stored Indoors
- Chock-Full of Biology



OrganicMechanicSoil.com

Exclusive with
 Sunlight Supply, Inc.
 National Garden Wholesale.





EARTH JUICE®

Since 1991



Unrivaled Excellence!

68 Products for Soil and Hydroponics

1st and Original Hi-Brix™ "Molasses For Plants"™



Sugar Peak



SeaBlast



BioRighteous



Sweet & Heavy



Bloom Master



GodSilica



Elements



BioZeus



OnlyGreen



Charts and more details, visit earthjuice.com

PREFERRED SUPPLIERS

BRINGING
NECTAR
FOR THE GODS

INTO THE SUNLIGHT

Sunlight Supply, Inc.
National Garden Wholesale.

OREGONONLY.COM

It's About Science... It's About Technology... It's About Time!

MICROBE Life HYDROPONICS

Improve Your Plant's Growth, Vigor & Yield!

From the leading manufacturer of photosynthetic bacteria for the past 35 years, we now introduce our superior technology to the HYDROPONIC and AQUAPONIC industries!

MICROBE LIFE HYDROPONICS Photosynthesis Plus is a breakthrough in biology and biophysics once thought impossible to achieve. By driving and accelerating the processes that contribute to photosynthesis, the photosynthetic bacteria in **MICROBE LIFE HYDROPONICS** Photosynthesis Plus can improve your plant's growth, vigor and yield.

Visit MicrobeLifeHydro.com to get catalogs or see what products are available in your state.



CALIFORNIA Registered

OREGON Registered

Different labels - same great results!



MicrobeLifeHydro.com

For questions, email us at info@ecologicalabs.com

Ecological Laboratories INC

microbelifehydro
 @HydroExpert
 microbelifehydro

Providing Environmental Solutions Since 1976

PREFERRED SUPPLIERS



JUST RIGHT XTRA

ALL ORGANIC POTTING MIX

“Bags of Biology”™

*WORKING BIOLOGICALLY WITH



CONTAINS THE THINGS YOUR PLANT DESIRES:

- CocoTek Coconut Coir** low sodium pith fibers.
- Ancient Forest Humus. Rare Earth** prophylactic clay blended with Humic acids.
- Diatomite Silica Stone* - from Australia. *Perlite.*
- Premium Earth Worm castings.*
- SubCulture** mycorrhizal that colonize plants roots.

**Get
Your
Bag
Today!**

AVAILABLE AT:



National Garden Wholesale
www.SunlightSupply.com

AND:



Nickel City Wholesale Garden Supply
www.NCWGS.com | 866-599-4404

Nickel City
Wholesale Garden Supply

trusted for

EXCELLENCE

in odor control



neutralizes odors, naturally

www.onaonline.com

ona
odor neutralizing agent



Sunlight Supply, Inc.
National Garden Wholesale

Black Lightning

POWDER FREE NITRILE GLOVES

PREFERRED SUPPLIERS



6 mil with pH5.5 Technology!

At **Atlantic Safety Products**, we take great pride in providing gloves that offer serious protection from your work environment while keeping your most important tools, your hands, in top condition for maximum productivity. Our **Black Lightning** gloves offer excellent barrier protection!

- **Breakthrough pH5.5 Technology!** Made to match healthy skin's natural pH 5.5 levels to ensure the MOST comfortable fit yet!
- *Unique formulation reduces excess perspiration*
- *Quadruple washed – no excess chemicals lingering on the glove*
- *Super strength and stretch – no more tearing*
- *Fully textured grip*
- *Approved for medical use*

Caution: Components used in making these gloves may cause allergic reactions in some users. Follow your institution's policies for use.

©2013 ATLANTIC SAFETY PRODUCTS, INC. ALL RIGHTS RESERVED. 2013.248

Item Number	Size
BL-S	SMALL
BL-M	MEDIUM
BL-L	LARGE
BL-XL	X-LARGE
BL-XXL	XX-LARGE
100 gloves/box, 10 boxes/case	



A family of hand protection and safety products under one roof.





**PURE
BLACK CASTINGS**
99% PURE WORM CASTINGS
(1-0.5-0.02)



VERMAPLEX
ORGANIC SPECIALTY FERTILIZER
(.48-0.01-0.016)

PROFESSIONAL ORGANICS FOR PROFESSIONAL GROWERS

ALL ORGANIC COMPANION PRODUCTS

6-20-6 WITH KELP | BLACK SEA KELP | LIQUID YUCCA | HYDROLIZED FISH | LIQUID HUMATE PLUS | CORAL CALCIUM



(6.0-20.0-6.0)

(1.0-1.0-17)

(0.16-0-0)

(2.0-5.0-0)

14% HUMIC ACID

34% CALCIUM
CARBONATE

**GARDENS
AND NURSERIES**



HYDROPONICS



**AGRICULTURE
AND TURF**



**ORCHARDS
AND VINEYARDS**



Sunlight Supply, Inc.
National Garden Wholesale.

Hi·LUX GRO™

made in Germany

professional grade horticulture lamps

PREFERRED SUPPLIERS

USHIO, a world leader in specialty light sources since 1964, introduces enhanced horticulture lamps to meet any grower's needs.

- Available in 400W, 600W & 1000W
- Super high output lamp technology
- Reliable operation throughout the growth cycle
- Ultimate full spectrum grow lamp
- Achieve maximum vegetative growth and maximum flower yield!
- Made in Germany in ISO 9001 certified factory

Visit www.ushio.com/HiLuxGro for technical details and a list of authorized distributors.

DIGITAL BALLAST FRIENDLY*

*operate lamps on suitable ballasts & ignitors only.

USHIO

USHIO America, Inc. 800-838-7446



Scan with a smartphone to view product data online.



www.VERMICROP.com

Better Soils. Amazing Results.



VERMICROP ORGANICS™



PREFERRED SUPPLIERS

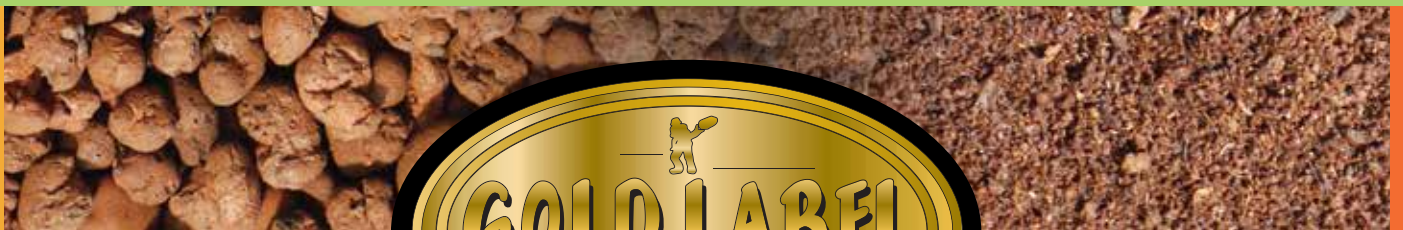

Hydrocorn

Expanded Clay Pebbles for Horticulture
Hydroton's cousin **Hydrocorn**,
it's cleaner, better and available now.

Coco

Buffered Coco for Horticulture
Simply the best **Coco** on the
market.



ANNO 1987®



Certified for
Horticulture



 MADE IN HOLLAND

www.goldlabelna.com

BIOAG

GROW SMART. GROW STRONG.



SAME GREAT PRODUCTS - NEW LOOK!

PREFERRED SUPPLIERS

**Exclusively Available
Through:**



National Garden Wholesale.
Sunlight Supply, Inc.

NO POWDERY MILDEW™
Goes to work Immediately!

NO SPIDER MITES™
Immediately Results • Seeding to Harvest

NO FUNGUS GNATS™
Dynamic Eliminator and Protector



PREFERRED SUPPLIERS

*100% ORGANIC
NO IMMUNITY
USE ANYTIME
NO TOXIC RESIDUES
NO AFTERTASTE*



FORMULATED WITH NATURAL
PLANT EXTRACTS AND ALL
NATURAL PENETRATIVE AGENTS

greenwaynutrients.com

Straight from Neptune to you.

PREFERRED SUPPLIERS



Increase your
 yield and quality
 with the all
 organic products
 from Neptune's
 Harvest.

The original organic fish
 fertilizer made from fresh
 caught North Atlantic fish right
 on the docks of Gloucester, MA.



www.neptunesharvest.com

Neptune's Harvest



Distributed by
 National Garden Wholesale®
 Sunlight Supply, Inc.



Introducing the new look from Phresh® Filter.



Remember, if it doesn't say
“Pro-4/8™ Carbon”
 ...then it's not a Phresh® Filter.

Phresh® Filter is the ONLY carbon filter in the industry that contains Pro-4/8™ triple activated and certified Australian virgin carbon.



Exclusively distributed by:
 National Garden Wholesale.
 Sunlight Supply, Inc.
www.SunlightSupply.com

www.phreshfilter.com



7 | UP

MAXIMIZE YOUR LIGHT
ACCELERATE YOUR YIELD



Serious Growers need Serious Equipment

SUNBLASTER LIGHTING

As serious as it gets.



FUTURE HARVEST
GROW BETTER



Universal T5 Light Strip

Secure up to seven T5's for overhead or supplemental side lighting . Give your plants the light they need. In a snap!



Just A Few Units From Our “pH” Group

Testers * Meters * Monitors * Controllers



Just a Few Units From Our “EC/TDS” Group

Milwaukee Instruments - Manufacturing A Complete Line of Growth Media Diagnostic Equipment For Use In Greenhouses & Hydroponics

See all our Instruments at - www.milwaukeeinstruments.com

UBER

PREFERRED SUPPLIERS

**punish
it!**



www.ubergrow.com

If you always do what you always did,
you will always get what you always got. [Albert Einstein]

NEW!

Buried Treasure™

HIGH QUALITY NATURAL BAT & SEABIRD GUANOS

We scoured the Seven Seas to find and capture four of nature's most powerful, natural fertilizers!

- **NITRO BAT** • **PERUVIAN SEABIRD**
 9-3-1 Available in 1 and 5 lb. bags, 14 lb. buckets.
- **PHOS BAT** • **PHOS SEABIRD**
 0-13-0 Available in 2.2 and 11 lb. bags, 40 lb. buckets.
- **PERUVIAN SEABIRD**
 12-10-3 Available in 2.2 and 11 lb. bags, 40 lb. buckets.
- **PHOS SEABIRD**
 0-12-0 Available in 2.2 and 11 lb. bags, 40 lb. buckets.

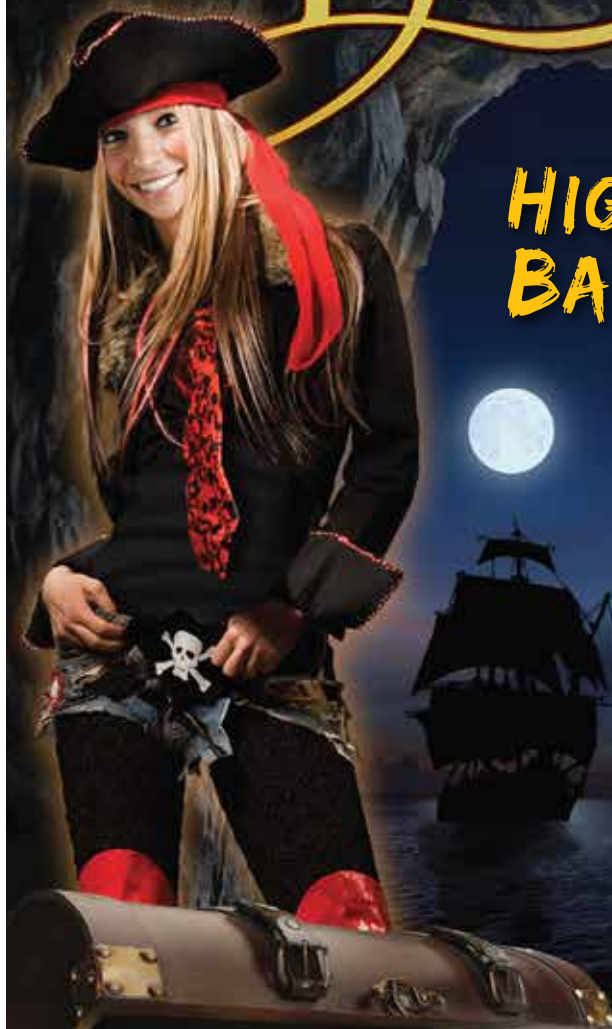

Distributed exclusively by:

National Garden Wholesale.
Sunlight Supply, Inc.

www.sunlightsupply.com



PREFERRED SUPPLIERS



Gro Pro Fabric Pots



Exclusively distributed by:
National Garden Wholesale.
Sunlight Supply Inc.
www.sunlightsupply.com

High Quality • Breathable
Non Woven • Eliminates Circling



Secure Support All Season Long

2ft - 8ft Super Steel Stakes

2ft - 6ft Packaged Bamboo Stakes

Jute Twine

BULK TIE TAPE

Plastic Saucers

Tie Tape Gun
Ties plants with a simple squeeze
-For plants, vines and small trees
-Use tape gun with Machine Staples, Blades, and Tie Tape (Each item sold separately)

Saves Time
SEE IT IN ACTION
▶▶▶▶

SCAN ME

bond

PREFERRED SUPPLIERS

Fight Root and Foliar Diseases

Use Actinovate® Biofungicide for protection against powdery mildew, *Botrytis*, *Pythium*, *Phytophthora*, *Fusarium* and other common plant diseases. Apply Actinovate® on your annuals, perennials, shrubs, vegetables, herbs and more. Actinovate® is safe for workers and beneficial insects.



Actinovate®
biofungicide

Novozymes is the world leader in bioinnovation. Together with customers across a broad array of industries we create tomorrow's industrial biosolutions, improving our customers' business and the use of our planet's resources. Read more at www.novozymes.com.

novozymes
Rethink Tomorrow

Actinovate® AG is a registered trademark of Natural Industries, Inc. 2013. All rights reserved.

THE GUANO COMPANY

A GUANO STORY

It has been known for centuries that seabird guano from the dry islands off the coast of South America and the bat guano from the dry desert caves of the world makes excellent food for plants.

The types of seabird guano, bat guano and earthworm castings used in this special blend are all chosen for their known effects on flower and fruiting plants (strong multiple blooms and sweet flavoured fruits.)

COMPLETELY ORGANIC

Try our Budswel Dry mix.
Super Tea Liquid or our Super Tea Dry Mix for your nitrogen needs.

ORGANIC HYDROPONIC & SOIL SOLUTION



0.01 - 0.10 - 0.01
BUDSWEL

It's Organic.
No Chemical Build-up.
The Secret Ingredient Since 1980.
For Aroma and Taste with Superior Yield:
Don't Forget the Budswel

NET WEIGHT - 1 U.S. Gallon (3.7853 Liters)

Budswel powered winning entries of the Emerald Triangle Cup with, the only unanimous decision in 2008, and no less than 3rd place in last 5 years and against 202 entries in 2012.

PRODUCT OF HUMBOLDT COUNTY - HOME OF THE WORLD'S TALLEST TREES

LittleGIANT®
Hydroponic Products

For all your growing needs.



LEARN MORE



888.956.0000
www.lg-outdoor.com



National Garden Wholesale.
Sunlight Supply, Inc.

PREFERRED SUPPLIERS

idealH₂O™

Premium Water Filtration Systems

Reverse Osmosis Water Filtration System



www.IdealH2O.net



PREFERRED SUPPLIERS

pH/Ion



EcoTestr™ pH 1 & pH 2



Range	0.0 to 14.0 pH	0.0 to 14.0 pH
Resolution	0.1 pH	0.1 pH
Accuracy	±0.1 pH	±0.1 pH
Calibration	Single point, automatic	3 point, automatic

EcoTestr™ TDS_{LOW}



0 to 1900 ppm
10 ppm
±1% full scale
Single point

pHTestr™ pH 10 & 30



-0.1 to 15.0 pH	-0.1 to 15.0 pH
0.1 pH	0.01 pH
±0.1 pH	±0.01 pH
3 point, automatic	
0 to 50°C (32 to 122°F)	

MultiTestr™ pH 35



Multiple
Up to 0.01 pH
Up to ±0.01 pH
Up to 5 points pH; up to 3 points EC/TDS

1 year warranty on meters only.

...setting the standard again and again®

www.4oakton.com



Providing Quality Gardening Products since 1978



SM-90 has proven itself time and time again. If your not using it...you should be! Available throughout the USA.

#102, 26730 - 56th Avenue, Aldergrove, BC V4W 3X5 CANADA 1-877-533-9572
www.nutrilifeproducts.com info@nutrilifeproducts.com



The Power of Cloning with Olivia's Cloning Solution® & Cloning Gel® NOW in a Complete Kit!

The Power of Cloning with Olivia's Cloning Solution® & Cloning Gel®



Solutions for all your growing needs™

www.OliviasSolutions.com



CASCADE MINERALS

make a **mountain** of difference in your soil.



Our 100% natural remineralizing soil booster is made from all-natural, finely milled volcanic basalt and contains essential minerals and trace elements for optimal plant growth and vitality.

- ✓ 100% natural with no synthetic chemicals or man-made additives
- ✓ Releases essential minerals and trace elements
- ✓ Made of volcanic basalt rock from Central Oregon
- ✓ Safe for plants, children and pets when used as directed
- ✓ Listed by the Organic Materials Review Institute (OMRI) for use in organic production
- ✓ Benefits can include stronger, more vigorous plants and higher yields

GIVES PLANTS THE ESSENTIAL MINERALS AND TRACE ELEMENTS THEY NEED

CASCADE MINERALS.
Nature's Original Recipe



Sunlight Supply, Inc.
National Garden Wholesale

cascademineralsnw.com | 541.475.3044

PREFERRED SUPPLIERS



fulham®

KNOWS HORTICULTURE



FLUORESCENT



HID

INDUCTION



Tel: 323.599.5000 • www.fulham.com

HOW GREENCURE® WORKS

Uses Multiple Modes of Action Against Powdery Mildew

Control PM

GreenCure splits open and dehydrates mildew spores, mycelium and conidia **killing them on contact.**

Prevent PM

New spores that land on treated plant surfaces are killed, preventing germination and **breaking the fungal lifecycle.**

Real Science Real Results

- Developed by Cornell plant pathologist, Dr. Ken Horst
- Proven effective in 200 university trials and 15 years of organic gardening and agriculture
- Harvest fruits and vegetables as soon as 1 hour after spraying
- For Organic Gardening - USDA's National Organic Program (NOP)
- Does not restrict plant growth, use on ornamentals, vegetables, herbs, fruits and turf
- Compatible with beneficial insects
- Ideal for indoor gardening; odorless spray - no foul smell - no mask required



For Organic Gardening

GreenCure® is available at:
 Sunlight Supply Inc.
 National Garden Wholesale.



Make Your Plants Happy, TAKE CONTROL

HI 2500pH Complete pH System

Designed for Hydroponics Irrigation

FEATURES

- HI 2500pH injects diluted acid to maintain optimal pH levels
- Simple probe connection for fast and easy maintenance
- Plug and play design combines the pump and controller in one compact unit

FREE pH Tester (HI 98103)
with every purchase of a HI2500ph



Ask your Sunlight representative about HANNA's HI2500pH!



www.hannainst.com



DUST SHROOM

Horti-CONTROL
horticontrol.com

- PATENT PENDING
- NO CFM LOSS
- Traps 99% of particles 1 micron +
- 4,6,8,10,12 inch models available
- 5 year hassle free warranty
- handcrafted in the USA
- New Bio-oil with cedar and rosemary oils to further inhibit molds, mildew and pests

REGENERATION KIT
OIL & CLEANER
CLEANS AND RE-OILS
a 6" to 8"
DUST SHROOM
2-3 TIMES!!

AVAILABLE THROUGH FINER
DISTRIBUTORS AND RETAILERS

MEDIA@MONKEYZ.COM

PREFERRED SUPPLIERS

Accept NO imitations...

HydroLogic®
PURIFICATION SYSTEMS

www.hydrologicsystems.com

the original and still the BEST.



Electric Atomist Sprayers

The **1026B's** adjustable output range selector can provide delivery from a fine mist of 1.5 gph to a heavy spray of 14 gph, up to 13.5 feet. The 1026B atomizes particle size of 22 microns on the fine setting and 46 microns on the heavy setting; is suitable for wettable powders.

1026B - Commercial grade 110 Volt AC, 60 Hertz, 7.0 Amp, 2 Stage Fan

The **1952B** is designed for stationary indoor atomized spraying. The adjustable output nozzle delivers particles of less than 50 microns up to 100 feet; average size is 20 microns.

1952B - Standard grade 110 Volt AC, 60 Hertz, 5.5 Amp, Single Stage Fan



5BP

5 Liter Battery-Powered Sprayer

Adjustable nozzle; 66" hose; Padded shoulder strap; 4 "D" batteries (included) Wand extends from 12" to 30"; Thumb-operated 3 position switch: On-Off-Reverse (reverse position draws residual fluid out of wand and hose, back into tank).



1401

1 gallon Sprayer; All-poly w/buna seals; Nozzle adjusts from fine mist to straight stream; Flow control features lock-on



36TS



40TS



1998TL

Hand Sprayers all feature adjustable poly nozzles; the 40TS and 1998TL feature lock-on/lock-off thumb control:

36TS is a 36 oz. trigger sprayer

40TS is a 40 oz. sprayer that sprays in any position, including upside-down

1998TL is a 4 pint hand sprayer



SNS-217™

**KILLS SPIDER
MITES &
THEIR EGGS**



Typical Mite Damage



Available in Bulk Sizes & Concentrate

Ask for **SNS 217™** at
Your Local Hydro Store

www.sierranaturalscience.com

877-626-5505

**THERE IS ONLY ONE PATH
TO TRUE PEACE OF MIND**



and it's available in Large
and Extra Large



SEALS IN FLAVOR AND AROMA

**PRODUCT PRESERVATION
MADE PERFECT**

ZIP-ZAG

World's Finest Resealable Bags

PREFERRED SUPPLIERS

Mother Nature's Mosquito Control



Mosquito Dunks®

Kills mosquitoes before they're old enough to bite!

- The #1 biological mosquito control product.
- 100% natural, biodegradable, works for 30 days or more.
- Use in ponds, bird baths, planters—or in any standing water.
- Controls larvae within 24 hours—will not harm animals, fish or birds, honey bees or plants.
- Labeled For Organic Production by the USEPA.
- Perfect for: Koi Ponds, Hydroponic systems, Rain Barrels, Animal Watering Troughs, Water Features

Mosquito Bits®

Kills mosquitoes before they're old enough to bite!

- Same proven ingredients as Mosquito Dunks® in a versatile granular application.
- Convenient shaker top easily broadcasts over treatment areas.
- Controls larvae within 24 hours—will not harm animals, fish or birds.
- Great for marshy areas, potted plants, fallen leaves, tire dumps, swampy areas, any standing water.



NEW!
Now Controls
Fungus Gnats...



Summit ... responsible solutions.

800.227.8664
SummitResponsibleSolutions.com

SUPERthrive®

1940 WORLD'S FAIR Gold Medal
The Original Vitamin Solution



SUPERthrive® Always ahead in science and value.

SUPERthrive® now includes kelp. We are proud to announce that our timeless formula is now enhanced with kelp, bringing contemporary research to your essential growing tool.

Note that the signature color and odor have slightly changed. Growers will experience the same results as always. Some will find increased benefits.

The directions are the same as always.
~ 1/4 tsp. per gallon of water ~ 3oz. per 100 gallons of water

Vitamin Institute ~ 12610 Satcoy Street South North Hollywood, CA 91605 ~ www.superthrive.com

Sunlight Supply tested it, end users tested it, the verdict is in: **LOVE IT!!** Sunlight Supply only brings you new products we have tested and used, **this one really impressed us and will impress you too!**



One handed cleaning:

Eliminates the need to set anything down to clean your scissors.

Get the right tool for the job.

Our SoftEdge cleaning media is a high-tech spin off from the aerospace industry. **Nothing works better!** Scissors stay cleaner longer!

6 unit display



100% PURE

A little near the roots does a lot.



PLANT GROWTH HORMONES:

Castings contain "Auxins and Cytokinins", which are growth hormones for bigger and more fibrous plant roots. ROOTS CAN EASILY GROW FAST, FULL AND FIBROUS.

HIGH AVAILABILITY OF NUTRIENTS:

The TRACE ELEMENTS combined with its structure and high MICROBIAL ACTIVITY allow it to outperform what is expected of a low analysis (NPK) fertilizer.

IMPROVED SOIL STRUCTURE AND AERATION:

Castings consist of thousands of durable cylindrically shaped pellets that RESIST PACKING AND KEEP SOIL LOOSE. This allows oxygen to permeate and remain in the root zone where it is vitally needed. The drainage is also improved by this non-packed environment.

The key facts mentioned above are what allows **Wiggle Worm Soil Builder™** to DRAMATICALLY EXCEED EXPECTATIONS.

Ask for **Wiggle Worm Soil Builder™**

Monterey® *Products that work*

For Organic Gardening

Monterey Neem Oil RTU and 70% Neem Oil

For broad spectrum control of insects, mites and fungus on vegetables, fruit trees, ornamental trees and shrubs.



for organic gardening

OMRI®
Listed



Products that work

For more information call: 559.499.2100 • www.montereylawnandgarden.com

rapiclip Plant Ties & Labels

Copper Labels #861



Vinyl Stretch Tie #845



Natural Twine #402



T Labels #820



Tomato Clips #819



Garden Wire #834



Zinc Labels #862



Twist Tie #846



Tomato Twine #875



Colored Labels #828



Twist & Clips #816



Foam Wire #835



For many more specialty ties and plant labels visit...

LusterLeaf.com

Safer®
BRAND



It's Organic*, It's Effective, It's Safer® Brand.
OMRI® Listed insecticides and fungicides.



*For use in Organic Gardening

NOW WITH MORE SOLUTIONS FOR HYDROPONIC PROFESSIONALS

BioMin® Iron

Organic Encapsulated Iron

Hypergro™ 4-5-2

Maintenance Fertilizer

Magic Crystals™ 20-20-20

Balanced N-P-K Plus Micronutrients

Mobilizer™

Fulvic Acid

Bestseller

Mildew Cure®

Organic Powdery Mildew Fungicide

Natural Wet®

Organic Wetting and Anti-Stress Agent

pH Down®

Organic Acidifier

Starter Crystals™ 5-10-27

Starter Fertilizer

Vita-Mins™

Trace Mineral Fertilizer

Made In California

SaferGro

NEW label designs!
GALLON size!

SaferGro Laboratories, Inc.
www.safergro.com

PREFERRED SUPPLIERS

DOKTOR DOOM PREMIUM QUALITY INSECTICIDES

PUNCH

The **ONE-TWO**

FOR SPIDER MITE ELIMINATION



DOKTOR DOOM TAKES SPIDER MITES & OTHER BUGS SERIOUSLY – WE KILL THEM!

what's bugging YOU?!

www.doktordoom.com

Gardens Grow with **GARDENEER** by Dalen



Trellis Netting
Enrejado de malla

For more information visit us at DalenProducts.com

CFM CONTINENTAL FAN

AXC In-Line Duct Fan

Powerful, Efficient, Ultra Quiet

- 4" to 14" diameters
- 120V pre-wired
- Up to 1,400 cfm
- Moisture resistant



Continental Fan Manufacturing Inc.  elicient
800-779-4021 www.continentalfan.com

Complete Climate Control



EXTREME Efficiency

www.hydroinnovations.com
Phone: 512.321-7575 Fax: 512.321-7577

just

ONE TOUCH

for Precise Watering Control

Watering Tools with Thumb Controlled Shut-Off for complete water flow control.



DRAMM

Professional Quality for Life

www.dramm.com

Panda Film

Heavy Duty Black & White Poly Sheeting

- UV resistant •
- Lets no light through •

Available in rolls, 10' x 25', 10' x 50' & 10' x 100'



Panda Brand Film



PREFERRED SUPPLIERS

ecomagination

To learn more, visit ge.com/ecomagination

imagination at work

QUEST Dehumidifiers

The World's **MOST** Energy-Efficient

- ✓ 176 pints a day
- ✓ Only 10 amps
- ✓ Internal pump
- ✓ 5 year warranty

Power Dry 4000 exclusively through

Sunlight Supply, Inc.
National Garden Wholesale.

Clean. Simple. Technology.

Plant Washes - NPK Industries / OGD



Plant Stimulators - NPK Industries / OGD



Pest Control - NPK Industries / OGD



**APHID, THRIP
AND WHITE FLY
KILLER**

Clean. Simple. Technology.

Solubles - NPK Industries / OGD

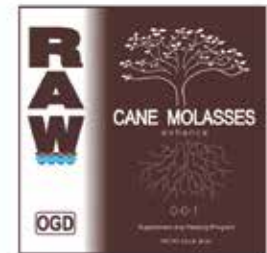
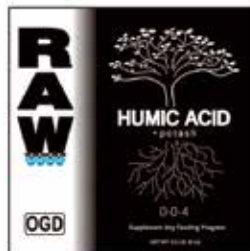
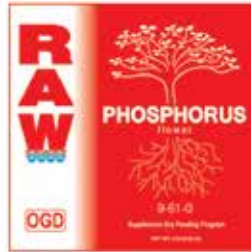

RAW=soluble™



PROTECT YOUR PLANTS



- **Necessary** for healthy plants, Silica is recognized by the CDFA as a key element for plant life. Normally derived from soil, silica is a necessity for any hydroponic or soilless garden.
- **Improves** resistance to wilt, heat, drought, and improves the strength, rigidity, and flexibility of cell walls.
- **Enhances** metabolic functions and plant growth rates by balancing nutrient uptake, distribution, and transport, leading to improved fruit and flower production.
- **Strengthens** cell walls and enhances the plants ability to adjust to and follow light, resulting in more light for the plant.

\$4.99
Product No. 092235



available in Pint, Quart, 1, 2.5 & 6 Gallon

 **GH**
genhydro.com
©2014 GH Inc.