



Sunlight Supply, Inc.

National Garden Wholesale.

2015-16 Product Catalog

INNOVATING
SINCE
1995
GROW WITH US™



America's premier manufacturer and distributor of year round gardening supplies®



Sunlight Supply, Inc.
National Garden Wholesale.

Specializing in the wholesale of indoor horticulture, organics and hydrogardening supplies. Proudly offering the industry's finest selection of signature, exclusive and semi-exclusive brands.

Our Exclusive Signature Brands

SUN SYSTEM
America's #1 Brand
of horticultural lighting fixtures

GALAXY®
RELIABLE LOW-EMISSION
DIGITAL BALLASTS

LEC® LIGHT
EMITTING
CERAMIC

SolarFLARE
SUNBLAZE
HO FLUORESCENT FIXTURES

BLACK OPS™
CARBON FILTERS

TITAN®
CONTROLS
Failure is not an option

MOTHER EARTH®
HYDROTON®
EXPANDED CLAY HYDROPONIC
GROWING MEDIA

Horticultural lamps optimized for
today's digital ballasts
DigiMax

IDEALair
COMMERCIAL GRADE™
Premium quality equipment to cool, heat,
dehumidify & humidify your indoor garden

idealH2O™
Premium Water Filtration Systems

PREMIUM QUALITY, VALUE
PRICED HORTICULTURAL
LAMPS
**ULTRA
SUN**

ECOPLUS®
Setting the standard for water
pumps, air pumps & accessories

**MEASURE
MASTER**
Measuring
devices for
today's grower

PHRESH
LIGHTWEIGHT AUSTRALIAN GRANULAR
CARBON AIR PURIFICATION PRODUCTS

GRO PRO
A complete line
of indoor and
outdoor growing
containers

**FLAME
DEFENDER**
AUTOMATIC SELF-CONTAINED
FIRE EXTINGUISHER
Automatic self-
contained fire
extinguisher

MOTHER EARTH®
Premium growing medias
and amendments

Buried Treasure
100% NATURAL GUANOS

Hurricane
Bring on the BIG AIR

FASTFIT
toolless assembly light
& tray stands

POWER ALL®
Quality extension cords, adapters
and power strips

HydroFlow
Quality, Compatible Irrigation Solutions

Flo-n-Gro
Hydrogardening Bucket Systems

GROVISION
HIGH PERFORMANCE SHADES

TRIM • PRUNE • CUT
**SHEAR
PERFECTION**

SUN GRIP
LIFT SYSTEMS FOR LIGHTING FIXTURES
SUN WINCH

RAINMAKER
Make it Rain
Value priced trigger pump,
battery and backpack sprayers

**Harvest
KEEPER**
STORAGE SOLUTIONS

Duralastics
Durable, lasting plastic grow trays and reservoirs

Grower's Edge
Growing accessories for
indoor gardeners

Hyperfan
Highest CFM per watt of any fan in the industry

Spectralux
Fluorescent Horticultural Grow Lamps

SURETEST™
ACCURATE TESTING SOLUTIONS

**Air Force
Pro**
High volume commercial-grade air pumps

SUN FILM
Quality Reflective
Film Products for Indoor Gardening

**URBAN
oasis**
BULK WATER
STORAGE SOLUTIONS

AgroLED
Energy Saving LED Garden Lights

Super Sprouter
Propagation heat mats, domes trays, and plugs

SUN HUT
GROW TENTS
AFFORDABLE INDOOR
GREENHOUSES

FELIZ
FELIZLIGHT
FLUORESCENT GROW LAMPS

Table of Contents

Intro Sections

Table of Contents	1	Quick Reference	1
-----------------------------	---	---------------------------	---

Lighting Sections

Sun System Reflectors DE	7	LEC/LED/LEP	38
Sun System Reflectors SE	11	Lamps	41
Magnetic Ballasts	20	Electrical Components	49
Electronic Ballasts	22	Lighting Components	50
Sun System Complete Systems	29	Extension, Power & Lamp Cords	52
Commercial Greenhouse Fixtures	31	Light Movers & Hangers	55
Fluorescent Lighting	35		

Garden Accessories Sections

● Safety Equipment	59	● AC/Dehumidify/Humidify	269
● Nutrients & Supplements	61	● Air Purification	281
● Water Treatment	133	● Sprayers & Wands	289
● Pest & Disease Control	134	● Plant Support	295
● Leaf Shines & Washes	144	● Growing Accessories	301
● Growing Media	145	● Food Storage	308
● Cloning & Seed Starting	161	● Hand Tools	311
● Grow Systems/Trays/Reservoirs	175	● Reflective & Greenhouse Films	316
● Tents/Indoor Greenhouses	187	● pH/EC/TDS Meters & Solutions	318
● Water Pumps & Irrigation Supplies	193	● Timers & Instruments	331
● Water Aeration	218	● Pots & Containers	337
● Water Chillers, Heaters & Purification	221	● Books	348
● Environmental Controls	232	● Preferred Suppliers	349
● Fans/Ventilation/Ducting & Access.	257	● Shopping List	422

National Garden Wholesale® is a division of Sunlight Supply®, Inc. Manufacturer of Sun System® brand lighting fixtures. Sun System is a registered brand name of Sunlight Supply®, Inc. Corporate office: Vancouver, WA USA. Prices and product offering subject to change without notice. Suggested retail prices will be higher in Alaska, Hawaii and Puerto Rico. Copyright 2015. Printed in Oregon State.

The Right Environment



- Key components include relative humidity, temperature, CO₂, and air circulation/exchange
- Ideal humidity is between 40%-60%
- Some plants like higher humidity, but that can lead to problems with fungus and disease
- Ideal temperature is between 68°-75° F
- Plants need CO₂ to grow - with good air circulation and exchange, a room will naturally have between 300-400 PPM without supplemental CO₂

Choose A Method



- Ebb & Flow gardens flood and drain a tray of plants with a nutrient solution at regular intervals
- Drip gardens provide a nutrient solution to each plant through tubes & emitters (drip stakes)
- Aeroponic gardens mist an oxygenated nutrient solution directly to the roots of its plants
- NFT (Nutrient Film Technique) gardens flow a slow moving nutrient solution over the plants roots
- Organics are possible using many methods, and are often grown in container gardens

Nutrients/Fertilizers



- Liquid/Dry nutrients can be organic or synthetic
- Over or under fertilizing can cause burning, curling or yellowing of plants
- Most nutrient bottles are labeled with N-P-K (Nitrogen, Phosphorus, and Potassium)
- Additives/supplements can bolster microbial activity at the root zone, strengthen plant cell walls, increase flower sites, shorten length to harvest, increase size, flavor and aroma of fruits and flowers and more
- When used together, nutrients and supplements will help you achieve maximum results

Testing Equipment



- There are many meters available for testing solution pH, PPM, and EC
- Environmental controllers and meters are available to automate and more accurately control and maintain the temperature, humidity, CO₂ and lights
- Testing equipment for the water-nutrient solution, light, room temperature and humidity, CO₂, and air circulation is the key to a providing optimal conditions for a bountiful garden

Start With Good Water

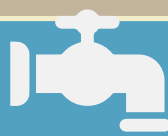

- Water quality is essential to plant growth
- PPM (parts per million) or EC (electrical conductivity) measure salts in a solution
- Start off with a low PPM or EC and add nutrients specific to your plant variety requirements
- A Reverse Osmosis system can reduce PPM/EC
- pH (potential hydrogen) measures acidity or alkalinity in a solution on a scale of 0-14
- pH should range 5.8-6.2 in hydro and 6.0-6.8 in soil
- Nutrient "lockout" occurs in too high or low pH levels

Choose A Media



- Growing mediums act as the root anchor system
- Coco is made from the husks of a coconut, is pH stable, and provides moisture retention and aeration
- Expanded Clay pebbles provide moisture retention and aeration and are reusable if sterilized
- Rockwool stone is heated and spun into fibers then compressed, provides an excellent oxygen to water ratio, though flushing/conditioning is recommended
- Silica helps slow transpiration, provides moisture retention and aeration, and is reusable if sterilized
- Peat mixes can be altered to varying air/water ratios

Grow Lighting



- MH (Metal Halide) and HPS (High Pressure Sodium) are types of HID lights used in grow rooms
- MH lamps = Blue spectrum for vegetative
- HPS lamps = Orange/Red spectrum for flowering
- TS lamps are high-output fluorescents with low heat/energy consumption ideal for cuttings, mother plants, and short growth cycles
- DE (Double-Ended) lighting is an improved spectrum HID lamp with a higher par reading than a single ended
- Plants in vegetative stage need 15-18 hrs. of light
- Plants in bloom stage need 10-12 hrs. of light

Optional Accessories



- Grow/Garden room accessories are essential for optimized growth and harvest
- Atmosphere drive devices such as fans, blowers, CO₂ emitters, and integrated timers are a grow rooms greatest accessory
- Trellising, stakes, supports, shears, and labels are useful when growing fruiting/flowering crops
- Pest and disease control may be needed and there are many organic options available
- For more information visit [SunlightSupply.com!](http://SunlightSupply.com)

HYDRO 101

AN 8 STEP GUIDE TO SUCCESSFUL INDOOR HYDRO GARDENING

hydroponics

noun: the science of growing or the production of plants in nutrient rich solutions or moist inert material, instead of soil.



Hydroponic crops can use up to 90% less water than soil grown crops, when in a recirculating system.

1/4

You can plant 4 times the amount of hydroponic crops in the same area that soil crops need to grow.

x2

Hydroponic crops can grow twice as fast.



Hydroponically grown crops can be grown organically and without the use of herbicides & pesticides.



Sunlight Supply, Inc.

National Garden Wholesale.
sunlightsupply.com

INDOOR SOIL GARDENING 101

A 7 STEP GUIDE TO SUCCESSFUL INDOOR ORGANIC GARDENING

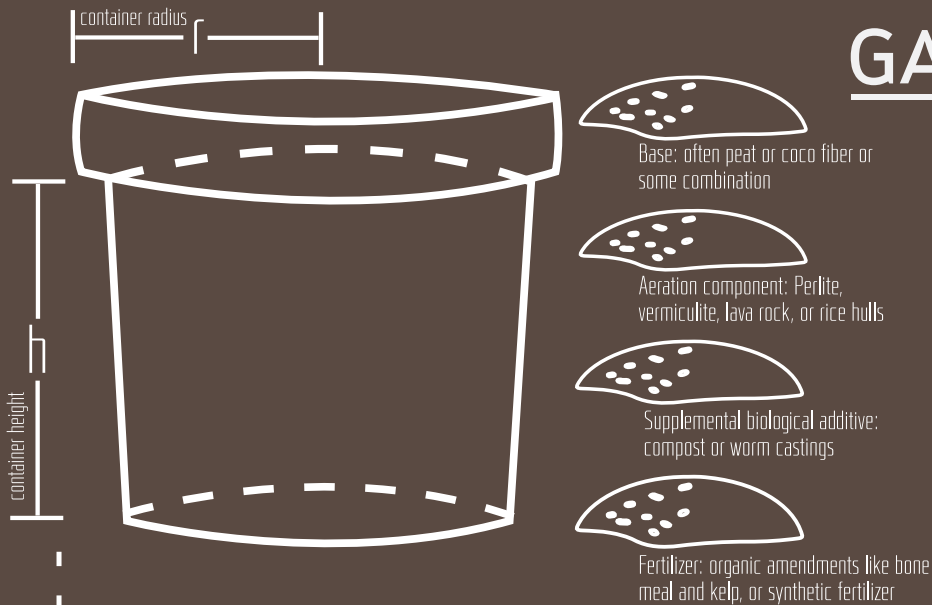

container volume estimate

$$V = \pi r^2 h$$



Sunlight Supply, Inc.

National Garden Wholesale,
sunlightsupply.com

Choose a Potting Mix/Mix Your Own



- Potting Mixes are typically peat-based mixes with perlite and other materials that unlike soil, are light weight and have great air/water holding properties
- Sphagnum Peat Moss is naturally acidic and often used with dolomite lime to raise pH
- Perlite is a coarse substrate derived from volcanic rock and used to improve drainage and aeration
- Coco is made from the husks of a coconut, is pH stable, and provides moisture retention and aeration
- Worm Castings and Composted Waste add beneficial biology that help plants access nutrients in the soil

The Right Environment



- Key components include relative humidity, temperature, CO₂, and air circulation/exchange
- Ideal humidity is between 40%-60%
- Some plants like higher humidity, but that can lead to problems with fungus and disease
- Ideal temperature is between 68°-75° F
- Plants need CO₂ to grow - with good air circulation and exchange, a room will naturally have between 300-400 PPM without supplemental CO₂

Start With Good Water



- Water quality is essential to plant growth
- PPM (parts per million) or EC (electrical conductivity) measure salts in a solution
- Start off with a low PPM or EC and add nutrients specific to your plant variety requirements
- A Reverse Osmosis system can reduce PPM/EC
- pH (potential hydrogen) measures acidity or alkalinity in a solution on a scale of 0-14
- pH should range 5.8-6.2 in hydro and 6.0-6.8 in soil
- Nutrient "lockout" occurs in too high or low pH levels

Nutrients/Fertilizers



- Liquid/Dry nutrients can be organic or synthetic
- Over or under fertilizing can cause burning, curling or yellowing of plants
- Most nutrient bottles are labeled with N-P-K (Nitrogen, Phosphorus, and Potassium)
- Additives/supplements can bolster microbial activity at the root zone, strengthen plant cell walls, increase flower sites, shorten length to harvest, increase size, flavor and aroma of fruits and flowers and more
- When used together, nutrients and supplements will help you achieve maximum results

Grow Lighting



- MH (Metal Halide) and HPS (High Pressure Sodium) are types of HID lights used in grow rooms
- MH lamps = Blue spectrum for vegetative
- HPS lamps = Orange/Red spectrum for flowering
- T5 lamps are high-output fluorescents with low heat/energy consumption ideal for cuttings, mother plants, and short growth cycles
- DE (Double Ended) lighting is a full spectrum HID lamp with a higher par reading than a single ended
- Plants in vegetative stage need 15-18 hrs. of light
- Plants in bloom stage need 10-12 hrs. of light

Testing Equipment



- There are many meters available for testing soil and solution pH, PPM, and EC
- Environmental controllers and meters are available to automate and more accurately control and maintain the temperature, humidity, CO₂ and lights
- Testing equipment for the water-nutrient solution, light, room temperature and humidity, CO₂, and air circulation is the key to providing optimal conditions for a bountiful garden

Optional Accessories



- Grow/Garden room accessories are essential for optimized growth and harvest
- Atmosphere drive devices such as fans, blowers, CO₂ emitters, and integrated timers are a grow rooms greatest accessory
- Trellising, stakes, supports, shears, and labels are useful when growing fruiting/flowering crops
- Pest and disease control may be needed and there are many organic options available
- For more information visit SunlightSupply.com!

Container Capacities



Common Size Conversion



2 Tbsp = 1 fluid oz
 4 Liter = 1.06 Gallons
 6 Liter = 1.59 Gallons
 10 Liter = 2.64 Gallons

 1 ml = 1/5 tsp
 5 ml = 1 tsp
 30 ml = 1 fluid oz
 1 ml = 20 drops



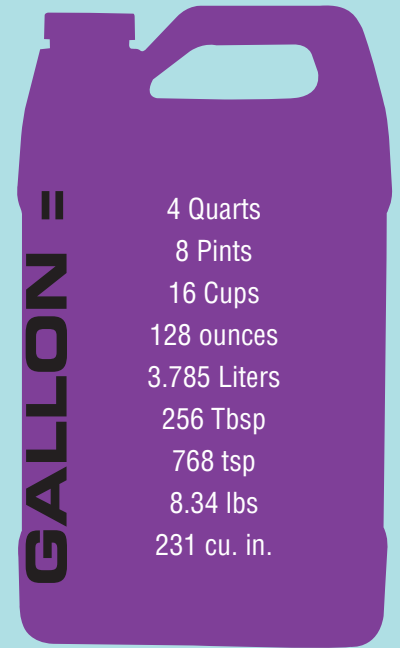
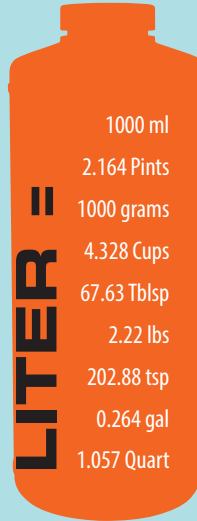
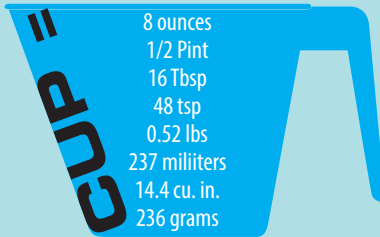
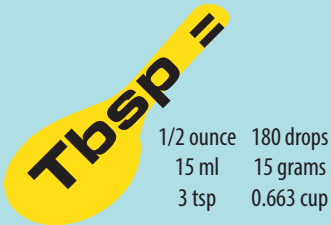



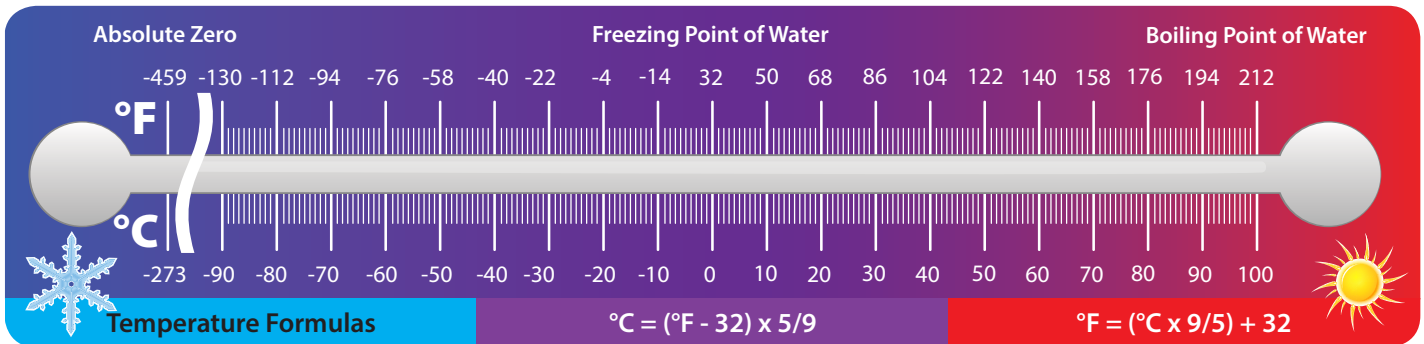

	3.38 ounces	100 milliliter	0.1 Liter
1/2 Cup	4 ounces	118.3 milliliter	0.118 Liter
1/2 Pint	8 ounces	237 milliliter	0.237 Liter
2.5 Gallon	320 ounces	9464 milliliter	9.464 Liter
5 Gallon	640 ounces	18930 milliliter	18.93 Liter
6 Gallon	768 ounces	22710 milliliter	22.71 Liter





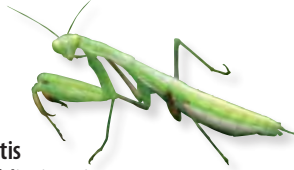















°F/°C Temperature Conversion

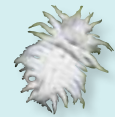

Beneficial Insects

 Aphid Predator Aphidus sp.	 Lacewing Chrysoperla rufilabris	 Lady Beetle Hippodamia convergens	 Mealybug Destroyer Montrosieri Cryprolaemus	 Minute Pirate Bug Orius sp.
 Praying Mantis Tendora aridifolia sinensis		 Predatory Mite Phytoseiulus persimillis	 Trichogramma spp.	 Whitefly Parasite Encarsia formosa

Destructive Insects, Mites

 Aphid	 Aphid (winged)	 Bagworm Larva	 Billbug	 Cucumber Beetle	 Cyclamen Mite
 Earwig	 Fungus Gnat (Adult)	 Fungus Gnat (Larva)	 Lacebug	 Mealybug	 Rose Chafer
 Sowbug	 Spider Mite	 Spittlebug	 Thrips	 White Fly	 White Grub

Definitions & Abbreviations

PPM ➤ parts per million	mho ➤ conductivity	mS ➤ millisiemen	uS ➤ microsiemen
TDS ➤ total dissolved solids	EC ➤ electrical conductivity	pH ➤ potential hydrogen	1 Siemen ➤ 100mS
1 mS ➤ 1000 uS	1 mS ➤ 500 ppm (standard)	1 mS ➤ 650 ppm (horticultural)	1 mg/liter ➤ 1 ppm

C Carbon

Ca Calcium

Cl Chlorine

Cu Copper

Fe Iron

F Fluorine

H Hydrogen

K Potassium

MN Manganese

Mo Molybdenum

N Nitrogen

Na Sodium

O Oxygen

P Phosphorus

S Sulfur

Zn Zinc

Light & Power Formulas

$$\text{Amps} = \text{Wattage} \div \text{Voltage}$$

$$\text{Voltage} = \text{Wattage} \div \text{Amps}$$

AMPS are how many electrons flow past a certain point per second. VOLTAGE is a measure of how much force that each electron is under. WATTAGE is the electric power required by an appliance or device.

$$1 \text{ footcandle} = \text{lumen/ft}^2$$

Organic Certifications



Products bearing this seal are registered with the California Department of Food & Agriculture Organic Input Material Program. The Organic Input Material (OIM) Program registers fertilizing materials to be used in organic crop and food production. The program is mandated by the Legislature and supported by the industry. Products claiming to be appropriate for use in organic production are verified to comply with the California Fertilizing Law and Regulations and USDA National Organic Program Standards.



Pro-Cert Organic Systems Ltd. (Pro-Cert) is one of North America's foremost national certifier's of organic products. Pro-Cert's certification program is recognized globally providing international access to the products and brands they certify. Their program is accredited under the USDA National Organic Program (NOP), the CFIA's Canada Organic Regime (COR), the Japanese Agricultural Standards (JAS) and Quebec's Committee on Accreditation for Evaluation of Quality (CAEQ). Pro-Cert's certification program is ISO 17065 compliant and accredited by the Standards Council of Canada – a globally recognized accreditor and member of the International Accreditation Forum (IAF).



Organic agriculture produces products using methods that preserve the environment and avoid most synthetic materials, such as pesticides and antibiotics. USDA organic standards describe how farmers grow crops and raise livestock and which materials they may use. Organic farmers, ranchers, and food processors follow a defined set of standards to produce organic food and fiber. Congress described general organic principles in the Organic Foods Production Act, and the USDA defines specific organic standards. These standards cover the product from farm to table, including soil and water quality, pest control, livestock practices, and rules for food additives.



The Organic Materials Review Institute is a national nonprofit organization that determines which input products are allowed for use in organic production and processing. OMRI Listed® products are allowed for use in certified organic operations under the USDA National Organic Program.

RHP What is it?



Since 1963, RHP has been the European knowledge & certification center for potting soil, substrates and growing media used by Dutch and European growers, professional horticulturists and consumers. If you are a grower and consider the quality of your finished product of paramount importance, you have found the right certification entity at RHP. The RHP quality mark applies for substrate producers, substrate suppliers, extraction and production sites of raw materials.

Registrations

EPA Registration

Federal law requires that before selling or distributing a pesticide in the United States, a person or company must obtain registration, or license, from EPA. The EPA must first ensure that the pesticide, when used according to label directions, can be used with a reasonable certainty of no harm to human health and without posing unreasonable risks to the environment. To make such determinations, EPA requires more than 100 different scientific studies and tests from applicants. Where pesticides may be used on food or feed crops, EPA also sets tolerances (maximum pesticide residue levels) for the amount of the pesticide that can legally remain in or on foods. Most states conduct a review of the pesticide label to ensure that it complies with federal labeling requirements and any additional state restrictions of use.

Criteria for FIFRA 25(b) Exemption

Minimum risk pesticides that meet certain criteria are exempt from federal registration under section 25(b) of the Federal Insecticide, Fungicide, and Rodenticide Act (FIFRA). The U.S. Environmental Protection Agency (EPA) does not review or register pesticides that satisfy the 25(b) criteria, though registration is required by most states. For more detailed information go to www.epa.gov.

Certification Marks

Sunlight Supply is committed to safety by investing in our own Satellite Laboratory. This Level 4 (the highest level on a 1 to 4 scale) accredited facility is the only one of its kind on the west coast certified for testing lighting fixtures. (Agreement No. L4-US-11-4012). This investment secures that we are a Nationally Recognized Testing Laboratory (NRTL) and the only one in the industry. Sunlight Supply is accredited by ETL, OSHA, and ISO/IEC 17025. We have invested in the space, top of the line testing equipment, and resources including hiring an ETL Compliance Manager with years of experience in safety certification. With this investment we not only provide the maximum safety possible to anyone who uses our products but also provides liability protection to our Indoor Garden Retail Stores. This is the benchmark that Sunlight Supply has set for the continued product safety excellence we strive to achieve with each and every product we sell.



Intertek Testing Services

ETL is a mark provided by Intertek Testing Services. Intertek (www.intertek.com) is a global leader in testing inspection and certification services. They are a Nationally Recognized Testing Laboratory and tests products to UL, CSA, IEC and CE standards. A product bearing the ETL Listed Mark is determined to have met the requirements of prescribed product safety standards. Moreover, the mark indicates that the manufacturer's production site conforms to a range of compliance measures and is subject to periodic follow-up inspections to verify continued conformance.



Canadian Standards Association

The Canadian Standards Association (CSA) is a nonprofit association serving business, industry, government and consumers in Canada and the global marketplace. Among many other activities, CSA (www.csa.ca) develops standards that enhance public safety. A Nationally Recognized Testing Laboratory, CSA is very familiar with U.S. requirements.



Underwriters Laboratories Inc.

Underwriters Laboratories Inc. (www.ul.com) is an organization that writes safety standards, tests products and certifies them. UL has developed over a thousand safety standards, and millions of products and their components are listed to these standards.



Underwriters Laboratories Inc. Recognized Component Mark

These are Marks consumers rarely see because they are specifically used on component parts that are part of a larger product or system. These components may have restrictions on their performance or may be incomplete in construction. The component recognition marking is found on a wide range of products, including some switches, power supplies, printed wiring boards, some kinds of industrial control equipment and thousands of other products.



Conformance European

The CE Mark is a requirement for products sold to the European Market. The CE Mark identifies a product as complying with the health and safety requirements spelled out in European legislation (Directives) and is mandatory for equipment operating in the European Union (EU). Once the product has received the CE Mark it can circulate freely throughout the European Union countries.



FCC is a mark provided by the Federal Communications Commission. The FCC limits the amount of radiated EMI that lighting systems may produce at certain frequencies.

A Listed mark with both "US" and "C" identifiers signifies that the product bearing the mark complies with both US and Canada product safety standards. If it bears just the "us" identifier, it has been tested and deemed compliant to the United States. A Listed mark with a "C" identifier means the product bearing it complies with Canada product safety standards only.

Shipping Restrictions



This logo represents No UPS for products due to size, material content or weight restrictions. This means the product cannot be shipped via UPS. These products are only available for truck orders.

DOUBLE-ENDED

Reflectors made specifically for double-ended horticultural lamps.



Unique double-ended construction allows for maximum optical efficiency and uniformity. Improved spectrum DE lamps used in this fixture focus on the red component for increased photosynthetic response. They offer improved PAR values and increased PAR/lumen maintenance (up to 90% PAR at 10,000 hours of operation).



DOUBLE-ENDED

USA MANUFACTURED AIR-COOLED - DE

AC/DE® Air-Cooled Double-Ended Reflector 8 in



The patented sealed optic technology allows removal of heat generated by the lamp without cooling the lamp. Features German made, UL listed double-ended sockets. 95% reflective textured German aluminum interior with 98% reflective corner inserts offer excellent uniformity, output and diffusion. Galvanized steel housing with durable powder coated finish. Includes built in level. Double neoprene gaskets for an air tight seal. Hinged glass makes changing lamps and cleaning glass easy. US patents: D698,987, D698,628, D737,498, D726,116, 9,016,907. US Patent Pending: 29/500,428, 29/520,168, 14/662,706, 13/533,189, PCTUS2014014959. Chinese patents: ZL201330634881.9, ZL201330642281.7. 5 Year Warranty.

Item No.	Description	Pit Qty	MSRP
904904	AC/DE Double Ended Air-Cooled Reflector 8 in	12	\$379.95

USA MANUFACTURED NON AIR-COOLED - DE

DE Boss™ Reflector



State-of-the-art, optically engineered for high performance based on proven, patented designs. Made specifically for double-ended horticultural lamps (not included). Features German made, UL listed double-ended sockets. Unique double-ended construction allows for maximum optical efficiency and uniformity. Deep reflector design holds the lamp heat to keep the DE lamp at optimal operating temperature. 95% reflective textured German aluminum interior with 98% reflective corner inserts offer unsurpassed uniformity, output and diffusion. Galvanized steel housing with durable powder coated finish. Detachable 15 ft lamp cord at the reflector and at ballast. Includes built in level. US Patent: D726,116. US Patents Pending: 29/492,972, 29/520,168, 29/516,334, 13/533,189, PCTUS2014014959. Chinese Design Patent: ZL201430167976.9. 5 Year Warranty.

Item No.	Description	Pit Qty	MSRP
904934	DE Boss Reflector	24	\$264.95

Super Sun® DE Reflector



The Super Sun® DE's compact & efficient design delivers maximum light to your growing space. Features German made, UL listed double-ended sockets. 95% reflective textured German aluminum interior for excellent uniformity, output and diffusion. Galvanized steel housing with durable powder coated finish. Manufactured with exacting standards and the finest quality components. US Patent: D726,116. US Patent Pending: 29/520,168. Chinese Patent: ZL201330582324.7. 5 Year Warranty.

Item No.	Description	Pit Qty	MSRP
904906	Super Sun DE Reflector	36	\$181.95

Agrotech® Magnum Double-Ended Reflector



Made specifically for double-ended horticulture lamps. Unique double-ended lamp construction allows for maximum optical efficiency and uniformity. Features German made, UL listed double-ended sockets. 95% reflective textured German aluminum for excellent reflectivity and diffusion. Detachable 15 ft lamp cord at the reflector and at the ballast. Does not accept glass. Some assembly required. US Patents: D726,116, D732,233. US Patent Pending: 29/520168. Chinese Patent: ZL201330582324.7. 5 Year Warranty.

Item No.	Description	Pit Qty	MSRP
904855	Agrotech Magnum Double Ended Reflector	30	\$181.95

Check out the newest products now. New products are added daily so check often!



Adjust-A-Wings Avenger DE Reflector



Made specifically for double-ended horticulture lamps (not included). Features German made, UL listed double-ended sockets. Unique double-ended construction allows for maximum optical efficiency and uniformity. Full spectrum DE lamps used in this fixture focus on the red component for increased photosynthetic response. They offer improved PAR values and increased PAR/lumen maintenance (up to 90% PAR at 10,000 hrs of operation). Made with 95% reflective German aluminum. US Patents: 6,053,624, 6,783,263, 7,156,539. 5 Year Warranty.

Item No.	Description	Pit Qty	MSRP
904910	Adjust-A-Wings Avenger DE Reflector Large	36	\$235.95

REFLECTOR ACCESSORIES - DE

Large DE Socket Kit with Lamp Cord



Make your existing single ended mogul base Adjust-A-Wings Large Reflector into a double-ended reflector. Simply remove your existing socket and add this new Double-Ended Socket Kit with lamp cord. Includes everything to make the switch. Made specifically for double-ended horticulture lamps (not included). Features German made, UL listed double-ended sockets. US Patent Pending: 29/481,879. Chinese Patent: ZL201430019222.9.

UL listed double-ended sockets. US Patent Pending: 29/481,879. Chinese Patent: ZL201430019222.9.

Item No.	Description	MSRP
904914	Large Double Ended Socket Kit w/ Lamp Cord	\$89.95

Super Spreader® for Adjust-A-Wings Large Double-Ended

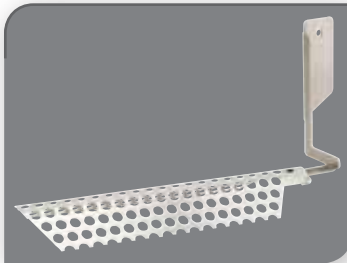

Made of 95% reflective glass coated prismatic surfaced super alloy. Creates wider, more even light spread by eliminating hot spots and shady spots. The Super-Spreader® allows for closer light placement for increased power. Reduces heat at the plant level by at least 9°F and increases your yields using less lights. Compatible with Adjust-A-Wings Double-Ended reflectors.

Item No.	Description	MSRP
904764	Super Spreader for AJW Large Double Ended	\$36.95

IMPORT NON AIR-COOLED - DE

Dominator XXXL® Double-Ended Non AC Reflector



Made specifically for double-ended horticultural lamps (not included). Features German made, UL listed double-ended sockets. Unique double-ended construction allows for maximum optical efficiency and uniformity. Improved spectrum DE lamps used in this fixture focus on the red component for increased photosynthetic response. They offer improved PAR values and increased PAR/Lumen maintenance (up to 90% PAR at 10,000 hours of operation). Deep reflector design holds the lamp heat to keep the DE lamp at optimal operating temperature. Highly reflective aluminum interior offers excellent uniformity, output and diffusion. Galvanized steel housing with durable powder coated finish. Includes pre-wired sockets and 15 ft lamp cord. US Patents: D732,235, D732,233 and Patent Pending 29/526,565. 5 Year Warranty.

Item No.	Description	Pit Qty	MSRP
904920	Dominator XXXL Double Ended Non AC Reflector 3/Pack	24	\$209.95

Blazer® DE Reflector



The shape of the Blazer® DE Reflector is perfect for square growing areas. Highly reflective aluminum offers excellent output, reflectivity and diffusion. Made specifically for double-ended horticulture lamps (not included). German made, UL listed double-ended sockets. Unique double-ended construction allows for maximum optical efficiency and uniformity. Deep reflector design holds the lamp heat to keep the DE lamp at optimal operating temperature. Galvanized steel housing with durable powder-coated finish. Includes pre-wired sockets and 15 ft lamp cord. 5 Year Warranty.

Item No.	Description	MSRP
904944	Blazer DE Reflector	\$149.95

Find a retailer near you to get your Sun System products!



Silver Sun® DE Reflector

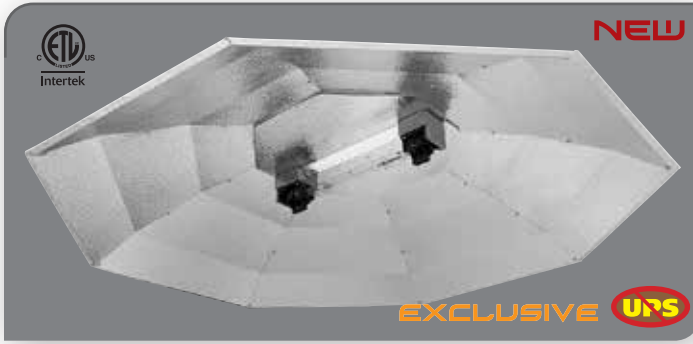

The Silver Sun® DE combines the features of the traditional vertical and horizontal reflectors into one exceptional reflector. Made specifically for double-ended horticultural lamps (not included). Features German made, UL listed double-ended sockets. Unique double-ended construction allows for maximum optical efficiency and uniformity. Made from highly reflective aluminum. Large size provides for a large coverage area even when placed close to plants. V-strike bend above lamp to increase performance. Comes unassembled and easily sets up in minutes. Pre-wired with 15 ft lamp cord and socket. 5 Year Warranty.

Item No.	Description	MSRP
904916	Silver Sun DE Reflector	\$159.95

Flex™ DE Reflector



The Flex™ DE Reflector is larger than most standard wing reflectors. Highly reflective aluminum offers excellent uniformity, output and diffusion. Patent pending enclosed end wing design for better control of the light footprint. Made specifically for double-ended horticultural lamps (not included). Features German made, UL listed double-ended sockets. Light weight and easy to hang. Comes completely assembled with prewired 15 ft lamp cord and sockets. 5 Year Warranty.

Item No.	Description	MSRP
904938	Flex DE Reflector	\$99.95

Gavita HortiStar 1000 DE Reflector



HortiStar 1000 DE has 95% Miro aluminum reflector that can be replaced easily. Specifically designed for high frequency electronic ballasts it has a connection at each side of the lamp, removing the need for a frame wire inside the lamp.

Item No.	Description	MSRP
906020	Gavita HortiStar 1000 DE Reflector Double Ended	\$124.95
906022	Gavita HortiStar 96 1000 DE Reflector Replacement	\$37.50



As seen on
YouTube



Scan to see how it's made

Or go to www.youtube.com and search "Sunlight Supply Manufacturing".

REFLECTOR QUICK REFERENCE GUIDE - DE

Description	Part No.	Integrated Air Cooled Fittings	Built In Socket & Lamp Cord	Glass Part No	Glass Retention	Reflectivity	Lamp Position	Assembly Required	Fabricated In USA	Pallet Count	Weight	Reflector Dimensions Long x Wide x High
AC/DE Double Ended Air-Cooled Reflector 8 in	904904	Yes - 8"	Yes	640689	Hinged	95 & 98%	Horizontal	No	Yes	12	18.4	32.0" x 20.0" x 9.4"
Adjust-A-Wings Avenger DE Reflector Large	904910	N/A	Yes	N/A	Hinged	95%	Horizontal	Yes	Yes	36	8.4	27.6" x 39.5" x "
Agrotech Magnum Double Ended Reflector	904855	N/A	Yes	N/A	Hinged	95%	Horizontal	Yes	Yes	30	6.0	34.3" x 29.1" x 8.1"
DE Boss Reflector	904934	N/A	Yes	N/A	Hinged	95 & 98%	Horizontal	No	Yes	24	7.3	19.8" x 19.1" x 8.6"
Dominator XXXL Double Ended Non AC Reflector	904920	N/A	Yes	N/A	Hinged	86%	Horizontal	No	Yes	24	20.0	34.8" x 29.5" x 8.8"
Super Sun DE Reflector	904906	N/A	Yes	N/A	Hinged	95%	Horizontal	No	Yes	36	6.1	24.0" x 13.4" x 6.8"
Blazer DE Reflector	904944	N/A	Yes	N/A	Hinged	86%	Horizontal	No	No	—	9.7	24.5" x 20.0" x 9.0"
Flex DE Reflector	904938	N/A	Yes	N/A	Hinged	86%	Horizontal	No	No	—	4.0	20.3" x 20.0" x 8.0"
Silver Sun DE Reflector	904916	N/A	Yes	N/A	Hinged	86%	Horizontal	Yes	No	—	9.5	49.4" x 49.4" x 7.8"

USA REFLECTORS



When it's the **Right Light** your plants will know the difference.

5 YEAR WARRANTY
- REPAIR OR REPLACE -

5



- ① Commercial grade! Galvanized steel housing with a durable, corrosion resistant powder-coated finish.
- ② Most Sun System® Reflectors include tempered glass, a built-in socket and lamp cord. Some even feature a patented detachable lamp cord.
- ③ All USA made Sun System® reflectors use HortiBright™, a five layer coating system that maintains it's high (95%-98%) reflectivity. Uncoated finishes begin to dull immediately, quickly losing their reflective properties which, even when new, are substantially less reflective (about 70%) than HortiBright™. Less reflectivity means poorer performance - a difference you'll see in the performance of your plants.
- ④ Our air-cooled reflectors are completely sealed with double gaskets! Swing Stop® retention cable keeps glass from abruptly swinging down. Captured thumb screws & closure mechanism for ease of use and excellent sealing.
- ⑤ Integrated air-cooled fittings allow for extremely efficient cooling. A bead ring helps to hold ducting firmly in place!

5 LAYER REFLECTIVE COATING

HortiBRIGHT™

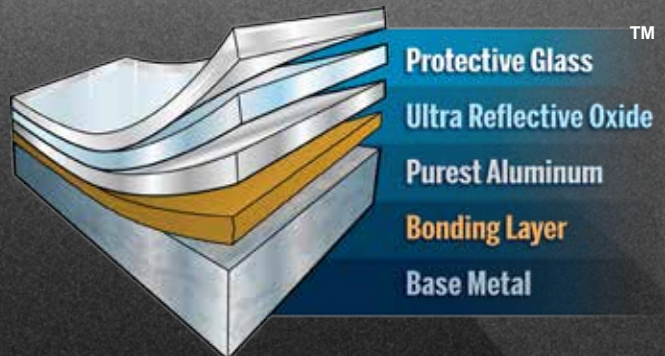

USA MANUFACTURED AIR-COOLED - SE

ULTRA PREMIUM REFLECTORS

Evolution™ 8 in Air-Cooled Reflector



The patented sealed optic technology allows removal of heat generated by the lamp without cooling the lamp below proper operating temperature. 95% reflective textured German aluminum interior with 98% reflective corner inserts offer excellent uniformity, output and diffusion. Manufactured with exacting standards and double neoprene gaskets for an air tight seal. Includes tempered glass, built-in socket & 15 ft detachable lamp cord. Includes built in level. Will not accept BT37 or larger lamps. US patents: D698,987, D698,628, D726,116, D737,498. US Patent Pending: 14/665,381, 29/520,168, PCTUS2014014959, 13/533,189, 13/945,794. Chinese Patents: ZL201330634881.9, ZL201330642281.7. 5 Year Warranty.

Item No.	Description	Pit Qty	MSRP
904930	Evolution 8 in Air-Cooled Reflector	12	\$354.95

Epic Reflector® 8 in Air-Cooled



Industry's largest air-cooled reflector. Features our exclusive 98% reflective Silver German aluminum for unmatched reflectivity. Completely sealed double gasketed glass lens with the Swing Stop® retention cable keeps glass from abruptly swinging down. Bolstered sealing points to ensure tight air-cooled integrity. Built in 8 inch air cooling ducts with bead ring to hold ducting securely in place. Integrated socket and detachable 15 ft lamp cord. Includes built in level. Galvanized steel housing with major brand powder coating. US Patents: D613,900, D717,636, D698,628. 5 Year Warranty.

Item No.	Description	Pit Qty	MSRP
904880	Epic 8 in Air-Cooled Reflector	6	\$381.95

PREMIUM REFLECTORS

Magnum Low Pro XXXL™ 8 in Air-Cooled Reflector

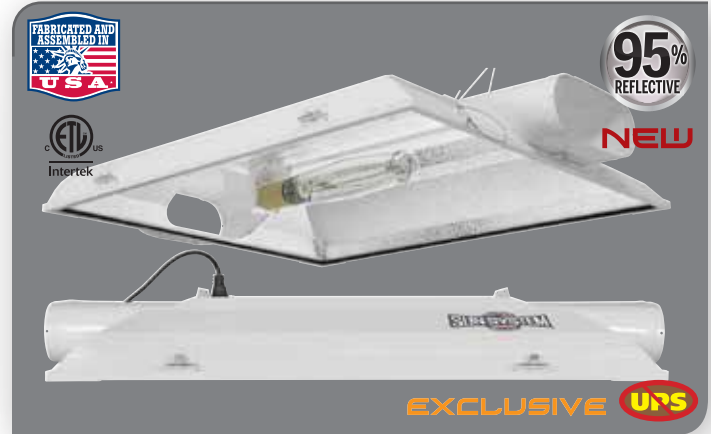

This patent pending, unique low profile design allows for maximum vertical growing space, especially in low ceiling applications. Although this fixture features 8 inch oval air-cooled fittings, it measures only 5.6 inches high! State-of-the-art 95% reflective German Hortibright™ aluminum interior offers unparalleled output, reflectivity and diffusion. Includes a Sun System® reflector level for easy, consistent, level hanging. Integrated mogul base socket and 15 ft lamp cord. Completely sealed — features double gasketed tempered glass and a hinged frame. Swing Stop® retention cable keeps glass from abruptly swinging down. Galvanized steel housing with durable powder coat finish. Captured thumb screws & closure mechanism for ease of use. Patent Pending No. 29/511,535. 5 Year Warranty.

Item No.	Description	Pit Qty	MSRP
904770	Magnum Low Pro XXXL 8 in Air-Cooled Reflector	15	\$299.95

Magnum XXXL® 6 in & 8 in Air-Cooled Reflectors - Generation 3



The Magnum XXXL® includes tempered glass, removable frame, built-in socket & new detachable 15 ft lamp cord. Completely sealed—features double gasketed glass and hinged frame to hold glass tightly in place. 95% reflective German Hortibright™ aluminum interior. Easy carry handles and built in level. US Patents: D613,900, D698,986, D698,628, D717,636, D644,185, D726,116. US Patent Pending: 29/520,168, 29/478,005. Chinese Patent: ZL 2013 3058 2331.7. 5 Year Warranty.

Item No.	Description	Pit Qty	MSRP
904520	Magnum XXXL 6 in Air-Cooled Reflector	12	\$263.95
904515	Magnum XXXL 8 in Air-Cooled Reflector	12	\$281.95

EXCELLENCE ○ QUAL

BlockBuster® 6 in & 8 in Air-Cooled Reflectors - Generation 3



The Air-Cooled BlockBuster® Reflector now offers a more efficient and even light distribution. It is pre-wired with lamp cord and socket. The interior is made from 95% reflective German Hortibrigh™ aluminum and is completely sealed with neoprene gaskets and hinged glass. Includes built in level. US Patents: D570,295, D634,469, D698,628, D644,185, D731,701, 7,641,367. US Patent Pending: 29/526,076. Chinese Patent: ZL201430019221.4. 5 Year Warranty.

Item No.	Description	Plt Qty	MSRP
904650	BlockBuster 6 in Air-Cooled Reflector	12	\$209.95
904655	BlockBuster 8 in Air-Cooled Reflector	12	\$217.95

USA MANUFACTURED NON AIR-COOLED - SE

Lumenmax® Reflector



Designed as a high performance commercial reflector for 1000 watt lamps. The vertical burning lamp configuration provides optimal light usage from the lamp. Fixture has 98% reflective German aluminum insert and 95% reflective textured corners for excellent output, uniformity and diffusion. Lightweight all aluminum reflector with a heavy duty powder coated galvanized steel junction box, detachable 15 ft lamp cord at the reflector and ballast. Minor assembly required. Patent Pending No. 29/522,849. Sold to retailers in increments of 3 only. 5 Year Warranty.

Item No.	Description	Plt Qty	MSRP Ea
904774	Lumenmax Reflector 3/Pack - 2/Boxes	12	\$269.95

Agrotech® Magnum Reflector



Lightweight all aluminum reflector with galvanized steel back plate. Made of 95% reflective German aluminum. Comes unassembled and easily sets up in minutes. Detachable 15 ft lamp cord at the reflector and at the ballast. US Patents: D726,116. US Patent Pending: 29/520,168. Chinese Patent: ZL201330582324.7. 5 Year Warranty.

Item No.	Description	Plt Qty	MSRP
904615	Agrotech Magnum Reflector	30	\$145.95

Adjust-A-Wings Avenger Reflectors



The Adjustable Light Spread allows growers to create ideal lighting conditions across all stages of plant growth for increased vitality, health & yield. Made of 95% reflective proprietary German aluminum. Increase the growing area under each lamp by up to 75%. Medium Dimensions: 22 in x 24 in, 25 in, 26 in or 27 in. Large Dimensions: 28 in x 36 in, 37 in, 38 in, 39 in or 40 in. An additional socket assembly can be added to a Large Adjust-A-Wings. Allows operation of two 400 watt MH & HPS lamps or two 600 watt HPS lamps. US Patents: 6,053,624, 6,783,263, 7,156,539. 5 Year Warranty.

Item No.	Description	Plt Qty	MSRP
904535	Adjust-A-Wings Avenger Medium Reflector w/ Cord	72	\$132.95
904540	Adjust-A-Wings Avenger Large Reflector w/ Cord	36	\$166.95
904550	Adjust-A-Wings Avenger Large Reflector No Cord	36	\$149.95
904555	Adjust-A-Wings Socket Assembly w/ Cord	—	\$41.95
904560	Adjust-A-Wings Socket Assembly No Cord	—	\$38.00
904565	Adjust-A-Wings Avenger Large Reflector w/ Cord 6/Pack	84	\$164.95
904910	Adjust-A-Wings Avenger DE Reflector Large	36	\$235.95

ITY ○ PERFORMANCE

Super Spreaders®



Super-Spreader® combines common sense and innovation with advancements in reflective surface technology to produce a Super Light Spreader! The Spreader Heads are made from 95% reflective glass coated aluminum with a prismatic micro-textured surface. By attaching the Super-Spreader® accessory, the Adjust-A-Wings performance may be enhanced significantly.

Item No.	Description	MSRP
904525	Super Spreader Medium	\$29.95
904530	Super Spreader Large	\$36.95



Watch how to assemble the Adjust-A-Wings



Watch how to set up for seasonal settings

The Equalizer® Hot Spot Diffuser

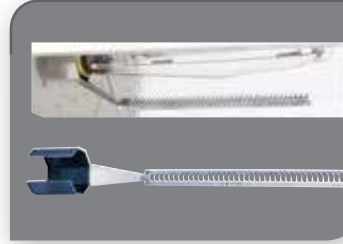

Simply slide this unique product over a mogul base socket on most horizontal burning reflectors to filter and disperse the intense hot spot of light directly under an HID lamp. With the hot spot diffused, you can hang reflectors closer to the plant canopy. Made of 95% reflective German aluminum. US Patent: D583,092. **EXCLUSIVE**

Item No.	Description	MSRP
904430	The Equalizer Hot Spot Diffuser HPS 1000	\$31.95
904435	The Equalizer Hot Spot Diffuser HPS 600/400	\$31.95
904440	The Equalizer Hot Spot Diffuser MH1000/400	\$31.95

IMPORTED REFLECTORS

Where performance meets affordability.

5 YEAR WARRANTY
- REPAIR OR REPLACE -

5



- 1 Galvanized steel housing with a durable, corrosion resistant powder-coated finish.
- 2 Most Sun System® Reflectors include tempered glass, a built-in socket and lamp cord.
- 3 Highly reflective aluminum interior.
- 4 Completely sealed with double gaskets! Swing Stop® retention cable keeps glass from abruptly swinging down. Captured thumb screws & closure mechanism for ease of use and excellent sealing.
- 5 Integrated air-cooled fittings allow for extremely efficient cooling. A bead ring helps to hold ducting firmly in place!

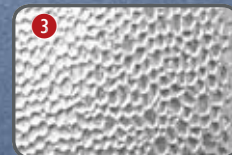

IMPORT AIR-COOLED - SE

PREMIUM REFLECTORS

Dominator XXXL® 6 in & 8 in Air-Cooled Reflectors

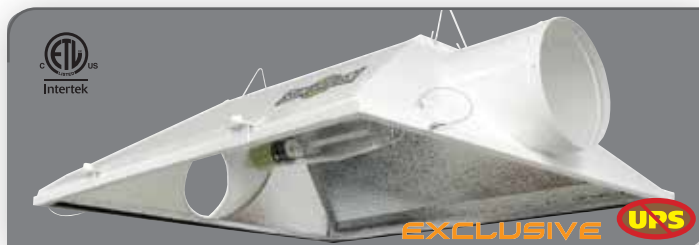

Massive size for increased coverage area and excellent uniformity. Includes tempered glass, removable frame, built-in socket & 15 ft lamp cord. Completely sealed—features gasketed glass and hinged frame to hold glass tightly in place. Powder-coated galvanized steel body. Highly reflective aluminum interior offers excellent reflectivity and diffusion. Air-cooling flanges have a bead ring to keep ducting securely in place. US Patents: D613,900, D698,628. 5 Year Warranty.

Item No.	Description	Pit Qty	MSRP
904415	Dominator XXXL 6 in Air-Cooled Reflector	12	\$209.95
904420	Dominator XXXL 8 in Air-Cooled Reflector	8	\$227.95

SunGro® 6 in & 8 in Air-Cooled Reflectors



The Air-Cooled SunGro® Reflector offers a uniform, square, intense light pattern and is pre-wired with lamp cord and socket. The interior is made from highly reflective aluminum and is completely sealed with neoprene gaskets and hinged glass. US Patents: D570,295, D644,185, D634,469, 7,641,367. 5 Year Warranty.

Item No.	Description	Pit Qty	MSRP
904682	SunGro 6 in Air-Cooled Reflector	12	\$149.95
904684	SunGro 8 in Air-Cooled Reflector	12	\$159.95

PERFORMANCE REFLECTORS

Sun Star® 6 in Air-Cooled Reflector



Completely sealed with double gasketed glass for an air-tight seal. Swing Stop® retention cable keeps glass from abruptly swinging down. 6 inch integrated air-cooled fittings with bead ring. Powder-coated galvanized steel housing. Highly reflective textured aluminum. Includes socket and 15 ft lamp cord. 5 Year Warranty.

Item No.	Description	Pit Qty	MSRP
904885	Sun Star 6 in Air-Cooled Reflector	36	\$90.95

Irradiator® 6 in & 8 in Air-Cooled Reflectors



Completely sealed with double gasketed glass for an air-tight seal. Highly reflective aluminum interior offers excellent reflectivity and diffusion. Swing Stop® retention cable keeps glass from abruptly swinging down. Captured thumb screws & closure mechanism for ease of use and excellent sealing. Integrated air-cooled fittings with bead ring. Powder-coated galvanized steel housing. US Patent: D698,628. 5 Year Warranty.

Item No.	Description	Pit Qty	MSRP
904865	Irradiator 6 in Air-Cooled Reflector	18	\$145.95
904870	Irradiator 8 in Air-Cooled Reflector	24	\$154.95

Yield Master® 6 in & 8 in Air-Cooled Reflectors



Completely sealed featuring hinged glass and double gasket for an air-tight seal. Includes tempered glass, built-in socket and 15 ft lamp cord. Highly reflective aluminum interior for excellent reflectivity and diffusion. Swing Stop® retention cable keeps glass from abruptly swinging down. Powder-coated galvanized steel housing. US Patents: D698,628, D543,652, D613,900. 5 Year Warranty.

Item No.	Description	Pit Qty	MSRP
904425	Yield Master 6 in Air-Cooled Reflector	24	\$112.95
904665	Yield Master 8 in Air-Cooled Reflector	12	\$121.95

IMPORT NON AIR-COOLED - SE

Dominator XXXL® Single Ended Non AC Reflector



Massive size for increased coverage area and excellent uniformity. Powder-coated galvanized steel housing. Highly reflective aluminum interior offers excellent reflectivity and diffusion. Includes unique socket assembly with 15 ft lamp cord that is attached with four wing nuts. Some assembly required. US Patent: D613,900. Sold to retailers in increments of 3 only. 5 Year Warranty.

Item No.	Description	Pit Qty	MSRP Ea
904442	Dominator XXXL Single Ended Non AC Reflector 3/Pack	24	\$162.95

Irradiator® Reflector



Integrated socket and 15 ft lamp cord. Powder-coated galvanized steel housing. Highly reflective aluminum reflector offers excellent diffusion properties. This is a non air-cooled hood that does not accept glass. 5 Year Warranty.

Item No.	Description	Pit Qty	MSRP
904860	Irradiator Reflector	24	\$126.95

Solartech Magnum® Reflector



Lightweight all aluminum reflector with galvanized steel back plate. Made of highly reflective aluminum. Comes unassembled and easily sets up in minutes. Includes socket and 15 ft lamp cord. Does not accept glass. US Patents: D726,116. US Patent Pending: 29/520,168. Chinese Patent: ZL201330582324.7. 5 Year Warranty.

Item No.	Description	Pit Qty	MSRP
904942	Solartech Magnum Reflector	30	\$95.95

Vertical Reflector®

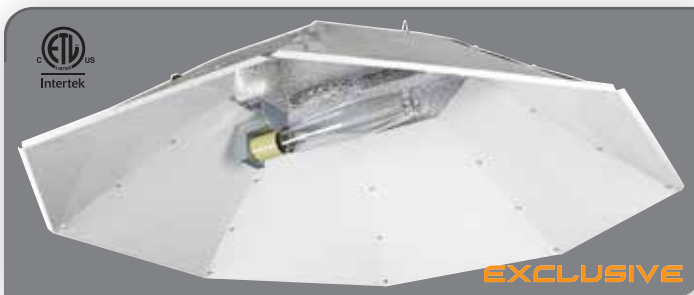

The Vertical Reflector® combines the traditional features of a vertical and horizontal reflector into one exceptional reflector. Brushed aluminum backing and white internal panels features a highly reflective aluminum insert for increased optical efficiency and performance. Reflector dimensions: 48 inch diameter by 10 inch deep. This reflector operates both metal halide (MH) and high pressure sodium (HPS) lamps in the horizontal position of this eight-sided parabolic reflector. Pre-wired with lamp cord and adjustable socket. Does not accept BT56 lamp. US Patent: D545,994. 5 Year Warranty.

Item No.	Description	Pit Qty	MSRP
904060	Vertical Reflector	56	\$159.95

Silver Sun® Reflector

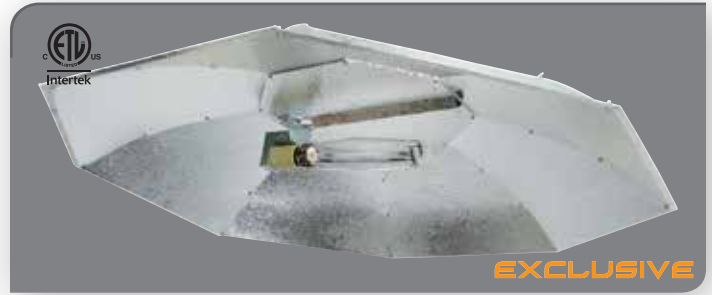

The Silver Sun® combines the features of the traditional vertical and horizontal reflectors into one exceptional reflector made of highly reflective aluminum. Pre-wired with lamp cord and socket. Assembly required. US Patent: D545,994. 5 Year Warranty.

Item No.	Description	Pit Qty	MSRP
904620	Silver Sun Reflector	56	\$135.95

Parabolic Reflector



This reflector is brushed aluminum on the outside and bright white on the inside. It includes our exclusive Adjust-a-Socket mounting bracket. This adjustable bracket allows the user to raise or lower the lamp within the interior of the reflector, to customize the light pattern. Designed to illuminate a large growing area. Assembly required. Shown with optional lamp and socket. 5 Year Warranty.

Item No.	Description	Pit Qty	MSRP
904110	Parabolic 48 in White Reflector	100	\$63.95

IMPORT WING REFLECTORS - SE

Econo Wing Reflector®

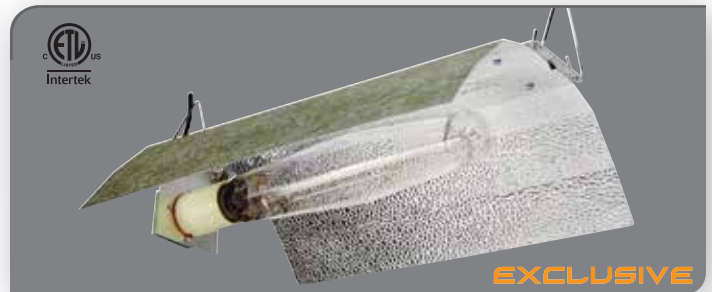

Made with highly reflective textured aluminum and a heavy duty galvanized steel mounting bracket. Corners are rounded — no sharp corners unlike competitive gull-wing type reflectors. Pre-wired with lamp cord and socket. US Patent No: D545,485. 5 Year Warranty.

Item No.	Description	Pit Qty	MSRP
904465	Econo Wing Reflector	72	\$41.95

Econo Wing Reflector® XL

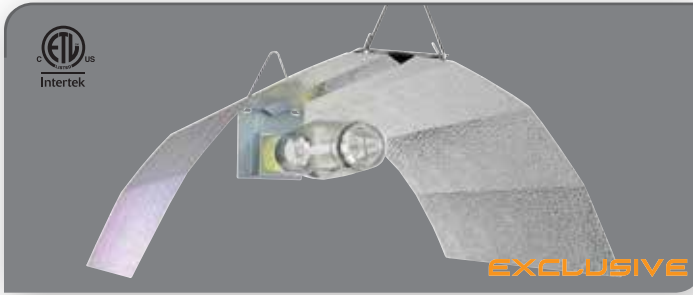

More than twice the size of a standard wing style reflector. Made with highly reflective textured aluminum for excellent output and diffusion. Light weight and easy to hang. Comes completely assembled with prewired socket and lamp cord. Superior photometric performance vs competitive wing reflectors. Heavy duty steel mounting bracket. 5 Year Warranty.

Item No.	Description	Pit Qty	MSRP
904462	Econo Wing Reflector XL	32	\$48.95

Adjust-A-Wings Enforcer Reflectors

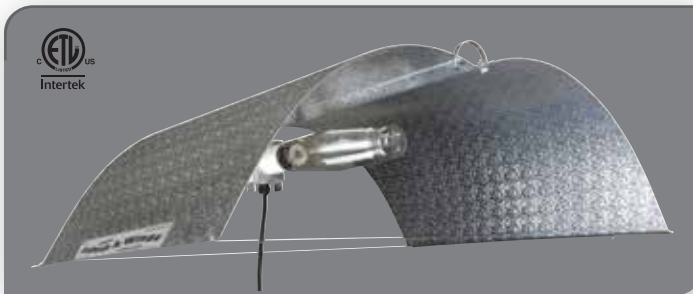

Adjust-A-Wings Enforcer reflectors are made using Chinese reflective made stucco aluminum. They include a molded plastic junction box with socket, pre-wired lamp cord and all parts required for assembly. Wing and socket packaged separately. US Patents: 6,053,624, 6,783,263, 7,156,539. 5 Year Warranty.

Item No.	Description	Pit Qty	MSRP
904730	Adjust-A-Wings Enforcer-Large	36	\$126.95
904735	Adjust-A-Wings Enforcer-Medium	72	\$92.95

Value Wing 8 Pack

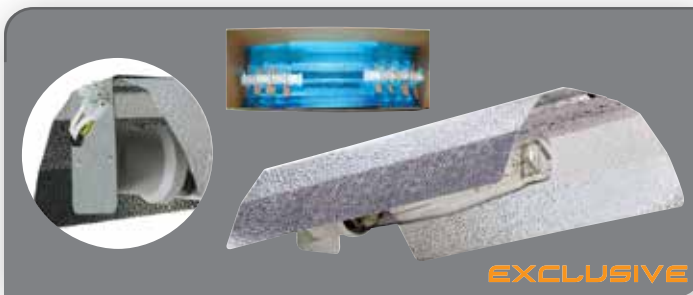

Terminal block for easy attachment of lamp cord. Socket pre-wired into reflector. Purchase 15 ft (903100) or 25 ft (903105) lamp cord separately. **Sold to retailers in increments of 8 only.** 5 Year Warranty.

Item No.	Description	Pit Qty	MSRP Ea
904467	Value Wing 8/Pack	240	\$23.95

REFLECTOR ACCESSORIES - SE

Reflector Replacement Glass Frame Assembly's

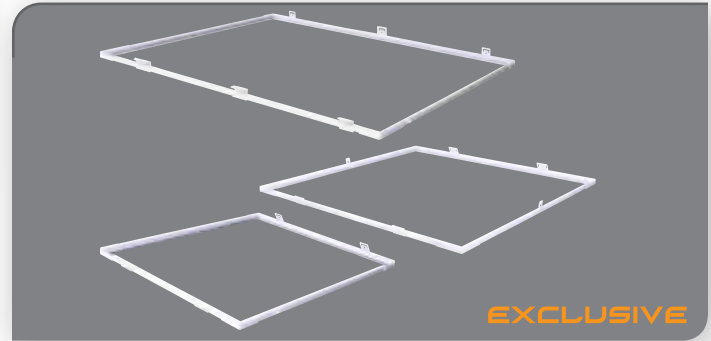

All reflector replacement glass frame assembly's are made to the same exacting standards as your original reflector. Part includes tempered glass attached to metal frame with high bond and high temperature tape.

Item No.	Description	MSRP
640584	Epic 8 in Reflector Replacement Glass Frame Assembly	\$126.95
640281	Magnum XXXL 6 in Gen 3 Replacement Glass Frame Assembly	\$108.95
640282	Magnum XXXL 8 in Gen 3 Replacement Glass Frame Assembly	\$108.95
640796	BlockBuster 6 in & 8 in Gen 3 Replacement Glass Frame Assembly	\$108.95
640689	AC/DE 8 in Replacement Glass Frame Assembly	\$108.95
640272	Dominator 6 in & Magnum XXXL 6 in Gen 2 Replacement Glass Frame Assembly	\$108.95
640273	Dominator 8 in & Magnum XXXL 8 in Gen 2 Replacement Glass Frame Assembly	\$108.95
640274	SunGro 6 in & 8 in Blockbuster 6 in & 8 in Gen 2 Replacement Glass Frame Assembly	\$108.95
640483	Irradiator Replacement Glass Frame Assembly	\$90.95
640271	Yield Master 6 in Replacement Glass Frame Assembly	\$90.95
640270	Yield Master 8 Replacement Glass Frame Assembly	\$90.95
640537	Sun Star 6 in Replacement Glass Frame Assembly	\$72.95
640892	Evolution 8 Replacement Glass Frame Assembly	\$90.95
641065	Magnum Low Pro XXXL Replacement Glass Frame Assembly NEW	\$108.95

Lamp & Reflector Cleaning Cloth



All light bulbs need to be wiped clean of finger prints after installation. Our micro fiber lamp cleaning cloth is perfect for doing this. Removes finger prints and dust from lamps, glass, light fixtures, etc.

Item No.	Description	MSRP
901475	Lamp & Reflector Cleaning Cloth	\$2.79

GAVITA REFLECTORS - SE

Gavita TripleStar 600 Reflector



Rugged, compact design that is adjustable to 3 different positions: Wide, medium and deep. For every position the efficiency is better than 90%. The three Miro Aluminum reflector plates are replaceable.

Item No.	Description	MSRP
906005	Gavita TripleStar 600 Reflector	\$139.95
906010	Gavita TripleStar 600 Inlay Reflector Kit	\$34.95

Gavita HortiStar 600 SE Reflector

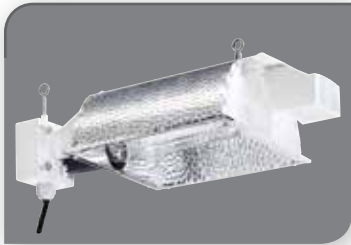

HortiStar 600 has 95% Miro aluminum reflector that can be replaced easily. This fixture is suitable for HPS and MH lamps 600 watt to 750 watts. The lamp cord terminal is shielded by a metal housing. Comes with 13 ft lamp cord.



Item No.	Description	MSRP
906015	Gavita HortiStar 600 SE Reflector	\$99.95
906017	Gavita HortiStar HR 96 600 SE Reflector Replacement	\$37.50

Hydro Innovations™ Ice Box Wall Mount Brackets



Use to mount Ice Box to the wall or ceiling. Complete wall mount kit that includes the bracket and ducting coupler.

Item No.	Description	MSRP
904491	Hydro Innovations Ice Box 6 in Wall Mount Bracket	\$24.95
904494	Hydro Innovations Ice Box 8 in Wall Mount Bracket	\$34.95

Hydro Innovations™ Ice Box 6 in & 8 in



The Ice Box is a high-quality, cold water circulated heat-exchanger with housing designed to install over a 6 in or 8 in air-cooled reflector duct flange. Air is passed through the reflectors with an inline fan & then passed over the Ice Box heat exchanger.

Item No.	Description	MSRP
904490	Hydro Innovations Ice Box 6 in	\$149.95
904493	Hydro Innovations Ice Box 8 in	\$199.95

www.sunlightsupply.com

SUN SYSTEM

America's #1 brand of horticultural lighting fixtures



REFLECTOR QUICK REFERENCE GUIDE - SE

Description	Part No.	Integrated Air Cooled Fittings	Built In Socket & Lamp Cord	Glass Part No	Glass Retention	Reflectivity	Lamp Position	Assembly Required	Fabricated In USA	Pallet Count	Weight	Dimensions Long x Wide x High
Adjust-A-Wings Avenger Large Reflector No Cord	904550	No	Socket	N/A	N/A	95%	Horizontal	Yes	Yes	36	5.7	27.6" x 39.5" x up to 40"
Adjust-A-Wings Avenger Large Reflector w/ Cord	904540	No	Yes	N/A	N/A	95%	Horizontal	Yes	Yes	36	7.2	27.6" x 39.5" x up to 40"
Adjust-A-Wings Avenger Large Reflector w/ Cord 6/Pack	904565	No	Yes	N/A	N/A	95%	Horizontal	Yes	Yes	84	7.2	27.6" x 39.5" x up to 40"
Adjust-A-Wings Avenger Medium Reflector w/ Cord	904535	No	Yes	N/A	N/A	95%	Horizontal	Yes	Yes	72	4.7	21.7" x 27.0" x 27"
Adjust-A-Wings Enforcer-Large	904730	No	Yes	N/A	N/A	80%	Horizontal	Yes	No	36	7.2	27.6" x 39.5" x up to 40"
Adjust-A-Wings Enforcer-Medium	904735	No	Yes	N/A	N/A	80%	Horizontal	Yes	No	72	4.7	21.7" x 27.0" x 27"
Agrotech Magnum Reflector	904615	No	Yes	N/A	N/A	95%	Horizontal	Yes	Yes	30	5.6	34.3" x 29.1" x 8.3"
BlockBuster 6 in Air-Cooled Reflector	904650	Yes - 6"	Yes	640796	Hinged	95%	Horizontal	No	Yes	12	23.0	29.9" x 25.6" x 9.9"
BlockBuster 8 in Air-Cooled Reflector	904655	Yes - 8"	Yes	640796	Hinged	95%	Horizontal	No	Yes	12	23.0	31.0" x 25.6" x 9.9"
Dominator XXXL Single Ended Non AC Reflector	904442	No	Yes	N/A	N/A	86%	Horizontal	No	No	24	20.0	34.8" x 29.5" x 8.8"
Dominator XXXL 6 in Air-Cooled Reflector	904415	Yes - 6"	Yes	640272	Hinged	86%	Horizontal	No	No	12	29.0	36.5" x 26.4" x 8.5"
Dominator XXXL 8 in Air-Cooled Reflector	904420	Yes - 8"	Yes	640273	Hinged	86%	Horizontal	No	No	8	36.0	39.4" x 29.9" x 9.3"
Econo Wing Reflector	904465	No	Yes	N/A	N/A	86%	Horizontal	No	No	72	4.2	21.1" x 13.3" x 4.4"
Econo Wing Reflector XL	904462	No	Yes	N/A	N/A	86%	Horizontal	No	No	32	4.9	21.0" x 24.6" x 7.6"
Epic 8 in Air-Cooled Reflector	904880	Yes - 8"	Yes	640584	Hinged	98 & 95%	Horizontal	No	Yes	6	38.5	44.9" x 32.7" x 11.4"
Evolution 8 in Air-Cooled Reflector	904930	Yes - 8"	Yes	640892	Hinged	98 & 95%	Horizontal	No	Yes	12	24.9	36.5" x 25.5" x 10.6"
Irradiator Reflector	904860	No	Yes	N/A	N/A	86%	Horizontal	No	No	24	18.0	22.4" x 21.0" x 8.8"
Irradiator 6 in Air-Cooled Reflector	904865	Yes - 6"	Yes	640483	Hinged	86%	Horizontal	No	No	18	18.2	27.3" x 21.3" x 9.2"
Irradiator 8 in Air-Cooled Reflector	904870	Yes - 8"	Yes	640483	Hinged	86%	Horizontal	No	No	24	18.5	27.9" x 21.3" x 9.2"
Lumenmax Reflector 3/Pack	904774	No	Yes	N/A	N/A	98 & 95%	Vertical	Yes	Yes	12	5.8	29.2" x 29.2" x 18.4"
Magnum Low Pro XXXL 8 in Air Cooled Reflector	904770	Yes - 8"	Yes	641065	Hinged	95%	Horizontal	No	Yes	15	29.0	41.0" x 30.0" x 5.6"
Magnum XXXL 6 in Air-Cooled Reflector	904520	Yes - 6"	Yes	640281	Hinged	95%	Horizontal	No	Yes	12	26.0	36.1" x 26.5" x 9.6"
Magnum XXXL 8 in Air-Cooled Reflector	904515	Yes - 8"	Yes	640282	Hinged	95%	Horizontal	No	Yes	12	30.4	39.9" x 29.9" x 10.0"
Parabolic 48 in White Reflector	904110	No	Yes	N/A	N/A	86%	Vertical	Yes	No	100	6.4	48.0" x 48.0" x 8.0"
Silver Sun Reflector	904620	No	Yes	N/A	N/A	86%	Horizontal	Yes	No	56	8.5	49.3" x 49.3" x 7.8"
Solartech Magnum Reflector	904942	No	Yes	N/A	N/A	86%	Horizontal	Yes	No	30	5.0	34.3" x 29.1" x 8.3"
Sun Star 6 in Air-Cooled Reflector	904885	Yes - 6"	Yes	640537	Hinged	86%	Horizontal	No	No	36	12.3	24.1" x 12.8" x 8.4"
SunGro 6 in Air-Cooled Reflector	904682	Yes - 6"	Yes	640274	Hinged	86%	Horizontal	No	No	12	25.7	28.0" x 25.7" x 9.8"
SunGro 8 in Air-Cooled Reflector	904684	Yes - 8"	Yes	640274	Hinged	86%	Horizontal	No	No	12	25.7	28.8" x 25.7" x 9.8"
Value Wing 8/Pack	904467	No	Socket	N/A	N/A	86%	Horizontal	Yes	No	240	1.9	18.6" x 14.8" x 4.8"
Vertizontal Reflector	904060	No	Yes	N/A	N/A	86%	Horizontal	Yes	No	56	10.1	49.3" x 49.3" x 7.8"
Yield Master 6 in Reflector	904425	Yes - 6"	Yes	640271	Hinged	86%	Horizontal	No	No	24	17.1	23.9" x 22.6" x 7.4"
Yield Master 8 in Air-Cooled Reflector	904665	Yes - 8"	Yes	640270	Hinged	86%	Horizontal	No	No	12	20.1	25.0" x 24.6" x 9.6"

Sun System® Harvest Pro® Ballasts



Exclusive EZ Cap® Door for easy capacitor replacement

Dual Universal Lamp Cord Receptacle

400/600/1000 Watt 120V/240V

1000 Watt 277 & 480 Volt



Our Harvest Pro® ballast with dual input voltage easily switches from 120 to 240 volt power! Simply unplug detachable 8 foot 120 volt power cord (included), turn power plate around for 240 volt power and plug in a 240 volt power cord. (240 volt power cord sold separately, Part #903082). Dual universal lamp cord receptacle is compatible with all Sun System® brand reflectors as well as other branded reflectors. Louvered end plates and heat slots help cool the ballast for years of trouble-free use! Aluminum ballast enclosure is engineered to dissipate heat and keep components cool. Heavy duty handle for easy carrying or wall hanging. A barrier wall between ballast and the capacitor/ignitor helps keep the critical components cool. The capacitor and ignitor temperatures are greatly reduced by being separate from the ballast core. Lower temperatures mean better reliability & longer life. Uses high quality capacitor using German sourced film to ensure long lasting durability. EZ Cap® Door offers easy access to the capacitor in

the event it needs to be replaced. 902449 and 902452 have a 2 year warranty, 5 Year Warranty.

Item No.	Description	MSRP
902444	Harvest Pro Switchable 400 Watt Ballast	\$179.95
902435	Harvest Pro HPS 600 Watt Ballast	\$193.95
902441	Harvest Pro Switchable 1000 Watt Ballast	\$197.95
902452	Harvest Pro Switchable 1000 Watt Ballast - 277 Volt	\$221.95
902449	Harvest Pro Switchable 1000 Watt Ballast - 480 Volt	\$229.95

Sun System® Hard Core® Ballasts



Dual Input Voltage for 120V or 240V

Dual Universal Lamp Cord Receptacle

Exposed ballast design is compact and runs cool! Hard Core® offers superior cooling capabilities while extending the longevity of the capacitor and ignitor. Dual universal lamp cord receptacle is compatible with all Sun System® brand reflectors as well as other branded reflectors. Our Hard Core® ballast with dual input voltage easily switches from 120 to 240 volt power! Simply unplug detachable 8 foot 120 volt power cord (included), turn power plate around for 240 volt power and plug in a 240 volt power cord. (240 volt power cord sold separately, Part #903082). Powder-coated steel housing with louvered venting and solid design helps protect internal components. Rubber feet reduce noise and vibration. Excellent

ballast quality with high temp 150°C wire connections will provide years of trouble-free operation. Removable stainless steel handles allow easy handling. 2 Year Warranty.

Item No.	Description	MSRP
902645	Sun System Hard Core HPS 600 Watt 120/240 Volt	\$137.95
902650	Sun System Hard Core HPS/MH 1000 Watt 120/240 Volt	\$137.95

Sun System® Hard Core® 277 Volt Ballast



Exposed ballast design is compact and runs cool! Hard Core® offers superior cooling capabilities while extending the longevity of the capacitor and ignitor. Dual universal lamp cord receptacle is compatible with all Sun System® brand reflectors as well as other branded reflectors. Powder-coated steel housing with louvered venting and solid design helps protect internal components. Rubber feet reduce noise & vibration. Excellent ballast quality with high temp 150°C wire connections will provide years of trouble-

free operation. Removable stainless steel handles allow easy handling. Ballast is hardwired with an eight foot 277 volt power cord including a L7-15p twist lock plug. 2 Year Warranty.

Item No.	Description	MSRP
902655	Sun System Hard Core Ballast HPS/MH 1000 Watt 277 Volt	\$163.95

Sun System® Hard Core® 480 Volt Ballast



Exposed ballast design is compact and runs cool! Hard Core® offers superior cooling capabilities while extending the longevity of the capacitor and ignitor. Dual universal lamp cord receptacle is compatible with all Sun System® brand reflectors as well as other branded reflectors. Powder-coated steel housing with louvered venting and solid design helps protect internal components. Rubber feet reduce noise & vibration. Excellent ballast quality with high temp 150°C wire connections will provide years of trouble-

free operation. Removable stainless steel handles allow easy handling. Ballast is hardwired with an eight foot 480 volt power cord does not include plug. 2 Year Warranty.

Item No.	Description	MSRP
902657	Sun System Hard Core Ballast HPS/MH 1000 Watt 480 Volt	\$177.95

Galaxy® DE Electronic Ballast - 120/240 Volt

GALAXY®

DE OPTIMIZED FOR DOUBLE-ENDED LAMPS

NEW EXCLUSIVE

SELECT-A-WATT®

600/750/875/1000 Watt

FEATURES

▶ Turbo Charge®

INCREASE OUTPUT BY APPROXIMATELY 10%
1000 WATT LAMP ONLY





NEW DUAL UNIVERSAL LAMP CORD RECEPTACLE

FC

ETL Intertek

120V / 240V

SOFT STARTING

QUIET OPERATION

3 YEAR WARRANTY

ENERGY EFFICIENT

Features High Frequency 105 kHz Microprocessing Technology for Running Double Ended Lamps

galaxyballasts.com

Features high frequency of 105 kHz microprocessing technology for running double-ended lamps. This Galaxy® DE Select-A-Watt® ballast can operate a 1000 watt lamp at 600, 750, 875, 1000 watts and Turbo Charge®. This ballast will properly drive 600, 750 and 1000 watt lamps. Set the desired wattage on the Select-A-Watt® dial and install the correct lamp. Very quiet operation and limited vibration. It has a thermally optimized non-fan cooled aluminum housing. Galaxy® DE ballast comes pre-wired with a dual universal lamp cord receptacle that is compatible with all Sun System® brand reflectors as well as

other branded reflectors. Includes a 6 foot 120 volt power cord. Purchase a 240 volt power cord separately (#903088). 3 Year Warranty.

Item No.	Description	MSRP
902682	Galaxy DE Select-A-Watt 600/750/875/1000/1150 - 120/240 Volt	\$306.95

Galaxy® DE Electronic Ballast - 277 Volt

GALAXY®

DE OPTIMIZED FOR DOUBLE-ENDED LAMPS

NEW EXCLUSIVE

SELECT-A-WATT®

600/750/875/1000 Watt

277 Volt

FEATURES

▶ Turbo Charge®

INCREASE OUTPUT BY APPROXIMATELY 10%
1000 WATT LAMP ONLY





Dual Universal Lamp Cord Receptacle

FC

ETL Intertek

277V ONLY

SOFT STARTING

QUIET OPERATION

3 YEAR WARRANTY

ENERGY EFFICIENT

Features a hard-wired 6 foot 277 volt power cord with a L7-15p twist lock plug

Features High Frequency 105 kHz Microprocessing Technology for Running Double Ended Lamps

galaxyballasts.com

This 1000 watt Galaxy® DE operates on 277 volt power and features high frequency 105 kHz microprocessing technology for running double-ended lamps. This Galaxy® DE Select-A-Watt® ballast can operate a 1000 watt lamp at 600, 750, 875, 1000 watts and Turbo Charge®. This ballast will properly drive 600, 750 and 1000 watt lamps. Set the desired wattage on the Select-A-Watt® dial and install the correct lamp. Very quiet operation and limited vibration. It has a thermally optimized non-fan cooled aluminum housing. Galaxy® DE ballast comes pre-wired with a dual universal lamp cord receptacle that

is compatible with all Sun System® brand reflectors as well as other branded reflectors. Includes a hard-wired 6 foot 277 volt power cord with a L7-15p 277 volt twist lock plug. 3 Year Warranty.

Item No.	Description	MSRP
902684	Galaxy DE Select-A-Watt 600/750/875/1000/1150 - 277 Volt Only	\$306.95

Galaxy® Grow Amp® Electronic Ballasts

GALAXY

GROW AMP™

EXCLUSIVE

SELECT-A-WATT®

400/600/1000 Watt

FEATURES

▶

Turbo Charge®

INCREASE OUTPUT BY APPROXIMATELY 10%

1000 WATT LAMP ONLY

Industry's Lowest RFI Broadband Emissions

NEW DUAL UNIVERSAL LAMP CORD RECEPTACLE









120V / 240V

SOFT STARTING

LIGHTWEIGHT

3 YEAR WARRANTY

99.9% EFFICIENT

galaxyballasts.com

Galaxy® Grow Amp ballasts are engineered to properly power every major brand lamp in the industry. They are compatible with metal halide, single-ended HPS and double-ended HPS lamps. The 1000 watt ballast can operate a 1000 watt lamp at 600, 750, 1000 watts and Turbo Charge®. It will also properly operate 600 and 750 watt lamps. The 750 watt ballast can operate a 750 watt lamp at 600, 750 watts & Turbo Charge®. It will also properly operate a 600 watt lamp. The 600 watt ballast can operate a 600 watt lamp at 400, 600 watts & Turbo Charge®. It will also properly operate a 400 watt lamp. All Grow Amp's come pre-wired with a dual universal lamp cord receptacle that is compatible with all Sun System® brand reflectors as well as other branded reflectors. The 120/240 volt models come standard with a 6 foot 120 volt power cord. Purchase a 240 volt power cord separately (903088). The 240 V model (902225) comes

standard with a 240 V power cord. Grow Amp's are extremely efficient at 99.9%. High-quality extruded aluminum housings. The 120/240 volt models are fan cooled for excellent thermal management. The 240 V model is not fan cooled. These ballasts are lightweight and very quiet. US Patents: D725,820 D698,074. US Patent Pending: 29/500,576. 3 Year Warranty.

Item No.	Description	MSRP
902215	Galaxy Grow Amp 600 Watt 400/600/Turbo Charge - 120/240 Volt	\$252.95
902220	Galaxy Grow Amp 1000 Watt 600/750/1000/Turbo Charge - 120/240 Volt	\$288.95
902225	Galaxy Grow Amp 1000 Watt 600/750/1000/Turbo Charge - 240 Volt Only	\$279.95

Galaxy® Grow Amp® Electronic Ballast - 277 Volt

GALAXY

GROW AMP®

EXCLUSIVE

SELECT-A-WATT®

600/750/1000 Watt

277 Volt

FEATURES

▶

Turbo Charge®

INCREASE OUTPUT BY APPROXIMATELY 10%

1000 WATT LAMP ONLY

Industry's Lowest RFI Broadband Emissions

NEW DUAL UNIVERSAL LAMP CORD RECEPTACLE









277 VOLT ONLY

SOFT STARTING

LIGHTWEIGHT

3 YEAR WARRANTY

99.9% EFFICIENT

#galaxyballasts
galaxyballasts.com

This 1000 watt Galaxy® Grow Amp operates on 277 volt power. The Select-A-Watt® feature allows the ballast to operate a 1000 watt lamp at 600, 750 or 1000 watts and Turbo Charge®. It will also properly operate a 600 and 750 watt lamps. Dual universal lamp cord receptacle is compatible with all Sun System® brand reflectors as well as other branded reflectors. It features a hard-wired 6 foot 277 volt power cord with a L7-15p twist lock plug. Grow Amp's are extremely efficient - 99.9%, soft starting,

feature an extruded aluminum housing, are very quiet and lightweight. 3 Year Warranty.

Item No.	Description	MSRP
902227	Galaxy Grow Amp 1000 Watt 600/750/1000/Turbo Charge - 277 Volt Only	\$288.95

Galaxy® Legacy® Electronic Ballast

GALAXY®

LEGACY® ELECTRONIC BALLAST

EXCLUSIVE

SELECT-A-WATT®

600/750/1000 Watt

FEATURES

Turbo Charge®

INCREASE OUTPUT BY APPROXIMATELY 10%

1000 WATT LAMP ONLY

NEW DUAL UNIVERSAL LAMP CORD RECEPTACLE

120V / 240V

SOFT STARTING

LIGHTWEIGHT

3 YEAR WARRANTY

99.9% EFFICIENT

galaxyballasts.com

This Galaxy® Select-A-Watt® ballast can operate a 1000 watt lamp at 600, 750, 1000 watts and Turbo Charge®. This ballast will properly drive 600, 750 & 1000 watt lamps. Set the desired wattage on the Select-A-Watt® dial and install the correct lamp. Comes pre-wired with a dual universal lamp cord receptacle that is compatible with all Sun System® brand reflectors as well as other branded reflectors. Includes a 6 foot 120 volt power cord. Purchase a 240 volt power cord separately (#903082). The Legacy® ballast runs on 120 or 240 volt power. This ballast has an extruded aluminum housing that is very

lightweight. It features soft starting and fan cooling. The Legacy® ballast is extremely efficient at 99.9%. This state-of-the-art ballast is manufactured to provide today's serious grower with maximum flexibility & performance. 3 Year Warranty.

Item No.	Description	MSRP
902518	Galaxy Legacy 600/750/1000 Turbo Charge Electronic Ballast - 120/240 Volt	\$252.95

Galaxy Digital Logic® Electronic Ballast

GALAXY®

DIGITAL LOGIC™

EXCLUSIVE

400/600/1000 Watt

+ Turbo Charge®

BUILT-IN Digital Timer

WITH 7 PRESET LIGHTING CYCLES

SPECIAL FEATURE

Thermally optimized non-air cooled aluminum housing

New Dual Universal Lamp Cord Receptacle

Features our proprietary Intelligent Control Interface™.

120V / 240V

SOFT STARTING

EXTREMELY RELIABLE

3 YEAR WARRANTY

99% POWER FACTOR

galaxyballasts.com

Galaxy Digital Logic® Ballast feature our proprietary Intelligent Control Interface™. This smart interface allows control of pre-programmed timing settings, lamp dimming, Turbo Charge® activation, self-diagnostic feature with easily identified error codes and an hour meter to monitor the age of your lamp. This is displayed with a green LED panel on the end of the ballast. Low current, staggered ignition delay feature eliminates circuit inrush overload and protects lamp for increased lumen maintenance. Internal ballast programming will protect unit in instance of open circuit, short circuit, over/under voltage or high temperature exposure. Thermally optimized non-air cooled aluminum housing. Dual universal lamp cord

receptacle is compatible with all Sun System® brand reflectors as well as other branded reflectors. The optional remote control #902234 can be used for integrated timer programming and operation. Control multiple units with one remote control (sold separately). 3 Year Warranty.

Item No.	Description	MSRP
902232	Galaxy Digital Logic 1000 Watt Select-A-Watt 400/600/1000 - Turbo Charge - 120/240 Volt	\$270.95

Galaxy Digital Logic® Wireless Remote Control



Galaxy Digital Logic® wireless remote control allows ballast configuration and setup. Pre-programmed cycle settings with digital timer integration. The Galaxy® wireless remote control allows you to setup and configure your ballast(s). Sync multiple Galaxy Digital Logic® Ballasts to the same schedule. Includes the Turbo Charge® setting for maximum output. Easy to use LCD display. **EXCLUSIVE**

Item No.	Description	MSRP
902234	Galaxy Digital Logic 1000 Watt Remote Control	\$19.95

Sun System®
www.sunlightsupply.com

INNOVATING SINCE 1995

Gavita Pro Classic Line 600 SE Complete Fixture 240 Volt



Professional 600 watt high frequency electronic ballast. Including high efficiency Miro aluminum horticultural HortiStar HR96 reflector (96% efficiency). Only suitable for use with 600 watt EL lamp (included): No acoustic resonance, up to 8% more grow light and light maintenance after 5000 hours >95%. Microprocessor controlled. Driver efficiency >95%. Sealed housing with Gore-Tex ventilation plug. Reflector easily replaceable. Very low heat dissipation and very low weight. LED status indicator. Comes with 8 ft power cord. Operates at 240 Volts. 1 year warranty on the lamp. 3 Year Warranty.

Item No.	Description	MSRP
906045	Gavita Pro Classic 600 SE Complete Fixture 240 Volt	\$425.95

Gavita Pro Classic Line 1000 DE Complete Fixture 240 Volt



Professional 1000 watt high frequency electronic ballast. Including high efficiency Miro aluminum horticultural HortiStar HR96 reflector (95% efficiency). Includes 1000 watt double ended EL lamp. Microprocessor controlled with electronic safety circuit. Very low heat dissipation and very low weight. Only suitable for use with 1000 watt double ended EL lamps: No acoustic resonance, more than 10% grow light compared to traditional lamps and light maintenance after 5000 hours >95%. Electronics by Gavita. Driver efficiency >95% and is adjustable to: 600/660/750/825/1150W. Sealed housing with Gore-Tex ventilation plug. Reflector is easily replaceable. Comes with 8 ft power cord. Operates at 240 volts. 1 year warranty on the lamp. 3 Year Warranty.

Item No.	Description	MSRP
906050	Gavita Pro Classic 1000 DE Complete Fixture 240 Volt	\$599.95

Gavita Pro Classic Line 1000 DE Complete Fixture 277 Volt



Professional 1000 watt high frequency electronic ballast. Including high efficiency Miro aluminum horticultural HortiStar HR96 reflector (95% efficiency). Includes 1000 watt double ended EL lamp. Microprocessor controlled with electronic safety circuit. Very low heat dissipation and very low weight. Only suitable for use with 1000 watt double ended EL lamps: No acoustic resonance, more than 10% grow light compared to traditional lamps and light maintenance after 5000 hours >95%. Electronics by Gavita. Driver efficiency >95%. Sealed housing with Gore-Tex ventilation plug. Reflector is easily replaceable. Comes with 6 ft power cord (10 ft power cord available by special order) that is not attached and has an open wire end. Eye bolts and nuts included for hanging. 906089 operates at 277 volts. 906094 (special order) operates at 400 volts. 1 year warranty on the lamp. 3 Year Warranty.

Item No.	Description	MSRP
906089	Gavita Classic 1000 Pro DE 277 Volt	\$599.95
906193	Gavita Classic 277 Volt Wieland Cordset 6 ft 6 in	\$14.95
906195	Gavita Classic 277 Volt Wieland Cordset 10 ft 6 in	\$16.95

Gavita Pro 600e SE E-Series Complete Fixture - 120/240 Volt



The Gavita Pro 600e SE is part of the new Gavita e-series fixtures that are suitable for remote control with the Gavita Master Controllers. Equipped with a 1190 $\mu\text{mol s}^{-1}$ 600W 400V electronic high frequency lamp it produces more light than any other 600W fixture. Suitable for lighting a 11 sq ft area with average 1000 $\mu\text{mol s}^{-1} \text{m}^{-2}$. Unit includes a 240 V power cord. A 120 V cord can be purchased separately. 1 year warranty on the lamp. 3 Year Warranty.

Item No.	Description	MSRP
906086	Gavita Pro 600e SE (300-660 Watt) 120/240 Volt	\$489.99

Gavita Pro 6/750e DE Flex E-Series Complete Fixture - 120/240 Volt



The new Gavita 6/750W 400V EL DE lamp has an efficiency of 2 $\mu\text{mol s}^{-1}$ per Watt in a wide control range of 600-825W. When necessary it can be dimmed down to 375W. Of course it is suitable for the Gavita Master Controller, eliminating the need for timers and contactors. This fixture is suitable for lighting a 15 sq ft area with 1000 $\mu\text{mol s}^{-1} \text{m}^{-2}$. Unit includes a 240 V power cord. A 120 V cord can be purchased separately. 1 year warranty on the lamp. 3 Year Warranty.

Item No.	Description	MSRP
906087	Gavita Pro 6/750e DE Flex (400-825 Watt) 120/240 Volt	\$569.99

Gavita Pro 1000e DE E-Series Complete Fixture - 120/240 Volt



The Pro 1000e DE is the new e-series flagship model. Together with the Pro 1000e DE Gavita also introduces its Pro plus 1000W Electronic lamp, with 2100 $\mu\text{mol s}^{-1}$ output. So now you have a choice of lamps as well. You can control up to 80 fixtures with a Gavita Master controller without the need for timers and contactors. The Pro 1000e can light 21 sq ft with 1000 $\mu\text{mol s}^{-1} \text{m}^{-2}$. Unit includes a 240 V power cord. A 120 V cord can be purchased separately. 1 year warranty on the lamp. 3 Year Warranty.

Item No.	Description	MSRP
906088	Gavita Pro 1000e DE (600-1150 Watt) 120/240 Volt	\$649.99

Gavita Master Controllers



The Gavita EL controller series currently comprises of two models: The EL1 and EL2. Both feature auto-dim, auto-shutdown, sunrise/sunset and timer. The EL1 has one output channel, while the EL2 has 2 output channels and additional outputs for External Contactor Modules and alarm contacts. 3 year Warranty.

Item No.	Description	MSRP
906080	Gavita Master Controller EL1	\$279.00
906081	Gavita Master Controller EL2	\$359.00

Gavita ECM1 - External Contactor Modules



External Contactor Module (15A) with blue indication LED follows lights-on for main channel. Use ECMs to switch CO₂, fertigation, heating etc. during lights-on or lights-off cycle. ECMs can be positioned close to the actual accessories. Cable outputs with female and male connector allow easy connection of accessories. 3 year Warranty.

Item No.	Description	MSRP
906082	Gavita ECM1 US 120 - External Contactor Module 120 Volt Plugs	\$99.50
906083	Gavita ECM1 US 240 - External Contactor Module 240 Volt Plugs	\$99.50

Gavita Interconnect Cables



NEW Gavita E-series interconnect cables are used to supply controller signal from ballast to additional ballasts (daisy chain), for use with the Gavita Master Controllers (EL1 & EL2). These come in 2, 5, 8 and 10 foot configurations to best fit your specific application.

Item No.	Description	MSRP
906180	Gavita Interconnect Cables RJ14 / RJ14 2 ft / 60 cm	\$4.20
906181	Gavita Interconnect Cables RJ14 / RJ14 5 ft / 150 cm	\$5.20
906182	Gavita Interconnect Cables RJ14 / RJ14 8 ft / 240 cm	\$6.20
906183	Gavita Interconnect Cables RJ14 / RJ14 10 ft / 300 cm	\$7.20

Gavita Controller Cables



NEW Gavita Controller Cables attach the Gavita Master controller (EL1 & EL2) to the Gavita E-Series ballast. These come in 5, 16 and 25 foot configurations to best fit your specific application.

Item No.	Description	MSRP
906184	Gavita Controller Cable RJ9 / RJ14 5 ft / 150 cm	\$5.50
906185	Gavita Controller Cable RJ9 / RJ14 16 ft / 5 m	\$9.20
906186	Gavita Controller Cable RJ9 / RJ14 25 ft / 7.5 m	\$12.00

Gavita 3 Way RJ14 Cable Splitter



NEW The 3 way cable splitter is needed to connect the Gavita Master Controller to your E-Series ballasts when running ballasts inline. Used with Gavita E-series interconnect cables.

Item No.	Description	MSRP
906187	Gavita 3 Way RJ14 Cable Splitter	\$5.00

Gavita ECM Controller Cable



NEW The ECM connect cable is used to connect an ECM1 (External Contactor Modules) to the Gavita Master Controller.

Item No.	Description	MSRP
906188	Gavita ECM - Controller Cable 10 ft / 3 m	\$6.00

Gavita Temperature Probe EL Controller Cable



NEW Replacement temperature probe for the Gavita Master Controller (EL1 & EL2).

Item No.	Description	MSRP
906189	Gavita Temperature Probe EL Controller Cable 5 m	\$17.50

Gavita Replacement Power Supply EL Controllers



NEW Replacement 120V power supply for the Gavita Master Controller (EL1 & EL2).

Item No.	Description	MSRP
906190	Gavita Power Supply US Version 120 Volt	\$20.00

Check out our **EXCLUSIVE**

**LIGHTING
LAYOUT TOOL**

Easily determine the
lighting configuration
in your growing space.



Eye Hortilux® Gold E-Ballasts



Designed by experts in lamp-ballast compatibility, the Eye Hortilux® Gold Series e-Ballasts provide consistent, stable power to the lamp for high intensity and a quality spectrum. These ballasts feature lamp detection for safe operation (open & short circuit protection), soft start technology, silent, high frequency sine wave operation, cool operating temperature and a long range igniter (up to 70 feet). Designed to extend the life of your lamp, the Gold Series e-Ballasts operate Hortilux Super HPS, Hortilux Blue and Hortilux e-Start Metal Halide Lamps. Generator ready, flip box ready and completely sealed

against dust and moisture, these ballasts are also UL listed for fire and electrical safety. 120V cord included (240V cord may be purchased separately). 3 Year Warranty.

Item No.	Description	MSRP
902582	Eye Hortilux Gold 1000 Watt E-Ballast 120/240 Volt	\$399.95
902584	Eye Hortilux Gold 600 Watt E-Ballast 120/240 Volt	\$249.95

We go to great lengths to insure you get the best quality equipment possible!



**All Galaxy
Ballasts are FCC
Certified.
What does that
mean?**

We had them tested at an independent lab, Northwest EMC, which has the certification below:
FCC – Designated by the FCC as a Telecommunications Certification Body (TCB). Certification chambers, Open Area Test Sites, and conducted measurement facilities are listed with the FCC.

Products are tested in the actual application they will be used. These photos are from the testing report. Download these reports from our website or scan QR code to see for yourself!



Sun System® Grow Beast™ - 1000 DE + 2 LEC® 315's

GROW BEAST™

RUNS 2 LEC 315'S AND 1 DOUBLE-ENDED LAMP

NEW



Includes

2 Philips Master CDM Elite Agro Lamps



Shown with optional DE lamp



EXCLUSIVE

The industry's first combination LEC®/DE Fixture. The Grow Beast™ utilizes cutting edge Light Emitting Ceramic® technology in combination with your preferred high PAR DE Lamp. The fixture has 95% reflective textured German aluminum insert and 98% reflective corners for excellent output, uniformity and diffusion. The wide throw DE reflector features 95% reflective textured German aluminum. DE lamp provides an extremely high photosynthetic photon flux (ppf) as the LEC® provides improved full color light spectrum with higher amounts of beneficial UV and far red spectrums. Galvanized steel housing with durable powder-coated finish, easy carry handles. 20 ft 240 volt power cord included. 15 ft

detachable lamp cord. Philips electronic LEC ballasts are built into the fixture. Two Philips CDM 315 lamps are included. Double-ended lamp (600, 750 or 1000 watt) and ballast are not included and must be purchased separately. US Patent Pending: 29/531,242. One year warranty on lamps. 2 Year Warranty.

Item No.	Description	MSRP
906300	Sun System Grow Beast 208-240 Volt w/ 3100 K Lamps	\$1,195.95
906302	Sun System Grow Beast 208-240 Volt w/ 4200 K Lamps	\$1,195.95

Show us your growing success! #thegrowbeast



Sun System® Trifecta®

1 **2** **3**

Everything you need to get growing in one convenient box!

EXCLUSIVE

UPS
ETL Intertek

Includes a magnetic ballast the Sun System® Hard Core® 1000 Watt Switchable 120/240 Volt Ballast, an Econo Wing Reflector® and an Ultra Sun® 1000 HPS lamp all packaged in one box. Everything you need to get growing in one convenient box!

Item No.	Description	MSRP
906500	Trifecta	\$209.95

Sun System® Digital 250/400

EXCLUSIVE

This state of the art digital fixture will run both 250 & 400 watt lamps. The integrated electronic ballast allows operation of both metal halide (MH) and high pressure sodium (HPS) lamps. The proprietary Smart Volt® ballast operates at either 120 or 240 volts (120 volt cord included). Lightweight (only 15 lb) and easy to set up. Highly reflective aluminum insert. On/Off switch. Powder-coated steel housing is attractive and durable. Purchase your choice of lamp separately. 2 Year Warranty.

Item No.	Description	MSRP
900514	Sun System Digital 250/400	\$234.95

Sun System® HPS 150 Grow Light Fixture

Includes Lamp
Ultra Sun®
HPS 150 Watt

EXCLUSIVE

ETL Intertek

This compact easy to use light fixture will work great for any gardener. The high intensity bulb delivers an amazing 16,000 lumens and provides the output and ideal color spectrum required for successful indoor gardening. Grow herbs, flowers or fresh vegetables all year, not just in summer. 150 watt high pressure sodium bulb (mogul base) included. Highly reflective aluminum insert. Vented housing helps dissipate heat. Durable white powder-coated finish. Backlit on/of switch. 7 ft grounded 120 volt power cord. Dimensions: 15 in long x 9-1/2 in wide x 3-3/4 in high. One year warranty on lamp. 2 Year Warranty.

Item No.	Description	MSRP
900490	Sun System HPS 150 w/ Ultra Sun Lamp	\$85.95

SunLight™ 125 Fluorescent Fixture with Lamp

Includes Lamp
Feliz 125 Watt
Fluorescent 6500° K

EXCLUSIVE

ETL Intertek

This fixture includes everything you need to get growing. It starts with a high quality 125 watt Feliz™ fluorescent 6500°K grow lamp. Add a wing reflector that has a bright white powder-coated finish providing excellent reflectivity and durability. It has a sturdy steel construction for long life and a heavy duty socket assembly. Includes mogul base socket and 8 ft 120 volt power cord. Integrated mounting bracket with wire hangers for hanging the fixture. Just plug in and start growing. 6 month warranty on lamp. US Patent Pending: 29/523,998. 1 Year Warranty.

Item No.	Description	Dimensions L x W x H	MSRP
960380	SunLight 125 Fluorescent Fixture w/ Lamp	16.5" x 11.6" x 5.1"	\$69.95

Sun System® ProMag™ Commercial Fixture - 120/240/277/480 Volts



NEW

EXCLUSIVE 

Sun System's® ProMag™ Professional 1000 watt magnetic commercial greenhouse lighting fixture features an open core ballast design providing cool operation and reliability for years of use. The ProMag™ commercial quint-tap ballast can be professionally installed at 120/208/240/277/480 volt. This unit does not include a power cord as it should be hard-wired by certified electrician. ProMag™ is a 1000 watt MH/HPS Switchable unit that can run both high pressure sodium and metal halide lamps (not included). Features an attached high output 95% reflective German aluminum wide throw reflector. The EZ Cap®

door allows for fast capacitor access. The ProMag™ includes unistrut mounting/hanging brackets and a safety cable. ETL listed for both dry and damp locations. US Patent Pending: 29/492,971. Chinese Patent: ZL201430166983.7. 2 Year Warranty.

Item No.	Description	MSRP
902692	Sun System ProMag Commercial Fixture 1000 Watt HPS/MH w/ Reflector 5 Tap	\$199.95

Sun System® LEC® 315 Commercial Fixture



Includes Lamp
Philips Master CDM
Elite Agro

NEW

FABRICATED AND ASSEMBLED IN USA

EXCLUSIVE 

Sun System® LEC® 315 Commercial utilizes cutting edge Light Emitting Ceramic® technology. State-of-the-art 95% reflective German aluminum interior offers unparalleled output, reflectivity and diffusion. Includes Philips highly efficient agriculturally engineered CDM-T Elite 315 Agro Lamp. This lamp creates amazing full color light spectrum out of next generation ceramic lamps. Higher amounts of beneficial UV and far red spectrums increase the lamp's growth power to the plants. Very high 1.95 PPF per second light source (3100° K lamp). 3100° K or 4200° K color temperature, high 92 CRI, 33,000 initial lumens (105Lm/W). Long life 20,000 hour lamp. High 90% lumen maintenance @ 8000 hr. High 85% PPF maintenance @ 20,000 hr. Unique open rated lamp construction reduces radiant heat from the arc tube and is suitable for open fixture use. The LEC® 315 Commercial has a Philips 50/60 Hz low frequency, square wave, highly efficient electronic ballast rated for 50,000 hour ballast life. The compact commercial design to minimize greenhouse sunlight blockage. Power cord/plug configuration varies

by fixture voltage. Detachable unistrut mounting hangers or traditional V-hangers. US Patent Pending: 29/518,803. 1 Year Warranty.

Item No.	Description	MSRP
906235	Sun System LEC Commercial Fixture 208-240 Volt 3100 K	\$499.95
906236	Sun System LEC Commercial Fixture 208-240 Volt 4200 K	\$499.95
906237	Sun System LEC Commercial Fixture 277 Volt 3100 K	\$499.95
906238	Sun System LEC Commercial Fixture 277 Volt 4200 K	\$499.95
906239	Sun System LEC Commercial Fixture 480 Volt 3100 K	\$529.95
906240	Sun System LEC Commercial Fixture 480 Volt 4200 K	\$529.95

Galaxy® DE Commercial Horizontal Hanging Brackets



The Galaxy® DE Horizontal Hanging Brackets safely hang your Galaxy® DE ballast in a horizontal mounted position in a greenhouse application. Commercial grade, bolt on mounting brackets used to attach your Galaxy® DE ballast to uni-strut/kindorf framing. Used for a rigid mount applications for additional safety and support. May be adaptable to other strut/framing applications, may fit additional types of electronic ballasts. These brackets are constructed in the USA of sturdy galvanized steel and powder coated to protect from wear and rust. US Patent Pending: 29/533,943.

Item No.	Description	MSRP
710189	Galaxy DE Commercial Hanging Bracket - Horizontal	\$16.95

Galaxy® DE Commercial Vertical Hanging Bracket



The Galaxy® DE Vertical Hanging Brackets safely hang your Galaxy® DE ballast in a vertical mounted position in a greenhouse application. Commercial grade, bolt on mounting brackets used to attach your Galaxy® DE ballast to uni-strut/kindorf framing. Used for a rigid mount applications for additional safety and support. May be adaptable to other strut/framing applications, may fit additional types of electronic ballasts. These brackets are constructed in the USA of sturdy galvanized steel and powder coated to protect from wear and rust. US Patent Pending: 29/533,943.

Item No.	Description	MSRP
710187	Galaxy DE Commercial Hanging Bracket - Vertical	\$16.95

Gavita Pro Classic Line 600 SE Complete Fixture - 240 Volt



Professional 600 watt high frequency electronic ballast. Including high efficiency Miro aluminum horticultural HortiStar HR96 reflector (95% efficiency). Only suitable for use with 600 watt EL lamp (included): No acoustic resonance, up to 8% more grow light and light maintenance after 5000 hours >95%. Microprocessor controlled. Driver efficiency >95%. Sealed housing with Gore-Tex ventilation plug. Reflector easily replaceable. Very low heat dissipation and very low weight. LED status indicator. Operates at 240Volts. Comes with 8 ft power cord. 1 year warranty on the lamp. 3 Year Warranty.

Item No.	Description	MSRP
906045	Gavita Pro Classic 600 SE Complete Fixture 240 Volt	\$425.95

Gavita Pro Classic Line 1000 DE Complete Fixture - 240 Volt



Professional 1000 watt high frequency electronic ballast. Including high efficiency Miro aluminum horticultural HortiStar HR96 reflector (95% efficiency). Includes 1000 watt double ended EL lamp. Microprocessor controlled with electronic safety circuit. Very low heat dissipation and very low weight. Only suitable for use with 1000 watt double ended EL lamps: No acoustic resonance, more than 10% grow light compared to traditional lamps and light maintenance after 5000 hours >95%. Electronics by Gavita. Driver efficiency >95% and is adjustable to: 600/660/750/825/1150W. Sealed housing with Gore-Tex ventilation plug. Reflector is easily replaceable. Comes with 8 ft power cord. Operates at 240 volts. 1 year warranty on the lamp. 3 Year Warranty.

Item No.	Description	MSRP
906050	Gavita Pro Classic 1000 DE Complete Fixture 240 Volt	\$599.95

Find a retailer near you!



Gavita Pro Classic Line 1000 DE Complete Fixture - 277 Volt



Professional 1000 watt high frequency electronic ballast. Including high efficiency Miro aluminum horticultural HortiStar HR96 reflector (95% efficiency). Includes 1000 watt double ended EL lamp. Microprocessor controlled with electronic safety circuit. Very low heat dissipation and very low weight. Only suitable for use with 1000 watt double ended EL lamps: No acoustic resonance, more than 10% grow light compared to traditional lamps and light maintenance after 5000 hours >95%. Electronics by Gavita. Driver efficiency >95%. Sealed housing with Gore-Tex ventilation plug. Reflector is easily replaceable. Comes with 6 ft power cord (10 ft power cord available by special order) that is not attached and has an open wire end. Eye bolts and nuts included for hanging. 906089 operates at 277 volts. 906094 (special order) operates at 400 volts. 1 year warranty on the lamp. 3 Year Warranty.

Item No.	Description	MSRP
906089	Gavita Classic 1000 Pro DE 277 Volt	\$599.95
906193	Gavita Classic 277 Volt Wieland Cordset 6 ft 6 in	\$14.95
906195	Gavita Classic 277 Volt Wieland Cordset 10 ft 6 in	\$16.95

Gavita Pro 600e SE E-Series Complete Fixture - 120/240 Volt



The Gavita Pro 600e SE is part of the new Gavita e-series fixtures that are suitable for remote control with the Gavita Master Controllers. Equipped with a 1190 umol s-1 600W 400V electronic high frequency lamp it produces more light than any other 600W fixture. Suitable for lighting a 11 sq ft area with average 1000 umol s-1 m-2. Unit includes a 240 V power cord. A 120 V cord can be purchased separately. 1 year warranty on the lamp. 3 Year Warranty.

Item No.	Description	MSRP
906086	Gavita Pro 600e SE (300-660 Watt) 120/240 Volt	\$489.99

Gavita Pro 6/750e DE Flex E-Series Complete Fixture - 120/240 Volt



The new Gavita 6/750W 400V EL DE lamp has an efficiency of 2 umol s-1 per Watt in a wide control range of 600-825W. When necessary it can be dimmed down to 375W. Of course it is suitable for the Gavita Master Controller, eliminating the need for timers and contactors. This fixture is suitable for lighting a 15 sq ft area with 1000 umol s-1 m-2. Unit includes a 240 V power cord. A 120 V cord can be purchased separately. 1 year warranty on the lamp. 3 Year Warranty.

Item No.	Description	MSRP
906087	Gavita Pro 6/750e DE Flex (400-825 Watt) 120/240 Volt	\$569.99

Gavita Pro 1000e DE E-Series Complete Fixture - 120/240 Volt



The Pro 1000e DE is the new e-series flagship model. Together with the Pro 1000e DE Gavita also introduces its Pro plus 1000W Electronic lamp, with 2100 umol s-1 output. So now you have a choice of lamps as well. You can control up to 80 fixtures with a Gavita Master controller without the need for timers and contactors. The Pro 1000e can light 21 sq ft with 1000 umol s-1 m-2. Unit includes a 240 V power cord. A 120 V cord can be purchased separately. 1 year warranty on the lamp. 3 Year Warranty.

Item No.	Description	MSRP
906088	Gavita Pro 1000e DE (600-1150 Watt) 120/240 Volt	\$649.99

Gavita Interconnect Cables



NEW Gavita E-series interconnect cables are used to supply controller signal from ballast to additional ballasts (daisy chain), for use with the Gavita Master Controllers (EL1 & EL2). These come in 2, 5, 8 and 10 foot configurations to best fit your specific application.

Item No.	Description	MSRP
906180	Gavita Interconnect Cables RJ14 / RJ14 2 ft / 60 cm	\$4.20
906181	Gavita Interconnect Cables RJ14 / RJ14 5 ft / 150 cm	\$5.20
906182	Gavita Interconnect Cables RJ14 / RJ14 8 ft / 240 cm	\$6.20
906183	Gavita Interconnect Cables RJ14 / RJ14 10 ft / 300 cm	\$7.20

Gavita 3 Way RJ14 Cable Splitter



NEW The 3 way cable splitter is needed to connect the Gavita Master Controller to your E-Series ballasts when running ballasts inline. Used with Gavita E-series interconnect cables.

Item No.	Description	MSRP
906187	Gavita 3 Way RJ14 Cable Splitter	\$5.00

Gavita ECM - Controller Cable



NEW The ECM connect cable is used to connect an ECM1 (External Contactor Modules) to the Gavita Master Controller.

Item No.	Description	MSRP
906188	Gavita ECM - Controller Cable 10 ft / 3 m	\$6.00

Gavita Temperature Probe EL Controller Cable



NEW Replacement temperature probe for the Gavita Master Controller (EL1 & EL2).

Item No.	Description	MSRP
906189	Gavita Temperature Probe EL Controller Cable 5 m	\$17.50

Gavita Controller Cables



NEW Gavita Controller Cables attach the Gavita Master controller (EL1 & EL2) to the Gavita E-Series ballast. These come in 5, 16 and 25 foot configurations to best fit your specific application.

Item No.	Description	MSRP
906184	Gavita Controller Cable RJ9 / RJ14 5 ft / 150 cm	\$5.50
906185	Gavita Controller Cable RJ9 / RJ14 16 ft / 5 m	\$9.20
906186	Gavita Controller Cable RJ9 / RJ14 25 ft / 7.5 m	\$12.00

Gavita Replacement Power Supply EL Controllers



NEW Replacement 120V power supply for the Gavita Master Controller (EL1 & EL2).

Item No.	Description	MSRP
906190	Gavita Power Supply US Version 120 Volt	\$20.00

SUN SYSTEM

Creating the best lighting in the industry. Choose the brand that continually outperforms the rest!



Sunlight Supply, Inc.
National Garden Wholesale.

#growwhatyouknow
www.sunlightsupply.com

Sun Blaze® T5 HO Fluorescent Light Fixtures - 120 Volt



Sun Blaze® fixtures feature an advanced reflector design that delivers excellent reflectivity and diffusion. White powder-coated steel housing. Wire cable hangers included. Hang horizontally or vertically. 12 foot power cord and on/off switch allows for easy operation. Eight lamp model features two on/off switches to run four lamps at a time. Louvered for cool operation. High output lamps have an extremely high lumen per watt rating at 5,000 lumens per lamp. Run on 120 volt power only. Comes with Spectralux® 6500°K (blue) T5 HO Lamps. 3000°K (red) lamps can be purchased separately. Daisy chain feature allows multiple fixtures to be plugged in together. One year warranty on lamps. 5 Year Warranty.

Item No.	Description	Dimensions L x W x H	MSRP
960290	Sun Blaze T5 HO 22 - 2 ft 2 Lamp - 120 Volt	23.5" x 7.3" x 2.5"	\$92.95
960295	Sun Blaze T5 HO 24 - 2 ft 4 Lamp - 120 Volt	23.5" x 12.0" x 2.5"	\$123.95
960293	Sun Blaze T5 HO 28 - 2 ft 8 Lamp - 120 Volt	23.5" x 22.0" x 2.5"	\$217.95
960296	Sun Blaze T5 HO 42 - 4 ft 2 Lamp - 120 Volt	47.0" x 7.5" x 2.5"	\$115.95
960300	Sun Blaze T5 HO 44 - 4 ft 4 Lamp - 120 Volt	47.0" x 12.0" x 2.5"	\$163.95
960302	Sun Blaze T5 HO 46 - 4 ft 6 Lamp - 120 Volt	47.0" x 17.0" x 2.5"	\$221.95
960305	Sun Blaze T5 HO 48 - 4 ft 8 Lamp - 120 Volt	47.0" x 22.0" x 2.5"	\$261.95

Sun Blaze® T5 HO Fluorescent Light Fixtures - 240 Volt



Sun Blaze® fixtures feature an advanced reflector design that delivers excellent reflectivity and diffusion. White powder-coated steel housing. Wire cable hangers included with every fixture. Now features additional hanging holes for V-hangers that are included with every fixture. Hang horizontally or vertically. 12 foot power cord and on/off switch allows for easy operation. Eight lamp model features two on/off switches to run four lamps at a time if desired. Louvered for cool operation. High output lamps have an extremely high lumen per watt rating at 5,000 lumens per lamp. Run on 120 volt power only. Comes with Spectralux® 6500°K (blue) T5 HO Lamps. 3000°K (red) lamps can be purchased separately. Daisy chain feature allows multiple fixtures to be plugged in together. Features eco-friendly recyclable packaging. One year warranty on lamps. 5 Year Warranty.

Item No.	Description	Dimensions L x W x H	MSRP
960382	Sun Blaze T5 HO 44 - 4 ft 4 Lamp - 240 Volt	47.0" x 12.5" x 2.5"	\$169.95
960384	Sun Blaze T5 HO 48 - 4 ft 8 Lamp - 240 Volt	47.0" x 22.5" x 2.5"	\$269.95

Solar Flare™ T5 HO Fluorescent Light Fixtures - 120 & 240 Volt



Lightweight industrial design with multiple hanging points including vertical from the end, vertical from the side and horizontal. Advanced wide T5 optical design for maximum coverage and diffusion. Pre-wired with either 120 or 240 volt 8 ft power cord for ease of use. Highly reflective aluminum insert for maximum performance. Cool operation housing design to keep electrical components thermally stable. Includes Spectralux® 54 watt T5 HO 6500°K Blue lamps. High lumen per watt rating at 5,000 lumens per lamp. Energy efficient electronic T5 ballast. The 8 lamp fixtures have dual on/off switches each operating four lamps. The 4 lamp fixture has an on/off switch that controls all four lamps. US Patent Pending: 29/511,663. Chinese Patent: ZL201530031833X. One year warranty on lamps. 3 Year Warranty.

Item No.	Description	Dimensions L x W x H	MSRP
960386	Solar Flare T5 HO 44 - 4 ft 4 Lamp - 120 Volt	48.0" x 15.0" x 3.0"	\$139.95
960388	Solar Flare T5 HO 48 - 4 ft 8 Lamp - 120 Volt	48.0" x 29.0" x 3.0"	\$219.95
960390	Solar Flare T5 HO 44 - 4 ft 4 Lamp - 240 Volt	48.0" x 15.0" x 3.0"	\$139.95
960392	Solar Flare T5 HO 48 - 4 ft 8 Lamp - 240 Volt	48.0" x 29.0" x 3.0"	\$219.95

New Wave® 44 & 48 T5 HO Fluorescent Light Fixtures - 120/208/240 Volt



These high quality T5 HO (high output) fixtures are fabricated and assembled in the USA with US and globally sourced parts. They feature reliable, name brand multi-volt 120-277 V ballast(s). These special order fixtures are custom-built to operate at 120, 208 or 240 Volts. New Wave's feature a heavy duty white steel housing that is louvered and slotted for efficient cooling. The reflectors are made with 95% reflective German aluminum for maximum reflectance & uniformity. Purchase your choice of lamps separately. These fixtures have a minimum order quantity of 100 units. Pricing will vary by quantity, voltage, cord length and plug type. Lead time to produce is approximately 3-4 weeks. US Patent No's: D543653, D543654, D544981, D544985 & D544626. 2 Year Warranty.

Item No.	Description	Dimensions L x W x H	MSRP
960200	New Wave T5 44 - 4 ft 4 Lamp 120/240 Volt	47.0" x 11.0" x 3.5"	\$192.95
960205	New Wave T5 48 - 4 ft 8 Lamp 120/240 Volt	47.0" x 21.0" x 3.5"	\$309.95

New Wave® 48 T5 HO Fluorescent Light Fixture - 277 Volt



These high quality T5 HO (high output) fixtures are fabricated and assembled in the USA with US and globally sourced parts. They feature reliable, name brand ballasts designed to operate at 277 Volts. They are hard wired with a 6 ft power cord with a NEMA L7-15p plug. The reflectors are made with 95% reflective German aluminum for maximum reflectance & uniformity. Purchase your choice of lamps separately. US Patent No's: D543653, D543654, D544981, D544985 & D544626. 2 Year Warranty.

Item No.	Description	Dimensions L x W x H	MSRP
960202	New Wave T5 48 - 4 ft 8 Lamp 277 Volt	47.0" x 21.0" x 3.5"	\$309.95

Sun Blaze® T5 HO Fluorescent Strip Light Fixtures



The Sun Blaze® Strip Light is an excellent light source for growing plants. Offers an energy efficient high output ballast for long life. Light weight and easy to install with mounting hardware included. Fixture comes with one 6500°K (blue) T5 HO lamp and a plastic removable cover for the lamp. Accommodates standard 2 ft and 4 ft replacement lamps. On/off switch for ease of use. Includes power cord and 4 in jumper cable to daisy chain multiple fixtures. 1 Year Warranty.

Item No.	Description	Dimensions L x W x H	Max Chain @ 120V	MSRP
960315	Sun Blaze T5 HO 21 - 2 ft 1 Lamp	23.8" x 1.0" x 1.8"	10	\$28.49
960320	Sun Blaze T5 HO 41 - 4 ft 1 Lamp	47.8" x 1.0" x 1.8"	5	\$33.95

Sun Blaze® T5 HO Supreme Fluorescent Strip Light Fixture with Reflector



The Sun Blaze® Supreme Strip Light has a reflector design that maximizes output and diffusion. It offers an energy efficient high output ballast and a durable aluminum housing. The fixture is lightweight and easy to install with the mounting hardware or hanging bracket kit included. Accommodates standard 2 ft and 4 ft replacement lamps. Fixture includes 6500°K (blue) T5 HO lamp. Comes with a power cord and 4 in jumper cable to daisy chain multiple fixtures. 1 Year Warranty.

Item No.	Description	Dimensions L x W x H	Max Chain @ 120V	MSRP
960345	Sun Blaze T5 HO Supreme 21 - 2 ft 1 Lamp	25.0" x 5.5" x 2.0"	10	\$39.95
960350	Sun Blaze T5 HO Supreme 41 - 4 ft 1 Lamp	48.0" x 5.5" x 2.0"	5	\$49.95

Super Sprouter™ T5 HO Grow Light Fixture



This fixture includes an integrated electronic ballast, 6400°K lamp, power cord, jumper cord, hanging and flat surface mounting clips. You can daisy chain up to a maximum of 8 lights per single cord. The reflector uses nanotechnology to maximize reflection. Specifically to fit Super Sprouter™ Light Track Domes. 1 Year Warranty.

Item No.	Description	MSRP
726420	Super Sprouter T5 HO 18 in Grow Light Blister Pack	\$34.95

SunBlaster™ NanoTech T5 HO Fixtures



Incorporates the SunBlaster™ T5 HO fluorescent fixture and the NanoTech reflector combining them into one fixture. Includes 6400°K lamp, power cord, jumper plug with both hanging/mounting hardware. SunBlaster fixtures link together to a maximum of 8 per single power cord. The NanoTech reflector was designed using Nanotechnology to produce the ultimate in a reflective surface that can increase lumen availability by as much as 300%. 18 in fixture was designed specifically to fit into the NanoDome. 1 Year Warranty.

Item No.	Description	MSRP
904296	SunBlaster NanoTech T5 HO 21 - 2 ft 1 Lamp w/ NanoTech Reflector	\$41.95
904297	SunBlaster NanoTech T5 HO 31 - 3 ft 1 Lamp w/ NanoTech Reflector	\$44.77
904298	SunBlaster NanoTech T5 HO 41 - 4 ft 1 Lamp w/ NanoTech Reflector	\$49.30

SunBlaster™ T5 HO Fluorescent Strip Light Fixtures



Built in electronic ballast provides instant starting with no flickering. Durable aluminum housing. Lasts up to 10,000 hours. Lightweight and easy to install. Fixture includes 6400°K full spectrum lamp. 1 Year Warranty.

Item No.	Description	Dimensions L x W x H	MSRP
904301	SunBlaster T5 HO 21 - 2 ft 1 Lamp	26.8" x 3.8" x 1.5"	\$27.95
904302	SunBlaster T5 HO 31 - 3 ft 1 Lamp	35.3" x 3.8" x 1.5"	\$30.45
904303	SunBlaster T5 HO 41 - 4 ft 1 Lamp	50.5" x 3.8" x 1.5"	\$32.95

Sun Blaze® T5 Strip Light Jumper Cords



Use the jumper cords to daisy chain two or more Sun Blaze® T5 Strip Lights together. The 18 in or 4 ft jumper cord replaces the 4 in jumper cord that is included with the fixture. Allows the user to space the fixtures further apart for added flexibility.

EXCLUSIVE

Item No.	Description	MSRP
960325	Sun Blaze T5 Strip Light Replacement Jumper Cord 18 in	\$2.99
960335	Sun Blaze T5 Strip Light Replacement Jumper Cord 4 ft	\$4.99

SunBlaster™ NanoTech T5 Reflectors



SunBlaster™ now has a snap on reflector. The SunBlaster™ NanoTech T5 Reflector was engineered using Nanotechnology to create a crystal reflective layer that dramatically increases the amount of light reaching each plant.

Item No.	Description	MSRP
904313	SunBlaster NanoTech T5 Reflector 2 ft	\$16.95
904314	SunBlaster NanoTech T5 Reflector 3 ft	\$19.95
904304	SunBlaster NanoTech T5 Reflector 4 ft	\$22.95

SunBlaster™ T5 Universal Light Stand



The Universal T5 Stand allows you to set the exact lighting height to get your seedlings or fresh cuttings off to their best starts ever. Achieving the optimum 3 - 6 in lighting distance from the plant canopy is now a breeze. Simple O-Ring adjustment makes setting just the right height quick and easy. These sturdy light stands are made of durable high quality injection molded plastic and rust free powder coated aluminum.

Item No.	Description	MSRP
710158	SunBlaster T5 Universal Light Stand	\$35.95

SunBlaster™ Universal T5 Light Strip Hanger



Allows you to add up to seven T5's above your target area. Snap any size of T5 into one or all of the seven mounting banks. Made to snap into your Universal T5 Stand, hang from above, with your choice of suspension hardware or wall mount. Includes 2 SunBlaster™ Universal Light Strips, 2 mounting screws and 4 easy clip hangers.

Item No.	Description	MSRP
710162	SunBlaster Universal T5 Light Strip Hanger	\$10.49

SunLight® 125 Fluorescent Fixture with Lamp



Includes Lamp
Feliz 125 Watt
Fluorescent 6500°K

EXCLUSIVE



This fixture includes everything you need to get growing. It starts with a high quality 125 watt Feliz™ fluorescent 6500°K grow lamp. Add a wing reflector that has a bright white powder-coated finish providing excellent reflectivity and durability. It has a sturdy steel construction for long life and a heavy duty socket assembly. Includes mogul base socket and 8 ft 120 volt power cord. Integrated mounting bracket with wire hangers for hanging the fixture. Just plug in and start growing. 6 month warranty on lamp. US Patent Pending: 29/523,998. 1 Year Warranty.

Item No.	Description	Dimensions L x W x H	MSRP
960380	SunLight 125 Fluorescent Fixture w/ Lamp	16.5" x 11.6" x 5.1"	\$69.95

Sun System® Garden Bright® Fluorescent Grow Light



EXCLUSIVE



The Garden Bright® Fluorescent grow light is ideal for home or greenhouse growing. This light is excellent for all stages of plant growth—from seed starting to full term growth. This fixture features a highly reflective textured aluminum interior and is slotted and louvered for maximum air-cooling. It has a durable powder coated finish. Includes a 8 ft grounded 120 volt power cord. The Garden Bright® is light weight and easy to set up at 19.75 in long x 12.25 in wide x 7.5 in tall. Accommodates Feliz™ self-ballasted lamps up to 250 watts. Grow your own garden fresh flowers, vegetable and herbs at home! US Patent: D542,460. 3 Year Warranty.

Item No.	Description	MSRP
960207	Sun System Garden Bright Fluorescent Grow Light	\$69.95

Sun System® White Wing Fluorescent Grow Light Fixture



EXCLUSIVE



Bright white powder-coated finish provides excellent reflectivity and durability. Sturdy steel construction for long life. Heavy duty socket assembly supports the weight of high wattage self-ballasted lamps with minimal lamp deflection. Lamp brace incorporated into design for high wattage CFL (300 watt). Includes mogul base socket and 8 ft 120 volt power cord. Integrated mounting bracket with chrome wire hangers. Size: 20 1/4 in long x 17 in wide x 7 5/8 in tall. Accommodates Feliz™ self-ballasted lamps 125, 200, 250 & 300 watt. 3 Year Warranty.

Item No.	Description	MSRP
904293	Sun System White Wing CFL Fixture	\$54.95

Sun System® LEC® 315 Light Emitting Ceramic® Fixture

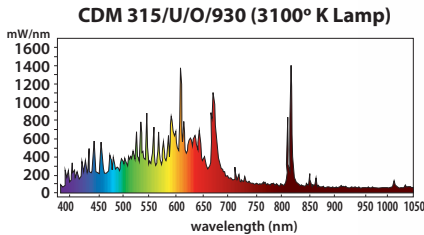
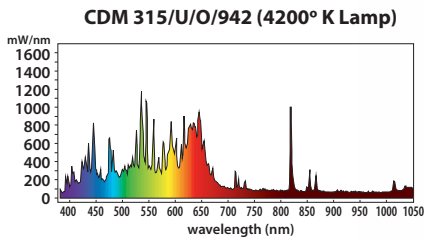

Includes Lamp
Philips Master CDM
Elite Agro



EXCLUSIVE

Sun System® LEC® 315 utilizes cutting edge Light Emitting Ceramic® technology. Fixture has 98% reflective German aluminum insert and 95% reflective textured corners for excellent output, uniformity and diffusion. Highly efficient agriculturally engineered CDM-T Elite 315 Agro Lamp (lamp included). Greatly improved full color light spectrum out of next generation ceramic lamps. Higher amounts of beneficial UV and far red spectrums increase the lamps growth power to the plants. Very high 1.95 PPF per second light source. 3100°K or 4200°K color temperature, high 92 CRI, 33,000 initial lumens (105Lm/W). Long life 20,000 hour lamp. High 90% lumen maintenance @ 8000 hr. High 85% PPF maintenance @ 20,000 hr. Unique open rated lamp construction reduces radiant heat from the arc tube and is suitable for open fixture use. 50/60 Hz low frequency, square wave, highly efficient electronic ballast rated for 50,000 hour ballast life. LEC® 315 driver incorporates built in thermal protection. One

year warranty on the lamp. 2 Year Warranty.

Item No.	Description	MSRP
906200	Sun System LEC315 120 Volt w/ 3100 K Lamp	\$609.95
906209	Sun System LEC315 120 Volt w/ 4200 K Lamp	\$609.95
906205	Sun System LEC315 208 / 240 Volt w/ 3100 K Lamp	\$579.95
906208	Sun System LEC315 208 / 240 Volt w/ 4200 K Lamp	\$579.95
906207	Sun System LEC315 277 Volt w/ 3100 K Lamp	\$599.95
906206	Sun System LEC315 277 Volt w/ 4200 K Lamp	\$599.95

Sun System® LEC® 630 Light Emitting Ceramic® Fixture

Includes
2 Philips Master CDM
Elite Agro Lamps



EXCLUSIVE

Sun System® LEC® 630 utilizes cutting edge Light Emitting Ceramic® technology. This fixture has a dual lamp configuration offering increased wattage in a single fixture design. Fixture has 98% reflective German aluminum insert and 95% reflective textured corners for excellent output, uniformity and diffusion. Highly efficient agriculturally engineered CDM-T Elite 315 Agro Lamps (lamps included). Greatly improved full color light spectrum out of next generation ceramic lamps. Higher amounts of beneficial UV and far red spectrums increase the lamps growth power to the plants. Very high 1.95 PPF per second light source. 3100°K or 4200°K color temperature, high 92 CRI, 33,000 initial lumens (105Lm/W). Long life 20,000 hour lamp. High 90% lumen maintenance @ 8000 hr. High 85% PPF maintenance @ 20,000 hr. Unique open rated lamp construction reduces radiant heat from the arc tube and is suitable for open fixture use. 50/60 Hz low frequency, square wave, highly efficient electronic ballast rated for 50,000 hour ballast life. LEC® 630 driver incorporates built in thermal protection. One year warranty on lamps. US Patent: D732,236. US Patent Pending: 25/516,347, 29/523,671. Chinese Patent Pending: 201430548157.9. 2 Year Warranty.

Item No.	Description	MSRP
906217	Sun System LEC 630 120 Volt w/ 3100 K Lamps	\$1,095.95
906223	Sun System LEC 630 120 Volt w/ 4200 K Lamp	\$1,095.95
906219	Sun System LEC 630 208 / 240 Volt w/ 3100 K Lamps	\$1,039.95
906225	Sun System LEC 630 240 Volt w/ 4200 K Lamp	\$1,039.95
906221	Sun System LEC 630 277 Volt w/ 3100 K Lamp	\$1,059.95
906227	Sun System LEC 630 277 Volt w/ 4200 K Lamp	\$1,059.95
906229	Sun System LEC 630 - 480 Volt w/ 3100 K Lamp	\$1,079.95
906231	Sun System LEC 630 - 480 Volt w/ 4200 K Lamp	\$1,079.95

Sun System® LEC® 315 Remote Fixture

Includes Lamp
Philips Master CDM
Elite Agro

NEW





CDM 315/U/O/942 (4200° K Lamp)



CDM 315/U/O/930 (3100° K Lamp)



ETL
Intertek

EXCLUSIVE UPS

The Sun System® LEC® 315 Remote Fixture utilizes cutting edge Light Emitting Ceramic® technology. This fixture features a remote style reflector for better versatility in your growing area. Fixture has 98% reflective German aluminum insert and 95% reflective textured corners for excellent output, uniformity and diffusion. Highly efficient agriculturally engineered CDM-T Elite 315 Agro Lamp (lamp included). Greatly improved full color light spectrum out of next generation ceramic lamps. Higher amounts of beneficial UV and far red spectrums increase the lamps growth power to the plants. Very high 1.95 PPF per second light source. 3100°K or 4200°K color temperature, high 92 CRI, 33,000 initial lumens (105Lm/W). Long life 20,000 hour lamp. High 90% lumen maintenance @ 8000 hr. High 85% PPF maintenance @ 20,000 hr. Unique open rated lamp construction reduces radiant heat from the arc tube and is suitable for open fixture use. 50/60 Hz low frequency, square wave, highly efficient electronic ballast rated for 50,000 hour ballast life. LEC® 315 Remote fixture driver incorporates built in thermal protection. 6 ft lamp cord (maximum specified by Philips). 240V models have a 15 ft power cord and 277V have a 6 ft power cord. One year warranty on lamp. US Patent Pending: 29/524,011. 2 Year Warranty.

Item No.	Description	MSRP
906250	Sun System LEC 315 Remote Fixture 208-240 Volt - 3100 K	\$599.95
906251	Sun System LEC 315 Remote Fixture 208-240 Volt - 4200 K	\$599.95
906252	Sun System LEC 315 Remote Fixture 277 Volt - 3100 K	\$609.95
906253	Sun System LEC 315 Remote Fixture 277 Volt - 4200 K	\$609.95

Philips Mastercolor LEC 315 Lamp



Superior color quality. Crisp white light. Very High 1.95 PPF per second light source. 3100°K or 4200°K color temperature, High 92 CRI, 33,000 initial lumens (105Lm/W). High 90% lumen maintenance at 8,000 hr/High 85% PPF maintenance at 20,000 hr. Unique Open Rated Lamp construction reduces radiant heat from the arc tube and is suitable for open fixture use. 1 Year Warranty.

Item No.	Description	Approx Initial Lumens	Glass Size	MSRP
901575	Philips Green Power Master Color CDM Lamp 315 Watt Elite Agro 3100K (Full Spectrum)	33,000	T-12	\$104.95
901573	Philips Master Color CDM Lamp 315 Watt Elite MW 4200K (Blue)	33,000	T-12	\$104.95

Sun System® LEC® 315 Commercial Fixture

Includes Lamp
Philips Master CDM
Elite Agro

NEW





ETL
Intertek

EXCLUSIVE

Sun System® LEC® 315 Commercial utilizes cutting edge Light Emitting Ceramic® technology. State-of-the-art 95% reflective German aluminum interior offers unparalleled output, reflectivity and diffusion. Includes Philips highly efficient agriculturally engineered CDM-T Elite 315 Agro Lamp. This lamp creates amazing full color light spectrum out of next generation ceramic lamps. Higher amounts of beneficial UV and far red spectrums increase the lamp's growth power to the plants. Very high 1.95 PPF per second light source (3100° K lamp). 3100° K or 4200° K color temperature, high 92 CRI, 33,000 initial lumens (105Lm/W). Long life 20,000 hour lamp. High 90% lumen maintenance @ 8000 hr. High 85% PPF maintenance @ 20,000 hr. Unique open rated lamp construction reduces radiant heat from the arc tube and is suitable for open fixture use. The LEC® 315 Commercial has a Philips 50/60 Hz low frequency, square wave, highly efficient electronic ballast rated for 50,000 hour ballast life. The compact commercial design to minimize greenhouse sunlight blockage. Power cord/plug configuration varies by fixture voltage. Detachable unistrut mounting hangers or traditional V-hangers. US Patent Pending: 29/518,803. 1 Year Warranty.

Item No.	Description	MSRP
906235	Sun System LEC Commercial Fixture 208-240 Volt 3100 K	\$499.95
906236	Sun System LEC Commercial Fixture 208-240 Volt 4200 K	\$499.95
906237	Sun System LEC Commercial Fixture 277 Volt 3100 K	\$499.95
906238	Sun System LEC Commercial Fixture 277 Volt 4200 K	\$499.95
906239	Sun System LEC Commercial Fixture 480 Volt 3100 K	\$529.95
906240	Sun System LEC Commercial Fixture 480 Volt 4200 K	\$529.95

AgroLED® Green Flashlight/Lamp by Feliz™



This unique 2-in-1 LED light system can be used either as a flashlight, a standard indoor/outdoor household lamp or both! To use it as a flashlight, just extend the handle and turn it on. To use it as a standard lamp, simply unscrew the end cap and insert it into any household light fixture with the same size standard base. 1 Year Warranty.

EXCLUSIVE

Item No.	Description	MSRP
960415	AgroLED 4 Watt Green Flashlight/Lamp AC/DC Rechargeable	\$29.95

Sun System® Grow Beast™ - 1000 DE + 2 LEC® 315's

Includes
2 Philips Master CDM
Elite Agro Lamps

NEW



EXCLUSIVE



Shown with optional DE lamp

The industry's first combination LEC®/DE Fixture. The Grow Beast™ utilizes cutting edge Light Emitting Ceramic® technology in combination with your preferred high PAR DE Lamp. The fixture has 95% reflective textured German aluminum insert and 98% reflective corners for excellent output, uniformity and diffusion. The wide throw DE reflector features 95% reflective textured German aluminum. DE lamp provides an extremely high photosynthetic photon flux (ppf) as the LEC® provides improved full color light spectrum with higher amounts of beneficial UV and far red spectrums. Galvanized steel housing with durable powder-coated finish, easy carry handles. 20 ft 240 volt power cord included. 15 ft

detachable lamp cord. Philips electronic LEC ballasts are built into the fixture. Two Philips CDM 315 lamps are included. Double-ended lamp (600, 750 or 1000 watt) and ballast are not included and must be purchased separately. US Patent Pending: 29/531,242. One year warranty on lamps. 2 Year Warranty.

Item No.	Description	MSRP
906300	Sun System Grow Beast 208-240 Volt w/ 3100 K Lamps	\$1,195.95
906302	Sun System Grow Beast 208-240 Volt w/ 4200 K Lamps	\$1,195.95

Gavita Pro 270e LEP



The Gavita Pro 270e LEP utilizes a new emitter design that allows for a more compact fixture design, making it lighter and smaller than the Pro 300 LEP model. The Pro 270e LEP is equipped with a Master Controller input to be able to switch the fixture on and off together with your HPS e-series fixtures. Unlike the Pro Line and DigiStar e-series ballasts does not dim: When autodim occurs due to a high temperature the LEP will stay at 100%, because it does not emit so much heat to your crop (4% compared to the >60% by HPS). This is an advantage when high temperatures force the controller to dim your lighting: though your crop will get less light, the quality of your light actually improves. You can also use this

feature to dim your HPS lights in veg while maintaining full plasma light output, improving the spectrum for the vegetative crop. Suitable for 120 - 240 Volt. Supplied with 240 V 8 ft cord with NEMA 6-15 plug, 120 V Nema 5-15 available separately. 3 Year Warranty.

Item No.	Description	MSRP
906090	Gavita Pro 270e LEP Sup US (41.01 emitter)	\$999.00
906092	Gavita Pro 270e LEP Grow US (41.02 emitter)	\$999.00



DigiMax® Lamps set a high standard for the modern HPS lamp. Engineered to operate specifically with today's high frequency HID ballasts, the DigiMax® lamp is constructed with thicker component welds and stainless steel materials designed to withstand the higher acoustic resonance and harmonic distortion emitted by electronic HID ballasts.

DigiMax's robust lamp construction, coupled with a light spectrum that is geared toward photosynthetic response, delivers a superior product for the high end horticulture market.

www.digimaxlamps.com



www.ultrasunlamps.com



Ultra Sun® brand lamps are high output, full spectrum lamps that have been specifically engineered for horticultural applications. They are ideal for plant growth - especially for growing fruits, vegetables, flowers and herbs.

We understand the importance of a good quality horticultural lamp. Our standards are high and you can rest assured that Ultra Sun® lamps boast robust construction and superior reliability. We also know that it is important to be able to create a customized lighting regimen for your plants. That is why we offer a complete line of lamps for versatility and variety. We offer Metal Halide, High Pressure Sodium, Conversion and Dual Arc Tube Lamps.

DigiMax® Double-Ended Lamp



Specifically designed for high frequency electronic ballasts. It has a connection at each side of the lamp, removing the need for frame wire inside the lamp. The absence of frame wire eliminates any shadows in the beam. For horizontal burning only. The jacket of this double ended lamp is made from quartz glass. Do not handle with bare hands. Oil from your hands can damage the lamp. 1 Year Warranty.

**NEW
LOWER
PRICE**

EXCLUSIVE

Item No.	Description	Approx Initial Lumens	Glass Size	MSRP
901465	Digimax 1000 Watt DE - Double Ended	146,000	T-7	\$89.95

DigiMax® Digital HPS Lamps



DigiMax® high output horticultural lamps have been specifically designed for use with electronic ballasts. They are distinct in appearance with a green ceramic base and heavier duty interior components. 1 Year Warranty.

**NEW
LOWER
PRICE**

EXCLUSIVE

Item No.	Description	Approx Initial Lumens	Glass Size	MSRP
901455	Digimax Digital 600 Watt HPS Lamp	92,000	T-15	\$63.95
901460	Digimax Digital 1000 Watt HPS Lamp	145,000	E-25	\$66.95

Ultra Sun® Dual Arc Tube Lamp



The Ultra Sun® Dual Arc Tube Lamp offers the best of both worlds with a 600 watt HPS and a 400 watt MH arc tube both inside one lamp jacket, operating simultaneously. This full spectrum lamp has a 3,000°K color temperature. 1 Year Warranty.

EXCLUSIVE

Item No.	Description	Approx Initial Lumens	Glass Size	MSRP
901546	Ultra Sun Dual Arc HPS/MH 1000	110,000	ET-25	\$109.95

Ultra Sun® HPS Lamps

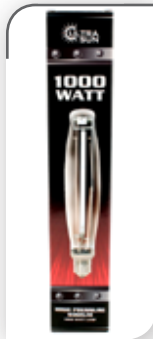

The Ultra Sun® High Pressure Sodium (HPS) lamps have a Kelvin temperature rating of 2000°K which is ideal for the fruiting and flowering stages of plants. It is also an excellent lamp for full term plant growth. 1 Year Warranty.

EXCLUSIVE

Item No.	Description	Approx Initial Lumens	Glass Size	MSRP
901523	Ultra Sun HPS 150	16,000	ED-23.5	\$18.95
901529	Ultra Sun HPS 250	29,000	ET-18	\$19.95
901528	Ultra Sun HPS 400	50,000	ET-18	\$19.95
901526	Ultra Sun HPS 600	90,000	T-15	\$59.95
901531	Ultra Sun HPS 1000	140,000	E-25	\$61.95

Ultra Sun® Metal Halide Blue Enhanced Performance Lamps



The Ultra Sun® Metal Halide (MH) Blue Enhanced Performance lamps offer extra emphasis in the blue and violet spectrums with Kelvin temperatures of 7,500°K and 10,000°K. These lamps are exceptional for vegetative growth. 1 Year Warranty.

EXCLUSIVE

Item No.	Description	Approx Initial Lumens	Glass Size	MSRP
901534	Ultra Sun MH 400 7,500K	32,000	T-18	\$37.95
901538	Ultra Sun MH 1000 7,500K	100,000	T-120	\$61.95
901542	Ultra Sun MH 400 10,000K	32,000	T-18	\$37.95
901544	Ultra Sun MH 1000 10,000K	90,000	T-120	\$61.95

Ultra Sun® Metal Halide - 4,200°K



Universal burn position. 4,200°K color temperature. Lamp has good spectral distribution. Emits the bluish and green regions of the light spectrum. Stimulates plant growth more efficiently than any other light source. 1 Year Warranty.

EXCLUSIVE

Item No.	Description	Approx Initial Lumens	Glass Size	MSRP
901524	Ultra Sun MH 400/U/T-15 4200K Lamp	36,000	T-46	\$23.95
901521	Ultra Sun MH 1000/U/BT-37 4200K Lamp	86,000	BT-37	\$39.95

Ultra Sun® Metal Halide Conversion Lamps



Ultra Sun® MH Conv. Lamps are for those who have an existing HPS ballast that want to also be able to run metal halide lamps w/o purchasing a separate MH ballast. With a 6500°K temp., these lamps are great for the vegetative cycle & full term growing. 1 Year Warranty.

EXCLUSIVE

Item No.	Description	Approx Initial Lumens	Glass Size	MSRP
901537	Ultra Sun MH 600 Conversion	57,000	T-25	\$97.95
901539	Ultra Sun MH 1000 Conversion	100,000	T-120	\$97.95



Eye Hortilux® Dual Arc - HPS & MH Combo Lamp



The Eye Super Blue lamp features the extraordinary power of Super HPS and the balanced spectrum of Hortilux® Blue in one bulb! The benefits of Metal Halide and High Pressure Sodium together: vigorous growth, accelerated development and hearty flowering! 1 Year Warranty.

Item No.	Description	Approx Initial Lumens	Glass Size	MSRP
902855	Hortilux LU1000 MH/HTL/EN Super Blue Dual Arc	110,000	E-25	\$259.95

Eye Hortilux® Super HPS - High Pressure Sodium Lamps



Provides 25% more energy in the violet, blue and green spectrum than standard High Pressure Sodium. The combination of Super HPS and the Metal Ace conversion lamp provides the optimum spectral energy levels through all stages of plant growth. 1 Year Warranty.

Item No.	Description	Approx Initial Lumens	Glass Size	MSRP
901541	Hortilux LU250S/HTL/EN	30,500	ET-18	\$89.95
901545	Hortilux LU400S/HTL/EN	55,000	ET-18	\$94.95
901565	Hortilux LU430S/HTL/EN	58,500	ET-18	\$104.95
901570	Hortilux LU600S/HTL/EN	88,000	ET-18	\$124.95
901585	Hortilux LU1000B/HTL/EN	145,000	E-25	\$129.95

Eye Hortilux® Metal Halide - Standard Metal Halide Lamps



Provides optimum spectral energy required for vegetative growth. High initial and maintained lumen output. High quality lamp for high quality plant growth. 1 Year Warranty.

Item No.	Description	Approx Initial Lumens	Glass Size	MSRP
901721	Hortilux MH 400/HOR/HTL	39,000	BT-37	\$74.95
901722	Hortilux MH 1000 B/U/BT-37	110,000	BT-37	\$86.95

Eye Hortilux® Blue Daylight Metal Halide Lamps



Revolutionizes lighting for plant growth! Exclusive Iwasaki (EYE) chemistry provides levels of red, blue and green spectral energy to optimize plant growth and yield. Designed to provide a fully balanced light spectrum that replicates natural sunlight. Part number 902852 is a protected metal halide lamp (MP) and is open fixture rated. 1 Year Warranty.

Item No.	Description	Approx Initial Lumens	Glass Size	MSRP
901791	Hortilux MT250D/HOR/HTL	18,000	T-15	\$124.95
901792	Hortilux MT400D/HOR/HTL	29,000	T-17	\$129.95
902852	Hortilux MP600LU/HOR/HTL Blue	39,000	BT-37	\$149.95
901796	Hortilux MT1000D/HOR/HTL	80,000	T-120	\$239.95

Eye Hortilux® e-Start Metal Halide Lamps



Hortilux® e-Start Metal Halide is a new family of lamps designed for use on electronic/digital ballasts. The starting and operating characteristics of electronic/digital ballasts are different than traditional magnetic core & coil ballasts. These differences allow us to optimize lamp performance over life to improve results in your indoor garden. 1 Year Warranty.

Item No.	Description	Approx Initial Lumens	Glass Size	MSRP
901745	Hortilux e-Start MH 250U/HTL/ES	21,500	BT-28	\$71.95
901747	Hortilux e-Start MH 400H/HOR/HTL/ES	36,000	BT-37	\$76.95
901750	Hortilux e-Start MH 1000B/U/BT37/HTL/ES	120,000	BT-37	\$94.95

Eye Hortilux® Protected Metal Halide Lamp



This is the first protected metal halide lamp (MP) designed to run in a horizontal position. Protective glass safety lens NOT required when using this lamp for UL listing to apply. 1 Year Warranty.

Item No.	Description	Approx Initial Lumens	Glass Size	MSRP
901677	Hortilux MP1000BX/U	90,000	BT-37	\$109.95



Gavita Pro Plus EL 400V Electronic Lamps



Gavita Pro Plus 1000W EL Double Ended 400V lamp is one of the best 1000 watt HPS lamps on the market. Specifically designed for high frequency electronic ballasts it has a connection at each side of the lamp, removing the need for a frame wire inside the lamp. For use with Gavita fixtures only. The jacket of this double ended lamp is made from quartz glass. Do not handle with bare hands. Oil from your hands can damage the lamp. Warranty applies only if these lamps are operated with a Gavita Pro series ballast. 1 Year Warranty.

Item No.	Description	μmol	Glass Size	MSRP
906025	Gavita Pro Plus 1000 Watt 400 Volt EL DE	2,100	T-7	\$147.95
906035	Gavita Pro GPT EL 600 Watt 400 Volt E39	1,190	T-15	\$99.95

Gavita Enhanced HPS Lamps



Gavita Enhanced HPS lamps, suitable for high frequency ballasts. 1 Year Warranty.

Item No.	Description	μmol	Glass Size	MSRP
902940	Gavita Enhanced HPS 400 Watt 230 Volt E39	725	T-15	\$59.95
902945	Gavita Enhanced HPS 600 Watt 230 Volt E39	1,100	T-15	\$74.95

Gavita Pro Double-Ended HPS Lamps



Gavita horticultural High Pressure Sodium (HPS) lamp with high output and extreme long light maintenance. Change once a year for best results. Light maintenance 5000 hrs: >96%. Color temperature is 2100° K and the lamp base is K12 x 30s. Suitable for High Frequency Gavita ballasts. The jacket of this double ended lamp is made from quartz glass. Do not handle with bare hands. Oil from your hands can damage the lamp. 1 Year Warranty.

Item No.	Description	µmol	Glass Size	MSRP
902957	Gavita Pro 6/750 Watt 400 Volt EL DE	1,500	T-7	\$109.95

PHILIPS LAMPS

Philips Mastercolor LEC 315 Watt Lamps



Superior color quality. Crisp white light. Very High 1.95 PPF per second light source. 3,100°K or 4,200°K color temperature, High 92 CRI, 33,000 initial lumens (105Lm/W). High 90% lumen maintenance at 8,000 hr/High 85% PPF maintenance at 20,000 hr. Unique Open Rated Lamp construction reduces radiant heat from the arc tube and is suitable for open fixture use. 1 Year Warranty.

Item No.	Description	Approx Initial Lumens	Glass Size	MSRP
901575	Philips Green Power Master Color CDM Lamp 315 Watt Elite Agro 3100K (Full Spectrum)	33,000	T-12	\$104.95
901573	Philips Master Color CDM Lamp 315 Watt Elite MW 4200K (Blue)	33,000	T-12	\$104.95

Philips CDM 860 Watt AllStart Lamp



NEW Philips Energy Advantage CDM lamp with AllStart Technology is a high-efficiency protected "O" rated CDM lighting solution that provides energy savings without compromising light quality. It will operate on any MH, HPS or Pulse Start 1000 watt magnetic ballast. Not approved to operate on electronic ballasts. The CDM 860 is vertical burning open rated lamp available in 4100° K color, high 92 CRI and 82,000 initial lumens. 1 Year Warranty.

Item No.	Description	Approx Initial Lumens	Glass Size	MSRP
901574	Philips CDM 860 Watt - 4000K - BT37 V EA Allstart	82,000	BT-37	\$124.95

Philips Enhanced Performance HPS Lamps



AgroLite XT 1000 watt HPS lamps are specifically developed for maximum growth light and are among the most efficient light sources available for horticultural applications. Enhanced spectrum grow lamp offers 22% more micromoles. Features the environmentally responsible ALTO® Lamp Technology. Initial Lumens = 146,000. PPF = 1,850 umols. 2,100 K. 1 Year Warranty.

Item No.	Description	Approx Initial Lumens	Glass Size	MSRP
902811	Philips Agrolite XT HPS 1000	146,000	E-25	\$108.95



Ushio Enhanced Performance HPS Lamps



400, 600 and 1000 watt SUPER high output HPS with maximized output in both red and blue spectral range. Runs on HPS Ballast. Optimized for maximum flower yield and added blue spectrum for vegetative growth efficiency. Outperforms standard HPS bulbs. 1 Year Warranty.

Item No.	Description	Approx Initial Lumens	Glass Size	MSRP
902900	Ushio AHS 400 Opti Red	56,000	T-15	\$75.95
902905	Ushio AHS 600 Opti Red	90,000	T-15	\$105.95
902910	Ushio AHS 1000 Opti Red	146,000	T-23	\$119.95

Ushio MH Conversion Lamps



400, 600 and 1000 watt SUPER high output MH with maximized output in both blue and red spectral range. Outperforms standard MH bulbs. Conversion bulb to operate on ANSI coded HPS ballast. Optimized for maximized branching and vegetative growth and added red spectrum for flowering efficiency. 1 Year Warranty.

Item No.	Description	Approx Initial Lumens	Glass Size	MSRP
902915	Ushio AMH 400 Opti Blue	39,000	T-15	\$89.00
902920	Ushio AMH 600 Opti Blue	47,000	T-25	\$105.00
902925	Ushio AMH 1000 Opti Blue	109,000	T-25	\$119.95

Ushio Double-Ended Lamps



Super High Pressure Sodium Double Ended lamp for Plant Growth. High red and blue spectral ratios for good photosynthesis efficiency. Great lumen output for high PAR values. Robust plants through high blue light output. High red light ratio for healthy plant growth. Economic. The jacket of this double ended lamp is made from quartz glass. Do not handle with bare hands. 1 Year Warranty.

Item No.	Description	μmol	Glass Size	MSRP
902912	Ushio AHS-DE 1000 Opti Red	1,950	T-7	\$129.95
902927	Ushio Double Ended Lamp - AHS-DE 1000W / PRO-PLUS	2,100	T-7	\$159.95

SolarMax™ MH Conversion Lamps



SolarMax™ lamps are specifically designed for horticultural applications. SolarMax™ Metal Halide Conversion lamps are designed to be used in High Pressure Sodium Ballasts. 1 Year Warranty.

Item No.	Description	Approx Initial Lumens	Glass Size	MSRP
902830	SolarMax Veg Conversion MH 600	55,000	T-25	\$130.95

solarMAX™

SUNMASTER®

LIGHTING SYSTEMS FOR GREATER YIELDS

SolarMax™ Enhanced Performance HPS Lamps



SolarMax™ lamps are specifically designed for horticultural applications. ISO certified engineering and manufacturing processes assure high quality and optimized performance. SolarMax™ grow lamps are designed with the grower in mind. 1 Year Warranty.

Item No.	Description	Approx Initial Lumens	Glass Size	MSRP
902800	SolarMax Super HPS 400	55,000	T-15	\$57.95
902805	SolarMax Super HPS 600	95,000	T-15	\$82.95
902810	SolarMax Super HPS 1000	147,000	T-23	\$123.95

Sunmaster® Yellow Blossom Enhanced Performance HPS Lamps



Yellow Blossom Lamps are High Pressure Sodium lamps designed to deliver 10% more light than standard HPS lamps. This extremely energy-efficient plant grow lamp provides more energy which is essential for optimized photosynthetic response. Compatible with electronic ballasts. Red output for stem elongation and flowering. 1 Year Warranty.

Item No.	Description	Approx Initial Lumens	Glass Size	MSRP
901582	Sunmaster HPS SL600 U15 2.1K	90,000	T-14.5	\$90.95
901871	Sunmaster Super HPS 1000 U25 2.1K	150,000	E-25	\$102.95

SolarMax™ Blue Enhanced Performance Metal Halide Lamps



The SolarMax™ Veg Metal Halide bulb delivers 30% more blue light than standard bulbs. The result is stronger roots during crucial early stages of development and more vigorous, vegetative growth throughout the plant's life. They are universal bulbs, which means that they can be burned horizontally or vertically. 1 Year Warranty.

Item No.	Description	Approx Initial Lumens	Glass Size	MSRP
902815	SolarMax Veg MH 1000	85,000	T-25	\$122.95

Sunmaster® Finishing Blue Metal Halide Lamp



NEW Sunmaster® Finishing Blue Metal Halide 10,000°K is designed to finish your plants out strong. Strongest blue-violet for the final stages in the flower cycle. Optimized for use on electronic ballasts. Designed for the last two weeks of flower with the highest UV output of any bulb on the market. Pulse start lamp designed for electronic or pulse start ballasts only. 1 Year Warranty.

Item No.	Description	Approx Initial Lumens	Glass Size	MSRP
901811	Sunmaster SM.1000W.U25.10.OK	62,000	T25	\$137.95

Sunmaster® Blue Ice Enhanced Performance Metal Halide Lamps



Blue Ice Grow Lamps emit light from 5,500°K, imitating the natural look of daylight. They are an ideal light source for the seedling and vegetative stages of plant growth, while still emitting a wide spectral distribution. Blue Ice Metal Halide Lamps surpass many other HID sources in PAR watts. Designed for optimal performance on electronic ballasts. 1 Year Warranty.

Item No.	Description	Approx Initial Lumens	Glass Size	MSRP
901800	Sunmaster M400 U37 5.5K	30,000	BT-37	\$123.95
901868	Sunmaster LM600 U25 5.5K	50,000	T-25	\$137.95
901867	Sunmaster LM1000 U37 5.5K	100,000	BT-37	\$120.95
901802	Sunmaster M1000 U37 5.5K	80,000	BT-37	\$128.95

Sunmaster® Red Sunrise Metal Halide Lamps



Red Sunrise Grow Lamps emit balanced light similar to a 3,200°K source, making them ideal for all phases of plant growth. Its enhanced orange-red component promotes flowering, stem elongation and germination while a rich blue content assures healthy vegetative growth. Designed for optimal performance on electronic ballasts. 1 Year Warranty.

Item No.	Description	Approx Initial Lumens	Glass Size	MSRP
901820	Sunmaster M1000 U37 3.2K	105,000	BT-37	\$114.95

Sunmaster® Full Nova Metal Halide Lamps



NEW Sunmaster® Full Nova Metal Halide Lamps is the best all in one lamp: the most objective measurement of total light energy available for photosynthesis. Optimized for use on electronic ballasts. Sunmaster® Full Nova 6,000°K Lamps set new standards in general plant lighting, promoting high levels of photosynthesis without compromise. Pulse start lamp designed for electronic or pulse start ballasts only. These are balanced, full spectrum lamps that is the closest to the sunlight. 1 Year Warranty.

Item No.	Description	Approx Initial Lumens	Glass Size	MSRP
901805	Sunmaster LM.600W.U25.6.OK	48,000	T25	\$125.95
901807	Sunmaster SM.1000W.U25.6.OK	90,000	T25	\$183.95

STANDARD HPS LAMPS

GE® Enhanced Performance HPS Lamps



Specially developed for greenhouses, Lucalox® PSL high pressure sodium lamps offer the benefits of stable lumen and micromole maintenance and a full spectrum content that promotes photosynthesis. Photosynthesis Active Radiation (PAR, measured in micromole/sec) is essential for plant growth. The Lucalox® PSL lamp has been specially developed to provide stable lumen maintenance and increased PAR output. 1 Year Warranty.

Item No.	Description	Approx Initial Lumens	Glass Size	MSRP
901548	GE Lucalox PSL/XO HPS 400	56,500	T-15	\$61.95
901583	GE Lucalox PSL/XO HPS 600	90,000	T-17	\$81.95
901584	GE Lucalox PSL/XO HPS 750	104,000	T-15	\$99.95

Standard High Pressure Sodium (HPS) Lamps



High Pressure Sodium Grow Lights emit the yellow and red regions of the spectrum. High pressure sodium bulbs help stimulate flower and fruit production in plants more efficiently than other grow light sources. 1 Year Warranty.

Item No.	Description	Approx Initial Lumens	Glass Size	MSRP
901530-3	Philips Ceramalux HPS LU1000	140,000	E-25	\$71.95

STANDARD MH LAMPS

Standard Metal Halide (MH) Lamps



Metal Halide Grow lights have good spectral distribution. MH Grow Lights emit the bluish and green regions of the light spectrum. Metal Halide Grow Systems stimulate plant growth more efficiently than any other grow light source. It is best to use Metal Halide Lamps in addition to or cycled with HPS grow lights. 1 Year Warranty.

Item No.	Description	Approx Initial Lumens	Glass Size	MSRP
901675-3	Philips MH 1000/U/BT-37	110,000	BT-37	\$69.95

Venture Super Metal Halide Horizontal Lamp



This 1000 Watt Super Metal Halide bulb provides 12% more light output than a standard universal metal halide lamp. This Metal Halide lamp must be burned in a horizontal position. 1 Year Warranty.

Item No.	Description	Approx Initial Lumens	Glass Size	MSRP
901720	Venture MS 1000/HOR/BT-37	115,000	BT-37	\$84.95

FLUORESCENT LAMPS

Ultra Sun® T5 HO Fluorescent Grow Lamps



These high quality T5 HO lamps are excellent for all indoor gardening applications. Use the color of your choice for the growth phase of your plants. Mix and match for a full spectrum effect. For use with T5 HO fixtures. Do not use with VHO fixtures. 1 Year Warranty.

Item No.	Description	Approx Initial Lumens	MSRP
901589	Ultra Sun T5 54 Watt HO Lamp 4 ft Blue 6500K	5,000	\$11.95
901592	Ultra Sun T5 54 Watt HO Lamp 4 ft Red 3000K	5,000	\$11.95
901593	Ultra Sun T5 24 Watt HO Lamp 2 ft Red 3000K	2,000	\$7.95
901594	Ultra Sun T5 24 Watt HO Lamp 2 ft Blue 6500K	2,000	\$7.95

Spectralux® T5 HO Fluorescent Grow Lamps



These high quality T5 HO lamps are excellent for all indoor gardening applications. Use the color of your choice for the growth phase of your plants. Mix and match for a full spectrum effect. For use with T5 HO fixtures. Do not use with VHO fixtures. 1 Year Warranty.

Item No.	Description	Approx Initial Lumens	MSRP
901618	Spectralux T5 54 Watt HO Lamp 4 ft Blue 6500K	5,000	\$11.95
901619	Spectralux T5 54 Watt HO Lamp 4 ft Red 3000K	5,000	\$11.95
901620	Spectralux T5 24 Watt HO Lamp 2 ft Red 3000K	2,000	\$7.95
901621	Spectralux T5 24 Watt HO Lamp 2 ft Blue 6500K	2,000	\$7.95

Spectralux® Green T5 HO Fluorescent Grow Lamps



These lamps illuminate green when turned on. They work great in our single lamp Sun Blaze® Strip Lights or Strip Light Supremes. Only use in T5 HO fixtures, not VHO. 1 Year Warranty.

EXCLUSIVE

Item No.	Description	MSRP
901610	Spectralux Green T5 HO 54 Watt 4 ft	\$13.95
901612	Spectralux Green T5 HO 24 Watt 2 ft	\$11.95

Spectralux® T5 VHO Fluorescent Grow Lamps



These T5 VHO (Very High Output) lamps are a brand new technology. T5 HO (High Output) lamps have an initial rating of 5,000 lumens. The VHO lamps are 7,200 lumens. They have to be paired with a VHO fixtures. 1 Year Warranty.

EXCLUSIVE

Item No.	Description	Approx Initial Lumens	MSRP
901480	Spectralux T5 VHO 95 Watt 4 ft 3000K	7,200	\$15.95
901485	Spectralux T5 VHO 95 Watt 4 ft 6500K	7,200	\$15.95

Spectralux® T8 Fluorescent Grow Lamp



These daylight lamps are perfect for starting seeds and cuttings. Length is 48 in. CRI-78. Horticultural spectrum. 1 Year Warranty.

EXCLUSIVE

Item No.	Description	Approx Initial Lumens	MSRP
901616	Spectralux T8 32 Watt HO Lamp 4 ft Blue 6500K	2,950	\$3.49

GE® Starcoat T5 HO Fluorescent Lamps

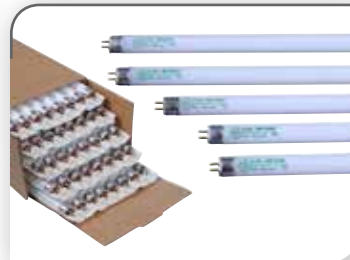

Use only these High Output (HO) lamps in fluorescent T5 fixtures. Lamps that are not marked HO will have significantly less output. Choose from the 6,500°K the blue spectrum or the 3,000°K the red spectrum. 1 Year Warranty.

Item No.	Description	Approx Initial Lumens	MSRP
901586	GE Starcoat T5 HO 24 Watt 2 ft 6500K	2,000	\$14.95
901591	GE Starcoat T5 HO 24 Watt 2 ft 3000K	2,000	\$14.95
901587	GE Starcoat T5 HO 54 Watt 4 ft 3000K	5,000	\$15.95
901588	GE Starcoat T5 HO 54 Watt 4 ft 6500K	5,000	\$15.95

Eye PowerVEG™ T5 HO Fluorescent Lamp



NEW PowerVEG™ is different than other T5 lamps. Not only does it produce a well balanced spectrum for your plants, it also provides UVA and UVB. UV is an essential component of the spectrum that produces stronger, healthier plants, allowing them to produce higher quality fruits and flowers. The sooner you introduce UV to your plants, the better your end product. No other T5 bulb on the

market produces a spectrum with this quality or UV of any kind. 1 Year Warranty.

Item No.	Description	MSRP
901678	Eye PowerVEG FS-UV 4 ft 54W HO T5	\$29.95
901679	Eye PowerVEG FS-UV 2 ft 24W HO T5	\$24.95

SunBlaster™ T5 HO Fluorescent Lamps



High Output 6,400°K lamps simulate natural sunlight and are ideal for cuttings or vegetative growth. Some horticulturist's choose 2,700°K for budding and blooming. SunBlaster's T5 HO lamp produces a light of much greater strength than a conventional tube and, as a result, the energy input into the area being lit is much greater and the light penetration is far superior. 1 Year Warranty.

Item No.	Description	MSRP
902192	SunBlaster T5 HO 18 in 6400K Replacement Lamp	\$7.95
901877	SunBlaster T5 HO 2 ft 6400K Replacement Lamp	\$7.95
901881	SunBlaster T5 HO 3 ft 6400K Replacement Lamp	\$8.49
901896	SunBlaster T5 HO 4 ft 2700K Replacement Lamp	\$9.95
901897	SunBlaster T5 HO 4 ft 6400K Replacement Lamp	\$9.95

FELIZ FLUORESCENT LAMPS

Feliz™ Fluorescent Grow Lamps



Proven success in high humidity. Compatible w/ digital timers. Fits standard mogul base socket. 300w lamps not ETL listed at the time of this catalog printing. Not for use with Garden Brite® or Bright Wing® Fixtures. 6 Month Warranty.

Item No.	Description	MSRP
901981	Feliz Blue Fluorescent 125 Watt 6500K	\$41.95
901991	Feliz Red Fluorescent 125 Watt 2700K	\$41.95
901983	Feliz Blue Fluorescent 200 Watt 6500K	\$72.95
901993	Feliz Red Fluorescent 200 Watt 2700K	\$72.95
901984	Feliz Blue Fluorescent 250 Watt 6500K	\$90.95
901986	Feliz Blue Fluorescent 300 Watt 6500K	\$115.95
901987	Feliz Red Fluorescent 300 Watt 2700K	\$115.95

AgroLED® Green Flashlight/Lamp by Feliz™



This unique 2-in-1 LED light system can be used either as a flashlight, a standard indoor/outdoor household lamp or both! To use it as a flashlight, just extend the handle and turn it on. To use it as a standard lamp, simply unscrew the end cap and insert it into any household light fixture with the same size standard base. 1 Year Warranty.

EXCLUSIVE

Item No.	Description	MSRP
960415	AgroLED 4 Watt Green Flashlight/Lamp AC/DC Rechargeable	\$29.95

SunBlaster™ Compact Fluorescent Bulb



State-of-the-art electronic, bulbs are the smallest sized full-spectrum, energy saving lights available. These 26 watt compact fluorescent bulbs fit into a variety of light fixtures. Full spectrum compact fluorescent bulbs 6400° Kelvin, provide natural color comparable to sunlight, increases visual activity and reduces eye fatigue. 1 Year Warranty.



Item No.	Description	MSRP
901892	SunBlaster CFL 26 Watt 6400K	\$9.29

Lamp & Reflector Cleaning Cloth



All light bulbs need to be wiped clean of finger prints after installation. Our micro fiber lamp cleaning cloth is perfect for doing this. Removes finger prints and dust from lamps, glass, light fixtures, etc.

Item No.	Description	MSRP
901475	Lamp & Reflector Cleaning Cloth	\$2.79

INNOVATING SINCE 1995

www.sunlightsupply.com

Titan Controls® 3P/120 Volt 50 Amp Relay



NEW High quality, definite purpose contactor relay. This product can be used to control high amperage loads such as lighting, heating, cooling, ventilation, etc. Features three poles, is rated for 50 amps and has a 120 volt activation coil.

EXCLUSIVE 

Item No.	Description	MSRP
310745	Titan Controls 3P /120V 50 A Relay	\$64.95

Durakool DPDT 80 Amp 240 Volt Coil Relay



NEW Heavy duty double pole, double throw relay. This item can be used to create lighting flippers and to switch high amperage loads on and off. The relay is rated for 80 amps and has a 240 volt activation coil.



Item No.	Description	MSRP
310140	Durakool DPDT 80 A 240V Coil Relay	\$84.95

Duplex Receptacles 120V & 240V 15 Amp



The 120 volt 15-amp white decorator duplex electrical outlet is rated for 125 volts. It is a standard residential receptacle. The 240 volt 15-amp duplex electrical outlet is rated for 250 volts. It is off white in color.



Item No.	Description	MSRP
350591	Receptacle 120 Volt 15 Amp	\$2.49
400021	Receptacle 240 Volt 15 Amp	\$6.95

Duplex Receptacle Universal 20 Amp



This universal outlet will handle 120 or 240 volt power cords. It is a 15 amp 125 volt with ground duplex outlet. Black nylon face.

Item No.	Description	MSRP
400025	120/240 20A-universal duplex outlet black	\$6.95

Power Cords



120 Volt or 240 Volt 8 ft 16/3 power cords that have 6 inches of the jacket removed, black and white wires have a 1/4 in strip and green 1/4 in ADD #8 ring terminal. These parts UL/ETL Listed or recognized.

EXCLUSIVE

Item No.	Description	MSRP
903160	Power Cord 120V 8 ft	\$8.95
903165	Power Cord 240V 8 ft	\$9.95
903108	Power Cord 277 V 6 ft NEW	\$11.95
903109	Power Cord 480V 6 ft NEW	\$11.95

Power Cord 50 Amp



High quality 3 wire replacement 50 amp power cord. This cord is 6/2 - 8/1 gauge, 50 amp, 125/250 volt. It is 6 feet in length and is also known as a range cord. Comes with a right angle male plug.

 **EXCLUSIVE**

Item No.	Description	MSRP
903198	Power Cord 50 Amp w/ Plug 6 ft 6/2 - 8/1 Gauge	\$18.95

Gray Wire Crimp



Closed end pre-insulated wire connector for 14-22 AWG wire. Compact design fits easily into tight locations. Wide wire range enables use on variety of applications. Slightly flared skirt protects against turned-back strands without taking up valuable space.



Item No.	Description	MSRP
240110	Wire Crimps - Gray	\$0.29

Show us your growing success! #sunlightsupply
Upload your images with our products!



Or get up-to-date information on new products, events, educational articles and much more on social media.

Ready to Grow® 1000 Watt HPS Ballast Kit



Kit includes Sunlight Supply® brand 1000 watt ballast, high quality capacitor using German sourced film and ignitor. Quad-tap ballast will run on 120, 208, 240 or 277 volt power. 2 Year Warranty.

Item No.	Description	MSRP
902446	Ready to Grow HPS 1000 Watt Ballast Kit	\$107.95

Replacement Metal Halide Capacitors



These major brand capacitors are rated for 100°C or 105°C temperature. The higher temperature rating means long lasting durability.

Item No.	Description	MSRP
902165	Replacement Capacitors MH 400 - 24 MFD 400 Volt	\$36.95
902170	Replacement Capacitors MH 1000 - 24 MFD 480 Volt	\$36.95

Replacement High Pressure Sodium Capacitors



These major brand capacitors are rated for 100°C or 105°C temperature. The higher temperature rating means long lasting durability.

Item No.	Description	MSRP
903000	Replacement Capacitors HPS 400 - 55 MFD 240 Volt	\$36.95
903010	Replacement Capacitors HPS 600 - 64 MFD 280 Volt (Single/Dry)	\$40.95
903015	Replacement Capacitors HPS 1000 - 26 MFD 525 Volt (Single/Wet)	\$40.95

Replacement High Pressure Sodium Ignitors



Replacement high pressure sodium ignitors for your system. Match the wattage to your system.

Item No.	Description	MSRP
200930	Replacement Ignitor CD 15 HPS 1000 (Imported)	\$23.95
200933	Replacement Ignitor CD 19 HPS 600 (Imported)	\$23.95
903040	Replacement Ignitor HPS 600 (Major Brand) L1561	\$39.95
903045	Replacement Ignitor HPS 1000 (Major Brand) L1571	\$37.95

T5 HO Fluorescent Electronic Ballasts - Fulham® Racehorse®



Major brand electronic ballast with a small profile for easy installation. Easy push-lock wire systems. Requires grounded power cord. All ballasts are program start. Use non-shunted sockets. Has 50 in leads.



Item No.	Description	MSRP
010555	T5 HO Replacement Ballast 54 Watt 4 Lamp - 120 - 277 Volts	\$71.95

T5 HO Fluorescent Electronic Ballasts - Fulham® Workhorse®



Reliable, high output ballasts. Easy installation. Instant start ballasts. Use shunted sockets. 36 in leads.



Item No.	Description	MSRP
010493	Fulham T5 HO Workhorse 5 - 120 Volt	\$36.95
010496	Fulham T5 HO Workhorse 3 - 120 Volt	\$28.95
010498	Fulham T5 HO Workhorse 7 - 120 Volt	\$62.95

Replacement T5 HO Electronic Ballasts



NEW Reliable, high output T5 ballasts. Easy Installation. Please note this is an instant start ballast. Use shunted sockets. 1 Year Warranty.



Item No.	Description	MSRP
010502	Ballast Replacement T5 HO 2 x 24 Watt - 120 Volt	\$31.95
010504	Ballast Replacement T5 HO 4 x 24 Watt - 120 Volt	\$39.95
010506	Ballast Replacement T5 HO 2 x 54 Watt - 120 Volt	\$39.95
010508	Ballast Replacement T5 HO 4 x 54 Watt - 120 Volt	\$59.95
010510	Ballast Replacement T5 HO 4 x 54 Watt - 240 Volt	\$59.95
010512	Ballast Replacement T5 HO 4 x 54 Watt - 120-277 Volt	\$69.95

Socket Mogul - 5KV/HOR



Position oriented to accept MH horizontal lamps. 5KV Socket. Leads attached.



Item No.	Description	MSRP
903066	Mogul Base Socket 5KV/HOR w/ 5 in Leads	\$9.95

Socket Assembly With Pigtail Strain Relief



Our universal socket assembly is compatible with all of our reflectors and both MH & HPS lamps. We go the extra mile by offering 5KV/ horizontal position oriented mogul base sockets. White powder coated junction box and cover. Includes strain relief but not lamp cord.

Item No.	Description	MSRP
903050	Socket Assembly w/ Pigtail Strain Relief	\$23.95

Socket Extender - Mogul Base - 4HV



These socket extenders are used to lengthen an existing socket in an HID lighting reflector. 600 Volt/4KV pulse rated for use with mogul base sockets and lamps up to 1500 watts. Extends socket 2-3/8 in.



Item No.	Description	MSRP
903073	Socket Extender Mogul Base 4KV	\$8.39

T5 HO Replacement Sockets



Excellent quality, reliable socket. UL listed component. Rotate lamp 90 degrees to lock in place. For use with instant start T5 HO ballasts.



Item No.	Description	MSRP
220177	T5 HO Replacement Sockets Shunted	\$1.59

Female Receptacle For Lamp Cord



Replacement lamp cord receptacle for all Sun System® ballasts. Donkey Ear flaps lock lamp cord in place. US Patent No: D543941.



Item No.	Description	MSRP
903090	Female Receptacle 6 in	\$6.95

Dual Female Lamp Cord Receptacle



Replacement Dual lamp cord receptacle for all Sun System® Magnetic ballasts. Dual receptacle is compatible with all Sun System® brand reflectors as well as other brands. Includes slide plate cover.



EXCLUSIVE

Item No.	Description	MSRP
903112	Dual Female Lamp Cord Receptacle	\$12.95

Strain Relief & Heyco Replacements



Strain relief and heyco replacements.



Item No.	Description	MSRP
270060	Strain Relief PG - 13 Pigtail	\$3.19
270090	Strain Relief 7W-2-1 Heyco	\$0.89

Sun System® Reflector Level



NEW The Sun System® Reflector Level is for use with all Sun System® brand reflectors and lighting fixtures. Use this triangle shape two-way level for easy, consistent, level hanging of your reflector. Easily attaches to any steel reflector or fixture with an integrated magnet. Another great Sun System® product for a better growing experience. Several of the US made Sun System® reflectors have this level included in the

box as a complimentary accessory. Actual size is 2-1/4 in by 1-3/4 in. **EXCLUSIVE**

Item No.	Description	MSRP
430025	Sun System Triangle 2 Way Level w/ Magnet	\$3.29

Reflector Hanging Hook



This is a universal replacement V hanging hook for Sun System® brand reflectors and fixtures.

Item No.	Description	MSRP
430020	Reflector Hanging Hooks	\$1.39

POWER ALL®

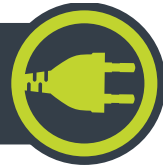

**HEAVY-DUTY COMMERCIAL GRADE
EXTENSION CORDS, ADAPTERS,
POWER STRIPS AND SURGE STRIPS
FOR ALL YOUR ELECTRICAL NEEDS.**

www.powerallproducts.com



Power All® Extension Cords with 3 Outlet Power Strip 120 & 240 Volt



These are 14 gauge commercial grade extension cords featuring a three outlet power strip. These heavy duty cords come in both a 120 volt and 240 volt grounded configuration. Cords are perfect for safely adding multiple power outlets in your growing area where they are not presently available. 1 Year Warranty.

EXCLUSIVE

Item No.	Description	MSRP
903250	Power All 120 Volt 12 ft Extension Cord w/ 3 Outlet Power Strip - 14 Gauge	\$16.29
903255	Power All 120 Volt 25 ft Extension Cord w/ 3 Outlet Power Strip - 14 Gauge	\$21.95
903257	Power All 240 Volt 12 ft Extension Cord w/ 3 Outlet Power Strip - 14 Gauge	\$24.95
903258	Power All 240 Volt 25 ft Extension Cord w/ 3 Outlet Power Strip - 14 Gauge	\$41.95

Power All® Commercial Grade Extension Cords with Circuit Breaker 125 Volt - 16 Gauge



These commercial grade extension cords incorporate a built in circuit breaker to protect you and your expensive equipment. These heavy duty cords are grounded with a molded connector. Power All® cords are moisture resistant and constructed to be flexible yet durable. 16 Gauge/13A/1625 Max watts. 1 Year Warranty.

EXCLUSIVE

Item No.	Description	MSRP
780065	Power All Commercial Grade 125 Volt 6 ft Cord w/ Circuit Breaker -16 Gauge	\$9.95
780005	Power All Commercial Grade 125 Volt 10 ft Cord w/ Circuit Breaker -16 Gauge	\$11.95
780010	Power All Commercial Grade 125 Volt 15 ft Cord w/ Circuit Breaker -16 Gauge	\$13.95
780015	Power All Commercial Grade 125 Volt 25 ft Cord w/ Circuit Breaker -16 Gauge	\$15.95
780020	Power All Commercial Grade 125 Volt 50 ft Cord w/ Circuit Breaker -16 Gauge	\$21.95

Power All® Commercial Grade 125 Volt Cords with Circuit Breaker - 14 Gauge



Ideal cord for use in your indoor/outdoor garden. These commercial grade extension cords incorporate a built in circuit breaker. These heavy duty cords are grounded with a molded connector. Cords are moisture resistant and constructed to be flexible yet durable. 14 Gauge/15A/1875 Max watts. 1 Year Warranty.

EXCLUSIVE

Item No.	Description	MSRP
780070	Power All Commercial Grade 125 Volt 6 ft Cord w/ Circuit Breaker -14 Gauge	\$10.95
780025	Power All Commercial Grade 125 Volt 15 ft Cord w/ Circuit Breaker -14 Gauge	\$16.95
780035	Power All Commercial Grade 125 Volt 50 ft Cord w/ Circuit Breaker -14 Gauge	\$33.95

Power All® Commercial Grade 125 Volt Cord with Circuit Breaker, Triple Plug



14 gauge extension cord with a 120 volt inline receptacle located every 8 feet. Two outlets are inline and one located at the end for a max of three. Has a built in circuit breaker to help protect you and your expensive equipment. Cords are moisture resistant and constructed to be flexible yet durable. 14 Gauge/15A/1875 Max watts. 1 Year Warranty.

EXCLUSIVE

Item No.	Description	MSRP
780030	Power All Commercial Grade 125 Volt 25 ft Cord w/ Circuit Breaker Triple Plug (1 every 8 ft) -14 Gauge	\$29.95

Power All® Commercial Grade - 125 Volt - 7 ft Lead Cord with 3 - 6 ft Extension Cords with Circuit Breaker



A 7 ft heavy duty commercial grade extension cord that splits off into 3 separate 6 ft cords, each with a female outlet. These extension cords incorporate a built in circuit breaker to help protect you and your expensive equipment. Double insulated, moisture resistant and durable with flexible molded connectors. 14 Gauge/15A/1875 Max watts. 1 Year Warranty.

EXCLUSIVE

Item No.	Description	MSRP
780060	Power All Commercial Grade 125 Volt -7 ft Lead Cord w/ three 6 ft Extension Cords w/ Circuit Breaker	\$27.95

Power All® 6 Outlet Grounded Adapter - 125 Volt



This 6 outlet adapter turns any dual 120 volt outlet into 6 separate outlets. Includes a built in safety cover on every receptacle. This increased outlet adapter is great for running multiple low amp accessories. 15A/1875 Max watts. 1 Year Warranty.

EXCLUSIVE

Item No.	Description	MSRP
780040	Power All 6 Outlet Grounded Adapter 125 Volt	\$2.99

Power All® Indoor GFCI Power Strip - 4 Outlet - 125 Volt



The Power All® GFCI Indoor power strip has 4 standard outlets. Each outlet is protected by a spring loaded plastic cover to prevent electrical shock, water and debris. Plugs are protected by a built in 15 amp circuit breaker with a GFCI. Cord is 6 ft unit includes a test and a reset button. 14 Gauge/15A/1875 Max watts. 1 Year Warranty.



EXCLUSIVE

Item No.	Description	MSRP
780045	Power All Indoor GFCI Power Strip 4 Outlet 125 Volt 6 ft Cord	\$36.95

Power All® Indoor Metal Power Strip - 4 Outlet - 125 Volt - 8 ft Cord



The Power All® heavy duty indoor metal power strip includes four 120 volt outlets. Each outlet is protected by a plastic cover to prevent electrical shock, water and debris. Unit includes a lighted on/off switch and built-in 15-amp circuit breaker. 14 Gauge/15A/1875 Max watts. 1 Year Warranty.



EXCLUSIVE

Item No.	Description	MSRP
780050	Power All Indoor Metal Power Strip 4 Outlet 125 Volt 8 ft Cord	\$12.95

Power All® Indoor Metal Surge Strip - 6 Outlet - 125 Volt



The heavy duty indoor surge strip has a sturdy impact resistant metal housing with 1500 joules surge protection. Power strip has 6 horizontal outlets with built-in safety covers, 15 amp surge protection with a LED indicator and a lighted on/off switch. 14 Gauge/15A/1875 Max watts. 1 Year Warranty.



EXCLUSIVE

Item No.	Description	MSRP
780055	Power All Indoor Metal Surge Strip 6 Outlet 125 Volt 4 ft Cord	\$13.95

Smart Volt® Power Cords



These power cords are compatible with all ballasts that feature Smart Volt® power cords. This includes Sun System® Harvest Pro®, Hard Core®, Eye Platinum and Gold and Galaxy®.



EXCLUSIVE

Item No.	Description	MSRP
903081	Smart Volt Power Cord 120 V - 6 ft	\$10.95
903082	Smart Volt Power Cord 240 V - 6 ft	\$10.95
903083	Smart Volt Power Cord 120 V - 20 ft	\$23.95
903084	Smart Volt Power Cord 240 V - 20 ft	\$25.95

Smart Volt® Dual Ferrite Power Cords



Dual Ferrite Smart Volt® power cords are used with our ultra low RFI emission Grow Amp® ballasts. These dual ferrite noise dampening cords may be used with other products, dampening ability will vary based on ballast used. Sunlight Supply® makes no claims of ballast compliance if this cord is used with any other brand electronic ballast. Cords are 6.5 feet long. Choose from 120 volt or 240 volt.



EXCLUSIVE

Item No.	Description	MSRP
903086	120 Volt Smart Volt Cord w/ 2 Molded Ferrites - 6 ft	\$14.95
903088	240 Volt Smart Volt Cord w/ 2 Molded Ferrites - 6 ft	\$18.95
903087	120 Volt Smart Volt Cord w/ 2 Molded Ferrites - 12 ft	NEW \$21.95
903089	240 Volt Smart Volt Cord w/ 2 Molded Ferrites - 12 ft	NEW \$25.95

Lamp Cords



Replacement lamp cords.

EXCLUSIVE

Item No.	Description	MSRP
903100	Lamp Cord 15 ft - 16 Gauge	\$16.95
903105	Lamp Cord 25 ft - 14 Gauge	\$39.95

Lamp Extension Cords - 10 Foot



These cords plug into the female lamp cord receptacle on a Sun System® ballast then into the male plug on the lamp cord coming from the reflector. Increase the distance between their ballast and reflector by 10 feet. Match cord gauge to your existing lamp cord gauge.

EXCLUSIVE

Item No.	Description	MSRP
903245	10 ft Lamp Extension Cord - 16 Gauge	\$18.95
903247	10 ft Lamp Extension Cord - 14 Gauge	\$26.95

Lamp Cord - 2 Point Detachable



Replacement cord for Sun System® reflectors that require the 15 ft 2 point detachable cord.

EXCLUSIVE

Item No.	Description	MSRP
903104	Lamp Cord 15 ft - 16 Gauge Replacement 2 Point Detachable	\$19.95

Lamp Cord With Molded Strain Relief



Use this to replace your lamp cord on your reflectors. Length is 15 ft. US Patent No: D570295.

EXCLUSIVE

Item No.	Description	MSRP
903102	Lamp Cord w/ Molded Strain Relief	\$18.95

Power Cord & Lamp Cord With Socket



8 ft power cord with socket for use with mogul based self-ballasted compact fluorescent lamps.

15 ft lamp cord with socket for use with all mogul based HPS & MH lamps (ballast required). 5 Year Warranty.

EXCLUSIVE

Item No.	Description	MSRP
903063	8 ft Power Cord w/ Mogul Base Socket	\$16.95
903064	15 ft Lamp Cord w/ Mogul Base Socket	\$23.95

Socket Assemblies With Lamp Cord



Use with all Sun System® reflectors that do not come standard with a socket. These sockets come with the patented male lamp receptacle which is compatible with all Sun System® ballasts. Flexible pigtail strain relief. 5KV mogul base socket. 5 Year Warranty.



EXCLUSIVE

Item No.	Description	MSRP
903055	Socket Assembly w/ 15 ft Lamp Cord - 16 Gauge	\$31.95
903060	Socket Assembly w/ 25 ft Lamp Cord - 14 Gauge	\$42.95

Socket Assembly - 5KV Short



These are shorter than our extended sockets (#903055). This is a multi-purpose socket, perfect for applications where a shorter socket is required. 5 Year Warranty.



EXCLUSIVE

Item No.	Description	MSRP
903057	Socket Assembly - Short 5KV	\$33.95

Titan Controls® Apollo® 4 - 120 Volt Ballast Timer



The Apollo® 4 is specifically designed for use with today's high in-rush lighting ballasts. This is achieved by installing a 'ballast rated' relay vs. the standard mechanical switch that is used in conventional 24 hour appliance timers. It features a precision German built 24 hour clock, quality enclosure and timer cover that resists dust and moisture. Assure **EXCLUSIVE**



the success of your plants by having the best lighting control in the market today. 10 Amp maximum/120 Volts/60 Hz./1000 Watts. 2 Year Warranty.

Item No.	Description	MSRP
734135	Titan Controls Apollo 4 - 120 Volt Ballast Timer	\$79.95

Titan Controls® Apollo® 5 - 240 Volt Ballast Timer



The Apollo® 5 is specifically designed for use with today's high in-rush lighting ballasts. This is achieved by installing a 'ballast rated' relay vs. the standard mechanical switch that is used in conventional 24 hour appliance timers. It features a precision German built 24 hour clock, quality enclosure and timer cover that resists dust and moisture. Assure the success of your plants by having the best lighting control in the market today. 10 Amp maximum/240 Volts/60 Hz./1000 Watts. 2 Year Warranty.

EXCLUSIVE

Item No.	Description	MSRP
734140	Titan Controls Apollo 5 - 240 Volt Ballast Timer	\$84.95



Continually pushing the limits of technology to create the best growth! #growwhatyouknow

The Original,
Patented, Lighting &
Equipment Hangers

SUN GRIP®

Excellent for
hanging reflectors
& light fixtures

Sun Grip® Light Hangers 1/8 in - White



Sun Grip® Light Hangers allow you to secure items quickly & easily. Sun Grip's patented system pulls tight, locks in place, & will never break, slip or rust. Heat & cold resistant. 8 ft braided polypropylene rope. Carabiner clips provide a secure hold.

EXCLUSIVE

Item No.	Description	MSRP
710122	SunGrip Light Hanger 1/8 in White - 1/Pair	\$14.95

Sun Grip® Light Hangers 1/8 in - The Original

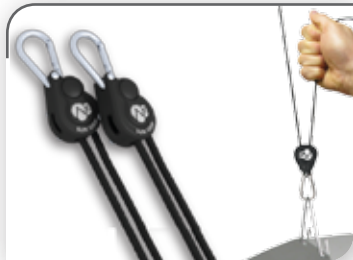

Sun Grip® Light Hangers allow you to secure items quickly & easily. Sun Grip's patented system pulls tight, locks in place, & will never break, slip or rust. Heat & cold resistant. 8 ft braided polypropylene rope. Carabiner clips provide a secure hold.

**New Easy Push
Button Release**

EXCLUSIVE

Item No.	Description	MSRP
710114	SunGrip Light Hanger 1/8 in - 1/Pair	\$14.95

Sun Grip® Heavy Duty Light & Equipment Hangers 1/4 in - The Original



Sun Grip® Light Hangers allow you to secure items quickly & easily. Sun Grip's patented system pulls tight, locks in place & will never break, slip or rust. Heat & cold resistant. 8 ft braided polypropylene rope. Carabiner clips provide a secure hold.

EXCLUSIVE

Item No.	Description	MSRP
710116	SunGrip Heavy Duty Light Hanger 1/4 in	\$14.95

SunLift® - The Original



SunLift® is a reflector suspension system which allows you to adjust the height of a hood in one simple movement. The tension mechanism will keep the hood in place once. The support strings pull out and retract like a yo-yo. A pair of SunLifts can support up to 22 lbs. Maximum extension length is 4.5 feet.

Item No.	Description	MSRP
710120	SunLift	\$7.95

Grow Yo-Yo



The Grow Yo-Yo allows the user to easily adjust the height of their reflectors as their plants grow. Also makes spraying or trimming your plants easy by being able to raise a reflector up and out of the way. Weight capacity is 22 lbs per pair.

Item No.	Description	MSRP
710129	Grow Yo-Yo 12/Box	\$7.95



FASTFIT®
toolless assembly light & tray stands

Revolutionary toolless light & tray stands. Unique patented "no hassle" toolless design allows for a quick and simple assembly in minutes!

Designed and engineered for the pieces to simply slide together. US Patent 8,714,498, Patent Pending 14/269,619, PCT Application CT/US12/00001 and Chinese Patent 201280018267.2



Unique patented "no hassle" toolless design allows for a quick and simple assembly.



Fast Fit® Tray Stand 2 ft x 4 ft



Heavy duty 2 ft x 4 ft quick assembly tray stand. Absolutely no tools required. Can be assembled in 5 minutes or less. Accommodates all popular brand trays and reservoirs. Overall height is 25 in. Height from bottom bar to floor is 18 in without casters. Outside dimensions: 53 in length by 28.5 in wide. Inside dimensions: 51 in length by 26.5 in wide. US Patent 8,714,498, Patent Pending 14/269,619, PCT **EXCLUSIVE**

Application CT/US12/00001 and Chinese Patent 201280018267.2. Tray sold separately.

Item No.	Description	MSRP
706120	Fast Fit Tray Stand 2 ft x 4 ft	\$109.95

Fast Fit® Tray Stand 3 ft x 3 ft



Heavy duty 3 ft x 3 ft quick assembly tray stand. Absolutely no tools required. Can be assembled in 5 minutes or less. Accommodates all popular brand trays and reservoirs. Overall height is 25 in. Height from bottom bar to floor is 18 in without casters. Outside dimensions: 41.3 in length by 41.3 in wide. Inside dimensions: 39.3 in length by 39.3 in wide. US Patent 8,714,498, Patent Pending 14/269,619, PCT Application CT/

US12/00001 and Chinese Patent 201280018267.2. Tray sold separately. **EXCLUSIVE**

Item No.	Description	MSRP
706121	Fast Fit Tray Stand 3 ft x 3 ft	\$126.95

Fast Fit® Tray Stand 4 ft x 4 ft



Heavy duty 4 ft x 4 ft quick assembly tray stand. Absolutely no tools required. Can be assembled in 5 minutes or less. Accommodates all popular brand trays and reservoirs. Overall height is 25 in. Height from bottom bar to floor is 18 in without casters. Outside dimensions: 53 in length by 53 in wide. Inside dimensions: 51 in length by 51 in wide. US Patent 8,714,498, Patent Pending 14/269,619, PCT **EXCLUSIVE**

Application CT/US12/00001 and Chinese Patent 201280018267.2. Tray sold separately.

Item No.	Description	MSRP
706122	Fast Fit Tray Stand 4 ft x 4 ft	\$149.95

Fast Fit® Tray Stand 3 ft x 6 ft



NEW Heavy duty 3 ft x 6 ft quick assembly tray stand. Absolutely no tools required. Can be assembled in 5 minutes or less. Accommodates all popular brand trays and reservoirs. Overall height is 25 in. Height from bottom bar to floor is 18 in without casters. US Patent 8,714,498, Patent Pending 14/269,619, PCT Application CT/US12/00001 and Chinese Patent

EXCLUSIVE

201280018267.2. Tray sold separately.

Item No.	Description	MSRP
706135	Fast Fit Tray Stand 3 ft x 6 ft	\$191.95

Fast Fit® Tray Stand 4 ft x 8 ft



Heavy duty 4 ft x 8 ft quick assembly tray stand. Absolutely no tools required. Can be assembled in 5 minutes or less. Accommodates all popular brand trays and reservoirs. Overall height is 25 in. Height from bottom bar to floor is 18 in without casters. Outside dimensions: 102 in length by 53 in wide. Inside dimensions: 100 in length by 51 in wide. US Patent 8,714,498, **UPS** Patent Pending **EXCLUSIVE**

14/269,619, PCT Application CT/US12/00001 and Chinese Patent 201280018267.2. Tray sold separately.

Item No.	Description	MSRP
706124	Fast Fit Tray Stand 4 ft x 8 ft	\$249.95

Fast Fit® Components

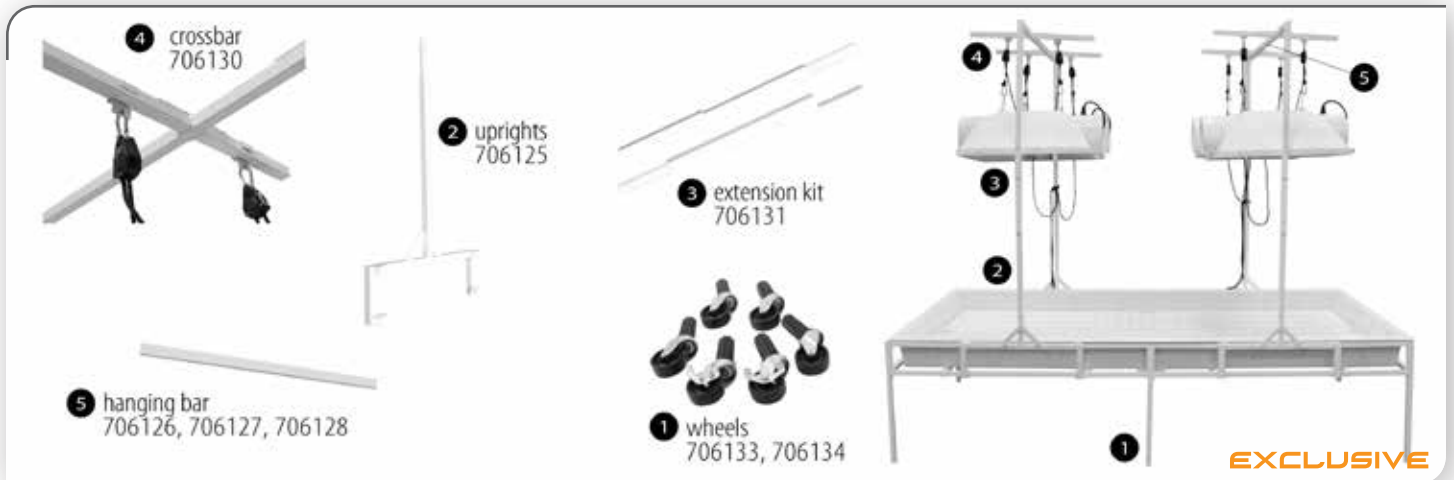

Fast Fit® A La Carte Components: Castor wheels - 4 pc (706133 - can support up to 240 lbs) and 6 pc (706134 - can support up to 360 lbs). Light Stand 4 ft Uprights (706125). Extension Kit (706131). Light Stand Crossbar (706130). Sturdy hanging bar comes in 2 ft, 3 ft and 4 ft sizes (706126, 706127, 706128).

Item No.	Description	MSRP
706125	Fast Fit Light Stand Kit Upright 4 ft	\$91.95
706126	Fast Fit Light Hanging Bar for 2 ft x 4 ft	\$18.95
706127	Fast Fit Light Hanging Bar for 3 ft x 3 ft	\$16.95
706128	Fast Fit Light Hanging Bar for 4 ft x 4 ft or 4 ft x 8ft (Width)	\$19.95
706129	Fast Fit Light Hanging Bar for 4 ft x 8 ft (Length)	\$34.95
706130	Fast Fit Light Stand Crossbar - 1 each	\$32.95
706131	Fast Fit Light Stand Extension Kit - 2 each	\$23.95
706132	Fast Fit Tray Stand Tray Support Bar 4 ft	\$19.95
706133	Fast Fit Caster Wheels - 4 pc	\$26.95
706134	Fast Fit Caster Wheels - 6 pc	\$37.95

Sun System® Sun Stand 2



Strong sturdy construction. The stand is 60 in wide with adjustable shuttles that go from 12 in to 48 in apart in 3 in increments. Adjustable height 52 in to 88 in. Includes a pair Sunlifts to easily hang light fixtures up to 22 lbs.

EXCLUSIVE

Item No.	Description	MSRP
710118	Sun Stand 2	\$99.95

Jack Chain



Heavy duty jack chain can be used for a variety of indoor gardening applications. Unique design allows for individual links to be easily opened with pliers. Great for hanging reflectors, light fixtures, carbon filters and ventilation equipment.

Item No.	Description	MSRP
350205	Jack Chain 100 ft Roll	\$43.95
350210	Jack Chain 200 ft Roll	\$79.95

LightRail® Components

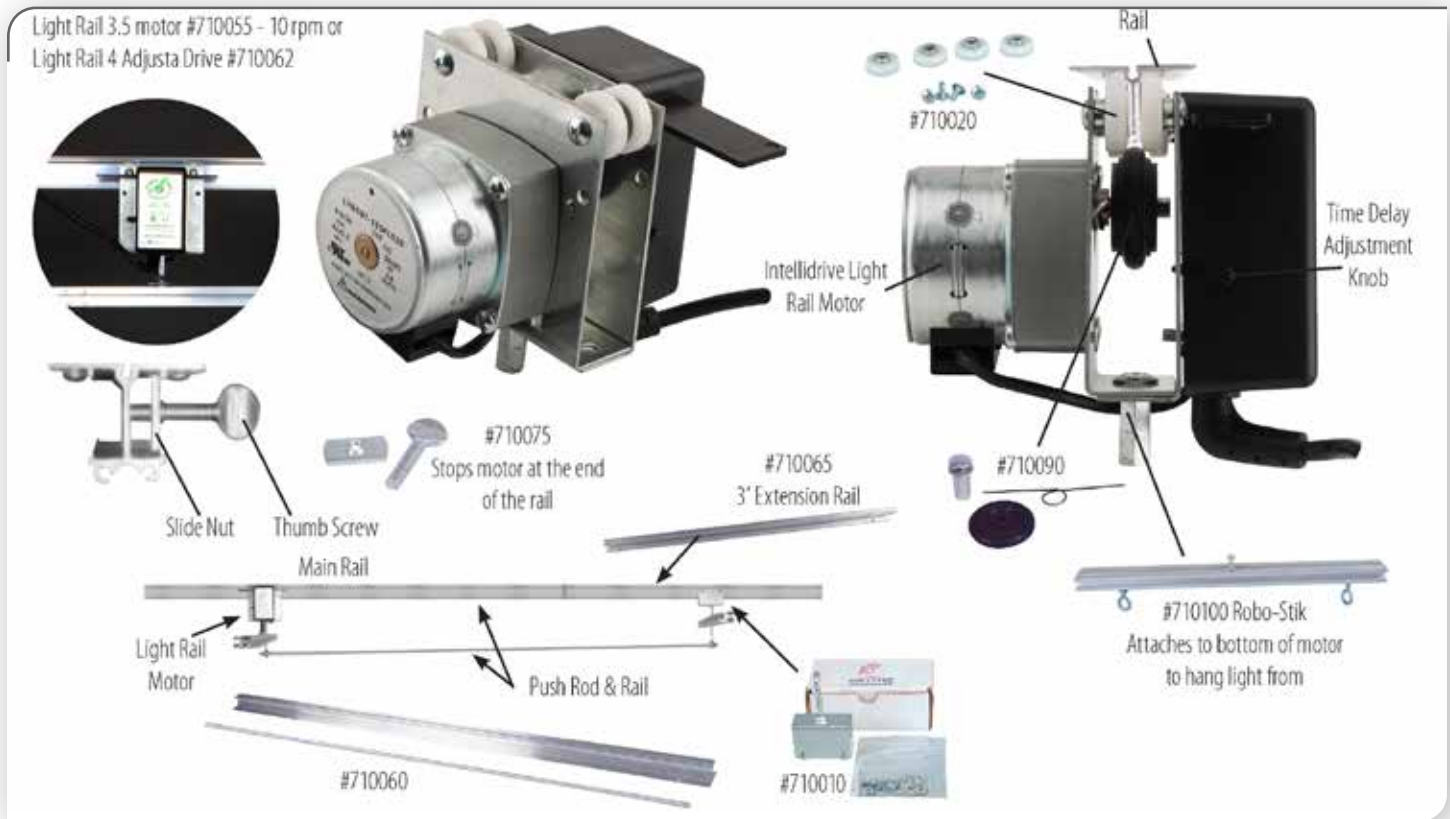

LightRail® moves your lights over the tops of the plants, reducing shadow patterns and getting the correct intensity of light on the leaves for optimum Leaf Area Index – the single most important factor in increasing your yield. You'll get much better yields plus up to 20% more area covered – you save energy and money, and with much better results. LightRail® is the single best way to get more from your grow lights. LightRail® – solidly made in the USA since 1986. 2 Year Warranty.

Item No.	Description	MSRP
LightRail 3.5 & 4.0 Motors		
710055	LightRail 10 RPM Intellidrive Light Rail 3.5 Motor	\$221.95
710062	LightRail 4.0 Adjusta Drive Motor Only	\$256.95
LightRail 3.5 & 4.0 Rails		
710085	LightRail 6.5 ft Rail	\$35.95
710065	LightRail 3 ft Extension Rail	\$15.95
710060	LightRail 6.5 ft Rail & Threaded Push Rod	\$41.95
LightRail 3.5 & 4.0 Accessories		
710100	LightRail Robo-Stik Lamp Stabilizing Bar	\$31.95
710090	LightRail Drive Wheel O Ring Kit	\$5.95
710010	LightRail Add A Lamp Hardware Only (No Rail or Rod)	\$24.95
710020	LightRail Trolley Wheel Replacement Kit	\$7.95
710075	LightRail Slide Nut w/ Thumb Screw	\$1.49

LightRail® 4.0 Adjusta Drive Complete



The LightRail® 4 Adjusta Drive now with fully adjustable variable speed control between 6 and 10 r.p.m. and 0 to 60 second adjustable time delay for promoting even plant growth at the ends of the lamps travel. Rail and motor kit in one box - box dimensions 41 in x 6 in x 5 in.

Item No.	Description	MSRP
710057	LightRail 4.0 Adjust A Drive 6/10 RPM	\$303.95

LightRail® 3.5 Complete Kit



Rail & motor kit in one box - box dimensions: 41 in x 6 in x 5 in. Excellent for shipping or conserving space in your store.

Item No.	Description	MSRP
710135	LightRail 3.5 Complete 10 RPM Kit	\$259.95

LightRail® 5 Complete Kit



The LightRail® 5 is extremely heavy-duty & functional. Great for multiple reflectors. 90+ lb capacity if properly balanced. Comes complete with a high torque 4 RPM motor, adjustable crossbar and 8 ft rail.

Item No.	Description	MSRP
710140	LightRail 5 Complete 4 RPM Kit	\$539.95
710141	LightRail 5 Motor Only - 4 RPM	\$369.95

LightRail® 5 Accessories



The LightRail® 5 Fore & Aft Crossbar Mounting kit for mounting crossbar, Add-A-Bar kit includes LightRail® 5 trolley, crossbar, 4 foot push rod and all the hardware needed. Does not include 4 ft rail. Auxiliary rail is a 4 ft extension.

Item No.	Description	MSRP
710146	LightRail 5 Add-A-Bar Kit	\$165.95
710147	LightRail 5 Auxiliary Rail 4 ft	\$73.95

LightRail® Hanging Bracket for Grow Tents



Rail Hangers are tent rail hanging brackets for hanging LightRail 3.0, 3.5 and 4.0 rails. Simply the easiest solution for hanging a LightRail® in a grow tent or greenhouse. These are recommended for use with one piece rails. They are blister packed 4 per package.

Item No.	Description	MSRP
710067	LightRail 3.0, 3.5, 4.0 Hanging Bracket for Grow Tents	\$15.95

SunBlaster™ T5 Universal Light Stand



The Universal T5 Stand allows you to set the exact lighting height to get your seedlings or fresh cuttings off to their best starts ever. Achieving the optimum 3 - 6 in lighting distance from the plant canopy is now a breeze. Simple O-Ring adjustment makes setting just the right height quick and easy. These sturdy light stands are made of durable high quality injection molded plastic and rust free powder coated aluminum.

Item No.	Description	MSRP
710158	SunBlaster T5 Universal Light Stand	\$35.95

SunBlaster™ Universal T5 Light Strip Hanger



Allows you to add up to seven T5's above your target area. Snap any size of T5 into one or all of the seven mounting banks. Made to snap into your Universal T5 Stand, hang from above, with your choice of suspension hardware or wall mount. Includes 2 SunBlaster™ Universal Light Strips, 2 mounting screws and 4 easy clip hangers.

Item No.	Description	MSRP
710162	SunBlaster Universal T5 Light Strip Hanger	\$10.49

Reflector Hanging Hook



This is a universal replacement V hanging hook for Sun System® reflectors and fixtures.

Item No.	Description	MSRP
430020	Reflector Hanging Hooks	\$1.39

Power All® Indoor GFCI Power Strip - 4 Outlet - 125 Volt



The Power All® GFCI Indoor power strip has 4 standard outlets. Each outlet is protected by a spring loaded plastic cover to prevent electrical shock, water and debris. Plugs are protected by a built in 15 amp circuit breaker with a GFCI. Cord is 6 ft unit includes a test and a reset button. 14 Gauge/15A/1875 Max watts. 1 Year Warranty.



EXCLUSIVE

Item No.	Description	MSRP
780045	Power All Indoor GFCI Power Strip 4 Outlet 125 Volt 6 ft Cord	\$36.95

GROVISION™
HIGH PERFORMANCE SHADES™

Specifically designed for the indoor grower. Improves contrast, corrects colors and reduces glare.
www.gro-vision.com

GroVision™ High Performance Shades™ - Classic



NEW GroVision™ “Classic” High Performance Shades™ feature color balancing polycarbonate lenses which are excellent for use in all grow room applications. The classic wayfarer style shades are suitable for both indoor and outdoor gardening. They feature scratch resistant lenses which meet ANSI Z87.1 American National Standards. The full black

frames are fitted with special, high-tech blue lenses that are optimized for use in HPS light. Includes a microfiber draw string bag for cleaning and storage.

EXCLUSIVE

Item No.	Description	MSRP
744140	GroVision High Performance Shades - Classic	\$23.95

GroVision™ High Performance Shades™ - Lite



NEW GroVision™ “Lite” High Performance Shades™ feature color balancing polycarbonate lenses which are excellent for use in all grow room applications. The GroVision™ “Lites” are designed for a tight, wrap around fit to help keep bright HPS lighting out. They feature scratch resistant lenses which meet ANSI Z87.1 American National Standards. The comfortable

frames are fitted with special, high-tech blue lenses that are optimized for use in HPS light. Includes a microfiber draw string bag for cleaning and storage.

EXCLUSIVE

Item No.	Description	MSRP
744142	GroVision High Performance Shades - Lite	\$21.95

GroVision™ High Performance Shades™ - Pro



NEW GroVision™ “Pro” High Performance Shades™ feature color balancing polycarbonate lenses which are excellent for use in all grow room applications. The “Pro” model is designed for an everyday comfortable fit. They feature scratch resistant lenses which meet ANSI Z87.1 American National Standards. The full black frames are fitted with special, high-tech blue

lenses that are optimized for use in HPS light. Includes a microfiber draw string bag for cleaning and storage.

EXCLUSIVE

Item No.	Description	MSRP
744144	GroVision High Performance Shades - Pro	\$21.95

Professional UV Safety Glasses



100% UVA UVB Protection with lightweight nylon frames. Excellent for use around HPS & MH lights in grow rooms. Scratch resistant polycarbonate lens. Wrap around protection with no side shield distortion. Adjustable temple for ultimate comfort.

Item No.	Description	MSRP
708035	Professional UV Safety Glasses	\$13.95



Method Seven Resistance HPS Glasses



NEW A must-have for anyone making critical plant health and harvest decisions, the Method Seven Resistance HPS delivers “Perfect Color” for the world’s ultimate grow experience in the intense yellow spectrum and harsh conditions of HPS lighting. Lenses are formulated with Method Seven signature color technology and manufactured using the highest quality

German mineral glass for unparalleled color, clarity and protection. Microfiber pouch and hard case included for proper cleaning and storage. 100% UV protection.

Item No.	Description	MSRP
744122	Method Seven Resistance HPS	\$149.00

Method Seven Coup HPSx Transition Glasses



NEW HPSx – Sunglass by day, grow glass by night, the Coup HPSx is the world’s first and only photochromic grow glasses. The HPSx lens is a proprietary polycarbonate blend that allows it to transition from the signature blue of our HPS color-balancing technology to a very dark grey/blue tint when exposed to direct sunlight. Microfiber pouch included for proper cleaning

and storage. 100% UV protection.

Item No.	Description	MSRP
744124	Method Seven Coup HPSx Transition	\$149.00

Method Seven Operator HPS Plus Glasses



NEW Experience exceptional color-balancing for HPS (high pressure sodium) lighting with our proprietary lenses manufactured to exacting standards by Carl Zeiss Vision. The Operator features curved 8 base lenses that are optically decentered to eliminate prismatic distortion in a 'sport-style' frame. Our Silver Plus lens coating makes the Operator

HPS+ a good choice for outdoors too. Microfiber pouch included for proper cleaning and storage. 100% UV protection.

Item No.	Description	MSRP
744126	Method Seven Operator HPS Plus	\$79.00

Method Seven Operator LED Glasses



NEW Like nothing else, the world's first and only lens optimized for LED lighting environments. Lenses manufactured to exacting standards and optical clarity by Carl Zeiss Vision. Color-balance for LED grow lights. The Operator features curved 8 base lenses that are optically decentered to eliminate prismatic distortion in a 'sports-style' frame. Color, clarity and protection

benefit you and your plants. Microfiber pouch included for proper cleaning and storage. 100% UV protection.

Item No.	Description	MSRP
744128	Method Seven Operator LED	\$79.00

Method Seven Cultivator HPS Plus Glasses



NEW Experience exceptional color-balancing for HPS lighting with our proprietary lenses manufactured to exacting standards by Carl Zeiss Vision. A no-compromise lens in a lightweight half jacket frame provides great budget value. Microfiber pouch included for proper cleaning and storage. 100% UV protection.

Item No.	Description	MSRP
744130	Method Seven Cultivator HPS Plus - POP Display Box	\$59.00

Method Seven Cultivator LED Plus Glasses



NEW Experience exceptional color-balancing for LED lighting with our proprietary lenses manufactured to exacting standards by Carl Zeiss Vision. A no-compromise lens in a lightweight half jacket frame provides great budget value. Lenses color-balance the most popular commercial LED grow lights. Microfiber pouch included for proper cleaning and storage.

100% UV protection.

Item No.	Description	MSRP
744132	Method Seven Cultivator LED Plus - POP Display Box	\$59.00

Grower's Edge® Black Diamond Textured Nitrile Gloves



NEW Grower's Edge® Disposable Diamond Textured Nitrile Gloves are latex and powder free. Heavy duty 6 mil thickness for strength and durability while still maintain its elasticity. Diamond Textured Nitrile Gloves are ambidextrous and highly resistant to puncture, solvents and grease. These gloves feature a one of a kind diamond print pattern on the glove to enhance grip **EXCLUSIVE**

and dexterity when compared to conventional disposable gloves.

Item No.	Description	MSRP
744400	Grower's Edge Black Powder Free Diamond Textured Nitrile Gloves 6 mil - Small (100/Box)	\$25.95
744402	Grower's Edge Black Powder Free Diamond Textured Nitrile Gloves 6 mil - Medium (100/Box)	\$25.95
744404	Grower's Edge Black Powder Free Diamond Textured Nitrile Gloves 6 mil - Large (100/Box)	\$25.95
744406	Grower's Edge Black Powder Free Diamond Textured Nitrile Gloves 6 mil - X-Large (100/Box)	\$25.95
744408	Grower's Edge Black Powder Free Diamond Textured Nitrile Gloves 6 mil - XX-Large (100/Box)	\$25.95

Grower's Edge® Black Nitrile Gloves



NEW Grower's Edge® Disposable Black Nitrile Gloves are latex and powder free. Heavy duty 6 mil thickness for strength and durability while still maintain its elasticity. Grower's Edge® Disposable Black Nitrile Gloves are ambidextrous and highly resistant to puncture, solvents and grease. These gloves feature an excellent grip and dexterity. Suitable for a variety application including gardening, automotive or cleaning.

EXCLUSIVE

Item No.	Description	MSRP
744409	Grower's Edge Black Powder Free Nitrile Gloves 6 mil - Small (100/Box)	\$19.95
744410	Grower's Edge Black Powder Free Nitrile Gloves 6 mil - Medium (100/Box)	\$19.95
744412	Grower's Edge Black Powder Free Nitrile Gloves 6 mil - Large (100/Box)	\$19.95
744414	Grower's Edge Black Powder Free Nitrile Gloves 6 mil - X-Large (100/Box)	\$19.95
744416	Grower's Edge Black Powder Free Nitrile Gloves 6 mil - XX-Large (100/Box)	\$19.95

Black Lightning Powder Free Nitrile Gloves



Made to match healthy skin's natural 5.5 pH levels to ensure the most comfortable fit yet! Unique formulation reduces excess perspiration. Super strength and stretch. Textured grip. Medical quality. Latex free. Ambidextrous.

Item No.	Description	MSRP
744200	Black Lightning Powder Free Nitrile Gloves Small (100/Box)	\$18.95
744205	Black Lightning Powder Free Nitrile Gloves Medium (100/Box)	\$18.95
744210	Black Lightning Powder Free Nitrile Gloves Large (100/Box)	\$18.95
744215	Black Lightning Powder Free Nitrile Gloves X-Large (100/Box)	\$18.95

Buried Treasure®

Buried Treasure® Phos Bat Guano 0 - 13 - 0



Buried Treasure® Phos Bat Guano is a natural fertilizer from the Philippines that contains phosphorus. It can be used indoors or outdoors on vegetables, herbs, flowers, ornamentals and in hydroponic applications. Buried Treasure® Guano is micronized for better solubility and delivery. Does not contain fillers. Not for sale in the following states at this time: NY.

EXCLUSIVE

Item No.	Description	MSRP
721100	Buried Treasure Phos Bat Guano 2.2 lb	\$8.95
721105	Buried Treasure Phos Bat Guano 11 lb	\$40.95
721110	Buried Treasure Phos Bat Guano 40 lb	\$126.95

Buried Treasure® Phos Seabird Guano 0 - 12 - 0



When blooming and ripening fruit, good phosphorus levels are very important. Straight from Indonesia Buried Treasure® Phos Seabird Guano is a natural fertilizer that contains phosphorus. It can be used indoors or outdoors on vegetables, herbs, flowers, ornamentals and in hydroponic applications. Buried Treasure® Guano is micronized for better solubility and delivery. Does not contain fillers. Not for sale in the following states at this time: NY.

EXCLUSIVE

Item No.	Description	MSRP
721115	Buried Treasure Phos Seabird Guano 2.2 lb	\$7.95
721120	Buried Treasure Phos Seabird Guano 11 lb	\$33.95
721125	Buried Treasure Phos Seabird Guano 40 lb	\$81.95

Buried Treasure® Nitro Bat Guano 9 - 3 - 1



Malaysian Nitro Bat Guano is a natural fertilizer that contains nitrogen, potassium and phosphorus. Plants use nitrogen to enhance leaf growth and plant vigor. It can be used indoors or outdoors on vegetables, herbs, flowers, ornamentals and in hydroponic applications. Buried Treasure® Guano is micronized for better solubility and delivery. Does not contain fillers. Not for sale in the following states at this time: NY.

EXCLUSIVE

Item No.	Description	MSRP
721130	Buried Treasure Nitro Bat Guano 1 lb	\$5.95
721135	Buried Treasure Nitro Bat Guano 5 lb	\$22.95
721140	Buried Treasure Nitro Bat Guano 14 lb	\$50.95

Buried Treasure® Peruvian Seabird Guano 12 - 10 - 3



NEW Peruvian Seabird Guano is a natural fertilizer that contains nitrogen, potassium and phosphorus. Nitrogen derived from Seabird Guano can enhance growth and plant vigor. It can be used indoors or outdoors on vegetables, herbs, flowers, ornamentals in soil or can be used to make a tea for hydroponic applications. Buried Treasure® Guano is micronized for better solubility and delivery. Does not contain fillers.

EXCLUSIVE

Item No.	Description	MSRP
721145	Buried Treasure Peruvian Seabird Guano 2.2 lb	\$7.95
721150	Buried Treasure Peruvian Seabird Guano 11 lb	\$36.95
721155	Buried Treasure Peruvian Seabird Guano 40 lb	\$116.95

Buried Treasure® Liquid Guano 0.5 - 0.5 - 0.7

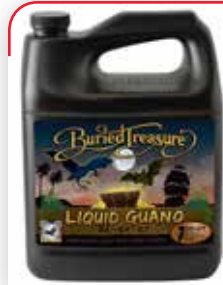

NEW The best of Buried Treasure® Guanos now available in a liquid format. Enhanced with the finest seaweed and humic substances around and complimented with premium earth worm casting extracts. These ingredients have been used successfully for centuries. Boost your standard nutritional package or use as a stand alone product.

EXCLUSIVE

Item No.	Description	MSRP
721400	Buried Treasure Liquid Guano Quart	\$13.95
721402	Buried Treasure Liquid Guano Gallon	\$39.95
721404	Buried Treasure Liquid Guano 2.5 Gallon	\$65.95
721406	Buried Treasure Liquid Guano 5 Gallon	\$119.95



Mother Earth® Sugar Load™ Heavy Brix Molasses™



NEW Mother Earth® Sugar Load™ Heavy Brix Molasses™ is a rich source of carbohydrates. It is also a good food source for beneficial microorganisms, making it excellent for the use in compost tea stimulation. High attention to balance between concentration and flowability makes Sugar Load™ very easy to use.

EXCLUSIVE

Item No.	Description	MSRP
721450	Mother Earth Sugar Load Heavy Brix Molasses Quart	\$8.95
721452	Mother Earth Sugar Load Heavy Brix Molasses Gallon	\$14.95
721454	Mother Earth Sugar Load Heavy Brix Molasses 2.5 Gallon	\$31.95
721456	Mother Earth Sugar Load Heavy Brix Molasses 5 Gallon	\$54.95
721458	Mother Earth Sugar Load Heavy Brix Molasses - 55 Gallon	\$495.00

Mother Earth® Meal Mix™ Grow 5 - 2 - 2



NEW Mother Earth® Meal Mix™ is a carefully selected blend of natural materials, formulated to provide a baseline media/soil amendment to build upon for the vegetative stage. It is a distinct mix of beneficial ingredients that is intended to be used as an additive to your favorite growing media (coco, soilless, raised beds and native soils) by either blending in, top dressing or making teas. Use for robust lush vegetative growth with compact internode spacing and building vigorous root systems. Derived from: Fish meal, feather meal, bone meal, crustacean meal, alfalfa meal, cotton seed meal, kelp meal, **EXCLUSIVE** dolomite, gypsum, langbeinite, volcanic ash and potassium sulfate.

Item No.	Description	MSRP
713286	Mother Earth Meal Mix Grow 4.4 lb	\$15.95
713288	Mother Earth Meal Mix Grow 25 lb	\$57.95
713290	Mother Earth Meal Mix Grow 50 lb	\$103.95
713292	Mother Earth Meal Mix Grow 1000 lb	\$1,799.95

Mother Earth® Meal Mix™ Bloom 2 - 6 - 4



NEW Mother Earth® Meal Mix™ is a carefully selected blend of natural materials, formulated to provide a baseline media/soil amendment to build upon for the flowering/fruiting stage. It is a distinct mix of beneficial ingredients that is intended to be used as an additive to your favorite growing media (coco, soilless, raised beds and native soils) by either blending in, top dressing or making teas. Use to promote ample amounts of high quality fruit and flower development. Derived from: Bone meal, alfalfa meal, kelp meal, langbeinite, cotton seed meal and volcanic ash. **EXCLUSIVE**

Item No.	Description	MSRP
713294	Mother Earth Meal Mix Bloom 4.4 lb	\$15.95
713296	Mother Earth Meal Mix Bloom 25 lb	\$57.95
713298	Mother Earth Meal Mix Bloom 50 lb	\$103.95
713300	Mother Earth Meal Mix Bloom 1000 lb	\$1,799.95



GH Flora Gro® 2 - 1 - 6



Stimulates structural and vegetative growth. Builds strong roots. Provides Nitrogen, Phosphorous, Potassium and secondary minerals.

Item No.	Description	MSRP
718040	GH Flora Gro Quart	\$12.50
718045	GH Flora Gro Gallon	\$31.88
718050	GH Flora Gro 2.5 Gallon	\$69.40
718055	GH Flora Gro 6 Gallon	\$140.00
718057	GH Flora Gro 15 Gallon	\$350.00
718060	GH Flora Gro 55 Gallon	\$1,283.34
718062	GH Flora Gro 275 Gallon Tote	\$4,019.60

GH Flora Bloom® 0 - 5 - 4



Stimulates flower and fruit development. Enhances flavor, aroma and essential oils. Provides high Phosphorous, Potassium, Magnesium and Sulfur.

Item No.	Description	MSRP
718010	GH Flora Bloom Quart	\$12.50
718015	GH Flora Bloom Gallon	\$31.88
718020	GH Flora Bloom 2.5 Gallon	\$69.40
718025	GH Flora Bloom 6 Gallon	\$140.00
718027	GH Flora Bloom 15 Gallon	\$350.00
718030	GH Flora Bloom 55 Gallon	\$1,283.34
718032	GH Flora Bloom 275 Gallon Tote	\$4,019.60

GH Flora Micro® 5 - 0 - 1



The foundation of the building-block system. Provides Nitrogen, Potassium, Calcium and trace elements. Combine with Flora Gro® and Flora Bloom®. Not for sale in the following states at this time: ND.

Item No.	Description	MSRP
718120	GH Flora Micro Quart	\$15.94
718125	GH Flora Micro Gallon	\$36.58
718130	GH Flora Micro 2.5 Gallon	\$84.30
718135	GH Flora Micro 6 Gallon	\$170.00
718137	GH Flora Micro 15 Gallon	\$425.00
718140	GH Flora Micro 55 Gallon	\$1,558.34
718142	GH Flora Micro 275 Gallon Tote	\$4,882.35

GH Hardwater Flora Micro® 5 - 0 - 1

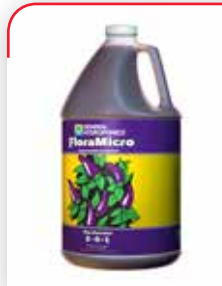

If your tap water is over 200 ppm or contains Calcium above 70 ppm, use Flora Micro® Hardwater. If your water contains 30 to 50 ppm Calcium, you can mix our original Flora Micro® with Flora Micro® Hardwater to create a perfect Micro blend for your plants.

Item No.	Description	MSRP
718150	GH Hardwater Flora Micro Quart	\$15.94
718155	GH Hardwater Flora Micro Gallon	\$36.58
718160	GH Hardwater Flora Micro 2.5 Gallon	\$84.30
718165	GH Hardwater Flora Micro 6 Gallon	\$170.00
718166	GH Hardwater Flora Micro 15 Gallon	\$425.00

GH Flora Series® Performance Pack



This box contains: 16 oz FloraMicro®, FloraGro® and FloraBloom®, 8 oz FloraBlend® and Liquid KoolBloom®, 4 oz FloraKleen®, 1 oz RapidStart®, Floralicious® Plus and pH Test Indicator.

Item No.	Description	MSRP
718145	GH Flora Series Performance Pack	\$49.99

GH FloraNova® Bloom 4 - 8 - 7



FloraNova® represents a breakthrough in fertilizer technology, as it gives users both the strength of a dry concentrate and the ease of a liquid. FloraNova® Bloom promotes explosive flowering and fruiting. FloraNova® Bloom induces phenomenal aroma, taste and colors while delivering extraordinary yields. Not for sale in the following states at this time: ND.

Item No.	Description	MSRP
718810	GH FloraNova Bloom Quart	\$27.50
718815	GH FloraNova Bloom Gallon	\$87.50
718808	GH FloraNova Bloom 2.5 Gallon	\$192.50

GH CocoTek® Coco Grow - A 3 - 0 - 1 & B 1 - 2 - 4



NEW CocoTek® Premium Coco Nutrient is a powerful, high quality base nutrient, specifically formulated to work with and enhance the unique properties of coconut coir. This aggressive formula contains proprietary blends of calcium to ensure your plants thrive. Backed by years of research, CocoTek® Premium Coco Nutrients are specifically designed to support and enhance your coco coir growing experience. Not for sale in the following states at this time: ND.

Item No.	Description	MSRP
726900	GH Cocotek Coco Grow - A & B Quart	\$15.00
726902	GH Cocotek Coco Grow - A & B Gallon	\$34.00
726904	GH Cocotek Coco Grow - A & B 2.5 Gallon	\$75.00
726906	GH Cocotek Coco Grow - A 6 Gallon	\$150.00
726908	GH Cocotek Coco Grow - B 6 Gallon	\$150.00

GH FloraNova® Grow 7 - 4 - 10



FloraNova® represents a breakthrough in fertilizer technology. FloraNova® gives users both the strength of a dry concentrate and the ease of a liquid. Works as a specialized nutrient for rapidly growing plants during the structural and foliar growth phase.

Item No.	Description	MSRP
718800	GH FloraNova Grow Quart	\$27.50
718805	GH FloraNova Grow Gallon	\$87.50
718807	GH FloraNova Grow 2.5 Gallon	\$192.50

GH CocoTek® Coco Bloom - A 2 - 0 - 1 & B 1 - 5 - 5



NEW CocoTek® Premium Coco Nutrient is a powerful, high quality base nutrient, specifically formulated to work with and enhance the unique properties of coconut coir. This aggressive formula contains proprietary blends of calcium to ensure your plants thrive. Backed by years of research, CocoTek® Premium Coco Nutrients are specifically designed to support and enhance your coco coir growing experience. Not for sale in the following states at this time: ND.

Item No.	Description	MSRP
726910	GH Cocotek Coco Bloom - A & B Quart	\$15.00
726912	GH Cocotek Coco Bloom - A & B Gallon	\$34.00
726914	GH Cocotek Coco Bloom - A & B 2.5 Gallon	\$75.00
726916	GH Cocotek Coco Bloom - A 6 Gallon	\$150.00
726918	GH Cocotek Coco Bloom - B 6 Gallon	\$150.00

GH FloraDuo® Hydroponics A 5 - 0 - 6



Using only two components growers can mix a large range of different nutrient blends for different kinds of plants and for phases of growth. The ratios of key ingredients, all change with different blends; each tailored to meet specialized plant needs.

Item No.	Description	MSRP
726870	GH Flora Duo A Quart	\$15.00
726875	GH Flora Duo A Gallon	\$34.00
726880	GH Flora Duo A 2.5 Gallon	\$75.00
726882	GH Flora Duo A 6 Gallon	\$150.00
726883	GH Flora Duo A 15 Gallon	\$375.00
726881	GH Flora Duo A 55 Gallon	\$1,375.00

GH FloraDuo® Hydroponics B 1 - 5 - 4



Using only two components, growers can mix a large range of different nutrient blends for different kinds of plants and for phases of growth. The ratios of key ingredients all change with different blends; each tailored to meet specialized plant needs.

Item No.	Description	MSRP
726885	GH Flora Duo B Quart	\$15.00
726887	GH Flora Duo B Gallon	\$34.00
726890	GH Flora Duo B 2.5 Gallon	\$75.00
726895	GH Flora Duo B 6 Gallon	\$150.00
726896	GH Flora Duo B 15 Gallon	\$375.00
726897	GH Flora Duo B 55 Gallon	\$1,375.00

GH Floralicious® Bloom 1 - 1 - 1

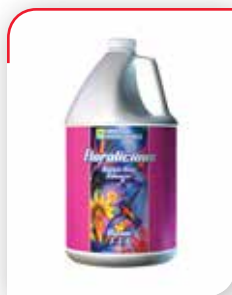

Floralicious® Bloom promotes maximum flower size and fruit swelling for heavier yields. Offers phenomenal flavor and bouquet upon harvest. Leads to more coloration that is vibrant with an improved overall appearance. Not for sale in the following states at this time: SD.

Item No.	Description	MSRP
732185	GH Floralicious Bloom Quart	\$26.84
732190	GH Floralicious Bloom Gallon	\$80.50
732191	GH Floralicious Bloom 2.5 Gallon	\$184.00

GH Floralicious® Grow 1 - 0.07 - 0.6



Floralicious® Grow enhances metabolic activities and nutrient assimilation that results in more vigorous growth. Builds the foundation of root and leaf mass needed for superior harvests. Not for sale in the following states at this time: SD.

Item No.	Description	MSRP
732200	GH Floralicious Grow Quart	\$26.84
732205	GH Floralicious Grow Gallon	\$80.50
732210	GH Floralicious Grow 2.5 Gallon	\$184.00

GH Floralicious® Plus 2.8 - 0.8 - 0.02



Floralicious® Plus is a vegan bio plant stimulator and nutrient additive. It is everything that is Floralicious® except it has been formulated to be applied in both the vegetative and regenerative or the flowering stages of growth. Not for sale in the following states at this time: SD.

Item No.	Description	MSRP
726754	GH Floralicious Plus 1 oz Display Box NEW	\$3.95
732208	GH Floralicious Plus 8 oz	\$21.84
732209	GH Floralicious Plus Pint	\$34.48
732206	GH Floralicious Plus Quart	\$60.90
732207	GH Floralicious Plus Gallon	\$212.76

GH Flora Nectar® FruitnFusion® 0 - 0 - 1



FloraNectar® contains all natural raw cane sugar, molasses, malt syrup, select plant based esters, L-amino acids, organic acids, vitamins and essential minerals.

Item No.	Description	MSRP
732176	GH Flora Nectar FruitnFusion Quart	\$21.00
732177	GH Flora Nectar FruitnFusion Gallon	\$58.80
732178	GH Flora Nectar FruitnFusion 2.5 Gal	\$132.30
732179	GH Flora Nectar FruitnFusion 6 Gal	\$262.50

GH Flora Nectar® Pineapple Rush 0 - 0 - 1



Pineapple Rush is an organic nutrient supplement designed as a sweetener for your fruits and flowers. It is made with sugars, including molasses and natural raw cane sugar. Pineapple Rush adds the essence of pineapple to the formula.

Item No.	Description	MSRP
732180	GH Flora Nectar Pineapple Rush Quart	\$21.00
732182	GH Flora Nectar Pineapple Rush Gallon	\$58.80
732181	GH Flora Nectar Pineapple Rush 2.5 Gallon	\$132.30
732183	GH Flora Nectar Pineapple Rush 6 Gallon	\$262.50

GH Flora Nectar® Banana Bliss 0 - 0 - 1



Banana Bliss is the latest addition to the GH FloraNectar® line. Banana Bliss contains all natural raw cane sugar, molasses, malt syrup, select plant based esters, L-amino acids, organic acids, polyflavonoids, vitamins & essential minerals. This unique blend of ingredients helps your plants regulate enzymes that trigger specific reactions involved in maintaining optimal metabolism. This allows your plants to achieve a balance between respiration and photosynthesis in high intensity growing environments where the rate of respiration can sometimes exceed the rate of photosynthesis.

EXCLUSIVE

Item No.	Description	MSRP
732196	GH Flora Nectar Banana Bliss Quart	\$21.00
732197	GH Flora Nectar Banana Bliss Gallon	\$58.80
732198	GH Flora Nectar Banana Bliss 2.5 Gallon	\$132.30
732199	GH Flora Nectar Banana Bliss 6 Gallon	\$262.50
733520	GH Flora Nectar Banana Bliss 275 Gallon Tote	\$6,274.50

GH Flora Nectar® Sugar Cane 0 - 0 - 1



FloraNectar® Sugar Cane is formulated to optimize the greatest transference of sweetness and aroma. It contains all natural raw cane sugar, molasses, malt syrup, select plant-based esters, L-amino acids, organic acids, vitamins and essential minerals.

Item No.	Description	MSRP
733500	GH Flora Nectar Sugar Cane Quart	\$21.00
733505	GH Flora Nectar Sugar Cane Gallon	\$58.80
733510	GH Flora Nectar Sugar Cane 2.5 Gallon	\$132.30
733515	GH Flora Nectar Sugar Cane 6 Gallon	\$262.50

GH FloraBlend® 0.5 - 1 - 1



FloraBlend® is a vegan plant booster that is made from a proprietary blend of plant materials, seaweed, rock powders & micronized leonardite. These compounds increase & promote healthy root structures & build the plant's immune system.

Item No.	Description	MSRP
732211	GH FloraBlend Quart	\$12.00
732212	GH FloraBlend Gallon	\$30.00
732213	GH FloraBlend 2.5 Gallon	\$70.00
732214	GH FloraBlend 6 Gallon	\$144.00
732216	GH FloraBlend 15 Gallon	\$360.00

GH FloraKleen®



FloraKleen® removes fertilizer residues that can accumulate over time in hydroponic systems, growing media and potting soils. Use it monthly to purge your systems or potted plants of excess salts that can accumulate.

Item No.	Description	MSRP
732915	GH Flora Kleen Quart	\$9.78
732920	GH Flora Kleen Gallon	\$23.00
732925	GH Flora Kleen 2.5 Gallon	\$54.66
732930	GH Flora Kleen 6 Gallon	\$124.20

GH CALiMAGic™ 1 - 0 - 0



CALiMAGic™ is a concentrated blend of readily available Calcium and Magnesium. It is formulated to assist fast growing plants by preventing secondary nutrient deficiencies.

Item No.	Description	MSRP
733525	GH CALiMAGic Quart	\$16.20
733530	GH CALiMAGic Gallon	\$40.50
733535	GH CALiMAGic 2.5 Gallon	\$90.00
733540	GH CALiMAGic 6 Gallon	\$205.20
733531	GH CALiMAGic 15 Gallon	\$513.00

GH RapidStart® 1 - 0.5 - 1



RapidStart® enhances your growing experience by delivering a powerful blend of premium plant extracts, amino acids and nutrients generating explosive root growth. Using RapidStart® will make your plants explode!

Item No.	Description	MSRP
726756	GH Rapid Start 1 oz Display Box NEW	\$6.50
726850	GH RapidStart 125 ml	\$26.49
726855	GH RapidStart 275 ml	\$39.99
726860	GH RapidStart 500 ml	\$74.36
726865	GH RapidStart 1 Liter	\$143.30
726861	GH Rapid Start Gallon NEW	\$490.00

GH Diamond Nectar® 0 - 1 - 1



Diamond Nectar® accelerates nutrient absorption where mineral foods enter the plant. It supercharges your nutrients in order to optimize the health of your plants and the quality of your crops. Not for sale in the following states at this time: SD.

Item No.	Description	MSRP
732160	GH Diamond Nectar Quart	\$17.25
732165	GH Diamond Nectar Gallon	\$46.00
732170	GH Diamond Nectar 2.5 Gallon	\$92.00
732175	GH Diamond Nectar 6 Gallon	\$184.00
732174	GH Diamond Nectar 15 Gallon	\$460.00

GH Subculture® M



SubCulture®-M, contains a wide diversity of endo & ecto mycorrhizal fungi that colonize plant roots. These beneficial fungi form a fine network of fibrous strands that serve as an extension of plant root systems helping plants absorb water & nutrients. Not for sale in the following states at this time: SD.

Item No.	Description	MSRP
722147	GH Subculture M 75 gm	\$12.55
722149	GH Subculture M 150 gm	\$20.65
722153	GH Subculture M 300 gm	\$30.80
722157	GH Subculture M 600 gm	\$53.49

GH Subculture® B 0.1 - 0.04 - 0.02



SubCulture®-B is a probiotic inoculum of beneficial microorganisms that will increase the vitality and yield in all plants. In soil or hydroponics, this blend of bacteria & trichoderma fungi colonize the root zone & media to form a symbiotic relationship. Not for sale in the following states at this time: VA.

Item No.	Description	MSRP
722146	GH Subculture B 75 gm	\$21.30
722148	GH Subculture B 150 gm	\$36.10
722151	GH Subculture B 300 gm	\$62.58
722156	GH Subculture B 600 gm	\$117.73

GH KoolBloom® 2 - 45 - 28



KoolBloom® is a highly concentrated nutrient supplement that promotes abundant flowering and facilitates ripening in annual flowers and herbs.

Item No.	Description	MSRP
732531	GH KoolBloom 2.2 lb	\$29.40
732535	GH KoolBloom 16 lb	\$212.00
732536	GH KoolBloom Dry 50 lb	\$431.37

GH Liquid KoolBloom® 0 - 10 - 10



Liquid KoolBloom® is a bulking agent that goes way beyond other bloom boosters. Enriched with stress reducing vitamins & nutrient transporting acids, it promotes heavy production of essential oils, fantastic flavors & increases fruiting & flowering.

Item No.	Description	MSRP
732537	GH Liquid KoolBloom Quart	\$21.76
732538	GH Liquid KoolBloom Gallon	\$63.50
732539	GH Liquid KoolBloom 2.5 Gallon	\$136.30
732541	GH Liquid KoolBloom 6 Gallon	\$305.50

GH Armor Si™ 0 - 0 - 4



Aarmor Si™ is suitable for all types of plants during all stages of growth. Armor Si™ improves plant structure and foliar development, increases yield and improves flower and fruit production. Your plants will additionally experience improved heat and cold tolerance, stress resistance, improved light absorption which leads to greater plant stature. Not for sale in the following states at this time: KY.

Item No.	Description	MSRP
732802	GH Armor Si Quart	\$15.80
732804	GH Armor Si Gallon	\$40.00
732806	GH Armor Si 2.5 Gallon	\$94.00
732808	GH Armor Si 6 Gallon	\$216.00

GH MaxiGro™ 10 - 5 - 14



MaxiGro™ is extremely potent, stand-alone, water-soluble, dry concentrate nutrients. MaxiGro™ encourages growth of seedlings and cuttings and stimulates rapid growth through the vegetative growth stage.

Item No.	Description	MSRP
718301	GH MaxiGro 2.2 lb	\$16.24
718310	GH MaxiGro 16 lb	\$118.00
718315	GH MaxiGro 50 lb	\$329.95

GH MaxiBloom™ 5 - 15 - 14



This is extremely potent, stand-alone, water-soluble, dry concentrate nutrients. MaxiBloom™ is for the reproductive stage in fast growing annuals. MaxiBloom™ encourages prolific flowering and fruiting and increases yields and crop quality. Not for sale in the following states at this time: ND.

Item No.	Description	MSRP
718281	GH MaxiBloom 2.2 lb	\$16.24
718290	GH MaxiBloom 16 lb	\$118.00
718295	GH MaxiBloom 50 lb	\$330.95



GH BioThrive® Grow 4 - 3 - 3



BioThrive® Grow is formulated to maximize vegetative growth by supplying plants with a custom diet that stimulates vigorous root and foliage development. Through proper nutrition, we create a strong frame for later flower, fruit and seed production. Not for sale in the following states at this time: SD.

Item No.	Description	MSRP
726800	GH BioThrive Grow Quart	\$18.00
726802	GH BioThrive Grow Gallon	\$62.66
726804	GH BioThrive Grow 2.5 Gallon	\$133.20
726806	GH BioThrive Grow 6 Gallon	\$271.68
726807	GH BioThrive Grow 15 Gallon	\$679.20
726805	GH BioThrive Grow 55 Gallon	\$2,425.04

GH BioThrive® Bloom 2 - 4 - 4



Provides flowering & fruiting plants with essential nutrients, balanced for superior blooms & bountiful harvests. Specially designed to maximize flower, fruit & seed production, this formulation will give bigger, more nutritious & delicious yields. Not for sale in the following states at this time: SD.

Item No.	Description	MSRP
726810	GH BioThrive Bloom Quart	\$17.84
726812	GH BioThrive Bloom Gallon	\$55.08
726814	GH BioThrive Bloom 2.5 Gallon	\$120.00
726816	GH BioThrive Bloom 6 Gallon	\$260.00
726817	GH BioThrive Bloom 15 Gallon	\$650.00
726818	GH BioThrive Bloom 55 Gallon	\$2,346.56

GH CaMg+®



CaMg+® is the ideal supplement to provide a natural source of Calcium and Magnesium, critical elements in a plants growth cycle. CaMg+® is biologically catalyzed from oyster shell, dolomite lime and natural plant extracts.

Item No.	Description	MSRP
726820	GH CaMg+ Quart	\$18.12
726822	GH CaMg+ Gallon	\$58.32
726821	GH CaMg+ 2.5 Gallon	\$130.40
726823	GH CaMg+ 6 Gallon	\$272.00
726819	GH CaMg+ 15 Gallon	\$662.88
726857	GH CaMg+ 55 Gallon	\$2,399.84

GH BioRoot® 1 - 1 - 1



BioRoot® is a natural root growth supplement that helps plants establish healthy and vibrant root systems. It contains vitamins, enzymes, organic and humic acids that stimulate root growth.

Item No.	Description	MSRP
726824	GH BioRoot Quart	\$16.98
726826	GH BioRoot Gallon	\$52.70
726825	GH BioRoot 2.5 Gallon	\$110.16
726827	GH BioRoot 6 Gallon	\$226.16

GH BioBud® 0.5 - 0.1 - 1



BioBud® is a powerful bloom stimulator that generates explosive flowering and massive fruit production. BioBud® increases metabolic activity and mineral uptake by utilizing bio-stimulants and organic transport enhancers.

Item No.	Description	MSRP
726828	GH BioBud Quart	\$42.04
726830	GH BioBud Gallon	\$158.20
726829	GH BioBud 2.5 Gallon	\$380.00
726831	GH BioBud 6 Gallon	\$870.00

GH BioWeed® 0.2 - 0 - 0.3



BioWeed® is derived from a blend of cold processed seaweeds that act as a plant and soil vitality enhancer. BioWeed® encourages prolific root and foliage growth as well as larger flowers and fruits. Not for sale in the following states at this time: VA.

Item No.	Description	MSRP
726832	GH BioWeed Quart	\$20.22
726834	GH BioWeed Gallon	\$62.16
726833	GH BioWeed 2.5 Gallon	\$141.24
726835	GH BioWeed 6 Gallon	\$330.00
726841	GH BioWeed 15 Gallon	\$825.92

GH BioMarine® 2 - 3 - 1



BioMarine® is a completely organic fish fertilizer that encourages rapid growth, improves color and helps increase plant's resistance to pests. BioMarine® benefits all types of plants during all phases of growth, from seedling to harvest.

Item No.	Description	MSRP
726836	GH BioMarine Quart	\$16.98
726838	GH BioMarine Gallon	\$51.48
726837	GH BioMarine 2.5 Gallon	\$112.96
726839	GH BioMarine 6 Gallon	\$229.92

GH Diamond Black™ 0 - 0 - 1



Diamond Black™ is derived from 100% pure mined Leonardite, a naturally occurring form of carbon. It supports beneficial microbial activity in soils and increases micronutrient availability. Not for sale in the following states at this time: SD.

Item No.	Description	MSRP
726840	GH Diamond Black Quart	\$16.98
726842	GH Diamond Black Gallon	\$52.30
726843	GH Diamond Black 2.5 Gallon	\$108.48
726844	GH Diamond Black 6 Gallon	\$220.96
726845	GH Diamond Black 15 Gallon	\$537.76

GH General Organics® GO Box



General Organics® now has the GO Box starter kit. The GO Box contains 16 oz BioThrive® Grow and Bloom fertilizers as well as 8 oz samples of every GO liquid supplement.

Item No.	Description	MSRP
726846	GH General Organics Go Box	\$51.36

GH Spigot For 6-Gallon Containers



For use with all General Hydroponics® 6 gallon containers.

Item No.	Description	MSRP
718445	GH 6 Gallon Container Spigot	\$3.50

Measure Master® Pump Dispensers - 1 oz



Great for quickly measuring & dispensing your liquid plant food & supplements! One pump dispenses one ounce of liquid. 740040 is designed specifically to a one gal bottle. 740042 is designed specifically to a 2.5 gal bottle (bottles not included).

EXCLUSIVE

Item No.	Description	MSRP
740040	Measure Master Pump Dispenser 1 oz For Gallon Jug	\$4.69
740042	Measure Master Pump Dispenser 1 oz For 2.5 Gallon Jugs	\$7.49



Botanicare® Kind® Base 4 - 0 - 0



Kind® Plant Nutrient System is a proprietary three part nutrient unlike any other. Kind® was formulated with the calcium and magnesium separate from the trace minerals. This allows you to customize Kind® to meet the specific needs of your garden, whatever Kind® you grow. A fusion of science and nature, Kind® provides optimal plant nutrition in perfect balance.

EXCLUSIVE

Item No.	Description	MSRP
733100	Botanicare Kind Base Quart	\$16.95
733105	Botanicare Kind Base Gallon	\$39.95
733110	Botanicare Kind Base 2.5 Gallon	\$89.95
733115	Botanicare Kind Base 5 Gallon	\$164.95
733120	Botanicare Kind Base 15 Gallon	\$456.00
733125	Botanicare Kind Base 55 Gallon	\$1,605.00

Botanicare® Kind® Grow 2 - 2 - 4



Kind® Plant Nutrient System is a proprietary three part nutrient unlike any other. Kind® was formulated with the calcium and magnesium separate from the trace minerals. This allows you to customize Kind® to meet the specific needs of your garden, whatever Kind® you grow. Kind® uses high quality minerals fortified with all natural ingredients.

EXCLUSIVE

Item No.	Description	MSRP
733130	Botanicare Kind Grow Quart	\$16.95
733135	Botanicare Kind Grow Gallon	\$39.95
733140	Botanicare Kind Grow 2.5 Gallon	\$89.95
733145	Botanicare Kind Grow 5 Gallon	\$164.95
733150	Botanicare Kind Grow 15 Gallon	\$456.00
733155	Botanicare Kind Grow 55 Gallon	\$1,605.00

Botanicare® Kind® Bloom 0 - 6 - 6



Kind® Plant Nutrient System is a proprietary three part nutrient unlike any other. Kind® was formulated with the calcium and magnesium separate from the trace minerals. This allows you to customize Kind® to meet the specific needs of your garden, whatever Kind® you grow. Kind® uses high quality minerals fortified with all natural ingredients.

EXCLUSIVE

Item No.	Description	MSRP
733160	Botanicare Kind Bloom Quart	\$16.95
733165	Botanicare Kind Bloom Gallon	\$39.95
733170	Botanicare Kind Bloom 2.5 Gallon	\$89.95
733175	Botanicare Kind Bloom 5 Gallon	\$164.95
733180	Botanicare Kind Bloom 15 Gallon	\$456.00
733185	Botanicare Kind Bloom 55 Gallon	\$1,605.00

Botanicare® Growilla™ Bud 2 - 5 - 4 & Veg 5 - 4 - 2



Growilla™ Veg & Bud, the simple to use natural and organic plant food. This premium plant food is hand mixed in small batches to provide a wide range of organic food sources for plants and beneficial microbes. While Growilla™ Veg was formulated to provide the specific ratio of macro and micro nutrients that encourages lush, vigorous, vegetative growth; Growilla Bud enhances flower development, maintains soil structure and increases nutrient uptake.

Item No.	Description	MSRP
733300	Botanicare Growilla Bud 12 lb	\$62.95
733305	Botanicare Growilla Bud 25 lb	\$110.95
733320	Botanicare Growilla Bud 50 lb Bag NEW	\$183.95
733310	Botanicare Growilla Veg 12 lb	\$62.95
733315	Botanicare Growilla Veg 25 lb	\$110.95
733325	Botanicare Growilla Veg 50 lb Bag NEW	\$183.95

Botanicare® Pure Blend® Tea 0.5 - 0.5 - 1



Pure Blend® Tea (formerly Pure Blend® Original Grow & Bloom). Pure Blend® Tea combines the key elements of both Pure Blend® Original Grow and Bloom, into one highly effective formula. Pure Blend® Tea is enhanced and fortified with a premium blend of ultra-soluble humates, organic plant acids, trace minerals, vitamins and select amino acids.

Item No.	Description	MSRP
732630	Botanicare Pure Blend Tea Quart	\$13.95
732635	Botanicare Pure Blend Tea Gallon	\$34.95
732640	Botanicare Pure Blend Tea 2.5 Gallon	\$77.95
732645	Botanicare Pure Blend Tea 5 Gallon	\$141.95
732650	Botanicare Pure Blend Tea 15 Gallon	\$399.00
732655	Botanicare Pure Blend Tea 55 Gallon	\$1,405.00

Botanicare® Pure Blend® Pro Bloom Formula 2 - 2 - 5



Pure Blend® Pro is a premium, one-part, natural and organic-based plant food. Pure Blend® Pro is a healthy environment-friendly alternative to commercial chemical fertilizers. Use Bloom during the fruiting and flowering stage.

Item No.	Description	MSRP
718450	Botanicare Pure Blend Pro Bloom Quart	\$22.95
718455	Botanicare Pure Blend Pro Bloom Gallon	\$55.95
718460	Botanicare Pure Blend Pro Bloom 2.5 Gallon	\$124.50
718465	Botanicare Pure Blend Pro Bloom 5 Gallon	\$226.95
718464	Botanicare Pure Blend Pro Bloom 15 Gallon	\$639.00
718466	Botanicare Pure Blend Pro Bloom 55 Gallon	\$2,248.00

Botanicare® Pure Blend® Pro Grow Formula 3 - 2 - 4



Pure Blend® Pro is a premium, one-part, natural and organic-based plant food. Pure Blend® Pro is a healthy environment-friendly alternative to commercial chemical fertilizers. Use Grow during the vegetative growth stage.

Item No.	Description	MSRP
718475	Botanicare Pure Blend Pro Grow Quart	\$22.95
718480	Botanicare Pure Blend Pro Grow Gallon	\$55.95
718485	Botanicare Pure Blend Pro Grow 2.5 Gallon	\$124.50
718490	Botanicare Pure Blend Pro Grow 5 Gallon	\$226.95
718478	Botanicare Pure Blend Pro Grow 15 Gallon	\$639.00
718479	Botanicare Pure Blend Pro Grow 55 Gallon	\$2,248.00

Botanicare® Pure Blend® Pro Soil 1 - 4 - 5



Designed specifically to be used in soil container gardens. When cultivating fruiting & flowering plants in soil, growers usually need to double or triple phosphorous levels, unlike hydroponics, thus making the 1.5-4-5 formula ideal for soil applications.

Item No.	Description	MSRP
718375	Botanicare Pure Blend Pro Soil Quart	\$22.95
718380	Botanicare Pure Blend Pro Soil Gallon	\$55.95
718385	Botanicare Pure Blend Pro Soil 2.5 Gallon	\$124.50
718390	Botanicare Pure Blend Pro Soil 5 Gallon	\$226.95
718467	Botanicare Pure Blend Pro Soil 15 Gallon	\$639.00
718468	Botanicare Pure Blend Pro Soil 55 Gallon	\$2,248.00

Botanicare® Liquid Karma® 0.1 - 0.1 - 0.5



100% water soluble humic acid source will not cause buildup in lines, clog drippers or contribute to pH fluctuations. Liquid Karma® contains metabolically active organic compounds that are absorbed immediately and act as regulatory signals, activators or catalysts to produce accelerated growth. Liquid Karma® promotes increased metabolic activity produces a large amount of energy, which translates into increased growth rates.

Item No.	Description	MSRP
732275	Botanicare Liquid Karma Quart	\$28.95
732280	Botanicare Liquid Karma Gallon	\$69.95
732285	Botanicare Liquid Karma 2.5 Gallon	\$157.95
732290	Botanicare Liquid Karma 5 Gallon	\$301.75
732283	Botanicare Liquid Karma 15 Gallon	\$859.95
732284	Botanicare Liquid Karma 55 Gallon	\$2,850.00

Botanicare® Sweet® - Carbo Raw



Sweet® Raw is a flavorless, all natural mineral supplement that meets the metabolic demands of your plants throughout their life cycle. Sweet® helps plants maintain an optimum metabolism and a proper balance between photosynthesis and respiration.

Item No.	Description	MSRP
732297	Botanicare Sweet Carbo Raw Quart	\$28.95
732298	Botanicare Sweet Carbo Raw Gallon	\$72.00
732299	Botanicare Sweet Carbo Raw 2.5 Gallon	\$159.50
732302	Botanicare Sweet Carbo Raw 5 Gallon	\$297.00
732303	Botanicare Sweet Carbo Raw 55 Gallon	\$2,810.50

Botanicare® Sweet® - Original Berry



Sweet® Berry is scientifically formulated for the bio-synthesis of crucial compounds to maintain optimal metabolism and contains: Select carbohydrates for amplified energy, increased sugar/brix content and plant bio-mass.

Item No.	Description	MSRP
732291	Botanicare Sweet Berry Quart	\$28.95
732292	Botanicare Sweet Berry Gallon	\$72.00
732293	Botanicare Sweet Berry 2.5 Gallon	\$159.50
732294	Botanicare Sweet Berry 5 Gallon	\$291.50
732301	Botanicare Sweet Berry 15 Gallon	\$821.95

Botanicare® Sweet® - Citrus



Sweet® Citrus now has enhanced lemon flavor. Sweet® Citrus is scientifically formulated for the bio-synthesis of crucial compounds to maintain optimal metabolism and contains: Select carbohydrates for amplified energy, increased sugar/brix content and plant bio-mass.

Item No.	Description	MSRP
732266	Botanicare Sweet Citrus Quart	\$28.95
732267	Botanicare Sweet Citrus Gallon	\$72.00
732268	Botanicare Sweet Citrus 2.5 Gallon	\$159.50
732269	Botanicare Sweet Citrus 5 Gallon	\$291.50
732271	Botanicare Sweet Carbo Citrus 15 Gal	\$797.95
732272	Botanicare Sweet Carbo Citrus 55 Gal	\$2,810.50

Botanicare® Sweet® - Grape



Sweet® Grape is scientifically formulated for the bio-synthesis of crucial compounds to maintain optimal metabolism and contains: Select carbohydrates for amplified energy, increased sugar/brix content and plant bio-mass.

Item No.	Description	MSRP
732384	Botanicare Sweet Carbo Grape Quart	\$28.95
732386	Botanicare Sweet Carbo Grape Gallon	\$72.00
732388	Botanicare Sweet Carbo Grape 2.5 Gallon	\$159.50
732390	Botanicare Sweet Carbo Grape 5 Gallon	\$291.50
732391	Botanicare Sweet Carbo Grape 15 Gallon	\$797.95

Botanicare® Hydroplex® 0 - 10 - 6



Hydroplex® Bloom Enhancer creates larger fruits and flowers and surpasses that standard by both increasing plants' resistance to external stresses and amplifying natural enzyme, chlorophyll and essential oil production.

Item No.	Description	MSRP
733090	Botanicare Hydroplex Bloom 8 oz	\$17.00
733092	Botanicare Hydroplex Bloom Quart	\$37.75
733094	Botanicare Hydroplex Bloom Gallon	\$93.50
733096	Botanicare Hydroplex Bloom 2.5 Gallon	\$203.95
733098	Botanicare Hydroplex Bloom 5 Gallon	\$391.25

Botanicare® Silica Blast™



Silicate is a beneficial nutrient supplement to be used in conjunction with a standard nutrient program. Silicate helps strengthen plant tissue helping plants flourish in adverse environmental conditions such as heat, drought and frost.

Item No.	Description	MSRP
732485	Botanicare Silica Blast Quart	\$17.95
732490	Botanicare Silica Blast Gallon	\$43.50
732491	Botanicare Silica Blast 2.5 Gallon	\$96.95
732492	Botanicare Silica Blast 5 Gal	\$178.95

Botanicare® Clearex® Salt Leaching Solution



Clearex® is an isotonic drenching solution that unlocks the ionic bond between the nutrient and the soil or soilless grow substrate, correcting the problem of nutrient salt toxicity and lockout, allowing plants to thrive again.

Item No.	Description	MSRP
732605	Botanicare Clearex Quart	\$13.25
732610	Botanicare Clearex Gallon	\$32.95
732615	Botanicare Clearex 2.5 Gallon	\$71.25
732620	Botanicare Clearex 5 Gallon	\$133.50
732622	Botanicare Clearex 15 Gal	\$393.50
732621	Botanicare Clearex 55 Gal	\$1,335.00

Botanicare® CNS17® Ripe 1 - 5 - 4



CNS17® Ripe was developed to maximize crop potential and quality during the final growth phase in fruiting and flowering plants. This specialty formula promotes ripening along with increased flower size, density and essential oil production.

Item No.	Description	MSRP
733020	Botanicare CNS17 Ripe Quart	\$10.95
733023	Botanicare CNS17 Ripe Gallon	\$27.50
733025	Botanicare CNS17 Ripe 2.5 Gallon	\$58.50
733027	Botanicare CNS17 Ripe 5 Gallon	\$108.95
733028	Botanicare CNS17 Ripe 15 Gallon	\$304.95
733026	Botanicare CNS17 Ripe 55 Gallon	\$1,072.50

Botanicare® CNS17® Grow 3 - 1 - 2



CNS17® Grow contains all seventeen essential elements, making it an ideal food source for plants. Optimal ratios of nitrogen and phosphorus promote increased root development, decreased internode spacing and sturdy stalks and branches.

Item No.	Description	MSRP
733205	Botanicare CNS17 Grow Quart	\$10.95
733210	Botanicare CNS17 Grow Gallon	\$27.50
733215	Botanicare CNS17 Grow 2.5 Gallon	\$58.50
733220	Botanicare CNS17 Grow 5 Gallon	\$108.95
733225	Botanicare CNS17 Grow 15 Gallon	\$304.95
733230	Botanicare CNS17 Grow 55 Gallon	\$1,072.50

Botanicare® CNS17® Bloom 2 - 2 - 3



The NPK ratio in CNS17® Bloom was designed to provide specific critical elements to support heavily fruiting and flowering crops which allows phosphorus and potassium levels to be maximized without leading to toxicity or nutrient burn.

Item No.	Description	MSRP
733240	Botanicare CNS17 Bloom Quart	\$10.95
733245	Botanicare CNS17 Bloom Gallon	\$27.50
733250	Botanicare CNS17 Bloom 2.5 Gallon	\$58.50
733255	Botanicare CNS17 Bloom 5 Gallon	\$108.95
733260	Botanicare CNS17 Bloom 15 Gallon	\$304.95
733265	Botanicare CNS17 Bloom 55 Gallon	\$1,072.50

Botanicare® Cal-Mag™ Plus 2 - 0 - 0



Cal-Mag™ Plus is a highly fortified calcium, magnesium and iron plant supplement formulated to correct common deficiencies. Supplementing your preferred nutrient program with Cal-Mag™ Plus is strongly recommended when using reverse osmosis water and when growing in Coco Coir based medias.

Item No.	Description	MSRP
732110	Botanicare Cal-Mag Plus Quart	\$19.50
732115	Botanicare Cal-Mag Plus Gallon	\$48.50
732120	Botanicare Cal-Mag Plus 2.5 Gallon	\$105.95
732125	Botanicare Cal-Mag Plus 5 Gallon	\$198.95
732124	Botanicare Cal-Mag Plus 15 Gallon	\$586.95
732126	Botanicare Cal-Mag Plus 55 Gallon	\$1,960.95

Botanicare® Vitamino®



Botanicare® developed Vitamino® to preserve balanced plant growth and optimal plant health in accelerated growth environments.

Item No.	Description	MSRP
739130	Botanicare Vitamino Quart	\$28.95
739135	Botanicare Vitamino Gallon	\$71.75
739140	Botanicare Vitamino 2.5 Gallon	\$157.50
739145	Botanicare Vitamino 5 Gallon	\$290.00

Botanicare® Fulvex®



Botanicare® Fulvex® is an OMRI listed liquid trace mineral extract that corrects nutrient lock out conditions and amplifies nutrient uptake.



Item No.	Description	MSRP
739075	Botanicare Fulvex Quart	\$19.75
739080	Botanicare Fulvex Gallon	\$47.25
739085	Botanicare Fulvex 2.5 Gallon	\$104.95
739090	Botanicare Fulvex 5 Gallon	\$195.25

Botanicare® Seaplex®



Seaplex® is a cold processed seaweed for foliar spraying, soil and soilless container gardens and hydroponic systems. This natural and organic supplement is packed with amino acids, enzymes, micronutrients and soil biology that encourage vigorous growth.



Item No.	Description	MSRP
739042	Botanicare SeaPlex Quart	\$23.00
739044	Botanicare SeaPlex Gallon	\$56.50

Botanicare® Pure® Granular Grow 6 - 6 - 5 + 8% Ca



Pure® natural and organic plant food is ideal for soil container gardens, raised bed gardens, potted plants & hydroponics. Beneficial for fruits, flowers, vegetables, trees, shrubs & turf. Pure's granular formula helps prevent nutrient leaching & runoff.



Item No.	Description	MSRP
739050	Botanicare Pure Granular Grow 2 lb	\$6.50
739051	Botanicare Pure Granular Grow 5 lb	\$15.95
739052	Botanicare Pure Granular Grow 12 lb	\$34.95
739054	Botanicare Pure Granular Grow 50 lb	\$65.00

Botanicare® Pure® Bloom Granular 1 - 5 - 4 + 6% Ca



Pure® Bloom's slow release all organic granules will satisfy your fruiting and flowering plant's nutritional needs during the bloom phase of their grow cycle.



Item No.	Description	MSRP
739064	Botanicare Pure Granular Bloom 2 lb	\$6.50
739066	Botanicare Pure Granular Bloom 5 lb	\$15.95
739068	Botanicare Pure Granular Bloom 12 lb	\$34.95
739070	Botanicare Pure Granular Bloom 50 lb	\$65.00



FoxFarm® Bush Doctor® Boomerang®



Boomerang's microbial-based formula nourishes damaged root tissue while encouraging new root development and internodal vegetative growth. It contains solubilized organic nutrition that is immediately available to plants. Boomerang® is the Comeback Formula that gives your plants a fighting chance. Not for sale in the following states at this time: FL, HI, PR.

Item No.	Description	MSRP
732864	FoxFarm Bushdoctor Boomerang Pint	\$11.95
732865	FoxFarm Bushdoctor Boomerang Quarts	\$21.95
732867	FoxFarm Bushdoctor Boomerang Gallon	\$73.95

FoxFarm® Bush Doctor® Flowers Hiss™



A spray-on foliar plant food is designed to be easily absorbed through stomata on the plant's leaves, like a soft rain, providing organic nutrition from the top down. It supplements micronutrients that are crucial in the early flowering phase of plant growth. Helps to alleviate stress in the transitional period between vegetative growth and flowering. Not for sale in the following states at this time: FL, PR.

Item No.	Description	MSRP
732869	FoxFarm Bushdoctor Flower Kiss Pint	\$11.95
732870	FoxFarm Bushdoctor Flower Kiss Quart	\$21.95
732872	FoxFarm Bushdoctor Flower Kiss Gallon	\$73.95

FoxFarm® Bush Doctor® SledgeHammer®



A unique rinse formula designed to remove excess fertilizer build up. Sledgehammer® encourages water movement through soil and soilless mediums, rinsing out unwanted mineral salt residues and relieving nutrient lock up. Use in established gardens, container plantings and hydroponic systems. Not for sale in the following states at this time: FL, IL, MN, MS, OK, PR, SC, SD, WI.

Item No.	Description	MSRP
732849	FoxFarm Bushdoctor Sledgehammer Pint	\$12.95
732850	FoxFarm Bushdoctor Sledgehammer Quart	\$20.95
732852	FoxFarm Bushdoctor Sledgehammer Gallon	\$70.95

FoxFarm® Bush Doctor® Microbe Brew®



Bush Doctor® Microbe Brew® is a complex blend of ingredients specially formulated to help plants achieve optimum microbial habitats at the rhizosphere or root zone environment. This concentrated brew supplies nutrition for your plants, as well as feeding the microbial colonies in the soil. Satisfy your plants' thirst by giving them the nutritional cocktail they deserve. Not for sale in the following states at this time: FL, HI, IL, PR.

Item No.	Description	MSRP
732853	FoxFarm Bushdoctor Microbe Brew Pint	\$12.95
732854	FoxFarm Bushdoctor Microbe Brew Quart	\$25.95
732856	FoxFarm Bushdoctor Microbe Brew Gallon	\$88.95

FoxFarm® Bush Doctor® Kangaroots®



Bush Doctor® Kangaroots® is a liquid root drench formulation for use on in-ground plantings, container gardens and hydroponic systems. Use Bush Doctor® Kangaroots® on seedlings and mature plants throughout the growing season to enhance the proliferation of root mass development. Not for sale in the following states at this time: FL, HI, IL, PR.

Item No.	Description	MSRP
732857	FoxFarm Bushdoctor Kangaroots Pint	\$11.95
732858	FoxFarm Bushdoctor Kangaroots Quart	\$21.95
732859	FoxFarm Bushdoctor Kangaroots Gallon	\$74.95

FoxFarm® Dirty Dozen™ Starter Kit



Includes 9 pints of liquid plant food: One each of the Bush Doctor® line, Big Bloom® Organic Fertilizer, Tiger Bloom® Viscous Bloomer and Grow Big® Soil Based Formula. Also includes three 6 oz soluble fertilizer: Open Sesame® early ripening, Beastie Bloomz® heavyweight blossoms and Cha Ching® for late flowering. Not for sale in the following states at this time: FL, PR.

Item No.	Description	MSRP
732886	FoxFarm Dirty Dozen Starter Kit	\$107.95

FoxFarm® Bush Doctor® Bembe™ 0 - 1 - 3



Bembe™ is a liquid concentrate that is precisely designed with a complex array of natural sugars. When used as directed, Bembe™ can help plants achieve enhanced sweetness qualities, while providing a food source for the microbial populations at the root zone. Not for sale in the following states at this time: PR.

Item No.	Description	MSRP
732880	FoxFarm Bushdoctor Bembe Pint	\$11.95
732882	FoxFarm Bushdoctor Bembe Quart	\$20.95
732884	FoxFarm Bushdoctor Bembe Gallon	\$60.95

FoxFarm® BushDoctor® Help Me Help You™ 0.5 - 0 - 0.5



NEW Kelp Me Kelp You™ is a natural, organic seaweed extract derived from Norwegian kelp, *Ascophyllum nodosum* that is a liquid concentrate. Seaweed extract is a plant biostimulant that can be sprayed on the foliage, applied to the soil or added to hydroponic systems. Kelp Me Kelp You™ improves water holding characteristics of soil and contains numerous plant growth promoting substances, most notably cytokinins. Not for sale in the following states at this time: MO.



Item No.	Description	MSRP
732932	FoxFarm Bushdoctor Kelp Me Kelp You Pint	\$11.95
732934	FoxFarm Bushdoctor Kelp Me Kelp You Quart	\$20.95
732936	FoxFarm Bushdoctor Kelp Me Kelp You Gallon	\$55.95

FoxFarm® BushDoctor® Wholly Mackerel™ 3 - 1 - 0



NEW Wholly Mackerel™ is a liquid plant nutrient derived from marine fish species. It is an enzymatically digested product. It provides readily available amounts of organic nitrogen and phosphorus to growing plants. Our extra strength fish fertilizer contains 20 different amino acids, 13 vitamins and 8 minerals including manganese, iron, copper and zinc. Not for sale in the following states at this time: MO.



Item No.	Description	MSRP
732938	FoxFarm Bushdoctor Wholly Mackerel Pint	\$11.95
732940	FoxFarm Bushdoctor Wholly Mackerel Quart	\$19.95
732942	FoxFarm Bushdoctor Wholly Mackerel Gallon	\$54.95

FoxFarm® Nutrient Trio - Hydro



Trio pack includes Big Bloom®, Grow Big® Hydroponic and Tiger Bloom® together to maximize your growing potential. A convenient quart 3-pack of fertilizers is a complete nutrition program. Optimizes vegetative growth, extreme flower canopy and multiple bud development. For hydroponic recirculating systems, use the FoxFarm® Hydroponic Nutrient Trio. Not for sale in the following states at this time: PR.

Item No.	Description	MSRP
718577	FoxFarm Nutrient Trio - Hydro	\$55.95

FoxFarm® American Pride® 9 - 6 - 6



American Pride® is a blend of potent, high-test plant foods, formulated to provide an abundance of essential elements that encourage vigorous plant growth. This fertilizer contains a unique blend of exotic ingredients. Some allow for instantly available nutrition, while others deliver slowly available nitrogen over time. It is an ideal fertilizer for all types of plants and has been specially formulated for use on roses. Not for sale in the following states at this time: PA, PR.

Item No.	Description	MSRP
718578	FoxFarm American Pride 4 lb	\$16.95
718581	FoxFarm American Pride 20 lb	\$65.95

FoxFarm® Marine Cuisine® 10 - 7 - 7



A comprehensive blend of powerful plant foods combined with Pacific Northwest sea going fish, crab meal, shrimp meal, bat guano and plenty of our own earthworm castings. Contains a unique blend of ingredients. Some allow for instantly available nutrition, while others deliver slowly available nitrogen over time. It is an ideal fertilizer for flowers and vegetable gardens, ornamental trees and shrubs, fruit trees, roses, container plants and lawns. Not for sale in the following states at this time: PR.

Item No.	Description	MSRP
718583	FoxFarm Marine Cuisine 4 lb	\$15.95
714311	FoxFarm Marine Cuisine Fertilizer 20 lb	\$66.95

FoxFarm® Big Bloom® 0.01 - 0.3 - 0.7



FoxFarm's Big Bloom® is a live culture of vitamins, amino acids, natural growth hormones, enzymes and beneficial organic microbes. Our special, micro-brewed formula incorporates earthworm castings, bat guano and other high-test organic ingredients that offer a full, balanced range of nutrients. Not for sale in the following states at this time: PR.



Item No.	Description	MSRP
718519	FoxFarm Big Bloom Pint	\$8.95
718520	FoxFarm Big Bloom Quart	\$15.95
718525	FoxFarm Big Bloom Gallon	\$53.95
718530	FoxFarm Big Bloom 2.5 Gallon	\$119.95
718535	FoxFarm Big Bloom 5 Gallon	\$221.95

FoxFarm® Nutrient Trio - Soil



Trio pack includes Big Bloom®, Grow Big® and Tiger Bloom® together to maximize your growing potential. This convenient quart 3-pack of fertilizers is a complete nutrition program. Optimizes vegetative growth, extreme flower canopy and multiple bud development. Not for sale in the following states at this time: PR.

Item No.	Description	MSRP
718576	FoxFarm Nutrient Trio - Soil	\$55.95

FoxFarm® Grow Big® 6 - 4 - 4



Grow Big® is a fast-acting, liquid concentrate fertilizer for lush, vegetative, compact growth. Fortified with earthworm castings, Norwegian kelp and a super-concentrated micronutrient package, this special brew encourages a strong compact branching structure. Not for sale in the following states at this time: PR.

Item No.	Description	MSRP
718499	FoxFarm Grow Big Pint	\$11.95
718500	FoxFarm Grow Big Quart	\$21.95
718505	FoxFarm Grow Big Gallon	\$66.95
718510	FoxFarm Grow Big 2.5 Gallon	\$158.95
718515	FoxFarm Grow Big 5 Gallon	\$283.95

FoxFarm® Grow Big® Hydroponic 3 - 2 - 6



Grow Big® Hydroponic Liquid Plant Food is a potent, fast acting, liquid concentrate fertilizer specifically formulated for hydroponic use. It encourages vigorous vegetative growth. Plant size and structure are enhanced, allowing for more abundant fruit, flower and bud development. Not for sale in the following states at this time: PR.

Item No.	Description	MSRP
718539	FoxFarm Grow Big Hydroponic Pint	\$11.95
718540	FoxFarm Grow Big Hydroponic Quart	\$22.95
718545	FoxFarm Grow Big Hydroponic Gallon	\$70.95
718550	FoxFarm Grow Big Hydroponic 2.5 Gallon	\$161.95
718555	FoxFarm Grow Big Hydroponic 5 Gallon	\$283.95

FoxFarm® Tiger Bloom® 2 - 8 - 4



FoxFarm® Tiger Bloom® is an ultra potent, high phosphorus fertilizer that also contains a good supply of nitrogen. It is formulated with a low pH to maintain stability in storage and keep micronutrients available. It encourages abundant fruit, flower and multiple bud development. Not for sale in the following states at this time: PR.

Item No.	Description	MSRP
718559	FoxFarm Tiger Bloom Pint	\$11.95
718560	FoxFarm Tiger Bloom Quart	\$21.95
718565	FoxFarm Tiger Bloom Gallon	\$66.95
718570	FoxFarm Tiger Bloom 2.5 Gallon	\$158.95
718575	FoxFarm Tiger Bloom 5 Gallon	\$283.95

FoxFarm® Open Sesame® 5 - 45 - 19



Open Sesame® is a pH balanced blend of extra strength nutrients specifically designed for use during early flowering and ripening in fruits, buds and flowers. Open Sesame® will also enhance flower size and multiple bud development. Use in soilless mixes, organic soils, hydroponics and aeroponic systems. Not for sale in the following states at this time: PR.

Item No.	Description	MSRP
719919	FoxFarm Open Sesame Soluble 6 oz Jar	\$15.95
719920	FoxFarm Open Sesame 1 lb	\$33.95
719925	FoxFarm Open Sesame 2 lb	\$57.95
719926	FoxFarm Open Sesame 15 lb NEW	\$174.95

FoxFarm® Beastie Bloomz® 0 - 50 - 30



Beastie Bloomz® is a pH balanced blend of extra strength nutrients specially formulated to produce heavy weight fruit and maximize blossom development during the critical last weeks of flowering. Beastie Bloomz® is designed to create unbelievable internal bud density. Not for sale in the following states at this time: PR.

Item No.	Description	MSRP
732758	FoxFarm Beastie Bloomz Soluble 6 oz Jar	\$15.95
732759	FoxFarm Beastie Bloomz 1 lb	\$33.95
732760	FoxFarm Beastie Bloomz 2 lb	\$57.95
732764	FoxFarm Beastie Bloomz 15 lb NEW	\$172.95

FoxFarm® Cha Ching® 9 - 50 - 10



Cha Ching® is a pH balanced blend of extra strength nutrients specifically formulated to increase essential oils and pump out heavy resins in fruit, buds and flowers. Formulated for use during late-flowering cycles, Cha Ching® contains a micronutrient pack that has all the essential elements needed to support juicy fruit. Not for sale in the following states at this time: PR.

Item No.	Description	MSRP
732748	FoxFarm Cha Ching Soluble 6 oz Jar	\$15.95
732749	FoxFarm Cha Ching 1 lb	\$33.95
732750	FoxFarm Cha Ching 2 lb	\$57.95
732751	FoxFarm Cha Ching 15 lb NEW	\$164.95

FoxFarm® Soluble Tri-Pack



A trio of high-octane fertilizers: Open Sesame®, Beastie Bloomz® and Cha Ching®. Achieve bumper crop harvests by utilizing all three soluble products at first bud development. Not for sale in the following states at this time: PR.

Item No.	Description	MSRP
719930	FoxFarm Soluble Tri-Pack	\$102.95

FoxFarm® Happy Frog® High Phosphorus Bat Guano 0 - 5 - 0



Bat guano has been known since ancient times to be a highly beneficial organic soil amendment that has a powerful effect on all kinds of plants. Happy Frog® High Phosphorus Bat Guano fertilizer is long aged and has no odor. It also contains natural bacteria and has certain properties that cannot be duplicated in a laboratory. It will deliver spectacular flowers and multiple bud development. Not for sale in the following states at this time: PR.

Item No.	Description	MSRP
720179	Happy Frog High Phosphorus Bat Guano 4 lb	\$15.95

FoxFarm® Happy Frog® Japanese Maple 4 - 8 - 5



Specifically formulated for use on Japanese maples, lilies, evergreens, hydrangeas, junipers, dogwoods, flowering ornamentals and other low pH feeders. A unique blend of natural fertilizers and micro-organisms that work in harmony with the soil to deliver optimum plant nutrition. Encourages brilliant reds, purples and oranges that make Japanese maples. Not for sale in the following states at this time: IL, PR.

Item No.	Description	MSRP
720163	Happy Frog Japanese Maple Fertilizer 4 lb	\$11.95

FoxFarm® Happy Frog® Fruit & Flower 5 - 8 - 4



Specifically designed to supply essential nutrients for luscious fruit and flower development. This blended formula will encourage vigorous root systems, robust bud size and multiple branching. Expect brighter colors, spellbinding scents and delicious flavors, thanks to the extra boost that comes from the micronutrients and living organisms. Not for sale in the following states at this time: IL, PR.

Item No.	Description	MSRP
720161	FoxFarm Happy Frog Fruit & Flower Fertilizer 4 lb	\$11.95
714307	FoxFarm Happy Frog Fruit & Flower 18 lb	\$38.95

FoxFarm® Happy Frog® Tomato & Vegetable 7 - 4 - 5



Precisely designed for use on all veggies, tomato varieties, soft fruits and berries. The ratios between nitrogen, phosphorus and potassium will allow the plant to feed vigorously while producing abundant high quality fruit development. Also contains calcium which helps prevent blossom end rot and builds stronger cell walls, making plants more disease resistant. Not for sale in the following states at this time: IL, PR.

Item No.	Description	MSRP
720165	Happy Frog Tomato & Vegetable Fertilizer 4 lb	\$11.95
714309	FoxFarm Happy Frog Tomato & Vegetable 18 lb	\$38.95

FoxFarm® Happy Frog® Acid Loving 6 - 4 - 4



Happy Frog® Acid Loving is specifically formulated for use on azaleas, rhododendrons, camellias, hydrangeas, evergreens, blueberries, raspberries, strawberries, potatoes and all other acid loving plants. Contains an additional boost of nitrogen for heavy feeding shrubs and cottonseed meal, an excellent slow release fertilizer for plants that need a low pH. Not for sale in the following states at this time: IL, PR.

Item No.	Description	MSRP
720167	Happy Frog Acid Loving Fertilizer 4 lb	\$11.95

FoxFarm® Happy Frog® All Purpose 5 - 5 - 5



A ready-to-use, pH balanced blend of natural fertilizers. Some ingredients allow for instantly available nutrition, while others deliver slow-release nitrogen over time. Highly recommended for vegetable gardens, annual and perennial flower gardens, ornamental plantings and all types of container gardening. Not for sale in the following states at this time: IL, PR.

Item No.	Description	MSRP
720169	Happy Frog All Purpose Fertilizer 4 lb	\$11.95
714365	FoxFarm Happy Frog All Purpose 18 lb	\$38.95

FoxFarm® Happy Frog® Steamed Bone Meal 3 - 15 - 0



Bone Meal is a wonderful food for bulbs and helps create abundant blossoms. It is super fine screened, allowing for quicker breakdown and easier absorption by plants. Provides a high level of phosphorus for all stages of plant growth and flowering. Bone meal also contains calcium, which creates strong cellular development in plants. Not for sale in the following states at this time: PR.

Item No.	Description	MSRP
720171	Happy Frog Steamed Bone Meal Fertilizer 4 lb	\$11.95

FoxFarm® Happy Frog® Bulb Food 3 - 8 - 8



Planting bulbs in the fall is an investment in the future. Formulated to encourage long term blooming, this fertilizer contains extra phosphorus for sustained flowering and potassium to help plants become more disease resistant. Happy Frog® Bulb Food works great on tulips, daffodils, gladiolas, dahlias and all flowering plants and trees. Not for sale in the following states at this time: IL, PR.

Item No.	Description	MSRP
720173	Happy Frog Bulb Food Fertilizer 4 lb	\$11.95

FoxFarm® Happy Frog® Jump Start 3 - 4 - 3



Get young transplants and seeds off to the right start. From their first day in the garden, they need the right mix of nutrients to germinate and grow. This gentle blend includes phosphorus for healthy root development and calcium, which helps buffer acidic soils and increases a plant's ability to fight off disease. Not for sale in the following states at this time: PR.

Item No.	Description	MSRP
720175	Happy Frog Jump Start Fertilizer 4 lb	\$11.95

FoxFarm® Happy Frog® Premium Lawn 8 - 2 - 6



A luxurious, thick, green lawn cannot exist without healthy soil. Happy Frog® Premium Lawn Fertilizer contains a blend of all natural nutrients designed to be applied year round. It will gently feed your lawn and enrich your soil with beneficial microbe populations. Premium Lawn Fertilizer will balance turf grass density, giving you a thicker, more luxurious lawn. Not for sale in the following states at this time: IL, PR.

Item No.	Description	MSRP
720177	Happy Frog Premium Lawn Fertilizer 4 lb	\$11.95

FoxFarm® Happy Frog® Rose Food 4 - 4 - 5



Happy Frog® Rose Food is custom blended to deliver optimum nutrition for roses. The benefits of kelp meal and alfalfa meal enable roses to become horticultural beauties. This extraordinary fertilizer will create strong plants, increase the color intensity and produce prize-winning blooms. Not for sale in the following states at this time: IL, PR.

Item No.	Description	MSRP
720181	Happy Frog Rose Food Fertilizer 4 lb	\$11.95



Roots Organics Buddha Grow 2 - 0.25 - 1.5



Buddha Grow is the finest organic ingredients specifically created to promote vigor, increase yields and enhance quality in soil grown plants during their vegetative stage.

Item No.	Description	MSRP
715175	Roots Organics Buddha Grow Quart	\$17.99
715180	Roots Organics Buddha Grow Gallon	\$49.99
715185	Roots Organics Buddha Grow 2.5 Gallon	\$109.99
715190	Roots Organics Buddha Grow 5 Gallon	\$209.99

Roots Organics Buddha Bloom 0.5 - 2 - 1



Buddha Bloom is a proprietary blend of the finest organic ingredients specifically created to promote vigor, increase yields and enhance quality in soil grown plants during their flowering stage.

Item No.	Description	MSRP
715195	Roots Organics Buddha Bloom Quart	\$17.99
715200	Roots Organics Buddha Bloom Gallon	\$49.99
715205	Roots Organics Buddha Bloom 2.5 Gallon	\$109.99
715210	Roots Organics Buddha Bloom 5 Gallon	\$209.99

Roots Organics Trinity Catalyst 0.1 - 0.5 - 0.25



This complex liquid blend of organic compounds is specifically designed for maximum effect as a plant, root and rhizosphere catalyst. This exclusive formula is a universal supplement for both growth and bloom.

Item No.	Description	MSRP
715005	Roots Organics Trinity Catalyst Quart	\$26.99
715010	Roots Organics Trinity Catalyst Gallon	\$69.99
715015	Roots Organics Trinity Catalyst 2.5 Gallon	\$159.99
715020	Roots Organics Trinity Catalyst 5 Gallon	\$299.99

Roots Organics HP2 0 - 4 - 0



This unique organic liquid bat guano is a specially extracted source of natural phosphorous specifically designed to enhance flower quality. In a liquid form, bat guano is easier to use, more concentrated, eliminates worries about dust-born pathogens.

Item No.	Description	MSRP
715025	Roots Organics HP2 Liquid Bat Guano Quart	\$17.99
715030	Roots Organics HP2 Liquid Bat Guano Gallon	\$49.99
715035	Roots Organics HP2 Liquid Bat Guano 2.5 Gallon	\$115.99
715040	Roots Organics HP2 Liquid Bat Guano 5 Gallon	\$219.99

Roots Organics HPK 0 - 5 - 4



This organic PK liquid bloom booster is extracted from our unique natural sources of phosphorous and potassium. Bat guano, renowned as an organic source of phosphorous, is combined with Langbeinite, a natural source of potassium.

Item No.	Description	MSRP
715045	Roots Organics HPK Bat Guano & K-Mag Quart	\$19.99
715050	Roots Organics HPK Bat Guano & K-Mag Gallon	\$53.99
715055	Roots Organics HPK Bat Guano & K-Mag 2.5 Gallon	\$125.99
715060	Roots Organics HPK Bat Guano & K-Mag 5 Gallon	\$235.99

Roots Organics Ancient Amber 0.1 - 0 - 0



Humic acids are extremely effective chelating agents, facilitating the uptake of micro and macro nutrients, increasing resistance to stress and boosting overall vigor, thereby producing larger, better quality harvests.

Item No.	Description	MSRP
715065	Roots Organics Ancient Amber Quart	\$19.99
715070	Roots Organics Ancient Amber Gallon	\$49.99
715075	Roots Organics Ancient Amber 2.5 Gallon	\$99.99
715080	Roots Organics Ancient Amber 5 Gallon	\$163.99

Roots Organics Extreme Serene 0 - 2 - 2



An organic liquid kelp extract which provides a natural source of growth promoting compounds and micronutrients. Specifically designed to encourage vigorous growth, increase flower sites and increase yields.

Item No.	Description	MSRP
715085	Roots Organics Extreme Serene Quart	\$35.99
715090	Roots Organics Extreme Serene Gallon	\$99.99
715095	Roots Organics Extreme Serene 2.5 Gallon	\$235.99

Roots Organics Surge 1 - 1 - 0.5



Roots Organics Surge nutritional and microbial stimulant is designed from sustainably-harvested and enzymatically processed marine protein materials. The addition of molasses, kelp and humic acid to a powerful fish base creates a potent fusion of natural compounds to enhance the distinctive qualities and flavor of your harvest.

Item No.	Description	MSRP
715465	Roots Organics Surge Quart	\$17.99
715470	Roots Organics Surge Gallon	\$49.99
715475	Roots Organics Surge 2.5 Gallon	\$109.99
715480	Roots Organics Surge 5 Gallon	\$207.99

Roots Organics Oregonism XL



A distinctive super-soluble formulation of endo/ecto-mycorrhizae, beneficial bacteria and Trichoderma. Mycorrhizae colonize the root zone, forming a symbiosis with the plant's roots, massively increasing the size.



Item No.	Description	MSRP
715130	Roots Organics Oregonism XL 1.8 oz	\$11.95
715135	Roots Organics Oregonism XL 4 oz	\$19.95
715140	Roots Organics Oregonism XL 8 oz	\$29.95
715145	Roots Organics Oregonism XL 1 lb	\$55.95
715150	Roots Organics Oregonism XL 3 lb	\$145.95
715155	Roots Organics Oregonism XL 6 lb	\$259.95

Roots Organics Nitro Bat Guano 9 - 3 - 1



Roots Organics Nitro Bat Guano is an excellent source of nitrogen, phosphorus and calcium. Carefully processed and sifted to make it easy to work with, Roots Organics Nitro Bat Guano encourages vigorous growth and is fast acting for quick results.



Item No.	Description	MSRP
720940	Roots Organics Nitro Bat Guano 3 lb	\$14.99
720945	Roots Organics Nitro Bat Guano 9 lb	\$35.99

Roots Organics Super Nitro Bat Guano 15.5 - 1 - 1



Roots Organics Super Nitro Bat Guano is incredibly high in Nitrogen and is extracted only from select caves when the quality is at its highest. Super Nitro Bat Guano is fast acting and is so powerful it should be used carefully and sparingly.



Item No.	Description	MSRP
720960	Roots Organics Super Nitro Bat Guano 3 lb	\$29.99
720965	Roots Organics Super Nitro Bat Guano 9 lb	\$79.99

Roots Organics Phos Bat Guano 0 - 7 - 0



Roots Organics Phos Bat Guano is an excellent source of phosphorus and calcium. Carefully processed and sifted to make it easy to work with, Roots Organics Phos Bat Guano encourages vigorous flowering and fruiting.



Item No.	Description	MSRP
720980	Roots Organics Phos Bat Guano 3 lb	\$11.99

Roots Organics Uprising Grow 6 - 5 - 1.5



Roots Organics Uprising Grow is a diverse blend of natural and organic ingredients specially formulated for maximum results. This formula is effective alone as an amendment or as a top dress for encouraging vigorous growth.



Item No.	Description	MSRP
715440	Roots Organics Uprising Grow 3 lb	\$20.00
715441	Roots Organics Uprising Grow 9 lb	\$45.99
715442	Roots Organics Uprising Grow 20 lb	\$80.99
715443	Roots Organics Uprising Grow 40 lb	\$144.99

Roots Organics Uprising Bloom 3 - 6 - 4



Roots Organics Uprising Bloom is a diverse blend of natural and organic ingredients specially formulated for maximum results. This formula is effective alone as an amendment or as a top dress for encouraging vigorous flowering and fruiting.



Item No.	Description	MSRP
715435	Roots Organics Uprising Bloom 3 lb	\$12.00
715436	Roots Organics Uprising Bloom 9 lb	\$32.99
715437	Roots Organics Uprising Bloom 20 lb	\$55.99
715438	Roots Organics Uprising Bloom 40 lb	\$96.99

Roots Organics Uprising Foundation 3 - 1 - 1



Roots Organics Uprising Foundation is a diverse blend of natural and organic ingredients specially formulated for maximum results. When used alone as an amendment or top dress, it is very effective for supplementing calcium, magnesium and iron.



Item No.	Description	MSRP
715430	Roots Organics Uprising Foundation 3 lb	\$18.00
715431	Roots Organics Uprising Foundation 9 lb	\$37.99
715432	Roots Organics Uprising Foundation 20 lb	\$66.99
715433	Roots Organics Uprising Foundation 40 lb	\$117.99

Roots Organics Sea Bird Guano 0 - 12 - 0



Roots Organics Seabird Guano is an excellent source of phosphate and calcium. Carefully sifted and processed to make it easy to work with, Roots Organics Seabird Guano encourages vigorous growth and is fast acting for quick results.



Item No.	Description	MSRP
720930	Roots Organics Seabird Guano Granular 3 lb	\$11.99
720935	Roots Organics Seabird Guano Granular 9 lb	\$29.99
720996	Roots Organics Seabird Guano Granular 20 lb	\$53.99
720990	Roots Organics Seabird Guano Powder 3 lb	\$10.99
720995	Roots Organics Seabird Guano Powder 9 lb	\$27.99
720937	Roots Organics Seabird Guano Powder 20 lb	\$49.99
720939	Roots Organics Seabird Guano Powder 40 lb	\$61.99

Roots Organics Elemental - 20% Calcium & 4% Magnesium



Elemental contains two absolutely essential macronutrients: Calcium, an essential nutrient for plant health due to its role in cell walls, membranes and other biochemical processes; and magnesium, which is a central component of the chlorophyll molecule.

Item No.	Description	MSRP
715445	Roots Organics Elemental 3 lb 20% Calcium 4% Magnesium	\$23.99
715450	Roots Organics Elemental 9 lb 20% Calcium 4% Magnesium	\$59.99
715455	Roots Organics Elemental 20 lb 20% Calcium 4% Magnesium	\$109.99
715460	Roots Organics Elemental 40 lb 20% Calcium 4% Magnesium	\$209.99

Roots Organics Player Pack



Roots Organics Player Pack includes the following: 16 oz Buddha Grow, 16 oz Buddha Bloom, 16 oz Trinity, 8 oz Extreme Serene, 8 oz Ancient Amber, 8 oz HP2, 8 oz HPK, 1.8 oz Oregonism XL. This nutrient line is designed to be used in potting soil.

Item No.	Description	MSRP
715395	Roots Organics Player Pak	\$44.99

Aurora Innovations Master Pack



Roots Organics Master Pack includes: 16 oz Buddha Grow, 16 oz Buddha Bloom, 16 oz Trinity, 8 oz Amino Aide, 8 oz Big Swell, 8 oz Ancient Amber, 8 oz Extreme Serene, 8 oz HP2, 8 oz HPK, 1.8 oz Oregonism XL. Designed to be used in potting soil.

Item No.	Description	MSRP
715400	Aurora Innovations Master Pack	\$49.99

Soul Player Pack



NEW The Soul Player Pack includes the following: 16 oz. Grow, 16 oz. Bloom, 16 oz. Infinity, 8 oz. Grow-N, 8 oz. Amino Aide, 8 oz. Big Swell, 8 oz. Peak. This nutrient line is designed for growing in coco fiber, hydroponics and works great in soil as well.

Item No.	Description	MSRP
715391	Soul Player Pack	\$44.99

aurora
Innovations
soul

Soul Grow 3 - 1 - 1



NEW Soul Grow is a synergistic blend of highly soluble synthetic fertility components enhanced with powerful organic extracts for both maximum yields and spectacular flavor. It was designed specifically for increased yields and enhanced quality in versatile and demanding applications. Soul Grow is balanced for more of what a plant needs during its vegetative growth stage and was purposely created to be user friendly and pH stable.

Item No.	Description	MSRP
715251	Soul Grow Quart	\$18.99
715256	Soul Grow Gallon	\$53.99
715261	Soul Grow 2.5 Gallon	\$115.99
715266	Soul Grow 5 Gallon	\$213.99

Soul Bloom 1 - 4 - 3



NEW Soul Bloom is a synergistic blend of highly soluble synthetic fertility components enhanced with powerful organic extracts for both maximum yields and spectacular flavor. Formulated from only the highest quality organic and synthetic ingredients and targeted to increase flower density for larger harvests. Soul Bloom is balanced for more of what a plant needs during its bloom stage and was purposely created to be user friendly and pH stable.

Item No.	Description	MSRP
715271	Soul Bloom Quart	\$18.99
715276	Soul Bloom Gallon	\$53.99
715281	Soul Bloom 2.5 Gallon	\$115.99
715286	Soul Bloom 5 Gallon	\$213.99

Soul Amino Aide 5 - 0 - 1



NEW Soul Amino Aide plant supercharger is a complex amino acid blend specifically formulated to increase plant vigor and yields. When used properly in conjunction with a high quality nutrient line, Amino Aide can substantially increase yields.

Item No.	Description	MSRP
715291	Soul Amino Aide Quart	\$49.99
715296	Soul Amino Aide Gallon	\$149.99
715301	Soul Amino Aide 2.5 Gallon	\$349.99
715306	Soul Amino Aide 5 Gallon	\$659.99

Soul Grow-N 8 - 0 - 0



NEW Soul Grow-N nitrogen supplement was specifically crafted for the gardener that demands faster growth from super available high performance fertilizers. A deliberate blend of organic and synthetic nitrogen and calcium sources intentionally designed for maximum effect and high solubility puts the controlled application of these essential nutrients in your hands.

Item No.	Description	MSRP
715311	Soul Grow-N Quart	\$21.99
715316	Soul Grow-N Gallon	\$59.99
715321	Soul Grow-N 2.5 Gallon	\$139.99
715326	Soul Grow-N 5 Gallon	\$259.99

Soul Big Swell 2 - 5 - 3



NEW Soul Big Swell bloom booster has been designed specifically to increase flower size, vigor, density and quality. Soul Big Swell can be used as an additive for increased yields in conjunction with any quality base nutrient program for exceptional results.

Item No.	Description	MSRP
715331	Soul Big Swell Quart	\$49.99
715336	Soul Big Swell Gallon	\$149.99
715341	Soul Big Swell 2.5 Gallon	\$349.99
715346	Soul Big Swell 5 Gallon	\$659.99

Soul Infinity 0 - 2 - 1



NEW Soul Infinity catalyst is a complex blend of powerful organic compounds combined with choice plant nutrition. Infinity is specially formulated to increase vigor and prevent micronutrient deficiencies common in fast growing and heavy feeding plants.

Item No.	Description	MSRP
715351	Soul Infinity Quart	\$27.99
715356	Soul Infinity Gallon	\$71.99
715361	Soul Infinity 2.5 Gallon	\$159.99
715366	Soul Infinity 5 Gallon	\$299.99

Soul PeaK 0 - 7 - 7



NEW Soul PeaK bloom finisher contains unique, proprietary botanical extracts as well as ample phosphorus and potassium to encourage the highest density in flowering. PeaK supports the development of intense features and show quality blooms.

Item No.	Description	MSRP
715371	Soul PeaK Quart	\$25.99
715376	Soul PeaK Gallon	\$79.99
715381	Soul PeaK 2.5 Gallon	\$179.99
715386	Soul PeaK 5 Gallon	\$319.99

GROTEK™

SCIENCE FOR PLANTS

Grotek™ VitaMax Plus™ 1 - 1 - 2



VitaMax Plus™ is specially formulated to improve plant growth. It encourages better root development, larger buds, blooms, fruits and flowers by developing a robust plant system. Not for sale in the following states at this time: PR.

Item No.	Description	MSRP
718855	Grotek VitaMaxPlus 1 Liter	\$23.47
718860	Grotek VitaMaxPlus 4 Liter	\$79.32
718862	Grotek VitaMaxPlus 10 Liter	\$157.52
718863	Grotek VitaMaxPlus 23 Liter	\$358.62

Grotek™ Insta-Green™ 3 - 0 - 0



InstaGreen™ is a dark greening solution, scientifically formulated to bring plants back to a lush, dark color and vigor. InstaGreen™ will eliminate yellow leaves in seedlings and cuttings. Not for sale in the following states at this time: PR.

Item No.	Description	MSRP
718900	Grotek InstaGreen 1 Liter	\$14.02
718902	Grotek InstaGreen 4 Liter	\$38.16

Grotek™ Pro-Silicate™ 0 - 0 - 3



Pro-Silicate™ is a nutritional silicate additive containing potassium and silicon. It helps keep the plants upright, positioning the leaves correctly for maximum light exposure that ultimately leads to a high rate of photosynthesis. Not for sale in the following states at this time: PR.

Item No.	Description	MSRP
718890	Grotek Pro-Silicate 1 Liter	\$15.03
718895	Grotek Pro-Silicate 4 Liter	\$42.15
718897	Grotek Pro-Silicate 10 Liter	\$104.51

Grotek™ Monster Grow™ 12 - 7 - 15



Monster Grow™ is a high nitrogen fuel for high performance growing that gives an added boost to your plants while they are in the vegetative stage. Not for sale in the following states at this time: PR.

Item No.	Description	MSRP
718840	Grotek Monster Grow 130 gm	\$13.15
718845	Grotek Monster Grow 500 gm	\$42.48

Grotek™ Monster Bloom™ 0 - 50 - 30



Monster Bloom™ is designed to increase the plant's ability to flower. It increases the essential oil content in herbs and speeds up the development of flower bud set and the total flowering phase. Not for sale in the following states at this time: PR.

Item No.	Description	MSRP
718820	Grotek Monster Bloom 130 gm	\$13.15
718825	Grotek Monster Bloom 500 gm	\$42.48
718830	Grotek Monster Bloom 2.5 kg	\$204.95
718835	Grotek Monster Bloom 5 kg	\$379.95
718833	Grotek Monster Bloom 10 kg	\$714.95

Grotek™ Black Pearl™ 1 - 1 - 2



This organic product is a blended powder that aims to build soil by replenishing nutrients. Black Pearl contains Nitrogen, Phosphorous and Potassium to support vegetative growth, larger root systems, vigorous blooming and increased drought tolerance. Not for sale in the following states at this time: PR.

Item No.	Description	MSRP
732979	Grotek Black Pearl 1.5 kg	\$62.00

Grotek™ Cal-Max 2 - 0 - 0



An excellent source of additional calcium, magnesium and iron, Cal-Max can be used on all plants, providing calcium, magnesium and iron for your garden. Using Cal-Max will help to eliminate leaf yellowing or flowers dropping off. Not for sale in the following states at this time: PR.

Item No.	Description	MSRP
732960	Grotek Cal-Max 1 Liter	\$13.30
732970	Grotek Cal-Max 4 Liter	\$43.17
732972	Grotek Cal-Max 10 Liter	\$104.30

Grotek™ Bloom Fuel™ 0 - 0 - 2



Bloom Fuel™ is a flowering supplement designed to be used alongside your regular fertilizer program. Begin adding Bloom Fuel half way through vegetative growth to encourage a flowering response. Not for sale in the following states at this time: PR.

Item No.	Description	MSRP
732765	Grotek Bloom Fuel 4 Liter	\$63.52

Grotek™ Vegetative Growth Booster™ 8 - 39 - 0



Vegetative Growth Booster™ is a specially formulated product for vegetative growth. Use Growth Booster to increase development in the early stages of growth. Not for sale in the following states at this time: PR.

Item No.	Description	MSRP
732975	Grotek Vegetative Growth Booster 20 gm	\$15.77
732977	Grotek Vegetative Growth Booster 300 gm	\$156.26

Grotek™ Blossom Blaster™ 0 - 39 - 25



Blossom Blaster™ is a powerful blend of phosphorous and potassium fertilizers. It supplies the plant with a reliable source of nutrition in the area where blossoms are developing. It gives high performance in all mediums. Not for sale in the following states at this time: PR.

Item No.	Description	MSRP
732980	Grotek Blossom Blaster 20 gm	\$11.31
732985	Grotek Blossom Blaster 500 gm	\$242.00
732986	Grotek Blossom Blaster 2.5 kg	\$844.95

NECTAR FOR THE GODS

Nectar For The Gods Medusa's Magic



Originally Oregon's Only's grow formula, Medusa's packs a punch. This product goes through an enzyme digest which strips proteins from organic meals and makes them totally available to plants. But worry not, whatever is not absorbed by the plant's roots will become a microbial feast for the soil's biota.

Item No.	Description	MSRP
746256	Medusa's Magic Quart	\$15.00
746258	Medusa's Magic Gallon	\$45.00
746260	Medusa's Magic 2.5 Gallon	\$90.00
746262	Medusa's Magic 5 Gallon	\$160.00

Nectar For The Gods Gaia Mania



Derived from digested forms of soybean, feather, kelp and bone meals as well as worm castings, Gaia offers up a buffet of nutrition for your plants and microbes alike. Free from salts and nitrates, Gaia is incredibly gentle. Rich in proteins, all plants are sure to love this product.

Item No.	Description	MSRP
746232	Gaia Mania Quart	\$17.00
746234	Gaia Mania Gallon	\$50.00
746236	Gaia Mania 2.5 Gallon	\$100.00
746238	Gaia Mania 5 Gallon	\$180.00

Nectar For The Gods Zeus Juice



Zeus Juice is a blend of enzymatically digested Humic acids from BioAg's arsenal of products, blended with kelp extract. These metabolically active compounds will promote optimal nutrient availability, healthy plant cell development and profound rooting. Zeus can be used in soil and hydroponic gardens and as an effective foliar feed.

Item No.	Description	MSRP
746296	Zeus Juice Quart	\$20.00
746298	Zeus Juice Gallon	\$65.00
746300	Zeus Juice 2.5 Gallon	\$135.00
746302	Zeus Juice 5 Gallon	\$250.00

Nectar For The Gods Herculean Harvest



Rich in calcium phosphate, liquid bone meal serves two major purposes in an indoor garden: As a feed, Herculean will promote stronger cell strength, solid stems and heavier fruit; As a flush, bone meal will tie up unwanted salts and facilitate the uptake of macro nutrients.

Item No.	Description	MSRP
746240	Herculean Harvest Quart	\$12.00
746242	Herculean Harvest Gallon	\$36.00
746244	Herculean Harvest 2.5 Gallon	\$75.00
746246	Herculean Harvest 5 Gallon	\$135.00

Nectar For The Gods Athena's Aminos



The basic components of living cells are proteins, which are made up of Amino Acids. Derived from animal byproducts, Athena's is a digested hydrolysate that will benefit every stage of your plants' life from vegetative to bloom.

Item No.	Description	MSRP
746200	Athena's Aminos Quart	\$15.00
746202	Athena's Aminos Gallon	\$45.00
746204	Athena's Aminos 2.5 Gallon	\$90.00
746206	Athena's Aminos 5 Gallon	\$160.00

Nectar For The Gods Demeter's Destiny



Demeter's is a highly available form of calcium phosphate blended with amino acids. Demeter's calcium bonds with natural elements in the soil to create a microbial feast without promoting unwanted elongation. When using Demeter's, you will notice stronger plants and increased flavors and sugar production.

Item No.	Description	MSRP
746224	Demeter's Destiny Quart	\$20.00
746226	Demeter's Destiny Gallon	\$60.00
746228	Demeter's Destiny 2.5 Gallon	\$120.00
746230	Demeter's Destiny 5 Gallon	\$215.00

Nectar For The Gods Mega Morpheus



Oregon's Only's answer to phosphate rich guano tea. Derived from seabird guano, digested worm humus and mineral rich Atlantic kelp, you can't go wrong with this triple filtered, salt and grit free bloom enhancer. Like no other liquid guano, you will find the availability second to none.

Item No.	Description	MSRP
746264	Mega Morpheus Quart	\$15.00
746266	Mega Morpheus Gallon	\$45.00
746268	Mega Morpheus 2.5 Gallon	\$90.00
746270	Mega Morpheus 5 Gallon	\$160.00

Nectar For The Gods Poseidonzyme



Nectar For The Gods' liquid kelp is rich in natural forms of potassium and is extremely gentle on plants. Poseidon works great as a foliar and root feed alike and also as an immediate food source for compost tea microbes. Use some Poseidon to increase your plants' metabolic potential and see what he can unlock.

Item No.	Description	MSRP
746272	Poseidonzyme Quart	\$22.00
746274	Poseidonzyme Gallon	\$65.00
746276	Poseidonzyme 2.5 Gallon	\$130.00
746278	Poseidonzyme 5 Gallon	\$240.00

Nectar For The Gods Aphrodite's Extraction



Aphrodite is the goddess of love, which is exactly how you will feel about your plants when you see the benefits. The digestion process that Aphrodite's Extraction goes through releases carbon in the form of sucrose. You can use it all of the way through or simply as a final flush.

Item No.	Description	MSRP
746208	Aphrodite's Extraction Quart	\$22.00
746210	Aphrodite's Extraction Gallon	\$60.00
746212	Aphrodite's Extraction 2.5 Gallon	\$120.00
746214	Aphrodite's Extraction 5 Gallon	\$215.00

Nectar For The Gods Triton's Trawl



For those gardeners who want the benefit of a liquid bonemeal but have issues with the farming practices of live stock, here is an alternative for them. Rich in calcium from cartilage, Triton is designed to deliver flavor, aroma and color to the finished product. It can be used alone or to enhance the effects of Herculean Harvest.

Item No.	Description	MSRP
746288	Triton's Trawl Quart	\$12.00
746290	Triton's Trawl Gallon	\$36.00
746292	Triton's Trawl 2.5 Gallon	\$75.00
746294	Triton's Trawl 5 Gallon	\$135.00

Nectar For The Gods Hygeia's Hydration



This multipurpose supplement has many jobs in the garden. Yucca shidigera is rich in saponins which aid in the absorption of nutrients in the soil. Saponins prevent the run off of nutrients from the medium allowing more nutrition to be consumed by microbes and plants alike.

Item No.	Description	MSRP
746248	Hygeia Hydration Quart	\$15.00
746250	Hygeia Hydration Gallon	\$45.00
746252	Hygeia Hydration 2.5 Gallon	\$90.00
746254	Hygeia Hydration 5 Gallon	\$160.00

Nectar For The Gods Pegasus Potion



WOW! this stinks, but for good reason. Pegasus Potion is a nitrate free, totally available protein source of nitrogen. Nitrogen proteins are extracted from feathers and digested into their simplest, most available forms. Pegasus works great as a foliar treatment with fast results and can be used as an additive to the rest of the line.

Item No.	Description	MSRP
746280	Pegasus Potion Quart	\$15.00
746282	Pegasus Potion Gallon	\$45.00
746284	Pegasus Potion 2.5 Gallon	\$90.00
746286	Pegasus Potion 5 Gallon	\$160.00

SUPERNATURAL[®] BRAND

Nectar For The Gods Bloom Khaos



Bloom Khaos is Oregon's Only's secret weapon. This patent pending product aids in the production of whatever stage your plants are in. As a foliar feed, it promotes branching and flower sites. As a water in nutrient, it promotes the uptake of calcium into fruiting bodies creating stronger, thicker and heavier fruit.

Item No.	Description	MSRP
746216	Bloom Khaos Quart	\$40.00
746218	Bloom Khaos Gallon	\$120.00
746220	Bloom Khaos 2.5 Gallon	\$240.00
746222	Bloom Khaos 5 Gallon	\$430.00

Nectar For The Gods Olympus Up



Olympus is derived from micronized limestone designed to not only raise the pH of your nutrient solution but also to buffer organic acids from healthy soil decomposition. The calcium in Olympus is also very effective at tying up salts in the medium.

Item No.	Description	MSRP
746312	Olympus Up Quart	\$14.00
746314	Olympus Up Gallon	\$40.00
746316	Olympus Up 2.5 Gallon	\$80.00
746318	Olympus Up 5 Gallon	\$135.00

Nectar For The Gods Hades Down



This blend of organic acids lowers your nutrient solution's pH. It's our pH down. Don't worry if you over shoot the down: just add some Olympus Up and see the benefits of adding more calcium.

Item No.	Description	MSRP
746304	Hades Down Quart	\$25.50
746306	Hades Down Gallon	\$80.00
746308	Hades Down 2.5 Gallon	\$160.00
746310	Hades Down 5 Gallon	\$325.00

Supernatural[®] Bloom Aqua[®] 11 - 8 - 18



Used during the flowering stage in hydroponics to promote beautiful blooms, Bloom Aqua[®] contains essential minerals and trace elements to support vigorous flowering. Bloom Aqua[®] also contains 8% calcium.

EXCLUSIVE

Item No.	Description	MSRP
717306	Supernatural Bloom Aqua 400 gm	\$27.99
717308	Supernatural Bloom Aqua 1 kg	\$60.99
717310	Supernatural Bloom Aqua 2.26 kg	\$126.99
717312	Supernatural Bloom Aqua 10 kg	\$524.99

Supernatural[®] Gro Aqua[®] 11 - 6 - 16



Used during the vegetative stage in hydroponics to promote healthy plant growth, Gro Aqua[®] contains essential macro and micro elements needed for proper plant development

EXCLUSIVE

Item No.	Description	MSRP
717326	Supernatural Gro Aqua 400 gm	\$27.99
717328	Supernatural Gro Aqua 1 kg	\$60.99
717330	Supernatural Gro Aqua 2.26 kg	\$126.99
717332	Supernatural Gro Aqua 10 kg	\$524.99

Supernatural[®] Bloom Terra[®] 15 - 31 - 14



Used during the flowering stage to promote beautiful blooms, Bloom Terra[®] contains essential minerals and trace elements to support vigorous flowering.

EXCLUSIVE

Item No.	Description	MSRP
717316	Supernatural Bloom Terra 400 gm	\$27.99
717318	Supernatural Bloom Terra 1 kg	\$60.99
717320	Supernatural Bloom Terra 2.26 kg	\$126.99
717322	Supernatural Bloom Terra 10 kg	\$524.99

Supernatural® Gro Terra® 20 - 20 - 20



Used during the vegetative stage to promote healthy plant growth, Gro Terra® contains essential macro and micro elements needed for proper plant development.

EXCLUSIVE

Item No.	Description	MSRP
717336	Supernatural Gro Terra 400 gm	\$27.99
717338	Supernatural Gro Terra 1 kg	\$60.99
717340	Supernatural Gro Terra 2.26 kg	\$126.99
717342	Supernatural Gro Terra 10 kg	\$524.99

Supernatural® Super Boost® 11 - 49 - 9



Used to promote rooting, late flowering and ripening, Super Boost® uses high quality ingredients critical to plants in the late stages of the growth cycle.

EXCLUSIVE

Item No.	Description	MSRP
717346	Supernatural Super Boost 400 gm	\$27.99
717348	Supernatural Super Boost 1 kg	\$60.99
717350	Supernatural Super Boost 2.26 kg	\$135.99
717352	Supernatural Super Boost 10 kg	\$527.99

Supernatural® Bud Blaster® 1 - 52 - 31



Used to promote increased flower size and quality, Bud Blaster® ensures a strong final ripening stage.

EXCLUSIVE

Item No.	Description	MSRP
717358	Supernatural Bud Blaster 100 gm	\$22.99
717360	Supernatural Bud Blaster 500 gm	\$101.99
717362	Supernatural Bud Blaster 1 kg	\$174.99
717364	Supernatural Bud Blaster 2.26 kg	\$337.99
717366	Supernatural Bud Blaster 10 kg	\$1,417.99

Supernatural® Super Soak® 5 - 30 - 20



Contains macro and micro nutrients essential to plant growth. It promotes the uniform spread of nutrients throughout any growth medium to enable vigorous rooting, heavy flower/fruit load and ripening. Use as directed to maximize food absorption in a stable root zone.

EXCLUSIVE

Item No.	Description	MSRP
717354	Supernatural Super Soak 100 gm	\$10.99
717356	Supernatural Super Soak 500 gm	\$34.99

Supernatural® Excellofizz®



Perfect for smaller gardens and areas with limited ventilation, Excellofizz® releases optimal amounts of carbon into the growth environment. Carbon is the building block for all plants and proper absorption greatly increases plant mass and fruit load.

EXCLUSIVE

Item No.	Description	MSRP
717368	Supernatural Excellofizz 15/Pack	\$62.99
717370	Supernatural Excellofizz 50/Pack	\$189.99

Supernatural® Rootburst Powder®



With superior stem adhesion and penetrating action, Rootburst Powder® is a high quality hormone formula that maintains the vibrancy of cuttings throughout the rooting phase, ensuring lush and vigorous plant growth during the vegetative stage. Not for sale in the following states at this time: AZ, FL, ME, NY.

EXCLUSIVE

Item No.	Description	MSRP
717376	Supernatural Rootburst Powder 2 oz	\$21.99
717378	Supernatural Rootburst Powder 6 oz	\$52.99

Supernatural® Superlicious® 3 - 0 - 0



Used throughout the bloom stage, Superlicious® is a supplement containing chelated metals that help intensify fragrance, flavor and the production of essential oils.

EXCLUSIVE

Item No.	Description	MSRP
717386	Supernatural Superlicious 100 gm	\$15.99
717388	Supernatural Superlicious 500 gm	\$67.99

Supernatural® Super Leach® 0 - 0 - 1



Used to dissolve mineral build-up that causes nutrient deficiency, Super Leach® gently flushes the growth medium to ensure a fresh nutrient profile throughout the growth cycle.

EXCLUSIVE

Item No.	Description	MSRP
717380	Supernatural Super Leach 160 gm	\$11.99
717382	Supernatural Super Leach 400 gm	\$25.99
717384	Supernatural Super Leach 2.26 kg	\$132.99

Supernatural® Green Stay® 1 - 0 - 0



Used to maintain green lower leaves needed to fuel fruit production, Green Stay® helps revive and refresh plants experiencing natural stress during the flowering cycle and should be used at the first sign of stress. Green Stay® aids against; calcium, magnesium and iron deficiencies.

EXCLUSIVE

Item No.	Description	MSRP
717390	Supernatural Green Stay 250 ml	\$13.99
717392	Supernatural Green Stay 1 Liter	\$38.99
717393	Supernatural Green Stay 4 Liter	\$127.99

Supernatural® Instant Jungle® 0.081 - 0.004 - 0.02

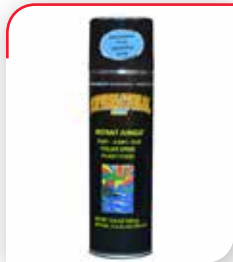

When the correct foliar spray plant food is applied properly the result is a feedback loop. Foliar feeding increases the rate of photosynthesis which in turn increases water and nutrient uptake by the plant's vascular system. A fine mist is all that is required.

EXCLUSIVE

Item No.	Description	MSRP
717394	Supernatural Instant Jungle 450 ml	\$17.99
717395	Supernatural Instant Jungle 450 ml (WA & NY Label)	\$17.99

Supernatural® Ultimate Thrive® 5 - 0 - 2



Helping to maintain a vigorous root environment and to promote seed germination, Ultimate Thrive® is a liquid macro and micro supplement used throughout the entire feeding program to aid the growth of energetic plants full of vibrant colors and heavy fruit loads.

EXCLUSIVE

Item No.	Description	MSRP
717396	Supernatural Ultimate Thrive 500 ml	\$33.99
717398	Supernatural Ultimate Thrive 1 Liter	\$58.99
717400	Supernatural Ultimate Thrive 4 Liter	\$178.99



Cutting Edge Solutions G-Rex 0 - 0 - 0.5



G-Rex is a proprietary blend of unique biologic fertilizer derived components that support root health and protection. Plant roots utilizes G-Rex to give a dose of strength that propels the plant into larger, more dramatic growth.

Item No.	Description	MSRP
715825	Cutting Edge G-Rex Quart	\$126.00
715830	Cutting Edge G-Rex Gallon	\$395.00

Cutting Edge Solutions T-Rex



T-Rex motivates your plants to get a head start during vegetating. This motivation can be seen in a more dynamic growth curve, which facilitates a greater internodal expansion. Greater expansion means more growth.

Item No.	Description	MSRP
715840	Cutting Edge T-Rex Quart	\$139.95
715845	Cutting Edge T-Rex Gallon	\$430.00

Cutting Edge Solutions Grow 2 - 1 - 6



To be used in the vegetative stage, Grow adds more nitrogen for growth and potassium to enhance the plant's photosynthetic rate and energy transfer throughout the plant.

Item No.	Description	MSRP
715600	Cutting Edge Grow Quart	\$12.00
715605	Cutting Edge Grow Gallon	\$28.00
715610	Cutting Edge Grow 2.5 Gallon	\$59.00
715615	Cutting Edge Grow 6 Gallon	\$131.00
715623	Cutting Edge Grow 15 Gallon	\$315.00
715625	Cutting Edge Grow 55 Gallon	\$1,016.00

Cutting Edge Solutions Bloom 0 - 6 - 5



Bloom is a phosphorus heavy formula for enhancing flower production, as well as to encourage a plant to shift its hormonal signals from vegetative to flowering.

Item No.	Description	MSRP
715630	Cutting Edge Bloom Quart	\$12.00
715635	Cutting Edge Bloom Gallon	\$28.00
715640	Cutting Edge Bloom 2.5 Gallon	\$59.00
715645	Cutting Edge Bloom 6 Gallon	\$131.00
715653	Cutting Edge Bloom 15 Gallon	\$315.00
715655	Cutting Edge Bloom 55 Gallon	\$1,016.00

Cutting Edge Solutions Micro 6 - 0 - 0



Micro is to be used throughout the entire growth cycle of a plant, regardless of vegetative or flowering cycles. Micro is highly concentrated and needs to be diluted and mixed first, before adding any other components of the CES system.

Item No.	Description	MSRP
715660	Cutting Edge Micro Quart	\$14.00
715665	Cutting Edge Micro Gallon	\$33.00
715670	Cutting Edge Micro 2.5 Gallon	\$70.00
715675	Cutting Edge Micro 6 Gallon	\$161.00
715677	Cutting Edge Micro 15 Gallon	\$370.00
715685	Cutting Edge Micro 55 Gallon	\$1,203.00

Cutting Edge Solutions Plant Amp™



Plant Amp™ is a chelated Calcium product that also contains a proprietary organic plant stimulating ingredient. Calcium is the basis of cell wall development in a plant and the chelated Calcium in Plant Amp™ is extremely soluble.



Item No.	Description	MSRP
715690	Cutting Edge Plant Amp Quart	\$29.00
715695	Cutting Edge Plant Amp Gallon	\$87.00
715700	Cutting Edge Plant Amp 2.5 Gallon	\$175.00
715705	Cutting Edge Plant Amp 6 Gallon	\$350.00
715707	Cutting Edge Plant Amp 15 Gallon	\$810.00

Cutting Edge Solutions Uncle John's Blend™ 0 - 0 - 2



Uncle John's Blend™ (UJB), is a complexed Potassium mixture that is used primarily to enhance a plant's metabolic rate, especially for flowering plants during the blooming stage.

Item No.	Description	MSRP
715715	Cutting Edge Uncle John's Blend Quart	\$29.00
715720	Cutting Edge Uncle John's Blend Gallon	\$87.00
715725	Cutting Edge Uncle John's Blend 2.5 Gallon	\$175.00
715730	Cutting Edge Uncle John's Blend 6 Gallon	\$350.00
715733	Cutting Edge Uncle John's Blend 15 Gallon	\$810.00

Cutting Edge Solutions Mag-Amped™



Mag-Amped™ is a pure Magnesium product, combined with an organic facilitator that helps with uptake and overall solubility. Magnesium is the basis of chlorophyll production in plants, in turn chlorophyll is a major component in photosynthesis.

Item No.	Description	MSRP
715740	Cutting Edge Mag-Amped Quart	\$29.00
715745	Cutting Edge Mag-Amped Gallon	\$87.00
715750	Cutting Edge Mag-Amped 2.5 Gallon	\$175.00
715755	Cutting Edge Mag-Amped 6 Gallon	\$350.00
715756	Cutting Edge Mag-Amped 15 Gallon	\$810.00

Cutting Edge Solutions Sugaree 0 - 0 - 2



Sugaree provides an organic carbohydrate and electrolyte source to stimulate amino acid production. It's specially designed organic formulation targets increases in fruit set, retention and sugar production.



Item No.	Description	MSRP
715760	Cutting Edge Sugaree Quart	\$20.00
715765	Cutting Edge Sugaree Gallon	\$60.00
715770	Cutting Edge Sugaree 2.5 Gallon	\$122.50
715775	Cutting Edge Sugaree 6 Gallon	\$288.00
715777	Cutting Edge Sugaree 15 Gallon	\$685.00

Cutting Edge Solutions Sour-Dee 0 - 0 - 2



The Sour-Dee provides organic carbohydrates and electrolytes to stimulate amino acid production and provide a superior carbohydrate source. The kind sweet and sour aroma of the organic SourDee is what you need to give your crop the characteristics that you desire.

Item No.	Description	MSRP
715850	Cutting Edge Sour-Dee Quart	\$20.00
715855	Cutting Edge Sour-Dee Gallon	\$60.00
715860	Cutting Edge Sour-Dee 2.5 Gallon	\$122.50
715865	Cutting Edge Sour-Dee 6 Gallon	\$288.00
715867	Cutting Edge Sour-Dee 15 Gallon	\$685.00

Cutting Edge Solutions Solar Gaia



Solar Gaia is an organic-based formulation of humic compounds, utilized to facilitate fertilizer uptake, especially lower levels of Nitrogen in organic fertilizers. Solar Gaia is intended for use throughout the vegetative stage and early flowering stage of growth. Used in conjunction with the Sonoma Gold line.

Item No.	Description	MSRP
715886	Cutting Edge Solar Gaia Quart	\$32.00
715887	Cutting Edge Solar Gaia Gallon	\$96.00
715888	Cutting Edge Solar Gaia 2.5 Gallon	\$189.00
715889	Cutting Edge Solar Gaia 6 Gallon	\$384.00
715892	Cutting Edge Solar Gaia 15 Gallon	\$860.00

Cutting Edge Solutions Sonoma Gold Grow 1 - 4 - 4



Sonoma Gold Grow is an all-purpose organic fertilizer. Sonoma Gold is formulated for all on demand fertilizer needs during the crop cycle.

Item No.	Description	MSRP
715780	Cutting Edge Sonoma Gold Grow Gallon	\$41.00
715785	Cutting Edge Sonoma Gold Grow 2.5 Gallon	\$85.00
715790	Cutting Edge Sonoma Gold Grow 6 Gallon	\$180.00
715793	Cutting Edge Sonoma Gold Grow 15 Gallon	\$460.00

Cutting Edge Solutions Bulletproof Si



In trace amounts, silicon forms silicon enzyme complexes, which function in metabolic roles in photosynthesis and respiratory processes. It has important roles in the formation of new leaves, pollination, fruit formation and fruit storage. Bulletproof Si 5% has additional natural components including amino acids and ascophyllum nodosum, facilitating an enhanced uptake, translocation and effectiveness.

Item No.	Description	MSRP
715873	Cutting Edge Bulletproof SI Quart	\$20.00
715874	Cutting Edge Bulletproof SI Gallon	\$70.00
715875	Cutting Edge Bulletproof SI 2.5 Gallon	\$140.00
715876	Cutting Edge Bulletproof SI 6 Gallon	\$280.00

Cutting Edge Solutions Sonoma Gold Bloom 0 - 6 - 6



Sonoma Gold Bloom is a formulated organic fertilizer for use during flowering and fruit set. Our Pacific Northwest sources of fish provide a local, renewable source of calcium, phosphorus and micronutrients.

Item No.	Description	MSRP
715800	Cutting Edge Sonoma Gold Bloom Gallon	\$41.00
715805	Cutting Edge Sonoma Gold Bloom 2.5 Gallon	\$85.00
715810	Cutting Edge Sonoma Gold Bloom 6 Gallon	\$180.00
715813	Cutting Edge Sonoma Gold Bloom 15 Gallon	\$460.00

Cutting Edge Solutions HumTea® Original 0 - 0 - 1



NEW HumTea® was the first beneficial tea to hit the market well over 10 years ago. HumTea® is not just a fertilizer, rather a specialized blend of proprietary ingredients, humic compounds, sea kelp and earthworm castings. Once brewed, these make a very clean and effective tea that functions as a living topsoil.

Item No.	Description	MSRP
715878	Cutting Edge HumTea Original 5 Gallon	\$45.00
715881	Cutting Edge HumTea Original 15 Gallon	\$120.00

Cutting Edge Solutions HumTea® BrewBall



NEW The HumTea® BrewBall provides a versatile and affordable way to brew actively aerated beneficial teas. The Brew Ball makes five gallons of tea or can be used directly in recirculating systems for two nutrient changes.

Item No.	Description	MSRP
715877	Cutting Edge HumTea BrewBall	\$30.00

Cutting Edge HumTea® Large Brewers



NEW These HumTea® Brewers provides a large scale way to brew the original actively aerated HumTea® in a 15 gallon or 60 gallon versions. They come complete with a sturdy stand with locking wheels. The brew chamber has a lid and is translucent with gallon marks for easy reference. The brewers have a spigot for dispensing the HumTea®.

Item No.	Description	MSRP
715884	Cutting Edge HumTea Brewer 15 Gallon	\$499.95
715885	Cutting Edge HumTea Brewer 60 Gallon	\$849.00

Soil Sulfur



Soil Sulfur - 99.0% purity. Packaged in easy to use resealable pouch. Available in 2 lb and 4 lb pouches. Not for sale in the following states at this time: CT, DE, FL, IN, MD, MN, NY, OR, TX, VA.

Item No.	Description	MSRP
704040	Soil Sulfur 2 lb	\$8.95
704045	Soil Sulfur 4 lb	\$13.95

Soil Sulfur - Oregon Label



Soil Sulfur - 97% purity. Packaged in easy to use resealable pouch. Available in 2 lb. and 4 lb. pouches. Labeled for sale only in the state of Oregon.

Item No.	Description	MSRP
704042	Soil Sulfur 2 lb (OR Label)	\$8.95
704047	Soil Sulfur 4 lb (OR Label)	\$13.95

Hygrozyme™



Hygrozyme™ - The World's Premier Horticultural Enzymatic Formula is an enzyme based cleaning product used to help clean systems and growing media. Hygrozyme™ offers a number of advantages over competing products. Hygrozyme™ is a bacteria free product and easy to use without introducing foreign and unknown bacteria into your growing environment.

Item No.	Description	MSRP
718975	Hygrozyme 500 ml	\$21.95
718980	Hygrozyme 1 Liter	\$36.99
718985	Hygrozyme 4 Liter	\$136.95
718990	Hygrozyme 10 Liter	\$323.95
718995	Hygrozyme 20 Liter	\$609.95



Reforestation
Technologies
International

Xtreme Gardening® CalCarb



Calcium is critical to the health of your plant, contributing to the strength of cell membranes and regulation of nutrient use. Calcium is known to play a major role in the quality of many crops, including peppers, tomatoes and watermelon. It is also able to reduce the effects of heat stress in plants.

Item No.	Description	MSRP
721270	Xtreme Gardening Calcarb 6 oz	\$33.99

Xtreme Gardening® Mykos



Mykos is very-specific specie of Mycorrhiza that works faster and stronger. It builds root mass and increases nutrient uptake. 'Leap start' new transplants and shield roots from disease. When it comes to mycorrhizae, Mykos can't be beat. Mykos is a beneficial additive that may be used with any nutrient line.



Item No.	Description	MSRP
721200	Xtreme Gardening Mykos 1 lb	\$20.99
721205	Xtreme Gardening Mykos 2.2 lb	\$31.99
721210	Xtreme Gardening Mykos 20 lb	\$209.99
721211	Xtreme Gardening Mykos 50 lb	\$499.99

Xtreme Gardening® Mykos Drops Root Paks 10 gm



Mykos Root Paks are great for hydroponic systems, such as deep water culture, aero and aquaponics. They grow big roots and keep the Mykos where they need to be and not clogging up your system and sprayers. Mykos works faster and inoculates stronger. May be used with any nutrient line.

Item No.	Description	MSRP
721240	Xtreme Gardening Mykos Drops 10 gm Paks 50/ct	\$25.99

Xtreme Gardening® Mykos Drops 100 gm Pouches Display

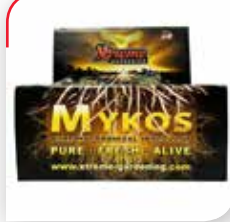

Mykos Root Paks are great for hydroponic systems, such as deep water culture, aero and aquaponics. They grow big roots and keep the Mykos where they need to be and not clogging up your system and sprayers. Mykos works faster and inoculates stronger. May be used with any nutrient line. Easy to use pouches resemble the look of a candy bar. Simply tear open pouch and pour.

Item No.	Description	MSRP
721215	Xtreme Gardening Mykos Drops 100 gm Packs 60/ct Display	\$221.99

Xtreme Gardening® Mykos WP



Mykos WP can be mixed with water or added to hydroponic reservoirs. It's a very-specific species of Mycorrhiza that works faster and stronger. It builds root mass and increases nutrient uptake. Also, protects roots from disease. With more roots, you get more fruits! May be used with any nutrient line.



Item No.	Description	MSRP
721220	Xtreme Gardening Mykos WP 12 oz	\$26.99
721225	Xtreme Gardening Mykos WP 2.2 lb	\$62.99
721230	Xtreme Gardening Mykos WP 15 lb	\$369.99

Xtreme Gardening® Tea Brew Packs



Tea Brews are a treasure trove of beneficial organisms, brought to life through a simple brewing process, which ensure the quality of harvest you've been looking for. They rapidly break down nutrients, improve growth rates and naturally increase plant production of secondary metabolites (aroma, taste and essential oils). 90 gm tea brew packs make 3 gallons of brew. The 500 gram tea brew packs make 25 gallons of brew.

Item No.	Description	MSRP
721320	Xtreme Gardening Tea Brews 90 gm Packs 10/ct	\$51.99
721335	Xtreme Gardening Tea Brews 500 gm Packs 14/ct	\$349.99

Xtreme Gardening® Azos



Azos is a beneficial microbe that rapidly increases natural plant hormone production, affecting cell division, growth rates, plant and root development. Use Azos to quickly and naturally root new cuttings; water-in or add to hydroponic reservoirs to feed and fuel abundant growth. May be used with any nutrient line.

Item No.	Description	MSRP
721259	Xtreme Gardening Azos 2 oz	\$20.99
721260	Xtreme Gardening Azos 6 oz	\$31.99
721265	Xtreme Gardening Azos 12 oz	\$52.99
721268	Xtreme Gardening Azos 8 lb	\$369.99

Xtreme Gardening® Tea Brew Packs Display

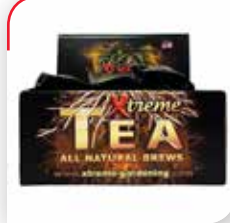

Tea Brews are a treasure trove of beneficial organisms, brought to life through a simple brewing process, which ensure the quality of harvest you've been looking for. They rapidly break down nutrients, improve growth rates and naturally increase plant production of secondary metabolites (aroma, taste and essential oils). Now in one use packages.

Item No.	Description	MSRP
721319	Xtreme Gardening Tea Brews 90 gm Pack 20/ct Display	\$231.99



Down To Earth™ Acid Mix 4 - 3 - 6



NEW A fertilizer blended specially for acid soil loving plants like rhododendrons, azaleas, hydrangeas, evergreen trees and shrubs, blueberries, raspberries and other plants that thrive in a low pH soil. To encourage lush flowers and fruit, apply Acid Mix in early spring for vegetative growth and again when blooms appear. Late fall applications promote healthy root growth and boost resistance to extreme winter temperatures.

Item No.	Description	MSRP
723606	Down To Earth Acid Mix - 6 lb	\$10.95
723608	Down To Earth Acid Mix - 25 lb	\$34.95
723610	Down To Earth Acid Mix - 50 lb	\$64.95

Down To Earth™ Agmino Powder 14 - 0 - 0



NEW Professional grade, water soluble, organic nitrogen fertilizer derived from non-GMO vegetable proteins. Does not contain any animal proteins! Ideal for supplementing plant nitrogen needs or correcting deficiencies in all types of plants. Fast acting, user friendly and effective as a foliar spray or in soil applications. Chloride free and safe around plants, people and pets.

Item No.	Description	MSRP
723614	Down To Earth Agmino Powder - 1 lb	\$16.95
723616	Down To Earth Agmino Powder - 5 lb	\$63.95

Down To Earth™ Alfalfa Meal 2.5 - 0.5 - 2.5



NEW An excellent soil conditioner, Alfalfa Meal is a rich source of trace elements and natural growth stimulants. Recommended for all flowering shrubs and especially roses, Alfalfa Meal accelerates growth and promotes larger, more plentiful blooms. It is also useful as a compost bio-activator due to its high organic matter content and ideal Carbon-to-Nitrogen ratio.



Item No.	Description	MSRP
723618	Down To Earth Alfalfa Meal - 5 lb	\$8.95
723620	Down To Earth Alfalfa Meal - 25 lb	\$23.95

Down To Earth™ All Purpose 4 - 6 - 2



NEW A gentle, non-burning fertilizer perfect for vegetables, herbs, flowers and container plants, our All Purpose mix is also ideal for all types of transplants. Formulated with top quality organic ingredients and designed to deliver a steady supply of essential nutrients to your plants while enhancing soil fertility and microbial activity naturally. Our best selling fertilizer!



Item No.	Description	MSRP
723624	Down To Earth All Purpose Mix - 6 lb	\$10.95
723626	Down To Earth All Purpose Mix - 25 lb	\$34.95
723628	Down To Earth All Purpose Mix - 50 lb	\$63.95

Down To Earth™ Azomite™ SR Powder 0 - 0 - 0.2



NEW Slow-Release grade of Azomite™ volcanic minerals with particle sizes ranging from 4 to 200 mesh. Ideal for blending with other fertilizer materials and amendments as a trace mineral resource to help meet complete plant nutritional needs. An economical way to fortify and re-mineralize soils, composts and potting mediums.



Item No.	Description	MSRP
723630	Down To Earth Azomite Sr Powder - 6 lb	\$8.95

Down To Earth™ Bat Guano 0 - 7 - 0



NEW An excellent source of Phosphorus and Calcium naturally mined from ancient fossilized deposits, our Bat Guano 0-7-0 promotes exceptional flower and fruit development in all types of plants, trees and ornamentals while encouraging strong root growth and plant hardiness. Can be mixed into soils, applied as a side dress or prepared as a liquid for foliar sprays or hydroponics.



Item No.	Description	MSRP
723632	Down To Earth High Phosphorus Bat Guano - 5 lb	\$13.95
723634	Down To Earth High Phosphorus Bat Guano - 25 lb	\$46.95
723636	Down To Earth High Phosphorus Bat Guano - 50 lb	\$79.95

Down To Earth™ Bat Guano 9 - 3 - 1



NEW The undisputed champion of organic fertilizers, Bat Guano is rich in readily available Nitrogen, Phosphorus and micronutrients and provides essential plant nutrition for vigorous vegetative growth and early fruit and flower development. Bat Guano is fast acting and highly effective when mixed into potting mediums, applied as a side dress or steeped to make a potent guano tea or foliar spray.



Item No.	Description	MSRP
723640	Down To Earth High Nitrogen Bat Guano - 2 lb	\$8.95
723642	Down To Earth High Nitrogen Bat Guano - 10 lb	\$31.95
723644	Down To Earth High Nitrogen Bat Guano - 25 lb	\$64.95

Down To Earth™ Bio-Fish 7 - 7 - 2



NEW A nutrient rich fertilizer ideal for heavy feeders like corn, cole crops and tomatoes, Bio-Fish is loaded with the finest marine based ingredients to improve your soil while nourishing your outdoor plants. An excellent source of Nitrogen and Phosphorus, Bio-Fish can be used throughout the growing season to promote vigorous growth, beautiful blooms and plentiful fruit.



Item No.	Description	MSRP
723646	Down To Earth Bio-Fish - 5 lb	\$10.95
723648	Down To Earth Bio-Fish - 25 lb	\$41.95
723650	Down To Earth Bio-Fish - 50 lb	\$77.95

Down To Earth™ Fish Powder 12 - 1 - 1



NEW Premium quality solution grade high nitrogen fertilizer for promotion of rapid plant growth or correction of nitrogen deficiencies. Enzymatically hydrolyzed and spray dried fish protein concentrate provides a valuable and plant available source of organic nitrogen, amino acids and minerals. More concentrated and economical than liquid fish fertilizers.

Item No.	Description	MSRP
723708	Down To Earth Fish Powder - 1 lb	\$11.95
723710	Down To Earth Fish Powder - 5 lb	\$42.95

Down To Earth™ Bio-Live 5 - 4 - 2



NEW A rich, organic fertilizer mix infused with a generous amount of beneficial bacteria and Mycorrhizal fungi to stimulate rooting, vigor and optimum plant development. Bio-Live encourages rapid colonization of soil and soilless mixes and may be combined with other Down To Earth™ fertilizers to further improve plant growth and yields.



Item No.	Description	MSRP
723652	Down To Earth Bio-Live - 5 lb	\$12.95
723654	Down To Earth Bio-Live - 25 lb	\$47.95
723656	Down To Earth Bio-Live - 50 lb	\$89.95

Down To Earth™ Blood Meal 12 - 0 - 0



NEW A high Nitrogen source, our Blood Meal is guaranteed to promote rapid, green growth. A wonderful fertilizer for heavy feeders like corn, spinach, salad greens and garlic in the early spring, it also helps compost piles heat up and break down fast.



Item No.	Description	MSRP
723660	Down To Earth Blood Meal - 5 lb	\$20.95
723662	Down To Earth Blood Meal - 20 lb	\$70.95
723664	Down To Earth Blood Meal - 50 lb	\$147.95

Down To Earth™ Bone Meal 3 - 15 - 0



NEW A wonderful source of Phosphorus and Calcium for flowering plants, trees and ornamentals, Bone Meal is recognized as the ideal organic fertilizer when planting bulbs to promote strong root development and enhance early season growth. One of the indispensable soil amendments all organic gardeners should have on hand.



Item No.	Description	MSRP
723666	Down To Earth Bone Meal - 6 lb	\$12.95
723668	Down To Earth Bone Meal - 25 lb	\$42.95
723670	Down To Earth Bone Meal - 50 lb	\$70.95

Down To Earth™ Cottonseed Meal 6 - 2 - 1



NEW We select only the finest feed grade Cottonseed Meal, which has little or no pesticide residue and contains no animal by-products. Somewhat acidic in nature, Cottonseed Meal is excellent for plants that need a low pH and is perfect for flowering acidic shrubs, berries and trees when used as a slow-release fertilizer.

Item No.	Description	MSRP
723672	Down To Earth Cottonseed Meal - 6 lb	\$11.95
723674	Down To Earth Cottonseed Meal - 20 lb	\$28.95
723676	Down To Earth Cottonseed Meal - 50 lb	\$56.95

Down To Earth™ Crab Meal 4 - 3 - 0



NEW Crab Meal is a superb source of organic nutrients for vegetable gardens and flower beds and is wonderful for building soil tilth. Crab Meal enhances beneficial soil microorganism populations due to its rich chitin content and also makes an incredible compost bio-activator.



Item No.	Description	MSRP
723678	Down To Earth Crab Meal - 5 lb	\$8.95
723681	Down To Earth Crab Meal - 20 lb	\$28.95
723682	Down To Earth Crab Meal - 40 lb	\$50.95

Down To Earth™ Feather Meal 12 - 0 - 0



NEW Feather Meal is a great source of slow release Nitrogen that is perfect for heavy feeders like corn, cole crops and leafy green vegetables. Incorporate into your soil before spring plantings for best results.



Item No.	Description	MSRP
723686	Down To Earth Feather Meal - 5 lb	\$14.95
723688	Down To Earth Feather Meal - 20 lb	\$45.95
723690	Down To Earth Feather Meal - 50 lb	\$92.95

Down To Earth™ Fish Bone Meal 3 - 16 - 0



NEW Fish Bone Meal is a marine based alternative to traditional steamed Bone Meal and is wonderful for all flowering plants, trees and shrubs. A great source of Phosphorus and Calcium, Fish Bone Meal also contains a small amount of Nitrogen and is an ideal fertilizer for new garden beds, perennials and bulbs.



Item No.	Description	MSRP
723694	Down To Earth Fish Bone Meal - 6 lb	\$9.95
723696	Down To Earth Fish Bone Meal - 25 lb	\$31.95
723698	Down To Earth Fish Bone Meal - 50 lb	\$51.95

Down To Earth™ Fish Meal 8 - 6 - 0



NEW Fish Meal is an excellent source of Nitrogen and Phosphorus and is recommended for vegetable gardens, flower beds and all types of outdoor plants, trees and shrubs. Fish Meal enhances soil microbial life, promotes vigorous root development and provides an early season boost for all of your plants.



Item No.	Description	MSRP
723700	Down To Earth Fish Meal - 5 lb	\$20.95
723702	Down To Earth Fish Meal - 20 lb	\$70.95
723704	Down To Earth Fish Meal - 50 lb	\$141.95

Down To Earth™ Granular Humic Acids



NEW A highly concentrated source of humic acids ideal for use on fields, turf and vegetable gardens. Derived from the ancient remains of decomposed organic plant materials, humic acids enhance nutrient uptake and stimulate soil microbial life. Naturally occurring, unaltered oxidized lignite containing 70% total humic acids, crushed, screened and graded to a particle size of 1-3 mm.



Item No.	Description	MSRP
723714	Down To Earth Granular Humic Acid - 25 lb	\$22.95
723716	Down To Earth Granular Humic Acid - 50 lb	\$35.95

Down To Earth™ Kelp Meal 1 - 0.1 - 2



NEW Down To Earth™ Kelp Meal is pure Ascophyllum nodosum seaweed from the clean, cold waters of the North Atlantic Ocean. Hand-harvested, carefully dried and finely milled, our Kelp Meal is a rich natural source of Potash and is ideal for early Spring or Fall application.



Item No.	Description	MSRP
723726	Down To Earth Kelp Meal - 5 lb	\$17.95
723728	Down To Earth Kelp Meal - 20 lb	\$59.95
723730	Down To Earth Kelp Meal - 50 lb	\$124.95

Down To Earth™ Langbeinite (Sul-Po-Mag) 0 - 0 - 22



NEW A unique 3-in-1 combination of Potassium, Magnesium and Sulfur, Langbeinite is a naturally occurring source of these three vital plant nutrients. Potassium is essential for high quality fruit, Magnesium is required for the synthesis of chlorophyll and Sulfur is needed for enzyme activation. Contains 22% K2O, 11% Mg and 22% S.



Item No.	Description	MSRP
723732	Down To Earth Langbeinite (Sul-Po-Mag) - 5 lb	\$10.95
723734	Down To Earth Langbeinite (Sul-Po-Mag) - 50 lb	\$68.95

Down To Earth™ Neem Seed Meal 6 - 1 - 2



NEW Neem Seed Meal is produced during the extraction of oil from the seed of the Indian Neem tree (Azadiracta indica). It is an excellent way to strengthen root systems, improve plant immunity and balance nutrient levels in the soil. Neem Seed Meal can be mixed into soil or potting mediums, used as a top dress or steeped to make a potent foliar tea.



Item No.	Description	MSRP
723736	Down To Earth Neem Seed Meal - 5 lb	\$15.95
723738	Down To Earth Neem Seed Meal - 20 lb	\$49.95
723740	Down To Earth Neem Seed Meal - 40 lb	\$79.95

Down To Earth™ Organic Soybean Meal 7 - 1 - 2



NEW Soybean Meal is an outstanding source of slow release Nitrogen for promoting vegetative growth and early plant development. Our Soybean Meal is derived from organically grown, GMO-free soybeans that are mechanically processed to preserve the highest plant nutrient value.



Item No.	Description	MSRP
723780	Down To Earth Organic Soybean Meal - 20 lb	\$49.95
723742	Down To Earth Organic Soybean Meal - 40 lb	\$81.95

Down To Earth™ Oyster Shell



NEW Oyster Shell flour is an all natural source of high quality Calcium that is ground into varying sizes to ensure an immediate and sustained release of this valuable nutrient. Calcium promotes strong root development, improves nutrient uptake and boosts plant immunity. Oyster Shell builds optimum tilth by improving the texture, aeration and water penetration of soils.



Item No.	Description	MSRP
723744	Down To Earth Oyster Shell - 6 lb	\$7.95
723746	Down To Earth Oyster Shell - 25 lb	\$12.95
723748	Down To Earth Oyster Shell - 50 lb	\$21.95

Down To Earth™ Shrimp Meal 6 - 6 - 0



NEW Excellent all purpose organic fertilizer derived from ground shrimp shells. Rich in Nitrogen, Phosphorus and Calcium, it is wonderful for all types of garden vegetables, flowers, herbs and ornamentals. Also acts as an exceptional compost bio-activator. Shrimp Meal is rich in Chitin, a natural polysaccharide that helps plants develop healthy immune responses and stimulates the growth of beneficial soil micro-organisms.

Item No.	Description	MSRP
723772	Down To Earth Shrimp Meal - 2 lb	\$7.95
723774	Down To Earth Shrimp Meal - 15 lb	\$21.95

Down To Earth™ Rose & Flower Mix 4 - 8 - 4



NEW A special fertilizer blend that provides ample nitrogen for vigorous growth, extra Phosphorus for beautiful blooms and Potassium and trace elements for healthy plant stock. Our Rose & Flower Mix supplies your favorite bulbs, annuals and perennials with the nutrients needed for a long, healthy season of sensational flowering.

Item No.	Description	MSRP
723754	Down To Earth Rose & Flower Mix - 6 lb	\$10.95
723756	Down To Earth Rose & Flower Mix - 25 lb	\$34.95
723758	Down To Earth Rose & Flower Mix - 50 lb	\$63.95

Down To Earth™ Seabird Guano 0 - 11 - 0



NEW Use our high phosphorous Seabird Guano to dramatically increase both the amount and size of blooms throughout the flowering period for all indoor and outdoor plants. Seabird Guano greatly enhances beneficial bacterial activity in the soil and because it's water soluble, it makes an excellent tea or foliar spray when filtered.

Item No.	Description	MSRP
723760	Down To Earth High Phosphorus Seabird Guano - 5 lb	\$16.95
723762	Down To Earth High Phosphorus Seabird Guano - 20 lb	\$37.95
723764	Down To Earth High Phosphorus Seabird Guano - 40 lb	\$62.95

Down To Earth™ Vegan Mix 3 - 2 - 2



NEW The indispensable all purpose fertilizer blended specially for vegan gardeners. Free of any animal products or by-products, Vegan Mix is formulated with plant derived essential nutrients and natural mineral elements plus humic acids. Its slow release formula is designed to continually nourish your vegetables, flowers and herbs while stimulating and building soil health.

Item No.	Description	MSRP
723782	Down To Earth Vegan Mix - 6 lb	\$10.95
723784	Down To Earth Vegan Mix - 25 lb	\$35.95
723786	Down To Earth Vegan Mix - 50 lb	\$66.95



Vermicrop™ VermiAll Broad Spectrum Fertilizer 6 - 6 - 6



NEW Vermicrop™ Organics is proud to introduce our VermiAll Broad Spectrum Dry Fertilizer. This game changing mix is formulated for all stages of growth in the fast paced gardens of champion vegetable and flower growers. We have gone to great lengths to acquire only the purest products and now we are sharing them with you but more importantly sharing them with your garden.



Item No.	Description	MSRP
720880	Vermicrop All Purpose Broad Spectrum Fertilizer 4 lb	\$18.99
720882	Vermicrop All Purpose Broad Spectrum Fertilizer 25 lb	\$159.99

Vermicrop™ VermiVeg Vegetative Stage Fertilizer 7 - 4 - 4



NEW VermiVeg Dry Fertilizer is created for all plant types in the growth stage (after propagation, before blooming). It is formulated to increase overall plant size, foliage cover and promote explosive root growth. This premium mix is designed for aggressive uptake of nutrients, leading to highly productive gardens full of fruit and flowers. When trying to get your plant as big as possible before it blooms.



Item No.	Description	MSRP
720884	Vermicrop Growth Vegetative Stage Fertilizer 4 lb	\$18.99
720886	Vermicrop Growth Vegetative Stage Fertilizer 25 lb	\$159.99

Vermicrop™ VermiBloom Fruit and Flower Fertilizer 3 - 10 - 5



NEW VermiBloom Dry Fertilizer is produced for all plant types in the fruit and flower stage. It goes to work quickly and has all the essentials to promote prolific blooming and ripening of all fruits, vegetables and flowers. The ultimate blend of natural fertilizers from the sea, earth and mountains are combined to form an unequalled Bloom fertilizer free of fillers.



Item No.	Description	MSRP
720888	Vermicrop Bloom Fruit and Flower Fertilizer 5 lb	\$18.99
720890	Vermicrop Bloom Fruit and Flower Fertilizer 35 lb	\$159.99

Vermicrop™ PH Boost Super Flower Fertilizer 1 - 13 - 6



NEW Vermicrop™ Organics is proud to introduce PK Boost to our product line! PK Boost is a complete organic fertilizer for heavy fruit, flower and vegetable varieties. This mixture of Seabird Guano, Fishbone Meal, Kelp Meal, and Potassium Sulfate is unequalled in its purity and consistency. Phosphorus and Potassium are very important and quickly depleted in the intense flowering cycles of prize winning plants.



Item No.	Description	MSRP
720892	Vermicrop PK Boost Super Flower Fertilizer 6 lb	\$28.75
720894	Vermicrop PK Boost Super Flower Fertilizer 45 lb	\$239.99

Vermicrop™ VermiLife™



VermiLife™ is the foundation of any good compost tea. VermiWorm™ Premium Worm Castings are combined with Alaskan Humus at a specific ratio tested by industry leaders. We then fortify the mixture with Fossilized Kelp to increase calcium levels. Finally a proprietary method of inoculation is used to add liquid compost concentrate to the blend.

Item No.	Description	MSRP
720768	Vermicrop VermiLife 5 Gallon	\$46.99

Vermicrop™ VermiFeast™



A mixture of premium food sources for compost tea. These food sources consist of a proprietary blend of specific simple and complex carbohydrates. Conveniently packaged and mixed specifically for compost tea.

Item No.	Description	MSRP
720770	Vermicrop VermiFeast 2 Gallon	\$99.99

Vermicrop™ VermiBrix™



This powdered molasses alternative is easy to use, 100% soluble, all natural and GMO-free. VermiBrix™ has all the benefits of readily available carbs in sugar form as well as rare earth minerals. These minerals slowly release silicon and humates to help protect the plant from nutrients fluctuations and stress.

Item No.	Description	MSRP
720772	Vermicrop VermiBrix 2 Gallon	\$102.00

Vermicrop™ Vermi T™ 5/10 Extractor



This lightweight, easy to clean Bio Extractor is designed to produce a fresh microbial rich extract in 24 hours. Unlike traditional compost tea, Vermi T™ will maintain 100% viability for 7-10 days if properly refrigerated.

Item No.	Description	MSRP
720720	Vermi T 5/10 Extractor	\$449.99

Vermicrop™ Vermi T™ Bio-Cartridges

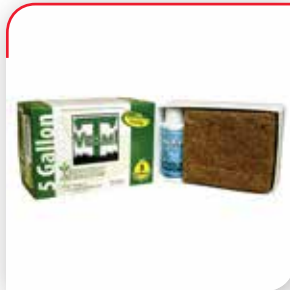

This Cartridge is the key to the multiplication of a diverse microbial rich solution from your Vermi T™ 5/10 Extractor.

Item No.	Description	MSRP
720725	Vermi T Bio-Cartridge 5 Gallon	\$84.99
720740	Vermi T Bio-Cartridge 10 Gallon	\$149.99

Vermicrop™ Polyester Tea Bag



NEW Introducing the Polyester Brewing Bag for compost tea home-brewers everywhere! Measuring 12 x 18 inches, this 200 micron bag is designed for proper bacterial and fungal extraction at an economical price. Made in the USA of polyester with a cotton drawstring.

Item No.	Description	MSRP
720723	Vermicrop Polyester Tea Bag	\$14.95



**HYDRODYNAMICS
INTERNATIONAL INC**

HydroDynamics™ Europonic® Silicate



Europonic® Silicate has 11% Silicon Dioxide, making it one of the strongest Silica products on the market. Silica helps to strengthen plants and increases resistance to environmental stresses including heat, drought and cold.

Item No.	Description	MSRP
718262	HydroDynamics Europonic Silicate Quart	\$15.95
718265	HydroDynamics Europonic Silicate Gallon	\$39.85
718267	HydroDynamics Europonic Silicate 2.5 Gallon	\$94.95
718270	HydroDynamics Europonic Silicate 5 Gallon	\$160.00

HydroDynamics™ Ionic® Bloom 3 - 2 - 6



Ionic® Bloom is for the reproductive and flowering stage of growing plants. It is enhanced with the crucial elements that support increased budding points and large, fragrant flowers. For best results use with Ionic® Boost.

Item No.	Description	MSRP
718175	HydroDynamics Ionic Bloom Quart	\$20.00
718180	HydroDynamics Ionic Bloom Gallon	\$50.00
718185	HydroDynamics Ionic Bloom 2.5 Gallon	\$100.00
718190	HydroDynamics Ionic Bloom 5 Gallon	\$180.00

HydroDynamics™ Ionic® Bloom Hardwater Formula 3 - 2 - 6



Ionic® Bloom Hardwater is blended to be more acidic than standard Ionic Bloom to neutralize bicarbonates on its own. This reduces the amount of acid needed to control the pH in the reservoir & reduces possibility of acute phosphate accumulation.

Item No.	Description	MSRP
718200	HydroDynamics Ionic Bloom Hardwater Gallon	\$50.00
718205	HydroDynamics Ionic Bloom Hardwater 2.5 Gallon	\$100.00

HydroDynamics™ Ionic® Grow 3 - 1 - 5



Specifically formulated for the green vegetative stage of growing plants. It is designed to maximize the potential for vigorous vegetative growth in green plants and during the vegetative cycle of flowering plants.

Item No.	Description	MSRP
718225	HydroDynamics Ionic Grow Quart	\$20.00
718230	HydroDynamics Ionic Grow Gallon	\$50.00
718235	HydroDynamics Ionic Grow 2.5 Gallon	\$100.00
718240	HydroDynamics Ionic Grow 5 Gallon	\$180.00

HydroDynamics™ Ionic® Grow Hardwater Formula 3 - 1 - 5



Ionic® Grow Hardwater is purposely blended to be more acidic than standard Ionic® Grow. A more acidic nutrient solution will neutralise bicarbonates on its own.

Item No.	Description	MSRP
718250	HydroDynamics Ionic Grow Hardwater Gallon	\$50.00

HydroDynamics™ Ionic® Tote Starter Kit



Ionic® Premium Plant Nutrients in the convenience of a triple pack. Each triple pack contains 1 quart of Ionic Grow, 1 quart of Ionic Bloom and 1 quart of Ionic Boost along product information card and feed schedule. Ionic® Premium Plant Nutrients are full spectrum mineral solutions formulated through a series of chemical reactions.

Item No.	Description	MSRP
718170	HydroDynamics Ionic Starter Kit (3 Quarts)	\$49.95

HydroDynamics™ Ionic® PK Boost 0 - 5 - 6



Ionic® Boost delivers the key mineral elements phosphorus (P) and potassium (K) and these crucial ingredients are used in abundance by plants in their fruiting or flowering cycle.

Item No.	Description	MSRP
732255	HydroDynamics Ionic PK Boost Quart	\$20.00
732260	HydroDynamics Ionic PK Boost Gallon	\$50.00
732265	HydroDynamics Ionic PK Boost 2.5 Gallon	\$100.00

HydroDynamics™ Mother Plant® A 2 - 0 - 0 & B 1 - 1 - 3



MotherPlant® is a two-part nutrient formula that provides balanced nutrition for stock plants, whether grown hydroponically, in soilless mixes or soil. MotherPlant® Nutrients will help your mother plants produce the most vigorous clones possible!

Item No.	Description	MSRP
732890	HydroDynamics Mother Plant A Quart	\$18.00
732891	HydroDynamics Mother Plant B Quart	\$18.00
732892	HydroDynamics Mother Plant A Gallon	\$45.95
732893	HydroDynamics Mother Plant B Gallon	\$45.95
732900	HydroDynamics Mother Plant A 2.5 Gallon	\$104.95
732902	HydroDynamics Mother Plant B 2.5 Gallon	\$104.95

HydroDynamics™ Europonic® Fossil Fuel®



Fossil Fuel® is created from the highest quality humic acids, which provide complex interactions with growing media to promote healthy soils and growing media which in turn helps to produce lush plant growth and expansive root systems.

Item No.	Description	MSRP
732220	HydroDynamics Europonic Fossil Fuel Quart	\$21.00
732225	HydroDynamics Europonic Fossil Fuel Gallon	\$49.95
732230	HydroDynamics Europonic Fossil Fuel 2.5 Gallon	\$115.00
732235	HydroDynamics Europonic Fossil Fuel 5 Gallon	\$180.00

HydroDynamics™ Europonic® Rockwool Conditioning Solution



Europonic® Rockwool Conditioning Solution is an advanced formulation of ingredients that stabilize rockwool for maximum nutrient utilization by the plants. Ideal for pre-conditioning rockwool and stonewool growing media products.

Item No.	Description	MSRP
732455	HydroDynamics Rockwool Conditioning Solution Quart	\$18.00
732460	HydroDynamics Rockwool Conditioning Solution Gallon	\$40.00

HydroDynamics™ Europonic Nitrozime® 0 - 4 - 4



Nitrozime® Marine Algae Extract is a plant nutrient supplement derived exclusively from Ascophyllum Nodosum Seaweed and is 100% organic. Nitrozime® enhances a plant's natural abilities with lush vegetation, earlier flowering and increased yields.

Item No.	Description	MSRP
732289	HydroDynamics Europonic Nitrozime 100 ml	\$10.00
732300	HydroDynamics Europonic Nitrozime Pint	\$35.00
732305	HydroDynamics Europonic Nitrozime Quart	\$65.00
732310	HydroDynamics Europonic Nitrozime Gallon	\$239.95

HydroDynamics™ Europonic® Boost 0 - 9 - 9



NEW Europonic® Nutrients are balanced and complete. Unlike the competition, Europonic® contains a profile of essential minerals including Nitrogen, Phosphorus, Potassium, Magnesium and Calcium, along with essential micronutrients that are needed by all plants for healthy, robust growth. Europonic® Boost is a continuous use liquid feed nutrient supplement designed to be used in combination with Bloom fertilizers.

Item No.	Description	MSRP
718288	HydroDynamics Europonic Boost Gallon	\$40.00
718289	HydroDynamics Europonic Boost 5 Gallon	\$154.95

HydroDynamics™ Europonic® Grow A 3 - 0 - 1 & B 2 - 2 - 5



NEW Europonic® Nutrients are balanced and complete. Europonic® contains a profile of essential minerals including Nitrogen, Phosphorus, Potassium, Magnesium and Calcium, along with essential micronutrients that are needed by all plants for healthy, robust growth. The combination of Europonic® Grow Part A and Part B contains a profile of the highest quality minerals including Nitrogen, Phosphorus, Potassium and Calcium plus other essential elements that all plants require for vigorous and strong growth. It is a continuous liquid feed nutrient designed to be used with each irrigation.

Item No.	Description	MSRP
718272	HydroDynamics Europonic Grow A Gallon	\$40.00
718274	HydroDynamics Europonic Grow B Gallon	\$40.00
718276	HydroDynamics Europonic Grow A 5 Gallon	\$154.95
718278	HydroDynamics Europonic Grow B 5 Gallon	\$154.95

HydroDynamics™ Europonic® Bloom A 3 - 0 - 1 & B 2 - 5 - 7



NEW Europonic® Nutrients are balanced and complete. Europonic® contains a profile of essential minerals including Nitrogen, Phosphorus, Potassium, Magnesium and Calcium, along with essential micronutrients that are needed by all plants for healthy, robust growth. The combination of Europonic® Bloom Part A and Part B contains a profile of the highest quality minerals including Nitrogen, Phosphorus, Potassium and Calcium plus other essential elements that all plants require for vigorous and strong growth. It is a continuous liquid feed nutrient designed to be used with each irrigation.

Item No.	Description	MSRP
718280	HydroDynamics Europonic Bloom A Gallon	\$40.00
718282	HydroDynamics Europonic Bloom B Gallon	\$40.00
718284	HydroDynamics Europonic Bloom A 5 Gallon	\$154.95
718286	HydroDynamics Europonic Bloom B 5 Gallon	\$154.95

HydroDynamics™ Green Fuse® Root Stimulator Concentrate



GreenFuse® Root Stimulator is a plant biostimulator that serves as an organic catalyst. This synergy invigorates the natural root development in plants which in turn can facilitate healthier plants, larger yields and superior quality fruit and flower. GreenFuse® Super Strength Concentrate has a phenomenal dilution rate of 15,000 to 1. Not for sale in the following states at this time: CA.

Item No.	Description	MSRP
732711	HydroDynamics Green Fuse ROOT Conc. 60 ml	\$50.00
732712	HydroDynamics Green Fuse ROOT Conc. 120 ml	\$80.00

HydroDynamics™ Green Fuse® Growth Stimulator Concentrate



While not a fertilizer, GreenFuse® Growth Stimulator serves as an organic catalyst that invigorates the natural growth cycle of plants which in turn can lead to healthier plants, larger yields and superior quality fruit and flower. GreenFuse® Super Strength Concentrate has a phenomenal dilution rate of 15,000 to 1. Not for sale in the following states at this time: CA.

Item No.	Description	MSRP
732726	HydroDynamics Green Fuse GROW Conc. 60 ml	\$50.00
732727	HydroDynamics Green Fuse GROW Conc. 120 ml	\$80.00

HydroDynamics™ Green Fuse® Bloom Stimulator Concentrate



GreenFuse® Bloom Stimulator serves as an organic catalyst that invigorates the natural blooming cycle of plants which in turn leads to larger yields & superior quality fruits and flowers. For use in soil gardens, containers, & hydroponic gardens. GreenFuse® Super Strength Concentrate has a phenomenal dilution rate of 15,000 to 1. Not for sale in the following states at this time: CA.

Item No.	Description	MSRP
732741	HydroDynamics Green Fuse BLOOM Conc. 60 ml	\$50.00
732742	HydroDynamics Green Fuse BLOOM Conc. 120 ml	\$80.00
732728	HydroDynamics Green Fuse BLOOM Conc. 300 ml	\$149.95

VermaPlex®

VermaPlex® 0.48 - 0.01 - 0.016



Apply VermaPlex® as a drench or spray to your orchards & vineyards, agriculture & turf, gardens & nurseries and enjoy amazing results. For soil and soil-less gardening and needs no aeration! VermaPlex® is a all natural organic specialty fertilizer that is derived entirely from 100% organic matter 1st processed by Pure Black Castings. It provides nutrients to the foliage.



EXCLUSIVE

Item No.	Description	MSRP
724200	VermaPlex Quart	\$15.95
724205	VermaPlex Gallon	\$37.95
724210	VermaPlex 2.5 Gallon	\$84.95

VermaPlex® Black Sea Kelp 1 - 1 - 17



Contains natural rooting hormones that improve root length, root mass and the efficiency of the root system. Black Sea Kelp stimulates root growth and beneficial microbe activity, allowing plants to absorb nutrients more efficiently. It is long lasting, 100% organic materials that is derived from sustainably-farmed seaweed.

EXCLUSIVE

Item No.	Description	MSRP
724215	VermaPlex Black Sea Kelp Quart	\$17.29
724220	VermaPlex Black Sea Kelp Gallon	\$39.95
724225	VermaPlex Black Sea Kelp 2.5 Gallon	\$93.95

VermaPlex® Liquid Humate Plus



Liquid Humate Plus contains naturally-occurring rooting hormones to increase root mass and root length, allowing plants to absorb nutrients more efficiently. Liquid Humate Plus feeds beneficial microbes, increasing soil fertility and stimulates root growth, allowing more efficient nutrient uptake. Contains composted organic poultry manure extract, an organic nitrogen source.



EXCLUSIVE

Item No.	Description	MSRP
724230	VermaPlex Liquid Humate Plus Quart	\$16.29
724235	VermaPlex Liquid Humate Plus Gallon	\$37.95
724240	VermaPlex Liquid Humate Plus 2.5 Gallon	\$87.95

VermaPlex® Hydrolyzed Fish 2 - 5 - 0



Hydrolyzed Fish is a 100% organic fertilizer made from fish extracts. It's an excellent source of nitrogen, manganese, potash and essential trace elements. Hydrolyzed Fish feeds these microbes, stimulating their growth and increasing their population, making the soil healthier and more fertile.

EXCLUSIVE

Item No.	Description	MSRP
724245	VermaPlex Hydrolyzed Fish Quart	\$17.49
724250	VermaPlex Hydrolyzed Fish Gallon	\$46.49
724255	VermaPlex Hydrolyzed Fish 2.5 Gallon	\$96.29

VermaPlex® Liquid Yucca 0.16 - 0 - 0



Liquid Yucca Extract is a 100% natural wetting agent derived from Yucca schidegera. Our Yucca Extract is cold-pressed for maximum biological activity. As a wetting agent, Yucca Extract can be added to almost any liquid fertilizer mix, as part of an overall fertilization program.

EXCLUSIVE

Item No.	Description	MSRP
724260	VermaPlex Liquid Yucca Quart	\$17.69
724265	VermaPlex Liquid Yucca Gallon	\$46.49
724270	VermaPlex Liquid Yucca 2.5 Gallon	\$101.95



Nutrilife™ Nutri Boost™ 1 0 - 0 - 1



NEW Nutri Boost™ 1 provides stressed plants with the enhanced natural ability to correct roots damaged by stress, as well as create new roots. Nutri Boost™ 1 is blended as a replenishment to replace lost growth generating properties that plants lose during stressful periods. Nutri Boost™ 1 will help create a strong new rooting system so the plant can regain its vigor.

Item No.	Description	MSRP
718750	Nutri Boost 1 - 1 Liter	\$42.00
718752	Nutri Boost 1 - 4 Liter	\$130.20
718754	Nutri Boost 1 - 10 Liter	\$231.00
718756	Nutri Boost 1 - 20 Liter	\$367.50

Nutrilife™ Heavy Weight 0 - 0 - 2



NEW Heavy Weight is a product developed to be used during the flowering stages of a plant's life. It will help increase the mass of the flower bud during the critical development stage. Include with your regular nutrient feed program in the 3rd, 5th and 6th week of flowering. Give your plants the boost they need to become great plants.

Item No.	Description	MSRP
717200	Nutrilife Heavy Weight 1 Liter	\$16.75
717202	Nutrilife Heavy Weight 4 Liter	\$32.95
717204	Nutrilife Heavy Weight 10 Liter	\$69.45
717206	Nutrilife Heavy Weight 20 Liter	\$125.80

Nutrilife™ SR-71 0 - 2 - 1



NEW SR-71 is a scientifically formulated product designed to be used at all stages of a plant's life from propagation through growth phase and right up until flowering. It provides a complete array of organic and inorganic compounds, coenzymes and additives often missing in growing media and other plant foods that help maximize the growth of plants. SR-71 supplies all the things your plants need and don't get with a regular nutrient. SR-71 also promotes the development of beneficial microorganisms in the growing media.

Item No.	Description	MSRP
717226	Nutrilife SR-71 1 Liter	\$15.25
717228	Nutrilife SR-71 4 Liter	\$40.45
717230	Nutrilife SR-71 10 Liter	\$78.75
717232	Nutrilife SR-71 20 Liter	\$136.40

Nutrilife™ Pro-Guard 0 - 0 - 2



NEW Pro-Guard is created to improve a plant's ability to tolerate heat and drought and to provide additional potassium and a high level of silica. Potassium also helps the plant withstand drought by regulating the opening and closing of stomata and accelerates nutrient absorption into plant roots and prevents oxygen deficiency. Pro-Guard is easily the most economical to use when compared to similar type products.

Item No.	Description	MSRP
717208	Nutrilife Pro-Guard 1 Liter	\$11.25
717210	Nutrilife Pro-Guard 4 Liter	\$29.25
717212	Nutrilife Pro-Guard 10 Liter	\$66.45
717214	Nutrilife Pro-Guard 20 Liter	\$109.95

Nutrilife™ PyroCLAY



NEW PyroCLAY provides a highly available source of silicon. It contains 97 natural elements. Improves plant vigor and provides several critical nutrients benefiting the soil by adding many rare minerals and elements. Much research has been done showing the huge benefit to the plants and soil by adding of small amounts of PyroCLAY to soil or soilless mixes.

Item No.	Description	MSRP
717216	Nutrilife PyroCLAY 400 g	\$8.70
717218	Nutrilife PyroCLAY 800 g	\$13.95
717220	Nutrilife PyroCLAY 1.5 kg	\$25.68
717222	Nutrilife PyroCLAY 7.5 kg	\$104.95
717224	Nutrilife PyroCLAY 15 kg	\$188.95



Preferred/Premier nutrient line for the Flo-n-Gro® Riptide Under Current™ System and high performance hydroponic systems.



Cultured Solutions™ UC Roots



NEW Cultured Solutions™ UC Roots is a multi-purpose root zone optimizer that uses proprietary chemistry to aid in mineral descaling and removal of potentially harmful biofilms in nutrient reservoirs. By reducing the potential habitat for plant pathogens, UC Roots encourages a healthy, well balanced nutrient solution, perfect for explosive root growth!

EXCLUSIVE

Item No.	Description	MSRP
733802	Cultured Solutions UC Roots Quart	\$29.95
733804	Cultured Solutions UC Roots Gallon	\$109.95
733806	Cultured Solutions UC Roots 2.5 Gallon	\$249.95
733808	Cultured Solutions UC Roots 5 Gallon	\$424.95
733810	Cultured Solutions UC Roots 15 Gallon	\$1,229.95
733812	Cultured Solutions UC Roots 55 Gallon	\$4,179.95
733814	Cultured Solutions UC Roots 275 Gallon	\$18,999.95

Cultured Solutions™ Veg A 5 - 0 - 0.3 & Veg B 1.3 - 2 - 5.9



NEW Cultured Solutions™ Veg A & B is a full spectrum, mineral based nutrient which contains all the elements necessary to produce lush, vegetative growth. Veg A & B combines all the macro and micro nutrients in their proper proportions, in a pH stable, chelated form which is ideal for high performance water culture applications. Veg A & B provides the optimal Nitrate to Ammoniacal Nitrogen ratio. This ensures healthy growth without promoting brittle stalk and stem formation.

EXCLUSIVE

Item No.	Description	MSRP
733818	Cultured Solutions Veg A Quart	\$19.95
733820	Cultured Solutions Veg A Gallon	\$44.95
733822	Cultured Solutions Veg A 2.5 Gallon	\$99.95
733824	Cultured Solutions Veg A 5 Gallon	\$169.95
733826	Cultured Solutions Veg A 15 Gallon	\$489.95
733828	Cultured Solutions Veg A 55 Gallon	\$1,649.95
733830	Cultured Solutions Veg A 275 Gallon	\$7,199.95
733834	Cultured Solutions Veg B Quart	\$19.95
733836	Cultured Solutions Veg B Gallon	\$44.95
733838	Cultured Solutions Veg B 2.5 Gallon	\$99.95
733840	Cultured Solutions Veg B 5 Gallon	\$169.95
733842	Cultured Solutions Veg B 15 Gallon	\$489.95
733844	Cultured Solutions Veg B 55 Gallon	\$1,649.95
733846	Cultured Solutions Veg B 275 Gallon	\$7,199.95

Cultured Solutions™ Bloom A 3.7 - 0 - 3 & B 0.9 - 4.8 - 6.2



NEW Cultured Solutions™ Bloom A & B is a full spectrum, mineral salt based nutrient which contains all the elements necessary to produce prolific blooms and fruit. Cultured Solutions™ Bloom A & B combines all the macro and micro nutrients in their proper proportions, in a pH stable, chelated form which is ideal for high performance water culture applications. Cultured Solutions™ Bloom A & B provides the optimal Nitrate to Ammoniacal Nitrogen ratio. This ensures healthy growth without promoting excessive vegetative growth, which can hinder and in many cases deter bud set and maturation in flowering plants. **EXCLUSIVE**

Item No.	Description	MSRP
733848	Cultured Solutions Bloom A Quart	\$19.95
733850	Cultured Solutions Bloom A Gallon	\$44.95
733852	Cultured Solutions Bloom A 2.5 Gallon	\$99.95
733854	Cultured Solutions Bloom A 5 Gallon	\$169.95
733856	Cultured Solutions Bloom A 15 Gallon	\$489.95
733858	Cultured Solutions Bloom A 55 Gallon	\$1,649.95
733860	Cultured Solutions Bloom A 275 Gallon	\$7,199.95
733862	Cultured Solutions Bloom B Quart	\$19.95
733864	Cultured Solutions Bloom B Gallon	\$44.95
733866	Cultured Solutions Bloom B 2.5 Gallon	\$99.95
733868	Cultured Solutions Bloom B 5 Gallon	\$169.95
733870	Cultured Solutions Bloom B 15 Gallon	\$489.95
733872	Cultured Solutions Bloom B 55 Gallon	\$1,649.95
733874	Cultured Solutions Bloom B 275 Gallon	\$7,199.95

Cultured Solutions™ Bud Booster Early Bloom 1 - 3.7 - 2.6



NEW Cultured Solutions™ Early Bud Booster is specifically formulated to aid in the development of flowering sites during transition from veg to bloom. This potent bud booster is fortified with added Nitrogen and Magnesium to ensure plants achieve peak performance. Cultured Solutions™ Early Bud Booster is a clean, mineral based bud booster which contains no harmful PGR's commonly found in other bloom enhancers.

EXCLUSIVE

Item No.	Description	MSRP
733876	Cultured Solutions Bud Booster Early Quart	\$24.95
733878	Cultured Solutions Bud Booster Early Gallon	\$79.95
733880	Cultured Solutions Bud Booster Early 2.5 Gallon	\$179.95
733882	Cultured Solutions Bud Booster Early 5 Gallon	\$299.95
733884	Cultured Solutions Bud Booster Early 15 Gallon	\$869.95
733886	Cultured Solutions Bud Booster Early 55 Gallon	\$2,959.95
733888	Cultured Solutions Bud Booster Early 275 Gallon	\$13,349.95

Cultured Solutions™ Bud Booster Mid Bloom 0 - 4.5 - 4.8



NEW Cultured Solutions™ Mid Bud Booster is a high potency fruit and flower stimulator, formulated to trigger and aid in the formation of prolific, fully developed reproductive growth in all flowering plant species. Mid Bud Booster combines high levels of Phosphorus and Potassium in solution to provide your plants with the mineral precursors necessary during early and prime flower production periods.

EXCLUSIVE

Item No.	Description	MSRP
733890	Cultured Solutions Bud Booster Mid Quart	\$24.95
733892	Cultured Solutions Bud Booster Mid Gallon	\$79.95
733894	Cultured Solutions Bud Booster Mid 2.5 Gallon	\$179.95
733896	Cultured Solutions Bud Booster Mid 5 Gallon	\$299.95
733898	Cultured Solutions Bud Booster Mid 15 Gallon	\$869.95
733900	Cultured Solutions Bud Booster Mid 55 Gallon	\$2,959.95
733902	Cultured Solutions Bud Booster Mid 275 Gallon	\$13,349.95

Cultured Solutions™ Bud Booster Late Bloom 1 - 40 - 22



NEW Cultured Solutions™ Late Bud Booster is an exceptionally pure powdered nutrient specifically formulated for the latter stage of bud and bloom production. By providing elevated levels of Phosphorus and Potassium during late maturation, plants are encouraged to reach their full genetic potential and maximize essential oil production. Cultured Solutions™ Late Bud Booster contains no added dyes or preservatives ensuring only the highest quality fruits and flowers.

EXCLUSIVE

Item No.	Description	MSRP
733904	Cultured Solutions Bud Booster Late 1.5 lb	\$29.95
733906	Cultured Solutions Bud Booster Late 7.5 lb	\$119.95
733908	Cultured Solutions Bud Booster Late 15 lb	\$229.95
733910	Cultured Solutions Bud Booster Late 50 lb	\$639.95

MAXSEA

BIOAG

Maxsea® All Purpose Plant Food 16 - 16 - 16



Maxsea® All Purpose Plant Food is designed for year round use on all plants, indoors and outdoors. A regular feeding program will promote vigorous, sturdy plants with distinct, dark, seaweed green foliage, quality blossoms and abundant fruit and vegetables. Not for sale in the following states at this time: FL.

Item No.	Description	MSRP
722250	Maxsea All Purpose Plant Food 1.5 lb (16-16-16)	\$15.79
722255	Maxsea All Purpose Plant Food 6 lb (16-16-16)	\$49.99
722260	Maxsea All Purpose Plant Food 20 lb (16-16-16)	\$149.50

Maxsea® Bloom Plant Food 3 - 20 - 20



Maxsea® Bloom Plant Food is specially formulated to improve flowering, bud set, bud count, blossom quality, quantity and size on all flowering plants, as well as promoting abundant fruit and vegetable yields. Use Maxsea® Bloom when flowering plants are beginning to set buds and continue to use throughout the blooming period. Not for sale in the following states at this time: FL.

Item No.	Description	MSRP
722265	Maxsea Bloom Plant Food 1.5 lb (3-20-20)	\$15.79
722270	Maxsea Bloom Plant Food 6 lb (3-20-20)	\$49.99
722275	Maxsea Bloom Plant Food 20 lb (3-20-20)	\$149.50

Maxsea® Acid Plant Food 14 - 18 - 14



Maxsea® Acid Plant Food is especially formulated for all acid loving plants. Boosted with soil acidifiers and fast acting chelated iron and zinc, this formula will acidify alkaline soils and correct and prevent chlorosis. In addition to a regular feeding program for acid loving plants, this is an excellent formula to give ailing plants a boost. Not for sale in the following states at this time: FL.

Item No.	Description	MSRP
722280	Maxsea Acid Plant Food 1.5 lb (14-18-14)	\$15.79
722285	Maxsea Acid Plant Food 6 lb (14-18-14)	\$49.99
722290	Maxsea Acid Plant Food 20 lb (14-18-14)	\$149.50

BioAg Ful-Power®



Ful-Power® will maximize your potential. It drives nutrients and minerals into the plant and results in healthier plants and tastier produce. Ful-Power® golden humic is purified by a special fermentation style extraction that increases the benefits.



EXCLUSIVE

Item No.	Description	MSRP
719770	BioAg Ful-Power Quart	\$19.95
719775	BioAg Ful-Power Gallon	\$49.95
719777	BioAg Ful-Power 2.5 Gallon	\$109.95
719779	BioAg Ful-Power 5 Gallon	\$179.95
719780	BioAg Ful-Power 55 Gallon	\$1,599.00

BioAg Ful-Humix®



It's all in the name. Ful-Humix® is a cost effective amendment that adds soluble carbon to your soil. Ful-Humix® should be regularly used throughout the plant life cycle, watered into greenhouse or outdoor soils.



EXCLUSIVE

Item No.	Description	MSRP
719740	BioAg Ful-Humix 100 gm	\$7.75
719745	BioAg Ful-Humix 300 gm	\$14.75
719747	BioAg Ful-Humix 1 kg	\$33.75

BioAg TM-7™



TM-7™ contains the seven micronutrients critical for plant success, plus premium concentrated humic powder for increased uptake. Use throughout the season to increase micronutrient uptake. We highly encourage adding it to your compost tea recipe.

EXCLUSIVE

Item No.	Description	MSRP
719750	BioAg TM-7 100 gm	\$10.75
719755	BioAg TM-7 300 gm	\$20.75
719757	BioAg TM-7 1 kg	\$54.25

BioAg CytoPlus™



CytoPlus™ has all the benefits of seaweed and micronutrients, enhanced by BioAg's premium humic concentrate. CytoPlus™ stimulates soil microbial activity and increases plant growth and yield. This is a perfect additive or soil amendment to use during key growth periods.

EXCLUSIVE

Item No.	Description	MSRP
719760	BioAg CytoPlus 100 gm	\$10.95
719765	BioAg CytoPlus 300 gm	\$23.95
719767	BioAg CytoPlus 1 kg	\$69.00

BioAg VAM™



VAM™ dramatically improves the surface area of your plant's root mass. Increases nutrient and water adsorbing capabilities. VAM™ includes 7 specially selected species of endo mycorrhizae with a heavy dose of the very aggressive Glomus intraradices.

EXCLUSIVE

Item No.	Description	MSRP
719730	BioAg VAM 100 gm	\$8.95
719732	BioAg VAM 300 gm	\$17.95
719734	BioAg VAM 1 kg	\$49.95
719736	BioAg VAM 5 lb	\$99.95

Bu's Brew™ Biodynamic® Compost Tea



NEW Bu's Brew™ Biodynamic® Compost Tea bags are ready-to-brew! Each single-use tea bag will make up to 5 gallons of microbially-rich tea ready for use as a foliar feed, transplant shock reducer, root stimulant, soil drench or compost inoculant. Restore your soil's vitality & support your plants' immune systems without synthetic chemicals.

Item No.	Description	MSRP
715978	Bu's Brew Biodynamic Compost Tea 12- 4/Pack	\$11.99

Bu's Buds™ Biodynamic® Compost Rose Tea 1 - 1 - 1



NEW Bu's Buds™ Biodynamic® Compost Rose Tea is ready-to-brew! Each single-use tea bag will make up to 5 gallons of microbially-rich tea ready for use as a foliar feed, transplant shock reducer, root stimulant, soil drench or compost inoculant. Specially formulated to bring out the best in your roses with our proprietary recipe featuring worm castings, kelp and an extra dose of Preparation 504 (stinging nettle).

Item No.	Description	MSRP
715980	Bu's Brew Biodynamic Compost Rose Tea 4/Pack	\$13.99

Bu's Best™ Biodynamic® Compost Tomato Tea 1 - 1 - 1



NEW Bu's Best™ Biodynamic® Compost Tomato Tea is ready-to-brew! Each single-use tea bag will make up to 5 gallons of microbially-rich tea ready for use as a foliar feed, transplant shock reducer, root stimulant, soil drench or compost inoculant. Specially formulated to bring out the best in your tomatoes with our proprietary recipe featuring worm castings, kelp and equisetum.

Item No.	Description	MSRP
715982	Bu's Brew Biodynamic Compost Tomato Tea 4/Pack	\$13.99

Vitamin Institute® Superthrive®

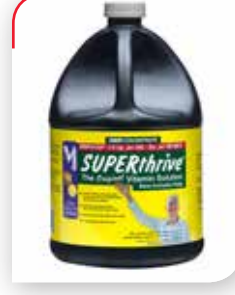

Now includes kelp which enhances SUPERthrive® with nutrition from the sea. SUPERthrive® World Champion activator, reviver, transplanter and grower. SUPERthrive® is a non-toxic vitamin solution. Super Concentrated! 1 Tbsp per 15 Gallons! Not for sale in the following states at this time: ID, MN, OK, PR, SD, WI.

Item No.	Description	MSRP
732810	Superthrive 2 oz	\$7.69
732815	Superthrive 4 oz	\$11.99
732820	Superthrive Pint	\$38.95
732823	Superthrive Quart	\$67.95
732825	Superthrive Gallon	\$192.95



TECHNAFLORA PLANT PRODUCTS LTD

Technaflora® Pura Vida Grow 6 - 4 - 3

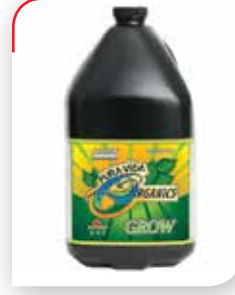

Formulated from various plant materials, Pura Vida Grow contain sufficient organic nitrogen, phosphorous and potassium. Pura Vida Grow specifically targets the vegetative growth phase rapidly creating lush green foliage.

Item No.	Description	MSRP
726717	Pura Vida Grow 1 Liter	\$38.42
726718	Pura Vida Grow 4 Liter	\$76.15
726719	Pura Vida Grow 10 Liter	\$173.93
726720	Pura Vida Grow 20 Liter	\$306.74

Technaflora® Pura Vida Bloom 2 - 6 - 6

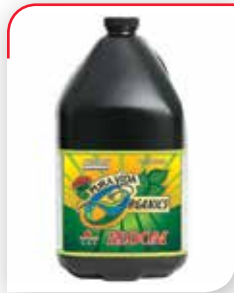

Formulated from various plant materials, Pura Vida Bloom contain sufficient organic nitrogen, phosphorous & potassium. It is formulated to promote and maximize the flowering & fruiting performance of plants during the reproductive stage.

Item No.	Description	MSRP
726722	Pura Vida Bloom 1 Liter	\$38.42
726723	Pura Vida Bloom 4 Liter	\$76.15
726724	Pura Vida Bloom 10 Liter	\$173.98
726725	Pura Vida Bloom 20 Liter	\$306.74

Technaflora® Sugar Daddy



Promotes strong plant structure. During the seedling stage, SugarDaddy rapidly accelerates sprout growth & prepares plants for transplanting. The unique combinations of ingredients in SugarDaddy are vital for all stages of plant growth and development.

Item No.	Description	MSRP
726732	Sugar Daddy 1 Liter	\$32.89
726734	Sugar Daddy 4 Liter	\$100.67
726736	Sugar Daddy 10 Liter	\$225.56
726738	Sugar Daddy 20 Liter	\$423.45

Technaflora® Root 66 1 - 1 - 1



At transplanting, Root 66 improves the establishment of seedlings and cutting by stimulating adventitious root development. Root 66 can be applied to soil, soilless and hydroponic based gardening mediums.

Item No.	Description	MSRP
720691	Root 66 250 ml	\$30.18
720692	Root 66 1 Liter	\$102.62
720693	Root 66 4 Liter	\$377.33
720694	Root 66 10 Liter	\$905.60

Technaflora® MagiCal 2 - 0 - 0



MagiCal is a highly enriched formulated blend of Magnesium, Iron and Calcium that promotes vigorous and healthy plant growth for both soil and soilless gardens. Highly soluble—works in conjunction with any nutrient.

Item No.	Description	MSRP
716453	MagiCal 1 Liter	\$20.82
716455	MagiCal 4 Liter	\$72.89
716456	MagiCal 10 Liter	\$173.56
716457	MagiCal 20 Liter	\$312.43

Technaflora® Thrive Alive B-1™ Green 1 - 1 - 1



Thrive Alive B-1™ is a power packed preventative and restorative general-purpose plant tonic. It stimulates rapid and lush vegetative growth and will ensure the success of floral crops by promoting profuse flowering during blossoming.



Item No.	Description	MSRP
720630	Thrive Alive B-1 Green 250 ml	\$25.38
720635	Thrive Alive B-1 Green 500 ml	\$42.31
720640	Thrive Alive B-1 Green 1 Liter	\$63.48
720645	Thrive Alive B-1 Green 4 Liter	\$195.17

Technaflora® Thrive Alive B-1™ Red 1 - 1 - 1



Thrive Alive B-1™ is a power packed preventative and restorative general-purpose plant tonic. It stimulates rapid and lush vegetative growth and will ensure the success of floral crops by promoting profuse flowering during blossoming.

Item No.	Description	MSRP
720605	Thrive Alive B-1 Red 250 ml	\$23.53
720610	Thrive Alive B-1 Red 500 ml	\$39.96
720615	Thrive Alive B-1 Red 1 Liter	\$57.95
720620	Thrive Alive B-1 Red 4 Liter	\$177.49
720625	Thrive Alive B-1 Red 10 Liter	\$399.78
720626	Thrive Alive B-1 Red 20 Liter	\$740.79

Technaflora® B.C. Boost 3 - 0 - 2



B.C. Hydroponic Nutrients are a power-packed trio for nurturing generous vegetative crops and extraordinary floral growth. Grow & Bloom contain a full complement of micronutrients, which are bolstered by the added calcium and iron in B.C. Boost.

Item No.	Description	MSRP
720540	B.C. Boost 1 Liter	\$27.66
720545	B.C. Boost 4 Liter	\$51.71
720550	B.C. Boost 10 Liter	\$117.56
720555	B.C. Boost 20 Liter	\$206.94

Technaflora® B.C. Bloom 1 - 4 - 7



B.C. Hydroponic Nutrients are a power-packed trio for nurturing generous vegetative crops and extraordinary floral growth. B.C. Bloom contain a full complement of micronutrients, which are bolstered by the added calcium and iron in B.C. Boost.

Item No.	Description	MSRP
720560	B.C. Bloom 1 Liter	\$23.49
720565	B.C. Bloom 4 Liter	\$47.01
720570	B.C. Bloom 10 Liter	\$105.81
720575	B.C. Bloom 20 Liter	\$166.61

Technaflora® B.C. Grow 1 - 3 - 6



B.C. Hydroponic Nutrients are a power-packed trio for nurturing generous vegetative crops and extraordinary floral growth. B.C. Grow contain a full complement of micronutrients, which are bolstered by the added calcium and iron in B.C. Boost.

Item No.	Description	MSRP
720580	B.C. Grow 1 Liter	\$23.49
720585	B.C. Grow 4 Liter	\$47.01
720590	B.C. Grow 10 Liter	\$105.81
720595	B.C. Grow 20 Liter	\$166.61

Technaflora® Awesome Blossoms™ 2 - 11 - 11



Awesome Blossoms™ is a scientifically blended superior flower stimulant designed to nurture prolific and bold blooms in all your flowering plants. Awesome Blossoms™ fosters explosive flower growth, promoting heavier blooms at multiple budding sites.

Item No.	Description	MSRP
720655	Awesome Blossoms 500 ml	\$24.00
720660	Awesome Blossoms 1 Liter	\$47.01
720665	Awesome Blossoms 4 Liter	\$141.09
720670	Awesome Blossoms 10 Liter	\$305.69

Technaflora® Recipe For Success Hit™



This kit consists of B.C. Bloom, B.C. Boost, B.C. Grow, Thrive Alive B-1™ Red, Thrive Alive B-1™ Green, Awesome Blossoms™, Rootech Cloning Gel, MagiCal, SugarDaddy, Root 66 and the famous Recipe for Success™ mixing chart.

Item No.	Description	MSRP
726740	Recipe For Success Starter Kit	\$47.95

Technaflora® Soluble Seaweed Extract 1 - 1 - 16



Soluble Seaweed Extract is a concentrated, comprehensive gardener's tool in powder form. The concentrate is made from 100% pure, organic kelp. It enhanced seed germination, promotion of a healthy root system and rapid stem and shoot development.



Item No.	Description	MSRP
720680	Soluble Seaweed Extract 225 gm	\$28.21

Technaflora® B. Seaweed 0 - 0 - 1

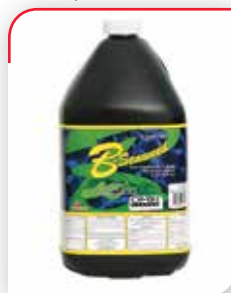

B. Seaweed is an optimal growth stimulant for all your plants. Technaflora's exceptional liquid extract is made from 100% pure, organic British Columbia kelp. B. Seaweed is ultra-concentrated and must be diluted with water.



Item No.	Description	MSRP
720685	B. Seaweed 1 Liter	\$60.95



Gold Label Hydro [A] 3 - 0 - 1 & [B] 1 - 2 - 5



NEW Gold Label Hydro is a professional grade mineral two component base plant nutrient for the vegetative and flowering phase on hydro substrates such as expanded clay pebbles (Gold Label RHP Hydrocorn #713750 & 713752) and rockwool. Add A & B in equal quantities, 0.5-3 ml/liter or until the desired EC. The chelated micro elements guarantee optimum availability in a wide pH range. Never combine pure nutrients together, always mix in water. Shake bottles before use, store at room temperature. Optimized for Gold Label single and mixed Hydro substrates.

Item No.	Description	MSRP
733604	Gold Label Hydro A 1 Liter	\$21.95
733606	Gold Label Hydro A 4 Liter	\$73.95
733608	Gold Label Hydro A 10 Liter	\$136.95
733610	Gold Label Hydro A 20 Liter	\$273.95
733616	Gold Label Hydro B 1 Liter	\$21.95
733618	Gold Label Hydro B 4 Liter	\$66.95
733620	Gold Label Hydro B 10 Liter	\$136.95
733622	Gold Label Hydro B 20 Liter	\$273.95

Gold Label Soil [A] 3 - 0 - 1 & [B] 1 - 2 - 5



NEW Gold Label Soil A & B is a professional grade mineral two component base plant nutrient for the vegetative and flowering phase on peat and compost substrates. Add Soil A & B in equal quantities, 0.5-3 ml/liter or until the desired EC. Never combine pure nutrients together, always mix in water. Shake bottles before use, store at room temperature. Optimized for Gold Label Special Mix.

Item No.	Description	MSRP
733628	Gold Label Soil A 1 Liter	\$21.95
733630	Gold Label Soil A 4 Liter	\$66.95
733632	Gold Label Soil A 10 Liter	\$136.95
733634	Gold Label Soil A 20 Liter	\$273.95
733640	Gold Label Soil B 1 Liter	\$21.95
733642	Gold Label Soil B 4 Liter	\$66.95
733644	Gold Label Soil B 10 Liter	\$136.95
733646	Gold Label Soil B 20 Liter	\$273.95

Gold Label Coco [A] 3 - 0 - 1 & [B] 1 - 2 - 5



NEW Gold Label Coco is a professional grade mineral two component base plant nutrient for the vegetative and flowering phase on coco substrates. Add A & B in equal quantities, 0.5-3 ml/liter or until the desired EC. The chelated micro elements guarantee optimum availability in a wide pH range. Never combine pure nutrients together, always mix in water. Shake bottles before use, store at room temperature. Optimized for Gold Label Coco substrate #713755.

Item No.	Description	MSRP
733676	Gold Label Coco A 1 Liter	\$21.95
733678	Gold Label Coco A 4 Liter	\$66.95
733680	Gold Label Coco A 10 Liter	\$136.95
733682	Gold Label Coco A 20 Liter	\$273.95
733688	Gold Label Coco B 1 Liter	\$21.95
733690	Gold Label Coco B 4 Liter	\$66.95
733692	Gold Label Coco B 10 Liter	\$136.95
733694	Gold Label Coco B 20 Liter	\$273.95

Gold Label Roots 0 - 0.5 - 1



NEW Gold Label Roots is a highly concentrated root and growth stimulator with biological extracts of kelp, humic acids and high quality amino acids. We incorporate EDDHMA chelated Fe which is the most stable Fe available on the market. Use Gold Label Roots for seedlings and cuttings through the vegetative phase of growth. Add 0.5 ml/liter continuously from first watering to 3rd week of flowering. Shake bottles before use, store at room temperature or in the refrigerator.

Item No.	Description	MSRP
733696	Gold Label Root 250 ml	\$74.95
733698	Gold Label Root 500 ml	\$112.95
733700	Gold Label Root 1 Liter	\$202.95
733702	Gold Label Root 4 Liter	\$534.95
733704	Gold Label Root 10 Liter	\$1,091.95
733706	Gold Label Root 20 Liter	\$2,182.95

Gold Label Ultra MG 4 - 0 - 0



NEW Gold Label Ultra MG is a nitrogen/magnesium additive for all plant development stages. Ultra MG has been specifically developed to perfectly balance your NPK and micro elements in all stages of vegetative and generative development. It contains high quality magnesium chelate which is easily absorbed by your crop in a wide pH range. Use continuously on inert media and as a replenishment on peat and compost media.

Item No.	Description	MSRP
733652	Gold Label Ultra Mg 1 Liter	\$42.95
733654	Gold Label Ultra Mg 4 Liter	\$111.95
733656	Gold Label Ultra Mg 10 Liter	\$228.95
733658	Gold Label Ultra Mg 20 Liter	\$456.95

Gold Label Ultra Pk 0 - 10 - 11



NEW Gold Label Ultra Pk is a flowering additive based on advanced polyphosphates and chelated trace elements. Ultra Pk has been specifically developed to perfectly balance your NPK and micro elements in all stages of vegetative and generative development. The Ultra Pk formula prevents phosphorus from depositing at pH levels >6.2, promotes availability of Ca, Mg and trace elements and keeps your drip lines clean. Use in combination with all Gold Label Base Nutrients, 0.5 ml–1 ml/liter. Never combine pure nutrients together; always mix in water. Shake bottles before use. Store at room temperature.

Item No.	Description	MSRP
733664	Gold Label Ultra Pk 1 Liter	\$55.95
733666	Gold Label Ultra Pk 4 Liter	\$145.95
733668	Gold Label Ultra Pk 10 Liter	\$297.95
733670	Gold Label Ultra Pk 20 Liter	\$595.95

Gold Label Goldzyme



NEW Gold Label Goldzyme is a professional highly concentrated enzyme additive based on natural enzymes. Enzymes are natural process catalysts. Gold Label Goldzyme contains enzymes that break down dead root material into nutrients that will benefit your plants and make room for new root development. You can regard them as the cleaners and recyclers of your medium. Use Goldzyme once a week starting week 3 of flowering or at least once in week 3 of flowering and once before flushing. Add 0.5 ml/liter once or 0.1 ml/liter continuously.

Item No.	Description	MSRP
733708	Gold Label Goldzyme 250 ml	\$52.95
733710	Gold Label Goldzyme 500 ml	\$62.95
733712	Gold Label Goldzyme 1 Liter	\$118.95
733714	Gold Label Goldzyme 4 Liter	\$314.95
733716	Gold Label Goldzyme 10 Liter	\$640.95
733718	Gold Label Goldzyme 20 Liter	\$1,281.95

Gold Label Ultra pH-



NEW Gold Label Ultra pH- is a universal acid for adjusting the pH levels of nutrient solutions. It contains a balanced mix of phosphoric acid, nitric acid and sulphuric acid. Add last to your nutrients solution, reduce pH carefully in small steps and stir well before measuring. Use Ultra pH- in the vegetative and flowering period.

Item No.	Description	MSRP
733724	Gold Label Ultra pH 1 Liter	\$25.95
733726	Gold Label Ultra pH 4 Liter	\$76.95

BIOBIZZ®

BioBizz® Alg-A-Mic™ 0.1 - 0 - 0.2



NEW Alg-A-Mic™ is a revitalizing product made from a high grade, organic seaweed concentrate extracted through cold pressing rather than chemical solvents. It contains a high level of natural nutrition that caters to the whole spectrum of plants needs, resulting in exuberant green foliage.

Item No.	Description	MSRP
722925	BioBizz Alg-a-Mic 500 ml	\$25.95
722927	BioBizz Alg-a-Mic 1 Liter	\$38.95
722929	BioBizz Alg-a-Mic 5 Liter	\$168.95
722931	BioBizz Alg-a-Mic 10 Liter	\$276.95

BioBizz® Bio-Bloom™ 1 - 2 - 2



NEW Bio-Bloom™ is a complete liquid organic fertilizer, which contains the perfect blend of nitrogen, phosphorous and potassium to ensure a platform for exuberant flowers and tasty fruits. Bio-Bloom™ also works in harmony with the soil to promote fruit and flower growth.

Item No.	Description	MSRP
722933	BioBizz Bio-Bloom 500 ml	\$12.95
722935	BioBizz Bio-Bloom 1 Liter	\$22.95
722937	BioBizz Bio-Bloom 5 Liter	\$81.95
722939	BioBizz Bio-Bloom 10 Liter	\$149.95

BioBizz® Bio-Grow® 3 - 0 - 8



NEW Bio-Grow® is a liquid fertilizer that can be applied to most types of soil and substrate mixtures. Bio-Grow® is made from 100% Dutch organic sugar beet extract, commonly known as beet vinasse. Beet vinasse is a by-product of turning sugar beets or sugar cane into sugar. In a natural fermentation process, starches in the sugar are treated with enzymes to produce glucose.

Item No.	Description	MSRP
722941	BioBizz Bio-Grow 500 ml	\$12.95
722943	BioBizz Bio-Grow 1 Liter	\$22.95
722945	BioBizz Bio-Grow 5 Liter	\$79.95
722947	BioBizz Bio-Grow 10 Liter	\$149.95

BioBizz® Bio-Heaven™ 1 - 0.1 - 0.1



NEW Bio-Heaven™ is specially formulated plant energy booster, which contains hydrolyzed proteins. Hydrolyzed proteins are the basic building blocks for proteins and enzymes, which are essential for the plants' structure and metabolism. As a result, Bio-Heaven™ enhances the utilization and translocation of nutrients in fertilizer blends & foliar sprays and boosts the anti-oxidant system of the plant.

Item No.	Description	MSRP
722949	BioBizz Bio-Heaven 500 ml	\$53.95
722951	BioBizz Bio-Heaven 1 Liter	\$96.95
722953	BioBizz Bio-Heaven 5 Liter	\$346.95
722955	BioBizz Bio-Heaven 10 Liter	\$606.95

BioBizz® Fish-Mix™ 4 - 0 - 3



NEW Fish-Mix™ has long been a loyal friend to gardeners, feeding their plants and the soil. The mixture of Dutch sugar beet vinasse and hydrolyzed (enzyme-digested) fish protein provides nutrition for plant growth. A Fish-Mix™ boost provides nutrition to stimulate the growth of microorganisms and useful bacteria in every type of soil and coco based substrates.

Item No.	Description	MSRP
722957	BioBizz Fish-Mix 500 ml	\$13.95
722959	BioBizz Fish-Mix 1 Liter	\$23.95
722961	BioBizz Fish-Mix 5 Liter	\$85.95
722963	BioBizz Fish-Mix 10 Liter	\$163.95

BioBizz® Root-Juice™ 0.1 - 0.1 - 0.1



NEW Root-Juice™ combines two amazing natural products, premium humic acid and seaweed. It is specially formulated to help promote vigorous root development and stimulate the biological life that surrounds and supports your plant's root system. Root-Juice™ is made entirely from vegetable ingredients and is designed for organic gardening.

Item No.	Description	MSRP
722965	BioBizz Root-Juice 500 ml	\$34.95
722967	BioBizz Root-Juice 1 Liter	\$59.95
722969	BioBizz Root-Juice 5 Liter	\$264.95
722971	BioBizz Root-Juice 10 Liter	\$473.95

BioBizz® Top-Max™ 0.2 - 0 - 0.1



NEW Top-Max™ is a 100% organic flowering enhancer. Using Top-Max™ can help your garden with three important tasks. First, the nutrients in Top-Max™ can help increase the actual size and weight of clusters of flowers. Second, plants grown with Top-Max™ have a sweet, smooth taste in the finished products. Third, using Top-Max™ can help increase your plants uptake of nutrients.

Item No.	Description	MSRP
722975	BioBizz Top-Max 500 ml	\$28.95
722977	BioBizz Top-Max 1 Liter	\$53.95
722979	BioBizz Top-Max 5 Liter	\$184.95
722981	BioBizz Top-Max 10 Liter	\$321.95

BioBizz® Starters-Pack™



NEW If you don't know where to start, then let Biobizz® make it easy for you! Our Starters-Pack™ is fully loaded with everything you need to initiate your own growing adventure, which will make you and your plants grow together. You don't need to be an expert: just follow our nutrient program and check it out yourself. Contains 1000 ml Bio-Bloom™, 1000 ml Bio-Grow®, 500 ml Top-Max™, 250 ml Bio-Heaven™, 250 ml Root-Juice™, literature, magnet, pen and measuring cup.

Item No.	Description	MSRP
722973	BioBizz Starters-Pack	\$93.95

BioBizz® Try-pack™ Indoor-Pack



NEW If indoor cultivation is your choice and you don't know how to start, let Biobizz® make it easy for you. Try our Indoor-Pack. Get to grow like a pro with a high quality complete pack. The Indoor-Pack contains 250 ml of each Bio-Bloom™, Bio-Grow® and Top-Max™. A combination that will allow the grower to gain experience with the Biobizz® fertilizers range as it provides basic feeding for 1-4 plants.

Item No.	Description	MSRP
722983	BioBizz Try-pack Indoor-Pack	\$23.95

BioBizz® Try-pack™ Outdoor-Pack



NEW If the climate in your region allows it and outdoor cultivation is your choice but you don't know how to start, let Biobizz® make it easy for you. Try our Outdoor-Pack. The Outdoor-Pack contains 250 ml of each Bio-Bloom™, Fish-Mix™ and Top-Max™. A combination that will allow the outdoor grower to gain experience with the Biobizz® fertilizers range as it provides basic feeding for 1-4 plants.

Item No.	Description	MSRP
722985	BioBizz Try-pack Outdoor-Pack	\$23.95

BioBizz® Try-pack™ Stimulant-Pack



NEW Do your plants need a boost? Let Biobizz® make it easy for you! Try our Stimulant-Pack. The Stimulant-Pack contains 250 ml of each Root-Juice™, Top-Max™ and Alg-A-Mic™. A combination that will allow both the hydroponic and the organic grower to gain experience with the Biobizz® stimulant range as it provides basic feeding for 1-4 plants.

Item No.	Description	MSRP
722987	BioBizz Try-pack Stimulant-Pack	\$45.95

BioBizz® Try-pack™ Hydro-Pack



NEW Get to grow like a pro with a high quality complete pack that has been designed to be easy to handle, easy to use and easy to combine. The Hydro-Pack contains 250 ml of each Bio-Bloom™, Bio-Heaven™ and Top-Max™. A combination that will allow the hydroponic grower to gain experience with the Biobizz® products that are suitable to be applied in any hydroponic system. The Hydro-Pack will stimulate an optimal root development and protection by using organics in your hydro system.

Item No.	Description	MSRP
722989	BioBizz Try-pack Hydro-Pack	\$53.95



TAPPIN' ROOTS

Tappin' Roots All Stages Plant Fertilizer 0.01 - 0 - 0.01



NEW Tappin' Roots is a user friendly timeless blend of wild harvested plant extracts infused with modern day horticultural technology. Our All Stages Plant Fertilizer has naturally occurring macro and micro-nutrients that provide for your plants without the harmful side effects of chemical fertilizers. Tappin' Roots can be used at any stage of a plant's development, from cuttings until flush. Use today see results tomorrow! Not for sale in the following states at this time: FL, OR.

Item No.	Description	MSRP
722227	Tappin' Roots Quart - Fertilizer	\$35.00
722229	Tappin' Roots Gallon - Fertilizer	\$96.00
722231	Tappin' Roots 2.5 Gallon - Fertilizer	\$250.00
722233	Tappin' Roots 5 Gallon - Fertilizer	\$424.95
722235	Tappin' Roots 15 Gallon	\$1,300.00

Tappin' Roots All Stages Plant Fertilizer - Oregon Label



NEW Tappin' Roots is a user friendly timeless blend of wild harvested plant extracts infused with modern day horticultural technology. Our All Stages Plant Fertilizer has naturally occurring macro and micro-nutrients that provide for your plants without the harmful side effects of chemical fertilizers. Tappin' Roots can be used at any stage of a plant's development, from cuttings until flush. Use today see results tomorrow! Not for sale in the following states at this time: AK, AL, AR, AZ, CA, CO, CT, DE, FL, GA, HI, IA, ID, IL, KS, KY, LA, MA, MD, ME, MI, MN, MO, MS, MT, NC, ND, NE, NH, NJ, NM, NV, NY, OH, OK, PA, PR, RI, SC, SD, TN, TX, UT, VA, VT, WA, WI, WV, WY.

Item No.	Description	MSRP
722228	Tappin' Roots Quart - Nutrient (OR Label)	\$35.00
722230	Tappin' Roots Gallon - Nutrient (OR Label)	\$96.00
722232	Tappin' Roots 2.5 Gallon - Nutrient (OR Label)	\$250.00
722234	Tappin' Roots 5 Gallon - Nutrient (OR Label)	\$424.95
722236	Tappin' Roots 15 Gallon (OR Label)	\$1,300.00

Tappin' Roots Dynamic Soil Amender 2 - 3 - 2



NEW Tappin' Roots Dynamic Soil Amender is a high potency formula designed to improve the quality of your growing medium and encourage superior plant development. Our formula is specially designed to contain many if not all of the key ingredients that play a vital role in plant functions and the dynamic nature of soil. Dynamic can also be used as a full spectrum plant food throughout a plants life cycle. Not for sale in the following states at this time: FL.

Item No.	Description	MSRP
722237	Tappin' Roots Dynamic 2 lb 8 oz	\$24.99
722239	Tappin' Roots Dynamic 11 lb 5 oz	\$99.95
722241	Tappin' Roots Dynamic 28 lb 5 oz	\$165.95

GROW MORE

Grow More® Mendocino Honey



Natural organic honey plus Montmorillinite, a source of over 70 trace elements. A naturally sweet carbohydrate plus organic carbon to stimulate growth. When used in a hydroponic system, it supplies a valuable source of organic carbon & carbohydrates.

Item No.	Description	MSRP
721627	Grow More Mendocino Honey Quart	\$13.76
721630	Grow More Mendocino Honey Gallon	\$28.87
721632	Grow More Mendocino Honey 2.5 Gallon	\$71.48

Grow More® Hawaiian Bud 5 - 50 - 17



Specially formulated to supply phosphate and potash for late flowering cycle. Fortified with six trace elements plus Humic Acid and Norwegian kelp extract to help produce heavy weight flowers and buds.

Item No.	Description	MSRP
721610	Grow More Hawaiian Bud 1.5 lb	\$13.90
721615	Grow More Hawaiian Bud 25 lb	\$85.03

Grow More® Mendocino Avalanche



Flower hardener specially developed and field tested in the Emerald Triangle of Humboldt, Mendocino and Trinity Counties in Northern California. Helps stimulate flower development in the final bloom stage, for an increase in the size and mass of flowers.

Item No.	Description	MSRP
721620	Grow More Mendocino Avalanche Quart	\$24.45
721625	Grow More Mendocino Avalanche Gallon	\$63.61
721626	Grow More Mendocino Avalanche 2.5 Gallon	\$157.50

Grow More® BioCozyme



A 100% organic biostimulant that enhances a plants ability to absorb and utilize nutrients. Derived from natural occurring cytokinins, hormones, enzymes, vitamins, amino acids and micronutrients. Works by enhancing the plants ability to control the movement of nutrients through the stem and leaves and augments the existing enzyme functions in the plant.

Item No.	Description	MSRP
721746	Grow More BioCozyme Quart	\$13.07
721748	Grow More BioCozyme Gallon	\$31.27

Grow More® Hula Bloom 0 - 50 - 30



Hula Bloom is formulated to help increase flowering quality and development of blooms, while helping to increase yields. Hula Bloom provides super phosphates and minerals that are rapidly absorbed in the flowering and final ripening stages of plant growth for a superior, top quality product.

Item No.	Description	MSRP
721617	Grow More Hula Bloom 1.5 lb	\$15.30
721618	Grow More Hula Bloom 25 lb	\$100.79

Grow More® Seagrow All Purpose 16 - 16 - 16



A hybrid blend of botanical seaweed extract, blood meal, organic carbon, amino acids, carbohydrates, primary N-P-K plant foods, yucca extract and micronutrients. Recommended for indoor or outdoor growing situations.

Item No.	Description	MSRP
721650	Grow More Seagrow All Purpose 1.5 lb	\$10.80
721655	Grow More Seagrow All Purpose 5 lb	\$27.09
721660	Grow More Seagrow All Purpose 25 lb	\$93.84

Grow More® Seagrow Flower & Bloom 4 - 26 - 26



A hybrid blend of botanical seaweed extract, blood meal, organic carbon, amino acids, carbohydrates, primary N-P-K plant foods, yucca extract and micronutrients. Recommended for indoor or outdoor growing situations.

Item No.	Description	MSRP
721665	Grow More Seagrow Flower & Bloom 1.5 lb	\$10.80
721670	Grow More Seagrow Flower & Bloom 5 lb	\$24.11
721675	Grow More Seagrow Flower & Bloom 25 lb	\$93.84

Grow More® Grow 20 - 6 - 16



Formulated to supply sufficient amounts of extra nutrients for high yields. Water Soluble Grow is designed for cool temperature climates, dark weather or spring time, when plants need extra vigor and growth. Not for sale in the following states at this time: OR.

Item No.	Description	MSRP
721705	Grow More Grow (20-6-16) 25 lb	\$63.95

Grow More® General Purpose 20 - 20 - 20



Grow More® Fertilizers are formulated to supply sufficient amounts of extra nutrients for high yields. High solubility, purity and the special forms of nitrogen, phosphorus and potassium make Grow More® Fertilizers the ideal product. General Purpose is an all purpose, balanced, high analysis formula for all field or greenhouse grown ornamental or agricultural crops.

Item No.	Description	MSRP
721729	Grow More General Purpose (20-20-20) 5 lb	\$12.95
721730	Grow More General Purpose (20-20-20) 25 lb	\$52.25

Grow More® Flower Hardener 0 - 50 - 30



Grow More® Fertilizers are formulated to supply sufficient amounts of extra nutrients for high yields. High solubility, purity and the special forms of nitrogen, phosphorus and potassium make Grow More® Fertilizers the ideal product. Hardener is designed for cool temperature climates, dark weather or spring time, when plants need extra vigor and growth.

Item No.	Description	MSRP
721712	Grow More Flower Hardener (0-50-30) 5 lb	\$18.95
721714	Grow More Flower Hardener (0-50-30) 25 lb	\$79.95

Grow More® High Foss 10 - 52 - 10



Grow More® Fertilizers are formulated to supply sufficient amounts of extra nutrients for high yields. High solubility, purity and the special forms of nitrogen, phosphorus and potassium make Grow More® Fertilizers the ideal product. Great for flowers or perennials, it can increase and extend bud set and flowering. Also used for root development of young plants.

Item No.	Description	MSRP
721717	Grow More High Foss (10-52-10) 5 lb	\$15.79
721719	Grow More High Foss (10-52-10) 25 lb	\$65.95

Grow More® Soilless 20 - 10 - 20



High solubility, purity and the special forms of nitrogen, phosphorus and potassium make Grow More® Fertilizers the ideal product. 20-10-20 is fast acting in foliar sprays or liquid fertilizer injector systems, designed for cool temperature climates when plants need extra vigor and growth. Contains 60% nitrate nitrogen, 40% ammoniacal nitrogen.

Item No.	Description	MSRP
721721	Grow More Soilless (20-10-20) 25 lb	\$52.99

Grow More® Foliage Developer 30 - 10 - 10



Grow More® Fertilizers are formulated to supply sufficient amounts of extra nutrients for high yields. High solubility, purity and the special forms of nitrogen, phosphorus and potassium make Grow More® Fertilizers the ideal product. A high nitrogen formula for Spring and early Summer applications, it provides an early nitrogen boost for fast, healthy plant growth.

Item No.	Description	MSRP
721735	Grow More Foliage Developer (30-10-10) 5 lb	\$11.59
721740	Grow More Foliage Developer (30-10-10) 25 lb	\$45.99

Grow More® Mendocino Veg Vigor 30 - 10 - 10



NEW Grow More's Mendocino Producer's Choice line of fertilizers are the most advanced powders we've ever created. They are 100% water soluble formulas containing a properly balanced mixture of all essential plant nutrients with quality-enhancing elements. This Mendocino line provides highly efficient, performance nutrients. A high nitrogen formula for Spring and early Summer applications, it provides an early nitrogen boost for fast, healthy plant growth.

Item No.	Description	MSRP
721573	Grow More Mendocino Veg Vigor (30-10-10) 25 lb	\$55.85

Grow More® Mendocino All Purpose 20 - 20 - 20



NEW Grow More's Mendocino Producer's Choice line of fertilizers are the most advanced powders we've ever created. They are 100% water soluble formulas containing a properly balanced mixture of all essential plant nutrients with quality-enhancing elements. This Mendocino line provides highly efficient, performance nutrients. This is an all purpose, balanced, high analysis formula for all field or greenhouse grown ornamental or agricultural crops.

Item No.	Description	MSRP
721574	Grow More Mendocino All Purpose (20-20-20) 25 lb	\$55.85

Grow More® Mendocino Flower & Bloom 6 - 30 - 30



NEW Grow More's Mendocino Producer's Choice line of fertilizers are the most advanced powders we've ever created. They are 100% water soluble formulas containing a properly balanced mixture of all essential plant nutrients with quality-enhancing elements. This Mendocino line provides highly efficient, performance nutrients. For those special requirement low Nitrogen situations when high amounts of Phosphate and Potassium are needed to firm or size fruits or vegetables.

Item No.	Description	MSRP
721576	Grow More Mendocino Flower & Bloom (6-30-30) 25 lb	\$68.75

Grow More® Mendocino Plant Starter 10 - 52 - 10



NEW Grow More's Mendocino Producer's Choice line of fertilizers are the most advanced powders we've ever created. They are 100% water soluble formulas containing a properly balanced mixture of all essential plant nutrients with quality-enhancing elements. This Mendocino line provides highly efficient, performance nutrients. High Phosphate in the plant usable form ideal for deficiency correction or as a young plant starter. No Chlorides. Recommended for use on vegetables.

Item No.	Description	MSRP
721578	Grow More Mendocino Plant Starter (10-52-10) 25 lb	\$68.75

Grow More® Mendocino Flower Hardener 0 - 37 - 37



NEW Grow More's Mendocino Producer's Choice line of fertilizers are the most advanced powders we've ever created. They are 100% water soluble formulas containing a properly balanced mixture of all essential plant nutrients with quality-enhancing elements. This Mendocino line provides highly efficient, performance nutrients. This high nitrate formula is designed for cool temperature climates, dark weather or spring time, when plants need extra vigor and growth.

Item No.	Description	MSRP
721580	Grow More Mendocino Flower Hardener (0-37-37) 25 lb	\$68.75

Grow More® Mendocino Bloom Blast 5 - 10 - 40



NEW Grow More's Mendocino Producer's Choice line of fertilizers are the most advanced powders we've ever created. They are 100% water soluble formulas containing a properly balanced mixture of all essential plant nutrients with quality-enhancing elements. This Mendocino line provides highly efficient, performance nutrients. Designed for cool temperature climates, dark weather or spring time, when plants need extra vigor and growth.

Item No.	Description	MSRP
721582	Grow More Mendocino Bloom Blast (5-10-40) 25 lb	\$55.85

Grow More® Mendocino Foliage Pro 20 - 6 - 16



NEW Grow More's Mendocino Producer's Choice line of fertilizers are the most advanced powders we've ever created. They are 100% water soluble formulas containing a properly balanced mixture of all essential plant nutrients with quality-enhancing elements. This Mendocino line provides highly efficient, performance nutrients. Designed for cool temperature climates, dark weather or spring time, when plants need extra vigor and growth. Urea free formula.

Item No.	Description	MSRP
721584	Grow More Mendocino Foliage Pro (20-6-16) 25 lb	\$57.00

Grow More® Mendocino Bloom Pro 9 - 21 - 12



NEW Grow More's Mendocino Producer's Choice line of fertilizers are the most advanced powders we've ever created. They are 100% water soluble formulas containing a properly balanced mixture of all essential plant nutrients with quality-enhancing elements. This Mendocino line provides highly efficient, performance nutrients. Mendocino Bloom Pro is complete with secondary and micro nutrients.

Item No.	Description	MSRP
721586	Grow More Mendocino Bloom Pro (9-21-12) 25 lb	\$57.00

Grow More® Mendocino Rock Wool 10 - 7 - 16



NEW Grow More's Mendocino Producer's Choice line of fertilizers are the most advanced powders we've ever created. They are 100% water soluble formulas containing a properly balanced mixture of all essential plant nutrients with quality-enhancing elements. This Mendocino line provides highly efficient, performance nutrients. Made especially to work with Rock Wool.

Item No.	Description	MSRP
721588	Grow More Mendocino Rock Wool (10-7-16) 25 lb	\$57.00

Grow More® Mendocino Hydro 5 - 11 - 26



NEW Grow More's Mendocino Producer's Choice line of fertilizers are the most advanced powders we've ever created. They are 100% water soluble formulas containing a properly balanced mixture of all essential plant nutrients with quality-enhancing elements. This Mendocino line provides highly efficient, performance nutrients. Special soluble non-acidifying sulfur provides increase in chlorophyll formation and availability of potassium. High rainfall or excessive irrigation can cause sulfur deficiencies. Magnesium helps transport phosphate in the plant and is essential in chlorophyll.

Item No.	Description	MSRP
721590	Grow More Mendocino Hydro (5-11-26) 25 lb	\$57.00

Grow More® Dolomite Lime



Helps correct acidic soil environments. A great source of calcium and magnesium. Some people use the term soil sweetener. Not for sale in the following states at this time: OR.

Item No.	Description	MSRP
721845	Grow More Dolomite Lime 4 lb	\$9.29

DYNA-GRO™
The Nutrition Solution®

Dyna-Gro™ Pro-Tekt® 0 - 0 - 3



Pro-Tekt® The Silicon Solution a silicon supplement, supplies higher levels of potassium and silicon to build stronger plant walls. Pro-Tekt® helps increase stem strength and leaf positioning, which improves photosynthesis.

Item No.	Description	MSRP
719025	Dyna-Gro Pro-Tekt Quart	\$18.00
719030	Dyna-Gro Pro-Tekt Gallon	\$44.00
719035	Dyna-Gro Pro-Tekt 5 Gallon	\$220.00

Dyna-Gro™ Liquid Grow™ 7 - 9 - 5



Liquid Grow™ is an all purpose complete nutrition formula used to promote both foliage and blooms. Ideal for poor, rocky soils, container grown plants and hydroponics. Excellent as a rapid cure for nutrient deficiencies.

Item No.	Description	MSRP
719000	Dyna-Gro Liquid Grow Quart	\$21.00
719005	Dyna-Gro Liquid Grow Gallon	\$61.00
719007	Dyna-Gro Liquid Grow 5 Gallon	\$285.00

Dyna-Gro™ Mag-Pro™ 2 - 15 - 4



The high phosphorus, magnesium and sulfur content of this formula bring out color, fragrance and size in flowers, fruit and many vegetable crops. Growers using reverse osmosis, rain or deionized water benefit from the addition of Mag-Pro™ to their watering schedule.

Item No.	Description	MSRP
726549	Dyna-Gro Mag-Pro Quart	\$21.00
726551	Dyna-Gro Mag-Pro Gallon	\$61.00
726553	Dyna-Gro Mag-Pro 5 Gallon	\$285.00

Dyna-Gro™ Liquid Bloom™ 3 - 12 - 6



Liquid Bloom™ is a low nitrogen, high phosphorus complete nutrition formula specifically formulated to encourage the development of large vibrant blooms. It is ideal for roses, orchids, African violets and all other flowering plants.

Item No.	Description	MSRP
719010	Dyna-Gro Liquid Bloom Quart	\$21.00
719015	Dyna-Gro Liquid Bloom Gallon	\$61.00
719017	Dyna-Gro Liquid Bloom 5 Gallon	\$285.00
719019	Dyna-Gro Liquid Bloom 15 Gallon	\$730.00

Dyna-Gro™ Foliage-Pro® 9 - 3 - 6



Foliage-Pro® tropical foliage concentrate has the 3-1-2 NPK ratio recommended for foliage production. The 3-1-2 ratio of NPK results in greater mineral uptake by foliage plants, reducing harmful salt build-up and eliminating deficiencies. Outperforms all other fertilizers in low light environments.

Item No.	Description	MSRP
726548	Dyna-Gro Foliage-Pro Quart	\$21.00
726550	Dyna-Gro Foliage-Pro Gallon	\$61.00
726552	Dyna-Gro Foliage-Pro 5 Gallon	\$285.00



Emerald Triangle Snow Storm Ultra 0 - 0 - 3



The name says it all. With an amino acid profile that is unique in the industry, Snow Storm Ultra consistently produces intense resin, fragrance and flavor plus the well known "frosted" look that growers love. Get the frosted look even on the leaves. No product on the market is more effective. This is not some carbohydrate or sugar water product. This is the real deal from "old school" Humboldt County. What the pros use. Not for sale in the following states at this time: AL, DE, HI, IA, ID, KS, KY, MS, ND, NH, RI, SC, SD, UT, WV, WY.

Item No.	Description	MSRP
719942	Emerald Triangle Snow Storm Ultra 8 oz	\$15.95
719944	Emerald Triangle Snow Storm Ultra Quart	\$43.89
719946	Emerald Triangle Snow Storm Ultra Gallon	\$131.83
719948	Emerald Triangle Snow Storm Ultra 2.5 Gallon	\$263.67

Emerald Triangle Crystal Burst 0 - 15 - 15



One of the most potent liquid PK Boosts on the market. 50% stronger than the most popular brand yet it costs the same! Increases mass and stimulates resinous oil and fragrance production in many culinary and medicinal herbs. Plus a healthy dose of vitamin B1 to help relieve stress caused by high performance bloom regimens. Works well with all nutrient lines. Not for sale in the following states at this time: AL, DE, HI, IA, ID, KS, KY, MS, ND, NH, OK, RI, SC, SD, UT, WV, WY.

Item No.	Description	MSRP
719650	Emerald Triangle Crystal Burst Quart	\$23.10
719655	Emerald Triangle Crystal Burst Gallon	\$69.30
719660	Emerald Triangle Crystal Burst 2.5 Gallon	\$137.50

Emerald Triangle Killer Tea



Not really a "Tea" like other teas because it's Ready-To-Use. This crystal clear yellow product has a long shelf life, no need to aerate and has no disgusting odor. Made from pure worm castings and the most potent seabird and bat guanos. Use at all stages. Particularly effective on clones and rooted cuttings. Makes tea brewing obsolete. Not for sale in the following states at this time: AL, DE, FL, HI, IA, ID, KS, KY, MS, ND, NH, RI, SC, SD, UT, WV, WY.

Item No.	Description	MSRP
739200	Emerald Triangle Killer Tea Gallon	\$35.95
739205	Emerald Triangle Killer Tea 2.5 Gallon	\$71.95

Emerald Triangle Magnum



With Vitamin B1 is a potent magnesium and sulfur supplement for preventing or treating chlorophyll deficiency which causes yellowing leaves in bloom, right when flowers are putting on mass at a rapid rate. Magnum will keep a plant's energy factories optimized and the B1 helps relieve the stress caused by high performance bloom formulations. Magnesium deficiency is one of the most common causes of poor flower development. Not for sale in the following states at this time: AL, DE, HI, IA, ID, KS, KY, MS, ND, NH, OK, RI, SC, SD, UT, WV, WY.

Item No.	Description	MSRP
739210	Emerald Triangle Magnum Quart	\$13.95
739215	Emerald Triangle Magnum Gallon	\$39.95
739220	Emerald Triangle Magnum 2.5 Gallon	\$79.90

Emerald Triangle Purple Maxx 0 - 0 - 3



The name says it all. Purple Maxx is unique in the industry. Get the color you want when it's time to harvest. Don't wait and hope. This amino acid based cocktail intensifies final color in susceptible varieties. Stimulates fragrance, resin and crystal production. Many new varieties respond very strongly and reliably to Purple Maxx. Can be used as a foliar. Not for sale in the following states at this time: AL, DE, HI, IA, ID, KS, KY, MS, ND, NH, RI, SC, SD, UT, WV, WY.

Item No.	Description	MSRP
719905	Emerald Triangle Purple Maxx 8 oz	\$29.95
719910	Emerald Triangle Purple Maxx Quart	\$84.95
719915	Emerald Triangle Purple Maxx Gallon	\$249.95

Emerald Triangle Sonic Bloom 0 - 51 - 34



Sonic Bloom (Sunshine Powder) contains 20 times the vitamin B1 of other popular boosts Plus heavy doses of B2, B3, B6 that put this product in its own class. Increases the size and mass of flowers and stimulates resinous oil and fragrance production in many culinary and medicinal herbs. Use with G10 and Killer Tea to induce the "Gravity Effect". Not for sale in the following states at this time: AL, DE, HI, IA, ID, KS, KY, MS, ND, NH, RI, SC, SD, UT, WV, WY.

Item No.	Description	MSRP
719950	Emerald Triangle Sonic Bloom 1 lb	\$41.95
719955	Emerald Triangle Sonic Bloom 5 lb	\$136.95
719960	Emerald Triangle Sonic Bloom 10 lb	\$249.95

Emerald Triangle Deep Breath



Are you impressed by the immediate and powerful effect of G10 on the size and density of your flowers? Wait till you add Deep Breath to your feeding regimen. Our honey & vitamin based cocktail, "primes the pump" during the vegetative and early bloom stage so plants experience an explosive surge in bulk when G10 is applied beginning the 3rd week of bloom. Deep Breath/G10 combo boosts yields to unheard of levels. Even beginners will see incredible effects in 2 weeks. Not for sale in the following states at this time: DE, FL, GA, HI, IA, ID, KS, KY, MS, ND, NH, PR, RI, SC, SD, UT, VA, WV, WY.

Item No.	Description	MSRP
719673	Emerald Triangle Deep Breath Quart	\$50.00
719675	Emerald Triangle Deep Breath Gallon	\$134.00
719677	Emerald Triangle Deep Breath 2.5 Gallon	\$300.00
719679	Emerald Triangle Deep Breath 5 Gallon	\$533.00

Emerald Triangle G 10 0 - 0 - 0.6



G10 (Gravitation #10) started as a substitute for Gravity but turned into something else. It's not Gravity- it's something MORE! Increases the size and mass of flowers. Seeing is believing! For even more drastic results, prime the pump with Deep Breath in veg and the first 2 weeks of bloom then switch to G10 in the 3rd week for a powerful finish. For maximum "Gravity effect" use with Sonic Bloom and Killer Tea. No PGR's. Not for sale in the following states at this time: AL, DE, FL, HI, IA, ID, KS, KY, MS, ND, NH, RI, SC, SD, UT, VA, WV, WY.

Item No.	Description	MSRP
719665	Emerald Triangle G 10 Quart	\$58.45
719667	Emerald Triangle G 10 Gallon	\$166.00
719669	Emerald Triangle G 10 - 2.5 Gallon	\$375.00
719671	Emerald Triangle G 10 - 5 Gallon	\$667.00



Humboldt Natural Bloom 0 - 10 - 0



Bloom Natural is an ultra-concentrated organic bloom formula designed to give your plants the large phosphorus and calcium boost needed during the flowering period. It induces an immediate flowering response in flowering plants.

Item No.	Description	MSRP
723052	Humboldt Nutrients Natural Bloom Quart	\$26.32
723054	Humboldt Nutrients Natural Bloom Gallon	\$93.60

Humboldt Natural Grow 3 - 1 - 3



Grow Natural is a blend of soy protein powder, soft rock phosphate, potassium sulfate, organic zinc sulfate, magnesium sulfate, kelp & Alaska Peat extracts. The base ingredients will promote & facilitate the growth of beneficial bacteria & fungi.

Item No.	Description	MSRP
723044	Humboldt Nutrients Natural Grow Quart	\$26.32
723046	Humboldt Nutrients Natural Grow Gallon	\$93.60
723050	Humboldt Nutrients Natural Grow 5 Gallon	\$421.20

Humboldt Nutrients Grow 2 - 1 - 6



Grow contains proprietary chelating agents that promote the availability and uptake of nutrients more efficiently than any competing three-part fertilizers.

Item No.	Description	MSRP
723000	Humboldt Nutrients Grow Quart	\$11.70
723002	Humboldt Nutrients Grow Gallon	\$29.84

Humboldt Nutrients Bloom 0 - 6 - 5



Bloom contains a proprietary, trademarked, Phosphorus booster which improves plant photosynthesis, metabolism, genetics and eventually crop quality and yield.

Item No.	Description	MSRP
723016	Humboldt Nutrients Bloom Quart	\$11.70
723018	Humboldt Nutrients Bloom Gallon	\$29.84

Humboldt Nutrients Micro 5 - 0 - 1



Micro contains three separate chelating agents, triple insurance against nutrients falling out of solution or nutrient lock-out. Humboldt Nutrients Micro has all the micronutrients necessary to create healthy plants, strong aromas & large yields.

Item No.	Description	MSRP
723008	Humboldt Nutrients Micro Quart	\$15.80
723010	Humboldt Nutrients Micro Gallon	\$36.28

Humboldt Verde 16 - 1 - 2



It's Spanish for green. Verde creates lush, green colors and vigorous growth. It is a well-balanced growth supplement. This organically derived growth supplement increases root, stem and stalk structure, while boosting chlorophyll levels.

Item No.	Description	MSRP
723156	Humboldt Nutrients Verde Quart	\$22.50
723158	Humboldt Nutrients Verde Gallon	\$80.00
723162	Humboldt Nutrients Verde 5 Gallon	\$360.00

Humboldt Honey Hydro Carbs 0 - 0 - 1



Honey Hydro Carbs is an excellent source of carbohydrates which promotes and facilitates the growth of beneficial bacteria and fungi in your media and dramatically enhances the quality of any plant's fruit.

Item No.	Description	MSRP
723104	Humboldt Nutrients Humboldt Honey Hydro Carbs Quart	\$12.88
723106	Humboldt Nutrients Humboldt Honey Hydro Carbs Gallon	\$43.28

Humboldt Honey Organic ES 0.45 - 0.25 - 1.8



Honey ES is a premium organic blend of cane molasses, yucca, quillaja, saponaria, amino acids, sea-plant extract and bentonite. The ES means Extra Strength. It increases brix levels by providing sugars to beneficial bacteria, fungi & your plants.

Item No.	Description	MSRP
723112	Humboldt Nutrients Humboldt Honey Organics ES Quart	\$23.40
723114	Humboldt Nutrients Humboldt Honey Organics ES Gallon	\$73.72
723116	Humboldt Nutrients Humboldt Honey Organics ES 2.5 Gallon	\$168.48
723118	Humboldt Nutrients Humboldt Honey Organics ES 5 Gallon	\$313.94

Humboldt Deuce Deuce 0 - 0 - 22



Deuce Deuce is derived from sulfate of Potash, Pro-biotic Potassium and Ascophyllum Nodosum. Potassium aids plants in enzymatic function. It will also harden flowers.

Item No.	Description	MSRP
723168	Humboldt Nutrients Deuce Deuce Quart	\$20.00
723170	Humboldt Nutrients Deuce Deuce Gallon	\$70.00
723172	Humboldt Nutrients Deuce Deuce 2.5 Gallon	\$165.00

Humboldt Sticky



Humboldt Sticky is a premier product that will give you phenomenal results. The state of the art binding agents present in Humboldt Sticky create a microscopic bond between your plant's leaves and your nutrient solution.

Item No.	Description	MSRP
724024	Humboldt Nutrients Humboldt Sticky 8 oz	\$11.10
724026	Humboldt Nutrients Humboldt Sticky Pint	\$18.50
724028	Humboldt Nutrients Humboldt Sticky Quart	\$30.00

Humboldt Nutrients Hydro Deuce 0 - 0 - 22



The high quality potassium used in our Deuce Deuce is now formulated in a lower viscosity (thickness) allowing this award winning formula to function without issue in your pumps and reservoirs.

Item No.	Description	MSRP
723234	Humboldt Nutrients Hydro Deuce Quart	\$21.94
723236	Humboldt Nutrients Hydro Deuce Gallon	\$76.28
723240	Humboldt Nutrients Hydro Deuce 5 Gallon	\$344.20

Humboldt Big Up Powder 0 - 33 - 23



Big Up Powder is a premium amino chelated bloom booster. By introducing Big Up powder in the first week of flowering, you effectively flip the switch in your plant, sending it immediately into an intense flowering cycle.

Item No.	Description	MSRP
723150	Humboldt Nutrients Big Up Powder 8 oz	\$30.00
723152	Humboldt Nutrients Big Up Powder 1 lb	\$50.00
723154	Humboldt Nutrients Big Up Powder 5 lb	\$200.00
723155	Humboldt Nutrients Big Up Powder 10 lb	\$380.00

Humboldt Myco Madness Soluble



Myco Madness is a bio-stimulant package that helps link the plant roots, organic matter and fertilizers of all types. Myco Madness helps plants improve nutrient and water uptake.

Item No.	Description	MSRP
723126	Humboldt Nutrients Myco Madness Soluble 4 oz	\$26.00
723128	Humboldt Nutrients Myco Madness Soluble 8 oz	\$50.00
723130	Humboldt Nutrients Myco Madness Soluble 1 lb	\$90.00
723132	Humboldt Nutrients Myco Madness Soluble 5 lb	\$400.00

Humboldt Myco Maximum Granular



Myco Maximum granular contains humic acids, organic fertilizer, 10 species of growth-enhancing mycorrhizal fungi, 19 strains of beneficial bacteria, 2 Trichoderma species, micronutrients, 11 time-released carbohydrates and 20 different amino acids.

Item No.	Description	MSRP
723134	Humboldt Nutrients Myco Maximum Granular 8 oz	\$30.00
723136	Humboldt Nutrients Myco Maximum Granular 1 lb	\$50.00

Humboldt FlavorFul



FlavorFul contains electrolytes that stimulate and relax the plant cells, resulting in the smooth and consistent delivery of vitamins, minerals, nutrients and trace elements in soil and fertilizers.

Item No.	Description	MSRP
723076	Humboldt Nutrients FlavorFul Quart	\$17.56
723078	Humboldt Nutrients FlavorFul Gallon	\$58.50
723080	Humboldt Nutrients FlavorFul 2.5 Gallon	\$134.56

Humboldt Nutrients Master A 4 - 0 - 3



Humboldt Nutrients Master A & B is a premium two-part amino acid-based fertilizer program designed for flowering plants. The amino acids and organic acid complexes makes all the macro and micro nutrients more available.

Item No.	Description	MSRP
723024	Humboldt Nutrients Master A Quart	\$23.40
723026	Humboldt Nutrients Master A Gallon	\$70.20

Humboldt Nutrients Master B 1 - 5 - 6



Humboldt Nutrients Master A & B is a premium two-part amino acid-based fertilizer program designed for flowering plants. The amino acids and organic acid complexes makes all the macro and micro nutrients more available.

Item No.	Description	MSRP
723034	Humboldt Nutrients Master B Quart	\$23.40
723036	Humboldt Nutrients Master B Gallon	\$70.20

Humboldt Mayan MicroZyme



It is an organic & ecologically safe bacterial-enzymatic complex with 24 species of soil microorganisms that increases fertility while providing vital nutrients to plants & crops. It mineralizes nutrients, regulates nitrogen & builds soil organic matter.

Item No.	Description	MSRP
723142	Humboldt Nutrients Mayan MicroZyme 8 oz	\$32.00
723146	Humboldt Nutrients Mayan MicroZyme Quart	\$96.50

Humboldt Prozyme



Prozyme is a concentrate made up of over 80 different beneficial enzymes. These enzymes will break down dead root mass, starches, carbohydrates and nutrients to make them readily available to the plant.

Item No.	Description	MSRP
723096	Humboldt Nutrients Prozyme Quart	\$40.00
723098	Humboldt Nutrients Prozyme Gallon	\$140.00
723100	Humboldt Nutrients Prozyme 2.5 Gallon	\$340.00

Humboldt Hum-Bolt Humic



HUM-BOLT is a 8% Humic Acid which promotes high ion exchange capabilities, stimulates plant enzymes, increases beneficial organisms and acts as an organic catalyst.

Item No.	Description	MSRP
723086	Humboldt Nutrients Hum-Bolt Humic Quart	\$17.56
723088	Humboldt Nutrients Hum-Bolt Humic Gallon	\$58.50
723090	Humboldt Nutrients Hum-Bolt Humic 2.5 Gallon	\$134.56

Humboldt Nutrients Royal Flush



Royal Flush is a salt-eliminating, finishing solution for all plants growing in soil, potting mixes, soil-less rooting media, hydroponics and other gardens. Royal Flush is applied to all of your favorite plants in the final weeks of bloom.

Item No.	Description	MSRP
723214	Humboldt Nutrients Royal Flush Quart	\$14.50
723216	Humboldt Nutrients Royal Flush Gallon	\$32.50

Humboldt Oneness 5 - 9 - 4



Oneness is the most advanced one part nutrient on the market. It is the perfect solution for the beginning gardener looking for experienced results. Oneness is formulated with over 30 different natural chelates.

Item No.	Description	MSRP
723178	Humboldt Nutrients Oneness Quart	\$24.00
723180	Humboldt Nutrients Oneness Gallon	\$85.08
723184	Humboldt Nutrients Oneness 5 Gallon	\$365.00

Humboldt Nutrients Ginormous 0 - 18 - 16



Ginormous is the most advanced super-bloom booster on the market. Your vegetables and fruits will be larger, even gigantic or Ginormous with this additive.

Item No.	Description	MSRP
723186	Humboldt Nutrients Ginormous Quart	\$30.00
723188	Humboldt Nutrients Ginormous Gallon	\$100.00
723190	Humboldt Nutrients Ginormous 2.5 Gallon	\$220.00
723192	Humboldt Nutrients Ginormous 5 Gallon	\$410.00

Humboldt Nutrients Equilibrium 1 - 1 - 2



To reap a large bountiful harvest, your plants must receive the correct ratio of Ca to Mg throughout its life cycle. Equilibrium Natural offers the ease of a one part Ca-Mg additive with the quality which has come to be associated with our products.

Item No.	Description	MSRP
723204	Humboldt Nutrients Equilibrium Natural Quart	\$21.56
723206	Humboldt Nutrients Equilibrium Natural Gallon	\$75.00
723208	Humboldt Nutrients Equilibrium Natural 2.5 Gallon	\$178.12
723210	Humboldt Nutrients Equilibrium Natural 5 Gallon	\$338.44

Humboldt Nutrients White Widow



White Widow is a Mycorrhizal powder containing an extremely high and diverse amount of mycological spores. With White Widow the speed and aggressiveness of your plant's root development is unprecedented.

Item No.	Description	MSRP
723222	Humboldt Nutrients White Widow 1 oz	\$18.11
723224	Humboldt Nutrients White Widow 2 oz	\$31.50
723226	Humboldt Nutrients White Widow 4 oz	\$54.60
723228	Humboldt Nutrients White Widow 8 oz	\$97.50
723230	Humboldt Nutrients White Widow 1 lb	\$185.26

Humboldt Nutrients S.I. (Structural Integrity)



S.I.'s proprietary blend is formulated to instantly supply your root zone with the silicate needed to build strong, thick cell walls and cellular membranes, thus giving your plants the ability to hold heavier fruits and flowers.

Item No.	Description	MSRP
723252	Humboldt Nutrients S.I. Structural Integrity Quart	\$24.00
723254	Humboldt Nutrients S.I. Structural Integrity Gallon	\$85.05

Humboldt Nutrients Liquid Underground 0.01 - 0.1 - 0.02



NEW Humboldt Nutrients Liquid Underground is a worm casting extract produced from the best worm castings in the world. Rich in essential nutrients, organic acids and beneficial organisms, it provides gardeners with a bio-stimulant for soil organisms, as well as facilitating better plant nutrition and uptake.

Item No.	Description	MSRP
723256	Humboldt Nutrients Liquid Underground 1/2 Gallon	\$19.92
723258	Humboldt Nutrients Liquid Underground Gallon	\$39.80
723260	Humboldt Nutrients Liquid Underground 2.5 Gallon	\$92.00
723262	Humboldt Nutrients Liquid Underground 5 Gallon	\$179.02
723264	Humboldt Nutrients Liquid Underground 15 Gallon	\$516.14

Humboldt Nutrients Calyx Magnum 2 - 0 - 0



NEW At Humboldt Nutrients we don't make new products very often, but when we do we take it to another level. We decided to make the best Calcium Magnesium product in the marketplace. With an available 2%(N), 3.4%(Ca) and 1.4%(Mg) + micronutrients, Calyx Magnum gives gardeners vital nutrients needed for plant development and growth. Another huge benefit is that we created Calyx Magnum without the use of chemical chelates like EDTA. Instead of chemical chelates like EDTA, Calyx Magnum utilizes plant based amino acids as a chelating agent. This means that Calyx Magnum is biodegradable.

Item No.	Description	MSRP
722915	Humboldt Nutrients Calyx Magnum Quart	\$19.30
722917	Humboldt Nutrients Calyx Magnum Gallon	\$48.00
722919	Humboldt Nutrients Calyx Magnum 2.5 Gallon	\$115.86
722921	Humboldt Nutrients Calyx Magnum 5 Gallon	\$222.10



Plant Success® Jellyfish® 2 - 2 - 6



Jellyfish® root inoculant binds highly effective beneficials to your transplant roots and keeps them moist and fed in the critical establishment phase. Simply dip your roots into the blend of mycorrhizae, nitrogen fixing and beneficial bacteria, seaweed, humic acids and vitamin B1. Jellyfish® will lessen transplant shock, feed your plant and ensure maximum beneficial establishment. Not for sale in the following states at this time: HI, ID, LA, OK, SD, WI.

Item No.	Description	MSRP
720200	Plant Success Jellyfish 10 gm	\$3.99
720202	Plant Success Jellyfish 2 oz	\$17.99

Plant Success® Mike O'Rizey®



A beneficial soil organism inoculant that contains a diverse blend of mycorrhizal fungi that once established increase the surface area of your root system 100 - 1,000 times. This greatly increases the nutrients and water available to your plant. What results is a larger more robust plant. Not for sale in the following states at this time: CT, HI, ID, IL, LA, MD, MN, NC, NE, OK, SD, WI.



Item No.	Description	MSRP
720204	Plant Success Mike O'Rizey 4 oz	\$6.99
720206	Plant Success Mike O'Rizey 2 lb	\$42.99
720208	Plant Success Mike O'Rizey 5 lb	\$86.99
720210	Plant Success Mike O'Rizey 25 lb	\$390.00

Plant Success® Soluble Mycorrhizae



Plant Success® Soluble is a soil drench for porous soil & contains 13 carefully selected mycorrhizal fungi, 2 trichoderma species & 17 bacterial species well-suited to a variety of soils, climates & plants. Plant enjoys improved nutrient & water uptake. Not for sale in the following states at this time: CT, HI, ID, IL, LA, MN, OK, PR, SD.

Item No.	Description	MSRP
720300	Plant Success Soluble Mycorrhizae 4 oz	\$18.99

Plant Success® Granular Mycorrhizae 3 - 1 - 2

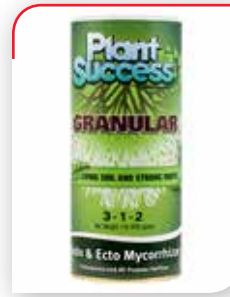

Mycorrhizal granular inoculum consists of 10 carefully selected species of endomycorrhizae, ectomycorrhizae & trichoderma fungal species. Contains kelp meal, humus, vitamins & amino acids is also added to improve mycorrhizal germination & effectiveness. Not for sale in the following states at this time: HI, LA, OK, PR, SD.

Item No.	Description	MSRP
720305	Plant Success Granular Mycorrhizae 1 lb	\$19.99
720307	Plant Success Granular Mycorrhizae 5 lb	\$90.99

Plant Success® Orca® Liquid Mycorrhizae



Orca® is a highly concentrate mycorrhizal & beneficial bacteria product. Bringing together 4 highly effective endo mycorrhizal species with 11 super aggressive bacteria strains, this all-in-one inoculant is all you need when it comes to beneficials. Not for sale in the following states at this time: CT, HI, ID, IL, LA, MN, OK, PR, SD, WI.

Item No.	Description	MSRP
720350	Orca Liquid Mycorrhizae Pint	\$39.99
720355	Orca Liquid Mycorrhizae Quart	\$66.99
720360	Orca Liquid Mycorrhizae Gallon	\$234.99

Plant Success® Great White® Mycorrhizae



Great White® is the most advance mycorrhizal product on the market today. The combination of mycorrhizae, beneficial bacteria, trichoderma and plant vitamins will give your plants a strong and developed root system. Not for sale in the following states at this time: CT, HI, IL, LA, OK, PR, SD.

Item No.	Description	MSRP
720308	Great White Mycorrhizae 1 oz	\$13.99
720310	Great White Mycorrhizae 4 oz	\$39.99
720315	Great White Mycorrhizae 8 oz	\$71.99
720320	Great White Mycorrhizae Quart	\$244.99
720311	Great White Mycorrhizae 5 lb	\$495.99

Premier Tech Pro-Mix® Pur™ Mycorrhizal Inoculant



NEW PRO-MIX® PUR™ is a line of advanced inoculants aiming for professional growers who seek growth enhancement and protection for high-value crops. PRO-MIX® PUR™ inoculants are designed to deliver proven results and are OMRI-Listed for organic growing. Increase yields with cutting-edge technologies offered in PRO-MIX® PUR™.



Item No.	Description	MSRP
713460	Premier Pro-Mix Pur-Mycorrhizal Powder 0.5 lb Dry	\$24.99
713465	Premier Pro-Mix Pur-Mycorrhizal Powder 5.3 lb Dry	\$119.99
713470	Premier Pro-Mix Pur-Mycorrhizal Granular 3.3 lb Dry	\$34.99
713475	Premier Pro-Mix Pur-Mycorrhizal Granular 19 lb Dry	\$189.99



Neptune's Harvest Fish Fertilizer 2 - 4 - 1



Neptune's Harvest is an organic fertilizer made from fresh North Atlantic fish. It is made by a unique cold process that protects the vitamins, amino acids, enzymes and growth hormones. Neptune's Harvest retains the fish proteins and oils and has no unpleasant odor.



Item No.	Description	MSRP
717430	Neptune's Harvest Fish Fertilizer Quart	\$15.69
717435	Neptune's Harvest Fish Fertilizer Gallon	\$35.99

Neptune's Harvest Seaweed Fertilizer 0 - 0 - 1



Neptune's Harvest Seaweed Plant Food is an organic storehouse of over 60 naturally occurring major and minor nutrients and amino acids. It's growth promoting substances enhance plant development, color and vigor.

Item No.	Description	MSRP
717445	Neptune's Harvest Seaweed Fertilizer Quart	\$16.99
717450	Neptune's Harvest Seaweed Fertilizer Gallon	\$40.95

Neptune's Harvest Fish & Seaweed Fertilizer 2 - 3 - 1



Neptune's Harvest Organic Fish/Seaweed Blend Fertilizer gives you the best of both products with a perfect blend of fish hydrolysate and seaweed, ensuring a complete fertilization program. Growers using our fertilizer regularly have reported increased marketable yields.



Item No.	Description	MSRP
717460	Neptune's Harvest Fish & Seaweed Fertilizer Quart	\$19.95
717465	Neptune's Harvest Fish & Seaweed Fertilizer Gallon	\$46.95

Neptune's Harvest Kelp Meal 1 - 0 - 2



Neptune's Harvest Organic Kelp Meal is *Ascophyllum Nodosum*, which is widely recognized as one of the finest marine plants available. It is suitable for all crops and applications. Kelp Meal contains minerals, carbohydrates and amino acids.

Item No.	Description	MSRP
717475	Neptune's Harvest Kelp Meal 4 lb Bag	\$17.59
717480	Neptune's Harvest Kelp Meal 12 lb Pail	\$54.95
717485	Neptune's Harvest Kelp Meal 50 lb Bag	\$104.95

Neptune's Harvest Crab Shell 2 - 3 - 0



Neptune's Harvest Organic Crab Shell is an excellent dry organic source of NPK, Calcium and Magnesium. It will also help with nematode and fungus problems.

Item No.	Description	MSRP
717490	Neptune's Harvest Crab Shell 4 lb Bag	\$11.95
717495	Neptune's Harvest Crab Shell 50 lb Bag	\$73.95



Sunlight Supply is continually searching for the best new gardening products. Go to the new product section to see the latest products that come in. Updated daily so check in often!



Multiply



Multiply is designed to assist all nutrient regimens and feeding programs. Multiply works in conjunction with nutrient regimens and feeding programs during the vegetative stage to promote vigorous growth. Want more? Multiply then Stack. Want the best? Finish with Sparkle.

Item No.	Description	MSRP
717805	Multiply 8 oz	\$58.95
717810	Multiply Pint	\$98.95
717815	Multiply Quart	\$148.95

Stack



Stack is designed to assist all nutrient regimens and feeding programs. Stack works in conjunction with nutrient regimens and feeding programs, promoting vigorous flowering and fruit development. Want more? Multiply then Stack. Want the best? Finish with Sparkle.

Item No.	Description	MSRP
717825	Stack 8 oz	\$58.95
717830	Stack Pint	\$98.95
717832	Stack Quart	\$148.95

Sparkle



Sparkle is designed to assist all nutrient regimens and feeding programs. Sparkle works in conjunction with nutrient regimens and feeding programs during the latter stages of flowering and fruit development. Want more? Multiply then Stack. Want the best? Finish with Sparkle.

Item No.	Description	MSRP
717840	Sparkle 8 oz	\$38.95
717845	Sparkle Pint	\$68.95
717850	Sparkle Quart	\$98.95

RAW Microbes Grow Stage



NEW Grow Stage Microbes are a specific group of beneficial bacteria and fungi formulated specially for the grow/vegetative stage of plants. This variety of Microbes is designed to promote root growth and nutrient availability during the grow stage. Inoculate seedlings and established vegetative plants with the highest CFU's on the market! All RAW Microbes are double tested, both the individual culture/species as well as the final blend.

Item No.	Description	MSRP
717970	RAW Microbes Grow Stage 2 oz	\$12.95
717972	RAW Microbes Grow Stage 8 oz	\$29.95
717974	RAW Microbes Grow Stage 2 lb	\$98.95
717976	RAW Microbes Grow Stage 10 lb	\$420.00

RAW Microbes Bloom Stage



NEW Bloom Stage Microbes are a specific group of beneficial bacteria and fungi formulated specially for the flower/bloom stage of plants. This variety of Microbes is designed to promote nutrient availability and plant protection during the bloom stage. Inoculate flowering and fruiting plants with the highest CFU's on the market! All RAW Microbes are double tested, both the individual culture/species as well as the final blend.

Item No.	Description	MSRP
717978	RAW Microbes Bloom Stage 2 oz	\$12.95
717980	RAW Microbes Bloom Stage 8 oz	\$29.95
717982	RAW Microbes Bloom Stage 2 lb	\$98.95
717984	RAW Microbes Bloom Stage 10 lb	\$420.00

RAW Grow All-In-One 7 - 4 - 5

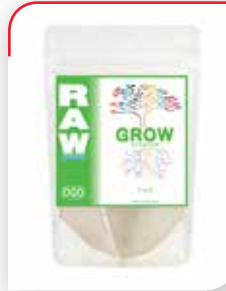

RAW Grow is a tested blend of RAW soluble plant nutrients, essential elements and supplements that has been proven to be an optimal all in one horticultural fertilizer. Add 1-2 teaspoon per gallon of water. Apply as needed. RAW Grow is used through out the entire vegetative stage.

Item No.	Description	MSRP
717930	Raw Grow 2 oz	\$14.85
717932	Raw Grow 8 oz	\$29.85
717934	Raw Grow 2 lb	\$89.85
717936	Raw Grow 10 lb	\$248.85

RAW Bloom All-In-One 3 - 12 - 12



RAW Bloom is a tested blend of RAW soluble plant nutrients, essential elements and supplements that has been proven to be an optimal all in one horticultural fertilizer. Add 1-2 teaspoon per gallon of water. Apply as needed. RAW Bloom is used through out the entire flowering stage.

Item No.	Description	MSRP
717938	Raw Bloom 2 oz	\$14.85
717940	Raw Bloom 8 oz	\$29.85
717942	Raw Bloom 2 lb	\$89.85
717944	Raw Bloom 10 lb	\$248.85

RAW B-Vitamin



RAW B-Vitamin is a soluble plant supplement that is used for horticultural purposes. RAW B-Vitamin contains 1% vitamin B1. This product contains the highest concentration of fully water soluble vitamin B1 available to the home gardener. RAW B-Vitamin can be used at all stages of growth and flowering.

Item No.	Description	MSRP
717855	RAW B-Vitamin 2 oz	\$16.85
717857	RAW B-Vitamin 8 oz	\$44.85
717859	RAW B-Vitamin 2 lb	\$124.85

RAW Calcium/Mag 9 - 0 - 0



RAW Calcium/Mag is a soluble plant supplement that is used for horticultural purposes. RAW Calcium/Mag contains 15% calcium and 3% magnesium. RAW Calcium/Mag is an optimum ratio of fully water soluble calcium and magnesium.

Item No.	Description	MSRP
717861	RAW Calcium/Mag 2 oz	\$12.85
717863	RAW Calcium/Mag 8 oz	\$34.85
717865	RAW Calcium/Mag 2 lb	\$88.85

RAW Yucca



RAW Yucca is a wetting agent used for horticultural purposes. RAW Yucca is 100% Yucca Extract. This product is fully water soluble and can be used to supplement any nutrient program or foliar spray regimen. A wetting agent is beneficial to nutrient solutions as well as foliar spray applications and can be used at all stages of growth and flowering.

Item No.	Description	MSRP
717921	RAW Yucca 2 oz	\$28.85
717923	RAW Yucca 8 oz	\$88.85

RAW Cane Molasses 0 - 0 - 1



RAW Cane Molasses is a soluble plant supplement that is used for horticultural purposes. RAW Cane Molasses is a fully water soluble powder which is highly concentrated. RAW Cane Molasses gives you all the benefits of liquid molasses without all the mess.

Item No.	Description	MSRP
717867	RAW Cane Molasses 2 oz	\$12.85
717869	RAW Cane Molasses 8 oz	\$34.85
717871	RAW Cane Molasses 2 lb	\$88.85

RAW Full Up



RAW Full Up (uptake) is a soluble plant supplement that is used for horticultural purposes. RAW Full Up (uptake) contains 10% Humic Acids derived from peat. This product is fully water soluble and may increase micronutrient uptake.

Item No.	Description	MSRP
717873	RAW Full Up 2 oz	\$18.85
717875	RAW Full Up 8 oz	\$48.85
717877	RAW Full Up 2 lb	\$138.85

RAW Humic Acid 0 - 0 - 4



RAW Humic Acid is a soluble plant supplement that is used for horticultural purposes. RAW Humic Acid contains 59% Humic Acids. This product contains the highest concentration of fully water soluble Humic Acids available to the home gardener. RAW Humic Acid can be used at all stages of growth and flowering.

Item No.	Description	MSRP
717879	RAW Humic Acid 2 oz	\$14.85
717881	RAW Humic Acid 8 oz	\$38.85
717883	RAW Humic Acid 2 lb	\$108.85

RAW Kelp 0 - 0 - 1



RAW Kelp is 99% Kelp extract from seaweed (Ascophyllum Nodosum). This product is water Soluble and contains only 1% soluble potash which is a direct reflection of its purity. Kelp extracts are also very rich in natural plant growth hormones. RAW Kelp is a beneficial supplement to all feeding schedules.

Item No.	Description	MSRP
717885	RAW Kelp 2 oz	\$16.85
717887	RAW Kelp 8 oz	\$44.85
717889	RAW Kelp 2 lb	\$124.85

RAW Nitrogen 20 - 0 - 0



RAW Nitrogen is a soluble plant supplement that is used for horticultural purposes. RAW Nitrogen contains 20% Nitrogen. This RAW form of fully water soluble Nitrogen does not contain nitrates or urea which enables it to be applied at all stages to treat deficiencies or boost Nitrogen levels.

Item No.	Description	MSRP
717891	RAW Nitrogen 2 oz	\$9.85
717893	RAW Nitrogen 8 oz	\$28.85
717895	RAW Nitrogen 2 lb	\$78.85

RAW OminA 14 - 0 - 0



RAW ominA (essential) is a soluble plant supplement that is used for horticultural purposes. RAW ominA (essential) is derived from plant protein Hydrolysate. This product is fully water soluble which contains an essential form of vegan nitrogen that can be used at all stages.

Item No.	Description	MSRP
717897	RAW OminA 2 oz	\$18.85
717899	RAW OminA 8 oz	\$48.85
717901	RAW OminA 2 lb	\$138.85

RAW Phosphorus 9 - 61 - 0



RAW Phosphorus is a soluble plant supplement that is used for horticultural purposes. RAW Phosphorus contains 61% available Phosphate which is the highest concentration of fully water soluble Phosphorus available to the home gardener. This product is used to treat deficiencies or boost Phosphorus levels.

Item No.	Description	MSRP
717903	RAW Phosphorus 2 oz	\$9.85
717905	RAW Phosphorus 8 oz	\$28.85
717907	RAW Phosphorus 2 lb	\$78.85

RAW Adjustable Measuring Spoon



Small compact measuring spoon made for use with the RAW product line. Measurements of 1/4 tsp., 1/2 tsp., 3/4 tsp. and 1 tsp.

Item No.	Description	MSRP
717925	RAW Adjustable Measuring Spoon	\$3.99

RAW Potassium 0 - 0 - 50



RAW Potassium is a soluble plant supplement that is used for horticultural purposes. RAW Potassium contains 50% soluble Potash which is the highest concentration of fully water soluble Potassium available to the home gardener. This product is used to treat deficiencies or boost Potassium levels.

Item No.	Description	MSRP
717909	RAW Potassium 2 oz	\$9.85
717911	RAW Potassium 8 oz	\$28.85
717913	RAW Potassium 2 lb	\$78.85

RAW Silica 0 - 0 - 3



RAW Silica is a flowable plant supplement that is used for horticultural purposes. RAW Silica contains 45% Silicon Dioxide. This product has the highest concentration of natural Silicon Dioxide available to the home gardener. Unlike other Silica products RAW Silica is relatively pH neutral.

Item No.	Description	MSRP
717915	RAW Silica 2 oz	\$14.85
717917	RAW Silica 8 oz	\$38.85
717919	RAW Silica 2 lb	\$108.85

Nature's Nectar™

Nature's Nectar™ Nitrogen 5 - 0 - 0



Completely solubilized, instantly available source of nitrogen with no sediment. Provides nutrition for beneficial bacteria improving conditions of growing medium. Increases photosynthesis for a greener plant.



Item No.	Description	MSRP
719870	Nature's Nectar Nitrogen Quart	\$18.95
719875	Nature's Nectar Nitrogen Gallon	\$49.99
719878	Nature's Nectar Nitrogen 55 Gallon	\$1,999.95

Nature's Nectar™ Phosphorus 0 - 4 - 0



Completely solubilized phosphorus source that also contains Calcium. Organic acid ensures phosphorus is easily absorbed. Adds size and weight to fruit and flowers. Aids in root development.



Item No.	Description	MSRP
719880	Nature's Nectar Phosphorous Quart	\$17.99
719885	Nature's Nectar Phosphorous Gallon	\$49.99
719888	Nature's Nectar Phosphorous 55 Gallon	\$1,999.95

Nature's Nectar™ Potassium 0 - 0 - 5



Fast release potassium completely solubilized. The potassium source also contains cytokinins to increase number of flower sites. Builds plant's immune system with a combination of sea kelp species.



Item No.	Description	MSRP
719890	Nature's Nectar Potassium Quart	\$17.99
719895	Nature's Nectar Potassium Gallon	\$49.99
719898	Nature's Nectar Potassium 55 Gallon	\$1,999.95

Organa-Add 2 - 0 - 0



Organa-Add functions as a growth and bloom catalyst containing all necessary organic activators. Adding the product to your regimen will increase the production of essential oils improving overall quality while maximizing your yield. Organa-Add is super concentrated at 1 teaspoon for 5 gallons.



Item No.	Description	MSRP
719710	Organa-Add Quart	\$19.95
719715	Organa-Add Gallon	\$68.95

Organa-Guano 0 - 4 - 0



Natural organic flowering stimulant derived from fruit eating bats. Organa-Guano functions as a flowering catalyst containing all necessary organic activators. The completely solubilized liquid contains the highest rate of phosphorus.



Item No.	Description	MSRP
719720	Organa-Guano Quart	\$19.95
719725	Organa-Guano Gallon	\$68.95

Pure Flowers



Pure Flowers 0-30-20 has the highest nutrient levels ever achieved in a completely solubilized liquid. The unique molecular structure of a phosphite is easily absorbed through the roots and leaves. Not for sale in the following states at this time: OR, WA.

Item No.	Description	MSRP
719700	Pure Flowers Quart 0-30-20	\$28.95
719705	Pure Flowers Gallon 0-30-20	\$88.95
719702	Pure Flowers Quart 0-0-20 (WA & OR Label)	\$28.95
719707	Pure Flowers Gallon 0-0-20 (WA & OR Label)	\$88.95

AmHydro

AmHydro Dark Energy™ 2 - 0 - 0



Dark Energy™ is a select blend of L-amino acids, specifically chosen for each of their beneficial effects on plant growth. It enhances the bloom stage of any plant by stimulating the natural production of ethylene, a flowering and ripening hormone.

Item No.	Description	MSRP
732410	Dark Energy Pint	\$30.95
732415	Dark Energy Quart	\$50.95
732420	Dark Energy Gallon	\$144.95
732421	Dark Energy 2.5 Gallon	\$319.95
732422	Dark Energy 5 Gallon	\$599.95

AmHydro SuperNova™ 1 - 1 - 1



SuperNova™ is an Ascophyllum nodosum based nutrient additive, containing a wide range of macro and micro-nutrients, carbohydrates, amino acids and vitamins. The wetting agent in SuperNova™ makes it perfect for use as a foliar spray!

Item No.	Description	MSRP
732545	Super Nova Pint	\$26.95
732550	Super Nova Quart	\$39.95

THE GUANO COMPANY

Budswel Dry 0 - 0.7 - 0



For fruiting and flowering plants. Easy to use! Just mix with water and broadcast lightly around roses or in flower beds. Contains earthworm castings, bat and seabird guano. Not for sale in the following states at this time: FL.

Item No.	Description	MSRP
720025	Budswel Dry 2 lb	\$25.95
720030	Budswel Dry 12 lb	\$135.95

Budswel Liquid 0.01 - 0.10 - 0.01



For fruiting and flowering plants. Easy to use! Just mix with water and broadcast lightly around roses or in flower beds. Contains earthworm castings, bat and seabird guano. Not for sale in the following states at this time: FL.

Item No.	Description	MSRP
720035	Budswel Liquid Gallon	\$41.95
720036	Budswel Liquid 5 Gallon	\$187.95

Super Tea Mix 5 - 5 - 1



Promotes general health and growth of houseplants and garden vegetables. This formula is ideal for seedlings - won't burn! Contains earthworm castings, bat and seabird guano.

Item No.	Description	MSRP
720040	Super Tea Dry 2 lb	\$25.95
720050	Super Tea Liquid Gallon	\$41.95

RX Green Solutions Axiom Harpin Protein



Axiom is derived from naturally occurring harpin proteins, proven to stimulate the plant's natural growth and defense systems. Harpin, the active ingredient, has been proven to increase plant yields and overall plant health. Use Axiom to boost overall plant growth, vigor and production and to aid in the management of disease. EPA No. 71771-3-89112. Not for sale in the following states at this time: CA.

Item No.	Description	MSRP
719496	RX Green Solutions Axiom Harpin Protein (3- .5 gm Packs)	\$9.99
719498	RX Green Solutions Axiom Harpin Protein (3- 2 gm Packs)	\$29.99

Terpinator 0 - 0 - 4



Terpinator was created from years of researching naturally occurring plant compounds that are bio-osmotic potentiators. Through our patented scientific process your plants will utilize these compounds to enhance their production of Terpinoids and plant oil producing glands. These glands are brought to their maximum potential and size using Terpinator along with any nutrient program.

Item No.	Description	MSRP
749300	Terpinator 1 Liter	\$19.95
749305	Terpinator 4 Liter	\$66.95
749310	Terpinator 10 Liter	\$116.95
749315	Terpinator 24 Liter	\$266.95

Microbe Life™ Photosynthesis Plus Beneficial Bacteria 0 - 0.05 - 0.09



Photosynthesis Plus enhances plant functions at the foliar level and the root zone in both soil and soilless substrates. Enhances photosynthesis and biological function by allowing plants to capture and utilize radiant energy more efficiently. Not for sale in the following states at this time: CA, HI, MS, NM, OK, PR, SD.

Item No.	Description	MSRP
717500	Microbe Life Photosynthesis Plus Pint	\$16.95
717505	Microbe Life Photosynthesis Plus Quart	\$24.95
717510	Microbe Life Photosynthesis Plus Gallon	\$79.95
717515	Microbe Life Photosynthesis Plus 2.5 Gallon	\$179.95
717618	Microbe Life Plus-C Pint (CA Label)	\$16.95
717620	Microbe Life Plus-C Quart (CA & NM Label)	\$24.95
717625	Microbe Life Plus-C Gallon (CA & NM Label)	\$79.95

EARTH JUICE

Earth Juice® Bloom™ 0 - 3 - 1



A natural-organic liquid fertilizer formulated for blooming plants that will assist in the rich development of flowers, fruit and vegetables, as well as aid in the creation of essential oils, resins and fragrances.

Item No.	Description	MSRP
718680	Earth Juice Bloom Quart	\$13.15
718685	Earth Juice Bloom Gallon	\$30.41
718688	Earth Juice Bloom 2.5 Gallon	\$68.44
718695	Earth Juice Bloom 5 Gallon	\$123.15

Earth Juice® Grow™ 2 - 1 - 1



Earth Juice® Grow™ is a natural-organic liquid fertilizer that is formulated to encourage robust vegetative growth for a variety of indoor/outdoor foliage and flowering plants. Non-burning and no salt residue.

Item No.	Description	MSRP
718655	Earth Juice Grow Quart	\$13.15
718660	Earth Juice Grow Gallon	\$30.41

Earth Juice® Meta-H™ 0 - 0 - 5



A natural liquid potassium formulation for potassium deficient plants and those plants that require increased potassium. Recommended to apply prior to and during flowering/fruitletting to aid the plant's ability to support production.

Item No.	Description	MSRP
732835	Earth Juice Meta-K Quart	\$12.34
732840	Earth Juice Meta-K Gallon	\$28.58

Earth Juice® Microblast™



A proprietary liquid micronutrient formula designed to be used to prevent and/or correct micronutrient deficiencies. For use with Earth Juice® Grow™ and Bloom™ Original Formulas as well as a variety of other liquid and dry soil and hydroponic fertilizers.

Item No.	Description	MSRP
732855	Earth Juice Microblast Quart	\$15.62
732860	Earth Juice Microblast Gallon	\$35.87

Earth Juice® Rooter's Mycorrhizae™



This special granular form, mycorrhizal blend can absorb organic forms of nutrients and promote green leaf growth, fruit and flower production while increasing drought and insect resistance.

Item No.	Description	MSRP
720325	Earth Juice Rooters Mycorrhizae 1 lb	\$13.39

Earth Juice® Hi-Brix™ Molasses 0 - 0 - 3



Take your plants to the next level with this rare molasses. Hi-Brix MFP is a natural source of carbohydrates (sugars) and plant nutrients that has been specially tailored into liquid formulation for indoor and outdoor plants in soil and hydroponics.

Item No.	Description	MSRP
720444	Earth Juice Hi-Brix Molasses Pint	\$5.09
720446	Earth Juice Hi-Brix Molasses Gallon	\$14.49
720448	Earth Juice Hi-Brix Molasses 2.5 Gallon	\$31.49
720450	Earth Juice Hi-Brix Molasses 5 Gallon	\$53.41

Earth Juice® Sugar Peak Flowering™ 2 - 4 - 5



Formula is designed specifically to encourage the development of flowers, fruit and vegetables. For high production plants use the Sugar Peak Vegetative™ formula during growth period and at bud and flower set, switch to Sugar Peak Flowering™.

Item No.	Description	MSRP
721905	Earth Juice Sugar Peak Flowering Quart	\$17.23
721910	Earth Juice Sugar Peak Flowering Gallon	\$39.64
721915	Earth Juice Sugar Peak Flowering 2.5 Gallon	\$89.18
721920	Earth Juice Sugar Peak Flowering 5 Gallon	\$160.54

Earth Juice® Sugar Peak Grand Finale™ 0 - 6 - 4



A finishing formula designed to help maximize the production of essential oils, resins, fragrances and yields of determinate flowering and fruiting plants.

Item No.	Description	MSRP
721930	Earth Juice Sugar Peak Grand Finale Quart	\$17.23
721935	Earth Juice Sugar Peak Grand Finale Gallon	\$39.64
721940	Earth Juice Sugar Peak Grand Finale 2.5 Gallon	\$89.18
721945	Earth Juice Sugar Peak Grand Finale 5 Gallon	\$160.54

Earth Juice® Catalyst® 0.03 - 0.01 - 0.10



A natural-organic molasses-kelp based liquid nutrient that aids plant growth and production. To be used as part of a complete fertilization program through all stages of plant development. Also functions as an excellent finishing formula for determinate plants.

Item No.	Description	MSRP
718705	Earth Juice Catalyst Quart	\$13.15
718710	Earth Juice Catalyst Gallon	\$30.41
718720	Earth Juice Catalyst 5 Gallon	\$123.15

Earth Juice® Primal Harvest™ 0 - 12 - 1



This bloom guano has been naturally processed into a zero nitrogen and high phosphorous fertilizer that will aid in focusing the plant's energy on the production of flowers, fruit, vegetables, resins and fragrances and not on green-leafy growth.

Item No.	Description	MSRP
720222	Earth Juice Primal Harvest 5 lb	\$13.63
720225	Earth Juice Primal Harvest 20 lb	\$32.69

Earth Juice® Bat Guano Grow™ 10 - 2 - 1



A tried and true fertilizer that has demonstrated to be a superior performing vegetative fertilizer. Very light flowing and mixes easily with most growing media.

Item No.	Description	MSRP
720263	Earth Juice Bat Guano 0.75 lb	\$4.98
720267	Earth Juice Bat Guano 3 lb	\$14.60

Earth Juice® Rainbow Mix™ Grow 5 - 5 - 2



A finely-tuned dry-blend of natural-organic nutrients with multiple strains of beneficial Mycorrhizae plus Humic Acid, all professionally formulated for vigorous vegetative growth for a variety of indoor/outdoor plants.

Item No.	Description	MSRP
720282	Earth Juice Rainbow Mix Grow 5 lb	\$18.49
720286	Earth Juice Rainbow Mix Grow 20 lb	\$59.20

Earth Juice® Rainbow Mix™ Bloom 1 - 9 - 2



A finely-tuned dry-blend of natural-organic ingredients with multiple strains of beneficial Mycorrhizae plus Humic Acid, all professionally formulated to encourage a profusion of flowers and abundant yields of fruit and vegetables for a variety of plants.

Item No.	Description	MSRP
720292	Earth Juice Rainbow Mix Bloom 5 lb	\$18.49
720296	Earth Juice Rainbow Mix Bloom 20 lb	\$59.20

Maxicrop®

Maxicrop® Liquid Seaweed Plus Iron 0.1 - 0 - 1



Contains 2% iron. It is a unique combination of pure seaweed extract with readily sequestered iron in an easy-to-use liquid form. This high iron formulated product, when sprayed directly onto foliage, or applied as a root drench will prevent yellowing (chlorosis) of leaves, especially in acid-low (calcifuge) plants.

Item No.	Description	MSRP
718615	Maxicrop Plus Iron Gallon	\$24.50

Maxicrop® Liquid Fish 5 - 1 - 1



Made from fresh fish from the Atlantic Ocean and contains no chemical additives. It contains naturally occurring amino acids, as well as a huge complex of chelated minor elements (especially B vitamins). Many professional gardeners recommend the use of both Maxicrop® Liquid Fish and Maxicrop® Liquid Seaweed.

Item No.	Description	MSRP
718620	Maxicrop Liquid Fish Quart	\$8.50
718625	Maxicrop Liquid Fish Gallon	\$19.00

Maxicrop® Original Soluble Powder 0 - 0 - 17



Natural product made from fresh Atlantic kelp. For trees, flowers, fruits and vegetables. Can be used for cuttings and rootings, outdoor plants, foliar feed, lawns, compost enhancer.



Item No.	Description	MSRP
718595	Maxicrop Original Soluble Powder 10.7 oz	\$17.35

Maxicrop® Original 0 - 0 - 1



Derived from seaweed. For trees, flowers, fruits and vegetables. Can be used for soaking seeds and bulbs before planting, ideal for houseplants, ideal for seedlings and cuttings.

Item No.	Description	MSRP
718600	Maxicrop Original Liquid Seaweed Quart	\$9.65
718605	Maxicrop Original Liquid Seaweed Gallon	\$22.50
718592	Maxicrop Original Liquid Seaweed 2.5 Gallon	\$50.65

Wholesome Sweetener® Organic Molasses



Wholesome Sweeteners Fair Trade Certified Organic Molasses is a blackstrap molasses with a rich, full-bodied robust flavor that adds natural color. It is loaded with vitamins, minerals and trace elements and is a good source of iron, vitamin B6, potassium, calcium and magnesium.



Item No.	Description	MSRP
715500	Wholesome Sweetener Certified Organic Molasses Quart	\$13.95

Organic Nutrients™ Insect Frass™ 2 - 2 - 2



Insect Frass™ is 100% Organic plant food. Insect Frass™ naturally contains the nutrition plants require, beneficial micro-organisms and immediately plant-available source of Chitin. Chitin fortifies a plant causing an auto-immune response that signals a plant to produce natural toxins fending off its natural enemies.

Item No.	Description	MSRP
719460	Organic Nutrients Insect Frass 2 lb	\$26.95
719465	Organic Nutrients Insect Frass 5 lb	\$58.95
719470	Organic Nutrients Insect Frass 25 lb	\$169.95

Monterey Epsom Salts



Promotes bloom in roses and other flowering plants. Absorbed through the roots and foliage of plant. Epsom Salts is a source of Magnesium that is essential to plant development. It is required by plants to produce chlorophyll. It also helps plants absorb Phosphorus. Not for sale in the following states at this time: ND, SD.



Item No.	Description	MSRP
704623	Monterey Epsom Salts 4 lb	\$15.49

Spray-N-Grow

Spray-N-Grow®

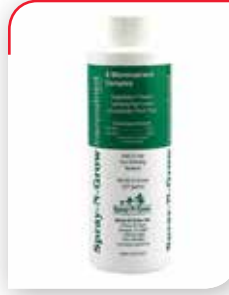

For earlier, larger, more plentiful blooms... more vibrant colors and greener plants... and larger, tastier harvests. Not a fertilizer or hormone, all-natural Spray-N-Grow® is a unique, organic-based micronutrient complex.

Item No.	Description	MSRP
719050	Spray-N-Grow 8 oz	\$14.95

Spray-N-Grow® Coco-Wet®



Add Coco-Wet® to any Spray-N-Grow® nutrient. Helps for better nutrient uptake. Coco-Wet® is compatible with all foliar nutrients.

Item No.	Description	MSRP
732000	Coco-Wet 8 oz	\$8.95
732002	Coco-Wet Gallon	\$49.95

B'cuzz ATAMI™

Atami® Rootbastic® 3 - 14 - 3



Rootbastic® is a super concentrated root stimulator with a combination of high NPK bio stimulants and bio minerals which creates explosive root production. Not for sale in the following states at this time: CA.

Item No.	Description	MSRP
733400	Rootbastic 80 ml	\$43.42
733410	Rootbastic 250 ml	\$82.84
733420	Rootbastic 500 ml	\$159.98
733415	Rootbastic 250 ml (CA Label)	\$82.84
733425	Rootbastic 500 ml (CA Label)	\$159.98

Atami® Bloombastic®



All bloom additives in one bottle: booster, accelerator, hardener & flower enhancer. Bloombastic® is highly concentrated. Bloombastic® stretches the flower cell, increasing intake capacity of potassium. It creates more compact & heavier blooms.

Item No.	Description	MSRP
732489	Bloombastic 80 ml	\$31.78
732500	Bloombastic 325 ml	\$95.43
732580	Bloombastic 1.25 Liter	\$222.74
732582	Bloombastic 5.5 Liter	\$933.59

B'Cuzz® Tabzz® 0 - 12 - 15



B'Cuzz® Blossom Builder Tabzz® are 100% sizzling flower multipliers that ensures an explosive flower development in the flower phase. They make sure that all the strength of the plant is directed towards the flowers at the end of the growth.

Item No.	Description	MSRP Ea
732069	B'Cuzz Tabzz	\$6.87

B'Cuzz® Blossom Builder 0 - 9 - 19



B'Cuzz® Blossom Builder liquid will increase the size and mass of flowers. Specifically created for the final weeks of the blooming phase. It works as a finisher that will lead your flowers to strong, healthy look and a beautiful attractive final weight and aroma of your flowers.

Item No.	Description	MSRP
733430	B'Cuzz Blossom Builder 3.38 oz / 100 ml	\$20.60
733435	B'Cuzz Blossom Builder 12 oz / 355 ml	\$48.95
733440	B'Cuzz Blossom Builder Quart / 946 ml	\$144.15

B'Cuzz® Bloom Stimulator 0 - 0 - 0.7



Specially formulated for the plant's blooming phase. B'Cuzz® Bloom encourages flower cell production and increases the manufacture and transport of sugar molecules in the flowers. This will lead to big, dense flowers and great taste.

Item No.	Description	MSRP
732025	BCuzz Bloom 12 oz	\$23.34
732030	BCuzz Bloom Quart	\$46.68
732035	BCuzz Bloom Gallon	\$159.14

B'Cuzz® Growth Stimulator 1.0 - 0 - 0.7

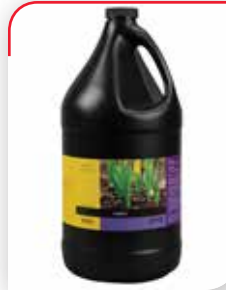

B'Cuzz® Growth has been developed specifically to stimulate the growth phase and it is a necessary supplement to normal nutrition. It is an all-in-one growing stimulator, containing micro-nutrients, aqua-bacteria, amino acids and proteins.

Item No.	Description	MSRP
732040	BCuzz Growth 12 oz	\$23.34
732045	BCuzz Growth Quart	\$46.68
732050	BCuzz Growth Gallon	\$159.14

B'Cuzz® Root Stimulator 0 - 0 - 0.7



B'Cuzz® Root will initiate an explosive root production. B'Cuzz Root solutions can be best used in cloning systems and for young plants, cuttings or seedlings.

Item No.	Description	MSRP
732055	BCuzz Root 12 oz	\$23.34
732060	BCuzz Root Quart	\$46.68
732065	BCuzz Root Gallon	\$159.14



Organic Bountea Brewer 5 Gallon



NEW This is a simple effective aeration system to brew 5 gallons of premium compost tea. Fits any 5 gallon bucket. Easy to set up and clean. Effective agitation releases microbes. Kit includes dual outlet air pump, clip-on air supply pipe, easy clean plastic air diffuser, air supply tubing, compost tea strainer bag and compost tea brewing instructions.

Item No.	Description	MSRP
720508	Organic Bountea Brewer 5 Gallon	\$79.95

Organic Bountea Brew Kit 50 Gallon



NEW Easy to clean, most affordable and effective 50 gallon compost tea brewer on the market. Ideal for small farmers. Ready to use, brand new 50 gallon container, air pump 70/L, specialized diffuser head, microperforated. Durable diffuser stem, champagne bubbles, quick connect to air pump, spigot threaded for a standard garden hose.

Item No.	Description	MSRP
720510	Organic Bountea 50 Gallon Brew Kit	\$489.95

Organic Bountea Bioactivator

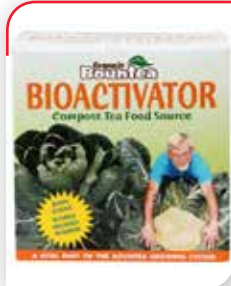

NEW A specialized compost tea catalyst. Boosts the growth of beneficial soil microorganisms - greatly increases their concentration and diversity. Creates a balanced bacterial/fungal compost tea. Helps the infiltration of beneficial microbes to the soil. 20+ years of proven effectiveness. Helps to restore soil ecology for optimal plant vitality.



Item No.	Description	MSRP
739700	Organic Bountea Bioactivator 1 lb	\$19.99
739702	Organic Bountea Bioactivator 5 lb	\$66.65
739704	Organic Bountea Bioactivator 20 lb	\$163.32

Organic Bountea Fungal Activator



NEW A specialized compost tea catalyst. Boosts the growth of beneficial fungi - greatly increases their concentration and resilience. Creates a fungally dominant compost tea beneficial for plants with fibrous or woody stems. Use to pretreat humus for more prolific fungal growth. Beneficial fungi increase the plants uptake of essential nutrients (P,K, and Ca) and sequesters CO2 into the soil. Helps plants develop flowers and fruit.



Item No.	Description	MSRP
739706	Organic Bountea Fungal Activator 1 lb	\$19.99
739708	Organic Bountea Fungal Activator 5 lb	\$66.65
739710	Organic Bountea Fungal Activator 20 lb	\$163.32

Organic Bountea Marine Mineral Magic M3 7 - 1 - 1



NEW A natural source of nitrogen and minerals. Boosts development of leaves and shoots. Fortifies stressed plants during growth phase. Re-mineralizes depleted soils. Supplies trace elements and nutrients. Invigorates soil ecology. An excellent source of diverse trace minerals from the land and the sea. Foliar feed plants with mineral or nutrient deficiencies.



Item No.	Description	MSRP
739712	Organic Bountea Marine Mineral Magic M3 1 lb	\$19.99
739714	Organic Bountea Marine Mineral Magic M3 5 lb	\$66.65
739716	Organic Bountea Marine Mineral Magic M3 20 lb	\$163.32

Organic Bountea Root Web



NEW 20 Species of beneficial fungal spores. Increases root growth and biomass. Increases fertilizer efficiency. Reduces water use. Increases plant yield. Reduces fungal disease.



Item No.	Description	MSRP
739718	Organic Bountea Root Web 1/4 lb	\$24.98
739720	Organic Bountea Root Web 1 lb	\$66.65
739722	Organic Bountea Root Web 5 lb	\$259.99

Organic Bountea Bountea Better Bloom B3 1 - 6 - 7



NEW A natural source of potassium and phosphorous. Promotes numerous buds and flowers. Encourages fragrant high-quality flowers. Supports setting and growth of nutritious fruit. Fortifies stressed plants during bloom phase.



Item No.	Description	MSRP
739724	Organic Bountea Bountea Better Bloom B3 1 lb	\$24.98
739726	Organic Bountea Bountea Better Bloom B3 5 lb	\$78.32
739728	Organic Bountea Bountea Better Bloom B3 20 lb	\$235.99

Organic Bountea SuperStart



NEW Gives all plants a surge of life. Encourages strong development of seedlings and transplants. Supports increased root growth. Supplies essential nutrients and beneficial microbes. Reduces transplant shock. Revitalizes soil life and fertility. Contains mycorrhizae and a slow release NPK. Excellent food source for soil biology.



Item No.	Description	MSRP
739730	Organic Bountea SuperStart 1 lb	\$19.99
739732	Organic Bountea SuperStart 5 lb	\$66.65
739734	Organic Bountea SuperStart 20 lb	\$163.32

DUTCHTM MASTER

Dutch Master Gold Add.27 Grow 1 - 1 - 4 & Flower 0 - 2 - 2



Gold ADD.27 adds power to your regular nutrient or mineral based supplements by helping to optimize the rate of cytoplasmic streaming. Optimized cytoplasmic streaming allows your nutrients and additives to work at their intended performance level!

Item No.	Description	MSRP
719580	Gold Add .27 Grow 1 Liter	\$23.95
719581	Gold Add .27 Flower 1 Liter	\$23.95
719585	Gold Add .27 Grow 5 Liter	\$93.95
719586	Gold Add .27 Flower 5 Liter	\$93.95

Dutch Master Gold Nutrient Flower Part A 4 - 0 - 4 & B 1 - 8 - 5



Gold Nutrients unique ionic technology delivers massive amounts of the best available nutrition to your plants. By providing a unique ionic charge to the elements contained within Gold Nutrient, we unlock nature's awesome genetic power!

Item No.	Description	MSRP
719262	Gold Flower A 1 Liter	\$11.98
719263	Gold Flower B 1 Liter	\$11.98
719267	Gold Flower A 5 Liter	\$39.95
719268	Gold Flower B 5 Liter	\$39.95
719271	Gold Flower A 20 Liter	\$137.98
719272	Gold Flower B 20 Liter	\$137.98

Dutch Master Gold Nutrient Grow Part A 3 - 0 - 2 & B 1 - 2 - 4



Gold Nutrients unique ionic technology delivers massive amounts of the best available nutrition to your plants. By providing a unique ionic charge to the elements contained within Gold Nutrient, we unlock nature's awesome genetic power!

Item No.	Description	MSRP
719242	Gold Grow A 1 Liter	\$11.98
719243	Gold Grow B 1 Liter	\$11.98
719247	Gold Grow A 5 Liter	\$39.95
719248	Gold Grow B 5 Liter	\$39.95
719257	Gold Grow A 20 Liter	\$137.98
719258	Gold Grow B 20 Liter	\$137.98

Dutch Master Gold Liquid Light 0 - 0.2 - 0.2



Gold Liquid Light puts your plants into overdrive by helping to restore their lost natural photosynthetic power. It provides your plants with selected minerals, carbohydrates, amino-acids and phyto-nutrients that optimizes the Calvin Cycle.

Item No.	Description	MSRP
719277	Gold Liquid Light 1 Liter	\$59.95
719278	Gold Liquid Light 5 Liter	\$199.95

Dutch Master Gold Saturator 0.008 - 0 - 0.003



Gold Saturator should be used with any mineral/carbohydrate/ amino-acid based specialty fertilizer foliar product to make it penetrate more effectively!

Item No.	Description	MSRP
719405	Gold Saturator 1 Liter	\$29.95
719406	Gold Saturator 5 Liter	\$119.95

Dutch Master Gold Silica 0 - 0 - 2



Gold Silica is a special formulation of plant available silicon, designed to help restore natural plant levels of silicon so your plant can build strong cell walls resulting in a well formed plant.

Item No.	Description	MSRP
719440	Gold Silica 1 Liter	\$25.95

Dutch Master Gold One Grow 1 - 0.7 - 3 & Flower 2 - 1 - 3



Gold One combines a unique calcium and sulphur binding technology together with a high performance, cutting edge nutrient formulation to provide you with a powerful nutrient that is crystal clear.

Item No.	Description	MSRP
719280	Gold One Grow 1 Liter	\$11.95
719285	Gold One Grow 5 Liter	\$34.95
719300	Gold One Flower 1 Liter	\$11.95
719305	Gold One Flower 5 Liter	\$34.95

Dutch Master Max Grow 1 - 1 - 5 & Flower 0.114 - 2 - 3



Max is legendary for providing assistance from problems caused by over or under watering, over fertilizing, excessive heat and light. Max provides a unique blend of nutrients that help the plant to maximize its nutrient sinks.

Item No.	Description	MSRP
719350	Max Grow 1 Liter	\$16.95
719370	Max Flower 1 Liter	\$16.95

Dutch Master Gold Potash Plus 0 - 4 - 9



Gold Potash+ is one of the most advanced root based phosphorus boosters in the world! Gold Potash+ is one of the best ways to maximize your plants natural genetic flowering potential!

Item No.	Description	MSRP
719330	Gold Potash Plus 1 Liter	\$19.95
719335	Gold Potash Plus 5 Liter	\$48.95

Dutch Master Gold A.P.S 0.007 - 0.01 - 0.015



Gold A.P.S perfectly conditions Rockwool cubes for cuttings and is ready to use straight out of the bottle. Gold A.P.S perfectly prepares your rockwool to successfully accept your newly taken cuttings by conditioning it to the perfect pH.

Item No.	Description	MSRP
719445	Gold A.P.S. 5 Liter	\$22.95



Hydrogardening Bucket Systems
Flo-n-Gro®



Liquid Oxygen H2O2



Liquid Oxygen H2O2 is composed of 34% Hydrogen Peroxide. Use with caution. Keep away from children. This product is excellent for cleaning hydroponic equipment, materials and grow areas. It is considered unlawful to sell, use or distribute this product in ways other than as claimed.



#704550 and #704555 Not for sale in the following states at this time: CT, DE, IA, ID, IL, MD, MN, NE, NJ, NM, OR, PA, PR, SD, TN, VA, WI, WV, WY.

#704552 and #704557 Not for sale in the following states at this time: AK, AL, AR, AZ, CA, CO, CT, FL, GA, HI, IA, ID, IL, IN, KS, KY, LA, MA, MD, ME, MI, MN, MO, MS, MT, NC, ND, NE, NH, NJ, NM, NY, NY, OH, OK, PA, PR, RI, SC, SD, TN, TX, UT, VA, VT, WA, WI, WV, WY.

EXCLUSIVE

Item No.	Description	MSRP
704550	H2O2 Liquid Oxygen 34% Gallon	\$32.99
704555	H2O2 Liquid Oxygen 34% 5 Gallon	\$129.95
704552	H2O2 Liquid Oxygen 34% Gallon (OR Label)	\$32.99
704557	H2O2 Liquid Oxygen 34% 5 Gallon (OR Label)	\$129.95

Nutrilife® SM-90



The organic composition of SM-90 results in its ability to be biodegradable and also non-toxic to humans, animals and plants. When added in small quantities directly to plant nutrient solutions, new root growth emerges.

Item No.	Description	MSRP
704490	Nutrilife SM-90 1 Liter	\$20.95
704495	Nutrilife SM-90 4 Liter	\$75.95
704496	Nutrilife SM-90 10 Liter	\$168.95
704498	Nutrilife SM-90 20 Liter	\$303.95

Z7 Enzyme Cleanser



Z7 is a two part proprietary enzymatic cleanser that is super concentrated. Z7 is not a plant food, it simply allows plant foods to work better because the nutrients that you are feeding them can actually get into the roots easier. Growers report a 25% decrease in plant food costs. Z7 increases the chances that the plant will grow to its genetic potential. Z7 is super concentrated and super economical.

Item No.	Description	MSRP
704510	Z7 Enzyme Cleanser 8 oz	\$26.95
704515	Z7 Enzyme Cleanser Quart	\$72.95
704517	Z7 Enzyme Cleanser Gallon	\$185.95
704525	Z7 Enzyme Cleanser 2.5 Gallon	\$419.95
704527	Z7 Enzyme Cleanser 5 Gallon	\$779.95

Microbe Life™ Dechlorinator+

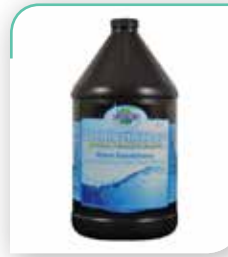

A full-function water conditioner that will neutralize chlorine, destroy chloramines, while adding essential electrolytes and alkalinity boosters (acid neutralizing). Formulated with R/O and UV sterilized water.

Not for sale in the following states at this time: PR.

Item No.	Description	MSRP
717673	Microbe Life Dechlorinator + Pint	\$9.95
717675	Microbe Life Dechlorinator + Quart	\$15.95
717680	Microbe Life Dechlorinator + Gallon	\$54.95
717685	Microbe Life Dechlorinator + 2.5 Gallon	\$103.95

GH FloraShield®



Maintain healthy roots without resorting to harsh, toxic chemicals. FloraShield's unique combination of compounds can thoroughly rinse systems and plants during all phases of the life cycle.

Item No.	Description	MSRP
704030	GH FloraShield Quart	\$28.75
704035	GH FloraShield Gallon	\$80.50

Botanicare® Hydroguard™



Hydroguard's reformulation makes it even more effective than before. It's unique formula, contains an isolated form of Bacillus bacteria known as Bacillus Amyloliquefaciens. This scientifically isolated bacterium was selected for its superior ability to amplify root mass and vigor, especially in hydroponic gardening, when compared with the more common and well known Bacillus Subtilis species.

Item No.	Description	MSRP
704078	Botanicare Hydroguard Quart	\$31.00
704080	Botanicare Hydroguard Gallon	\$75.90
704082	Botanicare Hydroguard 2.5 Gallon	\$169.00
704084	Botanicare Hydroguard 5 Gallon	\$307.90

Dutch Master™ Gold Zone 0.06 - 0 - 0.15



Zone ensures that your root system and environment are optimized so that your plants take up to 100% of what they need. Zone is specially formulated for use as a full time maintenance program outperforming everything in its class.

Item No.	Description	MSRP
719430	DutchMaster Gold Zone 1 Liter	\$26.95
719435	DutchMaster Gold Zone 5 Liter	\$93.95

GH AzaMax™



AzaMax™ is a natural product with a broad spectrum of pest control. It does not use hard chemical solvents. It is an antifeedant and insect growth regulator which controls pests through starvation & growth disruption.

#726750

#724464, 724475, and 724477EPA No. 71908-1-81268. Not for sale in the following states at this time: PR.

#724470 EPA No. 71908-1-81268.

Item No.	Description	MSRP
726750	GH Azamax 1 oz Display Box NEW	\$9.95
724464	AzaMax 4 oz	\$28.40
724470	AzaMax 16 oz	\$69.98
724475	AzaMax Quart	\$118.95
724477	AzaMax Gallon	\$372.99

Green Cleaner



NEW Spray Green Cleaner on plants of every age, from clones through harvest. Unlike other products, spider mites do not get immune to Green Cleaner. Kills mites and their eggs. Washes powdery mildew right off the plant. It is all natural. It is a concentrate that makes 2 oz 1 - 4 gallons, 4 oz 2 - 8 gallons, 8 oz 4 - 16 gallons, 32 oz 16 - 64 gallons and 128 oz 64 - 256 gallons.

Not for sale in the following states at this time: AL, AR, HI, IA, IN, KS, LA, MO, MS, ND, NJ, NM, OK, SD, UT, VA, WI, WV.

Item No.	Description	MSRP
749800	Green Cleaner 2 oz	\$19.95
749802	Green Cleaner 4 oz	\$34.95
749804	Green Cleaner 8 oz	\$59.95
749806	Green Cleaner Quart	\$179.95
749808	Green Cleaner Gallon	\$539.95

Nuke Em®



This is a zero residue multi-purpose pesticide. Kills broad mites, spider mites, thrips, white fly, powdery mildew and more. Reduces mold and mildew. Meets state requirements for zero pesticide residues. OMRI listed formula comprised of 100% food grade ingredients.



EPA No. FIFRA 25(b) Exempt. Not for sale in the following states at this time: IN, MS, NM, SD.

Item No.	Description	MSRP
704504	Nuke Em 8 oz	\$25.95
704506	Nuke Em Quart	\$56.96
704508	Nuke Em Gallon	\$176.95
704507	Nuke Em 2.5 Gallon NEW	\$409.95
704509	Nuke Em 5 Gallon NEW	\$769.95

FoxFarm® Don't Bug Me®



Don't Bug Me® is a fast, effective solution for most common garden pests. Because its active ingredient is Pyrethrum, which is derived from chrysanthemum flowers, it can be applied up to the day of harvest on any fruit or vegetable.

#704085 EPA No. 1021-1801-71996. Not for sale in the following states at this time: NY, PR.

Item No.	Description	MSRP
704085	FoxFarm Don't Bug Me 24 oz	\$14.95

Promis Aphid, Thrip and White Fly Killer



Promis, Aphid, Thrip and White Fly Killer dissolved in water and applied to soil is absorbed by the roots. Once absorbed, it moves through the entire plant to protect against insects. This product also moves into and protects new growth after application. To control insects, the insecticide must distribute completely throughout the plant.

EPA No. 53883-275-89819.

Item No.	Description	MSRP
704690	Promis Aphid, Thrip and White Fly Killer Conc. Quart	\$48.95

Promis Multi-Purpose Fungicide



NEW Promis Multi-Purpose Fungicide prevents and controls Powdery Mildew and other fungal diseases. This product is highly effective when it is used to prevent diseases or applied at the first sign of disease. Mix Promis Multi-Purpose Fungicide with water and uniformly apply (foliar spray) to all parts of the plant to point of runoff.

EPA No. 42750-196-89819.

Item No.	Description	MSRP
717994	Promis Multi-Purpose Fungicide	\$78.95

Doktor Doom® Spider Mite Knock Out®



Doktor Doom® Spider Mite Knock Out® is a 0.20% pyrethrin formula. Unlike soap based products which need to be applied liberally to the plant in order to drown the insects this product kills the pests on contact with just a light misting on the foliage.

EPA No. 2724-568-72804. Not for sale in the following states at this time: ND, PR.

Item No.	Description	MSRP
704415	Doktor Doom Spider Mite Knock Out Pint	\$15.99

Doktor Doom® Total Release Fogger



A total release fogger for use in homeowner greenhouses, fruit and vegetable storage areas and indoor gardening areas. Used for controlling fungus gnats, spider mites, two-spotted spider mites, aphids, whiteflies, scale, mealy bugs and thrips.

EPA No. 72804-1. Not for sale in the following states at this time: ND, PR.

Item No.	Description	MSRP
704400	Doktor Doom Fogger 3 oz	\$10.99
704405	Doktor Doom Fogger 5.5 oz	\$13.99
704410	Doktor Doom Fogger 12.5 oz	\$18.95

No Spider Mites™ Concentrate



Our No Spider Mites™ commercial concentrate sizes are ideal for any grower with a large commercial spider mite infestation. Also works well for future preventive measures. 100% organic.

EXCLUSIVE

Item No.	Description	MSRP
704780	No Spider Mites Conc. Pint (Makes 5 Gal)	\$249.95
704785	No Spider Mites Conc. Quart (Makes 10 Gal)	\$395.95
704790	No Spider Mites Conc. 64 oz (Makes 20 Gal)	\$649.95

No Spider Mites™ RTU



No Spider Mites™ quickly and safely kills spider mites on plants. It is ideal for the hobbyist or commercial grower. 100% Organic. Our 16-ounce No Spider Mites™ size is perfect coverage to kill spider mites on up to six (6) 24 inch plants.

EXCLUSIVE

Item No.	Description	MSRP
704765	No Spider Mites RTU Pint	\$25.95
704770	No Spider Mites RTU Quart	\$39.95
704775	No Spider Mites RTU Gallon	\$99.95

No Fungus Gnats™



No Fungus Gnats™ is a revolutionary, 100% safe and effective organic nano particulate insect eliminator. Our patented process uses only natural plant oils and extracts in their tiniest of elemental forms which allows No Fungus Gnats™ advanced organic technology to eliminate all carbon based insects and their larvae anytime.

Item No.	Description	MSRP
739190	No Fungus Gnats RTU 32 oz	\$24.95
739195	No Fungus Gnats Conc. Pint (Makes 5 Gal)	\$49.50

No Powdery Mildew™



No Powdery Mildew™ is your 100% safe & effective way to attack, control & prevent your powdery mildew outbreak immediately. It is a scientifically advanced, natural plant oil and extract technology that was developed with the most advanced nano surface technology that attacks the powdery mildew spores at the mycelium.

EXCLUSIVE

Item No.	Description	MSRP
739155	No Powdery Mildew Conc. Pint Dual Piston (Makes 5 Gal)	\$49.50
739160	No Powdery Mildew Conc. Quart (Makes 10 Gal)	\$89.50
739170	No Powdery Mildew Conc. Gallon Dual Piston (Makes 20 Gal)	\$159.50
739165	No Powdery Mildew RTU Quart	\$24.95

Arborjet® AzaSol™



Broad Spectrum insect control derived from the Botanical Plant Neem. This patented product, is the only Neem based insecticide that is a 100% water soluble powder. AzaSol™ is an anti-feedant, repellent and insect growth regulator. It can be used on indoor and outdoor plants, food crops, trees, shrubs and turf and it can be applied through spray, drench, injection and more.

#704981 EPA No. 81899-4.

#704985 EPA No. 81899-4. Not for sale in the following states at this time: AL, AR, DC, DE, GA, IA, ID, LA, ME, MS, MT, ND, NM, OK, RI, SC, SD, UT, VT, WY.

Item No.	Description	MSRP
704981	Arborjet Aza Sol Single Pack	\$48.95
704985	Arborjet Aza Sol Container	\$429.95

Whitmire 1600 X-Clude® Formula 2



It is a microencapsulated, time release insecticide packaged in a ready-to-use aerosol canister. Effectively controls ants, aphids, beetles, fungus gnats, spider mites, mealybugs, whiteflies and more than 20 other target insects. Test spot recommended. Registered in all states.

EPA No. 499-539. Not for sale in the following states at this time: US Virgin Island.

Item No.	Description	MSRP
704568	1600 X-Clude Formula 2 - 20oz	\$35.95

Whitmire Pro-Control Plus® Total Release Aerosol Insecticide



Pro-Control Plus® Total Release Insecticide is a ready-to-use, ultra low volume insecticide fogger that controls a wide variety of insects. Labeled for use in apartments, basements, non-food areas of commercial building, houses, office buildings, sheds, or storage areas. Controls thrips, whiteflies, scale, aphids, spiders, ants and more. Registered in all states.

EPA No. 499-462.

Item No.	Description	MSRP
704595	Pro Control Plus TR 6 oz	\$12.95

Actinovate® Fungicide



Actinovate® microbe grows on the plant's roots & leaves, living off the plant's by-products. It attacks harmful disease causing pathogens. This natural product effectively suppresses & controls a wide range of foliar & root diseases.



#721500 and 721505 EPA No. 73314-1.

#721507 EPA No. 73314-1-ZC. Not for sale in the following states at this time: AK, AL, AR, AZ, CO, CT, DE, FL, GA, HI, IA, ID, IL, KS, KY, LA, MA, MD, ME, MI, MN, MO, MS, MT, NC, ND, NE, NH, NJ, NM, NY, NY, OH, OK, OR, PA, RI, SC, SD, TN, TX, UT, VA, VT, WA, WI, WV, WY.

Item No.	Description	MSRP
721500	Actinovate Fungicide 2 oz	\$21.95
721505	Actinovate Fungicide 18 oz	\$149.95
721507	Actinovate Fungicide 18 oz (CA Label) NEW	\$149.95

SNS 217™ Mite Control RTU



Say good-bye to spider mites! SNS 217™ and SNS 217C™ kills mites and their eggs. It is fully biodegradable and non toxic to animals.

EPA No. FIFRA 25(b) Exempt. Not for sale in the following states at this time: AR, CT, DE, GA, IA, IN, KS, LA, MS, ND, NH, NM, OK, SC, SD, UT, WV, WY.

Item No.	Description	MSRP
746005	SNS 217 Mite Control RTU Quart	\$25.95
746007	SNS 217 Mite Control RTU Gallon	\$93.95

SNS 217C™ Mite Control Concentrate



Say good-bye to spider mites! SNS 217™ and SNS 217C™ kills mites and their eggs. It is fully biodegradable and non toxic to animals.

EPA No. FIFRA 25(b) Exempt. Not for sale in the following states at this time: AL, AR, CT, DE, GA, IA, IN, KS, LA, MS, ND, NH, NM, OK, SC, SD, UT, WV, WY.

Item No.	Description	MSRP
746072	SNS 217C Mite Control Conc. 1.5 oz Pouch	\$9.99
746010	SNS 217C Mite Control Conc. Pint	\$71.95
746015	SNS 217C Mite Control Conc. Gallon	\$350.00

SNS 244™ Fungicide RTU



Kills fungus and mildew and is highly effective for the control of a broad spectrum of vegetable, fruit and ornamental plant fungal diseases.

EPA No. FIFRA 25(b) Exempt. Not for sale in the following states at this time: AK, AL, AR, CT, DE, GA, IA, IN, KS, LA, MS, ND, NH, NM, OK, SC, SD, UT, WV, WY.

Item No.	Description	MSRP
746025	SNS 244 Fungicide RTU Quart	\$24.99
746030	SNS 244 Fungicide RTU Gallon	\$62.95

SNS 244C™ Fungicide Concentrate



Kills fungus and mildew and is highly effective for the control of a broad spectrum of vegetable, fruit and ornamental plant fungal diseases.

#746074 EPA No. FIFRA 25(b) Exempt. Not for sale in the following states at this time: AK, AL, AR, CT, DE, GA, IA, IN, KS, LA, MS, ND, NH, NM, OK, SC, SD, UT, WV, WY.

#746042, 746044 and 746046 EPA No. FIFRA 25(b) Exempt. Not for sale in the following states at this time: AK, AL, AR, AZ, CT, DE, GA, IA, ID, IN, KS, LA, MD, MS, MT, ND, NH, NM, OH, OK, SC, SD, UT, WV, WY.

Item No.	Description	MSRP
746074	SNS 244C Fungicide Conc. 4 oz Pouch	\$9.99
746042	SNS 244C Fungicide Conc. Pint	\$24.00
746044	SNS 244C Fungicide Conc. Quart	\$41.95
746046	SNS 244C Fungicide Conc. Gallon	\$110.00

SNS 203™ Concentrate Pesticide Soil Spray/Drench



SNS 203™ kills and repels fungus gnats, root aphids, thrips, shore flies and white flies. How it works: SNS 203™ Concentrated Natural Pesticide active ingredients cause the pests to dehydrate and dry up the ingredients also attack fungus and algae to reduce the food source for the pests.

EPA No. FIFRA 25(b) Exempt. Not for sale in the following states at this time: AK, AL, AR, CT, DE, GA, IA, IN, KS, LA, MS, ND, NH, NM, OK, SC, SD, UT, WV, WY.

Item No.	Description	MSRP
746068	SNS 203 Conc. Pesticide Soil Spray/Drench 4 oz Pouch	\$9.99
746035	SNS 203 Conc. Pesticide Soil Spray/Drench Pint	\$24.00
746040	SNS 203 Conc. Pesticide Soil Spray/Drench Gallon	\$110.00

SNS 209™ Systemic Pest Control Concentrate



Safely and easily make your plants resistant to pests! SNS 209™ All Natural Systemic Pest Control provides a barrier for plants to protect them against damaging insects.

EPA No. FIFRA 25(b) Exempt. Not for sale in the following states at this time: AK, AL, AR, AZ, CT, DE, GA, IA, ID, IN, KS, LA, MD, ME, MS, MT, ND, NH, NM, OH, OK, PA, RI, SC, SD, UT, VA, WV, WY.

Item No.	Description	MSRP
746070	SNS 209 Systemic Pest Control Conc. 2.5 oz Pouch	\$9.99
746048	SNS 209 Systemic Pest Control Conc. Pint	\$24.00
746050	SNS 209 Systemic Pest Control Conc. Gallon	\$110.00

SaferGro® Pest Out®



Pest Out® is a natural, organic miticide and insecticide that provides good control of pests, such as mites, thrips and aphids. Pest Out® is a safe, long-lasting product that will protect your crops all season up to and including the day of harvest.



EPA No. FIFRA 25(b) Exempt.

Item No.	Description	MSRP
743615	SaferGro Pest Out RTU Quart	\$9.95

SaferGro® Mildew Cure®



Mildew Cure® is a natural, organic fungicide that provides good control of powdery mildew on various crops and ornamentals. Mildew Cure® is derived from garlic extracts and other essential oils, these active ingredients are food grade materials.



EPA No. FIFRA 25(b) Exempt.

Item No.	Description	MSRP
743600	SaferGro Mildew Cure Quart	\$22.95
743605	SaferGro Mildew Cure RTU Quart	\$9.95

GreenCure®



GreenCure® is a potassium bicarbonate-based, broad spectrum foliar fungicide that cures and prevents powdery mildew, black spot, downy mildew, botrytis blight, gray mold, anthracnose, rust and other mold, mildew and garden fungi related plant diseases. 8 oz makes approximately 16 gallons of formula.

EPA No. 70870-1.

Item No.	Description	MSRP
704315	GreenCure 8 oz	\$16.95
704320	GreenCure 40 oz	\$68.95

SucraShield™



SucraShield™ sugar-based Insecticide/Miticide/Ovicide provides fast and sure biochemical control on a wide range of soft-bodied problem pests in the greenhouse and nursery as well as fruits, nuts, mushrooms and vegetables.



EPA No. 70950-2-84710. Not for sale in the following states at this time: PR.

Item No.	Description	MSRP
704700	SucraShield Pint	\$33.95
704705	SucraShield Gallon	\$149.95

Liquid Ladybug™



Liquid Ladybug™ is a bio miticide that employs organic botanical oils for controlling spider mite infestations on all indoor and outdoor plants and crops. It is designed to stop mite respiration and to rapidly evaporate away after application.

EPA No. FIFRA 25(b) Exempt.

Item No.	Description	MSRP
704630	Liquid Ladybug RTU Pint	\$19.95
704635	Liquid Ladybug RTU Quart	\$34.95
704640	Liquid Ladybug RTU Gallon	\$99.95
704645	Liquid Ladybug Conc. Gallon	\$199.95

Sensor Yellow Monitoring Cards 50 Pack

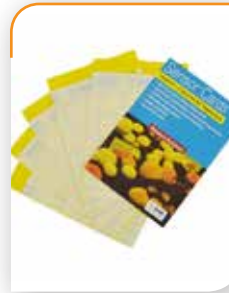

Featuring superior, Posi-Trap glue, these durable, long-lasting pest monitoring and trapping cards are designed to catch a variety of pests, including winged aphids, leafminer adults, thrips, whiteflies, fungus gnat adults, shore flies, fruit flies, leafhoppers and other flying insects. The 3 in x 5 in Sensor Cards are packed in poly-bag and coated on both sides with non-drip glue that will not stick to skin.

Item No.	Description	MSRP
704560	Sensor Yellow Monitoring Cards 50/Pack	\$34.95

Sticky Whitefly Traps



The Sticky Whitefly Traps do the following things: Protect plants from whiteflies, aphids and other flying insects. Last all season, even in rain, until completely coated with insects. Non-poisonous and easy to use.

Item No.	Description	MSRP
704190	Sticky Whitefly Trap 3/Pack	\$122.95
704195	Sticky Whitefly Trap 5/Pack	\$6.39

Sticky Thrip Leafminer Traps

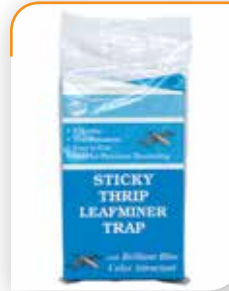

Protects plants from Thrips & Leafminers. Excellent protection for roses. Hang at plant level. Place traps every 7 ft apart or at end of each row. Lasts all season, even in rain, or until completely coated with insects or dust.

Item No.	Description	MSRP
704196	Stick Thrip Leafminer Trap 5/Pack	\$6.39

Yellow Sticky Ribbon Traps



The Yellow Ribbon Trap is a sticky, non-toxic double-sided tape that allows growers to monitor and control their flying pest infestations. The Yellow Ribbon Trap is 50 feet long by four inches wide and can be cut to any length.

Item No.	Description	MSRP
704564	Yellow Sticky Ribbon Traps - 50 ft Roll	\$21.99

Mosquito Dunks®



Mosquito Dunks® are formulated to release effective levels of BTI for a period of 30 days or more under typical environmental conditions. These dunks may be used in all types of containerized mosquito breeding areas.

EPA No. 6218-47.

Item No.	Description	MSRP
704650	Mosquito Dunks 2/Card	\$7.95
704655	Mosquito Dunks 6/Card	\$13.99

Mosquito Bits®



The Mosquito Bits® are now labeled to control Fungus Gnats in plant beds or pots! Utilizing a similar mode of action for control of mosquito larvae, the Bits, either sprinkled on the soils surface or mixed with potting soil prior to planting will kill fungus gnat larvae with the same safety and target specific control offered for mosquito larvae.

EPA No. 6218-73.

Item No.	Description	MSRP
704657	Mosquito Bits 8 oz	\$12.49
704659	Mosquito Bits 30 oz	\$19.29

Monterey Take Down Garden Spray



A ready-to-use insecticide containing natural pyrethrin plus canola oil. Use on vegetables, fruits, houseplants, ornamentals, etc. Controls aphids, beetles, mealy bugs, caterpillars, plant bugs, etc. Kills all stages of insects, including eggs.

#704603 EPA No. 67702-5-54705. Not for sale in the following states at this time: DC, ND, SD, WY.

#704604 EPA No. 67702-6-54705. Not for sale in the following states at this time: DC, FL, ND, OK, SD, WY.

Item No.	Description	MSRP
704603	Take Down Garden Spray Pint	\$18.95
704604	Take Down Garden Spray RTU Quart	\$12.29

Monterey Neem Oil RTU



Ready to use (RTU) formulation for organic gardening. Has both fungicidal and insecticidal properties to control black spot, powdery mildew, spider mites, aphids, whitefly and more.

EPA No. 70051-13-54705. Not for sale in the following states at this time: ME, ND, RI, VT, WY.

Item No.	Description	MSRP
704609	Monterey Neem Oil RTU Quart	\$14.49

Monterey Insect Spray with Spinosad



For control of foliage feeding worms (caterpillars), thrips, fire ants and other listed pests in: Lawns, outdoor ornamentals, vegetables, apples, citrus and stone fruit. Contains spinosad, produced by fermentation. U.S. Patent Nos. 5,362,634 and 5,496,931.

EPA No. 62719-314-54705. Not for sale in the following states at this time: DC.

Item No.	Description	MSRP
704606	Insect Spray w/ Spinosad Pint	\$23.49
704607	Insect Spray w/ Spinosad Quart	\$38.95
704608	Insect Spray w/ Spinosad Gallon	\$130.95

Monterey B.t.



Ready to use (RTU) formulation for organic gardening. Has both fungicidal and insecticidal properties to control black spot, powdery mildew, spider mites, aphids, whitefly and more.

EPA No. 70051-106-54705. Not for sale in the following states at this time: ME, MN, ND, NH, RI, WY.

Item No.	Description	MSRP
704596	Monterey B.t. Pint	\$14.95
704597	Monterey B.t. Gallon	\$92.95

Monterey 70% Neem Oil



A broad spectrum insecticide, miticide and fungicide that controls numerous diseases as well as insects and mites. Use on vegetables, fruit trees, ornamentals, etc. Neem is ideal for use in organic gardens.

EPA No. 70051-2-54705.

Item No.	Description	MSRP
704613	Monterey 70% Neem Oil Conc. Pint	\$24.95



Monterey Sluggo®



Snail and slug control at its best. Sluggo® contains iron phosphate and can be used around pets and wildlife. Use with vegetable gardens up until harvest and remains effective after rain or sprinkling. A pellet that breaks down into fertilizer! 1 lb covers up to 2,000 sq. ft.



EPA No. 67702-3-54705.

Item No.	Description	MSRP
704598	Monterey Sluggo 2.5 lb	\$19.49

Monterey Once A Year Insect Control II



This insecticide is used as a soil drench on ornamental trees, shrubs and certain fruit and nut trees. It controls adelgids, leaf beetles, leafhoppers, mealy bugs, scale, whiteflies, borers and many others. Gives a full year of control.

EPA No. 228-525-54705. Not for sale in the following states at this time: DC, HI, IA, ND, NE.

Item No.	Description	MSRP
704616	Monterey Once A Year Insect Control II Quart	\$15.95
704617	Monterey Once A Year Insect Control II Gallon	\$47.95

Monterey Bi-Carb Old Fashion Fungicide



Potassium bicarbonate soluble powder for control of powdery mildew on roses, vegetables, grapes, fruit trees and ornamentals. Control powdery mildew the organic way. This is like the baking soda Grandma used.



EPA No. 54705-10. Not for sale in the following states at this time: AK, AR, DC, KS, KY, MS, ND, NE, OK, SD, WY.

Item No.	Description	MSRP
704618	Monterey Bi-Carb Old Fashion Fungicide 4 oz	\$10.95

ProZap® Insect Guard™



Kills flying and crawling insect pests including mosquitoes, flies, moths and spiders. This is long lasting, round the clock protection. Simply remove from package to activate Prozap® and begin controlling action.

EPA No. 5481-533-47000. Not for sale in the following states at this time: CT, DC, ME, PR, RI.

Item No.	Description	MSRP
704545	ProZap Insect Guard	\$17.95

Serenade® Garden Disease Control



Controls bacterial spot, powdery mildew, rust, gray mold, leaf blight, scab & more. Safe for gardeners to use as a natural, broad spectrum, effective fungicide that controls harmful diseases. Concentrate is 1 oz per gallon. Registered in all states.



#704341 EPA No. 69592-16.

#704345 EPA No. 69592-12.

Item No.	Description	MSRP
704341	Serenade Garden RTU Quart	\$11.29
704345	Serenade Garden Conc. Quart	\$22.99

Organocide™ 3-in-1 Organic Insecticide



A nature-safe, organic spray oil effective on a wide variety of insects, mites, armored and soft scales and certain fungal diseases. It is insecticidal to the eggs, larvae, and nymphs of insects and adults of soft bodied insects. Dilution Rate: Mix 2 oz with 1 gallon of water.



EPA No. FIFRA 25(b) Exempt.

Item No.	Description	MSRP
704100	Organocide 3-In-1 Conc. Quart	\$20.99
704102	Organocide 3-In-1 RTU 24 oz	\$13.99

Safer® End ALL™ Insect Killer



Kills over 45 different types of insects indoors and out. Wipes out insects & eggs with the combined killing power of pyrethrin & neem oil. Can be used up to day of harvest. For use on fruits, vegetables, flowers, trees & ornamentals.



EPA No. 59913-14. Not for sale in the following states at this time: PR.

Item No.	Description	MSRP
704156	Safer End All Insect Killer RTU Quart	\$11.19

Safer® Yard & Garden Insect Killer™ II



An environmentally friendly solution. Kills insects on contact, gentle on plants. Use on flowers, vegetables, shrubs and ornamentals. Use up to day of harvest. Potassium salts (insecticidal soap) weaken the insect's protective outer shell. Registered in all states.



EPA No. 59913-10.

Item No.	Description	MSRP
704105	Safer Yard & Garden Insect Killer II RTU	\$10.99

Safer® Insect Killing Soap



Use on houseplants, ornamental foliage plants, flowering plants and fruits and vegetables. Kills aphids, mealy bugs, spider mites and whiteflies. Check your local dealer partner for availability.



#704115 EPA No. 42697-59.
#704116 and 704117 EPA No. 42697-60.

Item No.	Description	MSRP
704115	Safer Insect Killing Soap w/ Seaweed Extract II RTU Quart	\$10.99
704116	Safer Insect Killing Soap II Conc. 16 oz	\$15.39
704117	Safer Insect Killing Soap II Conc. Gallon	\$82.95

Safer® Garden Fungicide



Can be used on fruits, flowers, vegetables, flowering plants and ornamentals. Controls and prevents black spot, rust, leaf spot and powdery mildew on roses. Contains sulfur. Registered in all states.



#704140 EPA No. 59913-11.
#704141 EPA No. 42697-37.

Item No.	Description	MSRP
704140	Safer Garden Fungicide II RTU Quart	\$10.99
704141	Safer Garden Fungicide Conc. 16 oz	\$15.29

Safer® 3-in-1 Garden Spray II



Provides three garden solutions in one: fungicide, insecticide, miticide. Its formulation kills garden insects and mites and controls fungal diseases. Registered in all states.



#704145 EPA No. 59913-12.
#704147 EPA No. 59913-13.

Item No.	Description	MSRP
704145	Safer 3-in-1 Garden Spray II RTU Quart	\$11.39
704147	Safer 3-in-1 Garden Spray Conc. Gallon	\$82.95

Safer® BioNEEM® Insecticide & Repellent



Neem Oil insect control for bedding, potted plants, trees & shrubs, lawns, yard & landscape, house plants, vegetable & fruit crops. Unique insecticide and repellent that controls over 30 common insect pests. Use on trees, shrubs, ornamentals and flowers. Registered in all states.



EPA No. 70051-6-42697.

Item No.	Description	MSRP
704150	Safer BioNeem Multi-Purpose Insecticide Conc. 16 oz	\$20.95

Safer® Caterpillar Killer for Trees, Shrubs & Vegetables



Safer® Brand Caterpillar Killer utilizes Dipel which, once ingested by the wayward caterpillar or worm, kills them within a few days. This insect killer is the most economical and natural pest control solution to caterpillars and worms on the market!



EPA No. 42697-23.

Item No.	Description	MSRP
704155	Safer Caterpillar Killer Conc. 16 oz	\$15.95
704154	Safer Caterpillar Killer Conc. Gallon	\$177.99

Safer® Pyrethrin & Insecticidal Soap Concentrate II



Safer® Brand Insecticidal Soap and Pyrethrin Concentrate can be used in your organic farm without sacrificing certification. One bottle makes 25 gals (treats up to 14,000 sq. ft.) of solution to eliminate hard and soft bodied insects on contact! Check your local dealer partner for availability.



EPA No. 59913-9. Not for sale in the following states at this time: AK, HI, NM, PR.

Item No.	Description	MSRP
704138	Safer Pyrethrin & Insecticidal Soap II Conc. Gallon	\$82.99

Bonide® Captain Jack's Dead Bug Brew®



Captain Jack's Deadbug Brew® contains Spinosad, a product first isolated from a naturally occurring soil dwelling bacterium. Use on fruits, vegetables, berries, citrus, grapes, nuts and ornamentals.

#704715 EPA No. 4-472. Not for sale in the following states at this time: PR.

#704720 and 704725 EPA No. 4-471. Not for sale in the following states at this time: AK, HI, PR.

Item No.	Description	MSRP
704715	Bonide Captain Jack's Dead Bug Brew RTU Quart	\$9.93
704720	Bonide Captain Jack's Dead Bug Brew Conc. Pint	\$20.29
704725	Bonide Captain Jack's Dead Bug Brew Conc. Quart	\$33.95

Bonide® Thuricide® (BT)



BT Kurstaki 15% is a liquid formulation of bacteria. Controls caterpillars, loopers, cabbage worms, horn worms, leaf folders and leaf rollers. One pint treats up to 10,875 sq. ft. Won't harm beneficial insects.

EPA No. 4-226. Not for sale in the following states at this time: PR.

Item No.	Description	MSRP
704740	Bonide Thuricide (BT) Conc. Pint	\$18.62

Bonide® Pyrethrin Garden Insect Spray



Natural Pyrethrin in a concentrated formula for economical, natural, broad spectrum garden insect control.

EPA No. 4-371. Not for sale in the following states at this time: CA, DC, PR.

Item No.	Description	MSRP
704745	Bonide Pyrethrin Garden Insect Spray Conc. 8 oz	\$15.49
704750	Bonide Pyrethrin Garden Insect Spray Conc. Pint	\$24.99

Bonide® Systemic Insect Control



Economical, long lasting insect control for ornamental gardens, shrubs and trees. Use as little as 1 tablespoon/gal.

EPA No. 239-2461-4. Not for sale in the following states at this time: AK, CA, HI, PR.

Item No.	Description	MSRP
704760	Bonide Systemic Insect Control Conc. Pint	\$20.95

Orcon Beneficial Insect Mail-Backs



Insects via Mail-Back gives your customers delivery of fresh live beneficial insects to home or job site. Choose from: Predatory Mites - Seeks out and kills many kinds of mites; Ladybugs - Most popular beneficial insect, both adult and larvae eat pests; Beneficial Nematodes (including Fungus Gnats) - Attacks over 230 kinds of soil dwelling and wood boring insects.

Item No.	Description	MSRP
733592	Orcon Predatory Mites Mail-back	\$54.99
733594	Orcon Ladybugs Mail-back	\$19.99
733596	Orcon Beneficial Nematodes Mail-back	\$36.99

Microbe-Lift® BMC - Biological Mosquito Control



Microbe-Lift® BMC kills developing mosquitoes before they become breeding, biting adults. It is a liquid product, so it has no adverse effect on the aesthetics of ponds and water features. Microbe-Lift® BMC can be applied to areas that can contain aquatic life, fish and plants. It can also be applied to areas used by or in contact with humans, animals, horses, livestock, pets, birds or wildlife. 2 oz treats 400 gallons for 2 years. 6 oz treats 2,000 gallons for 16 months.

EPA No. 62637-1-74466.

Item No.	Description	MSRP
717497	Microbe-Lift BMC 2 oz	\$20.99
717499	Microbe-Lift BMC 6 oz	\$26.83

Perma-Guard™ Diatomaceous Earth Fossil Shell Flour Food Grade



Perma-Guard™ OMRI certified Diatomaceous Earth is the purest food grade fresh water amorphous silica diatomaceous earth available. Perma-Guard™ is derived from fossilized diatoms remains. Perma-Guard™ is OMRI certified food grade which allows it to be used on food crops through harvest and is safe for human consumption.



#704092 and 704096 Not for sale in the following states at this time: AK, CT, DE, HI, KY, LA, MA, MD, ME, MS, ND, NH, NJ, PR, RI, SC, SD, VT, WV, WY.

#704094 and 704098 Not for sale in the following states at this time: AK, CT, DE, HI, LA, MA, MD, ME, MS, ND, NH, NJ, PR, RI, SC, SD, VT, WV, WY.

Item No.	Description	MSRP
704092	Perma Guard Diatomaceous Earth Fossil Shell Flour Food Grade 2 lb	\$10.95
704094	Perma Guard Diatomaceous Earth Fossil Shell Flour Food Grade 5 lb	\$17.95
704096	Perma Guard Diatomaceous Earth Fossil Shell Flour Food Grade 10 lb	\$27.95
704098	Perma Guard Diatomaceous Earth Fossil Shell Flour Food Grade 50 lb	\$39.95

Bug Screens



Active carbon inserts are proven to keep most bugs and pollutants from entering grow room. Minimal air flow restriction. Easily slips on and off inline fans. Mildew and UV resistant.

EXCLUSIVE

Item No.	Description	MSRP
704215	Black Ops Bug Screen w/ Active Carbon Insert 4 in	\$9.95
704220	Black Ops Bug Screen w/ Active Carbon Insert 6 in	\$11.95
704225	Black Ops Bug Screen w/ Active Carbon Insert 8 in	\$13.29
704230	Black Ops Bug Screen w/ Active Carbon Insert 10 in	\$14.95
704235	Black Ops Bug Screen w/ Active Carbon Insert 12 in	\$16.95

Pure™ 3 Way



Kills all leaf dwelling insects on contact as well as molds and mildew and feeds foliage. Read directions for applications. For serious problems and infestations, we recommend saturation of the leaves. We recommend rinsing 24 hours later but that is up to grower (we never do).

EPA No. FIFRA 25(b) Exempt.

Item No.	Description	MSRP
746412	Pure 3 Way Quart	\$14.99
746414	Pure 3 Way Gallon	\$38.00
746416	Pure 3 Way 2.5 Gallon	\$72.00
746418	Pure 3 Way 5 Gallon	\$136.99

Pure™ 3 Way Commercial



Pure™ 3-Way Commercial uses a specialized polarized blend of natural lemongrass and other safe botanical insecticides to suffocate mites and other leaf dwelling insects on contact. Insects will never develop a tolerance to this formula. 3-Way also kills through ingestion. It is also a natural anti-fungal that helps kill and prevent mold and mildew. Commercial grade non-RTU. Mix with 9-18 parts pH balanced water.

EPA No. FIFRA 25(b) Exempt.

Item No.	Description	MSRP
746420	Pure 3 Way Commercial Pint	\$39.99

Pure™ Green Thumb



Weekly preventative and overall plant health. Will repel bugs, keep mildew and mold off the plant and give you 30 percent more foliage growth. This product is good from rooted clone or seedling until the second week of flower or fruit. Mist the entire plant 1 time per week.

EPA No. FIFRA 25(b) Exempt.

Item No.	Description	MSRP
746424	Pure Green Thumb Quart	\$14.99
746426	Pure Green Thumb Gallon	\$38.00
746428	Pure Green Thumb 2.5 Gallon	\$72.00

Physan 20™



NEW Physan 20™ is a broad range disinfectant, fungicide, virucide and algacide which effectively controls a wide variety of pathogens on hard surfaces and plants. Physan 20™ is an EPA approved concentrate formulated with unique germicidal agents to provide overall protection. Physan 20™ controls disease-spreading organisms which can be carried from plant to plant.

EPA No. 55364-5. Not for sale in the following states at this time: AL, AR, GA, IA, IN, LA, MA, MS, ND, NH, NM, OK, RI, SC, SD, WI, WV, WY.

Item No.	Description	MSRP
749200	Physan 20 - 8 oz	\$7.29
749202	Physan 20 - Pint	\$11.29
749204	Physan 20 - Gallon	\$53.99

Novozyme Met52® EC



NEW Met52® EC Bioinsecticide is composed of spores of the insect pathogenic fungus *Metarhizium anisopliae* strain F52. Once the product is sprayed onto the foliage or applied as a soil drench, insects that come into contact with the fungus will become infected. The spores of *Metarhizium anisopliae* attach to the surface of the insect, germinate and begin to grow. It will penetrate the exoskeleton of the insect and grow inside the insect, causing the insect to die. Under moderate temperatures it usually takes 3 to 7 days, once the insect is exposed, for death to occur.

EPA No. 70127-10. Not for sale in the following states at this time: AL, AR, DC, FL, HI, IL, LA, MD, MN, MO, MS, NH, NV, PA, RI, TN, VT, WV, WY.

Item No.	Description	MSRP
726980	Novozymes Met 52 EC 8 oz	\$69.95

Grower's Edge® Illuminated Microscope 30x



A precision illuminated microscope with 30x magnification power. Focus can be adjusted by turning the wheel. Rotatable bulb can pinpoint the light on the object. Use to classify the type of pest invading your plants. Requires 2 AA batteries (not included).

EXCLUSIVE

Item No.	Description	MSRP
704477	Grower's Edge Illuminated Microscope 30x	\$18.95

Grower's Edge® Illuminated Microscope 60x - 100x



A very powerful illuminated pocket microscope offers adjustable magnification from 60x - 100x. Identify even the smallest pests with this microscope. Includes batteries and protective case. Actual size of microscope is 1-1/4 inch wide by 3-1/4 inch tall.

EXCLUSIVE

Item No.	Description	MSRP
704478	Grower's Edge Illuminated Microscope 60x - 100x	\$18.95

Grower's Edge® Magnifier Loupe 30x



Extremely powerful 30x magnification from optical-quality double glass lenses shows ultra-fine detail. This teardrop shaped folding magnifier is compact in size. Great detail for finding the smallest of pests on your plants.

EXCLUSIVE

Item No.	Description	MSRP
704465	Grower's Edge Magnifier Loupe 30x	\$14.95

Grower's Edge® Illuminated Magnifier Loupe 40x



Powerful 40x lens. Unique, compact folding design with durable casing. Excellent illumination on specimen provided by two 6500K LED's. Can be used to identify plants and potential garden pests. On/off switch for the two LED lights. Batteries included.

EXCLUSIVE

Item No.	Description	MSRP
704467	Grower's Edge Illuminated Magnifier Loupe 40x	\$14.95

Grower's Edge® Illuminated Microscope 60x



Illuminated with 3 LED lights. Focus adjusting lens barrel. Battery operated. 60x magnification. 2 light settings - high and low. On/Off switch. Includes storage case.

EXCLUSIVE

Item No.	Description	MSRP
704476	Grower's Edge Illuminated Microscope 60x	\$10.99

Grower's Edge® iPhone 5 Case with LED pocket Microscope 60x



Attach microscope to the included iPhone case to take pictures with your iPhone's built in camera. Images are stored in your iPhone's photo library. Great for record keeping and photo sharing. 60x magnification power. Compatible only with iPhone 5.

**NEW
LOWER
PRICE**

EXCLUSIVE

Item No.	Description	MSRP
704473	Grower's Edge iPhone 5 Case w/ LED Pocket Microscope 60x	\$13.49

Grower's Edge® LED Headband Magnifier with 5 Lenses



NEW The Grower's Edge LED Headband Magnifier includes 5 lenses from 1.0x to 3.5x magnification. The lenses can be installed in pairs for magnification up to 6.0x and 11 different combinations. The adjustable headband and lenses allows for hands free operation. View things easily with two bright white LED lights above the lenses. Includes a protect case for all 5 lenses. Takes AAA batteries not included.

EXCLUSIVE

Item No.	Description	MSRP
704461	Grower's Edge LED Headband Magnifier w/ 5 Lenses 1.0x - 1.5x - 2.5x - 3.0x - 3.5x	\$19.99

Carson Optical® MagniScope™

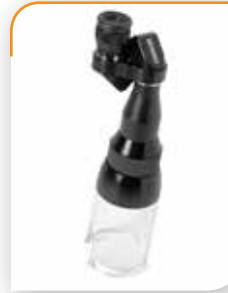

The MagniScope™ take two components combine to create three different optical devices...an 8 x 20mm Monocular, 3x power stand magnifier and when threaded together, a precision 30x portable Microscope.

Item No.	Description	MSRP
744010	Carson Optical MagniScope	\$71.95

Carson Optical® MicroMax™ LED Microscope



MicroMax™ LED is a powerful 60-100x power Magnification Microscope with an extremely lightweight and portable design. Features a built-in LED light that provides a bright, clear image and a rubberized eyepiece for comfortable viewing. Uses 3 SG3 button cell batteries (included).

Item No.	Description	MSRP
744015	Carson Optical MicroMax LED Microscope	\$15.49

Carson Optical® zOrb™ Digital Microscope



The zOrb™ is a digital microscope with an integrated camera that displays the magnified image on a computer screen. Impressive 35x magnification (14 in screen) allows you to see in great detail! Compatible with Microsoft Windows 98SE, ME, 2000, XP, XP Service Pack 3 Upgrade, Vista and MAC OSX 10.4 or later. A USB 2.0 port is required.

Item No.	Description	MSRP
744020	Carson Optical zOrb Digital Microscope	\$67.95

Buried Treasure®

HIGH QUALITY NATURAL BAT & SEABIRD GUANOS

WWW.BURIEDTREASUREGUANO.COM

LIKE PIRATE GOLD FOR YOUR PLANTS • Distributed exclusively by SUNLIGHT SUPPLY, INC.

Ultimate Wash™



Over the past few years NPK Industries/OGD has received numerous requests from gardeners to remove the food coloring from Mighty Wash®. We have heard these requests and created a new product – Ultimate Wash™ with no dyes. Ultimate Wash™ is the next generation of plant wash and can be used up to and including the day of harvest.

Item No.	Description	MSRP
704990	Ultimate Plant Wash Quart	\$15.95
704992	Ultimate Plant Wash Gallon	\$39.95
704994	Ultimate Plant Wash 2.5 Gallon	\$74.95
704996	Ultimate Plant Wash 5 Gallon	\$143.95
717992	Ultimate Wash Gravity Spray NEW	\$15.95

Mighty Wash®



Years of research have lead to the creation of this truly revolutionary plant wash. Apply it directly to the top and bottom of the leaves of your plant until the plant is fully saturated. Mighty Wash can be used throughout your plants entire growing and flowering cycle, up to and including the day of harvest.

Item No.	Description	MSRP
704800	Mighty Wash Quart	\$15.95
704805	Mighty Wash Gallon	\$39.95
704810	Mighty Wash 2.5 Gallon	\$74.95
704815	Mighty Wash 5 Gallon	\$143.95
717986	Mighty Wash Gravity Spray NEW	\$15.95

PM Wash



PM Wash works well for cleaning plants that are subject to humid environments. PM Wash is a non-toxic plant wash that leaves your plants vibrant and healthy. PM Wash can be used throughout your plants growing and flowering cycle, up to and including the day of harvest.

Item No.	Description	MSRP
704820	PM Wash Quart	\$15.95
704825	PM Wash Gallon	\$39.95
704830	PM Wash 2.5 Gallon	\$74.95
704835	PM Wash 5 Gallon	\$143.95
717988	PM Wash Gravity Spray NEW	\$15.95

Power Wash



Power Wash is a plant wash for removing unwanted residue left behind from foliar applied products. Pesticides, sticking agents, wetting agents and foliar applied nutrients can leave residue on your plants. Power Wash removes left behind residue, leaving your plants clean.

Item No.	Description	MSRP
704840	Power Wash Quart	\$13.95
704845	Power Wash Gallon	\$34.95
704850	Power Wash 2.5 Gallon	\$64.95
704855	Power Wash 5 Gallon	\$126.95
717990	Power Wash Gravity Spray NEW	\$15.95

Dyna-Gro™ Pure Neem Oil Organic Leaf Polish



Neem oil leaves a natural shine on leaves without clogging stomata that leaves need to take in carbon dioxide and release oxygen and water vapor essential to the basic functioning of the photosynthesis process.



Item No.	Description	MSRP
704425	Dyna-Gro Pure Neem Oil 8 oz	\$14.25
704430	Dyna-Gro Pure Neem Oil Quart	\$42.00

Earth Juice® goGnats® Liquid Concentrate



goGnats® is a poison-free alternative for the control of soil-fungus gnats, mites, aphids, moths & other garden/hydroponic pests. goGnats® liquid may be used as a plant & area spray, added to nutrient reservoirs or used as a soil drench. EPA No. FIFRA 25(b) Exempt. Not for sale in the following states at this time: IN, KY, MS, TN, VT.

Item No.	Description	MSRP
720327	GoGnats Liquid Conc. Pint	\$24.45

Einstein Oil®



Einstein Oil® uses only the finest grade, cold-pressed, wild-harvested, first extraction oil, making it the most effective neem product on the market. Mix 1/2 - 2 tsp. per quart of water and apply as a foliar spray to keep leaves and plants healthy.

Item No.	Description	MSRP
704535	Einstein Oil 4 oz	\$21.95
704540	Einstein Oil Pint	\$64.95

MOTHER EARTH



Premium Grow Media and Amendments

www.Mother-EarthProducts.com

Mother Earth® Coco - 100% Natural



Mother Earth® Coco substrate is 100% natural. It contains the highest quality mix of coco pith and coco fiber. RHP certified for quality, Mother Earth Coco® is pre-buffered and pH adjusted to neutral a 6.3-6.8. Mother Earth® Coco will promote strong root growth, populate microbial activity, discourage disease and insect outbreak and release nutrients evenly. This is uncharged inert media.

Item No.	Description	MSRP
714830	Mother Earth Coco 50 Liter 1.5 cu ft	\$22.95

Mother Earth® Charged Coco™ - 100% Natural



Mother Earth® Charged Coco™ is a natural plant growth media that is a great alternative to potting soil and other traditional growing medias. It is 100% natural, made from the fiber of coconut husks and is an alternative to peat based medias. It incorporates a specially formulated Nutrient Pack that allows growers to jump start their plants and help minimize the lag and stress of transplanting. Coco fiber provides an excellent water to air ratio. Not for sale in the following states at this time: WA.

Item No.	Description	MSRP
714835	Mother Earth Charged Coco 50 Liter 1.5 cu ft	\$23.95

Mother Earth® Coco + Perlite Mix - 100% Natural



Mother Earth® Coco + Perlite Mix is an RHP Certified natural plant growth media that is a great alternative to potting soil and other traditional growing medias. Coconut coir is 100% natural, made from the fiber of coconut husks and is an alternative to peat based Medias. Mother Earth® Coco + Perlite incorporates 70% of the finest coco pith and fiber blend as well as 30% perlite for better aeration and drainage. Increased aeration and more drainage allow gardeners to more aggressively feed without worrying about over watering. With its unsurpassed texture, porosity and high cation-exchange capacity, Mother Earth® Coco + Perlite creates the perfect growing environment.

Item No.	Description	MSRP
714837	Mother Earth Coco + Perlite Mix 50 Liter	\$23.95

Mother Earth® Hydroton® - Giant™



The original Hydroton® brand expanded clay is a unique, lightweight expanded clay aggregate made in Germany. This natural clay is mined, formed into pellets, then kiln fired at high temperatures to cause the clay to expand into tough, lightweight balls. Clay naturally has balanced capillary action, with an ideal surface structure. Hydroton® brand expanded clay is semi-porous and generally does not float like other products can. For best results, rinse all expanded clay before use. It is reusable as long as it is thoroughly cleaned between uses. 50 liter bags feature an easy pour spout. The size specification for Giant™ Hydroton® is 15-25 mm.

Item No.	Description	MSRP
714123	Hydroton Giant 50 Liter	\$37.95

Mother Earth® Hydroton® - Original



The original Hydroton® brand expanded clay is a unique, lightweight expanded clay aggregate made in Germany. This natural clay is mined, formed into pellets, then kiln fired at high temperatures to cause the clay to expand into tough, lightweight balls. Clay naturally has balanced capillary action, with an ideal surface structure. Hydroton® brand expanded clay is semi-porous and generally does not float like other products can. For best results, rinse all expanded clay before use. It is reusable as long as it is thoroughly cleaned between uses. 50 liter bags feature an easy pour spout. Size specification is 8-16 mm.

Item No.	Description	MSRP
714112	Hydroton Original 10 Liter	\$12.95
714114	Hydroton Original 25 Liter	\$21.95
714116	Hydroton Original 50 Liter	\$33.95

Mother Earth® Perlite & Coarse Perlite



Mother Earth® Perlite is naturally occurring siliceous rock that when heated to 1600° F expands up to 20 times its original volume. This kilning process is very similar to popping popcorn and produces a growing media that is sterile and has a neutral pH of 7.0. The exceptional physical properties of this perlite make it tops in the perlite world for adding porosity to soil and soilless mixes. This perlite has numerous hydroponic applications as well. The #4 is the largest perlite on the market and averages a whopping size of around 1 inch. The #3 measures around 1/2 inch and the Coarse is about 1/8 to 1/4 inch.

Item No.	Description	MSRP
713308	Mother Earth Coarse Perlite - 4 cu ft NEW	\$33.95
713310	Mother Earth Perlite # 3 - 4 cu ft	\$45.95
713315	Mother Earth Perlite # 4 - 4 cu ft	\$49.95

Mother Earth® Growstone Chunky Growing Media



Mother Earth® Growstone Chunky Growing Media is the perfect growing media for use in hydroponic growing systems as simple as manually irrigated containers or as advanced as automatically drip irrigated containers, Ebb-Flow systems and NFT tables. Mother Earth® Growstone Chunky Growing Media is designed to allow for rapid moisture absorption and enhanced drainage and oxygenation. 100% Recycled. 100% American made.

Item No.	Description	MSRP
713335	Mother Earth Growstone Chunky Growing Media 1.5 cu ft	\$31.95

Mother Earth® Growstone Coarse Soil Aerator



Mother Earth® Growstone Coarse Soil Aerator is the ideal aeration component of soil mixes. Its highly porous aggregates act as air pockets significantly enhancing aeration and drainage of an sphagnum peat, coco coir or composted soil-based mix. As a result, it creates the ideal environment for your plants' root systems and leads to healthy, thriving plants. 100% Recycled. 100% American made.

Item No.	Description	MSRP
713337	Mother Earth Growstone Coarse Soil Aerator 1.5 cu ft	\$21.95

Mother Earth® Composted Chicken Manure 3 - 2 - 2



Mother Earth® Composted Chicken Manure is a great amendment for mulching, feeding and retaining water in soil. Chicken Manure can add organic matter to a soil and also increase aeration. It has excellent water retaining properties along with the nutrients it supplies to plants make it a perfect addition to your soil. Mother Earth® Composted Chicken Manure is dry and composted for easy handling and application.

Item No.	Description	MSRP
713305	Mother Earth Composted Chicken Manure 25 lbs	\$15.95

Mother Earth® Premium BioChar



Mother Earth® BioChar is a fast and easy way to boost the performance of new soil and can improve the effectiveness of compost teas and mycorrhizal products. BioChar and its use in amending soil is an age old technique. Vegetative growth is more robust than areas that were not affected by the fires. Fire creates rich deposits of carbon in the soil and this increases soil fertility and encourages microbial activity, this is the effect that BioChar is used to recreate.

Item No.	Description	MSRP
713320	Mother Earth Premium BioChar 1 cu ft	\$34.95

Mother Earth® Worm Castings



Mother Earth® Worm Castings are an all-in-one soil amendment. Earthworms convert organic matter into humus, which is good for amending soils. Our worms are carefully fed with composted forest humus, corn meal, greensand, azomite, gypsum, oyster shell flour, walnut meal and alfalfa meal to ensure the best quality castings. Add Mother Earth® Worm Castings to any potting soil as an amendment or use as a primary ingredient in compost tea. Not for sale in the following states at this time: FL.

Item No.	Description	MSRP
713325	Mother Earth Worm Castings 1 cu ft	\$34.95

gro|dan®

Expect More. Demand Grodan.

Grodan® Stonewool A-OK Starter Plugs™



A-OK Starter Plugs™ for starting seeds and rooting of cuttings prior to plugging into the larger Gro-Blocks. A-OK Starter Plugs™ fit in a standard 10 x 20 tray.

Item No.	Description	Plugs/ Sheet	Sheets/ Case	Plugs/ Case	MSRP Case	MSRP Each
713020	Grodan A-OK 25/40 - 1 in x 1 in Plugs (200/ Sheet)	200	30	6000	\$412.13	\$15.11
713025	Grodan A-OK 36/40 1.5 in x 1.5 in Plugs (98/Sheet)	98	30	2940	\$374.33	\$13.73
713030	Grodan A-OK 50/40 2 in x 2 in Plugs (50/ Sheet)	50	30	1500	\$324.22	\$11.89

Grodan® Stonewool Gro-Slabs



Gro-Slabs provide the final stage for growing a spectacularly large plant. Transplant your Gro-Block™ plant onto a slab just like professional growers. Come in clearly marked biodegradable UV resistant sleeves for comfortable handling & algae prevention.

Item No.	Description	Slabs/ Case	MSRP Case	MSRP Each
713001	Grodan Expert Fat Slabs 15/100 6 in x 4 in x 36 in	12	\$124.03	\$11.37
713005	Grodan Expert Slab 15/75 6 in x 3 in x 36 in	12	\$93.04	\$8.53
713010	Grodan Expert Slab 20/75 8 in x 3 in x 36 in	12	\$120.79	\$11.07
713015	Grodan Classic Slab 30/75 12 in x 3 in x 36 in	8	\$121.41	\$16.69
713018	Grodan Uni-Slab 9.5 in x 8 in x 4 in	16	\$89.45	\$6.15

Grodan® Stonewool MacroPlugs™



Macroplugs™ are 1.5 in round with a slit that allows easy insertion of a cutting. These loose round plugs fit perfectly into the Gro-Block™ hole. For best results with these Macroplugs™ always insert them in a tray with individual cells.

Item No.	Description	Plugs/ Bag	Bags/ Case	MSRP Case	MSRP Each
713035	Grodan Macro Plug Round w/ Slit Bulk	—	—	\$319.38	\$0.18
713038	Grodan Macro Plug Round w/ Slit (50/Bag)	50	35	\$386.96	\$12.16

Grodan® Stonewool Delta Starter Mini-Blocks™



Mini-Blocks™ sit in a tray (flat) without support for easy starting of seeds and cuttings. These Mini-Blocks™ are individually wrapped in white plastic to minimize algae growth. Packed in easy tear away strips, labeled with instructions.

Item No.	Description	Blocks/ Strip	Strips/ Case	Blocks/ Case	MSRP Case	MSRP Each
713040	Grodan 1.5 in Starter Mini-Blocks MM40/40 1.5 in x 1.5 in x 1.5 in (3 Strips of 15 or 45 ct)	15	50	2250	\$429.81	\$9.46
713045	Grodan 2 in Starter Mini-Blocks MM50/40 2 in x 2 in x 2 in (2 Strips of 12 or 24 ct)	12	60	1440	\$388.52	\$7.12

Grodan® Stonewool Delta Gro-Blocks™ & Big Mama



Gro-Blocks™ are similar to a plant container. Need a 3 in pot? Then choose a 3 in Gro-Block™. Small plants can be fully grown in our larger Gro-Blocks™. Holes are perfect size for any 1.5 in starter plug. Come in packs labeled with instructions.

Item No.	Description	Blocks/ Strip	Strips/ Case	Blocks/ Case	MSRP Case	MSRP Each
713050	Grodan Delta 4 - 3 in Block 3 in x 3 in x 2.5 in No Hole	8	48	384	\$265.91	\$6.09
713055	Grodan Delta 4 Block 3 in x 3 in x 2.5 in w/ Hole	8	48	384	\$265.93	\$6.09
713060	Grodan Delta 5.6 - 3 in Block 3 in x 3 in x 4 in w/ Hole	8	32	256	\$265.84	\$9.14
713065	Grodan Delta 6.5 - 4 in Block 4 in x 4 in x 2.5 in w/ Hole	6	36	216	\$207.00	\$6.32
713075	Grodan Delta 8 - 4 in Block 4 in x 4 in x 3 in w/ Hole	6	30	180	\$238.99	\$8.76
713080	Grodan Delta 10 - 4 in Block 4 in x 4 in x 4 in w/ Hole	6	24	144	\$220.81	\$10.12
713085	Grodan Delta Hugo 6 in Block 6 in x 6 in x 6 in w/ Hole	1	48	48	\$162.55	\$3.73
713088	Grodan Delta Big Mama Block 8 in x 8 in x 8 in	1	18	18	\$141.87	\$8.67

Get Dialed in
to GROLOG™
Your free mobile
app from Grodan.

www.grodan101.com

Grodan® Stonewool Grow-Chunks™



Light, airy & versatile. Grow-Chunks™ are about 3/4 inch square each and can be used in pots around blocks or alone. They are easily combined with other media, such as layering with coco fiber or clay pellets.

Item No.	Description	MSRP Case	MSRP Each
713108	Grodan Stonewool Grow Chunks 2 cu ft	\$125.07	\$64.94

Grodan® Stonewool Grow-Cubes™



Grow-Cubes™ are small loose 1/2 in cubes of stonewool. Advantages are better aeration, maximum drainage so that you can hardly ever over water your plant, easy mixing with other loose media, lightweight and much cleaner than peat-based media.

Item No.	Description	MSRP Case	MSRP Each
713095	Grodan Growcubes Large 2 cu ft	\$125.07	\$45.86
713100	Grodan Growcubes Medium 1 cu ft	\$155.22	\$28.46
713105	Grodan Growcubes Bulk Loose Box	\$101.69	\$101.69

Grodan® Pargro Quick Drain™ Stonewool



Pargro Quick Drain™ Stonewool - Better quality and drainage than other value-priced rockwool. Driest value-priced rockwool on the market.

Item No.	Description	Pcs/ Unit	Units/ Case	MSRP Case	MSRP Each
713210	Grodan Pargro QD 1.5 in Plug (1372) 1.5 in x 1.5 in x 1.5 in	98	14	\$151.41	\$11.90
713215	Grodan Pargro QD 1.5 in Block (1170) 1.5 in x 1.5 in x 1.5 in	45	26	\$180.52	\$7.64
713220	Grodan Pargro QD 3 in Block (192) 3 in x 3 in x 2.5 in w/ Hole	8	24	\$104.50	\$4.79
713223	Grodan Pargro QD 3 in Block (192) 3 in x 3 in x 2.5 in No Hole	8	24	\$98.29	\$4.51
713225	Grodan Pargro QD 4 in x 2.5 in Block (216) w/ Hole	6	216	\$179.98	\$4.99
713230	Grodan Pargro QD 4 in x 4 in Block (72) w/ Hole	6	12	\$75.77	\$6.95
713235	Grodan Pargro QD 6 in x 36 in Slab	1	12	\$70.44	\$6.46
713250	Grodan Pargro QD Jumbo Block 6 in x 6 in x 4 in w/ Hole	1	36	\$81.81	\$2.50
713257	Grodan Pargro QD Biggie Block 6 in x 6 in x 6 in w/ Hole /48 Pack	1	48	\$128.88	\$2.95

Grodan® Gro-Wool™ Absorbent Granulate



Granulated rockwool works great on its own or mixed with other loose media such as expanded clay rocks or coconut fiber. If planting in containers outdoors, Water Absorbent Granulate is the best medium of choice.

Item No.	Description	Pkt Qty	MSRP Each
713090	Grodan Gro-Wool Absorbent Granulate	18	\$76.70

Mother Earth® Coco Covers



Mother Earth® Coco Covers are a naturally derived replacement for plastic covers. These 100% natural coconut coir fiber covers work great for preventing algae from growing on top of your rockwool blocks. Available in 4, 6 and 8 inch squares for use with Grodan blocks. Also the 8 inch custom cover works well with Flo-n-Gro® Ebb & Flow systems. Tired of algae growing on top of your media, Mother Earth® has you covered.

EXCLUSIVE

Item No.	Description	MSRP
714716	Mother Earth Coco Cover 4 in 1=10/Pack	\$4.49
714718	Mother Earth Coco Cover 6 in 1=10/Pack	\$5.49
714720	Mother Earth Coco Cover 8 in 1=10/Pack	\$8.29

Grower's Edge® Block Covers



For blocks of rockwool and other grow media. These Grower's Edge® Block Covers blocks light from media—which helps reduce algae. Use white side up to reflect light. Use toothpick to hold cover in place. Hole in center of cover measures 1/2 inch in diameter.

EXCLUSIVE

Item No.	Description	MSRP
714820	Grower's Edge Block Covers 4 in 40/Pack	\$9.95
714822	Grower's Edge Block Covers 6 in 40/Pack	\$17.95

Drip Cap®



The DripCap® is a patented water conservation tool & grow medium protector. It uses a new innovative dripping method, & hose holding technology.

Item No.	Description	MSRP
714867	Drip Cap 4 in	\$2.69
714873	Drip Cap 6 in	\$3.49

Cube Cap®



The CubeCap® deprives the cube of its light by reflecting it back up towards the plant and away from the top of the block. The CubeCaps® patented technology allows the necessary air exchange by way of its unique elevated, vented design.

Item No.	Description	MSRP
714870	Cube Cap 4 in	\$1.99
714875	Cube Cap 6 in	\$2.49

Supreme Extra Large Perlite



Perlite is a naturally occurring, volcanic rock and 100% natural. When furnaced at high temperatures, Perlite pops and expands up to 15 times its original volume. The resulting, lightweight particles are made up of microscopic spheres with a porous, broken surface that promotes plant growth. This allows aeration and drainage of the root system and provides holding capacity for water and nutrients.

Item No.	Description	MSRP
713330	Supreme Extra Large Perlite 4 cu ft	\$47.95

FoxFarm® Ocean Forest® Potting Soil 12 Quart



Ocean Forest® Potting Soil is perfect for containers and is ready to use right out of the bag. Nutrient rich, this mix is a powerful blend of Pacific Northwest Sea-Going fish, crab meal, shrimp meal and plenty of earthworm castings, one of nature's finest soil amendments. Ocean Forest® is pH adjusted at 6.3 to 6.8 to allow for optimum fertilizer uptake. Not for sale in the following states at this time: FL, IN, MO, PR, SD.

Item No.	Description	MSRP
714304	FoxFarm Ocean Forest 12 Quart	\$9.95
714317	FoxFarm Ocean Forest 12 Quart (FL,IN,MO Label)	\$9.95

FoxFarm® Ocean Forest® Potting Soil 1.5 cu ft



Ocean Forest® Potting Soil is perfect for containers and is ready to use right out of the bag. Nutrient rich, this mix is a powerful blend of Pacific Northwest Sea-Going fish, crab meal, shrimp meal and plenty of earthworm castings, one of nature's finest soil amendments. Ocean Forest® is pH adjusted at 6.3 to 6.8 to allow for optimum fertilizer uptake. Not for sale in the following states at this time: FL, IN, MO, PR.

Item No.	Description	MSRP
714305	FoxFarm Ocean Forest Organic Potting Soil 1.5 cu ft	\$21.95
714315	FoxFarm Ocean Forest Organic Potting Soil 1.5 cu ft (FL,IN,MO Label)	\$21.95

FoxFarm® Happy Frog® Soil 12 Quart



Highly recommended for container gardens. Ready to use right out of the bag and is pH adjusted. Our unique mix is alive with beneficial soil microbes and mycorrhizal fungi that dramatically expand root development enabling plants to feed more aggressively. The benefits are strong plant structure, vigorous vegetative growth, with enhanced fruit and flower production. Not for sale in the following states at this time: FL, GA, HI, IN, MO, PR, SD.

Item No.	Description	MSRP
714303	FoxFarm Happy Frog Soil 12 Quart	\$9.95
714322	FoxFarm Happy Frog Soil 12 Quart (FL,IN,MO Label)	\$9.95

FoxFarm® Happy Frog® Soil 2 cu ft



Highly recommended for container gardens. Ready to use right out of the bag and is pH adjusted. Our unique mix is alive with beneficial soil microbes and mycorrhizal fungi that dramatically expand root development enabling plants to feed more aggressively. The benefits are strong plant structure, vigorous vegetative growth, with enhanced fruit and flower production. Not for sale in the following states at this time: FL, GA, HI, IN, MO, PR, SD.

Item No.	Description	MSRP
714302	FoxFarm Happy Frog Soil 2 cu ft	\$21.95
714320	FoxFarm Happy Frog Soil 2 cu ft (FL,IN,MO Label)	\$21.95

FoxFarm® Happy Frog® Soil Conditioner



Our soil conditioner is fine-screened, with generous helpings of earthworm castings, bat guano and beneficial microbes. It is inoculated with naturally occurring mycorrhizal fungi that dramatically expand root development enabling plants to feed more aggressively. Add the Soil Conditioner to existing garden soil to increase aeration, improve soil drainage and break up clay. Not for sale in the following states at this time: FL, HI, IL, IN, MO, PR, SD.

Item No.	Description	MSRP
714301	FoxFarm Happy Frog Soil Conditioner 3 cu ft	\$25.95
714321	FoxFarm Happy Frog Soil Conditioner 3 cu ft (FL, IN, MO Label)	\$25.95

FoxFarm® Planting Mix



This premium organic planting mix has everything to get the garden off to a good start: earthworm castings, bat guano, Norwegian kelp meal, composted forest humus, sphagnum peat moss and a whole lot more. A carefully adjusted pH ensures optimum nutrient uptake. Original Planting Mix holds moisture in the soil. Not for sale in the following states at this time: FL, IL, IN, MO, PR.

Item No.	Description	MSRP
714300	FoxFarm Planting Mix 1 cu ft	\$17.95
714328	FoxFarm Planting Mix 1 cu ft (FL,IN,MO Label)	\$17.95

FoxFarm® Light Warrior® Grow Medium



All natural, pH balanced blend designed to promote optimal seed germination and enhance root development. Light Warrior® is packed with beneficial microbes that stimulate root growth and encourage nutrient uptake. We also include plenty of earthworm castings. Use Light Warrior® for seed germination, cuttings and new plant starts for both indoor and outdoor cultivation. Not for sale in the following states at this time: FL, GA, HI, IN, MO, PR, SD.

Item No.	Description	MSRP
714310	FoxFarm Light Warrior Grow Medium 1 cu ft	\$22.95
714325	FoxFarm Light Warrior Grow Medium 1 cu ft (FL,IN,MO Label)	\$22.95

FoxFarm® Bushdoctor® Coco Loco® Potting Mix



Coco Loco® Potting Mix has the ability to hold more than its weight in water while still draining well. The coir in Coco Loco® behaves like little sponges offering nutrients and water as needed by the plants. Lower humidity reduces the possibility of mold and root rot and leaving insects. Not for sale in the following states at this time: FL, GA, HI, IN, MO, NH, PR.

Item No.	Description	MSRP
714295	FoxFarm Coco Loco Potting Mix 2 cu ft	\$20.95
714297	FoxFarm Coco Loco Potting Mix 2 cu ft (FL, IN, MO Label)	\$20.95

FoxFarm® Bushdoctor® Lucky Dog™ K-9 Kube™ Growers Blend



This light airy blend of peat moss and perlite is the key to every gardener's quandary. Unleash the Lucky Dog™ K-9 Kube™ and plant directly into this richly amended mix. It is loaded with beneficial microbes that expand root development to optimize nutrient availability to plants. Not for sale in the following states at this time: FL, GA, HI, IN, MO, NH, PR.

Item No.	Description	MSRP
714290	FoxFarm Lucky Dog K-9 Kube 3.8 cu ft	\$60.95
714292	FoxFarm Lucky Dog K-9 3.8 cu ft (FL,IN,MO Label)	\$60.95

FoxFarm® Salamander Soil™ Potting Mix



NEW Plants that are grown in hot climates need that extra thirst quench so that they can stay vigorous and not get stressed from drying out. The inconvenience of frequent waterings is sometimes problematic for growers who just can't get to their plants in time. Use Salamander Soil™ for rooted cuttings and young plant starts for both indoor and outdoor cultivation. Plant directly into Salamander Soil™ Potting Mix.

Item No.	Description	MSRP
714277	FoxFarm Salamander Soil Potting Mix 1.5 Cu Ft	\$18.95
714278	FoxFarm Salamander Soil Potting Mix 1.5 Cu Ft (FL, IN, MO Label)	\$18.95

FoxFarm® Ocean Forest® Potting Soil Tote 55 cu ft



NEW Ocean Forest® Potting Soil is perfect for containers and is ready to use right out of the bag. Nutrient rich, this mix is a powerful blend of Pacific Northwest Sea-Going fish, crab meal, shrimp meal and plenty of earthworm castings, one of nature's finest soil amendments. Ocean Forest® is pH adjusted at 6.3 to 6.8 to allow for optimum fertilizer uptake. Totes may be stocked on a limited basis. They are available as special order or as drop shipments.

Item No.	Description	MSRP
714260	FoxFarm Ocean Forest Potting Soil Tote 55 Cu Ft	\$677.95
714262	FoxFarm Ocean Forest Potting Soil Tote 55 Cu Ft (FL, IN, MO Label)	\$692.95

FoxFarm® Happy Frog® Soil Tote 55 cu ft



NEW Highly recommended for container gardens. Ready to use right out of the bag and is pH adjusted. Our unique mix is alive with beneficial soil microbes and mycorrhizal fungi that dramatically expand root development enabling plants to feed more aggressively. The benefits are strong plant structure, vigorous vegetative growth, with enhanced fruit and flower production. Totes may be stocked on a limited basis. They are available as special order or as drop shipments.

Item No.	Description	MSRP
714264	FoxFarm Happy Frog Potting Soil Tote 55 Cu Ft	\$528.95
714266	FoxFarm Happy Frog Potting Soil Tote 55 Cu Ft (FL, IN, MO Label)	\$528.95

FoxFarm® Bushdoctor® Coco Loco® Potting Mix Tote 55 cu ft



NEW Coco Loco® Potting Mix has the ability to hold more than its weight in water while still draining well. The coir in Coco Loco® behaves like little sponges offering nutrients and water as needed by the plants. Lower humidity reduces the possibility of attracting mold and root rot, as well as leaving insects less likely to bother your potted plants. Totes may be stocked on a limited basis. They are available as special order or as drop shipments.

Item No.	Description	MSRP
714272	FoxFarm Coco Loco Potting Mix Bulk Tote 55 Cu Ft	\$512.95
714274	FoxFarm Coco Loco Potting Mix Bulk Tote 55 Cu Ft (FL, IN, MO Label)	\$512.95

FoxFarm® Bushdoctor® Lucky Dog™ H-9 Growers Blend Tote 55 cu ft



NEW This light airy blend of peat moss and perlite is the key to every gardener's success. Unleash the Lucky Dog® and plant directly into this richly amended mix. Ultra-premium Growers Blend is loaded with beneficial microbes that expand root development to optimize nutrient availability to plants. Lucky Dog® is Howling Good Stuff!™ Totes may be stocked on a limited basis. They are available as special order or as drop shipments.

Item No.	Description	MSRP
714268	FoxFarm Lucky Dog K-9 Grower's Blend Bulk Tote 55 Cu Ft	\$670.95
714270	FoxFarm Lucky Dog K-9 Grower's Blend Bulk Tote 55 Cu Ft (FL, IN, MO Label)	\$670.95

Roots Organics Soilless Hydro Coco Mix



A unique formulation of the highest quality coco fiber/Coir on the planet which is repeatedly washed for an incredibly low EC, composted for over twenty-four months, and specially blended with extra long fibers, perlite and pumice.

Item No.	Description	MSRP
715165	Roots Soilless Coco Media 1.5 Cu Ft	\$28.95

Roots Organics GreenFields Potting Soil



Roots Organics GreenFields potting mix was created as a super premium planting mix. It was designed with a high nitrogen content and greater water holding capacity, less perlite and pumice and specific ingredients for vigorously growing plants.

Item No.	Description	MSRP
715170	Roots Organics GreenFields Potting Soil 1.5 Cu Ft	\$25.95

Roots Organics Original Potting Soil



A truly exceptional ready-to-use coco fiber-based potting soil. We begin with the highest quality coco fiber/Coir which is repeatedly washed for low EC and composted. This soil is amended with organic ingredients.

Item No.	Description	MSRP
715157	Roots Organics Original Potting Soil .75 Cu Ft	\$15.95
715160	Roots Organics Original Potting Soil 1.5 Cu Ft	\$25.95

Roots Organics Formula 707



Formula 707 is a ready to use soil created for fast growing, heavy feeding plants. It was designed with greater water holding capacity, less perlite and pumice and a light charge of nutrients for a good back bone but plenty of room for you to amend.



Item No.	Description	MSRP
715167	Roots Organics Formula 707 3 Cu Ft	\$46.95
715168	Roots Organics Formula 707 1.5 Cu Ft	\$24.95

Roots Organics Big Worm



Roots Organics Premium Worm Castings is a distinctive natural soil amendment. Our worms are carefully tended and fed an unparalleled blend of organic compost, rock dust and kelp for exceptional quality castings.



Item No.	Description	MSRP
715158	Roots Organics Big Worm 1 Cu Ft	\$55.95

Roots Organics CocoPalms



Roots Organics CocoPalms is made from coconut husk. CocoPalms has a near perfect natural pH level for optimum nutrient uptake and is specifically designed as the ultimate growing media for vigorous plants.

Item No.	Description	MSRP
715162	Roots Organics CocoPalms 1.5 Cu Ft	\$25.95

Roots Organics Green Lite



Roots Organics Green Lite growing mix is an aggressive, free draining indoor/outdoor potting mix. Green Lite is designed with more perlite and pumice to give you enhanced drainage and greater oxygen in the root zone and with specific ingredients for versatile container gardening.

Item No.	Description	MSRP
715172	Roots Organics Green Lite 1.5 Cu Ft	\$26.95

Roots Organics Emerald Mountain Mix



Roots Organics Emerald Mountain Potting Mix is created for the quality conscious consumer, the special breed looking for the highest levels of performance and economy. Emerald Mountain is a more economical yet well balanced organic growing media incorporating more water holding capacity while still maintaining a reliably free draining indoor and outdoor potting mix.

Item No.	Description	MSRP
715216	Roots Organics Emerald Mountain Mix 1.5 Cu Ft	\$22.95

Roots Organics Earth Worm



NEW Roots Organics Earth Worm vermicompost contains organic matter to assist in soil aggregation and improve cation exchange capacity of soils. Our earthworms are carefully tended and fed an unparalleled blend of natural and organic feedstocks for exceptional quality vermicompost. Roots Organics Earth Worm is a great amendment or top dress to aid in the proliferation of soil microbes and encourage vigorous root growth.



Item No.	Description	MSRP
715159	Roots Organics Earth Worm 1 Cu Ft	\$22.95

Roots Organics B2 Professional Growing Mix



Well balanced between water holding capacity and drainage, B2 is designed for absolute consistency and control. The blend is composed of outstanding ingredients, which guarantees excellent performance as a primary media or as a foundation for any of your custom mixtures.

Item No.	Description	MSRP
715218	Roots Organics Professional Growing Mix 2 Cu Ft	\$27.95

Roots Organics Compressed Coco Fiber



Roots Organics Coco Fiber is made from 100% pure coco fiber. This specially designed Coco Fiber has been created with increased fiber content for an ideal air to water ratio, and is perfect for mixing into your other media.



Item No.	Description	MSRP
715405	Roots Organics Compressed Coco Fiber 5 kg	\$13.95

Roots Organics Coco Chips Block



Roots Organics Coco Chips are composed of 100% pure coco fiber from coconut husks. Ideal for mixing into outdoor potting soils or into indoor container media. Add water to expand block, makes approximately 2.1 cubic feet or 16 gallons of media.



Item No.	Description	MSRP
715410	Roots Organics Coco Chips Block 4.5 kg	\$19.95

Roots Organics Coco Bird's Nest



Roots Organics Coco Bird's Nest is composed of 100% pure coco fiber from coconut husks. Roots Organics Coco Bird's Nest has been specifically designed with increased fiber content for an ideal air to water ratio.



Item No.	Description	MSRP
715415	Roots Organics Coco Birds Nest 4 kg	\$19.95

Aurora Innovations Precision Perlite



Aurora Innovations' advanced sourcing and manufacturing produces only the highest quality and most consistent materials.



Item No.	Description	MSRP
715212	Aurora Innovations Precision Perlite Coarse 2 cu ft	\$18.95
715214	Aurora Innovations Precision Perlite Coarse 4 cu ft	\$33.95

Growstone® GS-1 Hydroponic



Growstone® GS-1 Hydroponic Substrate is the perfect growing media for use in hydroponic growing systems as simple as manually irrigated containers or as advanced as automatically drip irrigated containers, Ebb-Flow systems and NFT tables. Growstones® are designed to allow for rapid moisture absorption and enhanced drainage and oxygenation.



Item No.	Description	MSRP
714231	Growstone GS-1 Hydroponic 1.5 cu ft	\$31.95

Growstone® GS-2 Mix Soil Aerator



Ideal aeration component of soil mixes. Its highly porous aggregates act as air pockets significantly enhancing aeration and drainage of an sphagnum peat, coco coir or composted soil-based mix. As a result, it creates the ideal environment for your plants' root systems and leads to healthy, thriving plants. 100% Recycled. 100% American made.



Item No.	Description	MSRP
714233	Growstone GS-2 Mix This Soil Aerator 1.5 cu ft	\$21.95

Growstone® GS-3 Coco-Mix™



GS-3 Coco-Mix™ combines the high porosity of Growstone® with the great water holding capacity and biological benefits of high quality buffered coco coir and redwood fiber, topped with a high concentration of mycorrhizae from Xtreme Gardening (RTI).



Item No.	Description	MSRP
714242	Growstone GS-3 Coco Mix 1.5 cu ft. Bag	\$28.95

Growstone® GS-4 Moisture Coco-Mix™



NEW GS-4 Moisture is a ready-to-use Growstone® Coco-Mix™ designed for hand watering with triple washed coco coir and added beneficial microbes (Xtreme Mykos). This blend holds water while maintaining excellent aeration, eliminating compaction and preventing overwatering & root rot. Growstone® manufactures products for the horticultural industries like hydroponics, aquaponics, green roofs, vertical walls, water filtration and other markets making use of recycled glass that would otherwise be buried in landfills.



Item No.	Description	MSRP
714244	Growstone GS-4 Moisture Coco-Mix 1.5 cu ft	\$28.95

Growstone® Gnat Nix!™



Gnat Nix!™ is the only scientifically proven, environmentally friendly fungus gnat control product on the market. Trials at Kansas University have shown that used as a top dressing, Gnat Nix!™ is an effective physical barrier against fungus gnats. Gnat Nix!™ controls gnats at different points of their lifecycle, preventing adult emergence from hatching larvae and deterring females from laying eggs in the growing media.



Item No.	Description	MSRP
714240	Growstone Gnat Nix 9 Liter	\$13.99
714241	Growstone Gnat Nix 1.5 cu ft	\$57.95

Klasmann® Base Substrate 2 Medium Plus Perlite



NEW Klasmann® Base Substrate 2 is a tried and true universal blend of fine to medium structure peat that allows for a wide range of growing from trays to containers. It contains 20% perlite for better drainage and aeration. This particular mix is a base peat mix, giving growers full control over adding their fertilizer of choice. Klasmann® products contain a proprietary wetting agent called "Hydro S" that allows for more rapid water uptake, optimizes water distribution and has enhanced long-term action. RHP certified.



EXCLUSIVE

Item No.	Description	MSRP
714950	Klasmann Base Substrate 2 Medium Plus Perlite 4.0 cu ft	\$53.95

Klasmann® TS 1 Plus Perlite Fine



NEW Klasmann® TS 1 Fine plus perlite is an extra-fine structured mix that is rich and superior and a great universal blend. The peat used in TS 1 Fine plus 15% perlite is harvested carefully and there is no high speed milling involved. Because of this harvesting technique, growers are left with a highly porous, top performance mix that enhances root development, promotes sustainability and ultimate security. Klasmann® products contain a proprietary wetting agent called "Hydro S"



EXCLUSIVE that allows for more rapid water uptake, optimizes water distribution and has enhanced long-term action. Great for use in trays and small pots. RHP certified.

Item No.	Description	MSRP
714955	Klasmann TS 1 Plus Perlite Fine 4.0 cu ft	\$51.95

Klasmann® TS 4 Plus Perlite Medium



NEW Klasmann® TS 4 Medium plus perlite contains two very select types of peat structure, which create a state-of-the-art mix that is popular with professional growers all over the world. The first of these two peat structures is Sod Peat Fraction 2 which has larger pores that significantly increase air and drainage capacity. Secondly TS 4 contains short cut peat fibers. These short cut fibers evenly distribute water in a pot/container. The combination of these two different cuts of peat



EXCLUSIVE create a perfect universal blend for all types of growing. Klasmann® products contain a proprietary wetting agent called "Hydro S" that allows for more rapid water uptake, optimizes water distribution and has enhanced long-term action. 10% perlite further helps increase aeration and drainage. RHP certified.

Item No.	Description	MSRP
714960	Klasmann TS 4 Plus Perlite Medium 4.0 cu ft	\$50.95

Premier Tech Pro-Mix® BX



Pro-Mix® BX Mycorrhizae™ is a general purpose peat-based growing medium containing, a beneficial mycorrhizal inoculum (*Glomus intraradices*). These microscopic fungi attach to and colonize the root systems working in symbiosis with plants.

Item No.	Description	MSRP
713400	Premier Horticulture Pro-Mix BX 3.8 cu ft	\$49.95

Premier Tech Pro-Mix® BX Biofungicide™ + Mycorrhizae™



Pro-Mix® BX Biofungicide + Mycorrhizae™ is a general purpose peat-based professional growing medium suitable for a wide variety of horticultural plants and transplanting applications.

Item No.	Description	MSRP
713435	Premier Pro-Mix BX BioFungicide + Mycorrhizae 2.8 cu ft	\$25.95
713430	Premier Pro-Mix BX BioFungicide + Mycorrhizae 3.8 cu ft	\$53.95

Premier Tech Pro-Mix® HP



Pro-Mix® HP Mycorrhizae™ is a high porosity peat-based growing medium. This formula ensures optimum growth, especially when high air capacity and extra drainage are required.

Item No.	Description	MSRP
713405	Premier Horticulture Pro-Mix HP 3.8 cu ft	\$50.95

Premier Tech Pro-Mix® HP Biofungicide™ + Mycorrhizae™



Pro-Mix® HP Biofungicide + Mycorrhizae™ is a high porosity peat-based growing medium, ideal for water sensitive crops, rooting cutting and/or low-light growing conditions. Pro-Mix® HP Biofungicide + Mycorrhizae™ is suitable for a wide variety of horticultural plants, especially when high air capacity and extra drainage are required.

Item No.	Description	MSRP
713445	Premier Pro-Mix HP BioFungicide + Mycorrhizae 2.8 cu ft	\$27.95
713440	Premier Pro-Mix HP BioFungicide + Mycorrhizae 3.8 cu ft	\$54.95

Premier Tech Pro-Mix® HP-CC Mycorrhizae™



Pro-Mix® HP-CC Mycorrhizae™ is a lightweight, high-porosity peat-based growing medium that contains chunk coir. It ensures optimum growth, especially when high air capacity and extra drainage are required. It is ideal for water-sensitive crops, rooting cuttings and/or low-light growing conditions.

Item No.	Description	MSRP
713425	Premier Pro-Mix HP-CC Mycorrhizae 3.8 cu ft	\$51.95

Premier Tech Pro-Mix® CC40 Mycorrhizae



NEW With Pro-Mix® CC40 discover a new generation of coir growing media. The unique structure of the coir found in CC40 provides an optimized growing environment for plants such as long term crops especially under drought conditions. The well-designed air porosity and water retention qualities provided by this peat-coir based medium give growers the opportunity to react efficiently to a more hostile environment at the same time as balancing financial requirements and productivity.

Item No.	Description	MSRP
713407	Premier Pro-Mix CC40 Mycorrhizae 3.8 cu ft	\$50.95

Black Gold® Natural & Organic Potting Soil



This rich, loamy mix is a premium choice for all-purpose gardening applications. Our 100% organic base consists of screened earthworm castings, Canadian sphagnum peat moss, compost and forest humus.



Item No.	Description	MSRP
714750	Black Gold Natural & Organic Potting Soil 1.5 cu ft	\$15.95

Black Gold® Waterhold Cocoblend Soil



The combination of coconut fibers (coir) and Canadian sphagnum peat moss gives your outdoor container plants the advantage of water retention against constant exposure to heat, wind and sun.



Item No.	Description	MSRP
714754	Black Gold Waterhold Cocoblend Soil 2 cu ft	\$19.95

Black Gold® Just Coir Loose



This OMRI listed low salt organic material is just what the name implies, Just Coir, actually coconut coir pith. We take the highest quality coir available, rinse it to reduce salts and then reconstitute it from a compressed bale.



Item No.	Description	MSRP
714565	Black Gold Just Coir Loose 2 cu ft	\$19.95

Black Gold® Earthworm Castings



This all organic soil amendment is excellent for use as a top dressing, diluted to make a rich liquid tea or mixed with soil to stimulate plant growth.



Item No.	Description	MSRP
714765	Black Gold Earthworm Castings 16 Quart	\$12.95

Sunshine® Mix #4 - Aggregate Plus



Mix #4 is recommended where high air capacity and fast drainage are needed with water and salt sensitive crops or where frequent leaching is required.

Item No.	Description	MSRP
714745	Sunshine Mix #4 Aggregate Plus Bale 3.8 cu ft	\$55.95

Sunshine® Mix #4 with Mycorrhizae



Sunshine® Mix #4 with Mycorrhizae is an ideal choice for both indoor and outdoor gardening. Formulated with Canadian Sphagnum Peat Moss for increased moisture retention, optimum air exchange and high cation exchange capacity (CEC) plus coarse perlite for amplified root zone aeration.

Item No.	Description	MSRP
714743	Sunshine Mix #4 w/ Mycorrhizae 3.0 cu ft	\$43.95

Sunshine® Mix #4 Natural & Organic



Sunshine® Mix #4 Natural & Organic contains an organic fertilizer composed of feathermeal, sulfate of potash and bonemeal. As with all organic fertilizers, the nutrients are released by decomposition through fungi and bacteria. Therefore, you may note the presence of fungal hyphae on the surface of the mix during the active decomposition phase.



Item No.	Description	MSRP
714775	Sunshine #4 Natural & Organic 3.8 cu ft Compressed Bale	\$61.95

Sunshine® Mix #4 Natural & Organic with Mycorrhizae



Sunshine® Mix #4 Natural & Organic + Mycorrhizae contains an organic fertilizer composed of feathermeal, sulfate of potash and bonemeal. As with all organic fertilizers, the nutrients are released by decomposition through fungi and bacteria. Therefore, you may note the presence of fungal hyphae on the surface of the mix during the active decomposition phase.



Item No.	Description	MSRP
714776	Sunshine Mix #4 Natural & Organic w/ Mycorrhizae 3.8 cu ft	\$65.95

Sunshine® Advanced Mix #4 - 1 Cu. Ft. Compressed



Sunshine® Advanced Mix #4 is meticulously formulated to meet the needs of professional growers, yet is easy to use for beginners. It contains Canadian Sphagnum peat moss, coarse perlite, coconut coir & an organic starter nutrient charge.



Item No.	Description	MSRP
714766	Sunshine Advanced Mix #4 - 1 cu ft Compressed	\$16.95

Sunshine® Advanced Mix #4 - 2.2 Cu. Ft. Compressed



Sunshine® Advanced Mix #4 is meticulously formulated to meet the needs of professional growers, yet is easy to use for beginners. It contains Canadian Sphagnum peat moss, coarse perlite, coconut coir & an organic starter nutrient charge.



Item No.	Description	MSRP
714767	Sunshine Advanced Mix #4 - 2.2 cu ft Compressed	\$34.95

Sunshine® Advanced Mix #4 - 3 Cu. Ft. Compressed

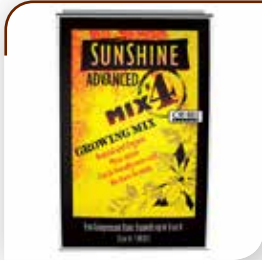

Sunshine® Advanced Mix #4 is meticulously formulated to meet the needs of professional growers, yet is easy to use for beginners. It contains Canadian Sphagnum peat moss, coarse perlite, coconut coir & an organic starter nutrient charge.



Item No.	Description	MSRP
714768	Sunshine Advanced Mix #4 - 3 cu ft Compressed	\$46.95

Sunshine® Advanced Mix #4 - 2 Cu. Ft. Loose



Sunshine® Advanced has the dual benefits of peat moss and coconut fiber to hold water and nutrients for optimal plant growth. The increased perlite provides excellent drainage, resulting in a growing mix that is adapted for a wide range of growing conditions. Our organic nutrient pack gives just enough starter fertilizer to get your plants going.



Item No.	Description	MSRP
714785	Sunshine Advanced Mix #4 Loose 2 cu ft	\$23.95

Sunshine® Advanced Rain Forest Loose 0.06 - 0.02 - 0.05



Sunshine® Advanced Rainforest Blend contains coconut fiber for nutrient and water retention. The organic nutrient pack along with humic acid, alfalfa meal and kelp meal gives a good dose of starter fertilizer to get your plants going.



Item No.	Description	MSRP
714780	Sunshine Advanced Rain Forest Loose 2 cu ft	\$23.95

Sunshine® Advanced Super Hydro Loose

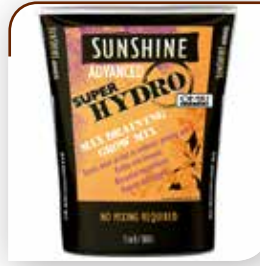

Sunshine® Advanced Super Hydro contains high levels of perlite to provide excellent drainage. Both peat moss and compost hold and release water and nutrients for optimal plant growth. This combination results in a growing mix that is adapted for a wide range of conditions.



Item No.	Description	MSRP
714778	Sunshine Advanced Super Hydro Loose 2 cu ft	\$23.95

Sunshine® Advanced Ultra Coir Loose



Sunshine® Advanced Ultra Coir has the dual benefits of peat moss and coconut fiber to hold water and nutrients for optimal plant growth. The perlite provides excellent drainage, resulting in a growing mix that is suitable for most growing conditions.



Item No.	Description	MSRP
714782	Sunshine Advanced Ultra Coir Loose 2 cu ft	\$23.95

VermaPlex Black Casting 1 - 0.5 - 0.02



Black Castings are the purest form of slow release natural organic plant food produced by earthworms. Derived from a proprietary process and blend of pure organics, Black Castings are raised in a controlled vermiculture feeding process and microbial enhancements, resulting in a consistent, bio-diverse, living organic fertilizer and conditioner.

EXCLUSIVE

Item No.	Description	MSRP
724275	VermaPlex Black Casting 5 lb	\$11.95
724280	VermaPlex Black Casting 20 lb	\$29.95
724285	VermaPlex Black Casting 40 lb	\$51.95

Bu's Blend™ Biodynamic® Compost



NEW Baby Bu's™ Biodynamic® Blend Potting Soil is made from a hand-crafted recipe that starts from a base of our signature Bu's Blend™ Biodynamic® Compost. We then add the highest quality organic ingredients, ensuring Baby Bu™ is free from GMOs, pesticides, growth hormones, sewage sludge and synthetic chemicals.

Item No.	Description	MSRP
715970	Bu's Blend Biodynamic Compost 1 cu ft	\$27.95

Baby Bu's™ Biodynamic® Blend Potting Soil



NEW Baby Bu's™ bursts with premium materials specially blended with Bu's Blend™ Biodynamic® Compost to Support plant and soil life in your raised beds, pots, container gardens, hanging baskets and houseplants. Baby Bu's™ contains no GMOs, pesticides, sewage sludge, growth hormones or synthetic chemicals. It is safe and non-toxic for your kids, your pets and our planet.

Item No.	Description	MSRP
715972	Baby Bu's Biodynamic Blend Potting Soil 1.5 cu ft	\$26.95

GH CocoTek® Bricks Organic Growing Medium



CocoTek® is pH balanced and contains low sodium content for coir fiber. It increases water holding capacity and nutrient retention, expanding to 5 times it's condensed brick size.



Item No.	Description	MSRP
714065	GH Cocotek Natural Coconut Coir Brick	\$2.38
714066	GH Cocotek Natural Mixed Brick	\$2.48

GH CocoTek® Mats Organic Growing Medium



CocoTek® Grow mats are made from a strong weave containing 100% organic coconut fiber and natural rubber. Roots will thrive in this natural media.



Item No.	Description	MSRP
714200	GH CocoTek Coco Mat 4 ft x 8 ft x 1/4 in	\$51.50
714201	GH CocoTek Coco Mat 4 ft x 4 ft x 1 in	\$66.52

GH CocoTek® Bale Organic Growing Medium



The CocoTek® line of Organic Growing Media consist of three different types of compressed coco coir. This high quality, low sodium, growing media are an environmentally friendly alternative to sphagnum peat moss. When hydrated with water, Cocotek Blocks rapidly expand. The Natural Coir Block contains only coconut pith and fibers. Great for water holding capacity these materials also provide plenty of aeration and drainage.



Item No.	Description	MSRP
714064	GH Cocotek Bale 5 kg	\$11.95

GH CocoTek® Premium Coir Growing Media



NEW CocoTek® Premium Coir is naturally free of bacteria, plant disease, fungal spores, weeds, seeds and pathogens. General Hydroponics® CocoTek® growing medias can be used by themselves, blended together, or mixed with expanded clay pebbles, perlite, topsoil, or any other growing media. CocoTek® Premium Coir contains pre-treated coco coir and can be used by itself or blended with other media to create your ideal mix.

Item No.	Description	MSRP
714070	GH Cocotek Premium Coir 1.5 cu ft	\$27.33

GH CocoTek® PX Premium Coir with Perlite



NEW CocoTek® Premium Coir is naturally free of bacteria, plant disease, fungal spores, weeds, seeds and pathogens. General Hydroponics® CocoTek® growing medias can be used by themselves, blended together, or mixed with expanded clay pebbles, perlite, topsoil, or any other growing media. CocoTek® PX is premixed with just the right amount of treated coir and perlite to provide aeration and optimum moisture retention. Ready to use right out of the bag, simply fill your container, plant, feed and get growing.

Item No.	Description	MSRP
714072	GH Cocotek PX 1.5 cu ft	\$28.26

General Organics® Ancient Forest



Ancient Forest is a natural product consisting of 100% pure forest humus. It is derived from thousands of years of naturally decomposed forest litter. Also aids in the retention of water and nutrients; creating stable, long lasting soil for your garden.

Item No.	Description	MSRP
720695	General Organics Ancient Forest .5 cu ft	\$17.95

Botanicare® ReadyGro™



ReadyGro™ Aeration Formula is specifically designed for automated hydrogardens and self-watering planters with small to midsize plants. The ReadyGro™ Moisture Formula (1 to 2 waterings daily) is specifically designed for hand-watering, automated pots and planters with large plants.

Item No.	Description	MSRP
714800	Botanicare ReadyGro Aeration Formula 1.5 cu ft	\$28.95
714805	Botanicare ReadyGro Moisture Formula 1.5 cu ft	\$28.95

Botanicare® Cocogro® Loose



Cocogro® is blended from 100% premium Coco Coir that has been carefully processed to meet our rigorous specifications. Cocogro® has excellent drainage properties and can be watered frequently while naturally maintaining optimum air to water ratios.

Item No.	Description	MSRP
714810	Botanicare Cocogro Loose 1.75 cu ft	\$24.95

Botanicare® Slacker®



NEW There's no longer any need to mix your own grow media because Slacker's® lightly fortified, all-purpose formula combines Botanicare's pure high-pith, twice-washed Cocogro® with all the ingredients and organic amendments you need to deliver excellent root aeration, exceptional hydroponic growth rates and high quality flavors and aromas. Pre-buffered, charged and pH balanced, it's ready to use right out of the bag.

Item No.	Description	MSRP
714788	Botanicare Slacker - Single Formula 1.75 Cu Ft	\$28.95

Botanicare® Cocogro® Premium Organic Soilless Grow Media



Cocogro® has a very low salt content that is available in 3/4 in double-sieved long fibers to reduce dust and give ample space within the mix. It has excellent drainage properties and can be used over a longer period of time.

Item No.	Description	MSRP
720440	Botanicare Cocogro Coir Fiber Bale 5 kg	\$16.50
720445	Botanicare Cocogro Brick Coir Fiber 650 gm	\$3.10

Gold Label Custom 80/20



80/20 is 80% Hydrocorn and 20% coco fiber with added mycorrhizae. The sodium and chloride contents are extremely low for a coco substrate. HydroCoco 80/20 is the tested and recommended growing medium for the Flo-n-Gro systems. 

Item No.	Description	MSRP
713760	Gold Label Custom 80/20 Mix 50 Liter	\$47.95

Gold Label Coco



Gold Label Coco is manufactured using the fibers from the husk of the coconut. Only matured woody brown husk is used for optimal quality and stability of the substrate. 

Item No.	Description	MSRP
713755	Gold Label Coco 50 Liter	\$34.95

Gold Label Hydrocorn



Gold Label Hydrocorn is manufactured using a mix of the best quality pure clay and are baked in an open furnace using high grade clean fuels, guaranteeing absence of heavy metals or other contaminants. The 8-16 mm size provides stability and the unique uneven shape of the pebble is an ideal surface for roots and beneficial bacteria. 

Item No.	Description	MSRP
713750	Gold Label Hydrocorn 36 Liter	\$37.95

Gold Label Hydrocorn XL



Gold Label Hydrocorn XL is the inert hydroponic substrate of choice for professionals. The 16-25 mm size and the unique, uneven shapes of the pebbles provides better stability than even shaped round pebbles. The porous structure has a high water capacity and is suitable for both ebb/flood and top irrigation systems. Larger size won't slip through basket and liner holes. 

Item No.	Description	MSRP
713752	Gold Label Hydrocorn XL 36 Liter	\$36.95

Gold Label HydroCoco 60/40



Gold Label Hydrocorn and Coco is an ideal match for high water capacity, lower watering frequency and better rooting. We utilize the 8-16 mm Hydrocorn from Gold Label and the purest Gold Label Coco to give you the perfect ebb and flood growing media which also works well in any pot based systems. 

Item No.	Description	MSRP
713765	Gold Label HydroCoco 60/40 - 45 Liter	\$47.95

Vermicrop™ Organics VermiFire Premium Soil



VermiFire™ doesn't follow trends, it starts them. VermiFire™ performs above and beyond the call of duty, it is a potting soil that over achieves at every opportunity. We took our proven formula of VermiSoil™ and added extremely high levels of specific nutrients. Ingredients: Coco Coir, Peat, Redwood, Compost, Alaskan Humus, Castings, Cinders, Perlite, Bat Guano, Mycorrhizal Fungi, Alfalfa Meal, Blood Meal, Kelp Meal, Feather Meal, Bone Meal, Sulfate of Potash and Greensand.

Item No.	Description	MSRP
720760	Vermicrop Vermifire 1.5 cu ft	\$27.95

Vermicrop™ VermiWorm™



VermiWorm™ Premium Worm Castings are created by Red Wigglers; these are pure *Eisenia Fetida* castings. They are farmed organically in California by agriculturists who truly care about what they do. VermiWorms™ are fed a specific diet of organic matter containing no manures or chemicals.



Item No.	Description	MSRP
720765	Vermicrop VermiWorm .75 cu ft	\$39.95

Vermicrop™ VermiSoil™ Premium Potting Soil



Vermicrop™ Organics Premium Potting Soil is a rich blend of organic materials creating the best high yielding plants. Coconut Coir, Earth Worm castings, Peat Moss, Vermicrop™ Organics Premium Compost, Bat Guano and Mycorrhizae are some of the key elements.



Item No.	Description	MSRP
720340	Vermicrop VermiSoil Premium Potting Soil 1.5 cu ft	\$27.95

Royal Gold Basement Mix



Light charged with organic nutrients and the proper ratios of air to moisture. As each component plays an important role in the quality and consistency of the end product, proportions are measured and mixed with state of the art equipment, which insures premium quality in each bag.

Item No.	Description	MSRP
715225	Royal Gold Basement Mix 1.5 cu ft	\$24.95

Vermicrop™ VermiBlend™ Premium Soil Amendment 1.0 - 1.5 - 0.6



VermiBlend™ Premium Soil Amendment has a unique blend of earthworm castings, compost, fossilized kelp, humus, rock minerals and mycorrhizae to provide ample amounts of micro nutrients, trace minerals and beneficial microbes.



Item No.	Description	MSRP
720755	Vermicrop VermiBlend Soil Amendment 1 cu ft	\$28.95

Royal Gold Mendo Mix



In their laboratory and in performance tests, Royal Gold states the Mendo Mix out preformed all its competitors, for transition, growth and quality of fruit. Fortified with the highest quality ingredients, the formula is based on years of standard Humboldt soil building techniques. Established plants that have been root bound in a smaller containers transplant the best.

Item No.	Description	MSRP
715230	Royal Gold Mendo Mix 1.5 cu ft	\$24.95

Vermicrop™ VermiPro™ Soilless Medium



NEW VermiPro™ is a soilless growing medium equipped with extremely high porosity which allows for aggressive feedings. Highly experienced gardeners designed the ultimate ratios of triple washed coco coir, the highest grade peat moss, aged softwood bark, perlite and mycorrhizal fungi. Professional growers use VermiPro™ as a standalone hydroponic/soilless medium, or combine their own nutrients and organic matter into VermiPro™ to create a custom soil blend. As a standalone medium, it is recommended for indoor or greenhouse use only.

Item No.	Description	MSRP
720762	VermiPro Soilless Medium 3.8 cu ft Bale	\$68.95

Royal Gold Loose Coco Fiber



Royal Gold loose coco fiber is designed for hydroponic use; but also works well with pots and beds and all other growing techniques. We have the highest air porosity rate of any coco on the market with 40% air porosity rate.

Item No.	Description	MSRP
715235	Royal Gold Coco Mix 1.5 cu ft	\$31.95

Royal Gold Tupur



Royal Gold Tupur was developed with one idea in mind, feeding the plant as much and as often as possible! This high porosity mix allows the gardener to feed often, supplying all major NPK with any nutrient system.

Item No.	Description	MSRP
715237	Royal Gold Tupur 2 cu ft	\$24.95

HydroDynamics™ Crop Circles



An organic potting medium made from natural coconut fibers, this medium is ideal for hydroponic and mixed media cultivation. Each Crop Circle disk expands to about five times its compressed size. Each disk fills a one gallon container. Dimensions of compressed disk 5 in diameter x 1-1/2 in thick.

Item No.	Description	MSRP
714550	Crop Circles Premium Coir Fiber	\$35.00

Just Right Xtra Potting Mix



Just Right Xtra is teaming with beneficial microbes, bacteria and fungi. This mix also contains the finest worm castings, natural organic potash and organic bone char. Just Right Xtra has a perfect pH to keep the bacteria and fungi happy and healthy!

Item No.	Description	MSRP
715240	Just Right Xtra Potting Soil Mix 1.5 cu ft	\$24.95

Wiggle Worm Soil Builder™ Earthworm Castings



Earthworm Castings is an all purpose natural fertilizer that comes to you straight from nature with no alterations whatsoever. Our nightcrawlers are fed a very rich peat humus which contains a wide variety of minerals and trace elements.



Item No.	Description	MSRP
720425	Wiggle Worm Soil Builder Earth Worm Castings 15 lb	\$12.95
720430	Wiggle Worm Soil Builder Earth Worm Castings 30 lb	\$24.95

GrubbyCup's Potting Mix



GrubbyCup's Potting Mix is a ready to use soil good for indoor, outdoor or greenhouse use. It contains sphagnum peat moss, perlite, rice hulls, humus, neem meal, soft rock phosphate and langbeinite. This potting mix is a light mix designed to provide aeration and assist in overwatering avoidance.

Item No.	Description	MSRP
715238	GrubbyCup's Potting Mix 1.5 cu ft	\$18.95

B'Cuzz® Coco



B'Cuzz® Coco is the only coir product available through the retail hydroponics industry that undergoes a unique steaming and buffering process, resulting in an optimized, premium quality hydroponic growing medium.

Item No.	Description	MSRP
720389	BCuzz Coco 50 Liter	\$32.95



Your complete irrigation source
for serious growers
www.hydro-flowproducts.com



Photo courtesy of Green Coast Hydroponics, CA

Super Sprouter™

YOUR BEST START FOR SEEDS AND CUTTINGS!



Super Sprouter products can help give your plants their best start.

www.SuperSprouter.com

Super Sprouter™ Premium Propagation Kit with 7 in Dome & T5 Light



NEW

EXCLUSIVE

Super Sprouter™ Premium Propagation Kit provides a complete system for starting your seeds or cuttings. The kit includes these Super Sprouter™ products: 7 in Ultra Clear Vented Dome with built in light tracks, 18 in high output T5 fluorescent grow light designed for the dome, Double Thick 10 x 20 in tray with no holes, Heat Mat, Art of Propagation booklet and Clonex® Rooting Gel packet (EPA No. 79664-1). Just choose your favorite media and you are good to grow. Mat is ETL listed and the light is UL listed. 1 Year Warranty.

Item No.	Description	MSRP
726402	Super Sprouter Premium Propagation Kit w/ T5 Light	\$79.95

Super Sprouter™ Simple Start™ Micro Greenhouse Kit



NEW

EXCLUSIVE

The Super Sprouter™ Simple Start™ Micro Greenhouse Kit is great for smaller projects. Ideal for separating plant or seed stock. This kit includes an 8 inch x 12 inch grow tray, 24 site tray insert pre-filled with Grodan Macro plugs, a 4 inch humidity dome with adjustable vent and the Super Sprouter™ Art of Propagation booklet with expert growing tips. This product is great for small spaces or you can fit two on one Super Sprouter Seedling Heat Mat®. Make it simple with the Simple Start™ Micro Greenhouse Kit.

Item No.	Description	MSRP
726430	Super Sprouter Simple Start Micro Greenhouse Kit w/ Grodan Plugs	\$22.95

Super Sprouter™ Propagation Station® with 7 in Dome



EXCLUSIVE

Everything you need to start your seedlings. This great kit includes Super Sprouter™ Seedling Heat Mat 10 in x 21 in, 72 site Seed Cell Plug Tray insert, 10 in x 20 in Propagation Tray and a Super Sprouter™ 7 in Propagation Dome with Vents. Clonex® Cloning Gel packet (EPA No. 79664-1). The Seedling Heat Mat is ETL listed.

Item No.	Description	MSRP
726400	Super Sprouter Propagation Station w/ 7 in Dome	\$43.95

Super Sprouter™ Heated Germination Kit with 2 in Dome



EXCLUSIVE

The Super Sprouter™ Heated Germination Kit is a great solution for your germination needs. The kit includes an Ultra Clear 2 inch germination dome with vents, 10 x 20 inch double-thick tray, 72 site insert tray, Super Sprouter™ heat mat, instructions and growing tips. All that's required is your preferred growing media for germination and you are ready to grow. Heat mat is ETL listed. 1 Year Warranty.

Item No.	Description	MSRP
714152	Super Sprouter Heated Germination Kit w/ 2 in Ultra Clear Dome	\$41.95

Super Sprouter™ Seedling Heat Mat



EXCLUSIVE

Warms root area approximately 10°F - 20°F over ambient temperature to improve germination process. Helps gardeners have better success rates with seedlings and cuttings. Dimensions: 10 in x 21 in. 1 Year Warranty.

Item No.	Description	MSRP
726695	Super Sprouter Seedling Heat Mat 10 in x 21 in	\$28.95

Super Sprouter™ Seedling Heat Mat - 2 Tray



EXCLUSIVE

Mat design allows placing propagation trays end to end (instead of side by side) on this mat. These mats are 20% larger than competitive mats. This allows warming of 2 complete propagation trays to their edges. Dimensions: 12 in x 48 in. 5 ft 120 volt power cord. One mat uses 60 watts. 1 Year Warranty.

Item No.	Description	MSRP
726685	Super Sprouter 2 Tray Seedling Heat Mat Daisy-Chainable 12 in x 48 in	\$51.95

Super Sprouter Seedling Heat Mat® - 4 Tray



NEW

WARMS UP TO 4 TRAYS AT ONCE!



EXCLUSIVE

Super Sprouter™ 4 Tray Seedling Heat Mat is designed for 4 standard 10 in x 20 in propagation trays placed side by side. The Super Sprouter™ 4 Tray Seedling Heat Mat warms the rooting area approximately 10°F - 20°F over ambient temperatures to improve the germination process. More consistent heating with fewer hot spots than other seedling heat mats on the market. Ed Hume seal of approval. 110 Watts. 5 ft 120 Volt power cord. Dimensions: 21 in x 48 in. 1 Year Warranty.

Item No.	Description	MSRP
726677	Super Sprouter 4 Tray Seedling Heat Mat 21 in x 48 in	\$84.95

Super Sprouter™ Seedling Heat Mat Digital Thermostat



Easy to read digital display unit. Accurately set ideal germination temperature. Simple to use: plug mat into the thermostat & temperature probe into your soil or growing media. Temperature control range 68°F - 108°F (20°C - 42°C). Rated for maximum of 1000 watts. 6 ft power cord and probe with suction cup. 1 Year Warranty.



EXCLUSIVE

Item No.	Description	MSRP
726700	Super Sprouter Digital Heat Mat Thermostat	\$43.95

Super Sprouter™ Seedling Heat Mat Thermostat



Designed to be used with the Super Sprouter™ Seedling Heat Mat or any other heat mat. It's precise control allows the user to closely control mat temperature and easily dial in the ideal germination temperature. 1 Year Warranty.

EXCLUSIVE

Item No.	Description	MSRP
726702	Super Sprouter Seedling Heat Mat Thermostat	\$39.95

Super Sprouter™ Perfect Plug Tray®



EXCLUSIVE

Pre loaded Super Sprouter® Perfect Plug Trays® are great for seed starting and cuttings. Uses a custom peat moss blend, with Mother Earth® BioChar added, to allow a great mixture of moisture and aeration. Pre drilled hole to foster the optimum environment for stem to media contact. Tray, insert and plugs are all included to make your cutting or seeding experience easy.

Item No.	Description	MSRP
714157	Super Sprouter Perfect Plug Custom Blend Tray 50/Count	\$23.25



Your best start for seedlings and cuttings!

- Heat Mats
- Heat Mat Thermostats
- Germination and Propagation Kits
- Plug Trays and Refills
- Domes, Trays and MORE

www.SuperSprouter.com

Super Sprouter™ Root Raft™ Floating Plug Tray



The Super Sprouter™ Root Raft™ is designed to be a self watering starter tray. Root Raft™ includes a 10 x 20 inch tray for holding water and a styrofoam 55 site floating insert loaded with Super Sprouter™ custom blended and custom sized grow plugs. Mother Earth® BioChar added to this exclusive formulation. No worries about watering — moisture is automatically wicked through the plugs. Floating grow tray! Just fill the tray and walk away.

Item No.	Description	MSRP
714161	Super Sprouter Root Raft Floating Plug Tray 55 ct	\$31.95

Super Sprouter™ Root Raft™ Replacement Plugs



NEW Super Sprouter™ Root Raft™ replacement plugs make reloading your Root Raft™ simple. Just clean your existing tray and insert, refill the floating insert tray, add water to your 10 x 20 inch tray and your good to grow. These plugs are specially sized for the Root Raft™ Floating Plug Tray. They are custom blended and custom sized grow plugs. Mother Earth® BioChar added to this exclusive formulation. **EXCLUSIVE**

Item No.	Description	MSRP
714163	Super Sprouter Root Raft Replacement Plugs 55 ct	\$19.95

Super Sprouter™ Perfect Plug Refill Pack



Super Sprouter™ Perfect Plug™ replacement plugs are great for seed starting and cuttings. Uses a custom peat moss blend, with Mother Earth® BioChar added, to allow a great mixture of moisture and aeration. Pre drilled dibble to foster the optimum environment for stem to media contact. If limiting your waste plastic is important to you, use these refill plugs to reload your Perfect Plug Tray®. **EXCLUSIVE**

Item No.	Description	MSRP
714159	Super Sprouter Perfect Plug Custom Blend Refill Pack 50/Count	\$14.95
714160	Super Sprouter Perfect Plug Custom Blend Bulk NEW	\$99.95

GH Rapid Rooter® Mat



Rapid Rooter® mat is a natural plant starters. It has 98 cross-cut planting sites that separate into one inch cubes for propagation cuttings and germinating seeds.

Item No.	Description	MSRP
714137	GH Rapid Rooter Mat 98	\$23.96

GH Rapid Rooter®



Rapid Rooter® plugs are all natural soilless grow plugs made of composted tree bark and organic materials. These plugs are perfect for seedlings or cuttings. Transplant plugs in soil or soilless hydrogardening applications.

Item No.	Description	MSRP
714135	GH Rapid Rooter 50/Pack Replacement Plugs	\$16.70
714140	GH Rapid Rooter 50 Cell Plug Tray	\$23.70
714150	GH Rapid Rooter Bulk Plugs	\$392.00

HDI Root Riot™ Trays



Root Riot™ are organic plant starter cubes for cuttings and seeds for soil or hydroponics. Includes a free Clonex® Gel 15 ml packet (EPA No. 79664-1). Made from organic material and are fully biodegradable. Root Riot will give you faster, more vigorous rooting.

Item No.	Description	MSRP
714130	Root Riot 50 Cube Tray w/ Clonex Gel	\$29.95

HDI Root Riot™ Replacement Cubes

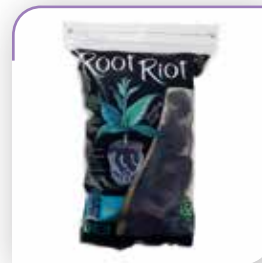

Root Riot™ Organic Plant Starter Cubes are available in bags of 50 and 100 replacement cubes. Root Riot™ Organic Plant Starter replacement cubes are pre-moistened so they are ready to use right out of the bag.

Item No.	Description	MSRP
714129	Root Riot Replacement Cubes - 50 Cubes	\$17.95
714132	Root Riot Replacement Cubes - 100 Cubes	\$29.95

Botanicare® ReadyGro™ Super Plugs



A sponge like material, all natural soilless grow plugs are made of composted tree bark and organic materials. Biodynamic plugs are perfect for seedlings or cuttings. ReadyGro™ Super plugs are biodegradable and 100% organic. 1.5 in x 1.5 in size fits perfectly into rockwool holes. 1400 count.

Item No.	Description	MSRP
714215	Ready Gro Super Plugs	\$349.95

Planters' Pride® Greenhouse Kits & Pellet Refills



Fiber Grow is made from coir, a highly renewable resource and 100% biodegradable. The coir has the capacity to absorb more water and retain it for longer periods. These all purpose kits include: pellets, tray and greenhouse dome. Pellets are universal, and fit in all Planters' Pride® Fiber Grow Greenhouse Kits.

Item No.	Description	MSRP
714250	Planters Pride 20 Pellet Greenhouse Kit	\$9.99
714252	Planters Pride 20 Pellet Refill Kit	\$6.59
714255	Planters Pride 50 Pellet Greenhouse Kit	\$17.99
714257	Planters Pride 50 Pellet Refill Kit	\$13.89
714258	Planters Pride 1000 Pellet Refill Kit	\$112.95

Oasis® Wedge® Growing Medium with Tray

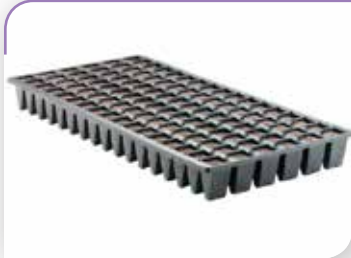

Wedge® Growing Medium aids strong, fast root development of vegetative spring flowering plants. Wedge® medium is ready and easy to use. Due to the unique shape of the Wedge® Medium, transplanting of the rooted cuttings is made fast and easy.

Item No.	Description	MSRP Cs	MSRP Ea
713710	Oasis 102 Count Wedge Tray & Medium	\$92.95	\$9.30

Oasis® Rootcubes® Bulk Pack

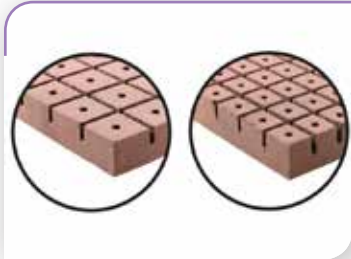

Rootcubes® Growing Medium has multiple applications for those crops that require high water usage. This medium is designed to drain off excess water from the base of the cutting or seed, yet provide balance of air/water needed for good root development.

Item No.	Description	Sheets/Cs	MSRP Cs	MSRP Ea
713700	Oasis Rootcubes 1.5 in Medium Cubes (5015) 50/Sheet	20	\$157.95	\$7.90
713705	Oasis Rootcubes 1.25 in Medium Cubes (5010) 104/Sheet	20	\$154.95	\$7.75

Super Sprouter™ T5 High Output Grow Light Fixture



This fixture includes an integrated electronic ballast, 6400°K lamp, power cord, jumper cord, hanging and flat surface mounting clips. You can daisy chain up to a maximum of 8 lights per single cord. The reflector uses nanotechnology to maximize reflection. Specifically to fit Super Sprouter™ Light Track Domes. 1 Year Warranty.



EXCLUSIVE

Item No.	Description	MSRP
726420	Super Sprouter T5 HO 18 in Grow Light Blister Pack	\$34.95

Super Sprouter™ Ultra Clear Vented Germination Dome 2 in



This excellent quality 2 inch Super Sprouter™ Ultra Clear Germination Dome fits standard 10 x 20 inch propagation flats. Use the 2 in tall dome for germinating seeds or for small clones. Two vents in the top of the dome can be opened or closed to control humidity. These are the most clear and transparent domes on the market.

EXCLUSIVE

Item No.	Description	MSRP
904288	Super Sprouter Ultra Clear Vented Germination Dome 2 in	\$2.75

Super Sprouter™ Ultra Clear Vented Humidity Domes with Light Tracks



These excellent quality 4 and 7 inch Ultra Clear Humidity Domes now have built in light tracks that accommodate the 18 inch Super Sprouter™ T5 HO Grow Light. The light tracks are directional to allow the light to run the length of the domes or the width of the domes, allowing two trays to run side by side. Two vents in the top of the dome can be opened or closed to control humidity.

EXCLUSIVE

Item No.	Description	MSRP
904289	Super Sprouter Ultra Clear Vented Humidity Dome 4 in w/ Light Tracks	\$4.79
904295	Super Sprouter Ultra Clear Vented Humidity Dome 7 in w/ Light Tracks	\$5.75
726245	Super Sprouter Ultra Clear Dome Replacement Vent	\$0.69

Super Sprouter™ Standard Domes 2 & 4 Inch



Excellent quality Super Sprouter™ 2 and 4 inch tall standard domes with straight sides that allows the use of all plant sites in the propagation tray. Both domes fit snugly on standard 10 x 20 inch propagation tray.

EXCLUSIVE

Item No.	Description	MSRP
726215	Super Sprouter Standard Germination Dome 2 in	\$2.25
726239	Super Sprouter Standard Humidity Dome 4 in	\$4.09

Super Sprouter™ Standard Vented Humidity Dome 7 in



Excellent quality 7 inch tall standard humidity dome with straight sides that allows use of all plant sites in the propagation tray. The dome has two vents in the top that can be opened or closed to control humidity and has a built in handle. Fit a standard 10 x 20 inch tray. Replacement circle vents available.

EXCLUSIVE

Item No.	Description	MSRP
726241	Super Sprouter Standard Humidity Dome 7 in	\$5.45
726243	Super Sprouter Replacement Vent for 7 in Dome (726241)	\$0.69

Super Sprouter™ Simple Start™ Dome 4 in with Vent



NEW Super Sprouter™ Simple Start™ 4 inch Dome provides an option for smaller runs of seeds or cuttings. It can also be used for separating plant stocks so they don't get mixed up. This 4 inch dome with vents is used in conjunction with the Simple Start™ 8 x 12 inch tray (#726424) and the Simple Start™ 24 cell insert (726426).

EXCLUSIVE

Item No.	Description	MSRP
726422	Super Sprouter Simple Start Dome 4 in w/Vent	\$2.09

Super Sprouter™ Simple Start™ Propagation Tray 8 x 12 in

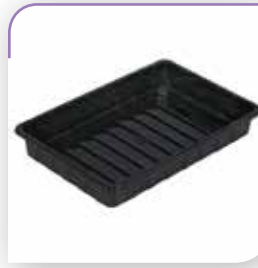

NEW Super Sprouter™ Simple Start™ Tray measures 8 inches by 12 inches. This tray has no drain holes and can be used with the Simple Start™ 4 inch vented dome (#726422) as well as the Simple Start™ 24 cell insert (#726424).

EXCLUSIVE

Item No.	Description	MSRP
726426	Super Sprouter Simple Start Propagation Tray 8 in x 12 in - No Holes	\$0.99

Mondi™ Propagation Domes - 4 in



Constructed from heavy duty, high grade plastic to maximize light penetration and stand up to repeated use. Perfectly fitted for standard 10 x 20 trays, to create tight seal and reduce moisture loss.

Item No.	Description	MSRP
726130	Mondi 4 in Propagation Dome - No Vents	\$4.19
726135	Mondi 4 in Propagation Dome w/ Easy Vents	\$5.19

Super Sprouter™ Simple Start™ Plug Tray Insert 24 Cell



NEW Super Sprouter™ Simple Start™ 24 cell insert works in conjunction with the Simple Start™ 8 x 12 inch no hole tray. A perfect solution when a few is enough. Fill the 1.5 inch cells with plugs, stonewool or soil to start your seeds. Use with the Simple Start™ 4 inch dome (#726422) to create a miniature green house.

EXCLUSIVE

Item No.	Description	MSRP
726424	Super Sprouter Simple Start Plug Tray Insert 24 Cell	\$0.99

Mondi™ Propagation Domes - 7 in



A professional propagation dome for starting seeds or cuttings. Temperature and humidity controlled by two adjustable vents for better growing results. Designed to provide more cubic volume for your growing plants. Perfectly fitted for standard 10 x 20 trays.

Item No.	Description	MSRP
726140	Mondi Mini Greenhouse 7 in Propagation Dome	\$5.95
726142	Mondi Mini Greenhouse 7 in Propagation Dome w/ No Vents	\$5.95

Super Sprouter™ Propagation Trays 10 x 20



Super Sprouter™ 10 in x 20 in tray is built to the Industry Standard size and thickness. Great for propagating your seedlings with rock wool, seedling mix or starter plugs. They come without holes to catch excess water to keep starts or plants moist. Also available with holes to be used in a flood and drain method. Raised channels are incorporated in the base of the tray to provide air circulation.

EXCLUSIVE

Item No.	Description	MSRP
726165	Super Sprouter Propagation Tray 10 x 20 - No Holes	\$1.15
726167	Super Sprouter Propagation Tray 10 x 20 w/ Holes	\$1.25

Mondi™ Greenhouse Thermo-Hygrometer



This revolutionary product mounts anywhere on your Mondi™ Mini Greenhouse and reads the temperature and humidity inside the dome. In combination with Mondi™ Easy Vents, it ensures plants get the start they need with the essential real-time information. Includes battery.

Item No.	Description	MSRP
726125	Mondi Mini Greenhouse Thermo-Hygrometer	\$16.95

Super Sprouter™ Double Thick Trays 10 x 20

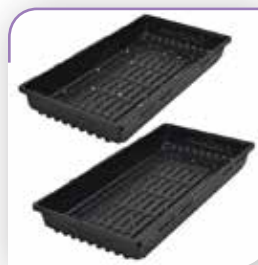

Super Sprouter™ Double thick 10 x 20 tray is twice as thick as standard trays, ensuring it will last season after season. Don't let your hard work end up on the floor; protect your efforts by using double thick 10 x 20 tray.

EXCLUSIVE

Item No.	Description	MSRP
726294	Super Sprouter Double Thick Tray 10 x 20 - No Hole	\$2.79
726296	Super Sprouter Double Thick Tray 10 x 20 - w/ Hole	\$2.99

Super Sprouter™ Quad Thick Tray & Insert 10 x 20



These trays are built tough. They are four times the thickness or regular 10 x 20 trays. No need to use multiple trays when one 10 x 20 tray will do the trick. The tray insert has a perforated bottom to allow for easy drainage.

EXCLUSIVE

Item No.	Description	MSRP
726298	Super Sprouter Quad Thick 10 x 20 Tray - No Hole	\$4.49
726300	Super Sprouter Quad Thick Tray Insert w/ Holes	\$4.49

Super Sprouter™ Mesh Bottom Tray



This mesh bottom plastic propagation tray can be inserted inside a standard 10 x 20 tray. Place your starter plugs (i.e. rockwool sheet of 98) inside the mesh bottom tray. Hand water your cuttings. The excess water will drain into the lower tray.

EXCLUSIVE

Item No.	Description	MSRP
726160	Super Sprouter Mesh Bottom 10 x 20 Propagation Tray	\$1.69

Super Sprouter™ 72 Cell Plug Insert Trays



Fits snugly in a standard 10 x 20 propagation flat. Heavier duty than competitive inserts. Choose from round hole or square hole openings.

EXCLUSIVE

Item No.	Description	MSRP
726220	Super Sprouter 72 Cell Plug Tray - Square Holes	\$2.99
726410	Super Sprouter 72 Cell Germination Insert Tray - Round Holes	\$1.99

Super Sprouter™ Root Star™ Tray Insert - 50 Count



Star Shape for Root Pruning

NEW Super Sprouter™ 50 cell Root Star™ tray insert is custom designed to properly support the Perfect Plugs™ while directing the roots down through its star pattern design. The patent pending design also allows partial root pruning to strengthen the directed roots. Fits snugly into Super Sprouter™ 10 x 20 in propagation trays. This Root Star™ insert is very durable at 2 mil thickness.

EXCLUSIVE

Item No.	Description	MSRP
726225	Super Sprouter 50 Count Root Star Insert	\$3.99

Super Sprouter™ 2 ft x 4 ft Propagation Tray



NEW

EXCLUSIVE

Super Sprouter™ 2 ft x 4 ft Propagation Tray is loaded with features. It measures 45 inches long, 25 inches wide and 3 inches high to accommodate steel, plastic or wooden rack and shelf units. It accommodate four 10 x 20 inch trays with or without domes. Twin overhanging drain wells with dual drill out fitting nipples to eliminate modifying shelves. Constructed using 1/8 inch food grade ABS plastic.

Item No.	Description	Thickness	Outside L x W x H	MSRP
726432	Super Sprouter 2 ft x 4 ft Propagation Tray	0.125	45.25" x 24.0" x 3.0"	\$69.95

Mondi™ Propagation Trays 10 x 20

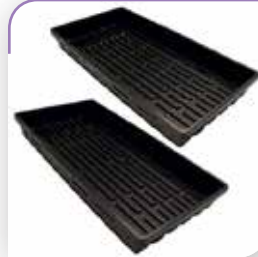

Mondi™ propagation trays have deep, continuous channels & level fit wide ridges prevent water pooling & provide better stability for propagation media. Super reinforced sides and lip with thick plastic and UV protection for durability & long life.

Item No.	Description	MSRP
726150	Mondi Propagation Tray 10 x 20 - No Holes	\$1.59
726155	Mondi Propagation Tray 10 x 20 - w/ Holes	\$1.59

Mondi™ Black & White Premium 10 x 20 Propagation Tray



This is a clean and strong premium propagation tray made from high quality materials for durability. Interior is made of premium white plastic for increase light reflectivity. Reinforced outside shell made from recycled materials provide the strongest support to date.

Item No.	Description	MSRP
726120	Mondi Black & White Premium 10 x 20 Propagation Tray	\$4.95

Mondi™ Propagation Tray Insert 55-01

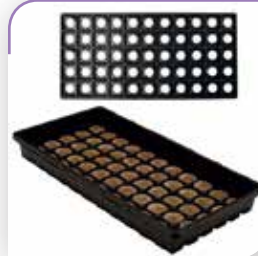

Insert 55-01 pellet pocket tray makes pellet expansion convenient and clean with even spacing and airflow for hassle free propagation. 55 propagation pellets fit snugly while maintaining excellent drainage through the large size holes.

Item No.	Description	MSRP
726145	Mondi Propagation Tray Insert 55-01	\$1.49

SunBlaster™ NanoDome Combo Kit



The SunBlaster™ NanoDome Combo Kit includes one 18 in TS HO SunBlaster NanoTech light fixture,  a unique 7 in high dome designed to accommodate the included NanoTech fixture and a 10 x 20 tray.

Item No.	Description	MSRP
904299	SunBlaster Nano Dome Combo Kit	\$45.95

Grodan® Gro-Smart™ Tray Insert



This durable tray has double-sided features. Use the 78-cell side to perfectly fit 1.5 in A-OK Starter Plugs™ or round Macroplugs™. Use the mesh side for sheets of A-OK's, Mini-Blocks™, or Gro-Blocks™. It fits in a 10 x 20 flat and keeps the Grodan® elevated.

Item No.	Description	MSRP
707445	Grodan Gro-Smart Tray Insert	\$13.98

Planters' Pride® Gel2Root™



Contains all the necessary ingredients for your plant cuttings to begin rooting - No need to water! Gel2Root™ is a non-toxic rooting gel that contains everything you need to start a cutting with no hassle, no mess and no worries.

Item No.	Description	MSRP
714222	Planters Pride Gel 2 Root 6/Pack	\$19.99

iHort® Quick Start Plugs



Quick start your seedlings and cuttings with the proprietary bonded Q plug. Plug dimension is 1.625 in round by 1.625 in deep. Q plugs are stabilized to create the optimum growing media, creating a stronger root system and superior lateral root development. 1500 count.

Item No.	Description	MSRP
714275	Quick Start Plugs Bulk 1.5 in x 1.5 in	\$349.95

TurboKlone T24 Cloner Turbo Mini



NEW The TurboKlone T24 Turbo Mini System helps you propagate a wide-variety of plants aeroponically - without the use of soil or other growing mediums. The System has 24 Clone Sites that allow your plant cuttings to be suspended inside the TurboKlone where multiple spray jets send a continuous mist of nutrient-rich water solution to the clone roots, promoting the development of a healthy, robust

root structure. TurboKlones design helps decrease root damage from pests and disease so your plants can grow healthier. Available with or without the humidity dome. 1 Year Warranty.

Item No.	Description	MSRP
747400	TurboKlone T24 Cloner Turbo Mini	\$164.95
747402	TurboKlone T24 Cloner Turbo Mini w/ Humidity Dome	\$184.95
747404	TurboKlone Humidity Dome T24	\$39.95

TurboKlone T48 Klone Machine



NEW The TurboKlone T48 Klone Machine helps you propagate a wide-variety of plants aeroponically - without the use of soil or other growing mediums. The System has 48 Clone Sites that allow your plant cuttings to be suspended inside the TurboKlone where multiple spray jets send a continuous mist of nutrient-rich water solution to the clone roots, promoting the development of a healthy, robust

root structure. TurboKlones design helps decrease root damage from pests and disease so your plants can grow healthier. Available with or without the humidity dome. 1 Year Warranty.

Item No.	Description	MSRP
747406	TurboKlone T48 Klone Machine	\$309.95
747408	TurboKlone T48 Klone Machine w/ Humidity Dome	\$339.95
747410	TurboKlone Humidity Dome T48	\$59.95

TurboKlone T96 Klone Machine



NEW The TurboKlone T96 Klone Machine helps you propagate a wide-variety of plants aeroponically - without the use of soil or other growing mediums. The System has 96 Clone Sites that allow your plant cuttings to be suspended inside the TurboKlone where multiple spray jets send a continuous mist of nutrient-rich water solution to the clone roots, promoting the development of a healthy, robust

root structure. TurboKlones design helps decrease root damage from pests and disease so your plants can grow healthier. Available with or without the humidity dome. 1 Year Warranty.

Item No.	Description	MSRP
747412	TurboKlone T96 Klone Machine	\$349.95
747414	TurboKlone T96 Klone Machine w/ Humidity Dome	\$409.95
747416	TurboKlone Humidity Dome T96	\$79.95

TurboKlone T144 Klone Machine



NEW The TurboKlone T144 Klone Machine helps you propagate a wide-variety of plants aeroponically - without the use of soil or other growing mediums. The System has 144 Clone Sites that allow your plant cuttings to be suspended inside the TurboKlone where multiple spray jets send a continuous mist of nutrient-rich water solution to the clone roots, promoting the development of a healthy, robust

root structure. TurboKlones design helps decrease root damage from pests and disease so your plants can grow healthier. Available with or without the humidity dome. 1 Year Warranty.

Item No.	Description	MSRP
747418	TurboKlone T144 Klone Machine	\$462.95
747420	TurboKlone T144 Klone Machine w/ Humidity Dome	\$529.95
747422	TurboKlone Humidity Dome T144	\$99.95

TurboKlone Klone Collars



NEW Customized polyethylene collars are more durable and maintain shape longer than other neoprene collars. All collars are configured for easy insertion of cuttings. Most importantly, these collars don't choke your cuttings. 52 collars in a pack. 1 Year Warranty.

Item No.	Description	MSRP
747424	TurboKlone Klone Collars (52/Pack)	\$23.95

EZ-Clone® Classic 16 Cutting System



EZ-Clone® Classics have been made from fully recyclable HDPE which highly chemically resistant and extremely durable. Now has leak resistant cord outlet that allows multiple cords. Also a specially designed recessed drain that allows it to be highly protected and gives the ability to easily tip the unit for draining. Limited Lifetime Warranty.

Item No.	Description	MSRP
706420	Ez-Clone Classic 16 Cutting System	\$162.95

EZ-Clone® Classic 32 Cutting System



EZ-Clone® Classics have been made from fully recyclable HDPE which highly chemically resistant and extremely durable. Now has leak resistant cord outlet that allows multiple cords. Also a specially designed recessed drain that allows it to be highly protected and gives the ability to easily tip the unit for draining. Limited Lifetime Warranty.

Item No.	Description	MSRP
706425	Ez-Clone Classic 32 Cutting System	\$259.95

EZ-Clone® Classic 64 Cutting System



EZ-Clone® Classics have been made from fully recyclable HDPE which highly chemically resistant and extremely durable. Now has leak resistant cord outlet that allows multiple cords. Also a specially designed recessed drain that allows it to be highly protected and gives the ability to easily tip the unit for draining. Limited Lifetime Warranty.

Item No.	Description	MSRP
706430	Ez-Clone Classic 64 Cutting System	\$329.95

EZ-Clone® Classic 128 Cutting System



EZ-Clone® Classics have been made from fully recyclable HDPE which highly chemically resistant and extremely durable. Now has leak resistant cord outlet that allows multiple cords. Also a specially designed recessed drain that allows it to be highly protected and gives the ability to easily tip the unit for draining. Limited Lifetime Warranty.

Item No.	Description	MSRP
706435	Ez-Clone Classic 128 Cutting System	\$429.95

EZ-Clone® Replacement Pumps



EZ-Clone® ultra efficient, super high output water pumps are great for any application. The pump is smaller in physical size, creating less heat. Fully coated impellers make for a smooth and quiet operation. Limited Lifetime Warranty.

Item No.	Description	MSRP
706395	Ez-Clone Replacement Water Pump 700 GPH for 16 & 32 Units	\$72.95
706400	Ez-Clone Water Replacement Pump 800 GPH for 64 & 128 Units	\$92.95

EZ-Clone® Clear Rez



EZ-Clone® Clear Rez is a pH balanced, noninvasive water treatment designed to keep all of the internal workings of your cloning system crystal clear and operating at peak performance. It is designed to be used through out your entire cloning cycle as a possible preventive measure for a multitude of problems in your reservoir. It is suitable for all Hydroponic, Aeroponic and Soil applications. Check your dealer partner for availability.

Item No.	Description	MSRP
708920	Ez-Clone Clear Rez 4 oz	\$6.95
708925	Ez-Clone Clear Rez 8 oz	\$11.95
708930	Ez-Clone Clear Rez Pint	\$19.95
708935	Ez-Clone Clear Rez Quart NEW	\$34.95
708940	Ez-Clone Clear Rez Gallon NEW	\$99.95

EZ-Clone® Sprayer



Replacement sprayer for all models of EZ-Clone® units.

Item No.	Description	MSRP
706392	EZ-Clone 360 Sprayer Red (100/Bag)	\$0.70

Botanicare® Power Cloner® White



Redeveloped with Botanicare® Low Profile Reservoirs, these systems decrease propagation time. Includes reservoir, Humidome, recessed cord guide, neoprene inserts, high pressure sprayers, ceramic airstones, Power Clone™ Solution, AquaShield™ and ZHO®.

Item No.	Description	MSRP
706178	Botanicare White Power Cloner 45 w/ Dome - 10 Gallon Reservoir	\$364.95
706186	Botanicare White Power Cloner 77 w/ Dome - 20 Gallon Reservoir	\$474.95
706187	Botanicare White Power Cloner 180 w/ Dome - 40 Gallon Reservoir 	\$737.00

Botanicare® Power Cloner® Black



Redeveloped with Botanicare® Low Profile Reservoirs, these systems decrease propagation time. Includes reservoir, recessed cord guide, neoprene inserts, high pressure sprayers, ceramic airstones, Power Clone™ Solution and AquaShield™.

Item No.	Description	MSRP
706189	Botanicare Black Power Cloner 45 - 10 Gallon Reservoir	\$299.95
706191	Botanicare Black Power Cloner 77 - 20 Gallon Reservoir	\$379.95
706193	Botanicare Black Power Cloner 180 - 40 Gallon Reservoir 	\$581.50

Botanicare® Power Cloner® Domes



A tight fitting dome for use with Botanicare® Power Cloners®. Made from high impact, clear, ABS plastic. All domes contain humidity control vents.

Item No.	Description	MSRP
706195	Botanicare Power Cloner 45 Dome w/ Vents	\$85.95
706197	Botanicare Power Cloner 77 Dome w/ Vents	\$82.30
706199	Botanicare Power Cloner 180 Dome w/ Vents	\$128.40

Clone Shipper™



NEW Designed to support clones or young live plants, the Clone Shipper™ Classic plant packaging holds the plant securely in place during transit. What makes the Clone Shipper™ Classic different from other plant shipping containers? A LED light keeps the plant thriving and growing throughout shipping whereas other containers ship the plant in the dark. The plant shipping packaging allows the plant to breathe and continue to grow during shipment.

Item No.	Description	MSRP
714167	Clone Shipper	\$9.95

EZ-Clone™ EZ-Coco Seed Starters



NEW EZ-Clone™ is proud to introduce the first eco-friendly, transplantable aeroponic seed starters perfect for the green gardener! This new product allows the grower to turn their cloning system into a seed germinating machine. Comprised of virgin coco fibers and organic latex, these earth friendly alternative aeroponic seed starters are perfect for saving time and money.

Not only are these coco seed starters 100% transplantable, but allow for superior root structure and growth.

Item No.	Description	MSRP
706460	EZ-Clone EZ-Coco Seed Starts - 35/Pack	\$15.75

EZ-Clone™ EZ-Coco Collars



NEW EZ-Clone™ is proud to introduce the first eco-friendly, transplantable coco cloning collar that is perfect for the green gardener! Comprised of virgin coco fibers and organic latex, these earth friendly alternative cloning collars are perfect for saving time and money. Not only are these coco collars 100% transplantable, but allow for superior root structure and growth. Not only will you cuttings root as normal, but they will also

be able to root within the collar, providing excellent structure for your cuttings as they continue to grow.

Item No.	Description	MSRP
706458	EZ-Clone EZ-Coco Collars - 35/Pack	\$15.75

EZ-Clone® Neoprene Replacement Inserts



Custom made neoprene collars are pre-slit for easy insertion of cuttings. Available in hard and original soft.

Item No.	Description	MSRP Ea
706390	Ez-Clone Neoprene Insert Soft (35/Bag)	\$0.47
706391	Ez-Clone Neoprene Insert Soft (65/Bag)	\$0.47
706388	Ez-Clone Neoprene Insert Hard (35/Bag)	\$0.47
706389	Ez-Clone Neoprene Insert Hard (65/Bag)	\$0.47

EZ-Clone® Colored Cloning Collars



NEW EZ-Clone® Colored Cloning Collars are designed specifically to be used in the EZ-Clone® Cloning Systems. They are manufactured from a sterile material and are engineered to protect and hold your cuttings upright in the lid, exposing the top leaves to air and light, while allowing the stems of your cuttings to be completely unrestricted to the inside of the misting chamber. All four colors come in packs of 35.

Item No.	Description	MSRP Ea
706450	Ez-Clone Colored Cloning Collars Green (35/Bag)	\$0.47
706452	Ez-Clone Colored Cloning Collars Purple (35/Bag)	\$0.47
706454	Ez-Clone Colored Cloning Collars White (35/Bag)	\$0.47
706456	Ez-Clone Colored Cloning Collars Gray (35/Bag)	\$0.47

Botanicare® Neoprene Inserts



Black foam inserts that act as root guards.

Item No.	Description	MSRP Ea
724299	Botanicare Neoprene Insert for Power Cloners 1.7 in (25/Sheet)	\$0.53
724300	Botanicare Neoprene Insert 2 in (25/Sheet)	\$0.55
724305	Botanicare Neoprene Insert 3 in (16/Sheet)	\$0.95
724310	Botanicare Neoprene Insert 3.75 in (12/Sheet)	\$1.40

Super Sprouter™ Neoprene Inserts



Variety of different colors to choose from: yellow, blue, orange, green, purple, red, black and multi-color pack. Prevents cuttings and clones from moving around. Pre-slit for easy insertion with a pre-drilled hole. Color selection allows for use as identifying markers. Easy to use.

EXCLUSIVE

Item No.	Description	MSRP Ea
870005	Super Sprouter Neoprene Insert 2 in Yellow 100/Pack	\$0.35
870010	Super Sprouter Neoprene Insert 2 in Blue 100/Pack	\$0.35
870015	Super Sprouter Neoprene Insert 2 in Orange 100/Pack	\$0.35
870020	Super Sprouter Neoprene Insert 2 in Green 100/Pack	\$0.35
870025	Super Sprouter Neoprene Insert 2 in Purple 100/Pack	\$0.35
870030	Super Sprouter Neoprene Insert 2 in Red 100/Pack	\$0.35
870035	Super Sprouter Neoprene Insert 2 in Black 100/Pack	\$0.35

Super Sprouter™ Multicolored Neoprene Inserts



Variety of different colors in one multi-color pack: yellow, blue, orange, green, purple and red. Prevents cuttings and clones from moving around. Pre-slit for easy insertion with a pre-drilled hole. Color selection allows for use as identifying markers. Easy to use.

EXCLUSIVE

Item No.	Description	MSRP Ea
870040	Super Sprouter Neoprene Insert 2 in Multicolor 192/Pack	\$0.35

GH RapidStart® 1 - 0.5 - 1

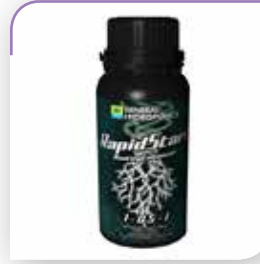

RapidStart® enhances your growing experience by delivering a powerful blend of premium plant extracts, amino acids, and nutrients generating explosive root growth. Using RapidStart® will make your plants explode!

Item No.	Description	MSRP
726756	GH Rapid Start 1 oz Display Box NEW	\$6.50
726850	GH RapidStart 125 ml	\$26.49
726855	GH RapidStart 275 ml	\$39.99
726860	GH RapidStart 500 ml	\$74.36
726865	GH RapidStart 1 Liter	\$143.30
726861	GH Rapid Start Gallon NEW	\$490.00

Clonex® Clone Kit



The Clonex® Clone Kit is an all-inclusive cloning kit for both beginners and experienced growers alike. It contains the items necessary to take cuttings and root them successfully. Use the included Clonex® Clone Solution, Mist and Gel to help your cuttings get the necessary nutrients they need for explosive root growth. EPA No. 79664-1.

Item No.	Description	MSRP
726020	HydroDynamics Clonex Clone Kit	\$34.95

Clonex® Rooting Gel Packets

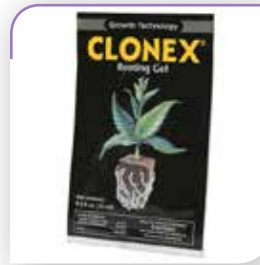

It is a tenacious gel which will remain in contact around the stem, sealing the cut tissue and supplying the hormones needed to promote root cell development and vitamins to protect the delicate new root tissue. Clonex® has a full spectrum of mineral nutrients and trace elements to nourish the young roots. EPA No. 79664-1.

Item No.	Description	MSRP
726004	HydroDynamics Clonex Gel Packets 15 ml	\$6.00

Clonex® Rooting Gel



It is a tenacious gel which will remain in contact around the stem, sealing the cut tissue and supplying the hormones needed to promote root cell development and vitamins to protect the delicate new root tissue. Clonex® has a full spectrum of mineral nutrients and trace elements to nourish the young roots. EPA No. 79664-1.

Item No.	Description	MSRP
726005	HydroDynamics Clonex Gel 100 ml	\$23.95
726010	HydroDynamics Clonex Gel 250 ml	\$49.95
726006	HydroDynamics Clonex Gel Pint	\$91.00
726007	HydroDynamics Clonex Gel Quart	\$169.00

Clonex® Clone Solution 1 - 0.4 - 1



Clonex® Clone Solution is a clone-specific nutrient formulated using a special blend of minerals and other helpful ingredients. Clonex® Clone Solution can be applied to the rooting medium and sprayed over the young clones.

Item No.	Description	MSRP
726011	HydroDynamics Clonex Clone Solution Quart	\$25.00
726012	HydroDynamics Clonex Clone Solution Gallon	\$70.00
726013	HydroDynamics Clonex Clone Solution 2.5 Gallon	\$160.00
726014	HydroDynamics Clonex Clone Solution 5 Gallon	\$300.00

Clonex® Mist



Clonex® Mist is a root stimulator to be used on both your mother plants and clones. It is designed to work in conjunction with Clonex® Gel to produce vigorous healthy cuttings with strong roots. It is used to mist cuttings at regular intervals during the rooting process. Clonex® Mist contains no hormones and is completely safe and non-toxic. Not for sale in the following states at this time: WA.

Item No.	Description	MSRP
726015	HydroDynamics Clonex Mist 100 ml	\$10.95
726017	HydroDynamics Clonex Mist 300 ml NEW	\$25.95

Grow More® Rapid Root



EPA registered cloning powder, 1 ounce of Rapid Root powder will treat over 1,500 cuttings. Our one dip treatment powder prevents cross contamination problem associated with liquid products. EPA No. 70908-2.

Item No.	Description	MSRP
721645	Grow More Rapid Root 2 oz	\$10.95

Botanicare® Power Clone™ Rooting Solution 0.2 - 0.3 - 0.2



Although the Liquid Concentrate can be used as effectively as the Rooting Gel in all kinds of media, the liquid is most beneficial in aeroponic systems and for transplanting potted or bare-root plants. The powerful, all natural ingredients present in this product offer long-term protection against transplant shock.

Item No.	Description	MSRP
726065	Botanicare Power Clone Solution 4 oz	\$22.95
726070	Botanicare Power Clone Solution 8 oz	\$34.95
726075	Botanicare Power Clone Solution Pint	\$58.95
726080	Botanicare Power Clone Solution Quart	\$107.95

Botanicare® Rhizo Blast™



Rhizo Blast™ is a proprietary blend of seaweed, minerals, vitamins, amino acids and the single celled algae, Chlorella which is cultivated specifically for Botanicare®. This revolutionary formula encourages plants to produce an abundant, bushy root mass with lush, stacked foliage and provides plants with naturally occurring plant growth hormones. 1 Year Warranty.

Item No.	Description	MSRP
732432	Botanicare Rhizo Blast 275 ml	\$39.95
732434	Botanicare Rhizo Blast 500 ml	\$54.95
732436	Botanicare Rhizo Blast 1000 ml	\$94.95

Botanicare® Rhizo Gel®



Rhizo Gel®, Botanicare's newest clone gel is a viscous agent designed to cling to cuttings and promote root growth on herbaceous and woody cuttings. Its allows for easy absorption of the rooting hormone Indole-3-Butyric Acid and spurs new root growth. Vitamin B1 as well as a light nutrient charge in Rhizo Gel® also strengthens delicate cuttings while antiseptic components ensure a sterile and clean wound for quick healing. EPA No. 89958-1. Not for sale in the following states at this time: AK, AL, AR, CT, DC, DE, HI, ID, IN, KS, KY, LA, MD, MN, MO, MS, MT, NC, ND, NE, NH, NJ, PA, SC, SD, UT, VA, VT, WI, WV, WY. 1 Year Warranty.

Item No.	Description	MSRP
732440	Botanicare Rhizo Gel 100 ml	\$19.95
732442	Botanicare Rhizo Gel 275 ml	\$39.95
732444	Botanicare Rhizo Gel 500 ml	\$69.95

Olivia's Cloning® Starter Kit



Olivia's Cloning® Starter Kit is the complete plant cloning starter kit for hydroponic cloning that includes everything you need to get started. The Starter-Kit contains Oliva's Cloning Solution®, Olivia's Cloning Gel® as well as a "How To Clone a Plant" with complete instructions, tips and drawings on hydroponic cloning and a trifold pamphlet.

Item No.	Description	MSRP
726355	Olivia's Cloning Starter Kit	\$25.95

Olivia's Cloning Solution®



This cloning solution is a nutrient and propagation liquid that promotes vigorous growth and rapid root development for all types of plants, flowers, fruits and vegetables. Mixing ratio is 6 oz to 1 Gallon of water.

Item No.	Description	MSRP
726345	Olivia's Clone Solution Quart	\$12.95
726350	Olivia's Clone Solution Gallon	\$37.95

Olivia's Cloning Gel®



A professional strength, easy/ready to use propagation gel. Just cut, clip and grow! Stimulates root development for all types of plants. Use for all stem, leaf, softwood, semi hard & some hardwood cuttings. Seals cutting & reduces transplant shock.

Item No.	Description	MSRP
726330	Olivia's Clone Gel 2 oz	\$14.95
726335	Olivia's Clone Gel 4 oz	\$22.95
726340	Olivia's Clone Gel 8 oz	\$37.95

Hormex® Concentrate



A vitamin, hormone concentrate and root growth stimulant. Hormex prevents transplant shock by stimulating growth of the small feeder roots, which become damaged during transplanting. For use on ornamental plants - do not use this product on plants intended for food or feed purposes. Not for sale in the following states at this time: OR.

Item No.	Description	MSRP
726625	Hormex Conc. 8 oz	\$17.19
726630	Hormex Conc. Pint	\$26.89
726635	Hormex Conc. Quart	\$42.99
726634	Hormex Conc. Gallon	\$128.99

Dip 'N Grow® Rooting Solution



Dip 'N Grow® is the most effective rooting hormone available. Choice of professional plant propagators. Roots everything - from hardwoods to succulents. Cost effective solution for cuttings! EPA No. 64388-1. Not for sale in the following states at this time: DC, ND, SD.

Item No.	Description	MSRP
726305	Dip 'N Grow Rooting Solution 2 oz	\$10.95
726310	Dip 'N Grow Rooting Solution Pint	\$55.95

EZ-Clone® Rooting Compound



Developed with cuttings in mind, EZ-Clone® Rooting Compound is superior gel that aids in root development. Packed with all the essential nutrients and hormones that roots need to begin a healthy life.

Item No.	Description	MSRP
726655	EZ-Clone Rooting Compound Gel 1 oz	\$6.95
726660	EZ-Clone Rooting Compound Gel 2 oz	\$12.25
726665	EZ-Clone Rooting Compound Gel 4 oz	\$21.95
726670	EZ-Clone Rooting Compound Gel 8 oz	\$39.95

Vita Grow™ Anti-Wilt Propagation & Transplant Spray



Tests show Vita Grow™ Anti-Wilt surpasses all other products in its class. Sold as a concentrate, this product should be diluted and sprayed onto the leaves of cuttings or newly transplanted starts. Dilution rate is 7 parts water to 1 part concentrate.

Item No.	Description	MSRP
726500	Vita Grow Anti-Wilt Conc. 4 oz	\$9.95
726505	Vita Grow Anti-Wilt Pint	\$26.95
726510	Vita Grow Anti-Wilt Conc. Quart	\$42.95

Vita Grow™ Rooting Compound



A quick 3 second dip of the cutting's stem into Vita Grow™ RTU Rooting Compound before placing it into your favorite growing media is all you need to start the growth of healthy new roots. A great choice for aeroponic cutting/cloning machines. EPA No. 68719-2.

Item No.	Description	MSRP
726515	Vita Grow Rooting Compound 4 oz	\$12.95
726520	Vita Grow Rooting Compound 8 oz	\$19.95
726525	Vita Grow Rooting Compound Pint	\$31.95

Technaflora® Rotech Cloning Gel™



Rotech Cloning Gel™ is an exceptional recipe to promote rapid, healthy root development during vegetative propagation. At application, Rotech's unique formulation surrounds the stem so it can be used immediately. Technaflora's formulation is among the strongest cloning gels on the market.

Item No.	Description	MSRP
726704	Rotech Gel .25 oz	\$3.80
726705	Rotech Gel 2 oz	\$21.71
726710	Rotech Gel 4 oz	\$36.21
726715	Rotech Gel 8 oz	\$59.78

Humboldt Roots



Humboldt Roots is a highly concentrated organic root stimulant that expands the root zone during the critical growth stage. A large yield is directly related to a plant's metabolic rate. Humboldt Roots was specifically designed to expand the root zone which results in larger yields. Check your local Dealer Partner for availability.

Item No.	Description	MSRP
723119	Humboldt Nutrients Humboldt Roots 50 ml	\$22.00
723120	Humboldt Nutrients Humboldt Roots 125 ml	\$42.00
723122	Humboldt Nutrients Humboldt Roots 250 ml	\$70.00
723124	Humboldt Nutrients Humboldt Roots 500 ml	\$115.00
723125	Humboldt Nutrients Humboldt Roots 1/2 Gallon	\$386.00
723127	Humboldt Nutrients Humboldt Roots Gallon NEW	\$728.00

Dyna-Gro™ K-L-N Concentrate



K-L-N Concentrate is a rooting solution that contain ingredients to promote vigorous root growth in trees, foliage and flowering plants. Use it for propagating cuttings, air layering and as a transplanting drench for newly potted plants. EPA No. 87394-3. Not for sale in the following states at this time: AK, AL, AR, AZ, DE, GA, HI, IA, ID, KS, KY, LA, MA, MD, ME, MN, MO, MS, MT, ND, NE, NH, NJ, NV, OH, PR, RI, SC, SD, UT, VA, VT, WI, WV, WY.

Item No.	Description	MSRP
726530	Dyna-Gro K-L-N Conc. 8 oz	\$11.00
726535	Dyna-Gro K-L-N Conc. Quart	\$32.00
726537	Dyna-Gro K-L-N Conc. Gallon	\$105.00

Gold Label Roots 0 - 0.5 - 1



NEW Gold Label Roots is a highly concentrated root and growth stimulator with biological extracts of kelp, humic acids and high quality amino acids. We incorporate EDDHMA chelated Fe which is the most stable Fe available on the market. Use Gold Label Roots for seedlings and cuttings through the vegetative phase of growth. Add 0.5 ml/liter continuously from first watering to 3rd week of flowering. Shake bottles before use, store at room temperature or in the refrigerator.

Item No.	Description	MSRP
733696	Gold Label Root 250 ml	\$74.95
733698	Gold Label Root 500 ml	\$112.95
733700	Gold Label Root 1 Liter	\$202.95
733702	Gold Label Root 4 Liter	\$534.95
733704	Gold Label Root 10 Liter	\$1,091.95
733706	Gold Label Root 20 Liter	\$2,182.95

Xtreme Gardening Azos



Azos is a beneficial microbe that rapidly increases natural plant hormone production, affecting cell division, growth rates, plant and root development. Use Azos to quickly and naturally root new cuttings; water-in or add to hydroponic reservoirs to feed and fuel abundant growth. May be used with any nutrient line.

Item No.	Description	MSRP
721259	Xtreme Gardening Azos 2 oz	\$20.99
721260	Xtreme Gardening Azos 6 oz	\$31.99
721265	Xtreme Gardening Azos 12 oz	\$52.99
721268	Xtreme Gardening Azos 8 lb	\$369.99

Clone Guard™



It has been estimated that powdery mildew, mold, leaf dwelling insects and leaf dehydration account for over 50% of clone death. Clone Guard™ locks in water molecules from escaping from the leaves preventing the clone from wilting. It also locks out insects, powdery mildew and mold, denying them the access to the clone.

Item No.	Description	MSRP
704519	Clone Guard 4 oz	\$11.95
704521	Clone Guard Pint	\$29.95
704523	Clone Guard Quart	\$49.95

Grower's Edge® Plant Stake Labels Multi-Colored



Use these colorful plant stake labels to mark the type of seeds that you plant. Each stake is 4 in x 5/8 in.

EXCLUSIVE

Item No.	Description	MSRP
801000	Grower's Edge Plant Stake Labels White - 1000/Box	\$29.95
801005	Grower's Edge Plant Stake Labels Red - 1000/Box	\$31.95
801010	Grower's Edge Plant Stake Labels Orange - 1000/Box	\$31.95
801015	Grower's Edge Plant Stake Labels Yellow - 1000/Box	\$31.95
801020	Grower's Edge Plant Stake Labels Green - 1000/Box	\$31.95
801025	Grower's Edge Plant Stake Labels Dark Blue - 1000/Box	\$31.95
801030	Grower's Edge Plant Stake Labels Lavender - 1000/Box	\$31.95

Super Sprouter™ Sterile Disposable Scalpel



Use this individually wrapped sterilized scalpel for all your plant cuttings. A sterile scalpel will help prevent disease and damage to any cutting.

EXCLUSIVE

Item No.	Description	MSRP
728000	Super Sprouter Sterile Disposable Scalpel	\$1.60

Luster Leaf® Plant Labels



Choose from 4 in or 6 in durable plant stake labels. Easily label your newly planted seeds. 50 labels per package.

Item No.	Description	MSRP
741415	Luster Leaf Plant Labels 4 in	\$2.79
741425	Luster Leaf Plant Labels 6 in	\$3.59

Luster Leaf® Colored Plant Labels



Choose from blue, yellow or green durable plant stake labels. Easily label your newly planted seeds on these 5 in stakes. 30 labels per package.

Item No.	Description	MSRP
741420	Luster Leaf Colored Plant Labels 5 in	\$3.39

Luster Leaf® T Label Plant Markers



Label your plants or seeds with these tall T shaped plant markers. 10 T labels per package.

Item No.	Description	MSRP
741410	Luster Leaf T Label Plant Markers 8 in	\$2.39

Bond® Reusable T-Markers



These are 10 in tall plastic reusable T-Markers. Use to identify plants within your garden.

Item No.	Description	MSRP
740840	Bond Reusable T-Markers - 25/Pack	\$4.19



*Have you
subscribed for
the Sunlight
Supply You Tube
Channel?*

Subscribe today to get:

- Latest product information
- Tips & tricks for product maintenance
- Installation instructions
- Product spotlights
- ... and much more!





Hydrogardening Bucket Systems
Flo-n-Gro®

Flo-n-Gro® Ebb & Flow System - 12 Site



Includes Industry Exclusive Tub Outlet Tee 3/4" Fitting

4 Gal Plant Sites

UPS

EXCLUSIVE

This Flo-n-Gro® system comes complete with a 55 gallon food grade reservoir, twelve (12) 4 gallon grow sites and twelve (12) 3 gallon 360 degree mesh aeration inserts. The complete system features Titan Controls® Oceanus® 1 - Flo-n-Gro® controller. The kit includes tubing and fittings to hook up the system. The 3/4 in fill lines improve water exchange and flow rates and two (2) dependable pumps. 120 Volts/60 Hz. Patent Pending 13/200559. 1 Year Warranty.

Item No.	Description	MSRP
702790	Flo-n-Gro Ebb & Flow System - 12 Site (2/Boxes)	\$639.95

Flo-n-Gro® Gro Giant® Ebb & Flow System - 6 Site



Includes Industry Exclusive Tub Outlet Tee 1" Fitting

6.6 Gal Plant Sites

UPS

EXCLUSIVE

The Gro Giant® – Oversized Ebb & Flow Grow System is for big plants. Comes with a 55 gallon reservoir, Oceanus® 2 system controller, two pumps, six food grade 6.6 gallon Gro sites, six 10 in mesh Gro inserts, fittings and irrigation tubing. All parts fit inside the 55 gallon barrel. 120 Volts/60 Hz. Patent Pending 13/200559. 1 Year Warranty.

Item No.	Description	MSRP
702811	Flo-n-Gro - Gro Giant Ebb & Flow System - 6 Site	\$699.95

Flo-n-Gro® Drip-n-Gro® Dual Top Feed Drip System - 6 Site



4 Gal Plant Sites

UPS

EXCLUSIVE

The Drip-n-Gro® top feed grow system takes hydroponic gardening techniques to a new level! This innovative bucket system comes ready to use with all the critical components pre-fabricated to allow easy set-up and get you gardening fast. The Drip-n-Gro® can be expandable using the Drip-n-Gro® Expansion Kit - 6 Site (available separately). 120 Volts/60 Hz. All parts fit inside the 55 gallon barrel. 1 Year Warranty.

Item No.	Description	MSRP
702792	Flo-n-Gro Drip-n-Gro Dual Top Feed Drip System w/ Reservoir - 6 Site	\$499.95

Flo-n-Gro® Tsunami™ 5 Gallon Ebb and Flow 6 Site System



5 Gal Plant Sites

UPS

EXCLUSIVE

The Flo-n-Gro® Tsunami™ System will makes serious waves with your garden. This unit is a complete system: (1) 55 gallon reservoir, (6) 5 gallon outer buckets, (6) 5 gallon inner buckets, (2) Bottom-Draw pumps, Oceanus® Tsunami™ controller bucket and all the fittings and tubing to run the system. The tubing included is 3/4 in diameter for efficient water transfer from the high quality bottom-draw pumps. Easy to follow instructions make setup and installation a breeze. 1 Year Warranty.

Item No.	Description	MSRP
702886	Flo-n-Gro Tsunami 5 Gallon Ebb and Flow 6 Site System (2/Boxes)	\$639.95

Flo-n-Gro® Riptide Under Current™ System - 4 Site



The Preferred Nutrient Line for the Riptide Under Current™



13 Gal Plant Sites



EXCLUSIVE

The Flo-n-Gro® Riptide Under Current™ system was built with serious growers in mind. Built under license from Current Culture H2O™ using their patented methodology known as the Sub Current Culture™, this system creates explosive growth. This system features 13 gallon growing sites, heavy duty 8 inch mesh pots, and sturdy injection molded lids with port hole. The Flo-n-Gro® Riptide Under Current™ 4 site expansion kit includes everything you need to expand your existing system by 4 growing sites. 1 Year Warranty.

Item No.	Description	MSRP
702890	Flo-n-Gro Riptide Undercurrent System - 4 Site	\$1,289.95
702891	Flo-n-Gro Riptide Undercurrent System - 4 Site Expansion Kit	\$459.95

Flo-n-Gro® Ebb & Flow Expansion Kit - 6 Site



The Expansion Kit is fully compatible with the 12 Site Ebb & Flow Gro System, as well as the 6 Site Gro System. The kit comes with six (6) 4 gallon Gro sites and six (6) 3 gallon 360 degree snap in mesh aeration inserts. The kit includes 3/4 in exclusive Tub Outlet Tee Fitting and tubing to hook up to your system.

EXCLUSIVE

Item No.	Description	MSRP
702785	Titan Controls Flo-n-Gro 6 Cell Expansion Kit	\$119.95

Flo-n-Gro® Drip-n-Gro® Expansion Kit - 6 Site



The Drip-n-Gro® 6 site expansion kit allows easy extension of your grow system. It comes with six 4 gallon Gro sites, six 360 degree black mesh Gro inserts, irrigation tubing and all the fittings you need to easily increase your garden size. The Drip-n-Gro® system can be multiplied up to 50 Gro sites.

EXCLUSIVE

Item No.	Description	MSRP
702793	Flo-n-Gro Top Feed 6 Site Expansion Kit	\$149.95

Flo-n-Gro® Gro Giant® Expansion Kit - 3 Site



The three site expansion kit is fully compatible for use with the Gro Giant® - Oversized Ebb & Flo Grow System. It comes with three huge 6.6 gallon Gro sites, three gigantic 10 inch mesh Gro inserts, irrigation tubing and fittings to easily expand your system.

EXCLUSIVE

Item No.	Description	MSRP
702812	Flo-n-Gro - Gro Giant Expansion Kit - 3 Site	\$99.95

Flo-n-Gro® Tsunami™ 6 Site Expansion Kit



NEW Use the Flo-n-Gro® Tsunami™ 6 site expansion kit to take your garden to the next level. The expansion kit includes everything necessary to expand your existing Flo-n-Gro® Tsunami™ another 6 sites. 90 Day Warranty.



EXCLUSIVE

Item No.	Description	MSRP
702887	Flo-n-Gro Tsunami 6 Site Expansion Kit	\$199.95

Oceanus® 1 Flo-n-Gro® Controller



The Oceanus® 1 - Flo-n-Gro® Controller features fully digital technology. The 24 hour timer allows you to set several watering patterns for your plants. LED lights indicate FILL and DRAIN functions. Purchase pump separately (recommend product #727085). 120 Volts/60 Hz. Patent Pending 13/200559. 1 Year Warranty.



EXCLUSIVE

Item No.	Description	MSRP
702780	Titan Controls Oceanus 1 Flo-n-Gro Controller	\$339.95

Flo-n-Gro® Flo-n-Brew® - Compost Tea Brewing System



This compact and easy to use compost tea brewer comes with everything you need to brew. It comes with a 3 gallon tea brewer, air pump with hose, Eco 185 submersible pump, fountain kit and 2 air stones. It is 120 Volts/1 Amp/60 Hz.



EXCLUSIVE

Item No.	Description	MSRP
702800	Flo-n-Brew Compost Tea Brewing System	\$69.95
702798	Flo-n-Brew Fountain Head Replacement	\$2.49

Flo-n-Gro® Gro Momma Bubbler Bucket



The Gro Momma 5 gallon Bubbler Bucket system allows both the experienced and inexperienced grower to garden with ease. Kit includes: 8in mesh bucket topper, Hydroton® growing media, EcoPlus® air pump, 3/16 in tubing, 4 in Air Stone and expansion Tee fitting with EZ Pull™ End Caps.



EXCLUSIVE

Item No.	Description	MSRP
702804	Flo-n-Gro - Gro Momma Bubbler Bucket	\$41.95

Flo-n-Gro® Big Momma Bubbler Bucket



This oversized single site grow system can grow big plants! It offers a 6.6 gallon gro site, grow media, air pump with tubing, air stone and a 10 inch mesh insert that promotes outstanding root growth. It also comes with a grommet and tee fitting to daisy chain or easily drain the sites.



EXCLUSIVE

Item No.	Description	MSRP
702808	Flo-n-Gro Big Momma Bubbler Bucket - 6.6 Gallon	\$79.95

Flo-n-Gro® Blue Bucket - 2 Gallon



NEW The Flo-n-Gro® Blue Bucket features food grade plastic, safe for you and your plants. Dimensions: 9.5 in wide x 9.5 in long x 10 in deep. Use to build your own hydroponic system! Does not include 3/4 in grommet. Use with Tub Outlet Tee Fitting 3/4 in #747186 or 1/2 in #742266 and Drip-n-Gro® Short Mesh Insert #350800 both sold separately. 0.835 inch hole pre-drilled in bucket. 90 Days Warranty. **EXCLUSIVE**

Item No.	Description	MSRP
707642	Flo-n-Gro Blue Bucket - 2 Gallon	\$5.75

55 Gallon Barrel with Lid - Food Grade



This is the original reservoir barrel used in our Flo-n-Gro® gardens. It is also a great multi-purpose, heavy-duty reservoir if you are building your own system. Made with food-grade plastic. Includes the lid (no holes) and clamp. Height is 36 in x Diameter of 23 in. Barrel capacity is 55 gallons and weighs 24 lb.



Item No.	Description	MSRP
707168	55 Gallon Barrel w / Lid - Food Grade	\$132.95

Flo-n-Gro® Blue Bucket - 4 Gallon



The Flo-n-Gro® Blue Bucket features food grade plastic, safe for you and your plants. At 4 gallon capacity. Dimensions: 9.5 in W x 9.5 in L x 13.5 in D. Compatible with the Ebb & Flow 6 & 12 Site Systems and Drip-n-Gro® System. Does not include 3/4 in grommet. Use with Tub Outlet Tee Fitting 3/4 in #747186 or 1/2 in #742266 sold separately. Works with Flo-n-Gro® 2 gallon #350800 and 3 gallon #707640 **EXCLUSIVE** mesh inserts.

Item No.	Description	MSRP
707635	Flo-n-Gro Blue Bucket - 4 Gallon	\$6.59

55 Gallon Replacement Lid



Use this lid for the 55 gallon barrel. It has no holes.

Item No.	Description	MSRP
707161	55 Gallon Replacement Lid	\$18.95
707166	55 Gallon Drum Ring Clamp	\$14.95

Flo-n-Gro® Drip-n-Gro® Mesh Insert - 2 Gallon



This 2 gallon black mesh insert fits snugly in the Flo-n-Gro® Ebb and Flow Grow System. The rigid plastic insert keeps its shape for years and the open mesh basket allows for optimal air and water flow that promotes healthy root growth for your plants.

EXCLUSIVE

Item No.	Description	MSRP
350800	Drip-n-Gro Short Mesh Insert	\$6.99

Flo-n-Gro® Square Fabric Liner



This breathable fabric liner provides good drainage and aeration. Compatible only with the Ebb & Flow 6 Site System and 12 Site Gro Systems. Helps contain growing media. Fits snugly into 360 degree plastic mesh inserts. Promotes lateral root growth. Eliminates circling and misguided roots. 3 gallon size.

EXCLUSIVE

Item No.	Description	MSRP
724975	Flo-n-Gro Square Fabric Liner 3 Gallon	\$4.05

Flo-n-Gro® Black Mesh Insert - 3 Gallon



This 3 gallon black mesh insert fits snugly in the Flo-n-Gro® Ebb and Flow Grow System. The rigid plastic insert keeps its shape for years and the open mesh basket allows for optimal air and water flow that promotes healthy root growth for your plants.

EXCLUSIVE

Item No.	Description	MSRP
707640	Flo-n-Gro Black Mesh Insert	\$6.59

Flo-n-Gro® Clear Vented Lid



The innovative Flo-n-Gro® clear vented cover allows you to maintain the perfect humidity level for your sensitive plant starts. By adjusting the ventilation slots on the top of the cover, you can dial in your garden for optimum growth. Can be used with both 2 and 3 gallon mesh inserts.

EXCLUSIVE

Item No.	Description	MSRP
707645	Flo-n-Gro Clear Vented Lid	\$8.29

Flo-n-Gro® Blue Bucket 6.6 Gallon



Oversized, food-grade, blue 6.6 gallon bucket. Dimensions: 14 in W x 14 in L x 12 in D – Polyethylene. This bucket not pre-drilled for outlet fitting. Works best with Hydro Flow® 3/4 in Tub Outlet Fitting #747186 or 1 in Tub Outlet Fitting #747308. Outlet fittings sold separately.



EXCLUSIVE

Item No.	Description	MSRP
724486	Flo-n-Gro 6.6 Gallon Blue Bucket	\$10.95

Flo-n-Gro® Black Bucket 6.6 Gallon



Oversized black 6.6 gallon bucket approved for potable water. Dimensions: 14 in W x 14 in L x 12 in D – Polyethylene.



EXCLUSIVE

Item No.	Description	MSRP
724480	Flo-n-Gro 6.6 Gallon Black Bucket	\$9.95

Flo-n-Gro® 6.6 Gallon Mesh Basket Lid 10 in



10 in wide black mesh insert basket for use with 6.6 gallon Gro Giant® black bucket. Dimensions: 14-1/4 in W x 14-1/4 in H x 7-1/4 in D - Polyethylene.



EXCLUSIVE

Item No.	Description	MSRP
724490	Flo-n-Gro 6.6 Gallon Mesh Basket Lid 10 in	\$9.95

Flo-n-Gro® Tsunami™ 5 Gallon Outer Bucket



NEW This is the outer bucket 5 gallon that is used in the Flo-n-Gro® Tsunami™ system. Comes pre-drilled with a 3/4 in grommet installed. No handle included. 90 Day Warranty.



EXCLUSIVE

Item No.	Description	MSRP
702888	Flo-n-Gro Tsunami 5 Gallon Outer Bucket	\$9.95

Flo-n-Gro® Tsunami™ 5 Gallon Inner Bucket



NEW This is the inner 5 gallon bucket that is used in the Flo-n-Gro® Tsunami™ system. Comes pre-drilled with aeration holes in the bottom of the bucket. No handle included. 90 Day Warranty.



EXCLUSIVE

Item No.	Description	MSRP
702889	Flo-n-Gro Tsunami 5 Gallon Inner Bucket	\$16.95

Flo-n-Gro® Low Profile Easy Clean Trays® Black - OD



NEW Flo-n-Gro® Low Profile Easy Clean Trays® offer the same the unique design as the full size versions. The low profile versions have a 3 in wall height. They are ideal for top feeding water systems and as a catchment tray for hand watered containers. The trays have a shallow channel draining network, creating

an effortless cleaning process. Made with 100% recycled ABS plastic. Manufactured in North America. 1 Year Warranty.

EXCLUSIVE

Item No.	Description	Thickness	Outside L x W x H	MSRP
707870	Flo-n-Gro Low Profile Easy Clean Tray Black - OD 4 ft x 4 ft	0.090	48.0" x 48.0" x 3.0"	\$74.95
707875	Flo-n-Gro Low Profile Easy Clean Tray Black - OD 4 ft x 8 ft	0.090	48.0" x 96.0" x 3.0"	\$144.95

Show us your growing success!
#growwhatyouknow
Upload your images with our products!



Flo-n-Gro® Easy Clean Trays® Outside Dimension (OD)



Uniquely designed to offer growers a simple to clean and fast draining tray at an affordable price. These trays has a drain pattern to effectively remove standing water through a peaks and valley concept. They have a shallow channel draining network, creating an effortless cleaning process. Made with 100% recycled plastic.

Item No.	Description	Thickness	Outside L x W x H	MSRP
707850	Flo-n-Gro Easy Clean Grow Tray - OD 2 ft x 4 ft	0.125	48.0" x 24.0" x 8.0"	\$52.95
707853	Flo-n-Gro Easy Clean Grow Tray - OD 3 ft x 3 ft	0.125	36.0" x 36.0" x 8.0"	\$60.95
707855	Flo-n-Gro Easy Clean Grow Tray - OD 4 ft x 4 ft	0.125	48.0" x 48.0" x 8.0"	\$84.95
707860	Flo-n-Gro Easy Clean Grow Tray - OD 4 ft x 6 ft	0.125	48.0" x 72.0" x 8.0"	\$113.95
707865	Flo-n-Gro Easy Clean Grow Tray - OD 4 ft x 8 ft	0.125	48.0" x 96.0" x 8.0"	\$136.95

Flo-n-Gro® Reservoirs and Lids



The Flo-n-Gro® reservoirs and lids are made from a premium ABS plastic. They feature a UV inhibitor that prevents them from breaking down when exposed to natural or artificial lighting. They are also resistant to cracking. The reservoirs feature a two piece lid which allows you to easily check your water level. They can be used as a water source for many different hydroponics systems. Reservoirs and lids sold separately.

Item No.	Description	Thickness	Outside L x W x H	MSRP
707228	Flo-n-Gro Black 30 Gallon Reservoir	5mm	31.0" x 31.0" x 12.5"	\$69.95
707229	Flo-n-Gro Black 30 Gallon Reservoir Lid (2 Pieces)	5mm	31.0" x 31.0" x 2.0"	\$51.95
707231	Flo-n-Gro Black 70 Gallon Reservoir	5mm	45.0" x 45.0" x 12.5"	\$112.95
707232	Flo-n-Gro Black 70 Gallon Reservoir Lid (2 Pieces)	5mm	45.0" x 45.0" x 2.0"	\$73.95
707241	Flo-n-Gro Black 100 Gallon Reservoir	5mm	51.0" x 51.0" x 13.5"	\$152.95
707242	Flo-n-Gro Black 100 Gallon Reservoir Lid (2 Pieces)	5mm	51.0" x 51.0" x 2.0"	\$89.95

Super Sprouter™ 2 ft x 4 ft Propagation Tray



NEW Super Sprouter™ 2 ft x 4 ft Propagation Tray is loaded with features. It measures 45 inches long, 25 inches wide and 3 inches high to accommodate steel, plastic or wooden rack and shelf units. It accommodate four 10 x 20 inch trays with or without domes. Twin overhanging drain wells with dual drill out fitting nipples to eliminate **EXCLUSIVE**

modifying shelves. Constructed using 1/8 inch food grade ABS plastic.

Item No.	Description	Thickness	Outside L x W x H	MSRP
726432	Super Sprouter 2 ft x 4 ft Propagation Tray	0.125	45.3" x 24.0" x 3.0"	\$69.95



Botanicare® Original Inside Dimension (ID) White Grow Trays



The ID trays now include a 7 in deep seat that accommodates larger root masses, taller pots and deeper saturation. A curved drainage grid with wider channels simplifies cleaning while newly engineered corner gussets allow for greater support. The ID trays maintain standard inside dimensions and are composed of durable white ABS plastic.

Item No.	Description	Capacity	Thickness	Outside L x W x H	MSRP
707050	Botanicare ID White 2 ft x 2 ft Grow Tray	7.6 gal	0.187	23.5" x 23.5" x 7.5"	\$67.50
707067	Botanicare ID White 2 ft x 4 ft Grow Tray	18 gal	0.187	29.0" x 53.0" x 8.0"	\$86.50
707080	Botanicare White 24 in x 44 in x 7 in Propagation Tray	17.5 gal	0.187	43.8" x 26.0" x 7.2"	\$88.25
707406	Botanicare ID White 2 ft x 8 ft Grow Tray	27 gal	0.187	92.5" x 24.5" x 3.8"	\$139.95
707065	Botanicare ID White 3 ft x 3 ft Grow Tray	36 gal	0.22	41.0" x 41.0" x 7.0"	\$117.95
707225	Botanicare ID White 3 ft x 6 ft Grow Tray	72 gal	0.22	77.0" x 41.0" x 7.0"	\$189.95
707090	Botanicare ID White 4 ft x 4 ft Grow Tray	52 gal	0.22	53.0" x 53.0" x 7.0"	\$149.95
707045	Botanicare ID White 4 ft x 8 ft Grow Tray	104 gal	0.24	102.5" x 53.3" x 7.0"	\$302.95
707030	Botanicare White 42 in x 8 in x 4 in Grow Tray	4.4 gal	0.187	42.0" x 8.0" x 4.0"	\$32.95

Botanicare® ID Black Grow Trays



These are the same high-quality trays as the industry standard Botanicare® White Grow Trays but are now also available in black. They feature the same thickness and design as their white trays.



Item No.	Description	Capacity	Thickness	Outside L x W x H	MSRP
707061	Botanicare ID Black 2 ft x 4 ft Grow Tray	17.5 gal	0.187	43.5" x 25.8" x 6.8"	\$77.50
707066	Botanicare ID Black 3 ft x 3 ft Grow Tray	36 gal	0.22	40.5" x 40.5" x 7.5"	\$94.95
707091	Botanicare ID Black 4 ft x 4 ft Grow Tray	72 gal	0.22	54.0" x 54.0" x 7.0"	\$124.95
707237	Botanicare ID Black 3 ft x 6 ft Grow Tray	52 gal	0.22	77.0" x 41.5" x 7.0"	\$159.95
707047	Botanicare ID Black 4 ft x 8 ft Grow Tray	104 gal	0.24	102.5" x 53.3" x 7.0"	\$241.95

Botanicare® Low Tide Black Trays



These newly designed trays offer a diagonal drainage grid that directs water out of the tray and sits in the same footprint as its growing space. The 3.5 in tall Low Tide trays are designed with the solution conserving gardener in mind.



Item No.	Description	Capacity	Thickness	Outside L x W x H	MSRP
707295	Botanicare LT Black 1 ft x 4 ft Tray	10 gal	0.15	48.0" x 14.3" x 4.0"	\$43.75
707320	Botanicare LT Black 1 ft x 8 ft Tray	19 gal	0.15	92.5" x 14.5" x 4.0"	\$64.50
707300	Botanicare LT Black 2 ft x 8 ft Tray	28.5 gal	0.15	92.0" x 24.0" x 3.8"	\$94.50
707305	Botanicare LT Black 3 ft x 3 ft Tray	15 gal	0.15	37.0" x 37.0" x 3.8"	\$57.75
707310	Botanicare LT Black 4 ft x 4 ft Tray	30 gal	0.15	49.0" x 49.0" x 3.8"	\$79.95
707315	Botanicare LT Black 4 ft x 8 ft Tray	60 gal	0.15	97.0" x 49.0" x 3.8"	\$154.95

Botanicare® Outside Dimension (OD) Black Trays



These trays sit in the precise footprint and fit easily into all growing tents on the market. The Botanicare® OD trays, available only in black ABS plastic, are formed with an easy to clean diagonal drainage grid to direct water towards drainage fittings.



Item No.	Description	Capacity	Thickness	Outside L x W x H	MSRP
707340	Botanicare OD Black 3 ft x 3 ft Tray	27.5 gal	0.187	36.0" x 36.0" x 6.0"	\$69.95
707342	Botanicare OD Black 3 ft x 6 ft Tray	56 gal	0.187	72.0" x 36.0" x 6.0"	\$134.45
707345	Botanicare OD Black 4 ft x 4 ft Tray	50 gal	0.187	48.0" x 48.0" x 6.0"	\$99.95
707347	Botanicare OD Black 4 ft x 6 ft Tray	75 gal	0.15	70.0" x 46.0" x 6.0"	\$160.50
707350	Botanicare OD Black 4 ft x 8 ft Tray	100 gal	0.187	96.0" x 48.0" x 6.0"	\$189.50

Botanicare® Premium Reservoirs & Lids

NEW



Designed for excellent performance and easy maintenance, Botanicare's Premium Reservoirs are true capacity with exceptional durability. They include front and side bulkhead ports to accommodate an internal pump and allow multiple reservoirs to be joined in line or side-by-side. Botanicare's Premium reservoirs are made with BPA-free recyclable materials, and include a virgin UV-resistant ABS cap that wraps the 70% recycled ABS core. Made in the USA using solar energy at Botanicare's own forming facility.

Item No.	Description	Outside L x W x H	MSRP
707115	Botanicare 10 Gallon Reservoir Lid	14.3" x 23.8" x 0.8"	\$36.95
707120	Botanicare 10 Gallon Reservoir	23.3" x 14.3" x 11.8"	\$57.95
707130	Botanicare 20 Gallon Reservoir Lid	26.3" x 20.0" x 1.0"	\$43.95
707135	Botanicare 20 Gallon Reservoir	26.0" x 20.0" x 11.3"	\$61.95
707150	Botanicare 40 Gallon Reservoir Lid	37.3" x 29.5" x 1.0"	\$57.95
707155	Botanicare 40 Gallon Reservoir	37.0" x 29.3" x 12.0"	\$89.95
707215	Botanicare 70 Gallon Reservoir Lid	54.0" x 31.0" x 1.5"	\$95.95
707210	Botanicare 70 Gallon Reservoir	53.8" x 30.3" x 12.0"	\$185.95
707160	Botanicare 115 Gallon Reservoir Lid	51.0" x 51.0" x 1.5"	\$146.95
707165	Botanicare 115 Gallon Reservoir	50.0" x 50.0" x 14.5"	\$238.95

Botanicare® Porthole Covers



For use with Botanicare® reservoirs.

Item No.	Description	Outside L x W x H	MSRP
707195	Botanicare Porthole Cover (for 10, 20, 40, 70, 115 Gallon)	7.3" x 5.5" x 1.0"	\$8.95
707197	Botanicare Porthole Cover for Turbogarden (25 Gallon)	6.8" x 6.5" x 0.3"	\$9.95
707246	Botanicare Porthole Cover for Microgarden & Eazy Drain	11.5" x 5.8" x 1.0"	\$10.95

EZ Store™ Container/Buckets 8 & 13 Gallon & Lid



Made with virgin, high density polyethylene material. These patented containers have no holes in them and can hold up to 8 or 13 gallons of liquid. EZ Store™ containers are nestable, with built in hand grips. The lid is compatible with both sizes. It has a recessed fit with a tear strip and a built in handle on the front portion of the hinged lid, creating easy access without removing the lid.

Item No.	Description	Outside L x W x H	MSRP
703990	EZ Store Container/Bucket 8 Gallon	11.3" x 11.6" x 12.7"	\$14.99
703992	EZ Store Container/Bucket 13 Gallon	14.2" x 11.5" x 18.6"	\$22.99
703994	EZ Store Lid for 8 and 13 Gallon	15.8" x 0.9" x 13.2"	\$4.99

Duralastics® Trays Black Inside Dimension (ID)



Made of black 100% recycled ABS plastic with virgin ABS cap on each side. Manufactured In the USA using 25% solar energy. Easy clean drainage grid allows the grower to clean their trays without the hassle of scrubbing sharp corners to remove build up. Built in water level indicators to easily identify the fill level in the trays.



EXCLUSIVE

Item No.	Description	Thickness	Outside L x W x H	MSRP
707920	Duralastics 2 ft x 4 ft ID Black Tray	0.13	54.3" x 30.3" x 7.0"	\$56.95
707915	Duralastics 3 ft x 3 ft ID Black Tray	0.13	42.8" x 42.8" x 7.0"	\$72.95
707905	Duralastics 3 ft x 6 ft ID Black Tray	0.16	43.0" x 79.0" x 7.0"	\$139.95
707910	Duralastics 4 ft x 4 ft ID Black Tray	0.16	54.3" x 54.3" x 7.0"	\$93.95
707900	Duralastics 4 ft x 8 ft ID Black Tray	0.16	54.3" x 102.5" x 7.0"	\$196.95

Duralastics® Trays White Inside Dimension (ID)



Made of white 80% recycled ABS plastic with virgin ABS cap on each side. Manufactured In the USA using 25% solar energy. Easy clean drainage grid allows the grower to clean their trays without the hassle of scrubbing sharp corners to remove build up. Built in water level indicators to easily identify the fill level in the trays.



EXCLUSIVE

Item No.	Description	Thickness	Outside L x W x H	MSRP
707950	Duralastics 2 ft x 4 ft ID White Tray	0.13	54.3" x 30.3" x 7.0"	\$57.95
707945	Duralastics 3 ft x 3 ft ID White Tray	0.13	42.8" x 42.8" x 7.0"	\$79.95
707935	Duralastics 3 ft x 6 ft ID White Tray	0.16	43.0" x 79.0" x 7.0"	\$126.95
707940	Duralastics 4 ft x 4 ft ID White Tray	0.16	54.3" x 54.3" x 7.0"	\$107.95
707930	Duralastics 4 ft x 8 ft ID White Tray	0.16	54.3" x 102.5" x 7.0"	\$206.95

Duralastics® Reservoirs



EXCLUSIVE

Made of black 100% recycled ABS plastic or white 80% recycled ABS plastic with virgin ABS cap on each side. Made to last at 0.160 in gauge thickness. Manufactured In the USA using 25% solar energy. Easy to clean design allows the grower to clean their reservoirs without the hassle of scrubbing sharp corners to remove build up. Built in water level indicators to easily identify the fill level in the reservoirs. Lids are not available for Duralastics® Reservoirs.

Item No.	Description	Outside L x W x H	MSRP
707925	Duralastics 75 Gallon Reservoir Black	47.3" x 47.3" x 13.0"	\$125.95
707955	Duralastics 75 Gallon Reservoir White	47.3" x 47.3" x 13.0"	\$145.95
707960	Duralastics 100 Gallon Reservoir Black	48.5" x 48.5" x 15.0"	\$173.95
707965	Duralastics 100 Gallon Reservoir White	48.5" x 48.5" x 15.0"	\$212.95

Grotek™ Reservoirs



Grotek™ reservoirs fit under a variety of flood tables or aeroponic systems. Each unit includes water level indicators for ease of use.



Item No.	Description	Outside L x W x H	MSRP
707230	Grotek 260 Liter (69 Gallon) Reservoir	45.0" x 45.0" x 12.0"	\$111.15
707240	Grotek 378 Liter (100 Gallon) Reservoir	51.0" x 51.0" x 13.5"	\$155.57

Heavy Duty Reservoirs



They are made with a high quality FDA approved, UV protected plastic to ensure uniform thickness and strength for maximum durability and longevity. One piece construction with rounded edges. Made in the USA. 5 Year Warranty.



Item No.	Description	Outside L x W x H	MSRP
707332	Heavy Duty Gray 55 Gallon Reservoir	51.5" x 27.5" x 13.0"	\$141.95
707335	Heavy Duty Gray 100 Gallon Reservoir	52.0" x 30.8" x 24.0"	\$179.95

Urban Oasis™ Reservoir - Stand Up - 105 Gallon



Rugged, impact and corrosion resistant, one piece seamless construction makes this tank the perfect choice for fertilizer solutions. The tank has capacity for 105 gallons and is 23 in diameter and 63 in tall. Each tank includes an 8 in threaded lid and a 2 in by 3/4 in bushing with a 3/4 in plug.



Item No.	Description	Outside L x W x H	MSRP
707169	Urban Oasis Stand Up Reservoir 105 Gallon	23.0" x 23.0" x 63.0"	\$399.95

Urban Oasis™ Reservoir - Stand Up - 48 Gallon



Foot print is only 18 in x 12 in. It is 63.5 in tall. Features standard hose threads for easy connection to a garden hose. Made from translucent FDA approved, durable plastic. Back is flat to go up against the wall. Made in the USA. 5 Year Warranty.



Item No.	Description	Outside L x W x H	MSRP
707322	Urban Oasis Stand Up Reservoir 48 Gallon	63.5" x 18.0" x 12.0"	\$169.95

Grodan® Dutch Leach Tray with 2 Elbows



Heavy duty plastic leach tray with 2 drain elbows & end caps. Designed to work with 6 in rock wool slabs, but also works well with a variety of other growing mediums.

Item No.	Description	Outside L x W x H	MSRP
707430	Dutch Leach Tray w/ Fittings	6.0" x 40.0" x 3.5"	\$15.81

Grodan® Dutch Leach Tray Elbows & Caps



For use with Dutch Leach Tray.

Item No.	Description	MSRP
707435	Dutch Leach Tray Elbows (25/Bag)	\$1.59
707440	Dutch Leach Tray Endcap (25/Bag)	\$0.65



GH Covert™ Tank



Our super reinforced, portable, light weight tank is ideal for use as a hydroponic reservoir, rain barrel or for water storage. Our tanks are collapsible and are extremely compact which makes it ideal for transportation and set up in small spaces.

Item No.	Description	Outside L x W x H	MSRP
707805	GH Covert Tank Black 66 Gallon	24.0" x 24.0" x 37.5"	\$118.95

GH Panda Reservoir



The GH Panda reservoir is 40 gallons. It has a white exterior (which reflects heat) and a black interior (which discourages algae growth). It offers a small foot print and is very durable. Purchase lid separately.

Item No.	Description	Outside L x W x H	MSRP
707265	GH 40 Gallon Panda Reservoir w/ out Lid	48.0" x 24.0" x 13.0"	\$142.00
707266	GH 40 Gallon Panda Reservoir Lid w/ Cover	48.0" x 24.0" x 2.0"	\$92.00

GH AeroFlo® Systems



Hydroponic systems come complete with everything needed to start growing - Flora Series® nutrients, clay pebbles, net cups, coco cup liners, pump (except 60 extension), support structure and manifold. AeroFlo® super-oxygenates the nutrient solution to deliver oxygen, water and nutrient in ideal combinations.

Item No.	Description	Outside L x W x H	MSRP
706028	GH AeroFlo2 - 18 Site 2/Boxes	64.0" x 23.0" x 22.0"	\$429.00
706030	GH AeroFlo2 - 20 Site 2/Boxes	84.0" x 18.0" x 24.0"	\$421.67
706035	GH AeroFlo2 - 30 Site 2/Boxes	90.0" x 23.0" x 22.0"	\$559.98
706040	GH AeroFlo2 - 36 Site 2/Boxes	50.0" x 55.0" x 24.0"	\$937.74
706045	GH AeroFlo2 - 60 Site 2/Boxes	61.0" x 82.0" x 24.0"	\$1,173.33
706050	GH AeroFlo2 - 60 Site Extension 2/Boxes	115.0" x 82.0" x 24.0"	\$935.00

GH AeroFlo® Replacement Parts



Replacement parts for all the AeroFlo® systems.

Item No.	Description	MSRP
706005	GH 6 ft Laser Drilled Spray Line	\$10.29
706832	GH 3 in Site Plug (20/Bag)	\$1.07
706833	GH 4 in Site Plug (10/Bag)	\$2.13
708325	GH Grommet 1 in (10/Bag)	\$1.90
708330	GH Grommet 1-1/4 in (10/Bag)	\$2.20

GH Water Farm® - Complete & Modular Systems



The complete WaterFarm® is designed to be a stand alone system and includes 4-gal reservoir, 2-gal growing chamber, pumping column, column support tube, drip ring, 1/2 in grommet, drain level tube, Elite 800 air pump, 9L clay pebbles and 3-part Flora Kit. The modular unit comes without a drain level tube, Elite air pump, clay pebbles or Flora kit.

Item No.	Description	Outside L x W x H	MSRP
706975	GH WaterFarm Complete	12.0" x 12.0" x 18.0"	\$65.63
706985	GH WaterFarm Module	12.0" x 12.0" x 18.0"	\$46.00

GH Farm Kit



Plumbing hardware for WaterFarm®. Kit includes drip ring, pumping column, drain level tube and clip, clear air hose and grommet. Also includes the WaterFarm® Module.

Item No.	Description	MSRP
706335	GH Farm Kit	\$14.30

GH Water Farm® 8 Pack Hit



The WaterFarm® 8-pack is 8 WaterFarm module units connected to 1 controller. These units can be arranged in a design that is suitable for any environment. The kit is powered by GH's Dual Diaphragm Air Pump & includes hardware, supplies & nutrients. Does not include clay pebbles.

Item No.	Description	Outside L x W x H	MSRP
706980	GH WaterFarm 8 Pack	79.0"x 30.0"x 15.0"	\$514.60

GH Water Farm® 8 Pack Circulating Upgrade Hit



The WaterFarm® 8 Pack Circulating Upgrade Kit contains everything needed to reconfigure an 8 Pack and add nutrient circulation capability to an existing system. This promotes even growth and more consistent results overall.

Item No.	Description	MSRP
706976	GH WaterFarm 8/Pack Circulating Upgrade Kit	\$49.50

GH Power Grower® - 8 Pack Hit



This hydroponic system features 8 of the 5.7 gal hex reservoirs with 3 gallon growing chambers, 17 gal master reservoir, 17 gal controller with float valve, tubing, fittings, drip rings and GH Flora nutrients. Does not include clay pebbles.

Item No.	Description	Outside L x W x H	MSRP
706638	GH PowerGrower 8/Pack	26.0"x 23.5"x 21.0"	\$687.48

GH Vortex® DC Sprayer



The spinning shaft of the Vortex® Sprayer creates a powerful eddy that not only stirs and lifts nutrients from the reservoir, but also gently oxygenates and evenly distributes nutrients and oxygen to plant cuttings and root systems.

Item No.	Description	MSRP
706720	GH Vortex 12 Volt DC Sprayer	\$134.99

GH Controller Complete & Texas Controller



The Controller Complete accommodates 8 farm modules. It includes a 13 gal reservoir, 8 gal controller, tubing, fittings & valve. The Texas Controller accommodates 16 farm modules 20 gal reservoir & 20 gal controller, tubing, fittings & a valve.

Item No.	Description	Outside L x W x H	MSRP
706215	GH Controller Complete	12.0"x 12.0"x 42.0"	\$134.36
706220	GH Texas Controller	24.0"x 24.0"x 42.0"	\$372.00

GH EuroGrower® - Complete System



The heart of the EuroGrower® is our custom designed 40-gallon Panda reservoir, which is more than adequate for its eight 2-gallon buckets. You can grow either numerous small plants or 1 large one. Comes complete with a 40-gallon Panda reservoir, 8 buckets, 250gph Mag-Drive 2, CocoTek bricks, clay pebbles, pH kit, Grasslin timer and 3-part Flora Series® nutrients.

Item No.	Description	Outside L x W x H	MSRP
706636	GH EuroGrower 8 Complete	48.0"x 24.0"x 24.0"	\$416.66

GH PowerGrower® Eco



Complete system includes: 5.7-gal reservoir, 3-gal growing chamber, pumping column and support tube, drip ring, 1/2 in grommet, drain level tube, Elite 800 air pump, 9L clay pebbles and 3-part Flora Kit.

Item No.	Description	Outside L x W x H	MSRP
706635	GH PowerGrower Eco	15.0"x 15.0"x 15.0"	\$108.00

GH RainForest 66 - Six 6 in Site Aeroponics System



The Rainforest 66 has a Vortex® Sprayer lifts and oxygenates the nutrient solution and then gently distributes it over cutting's bases or root systems. Includes: 17-Gal reservoir with lid, six - 6 in lid inserts, Vortex® Sprayer, 6 in plastic cups, CocoTek® liners, CocoTek® caps and 3-Part Flora Kit.

Item No.	Description	Outside L x W x H	MSRP
706705	RainForest 66 Aeroponic System	15.0" x 15.0" x 15.0"	\$291.50

GH RainForest 318 - Eighteen 3 in Site Aeroponics System



The RainForest 318 can accommodate up to 18 small plants from cuttings to harvest or up to ninety cuttings for rooting and transplantation using the 3 in CocoTek® coconut caps included. Includes everything you need to get started even 3-Part Flora Kit.

Item No.	Description	Outside L x W x H	MSRP
706710	RainForest 318 Aeroponic System	15.0" x 15.0" x 15.0"	\$295.95

GH RainForest 236 - Thirty-six 2 in Site Aeroponics System



Growers can use the RainForest 236 to create a modestly sized nursery. Use this model to propagate cuttings or to quick-start seeds in a small footprint area. Includes everything you need to get started even 3-Part Flora Kit.

Item No.	Description	Outside L x W x H	MSRP
706715	RainForest 236 Aeroponic System	15.0" x 15.0" x 15.0"	\$291.50

GH Eco Grower® Drip Hydroponic System



The EcoGrower® incorporates an air driven spider drip system and uses the same revolutionary hexagonal reservoir with removable six inch lid inserts. Each lid insert will accommodate one 6 in net pot. Includes everything you need to get started even media & nutrients.

Item No.	Description	Outside L x W x H	MSRP
706721	EcoGrower Drip Hydroponic System	24.0" x 24.0" x 24.0"	\$233.75

GH Snapture Snapstand 4 ft x 4 ft Tray Stand



The custom Snapture pieces turn standard 1-1/4 in PVC pipe into tray or system stands, trellis supports, light hangers, grow tent frames and more. A versatile design to support 4 ft x 4 ft trays.

Item No.	Description	MSRP
707262	Snapture Snapstand 4 ft x 4 ft Tray Stand	\$90.00

GH Snapture Snapstand Fittings



The custom Snapture pieces turn standard 1-1/4 in PVC pipe into tray or system stands, trellis supports, light hangers, grow tent frames and more.

Item No.	Description	MSRP
707250	Snapture Snapstand Cross Fitting	\$4.79
707255	Snapture Snapstand Foot Base	\$4.79
707260	Snapture Snapstand Dovetail 90 Degree	\$3.79

AutoPot 4-Pot System



The 4-Pot System is a gravity fed watering system which requires no power, pumps or timers to operate. It is extremely versatile and caters for gardeners and growers of all abilities guaranteeing great results. The system can easily be extended so many pots can be linked to a single reservoir.

Item No.	Description	Outside L x W x H	MSRP
707625	AutoPot 4-Pot System	15.0" x 11.0" x 24.0"	\$199.95

AutoPot FlexiTank Reservoirs



The FlexiTank Reservoir revolutionizes water storage. It requires no tools for assembly, reduces storage and shipping costs and takes minutes to assemble. Fit where other reservoirs cannot go and can be packed away and stored at the end of the season.

Item No.	Description	MSRP
708040	AutoPot 25 Gallon FlexiTank	\$79.95
708045	AutoPot 60 Gallon FlexiTank	\$107.95
708050	AutoPot 105 Gallon FlexiTank	\$179.95
708052	AutoPot 200 Gallon FlexiTank	\$259.95

Claber® Oasis Self Watering System



With this Watering System you do not have to worry about watering your plants when away. The Oasis has 4 independent watering programs: 10-20-30-40 days that can be selected by simply turning the dial to water a maximum of 20 plants. Operates on one 9v battery (not included). Gravity feed. No pump. Unit dimensions is 15 in x 15 in x 15 in & 9.5 lb.

Item No.	Description	MSRP
708775	Claber Oasis Self Watering System	\$119.95

Current Culture Under Current® Double Barrel XL13

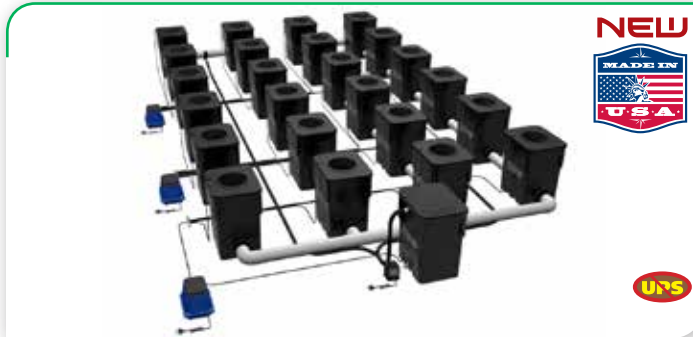

The Under Current® XL13 & XXL13 Systems Includes: 13 gallon Blackout Series growth modules, 3 in manifolds, 3 in UC Spin Tight Bulkheads, CCH20 8 in Heavy Duty Lids with Port Hole, CCH20 Heavy Duty 8 in Net Pots, Danner Mag-Drive™ Return Pump, Premium Linear Air Pump(s), 9 in Air Diffuser Disc, Aqua-Pore Air Diffusers, Air Distribution Manifold, Air Hose, In-Line Filter(s), Adjustable Float Valve with Reservoir Adapter Kit, Drain Valve, Chiller Adapter, Garden Hose Drain Adapter, Cultured Solutions™ VEG A/B. 30 inch plant centers with recommended growth time of 3-5 weeks. These items are drop ship only.

Item No.	Description	MSRP
703270	Current Culture Under Current Double Barrel 24XL13	\$4,664.95
703271	Current Culture Under Current Double Barrel 32XL13	\$5,819.95

Current Culture Under Current® Double Barrel XXL13

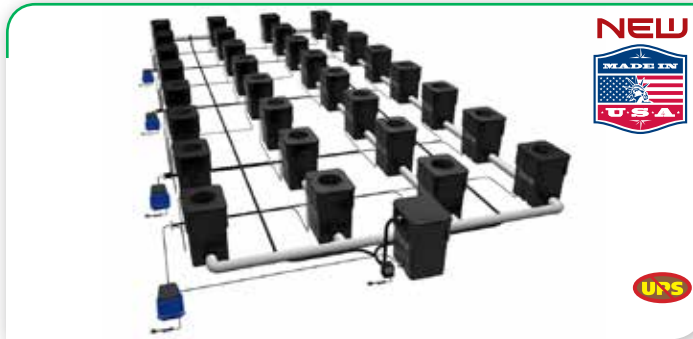

The Under Current® XL13 & XXL13 Systems Includes: 13 gallon Blackout Series growth modules, 3 in manifolds, 3 in UC Spin Tight Bulkheads, CCH20 8 in Heavy Duty Lids with Port Hole, CCH20 Heavy Duty 8 in Net Pots, Danner Mag-Drive™ Return Pump, Premium Linear Air Pump(s), 9 in Air Diffuser Disc, Aqua-Pore Air Diffusers, Air Distribution Manifold, Air Hose, In-Line Filter(s), Adjustable Float Valve with Reservoir Adapter Kit, Drain Valve, Chiller Adapter, Garden Hose Drain Adapter, Cultured Solutions™ VEG A/B. 40 inch plant centers with recommended growth time of 4-6 weeks. These items are drop ship only.

Item No.	Description	MSRP
703272	Current Culture Under Current Double Barrel 24XXL13	\$4,789.95
703273	Current Culture Under Current Double Barrel 32XXL13	\$6,079.95



FASTFIT® toolless assembly light & tray stands

This revolutionary unique patented “no hassle” toolless design allows for a quick and simple assembly in minutes! Designed and engineered for the pieces to simply slide together. US Patent 8,714,498, Patent Pending 14/269,619, PCT Application CT/US12/00001 and Chinese Patent 201280018267.2.



Fast Fit® Tray Stand 2 ft x 4 ft



Heavy duty 2 ft x 4 ft quick assembly tray stand. Absolutely no tools required. Can be assembled in 5 minutes or less. Accommodates all popular brand trays and reservoirs. Overall height is 25 in. Height from bottom bar to floor is 18 in without casters. Outside dimensions: 53 in length by 28.5 in wide. Inside dimensions: 51 in length by 26.5 in wide. US Patent 8,714,498, Patent Pending 14/269,619, PCT **EXCLUSIVE**

Application CT/US12/00001 and Chinese Patent 201280018267.2. Tray sold separately.

Item No.	Description	MSRP
706120	Fast Fit Tray Stand 2 ft x 4 ft	\$109.95

Fast Fit® Tray Stand 3 ft x 3 ft



Heavy duty 3 ft x 3 ft quick assembly tray stand. Absolutely no tools required. Can be assembled in 5 minutes or less. Accommodates all popular brand trays and reservoirs. Overall height is 25 in. Height from bottom bar to floor is 18 in without casters. Outside dimensions: 41.3 in length by 41.3 in wide. Inside dimensions: 39.3 in length by 39.3 in wide. US Patent 8,714,498, Patent Pending 14/269,619, PCT Application CT/

US12/00001 and Chinese Patent 201280018267.2. Tray sold separately. **EXCLUSIVE**

Item No.	Description	MSRP
706121	Fast Fit Tray Stand 3 ft x 3 ft	\$126.95

Fast Fit® Tray Stand 4 ft x 4 ft



Heavy duty 4 ft x 4 ft quick assembly tray stand. Absolutely no tools required. Can be assembled in 5 minutes or less. Accommodates all popular brand trays and reservoirs. Overall height is 25 in. Height from bottom bar to floor is 18 in without casters. Outside dimensions: 53 in length by 53 in wide. Inside dimensions: 51 in length by 51 in wide. US Patent 8,714,498, Patent Pending 14/269,619, PCT **EXCLUSIVE**

Application CT/US12/00001 and Chinese Patent 201280018267.2. Tray sold separately.

Item No.	Description	MSRP
706122	Fast Fit Tray Stand 4 ft x 4 ft	\$149.95

Fast Fit® Tray Stand 3 ft x 6 ft



NEW Heavy duty 3 ft x 6 ft quick assembly tray stand. Absolutely no tools required. Can be assembled in 5 minutes or less. Accommodates all popular brand trays and reservoirs. Overall height is 25 in. Height from bottom bar to floor is 18 in without casters. US Patent 8,714,498, Patent Pending 14/269,619, PCT Application CT/US12/00001 and Chinese Patent

EXCLUSIVE

201280018267.2. Tray sold separately.

Item No.	Description	MSRP
706135	Fast Fit Tray Stand 3 ft x 6 ft	\$191.95

Fast Fit® Tray Stand 4 ft x 8 ft



Heavy duty 4 ft x 8 ft quick assembly tray stand. Absolutely no tools required. Can be assembled in 5 minutes or less. Accommodates all popular brand trays and reservoirs. Overall height is 25 in. Height from bottom bar to floor is 18 in without casters. Outside dimensions: 102 in length by 53 in wide. Inside dimensions: 100 in length by 51 in wide. US Patent 8,714,498, Patent Pending 14/269,619, PCT Application CT/US12/00001 and Chinese Patent 201280018267.2.

UNS

EXCLUSIVE

Tray sold separately.

Item No.	Description	MSRP
706124	Fast Fit Tray Stand 4 ft x 8 ft	\$249.95

Fast Fit® Components

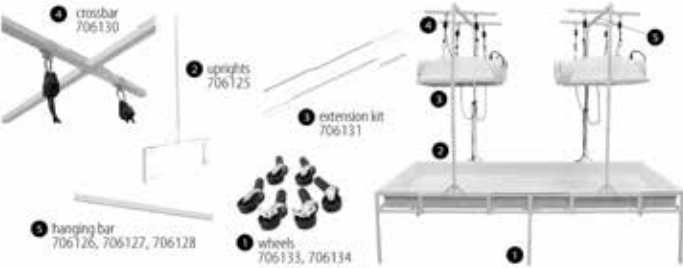

EXCLUSIVE

Fast Fit® A La Carte Components: Castor wheels - 4 pc (706133 - can support up to 240 lbs) and 6 pc (706134 - can support up to 360 lbs). Light Stand 4 ft Uprights (706125). Extension Kit (706131). Light Stand Crossbar (706130). Sturdy hanging bar comes in 2 ft, 3 ft and 4 ft sizes (706126, 706127, 706128).

Item No.	Description	MSRP
706125	Fast Fit Light Stand Kit Upright 4 ft	\$91.95
706126	Fast Fit Light Hanging Bar for 2 ft x 4 ft	\$18.95
706127	Fast Fit Light Hanging Bar for 3 ft x 3 ft	\$16.95
706128	Fast Fit Light Hanging Bar for 4 ft x 4 ft or 4 ft x 8ft (Width)	\$19.95
706129	Fast Fit Light Hanging Bar for 4 ft x 8 ft (Length)	\$34.95
706130	Fast Fit Light Stand Crossbar - 1 each	\$32.95
706131	Fast Fit Light Stand Extension Kit - 2 each	\$23.95
706132	Fast Fit Tray Stand Tray Support Bar 4 ft	\$19.95
706133	Fast Fit Caster Wheels - 4 pc	\$26.95
706134	Fast Fit Caster Wheels - 6 pc	\$37.95

Duralastics® Conical Step Drill Bit



Drill your own trays with ease with a self centering conical step drill bit! Drills holes from 1/4 in up to 1-3/8 in. Step measurement marks are etched directly on the drill bit. Titanium coated for durability and reduced friction. Drill up to 10 different sized holes with one bit!

EXCLUSIVE

Item No.	Description	MSRP
707202	Duralastics Conical Step Drill Bit - 1/4 in to 1-3/8 in	\$29.95

Hydro Flow® Drip Ring



NEW Pre-built ring uses four one gallon per hour cleanable emitters. The ring is constructed with 1/2 inch poly tubing. Emitters are evenly spaced to water 360 degrees around the plant. The intake fitting is a 1/2 inch barbed fitting. Ring is 10 inches in diameter.

EXCLUSIVE

Item No.	Description	MSRP
748420	Hydro Flow Drip Ring 10 in	\$9.07

Hydro Flow® Black Holes Drippers



Unique and innovative top feed dripper manufactured for use in hydroponics. 1/2 in and 1/4 in barb option. 1/4 in barb is compatible with standard drip emitters by plugging them into the barb (rec. 2 GPH emitter). Designed with 6 beveled emitter holes. 100% Made in the USA by 100% recycled plastic.

EXCLUSIVE

Item No.	Description	MSRP
748410	Hydro Flow Black Holes Dripper 1/4 in	\$5.19
748415	Hydro Flow Black Holes Dripper 1/2 in	\$5.19



Fast Fit® 4'x 8' Light Stand & Conversion Kit

You will need:

- 706124-4'x 8' Fast Fit (1)
- 706129-Fast Fit Hanging Bar for 4'x 8' (length) (1)
- 706125-4' Upright Kit (1)
- 706130-Light Stand Cross Bars (2)
- 706134-6 pc Caster Set (1)



* tray sold separately

TAKE A CLOSER LOOK AT OUR COMPLETE LINE OF SUN HUTS



SUN HUT®
THE BIG EASY®
TOUGH | SELECT QUALITY
190D fabric w/ 16 mm poles

4
models
to choose
from!



SUN HUT®
Black Out®
PRO GRADE | PREMIUM QUALITY
210D fabric w/ 19 mm poles

10
models
to choose
from!



SUN HUT®
FORTRESS
ELITE | SUPREME QUALITY
1680D fabric w/ 22 mm poles

8
models
to choose
from!



sun-huts.com



Larger than
competitive models



Highly reflective
silver interior



Quick and easy
assembly



Light-tight layered
tent material

Always choose Sun Hut® brand affordable enclosed greenhouses

Sun Hut® - The Big Easy® Grow Tent

CHECK OUT OUR 3 LEVELS OF SUN HUT:

- Sun Hut® - The Big Easy®: **Tough** / Select Quality
- Sun Hut® - Blackout®: **Pro Grade** / Premium Quality
- Sun Hut® - Fortress®: **Elite** / Supreme Quality

SUN HUT®

THE BIG EASY®

sun-huts.com



190D light weight and light-tight outer material

2 access doors in front and back

Sturdy 16 mm/.63" Galvanized steel pole frame

190D silver PE removable floor liner



All Big Easy Grow Tents have a U Shaped Rear Door for total access to your growing space.

Model Shown: 706920 Sun Hut Big Easy 70

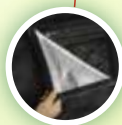

Dual 10" reducing silver/black ventilation socks

Clear viewing windows with Velcro covers

Improved zipper for rugged & durable grow environment

Oversized to fit most industry standard trays

FRONT



BACK



The assembly of this grow tent is both quick and simple.

The Big Easy has reinforced stitching in high wear areas.

Sun Hut® - The Big Easy® Grow Tents



EXCLUSIVE

Sun Hut® The Big Easy® Grow Tents are enclosed greenhouses that have a durable, lightweight and light-tight 190D outer material with a highly reflective interior surface. The Big Easy® has reinforced stitching in high wear areas and has a new improved zipper creating a rugged and durable grow environment. All sizes have a "U" shaped rear door for total access to your growing space. The frame of The Big Easy® consists of galvanized steel poles and unique quick connect molded plastic corners. With these two features combined, the assembly of this grow tent is both quick and simple. Other features include 10 in duct ports, high and low lamp/power cord ports and a tray bottom. The 2 ft x 4 ft, 4 ft x 4 ft, and 4 ft x 8 ft models are large enough to fit the largest plastic grow trays on the market. Note: model numbers identify the approximate cubic feet. 1 Year Warranty.

Item No.	Description	Tent Dimensions	MSRP
706915	Sun Hut Big Easy 80 - 4.3 ft x 2.8 ft x 6.5 ft	52.7" x 34.4" x 78.9"	\$178.95
706920	Sun Hut Big Easy 70 - 3.3 ft x 3.3 ft x 6.5 ft	40.2" x 40.2" x 78.9"	\$170.95
706925	Sun Hut Big Easy 145 - 4.7 ft x 4.7 ft x 6.5 ft	56.8" x 56.8" x 78.9"	\$225.95
706930	Sun Hut Big Easy 285 - 9.4 ft x 4.7 ft x 6.5 ft	56.8" x 112.8" x 78.9"	\$358.95

Always choose Sun Hut® brand affordable enclosed greenhouses

Sun Hut® - Blackout® Grow Tent

CHECK OUT OUR 3 LEVELS OF SUN HUT:

- Sun Hut® - The Big Easy: **Tough** / Select Quality
- Sun Hut® - Blackout: **Pro Grade** / Premium Quality
- Sun Hut® - Fortress: **Elite** / Supreme Quality



sun-huts.com



- 210D light-tight outer material
- Full service easy access door/s (see chart lower right)
- Sturdy 19 mm/.75" Galvanized steel pole frame
- 190D reflective mylar removable floor liner

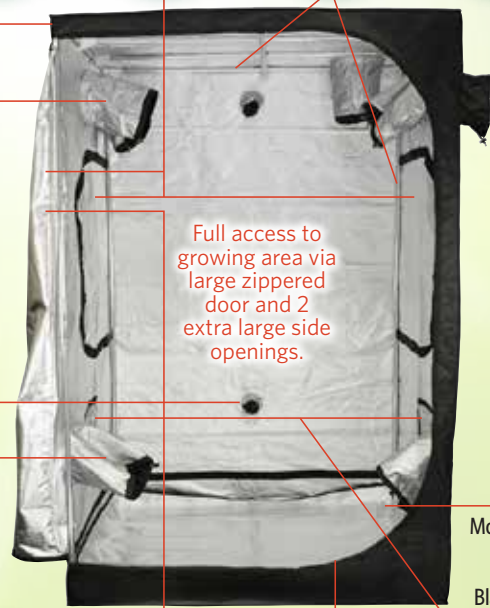

Full access to growing area via large zippered door and 2 extra large side openings.

Model Shown: 706298 Sun Hut Blackout 100



- Dual sock vent and lamp/power cord ports
- Clear viewing windows with Velcro covers
- Heavy duty light-tight zippers
- Lower vents with Micro-mesh screens & removable covers.

FRONT



SIDE



Sun Hut Blackout Tent door access configurations depend on the size of the tent.

MODEL	DOORS		
	FRONT	REAR	SIDE
706290	1	-	-
706292	1	-	-
706306	1	-	-
706294	1	-	-
706296	1	-	2
706298	1	-	2
706300	1	-	2
706308	2	2	-
706302	2	2	-
706304	2	2	-

Sun Hut® - Blackout® Grow Tents



EXCLUSIVE

The Blackout® tent line offers the most complete and diverse selection of tent sizes and configurations available. These tents are constructed from 210D light tight material with a highly reflective interior surface. The frame of the tent uses heavy duty galvanized steel poles and fit securely into our reinforced polypropylene connectors. Other features include clear viewing windows, removable reflective mylar floor liner, adjustable dual sock ports for ventilation and power cords and Micro-mesh ventilation windows. Note: model numbers identify the approximate cubic feet. 1 Year Warranty.

Item No.	Description	Tent Dimensions	MSRP
706290	Sun Hut Blackout 20 - 2.0 ft x 2.0 ft x 5.3 ft	24" x 24" x 63.6"	\$146.95
706292	Sun Hut Blackout 35 - 2.6 ft x 2.6 ft x 5.3 ft	31.6" x 31.6" x 63.6"	\$178.95
706306	Sun Hut Blackout 40 - 3.9 ft x 2.0 ft x 5.3 ft	46.5" x 24" x 63.6"	\$233.95
706294	Sun Hut Blackout 50 - 3.0 ft x 3.0 ft x 5.9 ft	36" x 36" x 70.8"	\$197.95
706296	Sun Hut Blackout 70 - 3.3 ft x 3.3 ft x 6.6 ft	39.6" x 39.6" x 79.2"	\$224.95
706298	Sun Hut Blackout 100 - 3.9 ft x 3.9 ft x 6.6 ft	46.8" x 46.8" x 79.2"	\$244.95
706300	Sun Hut Blackout 160 - 4.9 ft x 4.9 ft x 6.6 ft	58.8" x 58.8" x 79.2"	\$284.95
706308	Sun Hut Blackout 200 - 7.9 ft x 3.9 ft x 6.6 ft	94.8" x 46.8" x 79.2"	\$391.95
706302	Sun Hut Blackout 410 - 7.9 ft x 7.9 ft x 6.6 ft	94.8" x 94.8" x 79.2"	\$609.95
706304	Sun Hut Blackout 630 - 9.8 ft x 9.8 ft x 6.6 ft	117.6" x 117.6" x 79.2"	\$731.95

Always choose Sun Hut® brand affordable enclosed greenhouses

Sun Hut® Fortress® Grow Tent

CHECK OUT OUR 3 LEVELS OF SUN HUT:

- Sun Hut® - The Big Easy®:
Tough / Select Quality
- Sun Hut® - Blackout®:
Pro Grade / Premium Quality
- Sun Hut® - Fortress®:
Elite / Supreme Quality



sun-huts.com



1680D light-tight tent material

Full service 360° easy access doors

The industry's strongest steel frame with 22 mm poles & quick-connectors*

Highly reflective, pebbled surface is 100% safe for plants

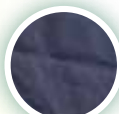

Full 360° access to growing area via 2 large zippered doors.



Heavy duty light-tight zippers

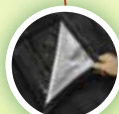

Clear viewing windows with Velcro covers



Dual sock vent and lamp/power cord ports



Rugged 5.5" deep rubberized floor liner

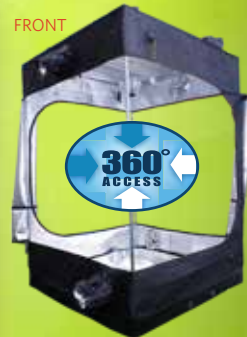

Industry exclusive! Sonic welded irrigation line access holes allows reservoir to be placed outside tent.

The Sun Hut Fortress supreme quality grow tent has extra high-end features.

Maximum flexibility and superior durability.

Sun Hut® - Fortress® Grow Tents



EXCLUSIVE

Sun Hut® Fortress® have exceptional quality with superior durability. Constructed from light tight material with a highly reflective interior surface that is 9 times thicker than popular industry tents! The frames are extremely robust and include heavy duty reinforced poly propylene connectors that fit securely into our galvanized steel poles. Rubberized waterproof floor. Includes a removable reflective floor liner, ports for ventilation and cords, two micro-mesh screened ventilation windows and many more great features. Note: model numbers identify the approximate cubic feet. 1 Year Warranty.

Item No.	Description	Tent Dimensions	MSRP
706652	Sun Hut Fortress 45 - 2.5 ft x 2.5 ft x 7.1 ft	30.0" x 30.0" x 85.0"	\$244.95
706654	Sun Hut Fortress 90 - 3.6 ft x 3.6 ft x 7.1 ft	43.0" x 43.0" x 85.0"	\$362.95
706656	Sun Hut Fortress 85 - 2.5 ft x 4.6 ft x 7.1 ft	56.0" x 30.0" x 85.0"	\$331.95
706658	Sun Hut Fortress 150 - 4.6 ft x 4.6 ft x 7.1 ft	56.0" x 56.0" x 85.0"	\$446.95
706660	Sun Hut Fortress 245 - 5.8 ft x 5.8 ft x 7.3 ft	70.0" x 70.0" x 88.5"	\$524.95
706662	Sun Hut Fortress 310 - 4.6 ft x 9.3 ft x 7.3 ft	112.0" x 56.0" x 88.5"	\$699.95
706664	Sun Hut Fortress 470 - 8 ft x 8 ft x 7.3 ft	96.0" x 96.0" x 88.5"	\$1,159.95
706666	Sun Hut Fortress 730 - 10 ft x 10 ft x 7.3 ft	120.0" x 120.0" x 88.5"	\$1,459.95

Sun Hut® Accessories

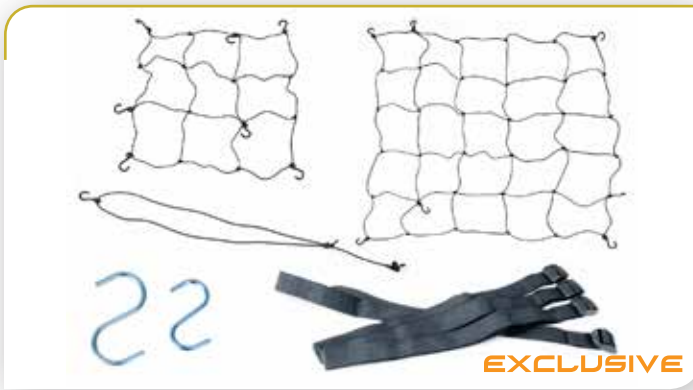

Sun Hut® tent accessories includes two sizes of tent trellis made of an elastic material that conveniently hooks horizontally on the corners of the tent poles. The adjustable elastic support is a vertical support for your plants that can reach up to 8 feet. Nylon Straps are fully adjustable and perfect for supporting your gardening equipment. S hooks come in sizes 16 mm or 23 mm and are great for positioning wires and cords through your indoor tent.

Item No.	Description	MSRP
706590	Sun Hut Elastic Support 4/Bag	\$1.59
706592	Sun Hut Elastic Trellis 2 ft x 3.33 ft 1/Bag	\$6.99
706594	Sun Hut Elastic Trellis 4 ft x 5 ft 1/Bag	\$14.99
706596	Sun Hut Strap 4/Bag	\$0.49
706598	Sun Hut S Hook 16 mm/.63 in 5/Bag	\$0.69
706600	Sun Hut S Hook 23 mm/.90 in 5/Bag	\$0.89

GrowLab™ Equipment Hanging Board



The Equipment board is designed to hang a fan or equipment from the walls of the tent. It offers sufficient space of hangable space and the weight capacity 65 lb Works with all of GrowLab™ tents excluding GL80 and smaller.

Item No.	Description	MSRP
706858	GrowLab Equipment Hanging Board 15.75 in x 78.74 in	\$57.00

GrowLab™ Hercules Support



Choose the Hercules Frame Support that coincides with the size of your GrowLab™ Portable Grow Room. Each Hercules Frame support is a complete kit which will go from floor to ceiling across the roof of the tent and back to the floor.

Item No.	Description	MSRP
706836	GrowLab Hercules Support For GrowLab 120	\$73.00
706846	GrowLab Hercules Support For GrowLab 145	\$80.00
706851	GrowLab Hercules Support For GrowLab 240	\$87.00
706856	GrowLab Hercules Support For GrowLab 290	\$118.00

GrowLab™



The next generation in portable grow rooms - The GrowLab™ Horticultural Grow Room. Here are just some of the unique and exciting features you won't find elsewhere. Clear viewing windows on all models except GL40, GL60, GL240 & GL290. Increased weight capacity with roof cross-members easily support 100 pounds. Sturdy powder coated framework helps protect against rust and gives a cleaner look; thicker than previous models. Highly reflective interior for significant increase in reflectivity for improved lighting performance. Thermally protected tent material reflects 97% of all radiant heat for superior insulation. Completely non-toxic and will not react under light and heat and no off-gassing to harm plants. Improved fabric & zippers that are thicker fabric than previous models, with the best zippers on the market. Moveable roof cross-members that easily adjust lighting and accessories; pieces snap into desired place for better functionality. Multiple intake/exhaust ports including two ports opposite each other at reflector level for air-cooling of lighting system on most models. Adjustable fan and ducting attachments so no more clamps or reducers needed! Waterproof floor features a second floor that is removable for easy cleaning between crops.

Item No.	Description	Tent Dimensions	MSRP
706820	GrowLab 40	16" x 16" x 47"	\$110.00
706825	GrowLab 60	24" x 24" x 63"	\$147.00
706830	GrowLab 80	31" x 31" x 71"	\$179.00
706835	GrowLab 120	47" x 47" x 79"	\$245.00
706845	GrowLab 145	57" x 57" x 79"	\$285.00
706850	GrowLab 240	95" x 95" x 79"	\$612.00
706855	GrowLab 290	114" x 114" x 79"	\$733.00
706860	GrowLab 80L	59" x 31" x 79"	\$233.00
706865	GrowLab 120L	47" x 95" x 79"	\$393.00
706870	GrowLab GL100	39" x 39" x 79"	\$225.00
706880	GrowLab 145L	57" x 114" x 79"	\$450.00
706885	GrowLab Clone Lab	25" x 49" x 47"	\$295.00
706887	GrowLab Clone Lab Tall	25" x 49" x 71"	\$336.00



Growlabs

Here is a complete breakdown of the standard features for each one of Growlab models. Includes measurements, weights, roof ports and if the model has a viewing window. Each Growlab has a suggested light wattage at the bottom as well.

GrowLAB Portable Grow Rooms	standard										wide			quad		other
	GL40	GL60	GL80	GL120	GL145	GL80L	GL120L	GL145L	GL240	GL290	GL Clonelab					
 size assembled (ft): length x width x height size assembled (cm):	14" x 14" x 31.1" 40 x 40 x 120	20" x 20" x 53" 60 x 60 x 160	27" x 27" x 51.1" 80 x 80 x 180	31.1" x 31.1" x 67" 120 x 120 x 200	49" x 49" x 67" 145 x 145 x 200	27" x 41.1" x 67" 80 x 150 x 200	31.1" x 71.1" x 67" 120 x 240 x 200	49" x 96" x 67" 145 x 290 x 200	71.1" x 71.1" x 67" 240 x 240 x 200	96" x 96" x 67" 290 x 290 x 200	21" x 41" x 31.1" 65 x 125 x 120					
size packaged (ft):	2' x 0.9' x 0.4'	2.7' x 0.9' x 0.4'	3' x 1' x 0.4'	4' x 1.2' x 0.4'	4.9' x 1.2' x 0.4'	5' x 1.1' x 0.3'	4' x 1.3' x 0.5'	4.9' x 1.3' x 0.5'	4' x 1.4' x 0.6'	4.9' x 1.4' x 0.6'	4.2' x 2.3' x 0.5'					
unit weight:	12 lbs	17 lbs	22 lbs	31 lbs	35 lbs	32 lbs	50 lbs	59 lbs	73 lbs	89 lbs	40 lbs					
square footage:	1.7	3.9	6.9	15.5	22.6	12.9	31	45.3	62	90.5	8.7					
cubic feet:	6.8	20.3	40.7	101.7	148.5	84.8	203.4	297	406.8	594	34.4					
hangable weight:	100+ lbs	100+ lbs	100+ lbs	100+ lbs	100+ lbs	100+ lbs	100+ lbs	100+ lbs	100+ lbs	100+ lbs	150 lbs per shelf					
viewing windows:	-	-	YES	YES	YES	YES	YES	YES	-	-	-					
reducing roof port:	5"	5"	5"	8"	8"	8"	10"	10"	10"	10"	6"					
reducing upper port:	-	-	-	8"	8"	8"	8"	8"	8"	8"	-					
reducing lower port:	-	5"	5"	8"	8"	8"	10"	10"	10"	10"	6"					
reducing cable port:	4"	4"	4"	4"	4"	4"	4"	4"	4"	4"	4"					
Intake flap:	top/bottom 2 left/right	top/bottom 3 left/right/back	top/bottom 3 left/right/back	top/bottom 3 left/right/back	top/bottom 3 left/right/back	top/bottom 3 left/right/back	top/bottom 4 left/right/back/back	TR/TL/BL/BR 4 left/right/back/back	TR/TL/BL/BR 4 left, right, rear	TR/TL/BL/BR 4 left, right, rear	top/bottom 3 left/right/back					
access panels:	-	-	-	-	left, right	-	rear	rear	left, right, rear	left, right, rear	-					
floor panels: (waterproof)	1	1	1	1	1	1	1	1	1	1	1					
fits DryNet:	-	-	-	YES	YES	2x	2x	2x	4x	4x	-					
sugg. wattage:	CFI	CFI/T5	250 - 400	400 - 600	1000	2x 400	2x 600	2x 1000	4x 600	4x 1000	T5					

EcoPlus® Eco Fixed Flow Rate Submersible Pumps



Great for everything from fountains to hydroponic systems. The pumps have an inside threaded fittings and the flow is non-adjustable. Powerful oil-free, rare earth rotor magnet. Ceramic shaft and bearing insures reliability. Strainer protects impeller from damage. Comes with a 120 volt cord. Include inlet and outlet fittings. 1 Year Warranty.

Item No.	Description	Watts	Max Height	MSRP
728490	EcoPlus Eco 66 Submersible Pump 75 GPH	5.75	2.5 ft	\$9.29
728492	EcoPlus Eco 100 Submersible Pump 100 GPH	10	3 ft	\$11.39
728495	EcoPlus Eco 132 Submersible Pump 132 GPH	28	4 ft	\$11.79
728300	EcoPlus Eco 185 Submersible Pump 158 GPH	26.5	4 ft	\$14.99
728305	EcoPlus Eco 264 Submersible Pump 290 GPH	28	6.5 ft	\$20.95
728310	EcoPlus Eco 396 Submersible Pump 396 GPH	36	6.5 ft	\$23.95
728315	EcoPlus Eco 633 Submersible Pump 594 GPH	54	7.5 ft	\$48.95
728320	EcoPlus Eco 1056 Submersible Pump 1083 GPH	89	9 ft	\$72.95
728325	EcoPlus Eco 1267 Submersible Pump 1347 GPH	192	13.5 ft	\$87.95
728330	EcoPlus Eco 1584 Submersible Pump 1638 GPH	245	12.5 ft	\$107.95
728333	EcoPlus Eco 2245 Submersible Pump 2166 GPH	246	16.5 ft	\$150.95
728335	EcoPlus Eco 3170 Submersible Pump 3170 GPH	192	13.1 ft	\$206.95
728485	EcoPlus Eco 4950 Submersible Pump 4750 GPH	250	20 ft	\$204.95
728340	EcoPlus Eco 7400 Submersible Pump 7400 GPH	550	23 ft	\$290.95

EcoPlus® Premio Jet® Pumps



EcoPlus® Premio Jet® water pumps are the original made in Italy premium water pumps. These pumps are submersible multi-use water pumps, delivering high performance with low power consumption. Premio Jet® water pumps can be used externally or submerged. The pumps were designed to be silent, versatile and extremely low maintenance. 1 Year Warranty.

Item No.	Description	Watts	Max Height	MSRP
728395	EcoPlus Premio Jet 600 - 158 GPH	7.5	53 ft	\$30.95
728397	EcoPlus Premio Jet 1200 - 317 GPH	20	69 ft	\$39.95

EcoPlus® Adjustable Flow Rate Water Pumps



This new line of adjustable water pumps offer an energy efficient magnetic ferrite rotor with a ceramic shaft, vastly improving GPH and head pressure that is needed in hydroponic systems, fountains and more. These pumps are manufactured with a built in flow regulator allowing full adjustability of your water movement. 172 GPH thru 370 GPH Models include a 6 ft 120 volt power cord. 528 GPH thru 1269 GPH models include a 15 ft 120 volt power cord. 1 Year Warranty.

Item No.	Description	Watts	Max Height	MSRP
727700	EcoPlus Adjustable Water Pump 172 GPH	9.5	4.75 ft	\$14.95
727705	EcoPlus Adjustable Water Pump 291 GPH	16	4.9 ft	\$23.95
727710	EcoPlus Adjustable Water Pump 370 GPH	24	6.9 ft	\$23.95
727715	EcoPlus Adjustable Water Pump 528 GPH	33	7.6 ft	\$42.95
727720	EcoPlus Adjustable Water Pump 655 GPH	43	8.8 ft	\$49.95
727725	EcoPlus Adjustable Water Pump 793 GPH	58	9.1 ft	\$57.95
727730	EcoPlus Adjustable Water Pump 1110 GPH	92	9.8 ft	\$72.95
727735	EcoPlus Adjustable Water Pump 1269 GPH	110	10.5 ft	\$87.95

EcoPlus® Convertible Bottom Draw Water Pumps



The EcoPlus® Convertible Bottom Draw Pump is the first hydroponic pump of its kind. With an interchangeable outlet fitting, this line of pumps fits almost all hydroponic applications. The bottom draw inlet allows the pump to operate in less than 1/2 inch of water. The convertible outlet offers the freedom of a horizontal or vertical water outlet. US Patent Pending No. 14/642,557. 1 Year Warranty.

Item No.	Description	Watts	Max Height	MSRP
727800	EcoPlus Convertible Bottom Draw Water Pump 265 GPH	27.0	7.22 ft	\$26.95
727805	EcoPlus Convertible Bottom Draw Water Pump 585 GPH	65.0	8.86 ft	\$54.95
727810	EcoPlus Convertible Bottom Draw Water Pump 730 GPH	75.0	10.33 ft	\$65.95

EcoPlus Mag Drive Utility Pumps™



EcoPlus Mag Drive Utility Pumps™ are premium quality, fixed flow, multi-use water pump. These are high performance pumps with low power consumption and increased head pressure. They can be used as a submersible pump or in an external in-line use with vertical output water flow. These pumps are quiet and have reliable operation. Comes with a 15 foot 120V power cord. They come with the industry's most complete and versatile fitting package ever included with a pump! 2 Year Warranty.

Item No.	Description	Watts	Max Height	MSRP
748450	EcoPlus Premium Mag Drive Water Pump 250 GPH	24	6 ft	\$63.95
748455	EcoPlus Premium Mag Drive Water Pump 350 GPH	38	10 ft	\$71.95
748460	EcoPlus Premium Mag Drive Water Pump 500 GPH	46	10.3 ft	\$81.95
748465	EcoPlus Premium Mag Drive Water Pump 700 GPH	63	12 ft	\$89.95
748470	EcoPlus Premium Mag Drive Water Pump 900 GPH	86	13 ft	\$109.95

EcoPlus® 1500 Elite Submersible Pump



This heavy duty, high quality pump is the latest introduction to the EcoPlus pump family. 190 watts. Bottom Intake. Removes water down to 0.125 in. Max height 20.3 ft. 12 ft power cord. Fittings included: 1 in NPT hose fitting and 1 in barbed fitting. 1 Year Warranty.

EXCLUSIVE

Item No.	Description	MSRP
728497	EcoPlus 1500 Elite Submersible Pump	\$144.95

Mondi™ Utility Sump Pump 1585x



A heavy duty, oil-less (water cooled)  multipurpose pump suitable for water control: basement/indoor flooding, plant watering, water recirculation and more! 2 Year Warranty.

Item No.	Description	MSRP
727095	Mondi Utility Sump Pump 1585 GPH	\$124.95

Mondi™ Utility Sump Pump 1200x



Great for controlling water in basement/indoor flooding, plant watering, water recirculation and more! Outfitted with a 2/5 HP motor that can pump up to 1200 gallons per hour. 2 Year Warranty. 

Item No.	Description	MSRP
727096	Mondi Utility Sump Pump 1200 GPH	\$127.95

Mondi™ 30 in Water Pump Extension With Ball Valve



Ergonomically designed extruded  aluminum bend that acts like a handle for safely moving the connected pump from rain barrels or reservoirs. You no longer have to pull the pump out by the electrical cord or hose. Aluminum poles that easily connect to each other for additional height to a maximum of 42 in.

Item No.	Description	MSRP
708710	Mondi 30 in Water Pump Extension w/ Ball Valve	\$19.95

GH WaterPOWER 120 Pump



The WaterPOWER pump has been designed for ease of use. It is constructed with the highest quality workmanship and finest materials to ensure long dependable use.

Item No.	Description	MSRP
728033	GH WaterPOWER 120 Pump 951 GPH	\$132.20

GH TNC 1/4 HP Pump



The TNC centrifugal inline water pump is powerful and dependable. This water pump moves 1250 GPH through 1 in pipe thread fittings and has a dependable ceramic/graphite seal. The TNC water pump is used in the AeroFlo® - 60 site units.

Item No.	Description	MSRP
728115	GH TNC 1/4 HP Pump 1250 GPH	\$232.00

Pondmaster® Hydro-Air™ Submersible Water and Air Pump



NEW The Hydro-Air™ Submersible Water and Air Pump combines two functions in one product. Only one electrical outlet is need for both water and air production. The unique patent pending design features a dual impeller mounted to one magnetic rotor assembly. One side of the unit produces up to 1200 gph water flow with up to a 17 ft pumping height; the other side produces aeration to service any application

requiring aerated return water flow. The water side of the pump has a male threaded 3/4 inch outlet, the aeration side is designed to accept 1/2 inch vinyl tubing and operates via venturi effect. 1 Year Warranty.



Item No.	Description	Watts	PSI	Max Height	Tube Outlet	MSRP
728048	Pondmaster Hydro-Air Combination / Submersible Water and Air Pump 1100 GPH	199	7.7	17 ft	1.5 in	\$266.95

Danner™ Mag Drive Pump 190 GPH



190 GPH maximum flow with a 7 ft shut-off. 10 ft grounded power cord. Built-in adjustable flow control. 3/8 in to 1/2 in NPT. Ceramic shaft. Foam pre-filter and elbow included. 3 Year Warranty.



Item No.	Description	Max Height	MSRP
728075	Mag Drive Pump 190 GPH	7 ft	\$59.95

Supreme® Hydroponics™ Sump Pump 300 GPH



Supreme® Hydroponics™ 300 GPH Sump Pump is completely submersible. It pumps down to 1/8 in and easily attaches to a garden hose. 25 ft power cord. Shut off height 6 ft. Outlet 3/4 in GHT. Watts: 18 max. 1 Year Warranty.



Item No.	Description	MSRP
727260	Supreme Hydroponics Utility Sump Pump 300 GPH	\$53.95

Danner™ Mag Drive Pumps 250 GPH - 700 GPH



These high quality pumps operates submerged or in-line. 10 foot grounded power cord. 1/2 in NPT. Ceramic shaft. Foam pre-filter included. 3 Year Warranty.



Item No.	Description	Max Height	MSRP
728065	Mag Drive Pump 250 GPH	7 ft	\$83.95
728070	Mag Drive Pump 350 GPH	10.5 ft	\$92.95
728060	Mag Drive Pump 500 GPH	10.5 ft	\$105.95
728072	Mag Drive Pump 700 GPH	12.5 ft	\$116.95

Danner™ Mag Drive Pumps 950 GPH - 2400 GPH



These high quality pumps operates submerged or in-line. 10 foot grounded power cord. 3/4 in NPT for all except 728085 which has 1 in NPT. Ceramic shaft. Foam pre-filter included. 3 Year Warranty.



Item No.	Description	Max Height	MSRP
728062	Mag Drive Pump 950 GPH	15 ft	\$150.95
728050	Mag Drive Pump 1200 GPH	15 ft	\$205.95
728080	Mag Drive Pump 1800 GPH	22 ft	\$233.95
728085	Mag Drive Pump 2400 GPH	22 ft	\$287.95

Little Giant® PE-1 Submersible Direct Drive Pump



Small submersible epoxy encapsulated pump for commercial, industrial and home use. Applications include hydroponic systems, water gardens, ponds, etc. 1 Year Warranty.



Item No.	Description	MSRP
727005	Little Giant PE-1 Submersible Direct Drive Pump 170 GPH	\$91.95

Little Giant® 1-ABS Submersible Pump



Shallow-pan tank style designed for in-pan mounting with bottom intake with 10 ft maximum lift. Has a stainless steel shaft with 6 ft power cord with 3-prong molded plug. 1 Year Warranty.

Item No.	Description	MSRP
727010	Little Giant 1-ABS Submersible Pump 205 GPH	\$136.95

Little Giant® 1 Submersible Pump



Permanently lubricated pumps for commercial, industrial and home use where liquid must be transferred or recirculated. Applications include hydroponic systems, water gardens, ponds, aquariums, etc. 1 Year Warranty.



Item No.	Description	MSRP
727015	Little Giant 1 Submersible Pump 205 GPH	\$119.95

Little Giant® NH-1 Submersible Pump



Permanently lubricated pumps for commercial, industrial and home use where liquid must be transferred or recirculated. Applications include hydroponic systems, water gardens, ponds, etc. Sump-type screened inlet. Bottom or side intake. Sump-type screened inlet. Corrosion-resistant nylon housing. 1/4 in MNPT outlet accepts 1/2 in I.D. tubing. Thermally protected. Bottom or side intake. Manufacturer Item No. 526003. 1 Year Warranty.

Item No.	Description	MSRP
727020	Little Giant NK-1 Submersible Pump 210 GPH	\$129.95

Little Giant® NH-2 Submersible Pump



Permanently lubricated pumps for commercial, industrial and home use where liquid must be transferred or recirculated. Applications include hydroponic systems, water gardens, ponds, etc. Corrosion-resistant nylon housing. Five position options. 6 ft power cord. 1/4 in MNPT outlet accepts 1/2 in I.D. tubing. Thermally protected. Bottom or side intake. Manufacturer Item No. 527003. 1 Year Warranty.

Item No.	Description	MSRP
727025	Little Giant NK-2 Submersible Pump 325 GPH	\$147.95

Little Giant® 5-MSP Submersible Pumps



Water Wizard

Permanently lubricated utility pump includes garden hose adapter and removable inlet screen for easy cleaning. Lifetime oil supply. Pumps down to 1/8 in (3.2 mm). 1/6 HP thermally protected, shaded pole motor. Epoxy-coated cast aluminum housing. Bottom inlet has removable screen for easy cleaning. Manufacturer Item No. 505000. 1 Year Warranty.

Item No.	Description	MSRP
727035	Little Giant 5-MSP Submersible Pump Blue 1200 GPH	\$162.95
727050	Little Giant 5-MSPR Submersible Pump Black 1200 GPH	\$168.95

Little Giant® RS-SLL Diaphragm Switch



The RS-SLL switch can be used anytime you have a basin usage for the pump. It works by diaphragm. If the water reaches a certain level, it will shut off the pump. The pump plugs into the switch. On level: 2 in - 3 in. Off level: 0.5 in - 1.5 in when mounted to 5-MSP. For pumps up through 1/3 HP or the following pumps, 5-MSP, 6-CIM-R, NK-1 & NK-2. 18 ft cord. 1 Year Warranty.

Item No.	Description	MSRP
727045	Little Giant RS-SLL Diaphragm Switch	\$94.95

Little Giant® 6-CIM-R Submersible Pump



Big John

Big John submersible sump pump for residential and light commercial use. The manual sump pump provides efficient and reliable service. Pump features a 1-1/2 in discharge with an 18 ft maximum head. Cast iron motor housing is oil-filled for lifetime lubrication and rapid heat dissipation. Poly carbonate cover and polypropylene volute-base. Garden Hose Adapter included for utility use.

Manual operation (pump easily converted to automatic operation using the RS-5). Mechanical shaft seal. 1/3 HP/115 Volt/10 ft Power Cord. Bottom intake with screened inlet. 1-1/2 in MNPT x 1-1/4 in FNPT (31.7 mm) Reducer Bushing. Epoxy coated housing for corrosion and rust resistance. Thermal overload protection. Manufacturer No. 506271. 1 Year Warranty.

Item No.	Description	MSRP
727040	Little Giant 6-CIM-R Submersible Pump 2760 GPH	\$249.95

Little Giant® Magnetic Drive External Inline Pump



NEW Little Giant® Magnetic Drive In-Line Pump is specifically designed for in-line saltwater and freshwater circulation and filtration applications. It has a thermally protected motor with 3-prong molded plug and 6 ft power cord. It is corrosion resistant to salt solutions and many other semi-corrosive fluids. 1 inch FNPT inlet, 1 inch MNPT outlet with barbs for 1-1/4 inch I.D. tubing. This is a on-submersible pump (inline only). 1 Year Warranty.

Item No.	Description	MSRP
727056	Little Giant Magnetic Drive External Inline Pump 1325 GPH	\$385.95

DAB E.SYBOX Electronic Water Pressure System



NEW E.Sybox by DAB solves the problem of maintaining consistent, constant water pressure in your hydro pump system across several rooms and installations, from a distance or to an elevated area. The E.Sybox is a compact booster pump that's about 30% smaller than traditional pump and controller systems. E.Sybox only uses the power necessary to provide the pressure and flow needed making

it highly energy-efficient and E.Sybox can be mounted horizontally or vertically. If multiple E.Sybox units are in use, an integrated wireless communication system allows the units to communicate with the other pumps for easy monitoring. Choose from two sizes. 2 Year Warranty.

Item No.	Description	MSRP
727958	DAB E.SYBOX Electronic Water Pressure System	\$1,895.95
727956	DAB E.SYBOX Mini Electronic Water Pressure System	\$929.95

Leader EcoPlus Horizontal Multistage Pumps



NEW Highly reliable self priming Horizontal Multistage c_{SP}^{us} Pumps. They are low noise with high flow and pressure performances, with 2, 3 or 4 impellers, for supplying water for domestic and irrigation applications. Built with anti-corrosive and rust-proof materials. Motors with thermic overload protection. Wear resistant shafts and impellers. Double sealing system between motor and

hydraulic part. High resistance to frost and icing. Manual on/off switch. 2 Year Warranty.

Item No.	Description	Watts	PSI	Max Height	Tube Inlet	Tube Outlet	MSRP
727960	Leader EcoPlus 230 1/2 HP 1 - 115 Volt	800	52	118 ft	1 in	1 in	\$329.99
727962	Leader EcoPlus 240 3/4 HP 1 - 115 Volt	1000	69	157 ft	1 in	1 in	\$345.99
727964	Leader EcoPlus 250 1 HP 1 - 115 Volt	1250	86	197 ft	1 in	1 in	\$404.99

Leader Vertygo Automatic Submersible Pumps



NEW Automatic Submersible pump with a manual override, specifically designed for uses c_{SP}^{us} in narrow pits with dimensions down to 8 in x 8 in. Suitable to pump clear water containing particles with maximum diameter up to 1/4 in. Built with anti-corrosive and rust-proof materials. The pump has low suction capability down to a 1/16 in. These pumps have an integrated float switch. 2 Year Warranty.

Item No.	Description	Watts	PSI	Max Height	Tube Inlet	Tube Outlet	MSRP
727966	Leader Vertygo 300 1/3 HP - 2040 GPH	300	9	21 ft	1.25 in	1.25 in	\$212.54
727968	Leader Vertygo 600 1/2 HP - 3120 GPH	600	13	30 ft	1.25 in	1.25 in	\$247.99

Leader Ecotronic Booster Pumps



NEW Highly reliable electronic booster sets for supplying water for domestic applications. c_{SP}^{us} Equipped with an electronic safety device that protects the pump from dry-running. Built-in non return valve. Designed to automatically start and stop the pump when taps are open or closed. Automatic and manual reset. These type of pumps give a constant pressure and flow rate so they are excellent for irrigation systems. 2 Year Warranty.

Item No.	Description	Watts	PSI	Max Height	Tube Inlet	Tube Outlet	MSRP
727978	Leader Ecotronic 110 1/2 HP Jet Pump - 960 GPH	800	27/63	138 ft	1 in	1 in	\$401.99
727980	Leader Ecotronic 120F 3/4 HP Jet Pump - 960 GPH	1000	27/73	164 ft	1 in	1 in	\$537.99
727982	Leader Ecotronic 130 1 HP Jet Pump - 1260 GPH	1250	27/73	164 ft	1 in	1 in	\$479.99
727984	Leader Ecotronic 230 1/2 HP Multistage	800	27/52	118 ft	1 in	1 in	\$525.99
727986	Leader Ecotronic 240F 3/4 HP Multistage	1000	27/73	157 ft	1 in	1 in	\$549.99
727988	Leader Ecotronic 250 1 HP Multistage	1250	27/86	197 ft	1 in	1 in	\$565.99

Leader Ecojet Self Priming Jet Pumps



NEW Highly reliable self priming JET Pumps with excellent c_{SP}^{us} suction capability which allows the free passage of air bubbles, which can be used for supplying water for domestic and irrigation applications. Built with anti-corrosive and rust-proof materials. Motors with thermic overload protection. Wear resistant shafts and impellers. Double sealing system between motor and

hydraulic part. High resistance to frost and icing. Manual on/off switch. 2 Year Warranty.

Item No.	Description	Watts	PSI	Max Height	Tube Inlet	Tube Outlet	MSRP
727970	Leader Ecojet R90	600	18	38 ft	1 in	1 in	\$204.99
727972	Leader Ecojet 110 1/2 HP 1 - 115 Volt - 960 GPH	800	63	138 ft	1 in	1 in	\$264.99
727974	Leader Ecojet 120 3/4 HP 1 - 115 Volt - 960 GPH	1000	73	164 ft	1 in	1 in	\$289.99
727976	Leader Ecojet 130 1 HP 1 - 115 Volt - 1260 GPH	1250	73	164 ft	1 in	1 in	\$339.99

Leader Hydrotronic Red Controller



NEW Computerized control system for surface and submersible pumps. Designed to allow the automatic operation of the pump and prevent it from dry-running. Suitable for pumps with power up to 1500 watts, flow rate up to 32 GPM, operating pressure more than 26 psi and maximum pressure range between 51 psi and 116 psi. Easy to install as it is supplied with power cable with plug and cable with socket for the connection to the pump.

Item No.	Description	MSRP
727990	Leader Hydrotronic Red 25 PSI	\$159.99

Leader FA5 Clear Filter Housing

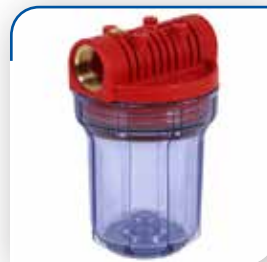

NEW 5 inch transparent container allows the user to check the filter clogging level and, when necessary, replace the cartridge or clean it. 1 inch female-thread couplings with brass inserts and brass blow-off valve. Filter cartridge (part #727992) is not included and must be purchased separately.

Item No.	Description	MSRP
727992	FA5 Clear Housing for Filter	\$29.99

Leader CRL5 Sediment Filter Mesh



NEW Wound polypropylene cartridge with rated filtering capacity of 20 microns. Particular suitable to remove suspended particles such as sand. Suitable for installation at the entrance of pumps, industrial refrigerators, softeners.

Item No.	Description	MSRP
727994	Leader CRL5 - Sediment Filter Mesh	\$11.99

Dosatron Water Powered Doser



NEW Inject nutrients, supplements/additives and pH adjusters into irrigation water with ease. No electricity needed. Dosatron is a passive precision fertilizer doser that accurately mixes from the pressure of your incoming water. Operating pressure range is 4.3 -85 PSI and water flow range is 0.05 - 11 GPM. Injection capabilities of 1:1000 to 1:112 (0.1 - 0.9%) [3.5 ml to 35 ml per gallon]. The unit has 3/4 in NPT connections and comes 6 ft suction hose complete with strainer. 709002, 709004 and **EXCLUSIVE**

709006 are special order only. 1 Year Warranty.

Item No.	Description	MSRP
709000	Dosatron Water Powered Doser 11 GPM 1:1000 to 1:112	\$720.00
709002	Dosatron Water Powered Doser 11 GPM 1:500 to 1:50	\$479.00
709004	Dosatron Water Powered Doser 14 GPM 1:3000 to 1:333	\$925.00
709006	Dosatron Water Powered Doser 14 GPM 1:100 to 1:10	\$925.00

Maxi-Jet® Water Pump



Energy-efficient and very durable with a sealed casing and superior internal design, it ensures that they won't overheat when ran dry, unlike most other pumps. Equipped with dual pre-filters and a simplistic design, for virtually maintenance free and long lasting. 3 Year Warranty.



Item No.	Description	MSRP
727085	Maxi-Jet 1200 Water Pump 295 GPH	\$30.99

Condensate Pump



These pumps are used as an accessory with air conditioners and dehumidifiers. This rugged pump has 22 feet of lift. Continuous duty 140° F. Maximum inlet temperature 160° F. 2 Year Warranty.



Item No.	Description	MSRP
728130	Condensate Pump 120 Volt	\$84.95

EcoPlus® Small & Large Pump Filter Bag



A submersible pump is inserted into this filter bag to prevent sediment from clogging it. Use of the filter bag will prolong the life and reduce cleaning/maintenance of the pump.

EXCLUSIVE

Item No.	Description	MSRP
728188	EcoPlus Pump Filter Bag Small - 6.5 in x 9 in	\$9.95
728190	EcoPlus Pump Filter Bag Large - 10 in x 12.5 in	\$11.95

Pondmaster® Pump Guard™ Water Pump Maintenance Solution



NEW This Pondmaster® Pump Guard™ Maintenance Solution will keep your water pump operating properly and efficiently. It instantly loosens mineral scale, lime, rust and other detritus from pond water pumps. Not only that, it is biodegradable and fast and easy to use. If you're treating just the impeller you can pour the Pondmaster® Pump Guard™ Maintenance Solution directly into the volute/impeller chamber of your pump. If treating the entire pump you can either pour directly into the volute/impeller or dunk/soak the whole pump.

Item No.	Description	MSRP
727360	Pondmaster Pump Guard Water Pump Maintenance Solution 4 oz	\$12.95
727362	Pondmaster Pump Guard Water Pump Maintenance Solution 32 oz	\$42.95
727364	Pondmaster Pump Guard Water Pump Maintenance Solution 1 Gallon	\$104.95

Hydro Flow® Complete Irrigation Kits

Hydro Flow® 3 ft x 3 ft & 4 ft x 4 ft Drip Kit



This Hydro Flow® Drip Kit is designed to simplify your irrigation set up on 3 ft x 3 ft and 4 ft x 4 ft grow tables. From reservoir to plant, this kit provides all the irrigation components required to set your garden. Hydro Flow® Drip Kits are compatible with all 3 ft x 3 ft and 4 ft x 4 ft grow trays. Trays purchased separately. Kit includes pump, timer, plumbing and hardware for 12 sites.

EXCLUSIVE

Item No.	Description	MSRP
742800	Hydro Flow 3 x 3 & 4 x 4 Drip Kit	\$127.62

Hydro Flow® 4 ft x 8 ft Drip Kit



This Hydro Flow® Drip Kit is designed to simplify your irrigation set up on 4 ft x 8 ft grow tables. From reservoir to plant, this kit provides all the irrigation components required to set your garden. Hydro Flow® Drip Kits are compatible with all 4 ft x 8 ft grow trays. Trays purchased separately. Kit includes plumbing and hardware for 24 sites.

EXCLUSIVE

Item No.	Description	MSRP
742805	Hydro Flow 4 x 8 Drip Kit	\$138.23

Hydro Flow® 3 ft x 3 ft & 4 ft x 4 ft Flood and Drain Kit



This Hydro Flow® Flood and Drain Kit are designed to simplify your irrigation set up on 3 ft x 3 ft and 4 ft x 4 ft flood tables. From reservoir to plant, this kit provides all the irrigation components required to set up your flood and drain tray. Trays sold separately.

EXCLUSIVE

Item No.	Description	MSRP
742810	Hydro Flow 3 x 3 & 4 x 4 Flood and Drain Kit	\$67.29

Hydro Flow® 4 ft x 8 ft Flood and Drain Kit



This Hydro Flow® Flood and Drain Kit are designed to simplify your irrigation set up on 4 ft x 8 ft flood tables. From reservoir to plant, this kit provides all the irrigation components required to set up your flood and drain tray. Trays sold separately.

EXCLUSIVE

Item No.	Description	MSRP
742815	Hydro Flow 4 x 8 Flood and Drain Kit	\$91.63

Hydro Flow® Fill & Drain Siphon Kit



The Hydro Flow® Fill & Drain Siphon Kit is a non-electric siphoning pump that works perfectly for filling and draining hydroponic reservoirs at 300 Gallons or less. Creates 20 pounds of vacuum pressure. Adapts to all faucets and hoses.

EXCLUSIVE

Item No.	Description	MSRP
747184	Hydro Flow Fill & Drain Kit	\$19.67
742230	Hydro Flow Fill & Drain Siphon Kit	\$19.58

Hydro Flow® Tubing & Tube Accessories

Hydro Flow® Premium Vinyl Tubing - Clear



Premium vinyl tubing made of excellent quality. Made in the USA. Ideal for air movement from an air pump to air stones, air discs, Aqua Lung™, Water Winds, etc.



EXCLUSIVE

Item No.	Description	MSRP
708215	Hydro Flow Vinyl Tubing Clear 3/16 in ID - 1/4 in OD 100 ft Roll	\$13.18
708222	Hydro Flow Vinyl Tubing Clear 1/4 in ID - 3/8 in OD 100 ft Roll	\$27.73
708227	Hydro Flow Vinyl Tubing Clear 3/8 in ID x 1/2 in OD 100 ft	\$30.91

Hydro Flow® Premium Vinyl Tubing - White



Premium vinyl tubing made of excellent quality. Made in the USA.



EXCLUSIVE

Item No.	Description	MSRP
708230	Hydro Flow Vinyl Tubing White 1/2 in ID - 5/8 in OD 100 ft Roll	\$54.55
708250	Hydro Flow Vinyl Tubing White 3/4 in ID - 1 in OD 100 ft Roll	\$128.78

Hydro Flow® Premium Vinyl Tubing - Black



Premium vinyl tubing made of excellent quality. Made in the USA.



EXCLUSIVE

Item No.	Description	MSRP
708214	Hydro Flow Vinyl Tubing Black 1/8 in ID - 1/4 in OD 100 ft Roll	\$15.91
708220	Hydro Flow Vinyl Tubing Black 3/16 in ID - 1/4 in OD 100 ft Roll	\$18.09
708221	Hydro Flow Vinyl Tubing Black 1/4 in ID - 3/8 in OD 100 ft Roll	\$27.73
708223	Hydro Flow Vinyl Tubing Black 3/8 in ID - 1/2 in OD 100 ft Roll	\$30.91
708265	Hydro Flow Vinyl Tubing Black 1/2 in ID - 5/8 in OD 100 ft Roll	\$32.95
708245	Hydro Flow Vinyl Tubing Black 3/4 in ID - 1 in OD 100 ft Roll	\$102.52
708251	Hydro Flow Vinyl Tubing Black 1 in ID - 1.25 in OD 50 ft Roll	\$70.91

Hydro Flow® Premium Vinyl Tubing - Blue



Premium vinyl tubing made of excellent quality. Made in the USA.



EXCLUSIVE

Item No.	Description	MSRP
708260	Hydro Flow Vinyl Tubing Blue 1/2 in ID - 5/8 in OD 100 ft Roll	\$40.44

Hydro Flow® Poly Tubing



Professional quality poly tubing. Carbon black pigment, provides an opaque tubing wall, blocking light from penetrating irrigation water. This durable tubing can be buried or used on the surface for year round water distribution. Made in the U.S.A.



EXCLUSIVE

Item No.	Description	MSRP
708655	Hydro Flow Poly Tubing 3/16 in ID x 1/4 in OD 50 ft Roll	\$6.87
708657	Hydro Flow Poly Tubing 3/16 in ID x 1/4 in OD 1000 ft Roll	\$78.05
708660	Hydro Flow Poly Tubing 1/2 in ID x 5/8 in OD 50 ft Roll	\$14.45
742280	Hydro Flow Poly Tubing 1/16 in ID x 1/8 in OD 50 ft Roll	\$4.76

Hydro Flow® EZ Flex™ PVC Tubing



Hydro Flow® EZ Flex™ PVC Tubing is made of a material that allows the tube to be non-rigid. The flexibility allows this tube to be easily applied to standard barbed drip stakes and push in fittings. It is soft to the touch, yet can make aggressive turns without kinking. Does not contain rubber.



EXCLUSIVE

Item No.	Description	MSRP
708210	Hydro Flow EZ Flex - PVC Tubing 1/4 in OD x 3/16 in ID 50 ft	\$7.00
708212	Hydro Flow EZ Flex - PVC Tubing 1/4 in OD x 3/16 in ID 1000 ft	\$111.17

Hydro Flow® Poly Tubing for Drip Stakes



This poly tubing is designed for water or nutrient solution distribution, on drip stakes that do not have barbs on the receiving posts of the stake. Gently slide the tubing onto the intake post and you are ready to water. Also works in conjunction with the Hydro Flow® Brass Tubing Insert.



EXCLUSIVE

Item No.	Description	MSRP
708662	Hydro Flow Poly Tubing .200 OD x .135 ID 50 ft	\$5.68
708664	Hydro Flow Poly Tubing .200 OD x .135 ID 1000 ft	\$95.72

Hydro Flow® Poly Dripper Line



The Hydro Flow® Poly Dripper Lines are used as feed lines from the distribution poly tubing line. These dripper lines are used to connect Hydro Flow® Blue or Black Dripper Stakes (#747196, 742415, 747198 or 742420). The Hydro Flow® Poly Dripper Lines may be installed above or below ground. The line has an inside



EXCLUSIVE

dimension of 3/16 inch and the outside dimension is 1/4 inch at 15 inch of length.

Item No.	Description	Bag Qty	MSRP Ea
708345	Hydro Flow Dripper Line 3/16 in ID x 1/4 in OD - 15 in	25	\$0.35
742290	Hydro Flow Poly Dripper Line 3/16 in ID x 1/4 in OD - 15 in - Display Box	—	\$0.27

Hydro Flow® Push-In Fittings



Hydro Flow® Poly Tube Push-In Straight Fitting for both indoor and outdoor drip irrigation. The Push-In Distribution Clamp provides a tight and secure fit to 1/2 in poly tubing. The clamping ability assures that the connection will not leak or be jarred loose in its application.

EXCLUSIVE

Item No.	Description	Bag Qty	Box Qty	MSRP Ea
747010	Hydro Flow 3/16 in Poly Tube Push-In-Straight Fitting	10	—	\$0.22
747192	Hydro Flow Push-In Distribution Clamp	10	—	\$0.44
742400	Hydro Flow 3/16 in Poly Tube Push-In-Straight Fitting - Display Box	—	250	\$0.13
742405	Hydro Flow Push-In Distribution Clamp - Display Box	—	200	\$0.36

Hydro Flow® Goof Plug Rack



Hydro Flow® Goof Plug Rack is perfect for repairing mistake holes or when changing the configuration of poly tubing setups. 10 plugs per rack.

EXCLUSIVE

Item No.	Description	Bag Qty	Box Qty	MSRP Ea
747194	Hydro Flow Goof Plug Rack	10	—	\$1.18
742410	Hydro Flow Goof Plug Rack - Display Box	—	50	\$0.62

Hydro Flow® Figure-Eight Poly Tube Clincher



Hydro Flow® Figure-Eight Poly Tube Clincher is an easy and effective way to block off the end of the line. Simply run one end of the poly tubing through one side, bend back and then run back through the other side.

EXCLUSIVE

Item No.	Description	Bag Qty	MSRP Ea
747128	Hydro Flow 3/4 in Figure-Eight Poly Tube Clincher	10	\$0.64

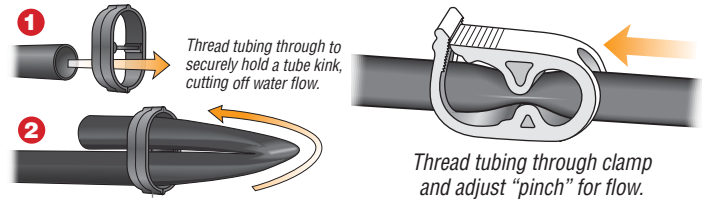

Hydro Flow® Flow Rate Adjusting Clamps



Single grip hose flow adjusting clamps provide a superior seal on hose or tubing. As interlocking teeth are pushed together, the sealing diameter closes evenly creating a uniform clamping surface. Large for 1/2 in tubing. Small for 1/4 in tubing.



EXCLUSIVE

Item No.	Description	Bag Qty	Box Qty	MSRP Ea
747180	Hydro Flow Flow Rate Adjusting Clamp Large	10	—	\$1.67
742215	Hydro Flow Flow Rate Adjusting Clamp Large - Display Box	—	50	\$1.45

Hydro Flow® Nylon Hose Clamps



Hydro Flow® single grip hose clamps provide a superior seal on hose or tubing. As interlocking teeth are pushed together, the sealing diameter closes evenly creating a uniform clamping surface.



EXCLUSIVE

Item No.	Description	Bag Qty	Box Qty	MSRP Ea
747040	Hydro Flow Nylon Hose Clamp 3/8 in	10	—	\$0.82
747062	Hydro Flow Nylon Hose Clamp 1/2 in	10	—	\$0.82
747114	Hydro Flow Nylon Hose Clamp 3/4 in	10	—	\$1.00
747154	Hydro Flow Nylon Hose Clamp 1 in	10	—	\$1.22
708002	Hydro Flow Nylon Hose Clamp 3/8 in - Display Box	—	500	\$0.71
708006	Hydro Flow Nylon Hose Clamp 1/2 in - Display Box	—	500	\$0.71
708013	Hydro Flow Nylon Hose Clamp 3/4 in - Display Box	—	250	\$0.87
708017	Hydro Flow Nylon Hose Clamp 1 in - Display Box	—	250	\$1.05

Hydro Flow® Butterfly Hose Clamps



Hydro Flow® Butterfly Hose Clamps make securing your hose over a fitting a breeze. Made from quality stainless steel, this hose clamps uses a butterfly style tightening tab. No screwdriver or tightening tool required. Just turn the tab to desired fit and rest assured the clamp won't stretch or slide off.

EXCLUSIVE

Item No.	Description	Bag Qty	Box Qty	MSRP Ea
747292	Hydro Flow Butterfly Hose Clamps 3/8 in 10/Bag	10	—	\$0.78
747294	Hydro Flow Butterfly Hose Clamps 1/2 in	10	—	\$0.80
747296	Hydro Flow Butterfly Hose Clamps 3/4 in	10	—	\$0.84
747298	Hydro Flow Butterfly Hose Clamps 1 in	10	—	\$0.87
742732	Hydro Flow Butterfly Hose Clamps 3/8 in Bulk - Display Box	—	100	\$0.71
742734	Hydro Flow Butterfly Hose Clamps 1/2 in Bulk - Display Box	—	100	\$0.73
742736	Hydro Flow Butterfly Hose Clamps 3/4 in Bulk - Display Box	—	100	\$0.76
742738	Hydro Flow Butterfly Hose Clamps 1 in Bulk - Display Box	—	100	\$0.80

Hydro Flow® EZ Pull™ End Cap



These easy to use caps can make your do-it-yourself gardening projects much easier. The EZ Pull™ End Caps are made from tough, flexible vinyl. They are easy to push on and pull off, yet provide a secure, leak proof fit.

EXCLUSIVE

Item No.	Description	Bag Qty	Box Qty	MSRP Ea
747068	Hydro Flow EZ Pull End Cap 1/2 in	10	—	\$0.51
747120	Hydro Flow EZ Pull End Cap 3/4 in	10	—	\$0.62
708595	Hydro Flow EZ Pull End Cap 1/4 in - Display Box	—	500	\$0.27
708596	Hydro Flow EZ Pull End Cap 3/8 in - Display Box	—	250	\$0.31
708597	Hydro Flow EZ Pull End Cap 1/2 in - Display Box	—	250	\$0.35
708598	Hydro Flow EZ Pull End Cap 3/4 in - Display Box	—	100	\$0.42
708599	Hydro Flow EZ Pull End Cap 1 in - Display Box	—	50	\$0.47

Seal and protect barbed fittings when capping off the end of an irrigation line.



Hydro Flow® Holding Stake



Hydro Flow® 6 in holding stake works great for securing tubing between 1/8 in-1/4 in.

EXCLUSIVE

Item No.	Description	Bag Qty	Box Qty	MSRP Ea
747212	Hydro Flow 6 in Holding Stake	10	—	\$0.55
742505	Hydro Flow 6 in Holding Stake - Display Box	—	100	\$0.35

Hydro Flow® Punch N' Cut



This lightweight all-purpose tool works as an insert, cut and hole punch tool. Can cut up to 1 inch tubing. The blade is 440° C stainless steel and the cutter has a 4 oz polycarbonate body.

EXCLUSIVE

Item No.	Description	Box Qty	MSRP Ea
747178	Hydro Flow Punch N'Cut Multi-Tool	—	\$16.49
742210	Hydro Flow Punch N'Cut Multi-Tool - Display Box	10	\$19.67

Hydro Flow® Punch Tool for Brass Tubing Insert



This specially designed punch tool allows you to place the brass insert directly on the punch tool and apply to the tubing in one clean motion. The brass insert receives 0.200 O.D. x 0.135 I.D. tubing to create a secure seal.



EXCLUSIVE

Item No.	Description	MSRP
747302	Hydro Flow Punch Tool for Brass Tubing Insert	\$18.16

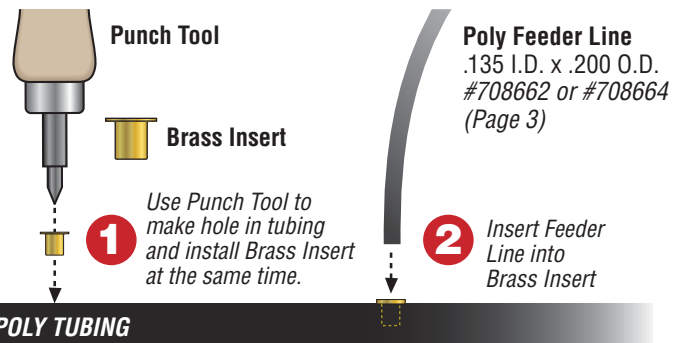

Hydro Flow® Brass Tubing Insert



The brass insert replaces the need for push in fittings. Use the specialized punch tool to apply the brass insert into your poly tubing. The brass insert creates a sealed base to receive 0.200 O.D. x 0.135 I.D. tubing into the center of the brass ring for a simple and secure seal.



EXCLUSIVE

Item No.	Description	Bag Qty	MSRP Ea
747304	Hydro Flow Brass Tubing Insert	10	\$0.67

Hydro Flow® Grommets, Seals & Screens

Hydro Flow® Uniseals



Hydro Flow® Uniseal is ideal for creating a secure seal in seconds for your reservoir or hydroponic system using PVC hard pipe or fittings.



EXCLUSIVE

Item No.	Description	Bag Qty	Box Qty	MSRP Ea
747276	Hydro Flow 1/4 in Uniseal	10	—	\$1.15
747278	Hydro Flow 3/8 in Uniseal	10	—	\$1.62
747280	Hydro Flow 1/2 in Uniseal	10	—	\$2.00
747282	Hydro Flow 3/4 in Uniseal	1	—	\$2.57
747244	Hydro Flow 1 in Uniseal	1	—	\$2.99
747246	Hydro Flow 1-1/2 in Uniseal	1	—	\$3.76
747284	Hydro Flow 2 in Uniseal	1	—	\$5.86
747248	Hydro Flow 3 in Uniseal	1	—	\$7.11
747250	Hydro Flow 4 in Uniseal	1	—	\$8.65
742705	Hydro Flow 1 in Uniseal - Display Box	—	25	\$2.59
742710	Hydro Flow 1-1/2 in Uniseal - Display Box	—	25	\$3.06
742715	Hydro Flow 3 in Uniseal - Display Box	—	10	\$6.68
742720	Hydro Flow 4 in Uniseal - Display Box	—	10	\$8.19

Hydro Flow® Rubber Grommets



Choose from the 4 sizes of Hydro Flow® Grommets to fit your needs.

EXCLUSIVE

Item No.	Description	Bag Qty	Box Qty	MSRP Ea
747042	Hydro Flow Rubber Grommet 3/8 in	10	—	\$0.49
747064	Hydro Flow Rubber Grommet 1/2 in	10	—	\$0.53
747116	Hydro Flow Rubber Grommet 3/4 in	10	—	\$0.64
747274	Hydro Flow Rubber Grommet 1 in	10	—	\$1.05
708376	Hydro Flow Rubber Grommet 3/8 in - Display Box	—	500	\$0.42
708378	Hydro Flow Rubber Grommet 1/2 in - Display Box	—	500	\$0.45
708380	Hydro Flow Rubber Grommet 3/4 in - Display Box	—	250	\$0.55
708390	Hydro Flow Rubber Grommet Bulk 1 in - Display Box	—	100	\$0.91

Seals fittings in holes drilled through trays, buckets and reservoirs.

Seals fittings in holes drilled through trays, buckets and reservoirs.

Seals fittings and air lines in holes drilled through trays, buckets and reservoirs.

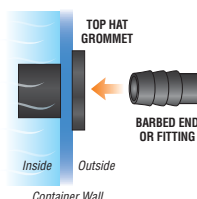
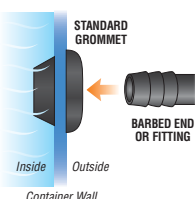
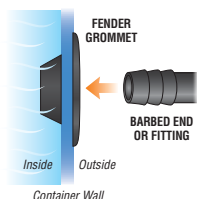

Hydro Flow® Fender Grommets



Grommets are commonly used when needing to transfer water from one container to another with tubing. Hydro Flow® Fender Grommets supply additional support on the front of the grommet, keeping the grommet from pushing through. The oversized front helps to keep grommet in place, while securing the fitting with a leak free seal.

EXCLUSIVE

Item No.	Description	Bag Qty	Box Qty	MSRP Ea
747306	Hydro Flow Fender Grommet 1/2 in	10	—	\$0.58
747290	Hydro Flow Fender Grommet 3/4 in NEW	10	—	\$0.69
708398	Hydro Flow Fender Grommet Bulk 1/2 in - Display Box	—	250	\$0.51
708400	Hydro Flow Fender Grommet Bulk 3/4 in - Display Box NEW	—	250	\$0.60

Hydro Flow® Top Hat Grommets



These grommets can be used to replace old, worn top hat grommets in your hydroponic system and can be a valuable solution when building your own garden system. Top Hat grommets have a straight side wall for easy installation. When the fitting is inserted into the grommet, the wall is pushed against the whole surface to create the seal.

EXCLUSIVE

Item No.	Description	Bag Qty	Box Qty	MSRP Ea
747028	Hydro Flow Top Hat Grommet 1/4 in	10	—	\$0.36
747066	Hydro Flow Top Hat Grommet 1/2 in	10	—	\$0.39
747118	Hydro Flow Top Hat Grommet 3/4 in	10	—	\$0.58
708382	Hydro Flow Top Hat Grommet Bulk 1/4 in - Display Box	—	250	\$0.31
708384	Hydro Flow Top Hat Grommet Bulk 1/2 in - Display Box	—	250	\$0.33
742842	Hydro Flow Top Hat Grommet Bulk 3/4 in - Display Box	—	250	\$0.51

Hydro Flow® Poly Replacement Screens



Hydro Flow® 150 Mesh Filter Replacement Screen for 3/4 in Tee Filter, In-Line Filter and Y Filter.

EXCLUSIVE

Item No.	Description	Bag Qty	Box Qty	MSRP Ea
747138	Hydro Flow Poly Y Filter Replacement Screen (150 Mesh)	1	—	\$5.61
747144	Hydro Flow Inline Filter Replacement Screen 150 Mesh	1	—	\$4.78
747146	Hydro Flow Swivel Tee Filter Replacement Screen 150 Mesh	1	—	\$5.13
742670	Hydro Flow Polyester Y Filter Replacement Screen 150 mesh - Display Box	—	25	\$4.87
742685	Hydro Flow Poly Replacement Screen 150 mesh for In Line Filter - Display Box	—	25	\$4.40
742690	Hydro Flow Poly Replacement Screen 150 mesh for 3/4 in tee Filter - Display Box	—	25	\$4.71

Hydro Flow® Fittings with 150 Mesh Screens



These Hydro Flow® fittings with 150 Mesh Screen removes particles from water, preventing clogged lines and providing a debris free watering source. Choose from the four types to meet your needs.

EXCLUSIVE

Item No.	Description	Bag Qty	Box Qty	MSRP Ea
747134	Hydro Flow 3/4 in Y Filter MPT x MPT 150 Mesh	1	—	\$15.29
747136	Hydro Flow 3/4 in Swivel Y Filter FGHT x GHT 150 Mesh	1	—	\$15.56
747140	Hydro Flow 3/4 in FHT x 3/4 in MHT In-Line Filter w/ Screen	1	—	\$7.15
747142	Hydro Flow 3/4 in Swivel Tee Filter FGHT x GHT 150 Mesh	1	—	\$7.15
742660	Hydro Flow 3/4 in Male NPT w/ 150 Mesh Screen - Display Box	1	—	\$14.01
742665	Hydro Flow 3/4 in Female NHT Swivel w/ 150 Mesh Screen - Display Box	1	—	\$14.25
742675	Hydro Flow 3/4 in FHT x 3/4 MHT In-Line Filter w/ Screen - Display Box	—	25	\$6.62
742680	Hydro Flow 3/4 in FHT Swivel Tee w/ Polyester Screen - Display Box	—	25	\$6.62

Hydro Flow® Fittings & Adapters

Hydro Flow® Barbed Fittings 1/8 in



These non-corrosive plastic fittings are guaranteed to provide a secure, watertight and airtight connection. These fittings offer strength and durability. Use these high quality barbed 1/8 in connectors for your irrigation or hydroponic systems.



EXCLUSIVE

Item No.	Description	Bag Qty	Box Qty	MSRP Ea
747002	Hydro Flow Barbed Tee 1/8 in	10	—	\$0.50
742000	Hydro Flow Barbed Straight 1/8 in to 1/8 in - Display Box	—	500	\$0.18
742005	Hydro Flow Barbed Tee 1/8 in - Display Box	—	500	\$0.35

Hydro Flow® Barbed Fittings 3/16 in



These non-corrosive plastic fittings are guaranteed to provide a secure, watertight and airtight connection. These fittings offer strength and durability. Hydro Flow® 3/16 in Connectors are perfect for using with irrigation or hydroponic systems.



EXCLUSIVE

Item No.	Description	Bag Qty	Box Qty	MSRP Ea
747004	Hydro Flow Barbed Straight 3/16 in to 3/16 in	10	—	\$0.32
747006	Hydro Flow Barbed Elbow 3/16 in	10	—	\$0.46
747008	Hydro Flow Barbed Tee 3/16 in	10	—	\$0.47
742010	Hydro Flow Barbed Straight 3/16 in to 3/16 in - Display Box	—	500	\$0.22
742015	Hydro Flow Barbed Elbow 3/16 in - Display Box	—	500	\$0.33
742020	Hydro Flow Barbed Tee 3/16 in - Display Box	—	500	\$0.36

Hydro Flow® Barbed Fittings 1/4 in



These non-corrosive plastic fittings are guaranteed to provide a secure, watertight and airtight connection. These fittings offer strength and durability. Use these high quality barbed 1/4 in connectors for your irrigation or hydroponic systems.



EXCLUSIVE

Item No.	Description	Bag Qty	Box Qty	MSRP Ea
747014	Hydro Flow Barbed Straight 1/4 in to 1/4 in	10	—	\$0.36
747016	Hydro Flow Barbed Elbow 1/4 in	10	—	\$0.49
747018	Hydro Flow Barbed Tee 1/4 in	10	—	\$0.62
747020	Hydro Flow Barbed Y Connector 1/4 in	10	—	\$1.57
742025	Hydro Flow Barbed Straight 1/4 in to 1/4 in - Display Box	—	500	\$0.31
742030	Hydro Flow Barbed Elbow 1/4 in - Display Box	—	500	\$0.44
742035	Hydro Flow Barbed Tee 1/4 in - Display Box	—	500	\$0.44
742040	Hydro Flow Barbed Y Connector 1/4 in - Display Box	—	250	\$1.29

Hydro Flow® Barbed Fittings 1/4 in



Use these high quality barbed 1/4 in connectors for your irrigation systems or hydroponic systems. Feature 3 barbs for a tight fit. Bump stop assures fittings are completely and securely inserted in tubing. Made with 100% virgin plastic.

EXCLUSIVE

Item No.	Description	Bag Qty	MSRP Ea
708405	Hydro Flow Premium Barbed Tee 1/4 in	10	\$0.35
708410	Hydro Flow Premium Barbed Straight 1/4 in	10	\$0.22
708415	Hydro Flow Premium Barbed Elbow 1/4 in	10	\$0.33

Hydro Flow® Barbed Fittings 3/8 in



These non-corrosive plastic fittings are guaranteed to provide a secure, watertight and airtight connection. These fittings offer strength and durability. Use these high quality 3/8 in Hydro Flow barbed connectors for your irrigation systems.



EXCLUSIVE

Item No.	Description	Bag Qty	Box Qty	MSRP Ea
747030	Hydro Flow Barbed Straight 3/8 in to 3/8 in	10	—	\$0.32
747032	Hydro Flow Barbed Elbow 3/8 in	10	—	\$0.47
747034	Hydro Flow Barbed Tee 3/8 in	10	—	\$0.64
747036	Hydro Flow Barbed Y Connector 3/8 in	10	—	\$1.56
742045	Hydro Flow Barbed Straight 3/8 in to 3/8 in - Display Box	—	250	\$0.24
742050	Hydro Flow Barbed Elbow 3/8 in - Display Box	—	250	\$0.38
742055	Hydro Flow Barbed Tee 3/8 in - Display Box	—	250	\$0.41
742060	Hydro Flow Barbed Y Connector 3/8 in - Display Box	—	250	\$1.36

Hydro Flow® Barbed Fittings 1/2 in



These non-corrosive plastic fittings are guaranteed to provide a secure, watertight and airtight connection. These fittings offer strength and durability. Use these high quality barbed 1/2 in connectors for your irrigation or hydroponic systems.



EXCLUSIVE

Item No.	Description	Bag Qty	Box Qty	MSRP Ea
747046	Hydro Flow Barbed Straight 1/2 in to 1/2 in	10	—	\$0.35
747048	Hydro Flow Barbed Elbow 1/2 in	10	—	\$0.64
747050	Hydro Flow Barbed Tee 1/2 in	10	—	\$0.56
747052	Hydro Flow Barbed Y Connector 1/2 in	10	—	\$1.67
742065	Hydro Flow Barbed Straight 1/2 in to 1/2 in - Display Box	—	250	\$0.29
742070	Hydro Flow Barbed Elbow 1/2 in - Display Box	—	250	\$0.51
742075	Hydro Flow Barbed Tee 1/2 in - Display Box	—	250	\$0.51
742080	Hydro Flow Barbed Y Connector 1/2 in - Display Box	—	100	\$1.45

Hydro Flow® Barbed Fittings & Valves 1/2 in



Use these high quality barbed 1/2 in connectors for your irrigation systems or hydroponic systems. Feature 4 barbs for a tight fit. Bump stop assures fittings are completely and securely inserted in tubing.

EXCLUSIVE

Item No.	Description	Bag Qty	MSRP Ea
708420	Hydro Flow Premium Barbed Tee 1/2 in	10	\$0.45
708425	Hydro Flow Premium Barbed Straight 1/2 in	10	\$0.42
708430	Hydro Flow Premium Barbed Elbow 1/2 in	10	\$0.47
708435	Hydro Flow Inline Valve 1/2 in	10	\$2.91

Hydro Flow® Barbed Fittings & Valves 3/4 in



Use these high quality barbed 3/4 in connectors for your irrigation systems or hydroponic systems. Feature 4 barbs for a tight fit. Bump stop assures fittings are completely and securely inserted in tubing.

EXCLUSIVE

Item No.	Description	Bag Qty	MSRP Ea
708440	Hydro Flow Premium Barbed Tee 3/4 in	10	\$1.04
708445	Hydro Flow Premium Barbed Straight 3/4 in	10	\$0.87
708450	Hydro Flow Premium Barbed Elbow 3/4 in	10	\$0.95
708455	Hydro Flow Inline Valve 3/4 in	10	\$3.18

Hydro Flow® Barbed Fittings 3/4 in

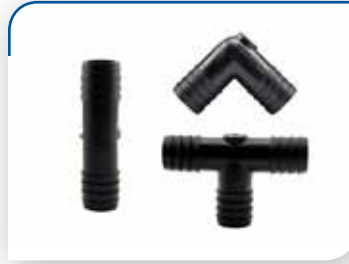

These non-corrosive plastic fittings are guaranteed to provide a secure, watertight and airtight connection. These fittings offer strength and durability. Use these high quality barbed 3/4 in connectors for your irrigation or hydroponic systems.

EXCLUSIVE

Item No.	Description	Bag Qty	Box Qty	MSRP Ea
747096	Hydro Flow Barbed Connector 3/4 in to 3/4 in	10	—	\$0.64
747098	Hydro Flow Barbed Elbow 3/4 in	10	—	\$0.80
747100	Hydro Flow Barbed Tee 3/4 in	10	—	\$0.75
742085	Hydro Flow Barbed Straight 3/4 in to 3/4 in - Display Box	—	100	\$0.55
742090	Hydro Flow Barbed Elbow 3/4 in - Display Box	—	100	\$0.65
742095	Hydro Flow Barbed Tee 3/4 in - Display Box	—	50	\$0.65

Hydro Flow® Barbed Fittings 1 in



These non-corrosive plastic fittings are guaranteed to provide a secure, watertight and airtight connection. These fittings offer strength and durability. Use these high quality barbed 1 in connectors for your irrigation or hydroponic systems.



EXCLUSIVE

Item No.	Description	Bag Qty	Box Qty	MSRP Ea
747148	Hydro Flow Barbed Connector 1 in to 1 in	10	—	\$0.90
747150	Hydro Flow Barbed Elbow 1 in	10	—	\$1.06
747152	Hydro Flow Barbed Tee 1 in	10	—	\$0.84
742100	Hydro Flow Barbed Straight 1 in to 1 in - Display Box	—	50	\$0.67
742105	Hydro Flow Barbed Elbow 1 in - Display Box	—	50	\$0.82
742110	Hydro Flow Barbed Tee 1 in - Display Box	—	50	\$0.73





Hydro Flow® Barbed Fittings 1 in



Use these high quality barbed 1 in connectors for your irrigation systems or hydroponic systems. Feature 4 barbs for a tight fit. Bump stop assures fittings are completely and securely inserted in tubing.

EXCLUSIVE

Item No.	Description	Bag Qty	MSRP Ea
708460	Hydro Flow Premium Barbed Tee 1 in	10	\$1.25
708465	Hydro Flow Premium Barbed Straight 1 in	10	\$1.07
708470	Hydro Flow Premium Barbed Elbow 1 in	10	\$1.18

MPT/FPT Male/Female Pipe Thread		GHT Garden Hose Thread	
<p>Male (MPT)</p>  <p>MPT/FPT threads have a slight taper, which helps create a good seal when fittings are tightened. Use Teflon tape on threads for extra seal assurance. Some MPT fittings also use rubber washers to assist in sealing.</p>	<p>Female (FPT)</p> 	<p>Male (GHT)</p>  <p>GHT threads are not tapered like MPT/FPT, so they require a "Garden Hose Washer" to make a seal when tightened.</p>	<p>Female (FGHT)</p> 
<p>MPT/FPT and GHT threads are NOT interchangeable</p>		<p>Garden Hose Washer</p> 	

Hydro Flow® Barbed Straight Reducers



These non-corrosive plastic fittings are guaranteed to provide a secure, watertight and airtight connection. These fittings offer strength and durability. Use these high quality Hydro Flow® Reducers for your irrigation or hydroponic systems.



EXCLUSIVE

Item No.	Description	Bag Qty	Box Qty	MSRP Ea
747158	Hydro Flow Reducer Fitting 1/4 in to 3/16 in	10	—	\$0.35
747162	Hydro Flow Reducer Fitting 3/8 in to 1/4 in	10	—	\$0.31
747168	Hydro Flow Reducer Fitting 1/2 in to 3/8 in	10	—	\$0.32
747174	Hydro Flow Reducer Fitting 3/4 in to 1/2 in	10	—	\$0.57
742115	Hydro Flow Barbed Reducer 1/4 in to 3/16 in - Display Box	—	500	\$0.25
742120	Hydro Flow Barbed Reducer 3/8 in to 1/4 in - Display Box	—	250	\$0.22
742125	Hydro Flow Barbed Reducer 1/2 in to 3/8 in - Display Box	—	250	\$0.25
742130	Hydro Flow Barbed Reducer 3/4 in to 1/2 in - Display Box	—	100	\$0.44

Hydro Flow® Barbed Straight Reducer 3/4 in to 3/8 in



NEW These fittings will adapt your Air Force Pro® Pumps to the EcoPlus® 3/8 in Air Manifolds and can be used to reduce water flow as well. Our complete line of fittings is known for its superior performance and reliability. These non-corrosive plastic fittings are guaranteed to



provided a secure, watertight and airtight connection. These fittings offer strength and durability.

EXCLUSIVE

Item No.	Description	Box Qty	MSRP Ea
742844	Hydro Flow Barbed Reducer 3/4 in to 3/8 in - Display Box	100	\$0.82

Hydro Flow® Barbed Tee Reducers



These non-corrosive plastic fittings are guaranteed to provide a secure, watertight and airtight connection. These fittings offer strength and durability. Use these Reducer Tees for your irrigation and hydroponic systems.



EXCLUSIVE

Item No.	Description	Bag Qty	Box Qty	MSRP Ea
747164	Hydro Flow Barbed Reducer Tee 3/8 in to 1/4 in	10	—	\$0.48
747166	Hydro Flow Barbed Reducer Tee 1/2 in to 1/4 in	10	—	\$0.53
747172	Hydro Flow Barbed Reducer Tee 1/2 in to 3/8 in	10	—	\$0.51
747176	Hydro Flow Barbed Reducer Tee 3/4 in to 1/2 in	10	—	\$0.77
742145	Hydro Flow Barbed Reducer Tee 3/8 in to 1/4 in - Display Box	—	250	\$0.41
742150	Hydro Flow Barbed Reducer Tee 1/2 in to 1/4 in - Display Box	—	250	\$0.45
742155	Hydro Flow Barbed Reducer Tee 1/2 in to 3/8 in - Display Box	—	250	\$0.44
742160	Hydro Flow Barbed Reducer Tee 3/4 in to 1/2 in - Display Box	—	100	\$0.64

Hydro Flow® Barbed Elbow Reducer



These non-corrosive plastic fittings are guaranteed to provide a secure, watertight and airtight connection. These fittings offer strength and durability. Use the Hydro Flow® Reducer Elbow for your irrigation or hydroponic systems.



EXCLUSIVE

Item No.	Description	Box Qty	MSRP Ea
742135	Hydro Flow Barbed Reducer Elbow 1/4 in to 3/16 in - Display Box	500	\$0.44

Hydro Flow® Garden Hose Adapters



These non-corrosive plastic fittings are guaranteed to provide a secure, watertight and airtight connection. These fittings offer strength and durability. Use these fittings to connect your hose to your irrigation tubing.

EXCLUSIVE

Item No.	Description	Bag Qty	Box Qty	MSRP Ea
747110	Hydro Flow Garden Hose Washer 3/4 in	10	—	\$0.39
747112	Hydro Flow Garden Hose Nut 3/4 in	10	—	\$0.42
742235	Hydro Flow Garden Hose Adapter Insert 1/4 in - Display Box	—	100	\$0.27
742240	Hydro Flow Garden Hose Adapter Insert 3/8 in - Display Box	—	100	\$0.31
742245	Hydro Flow Garden Hose Adapter Insert 1/2 in - Display Box	—	100	\$0.35
742250	Hydro Flow Garden Hose Adapter Insert 3/4 in - Display Box	—	50	\$0.40
742255	Hydro Flow Garden Hose Washer 3/4 in - Display Box	—	500	\$0.24
742260	Hydro Flow Garden Hose Nut 3/4 in - Display Box	—	100	\$0.33

Hydro Flow® GHT x Barbed Adapters



These non-corrosive plastic fittings are guaranteed to provide a secure, watertight and airtight connection. These fittings offer strength and durability. Use these Hydro Flow® Adapters with your irrigation and hydroponic systems.



EXCLUSIVE

Item No.	Description	Bag Qty	Box Qty	MSRP Ea
747102	Hydro Flow Garden Hose Threaded Adapter 3/4 in	10	—	\$0.59
747054	Hydro Flow 1/2 in FNPT x 1/2 in Barb	10	—	\$1.37
747260	Hydro Flow 3/4 in GHT x 1/2 in Barb	10	—	\$0.55
742165	Hydro Flow Garden Hose Threaded Adapter 3/4 in - Display Box	—	100	\$0.40
742170	Hydro Flow 1/2 in FNPT x 1/2 in Barbed - Display Box	—	100	\$1.15
742175	Hydro Flow Garden Hose Cap Assembly 3/4 in - Display Box	—	100	\$0.68
742180	Hydro Flow 1/2 in GHT x 1/2 in Barb - Display Box	—	100	\$0.36
742350	Hydro Flow 3/4 in GHT x 1/2 in Barb - Display Box	—	100	\$0.40

Hydro Flow® 3/4 in Filter Washer



Hydro Flow® garden hose filter washer has a stainless steel 30 x 30 mesh screen to prevent particles from passing. Fits any female garden hose or garden hose fitting.

EXCLUSIVE

Item No.	Description	Box Qty	MSRP Ea
742725	Hydro Flow 3/4 in Filter Washer 30 x 30 Mesh w/ PVC Gasket - Display Box	150	\$0.31

Hydro Flow® Adapters GHT x NPT



These Garden Hose Thread to National Pipe Thread adapters are commonly used to attach, couple or extend your garden hose to pumps or other gardening accessories.

EXCLUSIVE

Item No.	Description	Box Qty	MSRP Ea
742835	Hydro Flow Adapter 3/4 in GHT x 1/2 in NPT - Display Box	100	\$0.44
742838	Hydro Flow Adapter 3/4 in GHT x 3/4 in NPT - Display Box	100	\$0.45

Hydro Flow® Compression Fittings 1/2 in



Hydro Flow® 1/2 in Compression Fittings allows for a tight fit to 1/2 in poly tubing, perfect for outdoor or indoor applications.

EXCLUSIVE

Item No.	Description	Bag Qty	Box Qty	MSRP Ea
747078	Hydro Flow 1/2 in Compression Coupler	10	—	\$1.09
747080	Hydro Flow 1/2 in Compression Elbow	10	—	\$1.24
747074	Hydro Flow 1/2 in Compression Shut Off Valve	10	—	\$2.51
742460	Hydro Flow 1/2 in Compression Shut Off Valve - Display Box	—	25	\$2.28

Hydro Flow® Fitting - 1/2 in Compression x 1/2 in FPT



Hydro Flow® 1/2 in Compression Tee by 1/2 in FPT works as the base for the 2 in poly nipple and six outlet distribution manifold.

EXCLUSIVE

Item No.	Description	Bag Qty	MSRP Ea
747094	Hydro Flow 1/2 in Compression Tee x 1/2 in FPT	10	\$1.36

Hydro Flow® Compression Swivel Fittings



Hydro Flow® 1/2 in Compression Swivel Adapter with 3/4 in FHT allows for a secure fit to a garden hose end or spigot, supplying water to your 1/2 in poly tube.

EXCLUSIVE

Item No.	Description	Bag Qty	Box Qty	MSRP Ea
747090	Hydro Flow 1/2 in Compression x 3/4 in FHT Swivel Tee	10	—	\$1.44
742605	Hydro Flow 1/2 in Compression x 3/4 in FHT Swivel Adapter - Display Box	—	25	\$1.12
742610	Hydro Flow 1/2 in Compression x 3/4 in FHT Swivel Elbow - Display Box	—	25	\$1.28
742615	Hydro Flow 1/2 in Compression x 3/4 in FHT Swivel Tee - Display Box	—	25	\$1.29

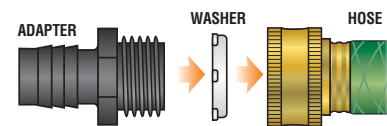
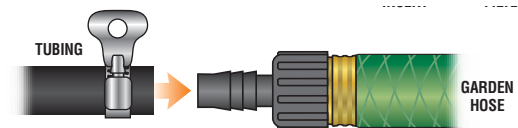
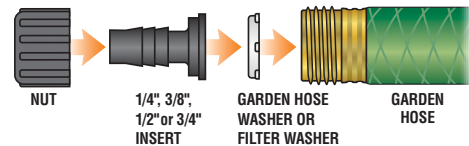

Hydro Flow® Tub Outlet Tee Fittings



Constructed of high quality impact resistant plastic. These fittings use tapered ends to help guide the hose onto the four barb securing points. It also includes two corrosion resistant gaskets. This material stands up to the most abrasive chemicals and provides an exceptional seal. The fitting is secured by a custom designed nut, **EXCLUSIVE**



that mounts from the inside of the container, making for a clean finished look.

Item No.	Description	Bag Qty	Box Qty	MSRP Ea
742266	Hydro Flow 1/2 in Tub Outlet Tee NEW	1	—	\$5.00
747186	Hydro Flow Tub Outlet Tee Fitting w/ 2 Gaskets 3/4 in	1	—	\$5.24
747308	Hydro Flow - Tub Outlet Tee Fitting w/ 2 Gaskets 1 in	1	—	\$5.44
747188	Hydro Flow Tub Outlet Tee Fitting Replacement Nut	10	—	\$0.76
747187	Hydro Flow 1/2 in Tub Outlet Tee NEW	—	25	\$4.35
742265	Hydro Flow Tub Outlet Tee Fitting w/ 2 Gaskets - 3/4 in - Display Box	—	25	\$5.47
742740	Hydro Flow - Tub Outlet Tee Fitting w/ 2 Gaskets 1 in - Display Box	—	25	\$4.71
742270	Hydro Flow Tub Outlet Tee Fitting Replacement Nut 3/4 in - Display Box	—	50	\$0.72

Hydro Flow® Tub Outlet Straight Fittings - 1/2, 3/4 and 1 Inch



NEW Made with high quality impact resistant virgin plastic. Incorporates tapered end to help guide the hose onto the four barb securing point. This fitting includes corrosion resistant gaskets. This material that up to the most abrasive chemicals and provides an exceptional seal. The fitting is secured by a custom nut that mounts **EXCLUSIVE**



from the inside of the container, making for a clean finished look. Eliminates the possibility of leaks.

Item No.	Description	Bag Qty	Box Qty	MSRP Ea
742276	Hydro Flow - Tub Outlet Straight Fitting w/ 2 Gaskets 1/2 in	1	—	\$4.82
742272	Hydro Flow - Tub Outlet Straight Fitting w/ 2 Gaskets 3/4 in	1	—	\$5.05
747310	Hydro Flow - Tub Outlet Straight Fitting w/ 2 Gaskets 1 in	10	—	\$5.16
747191	Hydro Flow - Tub Outlet Straight Fitting w/ 2 Gaskets 1/2 in	—	25	\$4.16
747189	Hydro Flow - Tub Outlet Straight Fitting w/ 2 Gaskets 3/4 in	—	25	\$4.38
742742	Hydro Flow - Tub Outlet Straight Fitting w/ 2 Gaskets 1 in - Display Box	—	25	\$4.45

Hydro Flow® Ebb & Flow Fitting Kit



Kit includes: 1 - 1/2 in Tub Outlet Fitting, 1 - 3/4 in Tub Outlet Fitting, 2 - Screen Fittings and 3 - Outlet Extension Fittings. Manufactured using the finest quality materials and craftsmanship. Hydro Flow® Tub Outlet Fittings each come with 2 gaskets ensuring a water tight seal.

EXCLUSIVE

Item No.	Description	MSRP
708562	Hydro Flow Ebb & Flow Fitting Kit	\$7.65

Hydro Flow® Ebb & Flow Fittings



Manufactured using high quality materials. Hydro Flow® Tub Outlet Fittings each come with 2 gaskets ensuring a water tight seal. All pieces offered a la carte for maximum flexibility.

EXCLUSIVE

Item No.	Description	Bag Qty	MSRP Ea
708560	Hydro Flow Ebb & Flow Outlet Extension Fitting	10	\$0.69
708565	Hydro Flow Ebb & Flow Screen Fitting	10	\$0.69
708570	Hydro Flow Ebb & Flow Tub Outlet Fitting 1/2 in (13mm)	10	\$2.67
708575	Hydro Flow Ebb & Flow Tub Outlet Fitting 3/4 in (19mm)	10	\$2.45
708580	EcoPlus Ebb & Flow Tub Outlet Fitting 1 in (25mm)	10	\$3.10

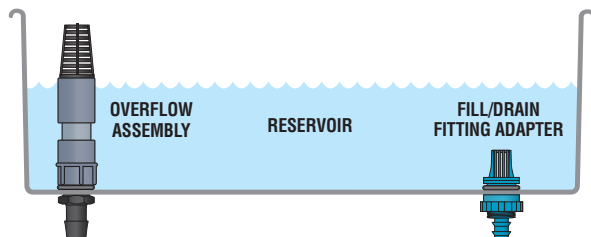

Hydro Flow® Fill/Drain Fitting Kit



The Fill/Drain Fitting Kit includes one fill/drain fitting (custom bulkhead fitting with 1/2 in screen, nut and O-ring) and one overflow fitting (PVC tube and adapter with 1 in screen). These work great individually, but work together to allow you to make a tray into an ebb/flow system.



EXCLUSIVE

Item No.	Description	MSRP
706750	Hydro Flow Gray & Teal Fitting Kit Kit	\$12.59
706751	Hydro Flow Fill & Drain Teal Fitting Adapter	\$5.03

Hydro Flow® Bottom Draw Pump Adapters



The Hydro Flow® 90 Degree Bottom Draw Adapters allow the user to draw water down close to the bottom of your hydroponic system or reservoir while using a standard submersible pump. The 1/2 inch MPT diameter adapter is compatible with EcoPlus® 264 and 396 pumps. This adapter will draw water down to **EXCLUSIVE**



1/2 inch in the bottom of your reservoir or tank. The 1 inch MPT diameter adapter is compatible with EcoPlus® 633, 1056 and 1267 pumps. This adapter will draw water down to 1 inch in the bottom of your reservoir or tank. Matching Male Pipe Thread (MPT) makes a secure connection. Quickly turn your front draw EcoPlus® pump into a bottom draw pump with a Hydro Flow® Bottom Draw Pump Adapter.

Item No.	Description	MSRP
747270	Hydro Flow Bottom Draw Pump Adapter 1/2 in	\$1.56
747272	Hydro Flow Bottom Draw Pump Adapter 1 in	\$3.00

Hydro Flow® Bulkhead Fittings



Designed to create a water tight seal when transferring liquid from or to a storage container/reservoir. These fittings are made from durable ABS Plastic and come with double gaskets for a secure seal as well as double female threads to incorporate fittings or filters into the bulkhead. Manufactured in the U.S.A.

EXCLUSIVE

Item No.	Description	Bag Qty	Box Qty	MSRP Ea
747266	Hydro Flow Bulkhead Thread/Thread 1/2 in Hole Size 1-1/8 in	10	—	\$6.16
747268	Hydro Flow Bulkhead Thread/Thread 3/4 in Hole Size 1-1/2 in	10	—	\$7.71
742825	Hydro Flow Bulkhead Thread/Thread 1/2 in Hole Size 1-1/8 in - Display Box	—	25	\$5.44
742830	Hydro Flow Bulkhead Thread/Thread 3/4 in Hole Size 1-1/2 in - Display Box	—	25	\$6.65

Can also be used with Threaded to Barbed Adapters as shown:

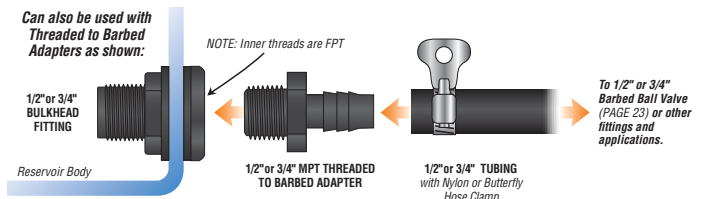

Hydro Flow® Valves, Regulators & Manifolds

Hydro Flow® Barbed Ball Valves



These non-corrosive plastic fittings are guaranteed to provide a secure, watertight connection. These fittings offer strength and durability. These Barbed Ball Valves regulate your hydroponic irrigation systems with an easy turn of the knob.

EXCLUSIVE

Item No.	Description	Bag Qty	Box Qty	MSRP Ea
747058	Hydro Flow Premium Barbed Ball Valve 1/2 in	10	—	\$2.51
747106	Hydro Flow Premium Ball Valve 3/4 in Barb	10	—	\$4.18
742200	Hydro Flow Premium Barbed Ball Valve 1/2 in - Display Box	—	50	\$2.09
742205	Hydro Flow Premium Barbed Ball Valve 3/4 in - Display Box	—	25	\$3.85

Hydro Flow® In-Line Micro Irrigation Valve



Hydro Flow® Micro Irrigation Valve allows you to adjust your flow rate in your drip application. Fits snugly to Hydro Flow® 3/16 in tubing.

EXCLUSIVE

Item No.	Description	Bag Qty	Box Qty	MSRP Ea
747012	Hydro Flow In-Line Micro Irrigation Valve 3/16 in	10	—	\$1.11
742440	Hydro Flow In-Line Micro Irrigation Valve 3/16 in - Display Box	—	150	\$0.86

Hydro Flow® Reservoir Shut Off Valve Kit



Hydro Flow® Shut Off Valve Kit is a simple fix when you need to transport fluid from a reservoir or storage container. Simply drill a hole in your container, insert bulk head fitting, tighten the bulk head nut on the inside of your container and you are ready to distribute fluid where you need it. Another simple solution exclusively from Hydro Flow.

EXCLUSIVE

Item No.	Description	Bag Qty	MSRP Ea
742840	Hydro Flow Reservoir Shut Off Valve Kit	1	\$11.82

Hydro Flow® Distribution Manifold 6 Outlet



Hydro Flow® 6 Outlet Distribution Manifold provides flexibility by distributing water to up to six sites. 2 in Poly Nipple is used for the body of the manifold. Simply push in flags to turn off desired outlets.

EXCLUSIVE

Item No.	Description	Bag Qty	Box Qty	MSRP Ea
747204	Hydro Flow Distributor Manifold 6 Outlet 1/2 in FPT	1	—	\$5.22
742435	Hydro Flow 6 Outlet Distribution Manifold - Display Box	—	25	\$4.75

Hydro Flow® 25 PSI Pressure Regulator



Hydro Flow® 25 PSI Pressure Regulator is connected directly to a garden hose spigot or faucet to reduce incoming pressure in your water line pressure to 25 PSI.

EXCLUSIVE

Item No.	Description	Bag Qty	Box Qty	MSRP Ea
747130	Hydro Flow 25 PSI Pressure Regulator 3/4 in FHT x 3/4 in MHT	1	—	\$6.54
742650	Hydro Flow 25 PSI Pressure Regulator 3/4 in FHT x 3/4 in MHT - Display Box	—	25	\$5.99

Hydro Flow® Backflow Preventor



Hydro Flow® Backflow Preventor is installed at the beginning of the irrigation line creating a siphon break which prevents water from continuing to siphon when the pump is turned off.

EXCLUSIVE

Item No.	Description	Bag Qty	Box Qty	MSRP Ea
747132	Hydro Flow Backflow Preventor 3/4 in FHT x 3/4 in MHT	1	—	\$3.89
742655	Hydro Flow Backflow Preventor 3/4 in FHT x 3/4 in MHT - Display Box	—	25	\$3.64

Hydro Flow® Shut Off Valves



Hydro Flow® Shut Off Valves allow you to adjust water flow from your spigot or garden hose application. Hydro Flow® 3/4 in Shut Off Valve with the swivel allows for easy installation and removal.

EXCLUSIVE

Item No.	Description	Bag Qty	Box Qty	MSRP Ea
747122	Hydro Flow 3/4 in Shut Off Valve MHT x FHT	1	—	\$2.52
747124	Hydro Flow 3/4 in Shut Off Valve MHT x FHT w/ Swivel	1	—	\$2.96
742445	Hydro Flow 3/4 in Shut Off Valve MHT x FHT - Display Box	—	25	\$2.06
742450	Hydro Flow 3/4 in Shut Off Valve MHT x FHT w/ Swivel - Display Box	—	25	\$2.49

Hydro Flow® Dual Shut Off Garden Hose Y



The Garden Hose Y not only splits the flow but it comes with two shut off switches to allow the user to utilize both sides or one depending on need.

EXCLUSIVE

Item No.	Description	Bag Qty	Box Qty	MSRP Ea
747206	Hydro Flow Garden Hose Y w/ Dual Shut Off	1	—	\$3.35
742455	Hydro Flow Garden Hose Y w/ Dual Shut Off - Display Box	—	25	\$2.87

Hydro Flow® Drippers, Sprayers & Emitters

Hydro Flow® Single Piece Spray Heads



Hydro Flow® Single Piece Spray Heads spray with a flat trajectory. 742570 has a 90 degree spray pattern, 742575 has a 180 degree spray pattern and 742580 has a 360 degree spray pattern.

EXCLUSIVE

Item No.	Description	Bag Qty	Box Qty	MSRP Ea
747238	Hydro Flow Single Piece Spray Heads 90 Degree Red/Orange	10	—	\$0.35
747240	Hydro Flow Single Piece Spray Heads 180 Degree Black	10	—	\$0.36
747242	Hydro Flow Single Piece Spray Heads 360 Degree Green	10	—	\$0.36
742570	Hydro Flow Single Piece Spray Heads 90 Degree Red/Orange - Display Box	—	250	\$0.24
742575	Hydro Flow Single Piece Spray Heads 180 Degree Black - Display Box	—	250	\$0.27
742580	Hydro Flow Single Piece Spray Heads 360 Degree Green - Display Box	—	250	\$0.26

Hydro Flow® Push In Regulated Button Emitters



Hydro Flow® Push In Regulated Button Emitters can be directly inserted into 1/2, 3/4 or 1 inch poly tubing or connected via Hydro Flow® 3/16 in ID Poly tubing. Emitter has a removable top for cleaning.

**CLEANABLE
REUSABLE**

EXCLUSIVE

Item No.	Description	Bag Qty	Box Qty	MSRP Ea
747218	Hydro Flow Regulated Push-In Button Emitter Yellow 0.5 GPH	10	—	\$0.58
747220	Hydro Flow Regulated Push-In Button Emitter Black 1 GPH	10	—	\$0.58
747222	Hydro Flow Regulated Push-In Button Emitter Blue 2 GPH	10	—	\$0.52
742520	Hydro Flow Regulated Push-In Button Emitter Yellow 0.5 GPH - Display Box	—	100	\$0.36
742525	Hydro Flow Regulated Push-In Button Emitter Black 1 GPH - Display Box	—	100	\$0.36
742530	Hydro Flow Regulated Push-In Button Emitter Blue 2 GPH - Display Box	—	100	\$0.36

Hydro Flow® Push-In Flag Emitters

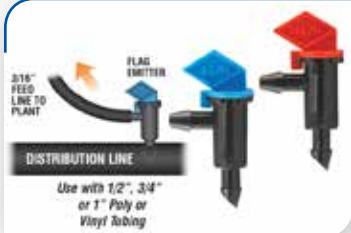

Hydro Flow® Push-in Flag Emitters are easily inserted into your main distribution line to add a feed line to your plant. The flags are removable and separate easily to allow for cleaning. Works with Hydro Flow® 3/16 in ID Poly Tubing.

**CLEANABLE
REUSABLE**

EXCLUSIVE

Item No.	Description	Bag Qty	MSRP Ea
747234	Hydro Flow Push-In Flag Emitter Blue 2 GPH	10	\$0.37
747236	Hydro Flow Push-In Flag Emitter Red 3 GPH	10	\$0.37

Hydro Flow® In-Line Flag Emitters

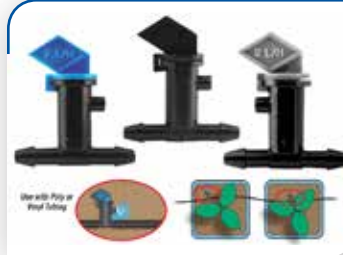

Hydro Flow® In-Line Flag Emitters allow water to flow smoothly at the designed GPH. The flags are removable and separate easily to allow for cleaning. Works with Hydro Flow® 3/16 in ID Poly or Vinyl Tubing.

**CLEANABLE
REUSABLE**

EXCLUSIVE

Item No.	Description	Bag Qty	Box Qty	MSRP Ea
747224	Hydro Flow In-Line Flag Emitter Gray 0.5 GPH	10	—	\$0.51
747226	Hydro Flow In-Line Flag Emitter Black 1 GPH	10	—	\$0.51
742545	Hydro Flow In-Line Flag Emitter Blue 2 GPH - Display Box	—	150	\$0.47

Hydro Flow® Adjustable Drip Stakes with Cleanout



Flow can be adjusted depending on the nature of use, also drip emitter can be turned off when not in use. Drip Emitters are two pieces and separate for easy cleanout.

EXCLUSIVE

Item No.	Description	Box Qty	MSRP Ea
742415	Hydro Flow Adjustable In-Line Drip Stake w/ Cleanout- 0-1.6 GPH - Display Box	100	\$0.69
742420	Hydro Flow Adjustable End-Line Drip Stake w/ Cleanout- 0-1.6 GPH - Display Box	100	\$0.61

Hydro Flow® Dripper Stake with Basket - Black



Made with high quality materials. Can be used with dripper line #708345.

EXCLUSIVE

Item No.	Description	Bag Qty	MSRP Ea
747254	Hydro Flow Dripper Stake w/ Basket - Black	10	\$0.53
742730	Hydro Flow Dripper Stake w/ Basket - Black - Display Box	—	\$0.53

Hydro Flow® Dripper Stake with Basket - Blue



Can be used with dripper line #708345.

EXCLUSIVE

Item No.	Description	Bag Qty	MSRP Ea
747256	Hydro Flow Dripper Stake w/ Basket - Blue	10	\$0.53
708341	Hydro Flow Dripper Stake w/ Basket - Blue - Display Box	—	\$0.53

Hydro Flow® DeepRoot Irrigation™ Drip Emitters



NEW Hydro Flow® DeepRoot Irrigation™ Drip Emitters deliver water and nutrients directly to the root zone. Surface watering can lose enormous amounts of water from run off and evaporation. They also promotes downward root growth. This will eliminate J-Roots and shallow root development. DeepRoot Irrigation™ Drip Emitters connects to common emitters, making installation a breeze. **EXCLUSIVE**

Item No.	Description	MSRP
747255	Hydro Flow DeepRoot Irrigation Drip Emitter - 6 in	\$4.19
747257	Hydro Flow DeepRoot Irrigation Drip Emitter - 12 in	\$4.39

Hydro Flow® Multi-Flow Emitter



This unique multi-position emitter stake distributes solutions using a broad fan-shaped spray. Multi-positions allows for low, medium and high spray volumes by simply changing the tubing position from one post to another. It also has a stopper post to plug. Uses 0.200 O.D. x 0.135 I.D. tubing. **EXCLUSIVE**

Item No.	Description	Bag Qty	MSRP Ea
747300	Hydro Flow Multi-Flow Emitter	10	\$0.75

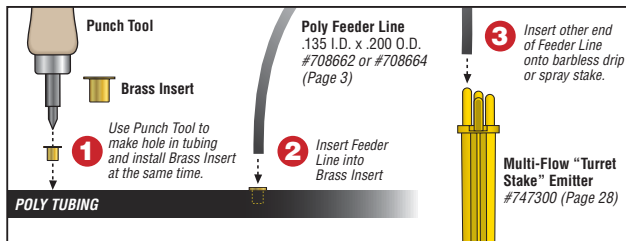

Hydro Flow® Mini-Bubbler



The Mini-Bubbler works perfectly for large plants or near groups of plants. Half-Circle Mini-Bubbler works perfectly for large plants or near groups of plants. Both have adjustable spray with a 0-3 ft diameter at 20 PSI. **EXCLUSIVE**

Item No.	Description	Box Qty	MSRP Ea
742510	Hydro Flow Mini-Bubbler w/ 6 in Stake Barbed Inlet - Display Box	100	\$0.83

Hydro Flow® Mini Flow Spray Stakes



The 160 degree stake sprayers are great for irrigating containers indoors or outdoors. Side tab indicates spray direction. Recommended operating pressure is 10 - 20 PSI. At 20 PSI, you will get approximately 5 gph for #742495 and 7 gph for #742500. **EXCLUSIVE**

Item No.	Description	Box Qty	MSRP Ea
742495	Hydro Flow 160 Degree Mini Flow Spray Stake- Orange - Display Box	100	\$0.34
742500	Hydro Flow 160 Degree Low Flow Spray Stake- Green - Display Box	100	\$0.32

Hydro Flow® Drip Ring



NEW Pre-built ring uses four one gallon per hour cleanable emitters. The ring is constructed with 1/2 inch poly tubing. Emitters are evenly spaced to water 360 degrees around the plant. The intake fitting is a 1/2 inch barbed fitting. Ring is 10 inches in diameter. **EXCLUSIVE**

Item No.	Description	MSRP
748420	Hydro Flow Drip Ring 10 in	\$9.07

Hydro Flow® Rain Ring™



NEW The Rain Ring™ is a great solution for automating your garden. Its versatility allows you to effectively water soil as well as hydroponic growing media. It has several strategically positioned distribution holes to fully moisten your grow media. Its heavy duty construction allows them to be used indoors or outdoor applications. Soak and rinse between cycles. Built-in 1/2 inch barbed fitting. **EXCLUSIVE**

Item No.	Description	MSRP
748086	Hydro Flow - Rain Ring 6 in	\$8.71
748084	Hydro Flow - Rain Ring 9 in	\$9.62
748082	Hydro Flow - Rain Ring 12 in	\$10.53

Hydro Flow® Black Holes Drippers



Unique and innovative top feed dripper manufactured for use in hydroponics. 1/2 in and 1/4 in barb option. 1/4 in barb is compatible with standard drip emitters by plugging them into the barb (rec. 2 GPH emitter). Designed with 6 beveled emitter holes. 100% Made in the USA by 100% recycled plastic. **EXCLUSIVE**

Item No.	Description	MSRP
748410	Hydro Flow Black Holes Dripper 1/4 in	\$5.19
748415	Hydro Flow Black Holes Dripper 1/2 in	\$5.19

Hydro Flow® /Netafim

Hydro Flow®/Netafim 17 mm Insert Adapter with Grommet



NEW Hydro Flow®/Netafim's 17 mm insert adapter is used to bring a dripline out of 1-1/2 inch or larger PVC pipe. Simply drill a hole in your PVC using the Hydro Flow®/Netafim drill bit, insert grommet and insert adapter fitting into the grommet. **EXCLUSIVE**

Item No.	Description	Bag Qty	MSRP Ea
747618	Hydro Flow / Netafim 17 mm Insert Adapter w/ Grommet for 1.5 in or Larger PVC	50	\$2.09

Hydro Flow®/Netafim Drill Bit for PVC



NEW Hydro Flow®/Netafim's drill bit is designed to make a clean cut in your PVC line to accept the Hydro Flow®/Netafim insert adapter. Simply drill hole in PVC, insert the top hat grommet and push adapter into grommet. This bit helps prevent burrs and cracking, which are common when using other style bits.

EXCLUSIVE

Item No.	Description	Bag Qty	MSRP Ea
747620	Hydro Flow / Netafim Drill Bit for PVC - 16.5 mm 21/32 in	1	\$35.93

Hydro Flow®/Netafim 6 in Soil Staple



NEW Hydro Flow®/Netafim's 6 in staple is used to secure irrigation lines to soil surfaces. The U shaped staple design is recommended because it is less likely to pinch the tubing. Use one staple every 3 feet in sandy soils, every 4 feet in loam and every 5 feet in clay. Use 2 staples over tee, elbow and cross fittings. Can be used above or below ground.

EXCLUSIVE

Item No.	Description	Bag Qty	MSRP Ea
747622	Hydro Flow / Netafim 6 in Soil Staple	25	\$0.29

Hydro Flow®/Netafim 17 mm CV Dripline Barbed Fittings



NEW Hydro Flow®/Netafim's 17 mm CV Dripline fittings are a one-piece construction for added strength, durability and long-term performance. The 17 mm dripline fittings are barbed fittings for a secure fit and easy installation without clamps, glue or tools. Its UV resistance withstands heat, direct sun and harsh chemicals. The 17 mm design fits Techline CV with inside

EXCLUSIVE

diameter of 17 mm. Maximum recommended system pressure: 50 psi.

Item No.	Description	Bag Qty	Box Qty	MSRP Ea
747625	Hydro Flow / Netafim 17 mm Insert Coupling	25	—	\$0.47
747627	Hydro Flow / Netafim 17 mm Insert Elbow	25	—	\$0.55
747629	Hydro Flow / Netafim 17 mm Insert Tee	25	—	\$0.77
747637	Hydro Flow / Netafim 17 mm V 2-Way Insert x 3/4 in MPT	10	—	\$1.65
747626	Hydro Flow / Netafim 17 mm Insert Elbow	—	250	\$0.43
747628	Hydro Flow / Netafim 17 mm Insert Tee	—	250	\$0.66
747636	Hydro Flow / Netafim 17 mm V 2-Way Insert x 3/4 in MPT	—	100	\$1.58

Hydro Flow®/Netafim 12 to 17 mm Dripline Reducing Coupling Fitting



NEW Hydro Flow®/Netafim's reducing coupler is designed to connect two drip tubes in a straight run. Easily reduces 17 mm drip line to 12 mm. Its UV resistance withstands heat, direct sun and harsh chemicals. Maximum recommended system pressure: 50 psi.

EXCLUSIVE

Item No.	Description	Bag Qty	MSRP Ea
747638	Hydro Flow / Netafim 12 mm x 17 mm Reducing Coupling	25	\$0.71

Hydro Flow®/Netafim 17 mm CV Dripline Male Adapter Barbed Fittings



NEW Hydro Flow®/Netafim Techline 3/4 inch Male Adapter for 17 mm Drip Line Poly Tubing. Fits Techline CV and Techline Dripperline. These barbed fittings go inside the 17 mm poly tubing instead of the other way around and connect to 3/4 inch Female Pipe Thread. Forms a tight, leak proof connection. Recommended operating pressure is 0 to 30 psi.

EXCLUSIVE

Item No.	Description	Bag Qty	Box Qty	MSRP Ea
747631	Hydro Flow / Netafim 17 mm Male Adapter 1/2 in	25	—	\$0.79
747633	Hydro Flow / Netafim 17 mm Male Adapter 3/4 in	25	—	\$0.82
747630	Hydro Flow / Netafim 17 mm Male Adapter 1/2 in	—	250	\$0.76
747632	Hydro Flow / Netafim 17 mm Male Adapter 3/4 in	—	100	\$0.77

Hydro Flow®/Netafim 17 mm CV Dripline Combination Tee Barbed Fittings



NEW Hydro Flow®/Netafim's Techline Combination Tee for 17 mm Drip Line Poly Tubing. Fits Techline CV Dripperline. These tee fittings connect to 3/4 inch Female Pipe Thread and have dual tee barbed tubing connectors that go inside the 17 mm poly tubing. Forms a tight, leak proof connection. Operating pressure is 0 to 30 psi.

EXCLUSIVE

Item No.	Description	Bag Qty	Box Qty	MSRP Ea
747635	Hydro Flow / Netafim 17 mm Combination Tee	10	—	\$1.93
747634	Hydro Flow / Netafim 17 mm Combination Tee	—	100	\$1.87

Hydro Flow®/Netafim 12 mm EZ Dripline Barbed Fittings



NEW Hydro Flow®/Netafim's 12 mm EZ Dripline fittings are a one-piece construction for added strength, durability and long-term performance. The 12 mm dripline fittings are barbed fittings for a secure fit and easy installation without clamps, glue or tools. Its UV resistance withstands heat, direct sun and harsh chemicals. The 12 mm design fits Techline EZ with inside

EXCLUSIVE

diameter of 12 mm. Maximum recommended system pressure: 50 psi.

Item No.	Description	Bag Qty	Box Qty	MSRP Ea
747641	Hydro Flow / Netafim 12 mm Insert Coupling	25	—	\$0.45
747643	Hydro Flow / Netafim 12 mm Insert Elbow	25	—	\$0.55
747645	Hydro Flow / Netafim 12 mm Insert Tee	25	—	\$0.60
747647	Hydro Flow / Netafim 12 mm Insert Cross	25	—	\$1.06
747655	Hydro Flow / Netafim 12 mm V 2-Way Insert x 3/4 in MPT	10	—	\$1.51
747640	Hydro Flow / Netafim 12 mm Insert Coupling	—	250	\$0.34
747642	Hydro Flow / Netafim 12 mm Insert Elbow	—	250	\$0.44
747644	Hydro Flow / Netafim 12 mm Insert Tee	—	250	\$0.49
747646	Hydro Flow / Netafim 12 mm Insert Cross	—	250	\$0.95
747654	Hydro Flow / Netafim 12 mm V 2-Way Insert x 3/4 in MPT	—	100	\$1.43

Hydro Flow®/Netafim 12 mm EZ Dripline Male Adapter Barbed Fittings



NEW Hydro Flow®/Netafim's Techline Male Adapter, 12 mm Tubing Insert x 1/2 inch MPT. Fits Techline EZ Dripperline. Use this fitting with any 1/2 inch female thread PVC fitting to convert to drip main line.

EXCLUSIVE

Item No.	Description	Bag Qty	Box Qty	MSRP Ea
747649	Hydro Flow / Netafim 12 mm Male Adapter 1/2 in	25	—	\$0.73
747651	Hydro Flow / Netafim 12 mm Male Adapter 3/4 in	25	—	\$0.84
747648	Hydro Flow / Netafim 12 mm Male Adapter 1/2 in	—	250	\$0.61
747650	Hydro Flow / Netafim 12 mm Male Adapter 3/4 in	—	250	\$0.74

Hydro Flow®/Netafim 12 mm EZ Dripline Combination Tee Barbed Fittings



NEW Hydro Flow®/Netafim's Techline Combination Tee for 12 mm Drip Line Poly Tubing. Fits Techline EZ Dripperline. These tee fittings connect to 3/4 inch Female Pipe Thread and have dual barbed tubing connectors that go inside the 12 mm poly tubing. Forms a tight, leak proof connection. Operating pressure is 0 to 30 psi.

EXCLUSIVE

Item No.	Description	Bag Qty	Box Qty	MSRP Ea
747653	Hydro Flow / Netafim 12 mm Combination Tee - Ins x Ins x 3/4 in FPT	10	—	\$1.77
747652	Hydro Flow / Netafim 12 mm Combination Tee - Ins x Ins x 3/4 in FPT	—	100	\$1.69

Hydro Flow®/Netafim Woodpecker Pressure Compensating Junior Drippers



NEW Hydro Flow® by Netafim Woodpecker Pressure compensating junior dripper with built in check valve and barbed outlet. These drippers adjust themselves automatically to the system pressure resulting in a watering uniformity, even on slopes. Since all water is delivered directly to the container, there is no run-off, saving water, fertilizer and energy. These drippers can be used in conjunction with dripper stakes and spray stakes. Recommended operating Pressure Range: 14.5 - 45 psi. **EXCLUSIVE**

Item No.	Description	Bag Qty	Box Qty	MSRP Ea
747662	Hydro Flow / Netafim Woodpecker Pressure Compensating Junior Dripper 3.2 GPH (Plum/Black)	25	—	\$0.45
747666	Hydro Flow / Netafim Woodpecker Pressure Compensating Junior Dripper 6.6 GPH (Orange/Grey)	25	—	\$0.37
747660	Hydro Flow / Netafim Woodpecker Pressure Compensating Junior Dripper 3.2 GPH (Plum/Black)	—	250	\$0.43
747664	Hydro Flow / Netafim Woodpecker Pressure Compensating Junior Dripper 6.6 GPH (Orange/Grey)	—	250	\$0.37

Hydro Flow®/Netafim 5 mm Insert Connector Barb x Threaded



NEW Hydro Flow® by Netafim 5 mm connectors are designed to make the connection between your poly distribution line and your 5 mm UV Super Flex white polyethylene (747560) feed line. Thread the connector into your 5 mm tubing. Select the location in the distribution line were you want your feed line to come out. Place a hole in your distribution line, using a hole punch and insert the barbed end of the connector. Now you are ready to choose your method of water delivery. **EXCLUSIVE**

Drip Stakes, Spray stakes and button emitters are all available.

Item No.	Description	Bag Qty	Box Qty	MSRP Ea
747658	Hydro Flow / Netafim 5 mm Insert Connector - Barb x Threaded	25	—	\$0.26
747656	Hydro Flow / Netafim 5 mm Insert Connector - Barb x Threaded	—	250	\$0.23

Hydro Flow®/Netafim Techline® CV Drip Tubing



NEW Hydro Flow®, Manufactured by Netafim™. Techline® CV Drip tubing is manufactured with flexible UV resistant tubing from post-consumer recycled polyethylene. Techline® CV Dripline is the most advanced dripper line available. Techline® CV's Check Valve feature keeps water from draining out of the dripline after a zone shut-downs. Techline® CV tubing is available in a 17 mm internal

diameter measurement for large on-surface/sub surface systems with flow rates from 0.26 GPH - 0.9 GPH. Available in three convenient emitter spacing configurations, including 12, 18 and 24 inch. Use our Hydro Flow® by Netafim™ dripline fittings to maximize your systems performance and reliability. **EXCLUSIVE**

Item No.	Description	MSRP
747572	Hydro Flow / Netafim Techline CV .26 GPH Flow - 18 in Dripper Spacing - 100 Ft Coil	\$52.48
747570	Hydro Flow / Netafim Techline CV .26 GPH Flow - 18 in Dripper Spacing - 250 Ft Coil	\$131.19
747568	Hydro Flow / Netafim Techline CV .26 GPH Flow - 18 in Dripper Spacing - 1,000 Ft Coil	\$469.00
747578	Hydro Flow / Netafim Techline CV .4 GPH Flow - 12 in Dripper Spacing - 100 Ft Coil	\$58.97
747576	Hydro Flow / Netafim Techline CV .4 GPH Flow - 12 in Dripper Spacing - 250 Ft Coil	\$147.41
747574	Hydro Flow / Netafim Techline CV .4 GPH Flow - 12 in Dripper Spacing - 1,000 Ft Coil	\$527.00
747582	Hydro Flow / Netafim Techline CV .4 GPH Flow - 18 in Dripper Spacing - 250 Ft Coil	\$131.19
747580	Hydro Flow / Netafim Techline CV .4 GPH Flow - 18 in Dripper Spacing - 1,000 Ft Coil	\$469.00
747586	Hydro Flow / Netafim Techline CV .9 GPH Flow - 12 in Dripper Spacing - 100 Ft Coil	\$58.97
747584	Hydro Flow / Netafim Techline CV .9 GPH Flow - 12 in Dripper Spacing - 1,000 Ft Coil	\$527.00
747590	Hydro Flow / Netafim Techline CV .9 GPH Flow - 18 in Dripper Spacing - 100 Ft Coil	\$52.48
747588	Hydro Flow / Netafim Techline CV .9 GPH Flow - 18 in Dripper Spacing - 1,000 Ft Coil	\$469.00

Hydro Flow®/Netafim Techline® EZ Drip Tubing



NEW Hydro Flow®, Manufactured by Netafim™. Techline® EZ Drip tubing - one coil, two fittings, less than one hour installation. It's the simplest solution for small sites. Netafim's Techline® EZ is a 12mm inner diameter dripline for on-surface looped systems that installs fast, saves water and "disappears" into the landscape. Manufactured with flexible UV resistant tubing from post-consumer recycled

polyethylene. Netafim's Techline® EZ provides flow rates from 0.26 GPH – 0.9 GPH. Techline EZ Emitters have an Anti-Siphon Feature which prevents ingestion of debris into tubing caused by vacuum. Emitter insert spacing is available in 6, 12 and 18 inches distances. Use our Hydro Flow® by Netafim™ EZ Driplines, along with Hydro Flow® by Netafim 12 mm fittings to complete your **EXCLUSIVE** next small project.

Item No.	Description	MSRP
747592	Hydro Flow / Netafim Techline EZ .26 GPH Flow - 6 in Drinker Spacing - 1,000 Ft Coil	\$306.00
747594	Hydro Flow / Netafim Techline EZ .26 GPH Flow - 12 in Drinker Spacing - 300 Ft Coil	\$92.31
747596	Hydro Flow / Netafim Techline EZ .26 GPH Flow - 12 in Drinker Spacing - 1,000 Ft Coil	\$306.00
747598	Hydro Flow / Netafim Techline EZ .26 GPH Flow - 18 in Drinker Spacing - 300 Ft Coil	\$92.31
747600	Hydro Flow / Netafim Techline EZ .26 GPH Flow - 18 in Drinker Spacing - 1,000 Ft Coil	\$306.00
747602	Hydro Flow / Netafim Techline EZ .4 GPH Flow - 12 in Drinker Spacing - 200 Ft Coil	\$61.54
747604	Hydro Flow / Netafim Techline EZ .4 GPH Flow - 12 in Drinker Spacing - 1,000 Ft Coil	\$306.00
747606	Hydro Flow / Netafim Techline EZ .4 GPH Flow - 18 in Drinker Spacing - 200 Ft Coil	\$61.54
747608	Hydro Flow / Netafim Techline EZ .4 GPH Flow - 18 in Drinker Spacing - 1,000 Ft Coil	\$306.00
747610	Hydro Flow / Netafim Techline EZ .9 GPH Flow - 12 in Drinker Spacing - 200 Ft Coil	\$61.54
747612	Hydro Flow / Netafim Techline EZ .9 GPH Flow - 12 in Drinker Spacing - 1,000 Ft Coil	\$306.00
747614	Hydro Flow / Netafim Techline EZ .9 GPH Flow - 18 in Drinker Spacing - 200 Ft Coil	\$61.54
747616	Hydro Flow / Netafim Techline EZ .9 GPH Flow - 18 in Drinker Spacing - 1,000 Ft Coil	\$306.00

Hydro Flow®/Netafim 80 Globe Valve with Flow Control



NEW Hydro Flow® by Netafim Series 80 Globe Control Valves are simple to operate and maintain. Reliable even in harsh conditions. Tight sealing valve with fully supported diaphragm. The 3/4 in flow range is 0.01 - 26 gpm and the 1 in is 0.01 - 44 gpm. 1 Year Warranty.

EXCLUSIVE

Item No.	Description	MSRP
747713	Hydro Flow / Netafim 3/4 in Series 80 Globe Valve w/ Flow Control 26 GPM Max Flow	\$41.00
747715	Hydro Flow / Netafim 1 in Series 80 Globe Valve w/ Flow Control 44 GPM Max Flow	\$41.00

Hydro Flow®/Netafim UV White™ Polyethylene Tubing



NEW With excellent Ultra-Violet (UV) resistance, our reflective white tubing is completely opaque to prevent algae growth. It withstands heat, direct sun and harsh chemicals while producing cooler water temperatures enhancing plant growth. The Super Flex tubing is solid opaque white. The white/black poly tubing is white on the outside and black on the inside. 1 Year Warranty.

Item No.	Description	MSRP
747561	Netafim Super Flex UV White Polyethylene Tubing 5 mm -1000 ft	\$72.92
747562	Netafim UV White / Black Polyethylene Tubing 1/2 in (.52 in ID x .62 in OD) - 500 ft	\$74.44
747564	Netafim UV White / Black Polyethylene Tubing 3/4 in (.82 in ID x .94 in OD) - 100 ft	\$31.80
747566	Netafim UV White / Black Polyethylene Tubing 1 in (1.06 in ID x 1.20 in OD) - 100 ft	\$41.36

Hydro Flow®/Netafim Disc Filters



NEW Disc Filter technology has grooves in the disc rings that criss-cross to form a network that traps debris between and on the outside of the discs. As dirty water is pumped into the filter and pressure increases, the water compresses the disc rings together tightly. The water is then forced to flow through the grooves of the disc rings, where debris is trapped, releasing only **EXCLUSIVE**

clean water to the irrigation system.

Item No.	Description	MSRP
747504	Hydro Flow / Netafim Disc Filter 3/4 in MPT x MPT 140 Mesh 17 GPM Maximum Flow	\$33.99
747506	Hydro Flow / Netafim Disc Filter 1 in MPT x MPT 140 Mesh 22 GPM Maximum Flow	\$99.58
747560	Hydro Flow / Netafim Disc Filter 3/4 in MPT x MPT 120 Mesh 17 GPM Max Flow	\$34.22

Hydro Flow®/Netafim Disc Filter Replacement Ring Sets



NEW The disc filter rings are made of polypropylene. Color coded for easy replacement.

EXCLUSIVE

Item No.	Description	MSRP
747510	Hydro Flow / Netafim Ring Set w/ Spine 140 Mesh, Black, for 3/4 in Filter	\$18.63
747512	Hydro Flow / Netafim Ring Set w/ Spine - 140 Mesh Black for 1 in and 1-1/2 in Filters	\$46.02

Hydro Flow®/Netafim Pressure Regulators



NEW These regulators are used in all irrigation systems. They easily install inline. The high flow regulator has a built-in indicator when proper outlet pressure is achieved. The low flow model has a 3/4 inch female inlet and outlet. The high flow model has female inlet and male outlet. The low flow is rated at 0.25 - 4.4 gallons per minute and the high flow is rated at 4.5 - 17.6 gallons per minute.

EXCLUSIVE

Item No.	Description	MSRP
747514	Hydro Flow / Netafim Pressure Regulator Low Flow Inline 3/4 in FPT Inlet x FPT Outlet 25 PSI 0.25-4.4 GPM	\$11.96
747516	Hydro Flow / Netafim Pressure Regulator High Flow Inline 3/4 in FPT Inlet x MPT Outlet 25 PSI 4.5-17.6 GPM	\$14.75

Hydro Flow®/Netafim Pressure Compensating Standard Spray Stakes



NEW Netafim PC (Pressure Compensating) Spray Stakes ensure every pot in the entire system receives exactly the same amount of water, from the first to the last. The spray pattern angles downward - just enough - to keep the spray on the soil and not flying into or over the wall of the pot. For simplicity, some growers place the spray stake near the edge of the pot, making the single-sided spray stake the best selection. Other growers

EXCLUSIVE

prefer our unique 'bow-tie' double-spray pattern.

Item No.	Description	MSRP
747544	Hydro Flow / Netafim Pressure Compensating Standard Spray Stake Plum 3.2 GPH	\$0.47
747546	Hydro Flow / Netafim Pressure Compensating Standard Spray Stake Single Pattern Grey 6.6 GPH	\$0.47
747548	Hydro Flow / Netafim Pressure Compensating Standard Spray Stake Double Pattern Grey 6.6 GPH	\$0.47

Hydro Flow®/Netafim Non-Pressure Compensating Spray Stakes



NEW Netafim Spray Stake's simple one-piece construction provides reliable long life performance. They are highly resistant to sunlight, fertilizers and chemicals. Installation is very simple and the Netafim micro tubing fits securely to the top of the spray stake. These stakes are simple and easy to clean. Each spray stake has a built-in spray direction indicator on one side of the stake. Quickly see or feel the spray

EXCLUSIVE

direction to speed and simplify installation without having to return and make adjustments.

Item No.	Description	MSRP
747550	Hydro Flow / Netafim Non-Pressure Compensating Spray Stakes Yellow 3.0 GPH	\$0.42
747552	Hydro Flow / Netafim Non-Pressure Compensating Spray Stakes Green 5.0 GPH	\$0.42
747554	Hydro Flow / Netafim Non-Pressure Compensating Spray Stakes Black 7.0 GPH	\$0.42

Hydro Flow®/Netafim Elbow



NEW The Netafim 5 mm Elbow is used with the Netafim PC Spray Stakes. This elbow easily attaches to the top of the PC Spray Stakes to connect the Netafim Super Flex Tubing #747561. The Netafim 5 mm Elbow can be used with the following parts: #747544, 747546 and 747548.

EXCLUSIVE

Item No.	Description	MSRP
747556	Hydro Flow / Netafim Elbow 5 mm	\$0.33

Hydro Flow®/Netafim Self Piercing Pressure Compensating Emitters



NEW A sharp barb makes it easy to install, no tools required. These emitters have a 1.74 psi internal check valve that helps prevent low emitter drainage holding back up to a 3.9 ft column of water. They are pressure compensating and delivers the same flow from 10.15 to 58 psi. Exclusive TurboNet® flow path design regulates flow and provides continuous self-cleaning action.

EXCLUSIVE

Item No.	Description	Bag Qty	MSRP Ea
747518	Hydro Flow / Netafim Self Piercing Pressure Compensating Emitters w/ 1.74 Internal Check Valve 0.5 GPH Barb Inlet 160 In Blue	25	\$0.63
747526	Hydro Flow / Netafim Self Piercing Pressure Compensating Emitters w/ 1.74 Internal Check Valve 1.0 GPH Barb Inlet 160 In Black	25	\$0.53
747534	Hydro Flow / Netafim Self Piercing Pressure Compensating Emitters w/ 1.74 Internal Check Valve 2.0 GPH Barb Inlet 160 In Red	25	\$0.51
747520	Hydro Flow / Netafim self Piercing Pressure Compensating Emitters W/ 1.74 internal check valve 0.5 GPH Barb Inlet 160 In Blue	100	\$0.33
747528	Hydro Flow / Netafim Self Piercing Pressure Compensating Emitters w/ 1.74 Internal Check Valve 1.0 GPH Barb Inlet 160 In Black	100	\$0.33
747536	Hydro Flow / Netafim Self Piercing Pressure Compensating Emitters w/ 1.74 Internal Check Valve 2.0 GPH Barb Inlet 160 In Red	100	\$0.33

Hydro Flow®/Netafim Self Piercing Emitter Insertion Tool



NEW This tool is designed to help assist with the insertion of the Netafim Self Piercing Emitters. This tool is optional for inserting the Self Piercing Emitters.

EXCLUSIVE

Item No.	Description	MSRP
747542	Hydro Flow / Netafim Self Piercing Emitter Insertion Tool	\$10.29

Hydro Flow®/Netafim Angle Barbed Stake



NEW The Angle Barbed Stake has a unique flow channel down the length of the stake directing the water into the container. It also has a pointed end for easy container insertion. For use with Super Flex UV White™ PE Tubing.

EXCLUSIVE

Item No.	Description	MSRP
747558	Hydro Flow / Netafim Angle Barbed Stake	\$0.40

Hydro Flow® Octa-Bubbler®



NEW Octa-Bubbler® is a pressure compensating device with a 1/2 inch FPT inlet and 8 swivel port 3/16 inch outlets. Constructed using ABS plastic. Built in back flow prevention engineered for added protection. Octa-Bubblers deliver water to multiple locations. Optional port plugs are available for unused ports. Each Octa-Bubbler® has a 150 mesh filter screen for clog resistance. Interchangeable color coded flow control gives you the ability to change your GPH without changing the bubbler. Available flow rates are 2

GPH, 6 GPH and 10 GPH, 20 GPH using a flow control device. Pressure **EXCLUSIVE** compensation range is 20 – 60 psi.

Item No.	Description	Bag Qty	MSRP Ea
708182	Hydro Flow Octa-Bubbler 2 GPH Per Outlet - Blue Low Flow Bubbler	10	\$12.95
708184	Hydro Flow Octa-Bubbler 6 GPH Per Outlet - Black Medium Flow Bubbler	10	\$12.95
708185	Hydro Flow Octa-Bubbler 10 GPH Per Outlet - Red High Flow Bubbler	10	\$12.95

Hydro Flow® Octa-Bubbler® Repair Kit



NEW Octa-Bubbler® Repair Kit provides the necessary pieces to service your Octa-Bubbler®.

EXCLUSIVE

Item No.	Description	MSRP
708186	Hydro Flow Irrigation Octa-Bubbler Repair Kit	\$4.95

Hydro Flow® Octa-Bubbler® Flow Control



NEW Octa-Bubbler® flow control device allows you to change the gallons per hour on your Octa-Bubbler® without replacing it. The flow control devices are color coded. Choose the red flow control device for 10 GPH and the green for 20 GPH.

EXCLUSIVE

Item No.	Description	Bag Qty	MSRP Ea
708188	Hydro Flow Irrigation Octa-Bubbler 10 GPH Flow Control Device - Red	8	\$0.10
708192	Hydro Flow Irrigation Octa-Bubbler 20 GPH Flow Control Device - Green	8	\$0.10

Hydro Flow® Port Plugs for Octa-Bubbler®



NEW Octa-Bubbler® port plugs are used to stop the water flow of unused Octa-Bubbler® outlet ports.

EXCLUSIVE

Item No.	Description	Bag Qty	MSRP Ea
708194	Hydro Flow Irrigation Port Plugs for Octa-Bubblers	25	\$0.29

Hose Punch



Tough enough to punch a hole in thick, flexible tubing. Makes a 1/8 in hole specifically for drip lines.

Item No.	Description	MSRP
708180	Hose Punch 1/8 in	\$1.50

Aeroponic Clone Spinner 360 Degree

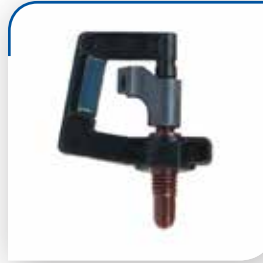

A rotating 360 Degree sprayer that is ideal for rooting cuttings aeroponically. The spinner comes complete with a male thread for a secure, no leak fit. (Used in Clone Machines).

EXCLUSIVE

Item No.	Description	MSRP
708190	Irrigation Aeroponic Clone Spinner 360	\$1.79

Botanicare® Ebb & Flow Fittings



Interior threads which accept 3/4 in standard pipe thread. Use as ebb and flow fittings and bulkhead fittings. Increased versatility; thread PVC pipe fittings into bulkhead fittings - ideal for use in aeroponic and drip applications.

Item No.	Description	Bag Qty	MSRP Ea
708551	Botanicare Ebb & Flow Barbed Fitting 1/2 in	25	\$1.90
708552	Botanicare Ebb & Flow Barbed Fitting 3/4 in	25	\$2.00
708558	Botanicare Ebb & Flow 1 in Barbed Fitting	25	\$2.10
708553	Botanicare Ebb & Flow Extension Fitting	25	\$0.70
708554	Botanicare Ebb & Flow Screen Fitting	25	\$0.69
708555	Botanicare Ebb & Flow Washer Fitting	25	\$0.69
708556	Botanicare Ebb & Flow Fitting Kit w/ 2 Extensions	—	\$6.75

Float Valve



An essential part for do-it-yourselfers! This float valve assembly controls the water/nutrient solution level in your primary reservoir (controller). Comes with 1/2 in brass barbed fitting.

Item No.	Description	MSRP
708170	Float Valve w/ Barbed Fitting	\$27.95

Raindrip® 1/2 GPH Drippers



Raindrip's turbulent flow PC (pressure compensating) drippers maintain their rated flow rate for 10-60 psi inlet pressure. These drippers can be used at the end of 1/4 in tubing feeders or can be inserted directly into 1/2 in Raindrip® hose.

Item No.	Description	MSRP Ea
708625	Raindrip 1/2 GPH Dripper Blister Card 10/Pack	\$0.80
708626	Raindrip 1/2 GPH Dripper Bag	\$0.52

Raindrip® 1 GPH Drippers



Raindrip's turbulent flow PC (pressure compensating) drippers maintain their rated flow rate for 10-60 psi inlet pressure. These drippers can be used at the end of 1/4 in tubing feeders or can be inserted directly into 1/2 in Raindrip® hose.

Item No.	Description	MSRP Ea
708630	Raindrip 1 GPH Dripper Blister Card 10/Pack	\$0.80
708631	Raindrip 1 GPH Dripper Bag	\$0.52

Raindrip® 2 GPH Drippers



Raindrip's turbulent flow PC (pressure compensating) drippers maintain their rated flow rate for 10-60 psi inlet pressure. These drippers can be used at the end of 1/4 in tubing feeders or can be inserted directly into 1/2 in Raindrip® hose.

Item No.	Description	MSRP Ea
708635	Raindrip 2 GPH Dripper Blister Card 10/Pack	\$0.80
708636	Raindrip 2 GPH Dripper Bag	\$0.52

Raindrip® Hole Punches



Both the hole punch and professional hole punch are designed for comfortable use. They punch holes in 1/2 in, 5/8 in or 0.710 in hose to insert PC drippers or 1/4 in fittings. The black hole punch includes 10 hole punches.

Item No.	Description	MSRP
708670	Raindrip Hole Punch Black	\$3.75
708675	Raindrip Professional Hole Punch	\$11.42

Raindrip® Stakes



4 in support stakes are plastic stakes that hold 1/4 in tubing in place next to plants. 6 in support stakes are heavy duty plastic stakes that hold 1/4 in lines in place.

Item No.	Description	MSRP Ea
708640	Raindrip 4 in Support Stakes Blister Card 10/Pack	\$0.29
708645	Raindrip 6 in Support Stakes Blister Card 10/Pack	\$0.39

Raindrip® Professional Tubing Cutter



The professional tubing cutter has a hardened stainless steel blade that is designed to cut all flexible plastic hose/tubing up to 1.5 in outside diameter.

Item No.	Description	MSRP
708665	Raindrip Professional Tubing Cutter	\$11.95

Hydro-logic® Tubing



Replacement tubing for Hydro-logic® products. Also can be used for a variety of other irrigation and water purification applications.

EXCLUSIVE

Item No.	Description	MSRP
728780	Hydro-Logic Poly Tubing White 1/2 in 25 ft Roll 10/Pack	\$14.95
728782	Hydro-Logic Poly Tubing Black 1/4 in 50 ft Roll 10/Pack	\$11.95
728784	Hydro-Logic Poly Tubing Blue 1/4 in 50 ft Roll 10/Pack	\$11.95
728786	Hydro-Logic Poly Tubing Black 3/8 in 50 ft Roll 10/Pack	\$16.95
728788	Hydro-Logic Poly Tubing Blue 3/8 in 50 ft Roll 10/Pack	\$16.95

Dripper Stake 45 Degree



This angled dripper stake fits 1/4 in irrigation tubing and has a 45 degree angle to reduce sharp bending of the tubing, which causes clogging. It delivers a light emission of water for regular top drip irrigation.

Item No.	Description	MSRP
708350	Dripper Stake 45 Degree	\$0.53

Botanicare® Dripper Stake with 3/16 in dripper line



Dripper stake with 3/16 in dripper line.

Item No.	Description	MSRP
708280	Dripper Stakes with 1/8 in Dripper Line	\$0.75

GH Grommets



1/2 in grommet used in the reservoir drain that is used with AeroFlo® 20/30. The 1 in grommet is used in the growing chamber laser sprayline on all AeroFlo® systems. The 1-1/4 in grommet is used for the growing chamber drain overflow tube grommet in all AeroFlo® systems.

Item No.	Description	MSRP
708325	GH Grommet 1 in	\$1.90
708330	GH Grommet 1-1/4 in	\$2.20
708320	GH Grommet 1/2 in	\$0.68
708321	GH Grommet 1/2 in	\$0.51

Bond® Medium Duty Hose 5/8 in



Solid brass couplings. Collar reduces kinking at the faucet. Crush proof couplings. Coils easily in all weather conditions. 10 Year Warranty.

Item No.	Description	MSRP
740810	Bond Medium Duty Hose 5/8 in 50 ft	\$23.49

Claber® Aquano Video 2 Timer



Programmable in advance to release water up to 2 times a day, for duration ranging from 1 min to 23 hrs and 59 min. Weekly programming; water cycles run on all days of week. 15 min preset manual override allows for watering between cycles or programs interruption. Low-battery indicator; saves settings for 10 min while 9V battery (not included) is replaced. 2 Year Warranty.

Item No.	Description	MSRP
708785	Claber Aquano Video 2 Water Timer	\$71.95

Claber® Aquadue Duplo Water Timer



2 independent outlets programmable in advance; watering cycles run on all days of the week. Each outlet releases water up to 3 times a day, for durations ranging from 1 min to 23 hrs and 59 min. 15 min preset manual override allows for watering between cycles or programs interruption. Low-battery indicator; saves settings for 10 min while 9V battery (not included) is replaced. 2 Year Warranty.

Item No.	Description	MSRP
708740	Claber Aquadue Duplo Water Timer	\$139.95

Claber® Hoala Indoor Faucet Connector



Easily attaches to an indoor straight neck faucet. Does not fit on curved neck faucet or wider than 1-1/4 inch. Rubber seal clamps on faucet preventing leaking or spraying. Lower attachment is adjustable to faucet length. Convenient quick-click coupler for fast and easy hose removal. 2 Year Warranty.

Item No.	Description	MSRP
708745	Claber Koala Indoor Faucet Connector	\$10.49

Claber® Spiral Hose Kit



33-Foot hose made of thermoplastic polyurethane compound for flexibility and kink resistance. Trigger action spray nozzle with powerful jet spray ideal for cleaning up after planting. Includes nozzle aerator accessory for gentle stream spray and 3 utility faucet adaptors. Spray nozzle wall mount for no struggling with heavy hose wind-up. 2 Year Warranty.

Item No.	Description	MSRP
708750	Claber Spiral Hose Kit	\$65.95

Claber® Faucet to Hose Connector



Easily connects hose to outdoor faucet. Includes one male faucet adapter and one male hose connector. Connector and adapter are simply snapped together using spring compression. Interchangeable with most polymer quick connector systems. 2 Year Warranty.

Item No.	Description	MSRP
708765	Claber Faucet to Hose Connector	\$4.59

Did you know that SunlightSupply.com New Product Section is updated as soon as new items come in? Check out the latest items now!



EcoPlus® Supreme Air Pumps



The EcoPlus® Supreme Air Pumps are great for providing oxygen to hydroponic systems. In hydroponic applications, the use of an air pump with an air stone will oxygenate the water and increase the uptake of nutrients by the plant. These air pumps are very quiet and built to be very durable. Low power oil-less motor. Use with EcoPlus® Check Valve #728400. 1 Year Warranty.

Item No.	Description	PSI	Tube Size	MSRP
728290	EcoPlus Supreme Air Pump 1 Outlet 140 L/H - 3 Watt 29 GPH	1.7	3/16 in	\$12.00
728295	EcoPlus Supreme Air Pump 2 Outlet 320 L/H - 4 Watt 71 GPH	1.7	3/16 in	\$19.50
728297	EcoPlus Supreme Air Pump 4 Outlet 640 L/H - 8 Watt 143 GPH	1.7	3/16 in	\$29.90

HELPFUL HINT: Air pumps should always be placed above the water level. This prevents water from flowing back into the air pump.

EcoPlus® Commercial Air Pumps



Widely used to provide oxygen in aquariums, fish farms and hydroponic systems. Includes chrome air manifold, ranging from six to twelve outlets. Cylinders and pistons are made of excellent materials, making the pump strong, durable. Convenient to operate without oil or much noise. 1 Year Warranty.

Item No.	Description	PSI	Tube Size	MSRP
728450	EcoPlus Commercial Air 1 - 18 Watt Single Outlet 793 GPH	2.9	1/4 in	\$43.95
728455	EcoPlus Commercial Air 3 - 35 Watt Single Outlet 1030 GPH	3.77	1/4 in	\$59.95
728457	EcoPlus Commercial Air 5 - 80 Watt Single Outlet 1300 GPH	5.22	3/8 in	\$87.95
728459	EcoPlus Commercial Air 7 - 200 Watt Single Outlet 3566 GPH	6.96	1/2 in	\$148.95

EcoPlus® Eco Air Pumps



Widely used in hydroponic systems. Convenient to operate without oil or much noise. Cylinders and pistons are made of excellent materials, making the pump strong and durable. Will meet many requirements of pumps with air dividers from four to twenty-two outlets. 1 Year Warranty.

Item No.	Description	PSI	Tube Size	MSRP
728350	EcoPlus Eco Air 8 Eight Outlet - 13 Watt 380 GPH	2.3	3/16 in	\$59.95
728355	EcoPlus Eco Air 4 Four Outlet - 6.5 Watt 253 GPH	2.1	3/16 in	\$28.95
728360	EcoPlus Eco Air 2 Two Outlet - 3 Watt 126 GPH	2.4	3/16 in	\$14.95
728365	EcoPlus Eco Air 1 Plus One Outlet - 2 Watt 44 GPH	2.1	3/16 in	\$9.95

Air Force Pro® Linear Air Pumps



Commonly used to provide oxygen in aquariums, fish farms, hydroponic systems and more. Solid aluminum body for enhanced durability. Designed to minimize noise and vibration. Oil-less compressor allows for easy maintenance. No lubrication required. Use with EcoPlus® Trumpet Style Air Manifolds. 2 Year Warranty.

Item No.	Description	PSI	MSRP
746500	Air Force Pro 15 Linear Air Pump 301 GPH	1.4	\$129.95
746505	Air Force Pro 40 Linear Air Pump 745 GPH	1.8	\$190.95
746510	Air Force Pro 60 Linear Air Pump 1078 GPH	2.1	\$227.95
746515	Air Force Pro 80 Linear Air Pump 1363 GPH	2.1	\$267.95

EcoPlus® Check Valve 3/16 in



NEW EcoPlus® Check Valve is a must have for every air pump. This product helps prevent back siphoning of water which can damage pumps or even flood water into your rooms. This check valve works by allowing air to flow in one direction and blocking water from getting to far down your air tube. Simply connect the Check

Valve between the air pump and airstone. Works with 3/16 in air tubing. **EXCLUSIVE**

Item No.	Description	MSRP
728400	EcoPlus Check Valve 3/16 in	\$2.49

GH Dual Diaphragm Air Pump



This high output pump has four adjustable 1/4 in outputs that can be teed off to power up to twelve air driven hydroponics growing systems such as the WaterFarm. Also use it to reliably oxygenate their reservoir with air stones. 3 psi, 320 gph (20 L/min).

Item No.	Description	MSRP
728040	GH Dual Diaphragm Air Pump 320 GPH	\$101.20
728043	GH Dual Diaphragm Air Pump Rebuild Kit	\$33.08

Hydor Bubble Maker



Improve aeration and water movement while minimizing energy use and maintenance. Hydor Bubble Maker boasts easy setup and reliable performance.

Item No.	Description	MSRP
728532	Hydor Bubble Maker	\$21.95

Danner Supreme Hydroponic Air Pumps AP Series



NEW Danner Supreme Hydroponic AP-Series air pumps have been designed to satisfy the requirements of a multitude of water-related applications. The non-oil lubricated motor is designed to operate efficiently and save energy. Single outlet discharge and includes air diffuser that accepts 3/16 in air line.



Item No.	Description	PSI	Watts	Tube Size	MSRP
728382	Danner Air Pump AP-20 1700 cu in/min	4	20	1/2	\$127.95
728384	Danner Air Pump AP-40 2900 cu in/min	5.66	40	5/8	\$165.95
728386	Danner Air Pump AP-60 5500 cu in/min	5.8	50	3/4	\$207.95
728390	Danner Air Pump AP-100 8900 cu in/min	6.53	100	3/5	\$269.95

Danner Supreme Hydroponic Air Pumps Low Volume



NEW The easy to use supreme hydroponic air pumps are the perfect way to stimulate root growth for your indoor plants by aerating nutrients. The energy-efficient motors are quiet with an air volume of 73 to 549 cubic inch per minute. Maximum water depth ranges from 3 feet to 4-1/2 feet. Accepts standard 3/16 inch airline tubing. 1 Year Warranty.



Item No.	Description	PSI	MSRP
727366	Danner Supreme Hydroponic Air Pump 1 Outlet - 2 Watt	1.45	\$10.50
727368	Danner Supreme Hydroponic Air Pump 1 Outlet - 3 Watt	1.45	\$15.50
727370	Danner Supreme Hydroponic Air Pump 2 Outlet - 4 Watt	2	\$22.50
727372	Danner Supreme Hydroponic Air Pump 4 Outlet - 8 Watt	2	\$39.00

EcoPlus® Air Manifolds - Plastic



Easily diffuse air with these high quality plastic air manifolds. Barbed ends for tight fitting tubing.

EXCLUSIVE

Item No.	Description	Tube Inlet	Tube Outlet	MSRP
728446	EcoPlus 4 Outlet Plastic Air Manifold	1/4 in	3/16 in	\$1.19
728447	EcoPlus 6 Outlet Plastic Air Manifold	3/8 in	3/16 in	\$1.79
728448	EcoPlus 8 Outlet Plastic Air Manifold	3/8 in	3/16 in	\$2.09
728449	EcoPlus 10 Outlet Plastic Air Manifold	3/8 in	3/16 in	\$2.79

EcoPlus® Air Manifold T Style 3/8 Inch Inlet



High quality chrome air manifolds. Each outlet has individually controlled valves. Barbed ends for use with tubing for a tight fit. Distributes air flow to four or more air stones or air diffusers in order to insure that equal air flow is provided to each air diffuser or air stone. Use with 3/16 inch airline product #708215.

EXCLUSIVE

Item No.	Description	Tube Inlet	Tube Outlet	MSRP
728460	EcoPlus Air Manifold T Style 3/8 in Inlet - 4 Valve Outlet	1/4 in	3/16 in	\$5.79
728465	EcoPlus Air Manifold T Style 3/8 in Inlet - 6 Valve Outlet	3/8 in	3/16 in	\$7.49
728470	EcoPlus Air Manifold T Style 3/8 in Inlet - 8 Valve Outlet	3/8 in	3/16 in	\$9.29

EcoPlus® Air Manifold Trumpet Style 1/2 Inch Inlet



Air Manifolds allow the adjustment of air flow to four or more air stones or air diffusers in order to insure that equal air flow is provided to each air diffuser or air stone. The manifold has individual barbed valves which control the outlet of air to your air stones or diffusers. Compatible with Air Force Pro® 40, 60 & 80. Use with 3/16 inch airline product #708215.

EXCLUSIVE

Item No.	Description	Tube Inlet	Tube Outlet	MSRP
728005	EcoPlus Air Manifold Trumpet Style 1/2 in Inlet - 4 Valve Outlet	5/8 in	3/16 in	\$7.95
728010	EcoPlus Air Manifold Trumpet Style 1/2 in Inlet - 6 Valve Outlet	5/8 in	3/16 in	\$9.95
728015	EcoPlus Air Manifold Trumpet Style 1/2 in Inlet - 12 Valve Outlet	5/8 in	3/16 in	\$15.95
728020	EcoPlus Air Manifold Trumpet Style 1/2 in Inlet - 16 Valve Outlet	5/8 in	3/16 in	\$20.95

EcoPlus® Flexible Air Diffusers



These air hoses are flexible and unbreakable. They provide excellent aeration. To clean, just wipe off under running water. Use with 3/16 inch airline product #708215.

EXCLUSIVE

Item No.	Description	MSRP
728435	EcoPlus Flexible Air Diffuser 2 ft	\$4.29
728440	EcoPlus Flexible Air Diffuser 3 ft	\$6.49
728445	EcoPlus Flexible Air Diffuser 4 ft	\$7.59

EcoPlus® Water Wind™ Micro Bubble Air Diffuser Rings



NEW EcoPlus® Water Wind™ Micro Bubble Air Diffusers are great for oxygenating hydroponic bucket systems, tanks and reservoirs. The tubing is made from a rubber polymer and utilizes tiny pores that create extremely small bubble diameters. The smaller the bubbles are the more efficiently it transfers oxygen into the water.

They require minimal maintenance and will last for years. 12 and 8 in rings come with 3/8 in inlet fitting and the 6 in comes with a 1/4 in inlet fitting.

EXCLUSIVE

Item No.	Description	MSRP
728217	EcoPlus Water Wind Micro Bubble Air Diffuser Ring 6 in	\$18.95
728219	EcoPlus Water Wind Micro Bubble Air Diffuser Ring 8 in	\$19.95
728221	EcoPlus Water Wind Micro Bubble Air Diffuser Ring 12 in	\$25.95

EcoPlus® Water Wind™ Micro Bubble Air Diffusers



NEW EcoPlus® Water Wind™ Micro Bubble Air Diffusers are great for oxygenating hydroponic bucket systems, tanks and reservoirs. The tubing is made from a rubber polymer and utilizes tiny pores that create extremely small bubble diameters. The smaller the bubbles are the more efficiently it transfers oxygen into the water. They require minimal maintenance and will last for years. 12 in length comes with 3/8 in inlet fitting and the 6 in comes with a 1/4 in inlet fitting.

EXCLUSIVE

Item No.	Description	MSRP
728223	EcoPlus Water Wind Micro Bubble Air Diffuser Straight 6 in	\$10.95
728225	EcoPlus Water Wind Micro Bubble Air Diffuser Straight 12 in	\$13.95

Hydro Flow® Premium Vinyl Tubing - Clear



Premium vinyl tubing made of excellent quality. Made in the USA. Ideal for air movement from an air pump to air stones, air discs, Aqua Lung™, Water Winds, etc.



EXCLUSIVE

Item No.	Description	MSRP
708215	Hydro Flow Vinyl Tubing Clear 3/16 in ID - 1/4 in OD 100 ft Roll	\$13.18
708222	Hydro Flow Vinyl Tubing Clear 1/4 in ID - 3/8 in OD 100 ft Roll	\$27.73
708227	Hydro Flow Vinyl Tubing Clear 3/8 in ID x 1/2 in OD 100 ft	\$30.91

EcoPlus® Air Stones



These great quality Air Stones aerates and adds oxygen to the water in your reservoir or grow system. Circulates nutrients into the water and helps to maintain an even water temperature. Use with 3/16 inch airline product #708215.

EXCLUSIVE

Item No.	Description	MSRP
728405	EcoPlus Large Round Air Stone	\$4.99
728410	EcoPlus Medium Round Air Stone	\$2.95
728415	EcoPlus Small Round Air Stone	\$1.95
728419	EcoPlus 12 in Air Stone NEW	\$2.49
728420	EcoPlus 8 in Air Stone	\$1.95
728425	EcoPlus 6 in Air Stone	\$1.49
728430	EcoPlus 4 in Air Stone	\$1.29

EcoPlus® Hydrovescent™ Air Discs



EcoPlus® Hydrovescent Air Discs are great for aerating or circulating nutrients in your tanks or reservoirs. Includes suction cup feet to keep your air disc secured. The air disc has a built-in 3/8 inch 90 degree elbow fitting that insures the airline connects freely to your fitting. Air discs are great for use with EcoPlus® or Air Force Pro® Air Pumps. 1 Year Warranty.

EXCLUSIVE

Item No.	Description	Tube Size	MSRP
728416	EcoPlus HydroVescent Air Disc 4 in	3/8 in	\$8.95
728417	EcoPlus HydroVescent Air Disc 6 in	3/8 in	\$19.95
728418	EcoPlus HydroVescent Air Disc 8 in	3/8 in	\$24.95

EcoPlus® Aqua Lung™ Air Diffuser with Base



NEW EcoPlus® Aqua Lung™ Air Diffuser with 10 in base uses a precision molded rubber membrane to expel micro bubbles that maximize oxygen transfer levels in your water or nutrient solution. Durable, cleanable and easy to use. The EcoPlus® Aqua Lung™ screws in to the top of the base and air supply connects to the 1/4 inch fitting. For use with EcoPlus®

Commercial Air Pumps and Air Force Pro® Linear Air Pumps.

EXCLUSIVE

Item No.	Description	MSRP
728432	EcoPlus Aqua Lung Air Diffuser w/ Base 10 in	\$29.99

Find a retailer near you!



ECOPLUS® WATER CHILLERS

KEEP YOUR
COOL!



EcoPlus® 1/10 HP Chiller



Each chiller provides a high performance titanium heat exchanger for optimum performance and corrosion resistance. High quality made compressor is extremely efficient and reliable. The micro computer with digital LCD display allows for easy operation. Fittings are 1/2 inch. 120V-60Hz/264 watts/2.2 amps. Pump Size: Minimum 66 GPH/Maximum 317 GPH. Dimensions are 15.75 in W x 8.58 in D x 16.34 in H and weighs 28.7 lb. 1 Year Warranty.



EXCLUSIVE

Item No.	Description	MSRP
728695	EcoPlus 1/10 HP Chiller	\$379.95

EcoPlus® 1/4 HP Chiller



Each chiller provides a high performance titanium heat exchanger for optimum performance and corrosion resistance. High quality made compressor is extremely efficient and reliable. The micro computer with digital LCD display allows for easy operation. Fittings are 3/4 inch. 120V-60Hz/360 watts/3 amps. Pump Size: Minimum 264 GPH/Maximum 660 GPH. Dimensions are 17.13 in W x 11.61 in D x 18.5 in H and weighs 42.5 lb. 1 Year Warranty.



EXCLUSIVE

Item No.	Description	MSRP
728700	EcoPlus 1/4 HP Chiller	\$524.95

EcoPlus® 1/2 HP Chiller



Digital control system for accurate, stable water temperature that helps to keep your reservoir cool. Environmentally safe, freon-free R134a refrigeration system that has high energy efficiency. Will chill the water from 37-90 degrees. Max water volume of 132 gallons. Recommended pump size 317 to 793 GPH. Dimensions are 21 in W x 15.5 in D x 22 in H and weighs 52 lb. 1 Year Warranty.



EXCLUSIVE

Item No.	Description	MSRP
728702	EcoPlus 1/2 HP Chiller	\$944.95

EcoPlus® Commercial Grade Water Chillers



EXCLUSIVE

Features a commercial-grade titanium heat exchanger for optimum performance and corrosion resistance. High-quality Japanese compressor is extremely efficient and reliable. Heavy-duty galvanized steel housing with a durable powder coated finish. Digital LCD display allows for easy operation. Remote temperature controller with a 30 ft cord allows user to monitor & adjust chiller settings, when the unit is installed in a remote location. Comes with 2 fittings to allow chiller to be plumbed with 1 inch hard PVC pipe or 1 inch flexible tubing.

Item No.	Description	MSRP
728707	EcoPlus Commercial Grade Water Chiller 1/2 HP	\$1,156.95
728708	EcoPlus Commercial Grade Water Chiller 1 HP	\$1,508.95
728709	EcoPlus Commercial Grade Water Chiller 1-1/2 HP	\$1,649.95
728711	Eco Plus Commercial Grade Chiller Fitting Kit	\$14.95

Hydro Innovations® CoolCoil™

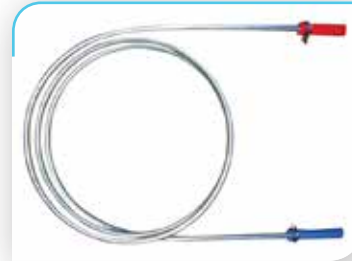

A 12 in stainless steel coil that is designed to be used with a water-cooled system. Includes 20 ft of 3/8 in heavy duty tubing, 1/2 in and 3/8 in brass hose barb adapters, and stainless steel hose clamps.

* Requires chilled water flowing through it to operate.

Item No.	Description	MSRP
703760	Hydro Innovations CoolCoil	\$154.95

Allow these units to set upright for 3 hours prior to startup.

EcoPlus® Aqua Heat® Titanium Reservoir & Aquarium Heater



These easy to use heaters are very durable and reliable. The double heater tubes are fully submersible. Automatic electronic heater ideal for saltwater and freshwater. 1 Year Warranty.



EXCLUSIVE

Item No.	Description	MSRP
728581	EcoPlus Aqua Heat Titanium Heater 200 Watt	\$36.95
728582	EcoPlus Aqua Heat Titanium Heater 300 Watt	\$38.95

Hydor Theo Heaters



Theo aquarium heater has all the necessary features for safe and precise temperature maintenance of the water in your tank. The exclusive technology and the high quality of the components guarantee a long lasting product.



Item No.	Description	MSRP
727625	Hydor Theo Heater 200 Watt for 26-53 Gallons	\$32.95
727630	Hydor Theo Heater 300 Watt for 53-80 Gallons	\$36.95
727635	Hydor Theo Heater 400 Watt for 80-105 Gallons	\$39.95

idealH₂O™

Premium Water Filtration Systems

Ideal H₂O™ offers a full line of water filtration systems using the most cost effective and efficient way to remove the majority of contaminants from your water. Our reverse osmosis units remove up to 98% of chlorine and chloramine out of your water, as well as removing up to 90% of sediment, rust, silt and particulates filtered down to 5 microns and wastes 25% less drain water than other RO systems on the market.

Ideal H₂O™ Classic 3 Stage RO Systems with Coconut Carbon Pre Filter - 100 & 200 GPD



GOOD

NEW Ideal H₂O™ Reverse Osmosis Water Filtration Systems produce up to 200 gallons per day of ultra-pure, low parts per million (PPM) water. These 3 Stage RO systems remove up to 98% of chlorine, 30% of chloramine and 90% of sediment, silt and rust. Ideal H₂O™ RO Systems also come with a 1:1 clean water to waste water ratio flow restrictor. This process wastes



40% less water than other RO systems on the market. Proudly assembled in the U.S.A. 1 Year Warranty.

EXCLUSIVE

Item No.	Description	MSRP
738366	Ideal H2O Classic 3 Stage RO System w/ Coconut Carbon Pre Filter - 100 GPD	\$184.95
738368	Ideal H2O Classic 3 Stage RO System w/ Coconut Carbon Pre Filter - 200 GPD	\$249.95

Ideal H₂O™ Premium 3 Stage RO Systems with Coconut Carbon Pre Filter + PSI Gauge - 100 & 200 GPD



BETTER

Reverse osmosis removes the majority of all contaminants from your water. Ideal H₂O™ Reverse Osmosis Water Filtration Systems produce up to 200 gallons per day of ultra-pure, low parts per million (PPM) water. These 3 Stage RO systems remove up to 98% of chlorine, 30% of chloramine and 90% of sediment, silt and rust. Includes a poly spun sediment pre-filter and



a coconut carbon pre-filter. Ideal H₂O™ RO Systems also come with a 1:1 clean water to waste water ratio flow restrictor. This process wastes 40% less water than other RO systems on the market. Includes incoming PSI gauge. Proudly assembled in the U.S.A. 1 Year Warranty.

EXCLUSIVE

Item No.	Description	MSRP
738300	Ideal H2O Premium 3 Stage RO System w/ Coconut Carbon Pre Filter + PSI Gauge - 100 GPD	\$216.95
738305	Ideal H2O Premium 3 Stage RO System w/ Coconut Carbon Pre Filter + PSI Gauge - 200 GPD	\$282.95

Ideal H2O™ Premium 3 Stage RO Systems with Catalytic Carbon - 100 & 200 GPD

BEST



NEW Ideal H2O™ Catalytic Reverse Osmosis Water Filtration Systems produce up to 200 gallons per day of ultra-pure, low parts per million (PPM) water. These 3 Stage RO systems remove up to 98% of chlorine, 80% of chloramine, and 90% of sediment, silt and rust. The Ideal H2O™ Catalytic RO Systems include a high quality poly spun sediment pre-filter and an advanced



catalytic carbon pre-filter. The advanced catalytic carbon pre-filter has 400% more capacity for chlorine and chloramine reduction than standard GAC filters. Comes with a 1:1 clean water to waste water ratio. Includes incoming PSI gauge. **EXCLUSIVE** Proudly assembled in the U.S.A. 1 Year Warranty.

Item No.	Description	MSRP
738306	Ideal H2O Premium 3 Stage RO System w/ Upgraded Catalytic Carbon Pre Filter + PSI Gauge - 100 GPD	\$259.95
738308	Ideal H2O Premium 3 Stage RO System w/ Upgraded Catalytic Carbon Pre Filter + PSI Gauge - 200 GPD	\$349.95

Ideal H2O™ Classic 3 Stage RO System with Granular Activated Carbon Pre Filter - 75 GPD



The Ideal H2O™ 75 GPD 3 Stage Reverse Osmosis Unit was designed to be light, compact and economical for today's gardening hobbyists. Utilizing a hybrid sediment/carbon filter and a full size RO membrane, this 75 GPD RO unit has the same great quality filtration as larger units in the market today. Built in 1:1 ratio flow



restrictor. Assembled in the USA. 1 Year Warranty.

Item No.	Description	MSRP
738325	Ideal H2O Classic 3 Stage RO System w/ Granular Activated Carbon (GAC) Pre Filter - 75 GPD	\$133.95

Ideal H2O™ Commercial 3 Stage RO Systems with Catalytic Carbon Pre Filter - 600 & 1200 GPD



NEW The Ideal H2O™ Catalytic Reverse Osmosis Systems offers the most absolute chlorine and chloramine reduction of any RO unit in the industry. Ideal H2O™ Catalytic Reverse Osmosis Water Filtration Systems produce up to 600 or 1200 gallons per day of ultra-pure, low parts per million (PPM) water. Constructed of industrial grade components and advanced catalytic pre-



filtration, these systems remove up to 98% of chlorine and 80% of chloramines from your source water. The Ideal H2O™ Systems uses a 1:1 ratio of clean water to water waste, providing you with more ultra clean water and less waste water. Proudly assembled in the U.S.A. 1 Year Warranty. **EXCLUSIVE**

Item No.	Description	MSRP
738370	Ideal H2O Commercial 3 Stage RO System w/ Catalytic Carbon Pre Filter - 600 GPD	\$624.95
738375	Ideal H2O Commercial 3 Stage RO System w/ Catalytic Carbon Pre Filter - 1,200 GPD	\$915.95

Ideal H2O™ Inline Garden Hose Filter with Catalytic Carbon



NEW The Ideal H2O™ Inline Garden Hose provides filtered water for your home and garden. This inline garden hose filter will reduce chlorine, chloramines and other harmful VOC's from your water supply. While other inline filters use standard GAC and KDF media for filtration, the Ideal H2O™ Inline water filter utilizes an advanced catalytic carbon, which provides up to



400% more capacity for chlorine and chloramine than standard GAC filters. Garden hose adapter included. 8000 gallon filter life span.

EXCLUSIVE

Item No.	Description	MSRP
738310	Ideal H2O Inline Garden Hose Filter w/ Catalytic Carbon	\$54.95

Ideal H2O™ De-Chlorinator System with Coconut Carbon Filter 1,400 GPD



The Ideal H2O™ 1,400 GPD De-Chlorinator removes up to 99% of chlorine out of your water, as well as removing up to 90% of sediment, rust, silt and particulates down to 5 microns. Filters 60 gallons of water per hour, providing crystal clear water for your plants. 1 Year Warranty.



EXCLUSIVE

Item No.	Description	MSRP
738315	Ideal H2O De-Chlorinator System w/ Coconut Carbon Filter - 1,400 GPD	\$99.95

Ideal H2O™ De-Chlorinator System with Coconut Carbon Filter 2,800 GPD



The Ideal H2O™ 2,800 GPD De-Chlorinator removes up to 99% of chlorine out of your water, as well as removing up to 90% of sediment, rust, silt and particulates down to 5 microns. Filters 120 gallons of water per hour, providing crystal clear water for your plants. 1 Year Warranty.



EXCLUSIVE

Item No.	Description	MSRP
738320	Ideal H2O De-Chlorinator System w/ Coconut Carbon Filter - 2,800 GPD	\$166.95

Ideal H2O™ De-Chlorinator System with Catalytic Carbon Filter 5,000 GPD



NEW The Ideal H2O™ 5,000 GPD De-Chlorinator removes up to 99% of chlorine and chloramines out of your water, as well as removing up to 90% of sediment, rust, silt, etc. and volatile organic compounds and particulates down to 5 microns. Filters 210 gallons of water per hour, providing crystal clear water for your plants. 1 Year Warranty.



EXCLUSIVE

Item No.	Description	MSRP
738317	Ideal H2O Commercial De-Chlorinator System w/ Catalytic Carbon Filter - 5,000 GPD	\$283.95

Ideal H2O™ De-Chlorinator System with Catalytic Carbon Filter 10,000 GPD



NEW The Ideal H2O™ 10,000 GPD De-Chlorinator removes up to 99% of chlorine and chloramines out of your water, as well as removing up to 90% of sediment, rust, silt, etc. and volatile organic compounds and particulates down to 5 microns. Filters 420 gallons of water per hour, providing crystal clear water for your plants. 1 Year Warranty.



EXCLUSIVE

Item No.	Description	MSRP
738322	Ideal H2O Commercial De-Chlorinator System w/ Catalytic Carbon Filter - 10,000 GPD	\$422.95

Ideal H2O™ RO 100/200 Booster Pump



The Ideal H2O™ RO 100/200 Booster pump is designed to increase the inlet pressure of your water source. Two 3/8 in Quick Connect fittings are preinstalled for quick operation.



EXCLUSIVE

Item No.	Description	MSRP
738345	Ideal H2O RO 100/200 Booster Pump	\$214.95



EXCLUSIVE

Ideal H2O™ Professional Series RO Systems with Catalytic Carbon Pre Filter - 2000 & 4000 GPD

NEW Ideal H2O™ Professional Series Reverse Osmosis Systems are state-of-the-art, versatile systems for treating tap and well water supplies and with flow rates ranging from 2,000 to 4,000 gallons per day. Minimal energy consumption, low maintenance and operation costs makes them the ideal choice for a variety of applications. A C23 switch controller with feed flush comes standard to reliably operate the system. HF5-Series Extra Low Energy membranes are standard on all systems and offer high rejection and flow rates for quality system performance. Recycle valve pushes waste water back into the feed line, allowing a four part clean water to a one part waste water ratio. Systems also feature a heavy duty 1/2 HP stainless steel multistage booster pump. Size: 18 x 18 x 45 inches. 120 volt 1 phase 60 Hz. #738400 has 1 membrane and weighs 100 lb. #738402 has 2 membranes and weighs 120 lb. 1 Year Warranty.



Item No.	Description	MSRP
738400	Ideal H2O Professional Series RO System w/ Catalytic Carbon Pre Filter - 2000 GPD	\$5,299.95
738402	Ideal H2O Professional Series RO System w/ Catalytic Carbon Pre Filter - 4000 GPD	\$5,999.95



EXCLUSIVE

Ideal H2O™ Professional Series RO Systems with Catalytic Carbon Pre Filter - 6000 & 8000 GPD

NEW Ideal H2O™ Professional Series Reverse Osmosis Systems are state-of-the-art, versatile systems for treating tap and well water supplies and with flow rates ranging from 6,000 to 8,000 gallons per day. Minimal energy consumption, low maintenance and operation costs makes them the ideal choice for a variety of applications. A C23 switch controller with feed flush comes standard to reliably operate the system. HF5-Series Extra Low Energy membranes are standard on all systems and offer high rejection and flow rates for quality system performance. Recycle valve pushes waste water back into the feed line, allowing a four part clean water to a one part waste water ratio. Systems also feature a heavy duty 1 HP stainless steel multistage booster pump. Size: 18 x 18 x 45 inches. 240 volt 1 phase 60 Hz. #738404 has 3 membrane and weighs 140 lb. #738406 has 4 membranes and weighs 160 lb. 1 Year Warranty.



Item No.	Description	MSRP
738404	Ideal H2O Professional Series RO System w/ Catalytic Carbon Pre Filter - 6000 GPD	\$6,999.95
738406	Ideal H2O Professional Series RO System w/ Catalytic Carbon Pre Filter - 8000 GPD	\$7,799.95

Ideal H2O™ Professional Series Upgrade Kits



NEW Ideal H2O™ Upgrade kits include everything you need to increase your water production on the Ideal H2O™ Professional RO Units. Converts the 2000 GPD RO System up to a 4000 GPD RO System and the 6000 GPD RO System up to an 8000 GPD RO System. Includes membrane, membrane vessel



and all necessary tubing and fittings for installation. 1 Year Warranty. **EXCLUSIVE**

Item No.	Description	MSRP
738408	Ideal H2O Professional Series Upgrade Kit - 2000 GPD to 4000 GPD	\$849.95
738410	Ideal H2O Professional Series Upgrade Kit - 6000 GPD to 8000 GPD	\$849.95

Ideal H2O™ Professional Series Chemical Injection System



NEW The Ideal H2O™ Chemical Injection System includes a 30 Gallon Reservoir with a 4 GPD Peristaltic pump. The included peristaltic pump is self-priming and has an electronic timer module to accurately flow 4 gallons per day. This system is ideal for use with the Ideal H2O™ Antiscalant Chemical, drastically reducing the source water's hardness before entering your RO system. 1 Year Warranty.



EXCLUSIVE

Item No.	Description	MSRP
738412	Ideal H2O Professional Series Chemical Injection System - Tank and Pump	\$899.95

Ideal H2O™ Antiscalant Chemical



NEW The Ideal H2O™ Antiscalant Chemical is an additive added to the water before going through the reverse osmosis process. It helps prevent the scaling of salts and particles on the membrane used in reverse osmosis. The Ideal H2O™ Antiscalant Chemical will prolong your membrane and will make the reverse osmosis process go smoother and faster.



EXCLUSIVE

Item No.	Description	MSRP
738414	Ideal H2O Antiscalant Chemical - 5 Gallon	\$529.95

RO Membranes



NEW The RO Membrane is the workhorse of an RO System. These membranes are classified as TFC (Thin-Film Composite), which has the highest removal capacity of contaminants from your water supply. Replacing the sediment and carbon filters on a regular basis will help protect your RO membrane from premature fouling.

EXCLUSIVE

Item No.	Description	MSRP
738340	Ideal H2O RO Membrane 100 GPD	\$58.95
738378	Ideal H2O RO Membrane - 600 GPD	\$206.95
738418	Ideal H2O RO Membrane - 2000 GPD	\$541.95
728815	Premium RO Membrane 100 GPD	\$83.95

Ideal H2O™ Catalytic Carbon Filters

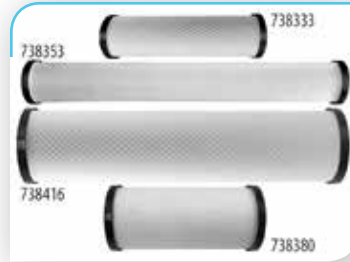

NEW Ideal H2O™ Catalytic Carbon filters are the most advanced pre-filtration carbon filters available. These filters remove 400% more chlorine and chloramine than standard GAC filters. Manufactured with Eco-friendly coconut carbon. These filters work with Hydro-logic™ systems as well as Ideal H2O™ systems. Due to manufacturing process, filter colors may vary.

EXCLUSIVE

Item No.	Description	MSRP
738333	Ideal H2O Catalytic Carbon Filter 2 in x 10 in	\$33.95
738353	Ideal H2O Catalytic Carbon Filter 2 in x 20 in	\$63.95
738380	Ideal H2O Catalytic Carbon Filter - 4.5 in x 10 in	\$79.95
738416	Ideal H2O Catalytic Carbon Filter - 4.5 in x 20 in	\$158.95

Premium KDF85 Carbon Filters

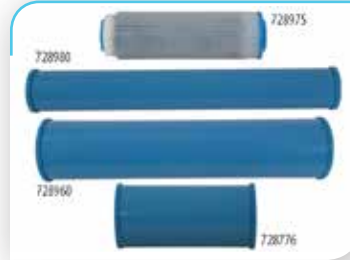

NEW The KDF85 Carbon Filter combines KDF with Catalytic Carbon to reduce chlorines, chloramines, iron, sulfur and other metals. Also controls scale, bacteria and algae. These filters work with Hydro-logic™ systems as well as Ideal H2O™ systems.



EXCLUSIVE

Item No.	Description	MSRP
728975	Premium KDF85 Carbon Filter - 2 in x 10 in	\$41.95
728980	Premium KDF85 Carbon Filter - 2 in x 20 in	\$77.95
728776	Premium KDF85 Carbon Filter - 4.5 in x 10 in	\$92.95
728960	Premium KDF85 Carbon Filter - 4.5 in x 20 in	\$132.95

Premium Green Coconut Carbon Filters

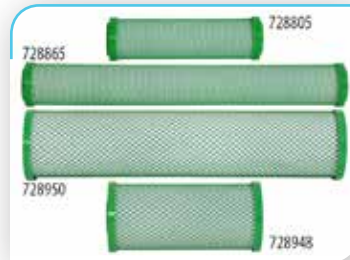

NEW The Premium Coconut Carbon Filter removes 200% more chlorine, chloramine, and other harmful VOC's than standard GAC filters. Manufactured with Eco-friendly coconut carbon. These filters work with Hydro-logic™ systems as well as Ideal H2O™ systems.

EXCLUSIVE

Item No.	Description	MSRP
728805	Premium Green Coconut Carbon Filter - 2 in x 10 in	\$16.25
728865	Premium Green Coconut Carbon Filter - 2 in x 20 in	\$29.95
728948	Premium Green Coconut Carbon Filter - 4.5 in x 10 in	\$49.95
728950	Premium Green Coconut Carbon Filter - 4.5 in x 20 in	\$79.95

Ideal H2O™ Coconut Carbon Filters

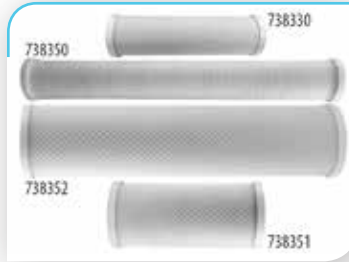

NEW Ideal H2O™ Coconut Carbon removes 200% more chlorine, chloramine and other harmful VOC's than standard GAC filters. Manufactured with Eco-friendly coconut carbon. These filters work with Hydro-logic™ systems as well as Ideal H2O™ systems.

EXCLUSIVE

Item No.	Description	MSRP
738330	Ideal H2O Coconut Carbon Filter 2 in x 10 in	\$13.95
738350	Ideal H2O Coconut Carbon Filter 2 in x 20 in	\$26.95
738351	Ideal H2O Coconut Carbon Filter - 4.5 in x 10 in	\$38.95
738352	Ideal H2O Coconut Carbon Filter - 4.5 in x 20 in	\$73.95

Premium Pleated Sediment Filters

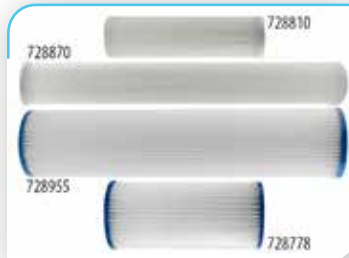

NEW Sediment Filters are the standard sediment pre-filter that come with many Reverse Osmosis systems. The Sediment Filter will remove silt, rust, sand, etc. These filters are pleated and cleanable. These filters work with Hydro-logic™ systems as well as Ideal H2O™. Match the filter to the size of your Reverse Osmosis system. Most filters last 6 - 12 months with regular cleaning. Due to **EXCLUSIVE**

manufacturing process, filter colors may vary.

Item No.	Description	MSRP
728810	Premium Pleated Sediment Filter 2 in x 10 in	\$11.95
728870	Premium Pleated Sediment Filter 2 in x 20 in	\$13.95
728778	Premium Pleated Sediment Filter 4.5 in x 10 in	\$36.95
728955	Premium Pleated Sediment Filter 4.5 in x 20 in	\$59.95

Ideal H2O™ Polyspun Sediment Filters



NEW Sediment Filters are the standard sediment pre-filter that come with many Reverse Osmosis systems. The Sediment Filter will remove silt, rust, sand, etc. These filters work with Hydro-logic™ systems as well as Ideal H2O™. Match the filter to the size of your Reverse Osmosis system. Most filters last 6 - 12 months with regular cleaning. **EXCLUSIVE**

Item No.	Description	MSRP
738335	Ideal H2O Polyspun Sediment Filter 2 in x 10 in	\$8.95
738355	Ideal H2O Polyspun Sediment Filter 2 in x 20 in	\$9.95
738356	Ideal H2O Polyspun Sediment Filter 4.5 in x 10 in	\$14.95
738358	Ideal H2O Polyspun Sediment Filter 4.5 in x 20 in	\$19.95

Ideal H2O™ Hybrid Sediment/Carbon Filter



The Ideal H2O™ Hybrid Filter combines both a sediment filter and a carbon filter, removing both particulates and chemicals from the water. Works only with the Ideal H2O™ RO System - 75 GPD.



EXCLUSIVE

Item No.	Description	MSRP
738360	Ideal H2O Hybrid Sediment/Carbon Filter	\$22.95

Hydro-logic® Evolution RO1000™ - 1000 GPD



Achieve the highest flow rates from the most efficient RO system on the planet! Capable of producing more than 1,000 GPD or 42 gallon per hour of pure water. Remove 95%+ of all parts per million from your tap water. Can produce up to 1500 gpd at 80 psi.

Item No.	Description	MSRP
728992	Hydro-logic Evolution RO1000 High Flow System	\$799.95

Hydro-logic® Evolution RO1000™ Filters



The standard pre-filter included with system. For chlorine and chloramines reduction for city water. Also for well water for iron, hydrogen sulfide and heavy metals reduction. 2 needed for system.

Item No.	Description	MSRP
728772	Hydro-logic Evolution RO1000 KDF/Catalytic Carbon Pre-Filter	\$53.95
728774	Hydro-Logic Evolution RO1000 Membrane	\$189.95

Hydro-logic® Evolution RO1000™ Wall Mount Bracket



Wall mount bracket for the Evolution-RO1000. Stainless steel, heavy duty.

Item No.	Description	MSRP
741585	Hydro-logic Evolution Wall Mount Bracket	\$77.95

Hydro-logic® Evolution Waste Reducer Elbow - 1:1 Ratio



Replaces standard Evolution RO1000™ green drain elbow to save 50% of the drain water. Gives a 1:1 ratio. Does not reduce flow of purified water. Orange with 3/8 in QC fitting- Save more water! Included as standard equipment with Evolution RO1000™.

Item No.	Description	MSRP
738220	Hydro-logic Evolution RO1000 Water Reducer Elbow	\$19.00

Hydro-logic® PreEvolution™ High Capacity Pre-Filter



Ensures your Evolution RO1000™ runs more efficiently. Less filter changes and maintenance - every 7,500 gallons of purified water. Cleanable sediment filter is re-usable.

Item No.	Description	MSRP
728792	Hydro-logic PreEvolution High Capacity Pre-Filter	\$291.95

Hydro-logic® Float Valve - 1/2 in Barbed

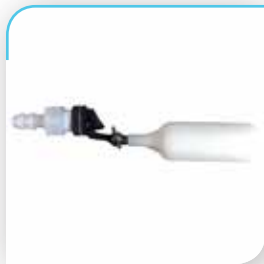

1/2 in barbed connection. Adjustable water level and can be mounted horizontally or vertically. Allows you to fill any tank or reservoir unattended - never flood your garden again! All plastic and stainless steel materials. Better than brass and fully adjustable.

Item No.	Description	MSRP
728790	Hydro-logic Float Valve 1/2 in Barbed	\$19.00

Hydro-logic® Stealth RO™ 100



Removes 98%+ of all contaminants in your tap water. Leading the industry in efficiency they have a 2:1 waste to product water ratio. Optional 1:1 ratio flow restrictor saves 50% more waste water. Optional high flow, low pressure, cold water membrane increases production to 200 GPD for Stealth RO™ 100 and 400 GPD for Stealth RO™ 200. Customized for gardening and hydroponics. 1 Year Warranty.

Item No.	Description	MSRP
728800	Hydro-logic Stealth RO 100	\$224.95
741570	Hydro-logic Stealth RO 100 w/ Upgraded KDF Carbon Filter	\$247.50

Hydro-logic® Stealth RO™ 200



Removes 98%+ of all contaminants in your tap water. Leading the industry in efficiency they have a 2:1 waste to product water ratio. Optional 1:1 ratio flow restrictor saves 50% more waste water. Optional high flow, low pressure, cold water membrane available to increase production to 200 GPD for Stealth RO™ 100 and 400 GPD for Stealth RO™ 200. Customized for gardening and hydroponics. 1 Year Warranty.

Item No.	Description	MSRP
728820	Hydro-logic Stealth RO 200	\$314.95
741575	Hydro-logic Stealth RO 200 w/ Upgraded KDF Carbon Filter	\$337.50

Hydro-logic® Stealth RO™ Low Pressure, High Flow Membrane



Low pressure, cold water, high flow membrane for Stealth RO models. Approximately 93% PPM rejection. Replaces standard membrane. Produces up to 200 Gallons Per Day. Stealth RO 100 requires one membrane and produces 200 GPD and Stealth RO 200 requires two membranes and produces 400 GPD.

Item No.	Description	MSRP
738240	Hydro-Logic RO Membrane 100 GPD - Low Pressure High Flow	\$99.95

Hydro-logic® Stealth RO™ Flow Restrictors 1:1



Replaces standard Stealth RO™ 100 & Stealth RO™ 200 flow restrictors to save 50% of the drain water. Gives a 1:1 ratio. Save more water!

Item No.	Description	MSRP
738225	Hydro-Logic Stealth Flow Restrictor - 100 GPD - 3:1 Ratio	\$9.95
738230	Hydro-Logic Stealth Flow Restrictor - 200 GPD - 3:1 Ratio	\$9.95

Hydro-logic® Upgrade Kit Stealth RO™ 100 to Stealth RO™ 200

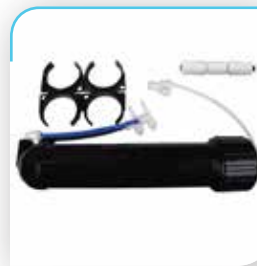

This kit upgrades your Stealth RO™ 100 unit into a Stealth RO™ 200. Double the flow rate of your purified water with this simple upgrade kit.

Item No.	Description	MSRP
738205	Hydro-logic Upgrade Kit to Convert RO 100 to Stealth RO 200	\$92.00

Hydro-logic® Stealth RO™ 100/200 - Membrane Flush Kit

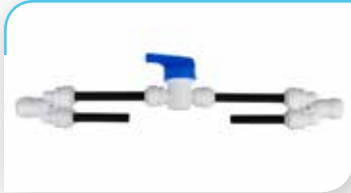

Power flushes Stealth RO™ membrane(s). Flushes away built up scale from the membrane surface to extend membrane(s) life.

Item No.	Description	MSRP
738100	Hydro-logic Stealth RO 100/200 Flush Kit for Membrane	\$19.95

Hydro-logic® QC Fitting for Stealth RO™ & Small Boy™ Systems



728937: 1/4 in Quick Connect In-line Shut Off Valve. This is used to shut off feed or outlet line to system. 728938: 1/4 in Quick Connect Union Connector. This is to connect 2 lengths of equal sized tubing together. 728939: 2 Way Splitter 1/4 in. This is a y splitter for multiple reservoirs.

Item No.	Description	MSRP
728937	Hydro-Logic QC In-line Shut Off Valve 1/4 in	\$5.00
728938	Hydro-Logic QC Union Connector 1/4 in	\$4.69
728939	Hydro-Logic QC 2-Way Splitter 1/4 in	\$5.50

Hydro-logic® Stealth Ultra-Violet Sterilizer Kit



Ultra Violet Sterilizer add on for either Stealth RO™ units. Kills any bacteria, viruses or biological contaminants in product water. Great for well or surface water sources. 1/4 in connections and up to 1/2 gallon per minute flow rate.

Item No.	Description	MSRP
728922	Hydro-logic Stealth UV Sterilizer Kit	\$99.00

Hydro-logic® Pressure Booster Pump For Stealth



This pump is designed to be installed before the Stealth RO™ to boost the inlet pressure. There needs to be at least 40 psi and up to 80 psi of inlet pressure for the Stealth RO™ to function properly. Wells and low pressure water sources can benefit greatly from this pump.

Item No.	Description	MSRP
728897	Hydro-logic Pressure Booster Pump for Stealth	\$214.95

Hydro-logic® Stealth & Small Boy™ Float Valve



Use this float valve to adjust water level and can be mounted horizontally or vertically. The kit allows you to fill a reservoir or tank, unattended, to your desired water level. For use with all Stealth and Small Boy™ models.

Item No.	Description	MSRP
728912	Hydro-Logic Float Valve QC 1/4 in	\$19.00

Hydro-logic® Algae Block Sleeve

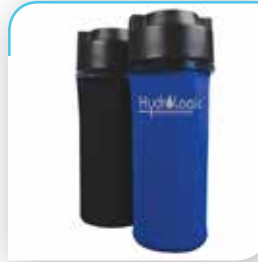

Neoprene sleeve that goes over all standard clear housings. Blocks light so no algae can grow. Easy to remove to check status of filters. Reversible blue and black. Fits Stealth RO™, Small Boy™ and Triton™.

Item No.	Description	MSRP
738235	Hydro-logic Algae Block Sleeve	\$13.95

Hydro-logic® Merlin GP Replacement Filters



The Merlin Garden Pro comes with two RO membranes elements. When it is time to replace them, both must be replaced simultaneously. 1,500 gallons of RO water filter life. The Carbon Filter is the carbon block pre-filter that will remove sediment, chlorine, organic chemicals and more. The Sediment Filter is a pre-filter that will remove silt, rust, sand, etc.

Item No.	Description	MSRP
728845	Hydro-logic Merlin GP Green Carbon Filter	\$34.95
728850	Hydro-logic Merlin GP Sediment Filter	\$26.95
728855	Hydro-logic Merlin GP Membrane	\$162.95

Hydro-logic® Evolution RO1000™ UV Sterilizer Kit



Ultra Violet Sterilizer add on for the Evolution RO1000™ unit. Kills any bacteria, viruses, or biological contaminants in product water. Great for well or surface water sources. Includes 3/8 in QC Elbow fittings. Up to 1 gpm flow rate. Also for use with Merlin GP.

Item No.	Description	MSRP
728920	Hydro-logic Evolution RO 1000 UV Sterilizer Kit	\$99.00

Hydro-logic® Flowmaster Flow Meter - 3/8 in



The Flowmaster measures how much filtered water that has gone through the system and alerts you when it's time to change filters. You can program in the filter capacity and when you reach the target number of gallons, the Flowmaster beeps.

Item No.	Description	MSRP
728905	Hydro-logic Flowmaster Flow Meter	\$59.00

Hydro-logic® Flowmaster 1/4 in - Ultra Low Flow Model



Flowmaster - 1/4 in QC - gallonage & filter capacity monitor. Operates at flow rates between 0.01-0.5 GPM. Ultra low-flow model. Alerts you when it's time to change your filters. For Stealth RO™ or most RO systems with 1/4 in fittings.

Item No.	Description	MSRP
741580	Hydro-logic Flowmaster Low Flow Model 1/4 in	\$59.00

HM Digital™ In-Line Dual TDS Monitor Model DM-1



Displays TDS levels of the feed water and product water with in & out electrode probes. Auto-Off function conserves battery power. Comes equipped with Mur-lok Quick-Connect T-fittings. Installs quickly and easily. 1 Year Warranty.

Item No.	Description	MSRP
716186	HM Digital In-Line Dual TDS Monitor	\$41.95

Hydro-logic® TDS Inline Monitor Pro for Evolution RO1000™



Highly efficient and accurate. Auto-Off function conserves battery power. The unit shuts off automatically after 20 seconds. Dual range - measures from 0-999 ppm, with a resolution of 1 ppm. Comes factory calibrated. Comes equipped with 3/8 in & 1/2 in Quick Connect T-fittings. 3 Year Warranty.

Item No.	Description	MSRP
728900	Hydro-logic TDS Inline Monitor Pro for Evolution RO 1000	\$75.00

Hydro-logic® Pressure Booster Pump for Merlin GP



It boosts the pressure up to 65 psi for Merlin Garden Pro. The 5 diaphragm pump is a workhorse but runs quietly. Requires at least 40 psi and up to 80 psi of inlet pressure for the Merlin Garden Pro to function properly. Comes with 120v cord and 1/2 in quick connect fittings. While supplies last.

Item No.	Description	MSRP
728895	Hydro-logic Pressure Booster Pump for Merlin GP	\$349.00

Hydro-logic® Pump Protector & Inlet Filter 1/2 in



Protects booster pump from sediment and other particles. Cleanable stainless steel mesh screen. Clear housing. 1/2 in fittings included to hook directly onto inlet of pump. Mandatory for pump unless a PreEvolution™ for your Evolution RO1000™ or a Tall Blue™ pre-filter for your Merlin Garden Pro. Works with all pumps with 1/2 in connections.

Item No.	Description	MSRP
741540	Hydro-logic Pump Protector & Inlet Filter 1/2 in	\$24.95

Hydro-logic® Pump Protector & Inlet Filter 3/8 in

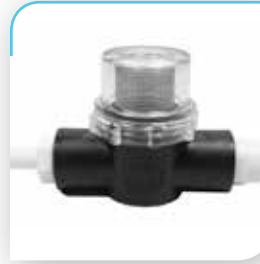

Protects booster pump from sediment and other particles. Cleanable stainless steel mesh screen. Clear housing. 3/8 in fittings included to hook directly onto inlet of pump. Mandatory for pump unless using dedicated pre-filter for your Stealth RO™ or Triton™ RO. Works with all pumps with 3/8 in connections.

Item No.	Description	MSRP
741545	Hydro-logic Pump Protector & Inlet Filter 3/8 in	\$19.95

Hydro-logic® Leak Protector & Shut Off Valves



Installs on inlet line. If there is a leak anywhere in the system and water reaches the pad on the bottom of the leak protector the valve shuts off all incoming water preventing further damage from the leak. Pads are replaceable. Comes with 2 pads, double sided mounting tape and stainless steel mounting screws.

Item No.	Description	MSRP
741550	Hydro-logic Leak Protector & Shut Off Valve 1/4 in	\$24.95
741555	Hydro-logic Leak Protector & Shut Off Valve 3/8 in	\$25.95
741560	Hydro-logic Leak Protector & Shut Off Valve 1/2 in	\$29.95

Hydro-logic® Green Drain Elbow for Merlin GP - 2:1 Ratio

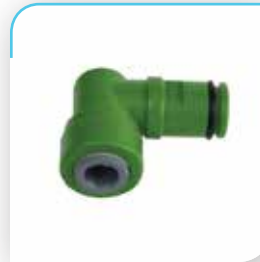

Merlin Garden Pro Eco Green drain elbow - 3/8 in QC replaces standard Merlin GP black drain elbow to save 25% of the drain water. Green with 3/8 in QC fitting.

Item No.	Description	MSRP
728944	Hydro-logic Green Drain Elbow 3/8 in for Merlin GP	\$19.00

Hydro-logic® Pressure Gauge with Garden Hose Connector



Pressure gauge with female garden hose connector. Allows one to measure line pressure to determine if a booster pump or pressure regulator is necessary. Diagnoses flow problems with RO filters.

Item No.	Description	MSRP
728946	Hydro-logic Pressure Gauge w/ Hose Connector	\$21.95

Hydro-logic® 3/8 in Stem x 1/4 in Quick Connect Straight



The 3/8 in Stem x 1/4 in Quick Connect Straight is used and to reduce a 3/8 in quick connect fitting down to 1/4 in. This is mainly used on the Flowmaster to make it's 3/8 in fitting reduce to 1/4 in and make it compatible with the Small Boy™.

Item No.	Description	MSRP
728907	Hydro-Logic QC Reducer Fitting - 3/8 in to 1/4 in	\$3.50

Hydro-logic® Quick Connect Fitting for Small Boy™



This is the replacement feed valve for the Small Boy™ system.

Item No.	Description	MSRP
728933	Hydro-Logic QC Garden Hose Connector 1/4 in	\$6.50

Hydro-logic® QC Fittings for Evolution & Tall Boy™



728940: 2 Way Splitter 3/8 in. 728941: 3 Way Splitter 3/8 in. Both splitters for Evolution RO1000™ & Tall Boy™ system. 728942: 3/8 in QC Inline Shut Off Valve for Evolution RO1000™ & Tall Boy™ system. 728943: 3/8 in QC Union Connector. Connects 2 lengths of equal sized tubing together for Evolution RO1000™ & Tall Boy™.

Item No.	Description	MSRP
728940	Hydro-Logic QC 2-Way Splitter 3/8 in	\$5.99
728941	Hydro-Logic QC 3-Way Splitter 3/8 in	\$12.00
728942	Hydro-Logic QC Inline Shut Off Valve 3/8 in	\$6.49
728943	Hydro-Logic QC Union Connector 3/8 in	\$5.00

Hydro-logic® QC Fittings for Evolution & Tall Blue™ Systems



728932: 1/2 in Quick Connect x Garden Hose Connector - Feed Valve. A replacement feed valve for the Evolution, Merlin GP & Tall Boy™. 728935: 1/2 in Quick Connect Inline Shut Off Valve to shut off feed or outlet line to Evolution & Tall Boy™. 728936: 1/2 in Quick Connect Union Connector. Connect 2 lengths of equal sized tubing together for the Evolution & Tall Boy™.

Item No.	Description	MSRP
728932	QC Garden Hose Connector 1/2 in	\$11.00
728935	Hydro-Logic QC Inline Shut Off Valve 1/2 in	\$8.49
728936	Hydro-Logic QC Union Connector 1/2 in	\$5.50

Hydro-logic® QC Fitting for Stealth RO™ & Tall Boy™ Systems



This is the replacement feed valve for the Stealth RO™ system as well as the Tall Boy™ system.

Item No.	Description	MSRP
728934	Hydro-Logic QC Garden Hose Connector 3/8 in	\$6.50

Hydro-logic® Small Boy™



Removes up to 99% of chlorine, 90% of sediment, rust, silt, etc. and volatile organic compounds and particulates down to 5 microns @ 1 GPM. Easily produces 60 gallons per hour of clear water and has a filter capacity of 3,000 gallons. Unit size is 11 in x 14 in and weight is 6.4 lb. 1 Year Warranty.

Item No.	Description	MSRP
728875	Hydro-logic Small Boy	\$106.95
738155	Hydro-logic Small Boy w/ KDF85 Catalytic Carbon Filter	\$134.95

Hydro-logic™ Small Boy Sediment Filter 10 in

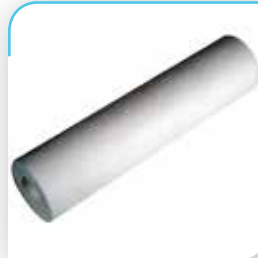

The Sediment Filter is a pre-filter that will remove silt, rust, sand, etc. Size is 2 inch by 10 inch.

Item No.	Description	MSRP
728885	Hydro-logic Small Boy Sediment Filter 10 in	\$11.00

Upgrade Kit to Convert Small Boy™ to Stealth RO™ 100

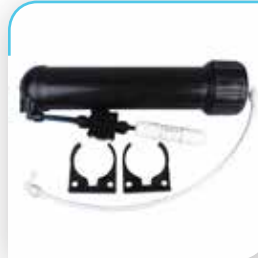

This kit upgrades your Small Boy™ unit into a Stealth RO 100.

Item No.	Description	MSRP
738200	Hydro-logic Upgrade Kit to Convert Small Boy to Stealth RO 100	\$100.00

Float Valve for Evolution RO1000™ & Tall Boy™



This valve comes with a 3/8 in quick connect fitting. Use this float valve to adjust water level and can be mounted horizontally or vertically. The kit allows you to fill a reservoir or tank, unattended, to your desired water level.

Item No.	Description	MSRP
728914	Hydro-Logic Float Valve QC 3/8 in	\$19.00

Hydro-logic® Tall Boy™



Removes up to 99% of chlorine, 90% of sediment, rust, silt, etc. and volatile organic compounds and particulates down to 5 microns @ 2 GPM. Easily produces 120 gals/hr of clear water and has a filter capacity of 7,500 gals. Great as a high capacity pre-filter for Stealth RO™ units. Unit size is 11 in x 24 in and weight is 11 lb. 1 Year Warranty.

Item No.	Description	MSRP
728890	Hydro-logic Tall Boy	\$183.95
738165	Hydro-logic Tall Boy w/ KDF85 Catalytic Carbon Filter	\$226.95

Hydro-logic® Big Boy™



Big Boy™ extra high capacity de-chlorinator and sediment filter. High flow rate of 7 gallons per minute or 420 gallons per hour. Whole house filter or stand alone (*with optional garden hose connection kit). It has a 25,000 gallon capacity. Removes 99% of chlorine and 95%+ of sediment. 1 Year Warranty.

Item No.	Description	MSRP
728985	Hydro-logic Big Boy	\$438.95
738150	Hydro-logic Big Boy w/ KDF85 Catalytic Carbon Filter	\$505.00

Hydro-logic® Big Boy™ Float Valve Big



Heavy duty float valve with 3/4 in male pipe thread and bulk head fitting. Adjustable water level and bulk head fitting. Up to 20 GM flow rates. Use this float for the Big Boy™ or garden hose.

Item No.	Description	MSRP
728945	Hydro-logic Float Valve for Big Boy	\$68.00

Hydro-logic® Big Boy™ Garden Hose Connection Kit

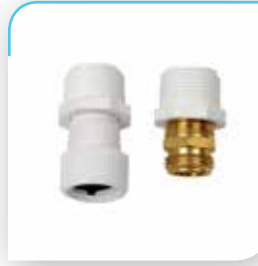

Female garden hose thread inlet and male garden hose thread outlet. To hook Big Boy™ up to garden hose.

Item No.	Description	MSRP
728930	Hydro-logic Big Boy Garden Hose Connection Kit	\$19.95

Hydro-logic® Pressure Regulator 3/4 in for Big Boy™

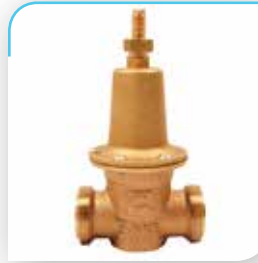

Brass pressure regulator. 3/4 in female pipe thread ports. Adjustable from 20-80 PSI. Compatible with Big Boy™ and other applications where you need to limit high pressure.

Item No.	Description	MSRP
741595	Hydro-logic Big Boy Pressure Regulator 3/4 in	\$149.95

Hydro-logic® Tubing

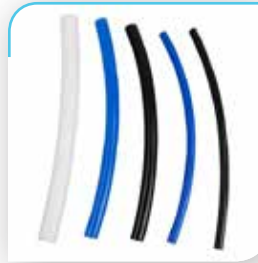

Replacement tubing for Hydro-logic® products. Also can be used for a variety of other irrigation and water purification applications.

Item No.	Description	MSRP
728780	Hydro-Logic Poly Tubing White 1/2 in 25 ft Roll 10/Pack	\$14.95
728782	Hydro-Logic Poly Tubing Black 1/4 in 50 ft Roll 10/Pack	\$11.95
728784	Hydro-Logic Poly Tubing Blue 1/4 in 50 ft Roll 10/Pack	\$11.95
728786	Hydro-Logic Poly Tubing Black 3/8 in 50 ft Roll 10/Pack	\$16.95
728788	Hydro-Logic Poly Tubing Blue 3/8 in 50 ft Roll 10/Pack	\$16.95

idealH₂O™
Premium Water Filtration Systems

Reverse Osmosis Water Filtration System

Clean water equals healthy plants!
Filter your growth with Ideal H₂O™



TITAN[®] CONTROLS

WWW.TITANCONTROLS.NET



Wireless Controller



Titan Controls[®] Hyperion™ 1 Wireless Environmental Controller



Get complete control of your grow room from up to 150 feet away without wires with the Hyperion™ 1 Wireless/Environmental/Lighting controller! Monitor & control the CO₂, temperature and humidity during the day & night periods. Includes a high temp shut-off, 15 min cool down with pre-set and custom lighting schedules. 15 Amps



maximum/120 Volts/ 60 Hz. US Patent No. D660,252. 3 Year Warranty. **EXCLUSIVE**

Item No.	Description	MSRP
702620	Titan Controls Hyperion 1 Wireless Environmental Controller	\$899.95



CO₂ Devices



Titan Controls[®] Atlas[®] 1 - CO₂ Monitor/Controller



Digital control board delivers precision CO₂ control. Maximize your CO₂ production while minimizing CO₂ or LP consumption. 50 parts per million (PPM) deadband/hysteresis built into set point. Adds CO₂ only during daylight period using the controllers integrated photocell. 15 Amps maximum/120 Volt/60 Hz. 3 Year Warranty.



EXCLUSIVE

Item No.	Description	MSRP
702615	Titan Controls Atlas 1 - CO ₂ Monitor/Controller	\$599.95

Titan Controls[®] Atlas[®] 2 - Preset CO₂ Monitor/Controller



Preset CO₂ control at 1500 PPM. Built-in self calibration feature. Simply plug in your CO₂ generator or regulator and you are ready to go. Built-in photocell allows CO₂ enrichment only during daylight hours. 5 Amps maximum/120 Volts/60 Hz. 3 Year Warranty.



EXCLUSIVE

Item No.	Description	MSRP
702618	Titan Controls Atlas 2 - Preset CO ₂ Monitor/Controller	\$333.95

Titan Controls[®] Atlas[®] 3 - Day/Night CO₂ Monitor/Controller



Controls and monitors CO₂ from 0 to 2000 parts per million (PPM). CO₂ enrichment or CO₂ exhaust features. Easy to set-up and operate. Plastic enclosure resists dust, rust and moisture. 5 Amps maximum/120 Volts/60 Hz. 2 Year Warranty.



EXCLUSIVE

Item No.	Description	MSRP
702608	Titan Controls Atlas 3 - Day/Night CO ₂ Monitor/Controller	\$499.95

Titan Controls[®] Atlas[®] 4 - 2 Room CO₂ Monitor/Controller



Controls and monitors CO₂ in (2) two rooms from 0 to 2000 parts per million (PPM). Two (2) remote room sensors with 25 ft cables (included). Integrated 24 hour data logging feature. Plastic enclosure resists dust, rust and moisture. 10 Amps maximum/120 Volts/60 Hz. 2 Year Warranty.



EXCLUSIVE

Item No.	Description	MSRP
702610	Titan Controls Atlas 4 - 2 Room CO ₂ Monitor/Controller	\$888.95

Titan Controls[®] Atlas[®] 5 - Portable Handheld CO₂, Temp & Humidity Monitor



A portable monitor that measures Carbon Dioxide (CO₂), Temp and Humidity. CO₂ Range: 0 PPM to 9,999 PPM. Temp Range: 14°F to 140°F. Humidity Range: 0.1% to 99.0%. Runs off 4 AA batteries (included). 1 Year Warranty.

EXCLUSIVE

Item No.	Description	MSRP
702611	Titan Controls Atlas 5 - Portable Handheld CO ₂ Temperature/Humidity Monitor	\$299.95

Titan Controls[®] Atlas[®] 7 - CO₂ Controller



Select CO₂ PPM levels at 1000 PPM, 1250 PPM or 1500 PPM. Integrated photocell. Built-in calibration feature. Single button control. Plastic enclosure resists dust, rust and moisture. 5 Amps maximum/120 Volts/60 Hz. 2 Year Warranty.



EXCLUSIVE

Item No.	Description	MSRP
702614	Titan Controls Atlas 7 - CO ₂ Controller	\$274.95

Titan Controls® Atlas® 8 - Digital CO2 Controller with Fuzzy Logic



A digital CO2 monitor/controller. Once the CO2 level has reached your desired set point it will disable the CO2 device. Features a photocell to ensure daytime only dosing of CO2. This controller comes with a 15 ft remote sensor. It also features fuzzy logic programming. The CO2 min/max can also be viewed on the LCD. 15 Amps maximum/120 Volts/60 Hz. 2 Year Warranty.



EXCLUSIVE

Item No.	Description	MSRP
702853	Titan Controls Atlas 8 - Digital CO2 Controller w/ Fuzzy Logic	\$549.95

Titan Controls® CO2 Regulator



Compatible with Titan Controls® CO2 Controllers or other 120 Volt controllers and timers. Precision accuracy flow meter - 0.5 to 15 SCF/hour. Features heavy-duty solenoid valve. Includes two plastic tank washers and 12 ft of CO2 dispensing line. 1 Amp/120 Volts/60Hz. 1 Year Warranty.

EXCLUSIVE

Item No.	Description	MSRP
702710	Titan Controls CO2 Regulator	\$99.95

CO2 Regulator Replacement Parts



Replacement parts for Titan Controls® CO2 Regulators. The white plastic washers are replacements for the Titan CO2 Regulator or the Titan CO2 Inline Heater. 1 Year Warranty.

EXCLUSIVE

Item No.	Description	MSRP
702712	Titan Controls CO2 Regulator Replacement Plastic Washer	\$0.99
702714	Titan Controls CO2 Regulator Replacement Outer Tube - Old Style	\$11.99
702716	Titan Controls CO2 Regulator Replacement Solenoid w/ Cord Set	\$59.95
702882	Titan Controls CO2 Regulator Replacement Plastic Tube - New Style	\$11.99

Titan Controls® CO2 Rain System



This CO2 Rain System includes 25 ft of laser drilled 1/8 in tubing, 6 eye hooks, 1/8 in plastic T fitting and instructions. Additional 100 ft roll of tubing is also available.

EXCLUSIVE

Item No.	Description	MSRP
702711	Titan Controls CO2 Rain System w/ 25 ft Tubing	\$18.95
702713	Titan Controls CO2 Rain Tubing Only 100 ft Roll	\$39.95

Titan Controls® CO2 Inline Heater



The CO2 Heater is installed between the CO2 cylinder valve and the regulator and warms the gas stream for increased flow rates without regulator freeze-up. Manufactured in USA. Not for use on GFI protected circuits. 1 Amp/120 Volts/60 Hz. 1 Year Warranty.

EXCLUSIVE

Item No.	Description	MSRP
702715	Titan Controls CO2 Inline Heater 120 Volt	\$208.95
702712	Titan Controls CO2 Regulator Replacement Plastic Washer	\$0.99

CO2 Tanks



Cylinders are made from exclusive aluminum alloy specially optimized by metallurgists to improve its durability, fracture toughness and resistance to tearing and cracking. CO2 tanks are shipped empty and do not contain CO2. UPS ground only with an additional oversize charge, as required.



Item No.	Description	MSRP
703360	CO2 Tank Aluminum 20 lb	\$199.95
703365	CO2 Tank Aluminum 50 lb	\$516.95

Simple CO2 Tubing Hanger



Simple CO2 is an inexpensive, easy and effective method for arranging CO2 tubing. Simple CO2 is an innovative product that allows for the CO2 to be evenly dispersed directly above the plant canopy. By releasing the CO2 from this optimal location, Simple CO2 is the only product that ensures 100% of the CO2 is released above the plant canopy.

EXCLUSIVE

Item No.	Description	MSRP
702170	Simple CO2 Tubing Hanger	\$2.49

Titan Controls® Ares® 2 - Two Burner CO2 Generators



Ares® Series CO2 generators comes with everything you need to get your CO2 system started. Includes: CO2 Generator, AC power supply, hanging chain, ceiling hook, appropriate hose and regulator. Ares® Series CO2 generators come in a variety of sizes from a small 2 burner model to a large adjustable 2 to 10 burner model. All you need to provide is a gas source! 1.5 Amps/120 Volts/60 Hz. 3 Year Warranty.

EXCLUSIVE

Item No.	Description	MSRP
702857	Titan Controls Ares 2 - Two Burner LP CO2 Generator	\$346.95
702858	Titan Controls Ares 2 - Two Burner NG CO2 Generator	\$346.95

Titan Controls® Ares® 4 - Four Burner CO2 Generators



Ares® Series CO2 generators comes with everything you need to get your CO2 system started. Includes: CO2 Generator, AC power supply, hanging chain, ceiling hook, appropriate hose and regulator. Ares® Series CO2 generators come in a variety of sizes from a small 2 burner model to a large adjustable 2 to 10 burner model. All you need to provide is a gas source! 1.5 Amps/120 Volts/60 Hz. 3 Year Warranty.

EXCLUSIVE

Item No.	Description	MSRP
702861	Titan Controls Ares 4 - Four Burner LP CO2 Generator	\$387.95
702862	Titan Controls Ares 4 - Four Burner NG CO2 Generator	\$387.95
702863	Titan Controls Ares 4 - High Altitude Four Burner LP CO2 Generator	\$387.95

Titan Controls® Ares® 8 - Eight Burner CO2 Generators



Ares® Series CO2 generators comes with everything you need to get your CO2 system started. Includes: CO2 Generator, AC power supply, hanging chain, ceiling hook, appropriate hose and regulator. Ares® Series CO2 generators come in a variety of sizes from a small 2 burner model to a large adjustable 2 to 10 burner model. All you need to provide is a gas source! 1.5 Amps/120 Volts/60 Hz. 3 Year Warranty.

EXCLUSIVE

Item No.	Description	MSRP
702865	Titan Controls Ares 8 - Eight Burner LP CO2 Generator	\$482.95
702866	Titan Controls Ares 8 - Eight Burner NG CO2 Generator	\$482.95
702867	Titan Controls Ares 8 - High Altitude Eight Burner LP CO2 Generator	\$482.95

Titan Controls® Ares® 10 - Ten Burner CO2 Generators



Ares® Series CO2 generators comes with everything you need to get your CO2 system started. Includes: CO2 Generator, AC power supply, hanging chain, ceiling hook, appropriate hose and regulator. Switchable from 2, 6, or 10 burners. All you need to provide is a gas source! 1.5 Amps/120 Volts/60 Hz. 3 Year Warranty.

EXCLUSIVE

Item No.	Description	MSRP
702869	Titan Controls Ares 10 - Ten Burner LP CO2 Generator	\$594.95
702870	Titan Controls Ares 10 - Ten Burner NG CO2 Generator	\$594.95

Titan Controls® Ares® Replacement CO2 Generator AC Power Supply



A/C Power Supply replacement part. Made specifically for to work with Titan Controls® Ares® CO2 generators. UL approved power supply. 15 Amps/120 Volts/60 Hz.



EXCLUSIVE

Item No.	Description	MSRP
702493	Titan Controls Ares Series Replacement CO2 Generator AC Power Supply	\$29.95

Titan Controls® Ares® Replacement Hose and Regulator



LP and NG hose and regulator replacement parts. Made specifically for to work with Titan Controls® Ares® CO2 generators.

EXCLUSIVE

Item No.	Description	MSRP
702490	Titan Controls Ares Series Replacement LP Hose & Regulator	\$49.95
702491	Titan Controls Ares Series Replacement NG Hose & Regulator	\$59.95

Titan Controls® Ares® Replacement Burners

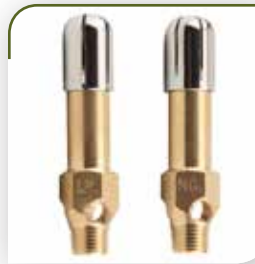

LP and NG replacement burners. Made specifically for to work with Titan Controls® Ares® CO2 generators.

EXCLUSIVE

Item No.	Description	MSRP
702495	Titan Controls Ares Series LP Replacement Burner	\$11.95
702496	Titan Controls Ares Series NG Replacement Burner	\$11.95

Titan Controls® 15 ft Sensor Extension Cable



Titan Controls® replacement 15 foot Sensor Extension Cable. This cable works with the Saturn® 6 and the Atlas® 8 products.

EXCLUSIVE

Item No.	Description	MSRP
702492	Titan Controls 15 ft Sensor Extension Cable	\$16.95

CO2 Test Hit



Product 702305 includes: 1 - 100cc syringe, 2 - test tubes and instructions. Product 702300 has a range: 300 - 5000 ppm, Sample Volume: 100 ml, Sample Time: 2 min., Color: White to Purple. Box contains 10 tests.

Item No.	Description	MSRP
702305	CO2 Test Kit	\$21.95
702300	CO2 Detector Tubes	\$46.95



Timing



Titan Controls® Apollo® 2 - Cycle Timer with Photocell



Controls timed equipment during daytime only, nighttime only or both. 10 seconds to 20 minutes ON TIME. 1 minute to 12 hours OFF TIME. Use to time fans, pumps or CO2. Plastic enclosure protects internal components. 15 Amps maximum/120 Volts/60 Hz. 2 Year Warranty.



EXCLUSIVE

Item No.	Description	MSRP
702740	Titan Controls Apollo 2 - Cycle Timer w/ Photocell	\$89.95

Titan Controls® Apollo® 3 - Fixed Cycle Timer



1 minute ON TIME & 4 minute OFF TIME. Timing is preset – requires no user adjustments. Ideal for aeroponic, ebb & flow or misting applications. Excellent for NFT – Nutrient Film Technique-systems. 10 Amps maximum/120 Volts/60 Hz. 2 Year Warranty.



EXCLUSIVE

Item No.	Description	MSRP
702635	Titan Controls Apollo 3 - Fixed Cycle Timer	\$74.95

Titan Controls® Apollo® 4 - 120 Volt Ballast Timer



The Apollo® 4 is specifically designed for use with today's high in-rush lighting ballasts. This is achieved by installing a 'ballast rated' relay vs. the standard mechanical switch that is used in conventional 24 hour appliance timers. It features a precision German built 24 hour clock, quality enclosure and timer cover that resists dust and moisture. Assure the success of your plants by having the best lighting control in the market today. 10 Amp maximum/120 Volts/60 Hz./1000 Watts. 2 Year Warranty.



control in the market today. 10 Amp maximum/120 Volts/60 Hz./1000 Watts. 2 Year Warranty.

EXCLUSIVE

Item No.	Description	MSRP
734135	Titan Controls Apollo 4 - 120 Volt Ballast Timer	\$79.95

Titan Controls® Apollo® 5 - 240 Volt Ballast Timer



The Apollo® 5 is specifically designed for use with today's high in-rush lighting ballasts. This is achieved by installing a 'ballast rated' relay vs. the standard mechanical switch that is used in conventional 24 hour appliance timers. It features a precision German built 24 hour clock, quality enclosure and timer cover that resists dust and moisture. Assure the success of your plants by having the best lighting control in the market

today. 10 Amp maximum/240 Volts/60 Hz./1000 Watts. 2 Year Warranty. **EXCLUSIVE**

Item No.	Description	MSRP
734140	Titan Controls Apollo 5 - 240 Volt Ballast Timer	\$84.95

Titan Controls® Apollo® 6 - One Outlet Mechanical Timer



24 hour timer is the perfect timing solution for your hydro systems. One (1) outlet. 15 minute intervals. Heavy duty construction. Easy to use & simple to operate. Plastic enclosure resists dust, rust and moisture. Do not use with digital ballasts. 15 Amps maximum/120 Volts/60 Hz. 1 Year Warranty.



EXCLUSIVE

Item No.	Description	MSRP
734110	Titan Controls Apollo 6 - One Outlet Mechanical Timer	\$10.95

Titan Controls® Apollo® 7 - One Outlet Digital Timer



24 hr digital timer is the perfect timing solution for your hydro systems. It's easy to set to run your pumps, fans, etc. One (1) outlet with 1 minute intervals. Battery back-up feature saves settings if power goes out. Do not use with digital ballasts. 15 Amps maximum/120 Volts/60 Hz. HINT: If not working properly, plug in for 5 minutes & press the reset button. Generally fixes the problem. 1 Year Warranty.



EXCLUSIVE

Item No.	Description	MSRP
734112	Titan Controls Apollo 7 - One Outlet Digital Timer	\$16.95

Titan Controls® Apollo® 8 - Two Outlet Mechanical Timer



24 hr timer is the perfect timing solution for your hydro systems. Two (2) outlets. 15 minute intervals. Heavy duty construction. Plastic enclosure resists dust, rust and moisture. Do not use with digital ballasts. 15 Amps maximum/120 Volts/60 Hz. 1 Year Warranty.



EXCLUSIVE

Item No.	Description	MSRP
734100	Titan Controls Apollo 8 - Two Outlet Mechanical Timer	\$12.95

Titan Controls® Apollo® 9 - Two Outlet Digital Timer



24 hr digital timer is the perfect timing solution for your hydro systems. Two (2) outlets with 1 minute intervals. Battery back-up feature saves settings if power goes out. Not for use with digital ballasts. 15 Amps maximum/120 Volts/60 Hz. HINT: If not functioning properly, plug in for 5 minutes and press the reset button. This generally fixes any problem. 1 Year Warranty.



EXCLUSIVE

Item No.	Description	MSRP
734105	Titan Controls Apollo 9 - Two Outlet Digital Timer	\$17.95

Titan Controls® Apollo® 10 - 240 Volt Mechanical Timer



240 Volt/24 hr timer is the perfect timing solution for your hydroponic systems. One (1) outlet with 15 minute intervals. Not for use with digital ballasts. 10 Amps maximum/240 Volts/60 Hz. 1 Year Warranty.

EXCLUSIVE

Item No.	Description	MSRP
734145	Titan Controls Apollo 10 - 240 Volt Mechanical Timer	\$14.95

Titan Controls® Apollo® 11 - 240 Volt Digital Timer



One (1) outlet. 1 minute intervals and run up to 20 schedules per day. Battery back-up feature saves settings in case of power failure. Daylight savings mode to accommodate time change. Do not use with digital ballasts. 10 Amps maximum/240 Volts/60 Hz. 1 Year Warranty.

EXCLUSIVE

Item No.	Description	MSRP
734155	Titan Controls Apollo 11 - 240 Volt Digital Timer	\$20.95

Titan Controls® Apollo® 14 - 8 Outlet Power Strip with Timer



8 outlets - 4 timed/4 constant. 24 hr mechanical programmable timer with 15 min intervals. All outlets surge protected up to 1000 joules. Circuit breaker switch for safety. 5 ft power cord set. Not for use with digital ballasts. 15 Amps maximum/120 Volts/60 Hz. 1 Year Warranty.



EXCLUSIVE

Item No.	Description	MSRP
734150	Titan Controls Apollo 14 - 8 Outlet Power Strip w/Timer	\$24.95

Titan Controls® Apollo® 12 - Short Cycle Timer With Photocell



Controls timed equipment during daytime only, nighttime only or both. 5 sec to 30 min ON TIME. 5 sec to 60 min OFF TIME. Precise short cycle timing of CO₂, pumps or fans. 15 Amps maximum/120 Volts/60 Hz./1/3 HP. 2 Year Warranty.



EXCLUSIVE

Item No.	Description	MSRP
702745	Titan Controls Apollo 12 - Short Cycle Timer w/ Photocell	\$89.95

Titan Controls® Apollo® 16 - Medium LCD Display Digital Cycle Timer



NEW The Apollo® 16 is a versatile digital timer that's simple to operate. It only takes four buttons to control the functions of the timer and features a large easy to read LCD display. A variety of schedules can be programmed in minutes and hours using 16 different ON and OFF schedules. Internal battery backup feature saves settings in case of a power failure. The Apollo® 16 may be used to control CO₂, fan, pump, light mover, etc. Plastic chassis resists dust, rust and moisture. 15 Amps maximum/120 Volts/60 Hz. Not for use with electronic/

digital ballasts. 1 Year Warranty.

EXCLUSIVE

Item No.	Description	MSRP
734116	Titan Controls Apollo 16 Medium LCD Display Digital Cycle Timer	\$18.95

Titan Controls® Apollo® 17 - Large LCD Display Digital Cycle Timer



NEW The Apollo® 17 is a versatile digital timer that's simple to operate. It only takes four buttons to control the functions of the timer and features an extra-large easy to read LCD display. A variety of schedules can be programmed in minutes and hours using 16 different ON and OFF schedules. Internal battery backup feature saves settings in case of a power failure. The Apollo® 17 may be used to control CO₂, fan, pump, light mover, etc. Plastic chassis resists dust, rust and moisture. 15 Amps maximum/120 Volts/60 Hz. Not for

use with electronic/digital ballasts. 1 Year Warranty.

EXCLUSIVE

Item No.	Description	MSRP
734117	Titan Controls Apollo 17 Large LCD Display Digital Cycle Timer	\$24.95

Power

Titan Controls® Hercules™ 2 - 50 Amp - High Amperage Controller



A trigger operated controller that allows you to operate up to 50 Amps of lights, heating or air conditioning by wiring 120 or 240 Volt power through the Power Input & connecting your lights, heater or A/C to the Power Output. 50 Amps maximum/120 or 240 Volt/60 Hz. 3 Year Warranty.



EXCLUSIVE

Item No.	Description	MSRP
702770	Titan Controls Hercules 2 - 50 Amp Controller	\$199.95

Titan Controls® Hercules™ 3 - Power Expander - 15 Amps



NEW The Hercules™ 3 is a trigger cord style power controller. It provides the opportunity to utilize an independent 15 amp outlet to run an appliance via the cord i.e. operate a dehumidifier. Your gear can be activated by the trigger cord set via an environmental controller or timer. The Hercules™ 3 comes with a 15 foot trigger cord set and a heavy duty ballast rated relay to handle the heaviest of power loads. Will operate any 120 volt appliance at 15 amps. Plastic enclosure resists dust, rust



and moisture. 15 Amps maximum/120 Volts/60 Hz. 2 Year Warranty.

EXCLUSIVE

Item No.	Description	MSRP
702773	Titan Controls Hercules 3 Power Expander - 15 Amp	\$59.95



Lighting Controls



Titan Controls® Apollo® 4 - 120 Volt Ballast Timer



The Apollo® 4 is specifically designed for use with today's high in-rush lighting ballasts. This is achieved by installing a 'ballast rated' relay vs. the standard mechanical switch that is used in conventional 24 hour appliance timers. It features a precision German built 24 hour clock, quality enclosure and timer cover that resists dust and moisture. Assure the success of your plants by having the best lighting control in the market today. 10 Amp maximum/120 Volts/60 Hz./1000 Watts. 2 Year Warranty.



EXCLUSIVE

Item No.	Description	MSRP
734135	Titan Controls Apollo 4 - 120 Volt Ballast Timer	\$79.95

Titan Controls® Apollo® 5 - 240 Volt Ballast Timer



The Apollo® 5 is specifically designed for use with today's high in-rush lighting ballasts. This is achieved by installing a 'ballast rated' relay vs. the standard mechanical switch that is used in conventional 24 hour appliance timers. It features a precision German built 24 hour clock, quality enclosure and timer cover that resists dust and moisture. Assure the success of your plants by having the best lighting control in the market today. 10 Amp maximum/240 Volts/60 Hz./1000 Watts. 2 Year Warranty.

EXCLUSIVE

Item No.	Description	MSRP
734140	Titan Controls Apollo 5 - 240 Volt Ballast Timer	\$84.95

Titan Controls® Helios® 1 - 4 Light 120 Volt Controller with Timer



Runs 4 HID lights at 120 Volts - maximum 4000 Watts. The only lighting controllers featuring industrial-grade ballast rated relays. 24 hr timer with 15 minute non-detachable setting tabs. 4 NEMA 5-20 outlets. 50 Amps input power/40 Amps output power/120 Volts/60 Hz./4000 watts. Patent No. D66,252. 3 Year Warranty.



EXCLUSIVE

Item No.	Description	MSRP
702660	Titan Controls Helios 1 - 4 Light 120 Volt Controller w/Timer	\$233.95

Titan Controls® Helios® 2 - 4 Light 120V Controller with Trigger Cord



Runs 4 HID lights at 120 Volts - maximum 4000 Watts. The only lighting controllers featuring industrial-grade ballast rated relays. Plug relay trigger cord set into 24 hr wall timer. 4 NEMA 5-20 outlets. 50 Amps input power/40 Amps output power/120 Volts/60 Hz./4000 watts. 3 Year Warranty.



EXCLUSIVE

Item No.	Description	MSRP
702665	Titan Controls Helios 2 - 4 Light 120 Volt Controller w/Trigger Cord	\$214.95

Titan Controls® Helios® 3 - 4 Light 240V Controller with Timer



Runs 4 HID lights at 240 Volts - maximum 4000 Watts. The only lighting controllers featuring industrial-grade ballast rated relays. 120 Volt accessory timed outlet to activate in-line fans to cool your lamps. Universal outlets allow total flexibility. 30 Amps input power/20 Amps output power/240 Volts/60 Hz./4000 watts. 3 Year Warranty.



EXCLUSIVE

Item No.	Description	MSRP
702670	Titan Controls Helios 3 - 4 Light 240 Volt Controller w/Timer	\$233.95

Titan Controls® Helios® 4 - 4 Light 240V Controller with Trigger Cord



Runs 4 HID lights at 240 Volts - maximum 4000 Watts. The only lighting controllers featuring industrial-grade ballast rated relays. 120 Volt accessory timed outlet to activate in-line fans to cool your lamps. Plug relay trigger cord set into 24 hr wall timer. 30 Amps input power/20 Amps output power/240 Volts/60 Hz./4000 watts. 3 Year Warranty.



EXCLUSIVE

Item No.	Description	MSRP
702675	Titan Controls Helios 4 - 4 Light Controller w/Trigger Cord	\$214.95

Titan Controls® Helios® 5 - 4 Light 240V Controller with Trigger Cord



Runs 4 HID lights at 240 Volts. Plug relay trigger cord set into 24 hr wall timer. The only lighting controllers featuring industrial-grade ballast rated relays. 120 Volt timed accessory outlet (max 2 Amps) for light mover or fan. 30 Amps input power/20 Amps output power/240 Volts/60 Hz./4000 Watts. 3 Year Warranty.



EXCLUSIVE

Item No.	Description	MSRP
702671	Titan Controls Helios 5 - 4 Light 240 Volt Controller w/Trigger Cord	\$221.95

Titan Controls® Helios® 6 - 8 Light 240V Controller with Dual Trigger Cords



Runs 8 HID lights at 240 volts. The only lighting controllers featuring 2 industrial-grade ballast rated relays. Plug relay trigger cord set into 24 hr wall timer. Removable front panel makes controller easy to wire into your power system. 50 Amps input power/40 Amps output power/240 Volts/60 Hz./8000 Watts. 3 Year Warranty.



EXCLUSIVE

Item No.	Description	MSRP
702672	Titan Controls Helios 6 - 8 Light 240 Volt Controller w/ Dual Trigger Cords	\$283.95

Titan Controls® Helios® 7 - 8 Light 240V Controller with Timer



Runs 8 HID lights at 240 volts. The only lighting controllers featuring industrial-grade ballast rated relays. 24 hr timer with 15 min non-detachable setting tabs. Universal outlets will accept a 120 Volt or 240 Volt ballast cord set. 50 Amps input power/40 Amps output power/240 Volts/60 Hz./8000 Watts. 3 Year Warranty.



EXCLUSIVE

Item No.	Description	MSRP
702676	Titan Controls Helios 7 - 8 Light 240 Volt Controller w/ Timer	\$299.95

Titan Controls® Helios® 8 - 8 Light 240V Controller with Dual Trigger Cords



Runs 8 HID lights at 240 Volts. The only lighting controllers featuring industrial-grade ballast rated relays. Dual trigger cord sets allow the operator to run two separate light timing schedules. 50 Amps input power/40 Amps output power/240 Volts/60 Hz./8000 Watts. 3 Year Warranty.



EXCLUSIVE

Item No.	Description	MSRP
702677	Titan Controls Helios 8 - 8 Light 240 Volt Controller w/ Dual Trigger Cords	\$274.95

Titan Controls® Helios® 9 - Pre-wired 4 Light 240V Controller with Trigger Cord & Timer



Runs 4 HID lights at 240 Volts. The only lighting controllers featuring industrial-grade ballast rated relays. Circuit breakers built right into the controller! Plug relay trigger cord into 24 hour wall timer (included)! 30 Amps input power/20 Amps output power/240 Volts/60 Hz./4000 Watts. 3 Year Warranty.



EXCLUSIVE

Item No.	Description	MSRP
702678	Titan Controls Helios 9 - Pre-Wired 4 Light 240 Volt Controller w/ Trigger Cord & Timer	\$308.95

Titan Controls® Helios® 10 - Pre-wired 8 Light 240V Controller with Trigger Cord & Timer



Runs 8 HID lights at 240 Volts. The only lighting controllers featuring industrial-grade ballast rated relays. Circuit breakers built right into the controller! Plug relay trigger cord into 24 hour wall timer (included)! 50 Amps input power/40 Amps output power/240 Volts/60 Hz./8000 Watts. 3 Year Warranty.



EXCLUSIVE

Item No.	Description	MSRP
702679	Titan Controls Helios 10 - Pre-Wired 8 Light 240 Volt Controller w/ Trigger Cord & Timer	\$409.95

Titan Controls® Helios® 11 - 4 Light 240V Controller with Trigger Cord



Runs 4 HID lights at 240 Volts. The only lighting controllers featuring industrial-grade ballast rated relays. Plug relay trigger cord into 24 hour wall timer to run your lights. Universal outlets allow total flexibility. 30 Amps input power/20 Amps output power/240 Volts/60Hz./4000 Watts. 2 Year Warranty.



EXCLUSIVE

Item No.	Description	MSRP
702820	Titan Controls Helios 11 - 4 Light 240 Volt Controller w/ Trigger Cord	\$158.95

Titan Controls® Helios® 12 - 8 Light 240V Controller with Dual Trigger Cords



Runs 8 HID lights at 240 Volts. The only lighting controllers featuring 2 industrial-grade ballast rated relays. Plug dual relay trigger cord set into 24 hr wall timers to run your lights. Universal outlets allow total flexibility. 50 Amps input power/40 Amps output power/240 Volts/60 Hz./8000 Watts. 2 Year Warranty.



EXCLUSIVE

Item No.	Description	MSRP
702825	Titan Controls Helios 12 - 8 Light 240 Volt Controller w/ Dual Trigger Cords	\$249.95

Titan Controls® Helios® 18 - 12 Light 240V Controller with Dual Trigger Cords



Runs 12 HID lights at 240 Volts. The only lighting controllers featuring industrial-grade ballast relays. 2 trigger cords allow the operator to run 2 separate light schedules. Removable front panel makes controller easy to wire. Universal outlets will accept either 120 or 240 Volt power cords. 80 Amps input power/60 Amps output power/240 Volts/60 Hz./12,000 Watts. 3 Year Warranty.



EXCLUSIVE

Item No.	Description	MSRP
702843	Titan Controls Helios 18 - 12 Light 240 Volt Controller w/ Dual Trigger Cords	\$449.95

Titan Controls® Helios® 13 - 16 Light 240V Controller with Timer



Runs 16 HID lights at 240 Volts. The only lighting controllers featuring industrial-grade ballast rated relays. Premium quality timer with battery back-up. 100 Amps input power/80 Amps output power/240 Volts/60 Hz./16,000 Watts. 3 Year Warranty.



EXCLUSIVE

Item No.	Description	MSRP
702828	Titan Controls Helios 13 - 16 Light Controller w/ Timer	\$1,191.95

Titan Controls® Helios® 14 - 24 Light 240V Controller with Timer



Runs 24 HID lights at 240 Volts. The only lighting controllers featuring industrial-grade ballast rated relays. Premium quality timer with battery back-up. 150 Amps input power/120 Amps output power/220 Volts/60 Hz./24,000 Watts. 3 Year Warranty.



EXCLUSIVE

Item No.	Description	MSRP
702832	Titan Controls Helios 14 - 24 Light Controller w/Timer	\$1,833.95

Titan Controls® Helios® 15 - 8 Light 240V Controller with Timer



Runs 8 HID lights at 240 Volts. The only lighting controllers featuring industrial-grade ballast rated relays. Reliable 24 hr timer built into the controller. NEMA 6-15 UL listed power outlets. 50 Amps input power/40 Amps output power/240 Volts/60 Hz./8000 Watts. 3 Year Warranty.



EXCLUSIVE

Item No.	Description	MSRP
702775	Titan Controls Helios 15 - 8 Light Controller w/Timer	\$308.95

Titan Controls® Helios® 16 - 16 Light 240V Controller with Dual Trigger Cords



Runs 16 HID lights at 240 Volts. The only lighting controllers featuring industrial-grade ballast rated relays. 2 trigger cord sets activate lighting controller via external timers. Sequenced lighting delays for each light bank. 100 Amps input power/80 Amps output power/240 Volts/60 Hz./16,000 Watts. 3 Year Warranty.



EXCLUSIVE

Item No.	Description	MSRP
702835	Titan Controls Helios 16 - 16 Light 240 Volt Controller w/ Dual Trigger Cords	\$1,191.95

Titan Controls® Helios® 17 - 24 Light 240V Controller with Dual Trigger Cords



Runs 24 HID lights at 240 Volts. The only lighting controllers featuring industrial-grade ballast rated relays. 2 trigger cord sets activate lighting controller via external timers. Sequenced lighting delays for each light bank. All duplex outlets have circuit breaker protection. 150 Amps input power/120 Amps output power/240 Volts/60 Hz./24,000 Watts. 3 Year Warranty.



EXCLUSIVE

Item No.	Description	MSRP
702840	Titan Controls Helios 17 - 24 Light 240 Volt Controller w/ Dual Trigger Cords	\$1,833.95

Titan Controls® Helios® Commercial Series Lighting Controllers - 200 Amp



NEW The Commercial Series 200 Amp Lighting Controller features: Allen-Bradley ballast rated industrial relays, Allen Bradley 30 Amp circuit breakers, dual trigger cord sets to activate lights, 0 - 30 second timing modules to delay HID bulb strikes. Available in single or three phase wiring configurations. It features a 20 gauge powder coated steel panel, convenient side wiring knock-outs, top power exit ports with knock-outs and are manufactured in the USA. Commercial Series panels are built to be Titan tough! 1 Year Warranty.



EXCLUSIVE

Item No.	Description	MSRP
703250	Titan Controls Helios 200 Amp Commercial Series Lighting Controller - Three Phase Wiring	\$2,999.95
703255	Titan Controls Helios 200 Amp Commercial Series Lighting Controller - Single Phase Wiring	\$2,999.95

Titan Controls® Hades® 1 - 15 Minute Lighting Delay Timer



Plug the 120 Volt relay trigger cord into the controller and you're protected. This timer makes lighting control safe and simple! Protects your lights from Hot Starts due to power failure. Pre-set 15 minute delay. 15 Amps maximum/120 Volts/60 Hz. 2 Year Warranty.



EXCLUSIVE

Item No.	Description	MSRP
702690	Titan Controls Hades 1 - 15 Minute Lighting Delay Timer	\$79.95

Titan Controls® Hades® 2 - Digital Recycle and Light Timer with High Temp. Shut-Off



Controls up to two light banks via your lighting controller trigger cords, has a high temperature shut-off function to turn off your grow lights and also a hot start protection function to allow your lights to cool before re-striking. Day only, night only or 24 hour mode. This controller has a 3 ft remote sensor. 15 Amps maximum/120 Volts/60 Hz. Patent Pending 29525627. 2 Year Warranty.



EXCLUSIVE

Item No.	Description	MSRP
702856	Titan Controls Hades 2 - Digital Recycle and Light Timer w/ High Temp Shut-Off	\$196.95

Titan Controls® Hades® 3 - Lighting Timer & High Temp Shut-Off



All in one digital lighting timer for use with trigger cord activated lighting systems! Set the preferred lighting schedule for a 24 hour period, then dial in the high temp limit. It even comes with a battery back-up and a 20 minute delay to avoid hot starts. Plastic enclosure protects from rust, dust and moisture. 6 foot temperature probe is accurate to within 2°F. 15 Amps/120 Volts/ 60 Hz. 2 Year Warranty.



EXCLUSIVE

Item No.	Description	MSRP
702621	Titan Controls Hades 3 - Lighting Timer w/ High Temp Shut Off	\$127.95

Titan Controls® Zephyr™ 2 - High Temperature Shut-Off with Delay



Controller turns off your lights if temperature exceeds set point. Built-in 0 – 30 minute Hot Start delay with HOLD feature. 6 foot temperature probe is accurate to within 2°F. 15 Amps maximum/120 Volts/60 Hz. 2 Year Warranty.



EXCLUSIVE

Item No.	Description	MSRP
702750	Titan Controls Zephyr 2 - High Temp Shut Off	\$89.95

Ventilation Controls

Titan Controls® Mercury® 2 - Fan Speed Controller



Adjusts fan speed from 10% - 100%. Fire-up feature extends life of your fan. Easy to operate. Plastic enclosure protects internal components from dust, rust and moisture. 6 Amps maximum/120 Volts/60 Hz. 2 Year Warranty.



EXCLUSIVE

Item No.	Description	MSRP
702753	Titan Controls Mercury 2 - Fan Speed Controller	\$77.95

Titan Controls® Mercury® 3 - Day/Night Fan Controller



Automatically increases or decreases fan speed based on controller set points. Adjustable deadband range to meet garden requirements. Temp control range is 55°F to 95°F. 6 foot temp probe is accurate to within 2°F. 6 Amps maximum/120 Volts/60 Hz. 2 Year Warranty.



EXCLUSIVE

Item No.	Description	MSRP
702755	Titan Controls Mercury 3 - Day/Night Fan Controller	\$119.95

Titan Controls® Mercury® 4 - Multi-Function Fan Speed Controller



Select minimum fan idle speed between 25% & 60% of fan rating. Enables the user to activate/deactivate low temperature safety feature. Temp control range is 55°F to 95°F. 6 foot temp probe is accurate to within 2°F. 6 Amps maximum/120 Volts/60 Hz. 2 Year Warranty.



EXCLUSIVE

Item No.	Description	MSRP
702760	Titan Controls Mercury 4 - Multi Function Fan Speed Controller	\$119.95

Titan Controls® Nyx® 1 - Day/Night Photocontroller



Activate your lamp cooling fan, light mover or night exhaust fan with this straightforward, easy to use controller. Goes from DAY to NIGHT mode with a flip of the switch. 15 Amps maximum/120 Volts/60 Hz. 3 Year Warranty.



EXCLUSIVE

Item No.	Description	MSRP
702625	Titan Controls NYX 1 - Day/Night Photocontroller	\$115.95

Titan Controls® Kronus® 2 - Temperature & Humidity Plus CO2 Integration



Controls exhaust equipment to maintain temperature & humidity set points. Integrated CO2 outlet can activate/deactivate CO2 Controller (Atlas 1) during daytime hours based on temperature & humidity settings. Features programmable delay. 15 Amps maximum/120 Volts/60 Hz. 3 Year Warranty.



EXCLUSIVE

Item No.	Description	MSRP
702645	Titan Controls Kronus 2 - Temperature & Humidity Controller	\$369.95

Titan Controls® Kronus® 4 - Day/Night Temp & Humidity Controller with Night Outlet Plus CO2 Integration



Independent temperature and humidity outlets to control two different devices (i.e fan and dehumidifier). Now featuring programmable delay. Integrated CO2 outlet can activate/deactivate CO2 Controller (Atlas® 1) during daytime hours based on temperature settings. 15 Amps/120 Volts maximum/60 Hz. 3 Year Warranty.



EXCLUSIVE

Item No.	Description	MSRP
702655	Titan Controls Kronus 4 - Temperature & Humidity Controller w/ Night Outlet	\$424.95



Temperature and Humidity



Titan Controls® Saturn® 3 - Digital Temperature, Humidity & CO2 Controller



Temperature control (Day & Night) from 55°F to 95°F. Humidity control (Day & Night) from 20% to 80%. Built-in CO2 sensor and CO2 calibration features. Auxiliary heating and cooling options. 12 Amps maximum/120 Volts/60 Hz. 2 Year Warranty.



EXCLUSIVE

Item No.	Description	MSRP
702657	Titan Controls Saturn 3 - Digital Temperature, Humidity & CO2 Controller	\$674.95
702658	Titan Controls Saturn 3 - Auxiliary Output - 1 Unit	\$64.95
702659	Titan Controls Saturn 3 - Auxiliary Output - 2 Units	\$116.95

Titan Controls® Saturn® 4 - Digital Environmental Controller



The Saturn® 4 is a basic environmental controller. Will operate a CO2 controller, fan, dehumidifier and a night only device to keep your garden flourishing. Comes with a 15 ft remote sensor and a photocell for nighttime control. 15 Amps maximum/120 Volts/60 Hz. 2 Year Warranty.



EXCLUSIVE

Item No.	Description	MSRP
702850	Titan Controls Saturn 4 - Digital Environmental Controller	\$171.95

Titan Controls® Saturn® 5 - Digital Environmental Controller with CO2 Timer



Digitally based environmental controller featuring a short cycle timer for CO2 enrichment. It uses a 15 ft remote sensor to operate your temp., humidity, CO2 system & night time gear. Has a LCD display & color coded push buttons for easy programming. Offers min/max data-logging capabilities for temp. & humidity. 15 Amps maximum/120 Volts/60 Hz. 2 Year Warranty.



EXCLUSIVE

Item No.	Description	MSRP
702851	Titan Controls Saturn 5 - Digital Environmental Controller w/ CO2 Timer	\$236.95

Titan Controls® Saturn® 6 - Digital Environmental Controller with CO2 PPM Control



Control of your temperature (day & night), humidity and CO2 PPM levels with digital accuracy. Comes with a 15 ft remote sensor which also features a photocell. LCD display and push buttons allow you to easily change the settings. Has min/max data logging capabilities. 15 Amps maximum/120 Volts/60 Hz. 2 Year Warranty.



EXCLUSIVE

Item No.	Description	MSRP
702852	Titan Controls Saturn 6 - Digital Environmental Controller with CO2 PPM Control	\$617.95
702494	Titan Controls Saturn 6 RS45 Cable & Software	\$71.95

Titan Controls® Eos® 1 - Humidify/Dehumidify Controller



Precise humidity control with a 20%-90% range. Change from humidification to dehumidification with a flip of a switch. Controls a humidifier, dehumidifier or fan. Grounded piggy-back cord. 15 Amps maximum/120 Volts/60 Hz. 3 Year Warranty.



EXCLUSIVE

Item No.	Description	MSRP
702605	Titan Controls Eos 1 - Humidify/Dehumidify Controller	\$128.95

Titan Controls® Zephyr™ 1 - Day/Night Temp Controller



Temperature control range is 55°F to 95°F. Controls cooling or heating equipment. Day and night settings keep temperature within 4°F of set point. 6 ft temp probe is accurate to within 2°F. 15 Amps/120 Volts/60 Hz. 2 Year Warranty.



EXCLUSIVE

Item No.	Description	MSRP
702630	Titan Controls Zephyr 1 - Day/Night Temp Controller	\$89.95

Titan Controls® Zephyr™ 3 - Heating/Cooling Controller



Precise temp control of your cooling and heating equipment. 40°F to 100°F gives the operator a great range of settings. Change from Heating to Cooling with just a flip of the switch. Discrete green power light indicates operation of equipment. Built in 4°F split differential. 15 Amps maximum/120 Volts/60 Hz. 3 Year Warranty.



EXCLUSIVE

Item No.	Description	MSRP
702845	Titan Control Zephyr 3 - Cooling/Heating Controller	\$92.95

Titan Controls® Zephyr™ 4 - Cooling Thermostat - Fan Control



Easy to use - plug fan into receptacle, then plug control into 120 volt power supply. Set thermostat to the temperature you want the fan to come on at and that's it! 13 Amps maximum/120 Volts/60 Hz. 1 Year Warranty.

EXCLUSIVE

Item No.	Description	MSRP
736167	Titan Controls Zephyr 4 - Cooling Thermostat Fan Control	\$79.95

TITAN CONTROLS® PRODUCT COMPARISON CHART

PURPOSE	SUNLIGHT SUPPLY / TITAN CONTROLS			HYDROFARM / C.A.P. CONTROLS			HYDROFARM / AUTOPILOT			DI. WHOLESALE / I.T.L. CONTROLS			SENTINEL / GPS			B.W.C.S. / BLUEPRINT CONTROLS		
	ITEM #	PRODUCT NAME	FUNCTION	ITEM #	PRODUCT NAME/FUNCTION	ITEM #	PRODUCT NAME / FUNCTION	ITEM #	PRODUCT NAME / FUNCTION	ITEM #	PRODUCT NAME / FUNCTION	ITEM #	PRODUCT NAME / FUNCTION	ITEM #	PRODUCT NAME / FUNCTION	ITEM #	PRODUCT NAME / FUNCTION	ITEM #
CO2	702710	CO2 Regulator	CO2 Regulator w/ Solenoid & Tubing	CAREG1	CO2 Regulator	COSYS20	CO2 Regulator w/ Timer	202200	Gro 1 CO2 Regulator	CO2-REG	CO2 Regulator w/ Solenoid & Tubing	BCR601	BCR-1 CO2 Regulator					
	702715	CO2 Heater	In-Line CO2 Heater	N/A	N/A	N/A	N/A	N/A	N/A	N/A	N/A	N/A	N/A					
	702615	Atlas 1	CO2 Monitor/Controller	CAPPM2A	Fuzzy Logic CO2 Controller, Complete w/ PPM Sensor	APCEC0D	Digital CO2 Controller Fuzzy Logic	202005	CO2 Air	CPPM-4i	CO2 Controller w/ Fuzzy Logic	BDCG601	BDDC-1 Digital CO2 Controller					
	702618	Atlas 2	Preset CO2 Monitor/Controller	N/A	N/A	N/A	N/A	N/A	N/A	N/A	N/A	N/A	N/A					
	702608	Atlas 3	Day or Night CO2 Monitor/Controller	CAPPM2A	Fuzzy Logic CO2 Controller, Complete w/ PPM Sensor	APCEC0D	Digital CO2 Controller Fuzzy Logic	202005	CO2 Air	CPPM-4i	CO2 Controller w/ Fuzzy Logic	BDCG601	BDDC-1 Digital CO2 Controller					
	702610	Atlas 4	2 Area CO2 Monitor/Controller	N/A	N/A	N/A	N/A	N/A	N/A	N/A	N/A	N/A	N/A					
	702611	Atlas 5	Portable Handheld CO2 Temp/Humidity Monitor	N/A	N/A	N/A	N/A	N/A	N/A	N/A	N/A	N/A	N/A					
	702613	Atlas 6	Wall/Desk Mount CO2 Temp/Humidity Monitor	N/A	N/A	N/A	N/A	N/A	N/A	N/A	N/A	N/A	N/A					
	702614	Atlas 7	CO2 PPM Monitor/Controller	N/A	N/A	N/A	N/A	N/A	N/A	N/A	N/A	N/A	N/A					
	702853	Atlas 8	CO2 Controller w/ Fuzzy Logic	CAPPM2A	Fuzzy Logic CO2 Controller, Complete w/ PPM Sensor	APCEC0D	Digital CO2 Controller Fuzzy Logic	202005	CO2 Air	CPPM-4i	CO2 Controller w/ Fuzzy Logic	BDCG601	BDDC-1 Digital CO2 Controller					
	702857	Ares 2 LP	Two Burner LP CO2 Generator	N/A	N/A	N/A	N/A	N/A	N/A	N/A	N/A	N/A	N/A					
	702858	Ares 2 NG	Two Burner NG CO2 Generator	N/A	N/A	N/A	N/A	N/A	N/A	N/A	N/A	N/A	N/A					
	702861	Ares 4 LP	Four Burner LP CO2 Generator	N/A	N/A	N/A	N/A	N/A	N/A	N/A	N/A	N/A	N/A					
	702862	Ares 4 NG	Four Burner NG CO2 Generator	N/A	N/A	N/A	N/A	N/A	N/A	N/A	N/A	N/A	N/A					
	702863	Ares 4 HA LP	High Altitude Four Burner LP CO2 Generator	N/A	N/A	N/A	N/A	N/A	N/A	N/A	N/A	N/A	N/A					
	702865	Ares 8 LP	Eight Burner LP CO2 Generator	N/A	N/A	N/A	N/A	N/A	N/A	N/A	N/A	N/A	N/A					
	702866	Ares 8 NG	Eight Burner NG CO2 Generator	N/A	N/A	N/A	N/A	N/A	N/A	N/A	N/A	N/A	N/A					
	702867	Ares 8 HA LP	High Altitude Eight Burner LP CO2 Generator	N/A	N/A	N/A	N/A	N/A	N/A	N/A	N/A	N/A	N/A					
	702869	Ares 10 LP	Ten Burner LP CO2 Generator	N/A	N/A	N/A	N/A	N/A	N/A	N/A	N/A	N/A	N/A					
	702870	Ares 10 NG	Ten Burner NG CO2 Generator	N/A	N/A	N/A	N/A	N/A	N/A	N/A	N/A	N/A	N/A					
702871	Ares 10 HA LP	High Altitude Ten Burner LP CO2 Generator	N/A	N/A	N/A	N/A	N/A	N/A	N/A	N/A	N/A	N/A						
702872	Ares 10 HA NG	High Altitude Ten Burner NG CO2 Generator	N/A	N/A	N/A	N/A	N/A	N/A	N/A	N/A	N/A	N/A						
TIMING	702740	Apollo 2	Recycle timer w/ PhotoCell	CAART-DNE	Adjustable Recycle Timer	APCTART	Analog 24-Hour Recycling Timer	205001	Stage 1	BRT-1AHR PB	Basic Recycle Timer High Range	BCT601	BCT-1 Cycle Timer					
	702635	Apollo 3	Fixed Cycle Timer 1 ON/4 OFF	CANFT1	Non-Adjustable Timer 1 Min On/4 Min Off	N/A	N/A	N/A	N/A	N/A	N/A	N/A	N/A					
	734110	Apollo 6	120 Volt 24 Hour Analog Timer - 1 Outlet	N/A	N/A	TM01015	120 Volt 24 Hour Analog Timer - 1 Outlet	710002	120 Volt Single Outlet Mechanical Timer	N/A	N/A	BMT601	BMT-1 Mechanical Timer 120 Volt - 1 Outlet					
	734112	Apollo 7	120 Volt 24 Hour Digital Timer - 1 Outlet	N/A	N/A	TM01715	120 Volt 24 Hour Digital Timer - 1 Outlet	710013	120 Volt Single Outlet Digital Timer	N/A	N/A	BDT601	BDT-1 Digital Timer 120 Volt - 2 Outlet					
	734100	Apollo 8	120 Volt 24 Hour Analog Timer - 2 Outlet	N/A	N/A	TM01015D	120 Volt 24 Hour Analog Timer - 2 Outlet	710001	120 Volt Dual Outlet Mechanical Timer	N/A	N/A	BMT602	BMT-2 Mechanical Timer 120 Volt - 1 Outlet					
	734105	Apollo 9	120 Volt 24 Hour Digital Timer - 2 Outlet	N/A	N/A	TM01715D	120 Volt 24 Hour Digital Timer - 2 Outlet	710010	120 Volt Dual Outlet Digital Timer	N/A	N/A	BDT602	BDT-2 Digital Timer 120 Volt - 2 Outlet					
	734145	Apollo 10	240 Volt 24 Hour Analog Timer - 1 Outlet	N/A	N/A	TM01240	240 Volt 24 Hour Analog Timer - 1 Outlet	710005	240 Volt Single Outlet Mechanical Timer	N/A	N/A	N/A	N/A					
	734155	Apollo 11	240 Volt 24 Hour Digital Timer - 1 Outlet	N/A	N/A	N/A	N/A	710015	240 Volt Single Outlet Mechanical Timer	N/A	N/A	BDT621	BDT-1C Digital Timer 120 Volt - 1 Outlet					
	702745	Apollo 12	Short Cycle Recycle Timer	N/A	N/A	N/A	N/A	N/A	N/A	BRT-1ALR PB	Basic Recycle Timer Low Range	N/A	N/A					
	734150	Apollo 14	8 Outlet Power Strip w/ 24-Hour Timer	N/A	N/A	TMSPB	8 Outlet Power Strip w/ 24-Hour Timer	710003	120 Volt Power Strip w/ Timer	N/A	N/A	SSEMT120	8 Outlet Power Strip w/ 24 Hour Timer					
	702896	Spartan Series	Recycle Adjustable Timer	CAART-DNE	Adjustable Recycle Timer	APCTART	Analog 24-Hour Recycling Timer	205001	Stage 1	BRT-1AHR PB	Basic Recycle Timer High Range	BCT601	BCT-1 Cycle Timer					

PURPOSE	ITEM #	PRODUCT NAME	SUNLIGHT SUPPLY / TITAN CONTROLS	HYDROFARM / C.A.P. CONTROLS	HYDROFARM / AUTOPILOT	DL WHOLESALE / I.T.L. CONTROLS	SENTINEL / GPS	B.W.G.S. / BLUEPRINT CONTROLS
		FUNCTION	ITEM #	PRODUCT NAME/FUNCTION	ITEM #	PRODUCT NAME/FUNCTION	ITEM #	ITEM #
VENTILATION	702625	Nyx 1	Day/Night Photocontroller	N/A	N/A	N/A	BPC-1A W/M	N/A
	702753	Mercury 2	Fan Speed Controller	N/A	N/A	206003	ITL Speed	N/A
	702755	Mercury 3	Day/Night Fan Speed Controller	CAVSC-DNE	Day/Night Adjustable Fan Speed Controller	206003	ITL Speed	N/A
	702760	Mercury 4	Multi-Function Fan Speed Controller	CAVSC-DNE	Day/Night Adjustable Fan Speed Controller	206003	ITL Speed	N/A
	702895	Spartan Series Fan Speed Controller	CATMPT	Cooling Thermostat	N/A	N/A	N/A	N/A
	702897	Spartan Series Cooling Controller	CAHUM1	Humidity Controller	N/A	N/A	N/A	N/A
	702605	Eos 1	Humidify/Dehumidify Controller	CATMP-DNE	Day/Night Cooling Thermostat	206002	ITL Temp	N/A
	702630	Zephyr 1	Day/Night Temp. Controller	CAHLC	Advanced HID Lighting Controller	N/A	N/A	N/A
	702750	Zephyr 2	High Temp. Shut-Off w/ Deby	CAHR3	Humidity Controller	N/A	N/A	N/A
	702865	Zephyr 3	Analog Heating/Cooling Controller	CAHR4	Atmosphere Controller, Temp. & Humidity	N/A	N/A	N/A
Temp. & HUMIDITY	702645	Kronus 2	Temp., Humidity & CO2 Controller	CAHR3	Atmosphere Controller, Temp. & Humidity	N/A	N/A	N/A
	702655	Kronus 4	Day/Night Temp., Humidity & CO2 Controller	CAHR4	Atmosphere Controller, Temp. & Humidity	203002	Element 2	N/A
	702657	Saturn 3	Day/Night Temp., Humidity & CO2 PPM Controller	N/A	N/A	203003	Element 3	N/A
	702850	Saturn 4	Digital Environmental Controller	CAHR4	Atmosphere Controller, Temp. & Humidity	203001	Element 1	N/A
	702851	Saturn 5	Digital Environmental Controller w/ CO2 Timer	CAHGC1	Complete Greenhouse Controller w/ PPM Option	203002	Element 2	N/A
	702852	Saturn 6	Digital Environmental Controller w/ CO2 PPM Control	N/A	N/A	203003	Element 3	N/A
	734135	Apollo 4	ETL Listed 120V In-Line Lighting Timer	N/A	N/A	N/A	N/A	N/A
	734140	Apollo 5	240V In-Line Lighting Timer	N/A	N/A	N/A	N/A	N/A
	702890	Hades 1	15 Minute Lighting Delay Timer	N/A	N/A	N/A	N/A	N/A
	702856	Hades 2	Recycle & Light Timer w/ High Temp Shut-Off	N/A	N/A	205003	Stage 3	N/A
LIGHTING	702621	Hades 3	Light Timer w/ High Temp Shut-Off	N/A	N/A	N/A	N/A	N/A
	702660	Helios 1	ETL Listed 120V - 4 Light Controller w/ Timer	N/A	N/A	N/A	N/A	N/A
	702665	Helios 2	ETL Listed 120V - 4 Light Controller w/ Relay Trigger	N/A	N/A	N/A	N/A	N/A
	702670	Helios 3	240V - 4 Light Controller w/ Timer	N/A	N/A	N/A	N/A	N/A
	702675	Helios 4	240V - 4 Light Controller w/ Relay Trigger	N/A	N/A	N/A	N/A	N/A
	702761	Helios 5	ETL Listed 240V - 4 Light Controller w/ Timer	N/A	N/A	N/A	N/A	N/A
	702762	Helios 6	ETL Listed 240V - 8 Light Controller w/ Relay Trigger	N/A	N/A	N/A	N/A	N/A
	702676	Helios 7	240V - 8 Light Controller w/ Timer	N/A	N/A	N/A	N/A	N/A
	702677	Helios 8	240V - 8 Light Controller w/ Dual Relay Trigger	N/A	N/A	N/A	N/A	N/A
	702678	Helios 9	240V - 4 Light Controller w/ Relay Trigger	N/A	N/A	N/A	N/A	N/A
POWER	702679	Helios 10	240V - 8 Light Controller w/ Relay Trigger	N/A	N/A	N/A	N/A	N/A
	702820	Helios 11	Classic Series 240V - 4 Light Controller w/ Relay Trigger	N/A	N/A	N/A	N/A	N/A
	702835	Helios 12	Classic Series 240V - 8 Light Controller w/ Relay Trigger	N/A	N/A	N/A	N/A	N/A
	702838	Helios 13	ETL Listed 240V - 16 Light Controller w/ Timer	N/A	N/A	N/A	N/A	N/A
	702832	Helios 14	ETL Listed 240V - 24 Light Controller w/ Timer	N/A	N/A	N/A	N/A	N/A
	702775	Helios 15	ETL Listed 240V - 8 Light Controller w/ Timer	N/A	N/A	N/A	N/A	N/A
	702835	Helios 16	ETL Listed 240V - 16 Light Controller w/ Dual Trigger Cords	CAMLC16	Master Lighting Controller 16 Light 240V w/ Trigger	N/A	N/A	N/A
	702840	Helios 17	ETL Listed 240V - 24 Light Controller w/ Dual Trigger Cords	CAMLC24D	Master Lighting Controller 24 Light 240V w/ Dual Trigger	N/A	N/A	N/A
	702843	Helios 18	240V - 12 Light Controller w/ Dual Triggers	N/A	N/A	N/A	N/A	N/A
	702899	Spartan Series 4 Light Controller - 240V	N/A	N/A	APCLC12DX	Commercial High Power HID Controller 12 Light	N/A	N/A
702898	Spartan Series 8 Light Controller - 240V	N/A	N/A	APCL4DX	High Power HID Controller 120V/240V 30A	270004	Master 4	
702770	Hercules 2	High Amperage Relay Controller - 50 Amps	N/A	N/A	APCL8DX	High Power HID Controller 120V/240V 60A	270008	Master 8
702773	Hercules 3	Power Expander - 15 Amps	N/A	N/A	N/A	N/A	N/A	

Titan Controls® Spartan Series™ Fan Speed Controller



NEW The Fan Speed Controller features:  Day & night temperature settings from 50°F to 100°F, variable fan idle mode settings, LED output indicator light and an accurate external temperature probe. For use with carbon filters and air filter systems. Housed in a rust, dust and water resistant plastic enclosure, this controller will function in the roughest environments. Ratings: 5 Amps maximum/120 Volts/60 Hz. 1 Year Warranty.

EXCLUSIVE

Item No.	Description	MSRP
702895	Titan Controls - Spartan Series Fan Speed Controller	\$89.95

Titan Controls® Spartan Series™ Recycle Adjustable Timer



NEW The Recycle Adjustable Timer features:  1 minute to 60 minutes 'ON' time, 5 minute to 12 hour 'OFF' time, LED indicator light, and adjustable 'ON' modes for day, night or both use. For use with pumps, fans or CO2 systems. Housed in a rust, dust and water resistant plastic enclosure, this controller will function in the toughest environments. Ratings: 12 Amps maximum/120 Volts/60 Hz. 1 Year Warranty.

EXCLUSIVE

Item No.	Description	MSRP
702896	Titan Controls - Spartan Series Recycle Adjustable Timer	\$74.95

Titan Controls® Spartan Series™ Repeat Cycle Timer



NEW The Spartan™ Series Repeat Cycle  Timer is an easy to use and reliable product. It features a 5 second to 30 minute ON time, a 5 second to 60 minute OFF time and adjustable modes for day, night or 24 hours. Designed to precisely control pumps, CO2 systems and fans. The Repeat Cycle Timer is cULus listed and features a durable plastic housing. 15 Amps maximum/120 Volts/60 Hz. 1 Year Warranty.

EXCLUSIVE

Item No.	Description	MSRP
702894	Titan Controls - Spartan Series Repeat Cycle Timer	\$44.95

Titan Controls® Spartan Series™ Cooling Controller



NEW The Cooling Thermostat features:  Day & night temperature settings, adjustable differential from +/- 2°F to +/- 6°F, LED output indicator light and an accurate external temperature probe. For use with exhaust fans. Housed in a rust, dust and water resistant plastic enclosure, this controller will function in the harshest environments. Ratings: 12 Amps maximum/120 Volts/60 Hz. 1 Year Warranty.

EXCLUSIVE

Item No.	Description	MSRP
702897	Titan Controls - Spartan Series Cooling Controller	\$74.95

Titan Controls® Spartan Series™ 4 Light 240 Volt Controller



NEW The 4 light controller operates up to 4000 Watts of grow lights in your garden. It features: heavy duty definite purpose contactor, trigger cord set that activates your lights via an external wall timer and universal outlets that allow the use of 120 Volt or 240 Volt cord sets. The controller is housed in a rust, dust and moisture proof enclosure. 30 Amps input power/20 Amps output power/240 Volts/60 Hz./4000 Watts. 1 Year Warranty.  **EXCLUSIVE**

Item No.	Description	MSRP
702898	Titan Controls - Spartan Series 4 Light Controller - 240 Volt	\$124.95

Titan Controls® Spartan Series™ 8 Light 240 Volt Controller



NEW The 8 light controller operates up to 8000 Watts of grow lights in your garden. It features: heavy duty definite purpose contactors, dual trigger cord sets that give you the flexibility to stagger lighting schedules or delay starting times via an external wall timer and universal outlets that allow the use of 120 Volt or 240 Volt cord sets. The controller is housed in a rust, dust and moisture proof enclosure. 50 Amps input power/40 Amps output power/240 Volts/60 Hz./8000 Watts. 1 Year Warranty.  **EXCLUSIVE**

Item No.	Description	MSRP
702899	Titan Controls - Spartan Series 8 Light Controller - 240 Volt	\$209.95

MyCO₂

MyCO₂ Mushroom Bags



MyCO₂ – Mycelium Derived Carbon Dioxide are CO₂ bags perfected. MyCO₂ has the patent pending customer activation technology, postponing the CO₂ cultivation until you get it home and are ready to use it. Use during the Bloom during the flowering stage. Use during Grow during the veg stage.

Item No.	Description	MSRP
749400	MyCO ₂ Mushroom Bag - Bloom	\$34.95
749405	MyCO ₂ Mushroom Bag - Grow	\$34.95

Grozone Control

Grozone Control TP1 Day/Night Tempstat



Controls cooling or heating equipment according to a daytime or nighttime setpoint. 6 foot cord with temperature sensor precise to 2°F/1°C. Can power 120V equipment up to 15 amps. Typical control differential 2°F/1°C. 3 year Warranty. 

Item No.	Description	MSRP
780100	Grozone Control TP1 Day/Night Tempstat	\$89.95

Grozone Control TP2 Adjustable Differential Tempstat



Controls cooling or heating equipment according to a setpoint and an adjustable differential from 4°F to 20°F/2°C to 11°C. 6 foot cord with temperature sensor precise to 2°F/1°C. Can power 120V equipment up to 15 amps. 3 year Warranty.



Item No.	Description	MSRP
780101	Grozone Control TP2 Adjustable Differential Tempstat	\$89.95

Grozone Control TP3 High Temperature Shut-Off Tempstat



Automatically shuts down lighting and/or other equipment when a high temperature setpoint is reached. 6 foot cord with temperature sensor precise to 2°F/1°C. Can power 120V equipment up to 15 amps. 3 year Warranty.



Item No.	Description	MSRP
780102	Grozone Control TP3 High Temperature Shut-Off Tempstat	\$89.95

Grozone Control CY1 Cyclestat with Day/Night Sensor



Controls any 120V equipment such as pumps or fans on a periodic repeat cycle. The ON duration spans from 10 sec to 20 minutes. The OFF duration spans from 1 minutes to 12 hours. The unit can function day and night or during day time only. 3 year Warranty.



Item No.	Description	MSRP
780103	Grozone Control CY1 Cyclestat with Day/Night Sensor	\$89.95

Grozone Control CY2 Short Period Cyclestat with Day/Night Sensor



Controls any 120V equipment such as pumps or fans on a periodic repeat cycle. The ON duration spans from 5 sec to 30 minutes. The OFF duration spans from 5 sec to 60 minutes. The unit can function day and night or during day time only. 3 year Warranty.



Item No.	Description	MSRP
780104	Grozone Control CY2 Short Period Cyclestat w/ Day/Night Sensor	\$89.95

Grozone Control CY3 Digital Cyclestat with Day/Night Sensor and Bargraph Display



Controls any 120V equipment such as pumps or fans on a periodic repeat cycle. Features day and night distinct cycles. Displays time countdown on bargraph readout. The ON duration spans from 5 sec to 60 minutes. The OFF duration spans from 1 minutes to 12 hours. 3 year Warranty.



Item No.	Description	MSRP
780105	Grozone Control CY3 Digital Cyclestat with Day/Night Sensor & Bargraph Display	\$174.95

Grozone Control TV1 Day/Night Fan Speed Control



Automatically slows down or speeds up centrifugal fans to respect user selected temperature day and night setpoints. TV1 will yield a variation below 2°F/1°C. 6 foot cord with temperature sensor precise to 2°F/1°C. Can drive single phase 120 V induction motor type fans up to 750 Watts. 3 year Warranty.



Item No.	Description	MSRP
780106	Grozone Control TV1 Day/Night Fan Speed Control	\$119.95

Grozone Control TV2 Multimode Fan Speed Control



Automatically slows down or speeds up centrifugal fans to respect user selected temperature setpoints. Enables the user to select the minimum fan speed (Idle Speed) between 25% and 60% of full power in 5% steps. 6 ft cord with temperature sensor precise to 2°F/1°C. Can drive single phase 120 V induction motor type fans up to 750 Watts. 3 year Warranty.



Item No.	Description	MSRP
780107	Grozone Control TV2 Multimode Fan Speed Control	\$119.95

Grozone Control DIM1 Fan Speed Dimmer with Optional Kick Start



Manual setting to slow down centrifugal fan speed between 10% and 100% of full power. Enables the user to activate/deactivate a 'Kick start' at power up or power failure return, to improve larger fan start-up. Can drive single phase 120 V induction motor type fans up to 750 Watts. 3 year Warranty.



Item No.	Description	MSRP
780108	Grozone Control DIM1 Fan Speed Dimmer w/ Optional Kick Start	\$77.95

Grozone Control OSW On/Off 120V Switcher (Trigger Cord)



Can turn on or shut off any piece of equipment by mean of a low-current 120V sense cord. On/Off switching functions (upper/lower receptacles) in one single module for increased flexibility. 3 year Warranty.



Item No.	Description	MSRP
780109	Grozone Control OSW On/Off 120 Volt Switcher (Trigger Cord)	\$67.95

Grozone Control OSWDN On/Off 120V Switcher (Day/Night Sensor)



The new OSWDN 120V switcher can turn on or shut off your equipment according to the day/night condition instead of the trigger cord voltage. The photocell sensitivity can also be adjusted to modify the Day/Night threshold level for dark days or clear nights conditions. 3 year Warranty.



Item No.	Description	MSRP
780110	Grozone Control OSWDN On/Off 120 Volt Switcher (Day/Night Sensor)	\$89.95

Grozone Control SCO2 0-5000 PPM CO2 Controller "Simple One Series"



This easy to use CO2 controller determines precisely when to activate and shut-off CO2 generators to maintain user-defined LOW and HIGH CO2 values in the grow room. The unit can deactivate CO2 enrichment during the night cycle and perform CO2 evacuation as well. The CO2 sensor is located in the controller box. 3 year Warranty.



Item No.	Description	MSRP
780111	Grozone Control SCO2 0-5000 PPM CO2 Controller - Simple One Series	\$499.95

Grozone Control CO2R 0-5000 PPM CO2 Controller with AUX Output and High Temp



This easy to use CO2 controller determines precisely when to activate and shut-off CO2 generators to maintain user-defined LOW and HIGH CO2 values in the grow room. The unit can deactivate CO2 enrichment during the night cycle and perform CO2 evacuation as well. NEW: the CO2R now includes a High Temperature Shut Off. 3 year Warranty.



Item No.	Description	MSRP
780112	Grozone Control CO2R 0-5000 PPM CO2 Controller w/ AUX Output & High Temp	\$574.95

Grozone Control CO2D 0-5000 PPM Dual Zone CO2 Controller



Controls the CO2 levels in two zones simultaneously. Review performance by reading through the integrated 24-hour data logger. Special operating mode to operate two zones with only one CO2 generator. Zone remote sensors include 25 ft cables. Affordable alternative when operating multiple zones. 3 year Warranty.



Item No.	Description	MSRP
780113	Grozone Control CO2D 0-5000 PPM Dual Zone CO2 Controller	\$888.95

Grozone Control USCO2 0-2000 PPM Single Zone Ultra Simple CO2 Controller



No bells and whistles, just connect your CO2 generator and you're set! This is Grozone's beginner solution for growers looking for affordable and easy-to-use CO2 controller. User can select one among five preset CO2 control values. User can select one among five preset Elevation values. 3-LED Display shows ambient CO2 value. Day/Night detection to turn off CO2 enrichment during the night. 3 year Warranty.



Item No.	Description	MSRP
780114	Grozone Control USCO2 0-2000 PPM Single Zone Ultra Simple CO2 Controller	\$274.95

Grozone Control HTC Climate Controller (Temp, rH and CO2) Two Outputs with Digital Display



Remote sensor provides higher precision and reliability. Performs any two of the following control functions: heating, cooling, humidifying, dehumidifying, cooling and dehumidifying, hourly ventilation. Review performance by reading through the integrated 24-hour data logger. Incorporates fail-safe values for each output in case of sensor problem. 3 year Warranty.



Item No.	Description	MSRP
780115	Grozone Control HTC Climate Controller (Temp, RH, & CO2) Two Outputs w/ Digital Display	\$674.95

Grozone Control SCC1 Temperature, Humidity and CO2 Controller "Simple One Series"



An easy-to-use alternate solution to HTC Climate Controller: just connect your fan, your dehumidifier or humidifier, your CO2 generator, set the knobs and you're ready! Two built-in LVC1 to control high power HVAC Systems. Also includes these smart features: Empty CO2 tank detection, Automatic competing equipment detection and high temp and low temp limits. 3 year Warranty.



Item No.	Description	MSRP
780116	Grozone Control SCC1 Temperature, Humidity, & CO2 Controller - Simple One Series	\$674.95

Grozone Control HT2 Climate Controller (Temp and rH) Single Output Bargraph Display



Day and night temperature settings: 48°F to 104°F. Day and night humidity settings: 10% to 100%. User can select one among five operating modes. User-set low-temperature limit. Remote sensor with 25 ft cable (included). Bargraph display. 15 Amps Output. 3 year Warranty.



Item No.	Description	MSRP
780117	Grozone Control HT2 Climate Controller (Temp & RH) Single Output Bargraph Display	\$224.95

Grozone Control LVCT1 Low Voltage Contact Module



NEW This module is designed to interface any 120V Output to Air Conditioning/Heating Low Voltage Control Inputs. Grozone Controller Outputs are ALL 120V Outputs (eg. Timer CY1, Thermostat TP1, Climate Controller HTC, CO2 Controller SCO2). Should you need to control any system whose inputs are not compatible with Grozone Controller Outputs, you must use this module and refer to the connection diagram in the user guide of the system you want to control. 3 Year Warranty.



Item No.	Description	MSRP
780118	Grozone Control LVC1 Low Voltage Contact Module	\$40.95

Grozone Garden Controls Cycle Timer



NEW The Cycle Timer controls any 120V equipment such as irrigation pumps, fogger, fans or CO2 generators on periodic cycles. The output is repeatedly turned ON and OFF for periods corresponding to the ON and OFF times. On time from 1 to 60 minutes. Off time from 5 minutes to 12 hours. 3 position slide switch: Day-Day cycle only, 24 Hour Day and Night cycles and Night-Night cycle only. 1 Year Warranty.



Item No.	Description	MSRP
703370	Grozone Garden Controls Cycle Timer	\$69.95

Grozone Garden Controls Fan Controller



NEW The Fan Controller automatically slows down or speeds up centrifugal fans to maintain the room temperature at a value corresponding to the day or night set points. Day and Night temperature set points: 50°F to 100°F. 3 position slide switch to select idle options: Idle Off-Fan will stop when set point is reached, Idle On-Fan maintains minimum (idle) speed when room temperature is equal or cooler than set point, Idle On with Low Temperature-Fan maintains minimum speed (idle) when



room temperature is equal or cooler than set point but fan will stop if room temperature gets cooler than 10°F below set point. 1 Year Warranty.

Item No.	Description	MSRP
703372	Grozone Garden Controls Fan Controller	\$79.95

Grozone Garden Controls Cooling Thermostat



NEW The Cooling Thermostat controls cooling fans to maintain the room temperature at a value corresponding to the day or night set points. Day & Night Temperature Set Points: 50°F to 100°F (10°C to 38°C). 3-position slide switch to select differential: +/- 2°F: Fan will start 2°F above set point and will stop 2°F below set point, +/- 4°F: Fan will start 4°F above set point and will stop 4°F below set point and +/- 6°F: Fan will start 6°F above set point and will stop 6°F below set point. 1 Year Warranty.



Item No.	Description	MSRP
703371	Grozone Garden Controls Cooling Thermostat	\$74.95

Grozone Garden Controls Light Timer



NEW The Light Timer controls either lighting systems with a trigger cord, or standard and electronic ballasts (two 600W or one 1000W at 120V). Day cycles (ON cycles) last 12 or 18 hours, as selected by the user. An internal rechargeable battery maintains the cycles in the event of a power outage. 3 position slide switch to select on/off cycles (corresponding to Day/Night cycles). Features 18 and 12 hour light schedules with a reset position to start a new ON cycle. 1 Year Warranty.



Item No.	Description	MSRP
703373	Grozone Garden Controls Light Timer	\$72.95

Agrowtek Controllers

Agrowtek Grow Control GC-Pro Climate & Hydro Controller



NEW Agrowtek's GC-Pro controls up to three climate zones and two nutrient reservoirs. Complete control of temperature, humidity, lighting, CO2 (sensor optional), timers, dosing, irrigation and more! Includes two sensor ports, four discrete inputs, twelve outputs for relays and one basic climate sensor. Serial & Ethernet ports for free remote monitoring software. Up



to three (3) climate zones, two (2) zones each with hydroponics dosing for up to eight (8) parts plus two (2) pH. 3 Year Warranty.

EXCLUSIVE

Item No.	Description	MSRP
703100	Agrowtek Grow Control GC-Pro Climate & Hydro Controller (Includes basic climate sensor & ethernet port)	\$2,028.00

Agrowtek Grow Control GC-Pro-Q Quad-Zone Climate Controller



NEW Agrowtek's GC-Pro controls up to four climate zones. Complete control of temperature, humidity, lighting, CO2 (sensor optional), timers, irrigation and more! Includes two sensor ports, four discrete inputs, twelve outputs for relays and one basic climate sensor. Serial & Ethernet ports for free remote monitoring software. Up



to four (4) climate zones with basic climate, lighting and timer controls (no dosing controls). 3 Year Warranty.

EXCLUSIVE

Item No.	Description	MSRP
703102	Agrowtek Grow Control GC-Pro Quad-Zone Climate Controller (Includes basic climate sensor & ethernet port)	\$2,028.00

Agrowtek Grow Control GC-ProXL Climate & Hydro Controller



NEW Agrowtek's GC-ProXL-E controls up to three climate zones and two nutrient reservoirs. Same great features as GC-Pro, with expanded hardware to handle more sensors and relays. Includes four sensor ports, eight discrete inputs, sixteen outputs for relays and one basic climate sensor. Serial & Ethernet ports for free remote monitoring software. Up to three (3) climate



zones, two (2) zones each with hydroponics dosing for up to eight (8) parts plus two (2) pH. 3 Year Warranty.

EXCLUSIVE

Item No.	Description	MSRP
703104	Agrowtek Grow Control GC-ProXL Climate & Hydro Controller (Includes basic climate sensor & ethernet port)	\$2,678.00

Agrowtek Grow Control GC-ProXL-Q Quad-Zone Controller



NEW Agrowtek's GC-ProXL-Q-E controls up to four climate zones. Same great features as GC-Pro-Q with expanded hardware to handle more sensors and relays. Includes four sensor ports, eight discrete inputs, sixteen outputs for relays and one basic climate sensor. Serial & Ethernet ports for free remote monitoring software. Up to four (4) climate zones with basic



climate, lighting and timer controls (no dosing controls). 3 Year Warranty.

EXCLUSIVE

Item No.	Description	MSRP
703106	Agrowtek Grow Control GC-ProXL Quad-Zone Controller (Includes basic climate sensor & ethernet port)	\$2,678.00

Agrowtek 8 Output Expansion XD



NEW XD Eight-output expansion module for Agrowtek's GC-Pro and GC-ProXL series controllers. Add eight more outputs to GrowControl™ controllers by installing an XD module. GC-Pro controllers accept up to one XD module; GC-ProXL controllers accept up to three XD modules. 3 Year Warranty.



EXCLUSIVE

Item No.	Description	MSRP
703108	Agrowtek 8 Output Expansion	\$199.00

Agrowtek 2 port Analog Input Expansion XA



NEW XA dual sensor-port expansion module for Agrowtek's GC-Pro and GC-ProXL series controllers. Add two more sensor ports to GrowControl™ controllers by installing an XA module. GC-Pro and GC-ProXL controllers accept up to one XA module. 3 Year Warranty.



EXCLUSIVE

Item No.	Description	MSRP
703110	Agrowtek 2 Port Analog Input Expansion (8 Channels)	\$399.00

Agrowtek AgrowTouch Color Touch Screen AT-PRO & AT-XL



NEW Add bright, colorful display of sensor readings and quickly access control settings and manual overrides to GC-Pro and GC-ProXL controllers with Agrowtek's AgrowTouch™ screens. Without a touch screen, controllers are configured by software. Screen installs into front panel of controller by removing knock-out panel. 3 Year Warranty.



EXCLUSIVE

Item No.	Description	MSRP
703112	Agrowtek AgrowTouch Color Touch Screen for GC-Pro	\$799.00
703114	Agrowtek AgrowTouch Color Touch Screen for GC-ProXL	\$799.00

Agrowtek Aspirated Indoor Climate Sensor SNS-C



NEW Precision aspirated climate sensors for Agrowtek's GrowControl™ series controllers provide temperature, humidity and light (irradiance W/m2) readings; optional CO2 ppm sensor module installs into climate sensor. Aspirator fan with cleanable filter ensures accurate sensor readings. Includes a 15 ft sensor cable. One climate sensor per



room. 1 Year Warranty.

EXCLUSIVE

Item No.	Description	MSRP
703116	Agrowtek Aspirated Indoor Climate Sensor (Temp/RH/Light)	\$249.00

Agrowtek CO2 Upgrade Kit for Climate Sensor SNS-CO2



NEW Carbon dioxide ppm sensor module installs into Agrowtek's climate sensors for GrowControl™ series controller's automatic CO2 injection and ventilation control features. Sensing range: 0-5000 ppm with automatic self-calibration. 1 Year Warranty.



EXCLUSIVE

Item No.	Description	MSRP
703118	Agrowtek CO2 Upgrade Kit for Climate Sensor	\$399.00

Agrowtek GrowControl Hydro Sensor Kit w/ Probes SNS-H



NEW GrowControl™ Hydroponics sensor kit includes pH, electrical conductivity and temperature sensors for monitoring nutrient reservoirs and operating dosing pumps for automatic nutrient and pH control. GC-Pro & GC-ProXL dose up to eight parts nutrients and two parts pH per kit for re-circulating and drain-to-waste systems. 15 ft sensor cable included. 1 Year Warranty.

EXCLUSIVE

Item No.	Description	MSRP
703120	Agrowtek Grow Control Hydro Sensor Kit w/ Probes (pH/EC/Temp)	\$599.00

Agrowtek Water Leak Detector Sensor SNS-LD



NEW Detect water leaks and take action automatically before they become floods! GrowControl™ systems monitor leak sensors connected to the controller's discrete inputs and can be placed on floors or under piping to detect water. Operate or disable equipment and be alerted with email/sms alerts from monitoring software. 1 Year Warranty.

EXCLUSIVE

Item No.	Description	MSRP
703122	Agrowtek Water Leak Detector Sensor	\$99.00

Agrowtek Replacement Sensor Probes pH, EC & Temp



NEW High quality lab-grade replacement probes for Agrowtek's hydroponics sensor kit. All come with a 3 ft waterproof cable. pH probe has a BNC connection. 0-14 pH measurement range. Electrical conductivity (EC) probe has tinned leads for terminal block connection. 0-5000 microSiemens measurement range. Temperature probe has tinned leads for terminal block connection. -40 – 145°F sensing range,

stainless steel probe sheath. 90 Day Warranty.

EXCLUSIVE

Item No.	Description	MSRP
703124	Agrowtek pH Probe	\$119.00
703126	Agrowtek EC Probe	\$149.00
703128	Agrowtek Temperature Probe	\$59.00

Agrowtek RX1 & RX6 Relay Outlets



NEW Relay-controlled outlet for equipment control with c_{us} GrowControl™ series controllers. The RX1 is a single outlet relay that plugs into a wall. RX6 has six independent relay outlets and each one is operated separately. Control power to plug connected devices such as fans, pumps, lighting box trigger cords, CO2 valves,

etc. Rated 120 Volt ac/15 Amps. 2 Year Warranty.

EXCLUSIVE

Item No.	Description	MSRP
703130	Agrowtek RX1 Single Relay Outlet 15A/120V	\$99.00
703132	Agrowtek RX6 Six Relay Outlet 15A/120V	\$249.00

Agrowtek CX4 Quad Outlet Contactor



NEW Four relay-controlled outlets for banked equipment control c_{us} with GrowControl™ series controllers. All four receptacles are operated simultaneously. Recommended for fans and small lighting loads. Rated at 120 Volt ac/15 Amps. 2 Year Warranty.

EXCLUSIVE

Item No.	Description	MSRP
703134	Agrowtek CX4 Quad Outlet Contactor 15A/120V	\$199.00

Agrowtek Dry-Contact Relays



NEW Four, six, eight or 12 c_{us} dry-contact pilot relays for equipment control with GrowControl™ series controllers. Normally open independent contacts allow control of customer relays, contactors and HVAC signals. Removable base-mounted relays for easy maintenance. Terminals rated 120 Volt ac/5 Amps. 2 Year

Warranty.

EXCLUSIVE

Item No.	Description	MSRP
703136	Agrowtek RD4 Four Dry-Contact Relays 24VDC/120VAC/5A	\$249.00
703138	Agrowtek RD6 Six Dry-Contact Relays 24VDC/120VAC/5A	\$269.00
703140	Agrowtek RD8 Eight Dry-Contact Relays 24VDC/120VAC/5A	\$289.00
703142	Agrowtek RD12 Twelve Dry-Contact Relays 24VDC/120VAC/5A	\$319.00

Agrowtek AgrowDose™ Dosing Pump AD-50



NEW AgrowDose™ dosing pump for c_{us} nutrient and pH buffer injection with GrowControl™ series controllers and hydroponics sensors. Heavy duty pumps draw concentrated nutrient or buffer from any size stock tank and pump into reservoirs. 3/16 in I.D. tubing and durable motor handles thick and thin liquids. Tubing adapters and power supply included. 1 Year Warranty.

EXCLUSIVE

Item No.	Description	MSRP
703144	Agrowtek AgrowDose Dosing Pump 46 ml/min	\$225.00

Agrowtek AgrowDose™ Dual Dosing Pump AD2-50



NEW Agrowtek's Dual dosing pump offers two independent dosing pumps in one economical, easy to install package. Simply place the suction end of each pump tube into any size nutrient or pH stock tank (may be located above or below the pump) and route the outlet of the pump to your reservoir, mixing tank or even pressurized lines up to 30psi! 1

Year Warranty.

EXCLUSIVE

Item No.	Description	MSRP
703188	Agrowtek AgrowDose Dual Dosing Pump 46ml/min	\$399.00

Agrowtek AgrowDose™ Quad Dosing Pump AD4-50



NEW AgrowDose™ Quad c_{us} dosing pump for nutrient and pH buffer injection with GrowControl™ controllers and hydroponics sensors. Four independent heavy-duty pumps in one enclosure with built-in relays for direct connection to a controller. Tubing adapters and power supply included. 1 Year Warranty.

EXCLUSIVE

Item No.	Description	MSRP
703146	Agrowtek AgrowDose Quad Dosing Pump 46 ml/min	\$799.00

Agrowtek Serial RS-232 to USB Converter



NEW USB to Serial adapter cable connects GrowControl™ controller's serial port to USB. Connect free GrowControl software to the controller's serial port, modify Ethernet IP address settings and perform firmware updates with the serial port. 1 Year Warranty.

EXCLUSIVE

Item No.	Description	MSRP
703148	Agrowtek Serial RS-232 (DB9) to USB Converter (FDTI)	\$38.00

Agrowtek Replacement Sensor Cables



NEW GrowControl™ replacement sensor cable, 15 ft (703150) male to male with molded plugs. GrowControl™ sensor extension cable, 15 ft (703152) or 50 ft (703154) male to female with molded plugs. 1 Year Warranty.

EXCLUSIVE

Item No.	Description	MSRP
703150	Agrowtek 15 ft Replacement Sensor Cable	\$6.00
703152	Agrowtek 15 ft Sensor Extension Cable	\$6.00
703154	Agrowtek 50 ft Sensor Extension Cable	\$18.00

Agrowtek Liquid Tight Gland Kit for Hydro Sensor Probes



NEW Water-proof probe gland kit for pH, conductivity and water temperature probes. Install sensor probes into a pipe or custom manifold for reliable, leak-free measurement. Pipe-thread glands have a polymer seal that clamps around the probes. pH and EC probe glands are 1/2 in NPT and temperature probe gland is 3/8 in NPT. 1 Year Warranty.

EXCLUSIVE

Item No.	Description	MSRP
703156	Agrowtek Liquid Tight Gland Kit for Hydro Sensor Probes	\$15.00

Agrowtek Aspirated Indoor Climate Sensor (Temp/RH/Light) with CO2 Upgrade Installed SNS-CC



NEW GrowControl™ GC-Pro and GC-Plus precision aspirated climate sensor. Senses air temperature, relative humidity, light irradiance and CO2. Add a climate sensor to your GC-Pro to control two independent climate zones from one control system! Noise-proof sensor can be mounted up to 2000 feet away from the controller! 1 Year Warranty.



EXCLUSIVE

Item No.	Description	MSRP
703162	Agrowtek Aspirated Indoor Climate Sensor (Temp/RH/Light) w/ CO2 Upgrade Installed	\$648.00

Agrowtek GrowControl™ Wind Sensor Kit with Weather Transmitter SNS-W



NEW GrowControl™ precision wind anemometer and direction vane precisely monitor wind speed and direction. Connect to Agrowtek's GrowControl™ controllers to monitor weather and control equipment. Wind Speed Anemometer: Wind speed anemometer with 3 cup rotor measures wind speeds from 1 to 125 MPH. Two-wire connection to transmitter. Wind Direction Vane: Wind vane uses German

Hall effect sensor for precision and durability. Agrowtek's wind vanes have zero dead band, are near-zero friction and have a theoretical infinite life. Weather Transmitter: Connect the wind anemometer and direction vanes to Agrowtek's Weather Transmitter. The weather transmitter is then connected to a GrowControl™ controller to display the readings and control equipment. Agrowtek's outdoor temperature sensor and sunlight sensor may be connected to the weather transmitter to complete the weather station. Anemometer and direction vane include mounting brackets and 25 ft of outdoor rated cable. Extend sensor wires up to 100 ft from transmitter. Mount transmitter indoors up to 2,000 ft from controller. 1 Year Warranty.



EXCLUSIVE

Item No.	Description	MSRP
703164	Agrowtek GrowControl Wind Sensor Kit w/ Weather Transmitter	\$799.00

Agrowtek Outdoor Air Temperature Sensor SNS-OAT



NEW Outdoor air temperature sensor module connects to Agrowtek's SNS-W Weather Station Transmitter or SNS-BOB break-out board to the GrowControl™ control system. Weather-proof enclosure and electronics. Stainless steel temperature probe. Can be mounted in a shade enclosure or in a shaded location for best results. Standard two-wire connection; up to 1000 ft from weather transmitter or break out board. 1 Year Warranty.



EXCLUSIVE

Item No.	Description	MSRP
703166	Agrowtek Outdoor Air Temperature Sensor	\$139.00

Agrowtek Outdoor Light Irradiance Sensor SNS-OLI



NEW Outdoor light irradiance sensor module connects to Agrowtek's SNS-W Weather Station Transmitter or SNS-BOB break-out board to the GrowControl™ control system. Weather-proof enclosure and electronics. Mount to a level horizontal surface for best results. Standard two-wire connection; up to 1000 ft from weather transmitter or break out board. 1 Year Warranty.



EXCLUSIVE

Item No.	Description	MSRP
703168	Agrowtek Outdoor Light Irradiance Sensor	\$199.00

Agrowtek Wind Speed Anemometer Sensor SNS-ANM

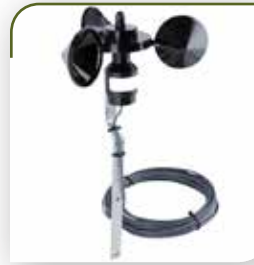

NEW Wind speed anemometer with 3 cup rotor measures wind speeds from 1 to 125 MPH. Extremely rugged for harsh conditions and sensitive to the slightest breeze. Simple two-wire connection to transmitter. Includes mounting brackets and 25 ft of outdoor rated cable. Extend sensor wires up to 100 ft from transmitter. Mount transmitter indoors up to 2,000 ft from controller. Must be connected to Agrowtek's Weather Transmitter for use with



EXCLUSIVE

Item No.	Description	MSRP
703170	Agrowtek Wind Speed Anemometer Sensor	\$199.00

Agrowtek Wind Direction Vane Sensor SNS-DIR



NEW Wind vane uses German Hall effect sensor for precision and durability. Many potentiometer type wind vanes have a dead spot of several degrees, friction from the sensor and a defined life span. Agrowtek's wind vanes have zero dead band, are near-zero friction and have a theoretical infinite life. Includes mounting brackets and 25 ft of outdoor rated cable. Extend



sensor wires up to 100 ft from transmitter. Mount transmitter indoors up to 2,000 ft from controller. Must be connected to Agrowtek's Weather Transmitter for use with GrowControl™ controllers. 1 Year Warranty. **EXCLUSIVE**

Item No.	Description	MSRP
703172	Agrowtek Wind Direction Vane Sensor	\$399.00

Agrowtek IR Digital Rain Sensor SNS-RAIN



NEW GrowControl™ Rain Sensor is a high quality optical type rain sensor with no moving parts. The rain gauge senses water hitting its outside surface using beams of infrared light. Connect to GC-Pro or GC-Extreme controllers' digital inputs to close vents and windows down to a weather set-point at the first sign of rain. Equipped with arm for mounting to structure or weather station. Includes a



built-in heater to allow use in temperatures down to 32°F (0°C). Smart logic prevents false triggers from dust and other slow build-up of accumulation. Adjustable sensitivity allows for four different settings which activate the sensor from the slightest amount of rain to heavy rainfall. Operates on 24Vdc from controller and connects directly to any digital input. 1 Year Warranty. **EXCLUSIVE**

Item No.	Description	MSRP
703174	Agrowtek IR Digital Rain Sensor	\$219.00

Agrowtek Water Leak Detector Sensor SNS-LD



NEW Be alerted to water leaks and shut-down pump equipment in the event of a leak. Simply wire this water leak sensor to one of the GC-Pro's four digital inputs and setup the leak sensor control. 1 Year Warranty.

EXCLUSIVE

Item No.	Description	MSRP
703176	Agrowtek Water Leak Detector Sensor	\$99.00

Agrowtek Water Flow Switch SNS-FLW

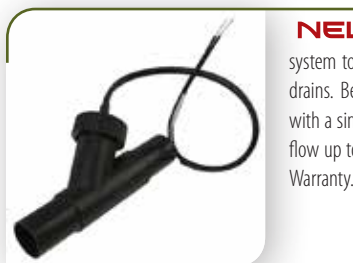

NEW Flow switches connect to your GC-Pro control system to detect the presence of water flow from pumps or drains. Be aware of pump failures as soon as they happen with a simple liquid flow switch. Can be installed inline with flow up to 8 gpm or parallel to flow for larger pumps. 1 Year Warranty.

EXCLUSIVE

Item No.	Description	MSRP
703178	Agrowtek Water Flow Switch	\$79.00

Agrowtek Vertical Float Switch SNS-VFT



NEW Float switches connect to the GC-Pro controller and are an economical way monitor and maintain proper reservoir levels. Vertical float sensors mount in the bottom or top of a reservoir. A magnet in the float activates a reed switch inside the sensor body when the float is raised (or lowered if reversed) on the sensor body. 1 Year Warranty.

EXCLUSIVE

Item No.	Description	MSRP
703180	Agrowtek Vertical Float Switch	\$66.00

Agrowtek Horizontal Float Switch SNS-HFT



NEW Float switches connect to the GC-Pro controller and are an economical way monitor and maintain proper reservoir levels. Horizontal float switches are installed in the side-wall of a container. The lever arm deflects to sense the presence or absence of water. A magnet in the lever arm activates a reed switch inside the sensor body when the arm is aligned with the sensor body. Includes a compression

seal and flange nut for leak-free performance. 1 Year Warranty.

EXCLUSIVE

Item No.	Description	MSRP
703182	Agrowtek Horizontal Float Switch	\$66.00

Agrowtek MX1 AC Reversible Motor Controller, Single Phase 120VAC/8A



NEW MX1 forward/reverse motor controller allows Agrowtek's control systems to directly operate single-phase AC vent and shade motors 120-240Vac up to 8 Amps or 3/4HP. Control opening and closing of vents and curtains with automatic control by wiring the MX1's input signal terminals to Agrowtek's controller outputs, or use the knob on the front of the MX1 to manually operate vent and curtain motors. Operates on 24VDC and includes manual override switch



for manual or automatic operation. Includes terminals for external limit switches and piggy-back connection of multiple units from a single hard-wired 24Vdc power supply. 2 Year Warranty. **EXCLUSIVE**

Item No.	Description	MSRP
703184	Agrowtek MX1 AC Reversible Motor Controller, Single Phase 120VAC/8A	\$279.00

Agrowtek MX1D DC Reversible Motor Controller 30Vdc/8A



NEW MX1D forward/reverse motor controller allows Agrowtek's control systems to directly operate DC vent and shade motors 30VDC up to 8 Amps or 3/4 HP. Control opening and closing of vents and curtains with automatic control by wiring the MX1D's input signal terminals to Agrowtek's controller outputs, or use the knob on the front of the MX1D to manually operate vent and curtain motors. Operates on 24VDC and includes manual override switch for manual or automatic operation. Includes



terminals for external limit switches and piggy-back connection of multiple units from a single hard-wired 24Vdc power supply. 2 Year Warranty. **EXCLUSIVE**

Item No.	Description	MSRP
703186	Agrowtek MX1D DC Reversible Motor Controller 30Vdc/8A	\$319.00

Agrowtek Sensor Cable Break-Out Board - Sensor Cable to Terminal Block SNS-BOB



NEW Sensor break-out board enables connection of hard-wired analog sensors such as Agrowtek's: outdoor temperature sensor, outdoor light sensor, power monitoring sensor, liquid level sensor and standard Industrial 4-20mA sensors. Typical applications include utilizing the fourth channel that is un-used by the hydro transmitter or a basic climate sensor (without CO2.) The hydro transmitter and basic climate sensor only use channels 1-3 of the four available. The SNS-BOB break out board allows access to

the un-used channels for other sensors. Can also be used to extend sensor cables using custom wire over long distances (up to 2000 ft) Includes a 6 ft cable for connection. 2 Year Warranty.



EXCLUSIVE

Item No.	Description	MSRP
703190	Agrowtek Sensor Cable Break-Out Board - Sensor Cable to Terminal Block	\$59.00

Agrowtek Weather-Proof Enclosures for GrowControl™



NEW Weather-resistant enclosure protects your GrowControl™ control system from dirt, dust, water, mild acids and the elements! Rugged all-polycarbonate construction is rated for indoor and outdoor use and is UV stabilized. Clear hinged door allows visibility and easy access to the controller screen. Snap latches and a seal secure the door water-tight for a NEMA 4X/IP66 seal.



EXCLUSIVE

Item No.	Description	MSRP
703192	Agrowtek Weather-Proof Enclosure for GrowControl GC-Pro	\$149.00
703194	Agrowtek Weather-Proof Enclosure for GrowControl GC-ProXL	\$159.00

Sentinel GPS

Sentinel GPS HPLC-4 High Power Lighting Controller 4 Outlet



NEW Run up to four (4) lights at 240 volts, maximum 4000 watts. Removable rear access panel makes controller easy to wire to existing power system. Convenient front panel On/Off switch. ETL listed to UL 508 STD for commercial use. Four (4) NEMA 6-15 outlets for ballasts. 14 ft (4.5m) 120V trigger cable for easy setup and operation. 240 Volts/20 Amps/60 Hz. 2 Year Warranty.



Item No.	Description	MSRP
703200	Sentinel GPS HPLC-4 High Power Lighting Controller 4 Outlet	\$179.95

Sentinel GPS HPLC-8 Dual Trigger High Power Lighting Controller 8 Outlet



NEW Run up to four (4) lights at 240 volts, maximum 4000 watts. Removable rear access panel makes controller easy to wire to existing power system. Convenient front panel On/Off switch. ETL listed to UL 508 STD for commercial use. Four (4) NEMA 6-15 outlets for ballasts. Integrated 24 hour timer for easy setup and operation. 240 Volts/20 Amps/60 Hz. 2 Year Warranty.



Item No.	Description	MSRP
703204	Sentinel GPS HPLC-8 Dual Trigger High Power Lighting Controller 8 Outlet	\$259.95

Sentinel GPS HPLC-4T High Power Lighting Controller 4 Outlet with Timer



NEW Run up to eight (8) lights at 240 volts, maximum 8000 watts. Removable rear access panel makes controller easy to wire to existing power system. Convenient front panel On/Off switch. ETL listed to UL 508 STD for commercial use. Eight (8) NEMA 6-15 outlets for ballasts. Dual 14 ft (4.5m) 120V trigger cables for easy setup and operation. 240 Volts/20 Amps x 2/60 Hz. 2 Year Warranty.



Item No.	Description	MSRP
703202	Sentinel GPS HPLC-4T High Power Lighting Controller 4 Outlet with Integrated Timer	\$209.95

Sentinel GPS HPLC-8T High Power Lighting Controller 8 Outlet with Timer



NEW Run up to eight (8) lights at 240 volts, maximum 8000 watts. Removable rear access panel makes controller easy to wire to existing power system. Convenient front panel On/Off switch. ETL listed to UL 508 STD for commercial use. Eight (8) NEMA 6-15 outlets for ballasts. Integrated 24 hour timer for easy setup and operation. 240 Volts/20 Amps x 2/60 Hz. 2 Year Warranty.



Item No.	Description	MSRP
703206	Sentinel GPS HPLC-8T High Power Lighting Controller 8 Outlet with Integrated Timer	\$279.95

Sentinel GPS CPPM-4i Fuzzy Logic CO2 Controller



NEW The CPPM-4i features Sentinel Intelligent CO2 Enrichment™ (S.I.C.E.) which allows interfaced CO2 enrichment with Sentinel ICG series generators for unparalleled control (Patents Pending). Sentinel True Fuzzy Logic™ gives the most precise compressed CO2 regulator enrichment available. Large, pixelated LCD display makes user programming intuitive and simplified. Remote Sensor is 15 ft (5m) expandable up to 160 ft (50m) accommodating a wider range of growing environments. 2 Year Warranty.

Item No.	Description	MSRP
703217	Sentinel GPS CPPM-4i Fuzzy Logic CO2 Controller	\$589.95

Sentinel GPS CHHC-4i



NEW The Sentinel CHHC-4i is the most advanced CO2 controller available on the market today. It incorporates the proprietary S.I.C.E. communication and control components and programming that are unique to Sentinel. It allows for communications between Sentinel S.I.C.E. series products, providing a level of control never before seen in your greenhouse, garden or grow room. The system works

by a Sentinel S.I.C.E. series controller, such as the Sentinel CHHC-4i, measuring and monitoring your growing environment. As the atmospheric CO2 levels change, the controller will tell the Sentinel ICG series generator to increase output, decrease output or go into idle mode...all computer controlled. As the optimal conditions are reached, the S.I.C.E. system can decrease CO2 output, making sure that the user defined optimal level is not overshoot. 2 Year Warranty.

Item No.	Description	MSRP
703211	Sentinel GPS CHHC-4i	\$689.95

Sentinel GPS BLC-4 Basic Lighting Controller 4 Outlet



NEW Run up to four (4) lights at 240 volts, maximum 4000 watts. Removable front access panel makes controller easy to wire to existing power system. Four (4) Universal outlets for ballasts. Includes heavy duty mounting bracket. 14 ft (4.5m) 120v trigger cable for easy setup and operation. 240 Volts/20 Amps/60 Hz. 2 Year Warranty.

Item No.	Description	MSRP
703208	Sentinel GPS BLC-4 Basic Lighting Controller 4 Outlet	\$129.95

Sentinel GPS BLC-8 Basic Lighting Controller 8 Outlet



NEW Run up to eight (8) lights at 240 volts, maximum 8000 watts. Removable front access panel makes controller easy to wire to existing power system. Eight Universal outlets for ballasts. Includes heavy duty mounting bracket. 14 ft (4.5m) 120V trigger cable for easy setup and operation. 240 Volts/20 Amps x 2/60 Hz. 2 Year Warranty.

Item No.	Description	MSRP
703210	Sentinel GPS BLC-8 Basic Lighting Controller 8 Outlet	\$209.95

Sentinel GPS ICG-30 Intelligent CO2 Generators



NEW Introducing the new Sentinel GPS ICG-30 Intelligent CO2 Generator available in Propane or Natural Gas configurations. Although designed to work with the new Sentinel Intelligent CO2 Enrichment (S.I.C.E.) with patented interface, the ICG-30 Intelligent CO2 Generator is fully compatible with older Sentinel products like the CHHC-4, CPPM-4, recycle timers or even competitor environmental controller units much in the same way as the Sentinel VCG-27. 2 Year Warranty.

Item No.	Description	MSRP
703212	Sentinel GPS ICG-30 NG Intelligent CO2 Generator (Natural Gas)	\$559.95
703214	Sentinel GPS ICG-30 LP Intelligent CO2 Generator (Propane)	\$559.95

Sentinel GPS BTC-1a Basic Temperature Controllers



NEW The BTC-1a Basic Temperature Controller is designed to control fans, heaters, air conditioners and other equipment in gardens, greenhouses, grow rooms and other environments. It can operate in either cooling or heating modes. The BTC-1a features a readily visible switch to alternate between cooling and heating. Easy-to-read dials make programming daytime and nighttime

settings uncomplicated. 2 Year Warranty.

Item No.	Description	MSRP
703216	Sentinel GPS BTC-1a PB Basic Temperature Controller (Plug Box)	\$74.95
703218	Sentinel GPS BTC-1a WM Basic Temperature Controller (Wall Mount)	\$89.95

Sentinel GPS BPR-1a Basic Power Relays



NEW The BPR-1a Basic Power Relay is designed to allow seamless integration of controllers, devices and equipment. The BPR-1a can operate in a Normally Off mode – where the trigger cable activates attached devices – allowing controllers or timers to operate multiple pieces of equipment or larger amounts of amperage.

The BPR-1a can also operate in a Normally On mode – where the trigger cable turns off attached devices – allowing controllers or timers to coordinate various functions. 2 Year Warranty.

Item No.	Description	MSRP
703220	Sentinel GPS BPR-1a PB Basic Power Relay (Plug Box)	\$74.95
703222	Sentinel GPS BPR-1a WM Basic Power Relay (Wall Mount)	\$89.95

Sentinel GPS BLC-1a Basic Lighting Temperature Controllers



NEW The BLC-1a Lighting Temperature Protection by Sentinel is designed to disconnect power to lighting equipment in gardens, greenhouses and grow rooms if temperatures exceed a user determined level due to equipment failures, extreme weather etc. The unit also features a 'Hot Start' delay, allowing equipment and lighting to cool

down before restarting in the event of a power outage). 2 Year Warranty.

Item No.	Description	MSRP
703224	Sentinel GPS BLC-1a PB Basic Lighting Temperature Controller (Plug Box)	\$74.95
703226	Sentinel GPS BLC-1a WM Basic Lighting Temperature Controller (Wall Mount)	\$89.95

Sentinel GPS BRT-1aLR Basic Recycle Timers



NEW The BRT-1aLR Basic Recycle Timer - Low Range is designed to control equipment that has to be turned On and Off at precise, repeated intervals. The BRT-1a features a readily visible switch to alternate between day or night or continuous operation making it easy for the end user to differentiate which mode it is operating in. Easy-to-read dials

make programming On and Off time settings uncomplicated. 2 Year Warranty.

Item No.	Description	MSRP
703228	Sentinel GPS BRT-1aLR PB Basic Recycle Timer Low Range (Plug Box)	\$69.95
703230	Sentinel GPS BRT-1aLR WM Basic Recycle Timer Low Range (Wall Mount)	\$84.95

Sentinel GPS BRT-1aHR Basic Recycle Timers High Range



NEW The BRT-1aHR Basic Recycle Timer - High Range is designed to control equipment that has to be turned On and Off at precise, repeated intervals. Hydroponics, drip irrigation, aeroponics, CO2 injection - these are just many of the tasks the BRT-1a can control. The BRT-1a features a readily visible switch to alternate between day or night

or continuous operation. Easy-to-read dials make programming On and Off time settings uncomplicated. 2 Year Warranty.

Item No.	Description	MSRP
703232	Sentinel GPS BRT-1aHR PB Basic Recycle Timer High Range (Plug Box)	\$69.95
703234	Sentinel GPS BRT-1aHR WM Basic Recycle Timer High Range (Wall Mount)	\$84.95

Sentinel GPS BEC-1a Basic Environmental Controllers



NEW The BEC-1a Basic Environmental Controller is designed to control fans, air conditioners, dehumidifier and other equipment in gardens, greenhouses, grow rooms or other environments. The BEC-1a can operate in 3 different modes: cooling/dehumidification, cooling only or dehumidification only. The BEC-1a features a

readily visible switch to alternate between its different settings. 2 Year Warranty.

Item No.	Description	MSRP
703236	Sentinel GPS BEC-1a PB Basic Environmental Controller (Plug Box)	\$99.95
703238	Sentinel GPS BEC-1a WM Basic Environmental Controller (Wall Mount)	\$114.95

Sentinel GPS BHC-1a Basic Humidity Controllers



NEW The BHC-1a Basic Humidity Controller is designed to control fans, dehumidifier, humidifiers, misters and other ventilation equipment in gardens, greenhouses, grow rooms or other environments. The BHC-1a can operate in either dehumidification or humidification modes. The BHC-1a features a readily visible switch to

alternate between dehumidify and humidify settings. 2 Year Warranty.

Item No.	Description	MSRP
703240	Sentinel GPS BHC-1a PB Basic Humidity Controller (Plug Box)	\$99.95
703242	Sentinel GPS BHC-1a WM Basic Humidity Controller (Wall Mount)	\$114.95

Sentinel GPS BPC-1a Basic Photoperiod Controllers



NEW The BPC-1a Basic Photoperiod Controller is designed to allow users easy daytime or nighttime control of equipment. The BPC-1a eliminates the need to coordinate many timers, simplifying the operation of CO2 equipment, exhaust fans, light movers, sulfur vaporizers, etc. The BPC-1a features a readily visible switch to alternate between DAY or NIGHT

control, making it easy for the end user to differentiate which mode it is operating in. 2 Year Warranty.

Item No.	Description	MSRP
703244	Sentinel GPS BPC-1a PB Basic Photoperiod Controller (Plug Box)	\$69.95
703246	Sentinel GPS BPC-1a WM Basic Photoperiod Controller (Wall Mount)	\$84.95

Sentinel GPS AFC-1a Advanced Fan Controllers



NEW The AFC-1a Advanced Fan Controller is designed to control ventilation fans in gardens, greenhouses, grow rooms and other environments. The AFC-1a comes equipped with a high quality remote temperature sensor for more accurate readings and features a readily visible switch to alternate between three different ranges of temperature

control, making it easy for the user to differentiate which mode it is operating in. A built in photocell and separate controls allow for different day and night temperature settings. 2 Year Warranty.

Item No.	Description	MSRP
703260	Sentinel GPS AFC-1a PB Advanced Fan Controller - Plug Box	\$84.95
703261	Sentinel GPS AFC-1a WM Advanced Fan Controller - Wall Mount	\$99.95

Sentinel GPS AFC-2a Advanced Fan Controllers



NEW The AFC-2a Advanced Fan Controller (Protection) is designed to control ventilation fans in gardens, greenhouses, grow rooms and other environments. In addition to regular continuous operation, users can select to have one of two optional low temperature shutdown protection settings-guarding against potentially harmful garden conditions. The AFC-

2a comes equipped with a high quality remote temperature sensor, a readily visible switch to alternate between modes and a photocell allowing for different day/night protection settings. Features durable construction built to withstand high impacts and provide years of reliable performance. 2 Year Warranty.

Item No.	Description	MSRP
703262	Sentinel GPS AFC-2a PB Advanced Fan Controller (Protection) - Plug Box	\$84.95
703263	Sentinel GPS AFC-2a WM Advanced Fan Controller - Wall Mount	\$99.95

Sentinel GPS SICE Cables



NEW S.I.C.E. (Sentinel Intelligent CO2 Enrichment) communications cables which allow for communication between S.I.C.E. series products including the CPPM-4i, CHHC-4i, ICG-30NG and ICG-30LP. These same cables allow for S.I.C.E. units to be placed up to 50 meters away from other S.I.C.E. units. 1 Year Warranty.

Item No.	Description	MSRP
703196	Sentinel G.P.S SICE 5 m Cable	\$19.95
703197	Sentinel G.P.S SICE 10 m Cable	\$34.95
703198	Sentinel G.P.S 25 m Cable	\$69.95
703199	Sentinel G.P.S 50 m Cable	\$129.95

Lightspeed Controllers

Lightspeed Controller FLIP 4 Lighting Flip Box



Lightspeed Flip 4 Lighting Controller powered by Allen Bradley. Automated 2 ballasts, 4 lights switching unit, allows you to run 4 lights from 2 ballasts. Works with any ballasts plugged into any voltage. Heavy duty Lightspeed construction, these units are built to last! Can be used with any 120V timer. 1 year Warranty.

Item No.	Description	MSRP
706100	Lightspeed Controller FLIP 4 Lighting Flip Box	\$299.95

Lightspeed Controller FLIP 8 Lighting Flip Box



Lightspeed Flip 8 Lighting Controller powered by Allen Bradley. Automated 4 ballast, 8 light switching unit, allows you to run 8 lights from 4 ballasts. Works with ballasts plugged into any voltage. Heavy duty Lightspeed construction, these units are built to last! Can be used with any 120V timer. 1 year Warranty.

Item No.	Description	MSRP
706101	Lightspeed Controller FLIP 8 Lighting Flip Box	\$499.95

Lightspeed Controller FLIP 16 Lighting Flip Box



Lightspeed Flip 16 Lighting Controller powered by Allen Bradley. Automated 8 ballast, 16 light switching unit, allows you to run 16 lights from 8 ballasts. Works with ballasts plugged into any voltage. Heavy duty Lightspeed construction, these units are built to last! Can be used with any 120V timer. 1 year Warranty.

Item No.	Description	MSRP
706102	Lightspeed Controller FLIP 16 Lighting Flip Box	\$889.95

Lightspeed Controller FLIP 20 Lighting Flip Box



Lightspeed Flip 20 Lighting Controller powered by Allen Bradley. Automated 10 ballast, 20 light switching unit, allows you to run 20 lights from 10 ballasts. Works with ballasts plugged into any voltage. Heavy duty Lightspeed construction, these units are built to last! Can be used with any 120V timer. 1 year Warranty.

Item No.	Description	MSRP
706103	Lightspeed Controller FLIP 20 Lighting Flip Box	\$1,099.95

Powerbox®

Powerbox® DPC-4000-240V-4P



The DPC-4000-240V is a versatile 240 Volt lighting controller that can effortlessly run up to four 1,000 watt lights. This model connects to a 3 or 4-wire 240 Volt service and in many cases, you can plug right into an existing dryer-type outlet. 5 Year Warranty.

Item No.	Description	MSRP
702915	Powerbox DPC-4000-240 Volt -4P	\$269.00

Powerbox® DPC-7500-120V-4P



This lighting controller connects to a 4-wire 240 Volt service but provides six 120 Volt outlets (5-15r) that allow you to run up to 60 amps at 120 Volts. Usually, you can plug this unit right into an existing dryer-type outlet (14-30r). 5 ft main power cord – plug & play (14-30p). 5 Year Warranty.

Item No.	Description	MSRP
702930	Powerbox DPC-7500-120 Volt -4P	\$399.00

Powerbox® DPC-7500-240V-4P



A versatile 240V lighting controller that can effortlessly run up to six 1000 Watt lights. Connects to a 3 or 4-wire 240 Volt service and in many cases, you can plug right into an existing dryer-type outlet. 5 ft main power cord, plug & play (10-30p or 14-30p). 5 Year Warranty.

Item No.	Description	MSRP
702920	Powerbox DPC-7500-240 Volt -4P	\$379.00

Powerbox® DPC-7500-COMBO-4P



A versatile 240V lighting controller that provides four 240 Volt outlets and two 120V outlets. Connects to a 4-wire 240 Volt service and in many cases, you can plug right into an existing dryer-type outlet. 5 ft main power cord - plug & play (14-30p). 5 Year Warranty.

Item No.	Description	MSRP
702925	Powerbox DPC-7500-COMBO-4P	\$399.95

Powerbox® DPC-8000-240V-4P



A 240 Volt lighting controller, you can control up to eight 1000 watt lights from one timer. Eight NEMA type 6-15 240 Volt outlet receptacles. 4 ft main power cord - Plug & play NEMA 14-50P, 4-Prong Plug. 5 Year Warranty.

Item No.	Description	MSRP
702935	Powerbox DPC-8000-240 Volt -4P	\$399.95

Powerbox® DPC-12000



Can run up to ten 1000 watt lights, plus 120 Volt accessories - safely and reliably. 50 Amp or 60 Amp main capacity. Detachable trigger cord can override the built-in timer. Ten timed 240 Volt outlets (6-15r) and five 120 Volt outlets (5-15r). Plug & play (14-50p) or hardwire. 5 Year Warranty.

Item No.	Description	MSRP
702940	Powerbox DPC-12000-50A-4P (Plug & Play)	\$799.95
702945	Powerbox DPC-12000-60A-4HW (Hardwire)	\$829.00

Powerbox® DPC-12000-D-60A-4HW



Runs up to twelve 1000 watt lights at 240 Volts. This is a dual trigger cord model with no built-in timer. Outlets are separated into 2 banks - each bank has six 240V outlets (6-15r) and three 120V outlets (5-15r). 30 Amp, 50 Amp or 60 Amp main capacity. 5 Year Warranty.

Item No.	Description	MSRP
702950	Powerbox DPC-12000-D-60A-4HW	\$859.95

Powerbox® DPC-15000



Runs up to ten 1000 watt lights, plus 120 Volt accessories - safely and reliably. 50 Amp or 60 Amp main capacity. Ten timed 240 Volt outlets (6-15r) and five 120 Volt outlets (5-15r). Plug & play (14-50P) or hardwire. Built-in AUBE digital timer with battery backup. 5 Year Warranty.

Item No.	Description	MSRP
702955	Powerbox DPC-15000-50A-4P (Plug & Play)	\$899.00
702960	Powerbox DPC-15000-60A-4HW (Hardwire)	\$869.00

Powerbox® DPC-15000TD



Powers ten 1000 watt lights at 240 Volts, plus it has a special feature to protect the life of your bulbs during power failures. Dial-in a delay of 1 to 10 minutes before your lights will restart when power is restored. Ten timed 240 Volt outlets (6-15r) and five 120 Volt outlets (5-15r) with built-in digital timer with battery backup. 5 Year Warranty.



Item No.	Description	MSRP
702965	Powerbox DPC-15000TD-50A-4P (Plug & Play)	\$969.00
702970	Powerbox DPC-15000TD-60A-4HW (Hardwire)	\$999.00

Powerbox® LSM-16 Flipbox®



A 8 ballast, 16 light Flipbox® that allows you to run 16 lights from 8 ballasts. Convenient single unit with built-in timer. Voltage independent - works with 120-volt and 240-volt ballasts. Fits Sunlight Supply® style ballasts. 5 Year Warranty.



Item No.	Description	MSRP
702990	Powerbox LSM-16 Flipbox	\$999.95

Powerbox® OG Flipbox®



The Flipbox® is an individual light switching module that allows an individual ballast to run two separate lights - one at a time - by switching back and forth between each light, at a user-specified interval. Voltage independent - works with 120 Volt and 240 Volt ballasts. Fits Sunlight Supply® style ballasts. 5 Year Warranty.



Item No.	Description	MSRP
702975	Powerbox OG Flipbox	\$174.00

Powerbox® LSM-20 Flipbox®



A 10 ballast, 20 light Flipbox® that allows you to run 20 lights from 10 ballasts. Paired with a DPC-15000 and 10 electronic ballasts, you can run 20 lights from just 50 Amps at 240 Volts. Voltage independent - works with 120 Volt and 240 Volt ballasts. Fits Sunlight Supply® style ballasts. 5 Year Warranty.



Item No.	Description	MSRP
702995	Powerbox LSM-20 Flipbox	\$1,159.00

Powerbox® LSM-8 Flipbox®



A 4 ballast, 8 light Flipbox® that allows you to run 8 lights from 4 ballasts. Convenient single unit with built-in timer. Voltage independent - works with 120 Volt and 240 Volt ballasts. Fits Sunlight Supply® style ballasts. 5 Year Warranty.



Item No.	Description	MSRP
702980	Powerbox LSM-8 Flipbox	\$579.00

Hydro Innovations™ HydroGEN™ CO2 Monitor



Calibrated and maintenance free, the HydroGEN™ CO2 Monitor utilizes top quality SenseAir brand CO2 detection technology. Will work with any CO2 generator or bottle regulator. Programmed to turn on at 1300 ppm and off at 1500 ppm. 120 Volt switched piggyback cord.

Item No.	Description	MSRP
703746	Hydro Innovations HydroGen CO2 Monitor	\$384.95

Powerbox® LSM-12 Flipbox®



A 6 ballast, 12 light Flipbox® that allows you to run 12 lights from 6 ballasts. The Flipbox LSM-12 has a built-in digital timer with battery backup. Voltage independent - works with 120 Volt and 240 Volt ballasts. Fits Sunlight Supply® style ballasts. 5 Year Warranty.



Item No.	Description	MSRP
702985	Powerbox LSM-12 Flipbox	\$759.00

LuxPro® Programmable Outlet Digital Thermostat - PSP300



Programmable outlet thermostat allows control any 120V device up to 15 amps. Use with a fan or air conditioner for cooling. Also may be used with a space heater for heating. 12 hr clock only. 2 G13A size 1.5V batteries included (for clock only). Battery free memory storage. 5 min. short cycle protection. Time & temp. alternate in display. 3 Year Warranty.



Item No.	Description	MSRP
734130	Luxpro Programmable Digital Thermostat	\$74.95

Hurricane® Centrifugal Inline Fans

powder coated finish | quiet operation | extremely reliable | quality steel housing | easy installation | mounting brackets included | high performance

Hurricane®

COMMERCIAL-GRADE INLINE FANS

FIVE YEAR WARRANTY 5

www.hurricane-fans.com

EXCLUSIVE

Hurricane® Inline Fans are commercial grade, high performance fans. The housings are made of steel with a durable powder coated finish. Made with quality UL components for quiet operation. Include mounting brackets with easy to follow instructions. Easily installs in minutes. These fans come with an 8 ft 120 volt power cord. Recommended for use with: Phresh® & Black Ops™ Carbon Filters, Ideal-Air™ Ducting and Clamps, and Titan Controls® Fan Speed & Ventilation controllers. 5 Year Warranty.

Item No.	Description	Amps	MSRP
736570	Hurricane Inline Fan 4 in 171 CFM	1	\$104.95
736575	Hurricane Inline Fan 6 in 435 CFM	1	\$129.95
736580	Hurricane Inline Fan 8 in 745 CFM	1.7	\$169.95
736585	Hurricane Inline Fan 10 in 780 CFM	2.1	\$219.95
736590	Hurricane Inline Fan 12 in 1060 CFM	3.1	\$259.95

Hurricane® After Burner® High Output Mixed Flow Fans

very compact size | proven aerodynamic performance | easy to install | maximum efficiency | lightweight sealed housing | lower monthly costs | extremely quiet

Hurricane®

AFTER BURNER®

High Output Mixed Flow Fans

FIVE YEAR WARRANTY 5

hurricane-fans.com

EXCLUSIVE

After Burner® High Output Mixed Flow Fans offer superior performance and outstanding efficiency. The powerful motor and injection molded plastic blade create forceful CFM's while withstanding heavy amounts of static pressure. With a foam cushioned mounting bracket, the After Burners® operate with less noise than traditional inline fans. Installation is very simple and each fan comes pre-wired with a 7 foot 120 volt power cord. 5 Year Warranty.

Item No.	Description	Amps	Watts	MSRP
736130	Hurricane After Burner Inline Fan 6 in 335 CFM	0.6	69	\$163.95
736135	Hurricane After Burner Inline Fan 8 in 660 CFM	1.5	161	\$199.95
736140	Hurricane After Burner Inline Fan 10 in 1000 CFM	1.7	197	\$254.95

Hyper Fan®



Hyperfan®

EXCLUSIVE **5 YEAR WARRANTY** **FRESH**

Hyper Fan® Features:

- Laminar Flow Fan Blade & Stator Technology creates optimal airflow similar in technology to an airplane propeller. The result is very high CFMs and exceptional static pressure performance.
- Hyper Fans® deliver the highest CFM's per watt of any fan in the industry.
- State-of-the-art digitally controlled DC powered Electronically Commutated Motor (ECM) is extremely quiet, long lasting and very reliable. Best of all, this unique technology uses about half the power as traditional fans.
- The included speed controller can adjust fan speed from 30% to 100%. It is detachable from the fan and independent from the power cord.
- Lightweight aluminum housing is one-third the weight of comparable steel bodied fans. They are compact and easy to install.
- Universal mounting positions – can be mounted in any position allowing maximum flexibility during installation.
- Heavy-duty 6/8/10 mm bearings, versus commonly used 4 mm bearings, ensure smoother operation and increased longevity of the fan.

www.Hyper-Fans.com

Best in its class – delivering the highest CFM's per watt of any fan in the industry. Hyper Fan's develop higher static pressures and higher airflows than any other mixed flow fans in the market. They are the answer to a unified environmental solution for your garden. Every fan includes a detachable, fully-adjustable speed control. 5 Year Warranty.

Item No.	Description	Amps	Watts	MSRP
701400	Hyper Fan 6 in Digital Mixed Flow Fan 315 CFM	0.5	35	\$196.95
701405	Hyper Fan 8 in Digital Mixed Flow Fan 710 CFM	1	75	\$242.95
701410	Hyper Fan 10 in Digital Mixed Flow Fan 1065 CFM	2.1	170	\$306.95

Hyper Fan® Stealth



Hyperfan Stealth
HIGHEST SOUND REDUCTION
OF ANY SILENCED FAN ON THE MARKET!

5 YEAR WARRANTY

6" | 315cfm | 35watts
8" | 710cfm | 75watts
10" | 1065cfm | 170watts

www.Hyper-Fans.com

INTRODUCING THE NEW ULTIMATE SOUND REDUCING COMBO!
STATE-OF-THE-ART DIGITALLY CONTROLLED MIXED FLOW HYPER FAN®

NOISE REDUCING, ACOUSTIC FOAM LINED DUCT SILENCER!

75% REDUCTION IN SOUND!



EXCLUSIVE

Hyper Fan's Laminar Flow Fan Blade & Stator Technology create optimal airflow similar in design to an airplane jet engine. The result is very high CFM's and exceptional static pressure performance. The Hyper Fan® Stealth delivers the highest CFM's per watt of any silenced fan in the industry. A speed controller and integrated mounting brackets are included. 5 Year Warranty.

Item No.	Description	Amps	Watts	MSRP
701420	Hyper Fan Stealth 6 in 315 CFM	0.5	35	\$282.95
701425	Hyper Fan Stealth 8 in 710 CFM	1	75	\$349.95
701430	Hyper Fan Stealth 10 in 1065 CFM	2.1	170	\$449.95

Hyper Fan® Speed Controller & Extension Cable



Hyper Fan® Speed Controller can adjust the Hyper Fan® from 35% to 100% airflow. It is detachable from the fan and independent from the power cord. Fan will automatically operate at full power when used without the supplied speed controller. You can also get the Hyper Fan® Extension Cable to control your fan from a distance. Main cable is 5m/16.4 ft long and connector cable is 15 cm/6 in long. 5 year Warranty.

EXCLUSIVE

Item No.	Description	MSRP
701435	Hyper Fan Speed Controller w/ 5 m Cable	\$21.95
701440	Hyper Fan Extension Cable	\$14.95

Fantech Revolution Stratos Mixed Flow Inline Fan



NEW The Fantech Revolution Stratos is an energy-efficient, in-line, mixed flow fan with a 115V AC external rotor motor. Air flow is increased using aerodynamically optimized impellers and guide vanes, all while producing lower decibels than most other fans on the market. The Stratos Fan can be installed in any position with the included mounting bracket. 5 Year Warranty.



EXCLUSIVE

Item No.	Description	Amps	Watts	MSRP
736142	Fantech Revolution Stratos Mixed Flow Inline Fan 6 in - 296 CFM	0.29	37	\$264.95
736144	Fantech Revolution Stratos Mixed Flow Inline Fan 8 in - 647 CFM	0.81	93	\$368.95

Fantech Inline Mixed Flow Fan FHD Series



Fantech FHD direct drive, mixed flow centrifugal fans blend the high flow of axial fans with the higher pressure, non-overloading characteristics of backward curved impellers. Automatic reset thermal overload protection and sealed ball bearings. External terminal box with prewired electrical strip. 100% speed controllable. Check your Dealer Partner for availability. 3 Year Warranty.



EXCLUSIVE

Item No.	Description	Amps	Watts	MSRP
736290	Fantech Indoor Inline Mixed Flow 10 in Fan FHD 10XL 1267 CFM	4.48	485	\$686.95
736120	Fantech Indoor Inline Mixed Flow 12 in Fan FHD 12XL 2013 CFM	4.7	467	\$866.95
736124	Fantech Indoor Inline Mixed Flow 14 in Fan FHD 14XL 2621 CFM	6.4	716	\$1,470.95

Atmosphere Vortex Powerfans S-line



A revolutionary series of fans that combine energy efficiency, ultra-quiet operations and a collection of advanced technologies that deliver unparalleled performances. Extremely energy efficient AC brushless motor powers the patented mixed-flow dual impellers. Built with double insulated walls, noise is reduced to levels that were previously thought to be unattainable. 10 Year Warranty.

Item No.	Description	MSRP
736708	Vortex S Line S-600 6 in Fan 347 CFM	\$209.99
736712	Vortex S Line S-800 8 in Fan 728 CFM	\$254.99

Atmosphere Vortex Inline Powerfans



Speed controllable and balanced motors with permanently lubricated ball bearings ensure vibration-free operation. The Vortex Powerfan comes with a 6 ft power cord, ready to plug in, installed by the manufacturer. 10 Year Warranty.



Item No.	Description	MSRP
736700	Vortex Inline Fan 4 in 175 CFM	\$168.95
736705	Vortex Inline Fan 6 in 452 CFM	\$215.95
736710	Vortex Inline Fan 8 in 747 CFM	\$270.95
736715	Vortex Inline Fan 10 in 790 CFM	\$290.95
736720	Vortex Inline Fan 12 in 1140 CFM	\$412.95

Atmosphere Vortex Powerfans V-Series



This fan is powered by a permanently lubricated & balanced external rotor motor equipped with a mixed-flow impeller. This impeller is a cross between axial & centrifugal design allowing more air volume. It operates at lower RPM making them quieter. Power cord kit NOT included in V-16XL Series. 3 Year Warranty.



Item No.	Description	MSRP
736690	Vortex V-12XL Inline Fan 12 in 2050 CFM	\$889.95
736691	Vortex V-14XL Inline Fan 14 in 2905 CFM	\$1,399.95
736698	Vortex V-16XL Inline Fan 16 in 4515 CFM	\$2,299.95

Vortex Replacement Mounting Brackets

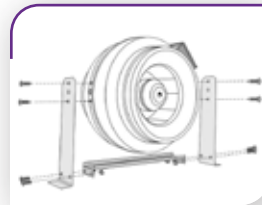

Made from galvanized steel, the mounting brackets are available for all sizes of Vortex Powerfans. They are made to be mounted in all positions either horizontally or vertically. For use with Vortex Power Fans, but not the V-Series Fans.

Item No.	Description	MSRP
736704	Vortex Mounting Bracket 6 in, 8 in & 10 in	\$14.95
736701	Vortex Mounting Bracket 12 in	\$16.95

Can-Fan® Speed Controller - Variable Voltage



This Can-Fan® variable voltage speed controller is for all 120 volt, 60 Hz. fans with less than 7.5 amps drawn. This product provides smooth sinusoidal wave, so there is no growl at running speed.

Item No.	Description	MSRP
736872	Speed Controller Variable Voltage	\$299.98

Can-Fan® Inline Fans



Can-Fan® bring its innovation to market and sets a new standard for performance. The outstanding performance of our fans set them apart from the competition. Each fan comes pre-wired with an 8 ft - 120 volt power cord. 5 Year Warranty.

Item No.	Description	Amps	Watts	MSRP
736780	Can-Fan S 4 in 120 CFM	0.69	68	\$131.03
736785	Can-Fan RS 4 in HO 155 CFM	1.15	78	\$155.55
736790	Can-Fan S 6 in 269 CFM	0.69	82	\$146.57
736795	Can-Fan RS 6 in HO 392 CFM	1.15	138	\$186.66
736800	Can-Fan S 8 in 483 CFM	1.16	139	\$164.34
736805	Can-Fan RS 8 in HO 722 CFM	2.36	283	\$246.51
736810	Can-Fan RS 10 in HO 763 CFM	2.36	283	\$266.65
736815	Can-Fan RS 12 in HO 975 CFM	3.04	365	\$328.68

Can-Fan® Max-Fan™



Can-Fan® bring its innovation to market and sets a new standard for performance. The Max-Fan™ is more powerful and efficient fan that takes less energy to run. 6 in - 14 in come pre-wired with an 8 ft - 120 volt power cord. 16 in does NOT come with a power cord (240 Volt). 5 Year Warranty.



Item No.	Description	Amps	Watts	MSRP
736820	Can-Fan Max Fan 6 in 334 CFM	0.7	75	\$197.77
736825	Can-Fan Max Fan 8 in 675 CFM	1.5	179	\$242.06
736745	Can-Fan Max Fan 8 in HO 932 CFM 3 Speed	1.85	213	\$388.64
736830	Can-Fan Max Fan 10 in 1019 CFM	1.9	228	\$306.73
736835	Can-Fan Max Fan 12 in 1709 CFM	4.1	489	\$479.69
736840	Can-Fan Max Fan 14 in 1700 CFM	2.1	253	\$763.95
736842	Can-Fan Max Fan 16 in 240 Volt 2436 CFM	1.5	347	\$1,254.74

Max-Fan™ Pro Series Mixed Flow Fans



Max-Fan™ Pro Series is even more efficient and stronger than the original Max-Fan™ design, it has a much more robust housing due to the fiberglass reinforced plastic compounds that meet all of the UL and CSA requirements. The fans have three control speeds and run quieter than the Max-Fan™. The fans come with the EZ Mount™ bracket for easy mounting.

Item No.	Description	Amps	Watts	MSRP
736746	Can-Fan Max Fan Pro Series 6 in - 420 CFM	0.62	69	\$230.95
736748	Can-Fan Max Fan Pro Series 8 in - 863 CFM	1.58	186	\$321.99

Can-Fan® Q-Max™ Fans



The Q-Max™ Fan is the quiet line of fans from Can-Fan®. Available in 10 in or 12 in sizes, the Q-Max™ is a ready to hang, true CFM silenced Max-Fan. The integrated Max-Fan™ with acoustic foam liner offers maximum sound absorption. The 10 in model is equipped with 3-speeds.



Item No.	Description	Amps	Watts	MSRP
736750	Can-Fan Q-Max 10 in 1019 CFM	1.95	231	\$508.56
736755	Can-Fan Q-Max 12 in 1709 CFM	4.5	489	\$592.95

Hurricane® Oscillating Fans - Supreme Series



These excellent quality wall mount fans feature 3 speeds with a speed control knob and cord. The fans have a powder coated steel grill and a chemical resistant polypropylene blade. They can oscillate 90 degrees or can be locked in a non-oscillating position. The fan head can also be tilted up and down for more directional control. Both are very quiet and efficient. 1 Year Warranty.



EXCLUSIVE

Item No.	Description	MSRP
736505	Hurricane Supreme Wall Mount Fan 16 in	\$46.95
736506	Hurricane Supreme Wall Mount Fan 18 in	\$66.95

Hurricane® Supreme Oscillating Stand Fan 16 In



The stand fan has 3-speed controls and a powder coated steel grill. The blade is chemical resistant polypropylene. 90 degrees oscillation or can be locked in non-oscillating position. Fan height is adjustable from 41 in to 55 in. 1 Year Warranty.

New improved version coming soon!

EXCLUSIVE

Item No.	Description	MSRP
736507	Hurricane Supreme Oscillating Stand Fan 16 in	\$61.95

Hurricane® W Stand Fan



Produces random air movement by operating in a "W" pattern with both up/down and side to side operation. 3 speed settings and 2 oscillation settings. Powder coated steel grill. Adjustable height and tilt. 1 Year Warranty.



EXCLUSIVE

Item No.	Description	MSRP
736535	Hurricane W Stand Fan 16 in	\$59.95

Hurricane®



Hurricane® Super 8 Digital Stand Fan 16 in



Hurricane®
Super 8
16" Digital Stand Fan

Easy-to-use Multifunctional LCD Display

Ideal for home, greenhouses, garages, workshops and other areas where a heavy-duty portable stand fan can be used.

Supreme Series





EXCLUSIVE





The Hurricane® Super 8 produces a figure 8 pattern for better and more uniform air circulation.

- 3 speed settings.
- 3 oscillation settings.
- 8 hour timer.
- Includes remote control.
- Powder coated steel grill.
- Adjustable height and tilt.

The Hurricane® Super 8 produces a figure 8 pattern for better and more uniform air circulation. It has 3 speed settings and 3 oscillation settings. Super 8 has an 8 hour timer with a remote control. The remote will work for all Super 8 family of fans. Powder coated steel grill. Adjustable height and tilt. Easy-to-use multifunctional LCD display. 1 Year Warranty.

Item No.	Description	MSRP
736540	Hurricane Super 8 Digital Stand Fan 16 in	\$79.95

Hurricane® Super 8 Digital Wall Mount Fan 16 in



Hurricane®
Super 8
Programmable Oscillating Wall Fan

Remote control allows the Hurricane Super 8 fan to be programmed easily

Supreme Series



EXCLUSIVE





The Hurricane® Super 8 fan produces a figure 8 pattern for better and more uniform air circulation.



Program precise fan movement patterns to fit any application.

Hurricane® Super 8 Programmable Oscillating Wall Mount Fan produces a figure 8 pattern for better and more uniform air circulation. This fan has reliable metal gear construction which makes for whisper quiet operation. Remote control makes for easy operation and will work for all the Super 8 family of fans. 1 Year Warranty.

Item No.	Description	MSRP
736565	Hurricane Super 8 Digital Wall Mount Fan 16 in	\$69.95

Hurricane® 16 in Wall Mount Fan - Classic Series



Classic series 16 inch wall mount oscillating fan. This fan has 3 speed settings controlled by a turn switch. The fan has a 90 degree oscillation motion. There are two convenient pull cords for speed and oscillation control. It has a durable steel neck support with a 60 inch power cord. 1 Year Warranty.



EXCLUSIVE

Item No.	Description	Amps	Watts	MSRP
736503	Hurricane Classic Wall Mount Oscillating Fan 16 in	0.5	60	\$39.95

Hurricane® 6 in Clip Fan - Classic Series



Easily mounts wherever needed. Strong clamp holds fan in place during use. Two speed operation. Adjustable tilt mechanism. 120 volt five foot power cord. 1 Year Warranty.



EXCLUSIVE

Item No.	Description	Amps	Watts	MSRP
736520	Hurricane 6 in Clip Fan	0.25	30	\$19.95

Air King® Fans



Clip on fan has impact resistant plastic grills with chemical resistant polypropylene blade, 2-speed and 1/300 HP motor. The 12 in, 16 in and 18 in fans oscillate 90 degree or can be locked in non-oscillating position and have 3-speeds. They also have powder coated steel front grill with impact resistant plastic rear grill. 1 Year Warranty.



Item No.	Description	MSRP
736735	Air King Clip On Fan 6 in	\$34.95
736725	Air King Wall Mount Fan 12 in	\$74.99
736730	Air King Wall Mount Fan 16 in	\$84.99
736740	Air King Wall Mount Fan 18 in	\$99.95

Air King® Pedestal Fans



Fans feature a 3-speed 1/20 HP motor with rear mounted rotary controls and a 7 ft white power cord. The grills are constructed of a powder coated steel front grill with an impact resistant plastic rear grill. 16 in fan height is adjustable from 36 in to 52 in. 18 in Fan height is adjustable from 37 in to 53.75 in.



Item No.	Description	MSRP
736731	Air King Pedestal Fan 16 in	\$69.99
736741	Air King Pedestal Fan 18 in	\$71.99

Hurricane® Blowers



Quiet, powerful and dependable — made with industrial grade quality. Intake flange adapters built right into fan, no need to purchase hose adapters separately. Attractive gray powder coated steel housing. 10 ft grounded power cord pre wired into each unit. 1 Year Warranty.

EXCLUSIVE

Item No.	Description	MSRP
736620	Hurricane Blower 180 CFM	\$97.95
736625	Hurricane Blower 265 CFM	\$105.95
736630	Hurricane Blower 465 CFM	\$119.95

Hurricane® Inline Duct Boosters



Perfect for boosting air flow in long runs of ducting. Come wired with junction box, strain relief and power cord. Fluted on both ends to receive ducting. 1 Year Warranty.

EXCLUSIVE

Item No.	Description	MSRP
736650	Hurricane Inline Duct Booster 4 in 70 CFM	\$49.95
736655	Hurricane Inline Duct Booster 6 in 160 CFM	\$52.95
736660	Hurricane Inline Duct Booster 8 in 370 CFM	\$58.95

Hurricane® Axial Fans



Hurricane® Axial Fans can be used in any application where ventilation/air movement is required. They are very reliable and will provide years of trouble-free use. Includes detachable power cord. 1 Year Warranty.

EXCLUSIVE

Item No.	Description	Amps	Watts	MSRP
736880	Hurricane Axial Fan 4.5 in 112 CFM	0.23	24	\$30.95
736885	Hurricane Axial Fan 6 in 235 CFM	0.25	28	\$65.95
736890	Hurricane Axial Fan 8 in 647 CFM	1	102	\$99.95
736895	Hurricane Axial Fan 10 in 806 CFM	0.62	67	\$99.95



Having trouble figuring out what product you need? Scan here for the Titan Controls Product Selector Guide.



Titan Controls® Mercury® 2 - Fan Speed Controller



Adjusts fan speed from 10% - 100%. Fire-up feature extends life of your fan. Easy to operate. Plastic enclosure protects internal components from dust and moisture. 6 Amps maximum/120 Volts/60 Hz. 2 Year Warranty.



EXCLUSIVE

Item No.	Description	MSRP
702753	Titan Controls Mercury 2 - Fan Speed Controller	\$77.95

Titan Controls® Zephyr™ 3 - Heating/Cooling Controller



Precise temp control of your cooling and heating equipment. 40°F to 100°F gives the operator a great range of settings. Change from Heating to Cooling with just a flip of the switch. Discrete green power light indicates operation of equipment. Built in 4°F split differential. 15 Amps maximum/120 Volts/60 Hz. 3 Year Warranty.



EXCLUSIVE

Item No.	Description	MSRP
702845	Titan Control Zephyr 3 - Cooling/Heating Controller	\$92.95

Titan Controls® Mercury® 3 - Day/Night Fan Controller



Automatically increases or decreases fan speed based on controller set points. Allows user to adjust deadband range to meet garden requirements. Temperature control range is 55°F to 95°F. 6 ft temp probe is accurate to within 2°F. 6 Amps maximum/120 Volts/60 Hz. 2 Year Warranty.



EXCLUSIVE

Item No.	Description	MSRP
702755	Titan Controls Mercury 3 - Day/Night Fan Controller	\$119.95

Titan Controls® Zephyr™ 4 - Cooling Thermostat Fan Control



Easy to use - plug fan into receptacle, then plug control into 120 volt power supply. Set thermostat to the temperature you want the fan to come on at and that's it! 13 Amps maximum/120 Volts/60 Hz. 1 Year Warranty.

EXCLUSIVE

Item No.	Description	MSRP
736167	Titan Controls Zephyr 4 - Cooling Thermostat Fan Control	\$79.95

Titan Controls® Mercury® 4 - Multi-Function Fan Speed Controller



Allows user to select minimum fan idle speed between 25% & 60% of fan rating. Enables the user to activate/deactivate low temp safety feature. Temp control range is 55°F to 95°F. 6 ft temp probe is accurate to within 2°F. 6 Amps maximum/120 Volts/60 Hz. 2 Year Warranty.



EXCLUSIVE

Item No.	Description	MSRP
702760	Titan Controls Mercury 4 - Multi Function Fan Speed Controller	\$119.95

Titan Controls® Spartan Series™ Fan Speed Controller



NEW The Fan Speed Controller features: Day and night temperature settings from 50°F to 100°F, variable fan idle mode settings, LED output indicator light and an accurate external temperature probe. For use with carbon filters and air filter systems. Housed in a rust, dust and water resistant plastic enclosure, this controller will function in the roughest environments. Ratings: 5 Amps maximum/120 Volts/60 Hz. 1 Year Warranty.



EXCLUSIVE

Item No.	Description	MSRP
702895	Titan Controls - Spartan Series Fan Speed Controller	\$89.95

Titan Controls® Zephyr™ 1 - Day/Night Temperature Controller



Temp control range is 55°F to 95°F. Controls cooling or heating equipment. Day and night settings keep temperature within 4°F of set point. 6 ft temp probe is accurate to within 2°F. 15 Amps maximum/120 Volts/60 Hz. 2 Year Warranty.



EXCLUSIVE

Item No.	Description	MSRP
702630	Titan Controls Zephyr 1 - Day/Night Temp Controller	\$89.95

Ideal-Air™ Fan Speed Controller



Works with AC/DC brush-type motors 15 amps or less. Three adjustable switch settings: full, variable and off. When switch is set to variable, adjustable knob controls fan speed. 6 ft - 120 volt power cord and up to 15 amps. Will not work with soft or slow-start motors. 1 Year Warranty.

EXCLUSIVE

Item No.	Description	MSRP
700515	Ideal-Air Fan Speed Controller	\$27.95

Speedster™ Variable Fan Speed Control



The Speedster™ is great multi purpose speed control. Three settings include off, on (full) and variable. Simply use the dial to increase or decrease fan motor speed. 120 volt/15 amps. 90 Day Warranty.

Item No.	Description	MSRP
736617	Speedster Variable Speed Control	\$29.95

Ideal-Air™ Adjustable 90 Degree Elbow Ducting



Strengthening beads ensure a stiffer, round elbow and a better seal. All elbows come standard with one end crimped. Ideal-Air adjustable elbows are used to make turns in round pipe and flexible duct through 90 degrees.

EXCLUSIVE

Item No.	Description	MSRP
750100	Ideal-Air Adjustable 90 Degree Elbow 4 in	\$3.49
750105	Ideal-Air Adjustable 90 Degree Elbow 6 in	\$4.99
750110	Ideal-Air Adjustable 90 Degree Elbow 8 in	\$6.99
750115	Ideal-Air Adjustable 90 Degree Elbow 10 in	\$9.99
750120	Ideal-Air Adjustable 90 Degree Elbow 12 in	\$16.99

Ideal-Air™ Wye Branch



Our heavy-duty Wye Branches are made of a thick gauge galvanized steel. We have improved the design for easier use and more secure duct connections. We offer a variety of sizes and configurations for all your ducting and HVAC needs.

EXCLUSIVE

Item No.	Description	MSRP
736185	Ideal-Air Wye Branch 4 in x 4 in x 4 in	\$15.79
736189	Ideal-Air Wye Branch 6 in x 4 in x 4 in	\$16.69
736190	Ideal-Air Wye Branch 6 in x 6 in x 6 in	\$17.99
736195	Ideal-Air Wye Branch 8 in x 6 in x 6 in	\$19.19
736200	Ideal-Air Wye Branch 8 in x 8 in x 8 in	\$21.39
736320	Ideal-Air Wye Branch 10 in x 6 in x 6 in	\$21.99
736205	Ideal-Air Wye Branch 10 in x 8 in x 8 in	\$22.39
736325	Ideal-Air Wye Branch 12 in x 8 in x 8 in	\$31.95
736217	Ideal-Air Wye Branch 12 in x 10 in x 10 in	\$33.95
736216	Ideal-Air Wye Branch 12 in x 12 in x 12 in	\$33.95

Ideal-Air™ Duct Reducers



Our heavy-duty Duct Reducers are made of a thick gauge galvanized steel. We have improved the design for easier use and more secure duct connections. We offer a variety of sizes for all your HVAC and ducting needs.

EXCLUSIVE

Item No.	Description	MSRP
736210	Ideal-Air Duct Reducer 6 in - 4 in	\$8.25
736211	Ideal-Air Duct Reducer 8 in - 6 in	\$10.95
736310	Ideal-Air Duct Reducer 10 in - 6 in	\$13.49
736212	Ideal-Air Duct Reducer 10 in - 8 in	\$13.49
736315	Ideal-Air Duct Reducer 12 in - 8 in	\$14.95
736213	Ideal-Air Duct Reducer 12 in - 10 in	\$14.95
736214	Ideal-Air Duct Reducer 14 in - 12 in	\$19.95

Ideal-Air™ Duct Couplers



Quick and easy solution for connecting flex ducting. Crimped on both ends with strengthening bead for secure connection. Made from galvanized steel.

EXCLUSIVE

Item No.	Description	MSRP
736416	Ideal-Air Duct Coupler 4 in	\$3.79
736418	Ideal-Air Duct Coupler 6 in	\$4.79
736420	Ideal-Air Duct Coupler 8 in	\$5.59
736422	Ideal-Air Duct Coupler 10 in	\$7.59
736424	Ideal-Air Duct Coupler 12 in	\$8.59

Ideal-Air™ Duct Collar Air Tight



For connecting your ducting to your wall, floor or ceiling opening. 1.5 in galvanized steel mounting flange with adhesive gasket.

EXCLUSIVE

Item No.	Description	MSRP
736456	Ideal-Air Duct Collar Air Tight 4 in	\$7.99
736458	Ideal-Air Duct Collar Air Tight 6 in	\$9.95
736460	Ideal-Air Duct Collar Air Tight 8 in	\$11.95
736462	Ideal-Air Duct Collar Air Tight 10 in	\$14.95
736464	Ideal-Air Duct Collar Air Tight 12 in	\$17.95

Ideal-Air™ Flange Kits



These Flange Kits are used to vent air through a wall or ceiling. Mount the Ideal-Air™ Flange Kit to the wall or ceiling, then attach your duct work to the flange. Also for use with Sun Huts®. Choose the size that will work with your ducting size.

EXCLUSIVE

Item No.	Description	MSRP
736355	Ideal-Air Flange Kit 4 in	\$8.95
736357	Ideal-Air Flange Kit 6 in	\$9.95
736359	Ideal-Air Flange Kit 8 in	\$10.95
736361	Ideal-Air Flange Kit 10 in NEW	\$19.95
736363	Ideal-Air Flange Kit 12 in NEW	\$22.95

Ideal-Air™ Back Draft Dampers



These are excellent quality back draft dampers. They are made from heavy-gauge galvanized steel with heavy duty springs. They use both an embossed bead & rubber gasket to help keep ducting securely in place.

EXCLUSIVE

Item No.	Description	MSRP
736980	Ideal-Air Back Draft Damper 4 in	\$17.95
736982	Ideal-Air Back Draft Damper 6 in	\$19.95
736984	Ideal-Air Back Draft Damper 8 in	\$29.95
736986	Ideal-Air Back Draft Damper 10 in	\$39.95
736988	Ideal-Air Back Draft Damper 12 in	\$49.95

Ideal-Air™ Screened Wall Vents



For bringing in fresh air or exhausting stale air. Made of galvanized sheet metal. Screened opening to help keep the pests out.

EXCLUSIVE

Item No.	Description	MSRP
736380	Ideal-Air Screened Wall Vent 4 in	\$16.95
736382	Ideal-Air Screened Wall Vent 6 in	\$18.95
736384	Ideal-Air Screened Wall Vent 8 in	\$21.95
736386	Ideal-Air Screened Wall Vent 10 in	\$26.95
736388	Ideal-Air Screened Wall Vent 12 in	\$34.95

Ideal-Air™ Supreme Silver/Black Ducting



NEW The Ideal-Air™ Supreme Silver/Black Flex Ducting is a high quality 3 ply aluminum foil duct. The duct has a black interior core and a silver reflective exterior. 100% made in the USA, this ducting is constructed with a spring steel wire helix, which is then encapsulated in a polyester, aluminum foil and polyester tri-laminate. Specifically oversized by 3/8 in to fit any application. Duct length is 25 foot and includes 4 zip ties per **EXCLUSIVE**



bag. UL Listed. 1 Year Warranty.

Item No.	Description	MSRP
736991	Ideal-Air Supreme Silver / Black Ducting 6 in x 25 ft	\$25.95
736992	Ideal-Air Supreme Silver / Black Ducting 8 in x 25 ft	\$31.95
736993	Ideal-Air Supreme Silver / Black Ducting 10 in x 25 ft	\$39.95
736994	Ideal-Air Supreme Silver / Black Ducting 12 in x 25 ft	\$52.95
736995	Ideal-Air Supreme Silver / Black Ducting 14 in x 25 ft	\$59.95

Ideal-Air™ Silver/Black Flex Ducting



Has a silver exterior and black inner core. 25 ft length silver/black ducting. Commercial grade. Black inner core helps reduce light transfer. Made with heavy duty materials.

EXCLUSIVE

Item No.	Description	MSRP
736971	Ideal-Air Silver/Black Flex Ducting 4 in x 25 ft	\$17.95
736972	Ideal-Air Silver/Black Flex Ducting 6 in x 25 ft	\$20.95
736973	Ideal-Air Silver/Black Flex Ducting 8 in x 25 ft	\$25.95
736974	Ideal-Air Silver/Black Flex Ducting 10 in x 25 ft	\$32.95
736975	Ideal-Air Silver/Black Flex Ducting 12 in x 25 ft	\$42.95

Ideal-Air™ Silver/Silver Flex Ducting



These Class 1 aluminum flexible air ducts are made from tough, puncture resistant 3 ply aluminum foil laminate and contain a high density, corrosion resistant wire helix in the duct wall for support.

EXCLUSIVE

Item No.	Description	MSRP
904165	Ideal-Air Silver/Silver Flex Ducting 4 in x 25 ft	\$14.95
904170	Ideal-Air Silver/Silver Flex Ducting 6 in x 25 ft	\$19.95
904175	Ideal-Air Silver/Silver Flex Ducting 8 in x 25 ft	\$26.95
904180	Ideal-Air Silver/Silver Flex Ducting 10 in x 25 ft	\$31.95
904185	Ideal-Air Silver/Silver Flex Ducting 12 in x 25 ft	\$39.95

Ideal-Air™ Silver Premium Insulated Flex Ducting



This premium Ideal-Air™ ducting has been developed to minimize heat gain or loss resulting from the temperature difference between the air flowing in the duct and the surrounding air.

EXCLUSIVE

Item No.	Description	MSRP
738702	Ideal-Air Silver Insulated Flex Ducting 6 in x 25 ft	\$50.95
738704	Ideal-Air Silver Insulated Flex Ducting 8 in x 25 ft	\$69.95
738706	Ideal-Air Silver Insulated Flex Ducting 10 in x 25 ft	\$79.95
738708	Ideal-Air Silver Insulated Flex Ducting 12 in x 25 ft	\$96.95

Ideal-Air™ Aluminum Semi-Rigid Premium Flex Ducting

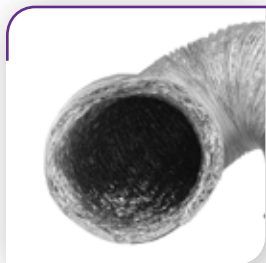

Idea-Air™ Semi Rigid Flexible Ducting is a commercial grade, high heat, aluminum laminated flex duct that will help hold its shape when bent reducing or eliminating the need for rigid elbows. The high strength comes from a high tensile steel wire helix.

EXCLUSIVE

Item No.	Description	MSRP
738726	Ideal-Air Aluminum Semi-Rigid Premium Flex Ducting 6 in x 25 ft	\$36.99
738728	Ideal-Air Aluminum Semi-Rigid Premium Flex Ducting 8 in x 25 ft	\$44.99
738730	Ideal-Air Aluminum Semi-Rigid Premium Flex Ducting 10 in x 25 ft	\$54.99

Ideal-Air™ White/Silver Vinyl Light Tight Flex Ducting



The Ideal-Air™ light tight flexible ducting has a heavy duty laminated aluminum inner core with an encapsulated high tensile steel wire helix. The outer core is covered with a UV resistant light tight white PVC jacket.

EXCLUSIVE

Item No.	Description	MSRP
738712	Ideal-Air White/Silver Vinyl Light Tight Flex Ducting 4 in x 25 ft	\$21.99
738714	Ideal-Air White/Silver Vinyl Light Tight Flex Ducting 6 in x 25 ft	\$33.99
738716	Ideal-Air White/Silver Vinyl Light Tight Flex Ducting 8 in x 25 ft	\$44.99
738718	Ideal-Air White/Silver Vinyl Light Tight Flex Ducting 10 in x 25 ft	\$56.99
738720	Ideal-Air White/Silver Vinyl Light Tight Flex Ducting 12 in x 25 ft	\$67.99

ThermoFlo Elbow

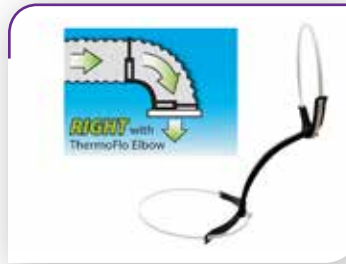

ThermoFlo Elbow is a radius forming brace for flexible ducts that's engineered to improve the airflow and efficiency of your grow room ventilation system. It saves energy by eliminating kinks and shapes flexible ducts into efficient 90-degree elbows.



Item No.	Description	MSRP
736979	ThermoFlo Elbow	\$6.49

ThermoFlo 2000 SR Ducting

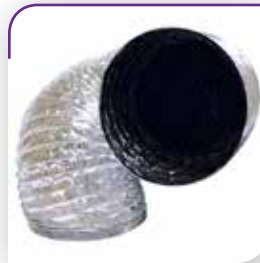

The 2000 SR Series Ducting is specifically engineered to handle unconditioned air. It can withstand high heat, high humidity and excessive CFM's without any duct failure or fatigue.



Item No.	Description	MSRP
736915	ThermoFlo SR Ducting 4 in x 25 ft	\$28.95
736920	ThermoFlo SR Ducting 6 in x 25 ft	\$40.95
736925	ThermoFlo SR Ducting 8 in x 25 ft	\$51.95
736930	ThermoFlo SR Ducting 10 in x 25 ft	\$65.95
736935	ThermoFlo SR Ducting 12 in x 25 ft	\$81.95
736940	ThermoFlo SR Ducting 14 in x 25 ft	\$100.95
736942	ThermoFlo SR Ducting 16 in x 25 ft	\$125.95

ThermoFlo SR Insulated Ducting



This insulated ducting is manufactured tough for consumers' and installers' peace of mind. A heavy duty fire retardant black polyethylene vapor barrier adds extra durability. The insulation reduces noise, heat loss and condensation.



Item No.	Description	MSRP
736955	ThermoFlo SR Insulated Ducting 6 in x 25 ft	\$70.95
736960	ThermoFlo SR Insulated Ducting 8 in x 25 ft	\$91.95
736965	ThermoFlo SR Insulated Ducting 10 in x 25 ft	\$111.95
736970	ThermoFlo SR Insulated Ducting 12 in x 25 ft	\$133.95

Can-Duct™ Silver/Silver 3 Ply



Can-Duct™ Silver/Silver 3-ply offers a triple foil laminate grade casing complete with 2 clamps.

Item No.	Description	MSRP
738605	Can-Fan Silver/Silver 3 Ply Ducting 6 in x 25 ft	\$26.66
738610	Can-Fan Silver/Silver 3 Ply Ducting 8 in x 25 ft	\$33.32
738615	Can-Fan Silver/Silver 3 Ply Ducting 10 in x 25 ft	\$44.43
738620	Can-Fan Silver/Silver 3 Ply Ducting 12 in x 25 ft	\$55.53

Max-Duct™ Vinyl



Max-Duct™ vinyl has triple foil laminate with very durable white PVC with UV inhibitor coating. Includes 2 clamps for easy installation.

Item No.	Description	MSRP
738630	Can-Fan Max Vinyl Ducting 4 in x 25 ft	\$24.43
738635	Can-Fan Max Vinyl Ducting 6 in x 25 ft	\$37.76
738640	Can-Fan Max Vinyl Ducting 8 in x 25 ft	\$51.09
738645	Can-Fan Max Vinyl Ducting 10 in x 25 ft	\$64.42
738650	Can-Fan Max Vinyl Ducting 12 in x 25 ft	\$77.74

HVAC Heavy-Duty Zip Ties



No more dealing with hose clamps! Commercial grade HVAC zip ties are simple to use and feature a locking mechanism for a firm hold. Made from thick, heavy duty natural colored nylon. The 36 in tie can fit up to 10 in ducting and the 48 in tie can fit up to 14 in ducting.

Item No.	Description	MSRP
380100	HVAC Heavy-Duty Zip Tie 36 in 50/Pack (1ea = Pack 50)	\$18.95
380105	HVAC Heavy-Duty Zip Tie 48 in 50/Pack (1ea = Pack 50)	\$36.95

Ideal-Air™ Stainless Steel Hose Clamps



These stainless steel hose clamps are perfect for attaching flexible ducting to air cooled hoods, exhaust fans, filters and silencers.

EXCLUSIVE

Item No.	Description	MSRP
380031	Ideal-Air Stainless Steel Hose Clamps 2/Pack 4 in	\$1.99
380051	Ideal-Air Stainless Steel Hose Clamps 2/Pack 6 in	\$2.95
380061	Ideal-Air Stainless Steel Hose Clamps 2/Pack 8 in	\$4.95
380071	Ideal-Air Stainless Steel Hose Clamps 2/Pack 10 in	\$6.19
380081	Ideal-Air Stainless Steel Hose Clamps 2/Pack 12 in	\$7.95

Ideal-Air™ Butterfly Hose Clamps



These Ideal-Air™ Butterfly Hose Clamps make for quick and each attachment of ducting to collar fittings. Made of heavy-duty stainless steel. Unique butterfly shaped screw head easily twists for hand tightening without tools. Conveniently packaged 2 per bag.

EXCLUSIVE

Item No.	Description	MSRP
380130	Ideal-Air Butterfly Hose Clamp 2/Pack 4 in	\$2.29
380132	Ideal-Air Butterfly Hose Clamp 2/Pack 6 in	\$3.29
380134	Ideal-Air Butterfly Hose Clamp 2/Pack 8 in	\$5.29
380136	Ideal-Air Butterfly Hose Clamp 2/Pack 10 in	\$6.39
380138	Ideal-Air Butterfly Hose Clamp 2/Pack 12 in	\$8.39

Ideal-Air™ Quick Release Stainless Steel Hose Clamps



Quick release stainless steel hose clamps. Just release the tension on the screw and flip up to instantly release the clamp. Allows for easy removal of the clamp for quicker flex duct removal when cleaning the glass in your air cooled fixture.

EXCLUSIVE

Item No.	Description	MSRP
380122	Ideal-Air Quick Release Stainless Steel Hose Clamps 2/Pack 6 in	\$3.95
380124	Ideal-Air Quick Release Stainless Steel Hose Clamps 2/Pack 8 in	\$6.19
380126	Ideal-Air Quick Release Stainless Steel Hose Clamps 2/Pack 10 in	\$6.95
380128	Ideal-Air Quick Release Stainless Steel Hose Clamps 2/Pack 12 in	\$8.95

Ideal-Air™ Noise Reduction Clamps



2-3/8 inch wide galvanized steel clamps are used with fans, silencers, reflectors, carbon filters and ducting. The neoprene lining makes for a tight, vibration free fit. Two Phillips head screws for tightening.

EXCLUSIVE

Item No.	Description	MSRP
380037	Ideal-Air Noise Reduction Clamp 6 in	\$4.79
380039	Ideal-Air Noise Reduction Clamp 8 in	\$5.49
380041	Ideal-Air Noise Reduction Clamp 10 in	\$6.59
380043	Ideal-Air Noise Reduction Clamp 12 in	\$7.69

Ideal-Air™ Noise Reduction Clamps - Supreme



2-3/8 in wide clamps are used with fans, silencers, reflectors, carbon filters and ducting. The neoprene lining helps to make for an airtight, vibration free fit. The top quality durable powder-coated finish helps prevent rust and dust. Individually boxed.

EXCLUSIVE

Item No.	Description	MSRP
380092	Ideal-Air Noise Reduction Clamp Supreme 4 in	\$10.99
380094	Ideal-Air Noise Reduction Clamp Supreme 6 in	\$11.99
380096	Ideal-Air Noise Reduction Clamp Supreme 8 in	\$12.99
380097	Ideal-Air Noise Reduction Clamp Supreme 10 in	\$14.99
380098	Ideal-Air Noise Reduction Clamp Supreme 12 in	\$17.99
380150	Ideal-Air Noise Reduction Clamp Supreme 14 in	\$23.99

Flex Duct Hanger Strap

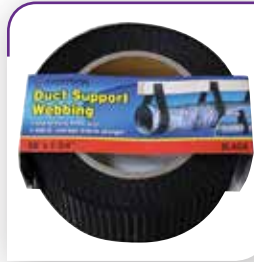

Cambridge's 1.75 in Support Webbing registers a remarkable tensile strength of up to 440 lb. Nylon webbing duct support strap. Use to hang HVAC duct. 440 lb average tensile strength. 1.75 in x 50 foot roll.

Item No.	Description	MSRP
700960	Flex Duct Hanger Strap	\$2.99

Ideal-Air™ Silver Duct Tape



1.88 in x 45 yard roll of heavy duty silver duct tape. General contractors duct tape of choice. Aggressive natural rubber adhesives for high performance applications.

EXCLUSIVE

Item No.	Description	MSRP
904196	Ideal-Air Silver Duct Tape 2 x 45 yd	\$8.99

Silver Flex Duct Tape



A 2 mil, heavy duty, high strength aluminum foil coated with a specially formulated pressure sensitive acrylic adhesive system. Will not leave behind messy adhesive residue. Use it to make your ducting to fixture connections airtight. 

EXCLUSIVE

Item No.	Description	MSRP
904161	Silver Flex Duct Tape 5 yd	\$4.95
904162	Silver Flex Duct Tape 120 yd	\$19.95

SUN SYSTEM

Creating the best lighting in the industry. Choose the brand that continually outperforms the rest!



Sunlight Supply, Inc.

National Garden Wholesale®

#growwhatyouknow

www.sunlightsupply.com

IDEALair™

Dehumidifiers

Ideal-Air™ Dehumidifiers 30, 50 & 70 Pint



Rated at 30, 50 & 70 pints per day at 86°F/80% RH. Quick maintenance with easy carbon filter access that is removable and washable. Low temperature defrosting. Easy to move with built in handles and wheels. Easy to use LED display panel. Removable water tank with an automatic shutoff when reservoir is full. The reservoir for the dehumidifiers is **EXCLUSIVE**



6 liters or 12.5 pints. Can be plumbed for permanent drainage. 1 Year Warranty.

Item No.	Description	MSRP
700830	Ideal-Air Dehumidifier 30 Pint	\$214.95
700826	Ideal-Air Dehumidifier 50 Pint	\$299.99
700828	Ideal-Air Dehumidifier 70 Pint	\$349.99

Ideal-Air™ Dehumidifier Up To 60 Pint



NEW Automatic restart allows unit to be used with humidity controllers. Built-in defrost system is designed for operation down to 45°F. Automatic shut off when tank is full. Set upright on their feet for 3 hrs prior to use. Temp. Range: 45°F- 105°F; Refrigerant: R410A. H2O removal: (24hrs) 60 pints (86°F, 80% R.H.); Power: 6.6 Amps/700 Watts; Supply Voltage: 115V-1 Phase-60Hz. All Ideal-Air™ dehumidifiers need surge protection and a dedicated power circuit. In the event of a power failure, a spike in power may occur when the power is reinstated. **EXCLUSIVE** This can damage the circuit board which is not covered under warranty. 1 Year Warranty.



Item No.	Description	MSRP
700834	Ideal-Air Commercial Grade Dehumidifier Up To 60 Pint	\$549.95

700830

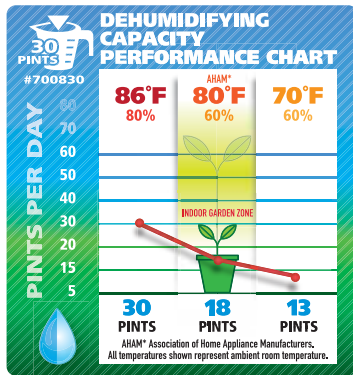

700826

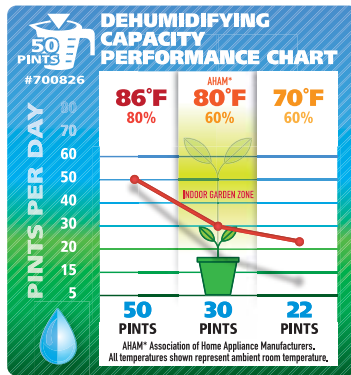

700828

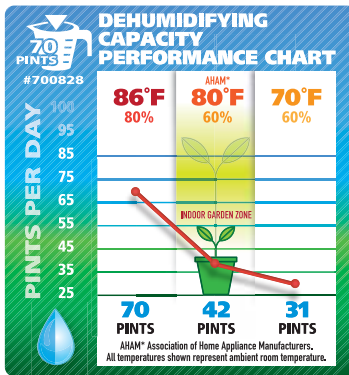

700834

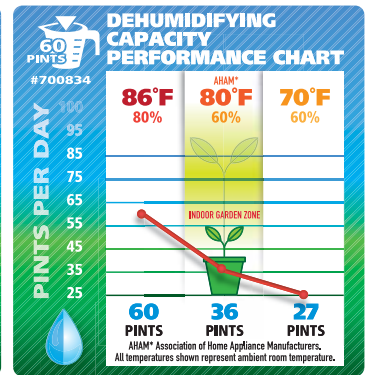

700836

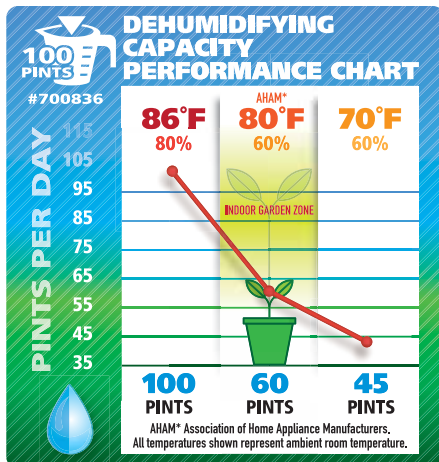

700899

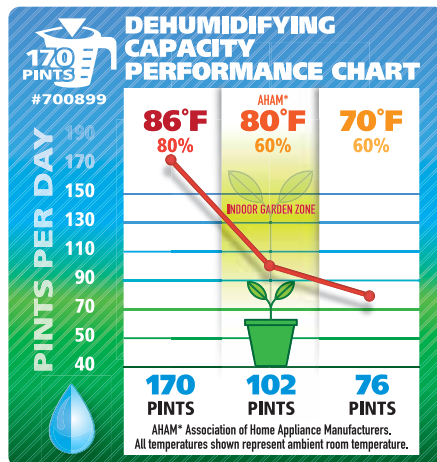

700897

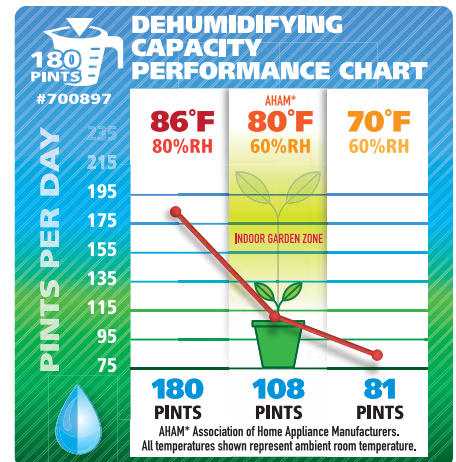

Ideal-Air™ Commercial Grade Dehumidifier Up To 100 Pint



NEW Automatic restart allows unit to be used with humidity controllers. Easy to use digital display with temp and humidity readings and a heavy duty compressor. Built-in defrost system is designed for operation down to 45°F. Automatic shut off when reservoir tank is full. Set upright on their feet for 3 hrs prior to use. Temp. Range: 45°F- 105°F; H2O removal:(24hrs) 100 pints (86°F, 80% R.H.); Power: 7.3 Amps/810 Watts; Supply Voltage: 115V-1 Phase-60Hz.; Refrigerant: R410A. All



Ideal-Air™ dehumidifiers need surge protection and a dedicated power circuit. In the event of a power failure, a spike in power may occur when the power is reinstated. This can damage the circuit board which is not covered under warranty. 1 Year Warranty. **EXCLUSIVE**

Item No.	Description	MSRP
700836	Ideal-Air Commercial Grade Dehumidifier Up To 100 Pint	\$789.95

Ideal-Air™ Commercial Grade 2 Dehumidifier - 170 Pint - Stackable



Rated at 170 pints per day at 86°F/80% RH and 100 pints per day at AHAM standard conditions (80°F/60% RH) 9.5 amps/115V. Easy filter access that is removable and washable. Space saving and stackable up to 2 high. Easy to use digital display panel with temp & humidity readings. Built-in heavy duty condensate pump and quick connecting hose. 1 Year Warranty.



EXCLUSIVE

Item No.	Description	MSRP
700899	Ideal-Air CG2 Dehumidifier 170 Pint	\$1,449.95

Ideal-Air™ Portable Dehumidifier - 180 Pint



Automatic restart allows unit to be used with humidity controllers. Easy to use digital display with temp and humidity readings, removable washable filter, 1 speed fan motor, powder coated metal casing for long life & a heavy duty compressor. Set upright on their feet for 3 hrs prior to use. 180 Pint unit: Temp. Range: 45°F- 100°F; H2O removal: (24 hrs) 180 pints (86°F, 80% R.H.); Power: 12 Amps/1350 Watts; Supply Voltage: 110V-1 Phase-60Hz; Refrigerant: **EXCLUSIVE**



R410A. 1 Year Warranty.

Item No.	Description	MSRP
700897	Ideal-Air Commercial Grade Dehumidifier 180 Pint	\$1,195.95

Quest Dehumidifiers

Quest PowerDry 1300 Dehumidifier



Dehumidifies 64 pints/day @ 80°F/60%RH and only uses 5.0 amps. Made of quality components and is protected by a heavy duty ROTO case. Includes a pleated filter. The Merv 7 filtration of the 1300 is designed to capture mold, spores, pollen and dust. Weighs 79 lb with 12 in wheels, retractable handle and a 20 ft 120 V power cord. Small footprint at 17 in x 20 in. Includes an internal pump with 33 ft detachable hose. Warranty and



Support: Provided by Quest. 5 Year Warranty. **EXCLUSIVE**

Item No.	Description	MSRP
700822	Quest PowerDry 1300 Dehumidifier	\$1,511.95

Quest Dry RDS 10 Dehumidifier



Dehumidifies 80 pints/day @ 80°F/60%RH at just 5.4 amps. Has improved performance over the PowerDry 1300, while only drawing 4/10ths of an amp more current. Comes with a pleated filter. The Merv 7 filtration is designed to capture mold, spores, pollen and dust. Small footprint at 20 in x 20 in with 12 in wheels, retractable handle and 20 ft 120V power cord. Has flexible controls. Includes an internal pump with 33 ft detachable hose. Has a heavy duty



ROTO case. Warranty and Support: Provided by Quest. 5 Year Warranty. **EXCLUSIVE**

Item No.	Description	MSRP
700823	Quest Dry RDS 10 Dehumidifier	\$1,942.95

Quest PowerDry 4000 Pro Dehumidifier



Dehumidifies 176 pints/day @ 80°F/60%RH that uses only 10 amps. This is the perfect solution for large, high grade growers. Has over 22 gallons (176 pints) of capacity. Comes equipped with a solid-state control panel with an onboard humidistat located on the panel. This gives the ability to set the unit at a particular humidity level (between 20-70%RH). Protected by a heavy duty Stainless Steel shell. Includes a filter that has Merv 11 filtration. Small footprint at 20 in x 23 in with 12 in wheels, retractable handle and 25 ft 120V power cord. Includes an internal pump with 33 ft detachable hose. This unit is ductable for intake and exhaust. Warranty and Support: Provided by Quest. 5 Year Warranty. **EXCLUSIVE**



Item No.	Description	MSRP
700824	Quest PowerDry 4000 Pro Dehumidifier	\$3,149.95

Quest Dual 205 Overhead Dehumidifier



Quest Dual 205 was designed to be placed overhead and out of the way, but can also be placed at ground level for plug and play operation. The Dual 205 was designed to be powerful yet energy efficient. It performs at over 5.7 pints per kWh. The Quest Duals' horizontal configuration, dual outlet design and insulated cabinet for quieter operation enables exceptional performance in almost any application. MERV-11 filtration is standard on these units, capturing particles down to 1 micron in size. Made in the USA. 5 Year Warranty. **EXCLUSIVE**



Item No.	Description	MSRP
700821	Quest Dual 205 Overhead Dehumidifier	\$3,042.00

Quest Dual 105 Overhead Dehumidifier



Quest Dual 105 was designed to be placed overhead and out of the way, but can also be placed at ground level for plug and play operation. It was designed to the most energy efficient dehumidifier at over 8.8 pints per kWh. The Quest Duals' horizontal configuration and insulated cabinet for quieter operation. Optional condensate pump and ducting kits provide the ultimate in flexibility. MERV-11 filtration is standard, capturing particles down to 1 micron. Made in the USA. 5 Year Warranty. **EXCLUSIVE**



Item No.	Description	MSRP
700819	Quest Dual 105 Overhead Dehumidifier	\$1,939.95

Quest Dual 110 Overhead Dehumidifier



Quest Dual 110 was designed to be placed overhead and out of the way, but can also be placed at ground level for plug and play operation. It provides improved value while still offering solid performance and energy efficiency at over 5.8 pints per kWh. Optional condensate pump and ducting kits provide the ultimate in flexibility.



Comes with a replaceable MERV-8 filter. Made in the USA. 5 Year Warranty.

EXCLUSIVE

Item No.	Description	MSRP
700817	Quest Dual 110 Overhead Dehumidifier	\$1,499.95

Quest Dual 150 Overhead Dehumidifier



Quest Dual 150 was designed to be placed overhead and out of the way, but can also be placed at ground level for plug and play operation. It provides improved value while still offering solid performance and energy efficiency at over 4.9 pints per kWh. Optional condensate pump and ducting kits provide the ultimate in flexibility.



Comes with a replaceable MERV-8 filter. Made in the USA. 5 Year Warranty.

EXCLUSIVE

Item No.	Description	MSRP
700816	Quest Dual 150 Overhead Dehumidifier	\$1,799.95

Quest Dual 155 Overhead Dehumidifier



Quest Dual 155 was designed to be placed overhead and out of the way, but can also be placed at ground level for plug and play operation. It performs at 7.3 pints per kilowatt-hour and very energy efficient. The Quest Duals' horizontal configuration and insulated cabinet for quieter operation enable their exceptional



performance. Optional condensate pump and ducting kits provide the ultimate in flexibility. MERV-11 filtration is standard, capturing particles down to 1 micron. Made in the USA. 5 Year Warranty.

EXCLUSIVE

Item No.	Description	MSRP
700818	Quest Dual 155 Overhead Dehumidifier	\$2,072.95

Quest Supply Air Duct Collars for Overhead Dehumidifiers

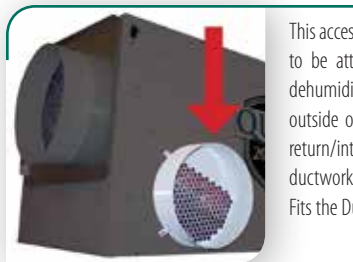

This accessory allows a limited amount of ductwork to be attached to the air outlet on Quest Dual dehumidifiers. This allows the dehumidifier to be located outside of the indoor garden. Be sure to also purchase the return/intake air attachment (part #310786) to attach ductwork to the air intake and pull moist air out of the garden. Fits the Dual 105, Dual 155, and Dual 205 only.

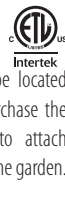

EXCLUSIVE

Item No.	Description	MSRP
310784	Quest Supply Air Duct Collar for Overhead Style Dehumidifier	\$59.95

Quest Return Air Duct Collar for Overhead Dehumidifiers



This accessory allows a limited amount of ductwork to be attached to the intake on Quest Dual dehumidifiers. This allows the dehumidifier to be located outside of the indoor garden. Be sure to also purchase the supply air attachment (part #310784) to attach ductwork to the air outlet and send dry air back into the garden. Fits the Dual 105, Dual 155, and Dual 205 only.

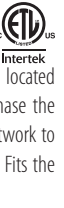

EXCLUSIVE

Item No.	Description	MSRP
310786	Quest Return Air Duct Collar for Overhead Style Dehumidifier	\$88.95

Quest Air Filter for PowerDry 1300 and RDS10 Dehumidifiers



Replacement MERV 11 filter for the Quest Portable Dehumidifiers PowerDry 1300 and RDS10. Captures particles (including mold spores) down to 1 micron in size.

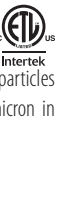

EXCLUSIVE

Item No.	Description	MSRP
310788	Quest Air Filter 12 in x 12 in x 1 in for PowerDry 1300 & RDS10	\$8.49

Quest Air Filter for PowerDry 4000 & Dual Overhead Dehumidifiers



Replacement MERV 11 filter for the Quest PowerDry 4000 Portable Dehumidifier and the Dual 105, 155 and 205 Overhead Dehumidifiers. Captures particles (including mold spores) down to 1 micron in size.



EXCLUSIVE

Item No.	Description	MSRP
310790	Quest Air Filter 16 in x 20 in x 2 in for PowerDry 4000 & Dual Overhead Model	\$13.95

Quest Condensate Pump Kit for Quest 105, 155 & 205



NEW Condensate pump kit for the Quest Dual 105, Dual 155 and Dual 205 models only. Kit includes pump, custom bracket that attaches to unit and flexible hoses. Pump requires 115 volt outlet. 1 Year Warranty.

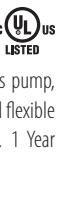

EXCLUSIVE

Item No.	Description	MSRP
700841	Quest Condensate Pump Kit for Quest 105, 155, and 205	\$134.95

Quest Condensate Pump Kit for Quest 110 & 150



NEW Condensate pump kit for the Quest Dual 110 and Dual 150 models only. Kit includes pump, custom bracket that attaches to unit and flexible hoses. Pump requires 115 volt outlet. 1 Year Warranty.



EXCLUSIVE

Item No.	Description	MSRP
700842	Quest Condensate Pump Kit for Quest 110 and 150	\$134.95

Quest Remote Humidistat



NEW Remote wall mounted humidistat made by Honeywell. It is adjustable from 20% - 80% RH humidity with positive On and Off settings. 1 Year Warranty.



EXCLUSIVE

Item No.	Description	MSRP
700843	Quest Remote Humidistat	\$92.95

Quest Replacement Filter for 110 & 150



NEW Merv 8 filter that measures 14 x 17-1/2 x 2 inches. Fits Quest Dual 110 and Dual 150 Dehumidifiers. 90 Day Warranty.

EXCLUSIVE

Item No.	Description	MSRP
700844	Quest Replacement Filter for 110 and 150	\$19.95

Humidifiers

Humidifier - Commercial Grade



Features a multi-directional fogging head. Size is 12.2 in x 12.2 in in diameter. Coverage is from 160-320 sq ft. Maximum output is 0.4 GPH. Industrial-grade motor for years of use. Connects directly to your water supply with your own hookup (uses 1/4 in tubing). Operates at 62 dBA. 110 volts/60 hz/0.9 amps. 1 Year Warranty.

EXCLUSIVE

Item No.	Description	MSRP
700860	Humidifier - Commercial Grade - .4 Gal Per Hour	\$329.95

Ideal-Air™ Mini Split Heating & Cooling

Ideal-Air™ Mini Split Inverter Heat Pumps 15 SEER - HEATING & COOLING - DIY



Can be used with the optional programmable thermostat with up to 4 temperature settings each day. Flexible stainless steel 23 ft pre-charged line set with quick connect fittings to allow for easy Do It Yourself installation. No technician required. Product No. 700500 features: Amp range: 2 to 14 amps. dB Rating: Indoor 32 dB, Outdoor 45 dB. Requires 120 volt



EXCLUSIVE dedicated 20 amp circuit. Product No. 700505 features: Amp range: 6 to 14 amps. dB Rating: Indoor 35 dB, Outdoor 45 dB. Requires 240 volt dedicated 20 amp circuit. Product No. 700510 features: Amp range: 8 to 20 amps. dB Rating: Indoor 42 dB, Outdoor 52 dB. Requires 240 volt dedicated 30 amp circuit. 1 Year Warranty.

Item No.	Description	MSRP
700505	Ideal-Air Mini Split Heat Pump 24,000 BTU 15 SEER - DIY	\$2,999.95
700510	Ideal-Air Mini Split Heat Pump 36,000 BTU 15 SEER - DIY	\$3,499.95

LuxPro® Deluxe Programmable Digital Thermostat



Easy to use digital programmable thermostat that features separate weekday and weekend programs for heating and cooling systems. 4 periods per day. Contractor grade. Default temperature program, ranges 46°F to 90°F. For use only with Ideal-Air™ Mini Split DIY units #700505 & #700510. Ideal-Air™ remote thermostat cable for thermostat LuxPro #700521, length 20 ft, 4 conductor, 24 AWG

with molded plug for connection to indoor unit. 3 Year Warranty.

Item No.	Description	MSRP
700520	LuxPro Digital Thermostat	\$59.95
700521	Ideal-Air Remote Thermostat Cable NEW	\$8.95

Mini Split Systems Line Sets



Line sets and interconnecting wires for Mini Split Systems. These parts are required for a Mini Split installation. Look to the description to match the correct part for your Mini Split. All parts contain 25 ft of 14 GA/3 conductor wire x 25 ft 16 GA/2 conductor wire (shielded) in addition to the insulated copper refrigerant line. The tube diameters for both 700570 and 700574 are 1/4 in and 3/8 in.



The tube diameters for both 700572 and 700576 are 1/4 in and 5/8 in. Tube diameters for both the 700566 and 700568 are 1/4 in and 1/2 in.

EXCLUSIVE

Item No.	Description	MSRP
700566	Mini Split Line Set - 1/4 in x 1/2 in - 25 ft for 700541 Multi Zone NEW	\$269.95
700568	Mini Split Line Set - 1/4 in x 1/2 in - 50 ft for 700541 Multi Zone NEW	\$469.95
700572	Mini Split Line Set - 1/4 in x 5/8 in - 25 ft for 2 and 3 Ton Single Zone	\$299.95
700576	Mini Split Line Set - 1/4 in x 5/8 in - 50 ft for 2 and 3 Ton Single Zone	\$529.95
700577	Mini Split Line Set - 3/8 in x 5/8 in - 25 ft for 700542 for 4 Ton Single Zone NEW	\$259.95
700579	Mini Split Line Set - 3/8 in x 5/8 in - 50 ft for 700542 for 4 Ton Single Zone NEW	\$465.95

GETTING STARTED



IDEAL-AIR™ IMPORTANT INFO

It is highly recommended that you understand your cooling requirements before purchasing any unit.

Consult with a trained and knowledgeable technician in advance.

If you find yourself waffling between two sizes of air conditioners, based on your specific needs, it is always recommended that you size UP and not down.

Multiple units may be required as well.

Use the Ideal-Air™ BTU Calculator at: www.ideal-air.com

If you have a QR reader scan our QR code (below) to calculate your cooling needs based upon your square footage.



Scan for access to the complete BTU calculator!

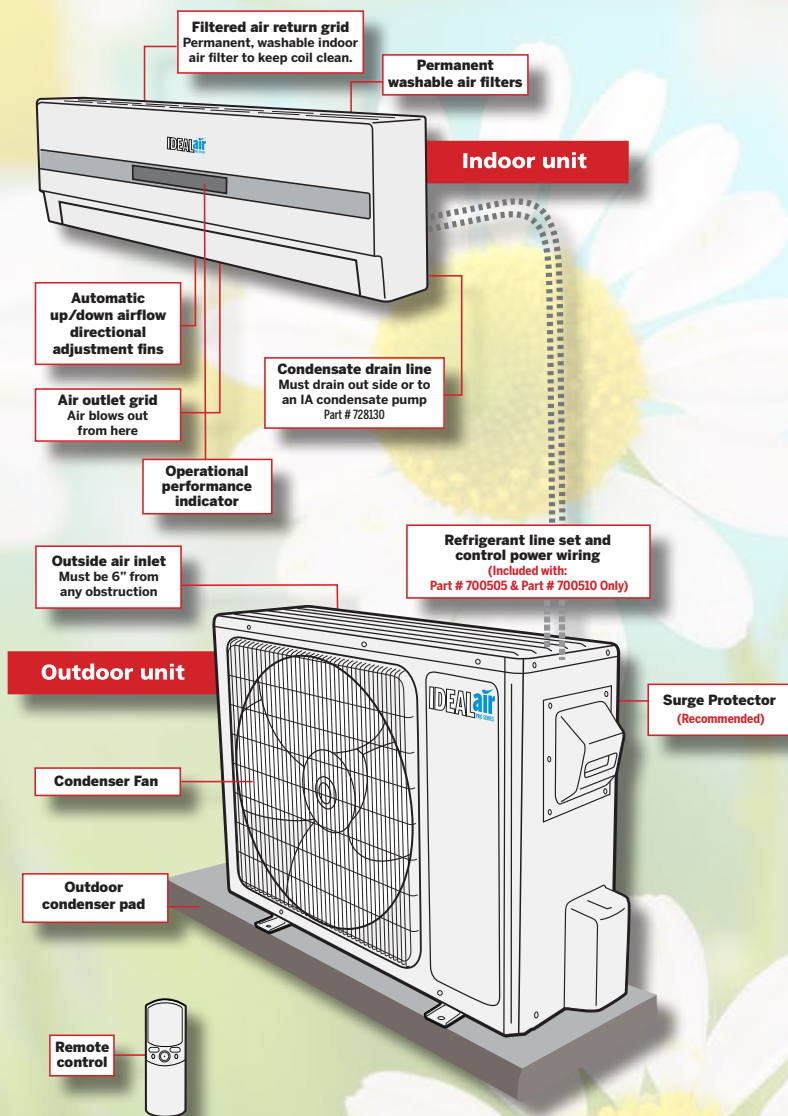

WHAT'S THE DIFFERENCE?

Creating the perfect climate is essential to indoor gardening success.

Ideal Air offers three proven series of heating and cooling systems expressly designed for indoor gardening applications. Built to withstand the rigors of temperature, humidity, fertilizers and plant nutrients, these air conditioning systems deliver unparalleled service day-in and day-out, year-after-year.

You can rely on your authorized Ideal Air dealer to help guide you in the selection of the proper unit for your application. It's vitally important that you select the right size air conditioning unit for your growing space. Your authorized Ideal Air dealer is eager to work with you in making your selection and assuring your complete satisfaction. For perfect climate solutions...it's Ideal Air.

DIY MINI-SPLIT

Ideal-Air™ 15 SEER Do It Yourself (DIY) Mini Split Heat Pumps - Standard Features:

- Heat & Cool Single Indoor Head
- HVAC Contractor Not Required
- 23' Line Set Included
- Inverter Compressor
- 208-230V 1 Phase 60 Hz electrical



Model # 700505
24,000 BTU – 2 Ton
1 YR Compressor, Parts and Labor Warranty
Needs 20 Amp Dedicated Circuit
MSRP \$2,999.95



Model # 700510
36,000 BTU – 3 Ton
2 YR Compressor, Parts and Labor Warranty
Needs 30 Amp Circuit
MSRP \$3,499.95

PRO SERIES MINI-SPLIT

Ideal-Air Pro Series 18 SEER Mini Split A/C's & HEAT PUMPS - Standard Features:

- Single Indoor Head
- Professional HVAC Installation Required
- 1/4" x 5/8" Line Set Required
- 1 YR Compressor, Parts & Labor Warranty
- Inverter Compressor
- 208-230V 1 Phase 60 Hz electrical



Model # 700480
Air Conditioner
24,000 BTU – 2 Ton
Needs 20 Amp Dedicated Circuit
MSRP \$1,699.95



Model # 700482
Air Conditioner
36,000 BTU – 3 Ton
Needs 20 Amp Dedicated Circuit
MSRP \$2,599.95



Model # 700476
Heat & Cool
24,000 BTU – 2 Ton
Needs 30 Amp Circuit
MSRP \$1,999.95



Model # 700478
Heat & Cool
36,000 BTU – 3 Ton
Needs 30 Amp Circuit
MSRP \$2,949.95



SAMSUNG MINI-SPLIT

Samsung 20 SEER Mini Split Heat Pumps - Standard Features:

- Heat & Cool
- Professional HVAC Installation Required
- Warranty: 10 Yr. Comp/10 Yr. Parts/1 Yr. Labor
- 208-230V 1 Phase 60 Hz electrical
- Inverter Compressor



Model # 700540
Single Head
24,000 BTU – 2 Ton
Needs 30 Amp Dedicated Circuit
1/4" x 5/8" Line Set Required
MSRP \$3,195.95



Model # 700558
Single Head
36,000 BTU – 3 Ton
Needs 30 Amp Dedicated Circuit
1/4" x 5/8" Line Set Required
MSRP \$4,399.95



Model # 700541
Dual Head
36,000 BTU – 3 Ton
Needs 30 Amp Dedicated Circuit
1/4" x 1/2" Line Set Required
MSRP \$5,795.95



Model # 700542
Commercial duct able unit
48,000 BTU – 4 Ton
3/8" x 5/8" Line Set Required
Needs 35 Amp Dedicated Circuit
MSRP \$8,999.95



Ideal-Air™ Pro Series Ductless Mini Split 18 SEER - Heating & Cooling



NEW Ideal-Air™ Pro Series Ductless Heating and Cooling Mini Splits are high efficiency performance at 18 SEER. They have inverter compressor technology offering 30% - 50% energy savings. The indoor evaporator unit can be easily installed with included wall mount. Includes LCD screen hand



EXCLUSIVE held programmable remote controller. Auto restart after power failure. Requires certified HVAC-professional installation. Refrigerant lines sold separately. Requires field supplied electrical and communication wiring. Mini Split interconnecting wires contain 25 ft of 14 GA/3 conductor wire x 25 ft 16 GA/2 conductor wire (shielded) in addition to the insulated copper refrigerant line. The tube diameters for both 700572 and 700576 are 1/4 in and 5/8 in.

700476 Supply Voltage: 208/230V, 15 amp, 60 Hz MOC Protection 20 amp. 700478 Supply Voltage: 208/230V, 25 amp, 1 ph, 60 Hz MOC Protection 40 amp. 700476 Operating Amps: 13.22/11.95 AMP, 700478 Operating Amps: 20.67/18.69 AMP. Cooling Capacity: 700476 25,000 BTU/H, 700478 36,000 BTU/H and Heating Capacity: 700476 26,000 BTU/H, 700478 36,000 BTU/H. Efficiency: 18 SEER, 700476 HSPF: 10.00, 700478 HSPF: 9.00. 700476 Indoor dB Rating: 63, Outdoor dB Rating: 68 and 700478 Indoor dB Rating: 64, Outdoor dB Rating: 75. Refrigerant Precharge: 700476 is 56.40 oz. 700478 is 91.71 of R410A. Outdoor Ambient operating range: (Cooling = 0° to 109°F), (Heating = 5° to 75°F). 1 Year Warranty.

Item No.	Description	MSRP
700476	Ideal-Air Pro Series Heating & Cooling 24,000 BTU 18 SEER	\$1,999.95
700478	Ideal-Air Pro Series Heating & Cooling 36,000 BTU 18 SEER	\$2,949.95
700572	Mini Split Line Set - 1/4 in x 5/8 in - 25 ft for 2 and 3 Ton Single Zone	\$299.95
700576	Mini Split Line Set - 1/4 in x 5/8 in - 50 ft for 2 and 3 Ton Single Zone	\$529.95

Ideal-Air™ Pro Series Ductless Mini Split 18 SEER - Cooling Only



NEW Ideal-Air™ Pro Series Ductless Mini Splits are high efficiency performance at 18 SEER Air Conditioners. They have inverter compressor technology offering 30% - 50% energy savings. The indoor evaporator unit can be easily installed with included wall mount. Includes LCD screen hand



EXCLUSIVE held programmable remote controller. Auto restart after power failure. Requires certified HVAC-professional installation. Refrigerant lines sold separately. Requires field supplied electrical and communication wiring. Mini Split interconnecting wires contain 25 ft of 14 GA/3 conductor wire x 25 ft 16 GA/2 conductor wire (shielded) in addition to the insulated copper refrigerant line. The tube diameters for both 700572 and 700576 are 1/4 in and 5/8 in.

700480 Supply Voltage: 208/230V, 15 amp, 1 ph, 60 Hz MOC Protection 20 amp. 700482 Supply Voltage: 208/230V, 25 amp, 1 ph, 60 Hz MOC Protection 40 amp. 700480 Operating Amps: 12.74/11.52 AMP, 700482 Operating Amps: 20.67/18.69 AMP. Cooling Capacity: 700480 25,000 BTU/H and 700482 36,000 BTU/H. Efficiency: 18 SEER Inverter Compressor. 700480 Indoor dB Rating: 63, Outdoor dB Rating: 68 and 700482 Indoor dB Rating: 61, Outdoor dB Rating: 75. Refrigerant Precharge: 700480 is 56.40 oz, 700482 is 84.66 oz of R410A. Outdoor Ambient operating range: (Cooling = 0° to 109°F). 1 Year Warranty.

Item No.	Description	MSRP
700480	Ideal-Air Pro Series Cooling Only 24,000 BTU 18 SEER	\$1,699.95
700482	Ideal-Air Pro Series Cooling Only 36,000 BTU 18 SEER	\$2,599.95
700572	Mini Split Line Set - 1/4 in x 5/8 in - 25 ft for 2 and 3 Ton Single Zone	\$299.95
700576	Mini Split Line Set - 1/4 in x 5/8 in - 50 ft for 2 and 3 Ton Single Zone	\$529.95

Samsung Mini Split Heating & Cooling

Samsung Mini Split System 20+ SEER - Heating & Cooling - 24,000 BTU



NEW 24,000 BTU Heating & Cooling Mini Split system. Professional Install Only. 208/230 Volt, 1 phase. Minimum circuit 20 amps. Requires 1/4 in x 5/8 in Line set (700572 & 700576 sold separately). Includes (1) 24K BTU wall mount indoor unit. SEER = 20, HSPF = 10.0. 1 Year Warranty.



EXCLUSIVE

Item No.	Description	MSRP
700540	Samsung Mini Split - 24,000 BTU Heat & Cool 20+ SEER (2 Boxes)	\$3,195.95

Samsung Mini Split Air Conditioner Systems



Samsung's line of Mini Split Air Conditioners provide both heating and cooling. These units combine stylish looks with robust performance and world-class reliability. The Smart Inverter compressor offers varying ranges of heating and cooling capacity.



EXCLUSIVE control. These units use R410A refrigerant and R410A flare connections. Hand-held controller included. (Optional wall mounted programmable thermostat may be purchased separately). Samsung Limited Warranty: Requires professional HVAC-Technician to fulfill warranty. NOTE: These products require professional installation. All warranty and technical support is to be handled directly through Samsung and require a professional HVAC-Technician to perform all warranty related work. This product cannot be returned to a retail store or to Sunlight Supply®. All repairs and warranty related services are handled on site by a professional HVAC-Technician.

Specifications for 36,000 BTU Unit: Operating temperature range, cooling: 14°F to 115°F, heating: 5°F to 75°F. Nominal Capacity cooling: 36,000 Btu/h, heating: 36,000 Btu/h. Capacity range cooling: 9,000 Btu/h to 38,000 Btu/h, heating: 9,000 Btu/h to 45,000 Btu/h. (SEER = 18.0) (HSPF = 9.0), Voltage: single phase, 208 - 230 volt. Max Breaker Size: 30 Amp. Pipe Connections: 1/4 in and 3/8 in up to 50 ft. in length, (not included with unit). Line Set: Offered separately and should be installed by a qualified HVAC-Technician. 3 Year Warranty.

Item No.	Description	MSRP
700558	Samsung MAX 36,000 BTU Mini Split Air Conditioner System	\$4,399.95
700578	Samsung Programmable Thermostat for Split Systems	\$299.95

Samsung Mini Split System w/ Two Heads 20+ SEER - Heating & Cooling - 36,000 BTU



NEW 36,000 BTU Heating & Cooling Two Head Mini Split system. Professional Install Only. 208/230 Volt, 1 phase. Minimum circuit 20 amps. Requires (2) 1/4 in x 1/2 in Line sets (700566 & 700576 sold separately). Includes (2) 18K BTU wall mount indoor units. SEER = 18.5, HSPF = 9.5. 1 Year Warranty.



EXCLUSIVE

Item No.	Description	MSRP
700541	Samsung Mini Split - 36,000 BTU Heat & Cool w/ Two 18K BTU Heads 20+ SEER (3 Boxes)	\$5,795.95

Samsung Mini Split System Ceiling Mounted Head 20+ SEER - Heating & Cooling - 48,000 BTU



NEW 48,000 BTU Heating & Cooling Ductable, Ceiling Hung system. Professional Install Only. 208/230 Volt, 1 phase. Minimum circuit 25 amps.

Requires 3/8 in x 5/8 in Line set (700577 & 700579 sold separately). Includes (1) 48K BTU ceiling hung indoor unit. SEER = 18.1, HSPF = 9.6. The Samsung Wireless



EXCLUSIVE Interface Kit for the 48,000 BTU Unit (700542) is required for operation but sold separately. This kit includes the receiver, wall display and 32 ft wire harness to interface with the Samsung Wireless Controller (700544), which is also sold separately but required for operation.

Refrigerant line sets are offered separately and should be installed by a qualified HVAC Technician. 1 Year Warranty.

Item No.	Description	MSRP
700542	Samsung Mini Split - 48,000 BTU Heat & Cool w/ Ceiling Mount Head 20+ SEER (2 Boxes)	\$8,999.95
700544	Samsung Wireless Controller for 48,000 BTU Unit	\$135.95
700545	Samsung Wireless Interface Kit for 48,000 BTU Unit	\$225.95

Samsung Wired Controller for Mini Splits - Non-Programmable



NEW Wired Controller for 700542, 36K mini split. Non-programmable. Functions: On/Off, set temperature, fan speed control, error code display, filter replacement alarm, auto mode, event timer. (16 AWG, 2 conductor shielded cable not included). 1 Year Warranty.



EXCLUSIVE

Item No.	Description	MSRP
700543	Samsung Wired Controller for 48,000 Mini Split - Non-Programmable	\$259.95

Samsung Wireless Controller for Wall Mounted Ductless Heads



NEW Samsung Ductless Mini Split replacement wireless remote control for all wall mounted head units. Works with units 700550, 700554, 700558, 700562, 700540 and 700541. 10 Year Warranty.



EXCLUSIVE

Item No.	Description	MSRP
700547	Samsung Wireless Controller for Wall Mounted Ductless Heads	\$189.95

Samsung Programmable Thermostat for Split Systems



Optional programmable thermostat for the Samsung (parts 700550, 700554, 700558) and Free Joint Multi (parts 700562 and 700564) Mini-Split systems. Features ON/OFF, Operating Mode, Fan Speed, Airflow, Temp Setting buttons. Error display. Filter replacement alarm reset and sleep mode. Built-in room temperature sensor. Wireless remote control restriction. Weekly schedule setting and vacation dates settings. Temperature range setting. 1 Year Warranty.

EXCLUSIVE

Item No.	Description	MSRP
700578	Samsung Programmable Thermostat for Split Systems	\$299.95

Ideal-Air™ Portable Air Conditioners

Ideal-Air™ Dual Hose Air Conditioner 12,000 BTU



High performance flexible dual hose design. Auto restart function. Digital control panel with remote control thermostat. Removable filter. Heavy duty compressor with 3-speed fan motor. Slinger up, no bucket self evaporative condensation removal system. Accessories included: 2 flexible duct hoses (5 ft each), 2-piece adjustable window insert, 1 foam window insert seal and 4 duct & hose fittings. Supply voltage: 115 Volt - 60 Hz. Power: 11.8 Amps/1355 Watts. 1 Year Warranty.



EXCLUSIVE

Item No.	Description	MSRP
700820	Ideal-Air Dual Hose Air Conditioner 12,000 BTU	\$499.95

MovinCool® Portable Air Conditioners

MovinCool® 24,000 BTU/h Air-Cooled Portable A/C Office Pro® 24



NEW Providing 24,000 BTU/h of cooling, the Office Pro® 24 is the ideal plug-in air conditioner to cool gardens. It uses a self-contained, portable design. No 3rd party installation required. Just roll it in, plug it in, turn it on and you're done. It features easy-to-use digital 24/7 programmable controls allowing automatic operation. Power: Single phase, 60 Hz, 208/230V power. Dedicated circuit with 20 amp max fuse protection recommended. Uses a NEMA 6 - 2 plug, 12 GA power cord. Typical power



consumption during operation is 13.2 amps and 2900 watts. Unit weighs 216 lb unboxed and 253 lb boxed. Unit dimensions are 21 in W x 27 in D x 49 in T. Operating conditions are 65° - 95° F. Max Duct lengths are 45 ft on condenser hot air and 50 ft on supply air (cold air). Noise level is 65 dB(A). Drop ship only. 1 Year Warranty.

EXCLUSIVE

Item No.	Description	MSRP
700099	MovinCool Portable 24,000 BTU Air Conditioner - Office Pro 24	\$4,985.00

MovinCool® 36,000 BTU/h Air-Cooled Portable A/C Office Pro® 36



Providing 36,000 BTU/h of cooling, the Office Pro 36 is the ideal plug-in air conditioner to cool gardens. It uses a self-contained, portable design. Just roll it in, plug it in, turn it on and your done. Features easy-to-use programmable controls allowing automatic operation. Use accessories to adapt the Office Pro 36 to your garden design. Power requirements: Single phase, 60 hz, 208/230V power. Dedicated circuit with 30 amp max fuse protection recommended. Uses a NEMA 6-30 plug on a 6 ft, 12 GA power cord. Power consumption is 19.6 amps and 4,300 watts. Unit weighs 427 lb unboxed and 527 lb boxed. Dimensions are 30 x 40 x 52 in tall. Operating conditions are 65° - 95° deg F. Max Duct lengths are 60 ft on condenser (hot air) and 40 ft on supply air (cold air). Noise level is 66 dB. Drop ship only. 1 Year Warranty.



EXCLUSIVE

Item No.	Description	MSRP
700450	MovinCool 36,000 BTU/h Air-Cooled Portable A/C 208/230 Volt	\$7,095.95

MovinCool® 60,000 BTU/h Air-Cooled Portable A/C Office Pro® 60



Providing up to 60,000 BTU/hr of cooling capacity, the Office Pro® 60 portable air conditioner is specifically designed for cooling large gardens. It uses a self-contained, portable design. Just roll it in, plug it in, turn it on and your done. Features easy-to-use programmable controls allowing automatic operation. Use accessories to adapt the Office Pro® 36 to your garden design. Power requirements: Single phase, 60 hz, 208/230V power. Dedicated circuit with 50 amp max fuse protection



recommended. Uses a NEMA 6-50 plug on a 6 ft, 6 GA power cord. Power consumption is 29 amps and 6,600 watts. Unit weighs 623 lb unboxed and 753 lb boxed. Unit dimensions are 30 x 52 x 64 in tall. Operating conditions are 65° - 105° deg F. Max Duct lengths are 100 ft on condenser (hot air) and 40 ft on supply air (cold air). Noise level is 69 dB. Drop ship only. 1 Year Warranty. **EXCLUSIVE**

Item No.	Description	MSRP
700452	MovinCool 60,000 BTU/h Air-Cooled Portable A/C 208/230 Volt	\$11,145.00

MovinCool® 60,000 BTU/h Air-Cooled Portable A/C Office Pro® 63



Providing up to 60,000 BTU/hr of cooling capacity, it uses three-phase power to reduce loads on circuits. Using a self-contained, portable design. Just roll it in, plug it in, turn it on and your done. Features easy-to-use programmable controls for automatic operation. Use accessories to adapt the Office Pro® 63 to your particular garden design. Power requirements: Three phase, 60 hz, 460V power. Dedicated circuit with 20 amp max fuse protection recommended. Uses a NEMA L16-20 plug on a 6 ft, 12 GA



power cord. Power consumption is 9.5 amps and 6,600 watts. Unit weighs 705 lb unboxed and 835 lb boxed. Unit dimensions are 30 x 52 x 64 in tall. Operating conditions are 65° - 105° deg F. Max duct lengths are 100 ft on condenser (hot air) and 40 ft on supply air (cold air). Noise level is 69 dB. Drop ship only. 1 Year Warranty. **EXCLUSIVE**

Item No.	Description	MSRP
700454	MovinCool 60,000 BTU/h Air-Cooled Portable A/C 460 Volt	\$12,695.95

MovinCool® 13,200 BTU/H Air-Cooled Portable A/C - Classic Plus 14



NEW Providing 13,200 BTU/h of cooling, the Classic Plus 14 is the ideal plug-in air conditioner to cool gardens. It uses a self-contained, portable design. Just roll it in, plug it in, turn it on and you're done. It features easy-to-use 24/7 programmable controls allowing automatic operation. Power: 1 phase, 60 Hz, 115V power. Dedicated circuit with 15 amp minimum fuse protection recommended. Typical power consumption during operation is 11.9 amps and 1300 watts. Unit weighs 166 lb



unboxed and 197 lb boxed. Unit dimensions are 19 in W x 26 in D x 41 in T. Operating conditions are 70° - 113° F. Max Duct lengths are 60 ft on condenser (hot air) and 30 ft on supply air (cold air). Noise level is 60 dB(A). Drop ship only. 1 Year Warranty. **EXCLUSIVE**

Item No.	Description	MSRP
700092	MovinCool Portable 13,200 BTU Air Conditioner - Classic Plus 14	\$3,395.00

MovinCool® 24,000 BTU/h Air-Cooled Portable A/C - Classic Plus 26



NEW Providing 24,000 BTU/h of cooling, the Classic Plus 26 is the ideal plug-in air conditioner to cool gardens. It uses a self-contained, portable design. No 3rd party installation required. Just roll it in, plug it in, turn it on and you're done. It features easy-to-use 24/7 programmable controls allowing automatic operation. Power: 1 phase, 60 Hz, 208/230V power. Dedicated circuit with 20 amp max fuse protection recommended. Typical power consumption during operation is 10.8 amps and 2400 watts.



Unit weighs 199 lb unboxed and 270 lb boxed. Unit dimensions are 19 in W x 29 in D x 47 in T. Operating conditions are 70° - 113° F. Max Duct lengths are 60 ft on condenser (hot air) and 45 ft on supply air (cold air). Noise level is 69 dB(A). Drop ship only. 1 Year Warranty. **EXCLUSIVE**

Item No.	Description	MSRP
700093	Movin Cool Portable 24,000 BTU Air Conditioner - Classic Plus 26	\$4,540.00

MovinCool® Semi Portable Air Conditioners

MovinCool® Indoor/Outdoor 39,000 BTU Air-Cooled Semi Portable A/C - Classic 40



NEW Providing 39,000 BTU/h of cooling, the Classic 40 is the ideal plug-in air conditioner to cool gardens. The Classic 40's unique design allows it to be located indoors or outdoors, it is designed to be in the weather if needed. It uses a self-contained, portable design. Just roll it in, plug it in, turn it on and you're done. It features easy-to-use Digital Temperature Controls allowing automatic operation. Power: 3 phase, 60 Hz, 208/230V power. Dedicated circuit with 25 amp max fuse protection recommended. Uses



a NEMA L15 - 30 plug. Typical power consumption during operation is 14 amps and 4200 watts. Unit weighs 344 lb unboxed and 396 lb boxed. Unit dimensions are 26 in W x 44 in D x 38 in T. Operating conditions are 75° - 115° F. Max Duct lengths are 40 ft on condenser (hot air) and on supply air (cold air) in varies. Noise level is 72 dB(A). Drop ship only. 1 Year Warranty. **EXCLUSIVE**

Item No.	Description	MSRP
700094	MovinCool Indoor/Outdoor 39,000 BTU Air Conditioner - Classic 40	\$7,890.00

MovinCool® Indoor/Outdoor 60,000 BTU Air-Cooled Semi Portable A/C - Classic 60



NEW Providing 60,000 BTU/h of cooling, the Classic 60 is the ideal plug-in air conditioner to cool gardens. The Classic 60's unique design allows it to be located indoors or outdoors, it is designed to be in the weather if needed. It uses a self-contained, portable design. Just roll it in, plug it in, turn it on and you're done. The Classic 60 features easy-to-use Digital Temperature Controls allowing automatic operation. Power: 3 phase, 60 Hz, 460V



power. Dedicated circuit with 20 amp max fuse protection recommended. Typical power consumption during operation is 8.8 amps and 5900 watts. Unit weighs 474 lb unboxed and 566 lb boxed. Unit dimensions are 32 in W x 49 in D x 42 in T. Operating conditions are 75° - 115° F. Max Duct lengths are 40 ft on condenser (hot air) and on supply air (cold air) in varies. Noise level is 72 dB(A). Drop ship only. 1 Year Warranty. **EXCLUSIVE**

Item No.	Description	MSRP
700095	MovinCool Indoor/Outdoor 60,000 BTU Air Conditioner - Classic 60	\$11,045.00

MovinCool® Ceiling Mount Air Conditioners

MovinCool® Ceiling Mount 10,500 BTU Air-Cooled A/C - CM12



NEW Providing 10,500 BTU/h of cooling, the CM12 is the ideal air conditioner to cool gardens. The CM12 uses a low profile design allowing it to fit in tight spaces. Just hang it, duct it, wire it in, turn it on and you're done. It's that simple (duct required in all cases). Power: 1 phase, 60 Hz, 115V power. Dedicated circuit with 15 amp max fuse protection recommended. Typical power consumption during operation is 11 amps and 1230 watts. Unit weighs 123 lb unboxed and 137 lb boxed. Unit dimensions are 32 in W x 20 in D x 15.2 in T without flange. Operating conditions are 65° - 113° F. Max Duct lengths are 10 ft on condenser (hot air) and 20 ft on supply air (cold air). Noise level is 52 dB(A). Drop ship only. 1 Year Warranty.



EXCLUSIVE

Item No.	Description	MSRP
700096	MovinCool Ceiling Mount 10,500 BTU Air Conditioner - CM12	\$2,975.00

MovinCool® Ceiling Mount 25,000 BTU Air-Cooled A/C - CM25



NEW Providing 25,000 BTU/h of cooling, the CM25 is the ideal air conditioner to cool gardens. It uses a low profile design allowing it to fit in tight spaces. Just hang it, duct it, wire it in, turn it on and you're done. It's that simple (duct required in all cases). Features easy-to-use a Wall Mounted thermostat. Power: 1 phase, 60 Hz, 208/230V power. Dedicated circuit with 20 amp max fuse



protection recommended. Typical power consumption during operation is 12.6 amps and 2900 watts. Unit weighs 310 lb unboxed and 353 lb boxed. Unit dimensions are 53 in W x 32 in D x 20.2 in T without flange. Operating conditions are 50° - 113° F. Max Duct lengths are 90 ft on condenser (hot air) and 120 ft on supply air (cold air). Noise level is 55 dB(A). Drop ship only. 1 Year Warranty.

EXCLUSIVE

Item No.	Description	MSRP
700097	MovinCool Ceiling Mount 25,000 BTU Air Conditioner - CM25	\$7,230.00

MovinCool® Water Cooled Ceiling Mount 29,400 BTU Air Conditioner - CMW30



NEW Providing 29,400 BTU/h of cooling, the CMW30 is the ideal air conditioner to cool gardens. This is a water cooled unit. The CMW30 uses a low profile design allowing it to fit in tight spaces. Just hang it, plum it, duct it, wire it in, turn it on and you're done. It's that simple (duct required in all cases). The CMW30 features easy-to-use a Wall Mounted thermostat. Power: 1 phase, 60



Hz, 208/230V power. Dedicated circuit with 20 amp max fuse protection recommended. Typical power consumption during operation is 8.9 amps and 1990 watts. Unit weighs 236 lb unboxed and 271 lb boxed. Unit dimensions are 45 in W x 32 in D x 20 in T without flange. Operating conditions are 45° - 95° F. Condenser water range 45° - 115°. Max Duct lengths are 120 ft on supply air (cold air). Noise level is 55 dB(A). Drop ship only. 1 Year Warranty.

EXCLUSIVE

Item No.	Description	MSRP
700098	MovinCool Water Cooled Ceiling Mount 29,400 BTU Air Conditioner - CMW30	\$7,550.00

MovinCool® Accessories

MovinCool® Condensate Pump Kit Office Pro® 36



The MovinCool® Condensate Pump Kit is a 220 volt pump kit that includes 3/8 inch diameter x 20 ft length hose and installation hardware. This kit is for use with the Office Pro® 60/63. Drop ship only. 1 Year Warranty.

EXCLUSIVE

Item No.	Description	MSRP
700456	MovinCool Condensate Pump Kit OfficePro 36	\$131.60

MovinCool® Condensate Tank & Tank Float for Office Pro® 60/63



The MovinCool® Condensate Tank is a drain tank storage for condensation. It requires condensate float, sold separately (For use on Office Pro® 60 only). The MovinCool® Condensate Tank Float controls water level in condensate tanks (For use on Office Pro® 60 only). Drop ship only. 90 Day Warranty.

EXCLUSIVE

Item No.	Description	MSRP
700457	MovinCool Condensate Tank for OfficePro 60/63	\$25.00
700458	MovinCool Condensate Tank Float for OfficePro 60/63	\$20.00

MovinCool® Condenser Air Plenum Office Pro® 36



MovinCool® Condenser Air Plenum is a white plastic plenum that easily attaches to unit to supply outside air to condenser. Hinged for filter cleaning. For use on part number 700450. Drop ship only. 90 Day Warranty.

EXCLUSIVE

Item No.	Description	MSRP
700459	MovinCool Condenser Air Plenum for OfficePro 36	\$495.00

MovinCool® Condenser & Evaporator Air Plenum for Office Pro® 60/63



Part Number 700460 white plastic plenum easily attaches to unit for use in supplying outside air to condenser. Hinged for filter cleaning. For use on 700452 and 700454. Part Number 700461 white plastic plenum easily attaches to unit, allowing for 16 in diameter ductwork to bring room air back to evaporator. For use on 700452 and 700454. Drop ship only. 90 Day Warranty.

EXCLUSIVE

Item No.	Description	MSRP
700460	MovinCool Condenser Air Plenum for OfficePro 60/63	\$595.00
700461	MovinCool Evaporator Air Plenum for OfficePro 60/63	\$495.00

MovinCool® Warm Air Self-Supported Duct 12 in Office Pro® 36



This is a white 12 inch diameter plastic duct that extends from 6-1/2 ft to 10 ft in length. For use with Plenum on Office Pro® 36. Drop ship only. 90 Day Warranty.

EXCLUSIVE

Item No.	Description	MSRP
700462	MovinCool Warm Air Self-Supported Duct - 12 in - OfficePro36	\$90.00

MovinCool® Cold Air Self-Supported Duct



The MovinCool® Cold Air Self-Supported Ducts are made of white plastic duct that has an adjustable diameter. The duct extends from 6-1/2 ft to 10 ft in length. 700471 is a 6 in and 700472 is an 8 in adjustable diameter. They work with all MovinCool® models. Drop ship only. 90 Day Warranty.

EXCLUSIVE

Item No.	Description	MSRP
700471	MovinCool Cold Air Self-Supported Duct - 6 in - All Models	\$50.00
700472	MovinCool Cold Air Self-Supported Duct - 8 in - All Models	\$65.00

MovinCool® Warm Air Flexible Duct Hits



Part Number 700463 is wire-reinforced 12 in diameter accordion style flexible duct with clamps that is 10 ft in length for make-up air. Part Number 700464 is wire-reinforced 16 in diameter accordion style flexible duct with clamps that is 25 ft in length for condenser exhaust or evaporator intake. Drop ship only. 90 Day Warranty.

EXCLUSIVE

Item No.	Description	MSRP
700463	MovinCool Warm Air Flexible Duct Kit - 12 in - OfficePro36	\$69.00
700464	MovinCool Warm Air Flexible Duct Kit - 16 in - All Models	\$260.00

MovinCool® Cold Air Flexible Duct 8 in



This is a wire-reinforced 8 in diameter accordion style duct that is 25 ft in lengths. Clamps sold separately. This duct works with all MovinCool® models. Drop ship only. 90 Day Warranty.

EXCLUSIVE

Item No.	Description	MSRP
700473	MovinCool Cold Air Flexible Duct - 8 in - All Models	\$158.00

MovinCool® Ceiling Tiles

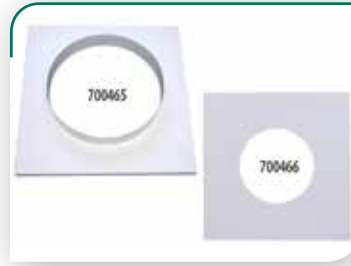

These MovinCool® Ceiling Tiles are 24 x 24 inch sheet metal tile with flanged holes for connecting warm air flexible duct kit or self supporting duct. Great for use in sending hot, condenser air out of the garden. Part number 700465 has a 16 inch opening and 700466 has a 12 inch opening. Drop ship only. 90 Day Warranty.

EXCLUSIVE

Item No.	Description	MSRP
700465	MovinCool Ceiling Tile - 16 in Hole - All Models	\$200.00
700466	MovinCool Ceiling Tile - 12 in Hole - OfficePro 36	\$50.00

MovinCool® Nozzle & Duct Adapter Hits



The Nozzle Adapter Kit 4 x 6 in (#700467) has a three-piece metal frame that converts airflow from louvers to nozzles. The kit includes mounting screws. (Nozzles sold separately.) The Duct Adapter Kit (#700468) is the same as Nozzle Adapter Kit, but for use with cold air flexible ducts. This kit includes a flange. (Cold air flexible ducts sold separately.) Drop ship only. 90 Day Warranty.

EXCLUSIVE

Item No.	Description	MSRP
700468	MovinCool Duct Adapter Kit - 2 x 8 in - All Models	\$390.00
700467	MovinCool Nozzle Adapter Kit - 4 x 6 in - All Models	\$285.00

MovinCool® Cold Air Flange Hit 6 in



The MovinCool® Cold Air Flange Kit is 6 in diameter white metal flange with wire clamp and mounting screws. Use with flexible air ducts. This kit works with all MovinCool® models. Drop ship only. 90 Day Warranty.

EXCLUSIVE

Item No.	Description	MSRP
700469	MovinCool Cold Air Flange Kit - 6 in - All Models	\$40.00

MovinCool® Nozzle Hit 6 in



The MovinCool® Nozzle Kit is a 6 in diameter white plastic nozzle that extends up to 2 feet in length. Includes flange, mounting screws and trim ring. (Comes in sets of two.) Works for all MovinCool® models. Drop ship only. 90 Day Warranty.

EXCLUSIVE

Item No.	Description	MSRP
700470	MovinCool Nozzle Kit - 6 in - All Models	\$45.00

MovinCool® Trim Ring 6 in



The MovinCool® Trim Ring is a 6 in diameter black plastic ring that mounts as end caps for self-supporting cold air extension duct (#700471). Works for all MovinCool® models. Drop ship only. 90 Day Warranty.

EXCLUSIVE

Item No.	Description	MSRP
700474	MovinCool Trim Ring - 6 in - All Models	\$5.00

Mini Split Accessories

Ideal-Air™ HVAC 3 CFM Vacuum Pump



High quality 3 CFM vacuum pump in a compact size. Comes with pump oil and a check valve. Quickly pull a vacuum with 3 cubic feet per minute vacuum rate. 1 Year Warranty.

**7 CFM Model
Coming Soon!**

EXCLUSIVE

Item No.	Description	MSRP
700582	Ideal-Air HVAC 3 CFM Vacuum Pump	\$154.95

Ideal-Air™ HVAC Compound Pressure-Vacuum Gauge and Hose Set



This product includes a single valve with an R410A compound gauge showing both pressure and vacuum. The sturdy brass valve comes attached to the gauge, which is covered with a rubber, shock resistant outer cover. Also included are two 36 inch refrigerant hoses with 1/4 inch equipment connections. 1 Year Warranty.

EXCLUSIVE

Item No.	Description	MSRP
700584	Ideal-Air HVAC Compound Pressure-Vacuum Gauge and Hose Set	\$36.95

Wall Bracket for Ductless Split Systems



These Wall Brackets are used for supporting condensing units. This wall mount bracket features a cross bar that is attached to a wall and two L-shaped brackets that are hooked and bolted into place on the cross bar. The condensing unit is mounted onto the L-shaped brackets and fastened using the bolts and anti-vibration washers provided.

Item No.	Description	MSRP
728104	Wall Bracket for Ductless Split System	\$64.95

Equipment Pad Foam & Cement for Mini-Split Systems



A plastic and foam and cement equipment pad that is 2 in thick. The equipment pads are a base for the outdoor mini-split air conditioner or heat pump unit to sit on. The industry standard used across a variety of applications.

Item No.	Description	MSRP
728184	Equipment Pad 16 x 36 (Foam & Cement) for Mini Split Systems	\$27.95

Surge Protector for Heating and Cooling Products



Protects electronics in lighting, air conditioners,  pumps, generators and more. Works on single-phase products to protect against lightning power surges and equipment voltage surges; 24,000 amps/240 joules protection; 120-240 VAC. 1 Year Warranty.

Item No.	Description	MSRP
700522	Surge Protector for Heating & Cooling Products	\$33.95

Low Ambient Outdoor Fan Control Kit for Ductless Air Conditioners



Allows air conditioners and dehumidifiers to  operate in colder conditions. Head pressure control of outdoor unit fan motor speed, 120-480 VAC; Eliminates overshoots common to on/off and pressure switch controls. Helps prevent evaporator freeze-ups, low pressure cut-outs and liquid-slugged compressors in low ambient conditions. 1 Year Warranty.

Item No.	Description	MSRP
700524	Low Ambient Outdoor Fan Control Kit for Ideal-Air 13 SEER A/C	\$229.95

Condensate Pump



These pumps are used as an  accessory with air conditioners and dehumidifiers and are suitable for use with condensate from high efficiency condensing furnaces and boilers which produce acidic condensate. This rugged pump has 22 ft of lift, compared to the typical 20 ft. 2 Year Warranty.

Item No.	Description	MSRP
728130	Condensate Pump 120 Volt	\$84.95

BLACK OPS
CARBON FILTERS
SIZED TO MEET ALL YOUR VENTILATION
AND AIR PURIFICATION NEEDS!

- BUILT IN FLANGE
- 2 BLACK PRE FILTERS INCLUDED
- LONG LIFE EXPECTANCY

www.BlackOpsFilters.com

Black Ops™ Carbon Filters



Feature virgin activated Australian RC-412 granular carbon that absorbs and traps pollutant molecules within the carbon removing contaminants, odors and impurities from the air. Machine packing allows for more carbon and less movement. These filters are light-weight and have powder coated aluminum tops & bases. They have a built in flange and 2 pre-filters are included. 2 year life expectancy.

Item No.	Description	Filter lb	Dimensions	MSRP
746700	Black Ops Carbon Filter 4 in x 12 in 200 CFM	5.6	7.6" x 7.6" x 12.0"	\$103.95
746702	Black Ops Carbon Filter 6 in x 16 in 400 CFM	10.5	9.6" x 9.6" x 16.0"	\$127.95
746704	Black Ops Carbon Filter 6 in x 24 in 550 CFM	16.7	9.6" x 9.6" x 24.0"	\$163.95
746706	Black Ops Carbon Filter 8 in x 24 in 750 CFM	20.5	11.5" x 11.5" x 24.0"	\$173.95
746708	Black Ops Carbon Filter 8 in x 39 in 950 CFM	35.9	11.5" x 11.5" x 39.0"	\$237.95
746710	Black Ops Carbon Filter 10 in x 24 in 850 CFM	25.3	13.5" x 13.5" x 24.0"	\$188.95
746712	Black Ops Carbon Filter 10 in x 39 in 1400 CFM	41.8	13.5" x 13.5" x 39.0"	\$264.95
746714	Black Ops Carbon Filter 12 in x 39 in 1700 CFM	49.7	15.5" x 15.5" x 39.0"	\$316.95
746716	Black Ops Carbon Filter 12 in x 48 in 2200 CFM	64.2	15.5" x 15.5" x 48.0"	\$356.95
746718	Black Ops Carbon Filter 14 in x 39 in 2100 CFM	57.3	17.4" x 17.4" x 39.0"	\$359.95
746720	Black Ops Carbon Filter 14 in x 48 in 2500 CFM	65.0	17.4" x 17.4" x 48.0"	\$404.95
746722	Black Ops Carbon Filter 14 in x 50 in XL 3500 CFM	68.8	18.0" x 18.0" x 50.0"	\$557.95



**LIGHTWEIGHT AUSTRALIAN GRANULAR
CARBON AIR PURIFICATION PRODUCTS**

Phresh® Filters



Aluminum tops and bases for reduced weight. Half the weight of other filters. 46mm (1.8in) RC-48 activated, certified virgin carbon bed. Machine packed carbon means more carbon and less movement. Cone shaped internal base for optimum air flow. Sealed, bagged, boxed and labeled directly after being manufactured for optimum life span, handling and presentation. 51% open air custom mesh. Unique Anti Air Bypass System. Large selection of sizes available to fit any application. Flange & pre-filter included.

Item No.	Description	Filter lb	Dimensions	MSRP
701000	Phresh Filter 4 in x 8 in 150 CFM	3.8	7.3" x 7.3" x 8.0"	\$104.95
701003	Phresh Filter 4 in x 12 in 200 CFM	6.3	7.3" x 7.3" x 12.3"	\$111.95
701004	Phresh Filter Lo-Pro 4 in x 20 in 125 CFM	5.1	5.3" x 5.3" x 20.0"	\$82.95
701005	Phresh Filter 6 in x 16 in 400 CFM	12.6	9.5" x 9.5" x 16.0"	\$171.95
701010	Phresh Filter 6 in x 24 in 550 CFM	16.5	9.5" x 9.5" x 24.0"	\$194.95
701015	Phresh Filter 8 in x 24 in 750 CFM	21.1	10.5" x 10.5" x 24.0"	\$207.95
701018	Phresh Filter 8 in x 39 in 950 CFM	37.4	10.5" x 10.5" x 39.5"	\$271.95
701020	Phresh Filter 10 in x 24 in 850 CFM	25.9	13.5" x 13.5" x 24.0"	\$229.95
701025	Phresh Filter 10 in x 39 in 1400 CFM	41.9	13.5" x 13.5" x 39.5"	\$304.95
701028	Phresh Filter 12 in x 24 in 950 CFM	27.5	15.5" x 15.5" x 23.6"	\$279.95
701030	Phresh Filter 12 in x 39 in 1700 CFM	53.5	15.5" x 15.5" x 39.5"	\$364.95
701033	Phresh Filter 12 in x 48 in 2200 CFM	55.2	15.5" x 15.5" x 47.2"	\$407.95
701035	Phresh Filter 14 in x 39 in 2100 CFM	60.9	17.5" x 17.5" x 39.5"	\$407.95
701040	Phresh Filter 14 in x 48 in 2500 CFM	72.1	17.5" x 17.5" x 48.0"	\$462.95
701045	Phresh Filter XL 14 in x 50 in 3800 CFM	97.0	19.0" x 19.0" x 50.5"	\$547.95

Phresh® Inline Filters



EXCLUSIVE

Phresh® Inline Filters are state of the art carbon filters that practically scour the air to clean it of dust, foreign particulates, organic compounds and odors. Phresh Inline Filters are twice as light and last twice as long. Phresh® In-Line Filters are perfect for the following applications: Grow tents, cupboards and cabinets.

Item No.	Description	MSRP
701175	Phresh Inline Filter 6 in 500 CFM	\$231.95
701180	Phresh Inline Filter 8 in 750 CFM	\$297.95
701185	Phresh Inline Filter 10 in 850 CFM	\$347.95
701190	Phresh Inline Filter 12 in 950 CFM	\$429.95

Phresh® Intake Filters



EXCLUSIVE

Removes 99.9% of bugs, molds, pollen and dust. Use for intake filtering, scrubbing and low intensity exhaust filtering. Ultra light filters use advanced nano carbon felt technology. Maintains 90% of air flow.

Item No.	Description	MSRP
701255	Phresh Intake Filter 4 in x 6 in 140 CFM	\$57.95
701260	Phresh Intake Filter 6 in x 8 in 270 CFM	\$67.95
701265	Phresh Intake Filter 6 in x 12 in 450 CFM	\$84.95
701270	Phresh Intake Filter 8 in x 12 in 460 CFM	\$97.95
701275	Phresh Intake Filter 8 in x 16 in 750 CFM	\$121.95
701280	Phresh Intake Filter 10 in x 12 in 700 CFM	\$122.95
701285	Phresh Intake Filter 10 in x 16 in 1000 CFM	\$152.95
701290	Phresh Intake Filter 12 in x 16 in 1060 CFM	\$169.95
701295	Phresh Intake Filter 12 in x 20 in 1200 CFM	\$222.95

Phresh® Duct Silencers



Sound reducing acoustic foam decreases fan noise by up to 50%. Use with fans in conjunction with carbon filters, light systems and more. Durable and light weight aluminum body. Compact size is easy to install. Attach a Phresh® Silencer to the intake or exhaust side of an inline fan.

EXCLUSIVE

Item No.	Description	MSRP
701200	Phresh Duct Silencer 4 in x 12 in	\$66.95
701205	Phresh Duct Silencer 6 in x 18 in	\$102.95
701210	Phresh Duct Silencer 8 in x 24 in	\$122.95
701215	Phresh Duct Silencer 10 in x 30 in	\$164.95
701220	Phresh Duct Silencer 12 in x 36 in	\$207.95
701225	Phresh Duct Silencer 14 in x 39 in	\$247.95

Can-Filters®



Can-Filters® provides one of nature's best odor control materials, activated carbon. Can-KV-4 (carbon type) is specially developed for this purpose. All filters include a low resistance pre-filter.

Item No.	Description	Flange	Carbon Filter		Dimensions	MSRP
			lb	lb		
700644	Can-Filter 150 w/ out Flange 1260 CFM	12 in	123.0	156.0	16.5" x 16.5" x 60.0"	\$421.95
700639	Can-Filter 125 w/ out Flange 1110 CFM	10 in	103.0	129.0	16.5" x 16.5" x 49.0"	\$366.43
700634	Can-Filter 100 w/ out Flange 840 CFM	8 in	82.0	103.0	16.5" x 16.5" x 39.5"	\$322.01
700629	Can-Filter 75 w/ out Flange 600 CFM	8 in	62.0	79.0	16.5" x 16.5" x 29.5"	\$277.60
700619	Can-Filter 66 w/ out Flange 412 CFM	6 in	42.0	44.0	12.0" x 12.0" x 26.0"	\$188.77
700614	Can-Filter 50 w/ out Flange 420 CFM	6 in	31.0	55.0	16.5" x 16.5" x 19.7"	\$222.08
700609	Can-Filter 33 w/ out Flange 200 CFM	6 in	16.0	25.0	12.0" x 12.0" x 13.0"	\$133.25
700595	Can-Filter 1500 w/ out Flange 35 CFM	4 in	2.5	5.5	5.5" x 5.5" x 10.0"	\$51.11
700599	Can-Filter 2600 w/ out Flange 94 CFM	4 in	5.3	9.0	5.5" x 5.5" x 18.0"	\$66.66
700604	Can-Filter 9000 w/ out Flange 118 CFM	5 in	7.0	12.0	5.5" x 5.5" x 25.0"	\$75.55

Can-Filters® Flanges



The flange is used to connect the Can-Filter® to the ducting or Can-Fan®, this is for airflow out of the ventilated area.

Item No.	Description	MSRP
700670	Can-Filter Flange 2600/9000 4 in	\$8.89
700675	Can-Filter Flange 6 in	\$14.44
700680	Can-Filter Flange 8 in	\$15.55
700685	Can-Filter Flange 10 in	\$16.67
700690	Can-Filter Flange 12 in	\$21.11
700692	Can-Filter Flange 14 in (For Std & Max Fan)	\$29.00

Can-Lite™ Active Filters



These filters use 10% more virgin activated Australian RC light weight granular carbon. The bed depth is 2 in. Up to 2.5 years of life expectancy. All filters include a low resistance pre-filter. Each filter is shrink wrapped, boxed and labeled for ease of use.

Item No.	Description	Carbon Filter			Dimensions	MSRP
		Flange	lb	lb		
700589	Can-Lite Filter 4 in 250 CFM	4 in	6.6	9.0	4.0" x 4.0" x 15.0"	\$115.48
700590	Can-Lite Filter 6 in 600 CFM	6 in	14.2	20.0	10.0" x 10.0" x 24.0"	\$182.10
700591	Can-Lite Filter 8 in 1000 CFM	8 in	31.6	42.0	12.0" x 12.0" x 40.0"	\$264.27
700592	Can-Lite Filter 10 in 1500 CFM	10 in	35.4	48.0	14.0" x 14.0" x 40.0"	\$286.48
700593	Can-Lite Filter 12 in 1800 CFM	12 in	43.2	58.0	16.0" x 16.0" x 40.0"	\$342.00
700594	Can-Lite Filter 14 in 2200 CFM	14 in	50.4	68.0	18.0" x 18.0" x 40.0"	\$379.75

Can-Lite™ Pre-Filters



Very low air resistance, easily changed, blocks dust and other contaminants from entering filter. Available in all sizes. A clean Can-Lite™ Pre-Filter is an excellent way of extending the working life of your Can-Lite™ Filter.

Item No.	Description	MSRP
700770	Can-Lite Pre-Filter 4 in	\$8.89
700775	Can-Lite Pre-Filter 6 in	\$12.22
700785	Can-Lite Pre-Filter 10 in	\$21.11
700790	Can-Lite Pre-Filter 12 in	\$23.33

Can-Filters® Can-Max™ Filter



For max air flow use Max-Filter™ 2500 CFM. Constructed with light weight aluminum (over 40% perforated) and high capacity carbon with an outside diameter of 20 in (over 17 sq/ft) of surface area.

Item No.	Description	MSRP
700600	Can-Max Filter w/out Flange 2500 CFM	\$426.65

Pre-Packaged Can-Filter® & Can-Fan® Combos



These pre-packaged combos are great for UPS shipping. Everything you need in one packaged set.

Item No.	Description	MSRP
700763	Can-Filter Pre Packaged Can 33 w/ Can-Fan 6 in 270 CFM	\$282.04

Air Box Stealth Edition



We call it Stealth for a reason! Obliterate bad air and odors once and for all! A new generation in air purification. Easy to install, easy to use, easy to maintain. The Stealth Air box uses 100% premium virgin coconut charcoal, uses 100% of the filter surface area and are a 100% air tight with continuous worry-free operation. 1 Year Warranty.

Item No.	Description	MSRP
706105	Air Box 2 Stealth Edition 800 CFM 6 in	\$399.95
706106	Air Box 3 Stealth Edition 1200 CFM 8 in	\$516.95
706109	Air Box Stealth 1-2-3 Refill Cartridge NEW	\$71.95

Odor-Sok™ Air Filters



Constructed using microscopic activated carbon filaments & fibers. Air flows evenly across the carbon accelerating absorption. Faster adsorption rates mean smaller filter equipment & up to 30x less carbon in use for the same result over a 1 yr period.

Item No.	Description	MSRP
700800	Odor-Sok 4 in x 12 in 190 CFM	\$37.95
700805	Odor-Sok 6 in x 16 in 380 CFM	\$61.95

Replacement Carbon



Use to refill any carbon filter. This is high quality virgin activated coconut carbon. It comes bulk in a box and inside a plastic bag.

Item No.	Description	MSRP
700070	Replacement Pelletized Carbon 16 lb	\$86.95
700080	Replacement Pelletized Carbon 35 lb	\$165.95

Bug Screens



Active carbon inserts are proven to keep most bugs and pollutants from entering grow room. Minimal air flow restriction. Easily slips on and off inline fans. Mildew and UV resistant.

EXCLUSIVE

Item No.	Description	MSRP
704215	Black Ops Bug Screen w/ Active Carbon Insert 4 in	\$9.95
704220	Black Ops Bug Screen w/ Active Carbon Insert 6 in	\$11.95
704225	Black Ops Bug Screen w/ Active Carbon Insert 8 in	\$13.29
704230	Black Ops Bug Screen w/ Active Carbon Insert 10 in	\$14.95
704235	Black Ops Bug Screen w/ Active Carbon Insert 12 in	\$16.95

Horti-Control Dust Shroom



This revolutionary filter will keep your air cooled reflectors, inline fans, ice boxes and ducting dust free. It will also keep mold, mildew, pests and bacteria out of your garden!

Item No.	Description	MSRP
700965	Horti-Control Dust Shroom 4 in	\$109.00
700970	Horti-Control Dust Shroom 6 in	\$119.00
700975	Horti-Control Dust Shroom 8 in	\$129.00
700980	Horti-Control Dust Shroom 10 in	\$219.00
700985	Horti-Control Dust Shroom 12 in	\$239.00

Horti-Control Dust Shroom Cleaning Kit



This kit includes biodegradable cleaner and a can of biodegradable plant based oil which contains rosemary & cedar oil. When your Dust Shroom is dirty, just spray the cleaner on, rinse it with warm water, allow it to dry & re-coat it with the oil.

Item No.	Description	MSRP
700990	Horti-Control Dust Shroom Cleaning Kit	\$21.95



Neutralize Odors Naturally

Ona Apple Crumble Spray Card



NEW About the size of a business card the Ona Spray Card is extremely portable and can fit virtually anywhere discretely to provide immediate odor control or to quickly freshen up. The Ona Spray Card uses the same industrial strength formula that has made Ona a go-to product for odor control.

Item No.	Description	MSRP
700417	Ona Apple Crumble Spray Card - 12 ml	\$2.99

Ona Apple Crumble Spray



So good, you have to try it! Use Ona Apple Crumble spray anywhere unwanted odors are present. Simply spray into the air as needed. Ideal for eliminating smoke, pet and garbage odors. 1 Year Warranty.

Item No.	Description	MSRP
700419	Ona Apple Crumble Spray 250 ml	\$9.95

Ona Apple Crumble Mist



Experience the power of Ona with a new blast of scent, Apple Crumble! Use our Mist Can with Ona Mist Dispenser to maximize your odor control and leave the air smelling great! 1 Year Warranty.

Item No.	Description	MSRP
700383	Ona Apple Crumble Mist Can 6 oz	\$11.95

Ona Apple Crumble Mini Mist Can



The all new Ona Apple Crumble Mini Mist combines our proven industrial strength formula with a convenient and portable mist can. Use for immediate odor control at home or on the road.

Item No.	Description	MSRP
700381	Ona Apple Crumble Mini Mist Can 1.2 oz	\$4.99

Ona Apple Crumble Gel



Eliminate odors safely and permanently with Ona Gel. The proven industrial strength odor neutralizing ability of Ona Gel has now been combined with a new exciting scent, Apple Crumble! Available in all size gel containers. It is non-toxic, environmentally friendly and safe to use around people, pets and plants. 1 Year Warranty.

Item No.	Description	MSRP
700440	Ona Apple Crumble 1 Liter Gel	\$17.95
700442	Ona Apple Crumble 4 Liter Gel Pail	\$40.95
700444	Ona Apple Crumble 4 Liter Gel Jar	\$40.95
700446	Ona Apple Crumble 20 Liter Gel	\$167.95

Ona Block Apple Crumble



Introducing the new scent of the all new Ona Black Label Series. The Black Label series uses the same unique formula as our other proven scents, with a pleasant new twist. Perfect for around the house to neutralize odors.

Item No.	Description	MSRP
700332	Ona Block Apple Crumble 6 oz	\$8.99

Ona Pro Block



Unpleasant odors are gone - quickly and easily. The best part is that the active ingredients in the ONA Blocks are plant based, and therefore safe to use around people, plants and pets.

Item No.	Description	MSRP
700327	Ona Pro Block 6 oz	\$8.95

Ona Pro Gel



Ona Pro Gel is as close to odorless. Although it has a slight scent when sniffed in the container, the final result when working on powerful odors is simply a clean, fresh smell - period.

Item No.	Description	MSRP
700400	Ona Pro Gel Quart	\$17.95
700405	Ona Pro Gel Gallon Pail	\$40.95
700410	Ona Pro Gel Gallon Jar	\$40.95
700415	Ona Pro Gel 5 Gallon	\$167.95

Ona Pro Mist



It is virtually odorless and leaves only a fresh smell - like after a summer rain. Ona Pro is plant-based and safe to use around people, plants and pets. The Ona Mist aerosol is designed to only spray a short burst into the air. It is so powerful, that's all you need!

Item No.	Description	MSRP
700386	Ona Pro Mist 6 oz	\$12.19

Ona Pro Spray



Would you like the air in your home or office to smell fresh and clean? Then use the Ona Pro Spray! It leaves nothing behind to indicate that any odors were present.

Item No.	Description	MSRP
700421	Ona Pro Spray 8 oz	\$9.95

Ona Spray - Fresh Linen



Would you like the air in your home or office to smell fresh and clean? Then use the Ona Spray now in Fresh Linen scent! It leaves nothing behind to indicate that any odors were present. It is all you will ever need.

Item No.	Description	MSRP
700425	Ona Spray Fresh Linen 8 oz	\$9.95

Ona Block



Ideal for small areas such as closets, foyers, attics, cars, gym bags, boats, kitchens, garbage cans, cupboards or vents. Simply remove the cap, or punch several small holes in the cap and place in desired location. Measures 3 in x 3 in and will fit in most places.

Item No.	Description	MSRP
700320	Ona Block Polar Crystal 6 oz	\$8.95
700325	Ona Block Fresh Linen 6 oz	\$8.95

Ona Mist



Ona is very powerful and will help take out odors in garages, restaurants, bathrooms, hotel rooms, kitchens, smoking rooms or any place in your home or small business facility.

Item No.	Description	MSRP
700380	Ona Mist Polar Crystal 6 oz	\$12.19
700385	Ona Mist Fresh Linen 6 oz	\$12.19

Ona Liquid



Ona Liquid can be added to commercial misting systems, humidifiers or simply sprayed freely into the air. Ona Liquid is water based and can easily be diluted for safe & effective washing of odor saturated garments.

Item No.	Description	MSRP
700300	Ona Liquid Polar Crystal Quart	\$17.95
700305	Ona Liquid Fresh Linen Quart	\$17.95
700310	Ona Liquid Polar Crystal Gallon	\$40.95
700315	Ona Liquid Fresh Linen Gallon	\$40.95

Ona Gel - Polar Crystal



The Ona Gel is our most popular product. The Ona odor neutralizing agents are released in a controlled manner so that every drop of this excellent product is fully optimized.

Item No.	Description	MSRP
700330	Ona Gel Polar Crystal Quart	\$17.95
700340	Ona Gel Polar Crystal Gallon Pail	\$40.95
700350	Ona Gel Polar Crystal Gallon Jar	\$40.95

Ona Gel - Fresh Linen



The Ona Gel is our most popular product. The Ona odor neutralizing agents are released in a controlled manner so that every drop of this excellent product is fully optimized.

Item No.	Description	MSRP
700335	Ona Gel Fresh Linen Quart	\$17.95
700345	Ona Gel Fresh Linen Gallon Pail	\$40.95
700355	Ona Gel Fresh Linen Gallon Jar	\$40.95
700365	Ona Gel Fresh Linen 5 Gallon	\$167.95

Ona Mist Dispenser



Has an electronic eye that senses light levels. Set it to only spray in the dark (low light) or during the day (or when lights are normally on). The third option allows you to set it to spray 24 hrs a day. The spray is metered out in three adjustable time intervals - 7.5 min, 15 min or 30 min. 1 Year Warranty.

Item No.	Description	MSRP
700390	Ona Mist Auto Dispenser	\$24.95

Ona Cyclone Dispenser Fan



This portable fan runs very quietly and effectively. Loaded with a 20 liter pail of Ona Gel, it will provide high volume, high capacity distribution. Using less power than a light bulb, the Ona Cyclone provides delivers up to 5,000 square feet. 1 Year Warranty.

Item No.	Description	MSRP
700396	Ona Cyclone Dispenser Fan	\$139.95

Ona Breeze Dispenser Fan



Redesigned to be lighter and uses less power and fits on either the Ona Gel Pail or Ona Gel Jar (both 4 liters, 1 US Gal). This makes the Ona Breeze excellent value for the dispensation of Ona Gel. The Ona Breeze provides a room up to 1,500 square feet. 1 Year Warranty.

Item No.	Description	MSRP
700395	Ona Breeze Dispenser Fan 35 CFM	\$59.95

Ona Odor Stop Dispenser Fan



A dispenser fan for medium duty application. It has a high volume of airflow combined with a profile that can be conveniently placed anywhere. A maximum airflow of 225 CFM. It provides distribution for a room up to 10,000 sq. ft. 1 Year Warranty.

Item No.	Description	MSRP
700397	Ona Odor Stop Dispenser Fan 225 CFM	\$299.95

Ona Storm Dispenser Fan



Ideal for larger facilities such as schools, gymnasiums and office buildings. With its adjustable airflow control, it evenly distributes Ona for areas up to 10,000 sq. ft. (1,100 sq. meters). Designed to be used with Ona Gel 5 gal size. 225 CFM. 1 Year Warranty.

Item No.	Description	MSRP
700398	Ona Storm Dispenser Fan 225 CFM	\$429.95

uvonair®

Industrial Strength Odor Eliminators

Uvonair® 1000



It attacks and neutralizes odors at the source. Ozone by ultraviolet light. It eliminates odor, mold, bacteria, smoke, etc. Easy to use with no maintenance required. For areas up to 1000 cubic ft. Warning: For commercial use only in unoccupied areas. 1 Year Warranty.

Item No.	Description	MSRP
741000	Uvonair 1000	\$245.95
741015	UV Bulb 6 in (For Uvonair 1000)	\$64.95

Uvonair® 3000



It attacks and neutralizes odors at the source. It eliminates odor, mold, bacteria, smoke, etc. Easy to use with no maintenance required. For areas up to 3000 cubic ft. Warning: For commercial use only in unoccupied areas. 1 Year Warranty.

Item No.	Description	MSRP
741005	Uvonair 3000	\$255.95
741020	UV Bulb 11 in (For Uvonair 3000)	\$64.95

Uvonair® 5000



It attacks and neutralizes odors at the source. It eliminates odor, mold, bacteria, smoke, etc. Easy to use with no maintenance required. For areas up to 5000 cubic ft. Warning: For commercial use only in unoccupied areas. 1 Year Warranty.

Item No.	Description	MSRP
741010	Uvonair 5000	\$271.95
741025	UV Bulb 14 in (For Uvonair 5000)	\$82.95

Uvonair® 8 in UV Inline Duct Ozonator - 2 Bulb



Ozone safely alters the molecular structure of offensive micro-organisms, to eliminate odor. An economical system that produces ozone using special ultra violet light bulbs. Ideal for rooms up to 5000-10000 cu.ft. (150-300 m3). Warning: For commercial use only in unoccupied areas. 6 month warranty on bulb. 1 Year Warranty.

Item No.	Description	MSRP
741035	Uvonair UV Inline Duct Booster Ozonator 8 in - 2 Bulb	\$370.50
741030	UV Bulb High Output 6 in (For Uvonair Inline 8 in)	\$67.95

Uvonair® 8 in CD Inline Duct Ozonator - 1 Cell



Ozone safely alters the molecular structure of offensive micro-organisms, to eliminate odor. Will treat all odors being exhausted by an 8 in (20 cm) ventilation system under most circumstances for rooms up to 20,000 cu.ft. Warning: For commercial use only in unoccupied areas. 1 Year Warranty.

Item No.	Description	MSRP
741040	Uvonair CD Inline Duct Ozonator 8 in - 1 Cell	\$562.95

Uvonair® 10 in CD Inline Duct Ozonator - 1 Cell



Will treat all odors being exhausted by a 10 in (25 cm) ventilation system under most circumstances. The CD-1000-1 is intended for a room size of 20,000 cu. ft. Warning: For commercial use only in unoccupied areas. 1 Year Warranty.

Item No.	Description	MSRP
741045	Uvonair CD Inline Duct Ozonator 10 in - 1 Cell	\$619.95

Uvonair® 10 in CD Inline Duct Ozonator - 2 Cell



Will treat all odors being exhausted by a 10 in (25 cm) ventilation system under most circumstances. The CD-1000-2 is intended for a room size of 40,000 cu. ft. Warning: For commercial use only in unoccupied areas. 1 Year Warranty.

Uvonair® 12 in CD Inline Duct Ozonator - 3 Cell



Will treat all odors being exhausted by a 12 in (30 cm) ventilation system under most circumstances. Intended for rooms up to 100,000 cu. ft. (3000 m3). Warning: For commercial use only in unoccupied areas. 1 Year Warranty.

Item No.	Description	MSRP
741050	Uvonair CD Inline Duct Ozonator 10 in - 2 Cell	\$729.95

Item No.	Description	MSRP
741055	Uvonair CD Inline Duct Ozonator 12 in - 3 Cell	\$889.95

Super Sprouter™

Your best start for seeds and cuttings!



- Heat Mats
- Heat Mat Thermostats
- Neoprene Inserts
- Germination & Propagation Kits
- Plug Trays & Refills
- Domes and Trays



VIGOROUS ROOTS STRONGER PLANTS

www.SuperSprouter.com





Rainmaker Watering Products are essential for anyone's garden. Our full line of multi-purpose watering devices include a variety of hand sprayers, pump sprayers, backpack sprayer and even an electric sprayer. No matter the size of your garden, we have the product to fit your needs. Rainmaker Watering Products are a great garden tool for you to take care of your plants and give them what they need, Water! Ask your local indoor garden center for Rainmaker Brand Sprayers.

www.rainmakersprayers.com

Rainmaker® Pressurized Pump Sprayer



This is a heavy duty, refillable pump sprayer. It features an adjustable brass spray nozzle. Capacity is 64 oz/1.9 Liters. Use to apply most pest/disease control products, foliar sprays or cleaning agents.

EXCLUSIVE

Item No.	Description	MSRP
708500	Rainmaker Pressurized Spray Bottle 64 oz / 1.9 Liter	\$10.95

Rainmaker® Trigger Sprayer



This 32 oz spray bottle has an adjustable nozzle and translucent bottle to easily see liquid levels. It can be used for a variety of home and garden applications.

EXCLUSIVE

Item No.	Description	MSRP
708502	Rainmaker Spray Bottle 32 oz	\$2.95

Rainmaker® 360 Spray Bottle



NEW The Rainmaker® 360 Degree Spray Bottle 32 ounce is made of a translucent plastic with graduations for easy viewing of liquid levels. This sprayer has a rotational nozzle that allows you to spray up, down, left and right without awkwardly needing to tilt the bottle to your intended direction. Each trigger pull is regulated to put out 1.3cc of water volume.

EXCLUSIVE

Item No.	Description	MSRP
708508	Rainmaker 360 Degree Spray Bottle 32 oz	\$5.49

360 Trigger Sprayer



The 360 trigger sprayer with 9.25 inch dip tube can be used to replace current trigger sprayers. The 360 trigger sprayer comes assembled to fit 32 oz bottles or the dip tube can be cut to a desired height to fit smaller bottles. Sprayer is equipped with a nozzle that rotates a full 360 degrees and holds that position to spray in any direction. Does not include bottle.

Item No.	Description	MSRP
708583	360 Trigger Sprayer w/ 9.25 in Dip Tube	\$2.49

Rainmaker® Battery Powered Sprayer



All purpose sprayer ideal for herbicides, pesticides, liquid fertilizers and many home applications! Unit is powered by a rechargeable battery. Has a pull cart or simply take the sprayer off its carriage and wear like a backpack. Includes four interchangeable sprayer nozzles for different applications. Trigger with a lock-on option can be engaged for a continuous spraying. This sprayer has an integrated filter included and a 4 ft hose. 1 Year Warranty.

EXCLUSIVE

Item No.	Description	MSRP
708900	Rainmaker 5 Gallon Battery Powered Sprayer	\$199.95

Rainmaker® Backpack Sprayer



All purpose sprayer ideal for herbicides, pesticides, liquid fertilizers and many home applications! Includes four interchangeable sprayer nozzles for different applications. Trigger with a lock-on option can be engaged for a continuous spraying. Padded shoulder straps for added comfort. Integrated filter included and a 4 ft hose. 1 Year Warranty.

EXCLUSIVE

Item No.	Description	MSRP
708902	Rainmaker 4 Gallon (16 Liter) Backpack Sprayer	\$41.95

Rainmaker® Pressurized Pump Sprayers



EXCLUSIVE

All purpose sprayer ideal for herbicides, pesticides, liquid fertilizers and many home applications! Funnel top opening makes for easy filling. Trigger with a lock-on option can be engaged for a continuous spraying. Translucent polyethylene for durability and easy viewing of liquid levels. Carry with the grip handle or use the included shoulder strap. Includes a pressure relieve valve and a 4 ft hose. 1 Year Warranty.

Item No.	Description	MSRP
708904	Rainmaker 1 Gallon (4 Liter) Pump Sprayer	\$19.95
708906	Rainmaker 2 Gallon (8 Liter) Pump Sprayer	\$27.95
708908	Rainmaker 3 Gallon (11 Liter) Pump Sprayer	\$31.95

Rainmaker® Watering Can



NEW The Rainmaker® watering can is light weight and well balanced. Use with rose spout for finer, even spray or detach rose spout to customize water flow. Rose spout can be opened for easy clean out. Features two handle positions with textured grip for more control and easy pouring. The small fill hole will eliminate water splashing out of the watering can. Measurement markings on side of watering can.

EXCLUSIVE

Item No.	Description	MSRP
708916	Rainmaker Watering Can 3.2 Gal / 12 Liter	\$23.95

Rainmaker® Flow Control Watering Wands



NEW Rainmaker® Adjustable Watering Wands make watering plants easy. Feel the comfort and ease of use with the ergonomic comfort grip handle with sliding thumb valve that lets you control the water flow. These watering wands incorporate a 180 degree adjustable spray head with 10 different spray patterns for all your watering needs. Constructed out of durable aluminum. Comes in two different

EXCLUSIVE

sizes 18 and 36 inch lengths.

Item No.	Description	MSRP
708512	Rainmaker Watering Wand w/ Thumb Slide Flow Control 36 in	\$19.95
708514	Rainmaker Watering Wand w/ Thumb Slide Flow Control 18 in	\$16.95

Rainmaker® Telescopic Watering Wand with Thumb Slide Flow Control



NEW Rainmaker® Telescopic Watering Wand make watering plants easy. This watering wand reaches from 36 in to 54 in. Feel the comfort and ease of use with the ergonomic comfort grip handle with sliding thumb valve that lets you control the water flow. This watering wand incorporates a 180 degree adjustable spray head with 8 different spray patterns for all your watering needs.

EXCLUSIVE

Item No.	Description	MSRP
708516	Rainmaker Telescopic Watering Wand w/ Thumb Slide Flow Control 36 in to 60 in	\$21.95

Rainmaker® Kink Free High Flow Single Hose Adaptor Outlet



NEW Rainmaker® Kink Free High Flow Single Shut-Off Hose Adaptor Outlet improves access to faucets that are in difficult to reach spots. This single flow hose adaptor outlet comes with a built in flex hose with a kink free coil which eliminates kinks at the faucet. Metal swivel coupling allows you to easily connect this adaptor to your faucet. Control your flow by a simply pushing down on the thumb slide flow control lever for full flow and push up to restrict flow.

EXCLUSIVE

Item No.	Description	MSRP
708992	Rainmaker Kink Free High Flow Single Hose Adaptor Outlet	\$8.99

Rainmaker® Kink Free High Flow Dual Hose Adaptor Outlet



NEW Rainmaker® Kink Free High Flow Dual Shut-Off Hose Adaptor Outlet improves access to faucets that are in difficult to reach spots. This dual shut-off hose adaptor outlet is also great when you need to water in two locations at once. This dual flow adaptor outlet comes with a built in flex hose with a kink free coil which eliminates kinks at the faucet. Metal swivel coupling allows you to easily connect this

adaptor to your faucet. Control your flow by simply pushing down on the thumb slide flow control lever for full flow and push up to restrict flow.

EXCLUSIVE

Item No.	Description	MSRP
708994	Rainmaker Kink Free High Flow Dual Hose Adaptor Outlet	\$15.99

Rainmaker® High Flow Dual Hose Adaptor Outlet



NEW Rainmaker® High Flow Dual Hose Adaptor Outlet is great for moving large amounts of water. This product works great for running dual hoses to different site locations from a faucet. Individually control each of the two valves by simply pushing down on the thumb slide flow control lever for full flow and push up to restrict flow.

EXCLUSIVE

Item No.	Description	MSRP
708996	Rainmaker High Flow Dual Hose Adaptor Outlet	\$6.99

Rainmaker® High Flow 4 Way Hose Adaptor Outlet



NEW Rainmaker® High Flow 4 Way Hose Adaptor Outlet is great for moving large amounts of water. This product works great for running multiple hoses to different site locations from a faucet. Individually control each of the 4 valves by simply pushing down on the thumb slide flow control lever for full flow and push up to restrict flow.

EXCLUSIVE

Item No.	Description	MSRP
708998	Rainmaker High Flow 4 Way Hose Adaptor Outlet	\$18.99

Solo® Directional Sprayer

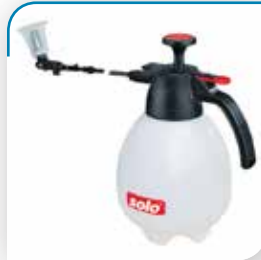

Solo's handheld sprayer is a one-hand pressure sprayer with a telescoping wand that is adjustable from 12 in to 23 in for comfortable ground level spraying without bending. The nozzle is fully adjustable from direct jet to fine mist. Locking trigger reduces user fatigue. A built-in shield provides added control if spraying in breezy conditions.

Item No.	Description	MSRP
708590	Solo Directional Sprayer w/ Extendable Wand 2 Liter	\$26.95

360 Spray Bottles



The 360 sprayer is equipped with a nozzle that rotates a full 360 degrees and holds that position to spray in any direction. By simply turning the nozzle, you eliminate the need to tilt the bottle.

Item No.	Description	MSRP
708585	360 Spray Bottle 8 oz	\$3.89
708586	360 Spray Bottle 16 oz	\$4.19
708587	360 Spray Bottle 24 oz	\$4.49
708588	360 Spray Bottle 32 oz	\$4.59

Root Lowell Commercial Portable Sprayer/Atomizer



This industrial grade atomizer can spray a wide variety of foliar feed products as well as pest and disease control products. This portable unit is meant to be carried around by the user as the liquid is dispensed. 2 gal capacity. Adjustable flow 1.5 to 14 GPH. Particle size: (micron) 22-46.

Item No.	Description	MSRP
708540	Root Lowell Commercial Portable Sprayer/Atomizer (1026B)	\$302.95

Root Lowell Commercial Stationary Sprayer/Atomizer



This industrial grade atomizer can spray a wide variety of foliar feed products as well as pest and disease control products. It is placed in a stationary location and is used to fog a greenhouse or confined gardening area. 2 gal capacity. Adjustable flow 1.5 to 5.3 GPH. Particle size: (micron) less than 50.

Item No.	Description	MSRP
708545	Root Lowell Commercial Stationary Sprayer/Atomizer (1952B)	\$239.95

Root Lowell Flo-Master® Battery Sprayer 5 L/1.3 Gallon



No pumping needed. Uses 4 D batteries (included). One set of batteries will spray approximately 18 gallons of liquid. Telescoping wand extends from 16 in to 35 in. Adjustable nozzle with padded shoulder strap.

Item No.	Description	MSRP
708537	Root Lowell Flo-Master Battery Powered Sprayer 5 Liter/1.3 Gallon	\$51.95

Root Lowell Flo-Master® Heavy Duty Sprayer 36 oz

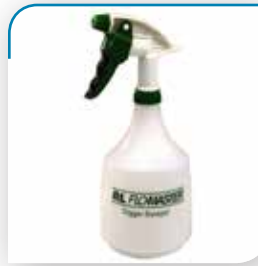

36 oz heavy duty trigger sprayer has nozzle that adjusts from fine mist to straight stream. Cushioned comfort grip minimizes user fatigue and rear support tab provides grip for greater comfort.

Item No.	Description	MSRP
708532	Root Lowell Flo-Master Heavy Duty Trigger Sprayer 36 oz	\$6.95

Root Lowell Flo-Master® Pressurized Sprayer 40 oz

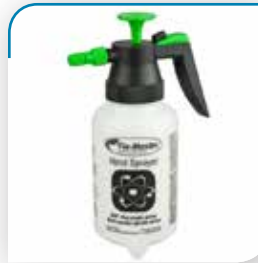

40 oz capacity. Compact version of standard compressed air sprayers. Adjustable poly nozzle which can spray a fine mist. Durable poly construction. 360 degree spraying capability allows spraying in any direction, including upside down.

Item No.	Description	MSRP
708534	Root Lowell Flo-Master Pressurized Pump Sprayer 40 oz	\$9.49

Root Lowell Flo-Master® Sprayer 1 Gallon



Root Lowell 1 Gallon Flo-Master® Pump Sprayer features funnel top with pour spout, durable poly construction, corrosion resistant poly wand & adjustable nozzle and poly flow control with lock-on feature. 1 Year Warranty.

Item No.	Description	MSRP
708538	Root Lowell Flo-Master Pump Sprayer 1 Gallon	\$20.95

Root Lowell Pro 180 Degree Sprayer 1.5 Liter



NEW Root Lowell 56 oz capacity hand held sprayer with adjustable multi-position nozzle pivots 180 degrees which makes this great for small jobs and for hard to reach areas. The sprayer tip adjusts from a straight stream to a fine mist. Equipped with Viton seals to stand up against abrasive chemicals. Trigger has lock-on feature for continuous use and reduces user fatigue. Durable poly construction.

Item No.	Description	MSRP
708549	Root Lowell Pro 180 Degree Sprayer w/ Adjustable Nozzle 1.5 Ltr	\$20.95

Root Lowell Chameleon® Adaptable Hose End Sprayer

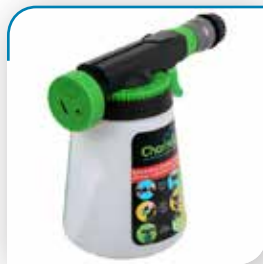

NEW The Chameleon® Adaptable Hose End Sprayer 36 oz offers a versatile hose end sprayer, featuring 3 different spray positions and a quick connect adapter. The sprayer can adapt to fit multiple container sizes and helps minimize contact with chemicals for a safer application method. Attach to yard hose for easy application of chemicals. Adapts to fit a variety of container sizes. 3 different spray patterns to get the job done. Quick connect adapter included for fast setup.

Item No.	Description	MSRP
708543	Root Lowell Chameleon Hose End Sprayer 36 oz	\$13.99

Mondi™ Mist & Spray Deluxe Sprayer 1.3 Quart



Superior quality, small capacity tank sprayer designed for use in the garden or home. Brass nozzles adjust spray from fine mist to gently shower. This sprayer features an extra long nozzle and extension. 2 Year Warranty.

Item No.	Description	MSRP
708715	Mondi Mist & Spray Deluxe Sprayer 1.3 Quart/1.2 Liter	\$17.49

Mondi™ Mist & Spray Premium Tank Sprayer 1.5 Quart



A superior quality, small capacity tank sprayer designed for use in the garden or home. Equipped with a swivel nozzle that adjusts from a jet stream to a fine mist spray. Packaged with a bonus 6 in extension nozzle for harder to reach areas. 2 Year Warranty.

Item No.	Description	MSRP
708725	Mondi Mist & Spray Premium Tank Sprayer 1.5 Quart/1.4 Liter	\$11.49

Mondi™ Mist & Spray Deluxe Sprayer 2.1 Quart

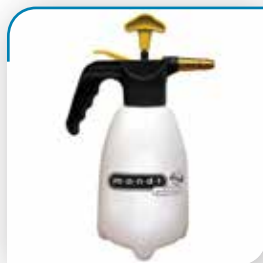

Superior quality, small capacity tank sprayer designed for use in the garden or home. Brass nozzles adjust spray from fine mist to gently shower. Features an extended brass head, extra long nozzle and extension. 2 Year Warranty.

Item No.	Description	MSRP
708720	Mondi Mist & Spray Deluxe Sprayer 2.1 Quart/2 Liter	\$18.95

Fiskars® Easy Pour Watering Can

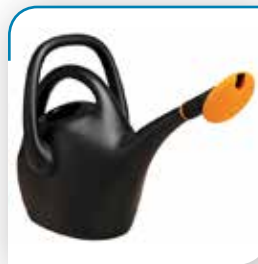

It holds 2.6 gals yet is easy to carry and pour. Dual handles accommodate multiple hand positions. The spout rotates for adjustable flow control, from a gentle shower to a steady stream. The filling hole is located on the side so the handles don't get in the way.

Item No.	Description	MSRP
708825	Fiskars Easy Pour Watering Can 2.6 Gallon	\$26.95

Dramm Rain Wand™ Colormark™



The Rain Wand™ is ideal for watering flowerbeds, gardens and shrubs. Colormark™ models include a 30 in Anodized aluminum extension handle, 8 in foam grip and brass water shut-off valve. Fingertip shut-off valve reduces overall water consumption. Made in the USA. Lifetime Warranty.



Item No.	Description	MSRP
708810	Dramm Rain Wand Colormark 30 in	\$39.99

Dramm Rain Wand™ Touch 'N Flow™



The Dramm Rain Wand™ is ideal for watering flowerbeds, gardens and shrubs. Touch 'N Flow™ Sunrise models have an anodized aluminum extension handle, lever activated water shut-off, color matched Water Breaker nozzle. Lifetime Warranty.



Item No.	Description	MSRP
708815	Dramm Rain Wand Touch N Flow Sunrise 30 in	\$28.99

Dramm One Touch™ Rain Wands™ Blue



Water with ease with Dramm One Touch™ Rain Wands™. Allows complete and total control of water flow by your thumb with the one touch valve. Efficiently saves water while watering from one plant to the next. Made with heavy-duty aluminum for lightweight feel. Available in 16 and 30 inch lengths in vibrant blue.

Item No.	Description	MSRP
708970	Dramm One Touch Rain Wand 30 in Blue	\$28.50
708974	Dramm One Touch Rain Wand 16 in Blue	\$23.50

Dramm One Touch™ Shower & Stream™ Sprayer



The One Touch™ Shower & Stream™ gives you complete and total water flow control with just one touch of your thumb. It has two pattern options: Shower, a cascading flow of fine water droplets that will not harm your plants; and Stream, a concentrated jet – powerful enough to wash even the muddiest sidewalks. Lifetime guarantee to the consumer.

Item No.	Description	MSRP
708972	Dramm One Touch Shower & Stream Sprayer – Blue	\$19.95

Dramm Revolver™ 9 Pattern Spray Gun

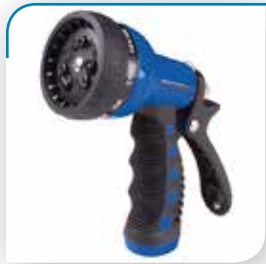

The nine-pattern Revolver™ Spray Gun aids in any outdoor function involving water. Patterns include: fan, cone, center, jet, mist, soaker, flat, angle and shower. The lightweight Revolver™ has an ergonomic insulated grip and is constructed with heavy-duty metal, comes with a lifetime guarantee.

Item No.	Description	MSRP
708978	Dramm Revolver 9 Pattern Spray Gun – Blue	\$14.95

Dramm Aluminum Quick Disconnect Fitting System



Eliminates the hassle of threaded connections between the hose and accessories. Made with lightweight aluminum construction for ease of use. Can use with any garden hose thread accessory. Set includes: 1 hose and 3 tool adapters.

Item No.	Description	MSRP
708980	Dramm Aluminum Quick Disconnect Fitting System – 4 Parts	\$23.95

Dramm Handi-Reach Extension Handles



Handi-Reach Handles eliminates stretching and stooping. Has a molded rubber grip for comfort. Made with professional grade materials. Choose from 48 or 72 inch handles. Made in the USA.

Item No.	Description	MSRP
708964	Dramm Handi-Reach Extension Handle 48 in	\$16.95
708982	Dramm Handi-Reach Extension Handle 72 in NEW	\$17.95

Dramm Water Breaker Nozzles



Dramm 400PL Water Breaker Nozzle is the original full flow nozzle. It is made of unbreakable plastic. Dramm 1000 Water Breaker Nozzle has over 1000 holes that creates the softest flow available. Made with a stainless steel disc. Use with Dramm Handi-Reach Extension Handle 48 in (#708964). Both nozzles are made in the USA.

Item No.	Description	MSRP
708950	Dramm 400PL Water Breaker Nozzle	\$8.50
708962	Dramm 1000 Water Breaker Nozzle	\$18.50

Dramm Seedling & Fogg-It Nozzles



Seedling Nozzle is designed for misting seedlings and plugs. Fogg-It Nozzle has three mist jets for watering all fragile plants. The nozzles are made out of brass for durability. Use with Dramm Handi-Reach Extension Handle 48 in (#708964). Both are made in the USA.

Item No.	Description	MSRP
708952	Dramm Seedling Nozzle	\$11.50
708954	Dramm Fogg-It Nozzle	\$14.95

Dramm Shut-Off Valves



Dramm Brass Shut-Off Valve is a professional quality full flow valve. Made of brass for durability. Aluminum Shut-Off Valve is identical to brass valve with lighter weight body made of aluminum. Dramm valves are made in the USA.

Item No.	Description	MSRP
708956	Dramm Heavy Duty Brass Shut-Off Valve	\$29.95
708958	Dramm Aluminum Shut-Off Valve	\$28.50

Dramm One Touch™ Valve Brass Outlet



Allows complete and total control of water flow by your thumb with the one touch valve. Has a molded rubber grip for comfort. Efficiently saves water while watering from one plant to the next. Has brass outlet for durability.

Item No.	Description	MSRP
708968	Dramm One Touch Valve-Brass Outlet	\$19.95

Dramm Handi-Grip Handle 6 in



Dramm Handi-Grip Handle is 6 inches in length. Has brass inlet and outlet for durability. Has foam cushion grip for comfort.

Item No.	Description	MSRP
708966	Dramm Handi-Grip Handle 6 in	\$9.95

Dramm Touch 'N Flow™ Pro Full Flow Shut Off



Touch 'N Flow™ Full Flow Shut-Off has the one-touch lever activated valve. Features an ergonomic insulated grip.

Item No.	Description	MSRP
708960	Dramm Touch N Flow Pro Full Flow Shut-Off	\$14.95

Dramm Hose Menders



NEW Perfect to repair the bent or damaged ends of your 5/8 in garden hose. Choose from Male or Female Hose Menders. Each package has a male or female end and the clamps to hold them in place for a lasting repair. The crushproof ends are crafted from nickel plated brass, while the die-cast zinc and aluminum clamps offer strength and durability. The barbed ends slide easily into your garden

hose for a tight fit.

Item No.	Description	MSRP
708984	Dramm Male Hose Mender	\$7.95
708986	Dramm Female Hose Mender	\$7.95

Dramm ColorStorm™ Premium Rubber Hose



Made in the USA, the ColorStorm™ Premium Rubber Hose is molded from quality EPDM rubber, which will not crack, check or separate. This Premium Rubber Hose resists kinking, coils easily and is flexible to -25° F. It also withstands hot water up to 160° F and has a working pressure of 125 PSI. Crush proof nickel-plated couplings complete this quality hose that is guaranteed for life.

Item No.	Description	MSRP
708948	Dramm ColorStorm Premium Rubber Hose 5/8 in 50 ft Blue	\$77.95

Dramm ColorStorm™ Premium Rubber Hose - 330 Ft



NEW Made in the USA, the ColorStorm™ Premium Rubber Hose is molded from quality EPDM rubber, which will not crack, check or separate. This Premium Rubber Hose resists kinking, coils easily and is flexible to -25° F. It also withstands hot water up to 160° F and has a working pressure of 125 PSI. Crush proof nickel-plated couplings complete this quality hose that is guaranteed for life. Great for creating your own

customized hose lengths. Use male and female hose menders for end connections.

Item No.	Description	MSRP
708949	Dramm Colorstorm Hose 330 ft	\$479.95

Mondi™ Telescopic Water Wand



A soft showering head that is gentle on plants and flowers. An extendable wand that reaches from 36 in to 52 in. Adjustable flow control on the handle with shaped soft grips for comfort. Includes premium Viton high quality seals and mesh filter. Lifetime Warranty.

Item No.	Description	MSRP
708711	Mondi Telescopic Water Wand	\$21.95

Bond® 8 Pattern Watering Wand 36 in



Aluminum tube expandable to 36 in. This nozzle comes with 8 selectable patterns; jet, cone, shower, full, flat, mist, soaker and angled. Tilt head.

Item No.	Description	MSRP
740815	Bond 9 Pattern Watering Wand 36 in	\$23.49

Bond® Medium Duty Hose 5/8 in x 50 ft



Solid brass couplings. Collar reduces kinking at the faucet. Crush proof couplings. Coils easily in all weather conditions. 10 Year Warranty.

Item No.	Description	MSRP
740810	Bond Medium Duty Hose 5/8 in 50 ft	\$23.49

**Growers
EDGE**
www.growers-edge.net



#growersedge

Top quality gardening accessories products. Tomato Cages
• Plant Ties • Drying Racks • Bamboo Stakes • Steel Stakes •
Trellis Netting • Plant Supports • Storage Bags • Vaporizers •
Labels and many more great products to make gardening easier.

Grower's Edge® High Stakes™ Heavy Duty Round Tomato Cage 4 Rings - 42 in



NEW Grower's Edge® High Stakes™ Heavy Duty Tomato Cages are great for supporting tomatoes, climbing plants and top heavy foliar plants. These tomato cages are constructed of heavy duty galvanized steel that will last for many seasons. Stackable for off season storage. Wire thickness is 9/64 in. Each cage is designed with 4 rings and 4 supporting legs for added support and stability. Top ring diameter is 13.5 in.

EXCLUSIVE

Item No.	Description	MSRP
740410	Grower's Edge High Stakes Tomato Cage - 4 Ring - 42 in	\$6.59

Grower's Edge® High Stakes™ Heavy Duty Round Tomato Cage 4 Rings - 54 in



NEW Grower's Edge® High Stakes™ Heavy Duty Tomato Cages are great for supporting tomatoes, climbing plants and top heavy foliar plants. These tomato cages are constructed of heavy duty galvanized steel that will last for many seasons. Stackable for off season storage. Wire thickness is 3/16 in. Each cage is designed with 4 rings and 4 supporting legs for added support and stability. Top ring diameter is 18 in. Proudly Made in the USA.

EXCLUSIVE

Item No.	Description	MSRP
740412	Grower's Edge High Stakes Tomato Cage - 4 Ring - 54 in	\$9.95

Grower's Edge® High Stakes™ Heavy Duty Round Wide Tomato Cage 6 Rings - 56 in

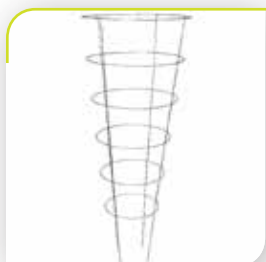

NEW Grower's Edge® High Stakes™ Heavy Duty Wide Tomato Cages are great for supporting tomatoes, climbing plants and top heavy foliar plants. These tomato cages are constructed of heavy duty galvanized steel that will last for many seasons. Stackable for off season storage. Wire thickness is 3/16 in. Each cage is designed with 6 rings and 4 supporting legs for added support and stability. Top ring diameter is 22 in. Proudly Made in the USA.

EXCLUSIVE

Item No.	Description	MSRP
740414	Grower's Edge High Stakes Wide Tomato Cage - 6 Ring - 56 in	\$13.95

Grower's Edge® High Stakes™ Commercial Grade Round Tomato Cage 5 Rings - 72 in

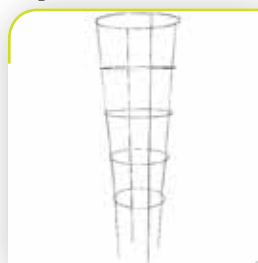

NEW Grower's Edge® High Stakes™ Commercial Grade Tomato Cages are great for supporting tomatoes, climbing plants and top heavy foliar plants. These tomato cages are constructed of heavy duty galvanized steel that will last for many seasons. Stackable for off season storage. Wire thickness is 1/4 in. Each cage is designed with 5 rings and 4 supporting legs for added support and stability. Top ring diameter is 24 in. Proudly Made in the USA.

EXCLUSIVE

Item No.	Description	MSRP
740416	Grower's Edge High Stakes Commercial Grade Tomato Cage - 5 Ring - 72 in	\$31.95

Grower's Edge® High Stakes™ Inverted Tomato Cages 4 Rings



NEW Grower's Edge® High Stakes™ Inverted Heavy Duty Tomato Cages are great for supporting tomatoes, climbing plants and top heavy foliar plants. These Tomato Cages are constructed of heavy duty galvanized steel that will last for many seasons. These inverted cages are wider at the base and narrow at the top which provides more stability as compared to traditional Cages. The benefit is the cage won't topple over in high winds or severe weather. Stackable for off season storage. Wire thickness for 740422 is 3/16 in. Wire thickness for 740424 and 740426 is 1/4 in. Each cage is designed with 4 rings and 4 supporting legs.

EXCLUSIVE

Item No.	Description	MSRP
740422	Grower's Edge High Stakes Inverted Tomato Cage - 4 Ring - 44 in	\$14.99
740424	Grower's Edge High Stakes Commercial Grade Inverted Tomato Cage - 4 Ring - 52 in	\$16.99
740426	Grower's Edge High Stakes Commercial Grade Inverted Tomato Cage - 4 Ring - 62 in	\$18.99

Grower's Edge® High Stakes™ Heavy Duty Square Folding Tomato Cage 4 Tiers - 48 in



NEW Grower's Edge® High Stakes™ Heavy Duty Folding Tomato Cages are great for supporting tomatoes, climbing plants and top heavy foliar plants who need a little extra room on top. Made of heavy duty galvanized steel that will last many seasons. Wire thickness is 3/16 in. Latch or unlatch cage for easy installation or removal. They also can be linked together to create any size or shape. After use, these cages fold flat for easy storage. Dimensions 48 x 15 x 15 inches with 4 tiers of support. Proudly Made in the USA.

EXCLUSIVE

Item No.	Description	MSRP
740418	Grower's Edge High Stakes Folding Tomato Cage - 4 Tier - 48 in x 15 in x 15 in	\$23.95

Grower's Edge® High Stakes™ Commercial Grade Square Folding Tomato Cage 5 Tiers - 60 in



NEW Grower's Edge® High Stakes™  Commercial Grade Folding Tomato Cage is great for supporting tomatoes, climbing plants and top heavy foliar plants who need a little extra room on top. Made of a heavy duty 1/4 inch galvanized steel that will last many seasons. Latch or unlatch cage for easy install and removal. After use these cages fold complete flat and can be stored easily. Dimensions 60 x 17.5 x 17.5 inches with 5 tiers of support. Proudly Made



in the USA.

EXCLUSIVE

Item No.	Description	MSRP
740419	Grower's Edge High Stakes Commercial Grade Square Folding Tomato Cage - 5 Tier - 60 in x 17.5 in x 17.5 in	\$34.95

Grower's Edge® High Stakes™ Commercial Grade Square Folding Tomato Cage 6 Tiers - 72 in



NEW Grower's Edge® High Stakes™  Commercial Grade Folding Tomato Cages are great for supporting tomatoes, climbing plants and top heavy foliar plants who need a little extra room on top. Made of heavy duty galvanized steel that will last many seasons. Wire thickness is 1/4 in. Latch or unlatch cage for easy installation or removal. They also can be linked together to create any size or shape. After use, these cages fold flat for easy storage. Dimensions



72 x 21 x 21 inches with 6 tiers of support. Proudly Made in the USA.

EXCLUSIVE

Item No.	Description	MSRP
740420	Grower's Edge High Stakes Commercial Grade Folding Tomato Cage - 6 Tier - 72 in x 21 in x 21 in	\$41.95

Grower's Edge® Natural Bamboo Stakes - Bulk



Grower's Edge® Natural Bamboo Stakes are all natural, strong, lightweight, inexpensive, weather well and last several seasons in the garden. Use these stakes as plant stakes and markers or as supports for potted plants. 6 ft, 8 ft, 10 ft and 12 ft stakes cannot be shipped UPS ground. Check your local Dealer Partner for availability.

EXCLUSIVE

Item No.	Description	MSRP
740745	Grower's Edge Natural Bamboo 2 ft Bulk	\$11.95
740750	Grower's Edge Natural Bamboo 3 ft Bulk	\$18.95
740755	Grower's Edge Natural Bamboo 4 ft Bulk	\$16.95
740760	Grower's Edge Natural Bamboo 6 ft Bulk	\$22.95
740765	Grower's Edge Natural Bamboo 8 ft Bulk	\$68.95
740770	Grower's Edge Natural Bamboo 10 ft Bulk	\$83.95
740775	Grower's Edge Natural Bamboo 12 ft Bulk	\$69.95

Grower's Edge® Natural Bamboo Stakes



Grower's Edge® Natural Bamboo Stakes are all natural, strong, lightweight, inexpensive, weather well and last several seasons in the garden. Use these stakes as plant stakes and markers, or as supports for potted plants. 6 ft & 8 ft stakes cannot be shipped UPS ground.

EXCLUSIVE

Item No.	Description	MSRP
740720	Grower's Edge Natural Bamboo 2 ft - 25/Bag (20 Bags/Bundle)	\$2.25
740725	Grower's Edge Natural Bamboo 3 ft - 25/Bag (20 Bags/Bundle)	\$3.49
740730	Grower's Edge Natural Bamboo 4 ft - 25/Bag (20 Bags/Bundle)	\$4.49
740735	Grower's Edge Natural Bamboo 6 ft - 6/Bag (40 Bags/Bundle)	\$4.19
740740	Grower's Edge Natural Bamboo 8 ft - 6/Bag (40 Bags/Bundle)	\$8.39

Grower's Edge® Deluxe Steel Stakes



Grower's Edge® Deluxe Steel Stakes are ideal for all your heavy-duty plant supporting needs. The steel core is coated with green plastic to make them weather and rust proof. They won't split, deteriorate or rot like bamboo stakes can. 6 ft stakes cannot be shipped UPS ground.

EXCLUSIVE

Item No.	Description	MSRP Ea
740392	Grower's Edge Deluxe Steel Stake 5/16 in Diameter 2 ft	\$0.93
740394	Grower's Edge Deluxe Steel Stake 5/16 in Diameter 3 ft	\$1.02
740396	Grower's Edge Deluxe Steel Stake 5/16 in Diameter 4 ft	\$1.25
740397	Grower's Edge Deluxe Steel Stake 7/16 in Diameter 5 ft NEW	\$1.89
740398	Grower's Edge Deluxe Steel Stake 7/16 in Diameter 6 ft	\$2.69

Bond® Natural Bamboo Stakes



Bamboo stakes are all natural, strong, lightweight, inexpensive, weather well and last several seasons in the garden. Use these stakes as plant stakes and markers or as supports for potted plants. 8 ft stakes cannot be shipped ground.

Item No.	Description	MSRP
740945	Bond Natural Bamboo Stakes 2 ft (25/Bag)	\$2.49
740950	Bond Natural Bamboo Stakes 3 ft (25/Bag)	\$4.19
740955	Bond Natural Bamboo Stakes 4 ft (25/Bag)	\$4.99
740960	Bond Natural Bamboo HD Stakes 6 ft (6/Bag)	\$4.29
740965	Bond Natural Bamboo HD Stakes 8 ft (5/Bag)	\$19.99

Bond® Green Bamboo Stakes



Dyed green to blend in with the plants. Bamboo stakes are all natural, strong, lightweight, inexpensive, weather well and last several seasons in the garden. Use these stakes as plant stakes and markers or as supports for potted plants.

Item No.	Description	MSRP
740925	Bond Green Bamboo Stakes 2 ft (25/Bag)	\$2.49
740930	Bond Green Bamboo Stakes 3 ft (25/Bag)	\$4.19
740935	Bond Green Bamboo Stakes 4 ft (25/Bag)	\$4.99
740940	Bond Green Bamboo Stakes 6 ft (6/Bag)	\$4.29

Bond® Super Steel Stakes



Green plastic coated plant stakes with a steel core. Rustproof with water tight closures on both ends, won't rot or split. Lightweight for indoor or outdoor use. 8 ft stakes cannot be shipped UPS or FedEx ground.

Item No.	Description	MSRP Ea
740890	Bond Super Steel Stake 2 ft	\$0.99
740895	Bond Super Steel Stake 3 ft	\$1.09
740900	Bond Super Steel Stake 4 ft	\$1.39
740910	Bond Super Steel Stake 6 ft	\$2.59
740920	Bond Super Steel HD Stake 8 ft (10/Bag)	\$6.99

Grower's Edge® Soft Mesh Trellis Netting with 6 in Squares



Soft, non-abrasive mesh gently protects stems, vines and foliage. Ideal for guiding and supporting vine, flowering and vegetable plants. Nylon mesh is durable and long lasting. 6 in square reach through holes. Install vertically or horizontally depending on your gardening application.

EXCLUSIVE

Item No.	Description	MSRP
740110	Grower's Edge Soft Mesh Trellis Netting 5 ft x 15 ft w/ 6 in Squares	\$7.95
740115	Grower's Edge Soft Mesh Trellis Netting 5 ft x 30 ft w/ 6 in Squares	\$11.95
740120	Grower's Edge Soft Mesh Trellis Netting 5 ft x 60 ft w/ 6 in Squares	\$21.95
740125	Grower's Edge Soft Mesh Trellis Netting Bulk Roll 5 ft x 350 ft w/ 6 in Squares NEW	\$115.95

Grower's Edge® Soft Mesh Trellis Netting with 3.5 in Squares



NEW The Grower's Edge® Soft Mesh Trellis Netting is soft, non-abrasive mesh that gently protects stems, vines and foliage. Ideal for guiding and supporting vine, flowering and vegetable plants. The nylon mesh is durable and long lasting. The trellis netting has 3.5 in square reach through holes. Install vertically or horizontally depending on your gardening application. 1 Year Warranty.

EXCLUSIVE

Item No.	Description	MSRP
740130	Grower's Edge Soft Mesh Trellis Netting 5 ft x 15 ft w/ 3.5 in Squares	\$10.95
740132	Grower's Edge Soft Mesh Trellis Netting 5 ft x 30 ft w/ 3.5 in Squares	\$17.95
740134	Grower's Edge Soft Mesh Trellis Netting 5 ft x 60 ft w/ 3.5 in Squares	\$33.95

Grower's Edge® Green Trellis Netting



Provides versatile plant support. Professional quality. Tangle-free. 6 in square reach through holes. Durable plastic allows multiple uses. Install horizontally or vertically.

EXCLUSIVE

Item No.	Description	MSRP
740095	Grower's Edge Green Trellis Netting 6.5 ft x 5 ft	\$6.29
740100	Grower's Edge Green Trellis Netting 6.5 ft x 10 ft	\$11.95
740105	Grower's Edge Green Trellis Netting 6.5 ft x 25 ft	\$21.95
740108	Grower's Edge Green Trellis Netting Bulk Roll 6.5 ft x 3300 ft	\$495.95

Grower's Edge® Commercial Grade Trellis Netting



Grower's Edge® Commercial Grade Trellis Netting is a strong, versatile polypropylene mesh specially designed for more efficient and economical cultivation of vegetables, fruits and flowers. It is easy to handle, simple to install and will not tangle. 6 inch x 6 inch reach through holes.

EXCLUSIVE

Item No.	Description	MSRP
740192	Grower's Edge Commercial Grade Trellis Netting 4 ft x 8 ft	\$5.89
740194	Grower's Edge Commercial Grade Trellis Netting 4 ft x 16 ft	\$9.79
740196	Grower's Edge Commercial Grade Trellis Netting 4 ft x 50 ft	\$21.79
740198	Grower's Edge Commercial Grade Trellis Netting 4 ft x 100 ft	\$34.49
740160	Grower's Edge Commercial Grade Trellis Netting 36 in x 328 ft	\$70.99
740164	Grower's Edge Commercial Grade Trellis Netting 48 in x 328 ft	\$77.99
740168	Grower's Edge Commercial Grade Trellis Netting 79 in x 328 ft	\$108.99

Grower's Edge® Commercial Grade Trellis Netting Bulk Rolls



Grower's Edge® Commercial Grade Trellis Netting is a strong, versatile polypropylene mesh specially designed for more efficient and economical cultivation of vegetables, fruits and flowers. It is easy to handle, simple to install and will not tangle. 6 inch x 6 inch reach through holes. Rolls cannot be shipped UPS ground.



EXCLUSIVE

Item No.	Description	MSRP
740162	Grower's Edge Commercial Grade Trellis Netting 36 in x 3280 ft - Bulk Roll	\$346.99
740166	Grower's Edge Commercial Grade Trellis Netting 48 in x 3280 ft - Bulk Roll	\$444.99
740170	Grower's Edge Commercial Grade Trellis Netting 79 in x 3280 ft - Bulk Roll	\$754.99

Botanicare® Horti-Trellis



Hortitrellis is a professional plant support trellis for horizontal or vertical applications. It's made of pliable plastic for multiple uses, and unlike string net trellis, it will not tangle. The Hortitrellis is 48 in wide with 6 in squares. Use vertically w/support stakes.

Item No.	Description	MSRP
740000	Botanicare Horti-Trellis 4 ft x 8 ft	\$5.35
740005	Botanicare Horti-Trellis 4 ft x 16 ft	\$9.35
740010	Botanicare Horti-Trellis 4 ft x 50 ft	\$20.85
740015	Botanicare Horti-Trellis 4 ft x 100 ft	\$33.35

Gardeneer® Trellis Netting



Heavy-duty nylon tangle-free netting is ideal for growing vining vegetables, fruits and flowers. Soft material protects tender vines, foliage and produce. 60-pound breaking strength for supporting heavy crop loads.

Item No.	Description	MSRP
740580	Gardeneer Trellis Netting 5 ft x 15 ft w/ 7 in Holes	\$11.99
740585	Gardeneer Trellis Netting 5 ft x 30 ft w/ 7 in Holes	\$17.99
740587	Gardeneer Trellis Netting 5 ft x 60 ft w/ 7 in Holes	NEW \$28.99
740589	Gardeneer Trellis Netting 5 ft x 15 ft w/ 3.5 in Holes	NEW \$17.99

Bond® Garden Net Trellis



Ideal for guiding growing plants. Use garden net trellis to support vine flower and vegetable plants. Attaches to stakes or poles to create a sturdy structure for plants to climb. An easy way to keep your plants neat. 5.5 in square mesh.

Item No.	Description	MSRP
740845	Bond Garden Net Trellis	\$5.95

Grower's Edge® Soft Garden Plant Tie



Use Grower's Edge® Soft Garden Plant Tie with UV inhibitors to attach plant stems to stakes or support racks easily without damaging your plants. It is great for indoor or outdoor use. The Grower's Edge® Soft Garden Plant Tie is reusable and long lasting. It is a soft, foam coated wire that is flexible and easy to cut.

EXCLUSIVE

Item No.	Description	MSRP
800060	Grower's Edge Soft Garden Plant Tie 5mm - 16 ft	\$2.59
800065	Grower's Edge Soft Garden Plant Tie 5 mm - 50 ft	NEW \$7.95
800070	Grower's Edge Soft Garden Plant Tie 5 mm - 250 ft	NEW \$33.95

Grower's Edge® Twist Tie

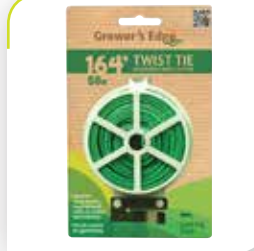

Ideal for tying plants, vegetables and vines to stakes and trellises. Plastic coated for gardening. 164 foot roll with built-in cutting tool.

EXCLUSIVE

Item No.	Description	MSRP
800055	Grower's Edge Twist Tie Dispenser w/ Cutter - 164 ft	\$3.39

Grower's Edge® Crop Clip™



NEW Grower's Edge® Crop Clip™ Hangers are plastic and work great to support your plants while they grow. Simply attach the clip around plant vine and then to a support system such as stakes or trellis. Easy to use and completely reusable.

EXCLUSIVE

Item No.	Description	MSRP Ea
740047	Grower's Edge Crop Clip - Black (100/Bag)	\$0.14

Grower's Edge® Vine Clips



These plastic clips work great to support your plants while they grow. Simply attach the clip around the vine and then to a support.

EXCLUSIVE

Item No.	Description	MSRP Ea
740045	Grower's Edge Vine Clip (100/Bag)	\$0.14

Grower's Edge® Clamp Clip®



NEW Quickly and easily secure plant stems to garden stakes. Allows room for natural plant movement and growth. Weatherproof clip with stainless steel spring. Choose from large 1-3/4 in or small 1 in size.

EXCLUSIVE

Item No.	Description	MSRP Ea
740176	Grower's Edge Clamp Clip - Small (12/Bag)	\$0.19
740178	Grower's Edge Clamp Clip - Large (12/Bag)	\$0.29

Grower's Edge® Sun Spool®



Support plants easily. Features a convenient hook and a non-removable stopper. 60 in of retractable line. Durable plastic housing.

EXCLUSIVE

Item No.	Description	MSRP Ea
740150	Grower's Edge Sun Spool (10/Bag)	\$1.59

Nie-Co-Rol - The Original



Supports plants easily with up to 60 inches of retractable line. Heavy duty plastic housing. Made in Holland.

Item No.	Description	MSRP Ea
740075	Nie-Co-Rol - The Original (100/Bag)	\$1.99

Grower's Edge® C-Bite™ Stake Coupler and Tie-Anchor

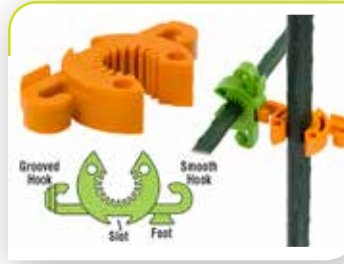

NEW Use C-Bites™ to anchor tie lines, netting and connect stakes together for strong plant supports of almost any size and configuration! Connect C-Bites™ together by inserting grooved hook or foot (located on smooth hook) into slot on another C-Bite™. Use hooks and holes to secure cords or ties. Snap on clips securely anchor ties, netting



and more to garden stakes. C-Bites™ are manufactured in the USA from UV resistant non-virgin plastic. They are made in two sizes that fit most commonly available garden stakes & canes. The #9 best fit the skinny 8 mm & 9 mm plastic coated stakes (Grower's Edge® 2, 3 & 4 ft). The #10 C-Bites™ best fit the 10 mm & 11 mm stakes (Grower's Edge® 5 & 6 ft).

EXCLUSIVE

Item No.	Description	MSRP Ea
740152	Grower's Edge C-Bite Stake Coupler #9 - Green (12/Bag)	\$0.89
740154	Grower's Edge C-Bite Stake Coupler #10 - Orange (12/Bag)	\$0.89

Bond® Twist Tie Spool



Comes on a spool with a built-in cutter. Twist tie is ideal for tying up plants, vegetables and vines. Plastic coated for gardening. Cut to any length using the built in easy cutter.

Item No.	Description	MSRP
740855	Bond Twist Tie Spool - 160 ft	\$3.99

Velcro® Plant Ties



Plant Ties are an easy way to train vines or support plants. No knots required. The plant ties are adjustable, UV resistant and durable. Plant ties wrap around your plant and back onto themselves for a secure self-gripping hold.

Item No.	Description	MSRP
740080	Velcro Plant Ties - 45 ft x 1/2 in Roll	\$3.49

Luster Leaf® Soft Wire Tie Strips



Use these light duty soft wire ties to hold you plants up. Easily bends and shapes to your desired needs. Light Duty, pre-cut 8 in pieces of multipurpose PVC/TPR (polyvinyl chloride/thermoplastic rubber) 5 mm cushioned 0.8 mm galvanized wire. 20 Soft Wire Tie Strips per package.

Item No.	Description	MSRP
741400	Luster Leaf Soft Wire Tie Strips	\$4.79

Luster Leaf® Foam Wire Tie Strips



Gently tie up your plants with these foam cover wire ties. Bend and twist as needed. 8 in pieces of 7 mm foam wrapped 1 mm garden wire. 20 Foam Wire Tie Strips in each package.

Item No.	Description	MSRP
741405	Luster Leaf Foam Wire Tie Strips	\$4.79

Luster Leaf® Rapiclip Foam Wire Tie



Rapiclip Foam Wire Tie is ideal for tying plants, vegetables and vines to stakes and trellises. The foam wrapped wire helps to minimize damage to plants. 32.5 ft length x 7 mm thickness.

Item No.	Description	MSRP
741435	Luster Leaf Rapiclip Foam Wire Tie	\$6.95

Luster Leaf® Rapiclip Twist & Clips



Rapiclip Twist & Clips are excellent for gardeners to stake and support plants. Twist & Clips are simple to use. Just overlap the hooked ends of the clips, twist slightly and you're done. 30 Twist & Clips per package.

Item No.	Description	MSRP
741430	Luster Leaf Rapiclip Twist & Clips	\$1.99

Luster Leaf® Rapiclip Vinyl Stretch Tie



Rapiclip Vinyl Stretch Tie is great for fastening, training and support of your plants. Heavy-duty vinyl expands with the growth of the plants. Not affected by hot or cold temperatures. Comes in two sizes 0.5 in thick x 150 ft long and 1 in thick x 150 ft long.

Item No.	Description	MSRP
741440	Luster Leaf Rapiclip Vinyl Stretch Tie 0.5 in	\$2.89
741445	Luster Leaf Rapiclip Vinyl Stretch Tie 1.0 in	\$4.49

Luster Leaf® Tomato Clips



Luster Leaf® Tomato Clips help keep your tomato vines supported and growing tall. 15 clips per package.

Item No.	Description	MSRP
741480	Luster Leaf Tomato Clips	\$2.35

Luster Leaf® Link-Ups® Grow Through Grid Plant Supports

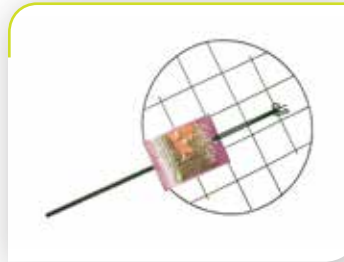

The vinyl coated steel supports are made to last any conditions. Easily hook together to allow plants to grow through the support. At the end of the season simply unhook and fold up for storage. The size of the medium support is 16 in wide x 24 in tall legs. The size of the large support is 20 in wide x 30 in tall legs.

Item No.	Description	MSRP
741450	Luster Leaf Link-Ups Medium Grow Through Grid Pant Support	\$7.29
741455	Luster Leaf Link-Ups Large Grow Through Grid Pant Support	\$8.99

Luster Leaf® Light Duty Garden Wire

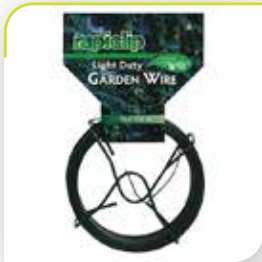

Luster Leaf® Light Duty Garden Wire is great for yard and garden applications. Sturdy and durable to ensure your garden plants get the support they need. 164 ft/50 meter roll.

Item No.	Description	MSRP
741485	Luster Leaf Light Duty Garden Wire	\$3.75

Woodstream Ultomato™ Plant Cage



Each cage is comprised of three 5 ft heavy-duty Sturdy Stakes and nine fully-adjustable support clips for continuous support throughout the plant's growth. The stakes of this cage have a strong steel core and tough, thick green plastic coating.

Item No.	Description	MSRP
740675	Woodstream Ultomato Plant Cage	\$10.95

Grower's Edge® Black Diamond Textured Nitrile Gloves



NEW Grower's Edge® Disposable Diamond Textured Nitrile Gloves are latex and powder free. Heavy duty 6 mil thickness for strength and durability while still maintain its elasticity. Diamond Textured Nitrile Gloves are ambidextrous and highly resistant to puncture, solvents and grease. These gloves feature a one of a kind diamond print pattern on the glove to enhance grip and dexterity when compared to

conventional disposable gloves.

EXCLUSIVE

Item No.	Description	MSRP
744400	Grower's Edge Black Powder Free Diamond Textured Nitrile Gloves 6 mil - Small (100/Box)	\$25.95
744402	Grower's Edge Black Powder Free Diamond Textured Nitrile Gloves 6 mil - Medium (100/Box)	\$25.95
744404	Grower's Edge Black Powder Free Diamond Textured Nitrile Gloves 6 mil - Large (100/Box)	\$25.95
744406	Grower's Edge Black Powder Free Diamond Textured Nitrile Gloves 6 mil - X-Large (100/Box)	\$25.95
744408	Grower's Edge Black Powder Free Diamond Textured Nitrile Gloves 6 mil - XX-Large (100/Box)	\$25.95

Grower's Edge® Black Nitrile Gloves



NEW Grower's Edge® Disposable Black Nitrile Gloves are latex and powder free. Heavy duty 6 mil thickness for strength and durability while still maintain its elasticity. Grower's Edge® Disposable Black Nitrile Gloves are ambidextrous and highly resistant to puncture, solvents and grease. These gloves feature an excellent grip and dexterity. Suitable for a variety application including gardening, automotive or cleaning.

EXCLUSIVE

Item No.	Description	MSRP
744409	Grower's Edge Black Powder Free Nitrile Gloves 6 mil - Small (100/Box)	\$19.95
744410	Grower's Edge Black Powder Free Nitrile Gloves 6 mil - Medium (100/Box)	\$19.95
744412	Grower's Edge Black Powder Free Nitrile Gloves 6 mil - Large (100/Box)	\$19.95
744414	Grower's Edge Black Powder Free Nitrile Gloves 6 mil - X-Large (100/Box)	\$19.95
744416	Grower's Edge Black Powder Free Nitrile Gloves 6 mil - XX-Large (100/Box)	\$19.95

Black Lightning Powder Free Nitrile Gloves

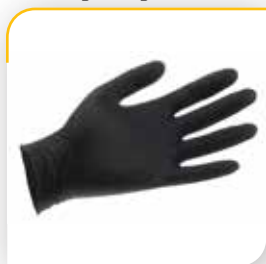

Made to match healthy skin's natural 5.5 pH levels to ensure the most comfortable fit yet! Unique formulation reduces excess perspiration. Super strength and stretch. Textured grip. Medical quality. Latex free. Ambidextrous.

Item No.	Description	MSRP
744200	Black Lightning Powder Free Nitrile Gloves Small (100/Box)	\$18.95
744205	Black Lightning Powder Free Nitrile Gloves Medium (100/Box)	\$18.95
744210	Black Lightning Powder Free Nitrile Gloves Large (100/Box)	\$18.95
744215	Black Lightning Powder Free Nitrile Gloves X-Large (100/Box)	\$18.95

Grower's Edge® Dry Rack with Clips

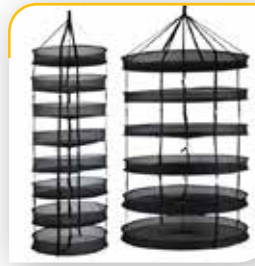

Use to easily dry flowers and herbs featuring snap together clips to quickly add or remove shelves. Topless tiers allow for 360 degree access to contents. Snap together buckles to quickly add or remove shelves. Durable polyester netting. Wire frames to make shelves rigid and sturdy. Each level contains an adjustable center strap for added weight support. 6 tiers.

EXCLUSIVE

Item No.	Description	MSRP
728730	Grower's Edge Dry Rack w/ Clips 3 ft	\$51.95
728735	Grower's Edge Dry Rack w/ Clips 2 ft	\$45.95

Grower's Edge® Dry Rack Enclosed with Zipper Opening



Use to easily dry flowers and herbs. Zipper allows for each level to be completely enclosed. Gently maneuver, shake and flip without losing contents. Durable polyester netting. Wire frames to make shelves rigid and sturdy. Each level contains an adjustable center strap for added weight support. 8 tiers.

EXCLUSIVE

Item No.	Description	MSRP
728740	Grower's Edge Dry Rack Enclosed w/ Zipper Opening - 3 ft	\$55.95
728745	Grower's Edge Dry Rack Enclosed w/ Zipper Opening - 2 ft	\$37.95

Grower's Edge® Dry Rack Partially Enclosed



Use to easily dry flowers and herbs. Each tier is partially enclosed with a front reach through entrance to access contents. Durable polyester netting. Wire frames to make shelves rigid and sturdy. Each level contains an adjustable center strap for added weight support. 8 tiers.

EXCLUSIVE

Item No.	Description	MSRP
728750	Grower's Edge Dry Rack Enclosed Partially - 3 ft	\$45.95
728752	Grower's Edge Dry Rack Partially Enclosed - 2 ft	\$31.95

Grower's Edge® Hang Time - Drying Rack

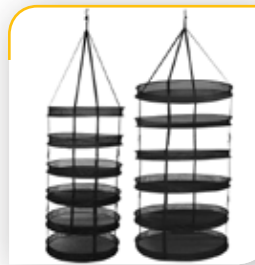

Use to easily dry flowers and herbs. Carabiner clip to make hanging simple. Durable polyester netting. Wire frames to make shelves rigid and sturdy. Snap together buckles to quickly add or remove shelves.

EXCLUSIVE

Item No.	Description	MSRP
728765	Grower's Edge Hang Time Drying Rack 24 in Medium	\$53.95
728766	Grower's Edge Hang Time Drying Rack 32 in Large	\$65.95

Measure Master offers a varied line of high quality, precision measuring devices designed for use with both liquids and solids.



www.measuremaster.net

Measure Master® Big Shot Measuring Glass



General purpose measuring pint glass. Graduation measurements include teaspoon, tablespoon, ounces and milliliters. Clear glass for easy and accurate measuring. Glass printed in the USA using baked on specialty ink. Rated PG-13.

EXCLUSIVE

Item No.	Description	MSRP
740625	Measure Master Big Shot Measuring Glass 16 oz	\$6.99

Measure Master® Sure Shot Measuring Glass



General purpose measuring shot glass. Graduation measurements include teaspoon, tablespoon, ounces and milliliters. Clear glass for easy and accurate measuring. Glass printed in the USA using baked on specialty ink.

EXCLUSIVE

Item No.	Description	MSRP
740615	Measure Master Sure Shot Measuring Glass 1.5 oz	\$3.59

Measure Master® Graduated Rectangle Measuring Containers



General purpose measuring cups. Chemically resistant polypropylene measurers. U.S. and metric graduations. Translucent for easy and accurate measuring.

EXCLUSIVE

Item No.	Description	MSRP
740600	Measure Master Graduated Rectangle Container 8 oz/250 ml	\$2.95
740605	Measure Master Graduated Rectangle Container 16 oz/500 ml	\$4.95
740607	Measure Master Graduated Rectangle Container 32 oz/1000 ml	\$7.49
740609	Measure Master Graduated Rectangle Container 64 oz/2000 ml	\$9.49

Measure Master® Graduated Round Containers



All-purpose Measure Master® Graduated Containers feature easy to read U.S. ounce and metric milliliter graduations. Measure Master® Graduated Containers are made from an impact resistant and translucent plastic for durability and clear view of liquid levels.

EXCLUSIVE

Item No.	Description	MSRP
740320	Measure Master Graduated Round Container 8 oz / 250 ml	\$2.95
740322	Measure Master Graduated Round Container 16 oz / 500 ml	\$4.95
740324	Measure Master Graduated Round Container 32 oz / 1000 ml	\$7.49
740326	Measure Master Graduated Round Container 64 oz / 2000 ml	\$9.49

Measure Master® Graduated Cylinder



NEW The Measure Master® Graduated Cylinders are a version that differ from traditional graduated cylinders because they are a little bit wider and shorter. With this construction the wider base provides more stability and easier adding or pouring of liquids. Includes metric milliliters, ounces and cups. The 250 ml units measure in 5 ml increments, 500 ml unit measure in 10 ml increments and 1000 ml measures in 20 ml increments.

EXCLUSIVE

Item No.	Description	MSRP
740642	Measure Master Graduated Cylinder 250 ml / 10 oz	\$9.99
740644	Measure Master Graduated Cylinder 500 ml / 20 oz	\$13.99
740646	Measure Master Graduated Cylinder 1000 ml / 35 oz	\$19.99

Measure Master® Spoons

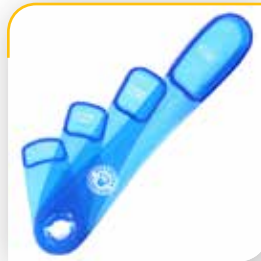

General purpose measuring spoons. Four attached spoons in increments of 1 Tablespoon, 1 teaspoon, 1/2 teaspoon, 1/4 teaspoon.

EXCLUSIVE

Item No.	Description	MSRP
740640	Measure Master Spoons	\$3.39

Measure Master® Sterile Disposable Pipettes

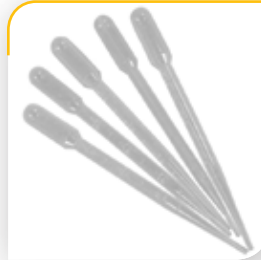

Measure Master® Pipettes will work well whenever there is a need for quick, safe transfer of liquids. Packaged individually in sterile packets, these disposable pipettes fit almost all needs for liquid transfer.

EXCLUSIVE

Item No.	Description	MSRP Ea
749600	Measure Master Sterile Disposable Pipette 3 ml	\$0.18
749605	Measure Master Sterile Disposable Pipette 5 ml	\$0.28

Measure Master® Dropper



Manufactured with food grade materials, the Measure Master® 5 ml Dropper features both milliliter and teaspoon measuring increments.



EXCLUSIVE

Item No.	Description	MSRP
740052	Measure Master Dropper 1 tsp / 5 ml	\$1.99

Measure Master® Garden Syringes



NEW The Measure Master® Garden Syringes are great for measuring nutrients, supplements and pesticides. These syringes are a clean and accurate alternative to pouring liquids into a measuring cup or spoon. Eliminates splashing or spilling of liquids. Made of heavy duty plastic with easy to read measurements. Graduation measurements in milliliters and cc's. For gardening use only.

EXCLUSIVE

Item No.	Description	MSRP Ea
740660	Measure Master Garden Syringe 20 ml/cc	\$1.19
740664	Measure Master Garden Syringe 60 ml/cc	\$2.99
740610	Measure Master Garden Syringe 100 ml/cc	\$4.99

Measure Master® Graduated Measuring Bucket 5 Gallon



Measure Master® 5 Gallon Graduated Measuring Bucket is made from a semi-transparent white heavy duty plastic. This Bucket holds 5 gallons of dry or wet materials and comes with a foam comfort grip handle for easy lifting and carrying. Imprinted on each bucket are calibrated measurements in quarts, gallons and liters for easy measuring and mixing.



EXCLUSIVE

Item No.	Description	MSRP
740050	Measure Master Graduated Measuring Bucket 5 Gallon	\$9.95

Measure Master® Pump Dispensers 1 oz



Great for quickly measuring & dispensing your liquid plant food & supplements! One pump dispenses one ounce of liquid. 740040 is designed specifically to a one gal bottle. 740042 is designed specifically to a 2.5 gal bottle (bottles not included).

EXCLUSIVE

Item No.	Description	MSRP
740040	Measure Master Pump Dispenser 1 oz For Gallon Jug	\$4.69
740042	Measure Master Pump Dispenser 1 oz For 2.5 Gallon Jugs	\$7.49

Grower's Edge® Vaporizer Commercial Grade



Stainless steel housing is very durable & will not rust. Aluminum cup maintains ideal temperature for vaporization. Holes in base allow natural convection action & unrestricted air movement. 5 ft grounded power cord. Suspend with jack chain at least 3 ft away from any combustible surface. Use only with properly registered materials. Follow all safety and licensing guidelines where applicable. 120 Volts | 0.4 Amps | 48 Watts

EXCLUSIVE

Item No.	Description	MSRP
740650	Grower's Edge Vaporizer Commercial Grade	\$109.95
740655	Grower's Edge Vaporizer Replacement Cup	\$17.95

Grower's Edge® Deluxe Vaporizer



Features a high quality aluminum body. Traditional electric heating element for reliable and consistent operation. Adjustable position of vaporizing cup allows control of temperature. Includes 6 foot power cord, vaporizing cup and wire hanger. Suspend with jack chain at least 3 ft away from any combustible surface. Use only with properly registered materials. Follow all safety and licensing guidelines where applicable. 120 Volts | 1.5 Amps | 180 Watts

EXCLUSIVE

Item No.	Description	MSRP
704050	Grower's Edge Deluxe Vaporizer	\$128.95
704051	Vaporizer Replacement Power Cord	\$17.95
704060	Vaporizer Cup	\$17.95

Honey Bee Pollen & Trim Tray Hit



The Honey Bee Pollen Collection & Trimming Tray is two helpful products in one. Finally gardeners have a feather-light laptop trimming surface that will separate flower pollen while manicuring. Our trays feature a comfortable nonslip base, 150 micron stainless steel screen and a pollen application brush. 100 micron white & 200 micron black stainless steel screens

can be purchased separately. 1 Year Warranty.

EXCLUSIVE

Item No.	Description	MSRP
725470	Honey Bee Pollen & Trim Tray Kit	\$49.99

Honey Bee Micron Trays



These micron screens features the top tray design. The Micron Trays will fit onto the Honey Bee Base Tray, or under the Yellow 150 Micron Screen on the base Tray. Choose from the finest screen at 100 micron, a standard screen at 150 micron or the widest screen at 200 micron stainless steel screen. Made for sifting pollen off manicured flowers. 1 Year Warranty.

EXCLUSIVE

Item No.	Description	MSRP
725475	Honey Bee Tray Top 100 Micron	\$33.99
725480	Honey Bee Tray Top 150 Micron	\$33.99
725485	Honey Bee Tray Top 200 Micron	\$33.99

Heavy Harvest Premium Compost Tea Brewing Bags



Heavy Harvest Compost Tea Bags will allow you to achieve the healthiest biological production possible! Finally a compost tea brewing bag with commercial durability, that is easy to clean and engineered for multiple operations, providing growers brewing flexibility. These bags can be used in any type of compost brewer. Small dimensions: 9.25 inches x 13 inches and Large 17.75 inches x 25 inches. 1 Year Warranty.

EXCLUSIVE

Item No.	Description	MSRP
725490	Heavy Harvest Premium Compost Tea Brewing Bag Small	\$19.99
725495	Heavy Harvest Premium Compost Tea Brewing Bag Large	\$29.99

Table Top Gardener® - Trim & Potting Tray



The Table Top Gardener® - The Trim & Potting Tray is perfect for seedlings, repotting and transplanting. Great for indoor and outdoor gardening work without creating a mess. The trim bin keeps debris from your trimmings and manicuring contained within the tray. Easy-grip handles for portability. Measures 23-1/2 in x 21 in x 6 in. Made in the USA.

Item No.	Description	MSRP
725190	Table Top Gardener - Trim & Potting Tray	\$16.95

Grower's Edge® C-Bite™ Stake Coupler and Tie-Anchor



NEW Use C-Bites™ to anchor tie lines, netting and connect stakes together for strong plant supports of almost any size and configuration! Connect C-Bites™ together by inserting grooved hook or foot (located on smooth hook) into slot on another C-Bite™. Use hooks and holes to secure cords or ties. Snap on clips securely anchor ties, netting



and more to garden stakes. C-Bites™ are manufactured in the USA from UV resistant non-virgin plastic. They are made in two sizes that fit most commonly available garden stakes & canes. The #9 best fit the skinny 8 mm & 9 mm plastic coated stakes (Grower's Edge® 2, 3 & 4 ft). The #10 C-Bites™ best fit the 10 mm & 11 mm stakes (Grower's Edge® 5 & 6 ft).

EXCLUSIVE

Item No.	Description	MSRP Ea
740152	Grower's Edge C-Bite Stake Coupler #9 - Green (12/Bag)	\$0.89
740154	Grower's Edge C-Bite Stake Coupler #10 - Orange (12/Bag)	\$0.89

Scissor-Fix™



Our SoftEdge cleaning media is a high tech spin off from the aerospace industry. Scissors stay cleaner longer! One handed cleaning! Increased Efficiency with every cleaning. Conditions with every cleaning. Will not dull or rust your scissors.

Item No.	Description	MSRP
704455	Scissor Fix	\$19.29

Roots Organics SOS Sap Off Soap



A unique and powerful hand and tool cleaning soap. Made from all natural and yet gentle ingredients Sap Off Soap works quickly to cut resins, oils, sap and even inks or certain stains from many surfaces including skin, all tools, containers and counter tops.

Item No.	Description	MSRP
740180	Roots Organics SOS Sap Off Soap 4 oz	\$9.99
740185	Roots Organics SOS Sap Off Soap 8 oz	\$15.99
740190	Roots Organics SOS Sap Off Soap Pint	\$23.99

Sticky Bye-Bye



Sticky Bye-Bye is an all-natural salt scrub solvent. This product is especially loved by gardeners with sticky fingers and tools. Remove tree sap from your car, sticker residue, gum from hair, scrub kitchen pots, pans, counter tops & bathrooms.

EXCLUSIVE

Item No.	Description	MSRP
704435	Sticky Bye-Bye 10 oz	\$10.99
704445	Sticky Bye-Bye Pint	\$16.99

Sticky Bye-Bye Sweet Orange Salt Free

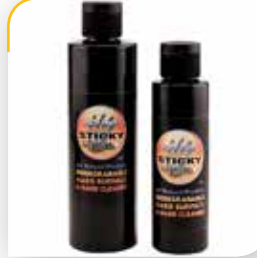

Sticky Bye-Bye is now available in a salt free concentrate. All natural yet truly effective citrus solvent for any sticky job in the home or garden. Can be used to remove permanent marker, duct tape/adhesive residues and more! Especially good for gardeners who deal with tree sap and other plant resins.

Item No.	Description	MSRP
704447	Sticky Bye-Bye Sweet Orange Salt Free 4 oz	\$10.25
704449	Sticky Bye-Bye Sweet Orange Salt Free 8 oz	\$16.99

AgroLED® Green Flashlight/Lamp by Feliz™



This unique 2-in-1 LED light system can be used either as a flashlight, a standard indoor/outdoor household lamp or both! To use it as a flashlight, just extend the handle and turn it on. To use it as a standard lamp, simply unscrew the end cap and insert it into any household light fixture with the same size standard base. 1 Year Warranty.

EXCLUSIVE

Item No.	Description	MSRP
960415	AgroLED 4 Watt Green Flashlight/Lamp AC/DC Rechargeable	\$29.95

Grower's Edge® Plant Stake Labels Multi-Colored



Use these colorful plant stake labels to mark the type of seeds that you plant. Each stake is 4 in x 5/8 in. Choose your favorite color.

EXCLUSIVE

Item No.	Description	MSRP
801000	Grower's Edge Plant Stake Labels White - 1000/Box	\$29.95
801005	Grower's Edge Plant Stake Labels Red - 1000/Box	\$31.95
801010	Grower's Edge Plant Stake Labels Orange - 1000/Box	\$31.95
801015	Grower's Edge Plant Stake Labels Yellow - 1000/Box	\$31.95
801020	Grower's Edge Plant Stake Labels Green - 1000/Box	\$31.95
801025	Grower's Edge Plant Stake Labels Dark Blue - 1000/Box	\$31.95
801030	Grower's Edge Plant Stake Labels Lavender - 1000/Box	\$31.95

Bond® Reusable T-Markers



These are 10 inch tall plastic reusable T-Markers. Use to identify plants within your garden.

Item No.	Description	MSRP
740840	Bond Reusable T-Markers - 25/Pack	\$4.19

Luster Leaf® T Label Plant Markers



Label your plants or seeds with these tall T shaped plant markers. 10 T labels per package.

Item No.	Description	MSRP
741410	Luster Leaf T Label Plant Markers 8 in	\$2.39

Luster Leaf® Colored Plant Labels



Choose from blue, yellow or green durable plant stake labels. Easily label your newly planted seeds on these 5 in stakes. 30 labels per package.

Item No.	Description	MSRP
741420	Luster Leaf Colored Plant Labels 5 in	\$3.39

Luster Leaf® Plant Labels



Choose from 4 in or 6 in durable plant stake labels. Easily label your newly planted seeds. 50 labels per package.

Item No.	Description	MSRP
741415	Luster Leaf Plant Labels 4 in	\$2.79
741425	Luster Leaf Plant Labels 6 in	\$3.59

Bond® Twine



This garden twine in green or natural is a roll of 200 ft of 2-ply soft garden twine. Jute Twine is made from natural fiber and is biodegradable. Can be used for countless jobs around the garden.

Item No.	Description	MSRP
740830	Bond Natural Twine 200 ft	\$4.19
740835	Bond Green Twine 200 ft	\$3.49

FloraFlex™ FloraCap™ - 6 in



NEW The FloraFlex™ FloraCap™ 6 in helps eliminates algae, stops powdery mildew and does away with pesticides. Place the revolutionary, FloraCaps™ on your 6 in rockwool cubes, and maximize your space in the vegetative cycle. Each cap features 34 flower designed louvers to block light, while allowing air, water and nutrients to your plant. Feed your plants less, allow the root zones to dry at more

consistent rates with the FloraCap™ that strategically covers the top of the media, while allowing in the necessary oxygen they need to thrive. Made from BPA and lead-free plastic. Dishwasher safe, stackable and reusable.

Item No.	Description	MSRP
714878	FloraFlex 6 in FloraCap	\$7.99

FloraFlex™ FloraClip™



NEW The FloraClip's intended use is to automate your FloraFlex™ FloraCap™. Using 1/4 in OD tubing, feed the tubing through the opening of the FloraClip, finally, clip it on your preferred location on the FloraCap™. It is recommended to use two FloraClip's per one FloraCap™. Made with BPA and lead-free plastic. Package contains 6 clips per bag. FloraCap™ #714878 sold separately.

Item No.	Description	MSRP
714876	FloraFlex FloraClip (1= 1/Bag)	\$2.99

GROVISION™

HIGH PERFORMANCE SHADES™

Specifically designed for the indoor grower.
Improves contrast, corrects colors and reduces glare.
www.gro-vision.com

GroVision™ High Performance Shades™ - Classic



NEW GroVision™ “Classic” High Performance Shades™ feature color balancing polycarbonate lenses which are excellent for use in all grow room applications. The classic wayfarer style shades are suitable for both indoor and outdoor gardening. They feature scratch resistant lenses which meet ANSI Z87.1 American National Standards. The full black frames are fitted with special, high-tech blue

lenses that are optimized for use in HPS light. Includes a microfiber draw string bag for cleaning and storage.

EXCLUSIVE

Item No.	Description	MSRP
744140	GroVision High Performance Shades - Classic	\$23.95

GroVision™ High Performance Shades™ - Lite



NEW GroVision™ “Lite” High Performance Shades™ feature color balancing polycarbonate lenses which are excellent for use in all grow room applications. The GroVision™ “Lites” are designed for a tight, wrap around fit to help keep bright HPS lighting out. They feature scratch resistant lenses which meet ANSI Z87.1 American National Standards. The comfortable frames are fitted with special, high-tech blue

lenses that are optimized for use in HPS light. Includes a microfiber draw string bag for cleaning and storage.

EXCLUSIVE

Item No.	Description	MSRP
744142	GroVision High Performance Shades - Lite	\$21.95

GroVision™ High Performance Shades™ - Pro



NEW GroVision™ “Pro” High Performance Shades™ feature color balancing polycarbonate lenses which are excellent for use in all grow room applications. The “Pro” model is designed for an everyday comfortable fit. They feature scratch resistant lenses which meet ANSI Z87.1 American National Standards. The full black frames are fitted with special, high-tech blue lenses that are optimized for use in HPS light.

Includes a microfiber draw string bag for cleaning and storage.

EXCLUSIVE

Item No.	Description	MSRP
744144	GroVision High Performance Shades - Pro	\$21.95

Professional UV Safety Glasses



100% UVA UVB Protection with lightweight nylon frames. Excellent for use around HPS & MH lights in grow rooms. Scratch resistant polycarbonate lens. Wrap around protection with no side shield distortion. Adjustable temple for ultimate comfort.

Item No.	Description	MSRP
708035	Professional UV Safety Glasses	\$13.95

METHOD SEVEN



Method Seven Resistance HPS Glasses



NEW A must-have for anyone making critical plant health and harvest decisions, the Method Seven Resistance HPS delivers “Perfect Color” for the world’s ultimate grow experience in the intense yellow spectrum and harsh conditions of HPS lighting. Lenses are formulated with Method Seven signature color

technology and manufactured using the highest quality German mineral glass for unparalleled color, clarity and protection. Microfiber pouch and hard case included for proper cleaning and storage. 100% UV protection.

Item No.	Description	MSRP
744122	Method Seven Resistance HPS	\$149.00

Method Seven Coup HPSx Transition Glasses



NEW HPSx – Sunglass by day, grow glass by night, the Coup HPSx is the world’s first and only photochromic grow glasses. The HPSx lens is a proprietary polycarbonate blend that allows it to transition from the signature blue of our HPS color-balancing technology to a very dark grey/blue tint when exposed to direct sunlight.

Microfiber pouch included for proper cleaning and storage. 100% UV protection.

Item No.	Description	MSRP
744124	Method Seven Coup HPSx Transition	\$149.00

Method Seven Operator HPS Plus Glasses



NEW Experience exceptional color-balancing for HPS (high pressure sodium) lighting with our proprietary lenses manufactured to exacting standards by Carl Zeiss Vision. The Operator features curved 8 base lenses that are optically decentered to eliminate prismatic distortion in a 'sport-style' frame. Our

Silver Plus lens coating makes the Operator HPS+ a good choice for outdoors too. Microfiber pouch included for proper cleaning and storage. 100% UV protection.

Item No.	Description	MSRP
744126	Method Seven Operator HPS Plus	\$79.00

Method Seven Operator LED Glasses



NEW Like nothing else, the world's first and only lens optimized for LED lighting environments. Lenses manufactured to exacting standards and optical clarity by Carl Zeiss Vision. Color-balance for LED grow lights. The Operator features curved 8 base lenses that are optically decentered to eliminate prismatic distortion in a

'sports-style' frame. Color, clarity and protection benefit you and your plants. Microfiber pouch included for proper cleaning and storage. 100% UV protection.

Item No.	Description	MSRP
744128	Method Seven Operator LED	\$79.00

Method Seven Cultivator HPS Plus Glasses



NEW Experience exceptional color-balancing for HPS lighting with our proprietary lenses manufactured to exacting standards by Carl Zeiss Vision. A no-compromise lens in a lightweight half jacket frame provides great budget value. Microfiber pouch included for proper cleaning and storage. 100% UV

protection.

Item No.	Description	MSRP
744130	Method Seven Cultivator HPS Plus - POP Display Box	\$59.00

Method Seven Cultivator LED Plus Glasses



NEW Experience exceptional color-balancing for LED lighting with our proprietary lenses manufactured to exacting standards by Carl Zeiss Vision. A no-compromise lens in a lightweight half jacket frame provides great budget value. Lenses color-balance the most popular commercial LED grow lights. Microfiber

pouch included for proper cleaning and storage. 100% UV protection.

Item No.	Description	MSRP
744132	Method Seven Cultivator LED Plus - POP Display Box	\$59.00

IDEALair
GROWING CLIMATE SOLUTIONS™
DEHUMIDIFIERS

**LEAVING THE
COMPETITION
"HIGH & DRY"**

www.ideal-air.com



STORAGE SOLUTIONS FOR YOUR EVERYDAY NEEDS

WWW.HARVEST-KEEPER.COM

Harvest Keeper® Glass Storage Apothecary Jars w/ Sealed Lid



Harvest Keeper® Apothecary Jars are a versatile countertop storage solution for: Herbs, dried fruits and vegetables and hundreds of other items! The wide mouth opening allows for easy access. The clear glass makes it quick and easy to see contents of the jars. The Harvest Keeper® Apothecary Jars have a nested lid with a seal to help seal in the freshness. Hand wash only.

EXCLUSIVE

Item No.	Description	MSRP Jar Ea
744320	Harvest Keeper Glass Storage Apothecary Jar w/ Sealed Lid - 4 oz	\$1.39
744322	Harvest Keeper Glass Storage Apothecary Jar w/ Sealed Lid - 29 oz	\$5.99
744324	Harvest Keeper Glass Storage Apothecary Jar w/ Sealed Lid - 1/2 Gallon	\$9.99
744326	Harvest Keeper Glass Storage Apothecary Jar w/ Sealed Lid - 1 Gallon	\$14.99
744328	Harvest Keeper Glass Storage Apothecary Jar w/ Sealed Lid 1.5 Gallon	\$17.99

Harvest Keeper® Glass Storage Jars w/ Metal Clamp Lid



Harvest Keeper® Glass Jars with Metal Clamp Lid are a vintage looking storage solution for: Herbs, dried fruits and vegetables and hundreds of other items! These metal clamp lid jars deliver freshness with an air-tight seal. The metal clamp closure with a gasket provides a strong secure seal with an added touch of charm. Hand wash only.

EXCLUSIVE

Item No.	Description	MSRP Jar Ea
744330	Harvest Keeper Glass Storage Jar w/ Metal Clamp Lid - 16 oz	\$3.99
744332	Harvest Keeper Glass Storage Jar w/ Metal Clamp Lid - 24 oz	\$4.99
744334	Harvest Keeper Glass Storage Jar w/ Metal Clamp Lid - 32 oz	\$5.99
744336	Harvest Keeper Glass Storage Jar w/ Metal Clamp Lid - 48 oz	\$6.99
744338	Harvest Keeper Glass Storage Jar w/ Metal Clamp Lid - 105 oz NEW	\$13.99

Harvest Keeper® Vacuum Sealer Commercial Grade



NEW Harvest Keeper® Vacuum Sealer Commercial Grade is a premium heavy duty vacuum sealer. Constructed from durable stainless steel material and features a digital display board for adjusting settings. Incorporated in the design is preset function control options which allows you to choose seal time, vacuum level and marinade mode making this unit the most versatile sealer in its class. This unit is fully automatic. The Sealer allows you to control the seal time of your bags between a 5-8 second range. Sealing time depends on the

thickness of bags and the material-type of the bag. Accommodates up to 15 inch wide bags or rolls. 1 Year Warranty.

EXCLUSIVE

Item No.	Description	MSRP
744370	Harvest Keeper Vacuum Sealer Commercial Grade	\$399.95

Harvest Keeper® Vacuum Seal Clear/Clear Storage Bags & Rolls



NEW Harvest Keeper® All Clear Sealer Bags keeps garden vegetables, meats and other food products fresh up to 5 times longer. These bags provide an airtight seal to keep moisture and air out. Harvest Keeper® All Clear Sealer Bags help save time and money by reducing freezer burn, extend the lifespan of your food and let you easily identify what is in the bag. Harvest Keeper® All Clear Sealer Bags are BPA

Free and produced from U.S. FDA food safe materials. Please follow FDA food safety guidelines. Come in precut bag sizes 15 in x 20 in or rolls 15 in x 19-1/2 ft.

EXCLUSIVE

Item No.	Description	MSRP
744372	Harvest Keeper All Clear Precut Bags 15 in x 20 in (50/Pack)	\$47.95
744378	Harvest Keeper All Clear Roll 15 in x 19.5 ft	\$13.95

Harvest Keeper® Vacuum Seal Black/Clear Storage Bags & Rolls



NEW Harvest Keeper® Black and Clear Sealer Bags keeps garden vegetables, meats and other food products fresh up to 5 times longer. These bags provides an airtight seal to keep moisture and air out. They save time and money by reducing freezer burn and extending the lifespan of your food. Black and Clear Bags blocks out harmful light while allowing you to see what's inside. Product is BPA Free and is

made from U.S. FDA food safe materials. Please Follow FDA food safety guidelines. Comes in precut bag sizes 15 in x 20 in or rolls 15 in x 19-1/2 ft.

EXCLUSIVE

Item No.	Description	MSRP
744374	Harvest Keeper Black and Clear Precut Bags 15 in x 20 in (50/Pack)	\$49.95
744380	Harvest Keeper Black and Clear Roll 15 in x 19.5 ft	\$14.95

Harvest Keeper® Vacuum Seal Silver/Silver Storage Bags & Rolls



NEW Harvest Keeper® Silver/Silver Sealer Bags keeps garden vegetables, meats and other food products fresh up to 5 times longer. These bags provide an airtight seal to keep moisture and air out. Silver/Silver Sealer Bags save time and money by reducing freezer burn extending the lifespan of your food. Silver/Silver bags are ideal for long term storage and give you more protection, security and privacy. Product is BPA

Free and is made from U.S. FDA food safe materials. Please Follow FDA food safety guidelines. Comes in precut bag sizes 15 in x 20 in or Rolls 15 in x 19-1/2 ft.

EXCLUSIVE

Item No.	Description	MSRP
744376	Harvest Keeper Silver / Silver Precut Bags 15 in x 20 in (50/Pack)	\$64.95
744382	Harvest Keeper Silver / Silver Roll 15 in x 19.5 ft	\$18.95

Harvest Keeper® Oven Storage Bags



NEW Harvest Keeper® Oven Storage Bags are the thickest and most durable bags on the market today. With a 1 mil thickness, these bags are puncture free, provide a strong odor barrier and will preserve your favorite foods natural flavors and color. The storage bags measure 18 in x 20 in and are manufactured for multiple uses. These bags can handle the heat which makes them great for use with ovens, microwaves, pans and slow cookers up to 400°F. They can also be used in

refrigerators and freezers. Proudly made in the USA.

EXCLUSIVE

Item No.	Description	MSRP
744312	Harvest Keeper Oven Bag- 1mil 18 In x 20 In 10/Box	\$11.95
744314	Harvest Keeper Oven Bag- 1 mil 18 In x 20 In 25/Box	\$26.95
744316	Harvest Keeper Oven Bag- 1 mil 18 In x 20 In 100/Box	\$89.95

Libbey

Libbey® Storage Jars



Libbey® glass jars are made to preserve the contents, resist scratching, corrosion and are BPA free. Each jar has a heavy base to prevent tipping. Use a press and seal lid to seal in the freshness of the contents. Choose from two sizes of jars. Lids are sold separately.

Item No.	Description	MSRP Jar Ea
748250	Libbey Storage Jar 12.5 oz	\$2.49
748255	Libbey Storage Jar 20.5 oz	\$2.99
748260	Libbey Storage Jar Press and Seal Lid - 12.5 oz and 20 oz	\$1.39

Ball

Ball® Wide Mouth Jars



Ball® Wide Mouth Glass Preserving Jars are ideal for fresh preserving apple and grape juices. Our famous glass jars and closures go beyond fresh preserving to help you with serving, creative decor and gift giving. Pack includes Ball® Wide Mouth Glass Jars, Ball® Wide Mouth Lids with Bands and step by step instructions.

Item No.	Description	MSRP Jar Ea
748115	Ball Jars Wide Mouth Pint	\$1.29
748120	Ball Jars Wide Mouth Pint & Half	\$1.79
748125	Ball Jars Wide Mouth Quart	\$1.49
748130	Ball Jars Wide Mouth Half Gallon	\$2.59

Ball® Quilted Crystal Jelly Jars



Ball® Regular Mouth Quilted Crystal Jelly Jars are ideal for fresh preserving recipes such as jams, jellies, sauces, mustards and flavored vinegars. The Quilted Crystal design adds a decorative touch to these multi-purpose jars—also use them for serving, creative decor and gift-giving.

Item No.	Description	MSRP Jar Ea
748135	Ball Jars Quilted Crystal Jelly 4 oz	\$1.09
748140	Ball Jars Quilted Crystal Jelly 8 oz	\$1.19
748145	Ball Jars Quilted Crystal Jelly 12 oz	\$1.43

Ball® Collection Elite® Wide Mouth Jars



Ball® Collection Elite® Brushed Silver Wide Mouth Jars capture your creativity. Perfect for sharing, this jar has a contemporary style that is ideal for creative preserving and storing. Elegant enough to take your fruit dressings, veggie and fruit salsa, luscious pie fillings and colorful fruit syrups from the kitchen to the table, these uniquely shaped jars hold endless imagination.

Item No.	Description	MSRP Jar Ea
748150	Ball Jars Collection Elite Wide Mouth Half Pint 4/Pack	\$1.89
748155	Ball Jars Collection Elite Wide Mouth Pint 4/Pack	\$1.89

Ball® Decorative Jar



Features: Easy push-down storage lid allows you to store items effortlessly One gallon size is perfect for dry storage, crafting and decoration – not for home canning use. Appearance replicates the charm of yester-year and it brings classic Americana style to your home.

Item No.	Description	MSRP Jar Ea
748160	Ball Jars Decorative 1 Gallon Commemorative Jar	\$21.95

Ball® Wide Mouth Lids & Bands



Ball® Wide Mouth Lids with Bands for preserving fit all regular mouth glass preserving jars. Seal in the freshness and enjoy freshly made foods tonight or tomorrow. Lids are for one-time use only. Bands can be reused. Includes 12 lids with bands.

Item No.	Description	MSRP Ea
748165	Ball Jars Wide Mouth Lids & Bands 12/Pack	\$0.75

Ball® Wide Mouth Lids



Ball® Wide Mouth Lids for preserving fit all wide mouth glass preserving jars. Seal in the freshness and enjoy freshly made foods tonight or tomorrow. Lids are for one-time use only. Includes 12 lids.

Item No.	Description	MSRP Ea
748170	Ball Jars Wide Mouth Lids 12/Pack	\$0.40

Ball® Basic Home Canning Funnel



This Ball® wide-mouth funnel is heat resistant to help you safely and easily fill jars to the appropriate headspace. It is designed to fit regular-mouth and wide-mouth jars. The blue translucent plastic lets you see the exact level of the food while filling the jar. Dishwasher safe on top rack.

Item No.	Description	MSRP Ea
748175	Ball Jars Basic Home Canning Funnel	\$2.05

Storage Bags

Grower's Edge® Nylon Storage Bags



Grower's Edge® Nylon Storage Bags are the thickest and most durable bags on the market today. With a 1 mil thickness, these bags seal in the freshness and odors of your favorite foods. The storage bags are 19 in x 23.5 in and can hold up to 34 pounds of food. Manufactured to have multiple uses, these bags can handle extreme heat (up to 450 degrees) and can be frozen as well. Proudly made in the USA.



EXCLUSIVE

Item No.	Description	MSRP
744305	Grower's Edge Nylon Storage Bag - 1 mil 19 in x 23.5 in - 10/Pack	\$14.95
744310	Grower's Edge Nylon Storage Bag - 1 mil 19 in x 23.5 in - 25/Pack	\$31.95

True Liberty® Bags Starter Pack



NEW True Liberty Bags Starter Kit includes the following products: True Liberty® Turkey Bags, pack of 100 - quantity of 1, True Liberty® Turkey Bags, pack of 25 - quantity of 4, True Liberty® Turkey Bags, pack of 10 - quantity of 10, True Liberty® Chicken Bags, pack of 100 - quantity of 1, True Liberty® Chicken Bags, pack of 25 - quantity of 4, True Liberty® Chicken Bags, pack of 10 - quantity of 10, True Liberty® Goose Bags, pack of 100 - quantity of 1, True Liberty® Goose Bags, pack of 25 - quantity of 4, True Liberty® Goose Bags, pack of 10 - quantity of 10, True Liberty® Ostrich Bags, pack of 25 - quantity of 1, and True Liberty® Ostrich Bags, pack of 10 - quantity of 1.



Item No.	Description	MSRP
744498	True Liberty Starter Pack	\$1,028.00

True Liberty® Bags



True Liberty® Bags are the original all-purpose home and garden bag. True Liberty® Bags are safe to use in your conventional oven, freezer, rice cooker, slow cooker or stove top, as they are resistant to cold, heat, fat, grease, oil and water. True Liberty® Bags have an excellent aroma barrier. BPA free material and burst, tear and puncture resistant. Thickest bag of its kind.

Item No.	Description	MSRP
744500	True Liberty Quail Bags 8 in x 16 in (100/Pack)	\$44.95
744502	True Liberty Chicken Bags 12 in x 20 in (10/Pack)	\$6.95
744504	True Liberty Chicken Bags 12 in x 20 in (25/Pack)	\$15.95
744506	True Liberty Chicken Bags (100/Pack)	\$56.95
744508	True Liberty Turkey Bags (10/Pack)	\$11.19
744510	True Liberty Turkey Bags 18 in x 20 in (25/Pack)	\$25.95
744512	True Liberty Turkey Bags 18 in x 20 in (100/Pack)	\$89.95
744514	True Liberty Goose Bags 18 in x 24 in (10/Pack)	\$13.95
744516	True Liberty Goose Bags 18 in x 24 in (25/Pack)	\$29.95
744518	True Liberty Goose Bags 18 in x 24 in (100/Pack)	\$99.95
744520	True Liberty Ostrich Bags (10/Pack)	\$49.95
744522	True Liberty Ostrich Bags 30 in x 48 in (25/Pack)	\$99.95

Sunlight Supply® carries over 4,900 products. Get what you need today by making a wish list!



www.shear-perfection.net

**SHEAR
PERFECTION™**



**PREMIUM JAPANESE SURGICAL STAINLESS STEEL BLADES
STAY SHARP LONGER!**

Shear Perfection™ Platinum Series Stainless Trimming Shear 2 in - Straight



NEW The Shear Perfection™ Platinum Series Trimming Shear comes with a stainless steel straight 2 inch blade. The stainless steel blade has strength, durability and makes for easy cleaning. This shear includes an ergonomically designed comfortable grip handle with a spring loaded action for less fatigue. An easy-lock mechanism makes for safe and easy storage. For right or left handed use.

EXCLUSIVE

Item No.	Description	MSRP
800375	Shear Perfection Platinum Series Stainless Trimming Shear 2 in - Straight	\$9.95

Shear Perfection™ Platinum Series Stainless Trimming Shear 2 in - Curved



NEW The Shear Perfection™ Platinum Series Trimming Shear comes with a stainless steel curved 2 inch blade. The stainless steel blade has strength, durability and makes for easy cleaning. This shear includes an ergonomically designed comfortable grip handle with a spring loaded action for less fatigue. An easy-lock mechanism makes for safe and easy storage. For right or left handed use.

EXCLUSIVE

Item No.	Description	MSRP
800380	Shear Perfection Platinum Series Stainless Trimming Shear 2 in - Curved	\$10.49

Shear Perfection™ Platinum Series Stainless Steel Bonsai Scissor - 40 mm



NEW The Shear Perfection™ Platinum Series Stainless Steel Bonsai Scissor has a 40 mm blade length. This scissor allows for the ultimate precision in tight and hard to reach spots. The scissor handle has a rubber grip that allows for comfort when trimming and pruning. The Bonsai Scissor can be used for right or left handed use.

EXCLUSIVE

Item No.	Description	MSRP
800395	Shear Perfection Platinum Series Stainless Steel Bonsai Scissors 40 mm	\$9.95

Shear Perfection™ Platinum Series Stainless Steel Bonsai Scissor - 60 mm



NEW The Shear Perfection™ Platinum Series Stainless Steel Bonsai Scissor has a 60 mm blade length. This scissor has additional length for the ultimate precision in tight and hard to reach spots. The scissor handle has a rubber grip that allows for comfort when trimming and pruning. The Bonsai Scissor can be used for right or left handed use.

EXCLUSIVE

Item No.	Description	MSRP
800400	Shear Perfection Platinum Series Stainless Steel Bonsai Scissors 60 mm	\$9.95

Shear Perfection™ Platinum Series Titanium Trimming Shear 2 in - Straight



NEW The Shear Perfection™ Platinum Series Titanium Trimming Shear comes with a Titanium coated stainless steel straight 2 inch blade. The stainless steel blade allows for strength, durability and easy cleaning. This shear includes an ergonomically designed comfortable grip handle with a spring loaded action for less fatigue. Easy-lock mechanism makes for safe and easy storage. These shears can be used for

EXCLUSIVE

right or left handed use.

Item No.	Description	MSRP
800385	Shear Perfection Platinum Series Titanium Trimming Shear 2 in - Straight	\$13.95

Shear Perfection™ Platinum Series Titanium Trimming Shear 2 in - Curved



NEW The Shear Perfection™ Platinum Series Titanium Trimming Shear comes with a Titanium coated stainless steel curved 2 inch blade. The stainless steel blade allows for strength, durability and easy cleaning. This shear includes an ergonomically designed comfortable grip handle with a spring loaded action for less fatigue. An easy-lock mechanism makes for safe and easy storage. These shears can be used for

EXCLUSIVE

right or left handed use.

Item No.	Description	MSRP
800390	Shear Perfection Platinum Series Titanium Trimming Shear 2 in - Curved	\$14.49

Shear Perfection™ Platinum Series Stainless Trimming Shear 2 in Curved - Pink



NEW The Shear Perfection™ Platinum Series Trimming Shear comes with a stainless steel curved 2 inch blade and now has a pink handle. The stainless steel blade allows for strength, durability and easy cleaning. This shear includes an ergonomically designed comfortable grip handle with a spring loaded action for less fatigue. An easy-lock mechanism makes for safe and easy storage. These shears can be used for

EXCLUSIVE

right or left handed use.

Item No.	Description	MSRP
800402	Shear Perfection Platinum Series Stainless Trimming Shear 2 in Curved - Pink	\$10.49

Shear Perfection™ Platinum Series Stainless Trimming Shear 2 in Straight - Pink



NEW The Shear Perfection™ Platinum Series Trimming Shear comes with a Stainless Steel straight 2 inch blade and now has a pink handle. The Stainless Steel blade allows for strength, durability and easy cleaning. This shear includes an ergonomically designed comfortable grip handle with a spring loaded action for less fatigue. An easy-lock mechanism makes for safe and easy storage. These shears can be used for

right or left handed use.

EXCLUSIVE

Item No.	Description	MSRP
800404	Shear Perfection Platinum Series Stainless Trimming Shear 2 in Straight - Pink	\$9.95

Shear Perfection™ Platinum Series Stainless Steel Bonsai Scissors 40 mm - Pink



NEW The Shear Perfection™ Platinum Series Stainless Steel Bonsai Scissor has a 40 mm blade length and now has a pink handle. This scissor has additional length for the ultimate precision in tight and hard to reach spots. The scissor handle has a rubber grip that allows for comfort when trimming and pruning. The Bonsai Scissor can be used for right or left handed use.

EXCLUSIVE

Item No.	Description	MSRP
800406	Shear Perfection Platinum Series Stainless Steel Bonsai Scissors 40 mm - Pink	\$9.95

Shear Perfection™ Gold Series Titanium Straight Trimming Shear - 2 in



The titanium coated stainless steel blade will stay sharp during multiple uses and is very easy to clean. This shear includes a comfort grip handle with spring loaded action for less fatigue on your hands. Storage is simple with an easy-lock mechanism. For right or left handed use.

EXCLUSIVE

Item No.	Description	MSRP
800350	Shear Perfection Gold Series Straight Trimming Shear 2 in	\$6.95

Shear Perfection™ Gold Series Titanium Curved Trimming Shear - 2 in



This shear allows users to fine tune their plants. The titanium coated stainless steel blade will stay sharp during multiple uses and is very easy to clean. This shear includes a comfort grip handle with spring loaded action for less fatigue on your hands. Storage is simple with an easy-lock mechanism. For right or left handed use.

EXCLUSIVE

Item No.	Description	MSRP
800355	Shear Perfection Gold Series Curved Trimming Shear 2 in	\$6.95

Shear Perfection™ Gold Series Titanium Cutting Shear - 1.5 in



A heavy duty shear used for thicker branches and stocks. The titanium coated stainless steel blade will stay sharp during multiple uses and is very easy to clean. Includes a comfort grip handle with spring loaded action for less fatigue. Storage is simple with an easy-lock mechanism. For right or left handed use.

EXCLUSIVE

Item No.	Description	MSRP
800360	Shear Perfection Gold Series Cutting Shear 1.5 in	\$6.95

Shear Perfection™ Gold Series Titanium Straight Trimming Shear - 3 in



Extra long titanium coated stainless steel blades, gives gardeners massive coverage of their plants. The titanium coated stainless steel blade will stay sharp during multiple uses and is very easy to clean. Includes a comfort grip handle with spring loaded action for less fatigue. Storage is simple with an easy-lock mechanism. For right or left handed use.

EXCLUSIVE

Item No.	Description	MSRP
800365	Shear Perfection Gold Series Straight Trimming Shear 3 in	\$7.95

Shear Perfection™ Gold Series Titanium Garden Snips



An all purpose snip that offers a full range of trimming possibilities. The titanium coated stainless steel blade will stay sharp during multiple uses and is very easy to clean. Includes a comfort grip handle with spring loaded action for less fatigue. Storage is simple with an easy-lock mechanism. For right or left handed use.

EXCLUSIVE

Item No.	Description	MSRP
800370	Shear Perfection Gold Series Garden Snips	\$3.95

Fiskars®

Fiskars® Softtouch® Micro-Tip® Pruning Snip



Super sharp, Micro-Tip® blades give you top-of-the-line precision and control. Fully hardened stainless steel blades holds sharp edge longer. Comfortable Softgrip® handles reduce stress and are non-slip for safety. Right or left-handed use. Lifetime Warranty.

Item No.	Description	MSRP
800015	Fiskars Softtouch Micro-Tip Pruning Snips	\$14.95

Fiskars® Comfort Grip® Floral Snip 9638



Comfort Grip® loop handles improve control, ease fatigue. Super sharp, Micro-Tip® blades give you top-of-the-line precision and control. Comfortable Softgrip® handles reduce stress and are non-slip for safety. Right or left-handed use. Lifetime Warranty.

Item No.	Description	MSRP
800020	Fiskars Comfort Grip Floral Snips	\$21.95

Fiskars® Short Cut® Snip



Fingertip control for small, detailed cuttings. Ideal for intricate houseplant cuttings. Right or left-handed use. Fully hardened stainless steel blades holds sharp edge longer. Lifetime Warranty.

Item No.	Description	MSRP
800025	Fiskars Shortcut Snips (3/cs)	\$8.95

Fiskars® Micro-Tip® Pruning Snips



Makes deadheading, trimming and shaping plants easy. Easy Action design opens the blades after cutting. Stainless-steel blades have a precision-ground edge that stays sharp longer. Includes a handle with Softgrip® touchpoints for a comfortable grip. Lifetime Warranty.

Item No.	Description	MSRP
800030	Fiskars Micro Tip Blades Pruning Snip 2/Pack	\$29.95

Fiskars® Premier Large Titanium Scissor

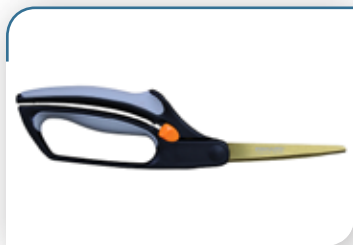

Spring-action design gently opens blades after each cut to reduce hand strain. High-grade stainless steel blades offer a lasting sharp edge. Titanium blade coating is three times harder than steel and resists wear, scratches and corrosion. Ergonomic Softgrip® handle is sculpted to fit your hand, maximizing cutting control, sensitivity and comfort. Lifetime Warranty.

Item No.	Description	MSRP
800035	Fiskars Premier Large Titanium Scissors	\$31.95

Fiskars® Performance Softgrip® Titanium Non-Stick Scissors



NEW These small, sharp detail scissors are a great choice for clipping delicate items, cutting out intricate shapes, making quick snips and more. They feature non-stick, titanium-enhanced stainless-steel blades that cut cleanly through materials with sticky adhesives and stay sharp through heavy use. A lightweight double-loop handle provides excellent control when cutting patterns and Softgrip® helps reduce

hand fatigue.

Item No.	Description	MSRP
800005	Fiskars Performance 5 in Softgrip Titanium Non-Stick Scissors	\$10.99

Fiskars® Premier Softgrip® Micro-Tip Scissors



NEW Our small, sharp Micro-Tip® Softgrip® Scissors are the perfect choice for making tight cuts, quick snips or cutting intricate details with a minimum of hand fatigue. High-grade, stainless-steel blades feature a precision-ground edge that stays sharp longer and cuts all the way to the tip. A lightweight double-loop handle provides excellent control, and Softgrip® helps reduce hand fatigue on big projects.

Item No.	Description	MSRP
800010	Fiskars Premier No.5 Softgrip Micro-Tip Scissors	\$16.99

Fiskars® Softgrip® Floral Pruner



Our Softgrip® Floral Pruner is designed to make deadheading flowers, cutting stems and removing thorns quick, easy and safe. The fully hardened, precision-ground steel blade stays sharp, and a low-friction coating makes every cut even easier. The stem stripper quickly and safely removes thorns.

Item No.	Description	MSRP
800040	Fiskars Softgrip Floral Pruner	\$11.95

Zenport

Zenport Floral/Thread Snips Model H370



These excellent quality snips offer stainless steel cutting blades and durable ABS plastic handles. They are perfect for fine clipping, including taking cuttings, removing dead foliage, etc. Also used for thread cutting.

Item No.	Description	MSRP
800705	Zenport Floral/Thread Snips H370	\$5.49

Zenport Micro Blade Pruner Model H355



Micro Blade Pruners have straight stainless steel blades. The handles have comfortable rubberized sides that improve gripping power. The pruning shear tips are narrow so they fit into small spaces. Length 6-5/8 in.

Item No.	Description	MSRP
800675	Zenport Micro Blade Pruner H355	\$13.10

Zenport Harvest Shears Long, Straight Blade H300S



Features cutlery grade, polished stainless steel blades. Ideal for cutting flowers and vegetables. Easy to sterilize.

Item No.	Description	MSRP
800240	Zenport Stainless Harvest Shear H300S	\$13.10

Zenport Curved Micro Blade Pruner Model H355C



Curved Micro Blade Pruners have curved tip stainless steel blades to prevent rusting and are easy to sterilize. The handles have comfortable rubberized sides that improve gripping power.

Item No.	Description	MSRP
800676	Zenport Curved Micro Blade Pruner H355C	\$13.10

Zenport 8.5 in Bypass Pruning Shear Model Z103



Euro design that is the choice of many professionals, but at a price that makes this the best choice for harvest and pruning labor crews. Tough, replaceable, carbon steel blade. Length: 8.5 in.

Item No.	Description	MSRP
800110	Zenport 8.5 in Bypass Pruning Shear Z103	\$12.20

Zenport Long Blade Micro Pruner Model H355L



Micro Blade Pruners have long, straight, stainless steel blades to prevent rusting and are easy to sterilize. The handles have comfortable rubberized sides. The pruning shear tips fit into dense foliage or hard to reach foliage. Overall length is 7.5 in.

Item No.	Description	MSRP
800095	Zenport Long Blade Micro Blade Pruner H355L	\$15.49

Zenport Heavy Duty Bypass Pruner Model Z201



Easily cuts limbs up to 1 in diameter. This tool features a replaceable, non-stick, carbon steel blade, a self-cleaning sap groove and a resilient shock absorbing bumper. Blade tension is adjustable. Length: 9.2 in.

Item No.	Description	MSRP
800155	Zenport Heavy Duty Bypass Pruner Z201	\$17.10

Zenport Needle Nose Shear Model H303



Lightweight, needle nose shear with a wishbone spring. The blades are made of carbon steel.

Item No.	Description	MSRP
800255	Zenport Needle Nose Shear H303	\$10.99

Zenport 6.5 in Deluxe Fruit Scissors Model ZS105



Tough horticulture scissors, designed for seasons of rigorous use. Length: 6.5 in.

Item No.	Description	MSRP
800430	Zenport Deluxe Fruit Scissors ZS105	\$13.10

Zenport All Purpose Stainless Scissors SS-330 HN-R



7 in Stainless steel all-purpose scissors. Great for kitchen, garden, craft applications. Soft grips.

Item No.	Description	MSRP
800445	Zenport All Purpose Stainless Scissors ZS108	\$12.40

ARS

ARS Harvesting Scissors SS-320BT



The slim blades are razor sharp and make it possible to pick fruit and remove culls in even the most crowded situations. Very popular for propagation. Soft bow grips fit any hand, reduce fatigue and can be used by lefties. Precision ground, Marquench hardened carbon steel blade. Super sharp blades are engineered to stay that way longer. Hard chrome plated carbon steel blades for rust/sap resistance and increased

hardness.

Item No.	Description	MSRP
801254	ARS Harvesting Scissors	\$23.95

ARS Sharpening Stone AC-SS240



The AC-SS240 is a sharpening stone designed by ARS. Made of hard stone, this stone is ideally shaped for pruners, scissors and hedge shears. It is hard enough to sharpen ARS high carbon tool steel blades. Perfectly shaped to sharpen blades easily.

Item No.	Description	MSRP
801256	ARS Sharpening Stone	\$15.49

ARS All Purpose Scissors Model SS-330H



These softbow scissors are a quick snipper for bonsai, small plants, flower stems, tape, string and even electric wire. High carbon steel blades are hard chrome plated and marquench hardened to stay sharp longer than normal blades.

Item No.	Description	MSRP
801250	ARS All Purpose Scissors SS-330H	\$24.79

ARS Curved Scissors Model SS-320BM



ARS Curved Scissor blades are razor sharp and make it possible to pick fruit and remove culls in even the most crowded situations. Soft bow grips fit any hand, reduce fatigue and can be used by lefties. Blades made of carbon steel. Length: 6 in.

Item No.	Description	MSRP
801252	ARS Curved Tip Scissors SS-320BM	\$24.19

Bond®

Bond® Precision Tip Pruner

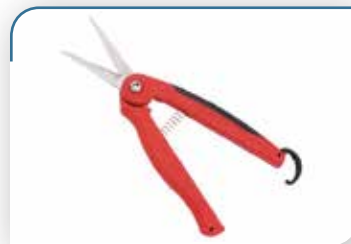

Perfect for precision pruning and thinning. Ideal for Bonsai, house plants or herb gardens. Features an ambidextrous lock.

Item No.	Description	MSRP
740800	Bond Precision Tip Pruner	\$7.95

Cleaner

Scissor-Fix™



Our SoftEdge cleaning media is a high tech spin off from the aerospace industry. Scissors stay cleaner longer! One handed cleaning! Increased Efficiency with every cleaning. Conditions with every cleaning. Will not dull or rust your scissors.

Item No.	Description	MSRP
704455	Scissor Fix	\$19.29

Elevate your growth!

Grower's Edge®

High Stakes™ Tomato Cages



SUNFILM®



Quality Reflective Film Products for Indoor Gardening - Mylar/Blocker/Panda

Sunfilm® Reflective Metalized Film



Used in indoor gardens to reflect the light back onto the plants. This film can be tacked or taped directly to a flat surface. Both sides are metalized for optimum reflectivity. Neatly wound on 2 in cores. Excellent, consistent quality. Comes in 54 inch width.

EXCLUSIVE

Item No.	Description	MSRP
730015	Sunfilm Reflective Metalized Film 1 mil - 54 in x 25 ft Roll	\$14.69
730020	Sunfilm Reflective Metalized Film 1 mil - 54 in x 50 ft Roll	\$27.99
730025	Sunfilm Reflective Metalized Film 1 mil - 54 in x 100 ft Roll	\$50.39
730030	Sunfilm Reflective Metalized Film 2 mil - 54 in x 25 ft Roll	\$22.70
730035	Sunfilm Reflective Metalized Film 2 mil - 54 in x 50 ft Roll	\$43.20
730040	Sunfilm Reflective Metalized Film 2 mil - 54 in x 100 ft Roll	\$77.80

Sunfilm® Sun Blocker® Foil Bubble



Sun Blocker® Foil Bubble is a barrier bubble film laminated between 2 layers of foil. Helps to manage heating problems associated with indoor gardening, conserves energy, reflects up to 97% of all radiant heat and inhibits the growth of fungi or bacteria.



EXCLUSIVE

Item No.	Description	MSRP
730140	Sun Blocker Foil Bubble Film 4 ft x 50 ft Roll	\$116.95
730145	Sun Blocker Foil Bubble Film 4 ft x 100 ft Roll	\$216.95

Sunfilm® Panda Film



Waterproof poly film that is black on one side and white on the other can be used for growing areas. Sunfilm® Panda Film works well as a reflective film (reflects 90% of the light back to the growing area) or as a room partition. This is a very heavy duty 5.5 mil film for a variety of uses. Individually packaged.

EXCLUSIVE

Item No.	Description	MSRP
730085	Sunfilm Black & White Panda Film 10 ft x 10 ft Folded	\$12.95
730070	Sunfilm Black & White Panda Film 10 ft x 25 ft Folded	\$30.80
730075	Sunfilm Black & White Panda Film 10 ft x 50 ft Roll	\$56.10
730080	Sunfilm Black & White Panda Film 10 ft x 100 ft Roll	\$100.50

Panda Film Black & White Poly Film



It is a heavy-duty waterproof poly film that is black on one side and white on the other. Works well as a reflective film (reflects 90% of the light back to the growing area) or as a room partition. This is a very heavy duty film at a thickness of 5.5 - 6 mil.



Panda Brand Film



Item No.	Description	Roll lb	MSRP
730090	Panda Black & White Poly Film 10 ft x 25 ft Roll	6.7	\$28.95
730095	Panda Black & White Poly Film 10 ft x 50 ft Roll	13	\$54.95
730100	Panda Black & White Poly Film 10 ft x 100 ft Roll	34.0	\$94.95

Orca Grow Film®



ORCA Grow Film® is 94% reflective across the full visible spectrum and provides 99% diffusion. It is 100% light-tight, thermally reflecting, waterproof, and will not yellow from UV light. 11 mil thick and is recyclable and Eco-Friendly, it contains no halogens, plasticizers or VOC's.

Item No.	Description	Roll lb	MSRP
730155	Orca Grow Film 54 in x 25 ft Roll	7.6	\$61.99
730160	Orca Grow Film 54 in x 50 ft Roll	11.35	\$119.99
730165	Orca Grow Film 54 in x 100 ft Roll	18.75	\$232.99

Easygrow™ Diamond Fusion Lightite Film



Easygrow™ Diamond Fusion Lightite Film has a diffused pattern to spread light more evenly. Produced to help eliminate grow room hot spots. 100% light. PET coated to protect against corrosion and wear with membrane memory to reduce creasing effect.

EXCLUSIVE

Item No.	Description	Roll lb	MSRP
730103	Easygrow Lightite Diamond Fusion Film 4.1 ft x 25 ft Roll	3.1	\$37.95
730105	Easygrow Lightite Diamond Fusion Film 4.1 ft x 50 ft Roll	6.2	\$69.95
730110	Easygrow Lightite Diamond Fusion Film 4.1 ft x 100 ft Roll	11.35	\$129.95

Easygrow™ Silver/White Lightite Film



A yield increasing spectrum enhanced silver reflector, applied to a gloss white - triple layered grow sheet. Lightite silver white grow sheet offers optimum light return and 100% Light tight capability. PET coated to protect against corrosion & wear.

EXCLUSIVE

Item No.	Description	Roll lb	MSRP
730120	Easygrow Lightite Silver/White Film 4.1 ft x 100 ft Roll	12.35	\$110.95

Easycrow™ Eco Diamond Diffusion Foil Film



Diamond diffusion pattern to spread light more evenly. Produced to help eliminate grow room hot spots. Membrane Memory to dramatically reduce creasing effect & PET coated to protect against corrosion & wear. This product is not light tight.

EXCLUSIVE

Item No.	Description	Roll lb	MSRP
730115	Easycrow Eco Diamond Diffusion Foil Film 4.1 ft x 50 ft Roll	3.6	\$51.95

Black/White Poly Sheeting - Commercial Sizes



The 5 mil thickness polyethylene film offers excellent protection for heavy weight applications and has outstanding puncture, scuff and scrape resistance. The white surface reflects the light striking it and sends the light back to the plants. The black surface helps block the light from getting to the ground which keeps the weed growth down and the soil warm.

Item No.	Description	MSRP
748526	Black/White Poly Sheeting Commercial Size - 5 mil 24 ft x 100 ft	\$274.95
748528	Black/White Poly Sheeting Commercial Size - 5 mil 32 ft x 100 ft	\$366.95
748532	Black/White Poly Sheeting Commercial Size - 5 mil 40 ft x 100 ft	\$457.95
748536	Black/White Poly Sheeting Commercial Size - 5 mil 50 ft x 100 ft	\$572.95
748542	Black/White Poly Sheeting Commercial Size - 5 mil 24 ft x 150 ft NEW	\$384.95
748544	Black/White Poly Sheeting Commercial Size - 5 mil 32 ft x 150 ft NEW	\$513.95
748538	Black/White Poly Sheeting Commercial Size - 5 mil 50 ft x 150 ft	\$858.95
748540	Black/White Poly Sheeting Commercial Size - 5 mil 56 ft x 150 ft NEW	\$908.95

Nursery Greenhouse Film - Clear



This Nursery Greenhouse Film will cover all your needs whether the it is for a single season or full year. This is a tri-layer polyethylene film for maximum protection and ease of installation. Offers high clarity to allow the most light possible. 6 mil thickness for strength.

Item No.	Description	MSRP
748500	Nursery Clear 6 mil 1 yr Greenhouse Film 12 ft x 100 ft	\$150.95
748502	Nursery Clear 6 mil 1 yr Greenhouse Film 20 ft x 100 ft	\$261.95
748504	Nursery Clear 6 mil 1 yr Greenhouse Film 24 ft x 100 ft	\$313.95
748506	Nursery Clear 6 mil 1 yr Greenhouse Film 32 ft x 100 ft	\$419.95
748508	Nursery Clear 6 mil 1 yr Greenhouse Film 40 ft x 100 ft	\$523.95

Tufflite IV™ UV Protected Greenhouse Film - Clear



These Greenhouse Films covers all your needs whether it is for single season, full year or 4 year protection. Tufflite™ brand Greenhouse Film is a tri-layer polyethylene film for maximum protection and ease of installation. All Tufflite™ products offer high clarity to allow the most light possible. This film is UV protected and has a 6 mil thickness for strength.

Item No.	Description	MSRP
748512	Tufflite IV 6 mil 4 yr UV Protected Greenhouse Film 16 ft x 100 ft	\$335.95
748514	Tufflite IV 6 mil 4 yr UV Protected Greenhouse Film 20 ft x 100 ft	\$418.95
748516	Tufflite IV 6 mil 4 yr UV Protected Greenhouse Film 24 ft x 100 ft	\$502.95
748518	Tufflite IV 6 mil 4 yr UV Protected Greenhouse Film 32 ft x 100 ft	\$670.95
748520	Tufflite IV 6 mil 4 yr UV Protected Greenhouse Film 40 ft x 100 ft	\$837.95
748522	Tufflite IV 6 mil 4 yr UV Protected Greenhouse Film 48 ft x 100 ft	\$1,005.95

Tarp Zip-Up™



Tarp Zip-Up™ peel and stick zipper system. Creates easy access into tarp or poly enclosures. Easy installation. Opens from either side. Hundreds of different applications. Great for containing dust, moisture and pests.

Item No.	Description	MSRP
730200	Tarp Zip-Up	\$12.29

Lite Tite™ Heavy Duty Peel & Stick Zipper



Black Tear Proof Tape Designed for use with ordinary construction vapor barrier. This adhesive-backed zipper is perfect for creating a simple, resealable access doorway. The 84 in long, heavy-duty, water proof #5 zipper is sewn to a 950-denier high-density polyethylene backing that has a permanent high-tack acrylic adhesive.

Item No.	Description	MSRP
730215	Lite Tite Heavy Duty Peel & Stick Zipper	\$14.95



For precise trimming choose between the Platinum Series or Gold Series by Shear Perfection™. Get yours today!

www.shear-perfection.net

Horticare

HortiCare pH Tester



Trans Instruments HortiCare pH check tester is specially designed with advanced features to ensure fast and accurate pH test, for the commercial as well as home growers. Operating Range: 0 to 14.0 pH; Resolution: 0.1 pH; Accuracy: ± 0.2 pH; Battery: 4 x 1.5V Button Cell (LR44).

EXCLUSIVE

Item No.	Description	MSRP
716020	HortiCare pH Tester	\$79.95

HortiCare Nutrient Check PPM



Trans Instruments HortiCare Nutrient concentration check tester is specially designed with advanced features to ensure fast and accurate concentration test, for the commercial as well as home growers. Operating Range: 0 to 1,990ppm; Display Resolution: 10ppm; Accuracy: $\pm 5\%$ full scale; Calibration Point: 990ppm (KCl); Battery: 4 x 1.5V Button Cell (LR44 equiv.).

EXCLUSIVE

Item No.	Description	MSRP
716021	HortiCare Nutrient Check PPM	\$85.95

HortiStick 3-in-1 Multimeter



The HortiStick 3-in-1 combines the measurement of the three most crucial parameters needed for a successful harvest: pH, Conductivity & Temperature. Simple & easy to use. Rugged & water resistant. Features: pH Range: 0-14.0, ppm Range: 0-1990, Temp range: 0-50°C; pH Resolution: 0.1pH, ppm Resolution: 10ppm, Temp. Resolution: 0.1°C; pH Accuracy: ± 0.2 , ppm Accuracy: $\pm 5\%$ F.S., Temp.

Accuracy 0.5°C. 1 Year Warranty.

EXCLUSIVE

Item No.	Description	MSRP
716023	HortiStick 3-in-1 Multimeter	\$199.95

Bluelab®

Bluelab® pH Meter



Supplied with double junction Bluelab® pH probe, 20 ml solution sachets and batteries. Range: 0.0 – 14.0 pH. Resolution: 0.1 pH. Accuracy @ 25°C: ± 0.1 pH. Power Source: 2 x AAA batteries included. Features: auto turn off, low battery indicator, over range and under range indicators, portable. 5 Year Warranty.

Item No.	Description	MSRP
716340	Bluelab pH Meter	\$210.00

Bluelab® Soil pH Meter



Measures the pH level of soil, media or substrates. Comes with a Soil pH Probe, Dibber/Auger, pH 4.0 and pH 7.0 calibration solutions, plus a helpful Quick Start guide. Features: simple push button calibration, auto turn off function, large easy to read LCD, low battery indicator, lightweight and portable. 5 Year Warranty.

Item No.	Description	MSRP
716190	Bluelab Soil pH Meter	\$240.00
716192	Bluelab Soil pH Replacement Probe	\$110.00

Bluelab® Soil pH Pen



This clever Soil pH Pen will help you manage the success of soil grown crops. The soil pH pen provides a pH and temperature reading of soils and media, so you know that the right nutrients will be made available to your plants. It will also measure solutions too. 1 Year Warranty.

Item No.	Description	MSRP
716438	Bluelab Soil pH Pen	\$185.00

Bluelab® pH Pen



Measures pH and temperature. Selectable units for temperature in °C & °F. It has a backlit LCD display with double junction probe (not replaceable). Successful calibration indicator. It has a hold function & low battery warning. Fully waterproof with auto off function. 1 Year Warranty.

Item No.	Description	MSRP
716480	Bluelab pH Pen	\$112.50

Bluelab® ppm Pen



Measures conductivity and temperature. Selectable units for conductivity and temperature. It has a backlit LCD display with low battery warning. This pen is fully waterproof that has a successful calibration indicator. Auto off function and hold function. 1 Year Warranty.

Item No.	Description	MSRP
716482	Bluelab PPM Pen	\$94.00

Bluelab® pH Controller



Our pH controller automatically monitors and fine-tunes the pH levels for you. For use with reservoirs up to 200 US gal/760 L. Green back lit large LCD with adjustable brightness. Push button navigate menu to program, adjust settings and calibration. Flashing high/low alarm with control lockouts to protect from over-dosing. Auto resume dosing on restart after power loss.

Includes: water resistant housing, 13 foot acid/alkali resistant dosing tube, power supply, replaceable double junction pH probe and Temperature Probe (for pH ATC). 6 month guarantee for Bluelab pH Probe. 2 Year Warranty.

Item No.	Description	MSRP
716342	Bluelab pH Controller	\$569.00

Bluelab® pH Controller Connect



Our pH controller connect constantly monitors and fine-tunes the pH levels for you. It wirelessly data logs to your computer too. You can also change the settings from your PC. One Bluelab Connect Stick is required, sold separately. Local and cloud data logging capability (download free Bluelab Connect Software). Option to view data and current status remotely via Google Docs™. For

use with reservoirs up to 200 US gal/760 L. Green back lit large LCD with adjustable brightness. Push button navigate menu to program, adjust settings and calibration. Flashing high/low alarm with control lockouts to protect from over-dosing. Auto resume dosing on restart after power loss. Includes: water resistant housing, 13 foot acid/alkali resistant dosing tube, power supply, replaceable double junction pH probe and Temperature Probe (for pH ATC). 6 month guarantee for Bluelab pH Probe. 2 Year Warranty.

Item No.	Description	MSRP
716343	Bluelab pH Controller - Connect	\$629.00

Bluelab® Connect Guardian Monitor



The Bluelab® Guardian Monitor Connect is not only a constant indicator of the desired levels of pH, conductivity and temperature of your nutrient solution, it also data logs these critical parameters to your computer for you. You can access the data via the cloud from a remote mobile device or computer to check for extreme variances to ensure these critical parameters are hitting the mark for crop success.

Item No.	Description	MSRP
716484	Bluelab Guardian Connect	\$450.00

Bluelab® Guardian Monitor



Large easy to read, plant safe green LED adjustable brightness displays. Selectable values for conductivity and temperature. Simple push button pH calibration system. No calibration required for conductivity and temperature. Water resistant design. 2 Year Warranty.

Item No.	Description	MSRP
716336	Bluelab Guardian Monitor	\$364.00
716445	Bluelab Replacement pH Probe	\$70.00

Bluelab® Connect Product Suite



The Bluelab® Guardian Monitor Connect, Bluelab® Connect Stick, Bluelab® Connect Range Extender and Bluelab® Connect Software. The Bluelab® Guardian Monitor Connect can connect wirelessly to a computer at the grow site via the Bluelab® Connect Stick, which enables the data logging of pH, Conductivity and Temperature to the FREE Bluelab® Connect Software, downloadable online.

Item No.	Description	MSRP
716486	Bluelab Connect Stick	\$151.70
716488	Bluelab Connect Range Extender	\$164.00

Bluelab® Combo Meter



A portable conductivity, pH and temperature meter all in one! Display options available in degrees °C & °F, EC, CF, ppm 500 and ppm 700. Simple push button pH calibration to pH 7, pH 4 and/or pH 10. Auto turn off function. Low battery indicator. Supplied with 2 x AAA batteries, replaceable double junction pH probe and solution sachets. 5 Year Warranty.

Item No.	Description	MSRP
716441	Bluelab Combo Meter	\$308.00
716445	Bluelab Replacement pH Probe	\$70.00

Bluelab® Carry Case



Provides a custom fit so you can use and read your Bluelab® Meter right from the carry case. A firm outer casing offers impact reduction for your Meter. There are two pockets in the top of the case especially made for meter probes. Ideal for use with the following Bluelab® Meters: Bluelab® Combo Meter, pH Meter, Soil pH Meter, pH & ppm Pens. Meter not included with case.

Item No.	Description	MSRP
716440	Bluelab Carry Case	\$25.00

Bluelab Truncheon® Meter



Tough, high quality with fully waterproof design. Daylight readable blue LEDs. Powered by three AA batteries. EC (0.2 - 3.6), CF (2 - 36) and ppm scales (TDS and 700 scale). Fully waterproof design. No calibration required. Auto sense on & off. No external switches or adjustable buttons. Meter length: 40.7 cm or 16-1/32 in. 5 Year Warranty.

Item No.	Description	MSRP
716050	Bluelab Original Truncheon Meter	\$140.00

Bluelab Commercial Truncheon® Meter



With a conductivity range right up to 6.0 EC (60 CF, 3000ppm x 500 & 4200ppm x 700), it will never leave you short. Designed for hydroponic crops that require a higher than normal EC or ppm requirement during their growing cycle. Its super tough, fully waterproof, has no on/off buttons & does not need calibrating. Battery life minimum 1 year. Meter length: 40.7 cm or 16-1/32 in. 5 Year Warranty.

Item No.	Description	MSRP
716049	Bluelab Commercial Truncheon Meter	\$140.00

EC Shake™

EC-Shake™ Nutrient Meter



Powered by a magnet instead of a battery! Use a gentle shaking action to generate power. Provides a quick & accurate reading of the EC. Green LED display. Factory calibrated. Automatic temperature compensation. Automatic on/off function. Waterproof. 1 Year Warranty.

EXCLUSIVE

Item No.	Description	MSRP
716010	EC Shake Nutrient Meter	\$99.95

CWP Instruments

E.C. Dipstick™



Has the 4 most popular scales: EC, CF, 500:1 ppm, and 700:1 ppm! Operates on 3 common inexpensive AA alkaline batteries. Measures in PPM, EC and CF scales. There is no calibration required. It calibrates itself each time you replace the batteries. The EC Dipstick™ is waterproof to one meter. 2 Year Warranty.

Item No.	Description	MSRP
716570	E.C Dipstick	\$87.95

24-7 Nutrient Monitor™



The 24-7 Nutrient Monitor™ is a great all around meter for constant monitoring. It measures PPM, pH and Temp. Comes with solution. 120 volt AC current to low voltage DC power supply. 1 Year Warranty.

Item No.	Description	MSRP
716572	24-7 Nutrient Monitor	\$216.95
716573	24-7 pH Replacement Probe	\$59.95
716579	24-7 PPM Replacement Probe	\$59.95

Accurate pH 7 & Accurate pH 8



The Accurate pH 7 utilizes the electronic ground field effect of the earth on two dissimilar metals. No batteries are required. This meter comes with a cleaning pad. The Accurate pH 8 is a professional pH and Moisture Meter with 12 in. Probe. This meter can measure pH and moisture at depths up to 12 inches. No batteries are required. This meter comes with a cleaning pad. 6 Month Warranty.

Item No.	Description	MSRP
716575	Accurate pH 7 Soil pH & Moisture Meter	\$66.95
716578	Accurate pH 8 Soil pH & Moisture Meter	\$77.95

Milwaukee

Milwaukee Instruments Martini pH55 pH/Temp Tester and Probe



This is a waterproof pH tester with large dual-level LCD that displays pH and temperature (°C or °F). The large display shows readings in an extended range from 2 to 16 pH and simultaneously shows temperature from 5°C to 105°C or 23°F to 221°F. Complete with a temperature probe for faster and more precise temperature measurement, this tester compensates automatically for temperature. 2 Year Warranty.

Item No.	Description	MSRP
716798	Milwaukee Martini pH55 - pH/Temp Tester	\$80.95
716799	Milwaukee Martini pH55 - pH/Temp Probe	\$51.95

Milwaukee Instruments Waterproof TDS Tester Model T75



Waterproof TDS tester with automatic temperature compensation and 1 point manual calibration range: 0.0 to 1999 ppm (mg/L), replaceable MA73075 probe. 2 Year Warranty.

Item No.	Description	MSRP
716605	Milwaukee T75 Waterproof TDS Tester	\$85.95
716606	Milwaukee Replacement Probe for T75 (MA73075)	\$78.95

Milwaukee Instruments pH Tester Model pH600 AQ



Milwaukee's most affordable pH tester, range: 0.0 to 14.0 pH, with one point manual calibration, and accuracy of ±0.1 pH. Battery Life: 700 hours. Calibration solution sold separately. 30 Day Warranty.

Item No.	Description	MSRP
716642	Milwaukee pH Meter pH600 AQ	\$33.95

Milwaukee Replacement pH Probe Model SE220



pH Probe with Double Junction. Comes with 1 meter cable, soaker bottle for storage and is KCL3.5 gel filled, hard epoxy shell, BNC connector & is for all general pH use. Replacement for all MW & old style SM pH units. NOTE: This probe replaces the old MA911B/1.

Item No.	Description	MSRP
716666	Milwaukee Replacement Probe SE220 (MA911B)	\$60.95

Milwaukee Instruments pH/EC/TDS Combo Meter - BEM802



Range: 0.00 – 14.00 pH, 0 – 4000 ppm, 0.00 – 6.00 mS/cm, Accuracy: ± 0.20 pH and $\pm 2\%$ full scale for EC & TDS, comes with SE600 combo probe, 110 volt power supply, unit mounting kit, a 20 ml Sachet of calibration solution of pH 7.01, 1500 ppm and 1413 $\mu\text{S}/\text{cm}$. Converts to a 9 volt battery for use as a portable field meter (9 volt battery included). 2 Year Warranty.

Item No.	Description	MSRP
716678	Milwaukee pH/EC/TDS Combo Meter	\$270.95

Milwaukee Instruments pH Controller - MC122



Range: 0.0 to 14.0, 2 point manual calibration and Accuracy: ± 0.2 pH. Set Point Range: 5.5 to 9.5 pH, LED visual alarm active & power plug socket for dosing turned on when reading is higher or lower user selected set point. Supplied with 12V DC power adapter, double junction pH probe, 20 ml pH 7.01 solution and screwdriver. 2 Year Warranty.

Item No.	Description	MSRP
716690	Milwaukee pH Controller	\$197.95

Milwaukee Instruments Smart pH/EC/TDS Combination Meter Model MW802



It calibrates manually in pH, EC & TDS. Range: 0.00 to 14.00 pH, 0 - 4000 ppm, 0.00 - 6.00 mS/cm, accuracy of ± 0.20 pH & $\pm 2\%$ full scale for EC & TDS. Comes with a combination electrode, 9V battery, 20ml packets of pH 7.01, 1500 ppm & 1413 $\mu\text{S}/\text{cm}$. 2 Year Warranty.

Item No.	Description	MSRP
716615	Milwaukee MW802 Smart pH/EC/TDS/ Combination Meter	\$249.95
716617	Milwaukee SE600 Replacement Probe for MW802	\$112.95

Milwaukee Instruments Portable pH Meter Model MW100



100% larger and easier to read LED Display and long battery life. pH meter, range: 0.0 to 14.0, 2 point manual calibration, and Accuracy: ± 0.2 pH. Supplied with a SE220 double junction pH electrode, 9V battery, 20 ml pH 7.01 packet buffer solution and screwdriver for calibration. 2 Year Warranty.

Item No.	Description	MSRP
716665	Milwaukee MW100 Portable pH Meter	\$115.95

Milwaukee Instruments pH Controller with Dosing Pump Kit MC720



NEW The small and precise flow of the MP810 provides fully automated pH control of aqueous solutions in the hydroponic systems. It has been specifically designed to control the pH in mixing tanks for fertilization. The peristaltic pump allows you to maintain the ideal pH values in your tank. After selecting the desired pH setting from 5.5 to 9.5 pH, the pH controller measures the pH value of the solution and automatically adds pH

adjustment (acid or alkaline) to change the liquid's pH to the desired selected level. 1 Year Warranty.

Item No.	Description	MSRP
716595	Milwaukee MC720 pH Controller w/ Dosing Pump Kit	\$333.95

Oakton®

Oakton® Multi PT Testr® 35



One pocket sized meter for pH, TDS and temperature! Advanced features include auto-shutoff, user-adjustable temperature coefficient, self-adjusting TDS and low-battery indicator. Up to 5 point pH calibration with NIST or USA auto buffer recognition. 1 Year Warranty.

Item No.	Description	MSRP
716108	Oakton Multi PT Testr 35 - PH/TDS/Temp	\$199.95

Oakton® Ecotestr™ pH 1



Economical, pocket sized meter. Waterproof, dust proof housing that floats. Easy to use; push-button calibration with auto buffer recognition. HOLD function, and error messages. Range: 0.0 to 14.0 pH. Power: four 1.5 Volt button cell batteries (included). 1 Year Warranty.

Item No.	Description	MSRP
716104	Oakton Waterproof EcoTestr pH 1	\$71.95

Oakton® EcoTestr™ pH 2



Automatic temperature compensation. Waterproof, dust proof housing that floats. Range: 0.0 to 14.0 pH. Low-cost pocket sized meter. Push-button calibration, HOLD function, and error messages. Power: four 1.5 Volt button cell batteries (included). 2 Year Warranty.

Item No.	Description	MSRP
716106	Oakton Waterproof EcoTestr pH 2	\$90.95

Oakton® EcoTestr™ TDS Low



The stainless steel electrodes are both rugged and chemical resistant, for use in a variety of applications. Other features include ATC, hold function and it is completely waterproof. Range: 0-1990 ppm, Resolution: 10 ppm, Accuracy: 1% full scale and Conversion Factor: 0.4 to 1. 1 Year Warranty.

Item No.	Description	MSRP
716115	Oakton Waterproof EcoTestr TDS Low	\$86.95

Oakton® Double Junction pHTestr® 10



Replaceable double junction electrode. Features ATC, push-button three-point calibration, microprocessor-based, auto buffer recognition, hold function, auto-off, error messages and it is certifiable to IP67 standards. The pH range is 1.0 to 15.0 pH. 1 Year Warranty.

Item No.	Description	MSRP
716046	Oakton Waterproof pHTestr 10	\$138.95
716047	Oakton Replacement Electrode pH 10/20/30	\$101.95

Oakton® Double Junction pHTestr® 30



It features high ± 0.01 pH accuracy, simultaneous pH and temperature ($^{\circ}\text{C}$) display, pH range - 1.0 to 15.0 pH, three point push-button calibration, double junction electrode. Certifiable to IP67 standards - waterproof and dust proof housing floats. Has replaceable sensor and automatic temperature compensation. 1 Year Warranty.

Item No.	Description	MSRP
716048	Oakton Waterproof pHTestr 30	\$167.95
716047	Oakton Replacement Electrode pH 10/20/30	\$101.95

HM Digital™

HM Digital™ EC/TDS HydroTester Model COM-80



The COM-80 is an economically priced, reliable EC/TDS meter that is ideal for testing applications such as hydroponics & gardening, pools & spas, aquariums & reef tanks, water ionizers, drinking water and more. Measures electrical conductivity (EC), total dissolved solids (TDS). Excellent for nutrient testing. Four scales: EC: μS , mS; TDS: ppm, ppt. 1 Year Warranty.

Item No.	Description	MSRP
716145	HM Digital Water Resistant Ec/TDS Meter w/ Temperature in C/F Hydrotester (Model COM-80)	\$47.95

HM Digital™ Waterproof EC/TDS/TEMP Combo Meter Model COM-100



Measures EC, TDS and temperature. Three different calibration options (KCl, 442TM, NaCl), each with its own non-linear conversion factor. ATC using three temperature coefficients. Measurement Range: 0-9990 μS ; 0-8560 ppm. Auto-off, data-hold functions and low-battery indicator. 1 Year Warranty.

Item No.	Description	MSRP
716160	HM Waterproof EC/TDS/Temp Combo Meter	\$76.95
716175	HM Digital Replacement Probe for EC/TDS	\$33.95

HM Digital™ Waterproof pH Meter Model PH-200



Measures pH and Temperature. Auto-ranging three point calibration. pH buffer 4 solution is in a sponge embedded in a clear cap. Measurement Range: 0-14 pH with a waterproof housing. Comes factory calibrated. Includes a cap, batteries, lanyard and pH 7.0 buffer. 1 Year Warranty.

Item No.	Description	MSRP
716165	HM Digital Waterproof pH Meter	\$99.95
716180	HM Digital Replacement Probe for pH	\$45.95

HM Digital™ pH Meter Model PH-80



Resolution: pH 0.1 pH, 0.00 - 14.0 pH. Accurate to ± 0.1 pH. Hold button and auto shut-off. Automatic Calibration: Auto-ranging to 4, 7 or 10 pH. Low battery indicator. Clear cap to notice moisture (or lack of) on probe. Glass encased reference electrode. Batteries included. 1 Year Warranty.

Item No.	Description	MSRP
716155	HM Digital pH 80 Meter	\$62.95

HM Digital™ Handheld TDS Tester Model TDS-3



Ideal for commercial use. Highly efficient and accurate due to its advanced microprocessor technology. Measurement Range: 0-9990 ppm. Display: large and easy-to-read LCD screen with built-in digital thermometer. 1 Year Warranty.

Item No.	Description	MSRP
716187	HM Digital Handheld TDS-3 Tester	\$36.95

HM Digital™ Aquapro TDS Water Tester Model AP-1



Measures total dissolved solids (TDS) and temperature. Automatic Temperature Compensation (ATC). Water-resistant housing. Measurement Range: 0-5000 ppm. Digital Calibration (push button). Auto-off function, data-hold function and low-battery indicator. Factory calibrated. 1 Year Warranty.

Item No.	Description	MSRP
716188	HM Digital Aquapro TDS Water Tester	\$42.95

HM Digital™ In-Line Dual TDS Monitor Model DM-1



Displays TDS levels of the feed water and product water with in & out electrode probes. Highly efficient and accurate with microprocessor technology. Auto-Off function conserves battery power. Dual Range 0-9990 ppm. Factory Calibrated. Equipped with Quick-Connect T-fittings. 1 Year Warranty.

Item No.	Description	MSRP
716186	HM Digital In-Line Dual TDS Monitor	\$41.95

Hanna®

Hanna® Grochek Combo pH/EC/TDS/TEMP Monitor [Model HI 991404]



The Combo meter is designed for continuous, high accuracy pH, EC/TDS and temperature measurements. These microprocessor indicators continuously monitor the three most important nutrient parameters in hydroponics. 2 Year Warranty.

Item No.	Description	MSRP
716800	Hanna Grochek Combo pH/EC/TDS/Temp Monitor (HI 991404)	\$249.95
716801	Hanna Replacement pH Probe (HI 1293)	\$121.95

Hanna® pH Grochek Water Resistant pH Indicator [Model HI 981401N]



Water-resistant & features a molded eye which allows installation above the sample area. Accurate measurements can be verified with one or two point calibrations. Comes with a 12 Volt DC power supply. Electrode is interchangeable & the connector is well-protected. The meter is supplied with a stainless steel probe. 1 Year Warranty.

Item No.	Description	MSRP
716805	Hanna pH Indicator w/ Electrode (HI 981401N)	\$132.95
716806	Hanna Replacement pH Probe (HI 1286)	\$65.95

Hanna® Grochek TDS Monitor [Model HI 983301N]



Housings and cable connections have been sealed against vapor and humidity. 12 volt DC power supply included, mean no low battery failures. Locate the meter above the sample to be monitored or take it with you for spot checking. Measurements with 0.7 TDS conversion factor or a 0.5 conversion factor. 1 Year Warranty.

Item No.	Description	MSRP
716870	Hanna GroCheck TDS Monitor (HI 983301N)	\$114.95

Hanna® pH/TDS/Temperature Monitor [Model HI 981504/7]



Designed for continuous monitoring of pH, TDS and temperature, it is simple to install and can be placed above the sample to be tested. pH, TDS and temperature measurements are simultaneously displayed on three backlit LCDs which can be easily viewed at a distance. This means no more switching between parameters. 6 Month Warranty.

Item No.	Description	MSRP
716810	Hanna pH/TDS/Temp Monitor (HI 981504/7)	\$274.95
716806	Hanna Replacement pH Probe (HI 1286)	\$65.95

Hanna® Combo pH/EC/TDS/Temperature Tester with Low Range EC [Model HI 98129]



The waterproof Combo (it even floats) has a large easy-to-read, dual-level LCD and automatic shut-off. pH and EC/TDS readings are automatically compensated for the effects of temperature (ATC). Has a replaceable pH electrode cartridge with an extendable cloth junction. 1 Year Warranty.

Item No.	Description	MSRP
716820	Hanna Combo Waterproof pH/EC/TDS/Temp (HI 98129)	\$199.95
716831	Hanna Replacement pH Probe (HI 73127)	\$68.95

Hanna® DiST® 5 Waterproof (Low Range) EC/TDS/Temperature Tester (Model HI 98311)



The DiST® 5 includes features such as a replaceable graphite electrode, adjustable TDS ratio, temp. in °C or °F, automatic temp. compensation (ATC) with adjustable B, battery level indicator, stability indicator, automatic shut-off & automatic calibrating all in a floating, waterproof casing. This 3-in-1 tester is unmatched in EC/TDS/Temp. measurements! 1 Year Warranty.

Item No.	Description	MSRP
716825	Hanna DiST 5 Waterproof EC/TDS Temperature Tester (HI 98311)	\$127.95

Hanna® Hydroponics pH Tester (HI99104)



Ideal pocket tester designed with a 0.01 pH resolution and two point manual calibration through easy to reach trimmers, it immediately displays pH variations to reflect the smallest change in the sample. It has a long and slim stem. Supplied with a rugged, plastic body electrode with a screw connector. Long battery life with common 1.5V batteries. 2 Year Warranty.

Item No.	Description	MSRP
716809	Hanna Hydroponics pH Tester (HI99104)	\$56.95

Hanna® Waterproof pHep® 4 Tester With Replaceable Electrode (Model HI 98127)



Efficient two button operation with a temperature in °C or °F. Include features such as a dual-level LCD, battery level indicator, replaceable pH electrode cartridge, instability indicator, automatic shut-off and automatic calibration all in a floating, waterproof casing. 1 Year Warranty.

Item No.	Description	MSRP
716830	Hanna PHEP 4 Waterproof Meter (HI 98127)	\$110.95
716831	Hanna Replacement pH Probe (HI 73127)	\$68.95

Hanna® Waterproof pH/EC/TDS Meter (Model HI 9813-6)



Versatile, water resistant multiparameter portable meter specifically designed for agricultural applications such as hydroponics, greenhouses, farming & nurseries. Designed for simplicity of use in taking pH, mS/cm, ppm & temperature in the °C scale measurements. Comes with the HI 1285 series pH/EC/TDS/temp. probe. 2 Year Warranty.

Item No.	Description	MSRP
716814	Hanna Water Resistant pH/EC/TDS Meter (HI 9813-6)	\$267.95
716816	Hanna Replacement pH Probe (HI 1285-6)	\$137.50

Hanna® pHep® Tester (Model HI 98107)



pHep feature a rugged & ergonomically enhanced casing that fits comfortably in your hand and a larger LCD which makes it easier to read. Has a non-clogging fiber junction that will last much longer. Simply pull out 1-2 mm (1/8 in) of the junction fiber to completely renew the junction. Range of 0.0 to 14.0 pH and an Accuracy of ±0.1 pH. 1 Year Warranty.

Item No.	Description	MSRP
716840	Hanna PHEP Tester (HI 98107)	\$62.95

Hanna® Primo TDS Tester

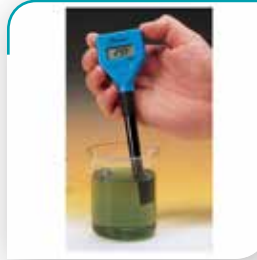

Provides a fast and dependable way to measure the total dissolved solids in your water samples. Primo TDS uses a single button at the top of the meter. Press it once and the meter is powered and ready for use. Press and hold the button for a few seconds and Primo automatically enters calibration mode. 1 Year Warranty.

Item No.	Description	MSRP
716833	Hanna Primo TDS Tester	\$46.95

Hanna® Checker® pH Tester (HI 98103)



The Checker® supplies fast and accurate readings from 0.00 to 14.00 pH with a resolution of 0.01 pH. This compact tester features a large easy-to-read LCD and a simple to perform 2-point calibration. The pH electrode of the Checker® can be replaced. 3000 hours of battery life. 1 Year Warranty.

Item No.	Description	MSRP
716435	Hanna Checker pH Tester (HI 98103)	\$45.95
716436	Hanna Checker Replacement Electrode (HI 1270)	\$31.95

Hanna® Batteries for pH/TDS Pens (Model HI 740026-P)



Hanna® Batteries for pH/TDS Pens. 12 per pack.

Item No.	Description	MSRP
716865	Hanna Batteries for pH/TDS Pens 12/Pack	\$24.95

Future Harvest

Future Harvest Nutradip® GrowBoss



NEW The Nutradip® GrowBoss is a nutrient monitoring system that assists growers in achieving maximum results for their growing efforts. The GrowBoss is a constant monitoring meter that indicates to the grower the exact levels of nutrient strength, pH and temperature. This allows the grower to adjust and optimize each parameter as the crop progresses through each growth cycle. 1 Year Warranty.

Item No.	Description	MSRP
716367	Future Harvest Grow Boss - Nutrient Monitor	\$269.95

Future Harvest Nutradip® Nutrient Meter



It is a continuous monitoring meter with automatic temperature compensation and DC power built in for portability. Lightweight, portable and splash resistant. Wall mount or hand held - AC & DC powered. Easy to read plant friendly display. Temperature compensated Food Grade Probe. 1 Year Warranty.

Item No.	Description	MSRP
716355	Future Harvest Nutradip Nutrient Meter EC Dual Power AC DC	\$99.95

Future Harvest Nutradip® pH Meter



Nutradip® pH Meter is a continuous monitoring pH meter with automatic temperature compensation and DC power built in for portability. High quality pH probe, plant friendly display and lightweight. 1 Year Warranty.

Item No.	Description	MSRP
716360	Future Harvest Nutradip pH Meter Dual Power AC DC	\$99.95

Future Harvest Nutradip® pH Replacement Probe

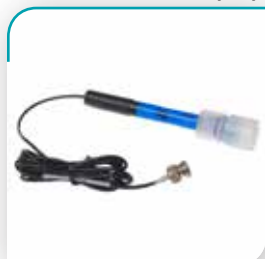

Nutradip® pH Probes are the reliable way to measure acidity in your nutrient solution. The pH Probe is a continuous monitoring pH meter with automatic temperature compensation and DC power built in for portability. 1 Year Warranty.

Item No.	Description	MSRP
716365	Future Harvest Nutradip pH Replacement Probe	\$69.95

Luster Leaf®

Luster Leaf® Rapitest® Digital Soil pH Meter



You can choose plants with the same pH preferences, avoid those that will not do well in your soil. By testing your soil, you determine the soil condition so that you can adjust pH more accurately, effectively and economically. Determines soil acidity/alkalinity. Batteries included. 1 Year Warranty.

Item No.	Description	MSRP
716910	Rapitest Digital Soil pH Meter	\$14.95

Luster Leaf® Rapitest® Digital Plus Soil pH Meter

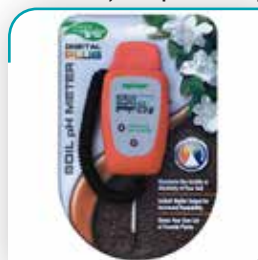

The Rapitest® Digital Plus Soil pH Meter is programmed with plant pH preferences for over 400 fruits, vegetables, grasses and landscape plants. Measures the acidity or alkalinity of your soil. All results are displayed on the digital LCD screen, ranging from 3.5 to 9.0. Stores your own list of favorite plants. 90 Day Warranty.

Item No.	Description	MSRP
716915	Rapitest Digital Plus Soil pH Meter	\$29.95

Luster Leaf® Rapitest® 4 Way Analyzer Model 1880



Measures four different levels for fertilizer, light, moisture and pH. Includes instructions and guides for all four measuring levels. 1 Year Warranty.

Item No.	Description	MSRP
716752	Luster Leaf Rapitest 4 Way Analyzer	\$37.95

Luster Leaf® Rapitest® pH Soil Tester 1612



Kit includes: color comparator, 10 pH test capsules, complete instructions for adjusting soil pH and pH preferences list for over 450 plants for the home, yard and garden.

Item No.	Description	MSRP
716755	Rapitest pH Soil Tester	\$5.95

Luster Leaf® Rapitest® Soil Test Hit Model 1601



Kit includes: 4 color comparators, 40 test capsules, 10 each for pH, N, P and K, complete instructions for adjusting soil pH, fertilization guidelines and pH preferences list for over 450 plants for the home, yard and garden.

Item No.	Description	MSRP
716756	Rapitest Soil Test pH N,P,K	\$18.49

Luster Leaf® Rapitest® Soil pH Meter Model 1040



Instantly tells you how acid or alkaline your soil is. Check which plants suit your garden. Enables you to alter soil condition. Includes pH preferences for over 400 plants. 1 Year Warranty.

Item No.	Description	MSRP
716750	Rapitest Soil pH Meter	\$22.95

Luster Leaf® Rapitest® Mini pH Tester Model 1015



Tests the acidity of soil. Check which plants suit your soil. Enables you to alter soil conditions. Use for fruits, flowers, shrubs and vegetables. No batteries required.

Item No.	Description	MSRP
716753	Rapitest Mini pH Tester	\$8.95

Bond®

Bond® 3 Way Soil Meter



Measures moisture content of soil. Lets you know to water. Helps you determine if plant is getting adequate light. Helps you control pH level in soil. No batteries need. For indoor or outdoor use. 1 Year Warranty.

Item No.	Description	MSRP
740865	Bond 3 Way Soil Meter	\$9.95

SureTest™

SureTest™ pH Test Strip Hit



NEW The SureTest™ Kit includes everything you need to test the pH of your water or nutrient solution. Includes 15 ft of pH dependent color changing paper. The testers have a pH range from 5.5 to 8.0 in either 0.2 or 0.3 increments. Full color chart to match your pH test results.

EXCLUSIVE

Item No.	Description	MSRP
716380	SureTest pH Test Strip Kit 5.5 - 8.0	\$9.99

SureTest™ pH Indicator Solution Test Hit



NEW SureTest™ liquid indicator pH test kit provides a fast and accurate way to determine the pH of your fertilizer solution. The attached snap caps on both the reagent bottle and the test vial allows rapid determination of pH without ever having to set each container down. Collect a sample and add 2 drops of the indicator solution and compare the color of the sample to the chart on the bottle. Makes approximately 300 tests.

EXCLUSIVE

Item No.	Description	MSRP
716384	Sure Test pH Indicator Solution Test Kit 1 oz	\$5.95

Testing, Calibration & Adjustment Products

GH pH Test Hit



General Hydroponics® pH Test Kits make pH testing easy. Simply fill a test-tube halfway with nutrient, add a few drops of pH Test Indicator and observe the coloration of the liquid in the test vial.

Item No.	Description	MSRP
722145	GH pH Test Kit 1 oz	\$7.54

GH pH Control Hit



General Hydroponics® pH Control Kit contains 8 oz pH UP, 8 oz pH DOWN, 1 oz indicator and vial.

Item No.	Description	MSRP
722080	GH pH Control Kit	\$17.20

GH pH UP Liquid & pH UP Dry



This Base solution is formulated using Potassium Hydroxide and Potassium Carbonate. Add a little at a time when your nutrient pH is too low in order to raise the pH to the proper level.

Item No.	Description	MSRP
722090	GH pH Up Liquid Quart	\$10.76
722095	GH pH Up Liquid Gallon	\$26.90
722105	GH pH Up Dry 2.2 lb	\$15.20

GH pH Down Liquid



The Acid formulation uses food grade Phosphoric acid to lower the pH to the proper level.

Item No.	Description	MSRP
722120	GH pH Down Liquid Quart	\$10.76
722125	GH pH Down Liquid Gallon	\$26.90

GH Meter Calibration Solutions



General Hydroponics® uses the highest quality reference solutions, allowing growers to calibrate many popular brands of pH, EC and TDS meters (NaCl scale or the 442 scale).

Item No.	Description	MSRP
722005	GH 1500 PPM Reference Solution 8 oz	\$8.20
722015	GH pH 4.01 Calibration Solution 8 oz	\$7.54
722020	GH pH 4.01 Calibration Solution Quart	\$21.50
722030	GH pH 7.01 Calibration Solution 8 oz	\$7.54
722035	GH pH 7.01 Calibration Solution Quart	\$21.50

Control Wizard 1382 Calibration Solution



Control Wizard Products 1382 Conductivity Standard. Use to calibrate all meters that use the 1 EC to 500 ppm water standard.

Item No.	Description	MSRP
716574	Control Wizard 1382 Calibration Solution 4 oz	\$5.95

Botanicare® pH Up & pH Down



With plants, nutrient availability can be affected by soil or solution pH. pH levels outside recommended ranges **UPS** can lead to nutrient lockout and nutrient deficiencies resulting in stunted growth and poor appearance. Control pH levels, minimize problems and maximize your plants' full potential with Botanicare's pH Up and pH Down solutions.

Item No.	Description	MSRP
722180	Botanicare pH Up Quart	\$11.95
722185	Botanicare pH Up Gallon	\$27.95
722190	Botanicare pH Down Quart	\$11.95
722195	Botanicare pH Down Gallon	\$27.95

Grow More® pH Up 30%



Convenient ready to use liquids, concentrated, fast acting, high purity food grade ingredients. Use pH Up to raise pH of nutrient solution with potassium hydroxide. Not for sale in the following states at this time: OR **UPS**

Item No.	Description	MSRP
721860	Grow More pH Up 30% Quart	\$8.34
721865	Grow More pH Up 30% Gallon	\$22.24

Grow More® pH Down 30%



Convenient ready to use liquids, concentrated, fast acting, high purity food grade ingredients. Use pH Down to lower pH of nutrient solution with phosphoric acid. Not for sale in the following states at this time: OR **UPS**

Item No.	Description	MSRP
721870	Grow More pH Down 30% Quart	\$8.34
721875	Grow More pH Down 30% Gallon	\$22.24

Oakton® pH 7.00 & 1413 TDS Solution



Solutions made specifically for Oakton® meters and testers. All Oakton® Conductivity/TDS calibration solutions are cross checked using different test methods, premixed and ready to use. NIST traceable materials. ±1% accuracy at 25°C.

Item No.	Description	MSRP
716112	Oakton Calibration pH 7.01 500 ml	\$20.95
716114	Oakton Calibration 1413 TDS 500 ml	\$20.95

Technaflora® pH Up & pH Down



Technaflora's pH Up and pH Down enable the gardener to moderate and maintain optimum pH levels. Both pH-balancing aids are manufactured using the highest-quality ingredients: potassium hydroxide to raise pH and nitric acid to lower pH.

Item No.	Description	MSRP
716461	Technaflora pH Up 1 Liter	\$14.09
716462	Technaflora pH Up 4 Liter	\$28.21
716464	Technaflora pH Down 1 Liter	\$14.09
716465	Technaflora pH Down 4 Liter	\$28.21

Earth Juice® Natural UP & Natural DOWN



pH adjusting crystals that will, once and for all, eliminate the hassles and worries of spilling, splashing and dealing with harsh liquid pH adjusters. Use to adjust the pH of fertilizer and plant micronutrient foliar solutions.

Item No.	Description	MSRP
722155	Earth Juice Natural Up 2 lb	\$20.99
722160	Earth Juice Natural Up 10 lb	\$70.10
722162	Earth Juice Natural Up 30 lb	\$202.19
722173	Earth Juice Natural Down 1.6 lb	\$17.95
722176	Earth Juice Natural Down 7.8 lb	\$58.42
722178	Earth Juice Natural Down 25 lb	\$168.50

Nectar For The Gods Hades Down



This blend of organic acids lowers your nutrient solution's pH. It's our pH down. Don't worry if you over shoot the down: just add some Olympus Up and see the benefits of adding more calcium.

Item No.	Description	MSRP
746304	Hades Down Quart	\$25.50
746306	Hades Down Gallon	\$80.00
746308	Hades Down 2.5 Gallon	\$160.00
746310	Hades Down 5 Gallon	\$325.00

Nectar For The Gods Olympus Up



Olympus is derived from micronized limestone designed to not only raise the pH of your nutrient solution but also to buffer organic acids from healthy soil decomposition. The calcium in Olympus is also very effective at tying up salts in the medium.

Item No.	Description	MSRP
746312	Olympus Up Quart	\$14.00
746314	Olympus Up Gallon	\$40.00
746316	Olympus Up 2.5 Gallon	\$80.00
746318	Olympus Up 5 Gallon	\$135.00

Milwaukee Instruments Buffer Solutions



Milwaukee standard calibration solutions are available in one use 20 ml sachets. Sachets are sealed against light and air and are ideal for on-the-spot calibration. Simply open, insert the tester or electrode into the sachet and calibrate.

Item No.	Description	MSRP
716301	Milwaukee M10004B - 20 ml Packet 4.01 Buffer Solution	\$1.07
716306	Milwaukee M10007B - 20 ml Packet 7.01 Buffer Solution	\$1.07

HM Digital™ TDS Calibration Solution



For optimal performance, re-calibrate your meters periodically or if testing TDS or conductivity levels in wide or different ranges. NaCl calibration solution. Comes in lightweight HDPE plastic bottles. Sealed with a coated foam liner.

Item No.	Description	MSRP
716170	HM Digital 1000 PPM Calibration Solution	\$6.69

HM Digital™ pH Electrode Storage Solution



For use with HM Digital's PH-200 and PH-80 (as well as other brands of pH meters). Always make sure your sensor is kept in an electrode storage solution. If dry, refill the pH meter cap with the PH-STOR storage solution. The sponge should be moist (not soaking wet).

Item No.	Description	MSRP
716150	HM Digital pH Electrode Storage Solution - 60 cc / 2 oz	\$7.95

Bluelab® pH Up & pH Down



NEW Our new pH Up and pH Down solutions can be used undiluted with the Bluelab pH Controller and Bluelab **UNS** pH Controller Connect. They're manufactured with premium quality acid/alkali concentration. Not for sale in the following states at this time: AK, AL, AR, DE, HI, IA, ID, KS, LA, MN, MS, MT, ND, NE, SD, UT, WV, WY.

Item No.	Description	MSRP
716344	Bluelab pH Up 500 ml	\$10.95
716345	Bluelab pH Up 1 Liter	\$16.95
716346	Bluelab pH Up 1 Gallon	\$47.00
716347	Bluelab pH Down 500 ml	\$8.50
716348	Bluelab pH Down 1 Liter	\$13.00
716349	Bluelab pH Down 1 Gallon	\$40.50

Bluelab® Probe Care Kit for Conductivity Probes



The instrument is only as accurate as the probe is clean. If the probe is contaminated or dirty, it affects the accuracy of the reading displayed. Conductivity kit contents: instructions, 500 ml 2.77 EC solution, plastic cup, conductivity probe cleaner, chamois (probe cleaning instrument).

Item No.	Description	MSRP
716052	Bluelab Nutrient Probe Care Kit Conductivity	\$11.90

Bluelab® Probe Care Kit pH & Conductivity



Everything you need to clean, hydrate and calibrate pH probes as well as clean and test conductivity (ppm/EC) probes. Includes instructions, 20 ml single-use Bluelab® Solution Sachets, 2 each of: pH 7.0 & pH 4.0, KCl, 2.77 EC, 3x plastic cups, pH Probe Cleaner, Conductivity Probe Cleaner, Toothbrush and Chamois.

Item No.	Description	MSRP
716448	Bluelab Probe Care pH & Conductivity	\$23.95

Bluelab® Probe Care Kit pH



NEW Everything you need to clean, hydrate and calibrate pH probes. Probe cleaning and correctly storing pH probes ensures you get the most accurate readings possible and will maximize the life of a probe. The probe surface is where the instrument takes the reading of the solution or soil/media. If the probe face is dirty or contaminated, the readings may be inaccurate.

Item No.	Description	MSRP
716053	Bluelab Probe Care Kit - pH	\$16.50

Bluelab® Calibration Solution 20 ml Sachets



pH instruments are calibrated to pH 7.0 first (buffer) then to pH 4.0 (slope). Bluelab's EC/CF equipment does not need calibrating as they are all factory calibrated. The CF 27.7 (EC 2.77) solution is used as a reference or checking solution to ensure you have adequately cleaned the EC/CF probe.

Item No.	Description	MSRP
732894	Bluelab pH 7.0 Calibration Solution 20 ml Sachets	\$1.80
732903	Bluelab pH 4.0 Calibration Solution 20 ml Sachets	\$1.80

Bluelab® pH 7.0 Calibration Solution



pH measuring equipment must be cleaned and calibrated regularly to ensure they are giving the user accurate readings. pH instruments are calibrated to pH 7.0 first (buffer) then to pH 4.0 (slope).

Item No.	Description	MSRP
732895	Bluelab pH 7.0 Calibration Solution 250 ml	\$8.15
732896	Bluelab pH 7.0 Calibration Solution 500 ml	\$11.00

Bluelab® pH 4.0 Calibration Solution



pH measuring equipment must be cleaned and calibrated regularly to ensure they are giving the user accurate readings. pH instruments are calibrated to pH 7.0 first (buffer) then to pH 4.0 (slope).

Item No.	Description	MSRP
732897	Bluelab pH 4.0 Calibration Solution 250 ml	\$8.15
732898	Bluelab pH 4.0 Calibration Solution 500 ml	\$11.00

Bluelab® 2.77 EC Conductivity Standard Solution



The EC2.77 solution is used as a reference or checking solution to ensure you have adequately cleaned the EC/ppm probe.

Item No.	Description	MSRP
732899	Bluelab 2.77EC Conductivity Solution 250 ml	\$8.15
732901	Bluelab 2.77EC Conductivity Solution 500 ml	\$11.00

BlueLab® pH Probe KCl Storage Solution



BlueLab® pH Probe KCl Storage Solution is made specifically for use with BlueLab pH products. It is designed to increase response time and maximize the life of BlueLab pH pens and pH probes. For best results, use the KCl solution to store the pH pen/probe after use and hydrate monthly.

Item No.	Description	MSRP
716056	BlueLab pH Probe KCl Storage Solution 100 ml	\$11.95

Hanna® 20 ml Packet Solutions



Hanna® 20 ml Packet Solutions are prepared according to precise formulas and are standardized with a pH meter calibrated according to the NIST standards. The 20 ml sachets are single-dose and are ready to use.

Item No.	Description	MSRP
716875	Hanna pH 4.01 Calibration Solution 20 ml	\$1.32
716876	Hanna pH 7.01 Calibration Solution 20 ml	\$1.32
716877	Hanna pH 10.01 Calibration Solution 20 ml	\$1.32
716878	Hanna Cleaning Solution 20 ml	\$1.65
716879	Hanna 1382 PPM TDS Solution 20 ml	\$1.32
716880	Hanna 1500PPM TDS Solution	\$1.32

Hanna® pH 4.01 [HI 7004L] & pH 7.01 [HI 7007L] Calibration Solutions



Hanna® buffer solutions are prepared according to precise formulas and are standardized with a pH meter calibrated according to the NIST standards. All pH 4.01 solutions show batch number, expiration date and the correlation table between pH and temperature. pH 7.01 is the most widely used among all buffer solutions.

Item No.	Description	MSRP
716845	Hanna pH 4 Calibration Solution Pint	\$18.75
716850	Hanna pH 7 Calibration Solution Pint	\$19.29

Hanna® Storage Solution [Model HI70300L]



To minimize clogging and ensure fast response time, always keep the glass bulb and the junction of your pH electrode moist. Store the electrode with a few drops of HI 70300 storage or pH 7.01 buffer solution in the protective cap.

Item No.	Description	MSRP
716468	Hanna Storage Solution Pint	\$18.95

Hanna® Cleaning Solution [Model HI7061L]



Clean the liquid junction of your electrodes once a day or at least once a week to prevent clogging and to maintain accuracy. Immerse the electrode in the proper cleaning solution for about 5 minutes.

Item No.	Description	MSRP
716470	Hanna Cleaning Solution Pint	\$18.95

Hanna® 1500 PPM [Model 70442L] & 1413 uS/CM [Model HI 7031L] Calibration Solutions



TDS solution are produced with high-quality potassium chloride in various concentrations. They are standardized using a conductivity meter calibrated with NIST potassium chloride. The 1413 $\mu\text{S}/\text{cm}$ solution is the one best suited for general use.

Item No.	Description	MSRP
716855	Hanna 1500PPM Calibration Solution Pint	\$20.49
716860	Hanna 1413uS/CM Calibration Solution Pint	\$20.49

Hanna® pH Cleaning & Calibration Solution Starter Kit [Model HIPHHT]



Single-dose sachets are quick and easy to use. Each sealed, light tight sachets holds just the right amount of solution. Kit Includes: (5) pH 4.01 buffer solution sachets, (5) pH 7.01 buffer solution sachets and (5) General cleaning solution sachets.

Item No.	Description	MSRP
716472	Hanna 4.01, 7.01, and Cleaning Solution	\$23.00

Gold Label Ultra pH-



NEW Gold Label Ultra pH- is a universal acid for adjusting the pH levels of nutrient solutions. It contains a balanced mix of phosphoric acid, nitric acid and sulphuric acid. Add last to your nutrients solution, reduce pH carefully in small steps and stir well before measuring. Use Ultra pH- in the vegetative and flowering period.

Item No.	Description	MSRP
733724	Gold Label Ultra pH 1 Liter	\$25.95
733726	Gold Label Ultra pH 4 Liter	\$76.95

Titan Controls® Apollo® 2 - Cycle Timer with Photocell



Controls timed equipment during daytime only, nighttime only or both. 10 seconds to 20 minutes ON TIME. 1 minute to 12 hours OFF TIME. Use to time fans, pumps or CO2. Plastic enclosure protects internal components. 15 Amps maximum/120 Volts/60 Hz. 2 Year Warranty.



EXCLUSIVE

Item No.	Description	MSRP
702740	Titan Controls Apollo 2 - Cycle Timer w/ Photocell	\$89.95

Titan Controls® Apollo® 3 - Fixed Cycle Timer



1 minute ON TIME & 4 minute OFF TIME. Timing is preset – requires no user adjustments. Ideal for aeroponic, ebb & flow or misting applications. Excellent for NFT – Nutrient Film Technique-systems. 10 Amps maximum/120 Volts/60 Hz. 2 Year Warranty.



EXCLUSIVE

Item No.	Description	MSRP
702635	Titan Controls Apollo 3 - Fixed Cycle Timer	\$74.95

Titan Controls® Apollo® 4 - 120 Volt Ballast Timer



The Apollo® 4 is specifically designed for use with today's high in-rush lighting ballasts. This is achieved by installing a 'ballast rated' relay vs. the standard mechanical switch that is used in conventional 24 hour appliance timers. It features a precision German built 24 hour clock, quality enclosure and timer cover that resists dust and moisture. Assure the success of your plants by having



the best lighting control in the market today. 10 Amp maximum/120 Volts/60 Hz./1000 Watts. 2 Year Warranty.

EXCLUSIVE

Item No.	Description	MSRP
734135	Titan Controls Apollo 4 - 120 Volt Ballast Timer	\$79.95

Titan Controls® Apollo® 5 - 240 Volt Ballast Timer



The Apollo® 5 is specifically designed for use with today's high in-rush lighting ballasts. This is achieved by installing a 'ballast rated' relay vs. the standard mechanical switch that is used in conventional 24 hour appliance timers. It features a precision German built 24 hour clock, quality enclosure and timer cover that resists dust and moisture. Assure the success of your plants by having the best lighting control in the

market today. 10 Amp maximum/240 Volts/60 Hz./1000 Watts. 2 Year Warranty.

EXCLUSIVE

Item No.	Description	MSRP
734140	Titan Controls Apollo 5 - 240 Volt Ballast Timer	\$84.95

Titan Controls® Apollo® 6 - One Outlet Mechanical Timer



24 hour timer is the perfect timing solution for your hydro systems. One (1) outlet. 15 minute intervals. Heavy duty construction. Easy to use & simple to operate. Plastic enclosure resists dust, rust and moisture. Do not use with digital ballasts. 15 Amps maximum/120 Volts/60 Hz. 1 Year Warranty.



EXCLUSIVE

Item No.	Description	MSRP
734110	Titan Controls Apollo 6 - One Outlet Mechanical Timer	\$10.95

Titan Controls® Apollo® 7 - One Outlet Digital Timer



24 hr digital timer is the perfect timing solution for your hydro systems. It's easy to set to run your pumps, fans, etc. One (1) outlet with 1 minute intervals. Battery back-up feature saves settings if power goes out. Do not use with digital ballasts. 15 Amps maximum/120 Volts/60 Hz. HINT: If not working properly, plug in for 5 minutes & press the reset button. Generally fixes the problem. 1 Year Warranty.



EXCLUSIVE

Item No.	Description	MSRP
734112	Titan Controls Apollo 7 - One Outlet Digital Timer	\$16.95

Titan Controls® Apollo® 8 - Two Outlet Mechanical Timer

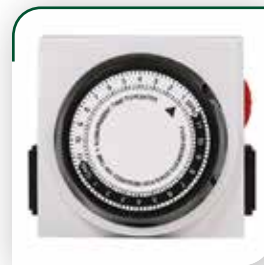

24 hr timer is the perfect timing solution for your hydro systems. Two (2) outlets. 15 minute intervals. Heavy duty construction. Plastic enclosure resists dust, rust and moisture. Do not use with digital ballasts. 15 Amps maximum/120 Volts/60 Hz. 1 Year Warranty.



EXCLUSIVE

Item No.	Description	MSRP
734100	Titan Controls Apollo 8 - Two Outlet Mechanical Timer	\$12.95

Titan Controls® Apollo® 9 - Two Outlet Digital Timer

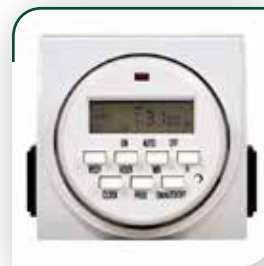

24 hr digital timer is the perfect timing solution for your hydro systems. Two (2) outlets with 1 minute intervals. Battery back-up feature saves settings if power goes out. Not for use with digital ballasts. 15 Amps maximum/120 Volts/60 Hz. HINT: If not functioning properly, plug in for 5 minutes and press the reset button. This generally fixes any problem. 1 Year Warranty.



EXCLUSIVE

Item No.	Description	MSRP
734105	Titan Controls Apollo 9 - Two Outlet Digital Timer	\$17.95

Titan Controls® Apollo® 10 - 240 Volt Mechanical Timer



240 Volt/24 hr timer is the perfect timing solution for your hydroponic systems. One (1) outlet with 15 minute intervals. Not for use with digital ballasts. 10 Amps maximum/240 Volts/60 Hz. 1 Year Warranty.

EXCLUSIVE

Item No.	Description	MSRP
734145	Titan Controls Apollo 10 - 240 Volt Mechanical Timer	\$14.95

Titan Controls® Apollo® 11 - 240 Volt Digital Timer



One (1) outlet. 1 minute intervals and run up to 20 schedules per day. Battery back-up feature saves settings in case of power failure. Daylight savings mode to accommodate time change. Do not use with digital ballasts. 10 Amps maximum/240 Volts/60 Hz. 1 Year Warranty.

EXCLUSIVE

Item No.	Description	MSRP
734155	Titan Controls Apollo 11 - 240 Volt Digital Timer	\$20.95

Titan Controls® Apollo® 12 - Short Cycle Timer With Photocell



Controls timed equipment during daytime only, nighttime only or both. 5 sec to 30 min ON TIME. 5 sec to 60 min OFF TIME. Precise short cycle timing of CO₂, pumps or fans. 15 Amps maximum/120 Volts/60 Hz./1/3 HP. 2 Year Warranty.



EXCLUSIVE

Item No.	Description	MSRP
702745	Titan Controls Apollo 12 - Short Cycle Timer w/ Photocell	\$89.95

Titan Controls® Apollo® 14 - 8 Outlet Power Strip with Timer



8 outlets - 4 timed/4 constant. 24 hr programmable mechanical timer with 15 min intervals. All outlets surge protected up to 1000 joules. Circuit breaker switch for safety. 5 ft power cord set. Not for use with digital ballasts. 15 Amps maximum/120 Volts/60 Hz. 1 Year Warranty.



EXCLUSIVE

Item No.	Description	MSRP
734150	Titan Controls Apollo 14 - 8 Outlet Power Strip w/ Timer	\$24.95

Titan Controls® Apollo® 16 - Medium LCD Display Digital Cycle Timer



NEW The Apollo® 16 is a versatile digital timer that's simple to operate. It only takes four buttons to control the functions of the timer and features a large easy to read LCD display. A variety of schedules can be programmed in minutes and hours using 16 different ON and OFF schedules. Internal battery backup feature saves settings in case of a power failure. The Apollo® 16 may be used to control CO₂, fan, pump, light mover, etc. Plastic chassis resists dust, rust and moisture. 15 Amps maximum/120

EXCLUSIVE

Volts/60 Hz. Not for use with electronic/digital ballasts. 1 Year Warranty.

Item No.	Description	MSRP
734116	Titan Controls Apollo 16 Medium LCD Display Digital Cycle Timer	\$18.95

Titan Controls® Apollo® 17 - Large LCD Display Digital Cycle Timer



NEW The Apollo® 17 is a versatile digital timer that's simple to operate. It only takes four buttons to control the functions of the timer and features an extra-large easy to read LCD display. A variety of schedules can be programmed in minutes and hours using 16 different ON and OFF schedules. Internal battery backup feature saves settings in case of a power failure. The Apollo® 17 may be used to control CO₂, fan, pump, light mover, etc. Plastic chassis resists dust, rust and moisture. 15 Amps

EXCLUSIVE

maximum/120 Volts/60 Hz. Not for use with electronic/digital ballasts. 1 Year Warranty.

Item No.	Description	MSRP
734117	Titan Controls Apollo 17 Large LCD Display Digital Cycle Timer	\$24.95

Titan Controls® Helios® 1 - 4 Light 120 Volt Controller with Timer



Runs 4 HID lights at 120 Volts - maximum 4000 Watts. The only lighting controllers featuring industrial-grade ballast rated relays. 24 hr timer with 15 minute non-detachable setting tabs. 4 NEMA 5-20 outlets. 50 Amps input power/40 Amps output power/120 Volts/60 Hz./4000 watts. Patent No. D66,252. 3 Year Warranty.



EXCLUSIVE

Item No.	Description	MSRP
702660	Titan Controls Helios 1 - 4 Light 120 Volt Controller w/ Timer	\$233.95

Titan Controls® Helios® 2 - 4 Light 120V Controller with Relay Trigger Cord



Runs 4 HID lights at 120 Volts - maximum 4000 Watts. The only lighting controllers featuring industrial-grade ballast rated relays. Plug relay trigger cord set into 24 hr wall timer. 4 NEMA 5-20 outlets. 50 Amps input power/40 Amps output power/120 Volts/60 Hz./4000 watts. 3 Year Warranty.



EXCLUSIVE

Item No.	Description	MSRP
702665	Titan Controls Helios 2 - 4 Light 120 Volt Controller w/ Trigger Cord	\$214.95

Titan Controls® Helios® 3 - 4 Light 240V Controller with Timer



Runs 4 HID lights at 240 Volts – maximum 4000 Watts. The only lighting controllers featuring industrial-grade ballast rated relays. 120 Volt accessory timed outlet to activate in-line fans to cool your lamps. Universal outlets allow total flexibility. 30 Amps input power/20 Amps output power/240 Volts/60 Hz./4000 watts. 3 Year Warranty.



EXCLUSIVE

Item No.	Description	MSRP
702670	Titan Controls Helios 3 - 4 Light 240 Volt Controller w/ Timer	\$233.95

Titan Controls® Helios® 7 - 8 Light 240V Controller with Timer



Runs 8 HID lights at 240 volts. The only lighting controllers featuring industrial-grade ballast rated relays. 24 hr timer with 15 min non-detachable setting tabs. Universal outlets will accept a 120 Volt or 240 Volt ballast cord set. 50 Amps input power/40 Amps output power/240 Volts/60 Hz./8000 Watts. 3 Year Warranty.



EXCLUSIVE

Item No.	Description	MSRP
702676	Titan Controls Helios 7 - 8 Light 240 Volt Controller w/ Timer	\$299.95

Titan Controls® Helios® 4 - 4 Light 240V Controller with Relay Trigger Cord



Runs 4 HID lights at 240 Volts – maximum 4000 Watts. The only lighting controllers featuring industrial-grade ballast rated relays. 120 Volt accessory timed outlet to activate in-line fans to cool your lamps. Plug relay trigger cord set into 24 hr wall timer. 30 Amps input power/20 Amps output power/240 Volts/60 Hz./4000 watts. 3 Year Warranty.



EXCLUSIVE

Item No.	Description	MSRP
702675	Titan Controls Helios 4 - 4 Light Controller w/ Trigger Cord	\$214.95

Titan Controls® Helios® 8 - 8 Light 240V Controller with Dual Trigger Cords



Runs 8 HID lights at 240 Volts. The only lighting controllers featuring industrial-grade ballast rated relays. Dual trigger cord sets allow the operator to run two separate light timing schedules. 50 Amps input power/40 Amps output power/240 Volts/60 Hz./8000 Watts. 3 Year Warranty.



EXCLUSIVE

Item No.	Description	MSRP
702677	Titan Controls Helios 8 - 8 Light 240 Volt Controller w/ Dual Trigger Cords	\$274.95

Titan Controls® Helios® 5 - 4 Light 240V Controller with Relay Trigger Cord



Runs 4 HID lights at 240 Volts. Plug relay trigger cord set into 24 hr wall timer. The only lighting controllers featuring industrial-grade ballast rated relays. 120 Volt timed accessory outlet (max 2 Amps) for light mover or fan. 30 Amps input power/20 Amps output power/240 Volts/60 Hz./4000 Watts. 3 Year Warranty.



EXCLUSIVE

Item No.	Description	MSRP
702671	Titan Controls Helios 5 - 4 Light 240 Volt Controller w/ Trigger Cord	\$221.95

Titan Controls® Helios® 9 - Pre-wired 4 Light 240V Controller with Trigger Cord & Timer



Runs 4 HID lights at 240 Volts. The only lighting controllers featuring industrial-grade ballast rated relays. Circuit breakers built right into the controller! Plug relay trigger cord into 24 hour wall timer (included)! 30 Amps input power/20 Amps output power/240 Volts/60 Hz./4000 Watts. 3 Year Warranty.



EXCLUSIVE

Item No.	Description	MSRP
702678	Titan Controls Helios 9 - Pre-Wired 4 Light 240 Volt Controller w/ Trigger Cord & Timer	\$308.95

Titan Controls® Helios® 6 - 8 Light 240V Controller with Dual Trigger Cords



Runs 8 HID lights at 240 volts. The only lighting controllers featuring 2 industrial-grade ballast rated relays. Plug relay trigger cord set into 24 hr wall timer. Removable front panel makes controller easy to wire into your power system. 50 Amps input power/40 Amps output power/240 Volts/60 Hz./8000 Watts. 3 Year Warranty.



EXCLUSIVE

Item No.	Description	MSRP
702672	Titan Controls Helios 6 - 8 Light 240 Volt Controller w/ Dual Trigger Cords	\$283.95

Titan Controls® Helios® 10 - Pre-wired 8 Light 240V Controller with Trigger Cord & Timer



Runs 8 HID lights at 240 Volts. The only lighting controllers featuring industrial-grade ballast rated relays. Circuit breakers built right into the controller! Plug relay trigger cord into 24 hour wall timer (included)! 50 Amps input power/40 Amps output power/240 Volts/60 Hz./8000 Watts. 3 Year Warranty.



EXCLUSIVE

Item No.	Description	MSRP
702679	Titan Controls Helios 10 - Pre-Wired 8 Light 240 Volt Controller w/ Trigger Cord & Timer	\$409.95

Titan Controls® Helios® 11 - 4 Light 240V Controller with Trigger Cord



Runs 4 HID lights at 240 Volts. The only lighting controllers featuring industrial-grade ballast rated relays. Plug relay trigger cord into 24 hour wall timer to run your lights. Universal outlets allow total flexibility. 30 Amps input power/20 Amps output power/240 Volts/60Hz./4000 Watts. 2 Year Warranty.



EXCLUSIVE

Item No.	Description	MSRP
702820	Titan Controls Helios 11 - 4 Light 240 Volt Controller w/ Trigger Cord	\$158.95

Titan Controls® Helios® 12 - 8 Light 240V Controller with Dual Trigger Cords



Runs 8 HID lights at 240 Volts. The only lighting controllers featuring 2 industrial-grade ballast rated relays. Plug dual relay trigger cord set into 24 hr wall timers to run your lights. Universal outlets allow total flexibility. 50 Amps input power/40 Amps output power/240 Volts/60 Hz./8000 Watts. 2 Year Warranty.



EXCLUSIVE

Item No.	Description	MSRP
702825	Titan Controls Helios 12 - 8 Light 240 Volt Controller w/ Dual Trigger Cords	\$249.95

Titan Controls® Helios® 18 - 12 Light 240V Controller with Dual Trigger Cords



Runs 12 HID lights at 240 Volts. The only lighting controllers featuring industrial-grade ballast relays. 2 trigger cords allow the operator to run 2 separate light schedules. Removable front panel makes controller easy to wire. Universal outlets will accept either 120 or 240 Volt power cords. 80 Amps input power/60 Amps output power/240 Volts/60 Hz./12,000 Watts. 3 Year Warranty.



EXCLUSIVE

Item No.	Description	MSRP
702843	Titan Controls Helios 18 - 12 Light 240 Volt Controller w/ Dual Trigger Cords	\$449.95

Titan Controls® Helios® 13 - 16 Light 240V Controller with Timer



Runs 16 HID lights at 240 Volts. The only lighting controllers featuring industrial-grade ballast rated relays. Premium quality timer with battery back-up. 100 Amps input power/80 Amps output power/240 Volts/60 Hz./16,000 Watts. 3 Year Warranty.



EXCLUSIVE

Item No.	Description	MSRP
702828	Titan Controls Helios 13 - 16 Light Controller w/ Timer	\$1,191.95

Titan Controls® Helios® 14 - 24 Light 240V Controller with Timer



Runs 24 HID lights at 240 Volts. The only lighting controllers featuring industrial-grade ballast rated relays. Premium quality timer with battery back-up. 150 Amps input power/120 Amps output power/220 Volts/60 Hz./24,000 Watts. 3 Year Warranty.



EXCLUSIVE

Item No.	Description	MSRP
702832	Titan Controls Helios 14 - 24 Light Controller w/ Timer	\$1,833.95

Titan Controls® Helios® 15 - 8 Light 240V Controller with Timer



Runs 8 HID lights at 240 Volts. The only lighting controllers featuring industrial-grade ballast rated relays. Reliable 24 hr timer built into the controller. NEMA 6-15 UL listed power outlets. 50 Amps input power/40 Amps output power/240 Volts/60 Hz./8000 Watts. 3 Year Warranty.



EXCLUSIVE

Item No.	Description	MSRP
702775	Titan Controls Helios 15 - 8 Light Controller w/ Timer	\$308.95

Titan Controls® Helios® 16 - 16 Light 240V Controller with Dual Trigger Cords



Runs 16 HID lights at 240 Volts. The only lighting controllers featuring industrial-grade ballast rated relays. 2 trigger cord sets activate lighting controller via external timers. Sequenced lighting delays for each light bank. 100 Amps input power/80 Amps output power/240 Volts/60 Hz./16,000 Watts. 3 Year Warranty.



EXCLUSIVE

Item No.	Description	MSRP
702835	Titan Controls Helios 16 - 16 Light 240 Volt Controller w/ Dual Trigger Cords	\$1,191.95

Titan Controls® Helios® 17 - 24 Light 240V Controller with Dual Trigger Cords



Runs 24 HID lights at 240 Volts. The only lighting controllers featuring industrial-grade ballast rated relays. 2 trigger cord sets activate lighting controller via external timers. Sequenced lighting delays for each light bank. Duplex outlets have circuit breaker protection. 150 Amps input power/120 Amps output power/240 Volts/60 Hz./24,000 Watts. 3 Year Warranty.



EXCLUSIVE

Item No.	Description	MSRP
702840	Titan Controls Helios 17 - 24 Light 240 Volt Controller w/ Dual Trigger Cords	\$1,833.95

Titan Controls® Spartan Series™ Repeat Cycle Timer



NEW The Spartan Series™ Repeat Cycle Timer is an easy to use and reliable product. It features a 5 second to 30 minute ON time, a 5 second to 60 minute OFF time and adjustable modes for day, night or 24 hours. Designed to precisely control pumps, CO2 systems and fans. The Repeat Cycle Timer is cULus listed and features a durable plastic housing. 15 Amps maximum/120 Volts/60 Hz. 1 Year Warranty.



EXCLUSIVE

Item No.	Description	MSRP
702894	Titan Controls - Spartan Series Repeat Cycle Timer	\$44.95

Intermatic® Multi-Purpose DT620 CL Digital Timer



Turns lights and appliances on and off automatically. Easy set up and operation. Auto cSF[®] adjusts to sunrise/sunset time for dusk/dawn setting. Automatic Daylight Saving Time option. Variable ON/OFF setting option for added security. 1 Year Warranty.



Item No.	Description	MSRP
734046	Intermatic 2 Outlet Digital Timer DT620CL 120 Volt	\$39.95

Titan Controls® Spartan Series™ Recycle Adjustable Timer

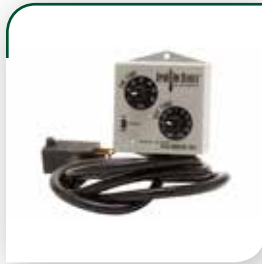

NEW The Recycle Adjustable Timer features: 1 minute to 60 minutes 'ON' time, 5 minute to 12 hour 'OFF' time, LED indicator light, and adjustable 'ON' modes for day, night or both use. For use with pumps, fans or CO2 systems. Housed in a rust, dust and water resistant plastic enclosure, this controller will function in the toughest environments. Ratings: 12 Amps maximum/120 Volts/60 Hz. 1 Year Warranty.



EXCLUSIVE

Item No.	Description	MSRP
702896	Titan Controls - Spartan Series Recycle Adjustable Timer	\$74.95

Intermatic® Heavy-Duty Plug-In Timer



This heavy duty, grounded timer is ideal for automatically controlling personal computers, cSF[®] heaters, heavy-duty appliances and HID lighting fixtures. It plugs directly into a wall outlet. TN311C - 1750W/120VAC/15 Amp/1 HP. HB111C Receptacle. 1 Year Warranty.



Item No.	Description	MSRP
734015	Intermatic TN311C Heavy Duty Timer 120 Volt	\$17.49

Titan Controls® Spartan Series™ 4 Light 240 Volt Controller



NEW The 4 light controller operates up to 4000 Watts of grow lights in your garden. It features: heavy duty definite purpose contactor, trigger cord set that activates your lights via an external wall timer and universal outlets that allow the use of 120 Volt or 240 Volt cord sets. The controller is housed in a rust, dust and moisture proof enclosure. 30 Amps input power/20 Amps output power/240 Volts/60 Hz./4000 Watts. 1 Year Warranty.



EXCLUSIVE

Item No.	Description	MSRP
702898	Titan Controls - Spartan Series 4 Light Controller - 240 Volt	\$124.95

Intermatic® Heavy-Duty Plug-In 240 Volt Timer

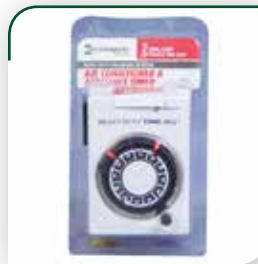

Automatically controls 240 volt heaters, heavy-duty appliances and lamps. 3,750 watt capacity. cSF[®] Plugs directly into wall outlet. 2 ON/2 OFF settings per day. 3-prong 220-240 volt grounded plug and receptacle. Manual override ON/OFF switch. HB112C Receptacle. 1 Year Warranty.



Item No.	Description	MSRP
734020	Intermatic HB112C Heavy Duty Timer 240 Volt	\$22.95

Titan Controls® Spartan Series™ 8 Light 240 Volt Controller



NEW The 8 light controller operates up to 8000 Watts of grow lights in your garden. It features: heavy duty definite purpose contactors, dual trigger cord sets that give you the flexibility to stagger lighting schedules or delay starting times via an external wall timer and universal outlets that allow the use of 120 Volt or 240 Volt cord sets. The controller is housed in a rust, dust and moisture proof enclosure. 50 Amps input power/40 Amps output power/240 Volts/60 Hz./8000 Watts. 1 Year Warranty.



EXCLUSIVE

Item No.	Description	MSRP
702899	Titan Controls - Spartan Series 8 Light Controller - 240 Volt	\$209.95

Intermatic® Heavy Duty Time Switch



Heavy duty lockable metal enclosure. Tamper proof design. 1/2 in & 3/4 in knock outs. T101 - 120 volt/ cSF[®] AC/60 Hz/Single pole/Single throw/40 amp. T104 - 208 to 277 volt/AC/60 Hz/Double pole/Single throw/40 amp. 1 Year Warranty.



Item No.	Description	MSRP
734030	Intermatic T101 Commercial Grade Timer 120 Volt	\$82.95
734035	Intermatic T104 Commercial Grade Timer 240/277 Volt	\$89.95

PAR Meter with Integrated Sensor - Sun System®



Sun System® PAR Meter comes with a integrated sensor to measure photosynthetic active radiation (PAR). Use inside with Sun System® grow lights or outside with natural sunlight. Simple and easy to use. Compact size with integrated sensor. 1 Year Warranty.

EXCLUSIVE

Item No.	Description	MSRP
748200	Sun System PAR Meter w/ Integrated Sensor	\$349.95

PAR Meter with Remote Sensor - Sun System®



Sun System® PAR Meter with remote sensor measures photosynthetically active radiation (PAR). Use inside with Sun System® grow lights or outside with natural sunlight. Simple and easy to use. Compact size with remote sensor. 1 Year Warranty.

EXCLUSIVE

Item No.	Description	MSRP
748205	Sun System PAR Meter w/ Remote Sensor	\$449.95

Grower's Edge® Large Display Digital Thermometer & Hygrometer



Measures indoor/outdoor temperature & indoor humidity. Stores the Min./Max. values of the indoor/outdoor temperature and indoor humidity. Switch between °C and °F. Clock function with 12/24 hour time format. Waterproof temperature probe. Comes with 1 AAA alkaline battery. 1 Year Warranty.

EXCLUSIVE

Item No.	Description	MSRP
716560	Grower's Edge Large Display Thermometer / Hygrometer	\$23.95

Grower's Edge® Thermometer/Hygrometer with Sensor



Large screen digital readout. Wireless sensor transmits up to 50 feet. Expandable to accept 2 additional sensors. Waterproof casing is chemical and UV resistant. Displays degrees in °F or °C. 2 AA batteries included.

EXCLUSIVE

Item No.	Description	MSRP
716555	Grower's Edge Digital Thermometer / Hygrometer w/ Remote Sensor	\$39.95
716557	Grower's Edge Wireless Remote Sensor	\$23.95

Kill A Watt



Measures electrical consumption accurately within 0.2% and is ETL approved. Features large LCD screen which displays 8 critical units of measurements. Enables you to cost forecast. 6 Month Warranty.



Item No.	Description	MSRP
716450	Kill A Watt Meter	\$39.95

Luster Leaf® Rapitest® Soil Tester



10 color coded tests: 4 for pH, 2 each for nitrogen, phosphorus and potash.

Item No.	Description	MSRP
716917	Luster Leaf Rapitest Soil Tester	\$5.99

Luster Leaf® Rapitest® 4 Way Analyzer Model 1880



Measures four different levels for fertilizer, light, moisture and pH. Includes instructions and guides for all four measuring levels. 1 Year Warranty.

Item No.	Description	MSRP
716752	Luster Leaf Rapitest 4 Way Analyzer	\$37.95

Luster Leaf® Rapitest® Digital Moisture Meter



The Rapitest® Digital Moisture Meter tests for moisture at the roots - where it matters - you no longer risk over watering a healthy plant just because the soil near the surface is dry or under-watering because it appears moist. 1 Year Warranty.

Item No.	Description	MSRP
716900	Luster Leaf Rapitest Digital Moisture Meter	\$13.49

Bond® Moisture Meter



Measures moisture content of soil. Lets you know when to water. No batteries needed. For indoor or outdoor use. 1 Year Warranty.

Item No.	Description	MSRP
740860	Bond Moisture Meter	\$8.95



The most complete line of indoor and outdoor growing containers for producing healthy plants and plentiful harvests

Gro Pro® Premium Round Fabric Pots - Black



Constructed from high quality non-woven fabric. This fabric provides great support, while allowing air to travel into the root system. They feature breathable fabric allowing for faster plant growth through better access to oxygen. Air-flow prunes the root structure for a healthier and happier plant. Gro Pro® Premium Round Fabric Pots will not trap water, which can help prevent overwatering of plants. Also keeps your roots cool in the heat. Made from 270 gram weight material for maximum durability and longevity. **EXCLUSIVE**

Item No.	Description	Bottom Dim	Height Dim	Vol [Gal]	Cu. Ft.	MSRP
725800	Gro Pro Premium Round Fabric Pot 1 Gallon	8.0"	6.3"	1.3	0.18	\$1.76
725805	Gro Pro Premium Round Fabric Pot 2 Gallon	8.0"	7.0"	1.5	0.20	\$2.18
725810	Gro Pro Premium Round Fabric Pot 3 Gallon	11.8"	8.3"	3.9	0.52	\$2.80
725815	Gro Pro Premium Round Fabric Pot 5 Gallon	14.0"	10.2"	6.8	0.91	\$3.56
725820	Gro Pro Premium Round Fabric Pot 7 Gallon	14.0"	12.0"	8	1.10	\$4.55
725825	Gro Pro Premium Round Fabric Pot 10 Gallon	18.0"	12.2"	13.4	1.80	\$5.20
725830	Gro Pro Premium Round Fabric Pot 15 Gallon	20.0"	14.0"	19.1	2.50	\$6.49
725835	Gro Pro Premium Round Fabric Pot 20 Gallon	21.0"	15.0"	22.5	3.00	\$7.80
725840	Gro Pro Premium Round Fabric Pot 30 Gallon	26.0"	16.0"	36.8	4.90	\$10.38
725845	Gro Pro Premium Round Fabric Pot 45 Gallon	27.0"	18.0"	44.6	5.90	\$13.87
725850	Gro Pro Premium Round Fabric Pot 65 Gallon	32.0"	18.0"	62.6	8.40	\$18.78
725855	Gro Pro Premium Round Fabric Pot 100 Gallon	38.0"	20.0"	98.2	13.10	\$25.13
725860	Gro Pro Premium Round Fabric Pot 150 Gallon	45.3"	22.0"	154.7	20.70	\$32.67
725865	Gro Pro Premium Round Fabric Pot 200 Gallon	50.0"	24.0"	204.1	27.30	\$37.65
725870	Gro Pro Premium Round Fabric Pot 300 Gallon	60.0"	24.0"	293.9	39.30	\$46.75
725875	Gro Pro Premium Round Fabric Pot 400 Gallon	70.0"	24.0"	400	53.50	\$57.15
725877	Gro Pro Premium Round Fabric Pot 500 Gallon	78.0"	24.0"	426.9	66.40	\$62.09
725879	Gro Pro Premium Round Fabric Pot 600 Gallon	86.0"	24.0"	518.8	80.70	\$67.45
725881	Gro Pro Premium Round Fabric Pot 700 Gallon	93.0"	24.0"	606.9	94.40	\$71.18
725883	Gro Pro Premium Round Fabric Pot 800 Gallon	99.0"	24.0"	687.9	107.00	\$81.00
725885	Gro Pro Premium Round Fabric Pot 900 Gallon	105.0"	24.0"	773.4	120.30	\$85.36
725887	Gro Pro Premium Round Fabric Pot 1000 Gallon	111.0"	24.0"	864.4	134.50	\$90.18

Gro Pro® Premium Round Fabric Pots - Tan



The Gro Pro® Tan Premium Round Fabric Pots are the same great quality as the black pots but in tan color. Constructed from high quality non-woven fabric. This fabric provides great support, while allowing air to travel into the root system. They feature breathable fabric allowing for faster plant growth through better access to oxygen. Air-flow prunes the root structure for a healthier and happier plant. Also keeps your roots cool in the heat. Made from 270 gram weight material for maximum durability and longevity. **EXCLUSIVE**

Item No.	Description	Bottom Dim	Height Dim	Vol [Gal]	Cu. Ft.	MSRP
725920	Gro Pro Premium 1 Gallon Round Fabric Pot-Tan	8.0"	6.3"	1.36	0.18	\$1.80
725925	Gro Pro Premium 2 Gallon Round Fabric Pot-Tan	8.0"	7.0"	1.52	0.20	\$2.25
725930	Gro Pro Premium 3 Gallon Round Fabric Pot-Tan	11.8"	8.3"	3.92	0.53	\$2.89
725935	Gro Pro Premium 5 Gallon Round Fabric Pot-Tan	14.0"	10.2"	6.80	0.91	\$3.75
725940	Gro Pro Premium 7 Gallon Round Fabric Pot-Tan	14.0"	12.0"	8	1.07	\$4.69
725945	Gro Pro Premium 10 Gallon Round Fabric Pot-Tan	18.0"	12.2"	13.46	1.80	\$5.36
725950	Gro Pro Premium 15 Gallon Round Fabric Pot-Tan	20.0"	14.0"	19.07	2.55	\$6.69
725955	Gro Pro Premium 20 Gallon Round Fabric Pot-Tan	21.0"	15.0"	22.51	3.01	\$8.04
725960	Gro Pro Premium 30 Gallon Round Fabric Pot-Tan	26.0"	16.0"	36.8	4.92	\$10.71
725965	Gro Pro Premium 45 Gallon Round Fabric Pot-Tan	27.0"	18.0"	44.65	5.97	\$14.31
725970	Gro Pro Premium 65 Gallon Round Fabric Pot-Tan	32.0"	18.0"	62.68	8.38	\$19.36
725975	Gro Pro Premium 100 Gallon Round Fabric Pot-Tan	38.0"	20.0"	98.22	13.13	\$25.25
725980	Gro Pro Premium 150 Gallon Round Fabric Pot-Tan	45.3"	22.0"	154.7	20.68	\$33.69
725985	Gro Pro Premium 200 Gallon Round Fabric Pot-Tan	50.0"	24.0"	204.1	27.28	\$38.84
725990	Gro Pro Premium 300 Gallon Round Fabric Pot-Tan	60.0"	24.0"	293.9	39.29	\$48.20
725995	Gro Pro Premium 400 Gallon Round Fabric Pot-Tan	70.0"	24.0"	399.98	53.47	\$58.91

Gro Pro® Square Fabric Pots - Black



Gro Pro® Square Fabric Pots have breathable fabric for drainage and aeration. They eliminate circling, misguided roots, promote lateral root development and vigorous plant growth. Also great for maintaining a consistent substrate temperature. **EXCLUSIVE**

Item No.	Description	MSRP
724950	Gro Pro Square Fabric Pot 1 Gallon	\$3.29
724955	Gro Pro Square Fabric Pot 3 Gallon	\$4.36
724960	Gro Pro Square Fabric Pot 5 Gallon	\$6.00
724965	Gro Pro Square Fabric Pot 7 Gallon	\$7.35
724970	Gro Pro Square Fabric Pot 10 Gallon	\$9.45
724985	Gro Pro Square Fabric Pot 20 Gallon	\$11.76
724990	Gro Pro Square Fabric Pot 30 Gallon	\$14.93
724995	Gro Pro Square Fabric Pot 100 Gallon	\$32.62
724975	Flo-n-Gro Square Fabric Liner 3 Gallon	\$4.05

Gro Pro® Essential Round Fabric Pots



NEW The Gro Pro® Essential Round Fabric Pots are constructed from high quality non-woven fabric. This fabric provides great support, while allowing air to travel into the root system. Feature breathable fabric allowing for faster plant growth through better access to oxygen. Air-flow prunes the root structure for a healthier and happier plant. They will not trap water, which can help prevent overwatering of plants. Also keeps your roots cool in the heat. Made from 220 gram weight material for great **EXCLUSIVE**

durability at an economic price.

Item No.	Description	Bottom Height		Vol		MSRP
		Dim	Dim	[Gal]	Cu. Ft.	
725305	Gro Pro Essential Round Fabric Pot 1 Gallon (10/Bag)	8.0"	6.3"	1.3	0.18	\$1.45
725310	Gro Pro Essential Round Fabric Pot 2 Gallon (10/Bag)	8.0"	7.0"	1.5	0.20	\$1.85
725315	Gro Pro Essential Round Fabric Pot 3 Gallon (10/Bag)	11.8"	8.3"	3.9	0.52	\$2.31
725320	Gro Pro Essential Round Fabric Pot 5 Gallon (10/Bag)	14.0"	10.2"	6.8	0.91	\$2.95
725325	Gro Pro Essential Round Fabric Pot 7 Gallon (10/Bag)	14.0"	12.0"	8.0	1.10	\$3.87
725330	Gro Pro Essential Round Fabric Pot 10 Gallon (10/Bag)	18.0"	12.2"	13.4	1.80	\$4.42
725335	Gro Pro Essential Round Fabric Pot 15 Gallon (10/Bag)	20.0"	14.0"	19.1	2.50	\$5.51
725340	Gro Pro Essential Round Fabric Pot 20 Gallon (10/Bag)	21.0"	15.0"	22.5	3.00	\$6.64
725345	Gro Pro Essential Round Fabric Pot 30 Gallon (10/Bag)	26.0"	16.0"	36.8	4.90	\$8.82

RediRoot™ Aeration Liners



RediRoot™ Aeration Liners are constructed of high quality non woven fabric. This fabric provides great support, while allowing air to travel into the root system. RediRoot™ Liners have sturdy handles, making lifting and transporting a breeze.

EXCLUSIVE

Item No.	Description	MSRP
724886	RediRoot Aeration Liner 5 Gallon	\$3.27
724887	RediRoot Aeration Liner 7 Gallon	\$4.18

RediRoot™ Aeration Frames



The RediRoots™ Aeration Frame is a heavy duty plastic frame with engineered air entry points to introduce oxygen to the root zone. It also provides air pruning of the roots, giving you strong lateral root growth, while reducing thin spiraling roots.

EXCLUSIVE

Item No.	Description	MSRP
724891	RediRoot Aeration Container 5 Gallon	\$5.09
724892	RediRoot Aeration Container 7 Gallon	\$7.44

Smart Pot® - Black with Handles



These soft growing containers allow more air to reach the growing medium and roots, improving drainage and keeping the root system from overheating on hot days. These pots are aeration containers allowing the air to prune the plant root structure. Easy handling with built in handles.

Item No.	Description	Vol		MSRP
		[Gal]	Cu. Ft.	
724710	Smart Pot Black 3 Gallon w/ handles	2.6	0.35	\$5.95
724715	Smart Pot Black 5 Gallon w/ handles	4.7	0.62	\$6.95
724720	Smart Pot Black 7 Gallon w/ handles	6	0.83	\$7.95
724725	Smart Pot Black 10 Gallon w/ handles	10	1.35	\$9.95
724730	Smart Pot Black 15 Gallon w/ handles	14.9	1.99	\$12.95
724736	Smart Pot Black 20 Gallon w/ handles	21	2.80	\$14.95

Smart Pot® - Black



These soft growing containers allow more air to reach the growing medium and roots, improving drainage and keeping the root system from overheating on hot days. These pots are aeration containers allowing the air to prune the plant root structure. Check your local dealer partner for availability.

Item No.	Description	Vol		MSRP
		[Gal]	Cu. Ft.	
724700	Smart Pot Black 1 Gallon	0.9	0.13	\$2.19
724705	Smart Pot Black 2 Gallon	1.5	0.20	\$2.39
724708	Smart Pot Black 3 Gallon	2.5	0.34	\$4.95
724713	Smart Pot Black 5 Gallon	4.6	0.62	\$5.95
724718	Smart Pot Black 7 Gallon	6.3	0.84	\$6.95
724723	Smart Pot Black 10 Gallon	10.0	1.31	\$8.95
724728	Smart Pot Black 15 Gallon	14.8	1.90	\$9.95
724735	Smart Pot Black 20 Gallon	21.0	2.80	\$11.95
724740	Smart Pot Black 25 Gallon	23.2	3.10	\$12.95
724745	Smart Pot Black 30 Gallon	30.4	4.00	\$14.95
724750	Smart Pot Black 45 Gallon	40.6	5.90	\$18.95
724755	Smart Pot Black 65 Gallon	60.9	8.30	\$22.95
724760	Smart Pot Black 100 Gallon	95.7	13.10	\$29.95
724763	Smart Pot Black 150 Gallon	151.5	20.20	\$39.95
724765	Smart Pot Black 200 Gallon	199.8	27.20	\$49.95
724766	Smart Pot Black 300 Gallon	293.8	39.20	\$69.95
724767	Smart Pot Black 400 Gallon	399.8	53.40	\$79.95
724771	Smart Pot Black 500 Gallon	496	66.30	\$88.95
724772	Smart Pot Black 600 Gallon	603	80.60	\$94.95
724773	Smart Pot Black 700 Gallon	705	94.30	\$112.95
724774	Smart Pot Black 800 Gallon	799	106.00	\$122.95
724775	Smart Pot Black 900 Gallon	899	120.00	\$138.95
724776	Smart Pot Black 1000 Gallon	1005	134.00	\$143.95

Smart Pot® Tray Liner



Gardeners can see all the benefits of growing with a Smart Pot® even if they grow in trays, thanks to the Smart Pot® Tray Liner! This soft material allows more air to reach the growing medium and roots, improving drainage and keeping the root system from overheating on hot days. Plant roots also benefit from their natural tendency to grow into soft surfaces like the Smart Pot® Tray Liner, becoming thick and healthy instead of circling the inside of the pot and becoming root bound.

Item No.	Description	Vol [Gal]	Cu. Ft.	MSRP
724769	Smart Pot Liner Black 4 ft x 4 ft x 12 in	148	19.79	\$39.95

Smart Pot® - Tan



We have color! The Tan Smart Pot® provides a decorative aspect to the Smart Pot®. The qualities that make the regular Smart Pot® work are just the same!

Item No.	Description	Vol [Gal]	Cu. Ft.	MSRP
725700	Smart Pot Tan 1 Gallon	0.9	0.13	\$3.99
725705	Smart Pot Tan 2 Gallon	1.5	0.20	\$4.49
725710	Smart Pot Tan 3 Gallon	2.5	0.34	\$5.49
725715	Smart Pot Tan 5 Gallon	4.6	0.62	\$6.49
725720	Smart Pot Tan 7 Gallon	6.3	0.84	\$7.49
725725	Smart Pot Tan 10 Gallon	10.0	1.33	\$9.95
725730	Smart Pot Tan 15 Gallon	14.8	1.98	\$11.95
725735	Smart Pot Tan 20 Gallon	21.0	2.80	\$13.95
725740	Smart Pot Tan 25 Gallon	23.2	3.10	\$14.95
725745	Smart Pot Tan 30 Gallon	30.4	4.00	\$16.95
725750	Smart Pot Tan 45 Gallon	40.6	5.90	\$19.95
725755	Smart Pot Tan 65 Gallon	60.9	8.30	\$24.95
725760	Smart Pot Tan 100 Gallon	95.7	13.10	\$32.95
725765	Smart Pot Tan 150 Gallon	151.5	20.20	\$43.95
725770	Smart Pot Tan 200 Gallon	199.8	27.20	\$52.95
725775	Smart Pot Tan 300 Gallon	293.8	39.20	\$74.95
725780	Smart Pot Tan 400 Gallon	399.8	53.40	\$85.00

Smart Pot® Transplanter



The Smart Transplanter is a re-usable Smart Pot® that has been specially designed to make transplanting easy. The Smart Transplanter has an opening on the sidewall that allows the gardener to peel off the Transplanter with ease. Because the fabric overlaps itself, it is able to hold most mediums and mixes without any problems. 6 in base by 6 in height.

Item No.	Description	MSRP
724698	Smart Pot Transplanter 1 Gallon 100/Pack	\$2.19

Root Pots



Root Pots last for multiple seasons of gardening and will generally begin to break down after about 3 to 5 years. They are designed to allow roots to breathe. Root Pots can be used with drip lines or hydroponic flood trays. Made from 100% recycled material. Root Pots are both reusable and biodegradable.

Item No.	Description	Bottom Dim	Height Dim	MSRP
728841	Root Pot 1 Gallon	6.0"	7.5"	\$1.89
728842	Root Pot 2 Gallon	8.5"	8.5"	\$2.09
728844	Root Pot 3 Gallon	9.0"	8.0"	\$2.99
728846	Root Pot 5 Gallon	11.0"	10.25"	\$3.89
728848	Root Pot 7 Gallon	13.875"	12.0"	\$4.49
728851	Root Pot 10 Gallon	16.0"	12.0"	\$5.29
728852	Root Pot 15 Gallon	17.0"	15.0"	\$6.29
728854	Root Pot 20 Gallon	18.875"	15.875"	\$8.99
728856	Root Pot 25 Gallon	21.0"	16.5"	\$9.99
728858	Root Pot 30 Gallon	24.0"	16.5"	\$11.99
728861	Root Pot 45 Gallon	27.0"	18.0"	\$13.99
728862	Root Pot 65 Gallon	32.0"	18.0"	\$18.99
728864	Root Pot 100 Gallon	38.0"	20.0"	\$23.99
728866	Root Pot 150 Gallon	45.0"	22.0"	\$31.99
728868	Root Pot 200 Gallon	50.0"	24.0"	\$37.99
728871	Root Pot 250 Gallon	55.0"	24.0"	\$34.99
728872	Root Pot 300 Gallon	60.0"	24.0"	\$46.99
728876	Root Pot 500 Gallon	80.0"	24.0"	\$69.99
728878	Root Pot 600 Gallon	80.0"	24.0"	\$84.99

Gro Pro® Nursery Pots with Textured Sides



NEW Gro Pro® Nursery Pots with Textured Sides are a heavy duty injection molded pots, and are much stronger than a traditional blow molded nursery pot. These pots are reusable and offer a long life span. The textured sides make these pots easy to handle and more aesthetically pleasing than traditional pots. Made with recycled material.

EXCLUSIVE

Item No.	Description	Vol [Gal]	Cu. Ft.	MSRP
725645	Gro Pro Nursery Pot w/ Textured Sides # 1	0.5	0.10	\$0.45
725650	Gro Pro Nursery Pot w/ Textured Sides # 2	1.4	0.20	\$1.02
725655	Gro Pro Nursery Pot w/ Textured Sides # 3	2.0	0.30	\$1.85
725660	Gro Pro Nursery Pot w/ Textured Sides # 5	2.9	0.40	\$2.22
725665	Gro Pro Nursery Pot w/ Textured Sides # 7	4.3	0.60	\$4.55
725670	Gro Pro Nursery Pot w/ Textured Sides # 10	8.4	1.20	\$5.35

Gro Pro® Premium Nursery Pots - Injection Molded



Gro Pro® Premium Nursery Pots are the best quality pots on the market! These injection molded pots have impact modified plastic added for extra strength and durability. They are much thicker and more durable than traditional blow molded nursery pots. BPA free.



EXCLUSIVE

Item No.	Description	Top Dim	Bottom Dim	Height Dim	MSRP
724800	Gro Pro Premium Nursery Pot 1 Gallon	6.3"	5.1"	7.0"	\$0.60
724805	Gro Pro Premium Nursery Pot 2 Gallon	9.0"	7.2"	8.5"	\$1.30
724810	Gro Pro Premium Nursery Pot 3 Gallon	10.5"	8.7"	8.8"	\$2.30
724815	Gro Pro Premium Nursery Pot 5 Gallon	12.0"	10.0"	10.2"	\$2.75
724816	Gro Pro Medium Duty Tall Nursery Pot 5 Gallon	11.4"	8.8"	12.0"	\$2.65
724820	Gro Pro Premium Nursery Pot 7 Gallon	15.1"	13.0"	11.6"	\$5.65
724825	Gro Pro Premium Nursery Pot 10 Gallon	17.7"	14.6"	11.8"	\$6.55
724830	Gro Pro Premium Nursery Pot 15 Gallon	19.0"	14.6"	15.0"	\$8.60
724835	Gro Pro Premium Nursery Pot 20 Gallon	21.7"	17.5"	17.0"	\$12.65
724808	Gro Pro Premium Nursery Pot 25 Gallon	25.3"	19.3"	18.7"	\$17.45

Gro Pro® Heavy Duty Container with Handles



This heavy duty pot is made with recycled Polyethylene (PE) plastic. The best feature is the built in lateral handles for an easy carrying.

EXCLUSIVE

Item No.	Description	MSRP
725458	Gro Pro Heavy Duty Container w/ Handles 9 Gallon NEW	\$5.82
725460	Gro Pro Heavy Duty Container w/ handles 20 Gallon	\$11.09
725465	Gro Pro Heavy Duty Container w/ handles 40 Gallon	\$26.00

Nursery Pots - Blow Molded



These traditional blow molded nursery pots offer quality at an economical price. They are engineered for strength, even in the large sizes. The integrated rim allows for convenient handling of large plants or trees.

Item No.	Description	MSRP
725520	Blow Molded Nursery Pot 7 Gallon	\$3.39
725525	Blow Molded Nursery Pot 10 Gallon	\$6.99
725530	Blow Molded Nursery Pot 15 Gallon	\$8.99
725535	Blow Molded Nursery Pot 20 Gallon	\$12.49
725540	Blow Molded Nursery Pot 25 Gallon	\$13.99

Nursery Pots - Thermoformed



The thermoforming process of these pots creates a thin wall nursery container of exceptional quality, which deliver several advantages over competitors' products including uniformity, durability, stackability and cost-effectiveness.

Item No.	Description	MSRP
725500	Thermoformed Nursery Pot 1 Gallon	\$0.52
725505	Thermoformed Nursery Pot 2 Gallon	\$1.23
725510	Thermoformed Nursery Pot 3 Gallon	\$1.73
725515	Thermoformed Nursery Pot 5 Gallon	\$2.27

Gro Pro® Round Plastic Mesh Bottom Pots



Excellent multipurpose pots made of hard black plastic. Works well for all indoor or outdoor applications.

EXCLUSIVE

Item No.	Description	MSRP
724120	Gro Pro Black Plastic Mesh Bottom Pot 12 in	\$4.95

Gro Pro® Premium Round Mesh Bottom Pots



Durable, thick black plastic with hole pattern that offers excellent drainage. Heavy duty injection molded design.

EXCLUSIVE

Item No.	Description	MSRP
724625	Gro Pro Premium Black Mesh Pot 6 in	\$1.60
724630	Gro Pro Premium Black Mesh Pot 8 in	\$2.95
724635	Gro Pro Premium Black Mesh Pot 10 in	\$3.50
724640	Gro Pro Premium Black Mesh Pot 12 in	\$6.00

Gro Pro® Square Plastic Cone Pots

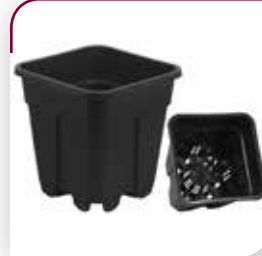

NEW Gro Pro® Square Plastic Cone Pots provide added oxygen to the soil environment. The bottom cone design allows oxygen to be drawn through the bottom of the container promoting healthy, strong roots. This cone technology promotes vigorous root growth while using less soil. Sturdy injection molded containers. Reusable and easy to clean.

EXCLUSIVE

Item No.	Description	MSRP
725052	Gro Pro Square Plastic Cone Pot 2 Gallon	\$4.00
725054	Gro Pro Square Plastic Cone Pot 4 Gallon	\$5.75

Gro Pro® Plant Warrior™ Pots



Gro Pro® Plant Warrior™ growing containers provide added oxygen to the soil environment. Patent pending design allows oxygen to be drawn through the bottom of the container promoting healthy, strong roots. Sturdy injection molded containers. Reusable and easy to clean.

EXCLUSIVE

Item No.	Description	MSRP
724790	Gro Pro Plant Warrior Pot 1 Gallon	\$1.05
724792	Gro Pro Plant Warrior Pot 2 Gallon	\$2.10
724794	Gro Pro Plant Warrior Pot 3 Gallon	\$2.65
724795	Gro Pro Plant Warrior Pot 5 Gallon	\$3.65

Gro Pro® Round Plastic Ribbed Tubs



NEW Gro Pro® Round Plastic Ribbed Tubs are made from recycled Polyethylene (PE) Plastic. These durable pots are reusable.

EXCLUSIVE

Item No.	Description	MSRP
725056	Gro Pro Round Plastic Tub .8 Gallon - 3 Liter	\$0.75
725058	Gro Pro Round Plastic Tub 1.2 Gallon - 4.5 Liter	\$1.00
725060	Gro Pro Round Plastic Tub 1.6 Gallon - 6 Liter	\$1.35
725062	Gro Pro Round Plastic Tub 2.4 Gallon - 9 Liter	\$1.85

Gro Pro® Root Master Pots

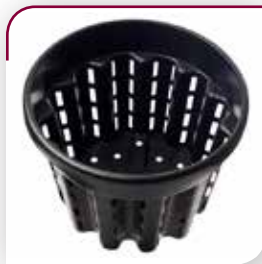

These unique pots allow proper root training & air pruning with strategically placed ventilation channels. They prevent spiraling & root burrowing which causes plant instability. Using these great pots will increase the overall health of plant's root structure, allow for greater stability when transplanting & increase nutrient & water uptake.

EXCLUSIVE

Item No.	Description	MSRP
744795	Gro Pro Root Master Pot 6 in (2 Liters)	\$1.53
744797	Gro Pro Root Master Pot 7 in (3 Liters)	\$1.62
744800	Gro Pro Root Master Pot 8 in (5 Liters)	\$2.18
744805	Gro Pro Root Master Pot 10 in (7.5 Liters)	\$3.82
744810	Gro Pro Root Master Pot 12 in (20 Liters)	\$6.55
744815	Gro Pro Root Master Pot 14 in (25 Liters)	\$8.73
744820	Gro Pro Root Master Pot 16 in (35 Liters)	\$10.91

RootMaker® Containers



RootMaker® containers do not allow the roots to wrap, instead, they direct the roots to air holes where they can't escape and the roots can get air pruned. This process is repeated with the branching roots to create a healthy, fibrous root system.

Item No.	Description	MSRP
724780	RootMaker Container 1 Gallon	\$2.49
724781	RootMaker Container 3 Gallon	\$6.95
724782	RootMaker Container 5 Gallon	\$9.95

RootBuilder® II

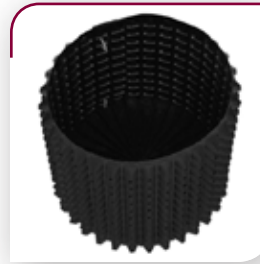

The RootBuilder® II design allows roots to reach the container wall to find the air holes immediately. The downward protrusions make the root virtually impossible to escape root tip pruning. They also create shade, keeping the root system much cooler.

Item No.	Description	MSRP
724783	RootBuilder II 1 Gallon	\$5.95
724786	RootBuilder II 3 Gallon	\$10.48

Gro Pro® Premium White Pots



These high quality pots can be used for a variety of indoor or outdoor gardening applications. Injection molded heavy duty plastic pots.

EXCLUSIVE

Item No.	Description	MSRP
724590	Gro Pro Premium White Square Pot 6 in x 6 in x 8 in	\$1.65
724592	Gro Pro Premium White Square Pot 7 in x 7 in x 9 in	\$2.75
724594	Gro Pro Premium White Square Pot 9 in x 9 in 10.5 in	\$4.65

Gro Pro® Anti-Spiraling Black Plastic Square Pots



NEW These unique pots allow for proper root training with strategically placed channels in the middle of the sides of this square pot. These channels prevent spiraling and root burrowing which causes plant instability. Using these great pots will increase the overall health of plant's root structure, allow for greater stability when transplanting and increase nutrient and water uptake.

EXCLUSIVE

Item No.	Description	MSRP
725042	Gro Pro Anti-Spiraling Black Plastic Square Pot 5 x 5 x 8 in	\$1.00
725044	Gro Pro Anti-Spiraling Black Plastic Square Pot 7 x 7 x 9 in	\$1.75

Gro Pro® Black Plastic Square Pots



NEW These pots are durable and versatile. They are injection molded containers manufactured with high-grade polypropylene.

EXCLUSIVE

Item No.	Description	MSRP
725046	Gro Pro Black Plastic Square Pot 5 x 5 x 5.25 in	\$0.55
725048	Gro Pro Black Plastic Square Pot 5 x 5 x 7 in	\$0.75
725050	Gro Pro Black Plastic Square Pot 7 x 7 x 10 in	\$1.65

Gro Pro® Premium Square Black Plastic Pots



Premium Square Black Plastic Pots are durable, thick black plastic. They feature injection molding, a heavy duty design, good grip for easy handling and stand off feet for better drainage.

EXCLUSIVE

Item No.	Description	MSRP
724645	Gro Pro Premium Black Square Pot 6 in x 6 in x 8 in	\$1.65
724650	Gro Pro Premium Black Square Pot 7 in x 7 in x 9 in	\$2.75
724655	Gro Pro Premium Black Square Pot 9 in x 9 in x 10.5 in	\$4.65
724660	Gro Pro Premium Black Square Pot 8 in x 8 in x 7.5 in	\$4.00

Gro Pro® Square Plastic Pot



Nice quality pots made from a slightly thinner material than other pots we offer. Great for a variety of hydroponic and soil applications.

EXCLUSIVE

Item No.	Description	MSRP
724425	Gro Pro Square Plastic Pot 5.5 in x 5.5 in x 6 in	\$0.55

Gro Pro® Black Plastic Pots



These pots are durable and versatile. They are injection molded containers manufactured with high-grade polypropylene.

EXCLUSIVE

Item No.	Description	MSRP
724042	Gro Pro Black Plastic Pot 3.5 in x 3.5 in x 3 in	\$0.37
724044	Gro Pro Black Plastic Pot 4 in x 4 in x 3.5 in	\$0.39
724046	Gro Pro Black Plastic Pot 5.5 in x 5.5 in x 5.75 in	\$1.20

Black Square Pots



The new square shape with the textured exterior and patterned design at the top stands out from the rest of the pots. Made from copolymeric polypropylene that is stabilized to handle the UV rays.

EXCLUSIVE

Item No.	Description	MSRP
725400	Black Square Pot 1/2 Gallon	\$0.76
725405	Black Square Pot 1 Gallon	\$1.27
725410	Black Square Pot 1.5 Gallon	\$1.80
725415	Black Square Pot 2 Gallon	\$2.25
725420	Black Square Pot 5 Gallon	\$3.80
725425	Black Square Pot 8 Gallon	\$6.40

Black Square Saucer for Black Square Pots



These saucers are made to work with the Black Square pots. Made from the same copolymeric polypropylene that is stabilized to handle the UV rays. Match your saucer size to the pot size to pair them up for a beautiful combination.

EXCLUSIVE

Item No.	Description	MSRP
725430	Black Square Saucer for 1/2 Gallon Pot	\$0.35
725435	Black Square Saucer for 1 Gallon Pot	\$0.58
725440	Black Square Saucer for 1.5 Gallon Pot	\$0.67
725445	Black Square Saucer for 2 Gallon Pot	\$0.85
725450	Black Square Saucer for 5 Gallon Pot	\$1.27
725455	Black Square Saucer for 8 Gallon Pot	\$2.67

Black Square Plastic Pots

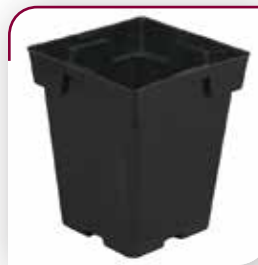

Reusable injection molded strength and durability. Bi-level drainage holes for excellent drainage. Smooth exterior resists salt and dirt. Tag slot is a great feature on our Jumbo, Senior and Magnum square pots. For hydroponic or soil use.

Item No.	Description	MSRP
724135	Black Square Pot (Jumbo) 5 in x 5 in x 5 in	\$1.39
724140	Black Square Pot (Jumbo Senior) 5 in x 5 in x 6.5 in	\$1.39
724160	Black Square Pot (Magnum) 6 in x 6 in x 7 in	\$1.59

Traditional Square Pots - Blow Molded



Economical blow-molded plastic pots. Flexible and smooth for easy plant removal and transplanting.

EXCLUSIVE

Item No.	Description	MSRP
724032	Square Plastic Pot Black 3.5 in	\$0.20
724034	Square Plastic Pot Black 4 in	\$0.24

Perfect Pot



The Perfect Pot is durable and flexible, designed for use with large plants, for soil and hydro growers alike. Dimensions: 8.5 in x 8.5 in x 7.5 in.

Item No.	Description	MSRP
724525	Perfect Pot	\$5.99

Grodan® Giant Pot



This large, durable Dutch pot can be used for a variety of gardening applications. 16 drain holes for excellent drainage. Great for use with all types of growing media. Made with heavy duty plastic. Thicker than standard pots. Dimensions: 12 in x 12 in (top) x 8.5 in x 8.5 in (bottom) x 12 in tall. Capacity: 4.75 gallons.

Item No.	Description	MSRP
724395	Giant Pot Black 12 in x 8.5 in x 12 in	\$6.86

Grodan® Rose Bucket



Rose bucket is another quality Dutch container that works great with one Hugo block, Growcubes, Granulate, coconut fiber or other loose media. Four bottom and side holes for excellent drainage. Dimensions: 7.6 in x 7.6 in x 9.7 tall. Capacity: 1.7 gallons.

Item No.	Description	MSRP
724385	Rose Bucket Black 7.6 in x 7.6 in x 9.7 in	\$4.35

Grodan® Maxipot



This excellent quality Dutch container hold two Hugo's or can be used for any loose media. Four bottom and four side holes for excellent drainage. Thicker than standard pots. Dimensions: 9.6 in x 9.6 in x 11.5 tall. Capacity: 3.1 gallons.

Item No.	Description	MSRP
724390	Maxipot Black 9.6 in x 9.6 in x 11.5 in	\$5.46

Gro Pro® Black Plastic Buckets - 3.5 & 5 Gallon



These premium quality, black plastic buckets can be used for a variety of gardening applications. Many growers use these as containers to grow their plants in. You can even place the 3.5 gallon bucket inside the 5 gallon bucket to build your own hydroponic growing system.



EXCLUSIVE

Item No.	Description	MSRP
724379	Gro Pro Black Plastic Bucket 3.5 Gallon	\$7.65
724380	Gro Pro Black Plastic Bucket 5 Gallon	\$9.10

Gro Pro® White Plastic Bucket 5 Gallon



NEW These premium quality, white plastic buckets can be used for a variety of gardening applications. Many growers use these as containers to grow their plants in. You can even place a 5 gallon bucket inside another 5 gallon bucket to build your own hydroponic growing system.



EXCLUSIVE

Item No.	Description	MSRP
724383	Gro Pro White Plastic Bucket 5 Gallon	\$9.10

Gro Pro® Bucket Lid

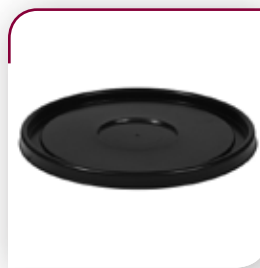

Made for use with Gro Pro® Black Plastic Buckets 3.5 and 5 gallon. Can be used with other standard 3.5 and 5 gallon buckets too.

EXCLUSIVE

Item No.	Description	MSRP
724381	Gro Pro Bucket Lid - Flat for 3.5 & 5 Gallon Buckets	\$3.65

Gamma Seal® Bucket Lid



Transform standard 3.5 & 5 gallon our (white or black) buckets into airtight, water proof, leak proof, pest-proof storage containers with this Gamma Seal® Lid. Simply snap the universal adapter ring onto your bucket and spin-on the removable, threaded lid. Can be used for dry or liquid storage. Made from high density polyethylene. FDA approved food grade plastic. BPA free. Approximately 12 in diameter.

Item No.	Description	MSRP
740780	Gamma Seal Lid for 3.5 and 5 Gallon Buckets	\$11.95

Gro Pro® Mesh Pots/ Bucket Lids



These heavy duty 6 in, 8 in & 10 in plastic pots are designed specifically to snugly fit on standard 3.5 and 5 gallon buckets. They are mesh on the sides and bottom for maximum aeration. They work great in all hydroponic applications. Much better quality than competitive bucket lids.

EXCLUSIVE

Item No.	Description	MSRP
724529	Gro Pro Mesh Pot/Bucket Lid 6 in	\$4.15
724530	Gro Pro Mesh Pot/Bucket Lid 8 in	\$4.15
724535	Gro Pro Mesh Pot/Bucket Lid 10 in	\$4.65

Aero Bucket Lid with Mesh Bottom

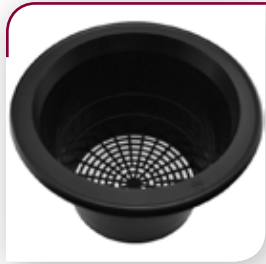

Fits on the top of standard 3.5 and 5 gallon buckets.

Item No.	Description	MSRP
724110	Aero Bucket Lid w/ Mesh Bottom 10 in	\$5.50

EZ Store™ Container/Buckets 8 & 13 Gallon & Lid



Made with virgin, high density polyethylene material. These patented containers have no holes in them and can hold up to 8 or 13 gallons of liquid. EZ Store™ containers are nestable, with built in hand grips. The lid is compatible with both sizes. It has a recessed fit with a tear strip and a built in handle on the front portion of the hinged lid, creating easy access without removing the lid.

Item No.	Description	MSRP
703990	EZ Store Container/Bucket 8 Gallon	\$14.99
703992	EZ Store Container/Bucket 13 Gallon	\$22.99
703994	EZ Store Lid for 8 and 13 Gallon	\$4.99

Flo-n-Gro® Blue Bucket - 2 Gallon



NEW The Flo-n-Gro® Blue Bucket features food grade plastic, safe for you and your plants. Dimensions: 9.5 in wide x 9.5 in long x 10 in deep. Use to build your own hydroponic system! Does not include 3/4 in grommet. Use with Tub Outlet Tee Fitting 3/4 in #747186 or 1/2 in #742266 and Drip-n-Gro® Short Mesh Insert #350800 both sold separately. 0.835 inch hole pre-drilled in bucket. 90 Days Warranty.

EXCLUSIVE

Item No.	Description	MSRP
707642	Flo-n-Gro Blue Bucket - 2 Gallon	\$5.75

Flo-n-Gro® Blue Bucket - 4 Gallon



The Flo-n-Gro® Blue Bucket features food grade plastic, safe for you and your plants. At 4 gallon capacity. Dimensions: 9.5 in W x 9.5 in L x 13.5 in D. Compatible with the Ebb & Flow 6 & 12 Site Systems and Drip-n-Gro® System. Does not include 3/4 in grommet. Use with Tub Outlet Tee Fitting 3/4 in #747186 or 1/2 in #742266 sold separately. Works with Flo-n-Gro® 2 gallon #350800 and 3 gallon #707640 mesh inserts.

EXCLUSIVE

Item No.	Description	MSRP
707635	Flo-n-Gro Blue Bucket - 4 Gallon	\$6.59

Flo-n-Gro® Black Mesh Insert - 3 Gallon



This 3 gallon black mesh insert fits snugly in the Flo-n-Gro® Ebb and Flow Grow System. The rigid plastic insert keeps its shape for years and the open mesh basket allows for optimal air and water flow that promotes healthy root growth for your plants.

EXCLUSIVE

Item No.	Description	MSRP
707640	Flo-n-Gro Black Mesh Insert	\$6.59

Flo-n-Gro® Clear Vented Lid



The innovative Flo-n-Gro® clear vented cover allows you to maintain the perfect humidity level for your sensitive plant starts. By adjusting the ventilation slots on the top of the cover, you can dial in your garden for optimum growth. Can be used with both 2 and 3 gallon mesh inserts.

EXCLUSIVE

Item No.	Description	MSRP
707645	Flo-n-Gro Clear Vented Lid	\$8.29

Flo-n-Gro® Drip-n-Gro® Mesh Insert - 2 Gallon



This 2 gallon black mesh insert fits snugly in the Flo-n-Gro® Drip-n-Gro® System. The rigid plastic insert keeps its shape for years and the open mesh basket allows for optimal air and water flow that promotes healthy root growth for your plants.

EXCLUSIVE

Item No.	Description	MSRP
350800	Drip-n-Gro Short Mesh Insert	\$6.99

Flo-n-Gro® Blue Bucket 6.6 Gallon



Oversized, food-grade, blue 6.6 gallon bucket. Dimensions: 14 in W x 14 in L x 12 in D – Polyethylene. This bucket not pre-drilled for outlet fitting. Works best with Hydro Flow® 3/4 in Tub Outlet Fitting #747186 or 1 in Tub Outlet Fitting #747308. Outlet fittings sold separately.



EXCLUSIVE

Item No.	Description	MSRP
724486	Flo-n-Gro 6.6 Gallon Blue Bucket	\$10.95

Flo-n-Gro® Black Bucket 6.6 Gallon



Oversized black 6.6 gallon bucket approved for potable water. Dimensions: 14 in W x 14 in L x 12 in D – Polyethylene.



EXCLUSIVE

Item No.	Description	MSRP
724480	Flo-n-Gro 6.6 Gallon Black Bucket	\$9.95

Flo-n-Gro® 6.6 Gallon Mesh Basket Lid 10 in



10 in wide black mesh insert basket for use with 6.6 gallon Gro Giant® black bucket. Dimensions: 14-1/4 in W x 14-1/4 in H x 7-1/4 in D - Polyethylene.



EXCLUSIVE

Item No.	Description	MSRP
724490	Flo-n-Gro 6.6 Gallon Mesh Basket Lid 10 in	\$9.95

Flo-n-Gro® Tsunami™ 5 Gallon Outer Bucket



NEW This is the outer bucket 5 gallon that is used in the Flo-n-Gro® Tsunami™ system. Comes pre-drilled with a 3/4 in grommet installed. No handle included. 90 Day Warranty.



EXCLUSIVE

Item No.	Description	MSRP
702888	Flo-n-Gro Tsunami 5 Gallon Outer Bucket	\$9.95

Flo-n-Gro® Tsunami™ 5 Gallon Inner Bucket



NEW This is the inner 5 gallon bucket that is used in the Flo-n-Gro® Tsunami™ system. Comes pre-drilled with aeration holes in the bottom of the bucket. No handle included. 90 Day Warranty.



EXCLUSIVE

Item No.	Description	MSRP
702889	Flo-n-Gro Tsunami 5 Gallon Inner Bucket	\$16.95

Gro Pro® Square Mesh Pot



This large mesh pot is perfect to hold plants in ebb and flow tables. The large base keeps the plant upright. The mesh on the sides and bottom allow for maximum aeration to the roots.

EXCLUSIVE

Item No.	Description	MSRP
724438	Gro Pro Square Mesh Pot 9 in x 9 in x 5-1/4 in	\$1.35

Gro Pro® Net Pots



Excellent quality net pots are thicker and more heavy-duty than most on the market. They offer a wider rim for better support. Smaller mesh allows the grower to use virtually all types of grow media.

EXCLUSIVE

Item No.	Description	MSRP
724500	Gro Pro Net Pot 2 in (100/Bag)	\$0.18
724505	Gro Pro Net Pot 3 in (100/Bag)	\$0.35
724510	Gro Pro Net Pot 3.75 in (100/Bag)	\$0.51
724515	Gro Pro Net Pot 5 in (30/Bag)	\$0.96
724520	Gro Pro Net Pot 6 in (30/Bag)	\$1.09

Gro Pro® Net Pot Lids



These durable white lids are designed specifically to fit net pots.

EXCLUSIVE

Item No.	Description	MSRP
724600	Gro Pro Net Pot Lid 2 in (10/Bag)	\$0.38
724605	Gro Pro Net Pot Lid 3 in (10/Bag)	\$0.56
724610	Gro Pro Net Pot Lid 3.75 in (10/Bag)	\$0.71
724615	Gro Pro Net Pot Lid 5 in (10/Bag)	\$1.31
724620	Gro Pro Net Pot Lid 6 in (10/Bag)	\$1.64

Gro Pro® Heavy Duty Net Pots



Gro Pro® Heavy Duty Net Pots are durable and designed to be re-used. The wider hole spacing allows for better root aeration. These net pots are great for use in flood and drain applications or in hydroponic systems.

EXCLUSIVE

Item No.	Description	MSRP
724429	Gro Pro Heavy Duty Net Pot 3 in	\$1.20
724430	Gro Pro Heavy Duty Net Pot 5.5 in	\$2.35
724435	Gro Pro Heavy Duty Net Pot 8 in	\$4.15

GH Net Cups



Made for use in a variety of different hydroponic or aeroponic systems. Works great with Hydroton®.

Item No.	Description	MSRP
724365	GH Net Cup 2 in (100/Bag)	\$0.29
724370	GH Net Cup 3 in (100/Bag)	\$0.54
724375	GH Net Cup 6 in (50/Bag)	\$2.20

GH CocoTek® Basket Liners



Perfect for aeroponic systems which use net baskets and loose growing mediums. This excellent CocoTek® product is designed to sit inside 2 in, 3 in and 6 in plastic baskets and prevent media from falling through.

Item No.	Description	MSRP
714025	GH CocoTek Basket Liner 3 in (20/Bag)	\$0.68
714045	GH CocoTek Basket Liner 8 in (10/Bag)	\$3.20

Gro Pro® NX Level™ Pot Elevators



NEW Gro Pro® NX Level™ Plant Elevation Platforms are specially designed to help raise your fabric or plastic pot out of the bottom of a saucer. This elevates the pot out of potential excess water that gathers in the saucers. This can be crucial in preventing root rot, mold issues and helps extend the longevity of your fabric or plastic pot. 725675 is best used for up to 7 gallon pots, 725677 is best used for up to 15 gallon pots, and 725679 is best used for up to 20 gallon pots.

EXCLUSIVE

Item No.	Description	MSRP
725675	Gro Pro NX Level Pot Elevator - 13 in	\$2.55
725677	Gro Pro NX Level Pot Elevator - 16 in	\$3.00
725679	Gro Pro NX Level Pot Elevator - 18.5 in	\$6.82

Gro Pro® Premium Clear Plastic Saucers



Clear PVC Premium Plastic Saucers for under your potted plants. Choose the size that will work with your pot.



EXCLUSIVE

Item No.	Description	Top Dim	Bottom Dim	Height Dim	MSRP
724665	Gro Pro Premium Clear Plastic Saucer 6 in	7.5"	6"	1.5"	\$0.45
724670	Gro Pro Premium Clear Plastic Saucer 8 in	9.5"	8"	1.5"	\$0.67
724675	Gro Pro Premium Clear Plastic Saucer 10 in	11.5"	10"	1.5"	\$1.07
724680	Gro Pro Premium Clear Plastic Saucer 12 in	13.8"	12"	1.5"	\$1.62
724685	Gro Pro Premium Clear Plastic Saucer 14 in	15"	13.8"	1.5"	\$1.80
724690	Gro Pro Premium Clear Plastic Saucer 16 in	17.5"	16"	1.5"	\$2.82
724695	Gro Pro Premium Clear Plastic Saucer 18 in	19.5"	17.8"	1.5"	\$3.64

Bond® Clear Plastic Saucers



Protection for your carpets and floors. Place under pots to catch leaking water. Use with plants and flowers to keep water where you want it without staining surfaces. Interior ridges keeps plant out of water to keep plant roots healthy. 100% recyclable plastic is waterproof and strong.

Item No.	Description	Top Dim	Bottom Dim	Height Dim	MSRP
740974	Bond Clear Plastic Saucer 8 in (25/Bag)	8"	6.8"	1.5"	\$0.45
740976	Bond Clear Plastic Saucer 10 in (25/Bag)	10"	8.8"	1.5"	\$0.67
740978	Bond Clear Plastic Saucer 12 in (25/Bag)	12"	10.8"	1.5"	\$1.07
740980	Bond Clear Plastic Saucer 14 in (25/Bag)	14"	12.8"	1.5"	\$1.30
740982	Bond Clear Plastic Saucer 16 in (25/Bag)	16"	14.5"	1.5"	\$2.18
740984	Bond Clear Plastic Saucer 21 in (25/Bag)	21"	19.5"	1.5"	\$3.59

Gro Pro® Heavy Duty Black Saucers



Durable, hard plastic. Washable and reusable. Many sizes to fit your needs.

EXCLUSIVE

Item No.	Description	Top Dim	Bottom Dim	Height Dim	MSRP
724930	Gro Pro Heavy Duty Black Saucer - 6 in	6"	5"	2.25"	\$0.60
724932	Gro Pro Heavy Duty Black Saucer - 8 in	8"	7"	2.25"	\$0.85
724934	Gro Pro Heavy Duty Black Saucer - 10 in	10"	9"	2.25"	\$1.30
724936	Gro Pro Heavy Duty Black Saucer - 12 in	12"	10.5"	2.25"	\$1.50
724938	Gro Pro Heavy Duty Black Saucer - 14 in	14"	12.6"	2.25"	\$2.45
724940	Gro Pro Heavy Duty Black Saucer - 16 in	16"	14.5"	2.25"	\$2.95
724942	Gro Pro Heavy Duty Black Saucer - 18 in	18"	17"	2.25"	\$6.55
724944	Gro Pro Heavy Duty Black Saucer w/ Tall Sides - 20 in	20"	17.7"	3.5"	\$9.80
724946	Gro Pro Heavy Duty Black Saucer w/ Tall Sides - 25 in	25"	22"	3.75"	\$17.40

Premium Plastic Saucers



Durable, hard plastic that is washable and reusable. New bigger sizes to accommodate larger nursery pots. Color - dark green, except 18 in, 20 in & 25 in which are black.

Item No.	Description	Top Dim	Bottom Dim	Height Dim	MSRP
724900	Green Premium Plastic Saucer 6 in	6"	5"	1.0"	\$0.63
724905	Green Premium Plastic Saucer 8 in	8"	7.8"	1.5"	\$0.95
724910	Green Premium Plastic Saucer 10 in	10"	8.8"	1.5"	\$1.35
724915	Green Premium Plastic Saucer 12 in	12"	10.3"	2.0"	\$1.79
724920	Green Premium Plastic Saucer 14 in	14"	12.3"	2.0"	\$2.59
724925	Green Premium Plastic Saucer 16 in	16"	14.3"	2.0"	\$3.09
724927	Black Premium Plastic Saucer 18 in	18"	16"	2.4"	\$5.93
724928	Black Premium Plastic Saucer 20 in	20"	18"	3.2"	\$8.70
724929	Black Premium Plastic Saucer 25 in	25"	22"	3.2"	\$15.51

Mondi™ Super Saucers



Ergonomic easy-grip edges allow you to grab and carry the saucer with pot from any side. Protects your carpet, tile, wood and metal shelves from moisture and dirt. Manufactured in high quality plastic. Ideal for potted plants that draw up water from below.

Item No.	Description	MSRP
724439	Mondi Super Saucer 6 in	\$0.66
724441	Mondi Super Saucer 8 in	\$0.96
724443	Mondi Super Saucer 10 in	\$1.48
724444	Mondi Super Saucer 12 in	\$1.99
724446	Mondi Super Saucer 14 in	\$2.79

Gro Pro® Grow Bags



Pre-packaged in quantities of 25 grow bags for easy handling. Durable & excellent quality bags. Holes in the bottom allow proper drainage. Use your favorite media and plant right in the bag.

EXCLUSIVE

Item No.	Description	MSRP
724400	Gro Pro Grow Bags 1 Gallon 25/Pack	\$0.16
724402	Gro Pro Grow Bags 2 Gallon 25/Pack	\$0.24
724405	Gro Pro Grow Bags 3 Gallon 25/Pack	\$0.27
724410	Gro Pro Grow Bags 5 Gallon 25/Pack	\$0.38
724412	Gro Pro Grow Bags 7 Gallon 25/Pack	\$0.44
724415	Gro Pro Grow Bags 10 Gallon 25/Pack	\$0.60
724418	Gro Pro Grow Bags 20 Gallon 25/Pack	\$1.05
724420	Gro Pro Grow Bags 30 Gallon 25/Pack	\$1.62

Botanicare® Camo Grow Bag - 30 Gallon



Sturdy 6 mil plastic bag with pre-punched drain holes and great digital camo print. Fill with preferred media. Plant right in the bag.

Item No.	Description	MSRP
740072	Botanicare Camo Grow Bag 30 Gallon	\$5.75

New products are updated daily. Check the Sunlight Supply® web site often to see the latest new products



The Indoor Gardening Guide



A comprehensive reference which covers all the topics needed to better understand the principles of gardening, both indoor and out. Contains detailed information on subjects ranging from growing methods, hydroponic systems, nutrients and additives, lighting and lighting accessories, fans and filters, CO₂, environment, pests and diseases as well as all the different mediums available to gardeners today.

Item No.	Description	MSRP
800910	The Indoor Gardening Guide	\$12.99

Gardening Indoors with Soil & Hydroponics by George F. Van Patten

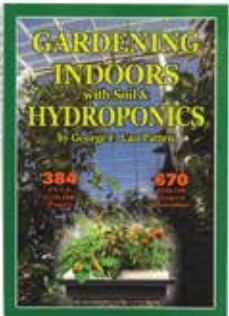

This Fifth Edition of this book is expanded and completely rewritten with all new information. More than 670 full color photos, drawings, charts and graphs illustrate every detail of this authoritative easy-to-understand book.

Item No.	Description	MSRP
800978	Gardening Indoors w/ Soil & Hydroponics	\$24.95

Hydroponic Basics - The Basics of Soilless Gardening Indoors by George F. Van Patten

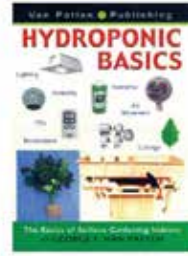

This simple, little book is packed with information on hydroponic gardening. The graphic color, layout, and design helps guide a hydroponic gardener through basic plant science and environment to purchasing a garden and appropriate supplies. Soft cover – 80 pages.

Item No.	Description	MSRP
800980	Hydroponic Basics - Soilless Gardening Indoors	\$5.99

**Thank you for choosing
Sunlight Supply products!
Make your wish list here!**



*A complete line of indoor
and outdoor growing containers*



gro-pro.net
#gropro

PRODUCT NO. 724800
**GRO PRO 1 GALLON
PREMIUM NURSERY POT**
MADE IN THE USA
BPA FREE

DO YOU WANT RESULTS?

FEWER PROBLEMS?

USE

HYGROZYME™

START 2 FINISH

CLEAN SYSTEMS = BETTER RESULTS

CLEANER

STABILIZED ENZYME COMPATIBLE
WITH HYDROGEN PEROXIDE

MEANER

HIGHLY CONCENTRATED
ENZYME POWER

GREENER™

BPA FREE BOTTLES
COMPATIBLE WITH ALL FERTILIZATION PROGRAMS

DON'T BE FOOLED BY FERTILIZERS
PRETENDING TO BE ENZYMES

PLANTS DON'T LIE - IT WORKS!™

GUARANTEED RESULTS OR YOUR MONEY BACK



SIPCO BIOENGINEERING INC
SIPCOBIO.COM
MANUFACTURER

HYGROZYME GLOBAL DISTRIBUTION LTD
HYGROZYME.COM
SALES AND MARKETING SUPPORT

Lighting control

Easy. Safe. Flexible. Sexy.



- Replaces traditional light controllers and eliminates inrush
- Central lighting control: switch, dim and boost **80 ballasts**
- Expand control to hundreds of fixtures with optional booster
- Control **one room, or 2 rooms** 12/12 alternating
- **Auto-dim** at high temperature
- **Auto shutdown** at emergency temperature with **alarm interface**
- **Sunrise / sunset** control
- Switches **2x15 amps accessories** (heating, fertigation, CO2 etc)
- Suitable for all Gavita **Pro** line and **DigiStar e-series** products
- Suitable for Gavita **Pro** line 277/347V **e-series** (Q3 2015)

Gavita Master Controllers

www.gavita-holland.com

GAVITA HOLLAND
PROFESSIONAL LIGHTING

The best just got better

Pro line e-series



Gavita **Pro** 6/750° DE FLEX



Suitable for
Gavita **Master** Controllers



In 2009 we introduced the first double ended fixtures in the hydroponics market, starting a revolution in high efficiency lighting. Now our fixtures have become a defacto standard in the industry. Gavita continues to set the standard with the new Pro line e-series fixtures and the Gavita Master Controller. Thirty years of experience and innovation in horticultural lighting come together in our best fixtures ever.



Gavita **Pro** 600° SE



Gavita **Pro** 1000° DE



Gavita **Pro** 270° LEP

GAVITA HOLLAND
PROFESSIONAL LIGHTING

www.gavita-holland.com



Unique, innovative products constructed with premium materials

BUY WITH CONFIDENCE!

FOUNDATION FOR YOUR *HEALTHY* PROPAGATION STARTER KIT

Mondi Easy Grow Combo

The Mini-Greenhouse, Clean & Strong premium propagation tray and Mondi Mini Greenhouse Thermo-Hygrometer combine seamlessly into the growers choice propagation solution!



Mondi Mini Greenhouse Thermo-Hygrometer
Temperature and Humidity Meter
Part #726125

Mondi Clean & Strong premium propagation tray
Part #726120

Call your local sales office



WHY DO YOU BUY MONDI?
It is the only product on the market that uses a proprietary plastic that is non-offgassing.

NEW!



Clean & Strong premium propagation tray



Super reinforced sides and lip, thick plastic and UV protection for durability and long life.



Engineered tray-ends add extra strength, making them easier to carry and move.



Deep, continuous channels and 'level fit' wide ridges prevent water pooling and provide better stability for propagation media.

CAPACITY: 6L / 1.6GAL - TRAY MEASUREMENTS: 21.5" x 11.2" x 2.5" - CASE MEASUREMENTS: 22" x 14" x 13" - UNITS PER CASE: 50

ALSO AVAILABLE

Mondi Propagation Tray 1020 no holes



Part #726150

Mondi Propagation Tray 1020 with holes



Part #726155

features

Clean

- Premium grade virgin materials for cleanliness and durability.
- Premium white plastic for increased light reflectivity.

Strong

- Reinforced outside shell made from recycled materials provide strongest support to date.
- Black base prevents light penetration to the root zone and reduces the chance of root disease.
- Best design 1020 flat (standard propagation tray) on the market.
- Perfectly fits all Mondri Mini Greenhouses.

Mondi Mini-Greenhouse 7" with Easy Vents

- A professional propagation dome for starting seeds or cuttings
- Constructed from proprietary food-grade materials that do not off gas and kill plants



Part #726140

Mondi Mini-Greenhouse 7" No Vents

- Perfectly fitted for standard trays, to create a tight seal and reduce moisture loss



Part #726142



Part #726135

Mondi Mini-Greenhouse 4" with Easy Vents

- Temperature and humidity controlled by two adjustable vents for better growing results



Part #726130

Mondi Mini-Greenhouse 4" No Vents

- Heavy duty plastic maximizes light penetration with lasting durability

For a complete product line visit: www.mondiproducs.com

Enhanced Plant Growth with Resilience™ Enriched Growing Mixes



PLANTS WILL BE STRONGER, MORE VIGOROUS AND MORE DROUGHT RESISTANT.



RESILIENCE™
LICON ENRICHED

ORGANIC STRENGTH™

**Results will vary by plant type and grower practices*

sungro
HORTICULTURE

Our Expertise is Growing

© 2014 Sun Gro Horticulture Canada Ltd. All Rights Reserved

*BlackGold is a registered trademark of OOM Enterprises, LLC, and used under a license.

Sunshine Advanced, Sunshine and Sun Gro are registered trademarks of Sun Gro Horticulture Canada Ltd.

Resilience and Organic Strength are used as trademarks of Sun Gro Horticulture Canada Ltd.

www.sungro.com

CONSISTENT GROW MIXES FOR EXTREME PERFORMANCE

Sunshine® Mix #4



Recommended where high air capacity and fast drainage are needed: during winter months, with water and salt sensitive crops, or where frequent leaching is required. Contains Resilience™ for stronger stems and improved root mass.

Available Sizes:

3.8 CF compressed bales - **SKU: #714745**
Sunshine Mix #4 with myco. 3.0 cu ft also available - **SKU: #714743**

Ingredients: Canadian Sphagnum peat moss, coarse Perlite, starter nutrient charge with gypsum, dolomitic limestone, long-lasting wetting agent.

Sunshine® Advanced Mix #4



- Sunshine Advanced #4 Growing Mix is recommended for indoor growing
- This myco-active mix retains moisture while providing improved root aeration and drainage
- Contains Resilience™ for stronger stems and improved root mass
- Expands up to 2x
- OMRI® Listed

Available Sizes:

1 CF (100/pallet) - **SKU: #714766**
2.2 CF (50/pallet) - **SKU: #714767**
3 CF (35/pallet) (expands to up to 6 CF) - **SKU: #714768**

Ingredients: Canadian Sphagnum peat moss, perlite, coir, dolomite lime, gypsum, organic fertilizer, proprietary blend of endomycorrhizae and organic wetting agent.

Black Gold® Natural & Organic Potting Mix



- Made from the finest ingredients, our Natural & Organic Potting Mix is an all-purpose mix recommended for containers and raised beds and ensures good aeration
- Contains Resilience™ for stronger stems and improved root mass
- OMRI® Listed

Available Sizes:

1.5 CF (50/pallet) - **SKU: #714750**

Ingredients: Canadian Sphagnum peat moss, bark, compost, perlite or pumice or cinders, earthworm castings, and organic fertilizer

Black Gold® Just Coir



- This natural soil amendment with high water-holding capacity is pure, processed, low-salt coconut coir
- We take the highest quality coir, and reconstitute it into a user-friendly, ready-to-use growing amendment
- OMRI® Listed

Available Sizes:

2 CF (40/pallet) - **SKU: #714565**

Ingredients: Coconut coir

Black Gold® Waterhold Cocoblend Potting Soil



- Our all-organic Waterhold Cocoblend Potting Soil naturally retains water and has added beneficial ingredients for optimal growth and aeration
- Blend with Black Gold's® Starter & Transplant Fertilizer with mycorrhizae to boost new plantings
- Contains Resilience™ for stronger stems and improved root mass
- OMRI® Listed

Available Sizes:

2.0 CF (40/pallet) - **SKU: #714754**

Ingredients: Canadian Sphagnum peat moss, coir, perlite or pumice or cinders, earthworm castings, dolomite lime, organic fertilizer and organic wetting agent

mondi™

Unique, innovative products
constructed with premium materials

**THANK YOU FOR MAKING MONDI™ YOUR #1 SELLING
GARDEN ACCESSORY IN NORTH AMERICA!**

Mondi Mini-Greenhouse
7" with Easy Vents



Part #726140

7" No Vents

Part #726142

Mondi Mini-Greenhouse
4" with Easy Vents



Part #726135

Part #726130

4" No Vents

**Mondi Premium
Propagation stand**



model #R100

**Mondi Mini Greenhouse
Thermo-Hygrometer**
Complete installation kit



Part #726125

**Mondi Clean & Strong Premium
Propagation Tray**
1020 no holes
Part #726120

NEW!



Mondi Propagation Tray
1020 no holes



Part #726150

1020 with holes
Part #726155



**Mondi Snip it!
Precision Shears**
straight or
curved blade
model #G700, #G705



Mondi Super Saucer
Part #724439, #724441,
#724443, #724444, #724446



**Mondi Metal
Bamboo Stakes**
model #G454, #G455, #G456,
#G464, #G465, #G466



**Mondi Bamboo
Stakes**
model #G430-68 #G440-68



Mondi Utility & Sump Pump
1585x - gold series
Part #727095

FITTINGS
INCLUDED

Mondi Telescopic Water Wand

36" to 52"
Part #708711

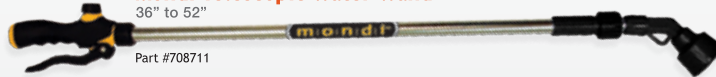

**Mondi Utility
& Sump Pump**
1200x - gold series
Part #727096



FITTING
INCLUDED

**Mondi Mist &
Spray Premium**
tank sprayer
1.4L / 1.5 QT



Part #708725

**Mondi Mist
& Spray Deluxe**

tank sprayer 1.2L / 1.3 QT
tank sprayer 2.0L / 2.1 QT



1.3 Qt
Part #708715



2.1 Qt
Part #708720



Mondi Water Pump Extension
with ball valve - 30" to 42"
Part #708710

Call your local
sales office



For a complete product line visit:
www.mondiproductions.com



GRODAN PRODUCTS ARE LIGHTWEIGHT WHEN IT COUNTS.

Lugging heavy products into a store and stacking it neatly on shelves takes considerable time and effort.

With lightweight GRODAN products, it's much easier to transport, organize and set up displays—leaving more time for you to focus on your customers.

Your customers will also appreciate how easy it is to purchase and use GRODAN's lightweight but superior growing media—leaving more energy for them to focus on their plants.

Why put your back into it when you can put your brain into it instead?

grodan101.com

Grow like a pro.



grodan[®]



Sunlight Supply, Inc.
National Garden Wholesale

Black Lightning

POWDER FREE NITRILE GLOVES



6 mil with pH5.5 Technology!

At Atlantic Safety Products, we take great pride in providing gloves that offer serious protection from your work environment while keeping your most important tools, your hands, in top condition for maximum productivity. Our **Black Lightning** gloves offer excellent barrier protection!

- **Breakthrough pH5.5 Technology!** Made to match healthy skin's natural pH 5.5 levels to ensure the **MOST** comfortable fit yet!
- **Unique formulation reduces excess perspiration**
- **Quadruple washed – no excess chemicals lingering on the glove**
- **Super strength and stretch – no more tearing**
- **Fully textured grip**
- **Approved for medical use**

Caution: Components used in making these gloves may cause allergic reactions in some users. Follow your institution's policies for use.

©2013 ATLANTIC SAFETY PRODUCTS, INC. ALL RIGHTS RESERVED. 2013.248

Item Number	Size
BL-S	SMALL
BL-M	MEDIUM
BL-L	LARGE
BL-XL	X-LARGE
BL-XXL	XX-LARGE

100 gloves/box, 10 boxes/case



A family of hand protection and safety products under one roof.





IF YOU START CLEAN, WHY GET DIRTY LATER?

Pro growers start plants in GRODAN media because it is hygienic, thus reducing the risk of pathogens and harmful insects that can pose a serious threat to the plants.

Pro growers also grow mature plants in GRODAN media because the grower can more precisely control the nutrients and water resulting in healthy, larger plants.

It is true that GRODAN media can be easily transplanted into other media. But why would you want to?

GRODAN...for the entire life of your plant.

grodan101.com

Grow like a pro.



DEFENSE SYSTEM FOR YOUR PLANTS

INSECT CONTROL • DISEASE CONTROL • FUNGUS CONTROL



Made from high quality botanical extracts, you can trust Arborjet's Eco-line to defend your plants from a broad range of insects and diseases.

- Won't burn under grow lights
- Use indoors & out
- Non-toxic to people & pets
- Same day harvest of food crops
- Available as Ready to Use & Concentrates

For more information call 781-935-9070
or visit www.arborjet.com

ARBORJET
Revolutionary Plant Health Solutions

PRO-MIX®

NOTHING SAYS GROWING MEDIA BETTER™



INOCULANTS WITH GUARANTEED VIABLE SPORES

- Improves nutrient and water uptake
- Increases plants' resistance to stresses from nutrient imbalances and drought to increase post-transplanting survival rate
- Increases crop vigour, plant quality and quantity of flowers/fruits

PROVEN RESULTS†

TOMATO	
+38%	INCREASE IN FRUIT PRODUCTION
GREEN PEPPER	
+90%	INCREASE IN FRUIT PRODUCTION

† Results obtained from independent plant growth trials. Individual growth results may vary to a degree. Additional results and details are available.



**FOR HIGHER YIELDS,
USE PRO-MIX® HP GROWING MEDIA
WITH CUTTING-EDGE BIO-ADDITIVES.**



1 800 667-5366
VISIT PTHORTICULTURE.COM

PRO-MIX® is a registered trademark of Premier Tech Ltd. or its affiliated companies © Premier Tech Ltd. All rights reserved.



RHIZO GEL™

RHIZO BLAST™

Rhizo Gel promotes root growth on herbaceous and woody cuttings, allowing easy absorption of the rooting hormone Indole-3-Butyric Acid. The addition of Vitamin B1 and a light, Botanicare nutrient charge will strengthen your delicate cuttings while antiseptic components ensure a sterile and clean wound for quick healing.

- 0.20% Indole-3-Butyric Acid.
- Vitamin B1.
- Antiseptic and Chelating Agents.

Rhizo Blast is a proprietary synthesis of seaweed, vitamins, minerals, amino acids, sugars, trace minerals, saponins, and the single celled algae, Chlorella. This particular form of Chlorella, the key ingredient in Rhizo Blast, is cultivated specifically for Botanicare and acts as a natural delivery system for plant growth hormones.

- Explosive root growth.
- Increased nutrient uptake which increases root and plant biomass.
- Ideal for use in transplanting.
- Promotes root branching and fine root hairs.
- Enhances plant vigor in fast flowering plants.



Visit botanicare.com to learn more.

PRO-MIX®

NOTHING SAYS GROWING MEDIA BETTER™



PROTECT & ENHANCE



OUTSTANDING RESULTS

NOW AVAILABLE
1.5 CU FT BAGS



A UNIQUE CHUNK COIR

NOW AVAILABLE
1.5 CU FT BAGS

PRO-MIX® HP GROWING MEDIA WITH CUTTING EDGE BIO-ADDITIVES

PROVEN RESULTS†

HP MYCORRHIZAE™

SALVIA

+39%

FLOWER & FOLIAGE DRY WEIGHT

LETTUCE

+44%

TOP DRY WEIGHT

HP-CC MYCORRHIZAE™

TOMATO

+38%

INCREASE IN FRUIT PRODUCTION

† Results obtained from independent plant growth trials. Individual growth results may vary to a degree. Additional results and details are available.

PROMIX® PUR™

PRO-MIX® PUR™ is a line of advanced inoculants aiming for professional growers who seek growth enhancement and protection for high-value crops.



1 800 667-5366

VISIT PTHORTICULTURE.COM

PRO-MIX® is a registered trademark of Premier Tech Ltd. or its affiliated companies © Premier Tech Ltd. All rights reserved.



PURE MYCORRHIZAL INOCULANT



Xtreme GARDENING

ORGANIC ROOT ENHANCER



Granular Mycorrhizae



Wettable Powder Mycorrhizae

MYKOS IS A SPECIFIC SUPER SINGLE SPECIES OF MYCORRHIZAE

- Supreme nutrient and water management
- Alleviate drought stress on plant growth, can and reduce the effects of transplant shock and saline conditions
- Mykos works fast and creates strong roots for 90% of common plants
- Supplies and balances all necessary minerals and vitamins
- Produces healthier and more vigorous plants
- Improves root size and root surface area
- Beneficial soil quality and nutrient cycling
- 9 World records grown with champion grade Mykos mycorrhizae

PROVEN RESULTS



FOR MORE BENEFITS IN YOUR GARDEN, USE XTREME GARDENING'S ORGANIC MICROBES



xtreme-gardening.com

BUSH DOCTOR

DESIGNED TO BE

AMAZING



HAND CRAFTED FOR
ORGANIC GARDENING

www.FoxFarmFertilizer.com

Call us at 800-4 FOXFARM

S C I E N C E M A D E S I M P L E



VERMI PRO™

0.03 - 0.03 - 0.03

Maximum Drainage Soilless Medium



**Coco Coir, Grower's
White Peat, Aged
Softwood Bark & Perlite** «

**Highest Mychorrizal
Fungi Count in any
Soilless Medium!** «

Available January 2015 «

VERMICROP ORGANICS | a Bio-Organic Solutions, Inc. Company
5050 Arboga Road | Olivehurst, CA 95961 | 800.994.8775

VISIT WWW.VERMICROP.COM FOR MORE INFO

FOXFARM

SOIL & FERTILIZER COMPANY

DESIGNED TO BE

AMAZING



www.FoxFarmFertilizer.com

Call us at 800-4 FOXFARM

Hi·LUX GRO™

made in Germany

professional grade horticulture lamps

USHIO, a world leader in specialty light sources since 1964, introduces enhanced horticulture lamps to meet any grower's needs.

- Available in 400W, 600W & 1000W
- Super high output lamp technology
- Reliable operation throughout the growth cycle
- Ultimate full spectrum grow lamp
- Achieve maximum vegetative growth and maximum flower yield!
- Made in Germany in ISO 9001 certified factory

Visit www.ushio.com/HiLuxGro for technical details and a list of authorized distributors.

DIGITAL BALLAST FRIENDLY*

*operate lamps on suitable ballasts & ignitors only.

USHIO

USHIO America, Inc. 800-838-7446



Scan with a smartphone to view product data online.



PREMIUM MICROBIAL INOCULANTS

Great White



Mycorrhizae
Beneficial Bacteria
Trichoderma
Glycine
B1
Plant Vitamins

Great White is the most complete mycorrhizal inoculant available. Just dust it on the roots and you're done. The original and still the best.



Orca

Mycorrhizae
Beneficial Bacteria

The Cleanest and easiest mycorrhizal product. Simply dilute a small amount of this concentrated blend into water and apply to plants.



Jellyfish

Mycorrhizae
Beneficial Bacteria
Trichoderma
Seaweed
Humic Acids
Glycine
B1

Jellyfish coats transplants in a living blend of beneficials and fungi. It bonds to the roots ensuring maximum colonization while keeping roots moist during transplant.



www.plant-success.com

SIMPLY THE BEST

No Ducting Failures, No Complaints, Just Satisfaction!

When you invest in ThermoFlo Ducting your investment **REALLY PAYS OFF ...**

What does this mean?

ThermoFlo 2000SR

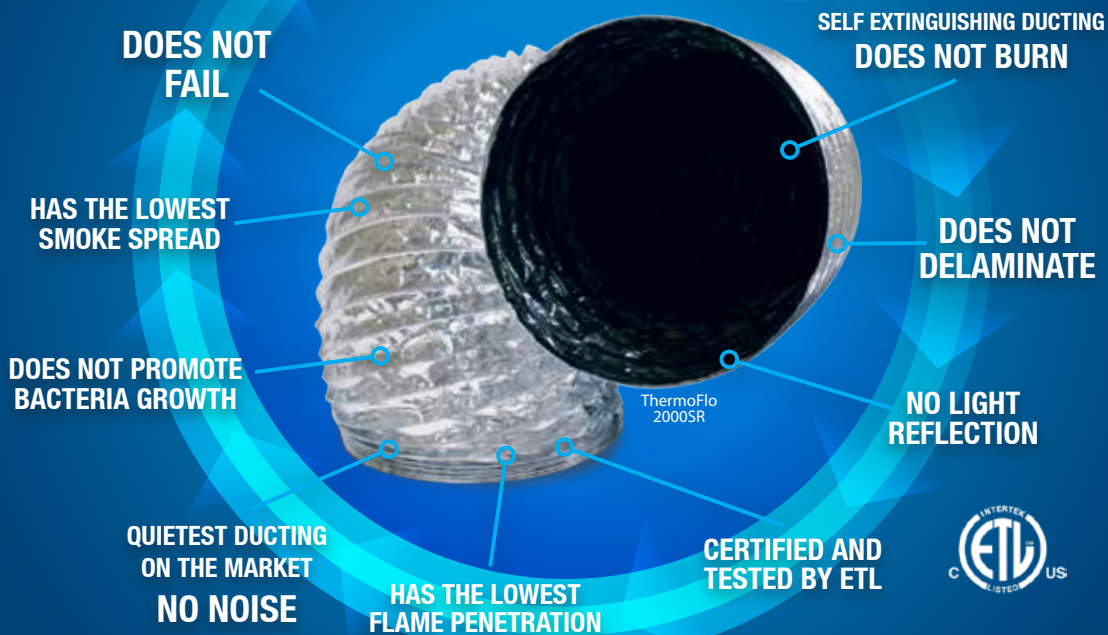

- Superior North American proprietary technology and design.
- We only use the Best American Made raw materials.
- Most technologically advanced machinery in the world.
- Made in North America - Keeping American Suppliers working.
- Exceeds all testing limits set by testing agencies - Guaranteed!
- Certified and tested to exceed the highest USA standards.
- Engineered to work in the harshes conditions.
- Strictest quality controls to ensure there are NO DEFECTS.

ThermoFlo
TECHNOLOGIES LTD

Call your local sales office



Proud to be associated with



1.866.321.1020

www.thermoflotech.com

Mike O'Rizey



IT'S ALL ABOUT
THE ROOTS

Pure ORGANIC Endo Mycorrhizae



4 oz Display



4 oz



2 lb



5 lb

4
SPECIES

**Plant
Success**
We Know Roots

www.plant-success.com

The Recipe For Success

10 Exceptional products for everything you grow.

Mixing Chart RECIPE for SUCCESS
Grow to Master Harvest!

CUTTING STAGE
For each the medium (soil, peat, perlite, vermiculite, etc.) with a solution of **Thrive Alive B-1 Root**. Mix 10 ml (2 tsp) of **Thrive Alive B-1 Root** for every 1 liter (1 quart) of water to prepare the solution. Increase the rest of each watering into **Research Cleaning Gel** for a few seconds, and immediately insert into the prepared medium.

TRANSPLANTING STAGE
While setting up initial a strong root system, keep the frequency with **Thrive Alive B-1 Green** solution. Mix 10 ml (2 tsp) of **Thrive Alive B-1 Green** for every 1 liter (1 quart) of water to water the container. Immediately after transplanting, apply a measure of both **SugarDaddy** and **NOCT 66** to produce both vegetative growth, to reduce aggressive root development, and to reduce the light related stress. Mix the following nutrients for water 1 liter (1 quart) of water to produce the solution:
SugarDaddy - 10 ml (2 tsp)
NOCT 66 - 10 ml (2 tsp)

VEGETATIVE STAGE
SHORT CYCLE: 100% - 100%
Once your plants have established root systems, they are ready to begin vegetative growth at an 18-hour light cycle. Change your medium and weekly. Apply the following **MIXTURE** formula with 10 ml (2 tsp) of each component to the water. Mix the following nutrients for water 1 liter (1 quart) of water to water dry **100% 100%** formula:
B-1 Root - 11 ml (2 tsp)
B-1 Green - 11 ml (2 tsp)
Thrive Alive B-1 Root - 11 ml (2 tsp)

ALWAYS ADD BOOST FIRST!



\$\$VALUE\$\$
EASE OF USE
PERFORMANCE



www.technaflora.com

©2015 Technaflora Plant Products Ltd.



LIKE US ON

Must be a
Bluelab grower

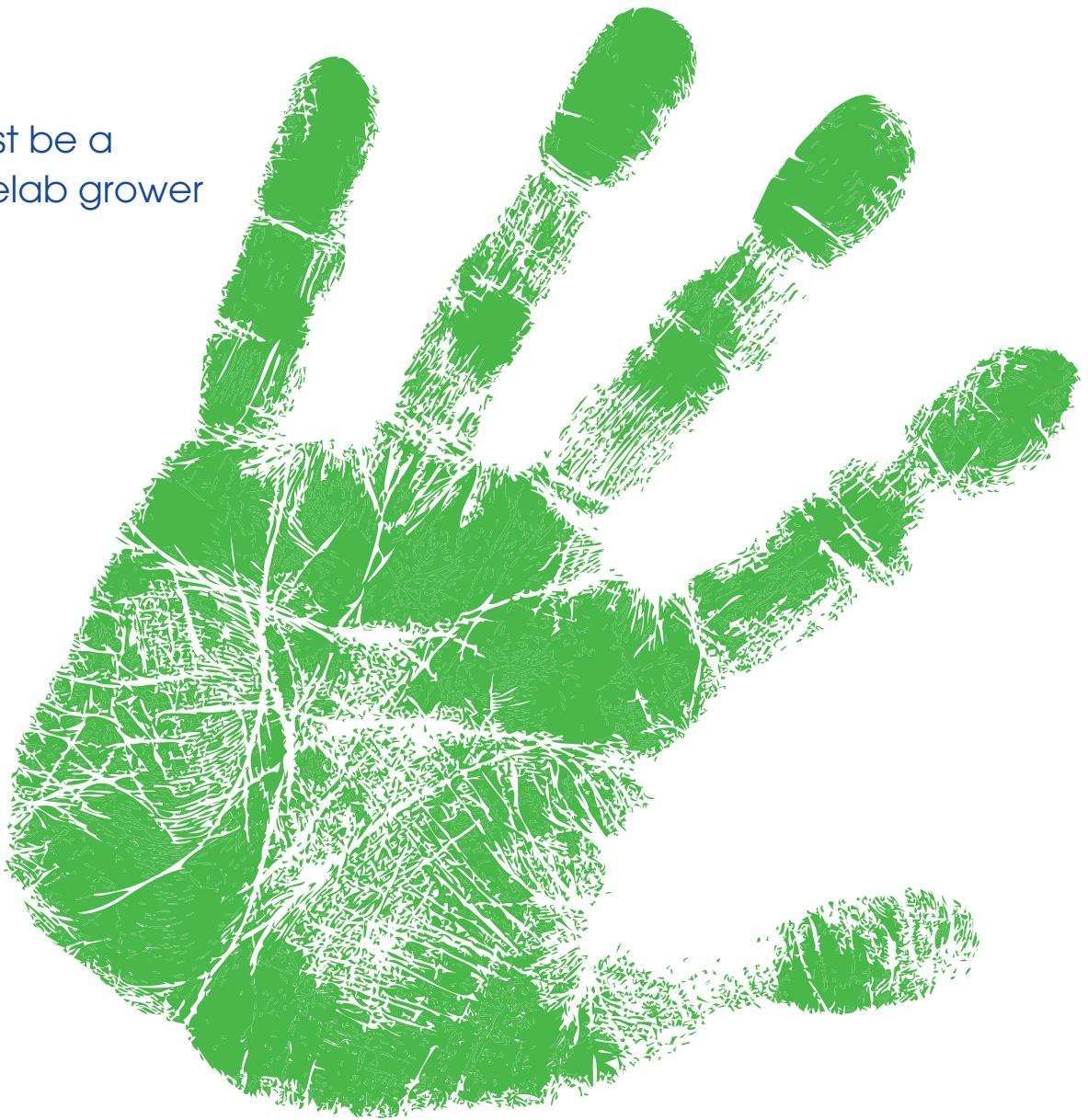

We make it easy to have green fingers.

Crop health? Crop productivity? At Bluelab, they're the air we breathe.

With simple, accurate monitoring of pH, conductivity and temperature, we'll tell you exactly what's happening in your growing environment. And help you manage growing conditions superbly, for the strongest, healthiest, most reliable plants.

Product reliability? Bank on it. We're made in New Zealand to the very highest manufacturing standards. We provide the longest guarantees around. And the easiest product returns and change-outs when needed.

All backed up with on-hand advice and support when you want it. It's all part of our unmatched, local North American customer focus.

They're qualities that have brought us brand leadership, and we stand by them day in day out. So your fingers stay green 24/7.

bluelab.com



Look for
the leaf!

BIOAG

The original trusted source.



STILL FAMILY OWNED AND OPERATED

Independence, Oregon

SUPERNATURAL[®]

BRAND



www.supernaturalbrand.com

FLYING



NUKE^{EM}

SKULL

PLANT PRODUCTS

World's Most Advanced Insecticide & Fungicide

- Kills Broad, Russet, Cyclamen and Spider Mites
- Kills Powdery Mildew, Mold and Yeast
- Can be used throughout including day of and after harvest
- Spray low dose for weekly maintenance
- Won't slow plant growth (No oil, No soap, No detergent)
- No harmful residue
- May reduce worker's comp or insurance claims



FLYING



Part 1

SKULL

PLANT PRODUCTS

Enzyme Cleanser

- World's Most Advanced Enzyme Cleanser
- Great for Soil and all Hydro Systems
- Super High Customer Satisfaction Rate
- Eliminates Bio-film and inanimate slime
- Answer to problem root zones
- Creates proper osmotic conditions
- Concentrated – Super Economical

FLYING



Part 2

SKULL

PLANT PRODUCTS



**FOR MORE INFORMATION
VISIT WWW.FLYINGSKULL.NET
(888) 770-8808**





EXCELLENCE DELIVERED

SUNMASTER[®]
LIGHTING SYSTEMS FOR GREATER YIELDS



Quality - Science - Integrity - Service
20 years as a leader the in Hydroponic industry
Designed and engineered in the US & Canada

Look for Sunmaster Products in this Catalog!



FOLLOW US



@SUNMASTERLAMPS!

SunmasterGrowLamps.com

© 2014 Venture Lighting International, Inc. Sunmaster is a registered trademark of Venture Lighting International. SUN-0166A5_v3-1214

Simply MAGnificent!

SUPREME AQUA-MAG® MAGNETIC DRIVE WATER PUMPS have been designed to handle the needs of professionals and hobbyists for over 20 years with efficient, quiet, and reliable performance.

Supreme Aqua-Mag® Magnetic Drive Water Pumps are ideal in either saltwater or freshwater environments and operate equally well in-line or submerged. With only one moving part, a magnetically-driven impeller, and an epoxy-encased power unit, there's never a fear that it will contaminate your water with harmful oils or chemicals.

Supreme Aqua-Mag® Magnetic Drive Water Pumps are available in capacities from 250 to 2400 GPH.

So when it comes to moving water... start with Supreme Aqua-Mag® Magnetic Drive Water Pumps! Their performance is simply MAGnificent!



Supreme®
AQUA-MAG®

MAGNETIC DRIVE WATER PUMP

A PRODUCT OF



ISLANDIA, N.Y. | 631.234.5261 | WWW.DANNERMFG.COM

SNS 203™ SNS 217™ SNS 217C™ SNS 244™ SNS 244C™ SNS 311™ SNS 604A™ SNS 604B™ SNS Hydrobiotics™



WATER IT IN, WIPE 'EM OUT!

SNS-209™ All Natural Systemic Pest Control
Repels and Controls Spider Mites, Whiteflies,
Fungus Gnats, Thrips, Root Aphids, Larvae and More.



Mites



Gnats



Thrips



Aphids



www.sierranaturalscience.com



S-600
347 CFM
 4.9 CFM PER WATT

S-800
728 CFM
 3.14 CFM PER WATT

TO FIND OUT WHAT SEPARATES THE S-LINE FROM OTHER FANS, YOU HAVE TO GET INSIDE IT.

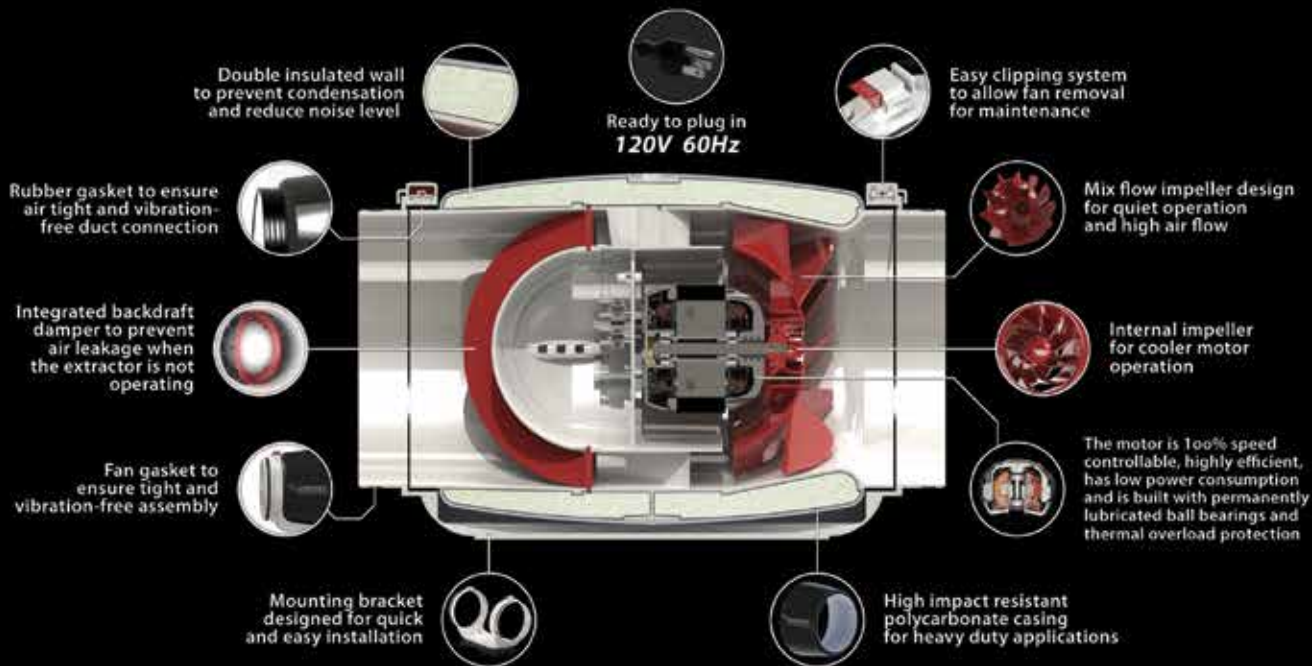

VORTEX
POWERFANS S-line

WHERE INNOVATION IS A STANDARD

WWW.ATMOSPHERE.COM



CLONEX[®]

Clonex Mist | Rooting Gel | Clonex Solution | Clonex Kit

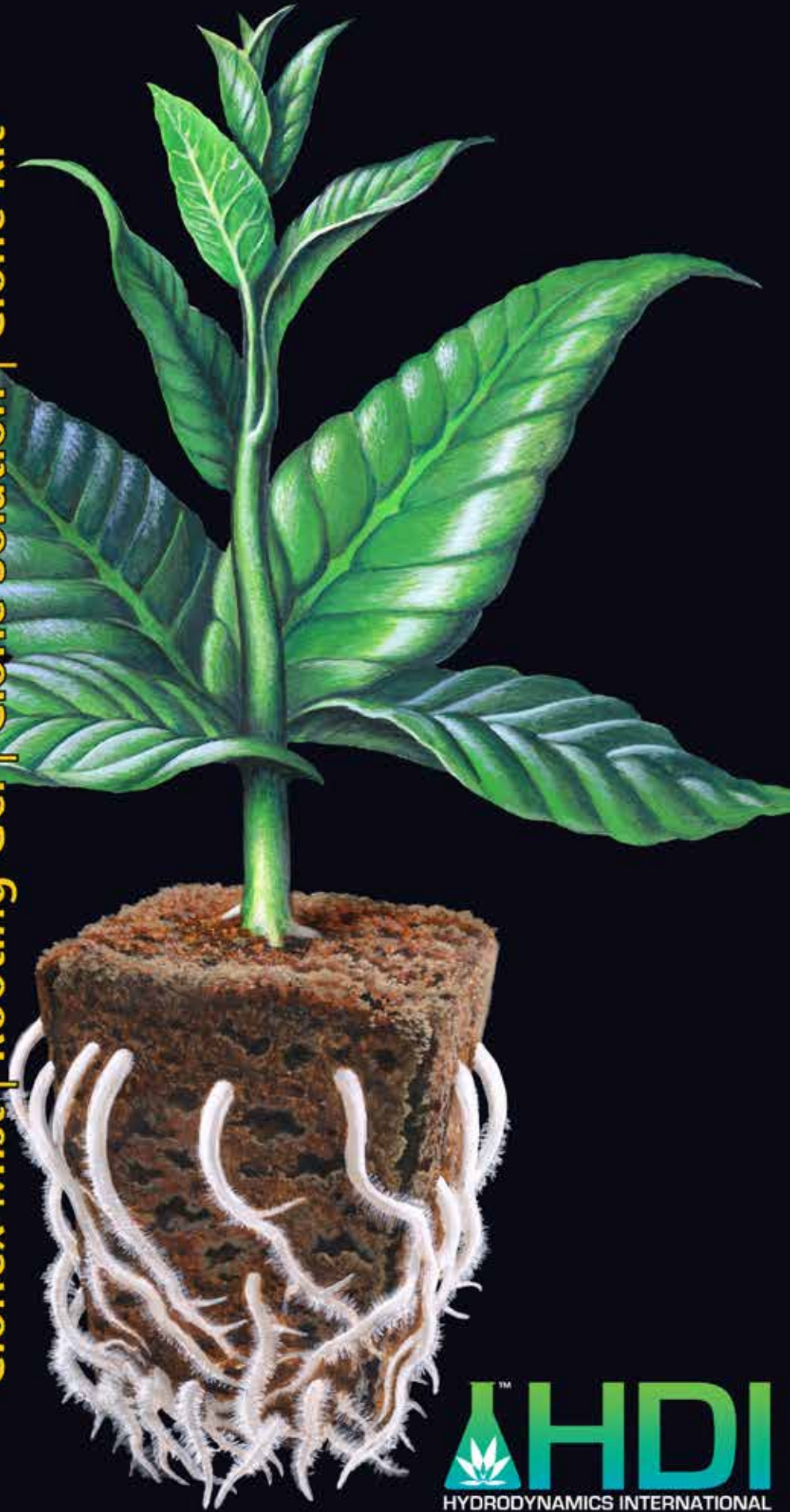

HDI
HYDRODYNAMICS INTERNATIONAL

San Francisco Indoor Cycling Show
July 26-27, 2014
 Can-Filters® Booths 826, 837, 724, and 738



Max-Fan
 PRO SERIES

canfilters.com

They were efficient and designed the original Max-Fan® design. The Max-Fan™ PRO SERIES has a built-in rubberizing Max in the fiberglass reinforced plastic compound that meets all of the UL and CSA requirements. Quiet, Strategic 3 Speed Control and True Performance.



I'M YOUR BIGGEST FAN



canfilters.com

I GOT 99 PROBLEMS BUT ODOR AIN'T ONE

The Original Can-Filters

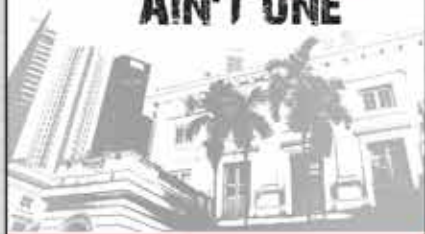

canfilters.com

Longer Lasting industrial quality filter

The real world test is whether it can survive the harsh conditions of industrial environments. Can-Filters® has a proven track record for longer lasting filters. The quality of our filters is proven by the fact that our filters are used in the most demanding industrial environments. The quality of our filters is proven by the fact that our filters are used in the most demanding industrial environments.



The Original Can-Filters. L'authentique.

Demand the Best. Accept No Imitations.

canfilters.com

ACTIVE CAN-LITE FILTER

The Can-Lite™ Active Filter. A further built filter.

51% More active carbon than standard filters	2.5 times more surface area than standard filters
10% More active carbon than standard filters	2" less depth than standard filters

Why is the Can-Lite™ a better built filter?

- Higher active carbon content
- Higher surface area
- Higher CFM (air flow)
- Higher efficiency
- Higher quality materials
- Higher quality construction
- Higher quality control
- Higher quality service
- Higher quality support

The Original Can-Fan

canfilters.com

Made in Canada

The Original Can-Filters. L'authentique.



SIMPLY THE BEST - ACCEPT NO IMITATIONS

MEET MAX

The most energy efficient fan of its type in the world.

- Smaller
- Quieter
- Proven by Action
- High CFM
- Low Voltage Consumption
- Proven by Action

Ask for it by name

Max-Fan

themaxfan.com

when you need the **BEST**



canfilters
 ACCEPT NO IMITATIONS



SOLD HERE



Max-Fan
 PRO SERIES

The Original Can-Filters
 canfilters.com

Q-Max™

The quiet line.

Integrated Max-Fan and smart fan blade for maximum sound reduction.

Standard Max-Fan™ | Ready to Hang | True CFM



Available in 10" and 12" diam.
 10" model is 115V/60Hz/1.5A/1.5HP

canfilters.com

trusted for

EXCELLENCE

in odor control



neutralizes odors, naturally

www.onaonline.com

ona

odor neutralizing agent

SAMSUNG

DUCTLESS AIR CONDITIONERS



WHISPER

Samsung reimagines the ductless air conditioner with the all new Energy Star-rated Whisper. With a revolutionary new triangle design, the Whisper can cool faster, farther and wider while using less energy than previous Samsung mini split systems. With the optional WiFi feature, you can even control your Whisper from anywhere with the convenience of your tablet or smartphone*. Experience a whole new frontier of ductless air conditioning with the truly innovative Whisper mini split.

MAIN FEATURES

- ▲ **Energy Star-Rated / Smart Inverter**
Works smart and saves energy.
- ▲ **Full HD Filtration**
Filters dust, contaminants and allergens.
- ▲ **2-Step Cooling**
Cools fast, then comfortably.
- ▲ **Single User Mode**
Use the Whisper when you're without wasting energy.
- ▲ **Triple Protector Plus**
3-step protection so your Whisper operates for a long time.
- ▲ **Easy Filter**
Clean and maintain your filter with ease.
- ▲ **Smart Features**
Convenient installation and maintenance.
- ▲ **WiFi Control**
Control your Whisper over the internet
(must install Smart AC app from Google Play Store).

*Internet connection is required for this feature



SAMSUNG



TAPPIN'ROOTS

**All Stages - 100% Natural -
Growth Simulant**

**Impressive
Results**

(No magic beans required)





Down To Earth™ Premium Natural and Organic Fertilizers

We take pride in offering only the highest quality ingredients, which contributes to an effective and environmentally friendly approach to plant care, crop fertilization and soil management.

For more than 30 years, *Down To Earth™* has been carefully formulating our fertilizers and soil amendments from the best sources of organic plant

nutrients in ideal proportions, without the use of synthetics, growth stimulants, or low quality fillers, such as poultry waste.

So, whether it's our multi-purpose blends or single ingredient fertilizers, you can be confident that you are providing your customers the best product available.



ALL NATURAL FERTILIZERS™

Trusted Quality since 1977

Now available through Sunlight Supply

We turn
Grow-Ops
into
Gardens.

NECTAR
FOR THE GODS
WWW.OREGONONLY.COM

ROYAL GOLD

Made In Humboldt



royalgoldcoco.com

NEW LABELS COMING SOON

SAME TOP QUALITY ORGANICS...NEW LOOK!



**PURE
BLACK CASTINGS**
99% PURE WORM CASTINGS
(1-0.5-0.02)



VERMAPLEX
ORGANIC SPECIALTY FERTILIZER
(.48-0.01-0.016)

PROFESSIONAL ORGANICS FOR PROFESSIONAL GROWERS

ALL ORGANIC COMPANION PRODUCTS

6-20-6 WITH KELP | BLACK SEA KELP | LIQUID YUCCA | HYDROLIZED FISH | LIQUID HUMATE PLUS | CORAL CALCIUM



(6.0-20.0-6.0)

(1.0-1.0-17)

(0.16-0-0)

(2.0-5.0-0)

4% HUMIC ACID

34% CALCIUM
CARBONATE

**GARDENS
AND NURSERIES**



HYDROPONICS



**AGRICULTURE
AND TURF**



**ORCHARDS
AND VINEYARDS**



Sunlight Supply, Inc.
National Garden Wholesale.



**NORTHERN
EMPIRE
ORGANICS**

Give Back Her
STOCKINGS!

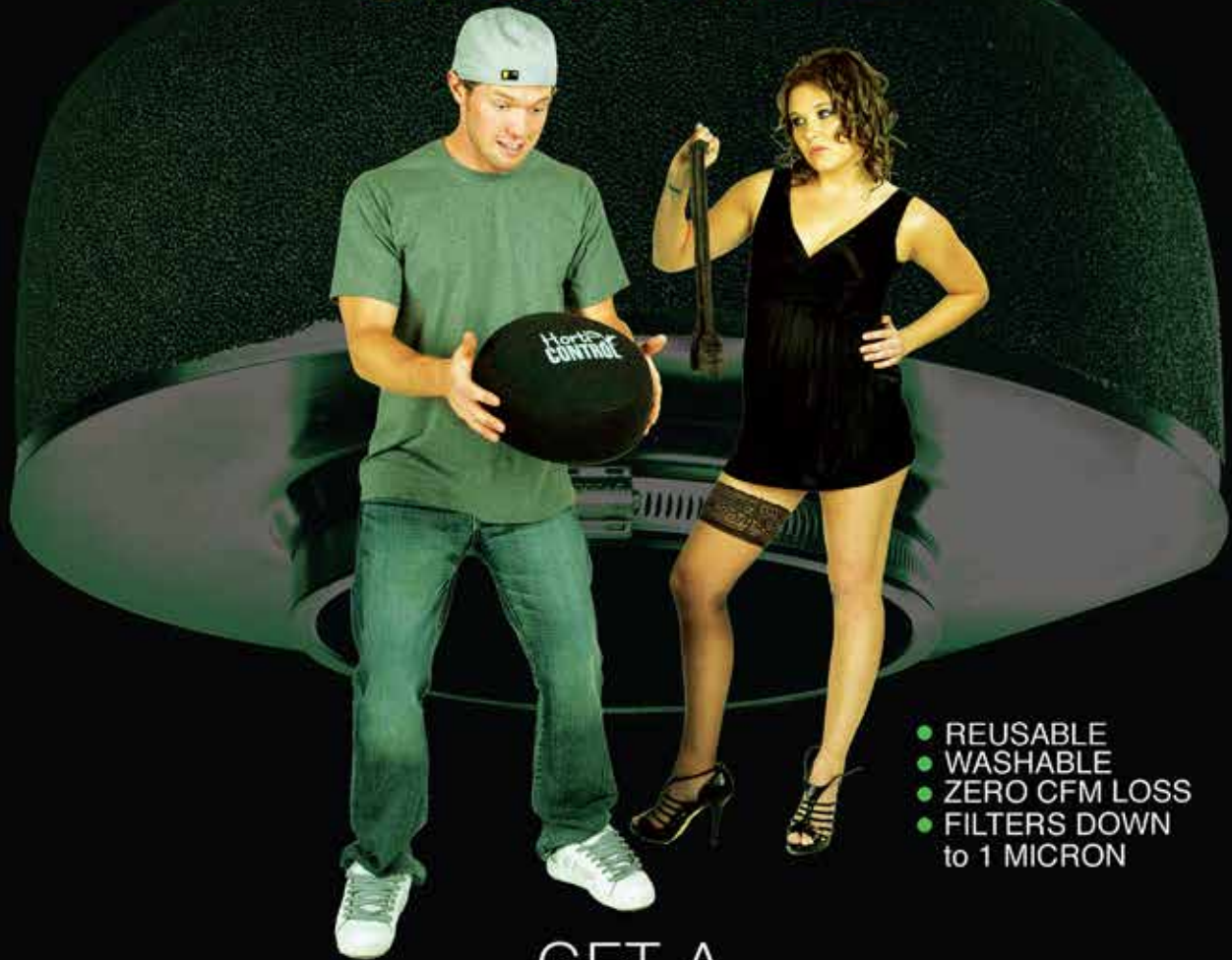

- REUSABLE
- WASHABLE
- ZERO CFM LOSS
- FILTERS DOWN to 1 MICRON

GET A
DUST SHROOM!

The Horti-Control Dust Shroom is a PATENT PENDING reusable foam HEPA filter designed to keep dust, dirt, bugs, mold, and bacteria out of indoor gardens and air cooled reflectors.

Horti-Control teamed up with UNI Filter, the world leader in foam filter design for motorcycles, autos, light trucks, and small engines to design a filter for indoor gardeners. This revolutionary filter will keep your air cooled reflectors, inline fans, ice boxes, and ducting dust free, and keep mold, mildew, pests and bacteria out of your garden! Each specific Dust Shroom model was designed on a flow bench for optimum airflow, and is hand crafted by UNI technicians at UNI Filters headquarters in Fullerton, CA.

Horti-
CONTROL
www.horticontrol.com



Did you know that
Hi-Brix™ Molasses For Plants
is also available as a
FULL ON 2-part plant nutrient
for hydroponics, soil and coir?



Hi-Brix™ Grow Hi-Brix™ Bloom

• EASY • ECONOMICAL • EFFECTIVE

For more details stop by
www.earthjuice.com

We Invite You to Feel the Power of a Dynamic Finish



"Nice job Dyna-Gro!! The new Dyna-FLUSH really made our product taste better. It also allowed the plant to better use up the available nutrients that were already stored in the plant which resulted in a better taste with a full and robust harvest!" Thanks team Dyna-Gro.
Aloha
Gerald Garrison
Green Applied Sciences

Use our complete line of nutrients for powerful results.

Product Name	Foliage-Pro®	Grow	Bloom	Mag-Pro	Pro-TekT®	K-L-N	Root-Gel®
Mineral Element	%	%	%	%	%	%	%
Nitrogen	9	7	3	2			
Ammoniacal Nitrogen	2.9	2.6	0.7	1.1			
Nitrate Nitrogen	6.1	4.4	2.3	0.9			
Phosphorus	3	9	12	15			
Potassium	6	5	6	4	3		
Calcium	2	2	2				
Magnesium	0.5	0.5	0.5	2.0			
Sulfur	0.05	0.05	0.09	1.5			
Boron	0.01	0.02	0.02				
Chlorine	0.006	0.1	0.1				
Cobalt	0.0005	0.0015	0.0015				
Copper	0.05	0.05	0.05				
Iron	0.1	0.1	0.1				
Manganese	0.05	0.05	0.05				
Molybdenum	0.0009	0.0009	0.0009				
Nickel	0.0001	0.0001	0.0001				
Sodium	0.05	0.1	0.1				
Zinc	0.05	0.05	0.05				
Silicon					7.8		
Indole 3-butyric acid						0.07	0.216
1-Napthaleneacetic acid						0.1	0.027

800-DYNA-GRO
WWW.DYNA-GRO.COM





HORTILUX[®]

only the sun can do it better

Grow Lamps & Ballasts



www.eyehortilux.com



MyCO2

mushroomgrowkits.com



GROW
Reishi Mushroom



BLOOM
Oyster Mushroom

CUSTOMER ACTIVATED CO₂ BAG Mushroom Kit

combination - patents pending

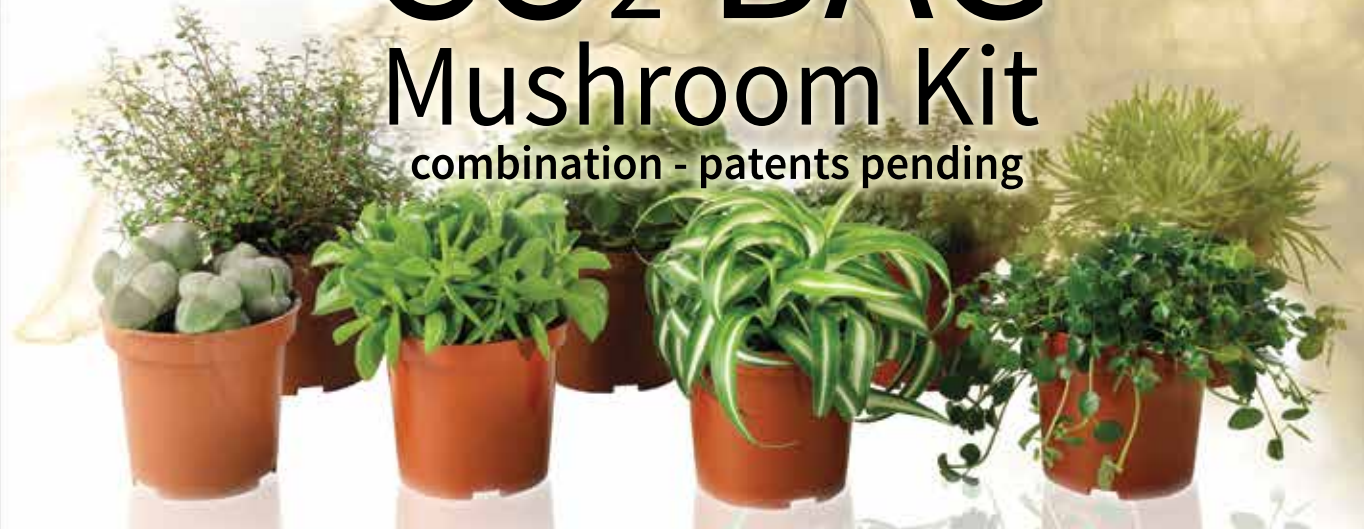

Recyclable



Reusable Clip



Sunlight Supply, Inc.
National Garden Wholesale.



GreenCleaner

Cutting Edge Pest Control



The Force is Strong With This One



www.CentralCoastGarden.com

Little GIANT®

Hydroponic Products

*Quality, Trust & Innovation
Since 1941.*



For decades you have been buying Little Giant pumps, and we are proud to build on that reputation with our new hydroponics product offering.



Learn more.
lg-outdoor.com/c/hydroponics



888.956.0000
www.lg-outdoor.com

Put some Humboldt in your Garden.

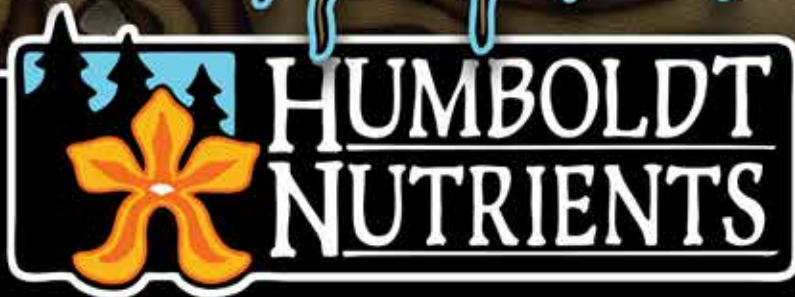

humboldtnutrients.com

TRUSTED BY GROWERS IN OVER
15 COUNTRIES
AROUND THE WORLD



GROTEK[™]
SCIENCE FOR PLANTS

www.grotek.com



Range: 0-3999ppm

The Combo pH/EC/TDS Tester Makes Measuring Quick and Easy!

HI98129/98130 is a lightweight, waterproof tester offering high accuracy pH/EC/TDS and temperature measurements in a single handheld unit. *No more switching between meters for your routine measurements.*



- **Replaceable pH electrode cartridge**
Easy-to-replace pH electrode. The sturdy, snap-in connector means there are no pins to bend or break.



- **Calibrate right in our buffer solution sachets**
An easy calibration can be performed right in our buffer solution sachets for the most accurate readings.



- **Cloth extendable junction**
When the cloth junction becomes dirty from routine testing, simply pull out (1/8") to increase response time and stability.

www.hannainst.com

Range: 0-1999ppm

All in One Easy to Use pH/EC/TDS Portable Meter!

HI 9813-6 is a versatile, water resistant, multiparameter portable meter specifically designed to measure pH and fertilizer concentration (EC/TDS).

When used in conjunction with the HI1285-6 pH/EC/TDS/temperature probe and HI 50021 check solution, the HI 9813-6's CAL CHECK™ feature allows the user to check the meter calibration status at any time.

HI 1285-6 Pre-amplified probe protects against electrical noise from ballasts, pumps and humid environments.

HANNA
instruments

GROW MORE®

Water Soluble Fertilizers

AAA Quality



Grow More first began manufacturing water soluble fertilizer in 1973, producing top quality innovative formulations and ingredients for a global market. Distributed in 35 countries worldwide and backed-up by our own in-house laboratory. Our formulas help growers produce higher yields with larger flowers and more evening ripening, improve overall aromatics, taste and essential oils of many herbs including Thyme, Basil, Oregano, Rosemary and others.

HAWAIIAN BUD: 5-50-17

SEA GROW AND MENDOCINO
MOST POPULAR FORMULAS:

0-50-30	4-26-26	30-10-10
16-16-16	20-20-20	10-52-10

Organic Based Bio-Stimulants & Additives

Developed to enhance any indoor or outdoor nutrient programs

Native Soil
Soilless Growing Media
Container Gardens
Hydroponics System



MENDOCINO AVALANCHE FLOWER HARDENER:

- Registered in California and 25 other States.
- Helps stimulate flower development in final bloom stage.
- Helps increase size and mass of flower.
- Helps increase post harvest shelf life.

MENDOCINO HONEY:

- Increases brix content of fruit and flower.
- Improves aroma and taste.
- Provides a source of organic carbon.
- High purity, natural sweet carbohydrate.

BIO-COZYME:

- Contains many naturally occurring organic compounds to help support an active root system.
- Promotes more robust plants with shorter flowering period.
- Helps augment enzyme function and metabolism for quality yields.

SEAWEED EXTRACT:

- Organic registration with California Department of Food and Agriculture.
- Helps improve overall yields and quality of fast growing flowers, fruits, vegetables.
- Contains over 56 trace elements plus naturally occurring growth promoting compound.

Manufactured By

GROW MORE®

5600 New Century Drive, Gardena, CA 90248
www.growmore.com



We've got a Growstone for that.



GS-1

BEST FOR ANY HYDROPONIC APPLICATION:

- Ebb/Flow
- Deep Water Culture
- Aeroponic misting systems
- Top feed drip irrigation systems
- Aquaponics
- Mix with Soil or Coco Coir
- Available in 9 liter & 1.5 cu ft bags

GS-2

BEST FOR SOIL AERATION:

- Perlite alternative
- Mix with Coco Coir
- Mix with Peat Mixes
- Mix with your favorite Soil
- Available in 9 liter or 1.5 cu ft bags

GS-3

BEST FOR A FAST DRAINING SOILLESS BLEND:

- Top feed irrigation drain-to-waste applications
- Ebb/Flow (flood and drain tables/tray or bucket systems)
- Available in 1.5 cu ft bag

Gnat Nix!

BEST ON TOP OF SOIL OR COCO COIR:

- Top dress mechanical barrier for fungus gnat control
- Available in 9 liter or 1.5 cu ft bags

Growstone®
100% Recycled. 100% American made

Join the Growing Revolution!

growstone.com

Like us on [facebook.com/growstone](https://www.facebook.com/growstone)

**Exclusively Available
Through:**



National Garden Wholesale
Sunlight Supply Inc.

NO POWDERY MILDEW™
Goes to work Immediately!

NO SPIDER MITES™
Immediately Results • Seeding to Harvest

NO FUNGUS GNATS™
Dynamic Eliminator and Protector



*100% ORGANIC
NO IMMUNITY
USE ANYTIME
NO TOXIC RESIDUES
NO AFTERTASTE*



FORMULATED WITH NATURAL
PLANT EXTRACTS AND ALL
NATURAL PENETRATIVE AGENTS

greenwaynutrients.com



20 Reasons To Make Gro Pro Your First Choice In Growing Containers



Gro Pro Black
Round Fabric Pots



Gro Pro Tan
Round Fabric Pots



Gro Pro Black
Square Fabric Pots



Gro Pro Premium
Nursery Pots
Injection Molded



Gro Pro Heavy
Duty Container
with Handles



Gro Pro Premium
Round Mesh
Bottom Pots



Gro Pro Round
Plastic Mesh
Bottom Pots



Gro Pro Black Plastic
Buckets and Lids



Gro Pro Mesh Pots /
Bucket Lids



Gro Pro Roots
Master Pots



Gro Pro Net Pots



Gro Pro Net Pot Lids



Gro Pro Premium
Square White
Plastic Pots



Gro Pro Premium
Square Black
Plastic Pots



Gro Pro Square Black
Pots and Saucers



Gro Pro Black
Plastic Pots



Gro Pro Square
Mesh Pot



Gro Pro Heavy Duty
Black Saucers



Gro Pro Clear
Plastic Saucers



Gro Pro Grow Bags

Gro Pro... Better By Design.



Exclusively distributed by:
National Garden Wholesale.
Sunlight Supply, Inc.
www.sunlightsupply.com

gro-pro.net

Cutting Edge

SOLUTIONS™

The Califormula

Our family of products are growing. Get ready for a new season of amazing results.



The secret to success is yours.™

www.CuttingEdgeSolutions.com

Sum System

XXXL[®]

REFLECTORS

UNDEFEATED!



METHOD SEVEN



DON'T GROW BLIND™

Method Seven delivers epic color and complete safety under HID lights. See foliage properly, spot pests and deficiencies early and easily. No headaches, no strain, and absolutely no long term eye damage.



Resistance HPS
German mineral glass
lens, Italian frame

Method Seven has you covered for all grow lights including the sun.

Coup HPSX



Resistance HPS



Operator LED



Cultivator HPS+



Cultivator LED+



methodseven.com

Invest in your crop,
NOT electricity.

Chilled-Water Climate Control systems from Hydro Innovations are **up to 30% more efficient and cost effective** than traditional HVAC



303.995.6050 | hydroinnovations.com
1780 55th St Suite A, Boulder, CO 80301
@hydroinnovation

Part of the  **SURNA** Family

Now Available from



Sunlight Supply, Inc.

National Garden Wholesale.

MICROBE *Life* HYDROPONICS



Just Add to Your Feeding Program

MicrobeLifeHydro.com



Providing Environmental Solutions Since 1976



/MicrobeLifeHydro



@Hydro Expert



/MicrobeLifeHydro

Please Note: The products featured in this advertisement have been approved in most states. Please check our website to confirm products that are registered for sale in your state. Currently, there are additional California and Oregon catalogs featuring products approved in those states.



1026

1952

Electric Atomist Sprayers

The **1026B's** adjustable output range selector can provide delivery from a fine mist of 1.5 gph to a heavy spray of 14 gph, up to 13.5 feet. The 1026B atomizes particle size of 22 microns on the fine setting and 46 microns on the heavy setting; is suitable for wettable powders.

1026B - Commercial grade 110 Volt AC, 60 Hertz, 7.0 Amp, 2 Stage Fan

The **1952B** is designed for stationary indoor atomized spraying. The adjustable output nozzle delivers particles of less than 50 microns up to 100 feet; average size is 20 microns.

1952B - Standard grade 110 Volt AC, 60 Hertz, 5.5 Amp, Single Stage Fan



5BP

5 Liter Battery-Powered Sprayer

Adjustable nozzle; 66" hose; Padded shoulder strap; 4 "D" batteries (included) Wand extends from 12" to 30"; Thumb-operated 3 position switch: On-Off-Reverse (reverse position draws residual fluid out of wand and hose, back into tank).



36TS



40TS



1998TL

Hand Sprayers all feature adjustable poly nozzles; the 40TS and 1998TL feature lock-on/lock-off thumb control:

36TS is a 36 oz. trigger sprayer

40TS is a 40 oz. sprayer that sprays in any position, including upside-down

1998TL is a 4 pint hand sprayer



1401

1 gallon Sprayer; All-poly w/buna seals; Nozzle adjusts from fine mist to straight stream; Flow control features lock-on

NEW ITEM



56PR is a 1.5 liter sprayer with an adjustable, multi-position nozzle



SUPERthrive®

A highly concentrated non-toxic vitamin solution maximizing potential by quickly building a strong root base & reducing transplant shock. For landscapers & growers to transplant saplings, save trees needing extra care, maintain green turf, & abundant edibles. Well-suited for hydro-seeding, hydroponics & foliar spraying.

Our timeless formula is enhanced with kelp to integrate contemporary research with the existing nutrition that **SUPERthrive®** has provided since 1940.

Directions:

1/4 tsp. per gal. of water.

Maintenance for large areas use at a rate of 3 oz. per 100 gallons.

Transplanting: 1 tsp. per gallon.

Tip: Soak until bubbles cease.

Lawns & Turf:

Apply **SUPERthrive®** after heavy use.

SUPERthrive®
1940 WORLD'S FAIR
Gold Medal
The Original Vitamin Solution

Vitamin Institute
North Hollywood, CA 91605
www.superthrive.com

SUPERthrive® ~ Always ahead in science and value.



Corona Discharge & Ultra Violet Ozonators

BE SURE!!

uvonair®

THE ULTIMATE ODOR ELIMINATORS



uvonair



uvonair CD



uvonair UV

It doesn't just mask odors. It destroys it!

THE WORLD'S LEADER IN
HYDROPONIC OZONATION FOR OVER 15 YEARS.



Industrial Strength Ozonators

TRUSTED, RELIABLE
HORTICULTURE SOLUTIONS

POWERED BY **FULHAM**

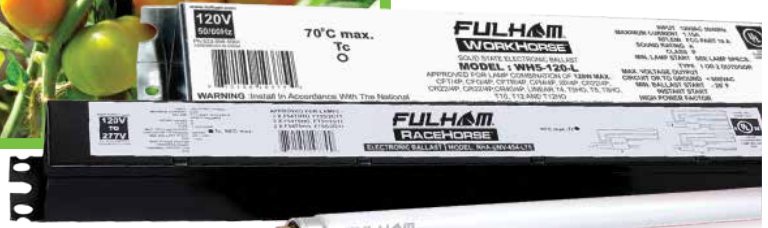

**FLUORESCENT
WORKHORSE® & RACEHORSE® BALLASTS**

©Fulham Co., Inc. All Rights Reserved.

www.fulham.com Tel: 323.599.5000

Preferred Suppliers
409

FUTURE HARVEST

GROW BETTER



Our only Business is Your Success

SUNBLASTER | NUTRADIP | PLANTLIFE PRODUCTS

Serving the Indoor Grower since 1996

futureharvest.com

MEET THE PROFESSIONALS



PH-200

COM-100

Waterproof Body

Waterproof Body

Measures
0.00 - 14.0 pH

Measures
EC/PPM/TEMP

Automatic Calibration

Highly Versatile:
0.5 & 0.7 scale!

Replaceable Probe

Replaceable Probe

PH-STOR

Keeps Probe Balanced
Helps Probe Last Longer



PH-BUF

pH Powder Packets



C-1000
For Optimized
Calibration



Milwaukee



Milwaukee Instruments - Manufacturing A Complete Line of Growth Media Diagnostic Equipment For Use In Greenhouses & Hydroponics
 See all our Instruments at - www.milwaukeeinstruments.com

LEADER DWT GROUP

LEADER Pumps



ECOJET



ECOPLUS



ECOTRONIC

ECOJET Highly reliable self priming JET Pumps with excellent suction capability which allows the free passage of air bubbles, for supplying water for domestic applications.

ECOPLUS Highly reliable self priming Horizontal Multistage Pump low noise with high flow and pressure performances, with 2,3 or 4 impellers, for supplying water for domestic and irrigation applications.

ECOTRONIC Highly reliable self priming ECOJET or ECOPLUS Pump with excellent suction capability fitted with the HYDROTRONIC Electronic control system to allow the automatic operation of the pump and prevent it from dry-running, for supplying water for domestic and irrigation applications.



VERTYGO



HYDROTRONIC



FA 5

VERTYGO Automatic Submersible pump with a manual override, specifically designed for uses in narrow pits with dimensions down to 8" x 8". Suitable to pump clear water containing particles with maximum diameter up to 1/4". With automatic or manual operation and a Low suction capability of down to 1/16".

HYDROTRONIC Electronic control system for surface and submersible pumps. Designed to allow the automatic operation of the pump and prevent it from dry-running. Suitable for pumps with power up to 1500 W, flow rate up to 120 l/min, operating pressure more than 26 psi and maximum pressure range between 26 psi and 116 psi. With manual and automatic reset and a built-in non return valve. Which is Easy to install as it is supplied with power cable with plug and cable with socket for the connection to the pump.

FA 5 5" Transparent filter housings with cartridge suitable for filtering the water for domestic uses.

LEADER is an established brand which is one of the largest domestic water pump brands worldwide selling to DIYer's and private households.

LEADER Pumps are produced by **DAB PUMPS SpA**

DAB PUMPS' production of more than 2.6 million motor-driven water pumps each year enables it to offer a complete line of products that meet even the most specific requirements, while ensuring the highest degree of reliability.

BIODYNAMIC COMPOST, TEAS AND POTTING SOIL

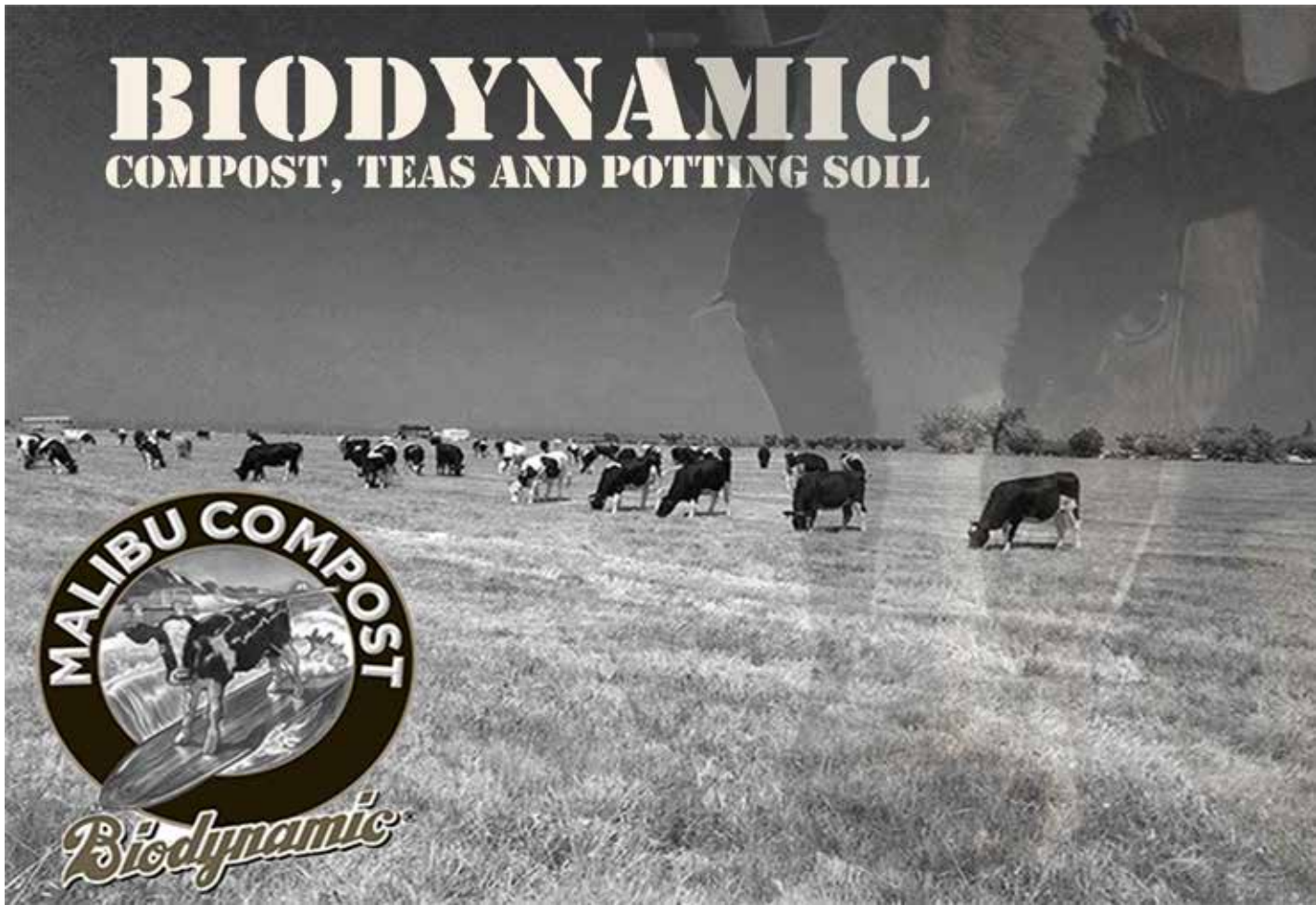
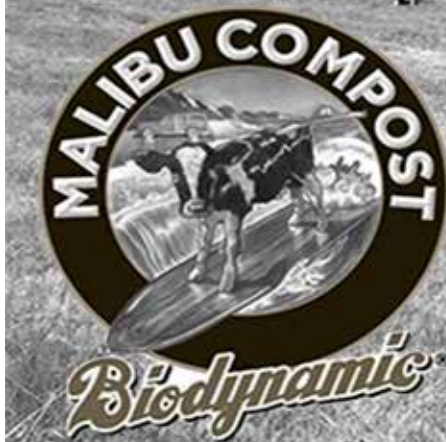

**Plants Do
Better
With
Maxicrop...
Naturally**



MAXICROP U.S.A., INC.
P.O. Box 964 • Arlington Heights, IL 60006
1-800-535-7964
maxicrop@maxicrop.com • www.maxicrop.com





Monterey Lawn & Garden

Meeting your Organic Control Needs

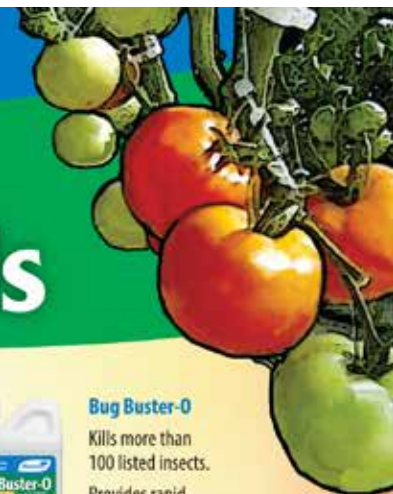

Monterey B.t.

OMRI Listed for control of worm-type (caterpillar) insects on vegetables, fruit trees and ornamentals.



Monterey Garden Insect Spray

OMRI Listed for control of foliage feeding worms (caterpillars), Thrips, Leafminers and other listed pests.



Take Down Garden Spray

Dormant and growing season insect spray. Kills all accessible stages of listed insects including eggs.



Bug Buster-0

Kills more than 100 listed insects. Provides rapid knockdown and kill of listed plant pests. Can be used on day of harvest.



70% Neem Oil

OMRI Listed organic insecticide, miticide and fungicide for use on roses, vegetables, fruit trees and ornamentals.



Fruit Tree Spray Plus

OMRI Listed multi-purpose insecticide, fungicide, miticide for use on vegetables, fruit & nuts, roses, herbs, flowers and turfgrass.



Products that work

For more information call: 559.499.2100

www.montereylawnandgarden.com

Always read and follow label directions for use.

Cover your cubes!



Reduce your water and fertilizer from 33-50%



DripCap®

CUBE COVERS

4 dripper holes for even distribution of water and nutrients

- Quick, easy "snap-on" installation.
- Minimize algae growth and related problems.
- Old, depleted nutrients are flushed out of the block, reducing EC/salt buildup.
- Prevent stem rot (water the roots, not the stem).
- Slow evaporation loss and irrigation frequency.
- No separate drip stakes or emitters to buy.
- Irrigation feed is securely locked in place

Works on all growing mediums!



IN STOCK NOW:

4"

#714867

6"

#714873

Available by Special Order:

3"
Square

10"
Round



ORGANIC FERTILIZER

Products from the Ocean,
to set your plants in motion.

Increase your yield
and quality with
Neptune's Harvest.



Family run from Gloucester, MA since 1965

neptunesharvest.com | 800.259.4769

Fight Root and Foliar Diseases

Use Actinovate® Biofungicide for protection against powdery mildew, *Botrytis*, *Pythium*, *Phytophthora*, *Fusarium* and other common plant diseases. Apply Actinovate® on your annuals, perennials, shrubs, vegetables, herbs and more. Actinovate® is safe for workers and beneficial insects.



Actinovate®
biofungicide

Novozymes is the world leader in bioinnovation. Together with customers across a broad array of industries we create tomorrow's industrial biosolutions, improving our customers' business and the use of our planet's resources. Read more at www.novozymes.com.

novozymes®
Rethink Tomorrow

Actinovate® AG is a registered trademark of Natural Industries, Inc. 2013. All rights reserved.

SUCCESS and POWER!

That's what you get when you use Nutrilife nutrients and additives. See our new line of products like Heavy Harvest, Heavy Weight, Nutriboost, SR-71, Pro Guard and many other performance enhancing products. Nutrilife has formulas to help fix a problem or to boost and amplify growth.



For more information on our complete line visit us on the web at www.nutrilifeproducts.com or contact us Toll free at 1-877-533-9572

**The Power of Cloning
with Olivia's Cloning Solution®
& Cloning Gel® NOW in a
Complete Kit!**

**The Power of Cloning
with Olivia's Cloning Solution®
& Cloning Gel®**



www.OliviasSolutions.com

Zenport INDUSTRIES

Quality Hand Tools Perfect
for Every Job



Gardens Grow
with **GARDENEER[®]**
by **Dalen**



For more information visit us at
DalenProducts.com

Revolution[™] is here

Revolutionize the way you
look at Hand Watering.

- Effortless, Thumb Controlled Valve
- Heavy-Duty Metal
- Eye-Catching Colors

Comfort
Style
Precision
Under Your Thumb.



DRAMM
Professional Quality for Life
www.dramm.com

watersafe[®]

hydroponics water test

TEST YOUR
SOURCE
WATER

- ✓ Detects six common growth inhibitors
- ✓ Do-it-yourself
- ✓ Results on the spot



- | | | |
|-----------------------|-------------------------|-----------------------|
| B
Bacteria | Pe
Pesticides | Cl
Chlorine |
| Hd
Hardness | pH
Ph | Fe
Iron |

THE ONE THAT WORKS

LIQUID ROOTING HORMONE

- Choice of professional plant propagators
- Roots everything from hardwoods to succulents
- As low as 5 cents per 100 cuttings

EASY TO USE



DIP 'N GROW®

Available in 3 convenient sizes for the professional nurseryman and the home gardener at leading nursery supply outlets.

www.dipngrow.com

Summit® ... responsible solutions.

SummitResponsibleSolutions.com

800.227.8664



MOSQUITO DUNKS®

Kills mosquitoes before they're old enough to bite!®

- The #1 biological mosquito control product.
- 100% natural, biodegradable, works for 30 days or more.
- Kills larvae,—will not harm fish, beneficial insects, or plants.
- Labeled For Organic Production.

FOR ORGANIC PRODUCTION

MOSQUITO BITS®

- Same proven ingredients as Mosquito Dunks
- Controls Fungus Gnats in plant soil, hydroponic & aquaponic systems
- Safe & natural, biological control!



Summit...responsible solutions®, MosquitoDunks® and MosquitoBits® are registered trademarks of Summit Chemical Company.

ALWAYS 100% PURE EARTHWORM CASTINGS



ALWAYS PURE:

UNCO INDUSTRIES weighs a set number of worms per sq. ft. of bedding twice a month. Knowing this set amount of worms will turn all the bedding into **PURE** Earthworm Castings. 😊

OTHERS using the bed or windrow system, leave worms in beds for months without reweighing them. Therefore, only guessing at how many worms they have per sq. ft. So **NOT** enough worms in the bedding to make Pure Earthworm Castings. 😞

PLANT GROWTH HORMONES:

Castings contain "Auxins and Cytokinins", which are growth hormones for bigger and more fibrous plant roots. **ROOTS CAN EASILY GROW FAST, FULL AND FIBROUS.**

HIGH AVAILABILITY OF NUTRIENTS:

The TRACE ELEMENTS combined with its structure and high MICROBIAL ACTIVITY allow it to outperform what is expected of a low analysis (NPK) fertilizer.

The key facts mentioned above are what allows **Wiggle Worm Soil Builder™** to **DRAMATICALLY EXCEED EXPECTATIONS.**



Ask for **Wiggle Worm Soil Builder™**
ALWAYS PURE EARTHWORM CASTINGS

©2014 Unco Industries All rights reserved.

BLACK HOLES HYDRO INC.

The only dripper for all seasons and any grow media!

- 1/4" barb works w/ standard emitters!
- Barb available in 1/2" and 1/4" options
 - 6 observable flow holes
 - Saves time and money!
 - Reusable product

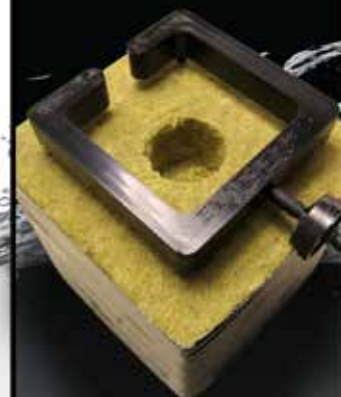

National Garden Wholesale
Sunlight Supply Inc.

blackholeshydro@gmail.com
www.blackholeshydro.com
Phone: (855) BHHydro (855-244-9376)



100% made in USA
100% recycled
Patent Pending

Preferred Suppliers

Sunlight Supply tested it, end users tested it, the verdict is in: **LOVE IT!!** Sunlight Supply only brings you new products we have tested and used, **this one really impressed us and will impress you too!**



One handed cleaning:

Eliminates the need to set anything down to clean your scissors.

Get the right tool for the job.

Our **SoftEdge** cleaning media is a high-tech spin off from the aerospace industry.

Nothing works better!

Scissors stay cleaner longer!

6 unit display



ATAMI
NATURALLY INNOVATING

ATAMI.... THE COMPLETE NUTRITION HOUSE



BeuZZ



Dynamic Duo



BLOOMBASTIC



ROOTBASTIC



wilma™



NO PLANT GROWTH REGULATORS

BeuZZ World Class Products Produce World Class Results!
INFO@NOU.COM • WWW.ATAMI.COM



The Sustainable Path to Safe & Organic Growing



AQUA POWER
All Purpose Organic Fertilizer

BIOMIN IRON
Shiny, Stronger, Greener leaves

MILDEWCURE
Premium Organic Pest Control



SaferGro

SaferGro Laboratories, Inc. Tel: (805)650-8918
www.safergro.com info@safergro.com

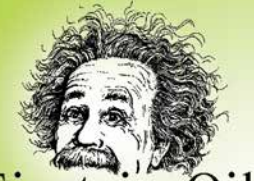

Einstein Oil
The brilliant solution

You've heard about it.
Now try it.



4 fl.oz.

16 fl.oz.

Available from Sunlight Supply Inc.
www.sunlightsupply.com

ORGANOCIDE[®] 3-in-1 GARDEN SPRAY

SAFE
Around your Home,
Children & Pets!

MADE IN USA

Insecticide ■ Fungicide ■ Miticide
Natural Oils for Organic Gardening

www.YourPlantDoctor.com

Rapiclip[®] Plant Supports, Ties and Labels

Grow Through Grid Plant Support 16" #972

Grow Through Grid Plant Support 20" #973

4" Plant Labels #827

6" Plant Labels #840

"T" Labels #820

Colored Labels #828

Foam Wire Tie #865

Twists & Clips #816

Foam Wire Tie #835

Vinyl Stretch Tie #844 - 1/2" W #845 - 1" W

For many more specialty ties and plant labels visit...

LusterLeaf.com

PREMIUM QUALITY INSECTICIDES

DOKTOR DOOM PUNCH

The ONE-TWO

FOR SPIDER MITE ELIMINATION

DOKTOR DOOM
TAKES SPIDER MITES & OTHER BUGS SERIOUSLY - WE KILL THEM!

what's bugging YOU?

www.doktordoom.com

grozonecontrol.com

GROZONE CONTROL

#1 Environmental Controllers & Customer Service

GARDEN CONTROLS

gardenccontrols.com

Safer
BRAND



It's Organic*, It's Effective, It's Safer® Brand.
OMRI® Listed insecticides and fungicides.



*For use in Organic Gardening



USA REFLECTORS

When it's the **Right Light** your plants will know the difference.



Pushing technology to the edge for you! Check out the Sun System® brand of lighting today!
#sunsystem



The most complete line of indoor and outdoor growing containers for producing healthy plants and plentiful harvests.



gro-pro.net
#gropro



MADE BY GROWERS, FOR GROWERS

www.centralcoastgarden.com

BROAD MITES, RUSSET MITES...

PREPARE TO MEET YOUR MAKER

FOR EVEN THE TOUGHEST MITES,
PESTS, AND POWDERY MILDEW...

GREEN CLEANER.
KILLS ON CONTACT

GreenCleaner

2
OZ

4
OZ

8
OZ

32
OZ

1
GAL

WWW.CENTRALCOASTGARDEN.COM



GENERAL HYDROPONICS®

COCOTEK



NEW!

PREMIUM COCO NUTRIENT

2-Part A/B Liquid Nutrient

- Easy to use two-part formula
- Formulated for aggressive growth
- Enhanced Calcium for Coco Coir
- Balanced Potassium and Magnesium levels
- Clean and consistent results
- Works with any media

PREMIUM COIR™ AND COCO TEK PX

Now available in loose-filled bags! Our premium coir is pre-treated, convenient, and ready to use right out of the bag. We offer straight Coco Coir or CocoTek PX, a 75/25 blend of premium coir and high grade perlite. Use by themselves, or blended with your favorite media to create the ideal environment for your plants to thrive.

NEW!



\$4.99

Product No. 092235



8 70883 00936 6

 **GH**
genhydro.com

©2015 GH Inc.