



Model: TB-12U1000-P

Instruction manual

Read and understand all of the instructions and safety information in this manual before operating or servicing this tool.

Table of Contents

Warranty and Servicing.....	3
Safety Symbols.....	3
Safety.....	4-5
Identification.....	6
Kit Includes.....	7
Technical Specifications.....	8
Identification of Battery Charger and Pack.....	9
Battery Charger.....	10-11
Battery Pack.....	12-13
Operating Instructions.....	14-15
Tool Maintenance.....	16
Head Assembly Breakdown and Parts List.....	17
Tool Parts Breakdown.....	18
Parts List.....	19

Thank you...

for buying a TASKMASTER TOOL. Our mission is to bring product innovation and exceptional customer service to the marketplace. This tool line is reliable, dependable, and durable for our customer's needs.

Please read this instruction manual carefully before using the product. If you have any questions about our product please reach out to our customer service department (see back cover). No part of the contents of this manual may be reproduced, transmitted or circulated in any form or by any means without the prior written authorization of TASKMASTER TOOLS.



WARRANTY AND SERVICING

TASKMASTER PRO 5-Year Tool Service Protection Program

Introducing the industry's best service & support program for all your ILSCO battery-powered crimping and cutting tools. All ILSCO battery-powered tool buyers are automatically registered in the TASKMASTER PRO Service Protection Program and will receive free tool repairs for defects in material or workmanship on their tool(s) for five years after their original purchase date. (Excludes abuse, non-intended use, tampered with or normal wear and tear.)

TASKMASTER PRO Tool 5-Day Repair Pledge

If your tool(s) need repair at any time within five years of your original purchase date, our TASKMASTER PRO service network will repair your registered tools within five business days of receipt.

TASKMASTER PRO Tool Loaner Program

If you need a replacement tool during any repair, our TASKMASTER PRO network can typically provide a comparable loaner tool to registered tool owners while your tool is being repaired.

FREE Tool Reconditioning

Your first reconditioning is on us! Call us after about 20,000 cycles.

To Find a TASKMASTER PRO Service Partner

Call ILSCO for assistance in solving tool performance issues or for any of your service needs. ILSCO tool owners will be offered options to solve any tool replacement, parts or repair issues.

Call 513-533-6200 or 800-776-9775

Monday to Friday

8:00AM to 5:00PM Eastern Time (ET)

MILWAUKEE Batteries- LIMITED 3-YEAR WARRANTY

Every MILWAUKEE Battery Pack (sold with ILSCO Battery-Powered product and/or as a replacement battery pack) is warranted to the original purchaser only to be free from defects in material and workmanship. Subject to certain exceptions, MILWAUKEE will repair or replace a battery pack which, after examination, is determined by MILWAUKEE to be defective in material or workmanship for the stated warranty period from date of purchase. Return of the battery pack to a MILWAUKEE factory Service Center location or MILWAUKEE Authorized Service Station, freight prepaid and insured, is required. For the proper shipping procedure of battery packs, contact 1.800.SAWDUST (1.800.729.3878), or go to www.milwaukeeetool.com. A copy of the proof of purchase should be included with the return product. This warranty does not apply to damage that MILWAUKEE determines to be from repairs made or attempted by anyone other than MILWAUKEE authorized personnel, misuse, alterations, abuse, normal wear and tear, lack of maintenance, or accidents.

SAFETY SYMBOLS



Attention!
Risk of
cutting injury



Never use
without dies



Read the operating
instructions
before use



Wear protective
goggles



Electric Shock
Hazard- use
proper protective
equipment



Do not dispose
of product.
Please recycle

SAFETY

Read all safety warnings, instructions provided with this battery operated tool. Failure to follow all instructions listed below may result in electric shock, fire and/or serious injury. Save all warnings and instructions for future reference.

WORK AREA SAFETY

- Keep work area clean and well lit. Cluttered or dark areas invite accidents.
- Do not operate battery operated tools in explosive atmospheres, such as in the presence of flammable liquids, gases or dust. Battery operated tools create sparks which may ignite the dust or fumes.
- Keep children and bystanders away while operating a battery operated tool. Distractions can cause you to lose control.

PERSONAL SAFETY

- Stay alert, watch what you are doing and use common sense when operating a battery operated tool. Do not use a battery operated tool while you are tired or under the influence of drugs, alcohol, or medication. A moment of inattention while using battery operated tools may result in serious personal injury.
- Use personal protective equipment. Always wear eye protection. Protective equipment such as rubber gloves, non-skid safety shoes, hard hat or hearing protection used for appropriate conditions will reduce personal injuries.
- Do not overreach. Keep proper footing and balance at all times. This enables better control of the battery operated tool in unexpected situations.
- Do not let familiarity gained from frequent use of battery operated tools allow you to become complacent and ignore tool safety principles. A careless action can cause severe injury within a fraction of a second.

BATTERY OPERATED TOOL USE AND CARE

- Do not force the battery operated tool. Use the correct tool for your application. The correct tool will do the job better and safer at the rate for which it was designed.
- Remove the battery pack from the tool before making any adjustments changing accessories, or storing tools. Such preventive safety measures reduce the risk of starting the battery operated tool accidentally.
- Store idle battery operated tools out of the reach of children and do not allow persons unfamiliar with the tool or these instructions to operate the tool. Battery operated tools are dangerous in the hands of untrained users.
- Maintain battery operated tools and accessories. Check for misalignment or binding of moving parts, breakage of parts and any other condition that may affect the tool's operation. If damaged, have the tool repaired before use. Many accidents are caused by poorly maintained tools.

- Keep cutting tools sharp and clean. Properly maintained cutting tools with sharp cutting edges are less likely to bind and are easier to control.
- Use the battery operated accessories in accordance with these instructions, taking into account the working conditions and the work to be performed. Use of the tool for operations different from those intended could result in a hazardous situation.

BATTERY USE AND CARE

- Recharge only with the charger specified by the manufacturer. A charger that is suitable for one type of battery pack may create a risk of fire when used with another battery pack.
- When battery pack is not in use, keep it away from other metal objects, like paper clips, coins, keys, nails, screws or other small metal objects, that can make a connection from one terminal to another. Shorting the battery terminals together may cause burns or a fire.
- Under abusive conditions, liquid may be ejected from the battery; avoid contact. If contact accidentally occurs, flush with water. If liquid contacts eyes, additionally seek medical help. Liquid ejected from the battery may cause irritation or burns.
- Do not use a battery pack or tool that is damaged or modified. Damaged or modified batteries may exhibit unpredictable behavior resulting in fire, explosion or risk of injury.
- Do not expose a battery pack or tool to fire or excessive temperature. Exposure to fire or temperature above 265°F (130°C) may cause explosion.
- Follow all charging instructions and do not charge the battery pack outside the temperature range specified in the instructions. Charging improperly or at temperatures outside the specified range may damage the battery and increase the risk of fire.

SERVICE

- Have your battery operated tool serviced by a qualified repair person using only identical replacement parts. This will ensure that the safety of the battery operated tool is maintained.
- Never service damaged battery packs. Service of battery packs should only be performed by the manufacturer or authorized service providers.

IDENTIFICATION



1 Die release buttons

2 Label

3 Carrying loop

4 Release button

5 Battery pack

6 Battery release buttons

7 LED worklight

8 Advance trigger

KIT INCLUDES

1 Battery Powered Tool



2 Milwaukee Batteries



1 Milwaukee Charger



1 Shoulder Strap



1 Case



2 Die Cases

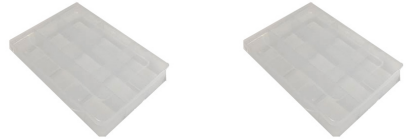

TECHNICAL SPECIFICATIONS

Force developed:	12 tons
Jaw Opening:	1.65 in.
Battery voltage:	18 V
Battery capacity:	5.0 Ah
Type of battery:	Lithium-ion
Charging time:	60 min (approx)
Hydraulic oil:	Shell Tellus S2 V 15
Operating temperature range:	-4° to 122° (F)
Dimensions:	16.5 in. x 13.2 in. x 3.2 in. (L x H x W)
Weight:	17.2 lbs. including battery

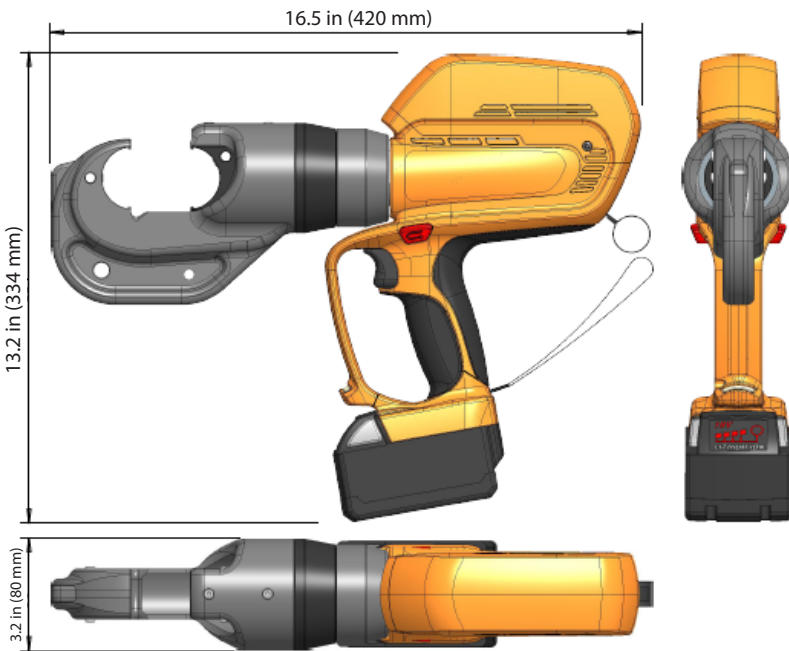

IDENTIFICATION OF BATTERY CHARGER AND PACK

Charger



Battery Pack



1 Light Indicators:

- Continuous red: Charging
- Slow flashing green: Approaching full charge
- Continuous green: Charging is complete
- Fast flashing red: Battery is too hot/cold- Charging will begin when battery reaches correct charging temperature
- Slow flashing red: Battery charge is pending - Charging will begin when the first pack is fully charged
- Flashing red/green: Damaged or faulty battery pack

2 Bays

3 Vents

4 Cord

5 Battery Contacts

6 Release Buttons

7 Fuel Gauge Button

8 Fuel Gauge

9 Rapid Charge-Capable Pack Indicator

BATTERY CHARGER

⚠WARNING Charge only MILWAUKEE M18™ Li-Ion batteries in this MILWAUKEE Li-Ion charger. Other types of batteries may cause personal injury and damage.

WHEN TO CHARGE THE BATTERY PACK WITH THIS MILWAUKEE CHARGER

Remove the battery pack from the tool for charging when convenient for you and your job. MILWAUKEE batteries do not develop a memory when charged after only a partial discharge. It is not necessary to run down the battery pack before placing it on the charger.

- Use the Fuel Gauge to determine when to charge your MILWAUKEE Li-Ion battery pack.
- You can Top-Off your battery pack's charge before starting a big job or long day of use.
- The only time it is necessary to charge the MILWAUKEE Li-Ion battery pack is when the battery pack has reached the end of its charge. To signal the end of charge, power to the tool will drop quickly, allowing you just enough power to finish making a crimp. Charge the battery pack as needed.

HOW TO CHARGE THE BATTERY PACK

Align the battery pack with the bay and slide the battery pack into the charger as far as possible. The red light will come on, either flashing quickly (battery pack is too hot or cold), flashing slowly (battery pack is waiting for another pack to finish charging) or continuous (pack is charging).

- A fully discharged battery pack with an internal temperature in the normal range will charge in about 30 to 185 minutes, depending on the battery pack.
- Heavily cycled batteries may take longer to charge completely.
- The Fuel Gauge lights on 18V battery packs are displayed as the pack is being charged, indicating how fully charged the pack is. The fuel gauge will turn off when charging is complete.
- After charging is complete, the continuous green light will come on.
- The charger will keep the battery pack fully charged if it is left on the charger. The light indicator will flash green during this maintenance charging.
- The second pack inserted in the charger will begin charging when the first pack inserted is fully charged.
- If the light indicator flashes red and green, check that the battery pack is fully seated into the bay. Remove the battery pack and reinsert. If the light continues to flash red and green, remove pack(s) and unplug charger for at least 2 minutes. After 2 minutes, plug charger back in and insert pack. If the problem persists, contact a MILWAUKEE service facility.
- If the light indicator does not come on, check that the battery pack is fully seated into the bay. Remove the battery pack and reinsert. If the light indicator still does not come on, remove pack(s) and unplug charger for at least 2 minutes. After 2 minutes, plug charger back in and insert pack. If after these attempts the light indicator still does not come on, contact a MILWAUKEE service facility.

CHARGING A HOT OR COLD BATTERY PACK

The Red Flashing Indicator light on the charger indicates that the battery pack temperature is outside the charging range. Once the battery pack is within the acceptable range, normal charging will take place and the red light will be continuous. Hot or cold batteries may take longer to charge.

Li-Ion Charging Status		
Battery Pack Temperature	Red Charger Indicator Light	Charging Status
Too Hot	Fast Flashing	Not charging
Normal Range	Continuous	Normal charging
Too Cold	Fast Flashing	Not charging

POWER THE CHARGER WITH AN INVERTER OR GENERATOR

The charger will operate with most generators and inverters rated at 350 Watts or higher.

MAINTENANCE AND STORAGE

Store your charger in a cool, dry place. As a general practice, it is best to unplug battery chargers and remove batteries when not in use. No battery pack damage will occur, however, if the charger and battery pack are left plugged in.

REPAIRS

The charger has no serviceable parts.

MOUNTING TO THE WALL

Use the wall mount guides to mark the hanging points.

⚠WARNING To reduce the risk of injury, always unplug the charger and remove the battery from the charger before performing any maintenance. Never disassemble the battery or charger.

Contact a MILWAUKEE service facility for ALL repairs.

To reduce the risk of injury and damage, never immerse your battery or charger in liquid or allow a liquid to flow inside them.

CLEANING

Clean out dust and debris from charger vents and electrical contacts by blowing with compressed air. Use only mild soap and a damp cloth to clean the battery pack and charger, keeping away from all electrical contacts. Certain cleaning agents and solvents are harmful to plastics and other insulated parts. Some of these include gasoline, turpentine, lacquer thinner, paint thinner, chlorinated cleaning solvents, ammonia and household detergents containing ammonia. Never use flammable or combustible solvents around batteries, charger, or tools.

BATTERY PACK

FUEL GAUGE

Use the Fuel Gauge to determine the battery pack's remaining run time. Press the Fuel Gauge button to display the lights. The Fuel Gauge will light up for 2-3 seconds. When less than 10% of charge is left, 1 light on the fuel gauge will flash slowly.

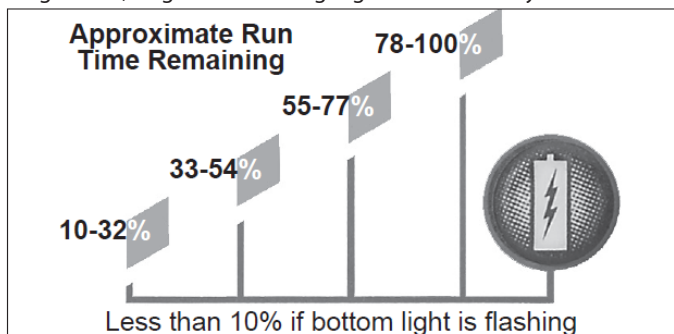

NOTE: If the Fuel Gauge doesn't appear to be working, place the battery pack on the charger and charge as needed.

Compared to NiCd battery pack types, MILWAUKEE Li-Ion battery packs deliver fade-free power for their entire run time. The tool will not experience a slow, gradual loss of power as you work. To signal the end of discharge, 1 light on the fuel gauge will flash quickly for 2-3 seconds and the tool will not run. Charge the battery pack.

NOTE: Immediately after using the battery pack, the Fuel Gauge may display a lower charge than it will if checked a few minutes later. The battery cells recover some of their charge after resting.

BATTERY PACK PROTECTION

To protect itself from damage and extend its life, the battery pack's intelligent circuit monitors current draw and temperature. In extremely high torque, binding, stalling, and short circuit situations, the battery pack will turn OFF the tool if the current draw becomes too high. All the fuel gauge lights will flash. Release the trigger and restart. Under extreme circumstances, the internal temperature of the battery could become too high. If this happens, the fuel gauge lights will flash in an alternating pattern and the tool will not run. Allow the battery to cool down.

Fuel Gauge Lights	Diagnosis	Solution
Lights 1 - 4 Solid	Remaining run time	Continue working
1 Light, flashing slowly	Less than 10% run time left	Prepare to charge pack
1 Light, flashing quickly	End of discharge	Charge pack
Lights 1-4, flashing quickly	Current draw too high	Release trigger and restart, reduce pressure
Lights 1&3 / 2&4, flashing alternatingly	Battery temperature too high	Release trigger and allow battery to cool

COLD WEATHER OPERATION

MILWAUKEE Li-Ion battery packs are designed to operate in temperatures below freezing. When the battery pack is too cold, it may need to warm up before normal use. Put the battery on a tool and use the tool in a light application. It may buzz for a short time until it warms up. When the buzzing stops, use the tool normally.

▲WARNING To reduce the risk of fire, personal injury, and product damage due to a short circuit, never immerse your tool, battery pack or charger in fluid or allow a fluid to flow inside them. Corrosive or conductive fluids, such as seawater, certain industrial chemicals, and bleach or bleach containing products, etc., can cause a short circuit.

MAINTENANCE AND STORAGE

Do not expose your battery pack or cordless tools to water or rain, or allow them to get wet. This could damage the tool and battery pack. Do not use oil or solvents to clean or lubricate your battery pack. The plastic casing will become brittle and crack, causing a risk of injury. Store battery packs at room temperature away from moisture. Do not store in damp locations where corrosion of terminals may occur. As with other battery pack types, permanent capacity loss can result if the pack is stored for long periods of time at high temperatures (over 120° F). MILWAUKEE Li-Ion battery packs maintain their charge during storage longer than other battery pack types. After about a year of storage, charge the pack as normal.

TRANSPORT

Personal transport of Li-Ion battery packs is allowed when done in accordance with these warnings and instructions. The proper classification, packaging, labeling, marking, and documentation requirements for shipping Li-Ion batteries is dependent upon whether the particular batteries are rated greater than or less than 100 Wh. Generally, Li-Ion batteries rated 100 Wh or less are excepted from certain Class 9 DG requirements. Always check compliance of Li-Ion battery consignments against the current regulations governing the chosen mode of transport. When in doubt, contact the carrier or other trained Dangerous Goods professional to confirm acceptability. Li-Ion packs are shipped under classification UN 3480 (battery only) or UN 3481 (batteries contained in or packed with equipment).

▲WARNING To reduce the risk of injury or explosion, never burn or incinerate a battery pack even if it is damaged, dead, or completely discharged. When burned, toxic fumes and materials are created.

DISPOSING OF MILWAUKEE LI-ION BATTERY PACKS

MILWAUKEE Li-Ion battery packs are more environmentally friendly than some other types of power tool battery packs (e.g., nickel-cadmium). Always dispose of your battery pack according to federal, state, and local regulations. Contact a recycling agency in your area for recycling locations. Even discharged battery packs contain some energy. Before disposing, use electrical tape to cover the terminals to prevent the battery pack from shorting, which could cause a fire or explosion.

RBRC BATTERY RECYCLING SEALS

The RBRC™ Battery Recycling Seals (see Symbology) on your tool battery packs indicate that MILWAUKEE has arranged for the recycling of that battery pack with the Rechargeable Battery Recycling Corporation (RBRC). At the end of your battery pack's useful life, return the battery pack to a MILWAUKEE Branch Office/Service Center or the participating retailer nearest you. For more information, visit the RBRC web site at www.rbrc.org.

OPERATING INSTRUCTIONS

Be sure to read instructions carefully, wear safety goggles, and keep fingers away from crimping head.

ATTACHING THE BATTERY TO THE TOOL

1. While pressing the two side buttons, pull out the battery cartridge. To replace the battery cartridge, push the new cartridge firmly into place.
2. After inserting a battery cartridge, check that it is securely in place by pulling gently. Do not press the side buttons when pulling the cartridge.

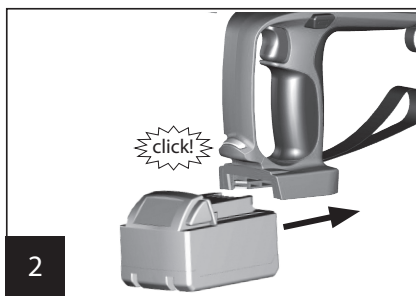
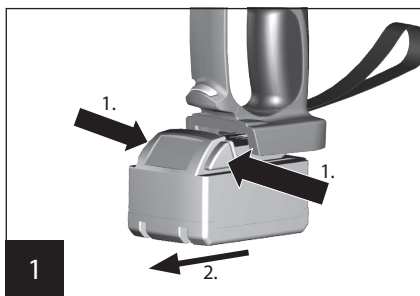

WRIST AND SHOULDER STRAP

Be sure to use the wrist strap to keep the tool secure when in use. Use shoulder strap as well.

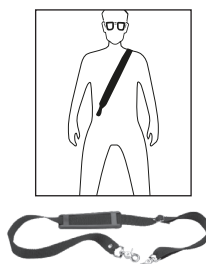
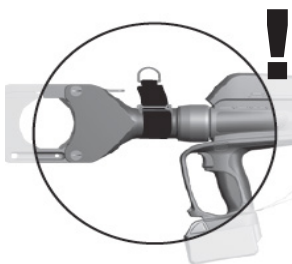

ADVANCE TRIGGER AND RELEASE BUTTON

1. The ram moves forward when the trigger is pressed and stops when the trigger is released.
2. To retract the ram, push the reverse trigger. The ram continues to retract as the release button is held down.

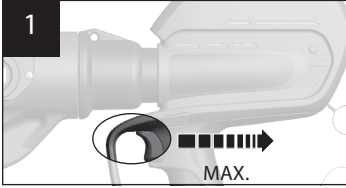

NOTE: Reverse trigger on both sides of tool

CRIMPING

1. Retract the ram fully by pressing the release button.
2. Insert dies by pressing die release buttons and sliding die into ram, then releasing the buttons until the die clicks into place.

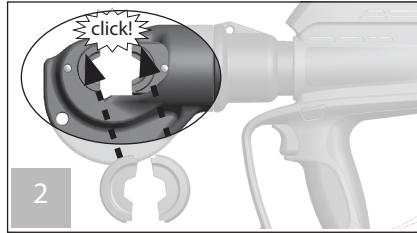

3. Place the connector between the dies.
4. Press the advance trigger and advance the ram so that the connector is held between the dies and insert conductor into the terminal.
5. Press the advance trigger until the compression is completed. A clacking sound will be heard while crimping. Once the clacking stops the crimp is completed.
6. Press the release button to retract the ram. The ram continues to retract while the release button is pressed. The ram stops when it reaches the end of the head.

NOTE: Ram can be retracted without battery in the tool.

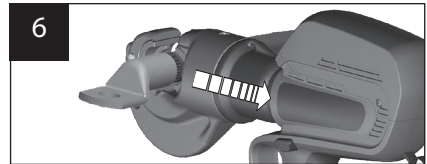
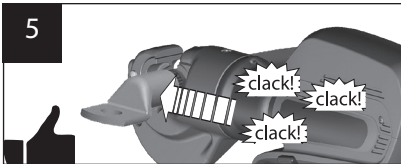

7. Remove dies when crimp is complete by pressing die release buttons.

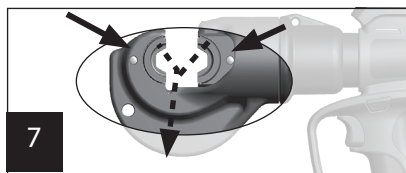

TOOL MAINTENANCE

Daily maintenance:

- Use a soapy cloth to wipe away any oil that may be on the housing of the tool.
- After each crimping cycle wipe the crimping head jaws free of metal shavings.
- Wipe down all steel parts with WD-40.
- Store the tool in a non-humid environment.

The tool should provide many years of service when given the proper maintenance and care. Should you experience any difficulty with the operation and maintenance of this tool, contact our customer service department (see back cover).



HEAD ASSEMBLY BREAKDOWN AND PARTS LIST

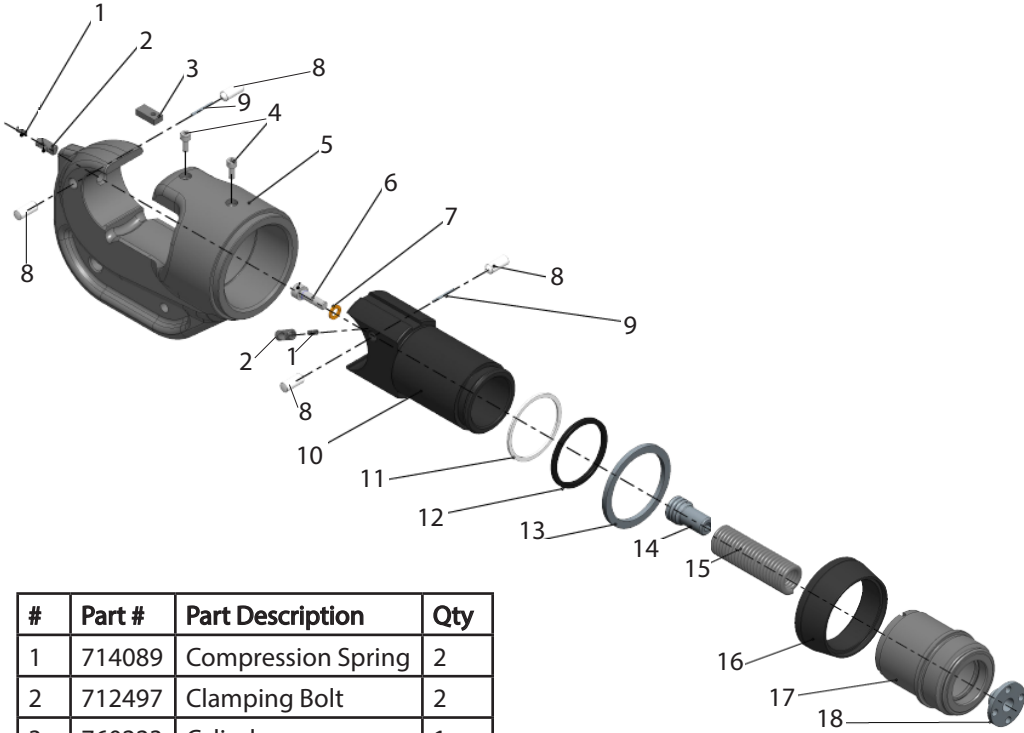

#	Part #	Part Description	Qty
1	714089	Compression Spring	2
2	712497	Clamping Bolt	2
3	760223	Cylinder	1
4	103521	Screw	2
5	715221	C-Head	1
6	714050	Screw	1
7	710973	Seal Disc	1
8	712496	Unlocking Bolt	4
9	101595	Needle Roller	2
10	715222	Piston	1

#	Part #	Part Description	Qty
11	715242	Support Ring	1
12	714820	Seal	1
13	760404	Guide Ring	1
14	714546	Spring Holder	1
15	715225	Tension Spring	1
16	715226	Cover Cap	1
17	715223	Cylinder	1
18	714599	Spring Holder	1

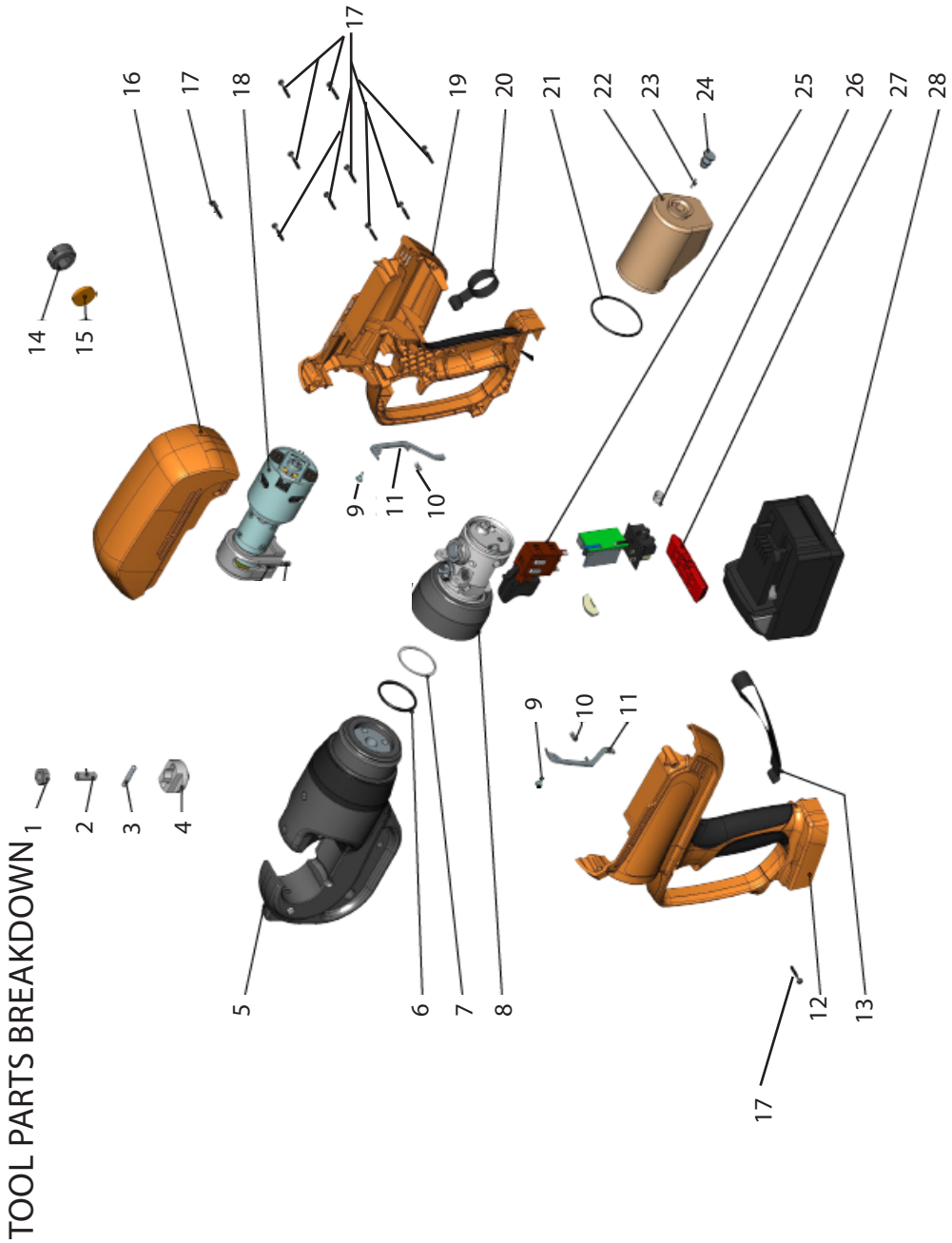

PARTS LIST

#	Part Number	Part Description	Qty
15	760232	Seal Disc	1
16	714318	Sliding Cover	1
17	714155	PT Screw	11
18	E 714330	Motor Assembly	1
19	714348	Housing Back	1
20	714332	Supporting Loop	1
21	712336	O-Ring Seal	1
22	711941	Oil Bladder	1
23	730781	Magnet	1
24	711942	Tank Plug	1
25	714331	Switch Assembly	1
26	201425	Compression Spring	1
27	715260	Release Button	1
28	714167	18V 5.0 Ah Battery	1

#	Part Number	Part Description	Qty
1	200322	Hexagonal Nut	1
2	710671	Grub Screw	1
3	101169	Needle Roller	1
4	714302	Bush-PD	1
5	E 715287	Crimping Head Unit	1
6	712802	O-Ring Seal	1
7	712803	Support Ring	1
8	E 715287	Pump Body Assembly	1
9	714315	Slotted Pan	2
10	710825	Compression Spring	2
11	714303	Lever-PD	2
12	714347	Housing Front	1
13	711867	Supporting Loop	1
14	760203	Lock Screw	1

TASKMASTER[®] TOOLS

from **ILSCO**[®]

Date: 03/18 Version 2

TASKMASTER TOOLS
4730 Madison Rd.
Cincinnati, OH 45227

Phone: 800-776-9775
513-533-6200

www.ilsco.com

Service: