

# TALON SRX / Victor SPX Software Reference Manual

Revision 2.1



Cross The Road Electronics

[www.ctr-electronics.com](http://www.ctr-electronics.com)

## Table of Contents

1. CAN bus Device Basics .....	11
1.1. Supported Hardware Platforms .....	12
1.1.1. Cross The Road Electronics HERO Control System .....	12
1.1.2. roboRIO FRC Control System .....	12
2. roboRIO Web-based Configuration: Firmware and diagnostics .....	13
2.1. Device ID ranges .....	14
2.2. Common ID Talons .....	15
2.2.1. – Light Device LED .....	16
2.3. Firmware Field-upgrade a Talon SRX / Victor SPX .....	17
2.3.1. When I update firmware, I get “You do not have permissions...” .....	19
2.3.2. What if Firmware Field-upgrade is interrupted? .....	21
2.3.3. Other Field-upgrade Failure Modes .....	22
2.3.4. Where to get CRF files? .....	23
2.4. Self-Test.....	24
2.4.1. Clearing Sticky Faults .....	26
2.5. Custom Names .....	27
2.5.1. Re-default custom name.....	28
3. Creating a Talon Object (and the basics) .....	29
3.1. Programming API and Device ID.....	29
3.1.1. Including Libraries (FRC).....	29
3.1.2. Configuration API.....	30
3.2. New Classes/Virtual Instruments.....	31
3.2.1. WPILIB Class integration.....	31
3.2.2. LabVIEW .....	31
3.2.3. C++.....	32
3.2.4. Java.....	32
3.3. Setting Output Mode and Value .....	33
3.3.1. LabVIEW .....	33
3.3.2. C++.....	33
3.3.3. Java.....	33
3.3.4. Check Control Mode with Self-Test.....	33
3.4. WPILib RobotDrive Class .....	34

- 3.4.1. LabVIEW ..... 34
- 3.4.2. C++..... 34
- 3.4.3. Java..... 34
- 4. Limit Switch and Neutral Brake Mode ..... 35
  - 4.1. Default Settings..... 35
  - 4.2. roboRIO Web-based Configuration: Limit Switch and Brake..... 36
  - 4.3. Overriding Brake and Limit Switch with API..... 37
    - 4.3.1. LabVIEW ..... 38
    - 4.3.2. C++..... 38
    - 4.3.3. Java..... 39
- 5. Getting Status and Signals..... 40
  - 5.1. LabVIEW ..... 41
  - 5.2. C++..... 41
  - 5.3. Java..... 41
- 6. Setting the Ramp Rate ..... 42
  - 6.1. LabVIEW ..... 42
  - 6.2. C++/ Java..... 42
  - 6.3. Web-based configuration limitations ..... 43
- 7. Feedback Device (Sensor Feedback)..... 44
  - 7.1. LabVIEW ..... 44
  - 7.2. C++..... 44
  - 7.3. Java..... 45
  - 7.4. Correcting sensor direction, best practices ..... 46
  - 7.5. Supported Feedback Devices ..... 47
    - 7.5.1. Quadrature ..... 47
    - 7.5.2. Analog (Potentiometer / Encoder) ..... 47
    - 7.5.3. Pulse Width Decoder ..... 48
    - 7.5.4. Cross The Road Electronics Magnetic Encoder (Absolute and Relative) ..... 48
  - 7.6. Multiple Talon SRXs and single sensor..... 50
  - 7.7. Pulse Width - Checking Sensor Health ..... 50
  - 7.8. Velocity Measurement ..... 51
    - 7.8.1. Changing Velocity Measurement Parameters..... 51
    - 7.8.2. Recommended Procedure..... 53

- 7.8.3. Self-Test Velocity Settings..... 54
- 7.9. Tachometer Measurement..... 55
  - 7.9.1. Tachometer Measurement – LabVIEW ..... 55
  - 7.9.2. Tachometer Measurement – Java..... 55
  - 7.9.3. Tachometer Measurement – C++ ..... 56
- 8. Soft Limits ..... 57
  - 8.1. LabVIEW ..... 58
  - 8.2. C++..... 58
  - 8.3. Java..... 58
- 9. Special Features..... 59
  - 9.1. Follower Mode ..... 59
    - 9.1.1. LabVIEW ..... 59
    - 9.1.2. C++..... 59
    - 9.1.3. Java..... 59
    - 9.1.4. Correcting Follower Direction ..... 60
  - 9.2. Voltage Compensation ..... 61
    - 9.2.1. LabVIEW ..... 61
    - 9.2.2. C++..... 62
    - 9.2.3. Java..... 62
    - 9.2.4. Self-Test..... 62
  - 9.3. Current Limits..... 63
    - 9.3.1. Current Limit – LabVIEW ..... 63
    - 9.3.2. Current Limit – C++..... 63
    - 9.3.3. Current Limit – Java..... 63
  - 9.4. Adjusting Deadband ..... 64
    - 9.4.1. Dead Band – LabVIEW..... 64
    - 9.4.2. Dead Band – C++ ..... 64
    - 9.4.3. Dead Band – Java ..... 64
- 10. Control Modes (Closed-Loop) ..... 65
  - 10.1. Position Closed-Loop Control Mode ..... 66
  - 10.2. Current Closed-Loop Control Mode..... 66
  - 10.3. Velocity Closed-Loop Control Mode ..... 67
  - 10.4. Motion Profile Control Mode ..... 67

- 10.5. Peak/Nominal Output ..... 68
  - 10.5.1. Peak/Nominal Closed-Loop Output – LabVIEW..... 68
  - 10.5.2. Peak/Nominal Output – C++ ..... 69
  - 10.5.3. Peak/Nominal Output – Java ..... 69
  - 10.5.4. Peak/Nominal Output – Web based Configuration Self-Test..... 69
- 10.6. Allowable Closed-Loop Error ..... 70
  - 10.6.1. Allowable Closed-Loop Error – LabVIEW..... 70
  - 10.6.2. Allowable Closed-Loop Error – C++ ..... 70
  - 10.6.3. Allowable Closed-Loop Error – Java ..... 70
  - 10.6.4. Allowable Closed-Loop Error – Web based Configuration Self-Test..... 71
- 10.7. Motion Magic Control Mode ..... 72
- 11. Motor Control Profile Parameters ..... 74
  - 11.1. Persistent storage and Reset/Startup behavior..... 75
  - 11.2. Inspecting Signals ..... 77
- 12. Closed-Loop Code Excerpts/Walkthroughs ..... 78
  - 12.1. Setting Motor Control Profile Parameters..... 78
    - 12.1.1. LabVIEW ..... 78
    - 12.1.2. C++ ..... 79
    - 12.1.3. Java ..... 79
  - 12.2. Setting/Clearing Integral Accumulator (I Accum) ..... 80
    - 12.2.1. LabVIEW ..... 80
    - 12.2.2. Java ..... 80
    - 12.2.3. C++ ..... 80
    - 12.2.4. Is Integral Accum cleared any other time? ..... 80
  - 12.3. Current Closed-Loop Walkthrough – LabVIEW..... 81
    - 12.3.1. Current Closed-Loop Walkthrough – Collect Sensor Data – LabVIEW ..... 81
    - 12.3.2. Current Closed-Loop Walkthrough – Calculating Feed Forward– LabVIEW..... 81
    - 12.3.3. Current Closed-Loop Walkthrough – Dialing Proportional Gain – LabVIEW..... 84
  - 12.4. Velocity Closed-Loop Walkthrough – Java..... 86
    - 12.4.1. Velocity Closed-Loop Walkthrough – Test Gamepad ..... 86
    - 12.4.2. Velocity Closed-Loop Walkthrough – Collect Sensor Data – Java ..... 86
    - 12.4.3. Velocity Closed-Loop Walkthrough – Calculating Feed Forward– Java..... 88
    - 12.4.4. Velocity Closed-Loop Walkthrough – Dialing Proportional Gain – Java ..... 89

- 12.5. Velocity Closed-Loop Example – LabVIEW ..... 90
- 12.6. Motion Magic Closed-Loop Walkthrough – Java..... 92
  - 12.6.1. Motion Magic Closed-Loop Walkthrough – General Requirements..... 93
  - 12.6.2. Motion Magic Closed-Loop Walkthrough – Test Gamepad ..... 93
  - 12.6.3. Motion Magic Closed-Loop Walkthrough – Collect Sensor Data – Java ..... 94
  - 12.6.4. Motion Magic Closed-Loop Walkthrough – Calculate F-Gain – Java ..... 96
  - 12.6.5. Motion Magic Closed-Loop Walkthrough – Initial Cruise-Velocity/Acceleration – Java 97
  - 12.6.6. Motion Magic Closed-Loop Walkthrough – P-Gain – Java ..... 99
  - 12.6.7. Motion Magic Closed-Loop Walkthrough – D-Gain – Java ..... 103
  - 12.6.8. Motion Magic Closed-Loop Walkthrough – I-Gain – Java..... 104
- 13. Setting Sensor Position ..... 105
  - 13.1. Setting Sensor Position – LabVIEW ..... 105
  - 13.2. Setting Sensor Position – C++..... 106
  - 13.3. Setting Sensor Position – Java ..... 106
  - 13.4. Auto Clear Position using Index Pin ..... 106
    - 13.4.1. Setting Sensor Position – LabVIEW ..... 107
    - 13.4.2. Setting Sensor Position – Java..... 107
    - 13.4.3. Setting Sensor Position – C++..... 107
- 14. Fault Flags ..... 107
  - 14.1. Fault Flags - LabVIEW..... 107
  - 14.2. Fault Flags - C++..... 109
  - 14.3. Fault Flags - Java..... 110
  - 14.4. Fault Flags – Clearing ..... 110
- 15. CAN bus Utilization/Error metrics ..... 111
  - 15.1. How many Talons can we use? ..... 112
- 16. Troubleshooting Tips and Common Questions..... 113
  - 16.1. When I press the B/C CAL button, the brake LED does not change, neutral behavior does not change. .... 113
  - 16.2. The robot is TeleOperated/Autonomous enabled, but the Talon SRX continues to blink orange (disabled)..... 113
  - 16.3. When I attach/power a particular Talon SRX to CAN bus, The LEDs on every Talon SRX occasionally blink red. Motor drive seems normal..... 113

16.4. If I have a slave Talon SRX following a master Talon SRX, and the master Talon SRX is disconnected/unpowered, what will the slave Talon SRX do?..... 113

16.5. Is there any harm in creating a software Talon SRX for a device ID that's not on the CAN bus? Will removing a Talon SRX from the CAN bus adversely affect other CAN devices? 114

16.6. Driver Station log says "Firm Vers could not be retrieved" ..... 114

16.7. Driver Station log says "Firmware too old" ..... 114

16.8. Why are there multiple ways to get the same sensor data? `GetSensorCollection().GetEncoder()` versus `GetSelectedSensor()`? ..... 114

16.9. All CAN devices have red LEDs. Recommended Preliminary checks for CAN bus.. 115

16.10. Driver Station reports "MotorSafetyHelper.cpp: A timeout...", motor drive no longer works. roboRIO Web-based Configuration says "No Drive" mode? Driver Station reports error - 44075? 116

16.11. Motor drive stutters, misbehaves? Intermittent enable/disable? ..... 116

16.12. What to expect when devices are disconnected in roboRIO's Web-based Configuration. Failed Self-Test? ..... 117

16.13. How do I get the raw ADC value (or voltage) on the Analog Input pin? ..... 118

16.14. Recommendation for using relative sensors. .... 118

16.15. Does anything get reset or lost after firmware updates?..... 119

16.16. Analog Position seems to be stuck around ~100 units? ..... 119

16.17. Limit switch behavior doesn't match expected settings. .... 120

16.18. How fast can I control just ONE Talon SRX? ..... 121

16.19. Expected symptoms when there is excessive signal reflection. .... 121

16.20. LabVIEW application reads incorrect Sensor Position. Sensor Position jumps to zero or is missing counts. .... 121

16.21. CAN devices do not appear in the roboRIO Web-based config..... 122

16.22. When I make a change to a setting in the roboRIO Web-based configuration and immediately flash firmware into the Talon, the setting does not stick? ..... 122

16.23. My mechanism has multiple Talon SRXs and one sensor. Can I still use the closed-loop/motion-profile modes? ..... 123

16.24. My Closed-Loop is not working? Now what? ..... 123

    16.24.1. Make sure Talon has latest firmware..... 123

    16.24.2. Confirm sensor is in phase with motor. .... 123

    16.24.3. Confirm Slave/Follower Talons are driving..... 123

    16.24.4. Drive (Master) Talon manually..... 123

    16.24.5. Re-enable Closed-Loop ..... 123

- 16.24.6. Start with a simple gain set ..... 124
- 16.24.7. Confirm gains are set ..... 125
- 16.25. Where can I find application examples? ..... 125
- 16.26. Can RobotDrive be used with Talon SRXs? What if there are six Talons? ..... 126
- 16.27. How fast does the closed-loop run? ..... 127
- 16.28. Driver Station log reports: The transmission queue is full. Wait until frames in the queue have been sent and try again. .... 127
- 17. Units and Term Definitions ..... 128
- 17.1. Signal Definitions and Sensor Units ..... 128
  - 17.1.1. (Quadrature) Encoder Position ..... 128
  - 17.1.2. Analog (Encoder/Potentiometer) ..... 128
  - 17.1.3. Motor output ..... 128
  - 17.1.4. (Open-Loop) Ramp ..... 129
  - 17.1.5. (Closed-Loop) Ramp ..... 129
  - 17.1.6. Integral Zone (I Zone) ..... 129
  - 17.1.7. Integral Accumulator (I Accum) ..... 129
  - 17.1.8. Motor Invert ..... 129
  - 17.1.9. Sensor Phase ..... 129
  - 17.1.10. Closed-Loop Error ..... 129
  - 17.1.11. Closed-Loop gains ..... 130
- 17.2. Sensor Resolutions ..... 130
- 18. How is the closed-loop implemented? ..... 131
- 19. Motor Safety Helper ..... 133
- 19.1. Best practices ..... 133
- 19.2. C++ example ..... 134
- 19.3. Java example ..... 134
- 19.4. LabVIEW Example ..... 134
- 19.5. RobotDrive ..... 134
- 20. Going deeper - How does the framing work? ..... 135
- 20.1. General Status 1 ..... 135
- 20.2. Feedback0 Status 2 ..... 135
- 20.3. Quadrature Encoder Status 3 ..... 135
- 20.4. Analog Input / Temperature / Battery Voltage Status 4 ..... 136



- 20.5. Pulse Width Status 8..... 136
- 20.6. Targets Status 10 (Motion Profile and Motion Magic) ..... 136
- 20.7. PIDF0 Status 13..... 136
- 20.8. Modifying Status Frame Period ..... 137
  - 20.8.1. C++ ..... 137
  - 20.8.2. Java ..... 137
  - 20.8.3. LabVIEW ..... 137
- 20.9. Control Frame (Control 3) ..... 138
- 20.10. Modifying the Control Frame Period ..... 138
  - 20.10.1. Modifying the Control Frame Rate – C++ ..... 138
  - 20.10.2. Modifying the Control Frame Rate – Java ..... 138
  - 20.10.3. Modifying the Control Frame Rate – LabVIEW ..... 138
- 21. Functional Limitations ..... 139
  - 21.1. roboRIO power up: User should manually refresh the web-based configuration after rebooting roboRIO. .... 139
  - 21.2. Phoenix 5.1.3.1: Motion profile disabled in 2018 kickoff firmware. .... 139
  - 21.3. Two sets of Param declarations for auto-clear position parameters..... 139
  - 21.4. getClosedLoopTarget() return milliamperes..... 139
  - 21.5. Auto-clear position feature on Quadrature Idx only works for rising edges. .... 140
- 22. CRF Firmware Version Information ..... 141
- 23. Document Revision Information ..... 141

### TO OUR VALUED CUSTOMERS

It is our intention to provide our valued customers with the best documentation possible to ensure successful use of your CTRE products. To this end, we will continue to improve our publications, examples, and support to better suit your needs.

If you have any questions or comments regarding this document, or any CTRE product, please contact [support@crosstheroadelectronics.com](mailto:support@crosstheroadelectronics.com)

To obtain the most recent version of this document, please visit [www.ctr-electronics.com](http://www.ctr-electronics.com).

## 1. CAN bus Device Basics

Talon SRX, when used with CAN bus, has similar functional requirements with other FRC supported CAN devices. Specifically, every Talon SRX requires a unique device ID for typical FRC use (settings, control and status). The device ID is usually expressed as a number between '0' and '62', allowing use for up to 63 Talon SRXs at once. This range does not intercept with device IDs of other CAN device types. For example, there is no harm in having a Pneumatics Control Module (PCM) and a Talon SRX both with device ID '0'. However, having two Talon SRXs with device ID '0' will be problematic.

Talon SRXs are field upgradable, and the firmware shipped with your Talon SRX will predate the "latest and greatest" tested firmware intended for FRC use. Firmware update can be done easily using the FRC roboRIO Web-based Configuration.

Talon SRX provides two pairs of twisted CANH (yellow) and CANL (green) allowing for daisy chaining. Unlike previous seasons, the CAN termination resistors are built into the FRC robot controller (roboRIO) and in the Power Distribution Panel (PDP) assuming the PDP's termination jumper is in the ON position.

More information on wiring and hardware requirements can be found in the **Talon SRX User's Guide**.

This guide references **Talon SRX** in most of the content, however much of this content also relates to **Victor SPX**.

## 1.1. Supported Hardware Platforms

### 1.1.1. Cross The Road Electronics HERO Control System

The CTR HERO Control System board allows developers to utilize all features of the Talon SRX. It is meant for education, custom development, and integration of Talon SRX into existing applications.

The HERO also provides a method for field upgrading Talons to non-FRC firmware. It is the ideal development kit for learning and integrating the Talon into custom applications!

Applications are developed in Visual Studio 2017 (C#) using .NETMF framework.

Be sure to look for the  for HERO related tips.



### 1.1.2. roboRIO FRC Control System

The only legal robot controller for FRC competition. This requires the FRC version of Talon SRX firmware. The roboRIO supports CAN bus and provides a Web-based configuration for re-flashing and diagnostics.

Be sure to look for the  for FRC related tips.



## 2. roboRIO Web-based Configuration: Firmware and diagnostics

A useful diagnostic feature in the FRC Control system is the roboRIO's Web-based Configuration and Monitoring page. This provides diagnostic information on all discovered CAN devices, including Talon SRXs. Talon SRXs can also be field-upgraded using this interface.

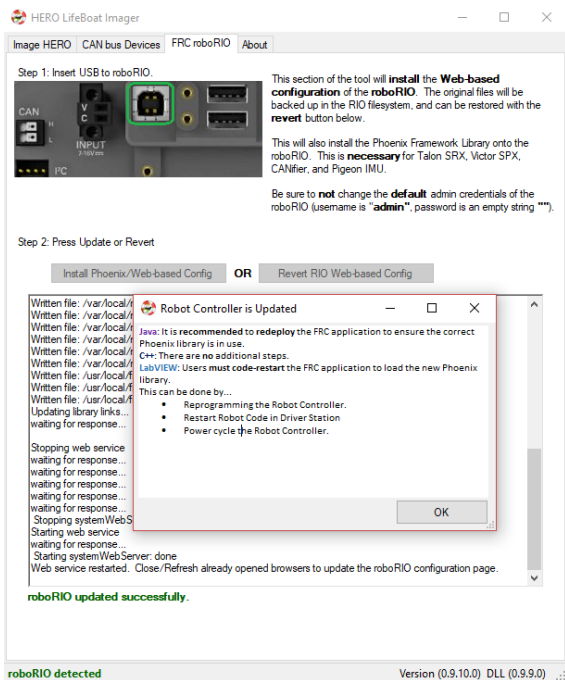

This feature is accessible by entering the mDNS name of your robot in a web browser, typically **roborio-XXXX-frc.local** where XXXX is the team number (no leading zeros for three digit team numbers).

**Web-based Configuration is not installed by default.**

User must install Phoenix Framework and run the roboRIO-Upgrade procedure in Phoenix LifeBoat. The installer can be found at [ctr-electronics.com](http://ctr-electronics.com)

 Because **Chrome** no longer supports NPAPI, **Silverlight** will not function.

**Internet Explorer** functions adequately though refreshing the page (F5 or CNTRL+R) often leaves an empty page. The workaround is to simply create a new tab with the same URL.

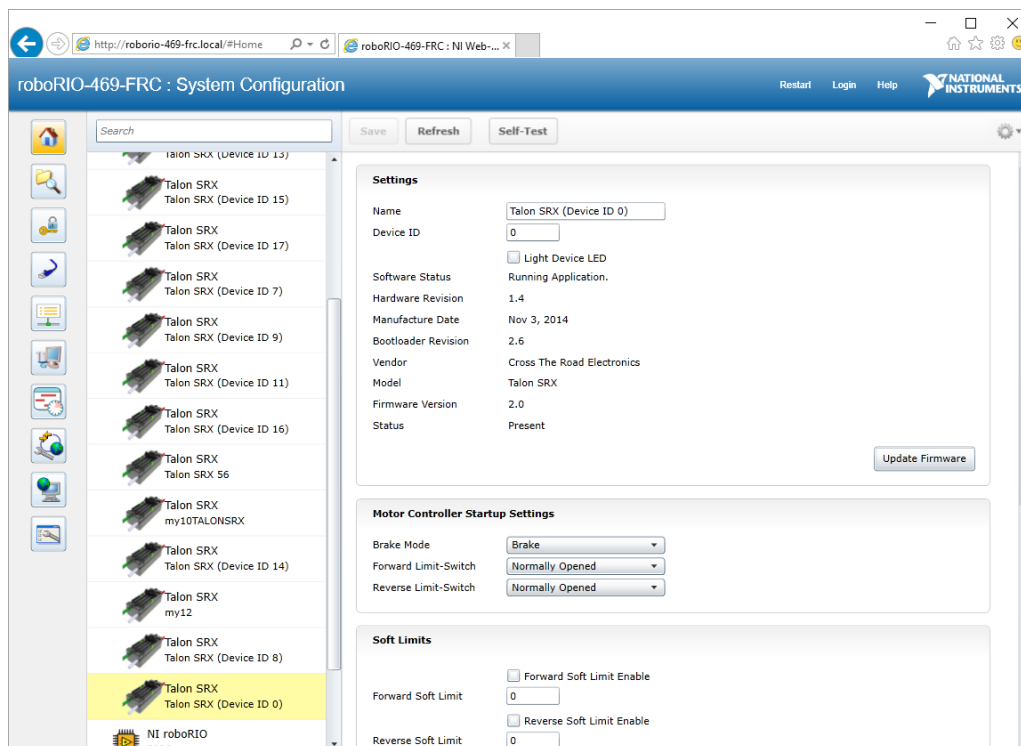

### 2.1. Device ID ranges

A Talon SRX can have a device ID from 0 to 62. 63 is reserved for broadcast. If you select an invalid ID, you will get an immediate prompt.

The screenshot shows a web-based settings interface for a device. At the top, there are three buttons: 'Save', 'Revert', and 'Self-Test'. Below the buttons is a yellow warning banner with a triangle icon and the text: 'There was a problem saving the settings for this device. Device ID must be in the range 0 - 62'. Underneath the banner is a 'Settings' section. It contains three rows of settings: 'Name' with the value 'Talon SRX (Device ID 3)', 'Device ID' with the value '63', and 'Light Device LED' with an unchecked checkbox. Below these is the 'Software Status' which reads 'Running Application.'.

## 2.2. Common ID Talons

During initial setup (and when making changes to your robot), there may be occasions where the CAN bus contains multiple running Talon SRXs with the same device ID. “Common ID” Talon SRXs are to be avoided since they prevent reliable communication and prevents your robot application from being able to distinguish one Talon SRX from another. However, the roboRIO’s Web-based Configuration and Talon SRX firmware is designed to be tolerant of this problem condition to a degree.

No two Talon SRXs should have the same ID. No two Victor SPXs should have the same ID. However, a Talon and Victor can have the same ID.

If there are “common ID” Talons, they will reveal themselves as a single tree element (see image below). In this example, there is only one “Talon SRX (Device ID 0)” graphical element on the left, however the software status shows that there are three detected Talon SRXs with that device ID. If the number of “common ID” Talon SRXs is small (typically five or less) you will still be able to firmware update, modify settings, and change the device ID. This makes solving device ID contentions possible without having to isolate/disconnect “common ID” Talon SRXs.

The screenshot shows the 'roboRIO-217 : System Configuration' web interface. On the left sidebar, a tree view lists various components: roboRIO, CAN Interface, PCM, PDP, and multiple Talon SRX units with different device IDs (10, 19, 16, 6, 12, 14, 17, 15, 13, 11, 8, and 0). The Talon SRX (Device ID 0) is highlighted in yellow. The main content area shows the configuration for this selected device. Under the 'Settings' section, the 'Device ID' is set to 0, and the 'Software Status' is highlighted with a blue box, displaying the message: 'There are 3 devices with this Device ID. Running Application.' Below this, the 'Motor Controller Startup Settings' section shows 'Brake Mode' set to 'Brake', and 'Forward Limit-Switch' and 'Reverse Limit-Switch' both set to 'Normally Opened'. The 'Soft Limits' section has 'Forward Soft Limit Enable' and 'Reverse Soft Limit Enable' both unchecked, with their respective limit values set to 0. The 'Motor Controller Closed-Loop Control Parameters Slot 0' section shows P Gain, I Gain, D Gain, and Feed-Forward Gain all set to 0.

When “common ID” Talon SRXs are present, correct this condition by changing the device ID to a “free” number, (one not already in use) before doing anything else. Then manually refresh the browser. This allows the web page to re-populate the left tree view with a new device ID.

Since the web page allows control of one Talon SRX at a time, you may need to determine *which* “common ID” Talon SRX you are modifying. Checking the “Light Device LED” and pressing “Save” can be used to identify *which* physical Talon SRX is selected, and therefore which one will be modified. This will cause the selected Talon SRX to blink its LEDs uniquely (fast orange blink) for easy identification. In the unlikely event the device is in boot-loader (orange/green LED), it will still respond to this by increasing the blink rate of the orange/green pattern. The “Light Device LED” will uncheck itself after pressing “Save”.

### 2.2.1. – Light Device LED

Save Revert Self-Test

**Settings**

Name	Talon SRX (Device ID 3)
Device ID	3
Light Device LED	<input checked="" type="checkbox"/>
Software Status	Running Application.
Hardware Revision	1.4

**Tip:** Since the default device ID of an “out of the box” Talon SRX is device ID ‘0’, start assigning device IDs at ‘1’. That way you can, at any time, add another default Talon to your bus and easily identify it.

**Tip:** Light Device LED can also be used to clear sticky faults.



### 2.3. Firmware Field-upgrade a Talon SRX / Victor SPX

Talon SRX firmware file is a CRF file. To firmware flash a Talon SRX, navigate to the following page and select it in the left tree view.

To get the latest firmware files see [Section 2.3.4. Where to get CRF files?](#)

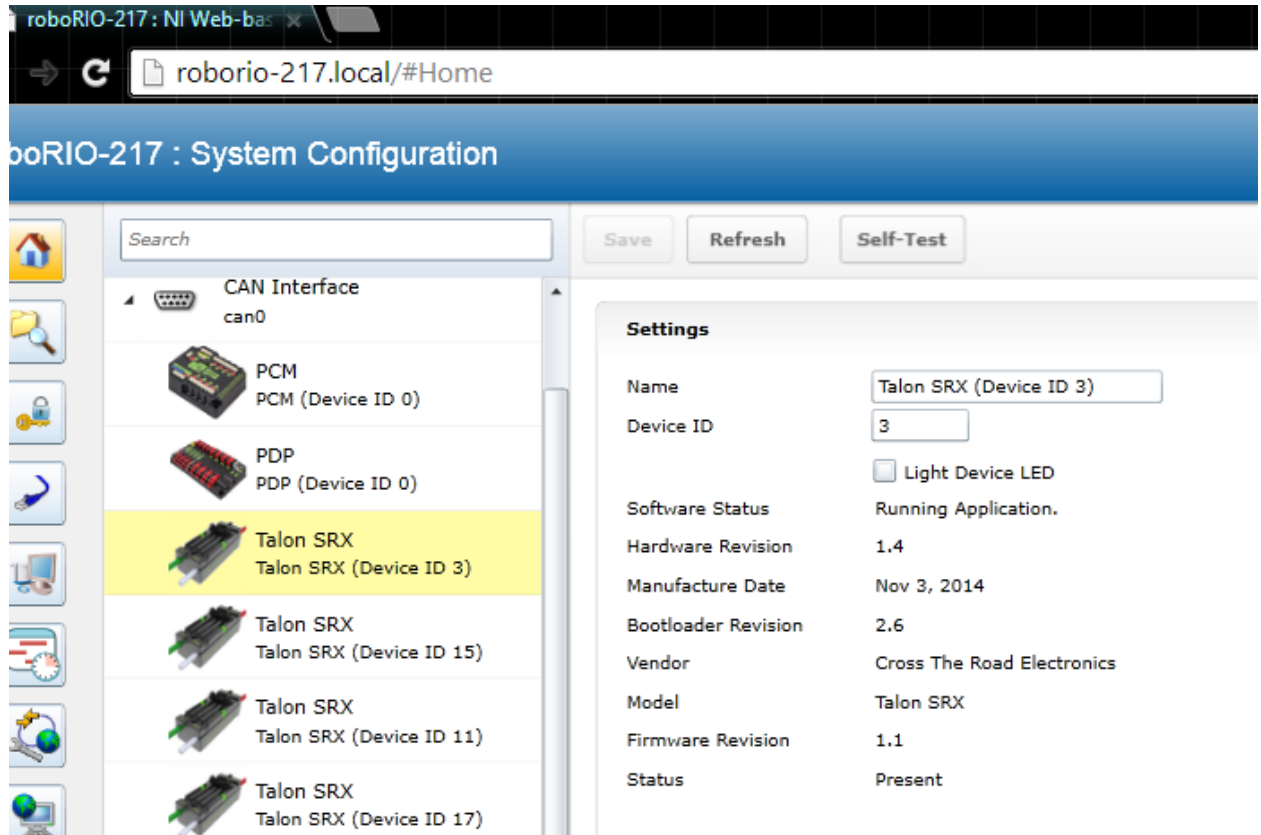

Press "Update Firmware".

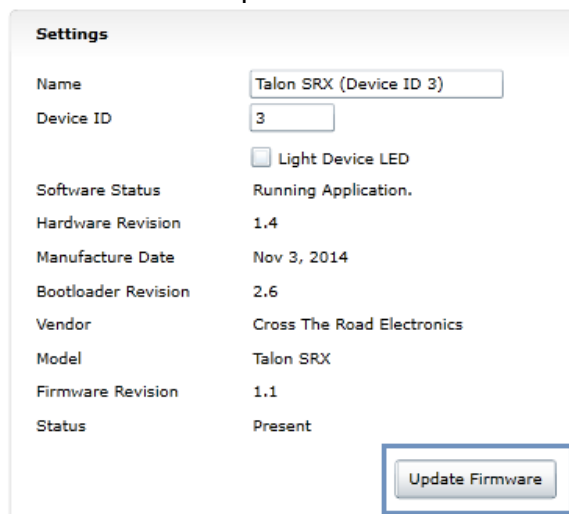

Select the firmware file (\*.crf) to flash.

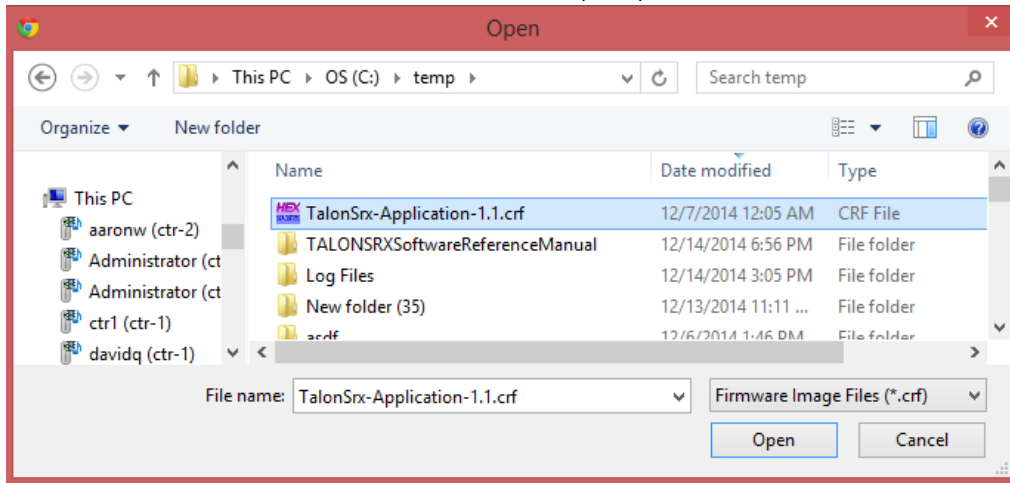

You will be prompted again, press "Begin Update".

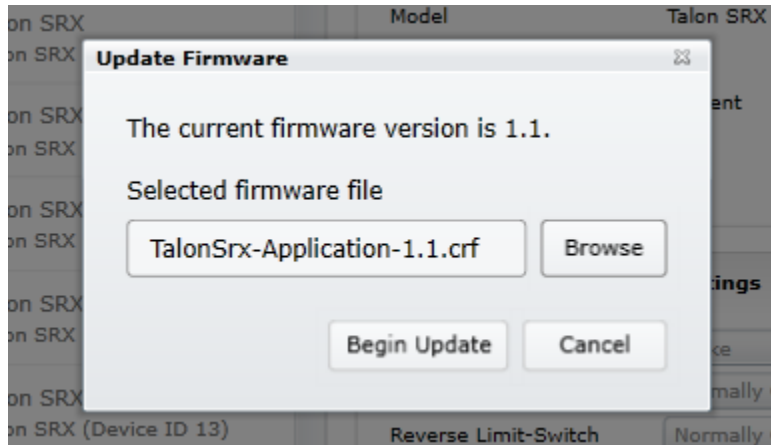

A progress bar will appear and finish with the following prompt. Total time to field-upgrade a Talon SRX is approximately ten seconds. The progress bar will fill quickly, then pause briefly at the near end, this is expected.

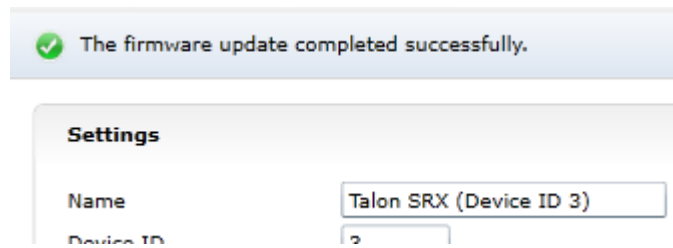

### 2.3.1. When I update firmware, I get “You do not have permissions...”

If you get the following error...

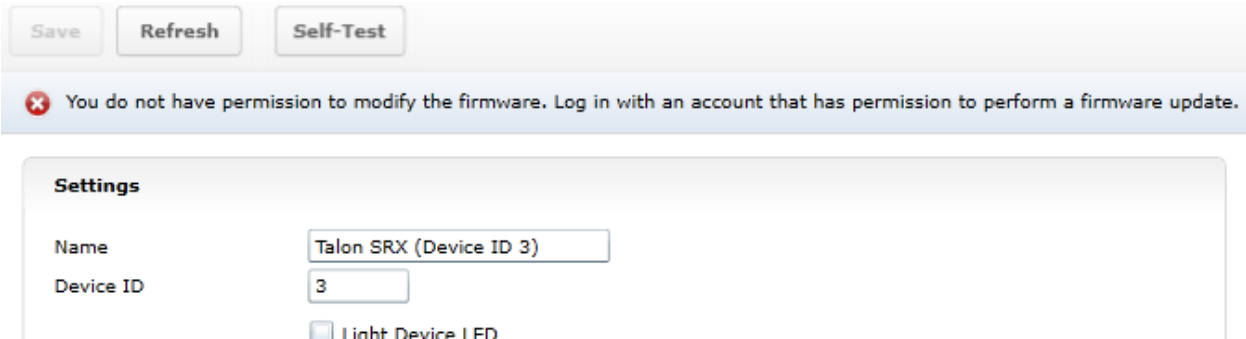

...then log into the web interface using the username “admin”.

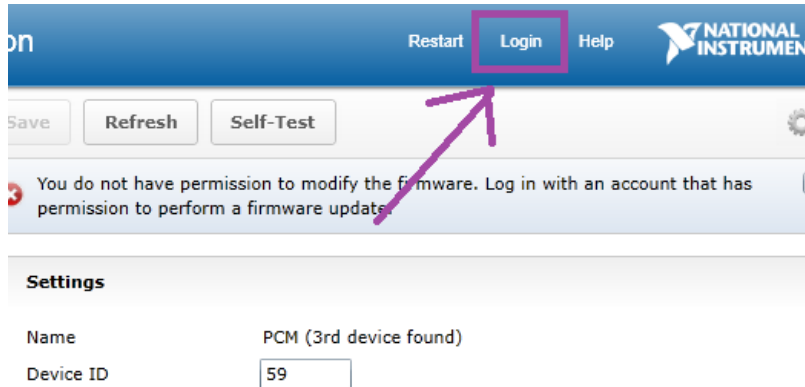

The user name is “admin” and the password is blank “”. Don’t enter any keys for password.

Additionally, you can modify permissions to allow field upgrade without being asked for login every single time. If security isn’t a concern, then modify the permissions so that “anyone” can access “FirmwareUpdate” features.

Click on the key/lock icon in the left icon list.

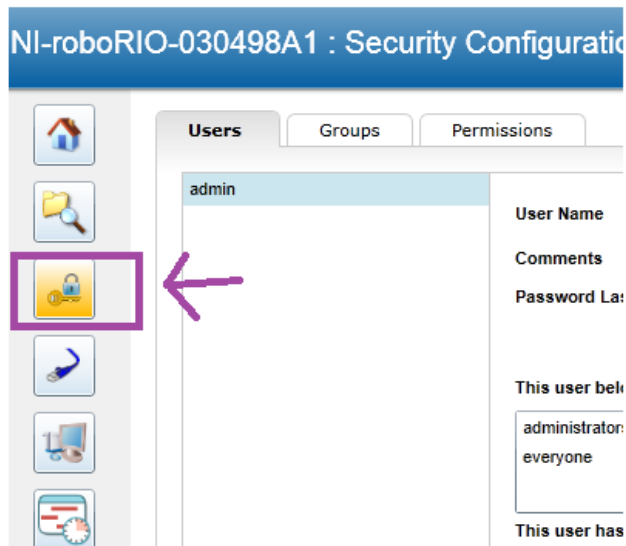

Then click on the “Permissions” tab. Select “FirmwareUpdate”, then press “Add” button.

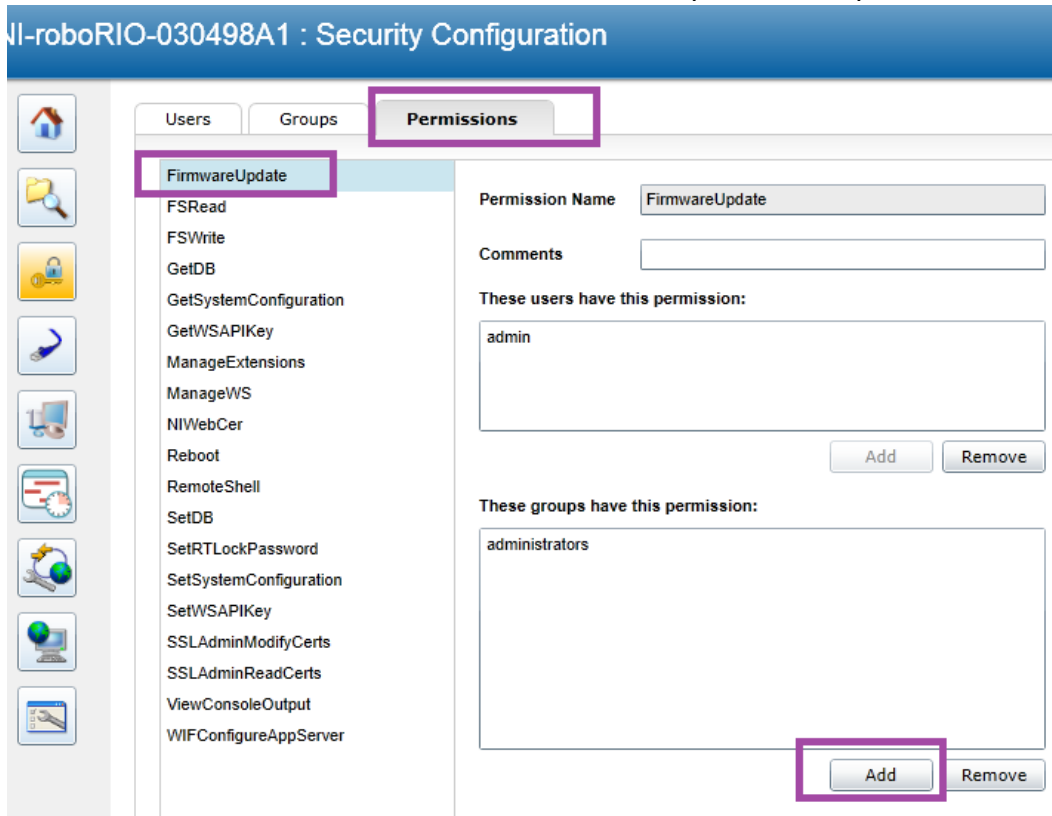

Select everyone, then OK.

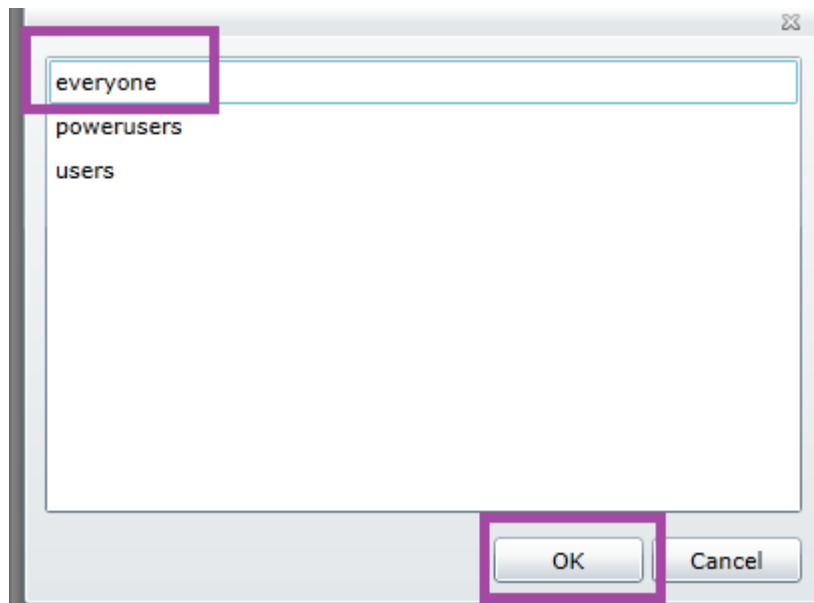

Click “Save” to save changes.

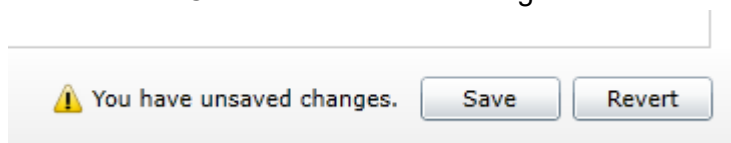

### 2.3.2. What if Firmware Field-upgrade is interrupted?

Because ten seconds is plenty of time for power or CAN bus to be disconnected, it is always possible for a field-update to be interrupted. An error code will be reported if the firmware field-update is interrupted or fails. Additionally, the Software Status will report “Bootloader” and Firmware Revision will be 255.255 (blank).

If a Talon SRX has no firmware, its boot-loader will take over and blink green/yellow on the device’s corresponding LED. It will also keep its device ID, so the roboRIO can still be used to change the device ID or (re)flash a new application firmware (crf). This means you can reattempt field-upgrade using the same web interface. There is no need for any sort of recovery steps, nor is it necessary to isolate no-firmware Talon SRXs.

Example capture of disconnecting the CAN bus in the middle of a firmware-upgrade...

The screenshot displays the roboRIO web interface. On the left, a sidebar lists various components: roboRIO (roboRIO-217), CAN Interface (can0), PCM (PCM (Device ID 0)), PDP (PDP (Device ID 0)), and four Talon SRX units (Device IDs 3, 15, 11, and an unlabeled one). The Talon SRX with Device ID 3 is highlighted in yellow. On the right, the 'Settings' page for this device is shown. At the top, a red error message box states: 'There was a problem updating the firmware for this device. Talon SRX (Device ID 3) : CTRE\_DI\_CouldNotSendFlash'. Below this, the 'Settings' table is visible:

Settings	
Name	Talon SRX (Device ID 3)
Device ID	3
Light Device LED	<input type="checkbox"/>
Software Status	Bootloader, LED is blinking green/orange.
Hardware Revision	1.4
Manufacture Date	Nov 3, 2014
Bootloader Revision	2.6
Vendor	Cross The Road Electronics
Model	Talon SRX
Firmware Revision	255.255 (No firmware)
Status	Present

### 2.3.3. Other Field-upgrade Failure Modes

Here's an example error when trying to flash the wrong CRF into the wrong product. The device will harmlessly stay in boot-loader, ready to be (re)flashed again.

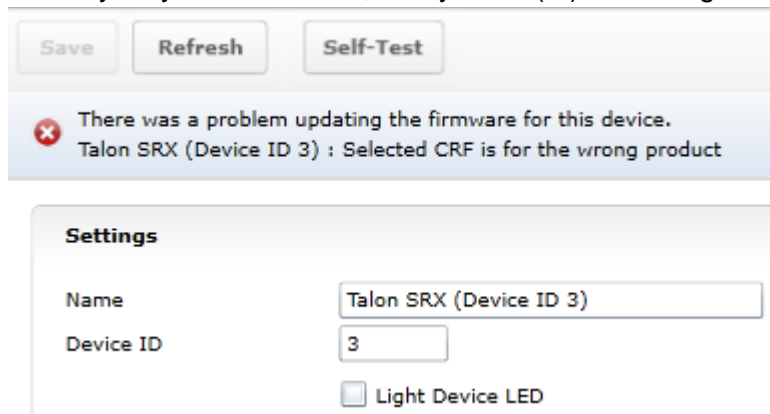

The screenshot shows a web interface with three buttons at the top: "Save", "Refresh", and "Self-Test". Below the buttons is a red error message box that reads: "There was a problem updating the firmware for this device. Talon SRX (Device ID 3) : Selected CRF is for the wrong product". Below the error message is a "Settings" section with the following fields: "Name" (Talon SRX (Device ID 3)), "Device ID" (3), and a checkbox for "Light Device LED" which is currently unchecked.

Here's what to expect if your CRF file is corrupted (different errors depending on where the file is corrupted). The device will harmlessly stay in boot-loader, ready to be (re)flashed again. Re-downloading the CRF firmware file is recommended if this is occurring persistently.

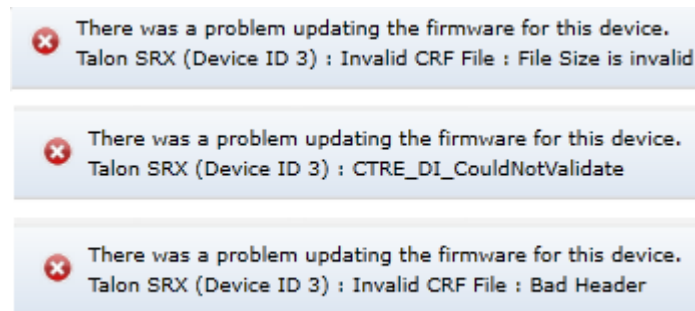

The screenshot shows three stacked error messages, each with a red 'x' icon. The first message reads: "There was a problem updating the firmware for this device. Talon SRX (Device ID 3) : Invalid CRF File : File Size is invalid". The second message reads: "There was a problem updating the firmware for this device. Talon SRX (Device ID 3) : CTRE\_DI\_CouldNotValidate". The third message reads: "There was a problem updating the firmware for this device. Talon SRX (Device ID 3) : Invalid CRF File : Bad Header".

Here's what to expect if you flash the wrong product's CRF. For example, if you try to flash the CRF for the Power Distribution Panel (PDP) into a Talon SRX, you will get an error prompt.

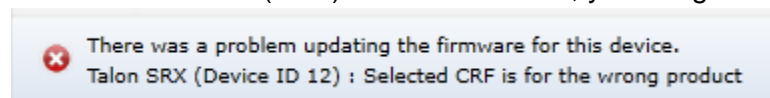

The screenshot shows a web interface with a red error message box that reads: "There was a problem updating the firmware for this device. Talon SRX (Device ID 12) : Selected CRF is for the wrong product".

### 2.3.4. Where to get CRF files?

The FRC Software installer will create a directory with various firmware files/tools for many control system components. Typically, the path is “**C:\Users\Public\Documents\FRC**”.

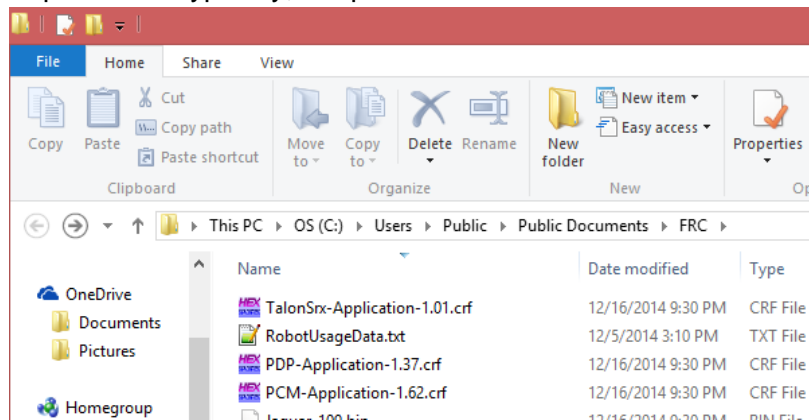

When the path is entered, the browser may fix-up the path into “**C:\Users\Public\Public Documents\FRC**”. This is typical in Windows.

In this directory are the initial release firmware CRF files for all CTRE CAN bus devices, including the Talon SRX.

The latest firmware to be used at time of writing is **version 3.X** (where X is the minor version).



TIP: Additionally, newer updates may be provided online at <http://www.ctr-electronics.com>.



FRC: Be sure to watch for team updates for what is legal and required!

## 2.4. Self-Test

Pressing Self-Test will display data captured from CAN bus at the time of press. This can include fault states, sensor inputs, output states, measured battery voltage, etc.

At the bottom of the Self-Test results, the build time of the library that implements web-based CAN features is also present.

Here's an example of pressing "Self-Test" with Talon SRX. Be sure to check if Talon SRX is ENABLED or DISABLED. If Talon SRX is DISABLED, then either the robot is disabled or the robot application has not yet created a Talon SRX object (see [Section 3. Creating a Talon SRX Object \(and basic drive\)](#)).

The screenshot shows the "roboRIO-3539-FRC : System Configuration" web interface. The left sidebar contains a navigation menu with icons for Home, Search, CAN Interface, PDP, Talon SRX, NI roboRIO RIO0, ASRL1::INSTR, and ASRL2::INSTR. The main content area is divided into two sections: a configuration list on the left and a detailed self-test report on the right. The "Talon SRX" device is highlighted in yellow in the configuration list. The self-test report shows a green checkmark and the message "The self test completed successfully. Device NOT ENABLED!". Below this, various parameters are listed, including Mode, Motor Leads, Brake during neutral, VCompEn, Slot Selects, SelfFeedback, PID0/PID1 errors, Quad/MagEnc(rel) status, Pins, Analog Input, PulseWidth/MagEnc(abs), TachVel, PosEncPulse, LimSw(F/R), ZeroPosOn, and a table of fault states (Under Vbat, Reset Dur En) comparing (Now) and (Sticky) values. At the bottom, current (Curr(A)), bus voltage (Bus(V)), and temperature (Temp(C)) are displayed, along with Nominal %, Peak %, Closed Loop AllowedErr, Vel Sampling, and VCompSat values.

roboRIO-3539-FRC : System Configuration

Search

Save Refresh Self-Test

roboRIO  
roboRIO-3539-FRC

CAN Interface  
can0

PDP  
PDP (Device ID 0)

Talon SRX  
Talon SRX (Device ID 0)

NI roboRIO  
RIO0

ASRL1::INSTR  
ASRL1::INSTR

ASRL2::INSTR  
ASRL2::INSTR

The self test completed successfully.  
Device NOT ENABLED!  
Mode:0:PercentOutput | Output:0.00% [0.00 V]  
Motor Leads (Inverted): M+:0 V M-:0 V  
Brake during neutral  
VCompEn:0 CurrLimited:0

Slot Selects:PID0: 0 PID1: 0  
SelfFeedback0:0:Quad/MagEnc(rel)|Pos:2718u Vel:0u/100r  
SelfFeedback1:0:Quad/MagEnc(rel)|Pos:0u Vel:0u/100ms  
PID0 err: 0 iaccum:0 derr:0  
PID1 err: 0 iaccum:0 derr:0

Quad/MagEnc(rel)  
Pos:-2718u Vel:0u/100ms  
Pins: A=1 B=0 Id=0 IdEdges:0

Analog Input Pos:99u Vel:0u/100ms|ADC:99|0.3 V

PulseWidth/MagEnc(abs) Per(us):4180.0  
TachVel: 24497 u/100ms | 14354.00 RPM  
PosEncPulse Pos:1377u Vel:0u/100ms

LimSw(F/R):Open,Open  
ZeroPosOn Idx=Off LimF=Off LimR=Off

	(Now)	(Sticky)
Under Vbat :	0	1
Reset Dur En :	0	1

Curr(A):0.12 | Bus(V):8.44 | Temp(C):23

Nominal %:0,0  
Peak %:-100,100  
Closed Loop AllowedErr:Slot0=0,Slot1=0  
Vel Sampling Per(ms):100,AvgWin:64  
VCompSat:0.0



After enabling the robot and repressing “Self-Test” we see the Talon SRX is enabled.

Additionally, we see there is a sticky fault asserted for low battery voltage and reset during enable (talon was powered cycled during robot enable).

Sticky faults persist across power cycles for identifying intermittent problems after they occur. They can be cleared via robot API, or via the “Light Device ID” checkbox.

roboRIO-3539-FRC : NI We... x

### roboRIO-3539-FRC : System Configuration

Search

Save Refresh Self-Test

- roboRIO  
roboRIO-3539-FRC
- CAN Interface  
can0
- PDP  
PDP (Device ID 0)
- Talon SRX  
Talon SRX (Device ID 0)**
- NI roboRIO  
RIO0
- ASRL1::INSTR  
ASRL1::INSTR
- ASRL2::INSTR  
ASRL2::INSTR

The self test completed successfully.  
 Device enabled  
 Mode:0:PercentOutput | Output:-1.55% [-0.12 V]  
 Motor Leads (Inverted): M+:0.12 V M-:0 V  
 Brake during neutral  
 VCompEn:0 CurrLimited:0

Slot Selects:PID0: 0 PID1: 0  
 SelFeedback0:0:Quad/MagEnc(rel)|Pos:2718u Vel:0u/100ms  
 SelFeedback1:0:Quad/MagEnc(rel)|Pos:0u Vel:0u/100ms  
 PID0 err: 0 iaccum:0 derr:0  
 PID1 err: 0 iaccum:0 derr:0

Quad/MagEnc(rel)  
 Pos:-2718u Vel:0u/100ms  
 Pins: A=1 B=0 Id=1 IdEdges:2

Analog Input Pos:97u Vel:0u/100ms|ADC:97|0.3 V

PulseWidth/MagEnc(abs) Per(us):4181.2  
 TachVel: 24490 u/100ms | 14349.00 RPM  
 PosEncPulse Pos:1378u Vel:5u/100ms

LimSw(F/R):Open,Open  
 ZeroPosOn Idx=Off LimF=Off LimR=Off

(Fault)	(Now)	(Sticky)
Under Vbat :	0	1
Reset Dur En :	0	1

Curr(A):0.12 | Bus(V):8.44 | Temp(C):22

Nominal %:0,0  
 Peak %:-100,100  
 Closed Loop AllowedErr:Slot0=0,Slot1=0  
 Vel Sampling Per(ms):100,AvgWin:64

### 2.4.1. Clearing Sticky Faults

Use the "Light Device LED" checkbox to clear the sticky faults and illuminate the device LEDs (rapid orange blink).

```
✓ The self test completed successfully.
Device NOT ENABLED!
Mode:0:PercentOutput | Output:0.00% [0.00 V]
Motor Leads: M+/M- off
Coast during neutral
VCompEn:0 CurrLimited:0

Slot Selects:PID0: 0 PID1: 0
SelfFeedback0:0:Quad/MagEnc(rel)|Pos:0u Vel:0u/100ms
SelfFeedback1:0:Quad/MagEnc(rel)|Pos:0u Vel:0u/100ms
PID0 err: 0 iaccum:0 derr:0
PID1 err: 0 iaccum:0 derr:0

Quad/MagEnc(rel)
Pos:0u Vel:0u/100ms
Pins: A=1 B=0 Id=0 IdEdges:1

Analog Input Pos:97u Vel:0u/100ms|ADC:97|0.3 V

PulseWidth/MagEnc(abs) Per(us):4112.8
TachVel: 24897 u/100ms | 14588.00 RPM
PosEncPulse Pos:3568u Vel:2u/100ms

LimSw(F/R):Open,Open
ZeroPosOn Idx=Off LimF=Off LimR=Off

Curr(A):0.00 | Bus(V):12.39 | Temp(C):21

Nominal %:0,0
Peak %:-100,100
Closed Loop AllowedErr:Slot0=0,Slot1=0
Vel Sampling Per(ms):100,AvgWin:64
VCompSat:0.0

"Light Device LED" clears sticky faults.

CTRE Build:Jan 1 2018 18:08:40
Press "Refresh" to close.
```

## 2.5. Custom Names

Another feature made available by the Web-based Configuration is the ability to rename Talon SRXs with custom string descriptions. A Talon SRX's custom name is saved persistently inside the Talon. To modify the default name, highlight the contents of the "Name" text entry.

...then replace with a custom text description and press "Save".

The new description will appear in the left tree view.

### 2.5.1. Re-default custom name

To re-default the custom name, clear the “Name” text entry and press “Save”.

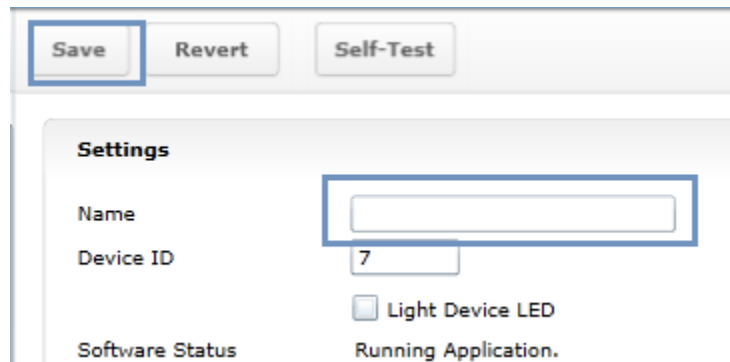

Left tree view will update with a temporary name until the “Refresh” button is pressed.

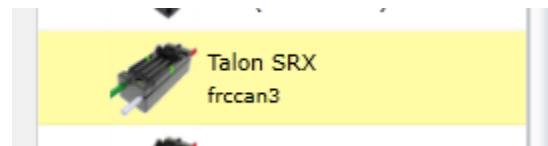

After pressing “Refresh” the default name will appear.

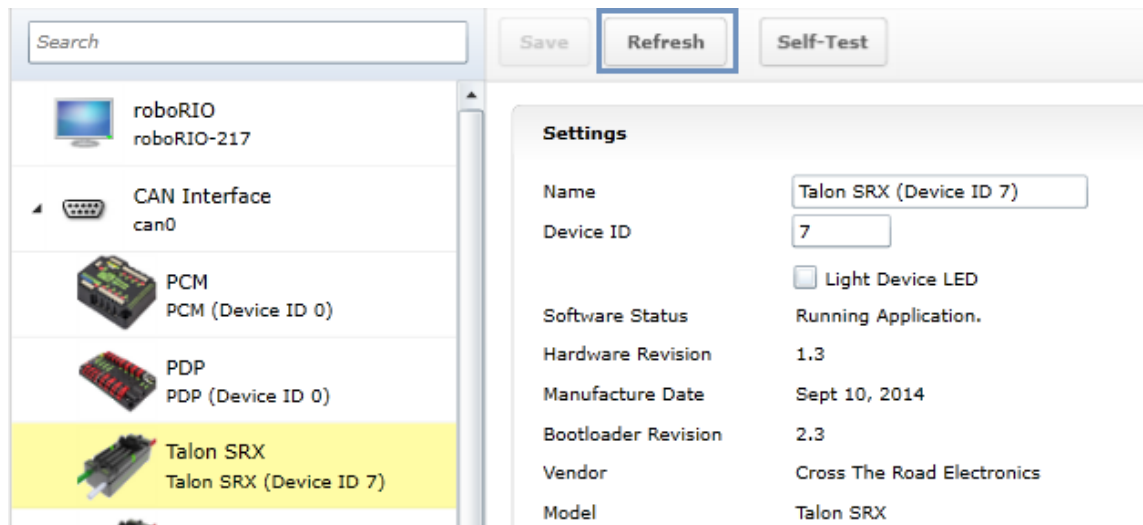

## 3. Creating a Talon Object (and the basics)

### 3.1. Programming API and Device ID

Regardless of what language you use on the FRC control system (LabVIEW/C++/Java), the method for specifying which Talon SRX you are programmatically controlling is the device ID. Although the roboRIO Web-based Configuration is tolerant of “common ID” Talon SRXs to a point, the robot programming API will not enable/control “common ID” Talons reliably. For the robot to function properly, there CANNOT BE “COMMON ID” Talon SRXs. See [Section 2.2. Common ID Talons](#) for more information.

**TIP:** Example projects for Talon SRX can also be found in the CTR GitHub account.

<https://github.com/CrossTheRoadElec/Phoenix-Examples-LabVIEW>

<https://github.com/CrossTheRoadElec/Phoenix-Examples-Languages>

Additional documentation may be found here...

<https://github.com/CrossTheRoadElec/Phoenix-Documentation>

#### 3.1.1. Including Libraries (FRC)

To use Talon SRX libraries, FRC Teams need to download and install the Phoenix Framework v5, which can be found on the CTR Electronics website.

Once the libraries have been installed, users can simply add them to their project using standard import/include statements.

For Java, users should add an import statement as follows:

```
import com.ctre.phoenix.motorcontrol.can.TalonSRX;
```

If using Eclipse IDE, typically the IDE will recommend imports as class names are typed into the Java source. Click on Import ‘TalonSRX’ to auto insert the import line.

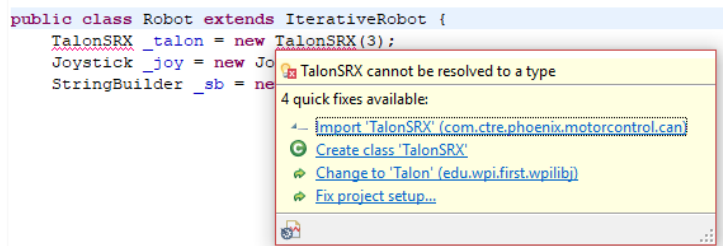

For C++, users should add the single include for Phoenix.

```
#include "ctre/Phoenix.h"
```

LabVIEW users will find the CAN Talon SRX VIs in a new CTRE subpalette.

### 3.1.2. Configuration API

Talon SRX and Victor SPX have many configuration functions / VIs.

These are recognizable as having the config\* prefix, and a trailing parameter called timeoutMs.

These functions manipulate parameters that are persistent within the motor controller, and therefore do not need to be called periodically unless the parameter value is genuinely changing as a requirement of the robot (which is not typical).

As an example, functions such as `configOpenloopRamp` and `configClosedloopRamp` exist to allow for once-on-boot configuration without having to continually change the ramp depending on use.

#### 3.1.2.1. Configuration API - timeoutMs

Since most config\* calls occur during the robot boot sequence, the recommended value for timeoutMs is 10 (ms). This ensures that each config will wait up to 10ms to ensure the configuration was applied correctly, otherwise an error message will appear on the Driver station.

This is also the case for setting/homing sensor values.

For configuration calls that are done during the robot loop, the recommended value for timeoutMs is zero, which ensures no blocking or checking is performed (identical to the implementation in previous seasons).

#### 3.1.2.2. Factory Default

The configuration values can be factory defaulted by holding the B/C CAL on power boot and confirming rapid green LEDs.

This will default all configurable parameters except for device ID and neutral brake.

This should be done when replacing/swapping TalonSRXs/VictorSPXs, otherwise the developer will need to set every config routine to ensure all parameters are set to the desired values.

## 3.2. New Classes/Virtual Instruments

C++/Java now contains a new class **TalonSRX** (.h/.cpp/.java). **CANTalon has been replaced with TalonSRX.**

Java TalonSRX and parent class is documented....

<http://www.ctr-electronics.com/downloads/api/java/html/com/ctre/phoenix/motorcontrol/can/TalonSRX.html>

<http://www.ctr-electronics.com/downloads/api/java/html/com/ctre/phoenix/motorcontrol/can/BaseMotorController.html>

C++ TalonSRX and parent class is documented....

[http://www.ctr-electronics.com/downloads/api/cpp/html/classctre\\_1\\_1phoenix\\_1\\_1motorcontrol\\_1\\_1can\\_1\\_1\\_talon\\_s\\_r\\_x.html](http://www.ctr-electronics.com/downloads/api/cpp/html/classctre_1_1phoenix_1_1motorcontrol_1_1can_1_1_talon_s_r_x.html)

[http://www.ctr-electronics.com/downloads/api/cpp/html/classctre\\_1\\_1phoenix\\_1\\_1motorcontrol\\_1\\_1can\\_1\\_1\\_base\\_motor\\_controller.html](http://www.ctr-electronics.com/downloads/api/cpp/html/classctre_1_1phoenix_1_1motorcontrol_1_1can_1_1_base_motor_controller.html)

### 3.2.1. WPILIB Class integration

Note: To use the various WPILIB features (Motor-safety, drive train classes, LiveWindow, etc), developers should use the **WPI\_TalonSRX** and **WPI\_VictorSPX** classes. These are subclasses that implement the various WPILIB interfaces. This also includes a single parameter `set()` that defaults the motor controller into PercentOutput mode.

LabVIEW contains a new palette for Victor SPX and Talon SRX.

The VI locations are documented here....

<https://github.com/CrossTheRoadElec/Phoenix-Documentation#labview---where-are-the-vis>



### 3.2.2. LabVIEW

Creating a “bare-bones” Talon SRX or Victor SPX object is similar to previously supported motor controllers. Start by using the OPEN VI and register a unique motor description.

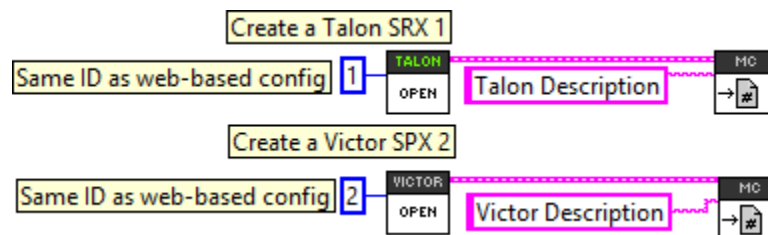

Create a constant for the “Device Number. The control mode is set later via the SET vi. Enter the appropriate Device ID that was selected in the roboRIO Web-based Configuration.

Also, similarly to other motor controllers, you may register a custom string reference to reference the motor controller by description in other block diagrams.

### 3.2.3. C++

When using a programming language, the API classes for the CAN Motor controllers are called **TalonSRX/ VictorSPX** (.cpp/.h/.java). When the object is constructed, the device ID is the single parameter.

Note: use **WPI\_TalonSRX/WPI\_VictorSPX** instead, when using WPILIB features such as motor-safety or drivetrain objects.

```

 8  #include <iostream>
 9  #include <string>
10
11  #include <TimedRobot.h>
12  #include "ctre/Phoenix.h"
13  #include "Joystick.h"
14
15  class Robot: public frc::TimedRobot {
16  public:
17
18      TalonSRX * talon = new TalonSRX(4);
19
20      Joystick * _joy = new Joystick(0);
21
22  void TeleopPeriodic() {
23
24      talon->Set(ControlMode::PercentOutput, _joy->GetY());
25
26  }
27
28  private:
29  };
30
31  START_ROBOT_CLASS(Robot)

```

### 3.2.4. Java

When a **TalonSRX/VictorSPX** object is constructed in Java, the device ID is the first parameter.

Note: use **WPI\_TalonSRX/WPI\_VictorSPX** instead, when using WPILIB features such as motor-safety or drivetrain objects.

```

public class Robot extends IterativeRobot {

    TalonSRX talon = new TalonSRX(4);
    Joystick joy = new Joystick(0);

    /**
     * This function is called periodically during operator control.
     */
    @Override
    public void teleopPeriodic() {
        talon.set(ControlMode.PercentOutput, joy.getY());
    }
}

```



### 3.3. Setting Output Mode and Value

After a Talon software object is created, the Talon SRX mode and output can be changed using the Set routine/VI. This season's set routine takes both the Control Mode and the output parameter. Because the output value is dependent on the control mode, the user must specify both. This produces cleaner robot code that is simpler to troubleshoot.

#### 3.3.1. LabVIEW

The control mode and output is specified using the same SET VI. Select PercentOutput to directly control the output. The SET value is the percent output with a range of [-1,1].

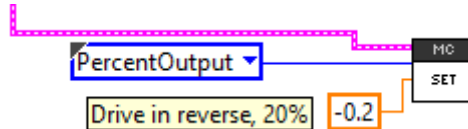

Note when using the standard Set Output VI, the control mode is set to PercentOutput. This is because the Set Output VI was designed for “simple” motor controllers.

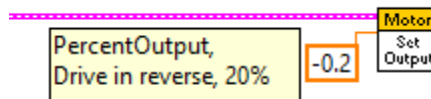

#### 3.3.2. C++

The function `set()` can be used to change the Talon SRX mode and output value.

```
talon.Set(ControlMode.PercentOutput, joy.getY());
```

#### 3.3.3. Java

The function `set()` can be used to change the Talon SRX mode and output value.

```
talon.set(ControlMode.PercentOutput, joy.getY());
```

#### 3.3.4. Check Control Mode with Self-Test

The Self-Test can be used to confirm the desired mode of the Talon SRX (PercentOutput, Follower, Position Closed-Loop, Velocity Closed-Loop, etc.).

##### Example Self-Test

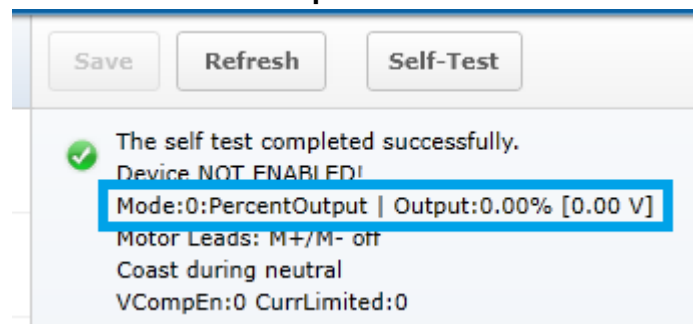

### 3.4. WPILib RobotDrive Class

The Robotdrive class is maintained by WPILib. **Any source intended to use these classes should create WPI\_TalonSRX and WPI\_VictorSPX objects.** These classes inherit the TalonSRX and Victor SPX classes, and implement the various WPILib interfaces.

#### 3.4.1. LabVIEW

The RoboDrive Vis are typically located in WPI Robotics Library -> RobotDrive.

To use Talon SRX with either the 2 or 4 motor options, first use a Talon SRX Open Motor VI. The RefNum output is then wired to the input of the Open 2/4 Motor VI when the “Existing Motors” drop-down option is selected. The RobotDrive RefNum Set is then used as normal.

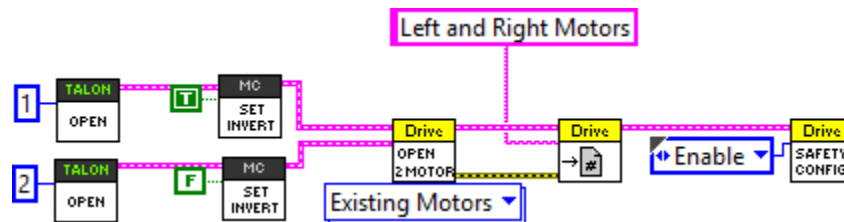

#### 3.4.2. C++

RobotDrive is included in WPILib.h. Construct the appropriate `WPI_TalonSRX` objects and pass them to the RobotDrive constructor.

```
FrontLeftMotor = new WPI_TalonSRX(1);
FrontRightMotor = new WPI_TalonSRX(2);
RearLeftMotor = new WPI_TalonSRX(3);
RearRightMotor = new WPI_TalonSRX(4);

drive = new RobotDrive(FrontLeftMotor, RearLeftMotor, FrontRightMotor,
    RearRightMotor);
```

#### 3.4.3. Java

RobotDrive is included in WPILib. Construct the appropriate `WPI_TalonSRX` objects and pass them to the RobotDrive constructor.

```
FrontLeftMotor = new WPI_TalonSRX(1);
FrontRightMotor = new WPI_TalonSRX(2);
RearLeftMotor = new WPI_TalonSRX(3);
RearRightMotor = new WPI_TalonSRX(4);

drive = new RobotDrive(FrontLeftMotor, RearLeftMotor, FrontRightMotor,
    RearRightMotor);
```

## 4. Limit Switch and Neutral Brake Mode

### 4.1. Default Settings

An “out of the box” Talon will default with the limit switch setting of “Normally Open” for both forward and reverse. This means that motor drive is allowed when a limit switch input is not closed (i.e. not connected to ground). When a limit switch input is closed (is connected to ground) the Talon SRX will disable motor drive and individually blink both LEDs red in the direction of the fault (red blink pattern will move towards the M+/white wire for positive limit fault, and towards M-/green wire for negative limit fault).

An “out of the box” Talon SRX will typically have a default brake setting of “Brake during neutral”. The B/C CALL button will be illuminated red (brake enabled).

Since an “out of the box” Talon will likely not be connected to limit switches (at least not initially) and because limit switch inputs are internally pulled high (i.e. the switch is open), the limit switch feature is default to “normally open”. This ensures an “out of the box” Talon will drive even if no limit switches are connected.

For more information on Limit Switch wiring/setup, see the **Talon SRX User’s Guide**.

Forward Limit Switch Mode	Limit Switch NO pin	Limit Switch NC pin	Limit Switch COM pin	Motor Drive Switch open Fwd. output	Motor Drive Switch closed Fwd. output	*Voltage (Switch Open)	*Voltage (Switch Closed)
Normally Open	pin4	N.A.	pin10	Y	N	~2.5V	0 V
Normally Closed	N.A.	pin4	pin10	N	Y	0 V	~2.5V
Disabled	N.A.	N.A.	N.A.	Y	Y	N.A.	N.A.
Reverse Limit Switch Mode	Limit Switch NO pin	Limit Switch NC pin	Limit Switch COM pin	Motor Drive Switch open Rev. output	Motor Drive Switch closed Rev. output	*Voltage (Switch Open)	*Voltage (Switch Closed)
Normally Open	pin8	N.A.	pin10	Y	N	~2.5V	0 V
Normally Closed	N.A.	pin8	pin10	N	Y	0 V	~2.5V
Disabled	N.A.	N.A.	N.A.	Y	Y	N.A.	N.A.
*Measured voltage at the Talon SRX Limit Switch Input pin.							
Limit Switch Input Forward Input - pin4 on Talon SRX							
Limit Switch Input Reverse Input - pin8 on Talon SRX							
Limit Switch Ground - pin10 on Talon SRX							

## 4.2. roboRIO Web-based Configuration: Limit Switch and Brake

Limit switch features can be disabled or changed to “Normally Closed” in the roboRIO Web-based Configuration. Similarly, the neutral brake mode can be selected.

The screenshot displays the 'roboRIO-217 : System Configuration' web interface. On the left, a sidebar contains navigation icons and a list of Talon SRX devices. The device 'Talon SRX (Device ID 0)' is selected and highlighted in yellow. The main content area shows the configuration settings for this device. The 'Settings' section includes fields for Name, Device ID, and a checkbox for 'Light Device LED'. Below this, various status and hardware information is displayed. The 'Motor Controller Startup Settings' section is highlighted with a blue box and contains three dropdown menus: 'Brake Mode' (set to 'Brake'), 'Forward Limit-Switch' (set to 'Normally Opened'), and 'Reverse Limit-Switch' (set to 'Normally Opened'). Buttons for 'Save', 'Refresh', 'Self-Test', and 'Update Firmware' are also visible.

Changing the settings will take effect once the “Save” button is pressed. The settings are saved in persistent memory.

If the Brake or Limit Switch mode is changed in the roboRIO Web-based Configuration, the Talon SRX will momentarily disable then resume motor drive. All other settings can be changed without impacting the motor drive or enabled-state of the Talon SRX.

Additionally, the brake mode can be modified by pressing the B/C CAL Button on the Talon SRX itself, just like with previous generation Talons.

### 4.3. Overriding Brake and Limit Switch with API

The Brake and Limit Switch can be changed programmatically (during a match). A great example of this would be for dynamic braking.

The programming API allows for overriding the active neutral brake mode. When this is done the Brake/Coast LED will reflect the overridden value (illuminated red for brake, off for coast) regardless of the startup brake mode specified in the roboRIO Web-based Configuration (i.e. what's saved in persistent memory).

Similarly, the enabled states of the limit switches (on/off) for the forward and reverse direction can be enabled/disabled by overriding them with programming API.

The brake and limit switch overrides can be confirmed in the Self-Test results. If limit switches are overridden by the robot application, the forced states are displayed as “forced ON” or “forced OFF”. The currently active brake mode is also in the Self-Test results.



(Self-test format has changed in 2018 since screenshot)

### 4.3.1. LabVIEW

The VIs below can be used to configure and override the limit switches. Select “Feedback Connector” when using the Limit Switch pins on the Talon’s Gadgeteer pinout.

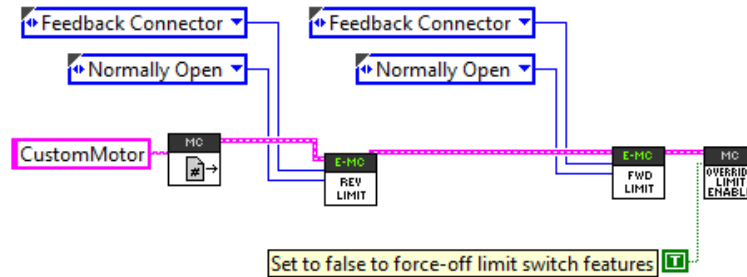

The neutral brake mode can also be overridden to Brake or Coast. If “EEPROMSetting” is selected, then the Startup Brake Mode is used (B/C Cal button)

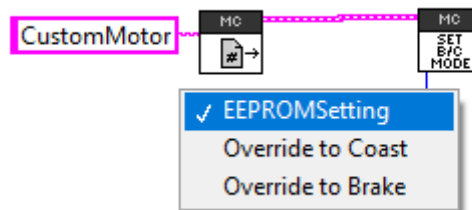

### 4.3.2. C++

Limit Switches and neutral brake can be configured using the functions below.

```

talon.ConfigForwardLimitSwitchSource (
    LimitSwitchSource::LimitSwitchSource_FeedbackConnector,
    LimitSwitchNormal::LimitSwitchNormal_NormallyOpen, 0);

talon.ConfigReverseLimitSwitchSource (
    LimitSwitchSource::LimitSwitchSource_FeedbackConnector,
    LimitSwitchNormal::LimitSwitchNormal_NormallyOpen, 0);

talon.OverrideLimitSwitchesEnable(true); // pass false to force disable the limit switch features

```

```

enum NeutralMode neutralMode
talon.SetNeutralMode(NeutralMode::)
    □ Brake
    □ Coast
    □ EEPROMSetting

```

### 4.3.3. Java

Limit Switches and neutral brake can be configured using the functions below.

```
talon.configForwardLimitSwitchSource(  
    LimitSwitchSource.FeedbackConnector,  
    LimitSwitchNormal.NormallyOpen, 0);  
  
talon.configReverseLimitSwitchSource(  
    LimitSwitchSource.FeedbackConnector,  
    LimitSwitchNormal.NormallyOpen, 0);  
  
talon.overrideLimitSwitchesEnable(true); // pass false to force disable the limit switch features
```

```
talon.setNeutralMode(NeutralMode.
```

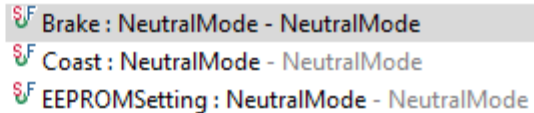

- Brake : NeutralMode - NeutralMode
- Coast : NeutralMode - NeutralMode
- EEPROMSetting : NeutralMode - NeutralMode

## 5. Getting Status and Signals

The Talon SRX transmits most of its status signals periodically, i.e. in an unsolicited fashion. This improves bus efficiency by removing the need for “request” frames, and guarantees the signals necessary for the wide range of use cases Talon supports, are available.

These signals are available in API regardless of what control mode the Talon SRX is in. Additionally, the signals can be polled in the roboRIO Web-based Configuration (see [Section 2.4. Self-Test](#)).

Included in the list of signals are...

- Quadrature Encoder Position, Velocity, Index Rise Count, Pin States (A, B, Index)
- Analog-In Position, Analog-In Velocity, 10bit ADC Value,
- Battery Voltage, Current, Temperature
- Fault states, sticky fault states,
- Limit switch pin states
- Applied output (duty cycle) regardless of control mode.
- Applied Control mode: Percent Output, Position/Velocity closed-loop, or slave follower.
- Brake State (coast vs brake)
- Closed-Loop Error, the difference between closed-loop set point and actual position/velocity.
- Sensor Position and Velocity, the signed output of the selected Feedback device (robot must select a Feedback device, or rely on default setting of Quadrature Encoder).



## 5.1. LabVIEW

The GET VI can be used to retrieve the latest value for the signals Talon SRX periodically transmits. Choose the correct signal group from the drop down.

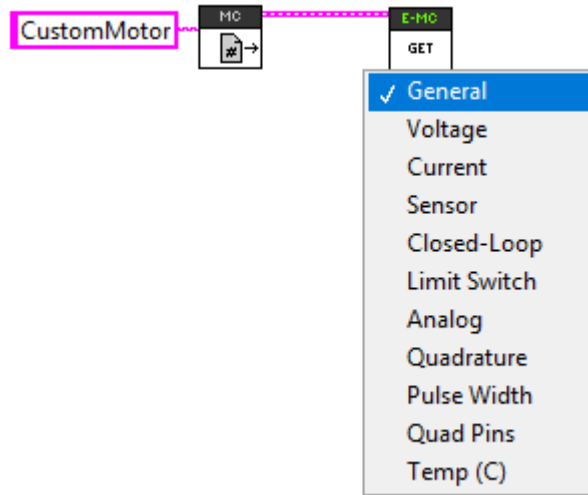

## 5.2. C++

Various get functions are available in C++. Here are a few examples...

```
double currentAmps = talon.GetOutputCurrent();
double outputV = talon.GetMotorOutputVoltage();
double busV = talon.GetBusVoltage();
double outputPerc = talon.GetMotorOutputPercent();

int quadPos = talon.GetSensorCollection().GetQuadraturePosition();
int quadVel = talon.GetSensorCollection().GetQuadratureVelocity();

int analogPos = talon.GetSensorCollection().GetAnalogIn();
int analogVel = talon.GetSensorCollection().GetAnalogInVel();

int selectedSensorPos = talon.GetSelectedSensorPosition(0); /* sensor selected for PID Loop 0 */
int selectedSensorVel = talon.GetSelectedSensorVelocity(0); /* sensor selected for PID Loop 0 */
int closedLoopErr = talon.GetClosedLoopError(0); /* sensor selected for PID Loop 0 */
double closedLoopAccum = talon.GetIntegralAccumulator(0); /* sensor selected for PID Loop 0 */
double derivErr = talon.GetErrorDerivative(0); /* sensor selected for PID Loop 0 */
```

## 5.3. Java

Various get functions are available in Java. Here are a few examples...

```
double currentAmps = talon.getOutputCurrent();
double outputV = talon.getMotorOutputVoltage();
double busV = talon.getBusVoltage();
double outputPerc = talon.getMotorOutputPercent();

int quadPos = talon.getSensorCollection().getQuadraturePosition();
int quadVel = talon.getSensorCollection().getQuadratureVelocity();

int analogPos = talon.getSensorCollection().getAnalogIn();
int analogVel = talon.getSensorCollection().getAnalogInVel();

int selectedSensorPos = talon.getSelectedSensorPosition(0); /* sensor selected for PID Loop 0 */
int selectedSensorVel = talon.getSelectedSensorVelocity(0); /* sensor selected for PID Loop 0 */
int closedLoopErr = talon.getClosedLoopError(0); /* sensor selected for PID Loop 0 */
double closedLoopAccum = talon.getIntegralAccumulator(0); /* sensor selected for PID Loop 0 */
double derivErr = talon.getErrorDerivative(0); /* sensor selected for PID Loop 0 */
```

## 6. Setting the Ramp Rate

The Talon SRX can be set to honor a ramp rate to prevent instantaneous changes in output. There are two separate ramps, one for Open Loop (PercentOutput) and another for Closed Loop.

Typically closed loop ramp is zero (off) or quite small as this can introduce oscillations.

### 6.1. LabVIEW

Use the ramp VIs to specify the ramp rate in seconds (from neutral to full).

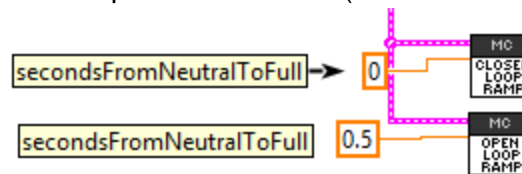

### 6.2. C++/ Java

`configOpenloopRamp` and `configClosedloopRamp` can be used to ramp the motor output in the respective modes. Having two global configs allows users to avoid having to set and clear the ramp when switching between open-loop and closed-loop use. Since these settings are persistent, they can be typically set once on robot boot.

```
double secondsFromNeutralToFull, int timeoutMs
talon.configOpenloopRamp (secondsFromNeutralToFull, timeoutMs)
```

The screenshot shows a code editor with a dropdown menu open for the parameter `secondsFromNeutralToFull` in the function call `talon.configOpenloopRamp (secondsFromNeutralToFull, timeoutMs)`. The dropdown list contains the following items: `secondsFromNeutralToFull`, `derivErr`, `closedLoopAccum`, `selectedSensorVel`, `selectedSensorPos`, `analogVel`, `analogPos`, `quadVel`, `quadPos`, `outputPerc`, and `busV`.

### 6.3. Web-based configuration limitations

The individual ramp rate inside the closed-loop slot has been replaced with `configOpenloopRamp` and `configClosedloopRamp`. Instead use these routine as the web-based config entry will always read zero.

Motor Controller Closed-Loop Control Parameters Slot 0	
P Gain	<input type="text" value="2"/>
I Gain	<input type="text" value="0"/>
D Gain	<input type="text" value="22"/>
Feed-Forward Gain	<input type="text" value="0"/>
I Zone	<input type="text" value="0"/>
Ramp Rate	<input type="text" value="0"/>

Setting has been removed. Instead use the Open-loop and Closed-loop ramp config functions.

## 7. Feedback Device (Sensor Feedback)

Although the analog and quadrature signals are available all the time, the Talon SRX requires the robot application to “pick” a “Feedback Device” for soft limit and closed-loop features.

The selected “Feedback Device” defaults to Quadrature Encoder.

Once a “Feedback Device” is selected, the “Sensor Position” and “Sensor Velocity” signals will update with the output of the selected feedback device. It may be multiplied by (-1) to ensure sensor is in phase with the motor.

### 7.1. LabVIEW

Use CONFIG SENSOR to select which Feedback Sensor to use for soft limits and closed-loop features. The supported selections include: Quadrature, Analog, and Tachometer.

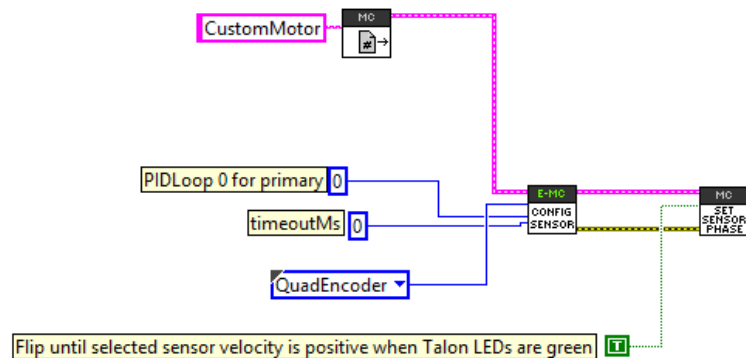

### 7.2. C++

SetFeedbackDevice() can be used to select Quadrature, Analog, or Tachometer (velocity).

```

/* analog signal with no wrap-around (0-3.3V) */
talon.ConfigSelectedFeedbackSensor(FeedbackDevice::Analog, 0, 0); /* PIDLoop=0,timeoutMs=0 */
/* eFeedbackNotContinuous = 1, subValue/ordinal/timeoutMs = 0*/
talon.ConfigSetParameter(ParamEnum::eFeedbackNotContinuous, 1, 0x00, 0x00, 0x00);

/* analog signal with wrap-arounds tracked (0-3.3V) */
talon.ConfigSelectedFeedbackSensor(FeedbackDevice::Analog, 0, 0); /* PIDLoop=0,timeoutMs=0 */
/* eFeedbackNotContinuous = 0, subValue/ordinal/timeoutMs = 0*/
talon.ConfigSetParameter(ParamEnum::eFeedbackNotContinuous, 0, 0x00, 0x00, 0x00);

/* quadrature */
talon.ConfigSelectedFeedbackSensor(FeedbackDevice::QuadEncoder, 0, 0); /* PIDLoop=0,timeoutMs=0 */

/* CTRE Magnetic Encoder relative, same as Quadrature */
talon.ConfigSelectedFeedbackSensor(FeedbackDevice::CTRE_MagEncoder_Relative, 0, 0); /* PIDLoop=0,timeoutMs=0 */

/* CTRE Magnetic Encoder absolute (within one rotation), same as PulseWidthEncodedPosition */
talon.ConfigSelectedFeedbackSensor(FeedbackDevice::CTRE_MagEncoder_Absolute, 0, 0); /*PIDLoop=0,timeoutMs=0 */

/* PulseWidthEncodedPosition, LIDAR for example */
talon.ConfigSelectedFeedbackSensor(FeedbackDevice::PulseWidthEncodedPosition, 0, 0); /*PIDLoop=0,timeoutMs=0 */

/* Tachometer (for velocity closed loop) */
talon.ConfigSelectedFeedbackSensor(FeedbackDevice::Tachometer, 0, 0); /* PIDLoop=0, timeoutMs=0 */

```

SetSensorPhase() can be used to keep the sensor and motor in phase for proper limit switch and closed loop features.

```

/* flip input until sensor is in phase */
talon.SetSensorPhase(true);

```

### 7.3. Java

`setFeedbackDevice()` can be used to select Quadrature, Analog, or Tachometer (velocity).

```
/* analog signal with no wrap-around (0-3.3V) */
talon.configSelectedFeedbackSensor(FeedbackDevice.Analog, 0, 0); /* PIDLoop=0, timeoutMs=0 */
/* eFeedbackNotContinuous = 1, subValue/ordinal/timeoutMs = 0*/
talon.configSetParameter(ParamEnum.eFeedbackNotContinuous, 1, 0x00, 0x00, 0x00);

/* analog signal with wrap-arounds tracked (0-3.3V) */
talon.configSelectedFeedbackSensor(FeedbackDevice.Analog, 0, 0); /* PIDLoop=0, timeoutMs=0 */
/* eFeedbackNotContinuous = 0, subValue/ordinal/timeoutMs = 0*/
talon.configSetParameter(ParamEnum.eFeedbackNotContinuous, 0, 0x00, 0x00, 0x00);

/* quadrature */
talon.configSelectedFeedbackSensor(FeedbackDevice.QuadEncoder, 0, 0); /* PIDLoop=0, timeoutMs=0
*/

/* CTRE Magnetic Encoder relative, same as Quadrature */
talon.configSelectedFeedbackSensor(FeedbackDevice.CTRE_MagEncoder_Relative, 0, 0); /* PIDLoop=0,
timeoutMs=0 */

/* CTRE Magnetic Encoder absolute (within one rotation), same as PulseWidthEncodedPosition */
talon.configSelectedFeedbackSensor(FeedbackDevice.CTRE_MagEncoder_Absolute, 0, 0); /* PIDLoop=0,
timeoutMs=0 */

/* PulseWidthEncodedPosition, LIDAR for example */
talon.configSelectedFeedbackSensor(FeedbackDevice.PulseWidthEncodedPosition, 0, 0); /* PIDLoop=0,
timeoutMs=0 */

/* Tachometer (for velocity closed loop) */
talon.configSelectedFeedbackSensor(FeedbackDevice.Tachometer, 0, 0); /* PIDLoop=0, timeoutMs=0 */
```

`setSensorPhase()` can be used to keep the sensor and motor in phase for proper limit switch and closed loop features.

```
/* flip input until sensor is in phase */
talon.setSensorPhase(true);
```

## 7.4. Correcting sensor direction, best practices.

For limit switches and closed-loop features to function correctly the sensor and motor must be “in-phase”. This means that the sensor position must move in a positive direction as the motor controller drives positive motor output. To test this, first drive the motor manually (using gamepad axis for example). Watch the sensor position either in the roboRIO Web-based Configuration Self-Test, or by calling `GetSelectedSensorPosition()` and printing it to console. If the “Sensor Position” moves in a negative direction while Talon SRX motor output is positive (blinking green), then use the `setSensorPhase()` routine/VI to multiply the sensor position by (-1). Then retest to confirm “Sensor Position” moves in a positive direction with positive motor drive. Additionally, the sensor-out-of-phase sticky fault will assert if the motor output exceeds 25% and the sensor is traveling in the wrong direction.

```

✓ The self test completed successfully.
Device enabled
Mode:0:PercentOutput | Output:31.95% [3.96 V]
Motor Leads: M+:3.96 V M-:0 V
Brake during neutral
VCompEn:0 CurrLimited:0

Slot Selects:PID0: 0 PID1: 0
SelfFeedback0:0:Quad/MagEnc(rel)|Pos:115946u Vel:994u/100ms
SelfFeedback1:0:Quad/MagEnc(rel)|Pos:0u Vel:0u/100ms
PID0 err: -1368 iaccum:0 derr:0
PID1 err: 0 iaccum:0 derr:0

Quad/MagEnc(rel)
Pos:-115380u Vel:-969u/100ms
Pins: A=1 B=0 Id=1 IdEdges:0

```

When using the Self-Test, be sure to track the selected feedback position and velocity, which is **above** the Quadrature Encoder signals. Only these signals will reflect changes to the sensor phase.

If the sensor is out of phase, typically the self-test will reveal a sensor velocity and motor output with mismatched signs. Additionally, the sensor out of phase fault will appear.

Note: sticky faults can be cleared via Light Device LED checkbox.

**Settings**

Name

Device ID

Light Device LED

```

✓ The self test completed successfully.
Device enabled
Mode:0:PercentOutput | Output:49.95% [6.11 V]
Motor Leads: M+:6.11 V M-:0 V
Brake during neutral
VCompEn:0 CurrLimited:0

Slot Selects:PID0: 0 PID1: 0
SelfFeedback0:0:Quad/MagEnc(rel)|Pos:-77569u Vel:-1636u/100ms
SelfFeedback1:0:Quad/MagEnc(rel)|Pos:0u Vel:0u/100ms
PID0 err: -1368 iaccum:0 derr:0
PID1 err: 0 iaccum:0 derr:0

Quad/MagEnc(rel)
Pos:-75412u Vel:-1434u/100ms
Pins: A=0 B=1 Id=1 IdEdges:3

Analog Input Pos:50u Vel:-6u/100ms|ADC:50|0.2 V

PulseWidth/MagEnc(abs) Per(us):4160.2
TachVel: 24613 u/100ms | 14422.00 RPM
PosEncPulse Pos:-377443u Vel:-1333u/100ms

LimSw(F/R):Open,Open
ZeroPosOn Idx=Off LimF=Off LimR=Off

(Fault) (Now) (Sticky)
Sens Out Of Phase: 1 1

Curr(A):3.00 | Bus(V):12.25 | Temp(C):22

Nominal %:0,0
Peak %:-100,100
Closed Loop AllowedErr:Slot0=0,Slot1=0
Vel Sampling Per(ms):100,AvgWin:64
VCompSat:14.6

"Light Device LED" clears sticky faults.

```

In the special case of using the “Tachometer” feedback device, the measured velocity is always signed to match the motor output. This ensures the sensor is in-phase despite the inability of a Tachometer signal to determine direction.

## 7.5. Supported Feedback Devices

Many feedback interfaces are supported. The complete list is below.

### 7.5.1. Quadrature

The Talon directly supports Quadrature Encoders. If Quadrature is selected, the decoding is done in 4x mode. This means that each pulse will correspond to four counts.

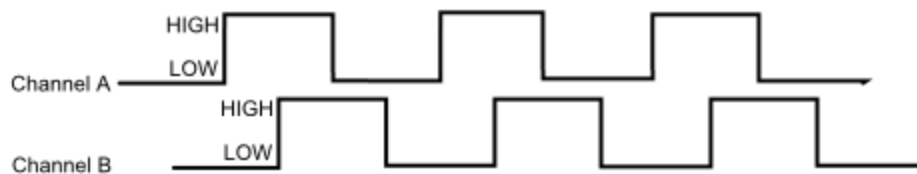

In this example pulse train, the Talon would decode 12 counts (each of the three pulses contributes four edges).

### 7.5.2. Analog (Potentiometer / Encoder)

Analog feedback sensors, or sensors that provide a variable voltage to represent position, are also supported. Some devices are continuous despite the voltage signal wrapping around from 3.3V back to 0V. For these sensors, the Talon will detect and count these wrap arounds. Despite the base analog measurement holding 10 bits [0,1023], the sensor position will continue from 1023 -> 1024.

#### 7.5.2.1. Potentiometer (Discontinuous) Sensor

For other sensors (like potentiometers) that do not wrap the voltage signal and therefore must not track the overflow, the Talon can be configured to wrap the position (1023 -> 0). This can be done by setting the **eFeedbackNotContinuous** configurable parameter to ‘1’.

#### 7.5.2.2. LabVIEW Example

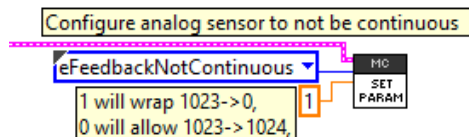

#### 7.5.2.3. C++ Example

```
/* analog signal with no wrap-around (0-3.3V) */
talon.ConfigSelectedFeedbackSensor(FeedbackDevice::Analog, 0, 0); /* PIDLoop=0, timeoutMs=0 */
/* eFeedbackNotContinuous = 1, subValue/ordinal/timeoutMs = 0 */
talon.ConfigSetParameter(ParamEnum::eFeedbackNotContinuous, 1, 0x00, 0x00, 0x00);
```

#### 7.5.2.4. Java Example

```
/* analog signal with no wrap-around (0-3.3V) */
talon.configSelectedFeedbackSensor(FeedbackDevice.Analog, 0,0); /* PIDLoop=0, timeoutMs=0 */
/* eFeedbackNotContinuous = 1, subValue/ordinal/timeoutMs = 0 */
talon.configSetParameter(ParamEnum.eFeedbackNotContinuous, 1, 0x00, 0x00, 0x00);
```

### 7.5.3. Pulse Width Decoder

For sensors that encode position as a pulse width, this sensor type can be used to decode the position. The pulse width decoder is 1us accurate and the maximum time between edges is 120ms, which is wide enough to support many LIDAR distance sensors.

### 7.5.4. Cross The Road Electronics Magnetic Encoder (Absolute and Relative)

The CTRE Magnetic Encoder is composed of two sensor interfaces packaged into one (pulse width and quadrature encoder). Therefore, the sensor provides two modes of use: absolute and relative.



The advantage of absolute mode is having a solid reference to where a mechanism is without re-tare-ing or re-zero-ing the robot. The advantage of the relative mode is the faster update rate. However, both values can be read/written at the same time. So, a combined strategy of seeding the relative position based on the absolute position can be used to benefit from the higher sampling rate of the relative mode and still have an absolute sensor position.

Parameter	Absolute Mode	Relative Mode
Update rate (period)	4ms	100 us
Max RPM	7,500 RPM	15,000 RPM
Accuracy	12 bits per rotation (4096 steps per rotation)	12 bits per rotation (4096 steps per rotation)
Software API	Use Pulse Width API	Use Quadrature API

#### 7.5.4.1. Selecting the Magnetic Encoder

Selecting the Magnetic Encoder for closed-loop / soft-limit features is no different than selecting other sensor feedback devices. Depending on language, there are two new feedback types: CTRE Magnetic Encoder (absolute) and CTRE Magnetic Encoder (relative). Alternatively, the user can select Quadrature or PulseWidthEncodedPosition to select between relative and absolute.



Additionally, the position and velocity can be retrieved without selecting the Magnetic Encoder as the selected feedback device. One method is to utilize the self-test in the roboRIO web-based configuration.

Save Refresh Self-Test

✓ The self test completed successfully.  
 Device enabled  
 Mode:0:PercentOutput | Output:49.95% [6.11 V]  
 Motor Leads: M+:6.11 V M:-0 V  
 Brake during neutral  
 VCompEn:0 CurrLimited:0

Slot Selects:PID0: 0 PID1: 0

SelfFeedback0:0:Quad/MagEnc(rel)|Pos:-77569u Vel:-1636u/100ms  
 SelfFeedback1:0:Quad/MagEnc(rel)|Pos:0u Vel:0u/100ms  
 PID0 err: -1368 iaccum:0 derr:0  
 PID1 err: 0 iaccum:0 derr:0

Selected feedback device will report Quad/MagEnc(rel) if selected.

Quad/MagEnc(rel)  
 Pos:-75412u Vel:-1434u/100ms  
 Pins: A=0 B=1 Id=1 IdEdges:3  
 Quadrature/MagEnc(relative)  
 is always decoded, even if  
 robot has no code.

Analog Input Pos:50u Vel:-6u/100ms|ADC:50|0.2 V

PulseWidth/MagEnc(abs) Per(us):4160.2  
 TachVel: 24613 u/100ms | 14422.00 RPM  
 PosEncPulse Pos:-377443u Vel:-1333u/100ms  
 PulseWidPosition/MagEnc(absolute)/Tach is  
 always decoded, even if robot has no code.

Note the purple entries are always available regardless of robot-code status.

To programmatically read the absolute and relative position and velocities, the robot API provides get routines for pulse width decoding and quadrature, which can be read any time without sensor selection.

#### 7.5.4.2. CTR Magnetic Encoder (absolute) – C++

```

/* get the decoded pulse width encoder position, 4096 units per rotation */
int pulseWidthPos = talon.GetSensorCollection().GetPulseWidthPosition();
/* get the pulse width in us, rise-to-fall in microseconds */
int pulseWidthUs = talon.GetSensorCollection().GetPulseWidthRiseToFallUs();
/* get the period in us, rise-to-rise in microseconds */
int periodUs = talon.GetSensorCollection().GetPulseWidthRiseToRiseUs();
/* get measured velocity in units per 100ms, 4096 units is one rotation */
int pulseWidthVel = talon.GetSensorCollection().GetPulseWidthVelocity();
/* is sensor plugged in to Talon */
bool sensorPluggedIn = false;
if (periodUs != 0) {
    sensorPluggedIn = true;
}

```

#### 7.5.4.3. CTR Magnetic Encoder (absolute) – Java

```

/* get the decoded pulse width encoder position, 4096 units per rotation */
int pulseWidthPos = _talon.getSensorCollection().getPulseWidthPosition();
/* get the pulse width in us, rise-to-fall in microseconds */
int pulseWidthUs = _talon.getSensorCollection().getPulseWidthRiseToFallUs();
/* get the period in us, rise-to-rise in microseconds */
int periodUs = _talon.getSensorCollection().getPulseWidthRiseToRiseUs();
/* get measured velocity in units per 100ms, 4096 units is one rotation */
int pulseWidthVel = _talon.getSensorCollection().getPulseWidthVelocity();
/* is sensor plugged in to Talon */
boolean sensorPluggedIn = false;
if (periodUs != 0) {
    sensorPluggedIn = true;
}

```

## 7.6. Multiple Talon SRXs and single sensor

There are many uses where a mechanism requires multiple Talon SRXs but a single sensor. For example, a single-side of a tank-drive or a shooter-wheel powered by two motors.

The recommended strategy for these mechanisms is to...

- Connect the sensor to one of the Talons. This Talon will be referred to the “master” Talon.
- Set the supplemental Talon(s) to follower mode and follow the device ID of the “master” Talon. See [Section 9.1](#) for details.
- Select PercentOutput Mode on the “master” Talon. Write a test robot application to drive the “master” Talon manually and confirm proper direction. Use `SetInverted()` to correct direction if need be. Note: A talon’s LEDs will not change when inverted, but the motor output voltage will. **Consult Talon User’s Guide to avoid damaging Talons by incorrectly wiring inputs/outputs.**
- Next, connect motor to first follower Talon and disconnect master Talon from master motor. **Consult Talon User’s Guide to avoid damaging Talons by incorrectly wiring inputs/outputs.** Test follower direction. If follower direction is incorrect, use `SetInverted()` on follower Talon to correct it. Repeat for each follower motor controller.

For example, when drive a shooter wheel, the motors may be oriented to require each motor to drive in opposite directions. If this is the case signal the slave Talon to invert its output ([Section 9.1.4](#)). **Do not use excessive motor output.** Otherwise you may stall your motors if the follower and master Talon are driving against each other.

- Instrument the Sensor Position or Velocity using the roboRIO Web-based Configuration Page Self-Test, or print/plot the values. Ensure that sensor moves in a positive direction when master Talon is given positive forward motor output (green LEDs).
- Now that the motor(s) and sensor orientation has been confirmed, select the desired control mode of the master Talon. Any of the closed-loop/motion-profile control modes can be used.
- When using Velocity Closed-Loop, Current Closed-Loop, or MotionProfile Control Mode, be sure to calculate the F gain when all slave Talon/motors are connected and used.

## 7.7. Pulse Width - Checking Sensor Health

When using the PulseWidthEncoded sensor, the health of the sensor can be determined by polling the measured period. The period will read zero or 120ms after the last received valid pulse.

## 7.8. Velocity Measurement

The Talon SRX measures the velocity of all supported sensor types as well as the current position. In the case of **quadrature** and **analog**, every 1ms, a velocity sample is measured and inserted into a rolling average.

The velocity sample is measured as the change in position at the time-of-sample versus the position sampled 100ms-prior-to-time-of-sample. The rolling average is sized for 64 samples. Though these configurations can be modified, the (100ms, 64 samples) parameters are default.

### 7.8.1. Changing Velocity Measurement Parameters.

The two characteristics for the Talon Velocity Measurement are...

- **Sample Period (Default 100ms)**
- **Rolling Average Window Size (Default 64 samples).**

These configurations are also persistent across power cycles.

Each can be modified through programming API, and through HERO LifeBoat (non-FRC).

NOTE – When the sample period is reduced, the **units** of the native velocity measurement is still change-in-position-per-100ms. In other words, the measurement is up-scaled to normalize the units. Additionally, a velocity sample is **always inserted every 1ms** regardless of setting selection.

NOTE – The Velocity Measurement **Sample Period** is selected from a fixed list of pre-supported sampling periods [1, 5, 10, 20, 25, 50, 100(default)] milliseconds.

NOTE – The Velocity Measurement **Rolling Average Window** is selected from a fixed list of pre-supported sample counts: [1, 2, 4, 8, 16, 32, 64(default)]. If an alternative value is passed into the API, the firmware will **truncate** to the nearest supported value.

#### 7.8.1.1. Changing Parameters – HERO C#

```
_talon.ConfigVelocityMeasurementPeriod(CTRE.TalonSrx.VelocityMeasurementPeriod.Period_10Ms, 0);  
_talon.ConfigVelocityMeasurementWindow(20, 0);
```

### 7.8.1.2. Changing Parameters – Hero LifeBoat

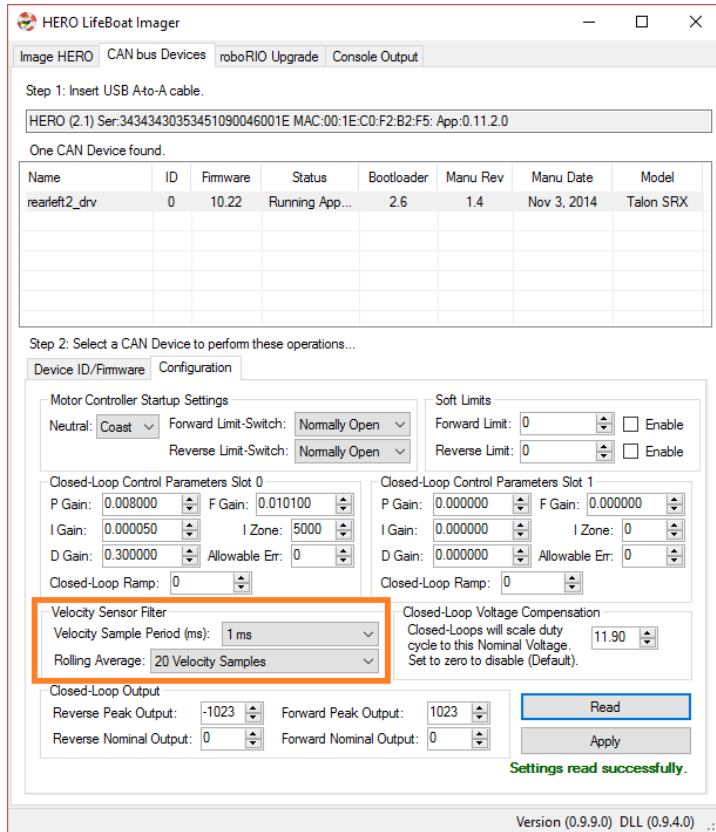

When using the HERO Development Board, the Sample Period and Rolling Average can be modified through the graphical interface.

### 7.8.1.3. Changing Parameters – FRC Java

```
talon.ConfigVelocityMeasurementPeriod(VelocityMeasPeriod.Period_100Ms, 0);
talon.ConfigVelocityMeasurementWindow(64, 0);
```

### 7.8.1.4. Changing Parameters – FRC C++

```
_talon.ConfigVelocityMeasurementPeriod(VelocityMeasPeriod::Period_100Ms, 0);
_talon.ConfigVelocityMeasurementWindow(64, 0);
```

### 7.8.1.5. Changing Parameters – FRC LabVIEW

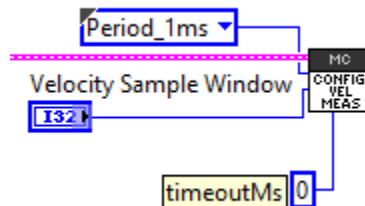

### 7.8.2. Recommended Procedure

The general recommended procedure is to first set these two parameters to the minimal value of '1' (Measure change in position per 1ms, and no rolling average). Then plot the measured velocity while manually driving the Talon SRX(s) with a joystick/gamepad. Sweep the motor output to cover the expected range that the sensor will be expected to cover.

Unless the sensor velocity is considerably fast (hundreds of sensor units per sampling period) the measurement will be very coarse (visual stair-stepping as the motor output is increased). Increase the sampling period until the measured velocity is sufficiently granular.

At this point the sensor velocity will have minimal stair-stepping (good) but will be quite noisy. Increase the rolling average window until the velocity plot is sufficiently smooth, but still responsive enough to meet the timing requirements of the mechanism.

### 7.8.3. Self-Test Velocity Settings

The current Velocity Measurement Settings can be confirmed by performing the Self-Test in the roboRIO Web-based configuration page.

In this screenshot the Sampling Period is set to 100ms and the Rolling Average Window is set to 1 sample.

The screenshot shows the configuration page for a Talon SRX motor. On the left, a list of devices is shown, with 'Talon SRX LEFT MASTER 6' selected. On the right, the configuration details for the selected device are displayed. The 'Vel Sampling Period (ms)' is set to 100 and 'Avg Window' is set to 1. Other settings include 'Vel Comp Rate (V/s): 0' and 'Closed-Loop Voltage Comp is off'.

#### 7.8.3.1. Self-Test reads 0 for Period and Window.

This screenshot shows the self-test results for the selected Talon SRX motor. The 'Vel Sampling Period (ms)' is reported as 0 and 'Avg Window' is reported as 0. The 'Vel Comp Rate (V/s)' is 0 and 'Closed-Loop Voltage Comp' is off. The interface also shows other motor parameters like position, velocity, and current.

If the firmware is too old to allow configuration of the velocity measurement settings, then the self-test will report '0' for both. In this configuration, the firmware is hardcoded to use 100ms and 64 samples.

## 7.9. Tachometer Measurement



Talon SRX also supports decoding a Tachometer for sensing velocity. Typically, this is used with velocity control mode.

The Talon SRX was tested using a CTRE Talon Tach

<http://www.ctr-electronics.com/talon-tach-tachometer-new-limit-switch.html>

Select Tachometer as the sensor type and use Self-test to review the measured values. The base unit of a Tachometer measured velocity is in units per 100ms, such that...

1024 units per 100ms = 1 rotations per 100ms.

OR

1024 units per 100ms = 600RPM

For the sensor decoder to function correctly, users can...

- Ensure Talon is aware how many edges per rotation there are.
- Optionally select a rolling average to smooth measurement (typically not necessary).

### 7.9.1. Tachometer Measurement – LabVIEW

Use the general SET PARAM VI to adjust the Tachometer decoding parameters.

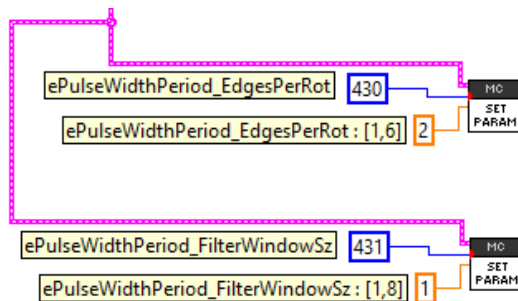

Set PulseWidthPeriod\_EdgesPerRot (430) to a value within [1,6], (default value is 1).

This should match the number of edges marked on the wheel being measured.

If filtering is required, set the filter window size (431) to a value within [1,8], (default is 1). This represents the number of cells in a rolling average.

### 7.9.2. Tachometer Measurement – Java

Use the general SET PARAM VI to adjust the Tachometer decoding parameters.

```
/* ePulseWidthPeriod_EdgesPerRot : [1,6] */
int edgesPerRotation = 2;
```

```
/* ePulseWidthPeriod_FilterWindowSz : [1,8] */
int filterWindowSize = 1;
```

```
talon.configSetParameter(430, edgesPerRotation, 0x00, 0x00, 0);
talon.configSetParameter(431, filterWindowSize, 0x00, 0x00, 0);
```

Set PulseWidthPeriod\_EdgesPerRot (430) to a value within [1,6], (default value is 1). This should match the number of edges marked on the wheel being measured.

If filtering is required, set the filter window size (431) to a value within [1,8], (default is 1). This represents the number of cells in a rolling average.

### 7.9.3. Tachometer Measurement – C++

Use the general SET PARAM VI to adjust the Tachometer decoding parameters.

```
/* ePulseWidthPeriod_EdgesPerRot : [1,6] */  
int edgesPerRotation = 2;  
  
/* ePulseWidthPeriod_FilterWindowSz : [1,8] */  
int filterWindowSize = 1;  
  
talon.ConfigSetParameter(430, edgesPerRotation, 0x00, 0x00, 0);  
talon.ConfigSetParameter(431, filterWindowSize, 0x00, 0x00, 0);
```

Set PulseWidthPeriod\_EdgesPerRot (430) to a value within [1,6], (default value is 1). This should match the number of edges marked on the wheel being measured.

If filtering is required, set the filter window size (431) to a value within [1,8], (default is 1). This represents the number of cells in a rolling average.



## 8. Soft Limits

Soft limits can be used to disable motor drive when the “Sensor Position” is outside of a specified range. Forward motor output will be disabled if the “Sensor Position” is greater than the Forward Soft Limit. Reverse motor output will be disabled if the “Sensor Position” is less than the Reverse Soft Limit. The respective Soft Limit Enable must be enabled for this feature to take effect.

The settings can be set and confirmed in the roboRIO Web-based Configuration.

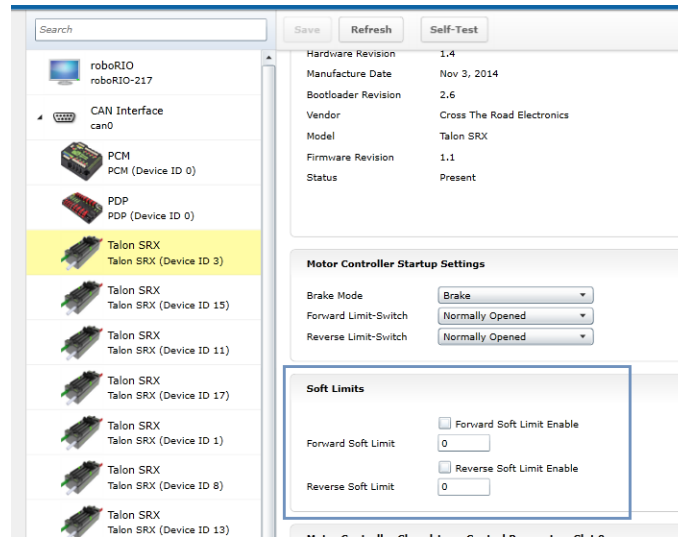

## 8.1. LabVIEW

The soft limits can also be set up programmatically. In LabVIEW, Soft Limit enables and thresholds can be set using the following VIs.

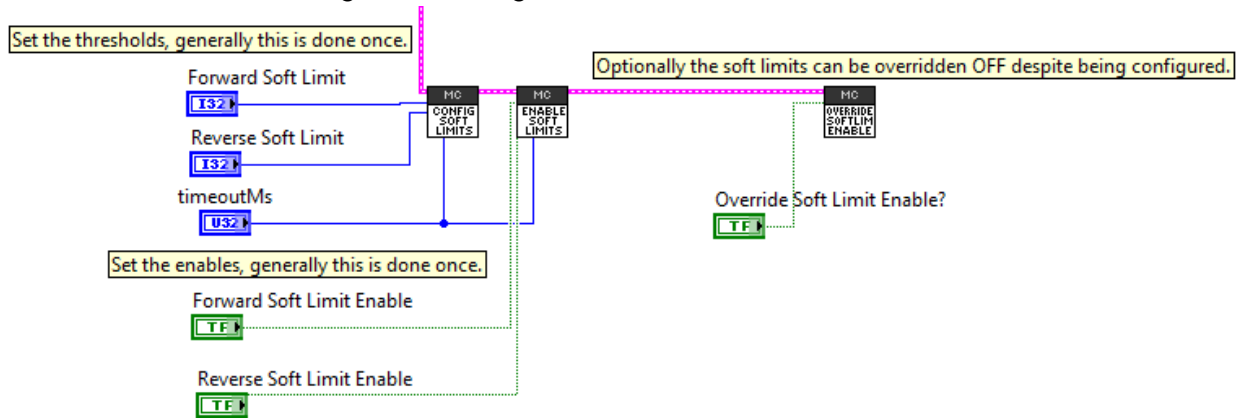

## 8.2. C++

The limit threshold and enabled states can be individually specified using:

```
/* +14 rotations forward when using CTRE Mag encoder */
talon.ConfigForwardSoftLimitThreshold(+14*4096, 10);

/* -15 rotations reverse when using CTRE Mag encoder */
talon.ConfigReverseSoftLimitThreshold(-15*4096, 10);

talon.ConfigForwardSoftLimitEnable(true, 10);
talon.ConfigReverseSoftLimitEnable(true, 10);

/* pass false to FORCE OFF the feature. Otherwise the enable flags above are honored */
talon.OverrideLimitSwitchesEnable(true);
```

## 8.3. Java

The limit threshold and enabled states can be individually specified using:

```
/* +14 rotations forward when using CTRE Mag encoder */
talon.configForwardSoftLimitThreshold(+14*4096, 10);

/* -15 rotations reverse when using CTRE Mag encoder */
talon.configReverseSoftLimitThreshold(-15*4096, 10);

talon.configForwardSoftLimitEnable(true, 10);
talon.configReverseSoftLimitEnable(true, 10);

/* pass false to FORCE OFF the feature. Otherwise the enable flags above are honored */
talon.overrideLimitSwitchesEnable(true);
```

## 9. Special Features

### 9.1. Follower Mode

Any given Talon SRX on CAN bus can be instructed to “follow” the drive output of another Talon SRX. This is done by putting a Talon SRX into “follower” mode and specifying the device ID of the “Master Talon” to follow. The “Slave Talon” will then mirror the output of the “Master Talon”. The “Master Talon” can be in any mode: closed-loop, percentOutput, motion profile control mode, or even following yet another Talon SRX.

#### 9.1.1. LabVIEW

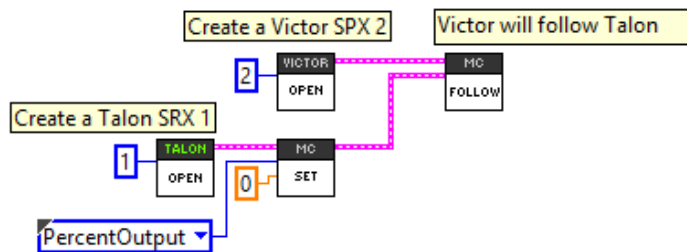

The follow VI can be used to set up a CTRE/VEX CAN motor controller to follow another CTRE/VEX CAN motor controller.

#### 9.1.2. C++

Followers can be set up by...

- using the follow routine.
- passing the device ID of the Master motor controller into `Set()` if the follower product model is the same as the master. The device ID should be between 0 and 62 (inclusive).

```
/* recommended method: use Follow routine */
victor.Follow(talon);

/* alternative method : victor will follow another Victor 7 - assume same model */
victor.Set(ControlMode::Follower, 7);

/* alternative method : talon will follow another Talon 7 - assume same model */
talon.Set(ControlMode::Follower, 7);
```

#### 9.1.3. Java

Followers can be set up by...

- using the follow routine.
- passing the device ID of the Master motor controller into `Set()` if the follower product model is the same as the master. The device ID should be between 0 and 62 (inclusive).

```
/* recommended method: use follow routine */
victor.follow(talon);

/* alternative method : victor will follow another Victor 7 - assume same model */
victor.set(ControlMode.Follower, 7);

/* alternative method : talon will follow another Talon 7 - assume same model */
talon.set(ControlMode.Follower, 7);
```

### 9.1.4. Correcting Follower Direction

If a follower motor controller must drive in the opposite direction use the motor controller invert to correct this.

#### 9.1.4.1. Correcting Follower Direction – C++

```
talon.SetInverted(true);
```

#### 9.1.4.2. Correcting Follower Direction – Java

```
talon.setInverted(true);
```

#### 9.1.4.3. Correcting Follower Direction – LabVIEW



## 9.2. Voltage Compensation

When voltage compensation is enabled, the output duty cycle is calculated to meet the desired output voltage. This is done by sampling the battery voltage and scaling the output duty cycle to match the desired output voltage. If the desired output voltage exceeds battery voltage, then Talon will drive full available voltage.

This feature affects all control modes, including...

- Percent Output Control Mode
- Position Closed-Loop Control Mode
- Velocity Closed-Loop Control Mode
- Current Closed-Loop Control Mode
- Motion Profile Control Mode
- Motion Magic Control Mode

As an example, if the Position Closed-Loop Control Mode calculates an output of 512 units (50% motor output), then instead of applying 50% of max voltage, the Talon will apply 50% of the specified Nominal Battery Voltage. This is accomplished by scaling the motor output against the measured battery voltage.

If the measured battery voltage is below the necessary voltage to reach the calculated output of the compensated closed-loop control mode, 100% motor output is applied.

This is done every 1ms synchronous with the closed-loop controller.

The configuration is persistent across power cycles and has a default value of 0.0.

Enabling this feature requires setting the saturation voltage and the feature enable. If either is 0/false, the feature is disabled.

Additionally, the voltage filter (rolling average) may be modified to tune out oscillations caused by the voltage compensation. The Rolling average window defaults to 32 samples (each sampled every millisecond).

Valid values for the rolling average window are {1,2,4,8,16, and 32}

### 9.2.1. LabVIEW

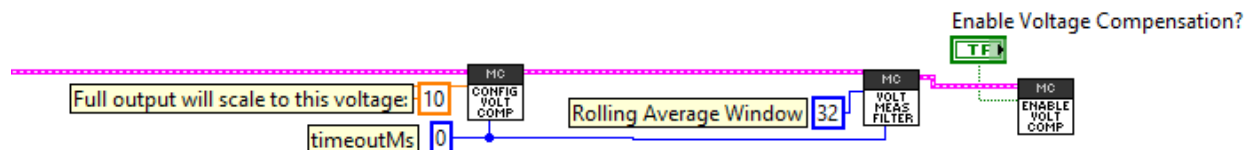

### 9.2.2. C++

```
/* "full" output will scale to 11 volts */
talon.ConfigVoltageCompSaturation(11.0, 10);
talon.EnableVoltageCompensation(true); /* turn on the feature */
/* tweak the voltage bus measurement filter,
 * default is 32 cells in rolling average (1ms per sample) */
talon.ConfigVoltageMeasurementFilter(32, 10);
```

### 9.2.3. Java

```
/* "full" output will scale to 11 volts */
talon.configVoltageCompSaturation(11.0, 10);
talon.enableVoltageCompensation(true); /* turn on the feature */
/* tweak the voltage bus measurement filter,
 * default is 32 cells in rolling average (1ms per sample) */
talon.configVoltageMeasurementFilter(32, 10);
```

### 9.2.4. Self-Test



```
The self test completed successfully.
Device NOT ENABLED!
Mode:0:PercentOutput | Output:0.00% [0.00 V]
Motor Leads: M+/M- off
Coast during neutral
VCompEn:0 CurrLimited:0
```

The feature enable can be checked via the Self-Test.

### 9.3. Current Limits

Talon SRX can limit the output current to a specified maximum threshold. This functionality is available in **all** control modes. **This feature is not available on Victor SPX.**

Regardless of language or mode, there are two parameters that must be set – the numeric current threshold (in amps) and the boolean flag to enable or disable the feature.

Additionally, a peak current and time threshold may be specified to allow excessive current before enforcing the continuous current limit.

#### 9.3.1. Current Limit – LabVIEW

The Talon SRX palette in LabVIEW contains a ConfigCurrentLimit VI for setting the current limit parameters.

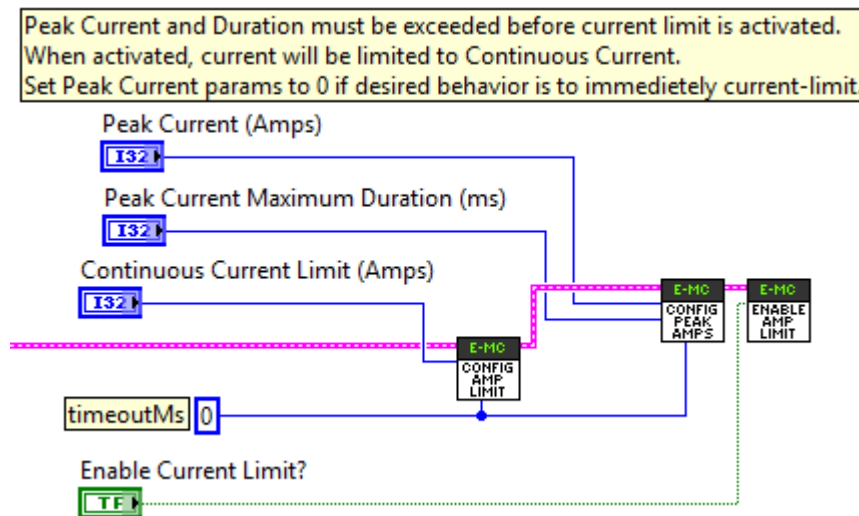

#### 9.3.2. Current Limit – C++

```
/* Peak Current and Duration must be exceeded before current limit is activated.
When activated, current will be limited to Continuous Current.
Set Peak Current params to 0 if desired behavior is to immediately current-limit. */
```

```
talon.ConfigPeakCurrentLimit(35, 10); /* 35 A */
talon.configPeakCurrentDuration(200, 10); /* 200ms */
talon.ConfigContinuousCurrentLimit(30, 10); /* 30A */
talon.EnableCurrentLimit(true); /* turn it on */
```

#### 9.3.3. Current Limit – Java

```
/* Peak Current and Duration must be exceeded before current limit is activated.
When activated, current will be limited to Continuous Current.
Set Peak Current params to 0 if desired behavior is to immediately current-limit. */
```

```
talon.configPeakCurrentLimit(35, 10); /* 35 A */
talon.configPeakCurrentDuration(200, 10); /* 200ms */
talon.configContinuousCurrentLimit(30, 10); /* 30A */
talon.enableCurrentLimit(true); /* turn it on */
```

## 9.4. Adjusting Deadband

The Deadband is the percentage of output around zero percent that causes the motor controller to have neutral output. The default deadband value is 4%, so the motor controller will have a neutral output if the commanded output is less than 4% in either direction. Talon SRX and Victor SPX support changing this deadband value. The deadband can be set to [0.001 – 0.25], where 0.25 is 25%.

### 9.4.1. Dead Band – LabVIEW

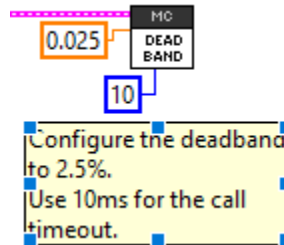

### 9.4.2. Dead Band – C++

```
//Configure a 2.5% deadband.  
_talon->ConfigNeutralDeadband(0.025, 10);
```

### 9.4.3. Dead Band – Java

```
//Configure a 2.5% deadband.  
talon.configNeutralDeadband(0.025, 10);
```



## 10. Control Modes (Closed-Loop)

Talon SRX supports position closed-loop, velocity closed-loop, current closed-loop, Motion Profiling, and Motion Magic. The actual implementation can be seen in [Section 18. How is the closed-loop implemented?](#)

All closed-loop modes update every 1ms (1000Hz).



TIP: While tuning the closed-loop, use the roboRIO web-based configuration to quickly change the gains “on the fly”. Once the PID is stable, set the gain values in code so that Talons can be swapped/replaced easily. Below is an example of tweaking the gains in the roboRIO Web-based configuration.

Motor Controller Closed-Loop Control Parameters Slot 0	
P Gain	<input type="text" value="0.3"/>
I Gain	<input type="text" value="0"/>
D Gain	<input type="text" value="0"/>
Feed-Forward Gain	<input type="text" value="0.025"/>
I Zone	<input type="text" value="0"/>
Ramp Rate	<input type="text" value="0"/>



TIP: Example code of the parameters in Java once initial tweaking is done. Parameters can also be tweaked “on the fly” using the roboRIO Web-based configuration or reading values from a file.

```
/* set closed loop gains in slot0 - see documentation */
_talon.selectProfileSlot(kSlotIdx, 0);
_talon.config_kF(kSlotIdx, 0.2, kTimeoutMs);
_talon.config_kP(kSlotIdx, 0.2, kTimeoutMs);
_talon.config_kI(kSlotIdx, 0, kTimeoutMs);
_talon.config_kD(kSlotIdx, 0, kTimeoutMs);
_talon.config_IntegralZone(0, 100, Constants.kTimeoutMs);
```

## 10.1. Position Closed-Loop Control Mode

The Talon's Closed-Loop logic can be used to maintain a target position. Target and sampled position is passed into the equation in [Section 18](#) in native units.

 TIP: A simple strategy for setting up a closed loop is to zero out all Closed-Loop Control Parameters and start with the Proportional Gain.

For example, if you want your mechanism to drive 50% motor output when the error is 4096, then the calculated Proportional Gain would be  $(0.50 \times 1023) / 4096 = \sim 0.125$ .

To check our math, take an error (native units) of  $4096 \times 0.125 \Rightarrow 512$  (50% motor output).

Tune this until the sensed value is close to the target under typical load. Many prefer to simply double the P-gain until oscillations occur, then reduce accordingly.

If the mechanism accelerates too abruptly, Derivative Gain can be used to smooth the motion. Typically start with 10x to 100x of your current Proportional Gain.

If the mechanism never quite reaches the target and increasing Integral Gain is viable, start with 1/100<sup>th</sup> of the Proportional Gain.

See [Section 12.5](#) for HERO C# complete example of Position Closed-Loop. The functions used are comparable to the WPILIB C++/Java API.

## 10.2. Current Closed-Loop Control Mode

The Talon's Closed-Loop logic can be used to approach a target current-draw. Target and sampled current is passed into the equation in [Section 18](#) in milliamperes. However, the robot API expresses the target current in amperes.

Note: Current Control Mode is separate from Current Limit. See [Section 9.3](#) for Current Limit.

 TIP: A simple strategy for setting up a current-draw closed loop is to zero out all Closed-Loop Control Parameters and start with the Feed-Forward Gain. Tune this until the current-draw is close to the target under typical load. Then start increasing P gain so that the closed-loop will make up for the remaining error. If necessary, reduce Feed-Forward gain and increase P Gain so that the closed-loop will react more strongly to the ClosedLoopError.

See [Section 12.3](#) for a walk-through in LabVIEW. Though the example is written in LabVIEW, the procedure is the similar for all supported languages.

### 10.3. Velocity Closed-Loop Control Mode

The Talon's Closed-Loop logic can be used to maintain a target velocity. Target and sampled velocity is passed into the equation in [Section 18](#) in native units per 100ms. See [Section 17.1](#) for information regarding native units.

 TIP: A simple strategy for setting up a closed loop is to zero out all Closed-Loop Control Parameters and start with the Feed-Forward Gain. Tune this until the sensed value is close to the target under typical load. Then start increasing P gain so that the closed-loop will make up for the remaining error. If necessary, reduce Feed-Forward gain and increase P Gain so that the closed-loop will react more strongly to the ClosedLoopError.

 TIP: Velocity Closed-Loop tuning is similar to Current Closed-Loop tuning in their use of feed-forward. Begin by measuring the sensor velocity while driving the Talon at a large motor output.

A complete Java example is available in [Section 12.4](#).

### 10.4. Motion Profile Control Mode

A recent addition to the Talon SRX is the motion profile mode. With this, a savvy developer can stream motion profile trajectory points into the Talon's internal buffer (even while executing the profile). This allows fine control of position and speed throughout the entire movement. Since this is an advanced feature addition, a separate document is provided to cover this.

## 10.5. Peak/Nominal Output

Since firmware 2.0, The Talon SRX supports bounding the output of the motor controller. These settings are in effect during all control modes.

To clearly communicate what these parameters accomplish, the following terms are introduced.

- Peak Output- The “maximal” or “strongest” motor output allowed.  
These settings are useful to reduce the maximum velocity of the mechanism, and can make tuning the closed-loop simpler.

The “Positive Peak Output” or “Forward Peak Output” refers to the “strongest” motor output when the motor output is positive. If the Output exceeds this setting, the motor output is capped.

This value is typically positive or zero. The default value is +1023 as read in the web-based configuration Self-Test.

The “Negative Peak Output” or “Reverse Peak Output” refers to the “strongest” motor output when the motor output is negative. If the Output exceeds this setting, the motor output is capped.



This value is typically negative or zero. The default value is -1023 as read in the web-based configuration Self-Test.

- Nominal Output- The “minimal” or “weakest” motor output allowed if the output is nonzero.

This is expressed using two signals: “Positive Nominal Output” and “Negative Nominal Output”, to uniquely describe a limit for each direction.

If the motor-output is too “weak”, the robot application can use these signals to promote the motor-output to a minimum limit. With this the robot application can ensure the motor-output is large enough to drive the mechanism. Typically in a closed-loop system, this is accomplished with Integral gain, however this method may be a simpler alternative as there is no risk of Integral wind-up.

### 10.5.1. Peak/Nominal Closed-Loop Output – LabVIEW

These signals can be set using  and .

Peak and nominal values range from -1.0 (full reverse) to +1.0 (full forward).

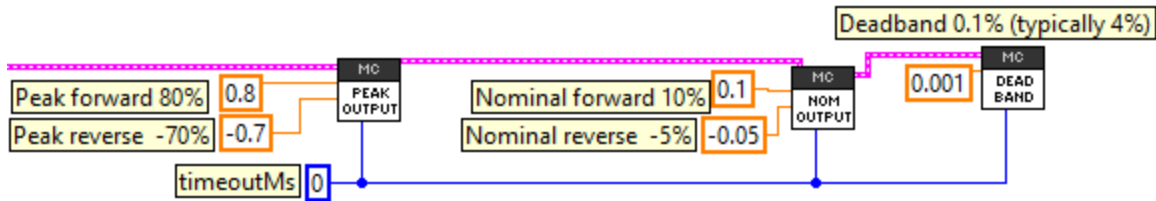

### 10.5.2. Peak/Nominal Output – C++

The parameters are expressed in percent output where +1 represents full forward, and -1 represents full reverse.

```
/* set the peak and nominal outputs, 1.0 means full */
_talon.ConfigNominalOutputForward(0, kTimeoutMs);
_talon.ConfigNominalOutputReverse(0, kTimeoutMs);
_talon.ConfigPeakOutputForward(1, kTimeoutMs);
_talon.ConfigPeakOutputReverse(-1, kTimeoutMs);
/* 0.001 represents 0.1% - default value is 0.04 or 4% */
_talon.ConfigNeutralDeadband(0.001, kTimeoutMs);
```

### 10.5.3. Peak/Nominal Output – Java

The parameters are expressed in percent output where +1 represents full forward, and -1 represents full reverse.

```
/* set the peak and nominal outputs, 1.0 means full */
_talon.configNominalOutputForward(0, kTimeoutMs);
_talon.configNominalOutputReverse(0, kTimeoutMs);
_talon.configPeakOutputForward(1, kTimeoutMs);
_talon.configPeakOutputReverse(-1, kTimeoutMs);
/* 0.001 represents 0.1% - default value is 0.04 or 4% */
_talon.configNeutralDeadband(0.001, kTimeoutMs);
```

### 10.5.4. Peak/Nominal Output – Web based Configuration Self-Test

The parameters are also available for review in the Self-Test.

```
Nominal %:0,0
Peak %:-100,100
Closed Loop AllowedErr:Slot0=0,Slot1=0
Vel Sampling Per(ms):100,AvgWin:64
VCompSat:0.0

"Light Device LED" clears sticky faults.

CTRE Build:Jan 1 2018 18:08:40
Press "Refresh" to close.
```

## 10.6. Allowable Closed-Loop Error

Since firmware 2.0, The Talon SRX supports specifying an Allowable Closed-Loop Error whereby the motor output is neutral regardless of the calculated result. This signal affects...

- Position Closed-Loop Control Mode
- Velocity Closed-Loop Control Mode
- Current Closed-Loop Control Mode
- Motion Profile Control Mode
- Motion Magic Control Mode

When the Closed-Loop Error is within the Allowable Closed-Loop Error

- P, I, D terms are zeroed. In other words, the math that uses P, I, and D gains is disabled. However, F term is still in effect.
- Integral Accumulator is cleared.

Allowable Closed-Loop Error defaults to zero, and is persistently saved.

### 10.6.1. Allowable Closed-Loop Error – LabVIEW

Use the  VI to set this signal. The Allowable Closed-Loop error is in the same units as Closed-Loop Error. See [Section 17.1](#) for more information. Each Closed-Loop Motor Profile slot has a unique Allowable Closed-Loop Error. Select '0' or '1' for slot 0 or slot 1 respectively.

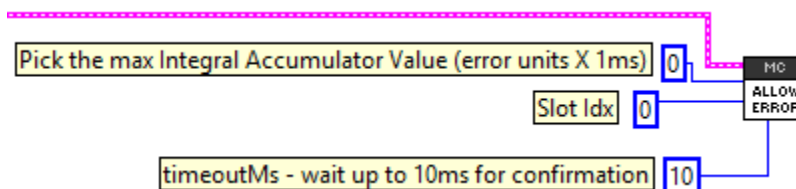

### 10.6.2. Allowable Closed-Loop Error – C++

The Allowable Closed-Loop error is in the same units as Closed-Loop Error. See [Section 17.1](#) for more information. Each Closed-Loop Motor Profile slot has a unique Allowable Closed-Loop Error. This function affects the currently selected slot/profile.

```
/* Slot 0 => allowable error = 409 units (10% or a rotation if using CTRE MagEncoder)*/
talon.ConfigAllowableClosedloopError(0, 409, 10);
```

In this example, 409 corresponds to 9.985% of a rotation or 35.95 degrees (assuming 4096 units per rotation, such as 1024CPR encoder or CTRE Mag Encoder).

### 10.6.3. Allowable Closed-Loop Error – Java

The Allowable Closed-Loop error is in the same units as Closed-Loop Error. See [Section 17.1](#) for more information. Each Closed-Loop Motor Profile slot has a unique Allowable Closed-Loop Error. This function affects the currently selected slot/profile.

```
/* Slot 0 => allowable error = 409 units (10% or a rotation if using CTRE MagEncoder)*/  
talon.configAllowableClosedLoopError(0, 409, 10);
```

In this example, 409 corresponds to 9.985% of a rotation or 35.95 degrees (assuming 4096 units per rotation, such as 1024CPR encoder or CTRE Mag Encoder).

#### 10.6.4. Allowable Closed-Loop Error – Web based Configuration Self-Test

```
Nominal %:0,0  
Peak %:-100,100  
Closed Loop AllowedErr:Slot0=40,Slot1=0  
Vel Sampling Per(ms):100,AvgWin:64  
VCompSat:0.0  
  
"Light Device LED" clears sticky faults.  
  
CTRE Build:Jan 1 2018 18:08:40  
Press "Refresh" to close.
```

The Allowable Closed-Loop Error for both slots can be read using the roboRIO Web based configuration Self-Test.

The values are in the same units as Closed-Loop Error.

In this example 40 corresponds to 0.9767% of a rotation or 3.52 degrees (assuming 4096 units per rotation, such as 1024CPR encoder or CTRE Mag Encoder).

## 10.7. Motion Magic Control Mode

Motion Magic is a control mode for Talon SRX that provides the benefits of Motion Profiling without needing to generate motion profile trajectory points. When using Motion Magic, Talon SRX will move to a set target position using a Trapezoidal Motion Profile, while honoring the user specified acceleration and maximum velocity (cruise velocity).

The benefits of this control mode over “simple” PID position closed-looping are...

- Control of the mechanism *throughout* the entire motion (as opposed to racing to the end target position).
- Control of the mechanism’s inertia to ensure smooth transitions between set points.
- Improved repeatability despite changes in battery voltage.
- Improved repeatability despite changes in motor load.

After gain/settings are determined, the robot-application only needs to periodically set the target position.

There is no general requirement to “wait for the profile to finish”, however the robot application can poll the sensor position and determine when the motion is finished if need be.

A Trapezoidal Motion Profile generally ramps the output velocity at a specified acceleration until cruise velocity is reached. This cruise velocity is then maintained until the system needs to deaccelerate to reach the target position and stop motion. Talon determines when these critical points occur on-the-fly.

NOTE: If the remaining sensor distance to travel is small, the velocity may not reach cruise velocity as this would overshoot the target position. This is often referred to as a “triangle profile”.

Example Trapezoidal Motion Profile

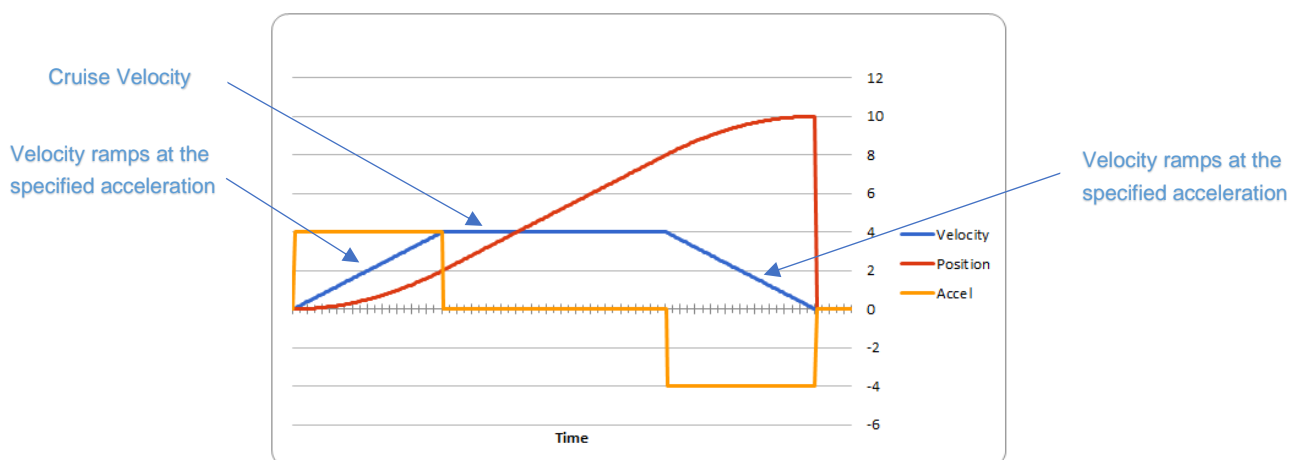

Motion Magic utilizes the same PIDF parameters as Motion Profiling.



The F parameter should be tuned using the process outlined in [Section 12.6.3](#). Note that while the F parameter is not normally used for Position Closed-Loop control, Motion Magic requires this parameter to be properly tuned.

See [Section 12.6](#) for complete FRC JAVA walkthrough on tuning.

Two additional parameters need to be set in the Talon SRX– Acceleration and Cruise Velocity.

The Acceleration parameter controls acceleration and deacceleration rates during the beginning and end of the trapezoidal motion. The Cruise Velocity parameter controls the cruising velocity of the motion.

This feature is further enhanced when used with Closed-Loop Voltage Compensation ([Section 10.8](#)).

The upper bound for trajectory velocity (RPM) is 278045700/sensor-units-per-rotation.

## 11. Motor Control Profile Parameters

The Talon persistently saves **four** unique Motor Control Profiles.

Each Motor Control Profile contains several configurable values, including...

**P Gain:**  $K_p$  constant to use when control mode is a closed-loop mode.

**I Gain:**  $K_i$  constant to use when control mode is a closed-loop mode.

**D Gain:**  $K_d$  constant to use when control mode is a closed-loop mode.

**F Gain:**  $K_f$  constant to use when control mode is a closed-loop mode.

**I Zone:** Integral Zone. When nonzero, Integral Accumulator is automatically cleared when the absolute value of Closed-Loop Error exceeds it.

**Allowable Closed-Loop Error:** When Closed-Loop Error's magnitude is less than this signal, Integral Accum and motor output are auto-zeroed during closed-loop.

**I Max** Maximum value Integral Accum can become. If Integral Accum becomes larger, it is capped to this value.

One unique feature of the Talon SRX is that gain values specified in a Motor Control Profile are not dedicated to just one type of closed-loop. When selecting a closed-loop mode (for example position or velocity) the robot application can select any of the four Motor Control Profiles to select *which* set of values to use. This can be useful for gain scheduling (changing gain values on-the-fly) or for persistently saving two sets of gains for two entirely different closed loop modes.

Reverse Soft Limit	<input type="text" value="-1000"/>
<b>Motor Controller Closed-Loop Control Parameters Slot 0</b>	
P Gain	<input type="text" value="0.2"/>
I Gain	<input type="text" value="0.002"/>
D Gain	<input type="text" value="2"/>
Feed-Forward Gain	<input type="text" value="0.0002"/>
I Zone	<input type="text" value="200"/>
Ramp Rate	<input type="text" value="256"/>
<b>Motor Controller Closed-Loop Control Parameters Slot 1</b>	
P Gain	<input type="text" value="0.1"/>
I Gain	<input type="text" value="0.001"/>
D Gain	<input type="text" value="1"/>
Feed-Forward Gain	<input type="text" value="0.0001"/>
I Zone	<input type="text" value="100"/>
Ramp Rate	<input type="text" value="256"/>

The settings for the first two slots can be set and read in the web control page.

Note that the Ramp Rate is **no longer supported**, as it has been replaced by Open-Loop and Closed-Loop Ramp API.

### 11.1. Persistent storage and Reset/Startup behavior

The Talon SRX was designed to reduce the “setup” necessary for a Talon SRX to be functional, particularly with closed-loop features. This is accomplished with efficient CAN framing and persistent storage.

All settings in the Motor Control Profile (MCP) are saved persistently in flash. Additionally, there are two complete Motor Control Profiles. Teams that use a constant set of values can simply set them using the roboRIO Web-based Configuration, and they will “stick” until they are changed again.

Additionally, Motor Control Profile (MCP) Parameters can be changed through programming API. When they are changed, the values are ultimately copied to persistent memory using a wear leveled strategy that ensures Flash longevity, but also meets the requirements for teams.

-Changing MCP values programmatically always take effect immediately (necessary for gain tuning).

-If the MCP Parameters have remained unchanged for fifteen seconds, and an MCP Parameter value is then changed using programming API, they are copied to persistent memory immediately.

-If the persistent memory has been updated within the last fifteen seconds due to a previous value change, and an MCP Parameter value is changed again, it will be applied to persistent memory once fifteen seconds has passed since the last persistent memory update. However the closed-loop will react immediately to the latest values sent over CAN bus.

-If power loss occurs during the period when MCP Parameters are being saved to persistent storage, the previous values for all MCP Parameters prior to last value-change is loaded. This is possible because the Talon SRX keeps a small history of all value changes.

These features fit well with the two common strategies that FRC teams utilize when programmatically changing closed-loop parameters...

- (1) Teams use programming API at startup to apply previous tested constants.
- (2) Teams use programming API to periodically set/change the constants because they are “gain scheduled” or action specific.

For use case (1), the constants are eventually saved in Talon SRX persistent memory (worst case fifteen seconds after robot startup). Once this is done the Talon SRX will have the values in persistent storage, so even after Talons are power cycled, they will load the constants that were previous set. This frees the robot controller from needing to re-set the values during a power cycle, reset, brownout, etc.... On subsequent robot startups, when the robot controller sends the same values again, and Talon SRX will still react by updating its variables, and comparing against what’s saved in persistent storage to see if it needs to be updated again. In the event the robot code changes to use new constants, the Talon will again update the persistent storage shortly after getting the new values.

For use case (2) teams, there are two “best” solutions depending on what’s being accomplished. If a team needs to switch between two sets of gains, they can leverage both MCP slots by setting one set of constants in slot 0, and another unique set of constants in slot 1. Then during the match, teams can switch between the two with a single API. This means that as far as the Talon is concerned, the values in each slot never changes so the contents of the Talon’s persistent storage never changes. Instead the robot controller just changes *which* slot to use. So this use case regresses to use case (1), and a freshly booted Talon already has all the MCP parameters it needs to function.

For use case(2) teams that requires more than two gain sets likely are changing gain values so frequently (as a function of autonomous, or state machine driven logic) that they would prefer not to rely on the previous set of gains sent to the Talon (despite it being available at startup). In which case they likely will periodically set the MCP parameters continuously (every number of loops or fixed period of time). Talon SRX always honors whatever parameters are requested over CAN bus, overriding what was loaded at startup or mirrored in persistent storage. And since the persistent storage is wear-leveled and mirrored at fifteen second intervals, this has no harmful impact on Flash longevity. So this use case is also supported well.

Beyond the Motor Control Profile Parameters, closed-loop modes require selecting

- which control mode (position or velocity)
- which feedback sensor to use
- if the feedback sensor should be reversed
- if the closed-loop output should be reversed
- what is the latest target or set point
- ramp rate (if needed)
- which Motor Control Profile Slot to use.

## 11.2. Inspecting Signals

When testing/calibrating closed-loops it is helpful to plot/check...

- Closed-Loop Error
- Applied motor percent output
- Profile Slot Select (which profile slot the closed-loop math is using).
- Position and Velocity depending control mode.

The Self-Test can provide these values for quick sanity checking. These values are also available with programming API for custom plotting, smart dashboard, LabVIEW front panels, etc...

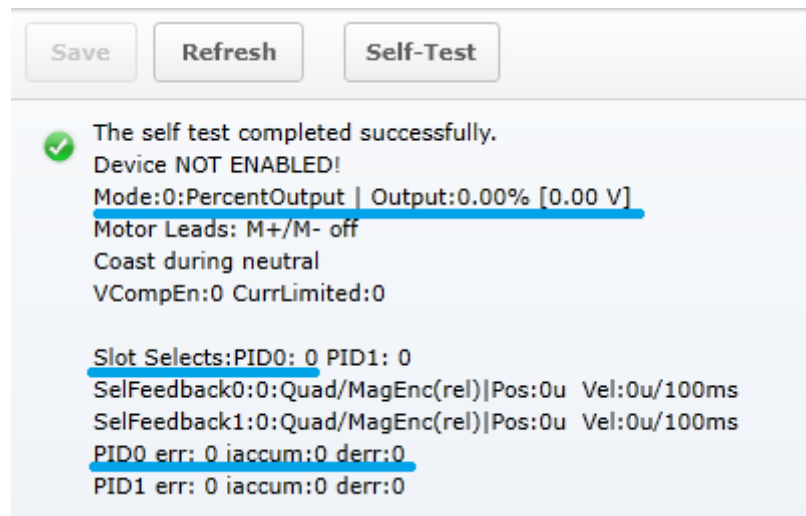

## 12. Closed-Loop Code Excerpts/Walkthroughs

### 12.1. Setting Motor Control Profile Parameters

#### 12.1.1. LabVIEW

Setting the Motor Controller Profile parameters can be done with the SET PID VI. This allows filling all parameters for a given Parameter Slot.

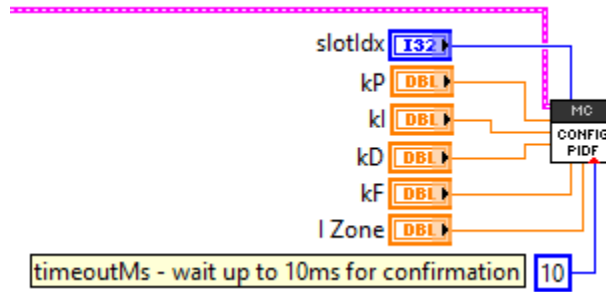

Specifying the set point is also done with the Set VI.

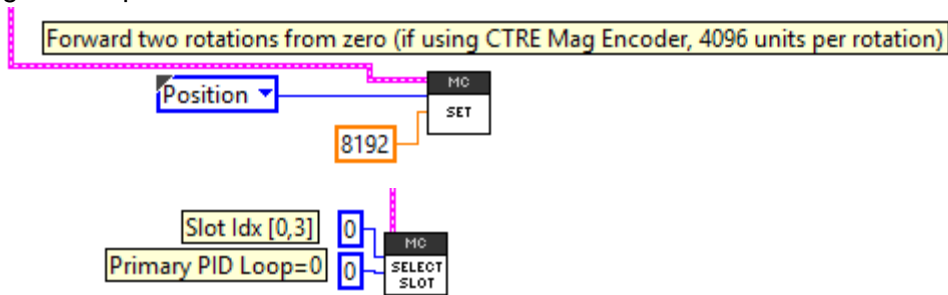

### 12.1.2. C++

Closed-loop parameters for a given profile slot can be modified with several different functions.

```
/* first param is the slot, second param is generally zero (for primary PID loop) */
talon.SelectProfileSlot(0, 0);
talon.Config_kF(0, 0.2, Constants.kTimeoutMs);
talon.Config_kP(0, 0.2, Constants.kTimeoutMs);
talon.Config_kI(0, 0, Constants.kTimeoutMs);
talon.Config_kD(0, 0, Constants.kTimeoutMs);
```

Setting the target position or velocity is also done with `set()`.

```
/* servo position, plus/minus one CTRE Mag Enc rotation via gamepad */
talon.set(ControlMode.Position, joy.getY() * 4096);
```

### 12.1.3. Java

Closed-loop parameters for a given profile slot can be modified using `setPID()`. This also sets the “Profile Slot Select” to the slot being modified. There are also individual Set functions for each signal.

```
/* first param is the slot, second param is generally zero (for primary PID loop) */
talon.selectProfileSlot(0, 0);
talon.config_kF(0, 0.2, Constants.kTimeoutMs);
talon.config_kP(0, 0.2, Constants.kTimeoutMs);
talon.config_kI(0, 0, Constants.kTimeoutMs);
talon.config_kD(0, 0, Constants.kTimeoutMs);
```

Setting the target position or velocity is also done with `set()`.

```
/* servo position, plus/minus one CTRE Mag Enc rotation via gamepad */
talon.set(ControlMode.Position, joy.getY() * 4096);
```

## 12.2. Setting/Clearing Integral Accumulator (I Accum)

Clearing the integral accumulator (“I Accum”) may be necessary to prevent integral windup. When using “I Zone” this is done automatically when the Closed-Loop Error is outside the “I Zone”. However, there may be other situations when manually clearing the integral accumulator is necessary. For example, if the mechanism that’s being closed-looped is “close enough” and its desirable to reduce occasional spurts of movement caused by a slowly incrementing integral term, then the robot logic can periodically clear the “I Accum” to prevent this.

### 12.2.1. LabVIEW

In this example a case structure is leveraged to conditionally clear the Integral Accumulator when the case structure conditional evaluates true (this example uses a system button on the front panel).

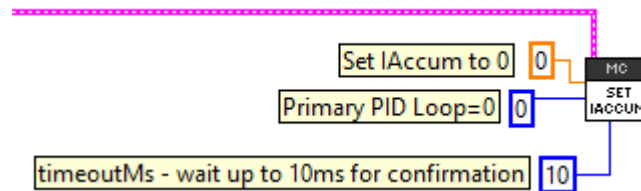

### 12.2.2. Java

```
double iaccum = 0;
talon.setIntegralAccumulator(iaccum, 0, 10);
```

### 12.2.3. C++

```
double iaccum = 0;
talon.SetIntegralAccumulator(iaccum, 0, 10);
```

### 12.2.4. Is Integral Accum cleared any other time?

In addition to the “I Zone” feature and manual clear, there are certain cases where the integral accumulator is automatically cleared for more predicable motor response...

- Whenever the control mode of a Talon is changed.
- When a Talon is in the disabled state.
- When the motor control profile slot has changed.
- When the Closed Loop Error’s magnitude is smaller than the “Allowable Closed Loop Error”.



## 12.3. Current Closed-Loop Walkthrough – LabVIEW

This example can be found on the CTR GitHub account.

<https://github.com/CrossTheRoadElec/Phoenix-Examples-LabVIEW>

### 12.3.1. Current Closed-Loop Walkthrough – Collect Sensor Data – LabVIEW

The first step is to confirm that the sensor is functional and in-phase with the motor.

Additionally, data can be collected to be used later to determine a decent Feed-forward gain.

When Button1 is released, y-axis controls the Talon SRX drive directly.  
When Button1 is held, y-axis closed-loops the target-current-draw.

When Button2 is held, the Closed-Loop gain parameters are sent to Talon.

$\text{CalcFgain} = 100\% \times 1023 / \text{CurrentMeasMilliAmps}$ , assuming measurement was at 100% motor output.

For example, if the CurrentDraw indicator reads 30.125 A at 75.56% throttle, the calculated Fgain is....  
 $\text{CalcFgain} = 0.7556 \times 1023 / 30125$   
 $\text{CalcFgain} = 0.02566$

Create a Talon and instrument its current draw and motor output. Also, provide a method to directly control the Talon to servo (Percent Output). In this example Talon is in Percent Output mode when button is off, and in current closed-loop when button is on.

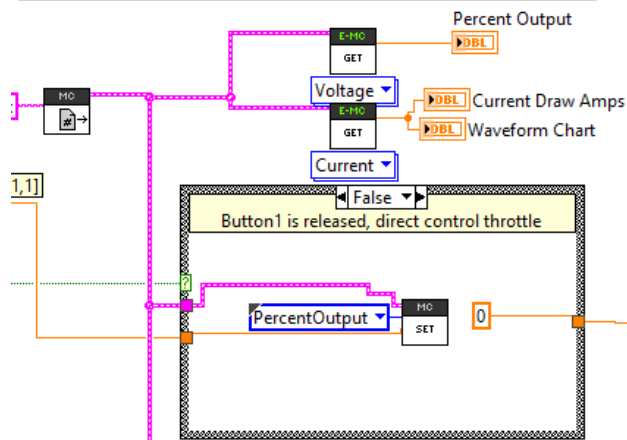

Enable the Robot and drive the motor to a reasonable output. Take note of what the motor output in percent. This will give us a basic relationship between current and motor-output.

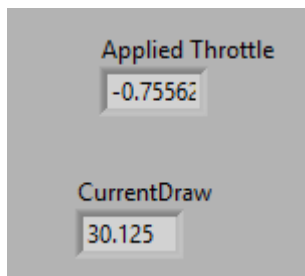

Shown to the left is the LabVIEW front panel, however these values can also be retrieved in the roboRIO web-based configuration (works for all FRC languages). Print statements can also be used for C++, JAVA, and HERO C#.

This example was taken by using a Talon SRX and CIM to back drive a secondary CIM motor with leads connected together. At full output this setup will exceed the 40A breaker rating so less-the-full output was used. However, in a typical mechanism, full output may be used to acquire a more accurate measurement.

### 12.3.2. Current Closed-Loop Walkthrough – Calculating Feed Forward– LabVIEW

From this we can calculate our initial Feed-Forward gain. Since measured current is always positive, we ignore the negative sign of applied output.

The Talon SRX firmware operates on the desired current in milliamps and outputs a motor output value [-1023 to +1023]. Knowing this, we calculate a Feedforward that will gives us 75% output when the Target current-draw is 30125 mA.

$$(0.7556 \times 1023) / 30125 \text{ mA} \Rightarrow -0.02566$$

As a math check, when the set point is 30125mA, the feedforward term will be  $30125 \times 0.02566$  gives us 773 motor output units (~75%).

Next we will set the F gain to **0.02566**, while zeroing the PID gains. This can be done in the web-based configuration or programmatically using the robot API.

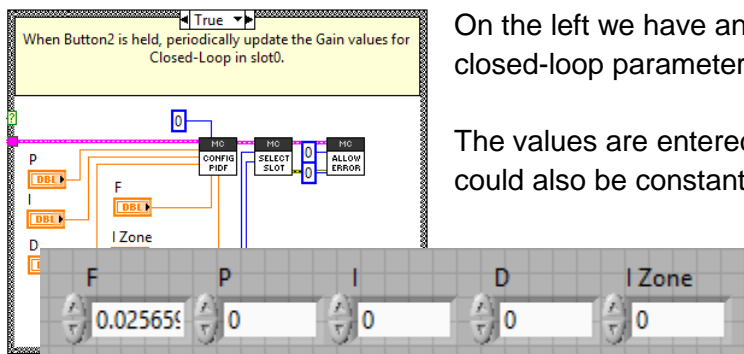

On the left we have an example in LabVIEW, setting the closed-loop parameters in Begin.vi.

The values are entered below in the front panel, though they could also be constants if need be.

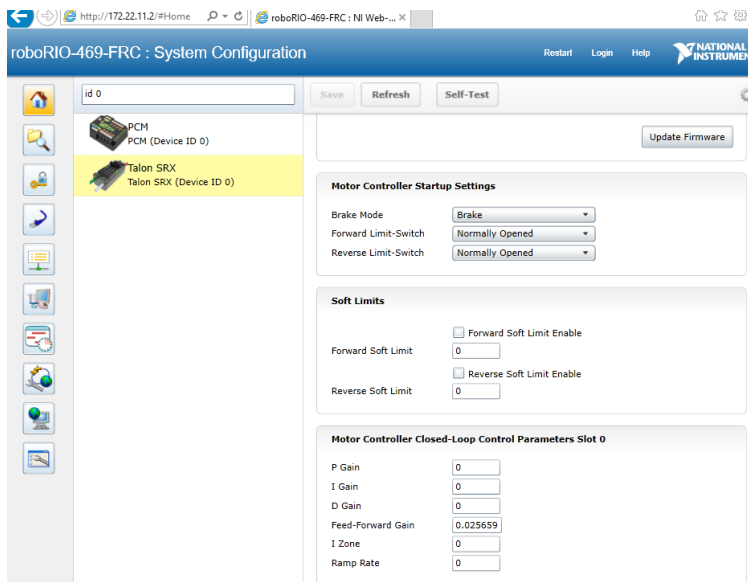

Additionally, the other languages have comparable APIs for gain-setting, or the gains can be set using the roboRIO web-based configuration.

Web-based configuration can also be used to double check that the settings are what you expect.

Now rerun the test setup, but now we will press and hold our button to conditionally enable Current-closed loop mode.

When Button1 is released, y-axis controls the Talon SRX drive directly.  
 When Button1 is held, y-axis closed-loops the target-current-draw.  
  
 When Button2 is held, the Closed-Loop gain parameters are sent to Talon.  
  
 $CalcFgain = 100\% \times 1023 / CurrentMeasMilliAmps$ , assuming measurement was at 100% motor output.  
  
 For example, if the CurrentDraw indicator reads 30.125 A at 75.56% throttle, the calculated Fgain is....  
 $CalcFgain = 0.7556 \times 1023 / 30125$   
 $CalcFgain = 0.02566$

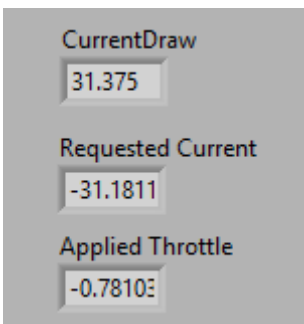
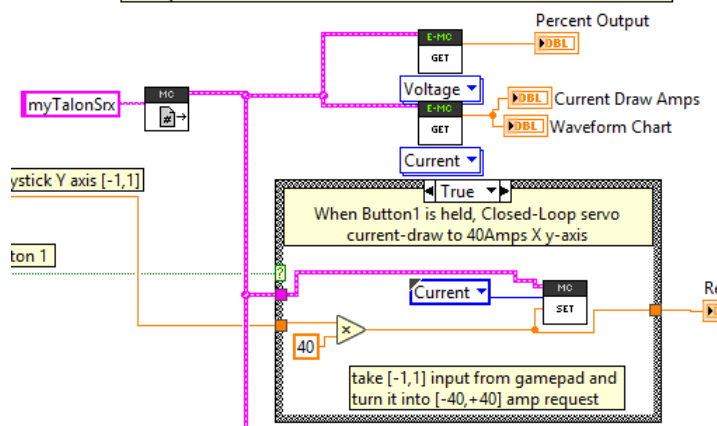

Not surprisingly the desired and measured current draw are nearly identical.

Of course, there is no guarantee this will be the case at all request current draws under differing battery conditions. Remember this is just Feed-forward, we're not close-looping yet! For example, as we deviate away from our tuned point, we see error between our desired and measured current.

Next we will tune P gain so that the closed-loop responds to error.

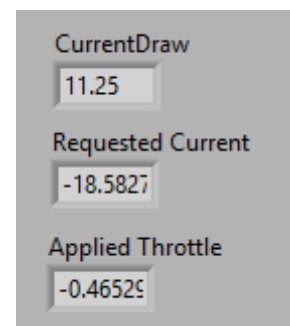

### 12.3.3. Current Closed-Loop Walkthrough – Dialing Proportional Gain – LabVIEW

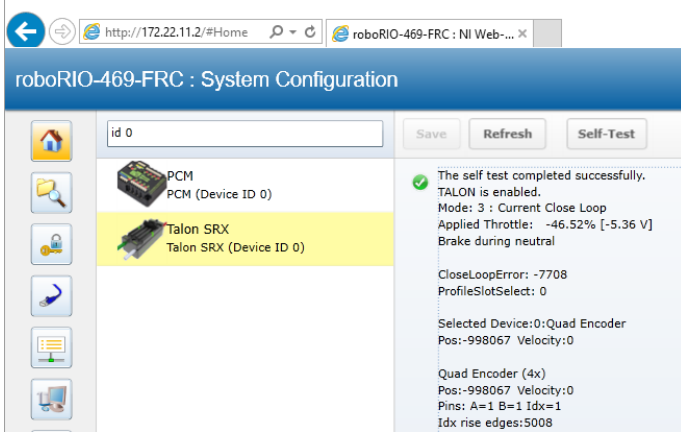

In this example the Closed-Loop Err was ~7000 (mA).

Perhaps we want to start with adding another 10% motor output to help approach our target current.

10% output X 1023 = 102 output units

Since we want 102 output units when the error is 7700, calculate P gain by dividing the two...

$$102.3 / 7700 = \mathbf{0.01329}$$

To check our math, let's take our P-gain of 0.01329 and multiply by Closed Loop Err (7700mA)

$$\mathbf{0.01329} \times 7700 = 102 \text{ (10\% of 1023 full output).}$$

Now we can expect approximately 10% more motor output when our error is ~7 amps.

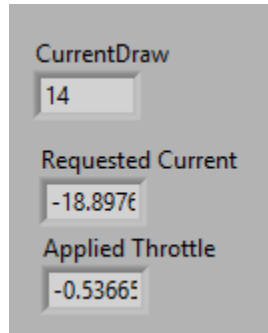
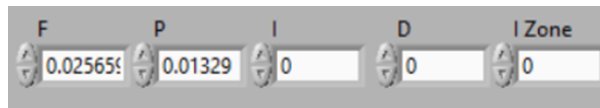

Here we attempt to reproduce the same target point. We see our motor output has increased because of the stronger P-gain and our current draw is closer to our target.

Keep increasing the P-gain until the desired response is achieved. To save time, many will double the P-gain until oscillation is observed (overshooting the target and then returning to target. This can also be observed by plotting, or watching the color change on the Talon SRX LEDs).

After further increasing P-gain, we see our desired and measured current-draw to follow closely.

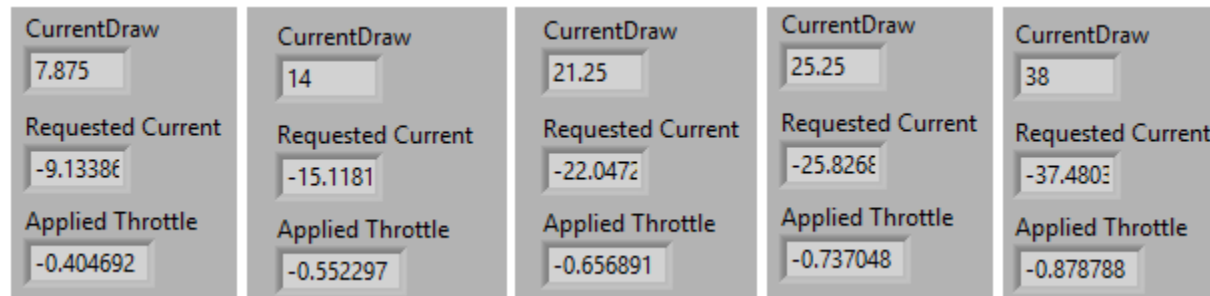

We can also observe how the closed-loop responds to a change in load. Disconnecting the back driven CIM motor's connected leads and connecting them to a 0.2 ohm power resistor reveals how the Closed-Loop increases its motor output to target the desired 20 amps.

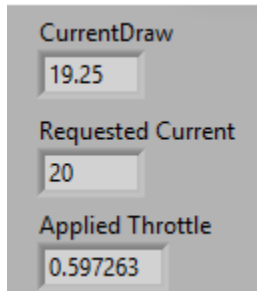

Closed Loop driving 59.7% when back-driven CIM has leads connected.

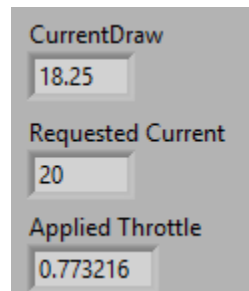

Closed Loop driving 77.7% when back-driven CIM has power resistor in series with leads.

With additional tweaking and leveraging the remaining gains (I and D), the closed-loop can be further improved, though many will find that a simple FP loop will be sufficient for many applications.

## 12.4. Velocity Closed-Loop Walkthrough – Java

This example is on the CTR GitHub account. <https://github.com/CrossTheRoadElec/Phoenix-Examples-Languages>

### 12.4.1. Velocity Closed-Loop Walkthrough – Test Gamepad

The first step is to check the axis of the gamepad is functional and configured in the correct direction. This is done by ensuring the robot is disabled, and moving the gamepad's desired stick to its extremities. While doing this, look at the Driver Station's USB devices under the 4<sup>th</sup> tab, and check that the gamepad's values are changing as expected.

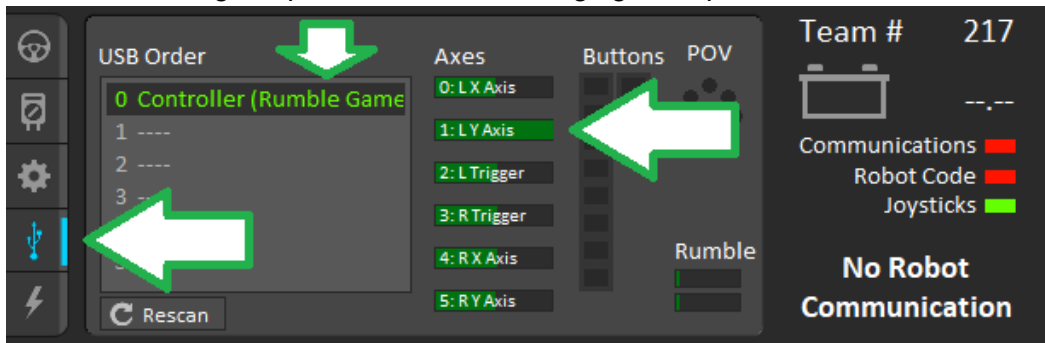

### 12.4.2. Velocity Closed-Loop Walkthrough – Collect Sensor Data – Java

Then, drive the Talon SRX manually to check that the selected sensor is functioning and in phase with the motor. The following example below will accomplish this. Deploy and drive the Talon forward by pulling the gamepad's y-axis.

```
public class Robot extends IterativeRobot {
    TalonSRX _talon = new TalonSRX(3);
    Joystick _joy = new Joystick(0);
    StringBuilder _sb = new StringBuilder();
    int _loops = 0;

    public void robotInit() {
        /* first choose the sensor */
        _talon.configSelectedFeedbackSensor(FeedbackDevice.CTRE_MagEncoder_Relative, 0,
            Constants.kTimeoutMs);

        _talon.setSensorPhase(true);

        /* set the peak, nominal outputs, and deadband */
        _talon.configNominalOutputForward(0, Constants.kTimeoutMs);
        _talon.configNominalOutputReverse(0, Constants.kTimeoutMs);
        _talon.configPeakOutputForward(1, Constants.kTimeoutMs);
        _talon.configPeakOutputReverse(-1, Constants.kTimeoutMs);

        /* set closed loop gains in slot0 */
        _talon.config_kF(Constants.kPIDLoopIdx, 0.34, Constants.kTimeoutMs);
        _talon.config_kP(Constants.kPIDLoopIdx, 0.2, Constants.kTimeoutMs);
        _talon.config_kI(Constants.kPIDLoopIdx, 0, Constants.kTimeoutMs);
        _talon.config_kD(Constants.kPIDLoopIdx, 0, Constants.kTimeoutMs);
    }

    /** This function is called periodically during operator control */
    public void teleopPeriodic() {
        /* get gamepad axis */
        double leftYstick = _joy.getY();
        double motorOutput = _talon.getMotorOutputPercent();
        /* prepare line to print */
        _sb.append("\tout:");
        _sb.append(motorOutput);
        _sb.append("\tspd:");
        _sb.append(_talon.getSelectedSensorVelocity(Constants.kPIDLoopIdx));

        if (_joy.getRawButton(1)) {
            /* Speed mode */
            /*
             * 4096 Units/Rev * 500 RPM / 600 100ms/min in either direction:
             * velocity setpoint is in units/100ms
             */
            double targetVelocity_UnitsPer100ms = leftYstick * 4096 * 500.0 / 600;
        }
    }
}
```

```

        /* 1500 RPM in either direction */
        _talon.set(ControlMode.Velocity, targetVelocity_UnitsPer100ms);

        /* append more signals to print when in speed mode. */
        _sb.append("\terr:");
        _sb.append(_talon.getClosedLoopError(Constants.kPIDLoopIdx));
        _sb.append("\ttrg:");
        _sb.append(targetVelocity_UnitsPer100ms);
    } else {
        /* Percent output mode */
        _talon.set(ControlMode.PercentOutput, leftYstick);
    }

    if (++_loops >= 10) {
        _loops = 0;
        System.out.println(_sb.toString());
    }
    _sb.setLength(0);
}
}

```

```

out:0.9708333333 spd:9368
out:0.975 spd:9359
out:0.975 spd:9367
out:0.975 spd:9365
out:0.975 spd:9346
out:0.975 spd:9368
out:0.975 spd:9324
out:0.9708333333 spd:9357
out:0.975 spd:9327
out:0.9708333333 spd:9341
out:0.975 spd:9345
out:0.975 spd:9329
out:0.975 spd:9357
out:0.975 spd:9330

```

While driving the Talon in the positive direction, make sure the sensor speed is also positive.

Additionally, note the approximate sensor speed while the Talon is driven.

`getSelectedSensorVelocity ()` will return the speed in position units per 100ms.

The screenshot shows the 'roboRIO-469-FRC : System Configuration' web interface. On the left, there is a search bar and a list of six Talon SRX devices with their respective Device IDs (13, 15, 17, 7, 9, 11). On the right, there are 'Save', 'Refresh', and 'Self-Test' buttons. Below these buttons, a green checkmark indicates that the self-test completed successfully. The configuration details for the selected device (6:CTRE MagEnc (rel)) are shown, including 'Applied Throttle: 100.00% [11.64 V]', 'Coast during neutral', 'CloseLoopError: 0', 'ProfileSlotSelect: 0', 'Selected Device: 6:CTRE MagEnc (rel)', 'Pos: 647099', and 'Velocity: 9323'. At the bottom, there are details for the 'Magnetic Encoder (Relative)', including 'Pos (rot): 158.255', 'Velocity (RPM): 1366.10', 'Pos: 648216', 'Velocity: 9326', 'Pins: A=0 B=0 Idx=0', and 'Idx rise edges: 8510'.

The same values can be read in the roboRIO web-based configuration under Self-Tests.

### 12.4.3. Velocity Closed-Loop Walkthrough – Calculating Feed Forward– Java

Now that we've confirmed that the position/speed moves in the positive direction with forward (green LEDs on Talon), we can calculate our Feed-forward gain. Our measurement of **9326** native units per 100ms is used for this. This was captured in the Self-Test.

Now let's calculate a Feed-forward gain so that **100%** motor output is calculated when the requested speed is 9328 native units per 100ms.

$$\text{F-gain} = (100\% \times 1023) / 9326$$

$$\text{F-gain} = 0.1097$$

Let's check our math, if the target speed is **9326** native units per 100ms, Closed-loop output will be  $(0.1097 \times 9326) \Rightarrow 1023$  (full forward).

```
_talon.setF(0.1097); Next we will set the calculated gain. This can also be done in the
_talon.setP(0); roboRIO web-based configuration or programmatically.
_talon.setI(0);
_talon.setD(0);
```

After applying the new gain, rerun the test but hold down button1 to put Talon into Speed Control Mode. Now review the target and measured speed to see how close we are.

A few DS console samples are shown below, which contain the print statements. Looking at "spd" and "trg" we see that we're within ~600 units per 100ms for most of the captures.

```
out:-84.375 spd:-576 err:-224 trg:-800
out:-89.6484375 spd:-612 err:-184 trg:-800
out:-91.25976563 spd:-623 err:-177 trg:-800
out:-85.69335938 spd:-585 err:-216 trg:-800
out:-86.42578125 spd:-590 err:-207 trg:-800
out:-93.45703125 spd:-638 err:-163 trg:-800
out:-87.01171875 spd:-594 err:-208 trg:-800
out:-84.81445313 spd:-579 err:-221 trg:-800
```

Since the sensor is 4096 units per rotation, ~600 units per 100ms scales to ~87 RPM for most of the speed-sweep.

```
out:-869.0917969 spd:-5933 err:-466 trg:-6400
out:-869.8242188 spd:-5938 err:-463 trg:-6400
out:-868.7988281 spd:-5931 err:-469 trg:-6400
out:-869.6777344 spd:-5937 err:-463 trg:-6400
out:-868.5058594 spd:-5929 err:-470 trg:-6400
out:-866.015625 spd:-5912 err:-488 trg:-6400
out:-866.7480469 spd:-5917 err:-484 trg:-6400
out:-868.7988281 spd:-5931 err:-469 trg:-6400
out:-867.9199219 spd:-5928 err:-472 trg:-6400
```



```

out:-916.9921875 spd:-6260 err:-538 trg:-6800
out:-920.9472656 spd:-6287 err:-513 trg:-6800
out:-924.0234375 spd:-6308 err:-491 trg:-6800
out:-920.2148437 spd:-6282 err:-517 trg:-6800
out:-917.2851562 spd:-6262 err:-538 trg:-6800
out:-916.5527344 spd:-6257 err:-543 trg:-6800
out:-920.9472656 spd:-6287 err:-512 trg:-6800
out:-920.5078125 spd:-6284 err:-516 trg:-6800
out:-920.3613281 spd:-6283 err:-437 trg:-6640

```

Additionally, since we have no feedback, you will find changes in load will impact the error considerably.

Remember “err” is in native units per 100ms. So an error of 900 units per 100ms equals an error of 131RPM since each rotation is 4096 units.

```

out:-1135.107422 spd:-7749 err:-889 trg:-8640
out:-1129.541016 spd:-7711 err:-930 trg:-8640
out:-1134.228516 spd:-7743 err:-904 trg:-8640
out:-1131.005859 spd:-7721 err:-922 trg:-8640
out:-1127.34375 spd:-7696 err:-944 trg:-8640
out:-1136.279297 spd:-7757 err:-882 trg:-8640
out:-1132.177734 spd:-7729 err:-912 trg:-8640
out:-1126.757813 spd:-7692 err:-948 trg:-8640

```

#### 12.4.4. Velocity Closed-Loop Walkthrough – Dialing Proportional Gain – Java

Next we will add in P-gain so that the closed-loop can react to error. Suppose given our worst error so far (900 native units per 100ms), we want to respond with another 10% of motor output. Then our starting p-gain would be...

$$(10\% \times 1023) / (900) = \mathbf{0.113333}$$

Now let's check our math, if the Talon SRX sees an error of 900 the P-term will be

$$900 \times \mathbf{0.113333} = 102 \text{ (which is about 10\% of 1023)}$$

$$\text{P-gain} = \mathbf{0.113333}$$

Apply the P -gain programmatically using your preferred method. Now retest to see how well the closed-loop responds to varying loads. Double the P -gain until the system oscillates (too much) or until the system responds adequately.

```

/* set closed loop gains in slot0 */
_talon.config_kF(Constants.kPIDLoopIdx, 0.1097, Constants.kTimeoutMs);
_talon.config_kP(Constants.kPIDLoopIdx, 0.113333, Constants.kTimeoutMs);
_talon.config_kI(Constants.kPIDLoopIdx, 0, Constants.kTimeoutMs);
_talon.config_kD(Constants.kPIDLoopIdx, 0, Constants.kTimeoutMs);

```

If the mechanism is moving to swiftly, you can add D-gain to smooth the motion. Start with 10x the p-gain.

If the mechanism is not quite reaching the final target position (and P -gain cannot be increased further without hurting overall performance) begin adding I-gain. Start with 1/100<sup>th</sup> of the P-gain.

Some mechanisms may require that the closed-loop can never spin in reverse of the desired direction (due to closed-loop wanting to slow down). This behavior can be achieved by reducing the peak output to zero.

```

/* set the peak, nominal outputs */
_talon.configNominalOutputForward(0, Constants.kTimeoutMs);
_talon.configNominalOutputReverse(0, Constants.kTimeoutMs);
_talon.configPeakOutputForward(+1, Constants.kTimeoutMs);
_talon.configPeakOutputReverse(0, Constants.kTimeoutMs); /* only positive */

/* set closed loop gains in slot0 */
_talon.config_kF(Constants.kPIDLoopIdx, 0.1097, Constants.kTimeoutMs);
_talon.config_kP(Constants.kPIDLoopIdx, 0.22, Constants.kTimeoutMs);
_talon.config_kI(Constants.kPIDLoopIdx, 0, Constants.kTimeoutMs);
_talon.config_kD(Constants.kPIDLoopIdx, 0, Constants.kTimeoutMs);

```

## 12.5. Velocity Closed-Loop Example – LabVIEW

This example can be found on the CTR GitHub account.

<https://github.com/CrossTheRoadElec/Phoenix-Examples-LabVIEW>

Look at the teleop VI to confirm how the Feed Forward gain is calculated.

There will be a text label similar to the following...

```

Press and Hold Button1 to enable Speed-Closed-Loop, otherwise Talon is in PercentVoltage Mode.
Use the Left Y-axis on Logitech Gamepad.

VelocityNativeUnits = Change In Sensor / 100mS
also
VelocityNativeUnits = RPM / 600 * SensorUnitsPerRotation

Fgain = 100% X 1023 / VelocityNativeUnits,
      where VelocityNativeUnits is measured at 100% throttle

Mag Encoder has 4096 units per rotation.

Example: VelocityRPM is 10198 at 100% throttle
=> VelocityNativeUnits = (10198 / 600 * 4096) = 69618
=> Fgain = (1023 / 69618) = 0.01469

```

The calibration procedure is identical to the Java Velocity Walkthrough.

## 12.6. Motion Magic Closed-Loop Walkthrough – Java

This latest example should be downloaded from the CTR GitHub account.

<https://github.com/CrossTheRoadElec/Phoenix-Examples-Languages>

The example will appear similar to the snippet below...

```
public class Robot extends IterativeRobot {
    TalonSRX _talon = new TalonSRX(3);
    Joystick _joy = new Joystick(0);
    StringBuilder _sb = new StringBuilder();

    public void robotInit() {

        /* first choose the sensor */
        _talon.configSelectedFeedbackSensor(FeedbackDevice.CTRE_MagEncoder_Relative,
                                           Constants.kPIDLoopIdx, Constants.kTimeoutMs);

        _talon.setSensorPhase(true);
        _talon.setInverted(false);

        /* Set relevant frame periods to be at least as fast as periodic rate*/
        _talon.setStatusFramePeriod(StatusFrameEnhanced.Status_13_Base_PIDF0, 10,
                                    Constants.kTimeoutMs);
        _talon.setStatusFramePeriod(StatusFrameEnhanced.Status_10_MotionMagic, 10,
                                    Constants.kTimeoutMs);

        /* set the peak and nominal outputs */
        _talon.configNominalOutputForward(0, Constants.kTimeoutMs);
        _talon.configNominalOutputReverse(0, Constants.kTimeoutMs);
        _talon.configPeakOutputForward(1, Constants.kTimeoutMs);
        _talon.configPeakOutputReverse(-1, Constants.kTimeoutMs);

        /* set closed loop gains in slot0 - see documentation */
        _talon.selectProfileSlot(Constants.kSlotIdx, Constants.kPIDLoopIdx);
        _talon.config_kF(0, 0.2, Constants.kTimeoutMs);
        _talon.config_kP(0, 0.2, Constants.kTimeoutMs);
        _talon.config_kI(0, 0, Constants.kTimeoutMs);
        _talon.config_kD(0, 0, Constants.kTimeoutMs);
        /* set acceleration and vcruise velocity - see documentation */
        _talon.configMotionCruiseVelocity(15000, Constants.kTimeoutMs);
        _talon.configMotionAcceleration(6000, Constants.kTimeoutMs);
        /* zero the sensor */
        _talon.setSelectedSensorPosition(0, Constants.kPIDLoopIdx, Constants.kTimeoutMs);
    }

    /**
     * This function is called periodically during operator control
     */
    public void teleopPeriodic() {
        /* get gamepad axis - forward stick is positive */
        double leftYstick = -1.0 * _joy.getY();
        /* calculate the percent motor output */
        double motorOutput = _talon.getMotorOutputPercent();
        /* prepare line to print */
        _sb.append("\tOut:");
        _sb.append(motorOutput);
        _sb.append("\tVel:");
        _sb.append(_talon.getSelectedSensorVelocity(Constants.kPIDLoopIdx));

        if (_joy.getRawButton(1)) {
            /* Motion Magic */
            double targetPos = leftYstick * 4096 * 10.0;
            /* 4096 ticks/rev * 10 Rotations in either direction*/
            _talon.set(ControlMode.MotionMagic, targetPos);

            /* append more signals to print when in speed mode. */
            _sb.append("\terr:");
            _sb.append(_talon.getClosedLoopError(Constants.kPIDLoopIdx));
            _sb.append("\ttrg:");
            _sb.append(targetPos);
        } else {
            /* Percent output mode */
            _talon.set(ControlMode.PercentOutput, leftYstick);
        }
        /* instrumentation */
        Instrum.Process(_talon, _sb);
    }
}
```

```

    try { TimeUnit.MILLISECONDS.sleep(10); } catch(Exception e) {}
}

```

### 12.6.1. Motion Magic Closed-Loop Walkthrough – General Requirements

Be sure to check that the firmware is up to date. See CRF release notes for when motion magic was added.

**Firmware should be in the format 3.X.**

Settings	
Name	RIGHT MASTER 3
Device ID	3
	<input type="checkbox"/> Light Device LED
Software Status	Running Application.
Hardware Revision	1.4
Manufacture Date	Nov 3, 2014
Bootloader Revision	2.6
Vendor	Cross The Road Electronics
Model	Talon SRX
Firmware Version	2.22
Status	Present

Additionally, a reliable signal plotter is helpful for tuning parameters.

The signals of interest are the...

- Sensor Position
- Sensor Velocity
- Active Trajectory Position
- Active Trajectory Velocity
- Applied Motor Output
- ClosedLoopErr

### 12.6.2. Motion Magic Closed-Loop Walkthrough – Test Gamepad

The first step is to check the axis of the gamepad is functional and configured in the correct direction. This is done by ensuring the robot is disabled, and moving the gamepad's desired stick to its extremities. While doing this, look at the Driver Station's USB devices under the 4<sup>th</sup> tab, and check that the gamepad's values are changing as expected.

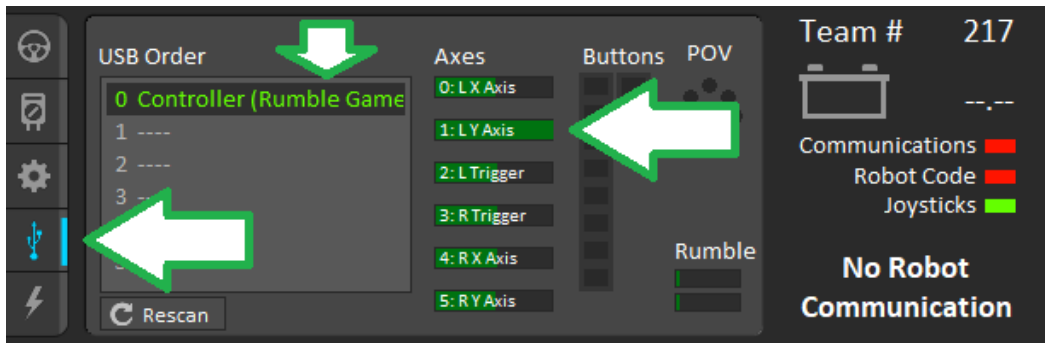

### 12.6.3. Motion Magic Closed-Loop Walkthrough – Collect Sensor Data – Java

Next, drive the Talon SRX manually to check that the selected sensor is functioning and in phase with the motor. Deploy the GitHub example (or similar drive code) and drive the Talon by pulling the gamepad's y-axis.

Checking the sensor means...

- Confirming the sensor direction matches Talon motor output.
- Confirm position and speed measurement is accurate throughout entire position/speed range.
- Confirming the velocity is approximately correct given the mechanical setup.
- Noting the measured speed at a given motor output for calculating f-gain
- Noting the measured max speed for initial selection of velocity cruise and acceleration.

While throttling the Talon in the **positive** direction, make sure the sensor speed is also **positive**. Talon should be illuminating green when doing this. If this is not the cause, change the parameter in `setSensorPhase()` and retest.

Additionally, note the approximate sensor velocity while the Talon is driven. The displayed value is in units per 100ms.

```

out:-1 spd:-4151
out:-1 spd:-4148
out:-1 spd:-4149
out:-1 spd:-4146
out:-1 spd:-4149
out:-1 spd:-4144
out:-1 spd:-4147
out:-1 spd:-4143
out:-1 spd:-4152
out:-1 spd:-4145

out:1 spd:4111
out:1 spd:4111
out:1 spd:4106
out:1 spd:4106
out:1 sod 4101
out:1 spd:4102
out:1 spd:4107
out:1 spd:4106
out:1 spd:4105
out:1 spd:4110
out:1 spd:4106
out:1 spd:4105
out:1 spd:4110

```

The same values can be read in the roboRIO web-based configuration under Self-Tests.

It's important to note the speed for calculating the f-gain and for picking cruise velocity and acceleration.

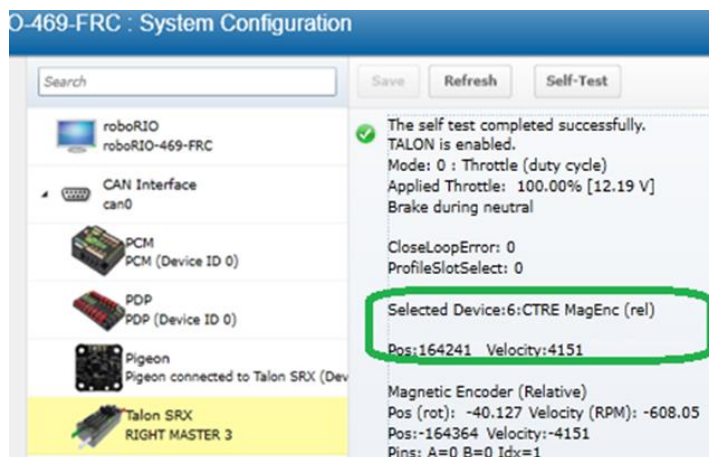

Example screenshot while driving shown here. Capture several to sanity check sensor.

The self-test capture used for testing showed **4123 native units per 100ms**, so this is used in the next section. This is comparable to the 4151 show in the left screenshot.

### 12.6.3.1. Is velocity magnitude correct?

In this example, we measure **4123 units per 100ms (captured from previous section)**. This scales to **~604 RPM** at full motor output (averaged of peak in both directions), assuming 4096 units per rotation (CTRE Mag encoder resolution).

This setup involves 1 X CIM Motor motor (free speed 5330 RPM). The selected gear ratio is ~9:1. The CTRE magnetic encoder is on the geared output. So, a measurement of **~604 RPM** is reasonable since it is close to 1/9<sup>th</sup> of 5330 RPM.

### 12.6.3.2. Is direction correct?

Looking at the screenshots above, positive motor output yielded a positive speed.

### 12.6.3.3. Sweep motor output and plots signals

While sweeping position and velocity, look for any discontinuities or unexplained behavior. In the capture below, the sensor velocity and position appear to follow with no discontinuities or plateaus.

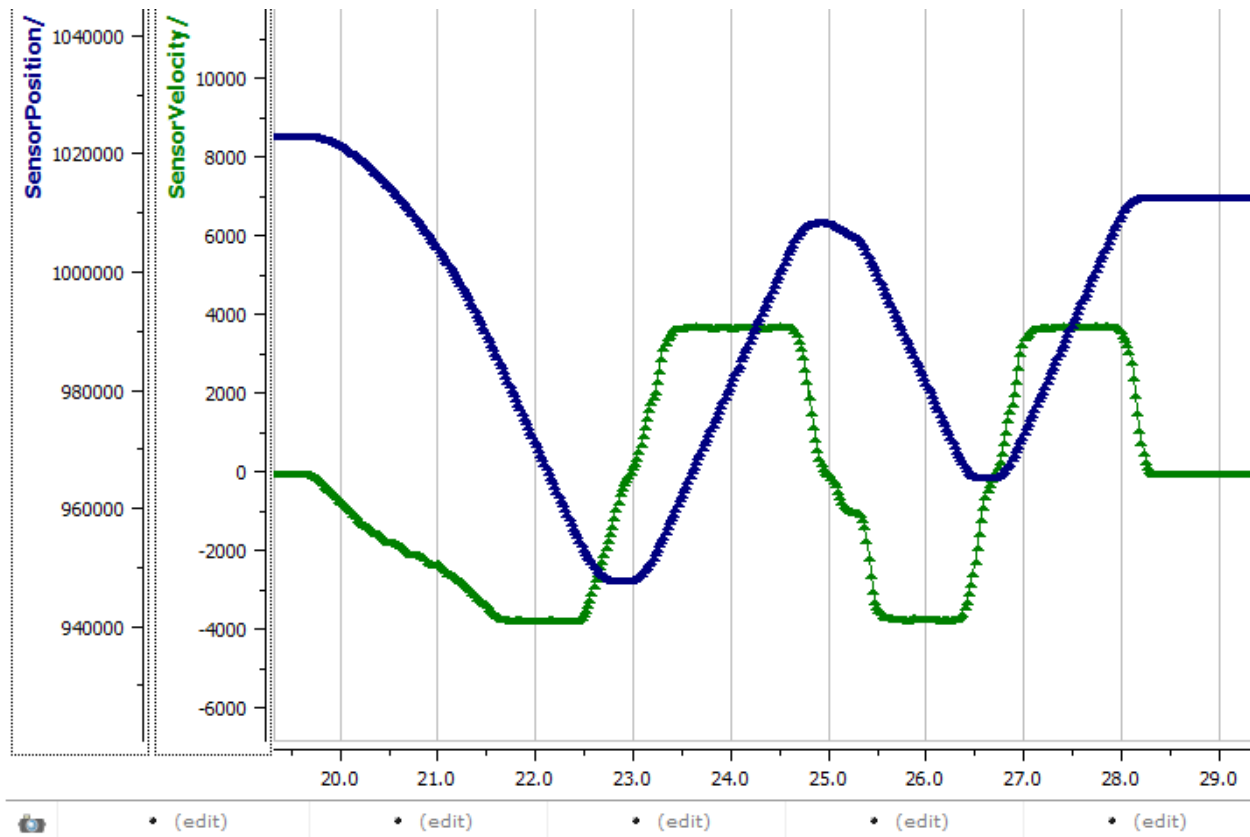

#### 12.6.3.4. Measurements

For the calculations done in the next section, the measurement **4123 units per 100ms** at full motor output is observed.

#### 12.6.4. Motion Magic Closed-Loop Walkthrough – Calculate F-Gain – Java

The Motion-Magic Closed-Loop mode operates by closed-loop servoing to a calculated position with a feed-forward calculated velocity. The calculations are based on the set-point, cruise velocity, acceleration parameter, and time. This requires knowing the sensor units per rotation. For this example, the CTRE Magnetic Encoder (quadrature) was used, which has 4096 native units per rotation. That is how we can deduce that the **4123** native units per 100ms measurement scales to **~604 RPM**.

Velocity is measured in change in native units per  $T_{velMeas} = 100\text{ms}$ .

Now let's calculate a Feed-forward gain so that **100%** motor output is calculated when the requested speed is 4123 native units per 100ms.

$$\text{F-gain} = (100\% \times 1023) / 4123$$

$$\text{F-gain} = 0.2481$$



Let's check our math, if the target speed is **4123** native units per 100ms, Closed-loop output will be  $(0.2481 \times 4123) \Rightarrow 1023$  (full forward).

Next we will set the calculated gain. This can also be done in the roboRIO web-based configuration or programmatically.

Motor Controller Closed-Loop Control Parameters Slot 0	
P Gain	<input type="text" value="0"/>
I Gain	<input type="text" value="0"/>
D Gain	<input type="text" value="0"/>
Feed-Forward Gain	<input type="text" value="0.2481"/>
I Zone	<input type="text" value="0"/>
Ramp Rate	<input type="text" value="0"/>

```

/* set closed loop gains in slot0 - see documentation */
_talon.selectProfileSlot(Constants.kSlotIdx, Constants.kPIDLoopIdx);
_talon.config_kF(0, 0.2481, Constants.kTimeoutMs);
_talon.config_kP(0, 0, Constants.kTimeoutMs);
_talon.config_kI(0, 0, Constants.kTimeoutMs);
_talon.config_kD(0, 0, Constants.kTimeoutMs);
/* set acceleration and vcruise velocity - see documentation */
_talon.configMotionCruiseVelocity(0, Constants.kTimeoutMs);
_talon.configMotionAcceleration(0, Constants.kTimeoutMs);

```

### 12.6.5. Motion Magic Closed-Loop Walkthrough – Initial Cruise-Velocity/Acceleration – Java

Since our peak measured velocity was **4123 units per 100ms**, the initial cruise velocity should be set to a smaller value to ensure the speed can be reached. In this example, we will arbitrarily take 75% of the top speed. Depending on the mechanism type, how safe the mechanism is, and what is trying to be accomplished, a lower or higher cruise velocity could be specified. Also remember that this setting can be changed easily and at any time.

$$75\% \times 4123 \text{ units per 100ms} = \sim 3092 \text{ units per 100ms}$$

For the initial acceleration value, we will arbitrarily choose a value so that it takes an entire second to reach our cruise velocity. This will ensure the acceleration is slow enough to be observable. If this is too fast/slow, adjust accordingly. Since the acceleration is in terms of change in velocity per second, an acceleration of **3092 units per 100ms per sec** will achieve our 1 second accel time.

```

/* set closed loop gains in slot0 - see documentation */
_talon.selectProfileSlot(Constants.kSlotIdx, Constants.kPIDLoopIdx);

```

```
_talon.config_kF(0, 0.2481, Constants.kTimeoutMs);
_talon.config_kP(0, 0, Constants.kTimeoutMs);
_talon.config_kI(0, 0, Constants.kTimeoutMs);
_talon.config_kD(0, 0, Constants.kTimeoutMs);
/* set acceleration and vcruise velocity - see documentation */
_talon.configMotionCruiseVelocity(3092, Constants.kTimeoutMs);
_talon.configMotionAcceleration(3092, Constants.kTimeoutMs);
```

With the F gain and initial cruise velocity/acceleration configured, potentially you may start the servo by holding down button 1 and manipulating the gamepad stick.

**Before doing this** be aware of the following...

- The servo range is programmed for  $\pm 10$  rotations (see code snippet below).

```
if (_joy.getRawButton(1)) {
    /* Motion Magic */
    double targetPos = leftYstick * 4096 * 10.0;
    /* 4096 ticks/rev * 10 Rotations in either direction */
    _talon.set(ControlMode.MotionMagic, targetPos);
}
```

If that is beyond the mechanism's range, reduce this and/or setup soft-limits/limit-switches so that there is no risk in reaching the mechanism's hard limits (potentially damaging mechanism).

- Consider that the current sensor position may be far from '0' because of manual-driving the motor when collecting sensor values in the previous sections. If needed, reset the sensor by calling `setSelectedSensorPosition()`.
- Since PID gains are zero, the movement may coast past the target position, particularly if the Talon's neutral mode is in coast. But the motor output will reach neutral near the final target position passed into `set()`.

In this example the mechanism is the left-side of a robot's drivetrain. The robot is elevated such that the wheels spin free. In the capture below we see the sensor position/velocity (blue) and the Active Trajectory position/velocity (brown/orange). At the end of the movement the closed-loop error (which is in raw units) is sitting at **~1400**.units. Given the resolution of the sensor this is approximately 0.34 rotations (4096 units per rotation). Another note is that when the movement is finished, you can freely back-drive the mechanism without motor-response (because PID gains are zero).

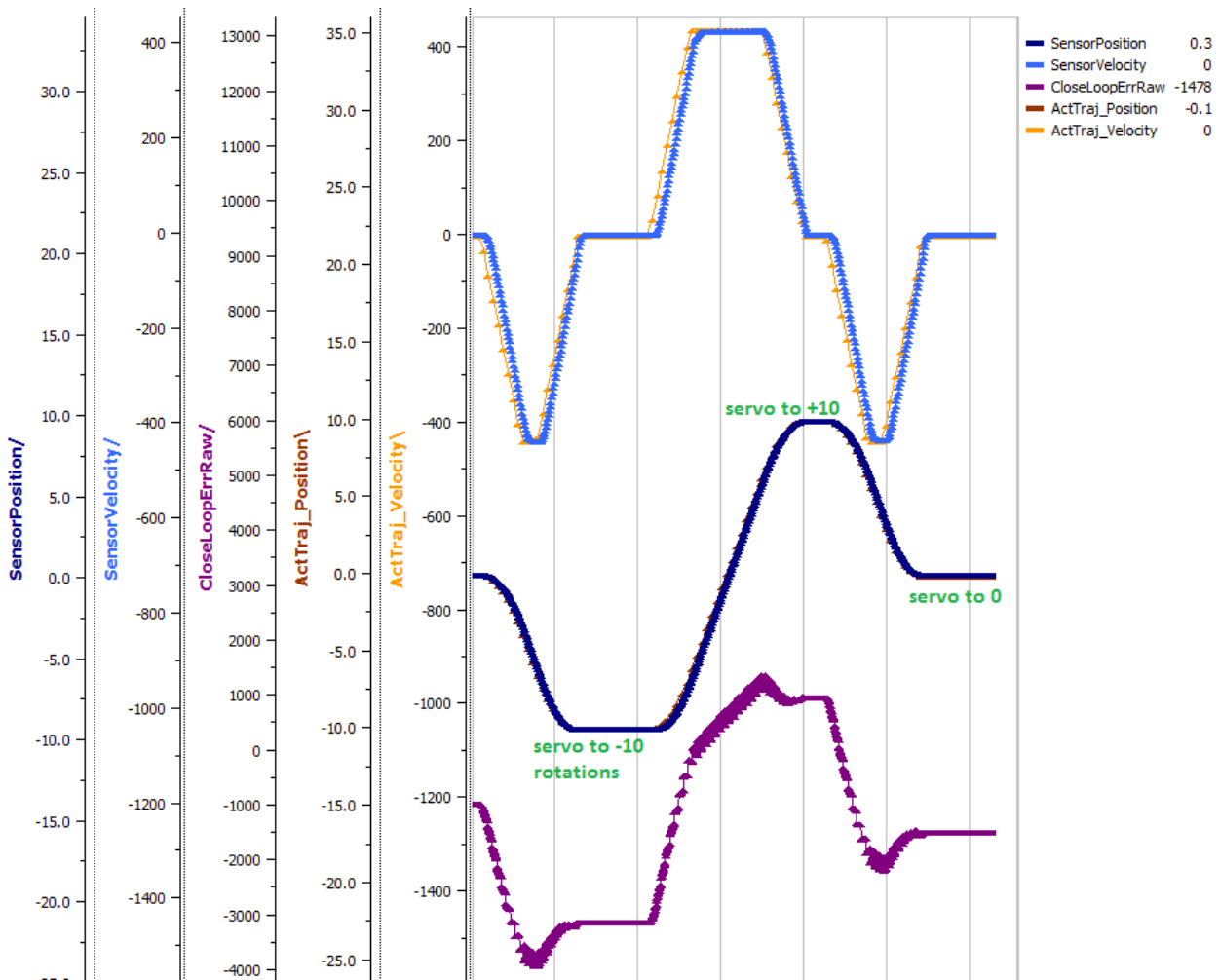

### 12.6.6. Motion Magic Closed-Loop Walkthrough – P-Gain – Java

Next we will add in P-gain so that the closed-loop can react to error. In the previous section, after running the mechanism with just F-gain, the servo appears to settle with an error or ~1400.

Given an error of (~1400.), suppose we want to respond with another 10% of motor output. Then our starting p-gain would be....

$$(10\% \times 1023) / (1400) = 0.0731$$

Now let's check our math, if the Talon SRX sees an error of 1400 the P-term will be

$$1400 \times 0.0731 = 102 \text{ (which is about 10\% of 1023)}$$

$$\text{P-gain} = 0.0731$$

Apply the P -gain programmatically using your preferred method. Now retest to see how well the closed-loop responds to varying loads.

Motor Controller Closed-Loop Control Parameters Slot 0	
P Gain	0.025575
I Gain	0
D Gain	0
Feed-Forward Gain	0.275
I Zone	0
Ramp Rate	0

```

/* set closed loop gains in slot0 - see documentation */
_talon.selectProfileSlot(Constants.kSlotIdx, Constants.kPIDLoopIdx);
_talon.config_kF(0, 0.2481, Constants.kTimeoutMs);
_talon.config_kP(0, 0.0731, Constants.kTimeoutMs);
_talon.config_kI(0, 0, Constants.kTimeoutMs);
_talon.config_kD(0, 0, Constants.kTimeoutMs);
/* set acceleration and vcruise velocity - see documentation */
_talon.configMotionCruiseVelocity(3092, Constants.kTimeoutMs);
_talon.configMotionAcceleration(3092, Constants.kTimeoutMs);

```

Retest the maneuver by holding button 1 and sweeping the gamepad stick. At the end of this capture, the wheels were hand-spun to demonstrate how aggressive the position servo responds. Because the wheel still backdrives considerably before motor holds position, the P-gain still needs to be increased.

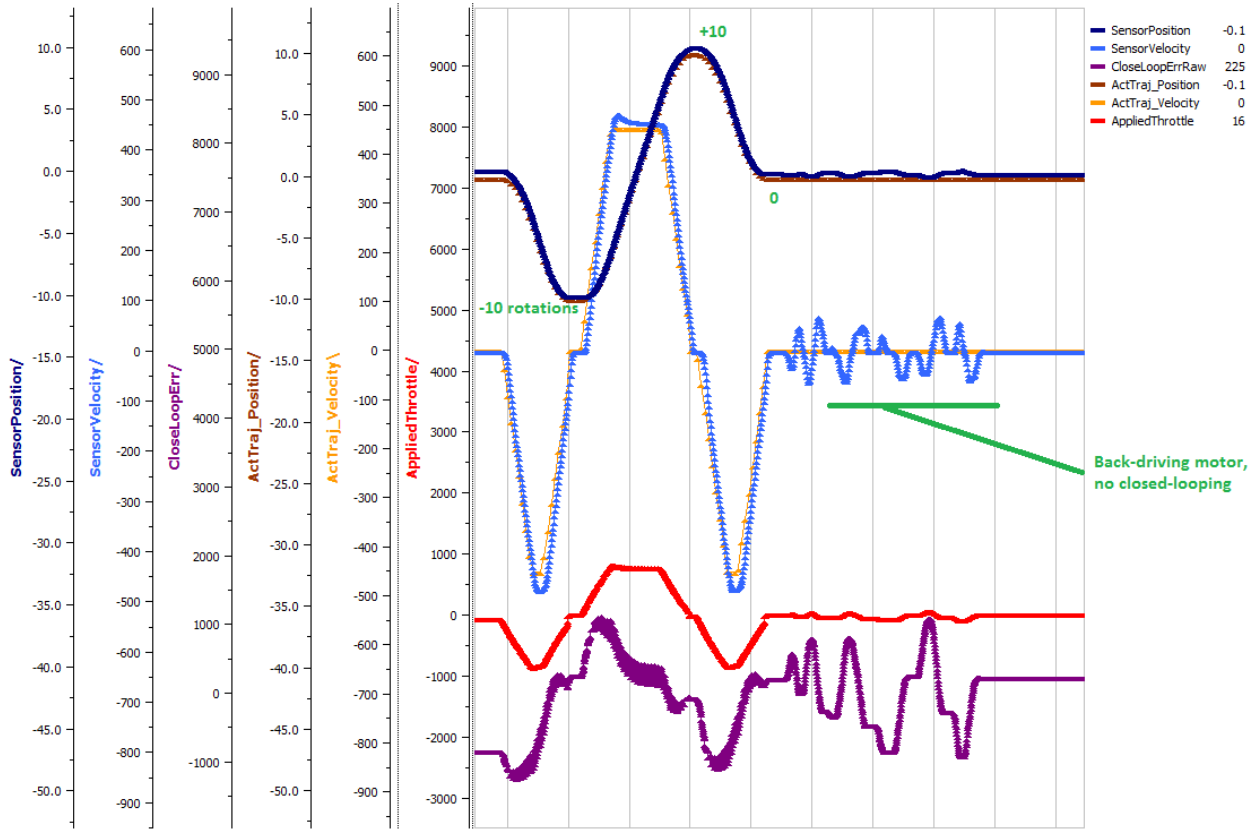

Double the P-gain until the system oscillates (by a small amount) or until the system responds adequately.

After a few rounds the P gain is at 0.6.

Scope captures below show the sensor position and target position follows visually, but back-driving the motor still shows a minimal motor response.

**Motor Controller Closed-Loop Control Parameters Slot 0**

P Gain	<input type="text" value="0.6"/>
I Gain	<input type="text" value="0"/>
D Gain	<input type="text" value="0"/>
Feed-Forward Gain	<input type="text" value="0.275"/>
I Zone	<input type="text" value="0"/>
Ramp Rate	<input type="text" value="0"/>

After several rounds, we've landed on a P gain value of 3. The mechanism overshoots a bit at the end of the maneuver. Additionally, back-driving the wheel is very difficult as the motor-response is immediate (good).

**Motor Controller Closed-Loop Control Parameters Slot 0**

P Gain	<input type="text" value="3"/>
I Gain	<input type="text" value="0"/>
D Gain	<input type="text" value="0"/>
Feed-Forward Gain	<input type="text" value="0.2481"/>
I Zone	<input type="text" value="0"/>
Ramp Rate	<input type="text" value="0"/>

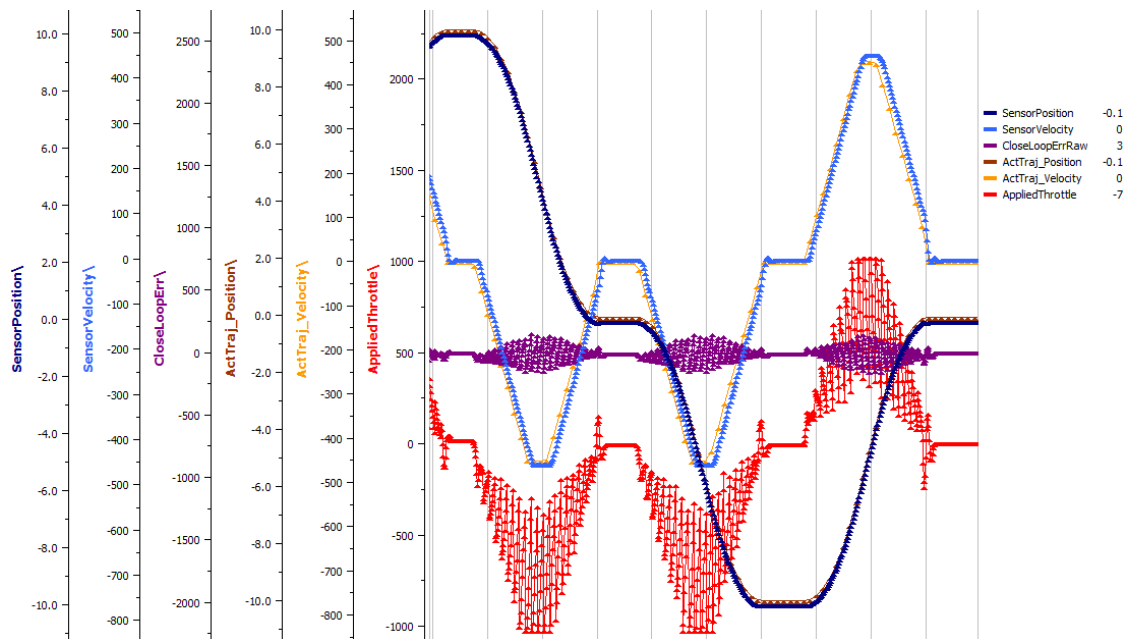

Once settles, the motor is back-driven to assess how firm the motor holds position.

The wheel is held by the motor firmly.

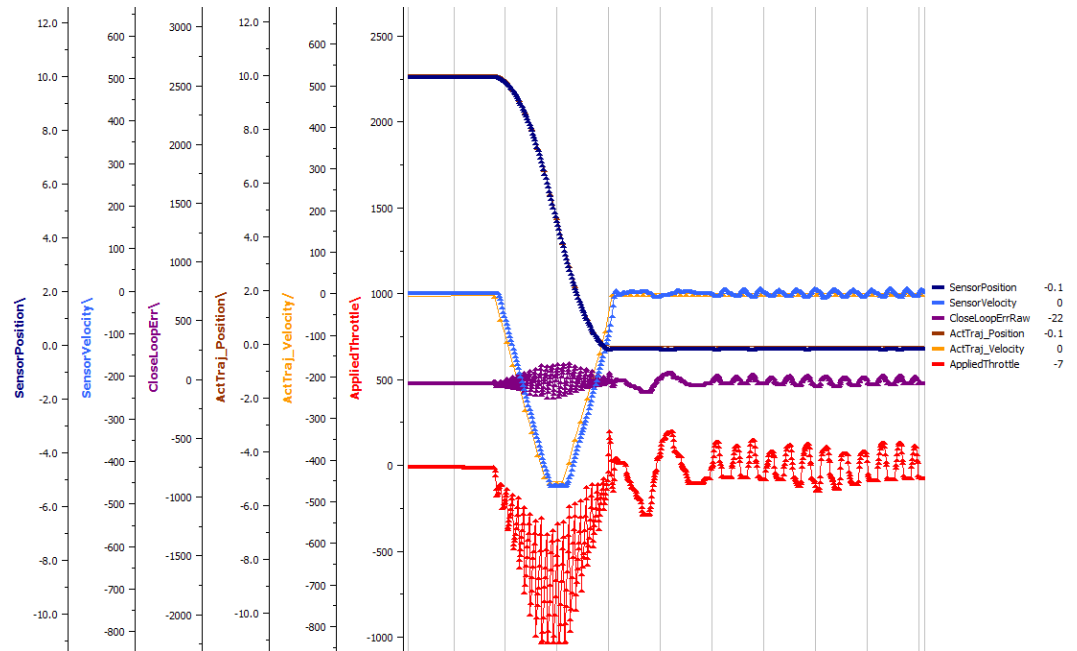

### 12.6.7. Motion Magic Closed-Loop Walkthrough – D-Gain – Java

To resolve the overshoot at the end of the maneuver, D-gain is added. D-gain can start typically at 10 X P-gain.

#### Motor Controller Closed-Loop Control Parameters Slot 0

P Gain	<input type="text" value="3"/>
I Gain	<input type="text" value="0"/>
D Gain	<input type="text" value="30"/>
Feed-Forward Gain	<input type="text" value="0.2481"/>
I Zone	<input type="text" value="0"/>
Ramp Rate	<input type="text" value="0"/>

With this change the visual overshoot of the wheel is gone. The plots also reveal reduced overshoot at the end of the maneuver.

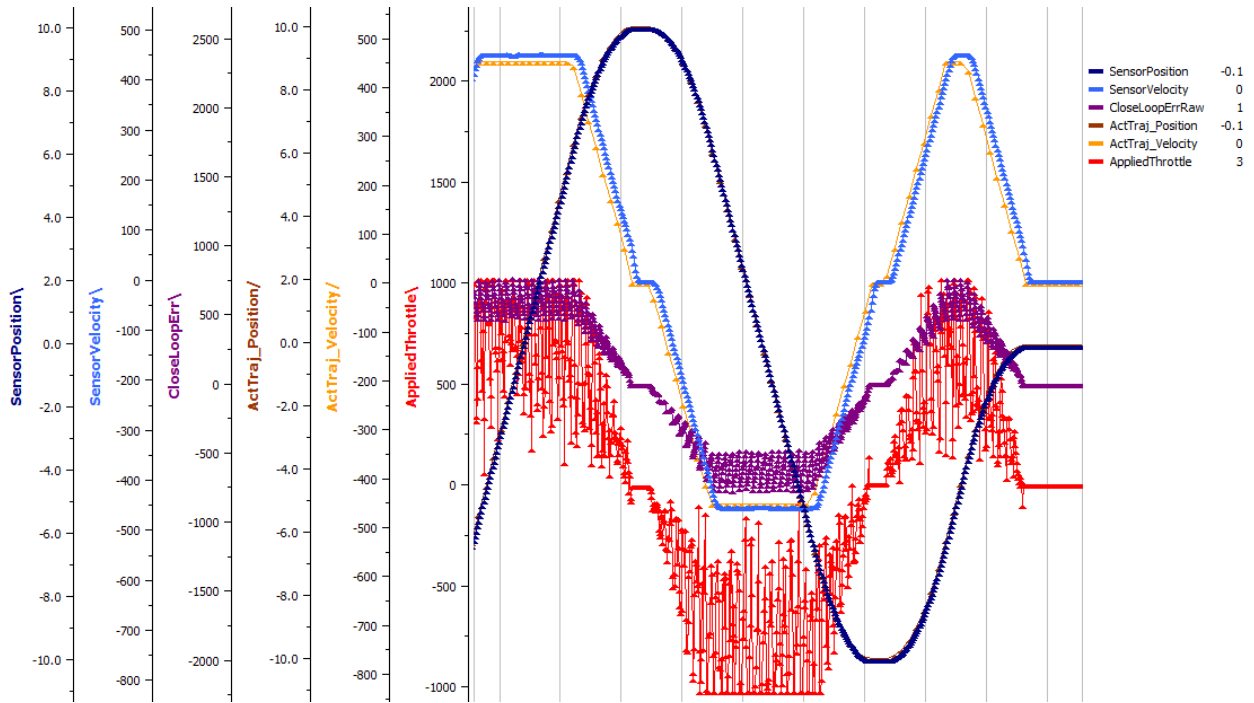

### 12.6.8. Motion Magic Closed-Loop Walkthrough – I-Gain – Java

Typically, the final step is to confirm the sensor settles **very close** to the target position. If the final closed-loop error is not quite close enough to zero, consider adding I-gain and I-zone to ensure the Closed-Loop Error ultimately lands at zero (or close enough).

In testing the closed-loop error settles around 20 units, so we'll set the Izone to 50 units (large enough to cover the typical error), and start the I-gain at something small (0.001).

Keep doubling I-gain until the error reliably settles to zero.

**Motor Controller Closed-Loop Control Parameters Slot 0**

P Gain	<input type="text" value="3"/>
I Gain	<input type="text" value="0.001"/>
D Gain	<input type="text" value="30"/>
Feed-Forward Gain	<input type="text" value="0.2481"/>
I Zone	<input type="text" value="50"/>
Ramp Rate	<input type="text" value="0"/>



**Motor Controller Closed-Loop Control Parameters Slot 0**

P Gain	<input type="text" value="3"/>
I Gain	<input type="text" value="0.02"/>
D Gain	<input type="text" value="30"/>
Feed-Forward Gain	<input type="text" value="0.2481"/>
I Zone	<input type="text" value="50"/>
Ramp Rate	<input type="text" value="0"/>

With some tweaking, we find an I-gain that ensures maneuver settles with an error of 0.

At this point the acceleration and cruise-velocity can be modified to hasten/dampen the maneuver as the application requires.

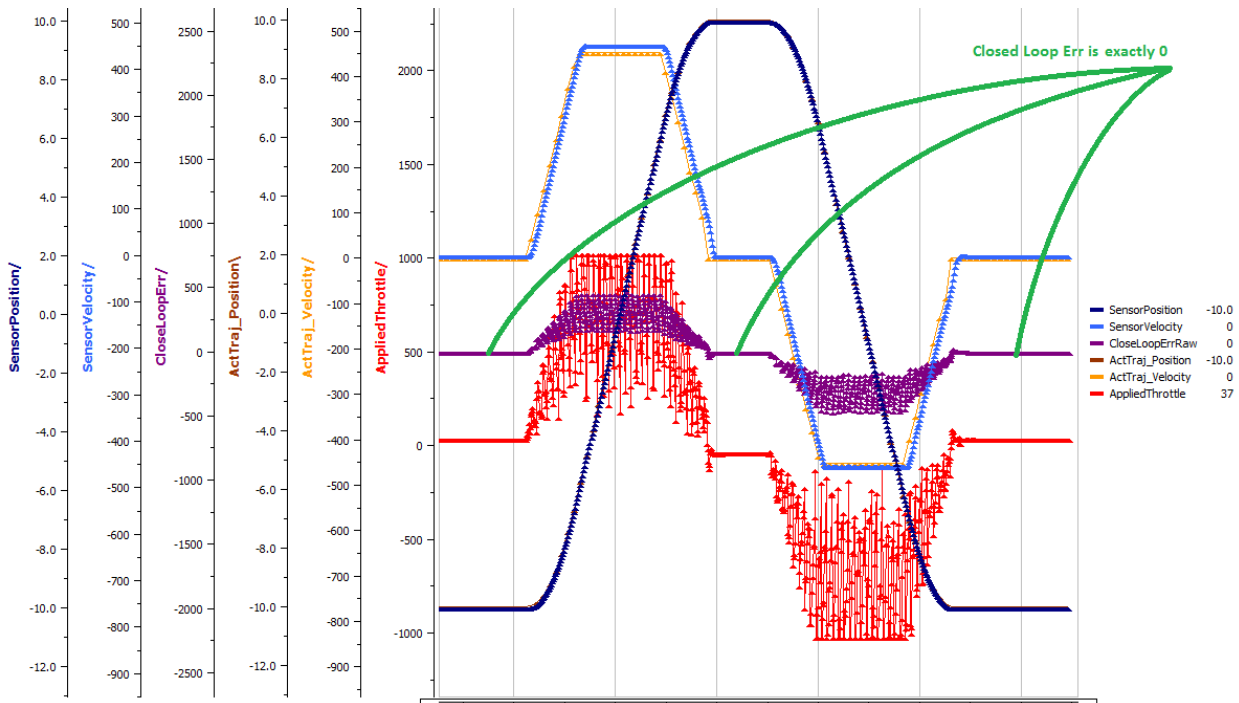

## 13. Setting Sensor Position

Depending on the sensor selected, the user can modify the "Sensor Position". This is particularly useful when using a Quadrature Encoder (or any relative sensor) which needs to be "zeroed" or "home-ed" when the robot is in a known position.

### 13.1. Setting Sensor Position – LabVIEW

To modify the "Sensor Position", user will likely have to leverage the SET SENSOR POS VI. In this example "0" is selected to re-zero the sensor.

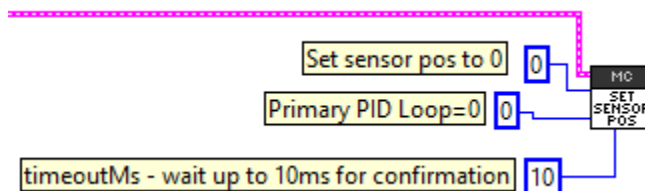

### 13.2. Setting Sensor Position – C++

SetSelectedPosition() can be used to change the current sensor position, if a relative sensor is used.

```
int sensorPos = 0; // sensor units
talon.SetSelectedSensorPosition(sensorPos, 0, 10);
```

### 13.3. Setting Sensor Position – Java

setSelectedPosition() can be used to change the current sensor position, if a relative sensor is used.

```
int sensorPos = 0; // sensor units
talon.setSelectedSensorPosition(sensorPos, 0, 10);
```

### 13.4. Auto Clear Position using Index Pin

In addition to manually changing the sensor position, the Talon SRX supports automatically resetting the Selected Sensor Position to zero whenever a digital edge is detected on the Quadrature Index Pin.

This feature can be enabled regardless of which sensor is selected. This allows a means of resetting the position using a digital sensor, switch, or any external event that can drive a 3.3V digital signal. Since the Quadrature Index Pin has an internal pullup, the signal source can be an open-drain signal that provides ground when asserted, and high-impedance when not asserted (or vice versa).

This feature is useful for minimizing the latency of resetting the Sensor Position after the external event since the robot controller is not involved. The maximum delay is <1ms. Additionally, this feature functions even if the Talon is disabled.

The feature can use the Quadrature Index Pin, (and/or Forward Limit/Reverse Limit), which is convenient if the selected sensor is a Quadrature encoder and the application requires syncing the position to the sensor's index signal.

When using Index Pin, a rising edge will clear the position register.

When using Forward/Reverse Limit Pin, position register is cleared when signal is "closed".

### 13.4.1. Setting Sensor Position – LabVIEW

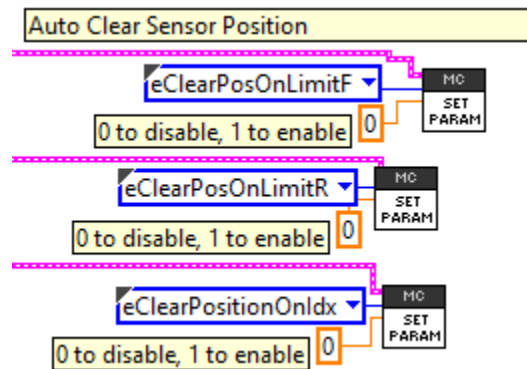

### 13.4.2. Setting Sensor Position – Java

```
double value = 1; // 1-on, 0-off
talon.configSetParameter(ParamEnum.eClearPositionOnQuadIdx, value, 0x00, 0x00, 10);
talon.configSetParameter(ParamEnum.eClearPositionOnLimitF, value, 0x00, 0x00, 10);
talon.configSetParameter(ParamEnum.eClearPositionOnLimitR, value, 0x00, 0x00, 10);
```

### 13.4.3. Setting Sensor Position – C++

```
double value = 1; // 1-on, 0-off
talon.ConfigSetParameter(ParamEnum::eClearPositionOnQuadIdx, value, 0x00, 0x00, 10);
talon.ConfigSetParameter(ParamEnum::eClearPositionOnLimitF, value, 0x00, 0x00, 10);
talon.ConfigSetParameter(ParamEnum::eClearPositionOnLimitR, value, 0x00, 0x00, 10);
```

## 14. Fault Flags

The GET STATUS VI can be used to retrieve sticky flags, and clear them.

### 14.1. Fault Flags - LabVIEW

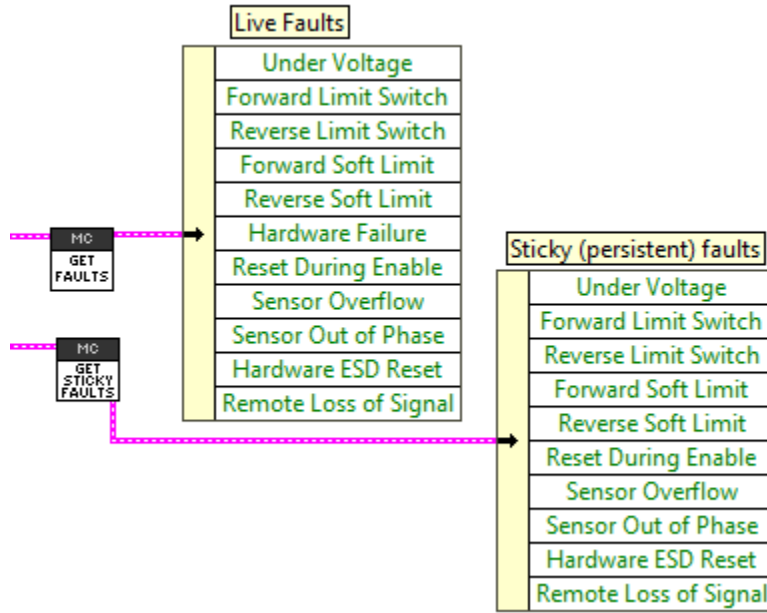

Clearing sticky faults can be done in the roboRIO web-based configuration page, or this VI.



## 14.2. Fault Flags - C++

```
Faults toFill;
talon.GetFaults(toFill);
toFill.
}
```

- ForwardLimitSwitch : bool
- ForwardSoftLimit : bool
- HardwareESDReset : bool
- HardwareFailure : bool
- RemoteLossOfSignal : bool
- ResetDuringEn : bool
- ReverseLimitSwitch : bool
- ReverseSoftLimit : bool
- SensorOutOfPhase : bool
- SensorOverflow : bool

Create an empty Faults object, and pass into the GetFaults routine to update. Now inspect the member variables to poll fault behavior.

```
StickyFaults toFill;
talon.GetStickyFaults(toFill);
toFill.
```

- ForwardLimitSwitch : bool
- ForwardSoftLimit : bool
- HardwareESDReset : bool
- RemoteLossOfSignal : bool
- ResetDuringEn : bool
- ReverseLimitSwitch : bool
- ReverseSoftLimit : bool
- SensorOutOfPhase : bool
- SensorOverflow : bool
- UnderVoltage : bool
- HasAnyFault(void) : bool

Sticky faults operate similarly.

Clearing the faults can be done via the clear routine.

```
talon.ClearStickyFaults(0);
```

### 14.3. Fault Flags - Java

```
/** create caching object once */
StickyFaults _stickyFaults = new StickyFaults();
/** create caching object once */
Faults _faults = new Faults();

public void testPeriodic() {
    talon.getStickyFaults(_stickyFaults);
    talon.getFaults(_faults);
}
1
```

Create an empty Faults object, and pass into the `GetFaults` routine to update. Now inspect the member variables to poll fault behavior.

Sticky faults operate similarly.

Clearing the faults can be done via the clear routine.

```
talon.clearStickyFaults(0);
```

### 14.4. Fault Flags – Clearing

The above examples include routines to programmatically clear sticky faults.

They can also be cleared via the web-based config as documented in [section 2.2.1](#).

Sticky Faults do not impact any motor controller behavior. They are purely a type of logging and do not need to be cleared to restore any base functionality.

## 15. CAN bus Utilization/Error metrics

The driver station provides various CAN bus metrics under the “lightning bolt” tab.

Utilization is the percent of bus time that is in use relative to the total bandwidth available of the 1Mbps Dual Wire CAN bus. So, at 100% there is no idle bus time (no time between frames on the CAN bus).

Demonstrated here is 70% bus use when controlling 16 Talon SRXs, along with 1 Pneumatics Control Module (PCM) and the Power Distribution Panel (PDP).

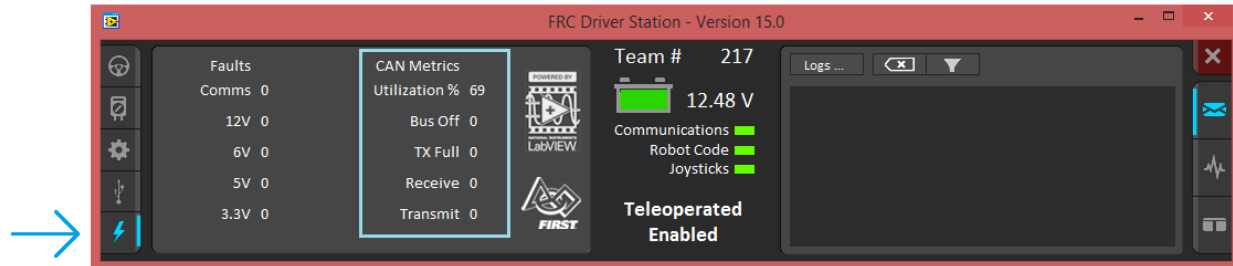

The “Bus Off” counter increments every time the CAN Controller in the roboRIO enters “bus-off”, a state where the controller “backs off” transmitting until the CAN bus is deemed “healthy” again. A good method for watching it increment is to short/release the CAN bus High and Low lines together to watch it enter and leave “Bus Off” (counter increments per short).

The “TX Full” counter tracks how often the buffer holding outgoing CAN frames (RIO to CAN device) drops a transmit request. This is another common symptom when the roboRIO no longer is connected to the CAN bus.

The “Receive” and “Transmit” signal is shorthand for “Receive Error Counter” and “Transmit Error Counter”. These signals are straight from the CAN bus spec, and track the error instances occurred “on the wire” during reception and transmission respectively. These counts should always be zero. Attempt to short the CAN bus and you can confirm that the error counts rise sharply, then decrement back down to zero when the bus is restored (remove short, reconnect daisy chain).

When starting out with the FRC control system and Talon SRXs, it is recommended to watch how these CAN metrics change when CAN bus is disconnected from the roboRIO and other CAN devices to learn what to expect when there is a harness or a termination resistor issue. Determining hardware related vs software related issues is key to being successful when using many CAN devices.

### **15.1. How many Talons can we use?**

Generally speaking, a maximum of 16 Motor controllers can be powered at once using a single PDP (sixteen breaker slots). However, FRC game rules should always be checked as it determines what is considered legal. This is typically the bottleneck for how many Talon SRXs can be used despite having CAN device ID space for 63 device IDs. Release software is always tested to support 16 Talon SRXs, 1 PCM, and 1 PDP with guaranteed control of each Talon at a rate of 10ms. However, this is not the limit. There is still additional bandwidth for more nodes. Additionally, if faster response time is desired, control frame periods can be decreased from the default 10ms, but keep a watchful eye of the CAN bus utilization to ensure reliable communication.



## 16. Troubleshooting Tips and Common Questions

 Just because a firmware issue has been resolved does not mean your out-of-the-box hardware doesn't have old firmware. **Immediately** update your CAN devices to ensure your development time is not wasted chasing down an issue that has already been solved.

### 16.1. When I press the B/C CAL button, the brake LED does not change, neutral behavior does not change.

This is the expected behavior if the robot application is overriding the brake mode. The B/C CAL button press does toggle the brake mode in persistent memory, however the LED and selected neutral behavior will honor the override sent over CAN bus. Check if the override API is being used in the robot application logic.

### 16.2. The robot is TeleOperated/Autonomous enabled, but the Talon SRX continues to blink orange (disabled).

Most likely the device ID of that Talon is not being used. In other words, there is no Open Motor (LabVIEW) or constructed TalonSRX (C++/Java) with that device ID. This can be confirmed by doing a Self-Test in the roboRIO Web-based Configuration, and confirm the "DEVICE IS NOT ENABLED!" message at the top.

### 16.3. When I attach/power a particular Talon SRX to CAN bus, The LEDs on every Talon SRX occasionally blink red. Motor drive seems normal.

If there is a single CAN error frame, you can expect all Talon SRXs on the bus to synchronously blink red. This is a great feature for detecting intermittent issues that normally would go unnoticed. If attaching a particular Talon brings this behavior out, most likely its device ID is common with another Talon already on the bus. This means two or more "common ID" Talon SRXs are periodically attempting to transmit using the same CAN arbitration ID, and are stepping on each other's frame. This causes an intermittent error frame which then reveals itself when all Talon SRXs blink red. Check the roboRIO Web-based Configuration for the "There are X devices with this Device ID" explained in [Section 2.2. Common ID Talons](#).

### 16.4. If I have a slave Talon SRX following a master Talon SRX, and the master Talon SRX is disconnected/unpowered, what will the slave Talon SRX do?

The follower Talon SRX monitors for motor output updates from the master. If the slave Talon doesn't see an update after 100ms, it will disable its drive. The LEDs will reflect robot-enable but with zero motor output (solid orange LEDs).

## 16.5. Is there any harm in creating a software Talon SRX for a device ID that's not on the CAN bus? Will removing a Talon SRX from the CAN bus adversely affect other CAN devices?

No! Attempting to communicate with a Talon SRX that is not present will not harm the communication with other CAN nodes. The communication strategy is very different than previously support CAN devices, and this use case was in mind when it was designed.

Creating more Talon software objects (LabVIEW Motor Open, or C++/Java class instances) will increase the bus utilization since it means sending more frames, however this should not adversely affect robot behavior so long as the bus utilization is reasonable.

However the resulted error messages in the DS may be a distraction so when permanently removing a Talon SRX from the CAN bus, it is helpful to synchronously remove it from the robot software.

## 16.6. Driver Station log says "Firm Vers could not be retrieved".

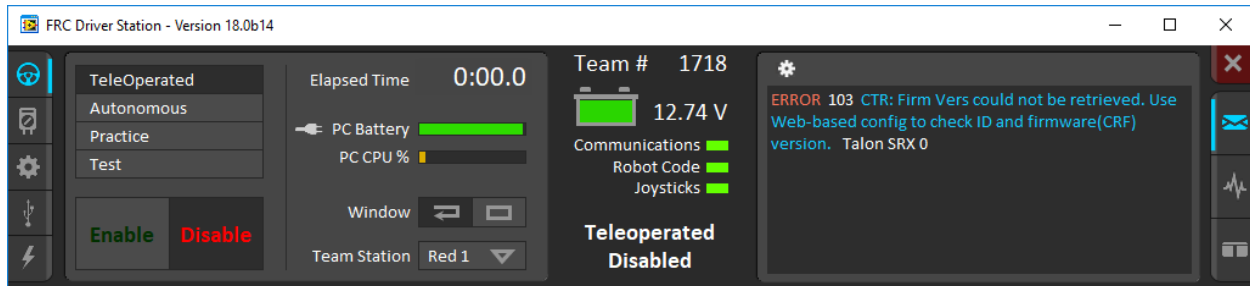

This is to be expected when constructing a TalonSRX with a device ID that is not present on CAN bus in C++/Java. This can also happen if the firmware predates to 2018 season.

## 16.7. Driver Station log says "Firmware too old"

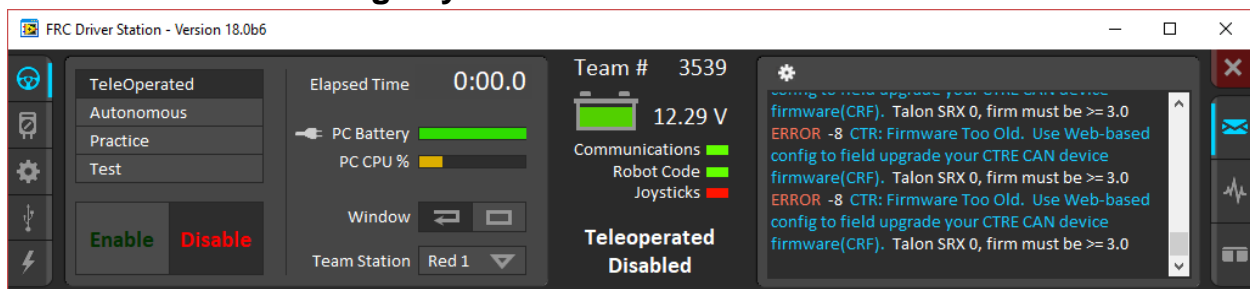

Follow the update procedure in [section 2.3](#).

## 16.8. Why are there multiple ways to get the same sensor data?

`GetSensorCollection().GetEncoder()` **VERSUS** `GetSelectedSensor()` ?

The API that fetches latest values for Encoder (Quadrature) and Analog-In (potentiometer or a continuous analog sensor) reflect the pure decoded values sent over CAN bus (every 100ms). They are available all the time, regardless of which control mode is applied or whether the

sensor type has been selected for soft limits and closed-loop mode. These signals are ideal for instrumenting/logging/plotting sensor values to confirm the sensors are wired and functional. Additionally, they can be read at the same time (you can wire a potentiometer AND a quadrature encoder and get both position and velocities programmatically). Furthermore, the robot application could use this method to process sensor information directly. If the 100ms update rate is not sufficient, it can be overridden to a faster rate.

For using soft limits and/or closed-loop modes, the robot application must select which sensor to use for position/velocity. Selecting a sensor will cause the Talon SRX to mux the appropriate sensor to the closed-loop logic, the soft limit logic, to the “Sensor Position” and “Sensor Velocity” signals (update 20ms). These signals can be signed using `setSensorPhase()` in order to keep the sensor in phase with the motor.

Since “Sensor Position” and “Sensory Velocity” are updated faster (20ms) they can also be used for processing sensor information instead of overriding the frame rates.

### **16.9. All CAN devices have red LEDs. Recommended Preliminary checks for CAN bus.**

Some basic checks for the CAN harness are...

Turn off robot, measure resistance between CANH and CANL.

- ~60 ohm is typical (120ohm at each end of the cable).
- ~120 ohm suggests that one end is missing termination resistor. Terminate the end using PDP jumper or explicit 120 ohm resistor.
- ~0 ohm suggests a short between CANH and CANL.
- INF or large resistances, missing termination resistor at each side.

More information can be found in **Talon SRX User’s Guide**.

Check the roboRIO’s Web-based Configuration to see if any devices appear, and ensure there are no Talon SRX’s sharing the same device ID.

## 16.10. Driver Station reports “MotorSafetyHelper.cpp: A timeout...”, motor drive no longer works. roboRIO Web-based Configuration says “No Drive” mode? Driver Station reports error -44075?

This can happen after enabling Motor Safety Enable and not calling `Set()` / `set()` often enough to meet the expiration timeout.

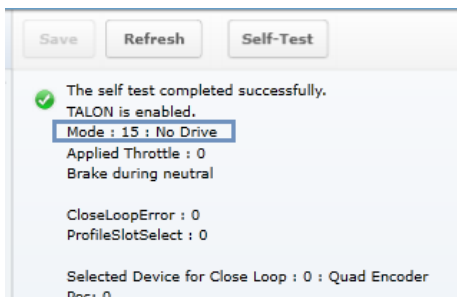
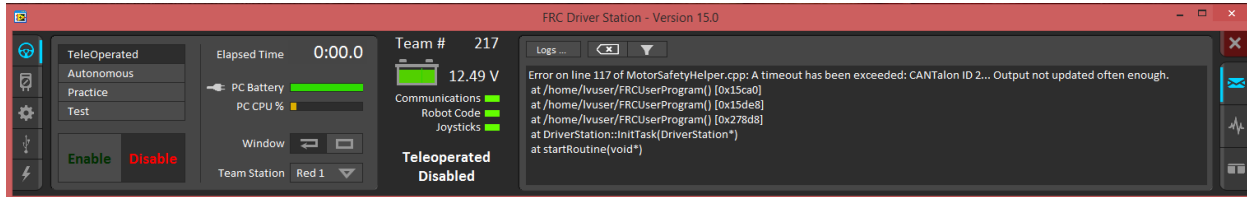

Another symptom of this is seeing “No Drive” has the control mode in the Self-Test.

When the safety timeout expires in LabVIEW, the error message will be different...

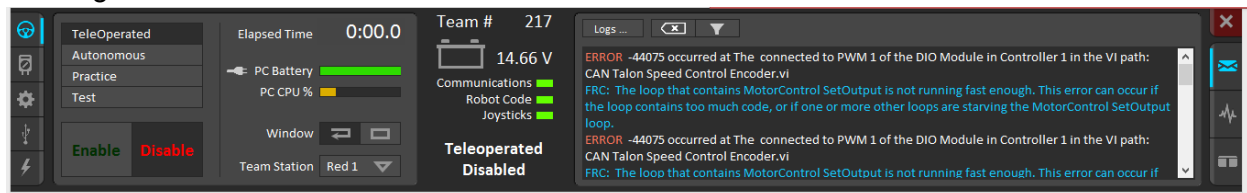

See [section 19](#) for more information.

## 16.11. Motor drive stutters, misbehaves? Intermittent enable/disable?

Check the CAN Utilization to ensure it's not near 100%. An abnormally high percent may be a symptom of “common ID” Talons. This also can occur when selecting custom frame rates that are too fast.

Ensure robot application calls `Set()` on each Talon at least once per loop. Avoid strategies that attempt to write the Talon set-output “only when it changes”. There is no cost to updating the set-output of the Talon SRX using the robot API, and often such strategies trip the motor-safety

features ([section 19](#)). If using LabVIEW avoid using tunnels/shift-registers to only call  when the input parameter has changed.

Check the roboRIO's Web-based Configuration to confirm all expected Talons are populated and are enabled per the Self-Test.

Check the “Under Vbat” sticky flag in the Self-Test. This will rule out power/voltage related issues.

Check the “Reset During Enable” sticky flag in the Self-Test. This will rule out power/voltage/ESD-or-reset related issues.

If the issues occur only during rapid changes in direction and magnitude, the power cables/crimps may not be efficient enough to deliver power during the stall-period when a loaded motor changes direction. This can be confirmed if increasing the voltage ramp rate removes/fixes this symptom.

Be sure to check the Driver Station Logs for packet loss since that can cause intermittent robot disables.

When using the DAP-1522 (or similar radio) be sure to use latest stable firmware. For example, rev-A DAP1522s (with production ship firmware) will not reliably enable the robot. Additionally, consult FRC rules and documentation for which hardware rev is legal for competition and how to properly setup the radio.

## 16.12. What to expect when devices are disconnected in roboRIO's Web-based Configuration. Failed Self-Test?

Depending what version of software is released, a discovered Talon will display loss of connection one of two ways.

The Firmware Version may report (Device is not responding).

The screenshot shows the roboRIO web-based configuration interface. On the left, there is a list of Talon SRX devices with their respective Device IDs: 2, 10, 8, 11, 17, 7, and 15. The 'Talon SRX (Device ID 2)' entry is highlighted in yellow. On the right, the 'Settings' panel for 'Talon SRX (Device ID 2)' is displayed. The 'Firmware Revision' field is highlighted with a red box and contains the text '1.1 (Device is not responding, this is stale)'. Other fields in the settings panel include Name, Device ID, Light Device LED, Software Status, Hardware Revision, Manufacture Date, Bootloader Revision, Vendor, Model, and Status.

Alternatively, the tree element will gray out to indicate loss of communication....

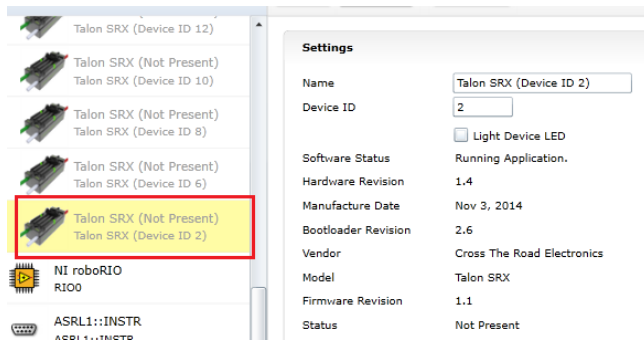

The roboRIO internals rechecks the CAN bus once every five seconds so when connecting/disconnecting Talons to/from the bus, be sure to wait at least five seconds and refresh the webpage to detect changes in connection state.

Doing a Self-Test when the Talon SRX is not present on the CAN bus will report a red 'X' in the top left portion of the Self-Test report. Depending on what robot controller image is release you may see the stale values of all signals when the red "X" is present.

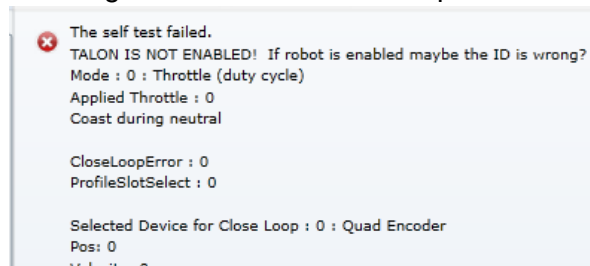

### 16.13. How do I get the raw ADC value (or voltage) on the Analog Input pin?

The bottom ten bits of Analog-In Position is equal to the converted ADC value. The range of [0, 1023] scales to [0V, 3.3V]. Additionally, if "Analog Potentiometer" is selected as the Feedback Device, the signal "Sensor Position" will exactly equal the bottom ten bits of Analog-In Position.

### 16.14. Recommendation for using relative sensors.

When using relative sensors for closed-loop control, it's always good practice to design in a way to re-zero your robot. Regardless of how/where relative sensors are connected (robot controller IO, Talon SRX, etc...), there is always the potential for sensors to "walk" or "drift" due to...

- Mechanical slip issues
- Skipped gear teeth in chain
- Intermittent electrical connections (harness gets damaged in middle of a match)
- Power cycle robot when armatures are not in their "home" position.
- Remote resets of robot controller when armatures are not in their "home" position.

A common solution to this is to design a way in the gamepad logic to force your robot into a "manual mode" where the driver/arm operator can manually servo motors to a home position and press a button (or button combination) to re-zero (or set to the "home" position values) all involved sensors.

Teams that do this already can continue to use this method with Talon SRX since there is are set functions to modify "Sensor Position".

### **16.15. Does anything get reset or lost after firmware updates?**

**The transition from v4\_legacy Tool suite to Phoenix will default the configuration parameters.** This occurs when firmware is updated to 3.X firmware from 2.X firmware. The device ID is not affected in this circumstance.

Notwithstanding the above, the device ID, limit switch startup settings, brake startup settings, Motor Control Profile Parameters, and sticky flags are generally unaffected by the act of field-upgrading. If a particular firmware release has a "back-breaking" change, it will be explicitly documented (see paragraph above).

### **16.16. Analog Position seems to be stuck around ~100 units?**

When the analog input is left unconnected, it will hover around 100 units. If an analog sensor has been wired, most likely it's connected to the wrong pin. Recheck wiring against the **Talon SRX User's Guide**.

### 16.17. Limit switch behavior doesn't match expected settings.

First check the Startup Settings in the roboRIO Web-based Configuration to determine that the "Normally Open"/ "Normally Closed" settings are correct. They can be changed programmatically and in the web page so it's worth confirming. Here we see both directions use NO limit switches...

**Motor Controller Startup Settings**

Brake Mode: Coast

Forward Limit-Switch: Normally Opened

Reverse Limit-Switch: Normally Opened

Then press the "Self-Test" button to check...

- The open/closed state of the limit switch input pin on the Talon SRX.
- If enable/disable state of the limit-switch logic is overridden programmatically.
- Check the fault and sticky faults to see if limit fault conditions are detected.

Save Refresh Self-Test

✔ The self test completed successfully.  
 TALON IS NOT ENABLED! If robot is enabled maybe the ID is wrong?  
 Mode : 0 : Throttle (duty cycle)  
 Applied Throttle : 0  
 Coast during neutral

CloseLoopError : 290  
 ProfileSlotSelect : 0

Selected Device for Close Loop : 3 : Analog Encoder  
 Pos: 728  
 Velocity: -1

Quad Encoder  
 Pos: -14795  
 Velocity : 0  
 A Pin : 1  
 B Pin : 0  
 Idx Pin : 1  
 Idx rise edges : 9

Analog Input  
 ADC : 728  
 Pos (with overflows) : 728  
 Velocity : -1

Fwd Limit Switch is Closed  
 Rev Limit Switch is Open  
 Fwd Limit Switch is forced OFF  
 Rev Limit Switch is forced OFF

	(Fault)	(Now)	(Sticky)
Fwd Limit Switch :	0	0	0
Rev Limit Switch :	0	0	0
Fwd Soft Limit :	0	0	0
Rev Soft Limit :	0	0	0
Under Vbat :	0	0	0
Over Temp :	0	0	0

In this example the Fwd. Limit Switch fault is not set despite the Fwd. Limit Switch being closed. This is because the Limit Switch logic forced OFF, because the feature is disable programmatically. As a result closing the forward limit switch will not disable motor drive.



### 16.18. How fast can I control just ONE Talon SRX?

The fastest control frame rate that can be specified is 1ms. That means that the average period at which the output/set point can be updated is 1ms. This will increase bus utilization by approximately 15%, which is acceptable if the number of Talon SRXs is few. Always check the CAN bus performance metrics in the Driver Station when doing this.

### 16.19. Expected symptoms when there is excessive signal reflection.

If the CAN bus harness has excessive signal reflection due to improper wiring or missing termination resistors, the following symptoms may be seen...

-Driver Station will show Rx and Tx CAN errors intermittently (see [Section 15](#)), particularly with higher bus utilization.

-CAN bus utilization will be higher than normal. This is because CAN devices transmit error frames in response to detecting improper frames. This is helpful if you are in the habit of checking your bus utilization every once in a while and knowing what is typical for your robot. See [Section 15](#) for more details.

-The LED of every CAN device on the bus will blink red intermittently during normal use (the same symptom as [Section 16.4](#)). Both common-ID Talons and excessive signal reflection can cause error frames to appear, which trigger every CTRE CAN device to intermittently blink red during normal use.

One reliable way to observe this LED behavior is to deliberately leave a couple common-ID Talon SRXs on your CAN Bus. Then, power up your robot and leave it disabled. All Talon SRXs will rail-road orange (healthy CAN bus and disabled). Now watch any particular Talon SRX for a minute or so. It will blink red intermittently as the two (or more) common-ID Talon SRXs inevitably disrupt each other's frame transmission.

-Measured DC resistance between CANH and CANL (when robot is unpowered) should be approximately 60  $\Omega$ . If this is not the case then recheck the CAN wiring and termination resistors (see Talon SRX User's Guide).

### 16.20. LabVIEW application reads incorrect Sensor Position. Sensor Position jumps to zero or is missing counts.

This is a common symptom if the LabVIEW application is calling the Motor Enable VI periodically. This VI has the side-effect of modifying the Sensor Position *every time it's invoked*. Additionally, wiring the current Sensor Position to this signal also will prevent proper signal decoding since the RIO will send stale positions to the Talon SRX, overwriting valid signal changes in the Talon. See [Section 13.1.1](#) for more information.

Additionally, check that the correct Feedback Device is selected ([Section 7](#)). Remember that the Feedback Device Select is sent only when the robot is enabled. Since there is only one control frame that contains all control signals, this ensures Talon has the correct sensor selected when Talon is enabled ([Section 20.6](#)).

**16.21. CAN devices do not appear in the roboRIO Web-based config.**  
Normally devices appear under the “CAN Interface” tree node...

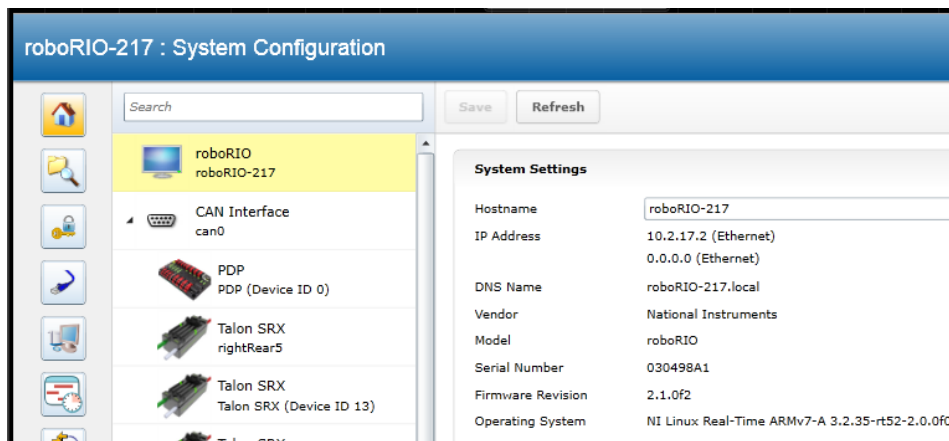

...however if the roboRIO is not correctly wired to the CAN Bus, then the tree node will have no elements listed underneath...

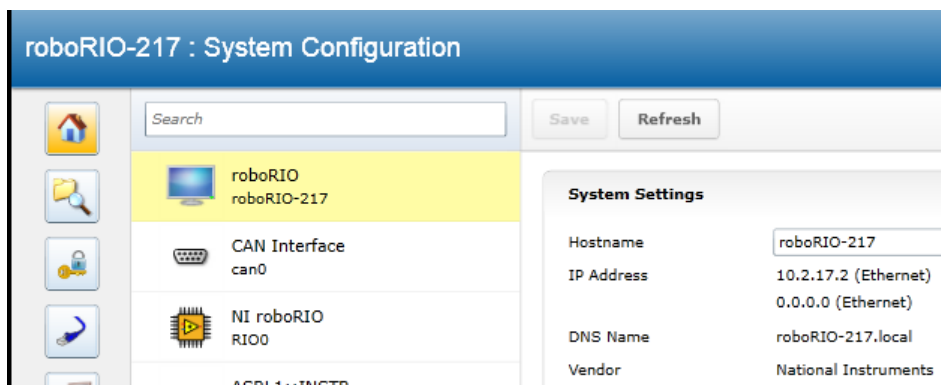

...in which case double-check the CAN bus wiring and termination strategy. See the Talon SRX User’s Guide for more information on wiring Talon SRXs. Also see the “FRC Screen steps” online documentation for more information on wiring the other CAN devices in the control system. Additionally, check the status LEDs of the CAN devices. Generally, red LED states reflect an unhealthy CAN connection, which will help diagnose wiring issues.

**16.22. When I make a change to a setting in the roboRIO Web-based configuration and immediately flash firmware into the Talon, the setting does not stick?**

When any of the Motor Control Profile (MCP) settings are changed, a certain amount of time must pass before the settings are committed to persistent storage (if a previous change hadn’t been made recently). See [section 11.1](#) for an explanation of how the wear-leveling works. This only occurs when re-flashing the firmware immediately after two subsequent setting changes where the two changes are also done immediately after each other.

### 16.23. My mechanism has multiple Talon SRXs and one sensor. Can I still use the closed-loop/motion-profile modes?

See [Section 7.6](#) for recommended procedure.

### 16.24. My Closed-Loop is not working? Now what?

The common observations when setting up a closed-loop initially is

- The motor output saturates immediately when enabled.
- The motor output is neutral despite sensor not being near target position/velocity.
- Oscillation or over-shooting the target.
- Motor output is not enough to reach target.

When debugging a closed-loop mechanism, follow the procedure **in order**.

#### 16.24.1. Make sure Talon has latest firmware.

See [Section 2.3](#) for instructions. See [Section 22](#) for firmware release notes.

#### 16.24.2. Confirm sensor is in phase with motor.

See [Section 7.4](#) for instructions on how to check if sensor and motor are in phase.

This is often the culprit if the closed-loop “runs away” or reaches maximum motor output immediately.

#### 16.24.3. Confirm Slave/Follower Talons are driving

If there are slave Talon SRXs, ensure their LED output matches the master Talon. If a slave Talon is not driving due to improper software setup or incorrect wiring, a master Talon may back-drive the slave Talon(s), causing excessive current-draw and/or breaker trips.

To test that the Slave Talons are functioning, unplug all motors and manually drive each motor one at a time. If the follower is driving in the wrong direction, it may need to be inverted using the API in [Section 7.4](#).

See [Section 7.6](#) for complete instructions on testing Slave/Follower Talons setup.

#### 16.24.4. Drive (Master) Talon manually

Drive the Talon (or if using slave Talons, drive the master Talon) using PercentOutput mode. Cover the full range of speed to ensure mechanical system is functioning as expected. Measure the sensor positions at the critical points to ensure sensor is functioning. This also aids in confirming what the target sensor positions should be if the goal is to use Position Closed-Loop.

See [Section 17](#) to lookup sensor resolution of each sensor type.

#### 16.24.5. Re-enable Closed-Loop

**Zero all four gains (F, P, I, D)** and place Talon SRX into Closed-Loop mode. Use the Self-Test to ensure Talon is enabled and in the appropriate mode ([Section 2.4](#)).

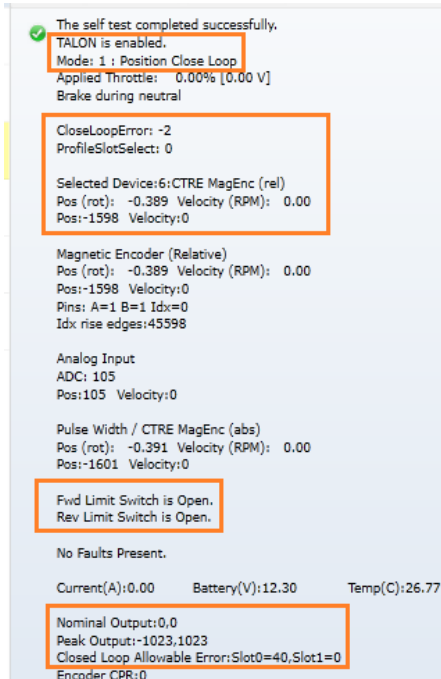

If Mode is “No Drive”, see [Section 16.12](#). If Mode is the wrong one, inspect robot-code to see why the wrong mode is selected.

Applied motor output will be 0% since the gains are all zeroed.

Ensure the Closed-Loop Peak Outputs are correct. “-100%, 100%” represent the full range (no restriction) of motor-output (default).

Ensure the Closed-Loop Nominal Outputs are correct. “0, 0” represent no restriction on the “smallest” nonzero motor-output of the Closed-Loop (default).

Ensure that Allowable Closed Loop Error is correct. A value of zero represent motor output is allowed anytime Closed Loop Error is nonzero (default).

## 16.24.6. Start with a simple gain set

The next step depends on whether you are using Position or Velocity Closed-Loop.

### 16.24.6.1. Start with a simple gain set – Position Closed-Loop

If using Position Closed-Loop, look at the Closed-Loop Error. This is the error between the target and currently-sampled position. It will be measured in native sensor units. This value is multiplied by the P gain and sent to the motor output.

For example, if the Closed Loop error is **4096** and the **P gain is 0.10**, then...

$$4096 \times 0.10 = 409.6$$

409 or 39.98% (409/1023) motor output.

An error of **4096** represent an error of one-full rotation when using the CTRE Magnetic Encoder). So with a **P gain of 0.10**, the Closed-Loop output will be 39.98% when sensor is off by one rotation.

Choose a P gain so that the worst case error yields a small motor-output. Set the P gain and re-enable the Closed-Loop. The motor-output will be “soft” meaning the movement will likely fail to reach the final target (or come up “short”). Double the P gain accordingly until the response is sharp without major overshoot. If the P gain is too large, the mechanism will oscillate about the target position.

At this point, the Closed-Loop will have the basic ability to servo to a target position. Additionally, tune the remaining Closed Loop Parameters (ramping, I, D, Peak/Nominal Output, etc.) to dial in the acceleration and near-target response of the closed-loop.

### 16.24.6.2. Start with a simple gain set – Velocity Closed-Loop

The first gain to set is the F gain. See [Section 12.6](#) for LabVIEW instruction/examples on how this is done. See [Section 12.4](#) for Java instruction/examples (C++ users should also review this section as the procedure is identical).

With just F gain, the motor's output should follow the requested target velocity reasonably. At this point you can begin dialing in P gain so that the closed-loop performs error correction.

### 16.24.7. Confirm gains are set

If the motion output is still neutral, use the roboRIO Web based configuration page to confirm that gains are actually nonzero, and that the correct slot is selected.

The screenshot shows the roboRIO configuration interface. On the left is a sidebar with a search bar and a list of components: roboRIO (roboRIO-469-FRC), CAN Interface (can0), Talon SRX (Talon SRX (Device ID 0)), NI roboRIO RIO0, ASRL1::INSTR (ASRL1::INSTR), and ASRL2::INSTR (ASRL2::INSTR). The main area displays two sections for 'Motor Controller Closed-Loop Control Parameters'. The first section, 'Slot 0', has the following values: P Gain: 2, I Gain: 0, D Gain: 0, Feed-Forward Gain: 0, I Zone: 0, and Ramp Rate: 0. The second section, 'Slot 1', has all values set to 0.

Here P gain of '2' is in Slot 0.

Now perform the Self-Test to confirm which Profile Slot is selected. In this example we would like to use slot '0'.

The screenshot shows the 'Self-Test' results. A green checkmark indicates the test was successful. The text reads: 'The self test completed successfully. TALON is enabled. Mode: 1 : Position Close Loop. Applied Throttle: 0.00% [0.00 V]. Brake during neutral.' Below this, 'CloseLoopError: -2' and 'ProfileSlotSelect: 0' are displayed, with 'ProfileSlotSelect: 0' highlighted by a red box. At the bottom, it says 'Selected Device: 6: CTRE MagEnc (rel)'.

### 16.25. Where can I find application examples?

Example projects for Talon SRX can also be found in the CTR GitHub account.

<https://github.com/CrossTheRoadElec/Phoenix-Examples-LabVIEW>

<https://github.com/CrossTheRoadElec/Phoenix-Examples-Languages>

## 16.26. Can RobotDrive be used with Talon SRXs? What if there are six Talons?

The default RobotDrive object in LabVIEW/C++/Java already supports two-Talon and four-Talon drivetrains. Simply create the WPI\_TalonSRX objects and pass them into the RobotDrive example.

For six drive Talons, the four-motor examples for Robot Drive can be used with four WPI\_TalonSRX objects, then create the final two Talons and set them to slave/follower mode.

The JAVA\_Six\_CANTalon\_ArcadeDrive example can be downloaded at...

<https://github.com/CrossTheRoadElec/Phoenix-Examples-Languages>

The screenshot below can be used as a reference.

Although the example is in Java, the strategy can be used in all three FRC languages.

Although the example uses arcadeDrive, the robot application could use tankDrive as well.

```
public class Robot extends IterativeRobot {

    /* talons for arcade drive */
    WPI_TalonSRX _frontLeftMotor = new WPI_TalonSRX(11); /* device IDs here (1 of 2) */
    WPI_TalonSRX _frontRightMotor = new WPI_TalonSRX(14);

    /* extra talons for six motor drives */
    WPI_VictorSPX _leftSlave1 = new WPI_VictorSPX(13);
    WPI_VictorSPX _rightSlave1 = new WPI_VictorSPX(15);
    WPI_VictorSPX _leftSlave2 = new WPI_VictorSPX(16);
    WPI_VictorSPX _rightSlave2 = new WPI_VictorSPX(17);

    final int kTimeoutMs = 10;

    DifferentialDrive _drive = new DifferentialDrive(_frontLeftMotor, _frontRightMotor);

    Joystick _joy = new Joystick(0);
    /**
     * This function is run when the robot is first started up and should be
     * used for any initialization code.
     */
    public void robotInit() {
        /* take our extra talons and just have them follow the Talons updated in arcadeDrive */
        _leftSlave1.follow(_frontLeftMotor);
        _leftSlave2.follow(_frontLeftMotor);
        _rightSlave1.follow(_frontRightMotor);
        _rightSlave2.follow(_frontRightMotor);

        _frontLeftMotor.configSelectedFeedbackSensor(FeedbackDevice.QuadEncoder, 0, kTimeoutMs);
        _frontRightMotor.configSelectedFeedbackSensor(FeedbackDevice.QuadEncoder, 0, kTimeoutMs);

        /* do this first */
        /*flip values until sensor is positive with positive motor output (green LEDs) */
        _frontLeftMotor.setSensorPhase(false);
        _frontRightMotor.setSensorPhase(true);

        /* do this second */
        boolean invertLeft = false;
        boolean invertRight = false;
        _frontLeftMotor.setInverted(invertLeft);
        _frontLeftMotor.setInverted(invertLeft);
        _frontLeftMotor.setInverted(invertLeft);
        _frontRightMotor.setInverted(invertRight);
        _frontRightMotor.setInverted(invertRight);
        _frontRightMotor.setInverted(invertRight);
    }
}
```

```
    }  
  
    /**  
     * This function is called periodically during operator control  
     */  
    public void teleopPeriodic() {  
        double forward = _joy.getY(); // logitech gampad left X, positive is forward  
        double turn = _joy.getZ(); //logitech gampad right X, positive means turn right  
        _drive.arcadeDrive(forward, turn);  
    }  
}
```

### 16.27. How fast does the closed-loop run?

Talon SRX updates the motor output every 1ms by recalculating the PIDF output.

Additionally, when using the motion magic control mode, the target position and target velocity is recalculated every 10ms to honor the user's specified acceleration and cruise-velocity.

### 16.28. Driver Station log reports: The transmission queue is full. Wait until frames in the queue have been sent and try again.

This error means the roboRIO is sending more CAN bus frames than can be physically sent. Usually because of a cable disconnect. Check your wiring for opportunities for CAN bus to disconnect.

Check for changes in the CAN error counts ([Section 15](#)) to confirm cable integrity.

[Section 16.24](#) has additional cable troubleshooting tips.

## 17. Units and Term Definitions

Listed below are the native units and term definitions for the signals inside the motor controller.

### 17.1. Signal Definitions and Sensor Units

#### 17.1.1. (Quadrature) Encoder Position

When measuring the position of a Quadrature Encoder, the position is measured in 4X encoder edges. For example, if a US Digital Encoder with a 360 cycles per revolution (CPR) will count 1440 units per rotation when read using “Encoder Position” or “Sensor Position”.

The velocity units of a Quadrature Encoder is the change in Encoder Position per  $T_{velMeas}$  ( $T_{velMeas}=0.1sec$ ). For example, if a US Digital Encoder (CPR=360) spins at 20 rotations per second, this will result in a velocity of 2880 (28800 position units per second).

#### 17.1.2. Analog (Encoder/Potentiometer)

When measuring the position of a 3.3V Analog Potentiometer, the position is measured as a 10 bit ADC value. A value of 1023 corresponds to 3.3V. A value of 0 corresponds to 0.0V.

The velocity units of a 3.3V Analog Potentiometer is the change in Analog Position per  $T_{velMeas}$  ( $T_{velMeas}=0.1sec$ ). For example if an Analog Potentiometer transitions from 0V to 3.3V (1023 units) in one second, the Analog Velocity will be 102.

Like 3.3V Analog Potentiometers, the 10 bit ADC is used to scale [0 V, 3.3 V] => [0, 1023]. However when the Analog Encoder “wraps around” from 1023 to 0, the Analog Position will continue to 1024. In other words, the sensor is treated as “continuous”.

The velocity units of a 3.3V Analog Encoder is the change in Analog Position per 100ms ( $T_{velMeas}=0.1sec$ ). For example if an Analog Encoder transitions from 0V to 3.3V (1023 units) in one second, the Analog Velocity will be 102.

#### 17.1.3. Motor output

The Talon SRX uses 10bit resolution for the percent output. This means a -1023 represents full reverse, +1023 represents full forward, and 0 represents neutral.

The programming API made available in LabVIEW and C++/Java performs the scaling into percent, so the duty cycle resolution is not necessary for programming purposes. However when evaluating PIDF gain values, it is helpful to understand how the calculated output of the closed-loop is interpreted.



#### 17.1.4. (Open-Loop) Ramp

The Talon SRX natively represents Open-Loop Ramp as the change in output per  $T_{\text{RampRate}}$  ( $T_{\text{RampRate}}=10\text{ms}$ ). Motor output is represented as a 10bit signed value (1023 is full forward, -1023 is full reverse). For example, if the robot application requires motor drive ramping from 0% to 100% to take one second of ramping, the result Ramp Rate would be  $([1023 - 0] / 1000\text{ms} \times T_{\text{RampRate}})$  or 10 units.

The programming API made available in LabVIEW and C++/Java performs the scaling into appropriate units (percent-output and time).

#### 17.1.5. (Closed-Loop) Ramp

The Talon SRX natively represents Closed-Loop Ramp as the change in output per  $T_{\text{RampRate}}$  ( $T_{\text{RampRate}}=10\text{ms}$ ). Motor output is represented as a 10bit signed value (1023 is full forward, -1023 is full reverse). For example, if the robot application requires motor drive ramping from 0% to 100% to take one second of ramping, the result Ramp Rate would be  $([1023 - 0] / 1000\text{ms} \times T_{\text{RampRate}})$  or 10 units.

The programming API made available in LabVIEW and C++/Java performs the scaling into appropriate units (percent-output and time).

#### 17.1.6. Integral Zone (I Zone)

The motor control profile contains Integral Zone (I Zone), which (when nonzero), is the maximum error where Integral Accumulation will occur during a closed-loop Mode. If the Closed-loop error is outside of the I Zone, "I Accum" is automatically cleared. This can prevent total instability due to integral windup, particularly when tweaking gains.

The units are in the same units as the selected feedback device (Quadrature Encoder, Analog Potentiometer, Analog Encoder, and EncRise).

#### 17.1.7. Integral Accumulator (I Accum)

The accumulated sum of Closed-Loop Error. It is accumulated in line with Closed-Loop math every 1ms.

#### 17.1.8. Motor Invert

Boolean signal for reversing the h-bridge output. This signal does not impact Talon LEDs in order to ensure LEDs are in phase with limit switch wiring and soft-limit configuration.

Changing the motor invert does not impact Sensor Phase. This is because the firmware will compensate for the motor inversion internally.

#### 17.1.9. Sensor Phase

Boolean signal for reversing the sensor phase. Generally, this will multiply the sensor value by -1 when set to true.

#### 17.1.10. Closed-Loop Error

Calculated as the difference between target set point and the actual Sensor Position/Velocity.

The units are matched to Analog-In or Encoder depending on which "Feedback Device" and control mode (position vs. speed) is selected.

### 17.1.11. Closed-Loop gains

P gain is specified in motor output unit per error unit. For example, a value of 102 is ~9.97% (which is  $102/1023$ ) motor output per 1 unit of Closed-Loop Error.

I gain is specified in motor output unit per integrated error. For example, a value of 10 equates to ~0.97% for each accumulated error (Integral Accumulator). Integral accumulation is done every 1ms.

D gain is specified in motor output unit per derivative error. For example, a value of 102 equates to ~9.97% (which is  $102/1023$ ) per change of Sensor Position/Velocity unit per 1ms.

F gain is multiplied directly by the set point passed into the programming API made available in LabVIEW and C++/Java. This allows the robot to feed-forward using the target set-point.

## 17.2. Sensor Resolutions

Sensor Type	Units per rotation
Quadrature Encoder : US Digital 1024 CPR	4096 (because Talon/CANifer counts every edge)
CTRE Magnetic Encoder (relative/quadrature)	4096
CTRE Magnetic Encoder (absolute/pulse width encoded)	4096
Any pulse width encoded position	4096 represents 100% duty cycle
AndyMark CIMcoder	80 (because 20 pulses => 80 edges)

Position units are in the natural units of the sensor. This ensures the best resolution possible when performing closed-loops in firmware.

Velocity is measured in sensor units per 100ms. This ensures sufficient resolution regardless of the sensing strategy. For example, when using the CTRE Magnetic Encoder, 1u velocity represents  $1/4096$  of a rotation every 100ms. Generally, you can multiply the velocity units by  $600/\text{UnitsPerRotation}$  to obtain RPM.

Tachometer velocity measurement is unique in that it measures time directly. Thus, the reported velocity is calculated where 1024 represents a full "rotation". This means that a velocity measurement of 1 represents  $1/1024$  of a rotation every 100ms.

## 18. How is the closed-loop implemented?

The closed-loop logic is the same regardless of which feedback sensor or closed-loop mode is selected. The verbatim implementation in the Talon firmware is displayed below.

This includes...

- The logic for PIDF style closed-loop.
- Inverting the output of the closed-loop if enabled in API.
- Capping the output to positive values only IF using a single direction feedback sensor.

**Note:** The `PID_Mux_Unsigned` and `PID_Mux_Sign` routines are merely multiply functions.

```

/**
 * lms process for PIDF closed-loop.
 * @param pid ptr to pid object
 * @param pos signed integral position (or velocity when in velocity mode).
 *
 *      The target pos/velocity is ramped into the target member from caller's 'in'.
 *      PIDF is traditional, unsigned coefficients for P,i,D, signed for F.
 *      Target pos/velocity is feed forward.
 *
 *      Izone gives the ability to autoclear the integral sum if error is wound up.
 * @param oneDirOnly when using positive only sensor, keep the closed-loop from outputting negative throttle.
 */
void PID_Calc1Ms(pid_t * pid, MotorControlProfile_t * slot, int32_t pos, int8_t oneDirOnly, int16_t peakOutput,
int periodMs)
{
    if (++pid->timeMs < periodMs) {
        /* don't run yet, keep out the same */
        return;
    }
    /* time to fire, reset time */
    pid->timeMs = 0;
    /* Save last sensor measurement for debugging. */
    pid->lastInput = pos;
    /* calc error : err = target - pos*/
    int32_t err = pid->target - pos;
    pid->err = err;
    /*abs error */
    int32_t absErr = err;
    if(err < 0)
        absErr = -absErr;
    /* integrate error and handle the first pass since PID_Reset() */
    if(0 == pid->notFirst){
        /* first pass since reset/init */
        pid->iAccum = 0;
        /* also tare the before ramp throt */
        pid->out = BXDC_GetThrot(); /* the save the current ramp */
    }else if ((!slot->IZone) || (absErr < slot->IZone) ){
        /* izeone is not used OR absErr is within izeone */
        pid->iAccum += err;
    }else{
        pid->iAccum = 0;
    }
    /* max iaccum */
    if (slot->maxIAccum == 0) {
        /* don't cap */
    } else if (pid->iAccum > slot->maxIAccum) {
        pid->iAccum = slot->maxIAccum;
    } else if (pid->iAccum < -slot->maxIAccum) {
        pid->iAccum = -slot->maxIAccum;
    } else {
        /* leave it alone */
    }
    /* dErr/dt */
    if(pid->notFirst){
        /* calc dErr */

```

```

        pid->dErr = pid->prevPos - pos;
    }else{
        /* clear dErr */
        pid->dErr = 0;
    }
    /* if error is within the allowable range, we will clear it and clear the integral accum */
    uint16_t allowClosedLoopEr = slot->allowableErr;
    if(absErr < allowClosedLoopEr){
        /* clear Iaccum */
        pid->iAccum = 0;
        /* clear dErr */
        pid->dErr = 0;
        /* wipe this out so PID response is identical to no error */
        err = 0;
    }
    //----- P -----//
    pid->out = PID_Mux_Unsigned(err, slot->P);
    //----- I -----//
    if(pid->iAccum && slot->I){
        /* our accumulated error times I gain. If you want the robot to creep up then pass a nonzero
Igain */
        pid->out += PID_Mux_Unsigned(pid->iAccum, slot->I);
    }
    //----- D -----//
    /* derivative gain, if you want to react to sharp changes in error (smooth things out). */
    pid->out += PID_Mux_Unsigned(pid->dErr, slot->D);
    //----- F -----//
    /* feedforward on the set point */
    pid->out += PID_Mux_Signed(pid->target, slot->F);
    /* arm for next pass */
    {
        pid->prevPos = pos; /* save the prev pos for D */
        pid->notFirst = 1; /* already serviced first pass */
    }
    if(oneDirOnly > 0){
        /* positive only */
        if(pid->out < 0)
            pid->out = 0;
    }else if(oneDirOnly < 0){
        /* negative only */
        if(pid->out > 0)
            pid->out = 0;
    }else{
        /* no bounds */
    }
    /* output cap */
    if (pid->out > +peakOutput) {
        pid->out = +peakOutput;
    } else if (pid->out < -peakOutput) {
        pid->out = -peakOutput;
    }
}
}

```

## 19. Motor Safety Helper

The Motor Safety feature works in a similar manner as the other motor controllers. The goal is to set an expiration time to a given motor controller, such that, if the `Set()`/`set()` routine is not called within the expiration time, the motor controller will disable. Additionally, the DS will report the error and the roboRIO Web-based Configuration Self-Test will report `Disabled` as the mode. Thus, the set routine must be called periodically for sustained motor drive when motor safety is enabled.

**Be sure to use `WPI_TalonSRX` and `WPI_VictorSPX` classes to leverage motor-safety.**

One example where this feature is useful is when laying breakpoints with the debugger while the robot is enabled and moving. Ideally when a breakpoint lands, its safest to disable motor drive while the developer performs source-level debugging.

### 19.1. Best practices

Be sure to test that the time between enabling Motor Safety features, and the first `Set()`/`set()` call is small enough to not risk accidentally timing out. Calling `Set()`/`set()` immediately after enabling the feature can be used to ensure transitioning into the enabled modes doesn't intermittently cause a timeout.

Even if tripping the motor-safety expiration time is not an expected condition, it's best to re-enable the motors somewhere in the source so that the timeouts can be reset easily, for example in `AutonInit()/TeleopInit()`. That way normal robot functionality can be safely resumed after a motor controller expires (usually during source-level debugging).

Additionally, if source-level debugging is not required (for example during a competition or if logging-style debugging is preferred) the motor-safety enable can be turned off.

## 19.2. C++ example

`SetSafetyEnabled()` can be used to turn on this feature. `SetExpiration()` can be used to set the expiration time. The default expiration time is typically 100ms.

## 19.3. Java example

`setSafetyEnabled()` can be used to turn on this feature. `setExpiration()` can be used to set the expiration time. The default expiration time is typically 100ms.

## 19.4. LabVIEW Example

The `Motor SAFETY CONFIG VI` can be used to turn on this feature. Select “Enable” for the mode and specify the timeout in seconds.

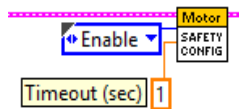

## 19.5. RobotDrive

The examples in this section refer to the `WPI_TalonSRX` objects directly. However higher level class types such as `RobotDrive` can have their own motor safety objects as well. Although `WPI_TalonSRX` safety features default **off**, the higher-level drive objects tend to default safety enable to **on**. If you are still witnessing disabled motor drive behavior and Motor Safety Driver Station Log Messages (see [Section 16.14](#)) then you may need to call `setSafetyEnabled(false)` (or similar routines/VI) on `RobotDrive` objects as well. Keep in mind that disabling safety enable means that motor drive can continue if a source-level breakpoint halts program flow. Take the necessary precautions to debug the robot safely or alternatively only enable motor safety features when performing source level debugging.

## 20. Going deeper - How does the framing work?

The Talon periodically transmits four status frames with sensor data at the given periods. This ensures that certain signals are always available with a deterministic update rate. This also keeps bus utilization stable.

Similarly, the control frame sent to the Talon SRX is periodic and contains almost all the information necessary for all control modes. The rest of the necessary parameters are persistent and modified via configuration function/VIs, which are typically configured during robot boot up.

Although the frame rates are default to ensure stable CAN bandwidth, there is API to override the frame rates for performance reasons. If this is done, be sure to check the CAN performance metrics to ensure custom settings don't exceed the available CAN bandwidth, see "CAN bus Utilization and Performance metrics".

**Changing the frame periods are not persistent.** This is deliberate to ensure you can power cycle a CTRE CAN Device and restore normal communication. Developers can use the "has reset" API to check if a device has been rebooted, and therefore restore custom frame periods.

### 20.1. General Status 1

The General Status frame has a default period of 10ms, and provides...

- Motor Output: The current 10bit motor output duty cycle (-1023 full reverse to +1023 full forward).
- Forward Limit Switch Pin State
- Reverse Limit Switch Pin State
- Fault bits
- Applied Control Mode
- Soft limit and limit switch overrides
- Invert/Brake selections

... These signals are accessible in the various get functions in the programming API.

### 20.2. Feedback0 Status 2

The Feedback0 Status 2 frame has a default period of 20ms, and provides...

- Sensor Position: Position of the selected sensor for PID Loop 0
- Sensor Velocity: Velocity of the selected sensor for PID Loop 0
- Motor Current
- Sticky Faults
- Motor Control Profile Select

... These signals are accessible in the various get functions in the programming API.

### 20.3. Quadrature Encoder Status 3

The Quadrature Encoder Status frame has a default period of 160ms.

- Encoder Position: Position of the quadrature sensor
- Encoder Velocity: Velocity of the selected sensor

- Number of rising edges counted on the Index Pin.
  - Quad A pin state.
  - Quad B pin state.
  - Quad Index pin state.
- ... These signals are accessible in the various get functions in the programming API.

The quadrature decoder is always engaged, whether the feedback device is selected or not, and whether a quadrature encoder is actually wired or not. This means that the Quadrature Encoder signals are always available in programming API regardless of how the Talon is used. The default update rate is sufficient for logging, instrumentation and debugging. If a faster update rate is required the robot application can select the appropriate sensor and leverage the Sensor Position and Sensor Velocity.

#### **20.4. Analog Input / Temperature / Battery Voltage Status 4**

The Analog/Temp/BattV status frame has a default period of 160ms.

- Analog Position: Position of the selected sensor
- Analog Velocity: Velocity of the selected sensor
- Temperature
- Battery Voltage
- Selected feedback sensor for PIDLoop 0.

... These signals are accessible in the various get functions in the programming API.

The Analog to Digital Convertor is always engaged, whether the feedback device is selected or not, and whether an analog sensor is wired or not. This means that the Analog In signals are always available in programming API regardless of how the Talon is used. The default update rate is sufficient for logging, instrumentation and debugging. If a faster update rate is required, the robot application can select the appropriate sensor and leverage the Sensor Position and Sensor Velocity.

#### **20.5. Pulse Width Status 8**

The status frame has a default period of 160ms.

- Period and pulse width capture on the Talon Idx pin.
- Velocity (of a PulseWidthEncoded sensor such as CTRE Mag Encoder).
- Position (of a PulseWidthEncoded sensor such as CTRE Mag Encoder).

... These signals are accessible in the various get functions in the programming API.

#### **20.6. Targets Status 10 (Motion Profile and Motion Magic)**

The status frame has a default period of 160ms.

- Target Position, velocity, and heading for the active trajectory point.

#### **20.7. PIDF0 Status 13**

The status frame has a default period of 160ms.

- Closed-loop error of PIDLoop 0.
- Integral Accumulator of PIDLoop 0.
- Derivative term of PIDLoop 0.



## 20.8. Modifying Status Frame Period

The frame rates of these signals may be modifiable through programming API.

### 20.8.1. C++

The `SetStatusFramePeriod()` function can be used to modify the frame rate period of a particular Status Frame.

```
/* change frame period to 7 ms */
talon.SetStatusFramePeriod(StatusFrameEnhanced::Status_10_MotionMagic, 7, 0);
```

Use `StatusFrameEnhanced` for products that have a Feedback Gadgeteer Port (such as Talon SRX). VictorSPX objects must use `StatusFrame`.

### 20.8.2. Java

The `setStatusFramePeriod()` function can be used to modify the frame rate period of a particular Status Frame.

```
/* change frame period to 7 ms */
talon.setStatusFramePeriod(StatusFrameEnhanced.Status_10_MotionMagic, 7, 0);
```

Use `StatusFrameEnhanced` for products that have a Feedback Gadgeteer Port (such as Talon SRX). VictorSPX objects must use `StatusFrame`.

### 20.8.3. LabVIEW

The  VI can be used to adjust the period of a status frame.

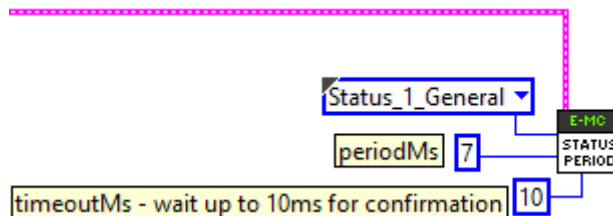

## 20.9. Control Frame (Control 3)

The Talon is primarily controlled by one periodic control frame. The default period of this frame is 10ms. The control frame provides the Talon...

- which Motor Control Profile Slot to use.
- which control mode (position, velocity, duty cycle, slave mode)
- if the feedback sensor should be reversed
- if the closed-loop output should be reversed
- the target/set point or duty cycle or which Talon to follow
- the (voltage) ramp rate
- brake neutral mode override if specified
- limit switch overrides if specified

... These signals are accessible in the various set functions in the programming API.

## 20.10. Modifying the Control Frame Period

Advanced users can modify the Control Frame Rate to increase the update rate of the control parameters, or decrease to reduce total bus bandwidth.

### 20.10.1. Modifying the Control Frame Rate – C++

Note there is no timeoutMs, as this setting is applied to the roboRIO.

```
/* change period to 7 ms */  
talon.SetControlFramePeriod(ControlFrame::Control_3_General, 7);
```

### 20.10.2. Modifying the Control Frame Rate – Java

Note there is no timeoutMs, as this setting is applied to the roboRIO.

```
/* change period to 7 ms */  
talon.setControlFramePeriod(ControlFrame.Control_3_General, 7);
```

### 20.10.3. Modifying the Control Frame Rate – LabVIEW

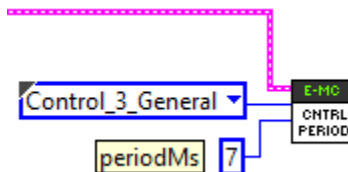

## 21. Functional Limitations

Functional Limitations describe behavior that deviates than what is documented. Feature additions and improvements are always possible thanks to the field-upgrade features of the Talon SRX.

Just because a firmware issue has been resolved does not mean your out-of-the-box hardware doesn't have old firmware. **Immediately** update your CAN devices to ensure your development time is not wasted chasing down an issue that has already been solved.

### 21.1. roboRIO power up: User should manually refresh the web-based configuration after rebooting roboRIO.

It is recommended to manually refresh the web browser if the roboRIO has been reset or power cycled. This ensures that the web browser and roboRIO are synchronized well. Otherwise device icons may not match the device type in the web-based config.

### 21.2. Phoenix 5.1.3.1: Motion profile disabled in 2018 kickoff firmware.

Talon SRX/ Victor SPX motion-profile mode is not available in the kickoff release. This is due to the modifications done to support Pigeon IMU integration. This will be remedied in a future release. [Resolved in Phoenix 5.2.1.1]

### 21.3. Two sets of Param declarations for auto-clear position parameters.

The paramEnum list includes two sets of enumerated values...

```
eClearPositionOnLimitF = 320,  
eClearPositionOnLimitR = 321,  
eClearPositionOnQuadIdx = 322,
```

```
eClearPositionOnIdx = 100,  
eClearPosOnLimitF = 144,  
eClearPosOnLimitR = 145,
```

...both sets are supported in Talon SRX firmware.

### 21.4. getClosedLoopTarget() return milliamperes.

`getClosedLoopTarget` reports in units of milliamperes when in current closed-loop mode. Divide the returned value by 1000 to obtain amperes.

### **21.5. Auto-clear position feature on Quadrature Idx only works for rising edges.**

eQuadIdxPolarity signal is not supported in current firmware.

If falling edge is necessary, use the Limit Forward or Limit Reverse auto-clear features.

## 22. CRF Firmware Version Information

CRF Version	Date	Description
3.3 (FRC)	Jan 2018	Motion profile feature re-enabled for Talon SRX.
3.1 (FRC)	Jan 2018	Initial release for Victor SPX and Talon SRX for 2018.

## 23. Document Revision Information

Rev	Date	Description
2.1	14-Jan-2018	-Updated Section 18.0 to the latest implementation. -Added Section ##
2.0	18-Jan-2018	-Initial release that is Phoenix compliant.