



# **cnpAPI Reference Guide**

January 2018

cnpAPI Release: 11.4

Document Version: 1.9

Vantiv cnpAPI Reference Guide Document Version: 1.9

All information whether text or graphics, contained in this manual is confidential and proprietary information of Vantiv, LLC and is provided to you solely for the purpose of assisting you in using a Vantiv, LLC product. All such information is protected by copyright laws and international treaties. No part of this manual may be reproduced or transmitted in any form or by any means, electronic, mechanical or otherwise for any purpose without the express written permission of Vantiv, LLC. The possession, viewing, or use of the information contained in this manual does not transfer any intellectual property rights or grant a license to use this information or any software application referred to herein for any purpose other than that for which it was provided. Information in this manual is presented "as is" and neither Vantiv, LLC or any other party assumes responsibility for typographical errors, technical errors, or other inaccuracies contained in this document. This manual is subject to change without notice and does not represent a commitment on the part Vantiv, LLC or any other party. Vantiv, LLC does not warrant that the information contained herein is accurate or complete.

All trademarks are the property of their respective owners and all parties herein have consented to their trademarks appearing in this manual. Any use by you of the trademarks included herein must have express written permission of the respective owner.

Copyright © 2003-2018, Vantiv, LLC - ALL RIGHTS RESERVED.

---

# CONTENTS

---

## About This Guide

Intended Audience .....	xxiii
Revision History .....	xxiii
Document Structure .....	xxvi
Documentation Set .....	xxvi
Typographical Conventions .....	xxviii
Contact Information.....	xxix

## Chapter 1 Introduction

The cnpAPI Data Format .....	2
Communications Protocols .....	2
General XML Coding Requirements .....	4
Other XML Resources.....	4
Batch Transaction Processing .....	5
Recommended Session File Size .....	5
Payment Integration Platform (cnpAPI SDKs) .....	6
Duplicate Transaction Detection .....	7
Batch Duplicate Checking .....	7
Batch Dupe Checking for Dynamic Payout Funding Instructions.....	8
Online Duplicate Checking.....	8
Coding for Report Groups.....	10
Additional/Alternate Methods of Tagging Transactions .....	11
Recovery .....	12
Authorization/Sale Recycling .....	12
Recycling Engine .....	12
Account Updater Service .....	14
Match Back .....	15
Merchant Requirements.....	16
Account Updater Features .....	17
Recurring Engine .....	18
Payment Plans.....	18
Subscriptions.....	19
Add Ons and Discounts .....	21
Recurring Reports.....	21
Transaction Types and Uses .....	22
Issuer Insights.....	24
Issuer Insights Secure Scheduled Report.....	24
Real Time Indicators .....	24

Prepaid Indicator .....	24
Affluence Indicator .....	25
Issuer Country Indicator .....	26
Cardholder Type Indicator .....	26
Extended Network Data .....	26
Insights Analytics Dashboard .....	28
Fraud Toolkit .....	29
Essential Tier .....	30
Prepaid Card Filtering .....	30
International BIN Filtering .....	31
Prior Chargeback Filtering .....	31
Security Code No-Match Filter .....	31
Card Velocity Filtering .....	32
Prior Fraud Advice Filtering .....	32
AVS Filter .....	32
Email Velocity Filter .....	33
Phone Velocity Filter .....	33
IP Velocity Filter .....	33
Device Velocity Filter .....	34
Application of Filters - Filtering Rules .....	34
Extended Tier .....	35
Premium Tier .....	36
Modifications to Your Web Page .....	36
cnpAPI Transactions .....	37
Information Only Option .....	39
Fraud Check Transactions .....	39
Tokenization Feature .....	40
How Tokenization Works .....	41
Token Formats .....	42
Obtaining Tokens .....	42
Bulk Token Registration .....	43
Supported Token Transactions .....	44
Compliance with Visa Best Practices for Tokenization .....	45
eCheck Processing .....	46
Validation Feature .....	46
Verification Feature .....	46
Required Contents of Decline Notice .....	47
Automatic Notice of Change (NoC) Updates .....	48
Auto Redeposit Feature .....	48
eCheck Prenotification .....	49
SEPA Direct Debit .....	51

SEPA Direct Debit - Vantiv Supplied Mandate.....	51
SEPA Direct Debit - Merchant Supplied Mandate.....	54
iDEAL, SOFORT, and Giropay .....	57
eCommerce Solution for Apple Pay™ .....	60
Overview of Apple Pay Operation .....	60
Vantiv Decryption of Apple Pay PKPaymentToken.....	61
Using the Browser JavaScript API for Apple Pay on the Web .....	61
Using the Vantiv Mobile API for Apple Pay .....	63
Submitting the Apple Pay PKPaymentToken in a cnpAPI Message .....	64
Merchant Decryption of Apple Pay PKPaymentToken.....	65
Recurring Payments with Apple Pay .....	67
eCommerce Solution for Android Pay™ .....	68
Android Pay using eProtect.....	68
Merchant Decryption Method .....	71
Recurring Payments with Android Pay .....	74
Supported Transaction Types .....	75
Authorization Transaction .....	75
AVS Only Transaction .....	76
Authorization Reversal Transactions .....	76
Notes on the Use of Authorization Reversal Transactions.....	77
Using Authorization Reversal to Halt Recycling Engine.....	78
Activate Transaction.....	78
Activate Reversal Transaction (Online Only) .....	79
Balance Inquiry Transaction.....	79
Cancel Subscription Transaction .....	79
Capture Transaction.....	79
Capture Given Auth Transaction.....	79
Create Plan Transaction .....	80
Credit Transaction.....	80
Deactivate Transaction .....	81
Deactivate Reversal Transaction (Online Only) .....	81
Deposit Reversal Transaction (Online Only).....	81
eCheck Credit Transaction.....	81
eCheck Prenotification Credit Transaction.....	81
eCheck Prenotification Sale Transaction .....	82
eCheck Redeposit Transaction .....	82
eCheck Sales Transaction .....	82
eCheck Verification Transaction .....	82
eCheck Void Transaction (Online Only).....	82
Force Capture Transaction .....	83
Gift Card Auth Reversal .....	83

Gift Card Capture .....	83
Gift Card Credit .....	83
Load Transaction .....	83
Load Reversal Transaction (Online Only) .....	83
Refund Reversal Transaction (Online Only) .....	84
Register Token Transaction .....	84
Sale Transaction .....	84
Status Query Transaction .....	84
Unload Transaction .....	85
Unload Reversal Transaction (Online Only).....	85
Update Card Validation Number Transaction .....	85
Update Plan Transaction.....	85
Update Subscription Transaction .....	85
Void Transaction (Online Only) .....	86
Using Void to Halt Recycling Engine.....	86
Instruction-Based Dynamic Payout Transactions .....	87

## Chapter 2 Testing Your cnpAPI Transactions

Certification and Testing Environments .....	90
Sandbox Environment.....	90
Pre-Live Environment.....	90
Pre-Live Environment Limitations and Maintenance Schedules .....	91
Post-Live Environment.....	91
Post-Live Environment Limitations and Maintenance Schedules .....	91
Overview of Testing .....	93
Planning for Certification Testing .....	93
Required Certification Testing.....	94
Optional Testing.....	94
System Doctor.....	94
Transferring Files .....	97
Transferring Session Files .....	97
Submitting a Session File for Processing.....	97
Retrieving Processed Session Files.....	98
Transferring Online Files.....	98
ASP Programming Example .....	99
Java Programming Example .....	100
Notes on Timeout Settings.....	101
Notes on Persistent Connections.....	101
Helpful Web Sites.....	102
Performing the Required Certification Tests .....	103

- Testing Authorization (including Indicators), AVS Only, Capture, Credit, Sale, and Void Transactions..... 103
- Testing Authorization Reversal Transactions..... 116
- Testing eCheck Transactions..... 119
- Testing Token Transactions..... 126
- Testing Query Transactions ..... 131
- Testing Online Duplicate Transaction Processing ..... 132
- Performing the Optional Tests ..... 134
  - Testing AVS and Card Validation..... 135
  - Testing Address Responses ..... 136
  - Testing Advanced AVS Response Codes..... 138
  - Testing Response Reason Codes and Messages ..... 139
  - Testing 3DS Responses ..... 142
  - Testing the Prepaid Filtering Feature..... 144
  - Testing the International Card Filter Feature ..... 146
  - Testing Security Code No-Match Filtering ..... 147
  - Testing Advanced Fraud Tools ..... 149
  - Testing Account Updater..... 151
    - Testing Account Updater Extended Response Codes..... 152
    - Testing Account Updater for Tokenized Merchants ..... 153
  - Testing Tax Billing..... 153
  - Testing Convenience Fees ..... 154
  - Testing the Recycling Engine..... 156
    - Testing Recycling Engine Cancellation ..... 164
  - Testing Recurring Engine Transactions ..... 166
  - Testing Gift Card Transactions ..... 179
  - Testing MasterPass Transactions..... 189
  - Testing Apple Pay Transaction Processing ..... 189
    - Testing the Submission of the Decrypted PKPaymentToken in cnpAPI ..... 190
    - Testing the Submission of PKPaymentToken in cnpAPI ..... 190
  - Testing Android Pay Transaction Processing ..... 192
    - Testing Android Pay using eProtect..... 192
  - Testing checkoutId..... 193
  - Testing SEPA Direct Debit Transaction ..... 195
  - Testing iDEAL Transactions..... 197
  - Testing Giropay Transactions ..... 198
  - Testing SOFORT Transactions..... 199
  - Testing Transaction Volume Capacity ..... 200

### Chapter 3 cnpAPI Transaction Examples

- Overview of Online and Batch Processing Formats ..... 202

Batch Process Format.....	202
Supported Communication Protocols.....	203
Batch Processing Request Format .....	203
Batch Processing Response Format.....	203
Online Processing Format .....	204
Supported Communication Protocols.....	205
Online Processing Request Format .....	205
Online Processing Response Format .....	205
Transaction Types and Examples.....	206
Authorization Transactions.....	208
Authorization Request Structure .....	208
Authorization Response Structure .....	215
Authorization Reversal Transactions .....	220
Authorization Reversal Requests.....	220
Authorization Reversal Responses .....	222
Activate Transactions.....	223
Activate Request .....	223
Activate Response .....	224
Activate Reversal Transactions (Online Only) .....	226
Activate Reversal Request.....	226
Activate Reversal Response .....	227
Balance Inquiry Transactions.....	228
Balance Inquiry Request .....	228
Balance Inquiry Response .....	229
Cancel Subscription Transactions.....	230
Cancel Subscription Request.....	230
Cancel Subscription Response .....	231
Capture Transactions.....	231
Capture Request .....	232
Capture Response .....	239
Capture Given Auth Transactions .....	240
Capture Given Auth Request .....	240
Capture Given Auth Response .....	244
Create Plan Transactions.....	246
Create Plan Request.....	246
Create Plan Response .....	247
Credit Transactions .....	247
Credit Request for a Vantiv Processed Transaction .....	248
Credit Request for a Non-Vantiv Processed Transaction .....	252
Credit Response .....	256
Deactivate Transactions.....	257



Deactivate Request.....	257
Deactivate Response .....	258
Deactivate Reversal Transactions (Online Only) .....	259
Deactivate Reversal Request.....	259
Deactivate Reversal Response .....	260
Deposit Reversal Transactions (Online Only) .....	261
Deposit Reversal Request .....	261
Deposit Reversal Response.....	262
eCheck Credit Transactions.....	263
eCheck Credit Request Against a Vantiv Transaction .....	263
eCheck Credit Request for a Non-Vantiv Processed Sale .....	265
eCheck Credit Response .....	266
eCheck Prenotification Credit Transactions (Batch Only) .....	266
eCheck Prenotification Credit Request .....	267
eCheck Prenotification Credit Response .....	268
eCheck Prenotification Sale Transactions (Batch Only) .....	269
eCheck Prenotification Sale Request.....	269
eCheck Prenotification Sale Response.....	270
eCheck Redeposit Transactions .....	271
eCheck Redeposit Request .....	271
eCheck Redeposit Response.....	273
eCheck Sale Transactions .....	274
eCheck Sale Request .....	274
eCheck Sale Response.....	276
eCheck Verification Transactions.....	277
eCheck Verification Request.....	278
eCheck Verification Response .....	280
eCheck Void Transactions (Online Only) .....	281
eCheck Void Request .....	281
eCheck Void Response.....	282
Force Capture Transactions.....	283
Force Capture Request.....	283
Force Capture Response .....	286
Fraud Check Transaction.....	288
Fraud Check Request .....	288
Fraud Check Response .....	289
Gift Card Auth Reversal Transactions.....	290
Gift Card Auth Reversal Request.....	290
Gift Card Auth Reversal Response .....	291
Gift Card Capture Transactions .....	292
Gift Card Capture Request.....	292

Gift Card Capture Response .....	293
Gift Card Credit Transactions.....	294
Gift Card Credit Request .....	294
Gift Card Credit Response .....	295
Load Transactions.....	296
Load Request.....	296
Load Response .....	297
Load Reversal Transactions (Online Only) .....	298
Load Reversal Request.....	298
Load Reversal Response .....	299
Status Query Transactions (Online Only) .....	300
Query Transaction Request .....	301
Query Transaction Response .....	301
Refund Reversal Transactions (Online Only).....	304
Refund Reversal Request .....	305
Refund Reversal Response .....	306
Register Token Transactions .....	307
Register Token Request .....	307
Register Token Response.....	310
RFR Transactions (Batch Only) .....	312
RFR Request .....	312
RFR Response.....	313
Sale Transactions .....	314
Sale Request.....	314
Sale Response.....	319
Unload Transactions .....	325
Unload Request .....	325
Unload Response.....	326
Unload Reversal Transactions (Online Only).....	326
Unload Reversal Request .....	327
Unload Reversal Response .....	328
Update Plan Transactions.....	329
Update Plan Request .....	329
Update Plan Response .....	329
Update Subscription Transactions .....	330
Update Subscription Request .....	330
Update Subscription Response.....	332
Update Card Validation Number Transactions.....	332
Update Card Validation Number Request.....	333
Update Card Validation Number Response .....	333
Void Transactions (Online Only) .....	334

Void Request.....	335
Void Response.....	335

## Chapter 4 cnpAPI Elements

accNum .....	338
accountInfo .....	339
accountInformation .....	340
accountNumber .....	341
accountNumberLength .....	342
accountUpdate .....	343
accountUpdateFileRequestData .....	344
accountUpdater .....	345
accountUpdateResponse .....	349
accType .....	350
actionReason .....	351
activate .....	352
activateResponse .....	353
activateReversal .....	354
activateReversalResponse .....	355
active .....	356
addOnCode .....	357
addressIndicator .....	358
addressLine1, addressLine2, addressLine3 .....	359
advancedAVSResult.....	360
advancedFraudChecks .....	361
advancedFraudResults .....	362
affiliate.....	363
affluence .....	364
allowPartialAuth .....	365
amexAggregatorData .....	366
amount .....	367
androidpayResponse .....	369
applepay .....	370
applepayResponse .....	371
applicationData .....	372
applicationExpirationDate .....	373
applicationPrimaryAccountNumber.....	374
approvedAmount.....	375
authAmount.....	376
authCode .....	377
authDate .....	378

authenticatedByMerchant .....	379
authentication.....	380
authenticationResult .....	381
authenticationTransactionId.....	382
authenticationValue .....	383
authInformation .....	384
authorization .....	385
authorizationResponse .....	386
authorizationSourcePlatform.....	387
authReversal.....	388
authReversalResponse.....	389
availableBalance .....	390
avsResult .....	391
balanceInquiry .....	392
balanceInquiryResponse .....	393
batchRequest.....	394
batchResponse .....	402
beginningBalance .....	403
billingDate .....	404
billMeLaterRequest.....	405
billMeLaterResponseData.....	407
billToAddress .....	408
bin .....	410
bmlMerchantId .....	411
bmlProductType.....	412
bypassVelocityCheck.....	413
campaign .....	414
cancelSubscription .....	415
cancelSubscriptionResponse .....	416
capability .....	417
capture .....	418
captureAmount.....	419
captureGivenAuth .....	420
captureGivenAuthResponse .....	421
captureResponse .....	422
card .....	423
cardAcceptorTaxId.....	425
cardholderAuthentication .....	426
cardholderId .....	427
cardholderName .....	428
cardOrToken .....	429

cardProductType.....	430
cardSuffix .....	431
cardValidationNum.....	432
cardValidationResult .....	433
cashBackAmount .....	434
catLevel .....	435
ccdPaymentInformation .....	436
chargeback .....	437
checkNum .....	438
checkoutId .....	439
city.....	440
clinicOtherAmount.....	441
code .....	442
commodityCode .....	443
companyName .....	444
country .....	445
createAddOn .....	446
createDiscount .....	447
createPlan .....	448
createPlanResponse .....	449
credit .....	450
creditAmount.....	451
creditLine .....	452
creditLittleTxnId .....	453
creditResponse .....	454
cryptogram .....	455
currencyCode .....	456
customAttribute1 .....	457
customBilling.....	458
customIdentifier .....	460
customerInfo .....	461
customerIpAddress.....	462
customerReference.....	463
customerRegistrationDate .....	464
customerType .....	465
customerWorkTelephone.....	466
data .....	467
deactivate .....	468
deactivateResponse .....	469
deactivateReversal .....	470
deactivateReversalResponse .....	471

debtRepayment.....	472
deleteAddOn .....	473
deleteDiscount .....	474
deliveryType.....	475
dentalAmount.....	476
depositReversal .....	477
depositReversalResponse .....	478
description .....	479
descriptor .....	480
destinationCountryCode .....	481
destinationPostalCode .....	482
detailTax .....	483
deviceManufacturerIdentifier.....	484
deviceReputationScore .....	485
deviceReviewStatus.....	486
discountAmount .....	487
discountCode .....	488
dob .....	489
dutyAmount.....	490
echeck.....	491
eCheckAccountSuffix .....	492
echeckCredit.....	493
echeckCreditResponse.....	494
echeckForToken .....	495
echeckOrEcheckToken.....	496
echeckPreNoteCredit .....	497
echeckPreNoteCreditResponse .....	498
echeckPreNoteSale .....	499
echeckPreNoteSaleResponse .....	500
echeckRedeposit .....	501
echeckRedepositResponse .....	502
echeckSale .....	503
echeckSalesResponse .....	504
echeckToken.....	505
echeckVerification.....	506
echeckVerificationResponse.....	507
echeckVoid .....	508
echeckVoidResponse .....	509
eciIndicator.....	510
email .....	511
employerName.....	512

encryptedTrack .....	513
endDate .....	514
endingBalance .....	515
endpoint .....	516
enhancedAuthResponse.....	517
enhancedData.....	519
entryMode .....	523
ephemeralPublicKey .....	524
expDate.....	525
expMonth .....	526
expYear .....	527
extendedCardResponse .....	528
fastAccessFunding .....	529
fastAccessFundingResponse .....	530
fieldValue .....	531
filtering .....	532
finalPayment .....	533
firstName.....	534
forceCapture .....	535
forceCaptureResponse .....	536
formatId .....	537
fraudCheck .....	538
fraudCheckResponse .....	539
fraudFilterOverride .....	540
fraudResult .....	541
fundingInstructionVoid .....	542
fundingInstructionVoidResponse .....	543
fundingSource.....	544
fundingSubmerchantId .....	545
fundsTransferId.....	546
giftCardAuthReversal.....	547
giftCardAuthReversalResponse.....	548
giftCardBin .....	549
giftCardCapture.....	550
giftCardCaptureResponse .....	551
giftCardCredit.....	552
giftCardCreditResponse.....	553
giftCardResponse .....	554
giropay .....	555
giropayResponse .....	556
header .....	557

healthcareAmounts .....	558
healthcareIIAS .....	559
iban .....	560
ideal .....	561
idealResponse .....	562
IIASFlag .....	563
incomeAmount .....	564
incomeCurrency .....	565
international .....	567
intervalType .....	568
invoiceReferenceNumber .....	569
issuerCountry .....	570
itemCategoryCode .....	571
itemDescription .....	572
itemDiscountAmount .....	573
itemSequenceNumber .....	574
ksn .....	575
lastName .....	576
lineItemData .....	577
lineItemTotal .....	579
lineItemTotalWithTax .....	580
litleInternalRecurringRequest .....	581
litleOnlineRequest .....	582
litleOnlineResponse .....	583
litleRequest .....	585
litleResponse .....	586
litleSessionId .....	588
litleToken .....	589
litleTxnId .....	590
load .....	592
loadResponse .....	593
loadReversal .....	594
loadReversalResponse .....	595
mandateProvider .....	596
mandateReference .....	597
mandateSignatureDate .....	598
mandateURL .....	599
matchCount .....	600
merchantData .....	601
merchantGroupingId .....	602
merchantId .....	603



message .....	604
middleInitial .....	605
mpos .....	606
name .....	607
networkField .....	608
networkResponse .....	610
networkSubField .....	611
networkTransactionId .....	612
newAccountInfo .....	613
newCardInfo .....	614
newCardTokenInfo .....	615
newTokenInfo .....	616
nextRecycleTime .....	617
number .....	618
numberOfPayments .....	619
onlinePaymentCryptogram .....	620
orderDate .....	621
orderId.....	622
orderSource .....	623
originalAccountInfo .....	625
origAccountNumber .....	626
origActionType .....	627
origId .....	629
originalAmount .....	630
originalCard.....	631
originalCardInfo .....	632
originalCardTokenInfo .....	633
originalNetworkTransactionId .....	634
originalRefCode .....	635
originalSequenceNumber .....	636
originalSystemTraceId .....	637
originalToken .....	638
originalTokenInfo .....	639
originalTransactionAmount .....	640
originalTxnTime .....	641
origLitleTxnId .....	642
origOrderId .....	643
password .....	644
payerId .....	645
payFacCredit .....	646
payFacCreditResponse .....	647

payFacDebit .....	648
payFacDebitResponse .....	649
paymentDataType .....	650
paymentPurpose .....	651
paypage .....	652
paypageRegistrationId .....	653
paypal .....	654
paypalNotes .....	655
paypalOrderComplete .....	656
phone .....	657
phone as a child of billToAddress and shipToAddress .....	657
phone as a child of customBilling .....	657
physicalCheckCredit .....	658
physicalCheckCreditResponse .....	659
physicalCheckDebit .....	660
physicalCheckDebitResponse .....	661
pin .....	662
planCode .....	663
pos .....	664
postDate .....	665
postDay .....	666
preapprovalNumber .....	667
preferredLanguage .....	668
prepaid .....	669
prepaidCardType .....	670
processingInstructions .....	671
processingType .....	672
productCode .....	673
publicKeyHash .....	674
quantity .....	675
queryTransaction .....	676
queryTransactionResponse .....	677
queryTransactionUnavailableResponse .....	678
recurringRequest .....	679
recurringResponse .....	680
recurringTxnId .....	681
recycleAdvice .....	682
recycleAdviceEnd .....	683
recycleBy .....	684
recycleEngineActive .....	685
recycleId .....	686

recycling .....	687
recycling Element as a Child of authorizationResponse or saleResponse .....	687
recycling Element as a Child of voidResponse .....	687
recyclingRequest .....	689
redirectToken .....	690
redirectUrl .....	691
refCode .....	692
refundReversal .....	693
refundReversalResponse .....	694
registerTokenRequest.....	695
registerTokenResponse.....	696
reloadable .....	697
reserveCredit .....	698
reserveCreditResponse .....	699
reserveDebit .....	700
reserveDebitResponse .....	701
residenceStatus .....	702
response .....	703
responseCode .....	704
responseMessage .....	705
responseTime .....	706
results_Max10 .....	707
RFRRequest .....	710
RFRResponse .....	711
routingNum .....	712
RxAmount .....	713
sale .....	714
saleResponse .....	715
salesTax.....	716
secondaryAmount .....	717
sellerId .....	718
sellerMerchantCategoryCode .....	719
sepaDirectDebit .....	720
sepaDirectDebitResponse .....	721
sequenceNumber.....	722
sequenceType .....	723
shipFromPostalCode .....	724
shippingAmount .....	725
shipToAddress .....	726
signature .....	727
sofort .....	728

sofortResponse .....	729
ssn .....	730
startDate .....	731
state .....	732
submerchantCredit .....	733
submerchantCreditResponse .....	734
submerchantDebit .....	735
submerchantDebitResponse .....	736
submerchantName.....	737
subscription .....	738
subscriptionId .....	740
surchargeAmount .....	741
systemTraceId .....	742
taxAmount.....	743
taxExempt .....	744
taxIncludedInTotal.....	745
taxRate.....	746
taxType .....	747
taxTypeIdentifier .....	748
terminalId .....	749
termsAndConditions.....	750
threatMetrixSessionId .....	751
token .....	752
token (Vantiv generated card number replacement).....	752
token (PayPal generated) .....	753
tokenMessage.....	754
tokenResponse .....	755
tokenResponseCode .....	756
totalHealthcareAmount .....	757
track .....	758
track1Status .....	759
track2Status .....	760
transactionAmount .....	761
transactionId .....	762
transactionId as a Child of the paypal element .....	762
transactionId as a Child of the header element.....	762
trialIntervalType .....	764
trialNumberOfIntervals .....	765
triggeredRule .....	766
txnTime .....	767
type .....	768

type Element as a Child of the parent elements listed below.....	768
type Element as a Child of fundingSource .....	769
unitCost .....	770
unitOfMeasure .....	771
unload .....	772
unloadResponse .....	773
unloadReversal .....	774
unloadReversalResponse .....	775
updateAddOn .....	776
updatedCard .....	777
updateCardValidationNumOnToken .....	778
updateCardValidationNumOnTokenResponse .....	779
updateDiscount .....	780
updatePlan .....	781
updatePlanResponse .....	782
updateSubscription .....	783
updateSubscriptionResponse .....	787
updatedToken .....	788
url .....	789
user .....	790
vendorCredit .....	791
vendorCreditResponse .....	792
vendorDebit .....	793
vendorDebitResponse .....	794
vendorName .....	795
verificationCode .....	796
verify .....	797
version .....	798
virtualAccountNumber .....	799
virtualAuthenticationKeyData .....	800
virtualAuthenticationKeyPresenceIndicator .....	801
virtualGiftCard .....	802
virtualGiftCardBin .....	803
virtualGiftCardResponse .....	804
visionAmount .....	805
void .....	806
voidResponse .....	807
wallet .....	808
walletSourceType .....	809
walletSourceTyped .....	810
yearsAtEmployer.....	811

yearsAtResidence ..... 812  
 zip ..... 813

**Appendix A Payment Transaction Response Codes**

Payment Transaction Response Codes ..... 816  
 3DS Authentication Result Codes ..... 840  
 AVS Response Codes ..... 842  
 AAVS Response Codes ..... 843  
 Card Validation Response Codes ..... 846  
 Advanced Fraud Tools Triggered Rules ..... 847  
 XML Validation Error Messages ..... 864  
 Additional Response Header Error Messages ..... 866  
 ACH Return Reason Codes ..... 868  
 ACH NoC Change Codes ..... 871  
 Canadian eCheck Return Codes ..... 872

**Appendix B Credit Card Number Formats**

**Appendix C Test Card Numbers**

**Appendix D PayFac™ Dynamic Payout**

Advantages of Using Dynamic Payout ..... 884  
 Overview of Dynamic Payout ..... 885  
     Timing of Transactions, Reports, and Money Movement ..... 886  
     Money Movement and Accounts ..... 887  
         Same Day Funding ..... 888  
         FastAccess Funding™ ..... 889  
         Account Balance Verifications ..... 890  
 Example of Funding Instructions ..... 891  
     Funding Instruction Void Transactions ..... 895  
 Funding Instruction Certification Testing ..... 896  
 SSR Reports ..... 898  
 Tax ID Validation Process ..... 900

# ABOUT THIS GUIDE

This manual serves as a reference to the cnpAPI transaction formats used for payment processing with Vantiv, LLC. It also explains how to perform unattended transaction testing and attended certification testing with Vantiv.

## Intended Audience

This document is intended for technical personnel who will be setting up and maintaining payment processing using the cnpAPI format.

## Revision History

This document has been revised as follows:

**TABLE 1** Document Revision History

Doc. Version	Description	Location(s)
1.0	Initial release of LitleXML Reference Guide for schema V11.0, including new Gift Card transactions and international alternate payment methods.	N/A
1.1	Added <customIdentifier> to several eCheck transactions. Added information about the iDEAL international payment method, which is now GA.	Chapters 3 and 4 Chapters 1, 2, and 4
1.2	Corrected maintenance window times for Pre-/Post-Live. Added "Appears in Declined Transaction report." note to certain Response Codes.	Chapter 2 Appendix A

**TABLE 1** Document Revision History

Doc. Version	Description	Location(s)
1.3	<p>Replaced LittleXML with cnpAPI.</p> <p>Added three new tests for new MC 3DS behavior.</p> <p>Moved Dupe Tests from Optional to Required test group.</p> <p>Added info about <code>checkoutId</code> element (not GA)</p> <p>Added info about <code>sameDayFunding</code> Batch Request attribute.</p> <p>Added info about SOFORT and Giropay alternate payment methods.</p> <p>Revised/renamed Customer Insights to Issuer Insights.</p> <p>Corrected several examples, replacing Response Code 001 - Transaction Received with 000 - Approved.</p>	<p>All</p> <p>Chapter 2</p> <p>Chapter 2</p> <p>Chapter 3</p> <p>Chapter 4 &amp; Appendix D</p> <p>Chapters 1, 2, and 4</p> <p>Chapter 1</p> <p>Chapter 3</p>
1.4	<p>Corrected Response Code for Test GC17 - 281 changed to 218.</p> <p>Updated Little to Vantiv in Response messages.</p> <p>Added Note about <code>expDate</code> to token element definition.</p>	<p>Chapter 2</p> <p>All</p> <p>Chapter 4</p>
1.5	<p>Added/modified information in section 2.1.</p> <p><code>orderId</code> element added to <code>accountUpdateResponse</code>.</p> <p>Removed " not yet supported " note from <code>checkoutId</code> element and added Cert tests</p> <p>Modified requirements for Level 2/3 data (<code>enhancedData</code> element).</p>	<p>Chapter 2</p> <p>Chapter 4</p> <p>Chapters 2 and 4</p> <p>Chapter 4</p>
1.6	<p>Added Response Codes 940 and 941.</p> <p>Added text clarifying limit of 25K for Same day Funding transaction and removed debit transaction restrictions.</p> <p>Added note about 30 minute wait for funds to be restored to Settlement account balance after issuing a Funding Instruction Void transaction.</p>	<p>Appendix A</p> <p>Appendix D</p> <p>Appendix D</p>
1.7	<p>Removed Mobile Point of Sale sections from guide</p> <p>Updated document for release of V11.3, including Online Dynamic Payout Funding Instructions and Fast Funding transaction.</p> <p>Fixed various links to github and test environments.</p> <p>Fixed error in definition of <code>customerReference</code> element.</p> <p>Added info about support for Visa token transactions with 3-D Secure (TAVV and DTVV), as well as new 3-DS response code definitions.</p>	<p>Chapters 1 and 2</p> <p>All</p> <p>Chapter 2</p> <p>Chapter 4</p> <p>Chapter 4 &amp; Appendix A</p>



**TABLE 1** Document Revision History

<b>Doc. Version</b>	<b>Description</b>	<b>Location(s)</b>
1.8	Remove reference to Recurring Snapshot report. Updated Android Pay Certification test results. Corrected maxLength of id attribute, which increased from 25 to 36 in V11.3.	Chapter 1 Chapter 2 Chapter 4
1.9	Added info about Response Reason Code 825. Added info about allowing 60 second gap between a transaction and submitting a Void. Added <code>processingType</code> enums for Card on File transactions.	Appendix A Chapters 1, 3, & 4 Chapter 4

## Document Structure

This manual contains the following sections:

### **Chapter 1, "Introduction"**

This chapter provides an introduction to transaction processing using cnpAPI.

### **Chapter 2, "Testing Your cnpAPI Transactions"**

This chapter provides information concerning the testing and certification process, which you must complete prior to submitting transactions to the Vantiv production environment.

### **Chapter 3, "cnpAPI Transaction Examples"**

This chapter provides information concerning the cnpAPI structure for transaction submission, as well as examples.

### **Chapter 4, "cnpAPI Elements"**

This chapter provides definitions and other information concerning each cnpAPI element.

### **Appendix A, "Payment Transaction Response Codes"**

This appendix lists all of the possible response codes and messages.

### **Appendix B, "Credit Card Number Formats"**

This appendix provides information about credit card number formats and Mod-10 validation.

### **Appendix C, "Test Card Numbers"**

This appendix provides credit card number that can be used for testing.

### **Appendix D, "PayFac™ Dynamic Payout"**

This appendix provides information about PayFac Dynamic Payout transactions.

## Documentation Set

For additional information concerning the Vantiv application, see any of the following guides in the documentation set:

- *iQ Reporting and Analytics User Guide*
- *Vantiv Chargeback API Reference Guide*
- *Vantiv Chargeback Process Guide*
- *Vantiv eCommerce Partner Integration Overview Guide*
- *Vantiv PayPal Integration Guide*

- *Vantiv PayFac™ API Reference Guide*
- *Vantiv PayFac™ Portal User Guide*
- *Vantiv PayFac™ Integration Overview Guide*
- *Vantiv eProtect™ Integration Guide*
- *Vantiv Enterprise eProtect™ Integration Guide*
- *Vantiv XML Differences Guide*
- *Vantiv Secure Scheduled Reports Reference Guide*

# Typographical Conventions

Table 2 describes the conventions used in this guide.

**TABLE 2** Typographical Conventions

Convention	Meaning
. . . . . .	Vertical ellipsis points in an example mean that information not directly related to the example has been omitted.
. . .	Horizontal ellipsis points in statements or commands mean that parts of the statement or command not directly related to the example have been omitted.
<>	Angle brackets are used in the following situations: <ul style="list-style-type: none"><li>• user-supplied values (variables)</li><li>• XML elements</li></ul>
[ ]	Brackets enclose optional clauses from which you can choose one or more option.
<b>bold text</b>	Bold text indicates emphasis.
<i>Italicized text</i>	Italic type in text indicates the name of a referenced external document.
<a href="#">blue text</a>	Blue text indicates either a hypertext link or an element name (in xml examples).
<code>monospaced text</code>	Used in code examples and elsewhere to designate field/element names.

## Contact Information

This section provides contact information for organizations within Vantiv.

**Implementation** - For technical assistance to resolve issues encountered during the on-boarding process, including cnpAPI certification testing.

### Implementation Contact Information

<b>E-mail</b>	<a href="mailto:implementation@vantiv.com">implementation@vantiv.com</a>
<b>Hours Available</b>	Monday – Friday, 8:30 A.M.– 5:30 P.M. EST

**Chargebacks** - For business-related issues and questions regarding financial transactions and documentation associated with chargeback cases, contact the Chargebacks Department.

### Chargebacks Department Contact Information

<b>Telephone</b>	1-844-843-6111 (option 4)
<b>E-mail</b>	<a href="mailto:chargebacks@vantiv.com">chargebacks@vantiv.com</a>
<b>Hours Available</b>	Monday – Friday, 7:30 A.M.– 5:00 P.M. EST

**Technical Support** - For technical issues such as file transmission errors, email Technical Support. A Technical Support Representative will contact you within 15 minutes to resolve the problem.

### Technical Support Contact Information

<b>E-mail</b>	<a href="mailto:eCommerceSupport@vantiv.com">eCommerceSupport@vantiv.com</a>
<b>Hours Available</b>	24/7 (seven days a week, 24 hours a day)

**Relationship Management/Customer Service** - For non-technical issues, including questions concerning iQ Reporting and Analytics, help with passwords, modifying merchant details, and changes to user account permissions, contact the Relationship Management/Customer Service Department. If you are a Payment Facilitator (PayFac), refer to the second table.

### Relationship Management/Customer Service Contact Information - Merchants

<b>Telephone</b>	1-844-843-6111 (Option 3)
<b>E-mail</b>	<a href="mailto:ecc@vantiv.com">ecc@vantiv.com</a>
<b>Hours Available</b>	Monday – Friday, 8:00 A.M.– 6:00 P.M. EST

## Relationship Management/Customer Service Contact Information - Payment Facilitators

<b>Telephone</b>	1-844-843-6111 (Option 5)
<b>E-mail</b>	<a href="mailto:PayFacEComm@vantiv.com">PayFacEComm@vantiv.com</a>
<b>Hours Available</b>	Monday – Friday, 8:00 A.M.– 5:00 P.M. EST

**Technical Publications** - For questions or comments about this document, please address your feedback to the Technical Publications Department. All comments are welcome.

## Technical Publications Contact Information

<b>E-mail</b>	<a href="mailto:TechPubs@vantiv.com">TechPubs@vantiv.com</a>
---------------	--

---

## INTRODUCTION

The cnpAPI data format supports two types of transaction submission methods: Online and Batch. With the Online method, you submit each transaction independently and receive a response in real-time. Typically, merchants use the Online method for Authorization transactions, as well as transactions available only via Online (for example, Void). The Batch method enables you to submit multiple transactions simultaneously in a single Session file. Vantiv recommends the Batch method for all transaction submissions except Authorizations and the transaction available only via Online.

This chapter provides an overview of the cnpAPI data format, including some basic XML coding requirements. Also discussed are the advantages of using batch processing, duplicate transaction detection, report groups, Value Added Services, and supported transaction types.

The topics discussed in this chapter are:

- [The cnpAPI Data Format](#)
- [Batch Transaction Processing](#)
- [Payment Integration Platform \(cnpAPI SDKs\)](#)
- [Duplicate Transaction Detection](#)
- [Coding for Report Groups](#)
- [Recovery](#)
- [Recurring Engine](#)
- [Issuer Insights](#)
- [Fraud Toolkit](#)
- [Tokenization Feature](#)
- [eCheck Processing](#)
- [SEPA Direct Debit](#)
- [iDEAL, SOFORT, and GiroPay](#)
- [eCommerce Solution for Apple Pay™](#)
- [eCommerce Solution for Android Pay™](#)
- [Supported Transaction Types](#)

## 1.1 The cnpAPI Data Format

There are several advantages to using the cnpAPI format as follows:

- **Easier Implementation, Operations, and Debugging** - Compared to fixed length or binary formats, the XML format is considerably easier for operations staff to read and edit, using virtually any text editor. This allows Vantiv's Implementation, First Line Support, and Relationship Managers to quickly communicate any issues and work with your own operations staff to make necessary corrections without worrying about line lengths, padding or encoding.
- **Fewer Downgrades** - Since the cnpAPI format allows you to explicitly tie deposits to their associated authorizations via the `<littleTxnId>` element, your transactions qualify for the best interchange rates at a higher frequency than with formats that do not support this transaction cross-referencing.
- **Simpler Capture (Deposit) and Refund Transactions** - Because the cnpAPI format associates related transactions using the `<littleTxnId>` element, our format does not require you to resubmit all of the authorization information on a deposit nor all of the deposit information on a refund. When you submit the unique transaction id, Vantiv automatically pulls the information from the original transaction. Most other formats require you to resubmit the related data with each transaction.
- **Superior Reporting** - The cnpAPI format allows you to separate your transactions into different categories by specifying a Report Group on each transaction. When accessing your data on the iQ reporting and Analytics Interface, this feature allows you to filter your financial reports by Report Groups, providing more granular detail based on a reporting hierarchy the Report Groups create. Most other formats restrict reporting categories to a batch or specific merchant id.
- **Improved Chargeback Management** - Unlike most other formats where transactional relationships can be a "best guess" proposition, the cnpAPI format explicitly ties related transactions, allowing you and Vantiv to see authorization-to-deposit and deposit-to-refund relationships with precision. This knowledge is indispensable when fighting chargebacks.
- **New Features** - New features developed for the Vantiv eCommerce platform are first exposed via the XML API. While the SDKs add new capabilities shortly after development, direct coding to the XML API gains access to these feature and capabilities earlier.

### 1.1.1 Communications Protocols

There are two communication protocols supported for the submission of Batch transactions to Vantiv eCommerce platform for processing and one for Online submissions as shown in [Table 1-1](#). For Batch submissions Vantiv recommends that you use one of the two FTP methods. Use the HTTPS Post method for Online transactions.



---

**NOTE:** Although the Vantiv eComm platform currently supports both TLS 1.1 and TLS 1.2, Vantiv strongly recommends the use of TLS 1.2 to ensure the best encryption security.

---

**TABLE 1-1** Communication Protocol Support Matrix

Protocol	Encryption	Batch	Online
HTTPS Post	TLS 1.2	N/A	Required
TCP/IP Socket	TLS 1.2	N/A	N/A
FTP	PGP or GPG (open source)	Recommended	N/A
sFTP	SSH Key	Recommended	N/A

If you use the standard FTP method, you must use either the Pretty Good Privacy (PGP) or the open source GNU Privacy Guard (GPG) encryption for your submissions. Both of these encryption methods use key cryptography and support message authentication and integrity checking. The alternate method, Secure FTP (sFTP), uses Secure Shell (SSH) to secure the transmission.

The Vantiv eComm platform supports the following ciphers for the TLS 1.2 encryption protocol:

**TABLE 1-2** Supported TLS Ciphers

Server Priority	Cipher Id	Cipher Name	TLS 1.2 Support	TLS 1.1 Support
1	c030	TLS_ECDHE_RSA_WITH_AES_256_GCM_SHA384	Yes	No
2	c02f	TLS_ECDHE_RSA_WITH_AES_128_GCM_SHA256	Yes	No
3	c028	TLS_ECDHE_RSA_WITH_AES_256_CBC_SHA384	Yes	No
4	c014	TLS_ECDHE_RSA_WITH_AES_256_CBC_SHA	Yes	Yes
5	c027	TLS_ECDHE_RSA_WITH_AES_128_CBC_SHA256	Yes	No
6	c013	TLS_ECDHE_RSA_WITH_AES_128_CBC_SHA	Yes	Yes
7	009d	TLS_RSA_WITH_AES_256_GCM_SHA384	Yes	No
8	009c	TLS_RSA_WITH_AES_128_GCM_SHA256	Yes	No
9	003d	TLS_RSA_WITH_AES_256_CBC_SHA256	Yes	No
10	003c	TLS_RSA_WITH_AES_128_CBC_SHA256	Yes	No
11	0035	TLS_RSA_WITH_AES_256_CBC_SHA	Yes	Yes
12	002f	TLS_RSA_WITH_AES_128_CBC_SHA	Yes	No

## 1.1.2 General XML Coding Requirements

As part of the on-boarding process, you receive XML schema files from your Implementation Consultant. Using those files and this document as a guide, you create the required XML documents for submission of your transactions. You should validate all XML you create using the supplied schema. Also, working with your Implementation Consultant, you are required to perform various tests of your XML (see [Chapter 2, "Testing Your cnpAPI Transactions"](#)) prior to submitting transactions to the production environment.

In addition to the process outlined above, there are a few XML basics of which you should be aware.

- Encode all data using the UTF-8 format.
- Although it is not required, Vantiv recommends that when formatting your XML, you keep each element on its own line. This will aid in debugging situations where an error message specifies an issue in a particular line of XML code (for example, line 20).
- Be aware of special characters that require specific handling (see [Table 1-3](#)). For example, the less than (<) and greater than (>) symbols define element tags in the XML code. Using the entity names **&lt;** and **&gt;** instead of < and > prevents a browser from interpreting these characters as element brackets.

Be sure to review data provided by customers for special character handling. For example, an address of "4th & Main," must be rewritten as "4th & Main" (including quotes) before being submitted via XML. Failure to quote this type of input causes rejection of XML submissions due to syntax errors.

**TABLE 1-3** Coding for Special Characters

Character	Description	Entity Reference (case sensitive)
<	less than	&lt;
>	greater than	&gt;
“	quotation	&quot;
‘	apostrophe	&apos;
&	ampersand	&amp;

## 1.1.3 Other XML Resources

There are several Internet sites that provide both reference and educational information that may help you when implementing your XML. A few of these sites are:

- [http://www.w3schools.com/xml/xml\\_syntax.asp](http://www.w3schools.com/xml/xml_syntax.asp)
- <http://www.w3.org/>
- <http://www.utf-8.com/>

## 1.2 Batch Transaction Processing

Batch processing involves a group of transactions submitted in a single file. In the case of a cnpAPI Batch the parent or root element is the `<littleRequest>` element. A single `<littleRequest>`, referred to as a Session, can contain many batches and each batch can contain multiple transactions. We recommend that you use Batch processing for all transaction types except Authorizations and Voids (Online only).

Some of the advantages of using Batch processing are:

- **Better Performance** - We optimize batch processing by processing multiple transactions in the batch simultaneously. This allows you to process thousands of transactions quickly without writing complicated logic or managing complicated processes.
- **Easier Reconciliation** - When processing a batch, all transactions within that batch post on the same day. In the case of Online transactions, you could submit two transactions at the same time and one could post today and the other tomorrow. This can cause confusion in your accounting process.
- **Easier Error Recovery** - A batch processes as a single unit, thus if you experience any system or communication issue while processing a batch, you can easily determine if the file was processed. With Online transactions, determining which individual transactions were not processed can be more difficult.

### 1.2.1 Recommended Session File Size

As stated above, a Session file is a group of batches. A batch is a set of transactions for a single merchant. Normally, you send in a single file which has one batch for each merchant. This works well when the overall number of transactions is small. The number of transactions you should submit in any individual Session or Batch depend on a number of factors, including whether or not you are an individual merchant or a presenter submitting transactions for multiple merchants. In general, you should keep the following recommendations and rules in mind when determining the number of transactions you submit in an Session/Batch file:

- A Batch should not exceed 20,000 transactions. If the number of transaction for a single merchant exceeds 20,000, you should create multiple batches for the same merchant, each batch containing not more than 20,000 transactions.
- A Batch should not contain only one transaction, unless the merchant has only one transaction for the day.
- A Session file must never contain more than 9,999 Batches.
- A Session file must never contain more than 1,000,000 transactions across all Batches.
- Always allow sufficient time between your submission time and your cut-off time for the processing of the Session. Larger files take longer to process.

## 1.3 Payment Integration Platform (cnpAPI SDKs)

In order to facilitate integration to the platform, Vantiv provides several language specific SDKs (Software Development Kits). The developers page on our website (<http://www.vantiv.com/developers>) provides links to SDK libraries for several popular languages, including:

- PHP
- Ruby
- Java
- .NET
- Python

Extensions for:

- Magento
- Opencart

In addition to the SDKs and extensions, Vantiv provides examples of each supported transaction type, as well as demonstration applications. Once you install the library appropriate to your language, the Vantiv Sandbox, which functions as an emulator of our production environment, is available to validate your transaction format.

## 1.4 Duplicate Transaction Detection

In order to help you avoid transaction errors, Vantiv performs duplicate transaction checking for both Online and Batch transaction submissions. While we use a robust duplicate checking methodology, we cannot guarantee our system will catch all duplicates and bear no responsibility for correcting the impact of erroneously submitted transactions. This section discusses the different checking methodologies used depending upon the type of submission.

---

---

**NOTE:** For tokenized transactions, the token is used in place of the card numbers by the Duplicate Transaction Detection process.

For PayPal transactions a combination of the PayPal Id + the (consumer's) email is used by the Duplicate Transaction Detection process.

For transactions submitted using other formats (e.g., PTI, Nabanco, etc.), the logic used to detect duplicates for these supported, but foreign APIs, is less robust and may miss duplicates in certain scenarios. Vantiv recommends, for better dupe checking, convert to the cnpAPI format, as soon as possible.

---

---

### 1.4.1 Batch Duplicate Checking

When processing a Batch, the system acts to detect duplicate transactions for the following transaction types: Authorization, Auth Reversal, Capture, Force Capture, Capture Given Auth, Credit, Sales, eCheck Credit, and eCheck Sales.

---

---

**NOTE:** For information about duplicate checking of Dynamic Payout Funding Instructions see [Batch Dupe Checking for Dynamic Payout Funding Instructions](#) on page 8.

---

---

For each of these transaction types, the application compares the transaction type, transaction amount, the <orderId> element from the request, credit card number, and credit card expiration date against transactions in other Batch processed within the previous five days. If the characteristics of the new transaction match a previously processed transaction, the system marks it as a duplicate.

The system only performs duplicate detection against valid transactions from the previous five days. For example, if an Authorization request matches a declined Authorization from the previous day, the system would not count it as a duplicate, because the declined Authorization was not a valid Authorization.

Also, a Batch must be processed completely to be included in the previous five days of data. For example, if multiple submitted Batches are processing simultaneously, the system will not compare the transactions in one batch with the transactions in the other, because neither has

completed processing. For this same reason the system cannot detect duplicate transactions within the same Batch.

If the system detects ten consecutive duplicate transactions or if the number of duplicate transactions is greater than or equal to 25% of the total transactions in the batch, the system flags the Batch as a duplicate. When either threshold is met, Vantiv will not process the Batch. If neither threshold is met, Vantiv continues processing the Batch, including any transactions that may have been duplicates.

#### 1.4.1.1 Batch Dupe Checking for Dynamic Payout Funding Instructions

Duplicate checking for funding instructions takes place at the Batch level. The system compares a submitted Batch of instructions to other Batches submitted and accepted on the same day. If a submitted Batch has the same totals and counts as a Batch accepted on the same day, the system rejects the new Batch as a duplicate. If you resubmit a previously rejected Batch, it will not fail dupe checking, because the initial submission was not accepted and is not included in dupe checking comparisons.

---

---

**NOTE:** If you believe we rejected a funding instruction Batch in error, please contact your Partner Account Manager. If necessary, we can disable the dupe check feature for a particular Batch.

---

---

### 1.4.2 Online Duplicate Checking

When processing an Online transaction, the system acts to detect duplicate transactions for the following transaction types: Auth Reversal, Capture, Force Capture, Capture Given Auth, Credit, Sales, eCheck Credit, eCheck Sales, eCheck Void, and Void, as well as Gift Card transactions.

For most transactions, the system compares the transaction type, the `id` attribute from the request, and the credit card number against other Online transactions processed within the previous two days. For transactions that reference other transactions (for example, a deposit referencing an authorization or a refund referencing a deposit), the system compares the transaction type, `id` attribute, and the card number from the referenced transaction (i.e. the transaction identified by the `<littleTxnId>` element) against other Online transactions processed within the previous two days.

The system only performs duplicate detection against valid transactions. For example, if a Capture request matches a declined Capture from the previous day, the system would not count it as a duplicate, because the declined Capture was not a valid transaction.

---

---

**NOTE:** While it is uncommon, under certain circumstances network latency may cause a duplicate Sale transaction to go undetected. This can occur if you submit a second, duplicate Sale transaction while the response from the network for the Authorization portion of the first transaction is sufficiently delayed such that the first Sale has not been recorded as a valid transaction in the system.

If you elect to submit Online Sale transactions, Vantiv recommends a timeout setting of not less than 60 seconds to reduce the chances of undetected duplicate Sale transactions.

---

---

If the system determines a transaction to be a duplicate, The duplicate transactions appears in the Declined Transaction report with a Response Reason Code of 251 - Duplicate Transaction. You can access this report in Vantiv iQ or via the Vantiv Secure Scheduled Report. The iQ version provides information in near real-time, while the SSR version runs daily, providing information for the transaction submitted the previous day.

---

---

**NOTE:** If you do not receive a response for a submitted transaction, Vantiv recommends you use the `queryTransaction` to determine the status of the original transaction (see [Status Query Transactions \(Online Only\)](#) on page 300)

---

---

## 1.5 Coding for Report Groups

You use Report Groups (`reportGroup` attribute) to separate your transactions into different categories, so you can view the financial reports by your specific report group names. If you are unsure what groupings to use, your Relationship Manager can help you determine the best practice for your business.

---

**CAUTION:** Creation of an excessive number of Report Groups (in excess of 250) will impact the amount of time required to compile various reports in the iQ. Report Groups are intended to allow you to segregate transactions by logically grouping them into the different segments of your business. Report Groups are not intended to track sales or marketing programs that exist for limited times. For this type of tracking, Vantiv provides other transaction tagging methods detailed in [Additional/Alternate Methods of Tagging Transactions](#) on page 11.

---

### Example: Report Groups

The merchant, Demo, wants to separate their domestic and international sales information. To do this the company submits all domestic transactions using `reportGroup = "Domestic Business"`, and all international transactions using `reportGroup = "International Business"`. When they access the Authorization Report in the iQ using the By Reporting Group tab, the transactions would be separated as shown in [Figure 1-1](#).

---

**NOTE:** The `reportGroup` attribute is case and space sensitive. A `reportGroup = "Picture Frame"` is a different report group than a `reportGroup = "pictureframe"`.

---

**FIGURE 1-1** Report Group Example - 2 Groups

By Reporting Group	By Activity Date	By Payment Method	By Reason	All Currencies	By Presenter	Recycling Summary	Recycling By Attempt
Reporting Group ▾							
<input type="checkbox"/> Demo <ul style="list-style-type: none"> <li><input checked="" type="checkbox"/> Domestic Business</li> <li><input type="checkbox"/> International Business</li> </ul>	Total Attempts	Declined Auths	Declined %	Approved Auths	Approved %		
	55	21	38.18%	34	61.82%		
	53	21	39.62%	32	60.38%		
	2	0	0.00%	2	100.00%		
Totals:	55	21	38.18%	34	61.82%		

The plus sign next to the Domestic Business report group signifies that there are child groups present. When fully expanded (see [Figure 1-2](#)), the iQ shows a report group hierarchy with information for the Domestic Business group further separated into Service A and Service B groups and Service A containing two additional child groups. If you find it necessary to establish this type of nested hierarchy, your Implementation Consultant will assist you.



**FIGURE 1-2** Report Group Example - Expanded to Show Child Groups

By Reporting Group	By Activity Date	By Payment Method	By Reason	All Currencies	By Presenter	Recycling Summary	Recycling By Attempt
Reporting Group ▼	Total Attempts	Declined Auths	Declined %	Approved Auths	Approved %		
<input checked="" type="checkbox"/> Demo	55	21	38.18%	34	61.82%		
<input checked="" type="checkbox"/> Domestic Business	53	21	39.62%	32	60.38%		
<input checked="" type="checkbox"/> Service A	23	14	60.87%	9	39.13%		
Product 1	19	14	73.68%	5	26.32%		
Product 2	4	0	0.00%	4	100.00%		
Service B	30	7	23.33%	23	76.67%		
International Business	2	0	0.00%	2	100.00%		
<b>Totals:</b>	<b>55</b>	<b>21</b>	<b>38.18%</b>	<b>34</b>	<b>61.82%</b>		

### 1.5.1 Additional/Alternate Methods of Tagging Transactions

If you are using schema version 7.x or above you can use the `merchantData` element and its children to tag transactions (Authorization, Sale, Credit, Force Capture, Capture Given Auth, eCheck Sale, and eCheck Credit) with additional information. The three children of `merchantData`: `campaign`, `affiliate`, and `merchantGroupingId`, allow you to designate transactions as members of different groups enabling a deeper analysis of sales patterns.

---

**NOTE:** The `merchantData` element and its children were added to the schema in V8.8 and backported to V7.3. If you are using a schema version between 7.0 and 8.7, you can code for the use of these elements and still pass the cnpAPI validation.

---

For example, if the merchant from the previous example were trying a new sales initiative for Product 2 during the month of September. They plan to run ads in Boston and New York to test the new offering. To allow a deeper analysis of sales resulting from the new campaign, they can add the `campaign` element with a value of "September Ads" to the transactions originating in both test markets. They can also include the `merchantGroupingId` with values that reflect the city where the order originates. By exporting either the Session report or the NSS by Transaction report from the iQ, the company can sort their sales data based upon these fields and gain a better understanding of the effectiveness of the sales campaign.

---

**NOTE:** The transaction tagging elements described above appear in the exported Session and NSS by Transaction reports. They are also visible within the iQ in the new Transaction Detail reports.

---

## 1.6 Recovery

Recovery is a bundle of services that include both Account Updater and Recycling Engine. By combining these two managed services into a single bundle, Vantiv simultaneously increases your approval rates, optimizes customer lifetime value, and improves your cash flow, while reducing the cost of implementing the individual features separately in terms of IT resources. For additional information about the capabilities included in this bundle, please refer to [Recycling Engine](#) on page 12, and (AAU) [Account Updater Service](#) on page 14.

### 1.6.1 Authorization/Sale Recycling

Authorization recycling is the process of retrying declined authorization attempts. Every merchant, especially those with a business model that uses recurring or installment payments, should devise a strategy for dealing with declined authorizations. As part of optimizing their operations, merchants must devise plans for both the timing and number of recycling attempts before contacting the cardholder or risking interruption of service. If a merchant does not recycle enough, they risk losing customers and revenue; whereas, if the merchant recycles too often, they risk increasing their total cost of payments. Implementing an optimal recycling strategy aids customer retention and therefore yields higher revenues, while lowering the costs of payment acceptance and improving cash flow.

#### 1.6.1.1 Recycling Engine

The Recycling Engine is a managed service that automatically retries declined authorization attempts on your behalf. It requires little or no IT investment on your part. Also, implementing the Vantiv service removes the need to plan your own recycling strategy.

Recycling Engine has the following benefits:

- Increases approval rates
- Shortens time to approval, improving cash flow
- Reduces the number of authorization retries
- Lowers the risk of account/service cancellation

In order to determine the most effective recycle timing, Vantiv performs statistical analysis of past recycling attempts across our entire merchant portfolio. This analysis examines many factors, including method of payment, response codes, and transaction amount among others, to determine the optimum intervals between attempts to obtain a successful authorization. When you receive a declined Authorization, the system automatically queues the transaction for a retry at a designated time. Recycling of the Auth continues until it is either successful or the algorithm determines that it is no longer advantageous to retry.

---

**NOTE:** For Visa transactions, the Recycling Engine will retry declined Authorizations a maximum of 4 times within 16 days, per Visa regulations. For MasterCard and Discover transactions, we retry declined Authorizations a maximum of 8 times within 28 days.

---

Vantiv provides the results of the recycling efforts to you in a Batch posted daily to your Vantiv sFTP account. This file contains transactions that either approved or exhausted the recycling pattern on the previous day. If you submit an Authorization for a transaction in the recycling queue, Vantiv returns the response from the last automatic recycling attempt. To halt recycling of a particular transaction, submit either an Authorization reversal transaction, if the original transaction was an Auth, or a Void transaction, if the original transaction was a Sale.

### Declined Transactions Not Recycled

The system does not recycle transactions declined with one of the Response Codes listed in [Table 1-4](#) below. The <recycleEngineActive> element in the response files indicates if the transaction is being handled by the Recycling Engine.

**TABLE 1-4** Response Codes Not Recycled

Response Code	Message
213	Pickup Card - Lost Card
214	Pickup Card - Stolen Card
303	Pick up Card <sup>1</sup>
304	Lost/Stolen Card <sup>1</sup>
305	Expired Card <sup>1</sup>
308	Restricted Card - Chargeback
309	Restricted Card - Prepaid Card Filtering Service
312	Restricted Card - International Card Filtering Service
315	Restricted Card - Auth Fraud Velocity Filtering Service
318	Restricted Card - Auth Fraud Advice Filtering Service
323	No such Issuer <sup>1</sup>
328	Cardholder requested that recurring or installment payment be stopped
358	Restricted by Vantiv due to security code mismatch
550	Restricted Device or IP - ThreatMetrix Fraud Score Below Threshold

1. Not recycled for MasterCard, unless updated account information is available.

## Transaction Signature

The Recycling Engine analyzes each Authorization or Sale request message to determine if it is a new request. The result of the analysis determines if the transaction should be added to the recycling pool upon decline or if the system should intercept the transaction to prevent a duplicate transaction entering the recycling pool. To perform the analysis, the system checks the transaction signature. Depending upon your configuration, the transaction signature can be:

- Value of the <recycleId> element
- Value of the <orderId> element
- Values of the <orderId>, <number>, and <amount> elements

---

---

**NOTE:** If you submit a transaction with the identical signature, but containing new information (for example, a new card number), the system updates the transaction in the recycling pool with the new info and continues to recycle.

---

---

## Additional Configuration Options

The Recycling Engine allows you the additional flexibility of excluding certain transactions from automatic recycling. You can exclude transactions manually by including the <recycleBy> element set to **None**. There are also global controls that allow you to exclude transactions based upon either submission by a particular presenter, or based upon the transaction type (authorization or sale). Please consult your Relationship Manager about the global options, since they must be configured in your Vantiv Merchant Profile.

## 1.6.2 Account Updater Service

Credit and debit card numbers change for a variety of reasons including card expirations, card product type upgrades, portfolio conversions, and compromised account numbers among others. For merchants who offer services that are billed on a recurring or installment basis (for example, web hosting, gym memberships, specialized social networking, career services, monthly donation plans, etc.) out-of-date payment information can result in lost revenue, involuntary churn and decreased customer satisfaction.

Prior to the development of the Account Updater service, the standard method for merchants to obtain updated account information was to submit a Batch containing existing card information, requesting that Vantiv check for updates. Typically, merchants request updates for customer accounts scheduled to be billed in the next billing cycle. This legacy method is a relatively slow process, requiring several days for Vantiv to accumulate responses from the card networks/issuers and then to make the response file available to the merchant. Merchants must then update their billing systems with the new information, requiring IT processing cost. Failure to update their files can result in multiple requests (and charges) for the update information, as well as delays in or lost revenue, higher Authorization expenses, and possibly chargebacks when old account information is used.

The Account Updater service shifts the workload of obtaining and maintaining updated account information to Vantiv. Utilizing configurable scheduling algorithms, we initiate account update requests on your behalf and then stores the updated card information for use in future transactions. You simply submit billing transactions normally and, if necessary, Vantiv updates the transaction with the stored card information before submitting it to the networks for authorization. This fully managed service requires no code update on your systems.

**FIGURE 1-3** Account Updater Overview

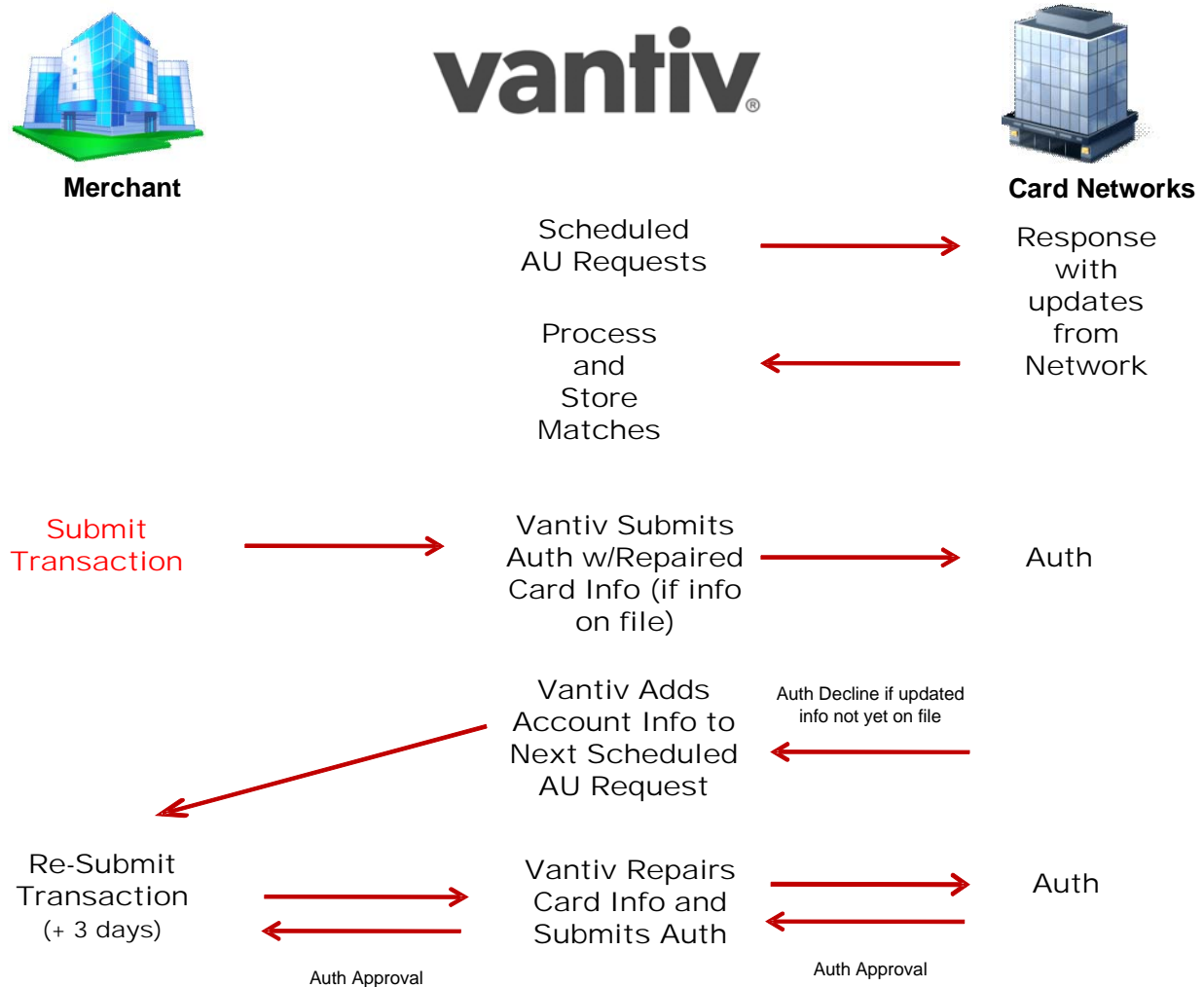

### 1.6.2.1 Match Back

If you decide you wish to have the updated card information returned to you, Vantiv offers the Match Back option. In this case, you can opt to receive updated information either in a Batch deposited to the merchant sFTP account, or in the XML transaction response messages. Once you update your systems, you can resubmit the failed transaction with the new card information. If,

after receiving an update, you submit a transaction with the old information, systems detect that you are using the old data and update the transaction for you prior to submitting it to the networks for authorization.

Please consult your Relationship Manager for additional information and configuration options.

**FIGURE 1-4** Match Back Overview

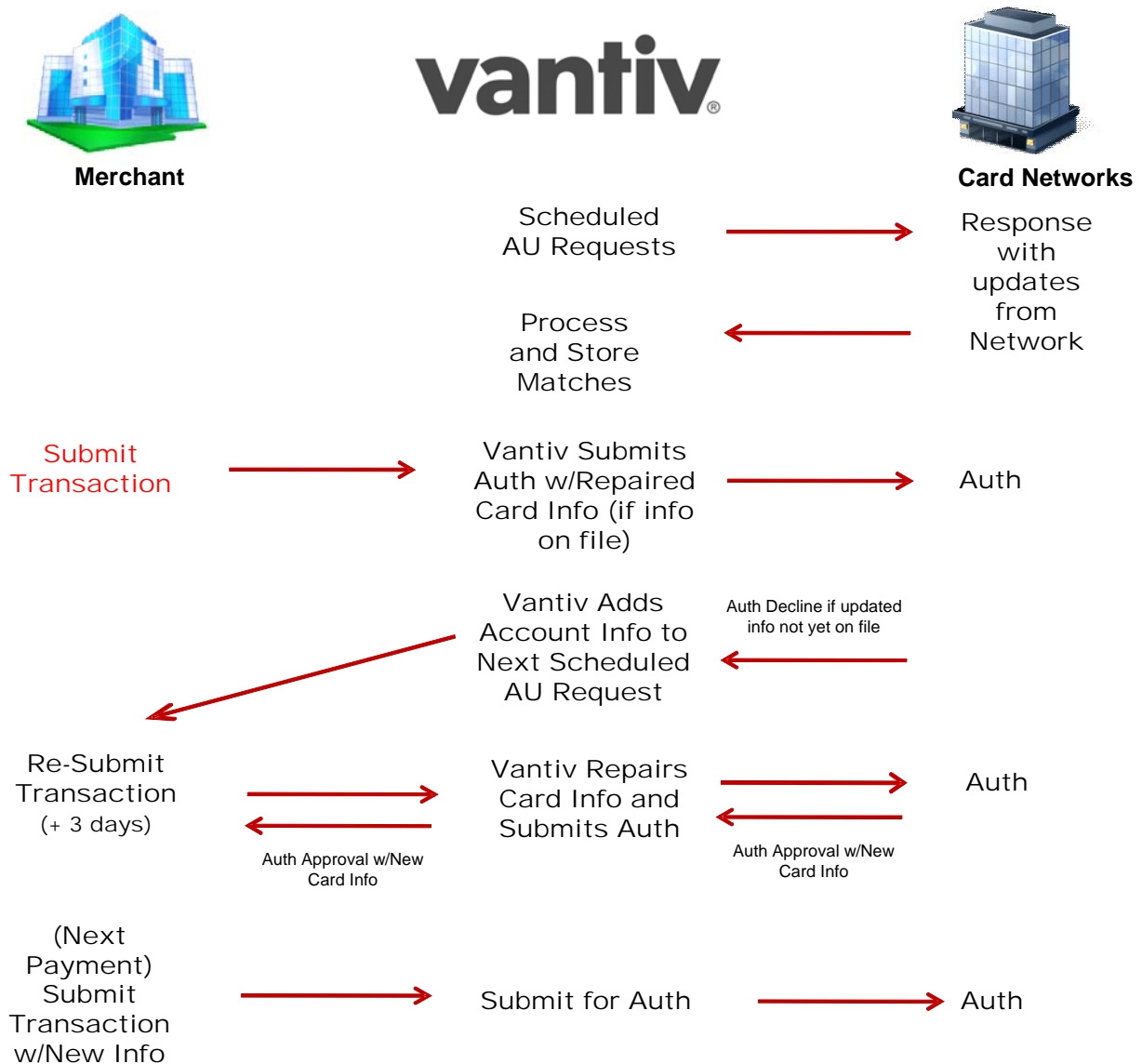

### 1.6.2.2 Merchant Requirements

In order to use the Account Updater service, you must first apply for membership to the following:

- MasterCard Automatic Billing Updater
- Visa Account Updater
- Discover Account Updater (not required by Discover for Vantiv acquired merchants)

Your Account Updater Welcome Kit includes the required application forms. If you have any questions about these forms, contact your Relationship Manager, who can walk you through the application process. Approval from Visa and MasterCard typically takes between 10-15 business days. Normally, merchants are approved without issue; however, you can be declined for a variety of reasons. For example, merchants on a risk mitigation program typically are not accepted.

---

---

**NOTE:** Visa does not allow merchants with SIC numbers 5962, 5966, 5967, or 7995 to participate in their Account Updater service. MasterCard has no restrictions against any specific MCC numbers

---

---

### 1.6.2.3 Account Updater Features

The Account Updater service can include the following features depending upon the implementation option you select:

- Vantiv initiates requests for updated account information to card networks based upon your billing cycle.
- Vantiv initiates requests for updated account information following certain failed Authorization attempts.
- All updated card information stored (per merchant) in our secure database.
- Automatic repair/replacement of outdated information with updated information in new Authorization/Sale transaction submissions.
- Return of the updated account information in the cnpAPI response message when auto-repair occurs.
- Maintenance of card information history, so that the system can repair a card even if multiple updates have occurred during the card's billing lifecycle.
- All linked (to an Authorization) transactions will use the updated account information from the repaired parent transaction, including Captures, Refunds, and Reversals. If a re-Auth is needed on an attempted capture due to an expired authorization, the system uses the updated account information.
- Integration with Vault for merchants utilizing Vantiv's tokenization solution.
- Return of Extended Response Codes in the cnpAPI response messages.

## 1.7 Recurring Engine

The Recurring Engine is a managed service that relieves the burden of developing an in-house billing solution for merchant engaged in installment or recurring transactions. This powerful, but flexible service allows you to create virtually any payment Plan required by your business model, whether it is part of a predetermined campaign or a marketing test, and then apply the Plan to customers as part of the standard Authorization or Sale transaction.

The Recurring Engine provides the following benefits:

- **Reduced Infrastructure Costs** - since you do not need to program your own solution, you save the up-front development cost, as well as ongoing maintenance expenses.
- **Reduced Labor** - once you create a Subscription in the Recurring Engine via a standard Authorization or Sale transaction, no further action is required for the life of the Subscription.
- **Integration with other Vantiv Value Added Services** - if you include the Recovery Services (Account Updater and Recycling Engine) as part of your implementation, you eliminate any concerns (and reduce expenses) associated with issues such as account number changes and recycling of declined payments.
- **Flexible Plans** - You can define the billing interval (weekly, monthly, quarterly, etc.), number of payments (including open ended schedules), amount of payments, as well as trial periods within a Plan. To add flexibility you can override several of these settings and set a specific start date at the individual Subscription level.
- **Flexible Creation of Discounts** - if you wish to offer a discount to selected customers, simply include the information at the time of the Subscription creation, or add it anytime afterward by updating the Subscription.
- **Flexible Creation of Add Ons** - similar to a discount, you can apply changes for additional services at the time of the Subscription, or anytime afterward.
- **Integrated Reporting** - in addition to the normal revenue reconciliation information available in the iQ Reporting and Analytics platform, there are a number of recurring specific reports that allow you to better analyze your revenue stream associated with recurring payment plans and strategies.

### 1.7.1 Payment Plans

The first step in setting up recurring billing on the Vantiv eCommerce platform is to establish one or more payment Plans. To establish a payment Plan you use a Create Plan transaction type, which allows you to define the payment interval, the number of payments, and the amount. For example, you could easily define any number of Plans to fulfill your business needs.

For example, suppose you are a SaaS company that sells your product under 1, 2, or 3 year deals, with either monthly or quarterly payment schedules and reduced rates for longer deals. You could easily set-up six Plans as shown in the table below.



**TABLE 1-5** Example Plans

Plan Code	Payment Interval	Amount per Payment	# of Payments	Total Subscription
1_Year_Monthly	Monthly	\$50.00	12	\$600.00
1_Year_Quarterly	Quarterly	\$150.00	4	\$600.00
2_Year_Monthly	Monthly	\$46.66	24	\$1119.84
2_Year_Quarterly	Quarterly	\$140.00	8	\$1120.00
3_Year_Monthly	Monthly	\$41.66	36	\$1499.76
3_Year_Quarterly	Quarterly	\$125.00	12	\$1500.00

As part of the Plan, you can also specify trial period. You want to have longer trials for longer Plans, so for either 1-year Plan, there is a 1 week trial, for either 2-year Plan there is a 2 week trial, and for the 3-year Plans, a 1 month trial. Below is a cnpAPI example transaction to create the 3\_Year\_Monthly Plan.

**Example: 3-Year Monthly Plan**

```
<createPlan>
  <planCode>3_Year_Monthly</planCode>
  <name>3Year_Monthly</name>
  <description>3 Year, monthly Payments, 1 month trial</description>
  <intervalType>MONTHLY</intervalType>
  <amount>4166</amount>
  <numberOfPayments>36</numberOfPayments>
  <trialNumberOfIntervals>1</trialNumberOfIntervals>
  <trialIntervalType>MONTH</trialIntervalType>
  <active>>true</active>
</createPlan>
```

## 1.7.2 Subscriptions

Subscriptions marry a customer order to a particular payment Plan and initiate the Recurring Engine to manage your future billing. You create a Subscription using either an Authorization or a Sale transaction. In the Auth/Sale you simply include a <recurringRequest> element to initialize the Subscription using a named Plan and set the start date for the first recurring bill. If you do not include a start date, the Recurring Engine uses the current date for the first payment.

If the recurring bill had an associated set-up or one-time fee use a Sale transaction. The amount of the Sale transaction would represent that fee, whereas the amount of future recurring payments are defined in the Plan. If you use an Authorization to create the Subscription, the transaction would normally be a \$0 Auth (or small amount followed by a reversal) and would include the billing information for Address Verification.

As part of the Subscription creation, you can also override both the number of payments and the amount, as well as include Add Ons and Discounts (discussed in the next section). The overrides give you a granular control to modify a standard payments Plan for a particular consumer without creating additional Plans. For example, if you offered a 1-year Plan with monthly payments as shown in the previous section, you could allow a consumer to complete their payments in 10 months instead of a year. In this case you would override the number of payments defined in the Plan (12) with 10 payments, while increasing the amount of each payment from \$50 to \$60.

### Example: Subscription with Overrides

```
<authorization id="834262" reportGroup="ABC Division" customerId="038945">
  <orderId>65347567</orderId>
  <amount>0</amount>
  <orderSource>ecommerce</orderSource>
  <billToAddress>
    .
    .
    .
  </billToAddress>
  <card>
    .
    .
    .
  </card>
  <recurringRequest>
    <subscription>
      <planCode>1_Year_Monthly</planCode>
      <numberOfPayments>10</numberOfPayments>
      <startDate>2016-09-21</startDate>
      <amount>6000</amount>
    </subscription>
  </recurringRequest>
</authorization>
```

### 1.7.2.1 Add Ons and Discounts

Occasionally, you might wish to modify a Subscription with either a Discount or an Add On without creating a new Plan that has limited use. A Discount reduces the recurring amount for one or more payments, while an Add On increases the payments in return for an added service or item. You can apply either of these payment modifications at the time you initialize the Subscription or anytime afterward by updating the Subscription. In both cases you define the start date, end date, and amount of the Discount/Add On.

For example, suppose as part of your standard offering, your customers received 2GB of cloud-based storage. You also offer additional storage in 2GB blocks for \$10 each. One of your customers wants an additional 4GB of storage for the 8 months remaining on his contract and you are discounting the first month at 50%, or \$10. The example below show the `updateSubscription` transaction with the Add On and Discount.

#### Example: Update Subscription with Discount and Add On

```
<updateSubscription>
  <subscriptionId>1234</subscriptionId>
  <createDiscount>
    <discountCode>4GBExtraDeal</discountCode>
    <name>Half-Off 1st Payment 4GB Extra</name>
    <amount>1000</amount>
    <startDate>2016-09-15</startDate>
    <endDate>2016-10-14</endDate>
  </createDiscount>
  <createAddOn>
    <addOnCode>4GB_Extra</addOnCode>
    <name>Four_GB_Extra</name>
    <amount>2000</amount>
    <startDate>2016-09-15</startDate>
    <endDate>2016-04-15</endDate>
  </createAddOn>
</updateSubscription>
```

### 1.7.3 Recurring Reports

In addition to recurring transactions appearing in the normal Vantiv reports (i.e., Payment Detail, Reconciliation report, etc.), there is an additional report associated specifically with the Recurring Engine. Available via sFTP, this report is in Batch format and contains cnpAPI `saleResponse` messages for all recurring transactions run that day, including all approvals and declines (see the example, [Batch Sales Response with Recurring Info](#) on page 323).

## 1.7.4 Transaction Types and Uses

The table below provides information about the various Recurring Engine transaction types and their uses.

**TABLE 1-6** Recurring Engine Transaction Types

Use Case/Intent	Parent Element	Description/Uses
Create Plan	createPlan	Used to create new Plans.
Update Plan	updatePlan	Used to toggle a Plan between an active and inactive state. You can not associate an inactive Plan with a Subscription. Toggling a Plan to an inactive state does not affect existing Subscriptions associated with the Plan.
Create Subscription	<authorization> or <sale> <recurringRequest> <subscription>	Used to initiate a Subscription with an associated Plan. The Subscription can include <code>amount</code> and <code>numberOfPayment</code> overrides to the Plan. Also, the Subscription can include <code>createAddOn</code> and <code>createDiscount</code> children.
Update Subscription	updateSubscription	Used to modify Subscription information including: changing the Plan, changing the billing name/address, and changing the method of payment. You can also use this transaction type to create/delete/update Add Ons and Discounts.
Cancel Subscription	cancelSubscription	Used to cancel an existing Subscription.
Create Add On	<authorization> or <sale> <recurringRequest> <subscription> <createAddOn> Or <updateSubscription> <createAddOn>	Used to create an Add On charge associated with the Subscription.
Update Add On	<updateSubscription> <updateAddOn>	Used to modify one or more of the parameters associated with the Add On.

**TABLE 1-6** Recurring Engine Transaction Types

Use Case/Intent	Parent Element	Description/Uses
Delete Add On	<updateSubscription> <deleteAddOn>	Used to delete an Add On charge from the associated Subscription.
Create Discount	<authorization> or <sale> <recurringRequest> <subscription> <createDiscount> Or <updateSubscription> <createDiscount>	Used to create a Discount charge associated with the Subscription.
Update Discount	<updateSubscription> <updateDiscount>	Used to modify one or more of the parameters associated with the Discount.
Delete Discount	<updateSubscription> <deleteDiscount>	Used to delete a Discount from the associated Subscription.

## 1.8 Issuer Insights

Issuer Insights provides you additional card/transaction, performance descriptive data, allowing you to understand the differences among Issuers and card products, and identify trends that may impact future transactions. Currently, Vantiv bundles four feature sets into Issuer Insights: the Issuer Insights Secure Scheduled Report, Real Time Indicators (i.e., Prepaid Indicator, Affluence Indicator, Issuer Country Indicator, Card Type Indicator), Network Response Data, and the Insights Analytics Dashboard.

### 1.8.1 Issuer Insights Secure Scheduled Report

Every merchant wants to maximize their approval rate and with it their customer conversion rate and sales. Unfortunately, issuing banks do not all use the same criteria and/or algorithms when approving or declining transactions. Getting an approval on an authorization is not a one size fits all proposition.

The weekly Issuer Insights report provides a range of data points that breakdown authorization approvals and declines by card type, BIN (i.e. Issuing Bank), and account ranges (indicating card product types). It also provides data about the four of the most often seen reasons for declines (i.e., Non-sufficient Funds, Do Not Honor, Invalid Account, and Lost/Stolen Card), as well as benchmark data for your MCC(s) across the Vantiv eComm portfolio, and Issuer participation in AU, as well as account update counts per account range across our portfolio. Using this data, you can create a wide range of useful analytics, such as approval/decline trending by BIN, account updates trending by account range, new card issuance/portfolio changes, or customer lifetime value by card type to name a few.

For additional information about this report please refer to the *Vantiv Scheduled Secure Reports Reference Guide*.

### 1.8.2 Real Time Indicators

The Real Time Indicators provide six data points in the Authorization/Sale transaction response message. This information includes the Prepaid Indicator, Affluence Indicator, Issuer Country Indicator, Card Type Indicator, Funding Source Indicator, and Virtual Account Number Indicator. Each of these pieces of information allows you to make a real time decision about how to proceed with the transaction. The sections that follow explain each indicator along with possible uses in your decision making process.

#### 1.8.2.1 Prepaid Indicator

Studies show that branded prepaid cards are growing in popularity with consumers. These cards are available in the form of non-reloadable Gift cards, Consumer Rebate/Incentive cards, and Teen cards among others. The Prepaid Indicator feature acts to determine if the submitted card is a prepaid card. If so, the system returns the `type` element with a value of Prepaid and the

availableBalance element stating the outstanding balance remaining on the card (if available).

Knowing that the card is prepaid at the time of sale, as well as if it is reloadable and the available balance, is especially useful for merchants engaged in recurring payment, installment payment, or deferred billing scenarios. Merchants in these situations can use the information made available by this feature to make intelligent decisions concerning the profitable management of prepaid card usage by avoiding several factors that may contribute to lost revenue, while taking advantage of other opportunities that may add to revenue and enhance the customer experience.

For example, one possible situation merchant can avoid is fraudulent deferred/installment payment purchases made with a prepaid card that does not have enough available balance to cover the subsequent payments. With the available balance known, merchants can determine if the card can meet the required payment structure. If the card's balance does not meet the required threshold, the merchant can request another payment method, which may result in eliminating fraudsters, while retaining legitimate customers. If the card is non-reloadable, it is advisable to not accept the card at all for recurring payments regardless of the available balance.

Another more common situation occurs when the consumer is unaware of the card balance. If the transaction is rejected due to inadequate balance, perhaps repeatedly, it could result in an unsatisfied customer and an abandoned purchase. Alternately, the card could have slightly more than the required balance, which the consumer would spend, if they had the knowledge. If the available balance is insufficient for the purchase, the merchant can obtain a second or alternate payment method. If the balance is higher than required for the purchase, the merchant may be able to encourage additional purchases.

In addition to indicating if the submitted card is a prepaid card and the available balance, this feature includes information about whether the card is reloadable and the specific type of prepaid card (e.g., TEEN, GIFT, PAYROLL, etc.). You can use this information to further refine your sales and marketing strategies.

### 1.8.2.2 Affluence Indicator

Visa, MasterCard, and Discover provide enhanced credit card products for consumers with high disposable incomes and high card spending. These cards encourage usage by offering the cardholders additional benefits usually including reward incentives, no pre-set spending limit, higher authorization approval rates, faster access to a customer service representatives, and dedicated chargeback resolution support.

Vantiv analysis of payments data indicates that consumers using these cards types typically spend more per order than consumers using traditional credit and debit cards. The Affluence Indicator feature provides the ability for merchants to segment their consumers based on the affluence level as determined by the issuer. Within the cnpAPI Authorization response, consumers using these enhanced card products are classified either as Mass Affluent or Affluent. Based upon the specific card type, high income consumers are classified as Mass Affluent, while high income-high spending consumers are classified as Affluent.

Having this information at the time of authorization, allows merchants the opportunity to adjust their sales approach to the needs and spending patterns of the consumer, potentially generating

additional sales. Having this information on file for later analysis also may provide the opportunity for targeted marketing campaigns and future sales.

### 1.8.2.3 Issuer Country Indicator

Knowing the country of the Issuing bank helps you in two respects. From a sales and marketing standpoint, this knowledge allows you to better analyze the purchasing patterns of your customers based upon their country of origin. Knowing these customer demographics can allow you to tailor marketing campaigns to take advantage of this geographic information. Likewise, you can use this information to analyze the successfulness of tailored campaigns.

The second advantage to having this information readily available is that you can use it to help determine possible patterns of fraud. With this knowledge in hand, you can use the International Card Filtering feature to limit your exposure to international fraud originating in particular geographic locations.

### 1.8.2.4 Cardholder Type Indicator

The Card Holder Type indicator is an additional data point Vantiv provides as part of Issuer Insights. This indicator returns an element specifying whether the submitted card is a commercial or consumer card, providing you with additional data useful when analyzing sales patterns and/or planning marketing campaigns, such as offering different products/services to a corporate customer as opposed to a regular consumer.

## 1.8.3 Extended Network Data

In an effort to provide more data for use in analyzing your transactions and customers, Vantiv added a number of data elements originating directly from the ISO 8583 network response messages. If you use V11.0 or above of the Vantiv cnpXML, you can receive up to 17 data elements as part of the Enhanced Auth Response (<enhancedAuthResponse> element). These elements provide more granular data, allowing you to gain a more nuanced understanding of the approval/decline behavior of particular Issuers. [Table 1-7](#) provides information about the fields returned.

---

---

**NOTE:** To receive the Extended Network Data elements you must code to Version V11.0 or above.

---

---



**TABLE 1-7** Possible Extended Network Data ISO 8583 Fields

Data Element	Field Name	Type	Notes
4	Transaction Amount	n 12	
15	Settlement Date	n 4	MMDD format
38	Authorization Identification Response	an 6	
39	Response Code	an 2	
44	Additional Response Data	an..25	
48	Private Use Additional Data	an...999	
50	Settlement Currency Code	n 3	Defines the currency of the settlement
51	Cardholder Billing Currency Code	n 3	
54	Additional Amounts	an...120	
63	Reserved Private	an...999	
104	Transaction Description	an...100	
116	Reserved for National Use	an...999	
123	Reserved for Private Use	an...999	

**Example: Extended Network Data**

```

<enhancedAuthResponse>
.
.
.
  <networkResponse>
    <endpoint>VISA</endpoint>
    <networkField fieldNumber="4" fieldName="Transaction Amount">
      <fieldValue>000000000962</fieldValue>
    </networkField>
    <networkField fieldNumber="44" fieldName="Additional Response Data">
      <networkSubField fieldNumber="0">
        <fieldValue></fieldValue>
      </networkSubField>
    </networkField>
  </networkResponse>
</enhancedAuthResponse>

```

```
</networkSubField>
<networkSubField fieldNumber="1">
  <fieldValue>5</fieldValue>
</networkSubField>
</networkField>
</networkResponse>
</enhancedAuthResponse>
```

## 1.8.4 Insights Analytics Dashboard

The Insights Dashboard provides insight into the quality of customers your organization acquires, based on the number and percentage of authorizations by card type or other indicator, and contrasts that with the number of customers whose authorizations are successfully converted to deposits. There are four categories of indicators: Affluence, Prepaid, Corporate Customers, and Country of Issuing Bank.

Using these values and the related charts, your organization can decide whether the customer mix you attract yields maximum revenue potential, or if a change in marketing is required. By using the adjustable date range and reporting groups, you can compare the quality of customers between different business units and affiliates, or monitor the response to marketing campaigns.

Please refer to the *Vantiv eCommerce Reporting and Analytics User Guide*.

## 1.9 Fraud Toolkit

Just because a credit card network/company returns a valid authorization for a purchase does not always mean that completing the transaction is in your best interest. There are multiple reasons you may wish to decline a sale on a particular card at a particular time. In many cases there are indicators that the transaction could be or likely is fraudulent. Acting to stop these transactions at submission prevents loss, as well as reducing the number fraud related chargebacks in the future. Vantiv offers a robust fraud solution, the Fraud Toolkit, to assist you in reducing the number of possibly fraudulent transactions inflicted upon you by bad actors.

The Fraud Toolkit has three tiers or levels of implementation, each providing more rigorous examination of transaction properties and data points, as well as valuable information and guidance. The table below provide an overview of the tool provided at each level. The items highlighted in blue require the inclusion of a small snippet of code on your checkout page.

**TABLE 1-8** Fraud Toolkit Implementation Levels

Filter/Feature	Essential	Extended	Premium
AVS Filter	X	X	X
CVV No-Match Filter	X	X	X
International BIN Filter	X	X	X
Prepaid Non-Reloadable Filter	X	X	X
Prior Chargeback Filter	X	X	X
Prior Fraud Advice Filter	X	X	X
Card Velocity Filter (Approved or Attempted)	X	X	X
Email Velocity Filter	X	X	X
Phone Velocity Filter	X	X	X
IP Velocity Filter	X	X	X
Device Velocity Filter	X	X	X
IP Address, Geolocation, and Proxy Detection		X	X
Merchant Customizable Rules Template		X	X
ThreatMetrix Cybercrime Dashboard		X	X
(Asynch) Transaction Review Queues		X	X
Rule Management and Portal Training		X	X
Standalone Transaction API Access		X	X
Cybercrime Industry Report (Quarterly)		X	X

**TABLE 1-8** Fraud Toolkit Implementation Levels

Filter/Feature	Essential	Extended	Premium
Access to Fraud Consultant			X

## 1.9.1 Essential Tier

The Essential tier includes a suite of eleven Fraud Filters that you can apply individually or in combination. Nine of the eleven filters, based on card/submitted data, potentially require no additional integration on your part, assuming you already submit the necessary information. The remaining two filters require you to add a small snippet of code on your checkout page.

---

**NOTE:** Technically, you can make use of the IP Velocity filter without integrating the code snippet on your checkout page. Instead you can simply include the originating IP Address that you detect in your transaction by submitting it as a `customAttribute`. Please note that this method will likely be less effective than making use of the ThreatMetrix functionality, which includes IP piercing to determine the true IP of the consumer's device.

---

### 1.9.1.1 Prepaid Card Filtering

Many merchants engaged in recurring payment, installment payment, or deferred billing experience some loss due to fraud schemes that make use of prepaid cards. Consider the case of a consumer using a prepaid card with a balance of \$100 to make a purchase that involves an initial charge of \$50 followed by three installments of \$50 each. The authorization would be approved for the initial transaction, and the card might have adequate balance for an additional charge, but if the consumer was attempting to defraud the merchant or simply used the card for other purchases, the card may not have sufficient balance for any additional payments. While the Prepaid Indicator feature provides you with the information necessary to make a decision at the time of the sale, and to request a secondary or different payment method, instead you may wish to have Vantiv filter these transactions automatically when you send the Authorization transaction.

If you elect to use the Prepaid Card Filtering Service, you can select one of two methods of implementation. Using the first filtering method, our system declines all Authorization and Sale transactions when the consumer uses a prepaid card. Upon a decline, the system returns a Response Reason Code of **309 - Restricted Card - Prepaid Card Filtering Service**. This method also allows you to disable the filtering logic on a transactional basis by including the `<prepaid>` element set to a value of **false**, allowing you to accept any prepaid card for these transactions.

The second method of implementing the Prepaid Card Filtering Service is per transaction. To enable the filter on a particular transaction, set the `<prepaid>` element to a value of **true**. This method is useful to a merchant who offers products with both one-time payments and installment

payments. For products involving a single payment, you may want to allow the use of prepaid cards, while for the product with multiple payments you may want to filter prepaid cards.

---

**NOTE:** Within either implementation method, you can elect to filter all prepaid cards, or only non-reloadable prepaid cards. Please speak to your Implementation Consultant for additional information about setting these global parameters.

---

### 1.9.1.2 International BIN Filtering

An examination of your historical fraud data may show a high percentage of fraudulent transactions originating with certain international cards. You can limit your exposure to this type of fraud by taking advantage of the International Card Filtering Service. This feature allows you to filter MasterCard and Visa cards originating in either all foreign countries or selected foreign countries based upon the country of the card issuer.

If you elect to use this feature, when you submit an Authorization/Sale transaction, the system determines the country of origin of the card. If the card originates outside the United States and you have elected to filter all international cards, the system declines the transaction. Likewise, if you have elected to filter a specific country or countries and the card originates from a designated country, the system declines the transaction. Upon a decline, the system returns a Response Reason Code of **312 - Restricted Card - International Card Filtering Service**.

You can override your settings on a transactional basis by including the `<international>` element set to **false** when you submit the Authorization/Sale transaction. In this case, the system ignores the filtering service and processes the transaction normally.

### 1.9.1.3 Prior Chargeback Filtering

If you elect to use the Chargeback Filter Service, there are two configuration options. You can elect to filter all transactions using a card for which you received a chargeback, or you can elect to filter only the subset of transactions for which you received a fraud related chargeback (determine by the associated chargeback reason code). In both cases, the system checks your historical data to see if you received an applicable chargeback from the same account within the last 90 days. Upon a decline, the system returns a Response Reason Code of **308 - Restricted Card - Chargeback**.

### 1.9.1.4 Security Code No-Match Filter

The Card brands added the 3- or 4-digit security code to act as a verification that the person ordering your product in a card-not-present environment has physical possession of the card. While this validation can be a useful anti-fraud tool, typically, many issuing banks do not decline the transaction based upon a failure to match the security code. Declining the transaction is left to the discretion of the merchant.

---

**NOTE:** Since American Express declines the transaction when the security code does not match, the Security Code No-Match filter does not apply to American Express transactions. Transactions declined by American Express for a failure to match the security code use the Response Reason Code of **352 - Decline CVV2/CID Fail**.

Similarly, if Visa, MasterCard, or Discover decline a transaction based upon the security code results, Vantiv does not apply the filter and the transaction response contains the **352 Reason Code**.

---

If you elect to use the Security Code No-Match Filter Service, the system takes action only if the issuer approves the submitted authorization/sale transaction, but includes a no-match code for the CVV2/CVC2/CID card validation check. In this case, the Vantiv declines the transaction with a Response Reason Code of **358 - Restricted by Vantiv due to security code mismatch**. The system also issues an Auth Reversal transaction on your behalf to remove the funds hold on the account.

### 1.9.1.5 Card Velocity Filtering

Often, when a person attempts to use a stolen credit card successfully, they will follow the initial purchase with a number of additional purchases within a short period of time. If you elect to use the Fraud Velocity Filter, the system filters the transaction based upon the number of previously approved Auth/Sale transactions plus the number of Auth/Sale transactions declined by another filter, for the same account within a designated time period. Both the total number of transactions and the time period are configured in the Vantiv Merchant Profile.

Upon a decline, the system returns a Response Reason Code of **315 - Restricted Card - Auth Fraud Velocity Filtering Service**.

### 1.9.1.6 Prior Fraud Advice Filtering

Vantiv maintains a database of Fraud Advice information received from the Visa and MasterCard networks for transactions you processed in the last 200 days. If you use the Prior Fraud Advice Filter, the system compares the account information from the new transaction against the database of accounts with prior Fraud Advice and filters the transaction if there is a match.

Upon a decline, the system returns a Response Reason Code of **318 - Restricted Card - Auth Fraud Advice Filtering Service**.

### 1.9.1.7 AVS Filter

One of the fraud prevention tools provided by all card networks is an Address Verification System. By submitting the customer's address information in the `billToAddress` section of the cnpAPI message, you can verify that the address/zip code supplied by the consumer matches the issuer's records. The card networks, however, do not decline transactions based upon the failure

to match the address or zip code. Using the AVS Filter, you can filter potentially fraudulent transactions based upon failure to match any of the following:

- the address
- the zip/postal code
- the address + zip/postal code (ANDed)
- the address or zip/postal code (ORed).

Upon a decline, the system returns a Response Reason Code of **319 - Restricted Card - Fraud AVS Filtering Service**.

### 1.9.1.8 Email Velocity Filter

Often, card testers or other bad actors submit a number of transaction using multiple cards, but with a common email address. The only requirement to make use of this filter is that you collect and include the consumer's email address with each transaction. We communicate the email address to our fraud partner, ThreatMetrix, who tracks and analyzes the information. If the filter detects the same email used in the configured number of transactions within the configured period of time, the system declines new transactions (using the same email) on your behalf and returns Response Code **550 - Restricted Device or IP - ThreatMetrix Fraud Score Below Threshold**.

### 1.9.1.9 Phone Velocity Filter

Similar to email, card testers or other bad actors often submit a number of transaction using multiple cards, but with a common phone number. The only requirement to make use of this filter is that you collect and include the consumer's phone number with each transaction. We communicate the phone number to our fraud partner, ThreatMetrix, who tracks and analyzes the information. If the filter detects the same phone number used in the configured number of transactions within the configured period of time, the system declines new transactions (using the same email) on your behalf and returns Response Code **550 - Restricted Device or IP - ThreatMetrix Fraud Score Below Threshold**.

### 1.9.1.10 IP Velocity Filter

The IP Velocity filter is one of the two filter in the Essential tier that requires (see note below) the addition of a code snippet to your checkout page. This snippet, which you also need to implement for the higher tiers of Fraud Toolkit, allows our partner, ThreatMetrix, to perform IP interrogation/piercing to determine the true IP Address of the device originating the order. As with the other velocity filters, if the filter detects the same IP Address used in the configured number of transactions within the configured period of time, the system declines new transactions from the same IP Address on your behalf and returns Response Code **550 - Restricted Device or IP - ThreatMetrix Fraud Score Below Threshold**.

---

**NOTE:** Technically, you can make use of the IP Velocity filter without integrating the code snippet on your checkout page. Instead you can simply include the originating IP Address that you detect in your transaction. Please note that this method will likely be less effective than making use of the ThreatMetrix functionality, which includes IP piercing to determine the true IP of the consumer's device.

---

### 1.9.1.11 Device Velocity Filter

The Device Velocity filter is the second Essential tier filter in the that requires the addition of a code snippet to your checkout page. In this case, the snippet allows ThreatMetrix to construct a device fingerprint of the system originating the order. As with the other velocity filters, if the filter detects the same device used in the configured number of transactions within the configured period of time, the system declines new transactions from the same device on your behalf and returns Response Code **550 - Restricted Device or IP - ThreatMetrix Fraud Score Below Threshold**.

### 1.9.1.12 Application of Filters - Filtering Rules

---

**NOTE:** Filter Rules are defined as part of your Merchant Profile. Please consult with your Relationship Manager and/or your Implementation Consultant concerning the provisioning of Filter Rules.

---

While you can have all submitted transactions flow through the Fraud toolkit, you likely want to exercise a finer control over the application of the filters based upon a particular product, service or other criteria. The system provides you the flexibility of restricting which transactions are submitted to the filtering service and which filters the system applies to which groups. This is accomplished by defining Filtering Rules.

For each Filtering Rule you first define a subgroup of transactions by selecting one of the following Flow Selectors: Report Group, Billing Descriptor, orderSource, or MID (for PayFacs, flow control by MID or order source only). Only one selector can be applied per rule. After selecting a particular Flow Selector, you then select which filters to have applied to that subset of transactions. You can define the Filter Rules so that filters are ORed (transaction filtered when any one of the filters conditions met), or ANDed (transaction filtered when multiple filter conditions met). [Table 1-9](#) defines five rules that a merchant might define.

**TABLE 1-9** Example - Fraud Filtering Service Rules

Filter	Flow Selector	Filters
1	Report Group = "XYZ"	Prepaid



**TABLE 1-9** Example - Fraud Filtering Service Rules

Filter	Flow Selector	Filters
2	Report Group = "XYZ"	International
3	orderSource = "recurring"	Prepaid + Prior Chargeback
4	orderSource = "ecommerce"	Card Velocity + Security Code No-match
5	Billing Descriptor = "GoldMember"	Prepaid + International

Table 1-9 defines five Filter Rules that a merchant might use. These rules would be applied as follows:

- Filters 1 and 2 apply to the subset of transactions that are members of Report Group XYZ and use the Prepaid and International Filters. Since the Filter Rules are defined separately, the rules are ORed. So, if a transaction uses either a Prepaid card or a card of International origin, the filtering occurs.
- Filter 3 applies to the subset of transactions that have an orderSource value set to recurring. Filtering occurs only if both the criteria for the Prepaid Filter AND the Prior Chargeback Filter are met.
- Filter 4 applies to the subset of transactions that have an orderSource value set to ecommerce. Filtering occurs only if both the criteria for the Card Velocity Filter AND the Security Code No-Match Filter are met.
- Filter 5 applies to the subset of transactions that have an Billing Descriptor value set to GoldMember. Filtering occurs only if both the criteria for the Prepaid Filter AND the International Filter are met.

## 1.9.2 Extended Tier

The Extended Tier include all of the Essential Tier filters, but offers an additional levels of fraud detection made available through Vantiv's partnership with ThreatMetrix. The addition of the same code snippet used for the IP and Device Velocity filters to your checkout page allows ThreatMetrix to gather additional data points, such as the consumer's device, proxy use, and location. Unlike the filters in the Essential Tier, which are basic accept/decline filters, the Extended Tier takes the data and compares the information to a rule list. Vantiv supplies an initial, Best Practices rules list designed for your business type (i.e., Retail, Digital, Non-profit, etc.), which you can modify and refine for you particular business model. Each rule, when triggered, add or subtract a preset value from the transaction score. If the score fall below a set threshold, the system declines the transaction, unless you prefer to make the final decision yourself. In either case, Vantiv returns the score and a list of triggered rules in the transaction response message.

In addition to the ThreatMetrix rules engine, you get access to the ThreatMetrix Portal allowing you to customize your rules list and scoring values. This level also allows you to white list/black list items, such as email addresses and phone numbers. Other items included in this tier are:

- ThreatMetrix Cybercrime Dashboard

- Asynchronous Transaction Review Queues
- Monthly Rules and Portal training
- API Access to Standalone Fraudcheck transaction.

### 1.9.3 Premium Tier

The Premium Tier provides all of the tools from the Essential and Extended Tiers, and most importantly, access to the Vantiv eComm Fraud Consulting service. With the service, the Fraud Consultant assigned to you helps analyze your transactional data, recommend rule changes to fine-tune your results, and advises you on fraud detection strategy.

### 1.9.4 Modifications to Your Web Page

For ThreatMetrix to gather information for analysis, you must add certain profiling tags (see example below) to selected pages served by your web application. These tags allow ThreatMetrix to collect information by loading objects used for detection into the consumer's browser. These tags are invisible to the consumer and add only a fraction of a second to your page's rendering time. Once loaded, these objects require only 3-5 seconds to gather profiling information from the consumer device.

Place the tags as early as possible on the page, inside the <body></body> tags of the page HTML.

#### Example: ThreatMetrix Profiling Tags

---

---

**NOTE:** Replace `UNIQUE_SESSION_ID` with a uniquely generated handle that includes the Vantiv supplied prefix.

The value for `ORG-ID` is a Vantiv supplied value.

The `pageid` tag is not used at this time. The value for `PAGE-ID` defaults to 1.

For production, replace `h.online-metrix.net` with a local URL and configure your web server to redirect to `h.online-metrix.net`.

---

---

```
<!-- Begin ThreatMetrix profiling tags below -->
<script type="text/javascript"
src="https://h.online-metrix.net/fp/tags.js?org_id=ORG_ID&session_id=UNIQUE_SESSION_ID&pageid=PAGE_ID"></script>
<noscript>
<iframe style="width: 100px; height: 100px; border: 0; position: absolute; top: -5000px;"
src="https://h.online-metrix.net/tags?org_id=ORG_ID&session_id=UNIQUE_SESSION_ID
&pageid=PAGE_ID"></iframe>
```

```
</noscript>  
<!-- End profiling tags -->
```

### 1.9.4.1 cnpAPI Transactions

To subject a transaction to the advanced fraud checks performed by ThreatMetrix and retrieve the results, you simply submit the `<threatMetrixSessionId>` element as part of your cnpAPI Authorization (or Sale) transaction. This session Id is the same unique value you assigned and sent to ThreatMetrix when your web page called the application (designated as `UNIQUE_SESSION_ID` in the ThreatMetrix Profiling Tags example). When we receive an Authorization/Sale that includes the `<threatMetrixSessionId>`, our system automatically queries the ThreatMetrix platform for the associated results. The cnpAPI response message includes the `<advancedFraudResults>` element containing the score and status and information about any triggered rules. The following two examples show a standard Authorization transaction, including a `<threatMetrixSessionId>` and a **pass** response.

#### Example: Authorization including `<threatMetrixSessionId>` Element

```
<cnpOnlineRequest version="12.0" xmlns="http://www.vnativcnp.com/schema"  
  merchantId="81601">  
  <authentication>  
    <user>User Name</user>  
    <password>password</password>  
  </authentication>  
  <authorization id="002" reportGroup="001601">  
    <orderId>10102013_sessionId_app</orderId>  
    <amount>1002</amount>  
    <orderSource>ecommerce</orderSource>  
    <billToAddress>  
      <name>John Doe</name>  
      <addressLine1>15 Main Street</addressLine1>  
      <city>San Jose</city>  
      <state>CA</state>  
      <zip>95032-1234</zip>  
      <country>USA</country>  
      <phone>9782750000</phone>  
      <email>nobody@vantiv.com</email>  
    </billToAddress>  
    <card>  
      <type>MC</type>  
      <number>5405102001000003</number>  
      <expDate>1115</expDate>  
    </card>  
    <advancedFraudChecks>
```

```
<threatMetrixSessionId>ASDFG-AXXXXAB999</threatMetrixSessionId>
</advancedFraudChecks>
</authorization>
</cnpOnlineRequest>
```

### Example: Authorization Response including <advancedFraudResults> Element

```
<cnpOnlineResponse version="12.0"
xmlns="http://www.vantivcnp.com/schema" response="0" message="Valid
Format">
  <authorizationResponse id="002" reportGroup="001601">
    <cnpTxnId>82823534116454639</cnpTxnId>
    <orderId>10102013_sessionId_app</orderId>
    <response>000</response>
    <responseTime>2017-10-08T21:36:50</responseTime>
    <postDate>2017-10-08</postDate>
    <message>Approved</message>
    <authCode>000003</authCode>
    <fraudResult>
      <avsResult>00</avsResult>
      <advancedFraudResults>
        <deviceReviewStatus>pass</deviceReviewStatus>
        <deviceReputationScore>50</deviceReputationScore>
        <triggeredRule>FlashImagesCookiesDisabled</triggeredRule>
      </advancedFraudResults>
    </fraudResult>
  </authorizationResponse>
</cnpOnlineResponse>
```

---

**NOTE:** The other possible values for the <deviceReviewStatus> element are *fail*, *review*, *unavailable*, and *invalid\_session*.

The <deviceReputationScore> value can range from -100 to 100. The resulting pass, fail, or review value depends upon your profile settings.

The <triggeredRule> element can occur multiple times, once for each rule triggered.

---

### 1.9.4.2 Information Only Option

If you wish to retain full control of the decision to accept or decline transactions, Vantiv offers the option of using the Advanced Fraud Tools in an Information Only mode. In this configuration, you receive the same information in the response as you would with the full implementation; however, Vantiv will not automatically decline transactions with a failing score.

If the authorization is declined by the network, you can choose to recycle the transaction or do nothing. If an authorization with a failing score receives approval from the network, it would be up to you to reverse the authorization should you decide not to proceed with the transaction. This is similar to the case of an approved transaction that has a status of Review, but you decide not to proceed. Issuing an authorization reversal allows you to avoid any misuse of Auth fees otherwise imposed by the card networks.

### 1.9.4.3 Fraud Check Transactions

If you wish to retrieve the Advanced Fraud results without introducing a Authorization or Sale transactions, use a Fraud Check transaction (see [Fraud Check Transaction](#) on page 288). Fraud Check transactions are only supported as Online transactions.

## 1.10 Tokenization Feature

Tokenization is the process by which a reference number, referred to as a token, replaces a credit card number or eCheck account number. Unlike the card or account number, you can store the token on your system without concern of a security breach exposing critical customer information. Instead, Vantiv stores the information in a secure vault and accesses it only when you submit a transaction using the supplied token.

---

---

**NOTE:** You must be enabled for card tokenization to use the eCheck tokenization feature.

---

---

In the case of credit cards, since you do not store the customer's account information, the scope of PCI requirements to which you must comply may be minimized. This may greatly reduce the cost of compliance and may limit your liability in the event of a breach. You can reduce the requirements further, as well as the possibility of exposure from a breach, through the use of the Vantiv eProtect™. By sending the card information from your checkout page directly to our systems you eliminate one more facet of handling the card information.

---

---

**NOTE:** Vantiv recommends you consult your own PCI Compliance and Legal departments to determine the specific advantages of tokenization for your company.

---

---

This section discusses the following topics:

- [How Tokenization Works](#)
- [Token Formats](#)
- [Obtaining Tokens](#)
- [Supported Token Transactions](#)

---

---

**NOTE:** Please refer to the *Vantiv eProtect Integration Guide* for additional information about the use of and integration to the Vantiv eProtect value added service.

---

---

## 1.10.1 How Tokenization Works

In a non-tokenized environment, multiple parties handle and store customer data, including the card/eCheck account number, for each transaction. From a merchant standpoint, they receive the information, store it in their own database, and transmit it to their processor with the transaction request, as shown in [Figure 1-5](#) for card information. While the access and transmission of the data may occur a single time, as in the case of a Sale transaction, frequently data transmission occurs multiple times in order to complete a single sale, as in the case of an Auth followed by a Capture or several partial Captures. The local storage and repeated transmission of the information creates additional possible breach points, where a malicious third party could compromise the information.

**FIGURE 1-5** Card Information Flow in Non-Token Environment

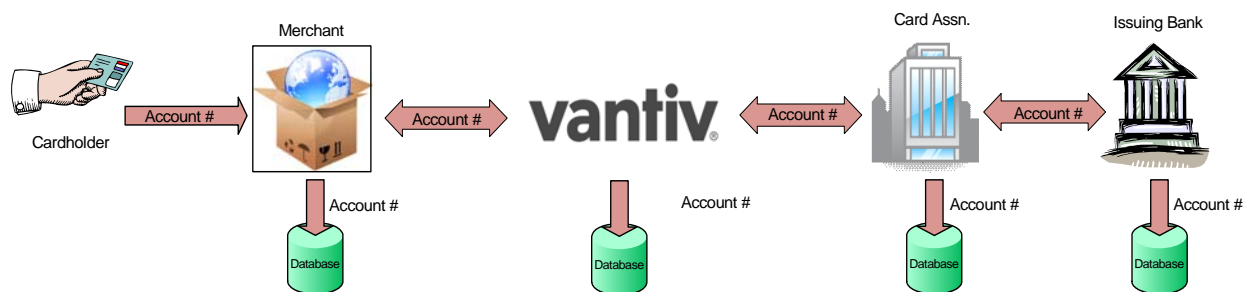

In a tokenized environment transmission of customer data ideally occurs a single time and the merchant never stores it locally, as shown in [Figure 1-6](#) for card data. Once account number registration occurs, using either a `registerTokenRequest` or by submitting the account number (or low value token, when using eProtect) with any supported transaction, Vantiv returns a (high value) token. You store the token locally and use it for all future transactions concerning that account. Vantiv takes responsibility for storing and safeguarding the account information.

---

**NOTE:** The difference between card data flow and eCheck data flow is that the entities upstream of Vantiv are different. The operation remains the same from a merchant standpoint.

---

**FIGURE 1-6** Card Information Flow in Tokenized Environment

---

---

**NOTE:** The use of eProtect allow the account information to come directly to Vantiv, so the merchant handles the token only.

---

---

## 1.10.2 Token Formats

For credit cards, in an effort to minimize development requirements on the merchant side, Vantiv elected to use a format-preserving tokenization scheme. In simple terms this means that the length of the original card number is reflected in the token, so a submitted 16-digit number results in a 16-digit token. Also, all tokens use only numeric characters, so you do not have to change your systems to accept alpha-numeric characters.

The credit card token numbers themselves have two parts. The last four digits match the last four digits of the card number. The remaining digits (length can vary based upon original card number length) are a randomly generated. Unlike credit card numbers, which are Mod 10 compliant, tokens are Mod 10 + 1 compliant.

**FIGURE 1-7** Token Format - Card

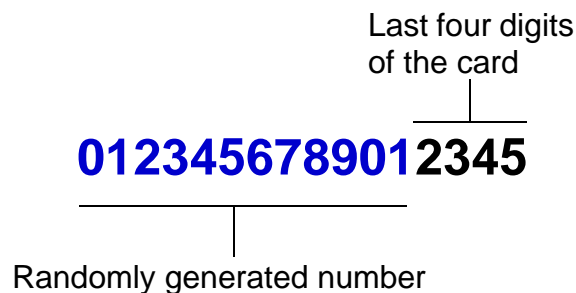

For an eCheck token, since the account number length can vary widely, we elected to make the tokens a uniform length of 17 digits. Unlike card tokens, the entire eCheck token number is a randomly generated. The system supplies the last three characters of the account number in a separate element, unless the account number is less than 4 characters. As with credit card tokens, eCheck tokens are Mod 10 + 1 compliant.

## 1.10.3 Obtaining Tokens

---

---

**NOTE:** You must be token enabled and certified prior to using the Vault feature. Please consult your Relationship Manager concerning the requirements and details of this process.

---

---

There are three ways for you to obtain tokens for account numbers. First, you can submit an existing card number/eCheck account information (account number and routing number) using a Register Token request. When Vantiv receives this transaction type, we generate a token and



return it to you via a Register Token response (see [Register Token Transactions](#) on page 307.) Although you can use this method to tokenize an account number at any time, it is most useful when initially tokenizing your customer database. Vantiv recommends that you collect all distinct credit card numbers in your database and submit the information in one or more large Batch. When you receive the response file, parse the returned token information to your database, replacing the card numbers.

The second method you can use to obtain a token is to submit a supported transaction with the card information. If you are a tokenized merchant, Vantiv will automatically convert the submitted card number to a token and return it to you in the transaction response. Typically, you would use this method when taking and submitting a transaction during the normal course of business. When you receive the response, you store the token instead of the card information.

---

---

**NOTE:** Once we convert a card number to a token for a particular merchant, subsequent submissions of the same card number return the same token.

---

---

The third method of obtaining a token applies only to merchants using the Vantiv eProtect feature. In this case, upon submission of an account number via the eProtect API, Vantiv issues a Registration Id. You then submit the Registration Id in an Authorization or Sale transaction and receive the token in the response message.

### 1.10.3.1 Bulk Token Registration

If you are new to Vantiv, and have utilized tokens with a previous processor, Vantiv can perform a bulk token registration on all the card numbers that were vaulted with your previous processor. The following is an example of the process:

1. During your implementation with Vantiv, you contact your previous processor and request an encrypted mapping file containing the card and token numbers for your customers. A Implementation Consultant will work with you and your previous processor to facilitate the secure transfer of this file without impacting your PCI compliance. The file can be comma-delimited, tab-delimited, or any other common format.
2. Vantiv performs a bulk token registration of all of the card numbers contained in the file.
3. Vantiv returns a mapping file to your organization containing the old tokens and the new Vantiv-issued tokens, so that you can update your order processing system.

Note that Vantiv supports token-extractor formats of all major token service providers. Contact your Implementation Consultant for more information or to initiate this process.

## 1.10.4 Supported Token Transactions

The following transactions support the generation and use of tokens:

- **Authorization** - You can submit the transaction either with a token or card information. If you submit card information, Vantiv automatically generates the token and returns it in the response.
- **Capture Given Auth** - You can submit the transaction either with a token or card information. If you submit card information, Vantiv automatically generates the token and returns it in the response.
- **Credit** - You can submit the transaction either with a token or card information. If you submit card information, Vantiv automatically generates the token and returns it in the response.
- **Force Capture** - You can submit the transaction either with a token or card information. If you submit card information, Vantiv automatically generates the token and returns it in the response.
- **Register Token** - You use this transaction to convert a card number or eCheck account number to a Vantiv token without an associated authorization, verification or payment transaction.
- **Sale** - You can submit the transaction either with a token or card information. If you submit card information, Vantiv automatically generates the token and returns it in the response.
- **eCheck Credit** - You can submit the transaction either with a token or account information. If you submit account information, Vantiv automatically generates the token and returns it in the response.
- **eCheck Redeposit** - You can submit the transaction either with a token or account information. If you submit account information, Vantiv automatically generates the token and returns it in the response.
- **eCheck Sale** - You can submit the transaction either with a token or account information. If you submit account information, Vantiv automatically generates the token and returns it in the response.
- **eCheck Verification** - You can submit the transaction either with a token or account information. If you submit account information, Vantiv automatically generates the token and returns it in the response.
- **Update Card Validation Number** - This is a special transaction type provided to allow the update of a CVV2/CVC2/CID code supplied at the time of the token registration. You should only use this transaction type if you had previously submitted the account number and security code in a `registerTokenRequest` transaction and now need to change the CVV2/CVC2/CID value.

## 1.10.5 Compliance with Visa Best Practices for Tokenization

As shown below, the Vault tokenization solution complies with 11 of the 12 items listed in the Visa Best Practices for Tokenization document. The twelfth item concerns the management of stored historical data (that may contain card information) within your systems. Tokenizing all historical card info when implementing the Vantiv solution would satisfy this item, as would protecting it per PCI DSS requirements.

**TABLE 1-10** Visa Best Practices for Tokenization Compliance

Item #	Who	Domain	Best Practice	Complies?
1	Vantiv	Tokenization System	Network Segmentation	Yes
2	Vantiv	Tokenization System	Authentication	Yes
3	Vantiv	Tokenization System	Monitoring	Yes
4	Vantiv	Tokenization System	Token Distinguishability	Yes
5	Vantiv	Token Generation	Token Generation	Yes
6	Vantiv	Token Generation	Single- vs. Multi- use Tokens	Yes
7	Vantiv	Token Mapping	PAN Processing	Yes
8	Vantiv	Card Data Vault	PAN Encrypted in Storage	Yes
9	Vantiv	Card Data Vault	Covered by PCI DSS	Yes
10	Vantiv	Cryptographic Keys	Key Strength	Yes
11	Vantiv	Cryptographic Keys	Covered by PCI DSS	Yes
12	Merchant	Historical Data Management	Non-tokenized data protected	Merchant Implementation Decision

## 1.11 eCheck Processing

An eCheck is an alternative payment method that directly debits a consumer's account via the Automatic Clearing House (ACH) network. From a merchant's standpoint offering eCheck as a payment method has several advantages, including a large consumer base in excess of 130 million accounts in the United States and no interchange fees.

This section provides information about several Vantiv eCheck processing features. Please consult with your Relationship Manager for additional information.

---

---

**NOTE:** Beginning in March, 2015, Vantiv also supports eCheck processing for our merchants doing business in Canada. All eCheck transaction types, except Verification and Prenotification transaction are supported. Please consult your Relationship Manager for additional information.

---

---

### 1.11.1 Validation Feature

Vantiv performs a validation of the eCheck routing number. This is done both to verify that the routing number is correctly formatted and that it exists in the Fed database. If the routing number fails this validation, the transaction is rejected. Vantiv performs this validation on all eCheck transactions automatically.

### 1.11.2 Verification Feature

Since there is no authorization process associated with eChecks allowing you to confirm the availability of funds and hold the purchase amount, there is a higher risk of certain types of fraud. The optional eCheck Verification feature allows you to submit an eCheck account number for comparison to a database containing historical information about the account, as well as the account holder. When you submit an eCheck Verification transaction the information you provide is compared to a negative database to see if the account is associated with activities, such as fraud, over drafts, or other items determined to be risk factors.

---

---

**NOTE:** Vantiv makes use of a third party service, Certegy Check Services Inc., for all verification operations.  
The verification service is not supported for Canadian eChecks.  
The verification service is not available for PayFacs.

---

---

You can also initiate an account verification operation as part of an eCheck Sale transaction by setting the <verify> element to **true**. In this case, the eCheck Sale transaction is conditional upon the verification passing. If the verification fails, the sale is not processed.

### 1.11.2.1 Required Contents of Decline Notice

In the event you elect to perform verification on a transaction and also elect not to proceed with the transaction based upon a verification failure, you must provide your customer with the following Decline Notice. You can provide the notice orally, electronically, via e-mail, and/or via U.S Mail, depending upon the type of transaction. The notice must be substantially as the notice set forth below that contains the disclosures required under the Fair Credit Reporting Act and instructs your customer how to contact Certegy directly.

---

---

**NOTE:** If the required language of the Decline Notice changes, Vantiv will notify you of the change. You must enact the changes within 10 days.

---

---

#### Example: Decline Notice

We're sorry, but we are unable to proceed with your transaction. This determination was based on information provided by Certegy Check Services, Inc. ("Certegy"). To protect your privacy, Certegy did not provide any financial information to [Client's Name] during the authorization process.

The reason your transaction was not authorized was due to [mark one of the following based on applicable decline code transmitted by Certegy]:

- account closed
- dishonored check or transfer information contained in Certegy's files
- Certegy had insufficient information available
- the identification information you entered did not conform to established guidelines

You have the right under the Fair Credit Reporting Act to know the information Certegy utilized to make a determination regarding your check. If you find that any information Certegy utilized in its decision is inaccurate or incomplete, you have a right to dispute it with Certegy.

You may call Certegy toll free at 800-695-1854, or write to Certegy Check Services, Inc., P.O. Box 30046, Tampa, FL 33680-3046.

If you contact Certegy, please provide the following information so they can respond promptly to your request:

- First Name
- Current Address
- Date Declined
- Dollar Amount
- Check/Draft/Transfer Number
- Driver's License Number & State
- Home Telephone Number
- Date of Birth
- Social Security Number
- Merchant Name

- Checking Account Number
- Name of Financial Institution

### 1.11.3 Automatic Notice of Change (NoC) Updates

Similar to an issuing bank providing credit card Account Updater information, RDFIs provide Notification of Change (NoC) files and deliver them through the ACH network. These NoCs include updated account information including bank routing numbers, account numbers, and account names.

Vantiv makes available the NoC information to you for your use in updating your customer files. Additionally, if you submit a transaction containing information that has changed, we automatically update the information and forward the corrected transaction to the ACH network. The cnpAPI response message to you also contains the updated information for your use in correcting your database.

---

---

**NOTE:** While we always make the NoC information available to you, Vantiv does not support automatic updating of account information for PayFacs.

---

---

### 1.11.4 Auto Redeposit Feature

NACHA rules allow merchants to redeposit entries when the initial deposit was returned for either Insufficient Funds or Uncollected Funds. Two redeposit attempts are allowed within 180 days of the settlement date of the initial deposit. Vantiv offers an optional service that allows you to preconfigure automatic redeposits of transactions returned for the those reasons. You define the number of days from the initial return for Vantiv to resubmit the transaction. You also define the number of days from the return of the first resubmission for the attempt of a second resubmission.

---

---

**NOTE:** You track the current state of your transactions, returns, and resubmissions via the iQ User Interface. Please refer to the *iQ Reporting and Analytics User Guide* for additional information.

---

---

For example, you submitted an eCheck Sale transaction on 29 January that is returned for Return Reason Code R01 - Insufficient Funds. The return occurs on 1 February. With the Auto Redeposit feature enabled and a preset period of 5 days for the first redeposit, the system would automatically generate a resubmission of the deposit on 6 February. If this transaction is also returned for the same reason code on 7 February and you have a preset time period for the second redeposit on 7 days, the system generates the second redeposit on 14 February.

## 1.11.5 eCheck Prenotification

An eCheck Prenotification is a non-monetary transaction used to verify the account information supplied by the consumer is valid. These transactions are sent to the ACH network to help ensure subsequent entries are posted appropriately. Since this is a verification of account information, typically, you would submit a Prenotification transaction in advance of processing the order, during the customer set-up process. There are two types of Prenotification transaction types: `echeckPreNoteCredit` and `eCheckPreNoteSale`. Per NACHA requirements, you must submit the Prenotification transaction that corresponds to the intended, subsequent transaction. For example, if you are planning to submit an `echeckSale` transaction and want to verify the account information, you should submit a `echeckPreNoteSale`.

The possible ACH network responses to a prenotification are as follows:

- **No response** - applies when the account is open and the account information is correct.
- **Notification of Change** - provides updated account information, including correct routing number, e.g. C02 Incorrect routing/transit number (visible in the SSR eCheck NOC report).
- **Return code** - provides account status, e.g. R02 Account is closed, R03 No account on file, R04 Invalid account number.

---

---

**NOTE:** Prenotification transactions are only supported in cnpAPI V9.1 or above and only in Batch submissions. Prenotification transactions are not supported for PayFacs or for Canadian eChecks.

---

---

When you submit either of the Prenotification transaction types, the system sends an acknowledgment in the Batch response file. This response file does not provide the results of the prenotification check, but rather a verification that we received the transaction and it was properly formatted. You receive the results to the check in the SSR eCheck Notification of Change report. This report is run daily and you can expect to see the results for submitted prenotification checks by the second or third business day after the settlement day. The settlement day for a Prenotification transaction is defined as the next business day after submission to the ACH network. Remember, if the account you are attempting to verify is open and the account information is correct, the report will not contain an entry for that transaction. The report only contains NOCs (update information).

Per NACHA regulations, you can submit the eCheck Sale or eCheck Credit transaction on the third business day after the settlement day; however, there might still be a forthcoming NOC on that day. Due to the timing of the responses from NACHA, the generation of the reports, and the movement of the transactions, you should wait until the fourth day after the settlement day to submit the live transaction unless you receive a NOC earlier. This timing is illustrated in the example below.

1. You submit a Prenotification transaction on Monday prior to your cut-off time.
2. Our system forwards the transaction to NACHA on Tuesday. Note, this makes Wednesday the settlement day.
3. NACHA responds with a NOC/return, if any, by Thursday night.

4. On Friday, the information from NACHA is processed by our systems.
5. On Saturday morning, the SSR NOC report containing the information is available to you.
6. You can submit the eCheck Sale or eCheck Credit transaction before your cut-off time on Saturday night. This is the fourth day after settlement, the fifth day after submission.



## 1.12 SEPA Direct Debit

When building a robust international ecommerce offering, you should always consider regional, preferred payment methods. Enabling payment methods with which consumers are both familiar and comfortable may provide a significant bump in your conversion rates and sales. In Europe there are dozens of regionally popular alternative payment methods. SEPA (Single Euro Payments Area) Direct Debit is a Pan-European network facilitating direct debit transactions in 34 countries. Currently, SEPA Direct Debit accounts for approximately 10% of all eCommerce sales in Europe and leads all alternative payment methods in Germany, accounting for more than 35% of eCommerce spending.

Although similar to eCheck transaction in the US, in that they are both direct debit methods of collecting funds, there are several differences in the process. Most of the difference concern the requirement for the presentation of a Mandate to the consumer. A Mandate is basically an agreement between the consumer and the merchant allowing the merchant to debit the consumer's account for the required funds. The agreement can specify either a one-time payment or recurring payments. The consumer must agree to the Mandate (Usually, by clicking a Confirm button on the Mandate page.) for the transaction to succeed.

The Vantiv eComm platform allows for two different Mandate scenarios. The first, and recommended method, involves the redirect from your site to a Vantiv provided Mandate page. Alternatively, you can provide your own Mandate page. The following sections discuss the purchase/order flow for each scenario.

### 1.12.1 SEPA Direct Debit - Vantiv Supplied Mandate

You cannot complete a SEPA Direct Debit transaction without an approved (by the consumer) Mandate. While you can produce your own Mandate page, Vantiv makes the implementation of SEPA Direct Debit easier for you by providing Mandates in various languages, for either single payments or recurring transactions.

[Figure 1-8](#) provides an overview of the order flow, when using a Vantiv supplied Mandate for a one-time payment, or the first payment in a recurring stream. The steps provide additional information.

**FIGURE 1-8** Order Flow for Vantiv Supplied Mandate

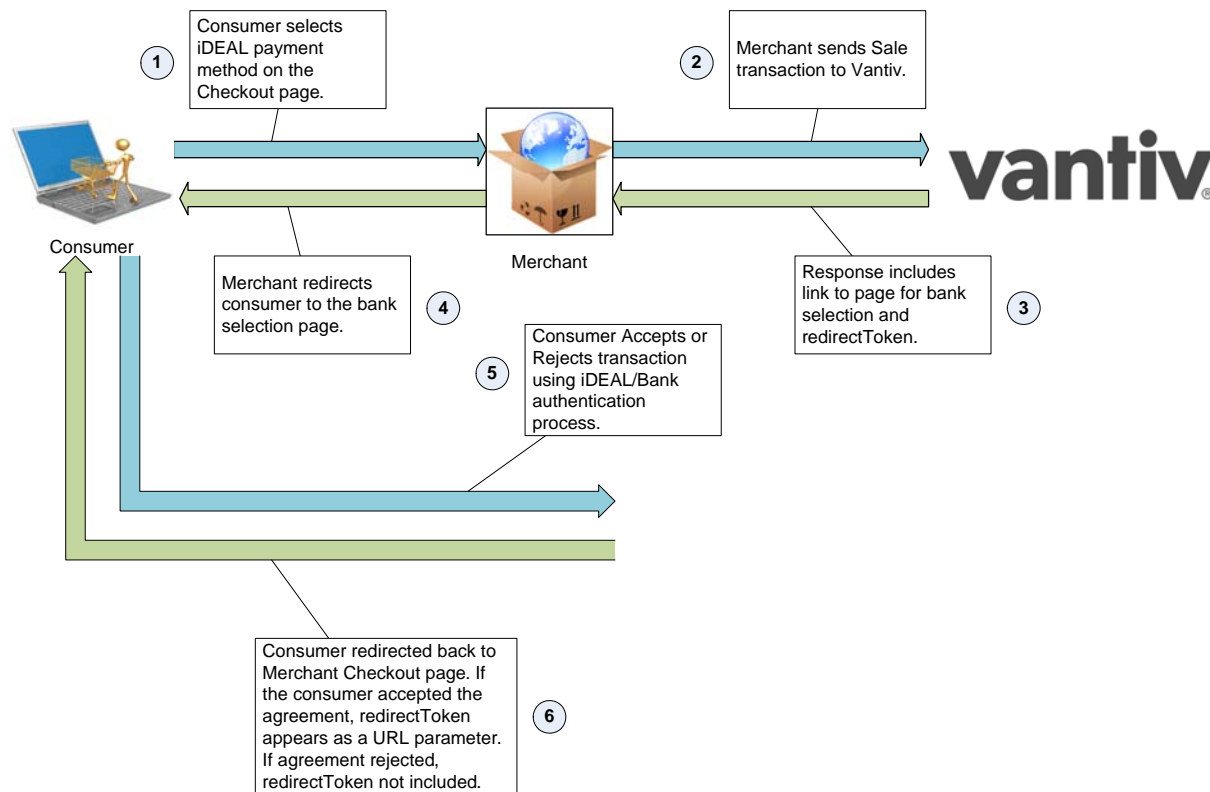

1. On your checkout page, the consumer selects SEPA Direct Debit as the payment method, enters their IBAN (International Banking Account Number), selects a preferred language for the Mandate (optional), and clicks the Submit button.

---

**NOTE:** If you do not specify a preferred language, or you specify an unavailable language, the Mandate page appears in English.

---

2. You create a Sale transaction and submit it to the Vantiv eComm platform, using `sepaDirectDebit` as the payment method and including its child elements shown below (preferredLanguage optional). In addition to the required child elements of `sepaDirectDebit` you must include the name, email, and country child elements of `billToAddress`.

**Example: SEPA Direct Debit Sale Request Message - Vantiv Supplied Mandate**

```
<littleOnlineRequest version="9.13" xmlns="http://www.little.com/schema"
  merchantId="SddMer1">
  <authentication>
    <user>SDD</user>
    <password>password</password>
```

```

</authentication>
<sale id="SEPA_Sale" reportGroup="SddMer1" customerId="SEPA_Customer1">
  <orderId>sddSale</orderId>
  <amount>1001</amount>
  <orderSource>ecommerce</orderSource>
  <billToAddress>
    <name>Johann Schmidt</name>
    <addressLine1>10 Hoch Strasse</addressLine1>
    <city>Hanover</city>
    <zip>30159</zip>
    <country>DE</country>
    <email>jschmidt@phoenixprocessing.com</email>
    <phone>781-270-1111</phone>
  </billToAddress>
  <sepaDirectDebit>
    <mandateProvider>Vantiv</mandateProvider>
    <sequenceType>OneTime</sequenceType>
    <iban>DE79850503003100180568</iban>
    <preferredLanguage>DE</preferredLanguage>
  </sepaDirectDebit>
</sale>
</litleOnlineRequest>

```

3. The response message (example shown below) includes the `redirectUrl` element, which hosts the Mandate. The `redirectToken` returned in the response allows you to verify the consumer accepted the Mandate. If this transaction is the first of a recurring stream, you use the `mandateReference` element in subsequent payments to reference the agreed to (recurring) Mandate.

### Example: SEPA Direct Debit Sale Response Message - Vantiv Supplied Mandate

```

<litleOnlineResponse version="9.13" xmlns="http://www.litle.com/schema"
  response="0" message="Valid Format">
  <saleResponse id="SEPA_Sale" reportGroup="SddMer1">
    <litleTxnId>82830949823203015</litleTxnId>
    <orderId>sddSale</orderId>
    <response>000</response>
    <responseTime>2017-01-21T17:07:27</responseTime>
    <postDate>2017-01-21</postDate>
    <message>Approved</message>
    <sepaDirectDebitResponse>
      <redirectUrl>http://MandateHostURL/DE</redirectUrl>
      <redirectToken>evr0kij413g8r85e32v7deov0c</redirectToken>
    </sepaDirectDebitResponse>
  </saleResponse>
</litleOnlineResponse>

```

```

    <mandateReference>1ABCA43</mandateReference>
  </sepaDirectDebitResponse>
</saleResponse>
</littleOnlineResponse>

```

4. You redirect the consumer from your checkout page to the `redirectUrl`.
5. The consumer either accepts or rejects the Mandate.
6. After the consumer either accepts or declines the Mandate, they are redirected back to your checkout page, or alternate page upon decline. If they accepted the Mandate, the URL contains a parameter exposing the `redirectToken` value (`redirectToken=token_value`). By comparing this value to the value you received in the Sale response message you can verify that the consumer accepted the Mandate. If they declined the Mandate, the URL does not include the parameter.

### 1.12.2 SEPA Direct Debit - Merchant Supplied Mandate

If you elect to produce and provide your own Mandate to the consumer, the order flow differs from the Vantiv supplied Mandate flow, as shown in [Figure 1-9](#) and explained in the steps that follow.

**FIGURE 1-9** Order Flow for Merchant Supplied Mandate

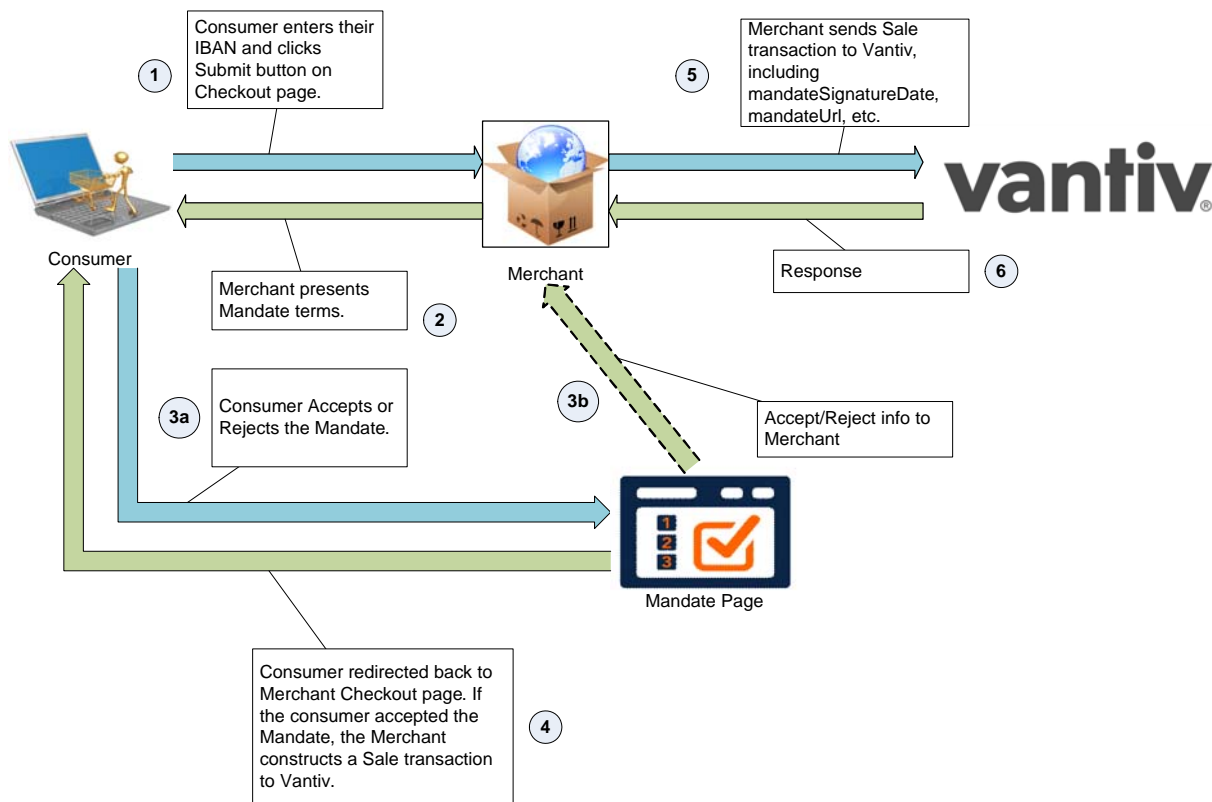

1. On your checkout page, the consumer selects SEPA Direct Debit as the payment method, enters their IBAN (International Banking Account Number), selects a preferred language for the Mandate (optional), and clicks the Submit button.
2. You redirect the consumer from your checkout page to your Mandate page.
3. The consumer take action on the Mandate page.
  - a. The consumer either accepts or rejects the Mandate.
  - b. Your Mandate page provides the Accept or Decline information to your servers.
4. Once the consumer takes action on the Mandate page, you return them to your checkout page. If the consumer rejected the Mandate, you can ask for a different payment method. If the consumer accepted the Mandate, you record the signature date and use it to construct a Sale transaction. Also, if this is the first of a series of recurring payments, you assign a `mandateReference` value.
5. You submit the Sale transaction to the Vantiv eComm platform, as shown in the example below. In addition to the required child elements of `sepaDirectDebit` you must include the `mandateReference`, `mandateUrl`, and `mandateSignatureDate`, as well as the `name`, `email`, and `country` child elements of `billToAddress`.

### Example: SEPA Direct Debit Sale Request Message - Merchant Supplied Mandate

```
<littleOnlineRequest version="9.13" xmlns="http://www.little.com/schema"
  merchantId="SddMer1">
  <authentication>
    <user>SDD</user>
    <password>password</password>
  </authentication>
  <sale id="SEPA_Sale" reportGroup="SddMer1" customerId="SEPA_Customer1">
    <orderId>sddSale</orderId>
    <amount>1001</amount>
    <orderSource>ecommerce</orderSource>
    <billToAddress>
      <name>Johann Schmidt</name>
      <addressLine1>10 Hoch Strasse</addressLine1>
      <city>Hanover</city>
      <zip>30159</zip>
      <country>DE</country>
      <email>jschmidt@phoenixprocessing.com</email>
      <phone>781-270-1111</phone>
    </billToAddress>
    <sepaDirectDebit>
      <mandateProvider>Merchant</mandateProvider>
      <sequenceType>FirstRecurring</sequenceType>
      <mandateReference>ABCD1234</mandateReference>
    </sepaDirectDebit>
  </sale>
</littleOnlineRequest>
```

```
<mandateUrl>http://MerchantMandateHostURL</mandateUrl>  
<mandateSignatureDate>2017-01-21</mandateSignatureDate>  
<iban>DE79850503003100180568</iban>  
</sepaDirectDebit>  
</sale>  
</littleOnlineRequest>
```

6. The Vantiv eComm platform returns a Sales response message. This message does not include the `sepaDirectDebitResponse` element, since Vantiv does not return any additional SEPA Direct Debit related information, such as a `redirectToken`.

## 1.13 iDEAL, SOFORT, and Giropay

iDEAL, SOFORT, and Giropay are International alternative payment methods. iDEAL services over 10 million consumers in the Netherlands, Giropay services German consumers, and SOFORT services consumers in several countries (predominantly Germany and other German speaking countries). Each of these alternative payment methods initiate a real-time transfer of funds from the consumer account to the merchant account. This method differs from credit cards and several other alternate payment methods in that the consumer is not agreeing to pay the settlement at a future time, rather they communicate directly with their bank and approve the transfer of fund from their account to yours. After their approval, their bank displays to them a confirmation of payment and debits their account within a few seconds.

---

**NOTE:** Although the bank debits the consumer's account immediately, the funds may not appear in your account for a few days, depending upon your settlement agreement.

---

The graphic and steps below illustrate the iDEAL, SOFORT, and Giropay processes.

**FIGURE 1-10** iDEAL, SOFORT, and Giropay Order Flow

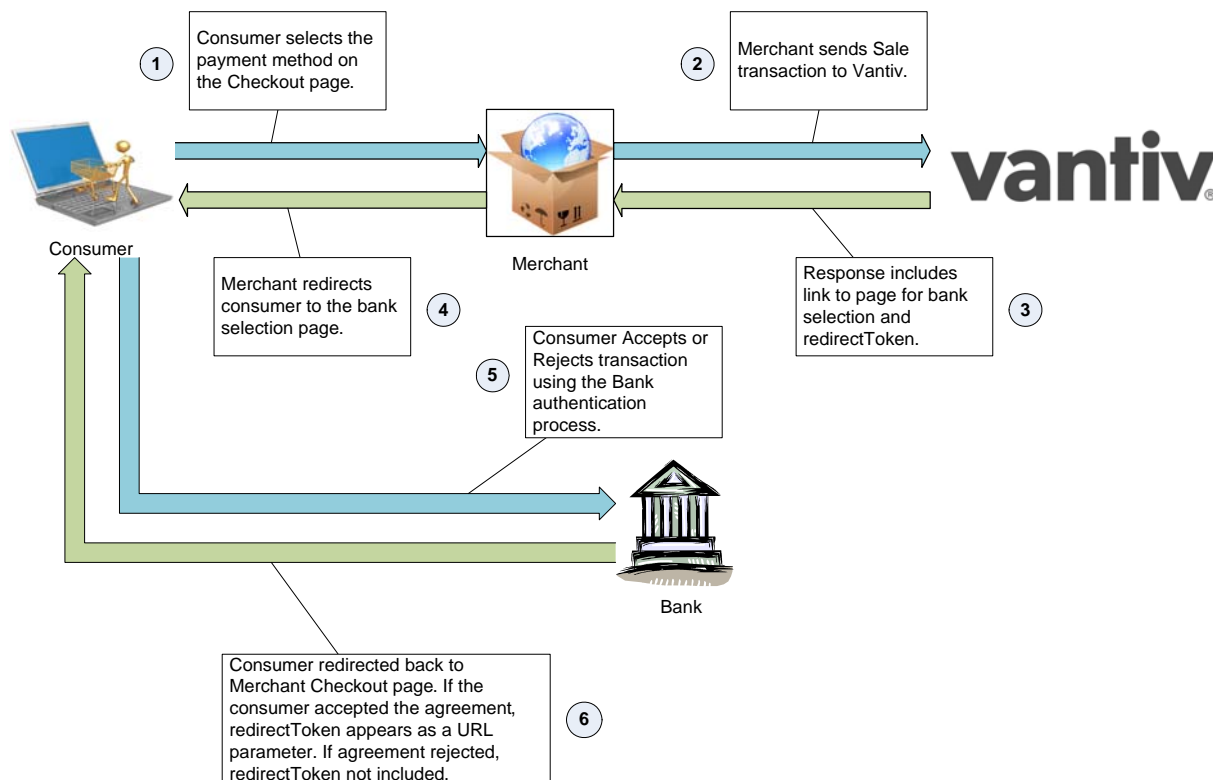

1. On your checkout page, the consumer selects iDEAL, SOFORT or Giropay as the payment method and clicks the Submit button.
2. You create a Sale transaction (iDEAL example below) and submit it to the Vantiv eComm platform, using `ideal` as the payment method and including its child elements, `preferredLanguage` if specified.

### Example: iDEAL Sale Request

```
<littleOnlineRequest version="11.0" xmlns="http://www.little.com/schema"
  merchantId="12345">
  <authentication>
    <user>user_name</user>
    <password>password</password>
  </authentication>
  <sale id="TC6900_1" reportGroup="Mer1" customerId="pproPosResponse">
    <orderId>p1_idealSale</orderId>
    <amount>10011</amount>
    <orderSource>ecommerce</orderSource>
    <billToAddress>
      <name>David Berman</name>
      <addressLine1>10 Noorderstraat</addressLine1>
      <city>Amsterdam</city>
      <zip>1000 AP</zip>
      <country>NL</country>
      <email>dberman@phoenixprocessing.com</email>
      <phone>020-1234567</phone>
    </billToAddress>
    <ideal>
      <preferredLanguage>NL</preferredLanguage>
    </ideal>
  </sale></littleOnlineRequest>
```

3. The `saleResponse` includes a `redirectURL`, which you use to redirect the consumer to a bank selection page. It also contains a `redirectToken`, which you use later to verify the acceptance and bank transfer by the consumer.

### Example: iDEAL Sale Response

```
<littleOnlineResponse version="11.0" xmlns="http://www.little.com/schema"
  response="0" message="Valid Format">
  <saleResponse id="TC6900_1" reportGroup="PayProMer1">
    <littleTxnId>84568456</littleTxnId>
    <orderId>p1_idealSale</orderId>
    <response>000</response>
    <responseTime>2017-04-03T10:24:31</responseTime>
```



```
<postDate>2017-04-03</postDate>
<message>Approved</message>
<idealResponse>
  <redirectUrl>http://ideal.bank.com</redirectUrl>
  <redirectToken>1234567890</redirectToken>
  <paymentPurpose>123456YourCompanyName</paymentPurpose>
</idealResponse>
</saleResponse>
</littleOnlineResponse>
```

4. The consumer selects their bank on the bank selection page.
5. The consumer accepts or rejects the transaction on their bank page. The bank determines the actual process of authenticating the user and accepting the transaction.
6. The consumer gets redirected back to your checkout page. If they accepted the agreement, the URL contains a parameter exposing the `redirectToken` value (`redirectToken=token_value`). By comparing this value to the value you received in the Sale response message you can verify that the consumer accepted the agreement and the bank transferred the funds. If they declined, the URL does not include the parameter.

---

---

**NOTE:** Although the consumer does not have chargeback rights when using these alternate payment methods, Vantiv recommends you maintain a robust and well documented returns system. European regulations require that you credit your customer's account within 30 days of a return.

---

---

## 1.14 eCommerce Solution for Apple Pay™

Vantiv supports Apple Pay for in-app and in-store purchases initiated on compatible versions of iPhone and iPad, as well as purchases from your desktop or mobile website initiated from compatible versions of iPhone, iPad, Apple Watch, MacBook and iMac (Apple Pay on the Web).

For in-store transactions, a consumer can use the Near Field Communications (NFC) chip in their device to make a purchase by simply touching the device to an NFC-compliant terminal. Identity verification is provided by Touch ID, a fingerprint reading application built into the device. If you wish to allow Apple Pay transactions from your native iOS mobile application, you must build the capability to make secure purchases using Apple Pay into your mobile application.

If you wish to allow Apple Pay payments on your desktop or mobile website, your website must be configured to work with Apple to request authorization from the consumers iPhone or iPad via Touch ID. See [Table 1-11, "Apple Pay on the Web Compatible Devices"](#) for more information.

This section provides an overview of the operation of Apple Pay and Apple Pay on the web, along with the several methods you can use to submit Apple Pay purchases to the Vantiv eCommerce platform. The topics discussed are:

- Overview of Apple Pay Operation
- Vantiv Decryption of Apple Pay PKPaymentToken
- Merchant Decryption of Apple Pay PKPaymentToken
- cnpAPI <applepay> Structure
- Vantiv Mobile API for Apple Pay HTTPS POST Components
- Recurring Payments with Apple Pay

### 1.14.1 Overview of Apple Pay Operation

The operation of Apple Pay and Apple Pay on the web is relatively simple, but will require either the development of new native iOS applications or the modification of your existing applications or website that include the use of the Apple PassKit Framework (or Apple Pay JavaScript for Apple Pay web) and the handling of the encrypted data returned to your application by Apple Pay. The basic steps that occur when a consumer initiates an Apple Pay purchase using your mobile application or website are:

1. When the consumer selects the Apple Pay option from your application, your application makes use of the Apple PassKit Framework (or Apple Pay JavaScript) to request payment data from Apple Pay.
2. When Apple Pay receives the call from your application and after the consumer approves the Payment Sheet (using Touch ID), Apple creates a PKPaymentToken using your public key. Included in the PKPaymentToken is a network (Visa, MasterCard, Discover, or American Express) payment token and a cryptogram.

3. Apple Pay returns the Apple PKPaymentToken (defined in Apple documentation; please refer to <https://developer.apple.com/library/ios/documentation/PassKit/Reference/PaymentTokenJSON/PaymentTokenJSON.html>).

The remainder of this section discusses the various options for handling the PKPaymentToken in the transaction flow.

## 1.14.2 Vantiv Decryption of Apple Pay PKPaymentToken

Vantiv recommends using one of the Vantiv Decryption methods. This transaction process relieves you from the burden of creating and maintaining public and private keys, as well as decrypting the PKPaymentToken. If you have already implemented eProtect in a mobile application, you should use eProtect for Apple Pay. A second, similar method, which still allows you to submit the PKPaymentToken without decryption, involves you sending the Authorization/Sale transaction with the PKPaymentToken key values in a new cnpAPI element structure (see [applepay](#)), typically from your server. This method can be used even if you are not tokenized with Vantiv.

In all of these implementations, your Vantiv Implementation Consultant will provide a CSR (Certificate Signing Request) you use in your registration process with Apple Pay. The CSR provides Apple Pay with the public key used for encryption, while Vantiv retains the private key used for decryption.

### 1.14.2.1 Using the Browser JavaScript API for Apple Pay on the Web

In this scenario, the Vantiv eProtect Customer Browser JavaScript API controls the fields on your checkout page that hold sensitive card data. When the cardholder clicks the Apple Pay button, communication is exchanged with Apple Pay via the JavaScript API to obtain the PKPaymentToken. From this point forward, your handling of the transaction is identical to any other eProtect transaction. The eProtect server returns a Registration ID (low-value token) and your server constructs the cnpAPI transaction using that ID. See the *Vantiv eProtect Integration Guide* for JavaScript and HTML page examples and more information on using the browser JavaScript API.

[Step 1](#), [Step 2](#), and [Step 3](#) are the same as those outlined in [Overview of Apple Pay Operation](#) on page 60. The process after Step 3 is detailed below (and shown in [Figure 1-11](#)):

4. Your website sends the PKPaymentToken to our secure server via the JavaScript Browser API and eProtect returns a Registration ID.
5. Your website forwards the transaction data along with the Registration ID to your order processing server, as it would with any eProtect transaction.
6. Your server constructs/submits a standard cnpAPI Authorization/Sale transaction using the Registration ID, setting the `<orderSource>` element to `applepay`.

7. Using the private key, Vantiv decrypts the PKPaymentToken associated with the Registration ID and submits the transaction with the appropriate information to the card networks for approval.
8. Vantiv sends the Approval/Decline message back to your system. This message is the standard format for an Authorization or Sale response and includes the Vantiv token.
9. You return the Approval/Decline message to your website.

Table 1-11 lists the requirements for your customers' Apple devices when making purchases via Apple Pay on the Web.

---

**NOTE:** Table 1-11 represents data available at the time of publication of this document, and is subject to change. See the latest Apple documentation for current information.

---

**TABLE 1-11** Apple Pay on the Web Compatible Devices

Apple Device	Operating System	Browser
iPhone 6 and later iPhone SE	iOS 10 and later	Safari only
iPad Pro iPad Air 2 and later iPad Mini 3 and later	iOS 10 and later	
Apple Watch <i>Paired with iPhone 6 and later</i>	Watch OS 3 and later	
iMac <i>Paired with any of the above mobile devices with ID Touch for authentication</i>	macOS Sierra and later	
MacBook <i>Paired with any of the above mobile devices with ID Touch for authentication</i>	macOS Sierra and later	

**FIGURE 1-11** Data/Transaction Flow using Browser JavaScript API for Apple Pay on the Web

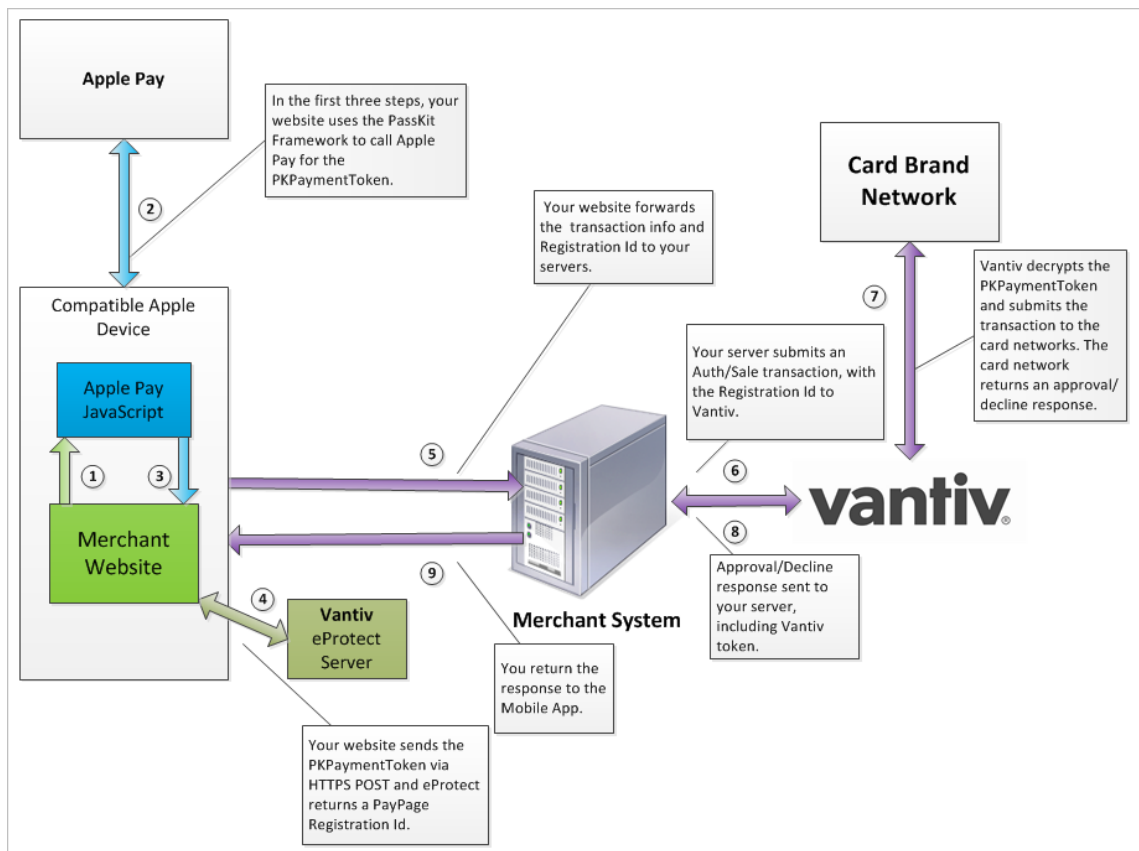

### 1.14.2.2 Using the Vantiv Mobile API for Apple Pay

In this scenario, your native iOS application performs an HTTPS POST of the Apple Pay PKPaymentToken using the Vantiv Mobile API for Apple Pay. From this point forward, your handling of the transaction is identical to any other PayPage transaction. The PayPage server returns a PayPage Registration ID and your Mobile App (or server) constructs the cnAPI transaction using that ID.

Step 1, Step 2, and Step 3 are the same as those outlined in [Overview of Apple Pay Operation](#) on page 60. The process after Step 3 is detailed below and in [Figure 1-12](#).

4. Your native iOS application sends the PKPaymentToken to our secure server via an HTTPS POST and eProtect returns a Registration ID. Please refer to the *Vantiv eProtect Integration Guide* for additional information.
5. Your native iOS application forwards the transaction data along with the Registration ID to your order processing server, as it would with any eProtect transaction.
6. Your server constructs/submits a standard cnAPI Authorization/Sale transaction using the Registration ID, setting the <orderSource> element to `applepay`.

7. Using the private key, Vantiv decrypts the PKPaymentToken associated with the Registration ID and submits the transaction with the appropriate information to the card networks for approval.
8. Vantiv sends the Approval/Decline message back to your system. This message is the standard format for an Authorization or Sale response and includes the Vantiv token.
9. You return the Approval/Decline message to your mobile application.

**FIGURE 1-12** Data/Transaction Flow using the Vantiv Mobile API for Apple Pay

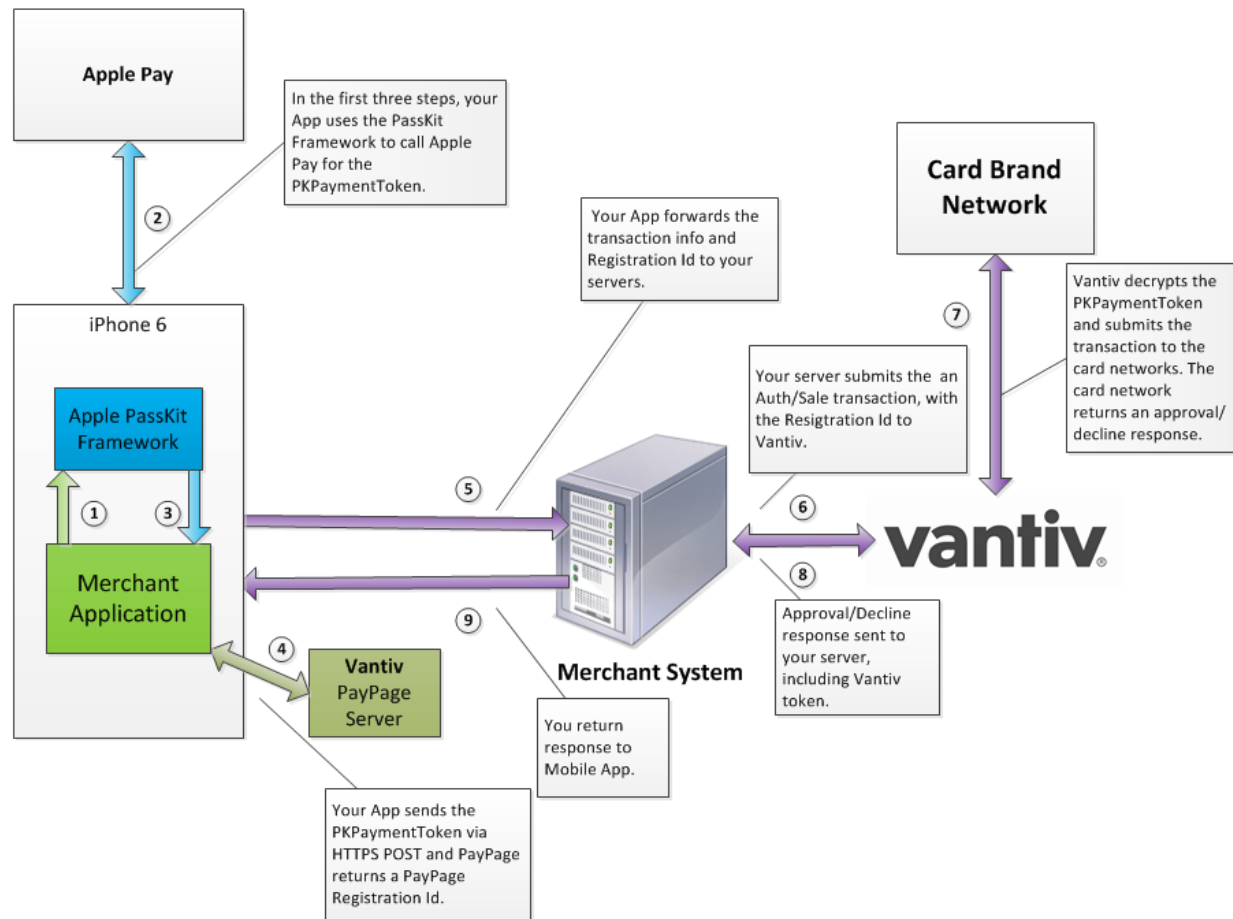

### 1.14.2.3 Submitting the Apple Pay PKPaymentToken in a cnpAPI Message

In this scenario, you submit the Apple Pay PKPaymentToken to the Vantiv eCommerce platform using a new cnpAPI structure (see [applepay](#)), typically from your server. As with the previous scenario, Vantiv decrypts the PKPaymentToken from Apple Pay using the private key.

Step 1, Step 2, and Step 3 are the same as those outlined in [Overview of Apple Pay Operation](#) on page 60. The process after Step 3 is detailed below and in [Figure 1-13](#).

4. Your mobile application forwards the PKPaymentToken from Apple Pay, along with other normal information from the transaction (such as Bill To and Ship To Address), to your order processing server.
5. You do not decrypt the PKPaymentToken, but rather forward the data to Vantiv in the Authorization/Sale transaction using the cnpAPI <applepay> element structure instead of <card> (Server-side API submit) and setting the <orderSource> element to applepay.
6. Using the private key retained by Vantiv, we decrypt the PKPaymentToken and submit the transaction with the appropriate information to the card networks for approval.
7. Vantiv sends the Approval/Decline message back to your system. This message is the standard format for an Authorization or Sale response.
8. You return the Approval/Decline message to your mobile application.

**FIGURE 1-13** Data/Transaction Flow with Direct Submission of PKPaymentToken via cnpAPI

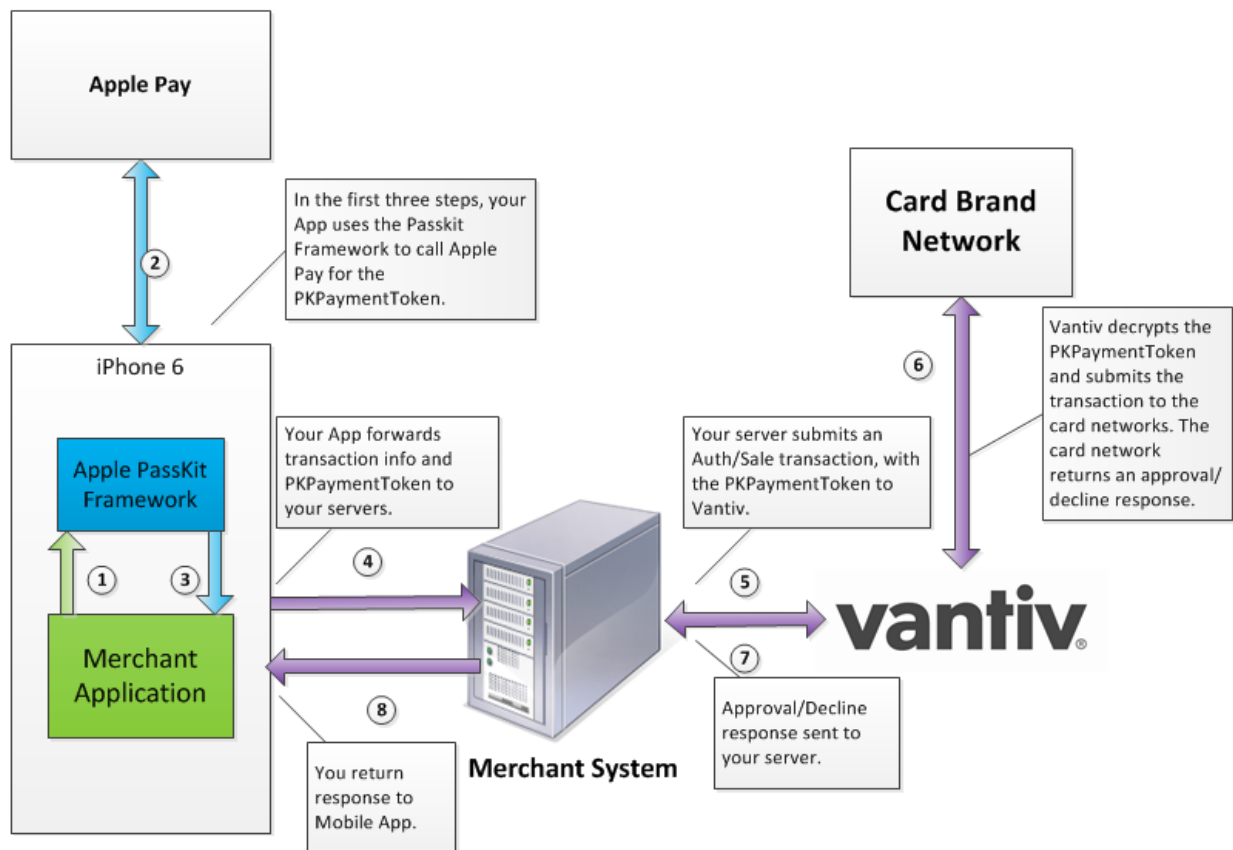

#### 1.14.2.4 Merchant Decryption of Apple Pay PKPaymentToken

Using this process, the responsibility for the decryption of the PKPaymentToken from Apple Pay falls to you. After completing the first three steps of the process as detailed in the [Overview of](#)

[Apple Pay Operation](#) section and depicted by the green and blue arrows in [Figure 1-14](#), the process continues as follows:

4. Your mobile application forwards the PKPaymentToken from Apple Pay, along with other normal information from the transaction (such as Bill To and Ship To Address), to your order processing server.
5. Using your private key, you decrypt the PKPaymentToken, construct the Authorization/Sale transaction, and submit it to Vantiv. In this case, you would populate the `cnpAPI <number>` element with the device primary account number, the `<expDate>` element with the expiration date, and the `<authenticationValue>` field with the cryptogram extracted from the PKPaymentToken. Also, set the `<orderSource>` element to `applepay` (Server-side API submit).
6. Vantiv detects that this is an Apple Pay transaction and submits the transaction with the appropriate information to the card networks for approval.
7. Vantiv sends the Approval/Decline message back to your system. This message is the standard format for an Authorization or Sale response.
8. You return the Approval/Decline message to your mobile application.

**FIGURE 1-14** Data/Transaction Flow with Merchant Decryption of Apple Pay PKPaymentToken

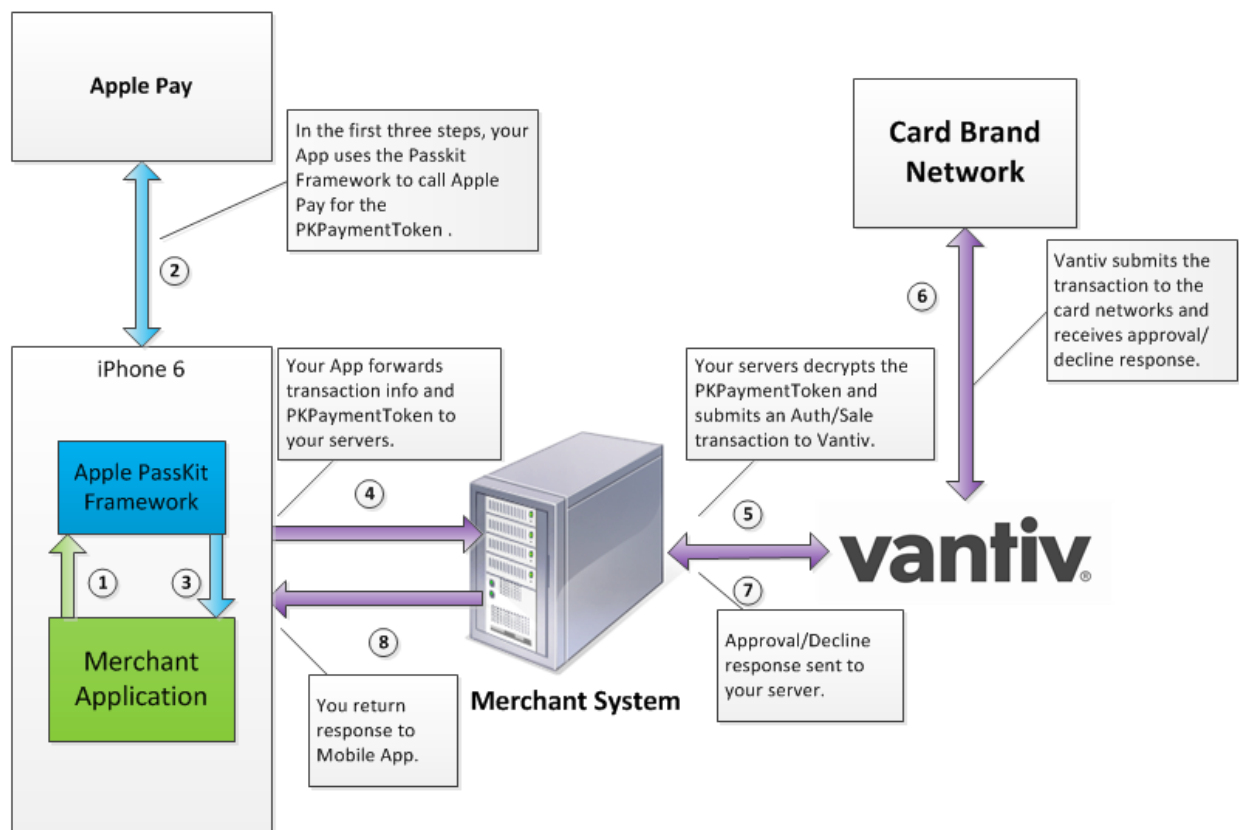



### 1.14.3 Recurring Payments with Apple Pay

When you submit the first transaction in a recurring/installment stream, you must set the `<processingType>` element to either **initialRecurring** or **initialInstallment**, as applicable. If the transaction involves a Visa or Discover card, the XML response message includes the `<networkTransactionId>` element. You must retain the value returned for use in future transactions. When you submit the next and all subsequent transactions in the recurring stream, set the `<orderSource>` to recurring or installment as appropriate, and include the `networkTransactionId` value in the `<originalNetworkTransactionId>` element. If it is a Discover transaction also include the `<originalTransactionAmount>` element. Since the original payment token was only for a single use and is not available for additional transactions, this allows Visa/Discover to tie the new transaction to the original approved transaction.

## 1.15 eCommerce Solution for Android Pay™

Android Pay is an in-store and in-app (mobile or web) payment method, providing a secure process for consumers to purchase goods and services. In-store purchases are done by using Near Field Communication (NFC) technology built into the Android Smart phone with any NFC-enabled terminal at the retail POS. For in-app purchases, the consumer need only select Android Pay as the payment method in your application. You will need to modify your application to use Android Pay as a payment method.

Vantiv supports two methods for merchants to submit Android Pay transactions from Web/Mobile applications to the eComm platform. The preferred method involves you sending certain Vantiv specific parameters to Google®. The response from Google includes a Vantiv `paypageRegistrationId`, which you use in you payment transaction submission to Vantiv. With the alternate method, you receive encrypted information from Google, decrypt it on your servers, and submit the information to Vantiv in a payment transaction.

This section provides an overview of both methods and includes the following sections:

- [Android Pay using eProtect](#)
- [Merchant Decryption Method](#)

### 1.15.1 Android Pay using eProtect

This is the recommended and typical method of implementing Android Pay for Web and Mobile Applications on the Vantiv eComm platform. The steps that follow, along with [Figure 1-15](#), illustrate the high level flow of messages associated with an Android Pay purchase, when utilizing the Vantiv eProtect service.

---

**NOTE:** This process assumes you have integrated with Google using the method that returns the Vantiv low-value token (`paypageRegistrationId`) from Google following the Full Wallet request.

---

1. When the consumer clicks the Android Pay button in your application, the action triggers a `MaskedWalletRequest` to Google. In the `MaskedWalletRequest`, you must set a new object `PaymentMethodTokenizationParameters` indicating that you are using Vantiv. Use the following code sample as a guide to setting this field.

#### Setting the `PaymentMethodTokenizationParameters`

```
PaymentMethodTokenizationParameters parameters =  
PaymentMethodTokenizationParameters .newBuilder()  
    .setPaymentMethodTokenizationType(PaymentMethodTokenizationType.PAYMENT_GATEWAY)  
    .addParameter("gateway", "vantiv")
```

```
.addParameter("vantiv:merchantPayPageId", payPageId)
.addParameter("vantiv:merchantOrderId", orderId)
.addParameter("vantiv:merchantTransactionId", id)
.addParameter("vantiv:merchantReportGroup", reportGroup)
.build();
```

---

---

**IMPORTANT:** You must use the same `orderId` value on all calls (i.e., Google, Register Token, Authorization, Sale, etc.). Failure to use the same `orderId` can prevent customers from tracking their orders using the Android Pay application.

---

---

### Setting New Object in the MaskedWalletRequest

```
MaskedWalletRequest request = MaskedWalletRequest.newBuilder()
    .setMerchantName(Constants.MERCHANT_NAME)
    .setPhoneNumberRequired(true)
    .setShippingAddressRequired(true)
    .setCurrencyCode(Constants.CURRENCY_CODE_USD)
    .setEstimatedTotalPrice(cartTotal)
    .setCart(Car.newBuilder())
    .setCurrencyCode(Constants.CURRENCY_CODE_USD)
    .setTotalPrice(cartTotal)
    .setLineItems(lineItems)
    .build()
    .setPaymentMethodTokenizationParameters(parameters)
    .build();
```

The information returned by Google in the MaskedWallet object may include a masked card number (last-four digits exposed) and shipping information. The consumer has the option of changing this information. If any info changes, Android Pay returns an updated MaskedWallet object.

2. Upon confirmation of the order by the consumer your application initiates a FullWalletRequest to Google.
3. After receiving the FullWalletRequest from your application, Google submits the card information to Vantiv eProtect. The eProtect servers return a low-value token (`paypageRegistrationId`).
4. Google returns the low-value token to your application along with the Full Wallet information.

5. Your applications sends the transaction information to your servers along with the low-value token. Your servers submit the Auth/Sale transaction to the Vantiv eComm platform. You must set the `orderSource` to **androidpay** in the transaction.

---

**NOTE:** Instead of submitting a Auth/Sale transaction, you can submit a Register Token transaction to convert the low-value token to a Vantiv high-value token. You would then use the high-value token in subsequent transactions submitted to the eComm platform.

---

6. Vantiv processes your transaction normally and returns the results along with a high-value token.

**FIGURE 1-15** High Level Message Flow for Android Pay using eProtect

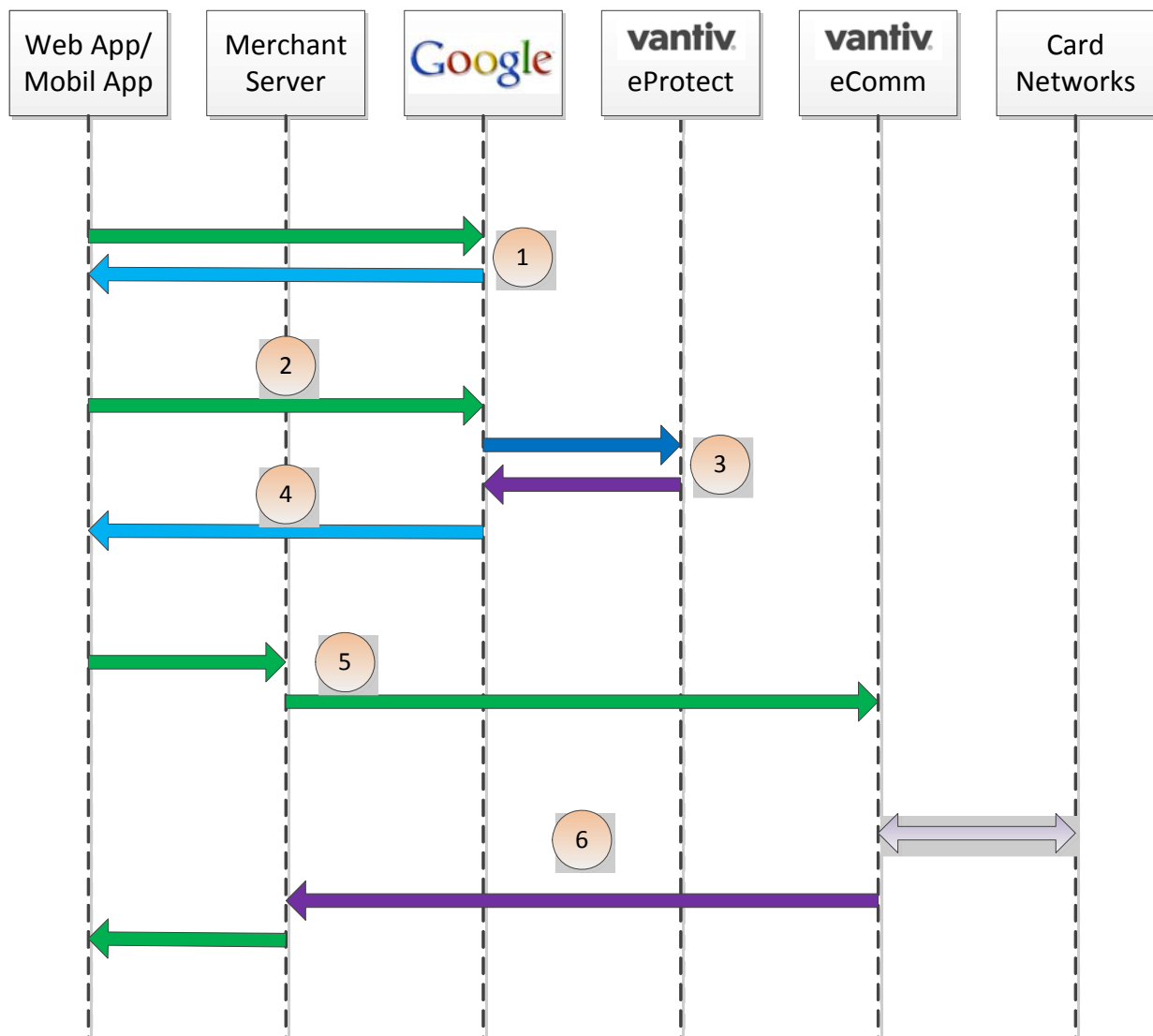

## 1.15.2 Merchant Decryption Method

Using this process, the responsibility for the decryption of the encrypted payload from Android Pay falls to you. The steps that follow, along with [Figure 1-16](#), illustrate the high level flow of messages associated with an Android Pay purchase, when you perform the decryption of the encrypted payload.

---

**NOTE:** The process assumes you have integrated with Google using the method that returns the encrypted payload from Google following the Full Wallet request.

---

1. When the consumer clicks the Android Pay button in your application, the action triggers a `MaskedWalletRequest` to Google. The information returned by Google in the `MaskedWallet` object may include a masked card number (last-four digits exposed) and shipping information. The consumer has the option of changing this information. If any info changes, Android Pay returns an updated `MaskedWallet` object.
2. Upon confirmation of the order by the consumer your application initiates a `FullWalletRequest` to Google. Google also returns the encrypted payload. The encrypted payload is a UTF-8 encoded serialized JSON dictionary with the following keys:
  - **encryptedMessage** (string base64) - an encrypted message containing the payment credentials
  - **ephemeralPublicKey** (string base64) - the ephemeral public key associated with the private key to encrypt the message
  - **tag** (string base64) - MAC of encryptedMessage
3. Your application sends the encrypted payload along with the transaction information to your server.
4. Your server decrypts the encrypted payload extracting the payment, which is a UTF-8 encoded, serialized JSON dictionary with the following keys:
  - **dpan** (string (digits only)) - the device-specific personal account number (i.e., device token)
  - **expirationMonth** (number) - the expiration month of the dpan (1 = January, 2 = February, etc.)
  - **expirationYear** (number) - The four-digit expiration year of the dpan (e.g., 2015)
  - **authMethod** (string) - the constant **3DS** (may change in future releases).
  - **3dsCryptogram** (string) - the 3DSecure cryptogram
  - **3dsEciIndicator** ((optional) string) - ECI indicator per 3DSecure specification

## Example of Decrypted Credentials in JSON

```
{
  "dpan": "4444444444444444",
  "expirationMonth": 10,
  "expirationYear": 2015,
  "authMethod": "3DS",
  "3dsCryptogram": "AAAAA...",
  "3dsEciIndicator": "eci indicator"
}
```

After decryption, submit the Authorization/Sale transaction to Vantiv, setting the `orderSource` element to **androidpay** and populating the following cnpAPI elements with the decrypted information:

- **number** - dpan value
  - **expDate** - MMYYY derived from the expirationMonth and expirationYear values
  - **authenticationValue** - the 3dsCryptogram value
5. Vantiv processes your transaction normally and returns the results in the response message.

**FIGURE 1-16** High Level Message Flow for Android Pay using Merchant Decryption

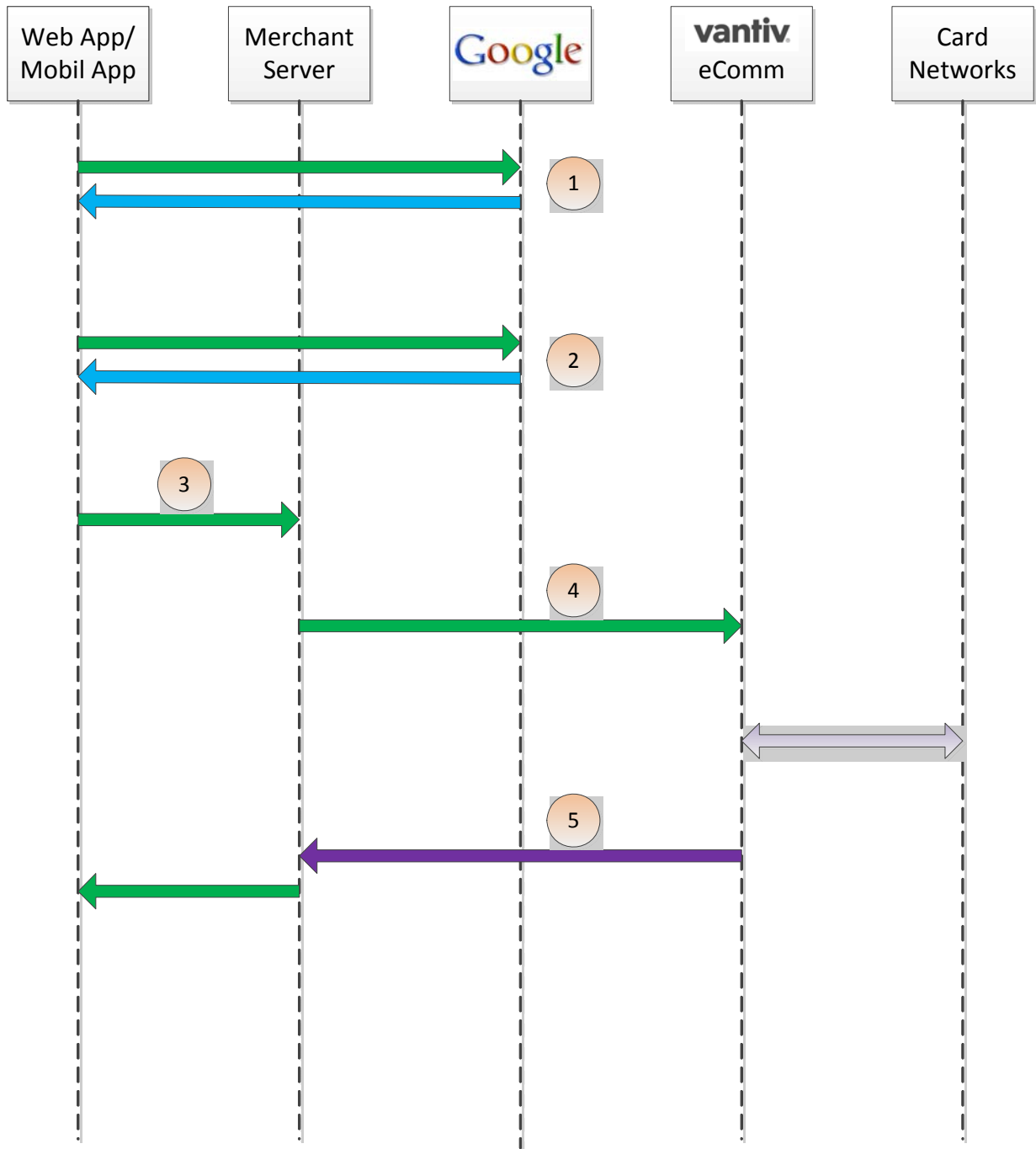

### 1.15.3 Recurring Payments with Android Pay

When you submit the first transaction in a recurring/installment stream, you must set the `<processingType>` element to either **initialRecurring** or **initialInstallment**, as applicable. If the transaction involves a Visa or Discover card, the XML response message includes the `<networkTransactionId>` element. You must retain the value returned for use in future transactions. When you submit the next and all subsequent transactions in the recurring stream, set the `<orderSource>` to recurring and include the `networkTransactionId` value in the `<originalNetworkTransactionId>` element. If it is a Discover transaction also include the `<originalTransactionAmount>` element. Since the original payment token was only for a single use and is not available for additional transactions, this allows Visa to tie the new transaction to the original approved transaction.



## 1.16 Supported Transaction Types

cnpAPI Batch processing supports all transaction types except Voids, eCheck Voids and Private Label Gift Card reversal transactions, which are handled as Online transactions only. Online processing handles all transaction types. This section provides a description of each transaction type, information concerning its use, and any special considerations.

---

---

**NOTE:** For information about Dynamic Payout Funding Instructions please refer to [Appendix D, "PayFac™ Dynamic Payout"](#).

---

---

### 1.16.1 Authorization Transaction

The Authorization transaction enables you to confirm that a customer has submitted a valid payment method with their order and has sufficient funds to purchase the goods or services they ordered. Setting the <allowPartialAuth> element to **true** in the Authorization request enables the system to return authorizations for a portion of the order amount for cases where the card does not have an adequate credit limit or balance available for the full amount.

An approved Authorization reduces the customer's credit limit (or bank balance, in the case of a debit card) by the amount of the approval by placing the amount on hold. If you have the Prepaid Indicator feature enabled, the Authorization response also includes an element that indicates if the card is Prepaid, as well as an element indicating the available balance on the card.

---

---

**NOTE:** To obtain better interchange rates, you should always perform an AVS check either as a standalone transaction, or as part of the Authorization/Sale transaction.

If you settle in a currency other than US or Canada, you cannot use partial Authorizations.

While most merchants perform Authorizations as Online transactions, there is no requirement to do so.

---

---

The lifespan of an Authorization depends upon the payment method. [Table 1-12](#) provides information concerning Authorization lifespans for various card types and alternate payment methods.

**TABLE 1-12** Lifespan of Payment Authorizations

Payment Type	Lifespan of Authorization
MasterCard	7 days
Visa	7 days

**TABLE 1-12** Lifespan of Payment Authorizations

Payment Type	Lifespan of Authorization
American Express	7 days
Discover	10 days
PayPal	29 days total by default; Vantiv recommends capture submission within three days. For more information, see the <i>Vantiv PayPal Integration Guide</i> .

As long as the authorization has not expired, or the amount exhausted, you can use it repeatedly to fulfill an order. This would be the case if the Authorization covered multiple items with staggered deliveries. In this scenario, you would issue a Partial Capture transaction as each item shipped until the order was completely fulfilled.

---



---

**NOTE:** If you obtain an Authorization through approved vendors for voice and terminal authorizations, you would use a Capture Given Auth transaction to deposit the funds (see [Capture Given Auth Transaction](#) on page 79).

---



---

### 1.16.1.1 AVS Only Transaction

An AVS Only transaction is a variation of an Authorization transaction that uses the Address Verification System to enable you to verify that a customer supplied address matches the billing address associated with the card. To submit an AVS Only transaction, submit an Authorization transaction with the <amount> element set to 000 and the optional `billToAddress` element with appropriate child values.

---



---

**NOTE:** To obtain better interchange rates, you should always perform an AVS check either as a standalone transaction, or as part of the Authorization/Sale transaction.

---



---

### 1.16.2 Authorization Reversal Transactions

The primary use of Authorization Reversal transactions is to eliminate any unused amount on an unexpired Authorization. Issuing an Authorization Reversal has the benefit of freeing any remaining held amount that reduces the buying power of your customer. Potentially, this both increases customer satisfaction and can allow them to proceed with additional purchases that may otherwise be blocked by credit limits. It also helps you avoid any misuse of Auth fees imposed by the card associations.

---

**NOTE:** For American Express transactions, the reversal amount must match the authorization amount. American Express does not allow partial reversals and reversals against remaining amounts after a partial capture. Attempts to perform these types of reversals result in a Response Code of 336 - Reversal amount does not match Authorization amount.

---

For example, consider the following scenario. A customer with a \$6,000 credit limit orders a \$3,000 stereo system, but the stereo is a discontinued item. The merchant notifies the customer, but does not perform an Authorization Reversal. The customer attempts to submit a new order for a \$3,001 stereo.

- If the customer uses the same credit card for both orders, the second order could be denied, since the account's remaining credit limit is only \$3,000.
- If the customer had used the same debit card for both orders, the second order places the customer's bank account in an overdraft situation (assuming a starting balance of \$6,000).

Either of these situations can result in the merchant losing a sale, as well as receiving a call from an angry customer.

Another advantage of Authorization Reversal transactions occurs on Visa transactions. In order for you to qualify for the best possible interchange rates from Visa, the amount of the Capture must match the amount of the associated Authorization. In order to take advantage of this situation for you, if the Capture amount is less than the associated Authorization amount, Vantiv automatically performs a partial Authorization Reversal for the unused amount (also see [Capture Request](#) on page 232).

### 1.16.2.1 Notes on the Use of Authorization Reversal Transactions

This section provides additional information concerning the requirements of and exceptions to the use of Authorization Reversal transactions.

- Authorization Reversal transactions are supported for the following methods of payment: PayPal, MasterCard, Visa, Discover, Diners Club, and JC and American Express, but American Express and PayPal only support reversals of the entire Authorized amount (no partial reversals).
- All transactional data, including associated Authorizations, Captures, and Refunds, must use cnpAPI format.
- Vantiv recommends that you send the Authorization Reversal transaction using the same submission method (Batch or Online) as used for the Capture transaction. This is to eliminate a possible race condition that may occur if you submit an Online Authorization Reversal prior to the processing of a Batch containing the associated Capture transaction.
- For Batch transactions, send Authorization Reversal transactions in a session separate from the both the associated Authorization and the associated Capture transactions.

- For Online transactions, when following an Authorization with an Auth Reversal, allow a minimum of one minute between the transactions.
- For Visa transactions and MasterCard, Vantiv automatically performs a partial Authorization Reversal, if the Capture amount is less than the associated Authorization amount.
- If you do not specify an amount (<amount> element) in the Authorization Reversal, Vantiv reverses the total amount of the associated Authorization.
- Do not send an Authorization Reversal against an expired Authorization. This results in a *306 - Auth expired, so amount does not need to be reversed* error. When an Authorization expires, the hold amount is automatically reversed.
- Do not send an Authorization Reversal against an Authorization that does not exist in our system. For example, if you sends a reversal against an Authorization that failed or an Authorization that was declined, the Authorization Reversal returns a *360 - No transaction found with specified transaction Id* error.
- Do not send an Authorization Reversal against a payment type that does not support Authorization Reversals. This results in a *335 - This method of payment does not support reversals* error.
- Do not send an Authorization Reversal for a fully depleted Authorization. This results in a *111 - Authorization amount has already been depleted* error.
- Do not use an Authorization Reversal to reverse an Authorization on a (Closed Loop) Gift Card. Use a Gift Card Auth Reversal instead (see [Gift Card Auth Reversal Transactions](#) on page 290).

### 1.16.2.2 Using Authorization Reversal to Halt Recycling Engine

If you are using the Recycling Engine to optimize your authorizations and need to discontinue the automatic recycling of the transaction, you use an Authorization Reversal transaction to halt the retries. For example, if a customer cancels an order and the authorization for the order is being retried by the Recycling Engine, you submit an Authorization Reversal transaction to halt the automatic recycling of the authorization.

---

---

**NOTE:** If the initial transaction you submitted is a Sale (conditional deposit) rather than an Authorization, you use a Void transaction to halt the recycling.

---

---

### 1.16.3 Activate Transaction

You use an Activate transaction to change the status of a (Closed Loop) Gift Card from an inactive to an active state with a value as specified by the amount element. You can also use this transaction type to create a Virtual Gift Card.

## 1.16.4 Activate Reversal Transaction (Online Only)

You use as Activate Reversal transaction to change the status of a newly activated (Closed Loop) Gift Card from active to inactive, thus reversing the operation of an Active transaction. The Activate Reversal references the associated Activate transaction by means of the `littleTxnId` element returned in the Activate response.

## 1.16.5 Balance Inquiry Transaction

You use the Balance Inquiry transaction to determine the balance available for use on a (Closed Loop) Gift Card.

## 1.16.6 Cancel Subscription Transaction

If you are using the Recurring Engine, you create Subscriptions as part of an Authorization or Sale transaction. You use the Cancel Subscription transaction to cancel the specified subscription, removing the transaction stream managed by the Recurring Engine.

## 1.16.7 Capture Transaction

You use a Capture transaction to transfer previously authorized funds from the customer to you after order fulfillment. You can submit a Capture transaction for the full amount of the Authorization, or for a lesser amount by setting the `partial` attribute to **true**.

---

---

**NOTE:** If you settle in a currency other than US or Canada, you cannot use partial captures.

For a Visa transaction, if you submit a Capture for an amount less than the Authorized amount, Vantiv automatically issues a partial Authorization Reversal for the balance of the Authorized amount.

---

---

Do not use a Capture transaction to capture funds on a (Closed Loop) Gift Card transaction; use a Gift Card Capture instead (see [Gift Card Capture Transactions](#) on page 292).

## 1.16.8 Capture Given Auth Transaction

Similar to a Capture transaction, you use a Capture Given Auth transaction to transfer previously authorized funds from the customer to you after fulfillment. However, you typically use a Capture Given Auth transaction if the associated Authorization occurred outside of the system (for example, if you received a telephone Authorization). Another possible use for a Capture Given Auth transaction is if the Authorization transaction occurred within the system, but the `littleTxnId` is unknown by the submitting party (for example, if the Auth was submitted by a merchant, but a fulfiller submits a Capture Given Auth).

Whenever you submit a Capture Given Auth transaction, Vantiv attempts to match it to an existing Authorization using COMAAR data (Card Number, Order Id, Merchant Id, Amount, Approval Code, and (Auth) Response Date) in order to obtain a better Interchange rate for the transaction. The application uses the following matching logic:

- If the Order Id was either not submitted (blank, spaces, or null) or does not match any Auth in the system, it is ignored and the matching attempt proceeds using the remaining COMAAR data.
- If the matching operation results in multiple possible matches, the application selects the Authorization with the lowest amount that is greater than or equal to the Capture Given Auth amount.

---

---

**NOTE:** In all cases, the Authorization amount must always be greater than or equal to the Capture Given Auth amount.

---

---

- If necessary, the application further narrows the match candidates to the one with the most recent response date.

---

---

**NOTE:** If Vantiv is able to match the Capture Given Auth to an Authorization and the following conditions are met: the card type is Visa and the Capture Given Auth amount is less than the Authorization amount, then Vantiv will issue an Auth Reversal transaction for the balance of the Authorization. This is done to obtain the best possible interchange rates from Visa.

---

---

## 1.16.9 Create Plan Transaction

You use the Create Plan transaction to define several attributes of a recurring payment schedule. Later, as part of an Authorization or sale transaction, you can associate existing, active plans with Subscriptions. This association establishes a recurring payment schedule managed by the Vantiv Recurring Engine.

## 1.16.10 Credit Transaction

You use a Credit transaction to refund money to a customer, even if the original transaction occurred outside of the system. You can submit refunds against any of the following payment transactions:

- Capture Transaction
- Capture Given Auth Transaction
- Force Capture Transaction
- Sale Transaction

- External Sale or Capture

---

---

**NOTE:** Vantiv recommends you send all Credit transactions in a Batch separate from the associated Capture or Sale transactions.

---

---

### 1.16.11 Deactivate Transaction

You use a Deactivate transaction to change the status of a (Closed Loop) Gift Card from an active to an inactive state.

### 1.16.12 Deactivate Reversal Transaction (Online Only)

You use a Deactivate Reversal transaction to change the status of a newly deactivated Gift Card from inactive to active, thus reversing the operation of an Deactivate transaction. The Deactivate Reversal references the associated Deactivate transaction by means of the `littleTxnId` element returned in the Deactivate response.

### 1.16.13 Deposit Reversal Transaction (Online Only)

Used only for (Closed Loop) Gift Card related transactions, a Deposit Reversal transaction to reverse the funds capture initiate by either a Capture or Sale transaction. The Deposit Reversal references the associated Capture/Sale transaction by means of the `littleTxnId` element returned in the Capture/Sale response. You should never attempt to use this transaction type to reverse credit card or eCheck transactions.

### 1.16.14 eCheck Credit Transaction

Similar to a Credit transaction, you use an eCheck Credit transaction to refund money to a customer, but only when the method of payment was an eCheck. You can submit an eCheck Credit transaction regardless of whether the original transaction occurred in or out of the system.

### 1.16.15 eCheck Prenotification Credit Transaction

You use this non-monetary transaction to verify the consumer's account information prior to submitting an eCheck Credit transaction (also see [eCheck Prenotification](#) on page 49). This transaction type is only supported for US transactions.

### 1.16.16 eCheck Prenotification Sale Transaction

You use this non-monetary transaction to verify the consumer's account information prior to submitting an eCheck Sale transaction (also see [eCheck Prenotification](#) on page 49). This transaction type is only supported for US transactions.

### 1.16.17 eCheck Redeposit Transaction

You use this transaction type to manually attempt redeposits of eChecks returned for either Insufficient Funds or Uncollected Funds. You can use this element in either Online or Batch transactions.

---

---

**NOTE:** Do not use this transaction type if you are enabled for the Auto Redeposit feature. If you are enabled for the Auto Redeposit feature, the system will reject any `echeckRedeposit` transaction you submit.

---

---

### 1.16.18 eCheck Sales Transaction

You use an eCheck Sales transaction to transfer funds from the customer to you after order fulfillment. It is the eCheck equivalent of a Capture transaction. Funding usually occurs within two days. You can also submit this transaction type as a conditional capture, which makes the processing of the deposit conditional upon a successful verification. If the verification fails, the deposit is not processed.

### 1.16.19 eCheck Verification Transaction

You use an eCheck Verification transaction to initiate a comparison to a database containing information about checking accounts. The database may include information as to whether the account has been closed, as well as whether there is a history of undesirable behavior associated with the account/account holder. This transaction type is only supported for US transactions.

### 1.16.20 eCheck Void Transaction (Online Only)

You use an eCheck Void transaction to either halt automatic redeposit attempts of eChecks returned for either Insufficient Funds or Uncollected Funds, or cancel an eCheck Sale transaction, as long as the transaction has not yet settled. This also applies to merchant initiated redeposits. You can use this element only in Online transactions.



### 1.16.21 Force Capture Transaction

A Force Capture transaction is a Capture transaction used when you do not have a valid Authorization for the order, but have fulfilled the order and wish to transfer funds.

---

**CAUTION:** Merchants must be authorized by Vantiv before processing this transaction. In some instances, using a Force Capture transaction can lead to chargebacks and fines.

---

### 1.16.22 Gift Card Auth Reversal

You use the Gift Card Auth Reversal transaction to reverse an Authorization on a (Closed-loop) Gift Card. This removes the hold on the previously authorized amount, freeing those funds for additional purchases by the cardholder.

### 1.16.23 Gift Card Capture

You use the Gift Card Capture transaction to capture or deposit previously authorized funds on a (Closed-loop) Gift Card.

### 1.16.24 Gift Card Credit

You use a Gift Card Credit transaction to refund money to a customer that used a (Closed Loop) Gift Card for the purchase, even if Vantiv did not process the purchase. You have a choice of two structures. You use the message type containing a transaction Id to apply a credit for a transaction processed by Vantiv. You use the message type containing an order Id to apply a credit for a transaction not processed by Vantiv.

### 1.16.25 Load Transaction

You use a Load transaction to add funds to an active Gift Card. The load amount cannot exceed the maximum allowed amount for the Gift Card. If you attempt to load more than the maximum amount, the transaction will be declined with a response Code of 221 - Over Max Balance.

### 1.16.26 Load Reversal Transaction (Online Only)

You use a Load Reversal transaction to reverse the operation of a Load transaction, removing the newly loaded amount from the Gift Card. You cannot perform a partial Load Reversal. This transaction always reverses the full amount of the referenced Load transaction.

### 1.16.27 Refund Reversal Transaction (Online Only)

The Refund Reversal transaction is a (Closed Loop) Gift Card only transaction that reverses the operation of a Refund transaction on the Gift Card. You cannot perform a partial Refund Reversal. This transaction always reverses the full amount of the referenced Refund transaction.

### 1.16.28 Register Token Transaction

You use the Register Token transaction to submit a credit card number, eCheck account number, or Registration Id to us and receive a token in return. While you can submit Register Token transactions at any time, typically, you would make use of this transactions when initially converting to the use of tokens. In this case you would submit large quantities of credit cards/eCheck account numbers in Batches and replace them in your database with the tokens returned.

### 1.16.29 Sale Transaction

The Sale transaction enables you to both authorize fund availability and deposit those funds by means of a single transaction. The Sale transaction is also known as a conditional deposit, because the deposit takes place only if the authorization succeeds. If the authorization is declined, the deposit will not be processed.

---

---

**NOTE:** If the authorization succeeds, the deposit will be processed automatically, regardless of the AVS or CVV2 response.

To obtain better interchange rates, you should always perform an AVS check either as a standalone transaction, or as part of the Authorization/Sale transaction.

---

---

### 1.16.30 Status Query Transaction

The Status Query Transaction allows you to verify that an Online transaction submitted within the prior 24 hours exists in the system. The response will be one of the following:

- A single transaction matching the search criteria
- Multiple transactions matching the search criteria
- Empty results, if no transactions matched the criteria
- A limited response, if a transaction was found, but processing was not complete

As search criteria, you must submit, at a minimum, the id (id attribute) and transaction type (i.e., authorization, deposit, void, etc.) of the original transaction, but to narrow the search, you can also include the transaction id, order id, and the account number (credit, debit, or gift card) from

the original transaction. The response message contains one of four response codes, 150 through 153 (see [Payment Transaction Response Codes](#) on page 816), and the results for the search.

---

**NOTE:** Use of this transaction type requires specific permissions. Please speak to your Vantiv Implementation Consultant for additional information.

---

### 1.16.31 Unload Transaction

You use an Unload transaction to remove funds from an active Gift Card. The unload amount cannot exceed the available balance on the Gift Card. If you attempt to unload more than the available balance, the transaction will be declined with a response Code of 209 - Invalid Amount.

### 1.16.32 Unload Reversal Transaction (Online Only)

The Unload Reversal transaction reverses the operation of a Unload transaction, returning the value removed from the Gift Card by the Unload transaction. You cannot perform a partial Unload Reversal. This transaction always reverses the full amount of the referenced Unload transaction.

### 1.16.33 Update Card Validation Number Transaction

When you submit the CVV2/CVC2/CID in a `registerTokenRequest`, the platform encrypts and stores the value on a temporary basis for later use in a tokenized Auth/Sale transaction submitted without the value. This is done to accommodate merchant systems/workflows where the security code is available at the time of token registration, but not at the time of the Auth/Sale. If for some reason you need to change the value of the security code supplied at the time of the token registration, use an `updateCardValidationNumOntoken` transaction.

### 1.16.34 Update Plan Transaction

You use the Update Plan transaction to activate/deactivate Plans associated with recurring payments. When you deactivate a Plan, by setting the `active` flag to **false**, you can no longer reference that Plan for use with subscriptions. Existing subscriptions already using the deactivated Plan will continue to use the Plan until the subscription is either modified or completed. You can also reactivate a deactivated Plan by updating the Plan and setting the `active` flag to **true**.

### 1.16.35 Update Subscription Transaction

You use an Update Subscription transaction to change certain subscription information associated with a recurring payment. Using this transaction type you can change the plan, card, billing

information, and/or billing date. You can also create, update, or delete a Discount and/or an Add On.

### 1.16.36 Void Transaction (Online Only)

The Void transaction enables you to cancel any settlement transaction as long as the transaction has not yet settled and the original transaction occurred within the system (Voids require a reference to a `littleTxnId`). Before submitting a Void, please allow a minimum of 60 seconds to elapse after submitting the transaction you wish to void. This timing ensures our system fully records the first (to be voided) transaction in our database.

---

---

**NOTE:** Do not use Void transactions to void an Authorization. To remove an Authorization use an Authorization reversal transaction (see [Authorization Reversal Transactions](#) on page 76.)

---

---

#### 1.16.36.1 Using Void to Halt Recycling Engine

If you use Recovery or the Recycling Engine service and use Sale transactions (conditional deposits) to authorize and capture the funds, you must use a Void transaction to discontinue the automatic recycling of the transaction should the need arise. For example, if a customer cancels an order and the Sale transaction is being retried by the Recycling Engine, you submit a Void transaction to halt the automatic recycling of the transaction.

---

---

**NOTE:** If the initial transaction you submitted is an Authorization rather than an Sale, you use an Authorization Reversal transaction to halt the recycling.

---

---

When using a Void transaction to halt recycling, there is a possibility that the recycled transaction has already been approved and captured. If this condition occurs, depending upon your configuration, the system takes one of two actions:

- If you are not configured for the Automatic Refund option (default = disabled), the system declines the Void transaction. You must issue the Credit transaction to refund the money to the consumer. The daily Recycling file will include the approved/captured transaction.
- If you are configured for the Automatic Refund option, the system issues a Credit transaction on your behalf. The system returns the transaction Id for the Credit transaction in the Void response message (`creditLittleTxnId` element). The daily Recycling file will include the approved/captured transaction only if the file was generated prior to the system receiving the Void and issuing the automatic refund.

## 1.16.37 Instruction-Based Dynamic Payout Transactions

If you are a PayFac using the Instruction-Based Dynamic Payout model, there are a number of Batch only transaction types you use to move funds between various accounts, including funding Sub-merchants. This section provides information about these transaction types. For additional information, please refer to the [Appendix D, "PayFac™ Dynamic Payout"](#).

- **Funding Instruction Void** - You use this transaction type to void a submitted funding instruction. You must submit the void prior to your daily cutoff time for an instruction not yet processed.
- **PayFac Credit Transaction** - You use this transaction type to move funds from the PayFac Settlement Account to your Operating Account.
- **PayFac Debit Transaction** - You use this transaction type to move funds from your Operating Account to the PayFac Settlement Account.
- **Physical Check Credit** - You use this transaction type to move funds from the PayFac Settlement Account to the account of a third party that issues physical checks on your behalf.
- **Physical Check Debit** - You use this transaction type to move funds from the physical check issuer's Account to the PayFac Settlement Account.
- **Reserve Credit Transaction** - You use this transaction type to move funds from the PayFac Settlement Account to the Reserve Account.
- **Reserve Debit Transaction** - You use this transaction type to move funds from the Reserve Account to the PayFac Settlement Account.
- **Sub-merchant Credit Transaction** - You use this transaction type to move funds from the PayFac Settlement Account to the Sub-merchant Account, funding the Sub-merchant.
- **Sub-merchant Debit Transaction** - You use this transaction type to move funds from the Sub-merchant Account to the PayFac Settlement Account.
- **Vendor Credit** - You use this transaction type to move funds from the PayFac Settlement Account to the account of a third party involved in the sale transactions, but are not the sub-merchant.
- **Vendor Debit** - You use this transaction type to move funds from the Vendor Account to the PayFac Settlement Account.



---

## TESTING YOUR CNPAPI TRANSACTIONS

The information provided in this chapter enables you to test and verify that your submitted transaction data conforms to the required cnpAPI schema. This chapter contains the following topics:

- [Certification and Testing Environments](#)
- [Overview of Testing](#)
- [Transferring Files](#)
- [Performing the Required Certification Tests](#)
- [Performing the Optional Tests](#)

---

**IMPORTANT:** Per PCI DSS Requirements and Security Assessment Procedure, Section 6.4.3, "Production data (live PANs) are not used for testing or development."

---

---

**NOTE:** This chapter does not include Certification tests for the PayFac Instruction-Based Dynamic Payout transaction types. Additional information about these transactions, as well as the Certification tests are in [Appendix D, "PayFac™ Dynamic Payout"](#).

---

## 2.1 Certification and Testing Environments

Vantiv has several testing and certification platforms optimized for different uses. These environments are called: Sandbox, Pre-Live, and Post-Live. This section discusses the various environments, their uses, and limitations. The certification and testing environments do not have the full capacity, performance, or availability of the Vantiv Production platform.

### 2.1.1 Sandbox Environment

The Sandbox environment is a simulator that provides a basic interface for functional level testing of transaction messages. Typically, merchants using one of the available Software Development Kits (SDKs) would use the Sandbox to test basic functionality, but it could also be used by any merchant using cnpAPI. This is a stateless simulator, so it has no historical transactional data, and does not provide full functionality. This environment is not intended for certification or regression testing.

---

---

**NOTE:** At his time, the Sandbox does not support Batch transactions (Online transactions only).

---

---

Use of the Sandbox does not require a password. The environment is available on the public internet (at [www.testvantivcnp.com/sandbox/communicator/online](http://www.testvantivcnp.com/sandbox/communicator/online)). Supporting documentation, including test case documentation, is available at [vantiv-ecommerce.github.io/sandbox](https://github.com/vantiv-ecommerce/sandbox).

### 2.1.2 Pre-Live Environment

The Pre-Live test environment is the platform used for all merchant Certification testing. This environment should be used by both newly on-boarding Vantiv merchants (for example, coding a direct XML integration for the first time), and existing Vantiv merchants seeking to incorporate additional features or functionalities into their current XML integrations. While the Pre-Live system provides a working version of the Vantiv production system, it does not have the full capacity or performance of the production platform and operates using simulators rather than communicating with the card associations.

The Pre-Live environment provides for the self-provisioning of a basic test account via [www.testvantivcnp.com/sandbox](http://www.testvantivcnp.com/sandbox). Using this account, you can submit most standard transaction types, including those specified in the Certification test sections provided later in this chapter. You will not be able to test many of the Vantiv eCommerce Value Added Services (VAS) using this basic account. To add the capability to perform test scenarios for the VAS services, please contact a Vantiv Implementation Consultant. They will adjust the configuration of your test account to enable the additional, desired features.



### 2.1.2.1 Pre-Live Environment Limitations and Maintenance Schedules

When using the Pre-Live environment for testing, please keep in mind the following limitations and maintenance schedules:

- The number of merchants configured per organization will be limited to the number necessary to perform the required certification testing.
- Data retention is limited to a maximum of 30 days.

---

---

**NOTE:** Depending upon overall system capacity and/or system maintenance requirements, data purges may occur frequently. Whenever possible, we will provide advanced notification.

---

---

- Merchant profile and data deleted after 7 consecutive days with no activity.
- Maintenance window - each Tuesday and Thursday from 4:00-8:00 AM ET.
- Maintenance window (Enterprise eProtect) - every other Thursday from 10:00 PM to 6:00 AM ET.
- Daily limit of 1000 Online transactions.
- Daily limit of 10000 Batch transactions.

---

---

**NOTE:** Due to the planned maintenance windows, you should not use this environment for continuous regression testing.

---

---

### 2.1.3 Post-Live Environment

The Post-Live testing environment is intended for merchants that are already fully certified and submitting transactions to the Vantiv production platform, but wish to perform regression or other tests to confirm the operational readiness of modifications to their own systems. Upon completion of the initial certification and on-boarding process, Vantiv migrates merchants that are Production-enabled to the Post-Live environment for any on-going testing needs.

In Post-Live, the merchant profile matches your profile from the Vantiv Production environment. Similar to Pre-Live, the Post-Live system provides a working version of the Vantiv production system, but it does not have the full capacity or performance of the production platform and operates using simulators rather than communicating with the card associations. Unlike the Pre-live platform, all Merchant accounts/IDs are synchronized with the Vantiv production environment.

#### 2.1.3.1 Post-Live Environment Limitations and Maintenance Schedules

When using the Post-Live environment for testing, please keep in mind the following limitations and maintenance schedules:

- Daily limit of 1000 Online transactions.
- Daily limit of 10000 Batch transactions.
- Maintenance window - each Tuesday and Thursday from 4:00-8:00 AM ET.
- Data retention limited to a maximum of 30 days.

---

---

**NOTE:** Depending upon overall system capacity and/or system maintenance requirements, data purges may occur frequently. Whenever possible, Vantiv will provide advanced notification.

Also, due to the planned maintenance windows, you should not use this environment for continuous regression testing.

---

---

## 2.2 Overview of Testing

The purpose of the testing and certification process is to verify that your order entry and supporting systems construct and send XML messages that comply with the cnpAPI requirements. The testing process involves submitting Vantiv supplied data for specific fields in a request, and receiving specific data back in a response. The response returned by Vantiv allows you to verify that you parse the cnpAPI response file correctly.

Various tables in this chapter provide the data you use while testing, including card numbers, expiration dates, transaction amounts, and other values as required by the testing process. You use this data as input to your systems resulting in structured requests that conform to the required cnpAPI schema.

---

---

**IMPORTANT:** The test data supplied does not necessarily account for all data fields/xml elements in a particular request. Where test data is not supplied, you should provide appropriate information. You should never override your own system to enter supplied data. If you are unable to enter the supplied data without overriding your system, please consult your Implementation Consultant concerning the test and how to proceed.

---

---

Typically, Vantiv assigns an Implementation Consultant to work with you after the completion of contract negotiations. Before you begin the testing phase, your assigned Implementation Consultant establishes a test account and supplies you with instruction for accessing the account along with the username and password. You must supply the IP address from which the data originates so we can grant access.

---

---

**NOTE:** Until you complete all required testing, you will only have access to the test and certification environment.

---

---

The testing process involves the following steps:

### 2.2.1 Planning for Certification Testing

Before you begin testing, determine which transaction types you will use according to your business needs. Virtually everyone will make use of the following basic transaction types: Authorization, Capture, Sale, Credit, and Void. There are several other transaction types and most transaction types offer many options/optional fields that you may wish to utilize and therefore test. For example, if you decide to offer eChecks as a alternate payment method, there are several associated certification tests required. Similarly, if you elect to make use of the Insights feature set, there are additional Authorization tests required for certification.

---

---

**NOTE:** For information about certification testing for PayPal, eProtect, Chargeback API, and the PayFac API, please refer to the following documents:

- *Vantiv PayPal Integration Guide*
  - *Vantiv eProtect Integration Guide*
  - *Vantiv Chargeback API Reference Guide*
  - *Vantiv PayFac API Reference Guide*
- 
- 

## 2.2.2 Required Certification Testing

Certification testing is a required phase of implementing the cnpAPI format. During the certification testing, a Vantiv Implementation Consultant works with you to verify that your transaction submissions meet the requirements of the cnpAPI specifications. Each transaction type has specific test scenarios that use specific data sets simulating real transactions. The Vantiv Certification environment responds to each submission with an XML response message, allowing you to verify that you have coded correctly to parse and store the transaction data returned to you. For more detailed information, see [Performing the Required Certification Tests](#) on page 103.

## 2.2.3 Optional Testing

Vantiv provides you with test data, test scenarios, a test environment, and credentials for using that test environment so you can perform these tests on your own keeping in mind the limitations of the certification environment (see [Certification and Testing Environments](#) on page 90). During unattended testing, you use these resources to perform all of the tests that apply to your business needs.

---

---

**NOTE:** If you have questions or need assistance while performing unattended testing, feel free to call your assigned Implementation Consultant or email [implementation@vantiv.com](mailto:implementation@vantiv.com).

---

---

## 2.2.4 System Doctor

The System Doctor is a tool you can use to both verify the operation of the Pre-Live environment and to verify operation and message structures of individual certification tests. Every 30 minutes the System Doctor runs each certification test specified in this chapter, except the Recycling and Recurring tests. You access the System Doctor through the Pre-Live iQ (Operations>System Doctor).

**FIGURE 2-1** System Doctor

The screenshot shows the 'Systems Doctor' interface. At the top, it displays 'Phoenix Processing Friday, March 14, 2014 Environment: prelive'. The main navigation bar includes 'Transaction Search', 'Transaction Summary', 'Sessions', 'BIN Lookup', 'Authorization', 'Virtual Terminal', 'Presenter Credentials', 'Payfac Portal', and 'Systems Doctor'. The 'Systems Doctor' section is active, showing an 'Overall Status' panel with a cloud and rain icon, indicating '210 of 210 Transactions Successful' and 'Average FTP Response Time: 60 seconds'. Below this is a 'Search Tags' section with a grid of buttons for various transaction types and statuses, and a 'Select Order Id:' pull-down menu. The bottom section is 'Test Execution History', which contains a table of test runs.

Time Stamp	Status	Transaction Remarks
2014-3-14 9:31:29 AM	●	210 / 210 Transactions Successful
2014-3-14 9:01:16 AM	●	210 / 210 Transactions Successful
2014-3-14 8:31:11 AM	●	210 / 210 Transactions Successful
2014-3-14 8:01:24 AM	●	210 / 210 Transactions Successful
2014-3-14 7:31:15 AM	●	210 / 210 Transactions Successful

As shown in [Figure 2-1](#), the system displays an overall assessment of the system status in the top panel and the results from each test set in the Test Execution History section (bottom panel). The center panel has a list of all individual tests by Order Id (pull-down), which you can filter by clicking on or more of the Search Tag buttons. Selecting one of the Order Ids from the list displays the XML request and response for that test (see [Figure 2-2](#)). You can also display the XML request and response information by selecting a test run from the Test Execution History and then selecting an individual test from the expanded list.

---

**NOTE:** The search tags filter the Order Ids shown in the selection pull-down, but do so in an ORed manner. For example, if you select the Visa Filter and the Prepaid Filter, the pull-down displays Order Ids for tests that either use a Visa card OR a Prepaid card, rather than tests for a Prepaid Visa card.

---

**FIGURE 2-2** XML Request and Response Messages

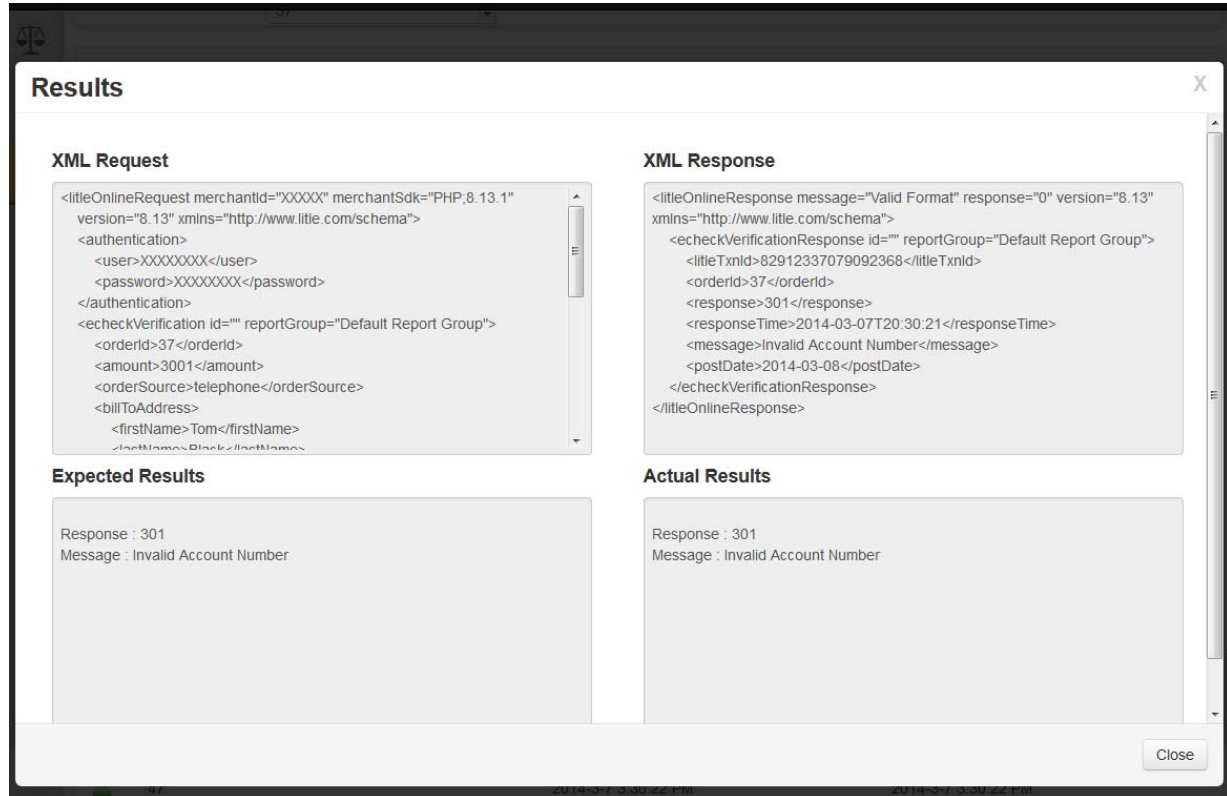

If one of your certification tests did not yield the expected results, you can use the System Doctor to determine if the test is performing as expected in the environment and if there is a discrepancy between your submitted XML and the XML message used in the automated test. If the test failed in the last automated run, you will know that there is a system issue and can contact your Implementation Consultant to determine when it will be resolved. If the test passed in the automated run, you can compare the automated XML message to your submission to determine why you are not receiving the expected results.

## 2.3 Transferring Files

As discussed in [Communications Protocols](#) on page 2, there are several protocols you can use to submit your transactions to Vantiv for processing. This section provides additional information concerning the recommended methods for transferring your cnpAPI Batch and Online transaction files.

### 2.3.1 Transferring Session Files

This section describes how to FTP your files (not test system specific) and includes the following topics:

- [Submitting a Session File for Processing](#)
- [Retrieving Processed Session Files](#)

---

---

**NOTE:** Before you begin transferring files via FTP, Vantiv provides the FTP Host and a username/password for the Vantiv test system.

---

---

#### 2.3.1.1 Submitting a Session File for Processing

---

---

**CAUTION:** When submitting a file via FTP/sFTP, verify that the file permission is set to 664.

Also, file naming conventions are crucial to the file submission process. Incorrect file names will prevent the file from being processed or may stop processing due to an incomplete file transfer.

Do not append .asc to the end of the filename (Step 3). You must replace the .prg extension with .asc. If .prg appears in the filename, the system will not process the file.

---

---

1. On your local system, add the extension .prg (lowercase) to the name of the file you want to submit. For example, you could name the file MerchantName\_YYMMDD.prg. Keep in mind the following rules:
  - Spaces are not allowed in the file name
  - The .prg extension must be lower case
2. Open your FTP connection to the Vantiv inbound directory and move your file to the Vantiv directory.
3. After the FTP process completes, change the extension of the transmitted file (in the Vantiv inbound directory) from .prg to .asc (lowercase). Also, change the file permission to 664. The system polls the directory for files with an .asc extension every thirty seconds. When the system encounters files with the proper extension, it retrieves them for processing.

### 2.3.1.2 Retrieving Processed Session Files

Depending on the size of your file, your response should be ready within a few minutes. Batches containing large number of transactions take longer. For example, a batch of 10,000 transactions may require as long as ten minutes to process.

The initial response represents an acknowledgment that we received the transactions and notification that we will deliver them upstream to Visa and/or MasterCard for review. Since we perform validation operations against the credit card number and the expiration date, you may also receive a decline responses containing the appropriate response code.

To retrieve response files from the outbound directory:

---

---

**NOTE:** Vantiv removes response files from the outbound directory after 24 hours. Plan to retrieve your files daily.

---

---

1. Open your FTP connection to the Vantiv outbound directory.
2. Locate the response file, which will have the same name as the file you submitted. If the response file has a .prg extension, it is still transferring. The extension changes to .asc when the transfer to the outbound directory completes.
3. Retrieve the response file.

### 2.3.2 Transferring Online Files

The recommended method for submitting Online transactions is via HTTPS POST. The sections that follow provide examples of ASP and Java programming methods for submitting your data using HTTPS POST.

- [ASP Programming Example](#)
- [Java Programming Example](#)
- [Helpful Web Sites](#)

---

---

**NOTE:** Before you begin testing, Vantiv provides the test system URL, a username/password, and any additional information required to test your XML transactions.

---

---



### 2.3.2.1 ASP Programming Example

The following code is an example of a cnpAPI Authorization transaction submitted via HTTPS Post using ASP.

```
Dim xml

Dim strXML

strXML = strXML & "<litleOnlineRequest version=""11.1""
xmlns=""http://www.litle.com/schema"" merchantId=""MERCHANTID"">"

strXML = strXML & "<authentication>"

strXML = strXML & "<user>USERNAME</user>"

strXML = strXML & "<password>#####</password>"

strXML = strXML & "</authentication>"

strXML = strXML & "<authorization id=""834262""
reportGroup=""123"" customerId=""038945"">"

strXML = strXML & "<orderId>3235059</orderId>"

strXML = strXML & "<amount>54399</amount>"

strXML = strXML & "<orderSource>ecommerce</orderSource>"

strXML = strXML & "<billToAddress>"

strXML = strXML & "<name>Todd Wilson</name>"

strXML = strXML & "<addressLine1>123 Blue
Street</addressLine1>"

strXML = strXML & "<addressLine2>Suite 108</addressLine2>"

strXML = strXML & "<addressLine3>Address Line 3</addressLine3>"

strXML = strXML & "<city>Lowell</city>"

strXML = strXML & "<state>MA</state>"

strXML = strXML & "<zip>01851</zip>"

strXML = strXML & "<country>USA</country>"

strXML = strXML & "<email>twilson@email.com</email>"

strXML = strXML & "<phone>323-222-2222</phone>"

strXML = strXML & "</billToAddress>"

strXML = strXML & "<card>"

strXML = strXML & "<type>VI</type>"

strXML = strXML & "<number>#####</number>"

strXML = strXML & "<expDate>0521</expDate>"

strXML = strXML & "<cardValidationNum>###</cardValidationNum>"

strXML = strXML & "</card>"
```

```
    strXML = strXML & "</authorization>"
    strXML = strXML & "</litleOnlineRequest>"
    set xml = CreateObject("Microsoft.XMLHTTP")
    xml.setRequestHeader "Content-type", "text/html; charset=UTF-8"
    xml.Open "POST", "https://site.info.com/from_Litle", False
    xml.Send strXML
    Response.write (xml.responseText)
    set xml = Nothing
```

### 2.3.2.2 Java Programming Example

The following is an example of Java code used for HTTPS Post.

PostMethod and HttpClient are both part of the Apache HttpClient library located at <http://jakarta.apache.org/commons/httpclient/>.

```
PostMethod post = new PostMethod(url); // url = fully qualified url
of the server to which you are posting
post.setRequestHeader("Content-type", "text/html; charset=UTF-8");
post.setRequestBody(data); //data = request data in XML format

HttpClient client = new HttpClient();
client.setTimeout(10000); //10 second timeout (in milliseconds) is
suggested minimum, 30 second recommended for alternate payment
methods
client.executeMethod(post);

String response = post.getResponseBodyAsString();

//if the server throws an exception you get a null response
//to get around this set it to ""
if (response == null) {
    response = "";
}
post.releaseConnection();
```

### 2.3.2.3 Notes on Timeout Settings

While Vantiv optimizes our systems to ensure the return of Authorization responses as quickly as possible, some portions of the process are beyond our control. The round-trip time of an Authorization can be broken down into three parts, as follows:

1. Transmission time (across the internet) to Vantiv and back to the merchant
2. Processing time by the card association or authorization provider
3. Processing time Vantiv

Under normal operating circumstances, the transmission time to and from Vantiv does not exceed 0.6 seconds and processing time by Vantiv occurs in 0.1 seconds. Typically, the processing time by the card association or authorization provider can take between 0.5 and 3 seconds, but some percentage of transactions may take significantly longer.

Because the total processing time can vary due to a number of factors, Vantiv recommends using a timeout setting of 10 seconds minimum for card transactions and 30 seconds minimum for alternate payment methods. These settings should ensure that you do not frequently disconnect prior to receiving a valid authorization causing dropped orders and/or re-auths and duplicate auths.

---

---

**NOTE:** While it is uncommon, under certain circumstances network latency may cause a duplicate Online Sale transaction to go undetected as a duplicate. This can occur if you submit a second, duplicate Sale transaction while the response from the network for the Authorization portion of the first transaction is sufficiently delayed such that the first Sale has not been recorded as a valid transaction in the system.

If you elect to submit Online Sale transactions, Vantiv recommends a timeout setting of not less than 60 seconds to reduce the chances of undetected duplicate Sale transactions.

---

---

### 2.3.2.4 Notes on Persistent Connections

In order to provide a highly scalable service that meets the needs of high-throughput merchants, while reducing the number of idle connections that could result in some merchants exceeding their connection limits, Vantiv systems allow for 10 seconds of idle time before closing a connection. We selected this value because it is the midpoint between the Apache httpd 2.0 default value of 15 seconds and the Apache 2.2 default value of 5 seconds. Also, HTTP/1.1, which most modern HTTP client libraries use, employ persistent connections by default. When using a persistent connection, please keep the 10 second idle time limit in mind, when coding. If you do not use persistent connections, to avoid connection limit issues, please validate that your default configuration closes connections after each request.

---

---

**NOTE:** Proper use of persistent connections is considerably faster than opening and closing connections with each request.

---

---

### 2.3.2.5 Helpful Web Sites

The following web sites provide additional information, helpful hints, and examples of different programming methods used in combination with HTTPS POST.

- <http://p2p.wrox.com>
- <http://en.allexperts.com/q/Active-Server-Pages-1452/XML-ASP-Parser-2.htm>
- <http://www.java-samples.com/java/POST-toHTTPS-url-free-java-sample-program.htm>

## 2.4 Performing the Required Certification Tests

You are required to complete a number of certification tests prior to submitting real transactions to the Vantiv production system. This testing process allows you to verify that your system not only submits correctly formatted transaction data, but also correctly parses the data returned to you in the response messages. To facilitate the certification process, Vantiv has established a certification environment that simulates the production environment.

---

---

**IMPORTANT:** To determine the final status and response Code of a declined or duplicate transactions, please refer to the Declined Transaction Report in Vantiv iQ. Once in the production environment, you can also obtain this daily report via Secure Scheduled Reports.

---

---

During certification testing, a Vantiv Implementation Consultant will guide you through each required test scenario. For each transaction type specific data is supplied that you must use in your cnpAPI transactions. Use of this data allows the validation of your transaction structure/syntax, as well as the return of a response file containing known data.

---

---

**NOTE:** The test data supplied does not account for all data fields/xml elements in a particular request. Where data is not supplied, you should provide appropriate information. You should never override your own system to enter supplied data. If you are unable to enter the supplied data without overriding your system, please consult your Implementation Consultant concerning the test and how to proceed.

Never use the supplied test data in the production environment.

---

---

### 2.4.1 Testing Authorization (including Indicators), AVS Only, Capture, Credit, Sale, and Void Transactions

---

---

**NOTE:** To test your handling of 2-series (BIN) number for MasterCard, you can substitute a 2-series test card number (see [Appendix C, "Test Card Numbers"](#)) in any Auth/Sale test and you will receive a 000 - Approved Response Code in the response message.

---

---

Table 2-1 provides 26 data sets you use to test your construction of Authorization, AVS Only, Sale and Force Capture transactions, as well as your ability to parse the information contained in the XML response messages. You also use some of the approved authorizations as the basis for testing Capture and Credit transactions.

You do not necessarily have to perform all Authorization test. The tests you perform depend upon the Vantiv features you have elected to use. The tests are divided as follows:

- Order Ids 1 through 9 - used to test standard Authorization requests and responses. Also used for AVS Only test and Sale test. (Capture test use the `littleTxnId` returned in the response messages.)
- Order Ids 10 through 13 - include if you plan to use **Partial Authorization**
- Order Ids 14 and 20 - include if you plan to use the **Prepaid Indicator** feature (see [Prepaid Indicator](#) on page 24)
- Order Ids 21 through 24 - include if you plan to use the **Affluence Indicator** feature (see [Affluence Indicator](#) on page 25)
- Order Id 25 - include if you plan to use the **Issuer Country** feature (see [Issuer Country Indicator](#) on page 26)

To test **Authorization** transactions:

1. Verify that your Authorization XML template is coded correctly (refer to [Authorization Transactions](#) on page 208.)
2. Submit `authorization` transactions using the data shown in the Supplied Data Elements of Order Ids 1 through 9 of [Table 2-1](#).
3. Verify that your response values match those shown in Key Response Elements for Order Ids 1 through 9 as shown in [Table 2-1](#).
4. If you wish to test **AVS only** transactions, re-submit Order Ids 1 through 5, 7, 8, and 9 (skip order 6), but substitute 000 for the amount. The AVS result returned will be the value shown in the Key Response Elements section.
5. If you plan to use **Partial Authorizations**, submit `authorization` transactions using the data shown in the Supplied Data Elements of Order Ids 10 through 13 of [Table 2-1](#).
6. Verify that your response values match those shown in Key Response Elements for Order Ids 10 through 13 as shown in [Table 2-1](#).
7. If you elected to receive **Prepaid Indicators**, submit `authorization` transactions using the data shown in the Supplied Data Elements of Order Ids 14 through 20 of [Table 2-1](#). Verify that your response values match those shown in Key Response Elements for Order Ids 14 and 15 as shown in [Table 2-1](#).
8. If you elected to receive **Affluence Indicators**, submit `authorization` transactions using the data shown in the Supplied Data Elements of Order Ids 21 through 24 of [Table 2-1](#). Verify that your response values match those shown in Key Response Elements for Order Ids 16 through 19 as shown in [Table 2-1](#).
9. If you elected to receive **Issuer Country** information, submit an `authorization` transaction using the data shown in the Supplied Data Elements of Order Id 25 of [Table 2-1](#). Verify that your response values match those shown in Key Response Elements for Order Id 25 as shown in [Table 2-1](#).

---

**NOTE:** Some Issuers do not return an Auth Code for \$0 Authorizations. You should code your systems to handle this possibility.

---

**To Test Sale transactions:**

1. Verify that your Sale XML template is coded correctly (refer to [Sale Transactions](#) on page 314.)
2. Submit `sale` transactions using the data shown in the Supplied Data Elements of Order Ids 1 through 9 of [Table 2-1](#).
3. Verify that your response values match those shown in Key Response Elements for Order Ids 1 through 9 as shown in [Table 2-1](#).

**To Test Capture transactions:**

1. Verify that your Capture XML template is coded correctly (refer to [Capture Transactions](#) on page 231.).
2. Submit `capture` transactions for Order Ids 1A through 5A using the `littleTnxId` value returned in the response messages for Authorization Order Ids 1 through 5.
3. Verify that your response values match those shown in Key Response Elements for Order Ids 1A through 5A as shown in [Table 2-1](#).

**To test Credit transactions:**

1. Verify that your Credit XML template is coded correctly (refer to [Credit Transactions](#) on page 247.)
2. Submit `credit` transactions for Order Ids 1B through 5B using the `littleTnxId` value returned in the response messages for Capture Order Ids 1A through 5A.
3. Verify that your response values match those shown in Key Response Elements for Order Ids 1B through 5B as shown in [Table 2-1](#).

**To test Void transactions (in this test you have the option of voiding either Credit or Sale transactions):**

1. Verify that your Void XML template is coded correctly (refer to [Void Transactions \(Online Only\)](#) on page 334.)
2. Submit `void` transactions for Order Ids 1C through 5C (and 6B if voiding Sale transactions) using the `littleTnxId` value returned in either the response messages for Credit Order Ids 1B through 5B, or the response messages for Sale (not Auth) Order Id 1 through 6.
3. Verify that your response values match those shown in Key Response Elements for Order Ids 1C through 5C (include 6B only if you elect to void the Sales transactions) as shown in [Table 2-1](#).

**TABLE 2-1** Authorization Test Data

orderId	Supplied Data Elements		Key Response Elements	
	Element	Value	Element	Value
1	<b>Authorization/Sale/AVS:</b>		<b>Authorization Response:</b>	
	<amount>	10100	<response>	000
	<name>	John & Mary Smith	<message>	Approved
	<addressLine1>	1 Main St.	<authCode>	11111
	<city>	Burlington	<avsResult>	01
	<state>	MA	<cardValidationResult>	M
	<zip>	01803-3747		
	<country>	US		
	<type>	VI		
	<number>	4457010000000009		
	<expDate>	0121		
	<cardValidationNum>	349		
1A	<b>Capture:</b>		<b>Capture Response:</b>	
	<littleTxnId>	Value returned in Auth response for Order Id 1	<response>	000
			<message>	Approved
1B	<b>Credit:</b>		<b>Credit Response:</b>	
	<littleTxnId>	Value returned in Capture response for Order Id 1A	<response>	000
			<message>	Approved
1C	<b>Void:</b>		<b>Void Response:</b>	
	<littleTxnId>	Use either the value returned in the Credit response for Order Id 1B, or the value returned in the Sale response (not Auth) for Order Id 1.	<response>	000
			<message>	Approved



**TABLE 2-1** Authorization Test Data (Continued)

orderId	Supplied Data Elements		Key Response Elements	
	Element	Value	Element	Value
2	<b>Authorization/Sale/AVS:</b>		<b>Authorization Response:</b>	
	<amount>	10100	<response>	000
	<name>	Mike J. Hammer	<message>	Approved
	<addressLine1>	2 Main St.	<authCode>	22222
	<addressLine2>	Apt. 222	<avsResult>	10
	<city>	Riverside	<cardValidationResult>	M
	<state>	RI	<authenticationResult>	<b>Note:</b> Not returned for MasterCard
	<zip>	02915		
	<country>	US		
	<type>	MC		
	<number>	5112010000000003		
	<expDate>	0221		
	<cardValidationNum>	261		
	<authenticationValue>	BwABBJQ1AgAAA AAgJDUCAAAAAA A=		
2A	<b>Capture:</b>		<b>Capture Response:</b>	
	<littleTxnId>	Value returned in Auth response for Order Id 2	<response>	000
			<message>	Approved
2B	<b>Credit:</b>		<b>Credit Response:</b>	
	<littleTxnId>	Value returned in Capture response for Order Id 2A	<response>	000
			<message>	Approved
2C	<b>Void:</b>		<b>Void Response:</b>	
	<littleTxnId>	Use either the value returned in the Credit response for Order Id 2B, or the value returned in the Sale response (not Auth) for Order Id 2.	<response>	000
			<message>	Approved

**TABLE 2-1** Authorization Test Data (Continued)

orderId	Supplied Data Elements		Key Response Elements	
	Element	Value	Element	Value
3	<b>Authorization/Sale/AVS:</b>  <amount> <name> <addressLine1> <city> <state> <zip> <country> <type> <number> <expDate> <cardValidationNum>	10100 Eileen Jones 3 Main St. Bloomfield CT 06002 US DI 6011010000000003 0321 758	<b>Authorization Response:</b>  <response> <message> <authCode> <avsResult> <cardValidationResult>	000 Approved 33333 10 M
3A	<b>Capture:</b>  <litleTxnId>	Value returned in Auth response for Order Id 3	<b>Capture Response:</b>  <response> <message>	000 Approved
3B	<b>Credit:</b>  <litleTxnId>	Value returned in Capture response for Order Id 3A	<b>Credit Response:</b>  <response> <message>	000 Approved
3C	<b>Void:</b>  <litleTxnId>	Use either the value returned in the Credit response for Order Id 3B, or the value returned in the Sale response (not Auth) for Order Id 3.	<b>Void Response:</b>  <response> <message>	000 Approved

**TABLE 2-1** Authorization Test Data (Continued)

orderId	Supplied Data Elements		Key Response Elements	
	Element	Value	Element	Value
4	<b>Authorization/Sale/AVS:</b>  <amount> <name> <addressLine1> <city> <state> <zip> <country> <type> <number> <expDate>	10100 Bob Black 4 Main St. Laurel MD 20708 US AX 375001000000005 0421	<b>Authorization Response:</b>  <response> <message> <authCode> <avsResult>	000 Approved 44444 13
4A	<b>Capture:</b>  <littleTxnId>	Value returned in Auth response for Order Id 4	<b>Capture Response:</b>  <response> <message>	000 Approved
4B	<b>Credit:</b>  <littleTxnId>	Value returned in Capture response for Order Id 4A	<b>Credit Response:</b>  <response> <message>	000 Approved
4C	<b>Void:</b>  <littleTxnId>	Use either the value returned in the Credit response for Order Id 4B, or the value returned in the Sale response (not Auth) for Order Id 4.	<b>Void Response:</b>  <response> <message>	000 Approved

**TABLE 2-1** Authorization Test Data (Continued)

orderId	Supplied Data Elements		Key Response Elements	
	Element	Value	Element	Value
5	<b>Authorization/Sale/AVS:</b> <amount> 10100 <type> VI <number> 4100200300011001 <expDate> 0521 <cardValidationNum> 463 <authenticationValue> BwABBJQ1AgAAA AAgJDUCAAAAAA A=		<b>Authorization Response:</b> <response> 000 <message> Approved <authCode> 55555 <avsResult> 32 <cardValidationResult> M	
5A	<b>Capture:</b> <litleTxnId>	Value returned in Auth response for Order Id 5	<b>Capture Response:</b> <response> 000 <message> Approved	
5B	<b>Credit:</b> <litleTxnId>	Value returned in Capture response for Order Id 5A	<b>Credit Response:</b> <response> 000 <message> Approved	
5C	<b>Void:</b> <litleTxnId>	Use either the value returned in the Credit response for Order Id 5B, or the value returned in the Sale response (not Auth) for Order Id 5.	<b>Void Response:</b> <response> 000 <message> Approved	

**TABLE 2-1** Authorization Test Data (Continued)

orderId	Supplied Data Elements		Key Response Elements	
	Element	Value	Element	Value
6	<b>Authorization/Sale:</b> <amount> 10100 <name> Joe Green <addressLine1> 6 Main St. <city> Derry <state> NH <zip> 03038 <country> US <type> VI <number> 4457010100000008 <expDate> 0621 <cardValidationNum> 992		<b>Authorization Response:</b> <response> 110 <message> Insufficient Funds <avsResult> 34 <cardValidationResult> P	
6A	<b>Void:</b> <littleTxnId> Use the value returned in the Sale response (not Auth) for Order Id 6.		<b>Void Response:</b> <response> 000 <message> Approved  Declined Transaction report result = 360 - No transaction found with specified littleTxnId	
7	<b>Authorization/Sale/AVS:</b> <amount> 10100 <name> Jane Murray <addressLine1> 7 Main St. <city> Amesbury <state> MA <zip> 01913 <country> US <type> MC <number> 5112010100000002 <expDate> 0721 <cardValidationNum> 251		<b>Authorization Response:</b> <response> 301 <message> Invalid Account Number <avsResult> 34 <cardValidationResult> N	

**TABLE 2-1** Authorization Test Data (Continued)

orderId	Supplied Data Elements		Key Response Elements	
	Element	Value	Element	Value
8	<b>Authorization/Sale/AVS:</b> <amount> 10100 <name> Mark Johnson <addressLine1> 8 Main St. <city> Manchester <state> NH <zip> 03101 <country> US <type> DI <number> 6011010100000002 <expDate> 0821 <cardValidationNum> 184		<b>Authorization Response:</b> <response> 123 <message> Call Discover <avsResult> 34 <cardValidationResult> P	
9	<b>Authorization/Sale/AVS:</b> <amount> 10100 <name> James Miller <addressLine1> 9 Main St. <city> Boston <state> MA <zip> 02134 <country> US <type> AX <number> 3750010100000003 <expDate> 0921 <cardValidationNum> 0421		<b>Authorization Response:</b> <response> 303 <message> Pick Up Card <avsResult> 34 <cardValidationResult> P	
<b>NOTE:</b> The data sets for orderId 10 through 13 are designed to test Authorization transactions resulting in partial authorizations. If you are not coding to use partial authorizations, you may skip these tests.				
10	<amount> 40000 <type> VI <number> 4457010140000141 <expDate> 0921 <allowPartialAuth> true		<response> 010 <message> Partially Approved <approvedAmount> 32000	

**TABLE 2-1** Authorization Test Data (Continued)

orderId	Supplied Data Elements		Key Response Elements	
	Element	Value	Element	Value
11	<amount> <type> <number> <expDate> <allowPartialAuth>	60000 MC 5112010140000004 1121 true	<response> <message> <approvedAmount>	010 Partially Approved 48000
12	<amount> <type> <number> <expDate> <allowPartialAuth>	50000 AX 375001014000009 0421 true	<response> <message> <approvedAmount>	010 Partially Approved 40000
13	<amount> <type> <number> <expDate> <allowPartialAuth>	15000 DI 6011010140000004 0821 true	<response> <message> <approvedAmount>	010 Partially Approved 12000
<b>NOTE:</b> The data sets for orderId 14 through 20 are designed to test Authorization transactions that return Prepaid Indicator information in the response message. If you are not coding to use the optional Prepaid Indicator feature of the Insights feature set, you may skip these tests.				
14	<amount> <type> <number> <expDate>	10100 VI 4457010200000247 0821	<response> <message> <type> <availableBalance> <reloadable> <prepaidCardType>	000 Approved PREPAID 2000 NO GIFT
15	<amount> <type> <number> <expDate>	10100 MC 5500000254444445 0321	<response> <message> <type> <availableBalance> <reloadable> <prepaidCardType>	000 Approved PREPAID 2000 YES PAYROLL

**TABLE 2-1** Authorization Test Data (Continued)

orderId	Supplied Data Elements		Key Response Elements	
	Element	Value	Element	Value
16	<amount> <type> <number> <expDate>	10100 MC 5592106621450897 0321	<response> <message> <type> <availableBalance> <reloadable> <prepaidCardType>	000 Approved PREPAID 0 YES PAYROLL
17	<amount> <type> <number> <expDate>	10100 MC 5590409551104142 0321	<response> <message> <type> <availableBalance> <reloadable> <prepaidCardType>	000 Approved PREPAID 6500 YES PAYROLL
18	<amount> <type> <number> <expDate>	10100 MC 5587755665222179 0321	<response> <message> <type> <availableBalance> <reloadable> <prepaidCardType>	000 Approved PREPAID 12200 YES PAYROLL
19	<amount> <type> <number> <expDate>	10100 MC 5445840176552850 0321	<response> <message> <type> <availableBalance> <reloadable> <prepaidCardType>	000 Approved PREPAID 20000 YES PAYROLL
20	<amount> <type> <number> <expDate>	10100 MC 5390016478904678 0321	<response> <message> <type> <availableBalance> <reloadable> <prepaidCardType>	000 Approved PREPAID 10050 YES PAYROLL



**TABLE 2-1** Authorization Test Data (Continued)

orderId	Supplied Data Elements		Key Response Elements	
	Element	Value	Element	Value
<b>NOTE:</b> The data sets for orderId 21 through 24 are designed to test Authorization transactions that return Affluence Indicator information in the response message. If you are not coding to use the optional Affluence Indicator feature of the Insights feature set, you may skip these tests.				
21	<amount> <type> <number> <expDate>	10100 VI 4100200300012009 0921	<response> <message> <affluence>	000 Approved AFFLUENT
22	<amount> <type> <number> <expDate>	10100 VI 4100200300013007 1121	<response> <message> <affluence>	000 Approved MASS AFFLUENT
23	<amount> <type> <number> <expDate>	10100 MC 5112010201000109 0421	<response> <message> <affluence>	000 Approved AFFLUENT
24	<amount> <type> <number> <expDate>	10100 MC 5112010202000108 0821	<response> <message> <affluence>	000 Approved MASS AFFLUENT
<b>NOTE:</b> The data set for orderId 25 is designed to test Authorization transactions that return Issuer Country information in the response message. If you are not coding to use the optional Issuer Country feature of the Insights feature set, you may skip these tests.				
25	<amount> <type> <number> <expDate>	10100 VI 4100200310000002 1121	<response> <message> <issuerCountry>	000 Approved BRA

## 2.4.2 Testing Authorization Reversal Transactions

If you plan to use Authorization Reversal Transactions, you must perform this test. If you do not plan to use Authorization Reversal transactions, skip this test and go to [Testing eCheck Transactions](#) on page 119.

To test Authorization Reversal Transactions:

1. Verify that your Authorization Reversal XML templates are coded correctly (refer to [Authorization Reversal Transactions](#) on page 220).
2. Submit the Authorizations, Captures (if applicable), and Authorization Reversal Transactions using the orders shown in [Table 2-2](#).
3. Verify that your response values match those shown in Key Response Elements as shown in [Table 2-2](#).

**TABLE 2-2** Authorization Reversal Test Data

orderId	Supplied Data Elements		Key Response Elements	
	Element	Value	Element	Value
32	<b>Authorization:</b> <amount> 10010 <name> John Smith <addressLine1> 1 Main St. <city> Burlington <state> MA <zip> 01803-3747 <country> US <type> VI <number> 4457010000000009 <expDate> 0121 <cardValidationNum> 349		<b>Authorization Response:</b> <response> 000 <message> Approved <authCode> 11111 <avsResult> 01 <cardValidationResult> M	
32A	<b>Capture:</b> <amount> 5050 <littleTxnId> Value returned in Auth response for Order Id 32		<b>Capture Response:</b> <response> 000 <message> Approved	

**TABLE 2-2** Authorization Reversal Test Data

orderId	Supplied Data Elements		Key Response Elements	
	Element	Value	Element	Value
32B	<b>Authorization Reversal:</b> <littleTxnId> <amount>	Value returned in Auth response for Order Id 32  Do Not Submit an Amount	<b>Auth Reversal Response:</b> <response> <message>	000 Approved  Declined Transaction report result = 111 - Authorization amount has already been depleted  <b>Note:</b> This transaction returns 111 instead of 000, because it is unnecessary to submit an Authorization Reversal for the Visa payment card.
33	<b>Authorization:</b> <amount> <name> <addressLine1> <addressLine2> <city> <state> <zip> <country> <type> <number> <expDate> <cardValidationNum> <authenticationValue>	20020 Mike J. Hammer 2 Main St. Apt. 222 Riverside RI 02915 US MC 5112010000000003 0221 261 BwABBJQ1AgAAA AAgJDUCAAAAAA A=	<b>Authorization Response:</b> <response> <message> <authCode> <avsResult> <cardValidationResult> <authenticationResult>	000 Approved 22222 10 M <b>Note:</b> Not returned for MasterCard
33A	<b>Authorization Reversal:</b> <littleTxnId> <amount>	Value returned in Auth response for Order Id 33  Do Not Submit an amount	<b>Auth Reversal Response:</b> <response> <message>	000 Approved

**TABLE 2-2** Authorization Reversal Test Data

orderId	Supplied Data Elements		Key Response Elements	
	Element	Value	Element	Value
34	<b>Authorization:</b> <amount> 30030 <name> Eileen Jones <addressLine1> 3 Main St. <city> Bloomfield <state> CT <zip> 06002 <country> US <type> DI <number> 6011010000000003 <expDate> 0321 <cardValidationNum> 758		<b>Authorization Response:</b> <response> 000 <message> Approved <authCode> 33333 <avsResult> 10 <cardValidationResult> M	
34A	<b>Authorization Reversal:</b> <littleTxnId> Value returned in Auth response for Order Id 34 <amount> Do Not Submit an Amount		<b>Auth Reversal Response:</b> <response> 000 <message> Approved	
35	<b>Authorization:</b> <amount> 10100 <name> Bob Black <addressLine1> 4 Main St. <city> Laurel <state> MD <zip> 20708 <country> US <type> AX <number> 3750010000000005 <expDate> 0421		<b>Authorization Response:</b> <response> 000 <message> Approved <authCode> 44444 <avsResult> 13	

**TABLE 2-2** Authorization Reversal Test Data

orderId	Supplied Data Elements		Key Response Elements	
	Element	Value	Element	Value
35A	<b>Capture:</b>  <amount> <littleTxnId>	5050 Value returned in Auth response for Order Id 35	<b>Capture Response:</b>  <response> <message>	000 Approved
35B	<b>Authorization Reversal:</b>  <littleTxnId>  <amount>	Value returned in Auth response for Order Id 35  5050	<b>Auth Reversal Response:</b>  <response> <message>  Declined Transaction report result = 336 - Reversal amount does not match Authorization amount	000 Approved
36	<b>Authorization:</b>  <amount> <type> <number> <expDate>	20500 AX 375000026600004 0521	<b>Authorization Response:</b>  <response> <message>	000 Approved
36A	<b>Authorization Reversal:</b>  <littleTxnId>  <amount>	Value returned in Auth response for Order Id 36  10000	<b>Auth Reversal Response:</b>  <response> <message>  Declined Transaction report result = 336 - Reversal amount does not match Authorization amount	000 Approved

### 2.4.3 Testing eCheck Transactions

If you have elected to offer eChecks as an alternate payment method, you are required to complete the tests in this section. Data sets are provided for you to use to test your construction of XML request messages, as well as the parsing of the response messages for eCheck transactions.

---



---

**NOTE:** The eCheck Verification test is required only if you plan to perform eCheck Verifications.

---



---

To test **eCheck Verification** transactions:

1. Verify that your eCheck XML template is coded correctly (refer to [eCheck Verification Transactions](#) on page 277.)
2. Submit the eCheck Verification transactions using the data sets supplied in [Table 2-3](#).

---

**NOTE:** In addition to the test data provided in the table, you must also provide appropriate data for other child elements of the `billToAddress` element, such as `Address1` (2, 3), `city`, `state`, `phone`, etc.

For Corporate accounts (Order ID 39 and 40) you must include the `firstName`, `lastName`, and `companyName` in the `echeckVerification` request.

---

3. Verify that your response values match those shown in the Key Response Elements section of [Table 2-3](#).
4. After you complete this test, go to the next eCheck test.

**TABLE 2-3** eCheck Verification Test Data

orderId	Supplied Data Elements		Key Response Elements	
	Element	Value	Element	Value
37	<code>&lt;amount&gt;</code> <code>&lt;orderSource&gt;</code> <code>&lt;firstName&gt;</code> <code>&lt;lastName&gt;</code> <code>&lt;accType&gt;</code> <code>&lt;accNum&gt;</code> <code>&lt;routingNum&gt;</code>	3001 telephone Tom Black Checking 10@BC99999 053100300	<code>&lt;response&gt;</code> <code>&lt;message&gt;</code>	301 Invalid Account Number
38	<code>&lt;amount&gt;</code> <code>&lt;orderSource&gt;</code> <code>&lt;firstName&gt;</code> <code>&lt;lastName&gt;</code> <code>&lt;accType&gt;</code> <code>&lt;accNum&gt;</code> <code>&lt;routingNum&gt;</code>	3002 telephone John Smith Checking 1099999999 011075150	<code>&lt;response&gt;</code> <code>&lt;message&gt;</code>	000 Approved

**TABLE 2-3** eCheck Verification Test Data (Continued)

orderId	Supplied Data Elements		Key Response Elements	
	Element	Value	Element	Value
39	<amount>	3003	<response>	950
	<orderSource>	telephone	<message>	Declined - Negative Information on File
	<firstName>	Robert		
	<lastName>	Jones		
	<companyName>	Good Goods Inc		
	<accType>	Corporate		
	<accNum>	3099999999		
	<routingNum>	053100300		
40	<amount>	3004	<response>	951
	<orderSource>	telephone	<message>	Absolute Decline
	<firstName>	Peter		
	<lastName>	Green		
	<companyName>	Green Co		
	<accType>	Corporate		
	<accNum>	8099999999		
	<routingNum>	011075150		

To test **eCheck Prenotification** transactions:

---

**NOTE:** The eCheck Prenotification tests are required only if you plan to perform eCheck Prenotification.  
You can only submit eCheck Prenotification transactions in Batches.

---

1. Verify that your eCheck XML templates are coded correctly (refer to [eCheck Prenotification Credit Transactions \(Batch Only\)](#) on page 266 and [eCheck Prenotification Sale Transactions \(Batch Only\)](#) on page 269.)
2. Submit the eCheck Verification transactions using the data sets supplied in [Table 2-4](#).
3. Verify that your response values match those shown in the Key Response Elements section of [Table 2-4](#).
4. After you complete this test, go to the next eCheck test.

**TABLE 2-4** eCheck Prenotification Test Data

orderId	Supplied Data Elements		Key Response Elements	
	Element	Value	Element	Value
ECPreNoteSale	<orderSource> <name> <accType> <accNum> <routingNum>	ecommerce PreNote Sale Corp Corporate 1092969901 011075150	<response> <message>	000 Approved
ECPreNoteCredit	<orderSource> <name> <accType> <accNum> <routingNum>	ecommerce PreNote Credit Corp Corporate 1099339999 011075150	<response> <message>	000 Approved
PreNoteSaleAccNumErr	<orderSource> <name> <accType> <accNum> <routingNum>	ecommerce PreNote Sale Corp Corporate 10@2969901 011100012	<response> <message>	301 Invalid Account Number
PreNoteCreditAccNumErr	<orderSource> <name> <accType> <accNum> <routingNum>	ecommerce PreNote Credit Personal Savings 10@2969901 011100012	<response> <message>	301 Invalid Account Number
PreNoteSaleRoutingNumErr	<orderSource> <name> <accType> <accNum> <routingNum>	ecommerce PreNote Sale Personal Checking 6099999992 053133052	<response> <message>	900 Invalid Bank Routing Number



**TABLE 2-4** eCheck Prenotification Test Data (Continued)

orderId	Supplied Data Elements		Key Response Elements	
	Element	Value	Element	Value
PreNoteCredit RoutNumErr	<orderSource>	ecommerce	<response>	900
	<name>	PreNote Credit Personal	<message>	Invalid Bank Routing Number
	<accType>	Checking		
	<accNum>	6099999992		
	<routingNum>	053133052		

To test **eCheck Sale** transactions:

1. Verify that your eCheck XML template is coded correctly (refer to [eCheck Sale Transactions](#) on page 274).
2. Submit the `echeckSale` transactions using the Supplied Data elements shown in [Table 2-5](#).

---

**NOTE:** In addition to the test data provided in the table, you must also provide appropriate data for other child elements of the `billToAddress` element, such as `Address1` (2, 3), `city`, `state`, `phone`, etc.

---

3. Verify that your response values match those shown in [Table 2-5](#).
4. After you complete this test, go to the next test.

**TABLE 2-5** eCheck Sale Test Data

orderId	Supplied Data Elements		Key Response Elements	
	Element	Value	Element	Value
41	<amount>	2008	<response>	301
	<orderSource>	telephone	<message>	Invalid Account Number
	<firstName>	Mike		
	<middleInitial>	J		
	<lastName>	Hammer		
	<accType>	Checking		
	<accNum>	10@BC99999		
	<routingNum>	053100300		

**TABLE 2-5** eCheck Sale Test Data (Continued)

orderId	Supplied Data Elements		Key Response Elements	
	Element	Value	Element	Value
42	<amount> <orderSource> <firstName> <lastName> <accType> <accNum> <routingNum>	2004 telephone Tom Black Checking 4099999992 011075150	<response> <message>	000 Approved
43	<amount> <orderSource> <firstName> <lastName> <companyName> <accType> <accNum> <routingNum>	2007 telephone Peter Green Green Co Corporate 6099999992 011075150	<response> <message>	000 Approved <b>Note:</b> This response will include the accountUpdater element (see <a href="#">accountUpdater</a> on page 345).
44	<amount> <orderSource> <firstName> <lastName> <companyName> <accType> <accNum> <routingNum>	2009 telephone Peter Green Green Co Corporate 9099999992 053133052	<response> <message>	900 Invalid Bank Routing Number

To test **eCheck Credit** transactions:

1. Verify that your eCheck XML template is coded correctly (refer to [eCheck Credit Transactions](#) on page 263.)

---

**NOTE:** In addition to the test data provided in the table, you must also provide appropriate data for other child elements of the `billToAddress` element, such as `Address1` (2, 3), `city`, `state`, `phone`, etc.

---

2. Submit the `echeckCredit` transactions using the data in the Supplied Data Elements section of [Table 2-6](#).

3. Verify that your response values match those shown in the Key Response Elements section of Table 2-6.
4. After you complete this test, go to the next test.

**TABLE 2-6** eCheck Credit Test Data

orderId	Supplied Data Elements		Key Response Elements	
	Element	Value	Element	Value
45	<amount> <orderSource> <firstName> <lastName> <accType> <accNum> <routingNum>	1001 telephone John Smith Checking 10@BC99999 053100300	<response> <message>	301 Invalid Account Number
46	<amount> <orderSource> <firstName> <lastName> <companyName> <accType> <accNum> <routingNum>	1003 telephone Robert Jones Widget Inc Corporate 3099999999 011075150	<response> <message>	000 Approved
47	<amount> <orderSource> <firstName> <lastName> <companyName> <accType> <accNum> <routingNum>	1007 telephone Peter Green Green Co Corporate 6099999993 211370545	<response> <message>	000 Approved <b>Note:</b> This response will include the accountUpdater element (see <a href="#">accountUpdater</a> on page 345.)
48	<litleTxnId>	Value returned in eCheck Sale response for Order Id 43	<response> <message>	000 Approved

**TABLE 2-6** eCheck Credit Test Data (Continued)

orderId	Supplied Data Elements		Key Response Elements	
	Element	Value	Element	Value
49	<litleTxnId>	2	<response> <message>	000 Approved
			Declined Transaction report result = 360 - No transaction found with specified litleTxnId	

To test **eCheck Void** transactions:

1. Verify that your eCheck XML template is coded correctly (refer to [eCheck Void Transactions \(Online Only\)](#) on page 281.)
2. (Re)Submit the `echeckSale` transaction for Order ID #42 as shown in [Table 2-5](#) with a different value for the `id` attribute.
  - a. Using the `litleTxnId` returned in the `echeckSaleResponse` message, submit an `echeckVoid` transaction.
  - b. The system returns an `echeckVoidResponse` Response Code of “000” and a message of “Approved”.
3. Using the `litleTxnId` returned in the `echeckCreditResponse` message for Order ID #46, submit an `echeckVoid` transaction.
  - a. The system returns an `echeckVoidResponse` Response Code of “000” and a message of “Approved”.
4. Submit an `echeckVoid` request using a value of “2” for the `litleTxnId`.
  - a. The system returns an `echeckVoidResponse` Response Code of “360” and a message of “No transaction found with specified litleTxnId”.
5. After you complete this test, go to the next test.

## 2.4.4 Testing Token Transactions

You can obtain tokens in two ways. The first method is explicit registration using the `registerTokenRequest` transaction. The second method is implicit registration, which is achieved by submitting the card or account information (for eChecks) in a normal payment transaction. This section provides test data sets using both methods for both credit card and eCheck tokenization.

Perform this test only if you plan to use the Vault feature.

---

**NOTE:** The test data does not include values for all elements. You should use appropriate values for all elements as required to create a properly structured cnpAPI request.

---

To test explicit Token Registration transactions:

1. Verify that your cnpAPI template is coded correctly for this transaction type (refer to [registerTokenRequest](#) on page 695.)
2. To test credit card tokenization, submit `registerTokenRequest` transactions using the data for Order Ids 50 through 52 from [Table 2-7](#).
3. If you also use eCheck transactions and have elected to tokenize eCheck account numbers, submit `registerTokenRequest` transactions using the data for Order Ids 53 and 54 from [Table 2-7](#); otherwise, skip those two tests.
4. Verify that your `registerTokenResponse` values match those shown in the Key Response Elements section of [Table 2-7](#). The complete token values are not defined in the table, because the system generates the tokens dynamically.
5. After completing this test, proceed to the next set of tests for implicit tokenization.

**TABLE 2-7** Register Token Test Data

orderId	Supplied Data Elements		Key Response Elements	
	Element	Value	Element	Value
50	<accountNumber>	4457119922390123	<litleToken> <bin> <type> <response> <message>	xxxxxxxxxxxx0123 445711 VI 801 Account number was successfully registered <b>Note:</b>
51	<accountNumber>	4457119999999999	<litleToken> <response> <message>	none returned 820 Credit card number was invalid

**TABLE 2-7** Register Token Test Data

orderId	Supplied Data Elements		Key Response Elements	
	Element	Value	Element	Value
52	<accountNumber>	4457119922390123	<littleToken> <bin> <type> <response> <message>	xxxxxxxxxxxx0123 445711 VI 802 Account number was previously registered
53	<accNum> <routingNum>	1099999998 011100012	<littleToken> <type> <eCheckAccountSuffix> <response> <message>	xxxxxxxxxx EC 998 801 Account number was successfully registered
54	<accNum> <routingNum>	1022222102 1145_7895	<response> <message>	900 Invalid bank routing number

To test the submission of card data in an tokenized environment using Authorization transactions, as well as the submission of tokens in transactions, do the following:

1. Verify that your cnpAPI template is coded correctly for this transaction type (refer to [Authorization Transactions](#) on page 208.)
2. Submit three authorization transactions using the Supplied Data Elements from Order Ids 55 through 57 from [Table 2-8](#).
3. Verify that your authorizationResponse values match those shown in the Key Response Elements section of [Table 2-8](#) for Order Ids 55 through 57.
4. To verify that your cnpAPI template is coded correctly for the submission of tokens in authorization transactions, submit authorization transactions using the Supplied Data Elements from Order Ids 58 through 60 from [Table 2-8](#).

To test the submission of eCheck data in an tokenized environment, as well as the submission of tokens in eCheck transactions, do the following:

1. Verify that your cnpAPI template is coded correctly for these transaction types as applicable (refer to [eCheck Sale Transactions](#) on page 274 and [eCheck Credit Transactions](#) on page 263).

2. Submit the four transactions, Order Ids 61 through 64, using the Supplied Data Elements from [Table 2-8](#).
3. Verify that your response values match those shown in the Key Response Elements section of [Table 2-8](#) for Order Ids 61 through 64.

**TABLE 2-8** Implicit Registration Test Data

orderId	Supplied Data Elements		Key Response Elements	
	Element	Value	Element	Value
55	<amount> <type> <number> <expDate> <cardValidationNum>	15000 MC 5435101234510196 1121 987	<response> <message> <littleToken> <tokenResponseCode> <tokenMessage>  <type> <bin>	000 Approved xxxxxxxxxxxx0196 801 Account number was successfully registered  MC 543510
56	<amount> <type> <number> <expDate> <cardValidationNum>	15000 MC 5435109999999999 1121 987	<<response> <message>	301 Invalid account number
57	<amount> <type> <number> <expDate> <cardValidationNum>	15000 MC 5435101234510196 1121 987	<response> <message> <littleToken> <tokenResponseCode> <tokenMessage>  <type> <bin>	000 Approved xxxxxxxxxxxx0196 802 Account number was previously registered  MC 543510
58	<amount> <littleToken> <expDate> <cardValidationNum>	15000 xxxxxxxxxxxx0196 1121 987  <b>Note:</b> Use the token returned in Order Id 57.	<response> <message>	000 Approved

**TABLE 2-8** Implicit Registration Test Data (Continued)

orderId	Supplied Data Elements		Key Response Elements	
	Element	Value	Element	Value
59	<amount> <litleToken> <expDate>	15000 1111000100092332 1121	<response> <message>	822 Token was not found
60	<amount> <litleToken> <expDate>	15000 1112000100000085 1121	<response> <message>	823 Token was invalid
61	<b>eCheck Sale:</b> <accType> <accNum> <routingNum>	Checking 1099999003 011100012	<litleToken> <tokenResponseCode> <tokenMessage> <type> <eCheckAccountSuffix>	xxxxxxxxxxxxxxxxxxxx 801 Account number was successfully registered EC 003
62	<b>eCheck Sale:</b> <accType> <accNum> <routingNum>	Checking 1099999999 011100012	<litleToken> <tokenResponseCode> <tokenMessage> <type> <eCheckAccountSuffix>	xxxxxxxxxxxxxxxxxxxx 801 Account number was successfully registered EC 999
63	<b>eCheck Credit:</b> <accType> <accNum> <routingNum>	Checking 1099999999 011100012	<litleToken> <tokenResponseCode> <tokenMessage> <type> <eCheckAccountSuffix>	xxxxxxxxxxxxxxxxxxxx 801 Account number was successfully registered EC 999



**TABLE 2-8** Implicit Registration Test Data (Continued)

orderId	Supplied Data Elements		Key Response Elements	
	Element	Value	Element	Value
64	<b>eCheck Sale:</b>		<originalTokenInfo>	(parent element)
	<accType>	Corporate	<accType>	Checking
	<accNum>	6099999993	<litleToken>	11190000001003001
	<routingNum>	211370545	<routingNum>	211370545
			<newTokenInfo>	(parent element)
			<accType>	Checking
			<litleToken>	11190000001154101
			<routingNum>	211370545
			<litleToken>	xxxxxxxxxxxxxxxxxxxx
			<tokenResponseCode>	801
			<tokenMessage>	Account number was successfully registered
			<type>	EC
			<eCheckAccountSuffix>	993

---

**NOTE:** Order ID 64 returns accountUpdater information. This test allows you to test responses you might receive when a NOC exists against the eCheck account, but you submit the old account information. In this case, the system provides the old token information, but issues a new token based upon the new account information and provides it as well.

---

### 2.4.5 Testing Query Transactions

You can use the following test scenarios to verify your coding of the queryTransaction, as well as various responses. To test the query transaction, please do the following:

---

**NOTE:** If you are enabled for the use of the queryTransaction, you will not be able to test for response code 153 - Query Transaction not enabled.

---

1. Submit a queryTransaction with the following elements:
  - <origId>newTransaction</origId> (**Note:** You can use any value never used as an id attribute.)
  - <origActionType>A</origActionType> (**Note:** You can use any valid action type as detailed in the enumerations table of origActionType on page 627.)

Verify that you receive a response value of **151** and message of **Original transaction not found**.

2. Submit an authorization or sale transaction using a unique id attribute.
3. Submit a queryTransaction using the id attribute value from Step 2 as the value for the <origId> element and the <origActionType> element set to the transaction type you submitted in Step 2.

Verify that you receive a response value of **150** and message of **Original transaction found**, a <matchCount> value of 1, and the response message for the transaction submitted in Step 2, as a child of the <result\_Max10> element.

4. Submit a second authorization or sale transaction (use the same transaction type as Step 2), using the same value for the id attribute. **Note:** If you use a sale transaction for this test, you must change the credit card number from the one you used in Step 2 to avoid having the transaction flagged as a duplicate.
5. Submit a queryTransaction using the id attribute value from Step 2 as the value for the <origId> element and the <origActionType> element set to the transaction type you submitted in Step 2.

Verify that you receive a response value of **150** and message of **Original transaction found**, a <matchCount> value of 2, and the response messages for the transactions submitted in Steps 2 and 4, as a children of the <result\_Max10> element.

6. Submit an authorization or sale transaction using a value of **error\_id** for the id attribute.
7. Submit a queryTransaction using **error\_id** for the origId value.

Verify that you receive a response value of **152** and message of **Original transaction found but response not yet available**, a <matchCount> value of 1, and the <queryTransactionUnavailableResponse> element as a child of the <result\_Max10> element.

## 2.4.6 Testing Online Duplicate Transaction Processing

When you submit certain Online transactions, the system acts to detect if it is a duplicate by comparing the id attribute and the credit card number against other successful Online transactions of the same type processed within the previous two days. The system performs this checking routine for the following transaction types: Capture, Force Capture, Capture Given Auth, Credit, Sales, eCheck Credit, eCheck Sales, eCheckVoid, and Void, as well as Gift Card transactions.

If the system determines a transaction to be a duplicate, The transaction appears in the Declined Transaction report. This report is available in near real-time via Vantiv iQ, and as an Secure Scheduled Report, which is generated daily for the previous days transactions. Please refer to [Online Duplicate Checking](#) on page 8 for additional information.

To test your handling of duplicate transactions:

---

---

**NOTE:** When you submit the duplicate transaction, make sure that all information, including the `id` attribute, is identical.

---

---

1. Send any of the following Capture transactions more than once within a two day period: Order numbers 1A, 2A, 3A, 4A, or 5A. The second submission will appear in the Declined Transaction report with a response Reason Code of 251 - Duplicate Transaction. Note: You may have to submit the corresponding Authorization transaction prior to submitting the Capture transaction.
2. Send any of the following Credit transactions more than once within a two day period: Order numbers 1B, 2B, 3B, 4B, or 5B. The second submission will appear in the Declined Transaction report with a response Reason Code of 251 - Duplicate Transaction. Note: You may have to submit the corresponding Capture transaction prior to submitting the Credit transaction.
3. Send any of the following Void transactions more than once within a two day period: Order numbers 1C, 2C, 3C, 4C, or 5C. The second submission will appear in the Declined Transaction report with a response Reason Code of 251 - Duplicate Transaction. Note: You may have to submit the corresponding Sale transaction prior to submitting the Void transaction.
4. Send either of the following eCheck Sale transactions more than once within a two day period: Order numbers 42 or 43. The second submission will appear in the Declined Transaction report with a response Reason Code of 251 - Duplicate Transaction.
5. Send any of the following eCheck Credit transactions more than once within a two day period: Order numbers 46, 47, or 48. The second submission will appear in the Declined Transaction report with a response Reason Code of 251 - Duplicate Transaction.

## 2.5 Performing the Optional Tests

This section describes data that you can use to test different response codes, messages, and AVS response codes from the Vantiv system for American Express, Visa, MasterCard, Discover, and Diner's Club cards. You can perform these tests after completing the certification testing.

This section contains the following topics:

- [Testing AVS and Card Validation](#)
- [Testing Address Responses](#)
- [Testing Advanced AVS Response Codes](#)
- [Testing Response Reason Codes and Messages](#)
- [Testing 3DS Responses](#)
- [Testing the Prepaid Filtering Feature](#)
- [Testing the International Card Filter Feature](#)
- [Testing Security Code No-Match Filtering](#)
- [Testing Advanced Fraud Tools](#)
- [Testing Account Updater](#)
- [Testing Tax Billing](#)
- [Testing Convenience Fees](#)
- [Testing the Recycling Engine](#)
- [Testing Recurring Engine Transactions](#)
- [Testing Gift Card Transactions](#)
- [Testing MasterPass Transactions](#)
- [Testing MasterPass Transactions](#)
- [Testing Apple Pay Transaction Processing](#)
- [Testing Android Pay Transaction Processing](#)
- [Testing SEPA Direct Debit Transaction](#)
- [Testing iDEAL Transactions](#)
- [Testing Giropay Transactions](#)
- [Testing SOFORT Transactions](#)
- [Testing Transaction Volume Capacity](#)

## 2.5.1 Testing AVS and Card Validation

Use the AVS tests to test all of the possible AVS response codes that the system can produce, including those response codes that cannot be produced by varying the address and ZIP code data. For these tests the AVS response codes are independent of any address or ZIP code data that you submit.

To test AVS response codes:

1. Submit transactions using the card data in [Table 2-9](#). If you are using Card Validation, include the `cardValidationNum` element. The Card Validation test will return all possible Card Validation response codes. The response codes that are returned are independent of the card validation value that you submit.
2. Verify that the AVS tests return the following response:

```
<response>000</response>
<message>Approved</message>
<authCode>654321</authCode>
<avsresult>See Table 2-9</avsresult>
<cardValidationResult>See Table 2-9</cardValidationResult>
```

---

**NOTE:** For a list of all possible AVS response codes, see [AVS Response Codes](#) on page 842.  
 For a list of all possible card validation response codes, see [Card Validation Response Codes](#) on page 846.

---

**TABLE 2-9** AVS and Card Validation Test Data

orderId	Supplied Data Elements		Key Response Elements	
	Element	Value	Element	Value
65	<code>&lt;type&gt;</code>	VI	<code>&lt;avsResult&gt;</code>	00
	<code>&lt;number&gt;</code>	4457000300000007	<code>&lt;cardValidationResult&gt;</code>	U
66	<code>&lt;type&gt;</code>	VI	<code>&lt;avsResult&gt;</code>	01
	<code>&lt;number&gt;</code>	4457000100000009	<code>&lt;cardValidationResult&gt;</code>	M
67	<code>&lt;type&gt;</code>	VI	<code>&lt;avsResult&gt;</code>	02
	<code>&lt;number&gt;</code>	4457003100000003	<code>&lt;cardValidationResult&gt;</code>	M
68	<code>&lt;type&gt;</code>	VI	<code>&lt;avsResult&gt;</code>	10
	<code>&lt;number&gt;</code>	4457000400000006	<code>&lt;cardValidationResult&gt;</code>	S
69	<code>&lt;type&gt;</code>	VI	<code>&lt;avsResult&gt;</code>	11
	<code>&lt;number&gt;</code>	4457000200000008	<code>&lt;cardValidationResult&gt;</code>	M

**TABLE 2-9** AVS and Card Validation Test Data

orderId	Supplied Data Elements		Key Response Elements	
	Element	Value	Element	Value
70	<type> <number>	MC 5112000100000003	<avsResult> <cardValidationResult>	12 M
71	<type> <number>	MC 5112002100000009	<avsResult> <cardValidationResult>	13 M
72	<type> <number>	MC 5112002200000008	<avsResult> <cardValidationResult>	14 N
73	<type> <number>	MC 5112000200000002	<avsResult> <cardValidationResult>	20 N
74	<type> <number>	MC 5112000300000001	<avsResult> <cardValidationResult>	30 P
75	<type> <number>	MC 5112000400000000	<avsResult> <cardValidationResult>	31 U
76	<type> <number>	MC 5112010400000009	<avsResult> <cardValidationResult>	32 S
78	<type> <number>	MC 5112000600000008	<avsResult> <cardValidationResult>	34 P
80	<type> <number>	AX 374313304211118 <b>Note:</b> American Express CID failures are declined by American Express.	<cardValidationResult> <response> <message>	N 352 Decline CVV2/CID Fail

## 2.5.2 Testing Address Responses

Use the address tests to test different AVS responses by varying the address and ZIP code data. The address tests are intended to return a realistic AVS response code.

To test address responses:

1. Submit Authorization or Sale transactions in [Table 2-10](#). The AVS tests always return an `avsResult` of 00 when submitting 95 Main St. and 95022. If you extend the Zip Code to 9 digits, by appending 1111, the system returns an `avsResult` of 01, as shown in the second test.

- The AVS response code depends on the Address Line 1 and ZIP Code that are passed in with the transaction. Submit additional transactions using the card data from the table, but varying the address/zip information to receive other `avsResult` codes in the response messages as shown in the tests for orderIds AVS3 and AVS4.

For a detailed list of all possible AVS response codes, see [AVS Response Codes](#) on page 842.

**TABLE 2-10** AVS and Card Validation Test Data

orderId	Supplied Data Elements		Key Response Elements	
	Element	Value	Element	Value
AVS1	<type> <number> <addressLine1> <zip>	VI 4457000600000004 95 Main St. 95022	<avsResult>	00
AVS2	<type> <number> <addressLine1> <zip>	VI 4457000600000004 95 Main St. 950221111	<avsResult>	01
AVS3	<type> <number> <addressLine1> <zip>	VI 4457000600000004 100 Main St. 95022	<avsResult>	10
AVS4	<type> <number> <addressLine1> <zip>	VI 4457000600000004 100 Main St. 02134	<avsResult>	20

### 2.5.3 Testing Advanced AVS Response Codes

The Advanced AVS (AAVS) feature is an offering from American Express that allows you to check several parameters not normally covered by a standard AVS check, including name, phone, and email.

To test AAVS Response Codes:

1. Submit an Authorization transaction using the data supplied in [Table 2-12](#).
2. Verify that you handle the response correctly.
3. Enter additional transaction varying the values for name, phone, and/or email to trigger other AAVS results (see [AAVS Response Codes](#) on page 843 for other result codes). To obtain a value of 3 in any position, use one of the following values in the appropriate position:
  - `<name>Jane Doe</name>`
  - `<phone>5555551234</phone>`
  - `<email>badtest@test.com</email>`

For example, if you submit a second transaction using the name Jane Doe instead of John Doe, the AAVS result would be 311 indicating No Match for name, but Match for phone and email.

**TABLE 2-11** Advanced AVS Test Data

orderId	Supplied Data Elements		Key Response Elements	
	Element	Value	Element	Value
81	<code>&lt;amount&gt;</code> <code>&lt;name&gt;</code> <code>&lt;addressLine1&gt;</code> <code>&lt;city&gt;</code> <code>&lt;state&gt;</code> <code>&lt;zip&gt;</code> <code>&lt;country&gt;</code> <code>&lt;email&gt;</code> <code>&lt;phone&gt;</code> <code>&lt;type&gt;</code> <code>&lt;number&gt;</code> <code>&lt;expDate&gt;</code>	12523 John Doe 95 Main St. Palo Alto CA 950221111 US test@test.com 6178675309 AX 341234567890127 1121	<code>&lt;advancedAVSResults&gt;</code>	111



## 2.5.4 Testing Response Reason Codes and Messages

Use the data provided in this section to test Response Reason Codes and Messages.

---

**NOTE:** If you submit account numbers not specified in the tables, you will receive the following response:

```
<response>000</response>
<message>Approved</message>
<authCode>123457</authCode>
<avsResult>00</avsResult>
```

---

To test Response Codes and Messages:

1. Submit transactions using the data in [Table 2-12](#). In each case use the supplied card number with a prefix of **RRC-** as the orderId.
2. Verify that you handle the response correctly.

---

**NOTE:** The messages listed are samples of messages that the system can return. Since the messages are subject to change at any time, you should use them only for human readability purposes and not for coding purposes. Always code to the response codes, since these do not change.

---

- For a list of all possible response reason codes, see [Payment Transaction Response Codes](#) on page 816.
- For a list of all possible AVS response codes, see [AVS Response Codes](#) on page 842.

**TABLE 2-12** Response Code Test Data

orderId	Supplied Data Elements		Key Response Elements	
	Element	Value	Element	Value
RRC-card #	<type>	VI	<response>	000
	<number>	4457000800000002	<message>	Approved
	<type>	VI	<response>	000
	<number>	4457000900000001	<message>	Approved
RRC-card #	<type>	VI	<response>	000
	<number>	4457001000000008	<message>	Approved
RRC-card #	<type>	MC	<response>	000
	<number>	5112000900000005	<message>	Approved

**TABLE 2-12** Response Code Test Data

orderId	Supplied Data Elements		Key Response Elements	
	Element	Value	Element	Value
RRC-card #	<type>	AX	<response>	120
	<number>	375000030000001	<message>	Call Issuer
	<type>	DI	<response>	123
	<number>	6011000400000000	<message>	Cal Discover
	<type>	VI	<response>	120
	<number>	4457001200000006	<message>	Call Issuer
	<type>	VI	<response>	120
	<number>	4457001300000005	<message>	Call Issuer
	<type>	VI	<response>	120
	<number>	4457001400000004	<message>	Call Issuer
	<type>	MC	<response>	101
	<number>	5112001000000002	<message>	Issuer Unavailable
	<type>	VI	<response>	321
	<number>	4457001900000009	<message>	Invalid Merchant
<type>	VI	<response>	303	
<number>	4457002000000006	<message>	Pick Up Card	
<type>	VI	<response>	110	
<number>	4457002100000005	<message>	Insufficient Funds	
<type>	VI	<response>	120	
<number>	4457002200000004	<message>	Call Issuer	
<type>	AX	<response>	350	
<number>	3750000500000006	<message>	Generic Decline	
<type>	VI	<response>	349	
<number>	4457002300000003	<message>	Do Not Honor	
<type>	VI	<response>	340	
<number>	4457002500000001	<message>	Invalid Amount	
<type>	MC	<response>	301	
<number>	5112001600000006	<message>	Invalid Account Number	

**TABLE 2-12** Response Code Test Data

orderId	Supplied Data Elements		Key Response Elements	
	Element	Value	Element	Value
RRC-card #	<type> <number>	MC 5112001700000005	<response> <message>	301 Invalid Account Number
	<type> <number>	MC 5112001800000004	<response> <message>	321 Invalid Merchant
	<type> <number>	VI 4457002700000009	<response> <message>	101 Issuer Unavailable
	<type> <number>	MC 5112001900000003	<response> <message>	305 Expired Card
	<type> <number>	VI 4457002800000008	<response> <message>	322 Invalid Transaction
	<type> <number>	VI 4457002900000007	<response> <message>	350 Generic Decline
	<type> <number>	VI 4457003000000004	<response> <message>	101 Issuer Unavailable
	<type> <number>	MC 5112002000000000	<response> <message>	101 Issuer Unavailable
	<type> <number>	VI 4457000100000000	<response> <message>	301 Invalid Account Number

## 2.5.5 Testing 3DS Responses

The cardholder authentication value should only be included by merchants who support 3DS (3 Domain Secure) electronic commerce transactions. Your systems must be in compliance with the Verified by Visa or MasterCard Secure Code implementations of 3DS.

To test 3DS responses:

1. Submit Authorization transactions or Sale transactions using the data in [Table 2-13](#). For all tests except the last three Discover tests, set the `orderSource` element to either `3dsAuthenticated` or `3dsAttempted` and the `cardholderAuthentication` element to the following base64 encoded string:

```
BwABBJQ1AgAAAAAgJDUCAAAAAA=
```

The response from a 3DS test will be the same as an Authorization or Sale response, except the `authenticationResult` element will be included in the response as a child of the `fraudResult` element.

**TABLE 2-13** 3DS Test Data

orderId	Supplied Data Elements		Key Response Elements	
	Element	Value	Element	Value
3DS1	<type> <number>	VI 4100200300000004	<authenticationResult>	0
3DS2	<type> <number>	VI 4100200300000012	<authenticationResult>	1
3DS3	<type> <number>	VI 4100200300000103	<authenticationResult>	2
3DS4	<type> <number>	VI 4100200300001002	<authenticationResult>	A
3DS5	<type> <number>	VI 4100200300000020	<authenticationResult>	3
3DS6	<type> <number>	VI 4100200300000038	<authenticationResult>	4
3DS7	<type> <number>	VI 4100200300000046	<authenticationResult>	5
3DS8	<type> <number>	VI 4100200300000053	<authenticationResult>	6

**TABLE 2-13** 3DS Test Data

orderId	Supplied Data Elements		Key Response Elements	
	Element	Value	Element	Value
3DS9	<type> <number>	VI 4100200300000061	<authenticationResult>	7
3DS10	<type> <number>	VI 4100200300000079	<authenticationResult>	8
3DS11	<type> <number>	VI 4100200300000087	<authenticationResult>	9
3DS12	<type> <number>	VI 4100200300000095	<authenticationResult>	B
3DS13	<type> <number>	VI 4100200300000111	<authenticationResult>	C
3DS14	<type> <number>	VI 4100200300000129	<authenticationResult>	D
3DS15	<orderSource> <type> <number>	3dsAttempted MC 5112010200000001	<authenticationResult>	N/A
3DS16	<orderSource> <type> <number>	3dsAttempted MC 5112010200000001	<authenticationResult>	N/A
3DS17	<orderSource> <type> <number>	3dsAuthenticated MC 5407102010000018	<authenticationResult>	0
3DS18	<orderSource> <type> <number>	3dsAuthenticated MC 5167001020236549	<authenticationResult>	1
3DS19	<orderSource> <type> <number>	3dsAttempted MC 5154605300000121	<authenticationResult>	0

**TABLE 2-13** 3DS Test Data

orderId	Supplied Data Elements		Key Response Elements	
	Element	Value	Element	Value
DI3DS1	<orderSource> <type> <number> <cardholderAuth entication>	3dsAuthenticated DI 6011000400001008 BRICAIASNBERERER ERERARERERE=	<authenticationResult>	0
DI3DS2	<orderSource> <type> <number> <cardholderAuth entication>	3dsAuthenticated DI 6011000400000018 BRIBAIASNBERERER ERERARERERE=	<authenticationResult>	1
DI3DS3	<orderSource> <type> <number> <cardholderAuth entication>	3dsAuthenticated DI 6011000400000109 BRIAAIASNBERERER ERERARERERE=	<authenticationResult>	2

## 2.5.6 Testing the Prepaid Filtering Feature

Complete this test only if you are planning on using the Prepaid Filtering Feature and are using schema version 8.3 or above.

To test the Prepaid Filtering feature:

1. Submit authorization transactions using the values provided in Supplied Data Elements of [Table 2-14](#).
2. Verify that your response values match those shown in the Key Response Elements section of [Table 2-14](#).
3. After you complete this test, go to the next test.

**TABLE 2-14** Prepaid Filtering Test Data

orderId	Supplied Data Elements		Key Response Elements	
	Element	Value	Element	Value
filterPrepaidMC	<amount>	9100	<response>	309
	<orderSource>	recurring	<message>	Restricted Card - Prepaid Card Filtering Service
	<name>	John Doe	<avsResult>	02
	<addressLine1>	10 Main St.		
	<city>	San Jose		
	<state>	CA		
	<zip>	95032		
	<country>	US		
	<email>	jdoe@phoenixProcessing.com		
	<phone>	7812701111		
	<type>	MC		
	<number>	5500000958501839		
	<expDate>	1121		
	<prepaid>	true		
filterPrepaidVI	<amount>	9100	<response>	309
	<orderSource>	recurring	<message>	Restricted Card - Prepaid Card Filtering Service
	<name>	John Doe	<authCode>	none
	<addressLine1>	10 Main St.	<avsResult>	34
	<city>	San Jose		
	<state>	CA		
	<zip>	95032		
	<country>	US		
	<email>	jdoe@phoenixProcessing.com		
	<phone>	7812701111		
	<type>	VI		
	<number>	4650002010001478		
	<expDate>	1121		
	<prepaid>	true		

## 2.5.7 Testing the International Card Filter Feature

Complete this test only if you are planning on using the International Card Filtering Feature and are using schema version 8.3 or above.

To test the International Card Filtering feature:

1. Submit authorization transactions using the values provided in Supplied Data Elements of [Table 2-15](#).
2. Verify that your response values match those shown in Key Response Elements section of [Table 2-15](#).
3. After you complete this test, go to the next test.

**TABLE 2-15** International Filtering Test Data

orderId	Supplied Data Elements		Key Response Elements	
	Element	Value	Element	Value
filterInternational1	<amount>	9100	<response>	312
	<orderSource>	recurring	<message>	Restricted Card - International Card Filtering Service
	<name>	John Doe	<avsResult>	34
	<addressLine1>	10 Main St.		
	<city>	San Jose		
	<state>	CA		
	<zip>	95032		
	<country>	US		
	<email>	jdoe@phoenixProcessing.com		
	<phone>	7812701111		
	<type>	VI		
	<number>	4100200309950001		
	<expDate>	1121		



**TABLE 2-15** International Filtering Test Data

orderId	Supplied Data Elements		Key Response Elements	
	Element	Value	Element	Value
filterInternational2	<amount>	9100	<response>	000
	<orderSource>	recurring	<message>	Approved
	<name>	John Doe	<authCode>	123457
	<addressLine1>	10 Main St.	<avsResult>	00
	<city>	San Jose		
	<state>	CA		
	<zip>	95032		
	<country>	US		
	<email>	jdoe@phoenixProcessing.com		
	<phone>	7812701111		
	<type>	VI		
	<number>	4100200309950001		
	<expDate>	1121		
	<international>	false		

## 2.5.8 Testing Security Code No-Match Filtering

Complete this test only if you are planning on using the Security Code No-Match Filtering Feature.

To test the Security Code No-Match feature:

1. Submit authorization transactions using the values provided in Supplied Data Elements of [Table 2-16](#).
2. Verify that your response values match those shown in Key Response Elements section of [Table 2-16](#).

After you complete this test, go to the next test.

**TABLE 2-16** Security Code No-Match Filtering Test Data

orderId	Supplied Data Elements		Key Response Elements	
	Element	Value	Element	Value
securityCodeFilter1	<amount>	9100	<response>	358
	<orderSource>	ecommerce	<message>	Restricted by Litle due to security code mismatch.
	<name>	John Doe		
	<addressLine1>	10 Main St.	<avsResult>	14
	<city>	San Jose	<cardValidationResult>	N
	<state>	CA		
	<zip>	95032		
	<country>	US		
	<type>	MC		
	<number>	5112002200000008		
	<expDate>	1121		
	<cardValidationNum>	123		
securityCodeFilter2	<amount>	9100	<response>	358
	<orderSource>	ecommerce	<message>	Restricted by Litle due to security code mismatch.
	<name>	Jane Doe		
	<addressLine1>	10 Main St.	<avsResult>	20
	<city>	San Jose	<cardValidationResult>	N
	<state>	CA		
	<zip>	95032		
	<country>	US		
	<type>	MC		
	<number>	5112000200000002		
	<expDate>	1121		
	<cardValidationNum>	123		
	<international>	false		

## 2.5.9 Testing Advanced Fraud Tools

Complete this test only if you are planning on using the Advanced Fraud Tools Feature.

To test the Advanced Fraud Tools feature:

1. Submit authorization transactions using the values provided in Supplied Data Elements of [Table 2-17](#). For each test, replace "Your Prefix-" with the prefix supplied by your Implementation Consultant.
2. Verify that your response values match those shown in Key Response Elements section of [Table 2-17](#).

---

**NOTE:** You can submit these tests as `sale` transactions using the supplied data, or as standalone `fraudCheck` transactions using just the designated `orderId` and `threatMetrixsessionId`. The results for each test type will be as shown in the Key response elements section.

Also, please note that the third test, `orderId = tmx_fail_order_id`, has two possible results depending upon whether you are configured for Info Only or Auto-Decline.

---

After you complete this test, go to the next test.

**TABLE 2-17** Advanced Fraud Tools Test Data

orderId	Supplied Data Elements		Key Response Elements	
	Element	Value	Element	Value
tmx_pass_order_id	<amount>	150	<response>	000
	<type>	VI	<message>	Approved
	<number>	4111111111111111	<deviceReviewStatus>	pass
	<expDate>	1230	<deviceReputationScore>	50
	<threatMetrixSessionId>	<b>Your Prefix-</b> A980A93LP2O3-KNP0050	<triggeredRule>	FlashDisabled

**TABLE 2-17** Advanced Fraud Tools Test Data

orderId	Supplied Data Elements		Key Response Elements	
	Element	Value	Element	Value
tmx_review_order_id	<amount> <type> <number> <expDate> <threatMetrixSessionId>	150 VI 4111111111111111 1230 <b>Your Prefix</b> -A0S9D8F7G6H5J4-KMR-020	<b>Result if Info Only:</b> <response> <message> <deviceReviewStatus> <deviceReputationScore> <triggeredRule> <triggeredRule>	000 Approved review -20 PossibleVPNConnection PossibleCookieWipingWeek
tmx_fail_order_id	<amount> <type> <number> <expDate> <threatMetrixSessionId>	150 VI 4111111111111111 1230 <b>Your Prefix</b> -Q1W2E3R4T5Y6U7I8-KHF-100	<b>Result if Info Only:</b> <response> <message> <deviceReviewStatus> <deviceReputationScore> <<triggeredRule> <triggeredRule> <triggeredRule>  <b>Result if Auto-decline:</b> <response> <message>  <deviceReviewStatus> <deviceReputationScore> <triggeredRule> <triggeredRule> <triggeredRule>	000 Approved fail -100 5PaymentsOnExactDevice ProxyHasNegativeReputation TrueIPProxyIPCityMismatch  550 <b>Restricted Device or IP - ThreatMetrix Fraud Score Below Threshold</b> fail -100 5PaymentsOnExactDevice ProxyHasNegativeReputation TrueIPProxyIPCityMismatch

**TABLE 2-17** Advanced Fraud Tools Test Data

orderId	Supplied Data Elements		Key Response Elements	
	Element	Value	Element	Value
tmx_unavail_order_id	<amount>	150	<response>	000
	<type>	VI	<message>	Approved
	<number>	4111111111111111	<deviceReviewStatus>	unavailable
	<expDate>	1230		
	<threatMetrixSessionId>	<b>Your Prefix</b> -Q1W2E3R4T5Y6U7I8-XLP0050		

### 2.5.10 Testing Account Updater

To test Account Updater, you submit a normal Authorization transaction. The certification system returns an Authorization response that includes Account Update information. You should verify that you correctly parse the update information.

---

**NOTE:** You can also perform the tests in this section using Sale transactions instead of Authorization transactions.

---

To test the Account Updater service:

1. Submit authorization transactions using the values provided in Supplied Data Elements of [Table 2-18](#).
2. Verify that your response values match those shown in Key Response Elements section of [Table 2-18](#).
3. If you have coded to receive Extended Response Codes, proceed to the next test.

**TABLE 2-18** Account Updater Test Data

orderId	Supplied Data Elements		Key Response Elements	
	Element	Value	Element	Value
100	<amount> 10000 <type> VI <number> 4457000300000007 <expDate> 0115		<originalCardInfo> (parent element) <type> VI <number> 4457000300000007 <expDate> 0115 <newCardInfo> (parent element) <type> MC <number> 5112000100000003 <expDate> 0115	
101	<amount> 10000 <type> DI <number> 6500102087026221 <expDate> 0115		<originalCardInfo> (parent element) <type> DI <number> 6500102087026221 <expDate> 0115 <newCardInfo> (parent element) <type> DI <number> 6011102077026225 <expDate> 0115	

### 2.5.10.1 Testing Account Updater Extended Response Codes

To test the Account Updater Extended Response Codes feature:

1. Submit authorization transactions using the values provided in Supplied Data Elements of [Table 2-19](#).
2. Verify that the response values match those shown in Key Response Elements section of [Table 2-19](#) and that your systems parse the data correctly. The second test case does not include account repair information only the Extended Response Code.

**TABLE 2-19** Account Updater Extended Response Test Data

orderId	Supplied Data Elements		Key Response Elements	
	Element	Value	Element	Value
102	<amount> 10000 <type> MC <number> 5112000101110009 <expDate> 1199		<originalCardInfo> (parent element) <type> MC <number> 5112000101110009 <expDate> 1199 <newCardInfo> (parent element) <type> VI <number> 4457000302200001 <expDate> 1199 <extendedCardResponse> (parent element) <code> 501 <message> The account was closed.	
103	<amount> 10000 <type> VI <number> 4457000301100004 <expDate> 1199		<extendedCardResponse> (parent element) <code> 504 <message> Contact the cardholder for updated information.	

### 2.5.10.2 Testing Account Updater for Tokenized Merchants

If you are a tokenized merchant using the Account Updater service, you can test this service using the card information provided in [Table 2-18](#). In this case you will receive an original and new token in the <accountUpdater> section of the Authorization response message (see [accountUpdater Structure - Credit Cards \(tokenized Merchant\)](#) on page 347).

## 2.5.11 Testing Tax Billing

This test applies only to merchants with MCC 9311.

To test Tax Billing and Convenience Fee transactions:

1. Submit `authorization` transactions using the values provided in Supplied Data Elements of [Table 2-20](#). Note: The second transactions omits the <taxType> element.
2. Verify that the system returns a response code of 000 - Approved for the first transaction and response code of 851 - MCC 9311 requires taxType element for the second.

**TABLE 2-20** Tax Billing Test Data

orderId	Supplied Data Elements		Key Response Elements	
	Element	Value	Element	Value
MCC9311Test	<amount> <type> <number> <expDate> <taxType>	3000 VI 4457010200000247 1121 fee	<response> <message>	000 Approved
MCC9311Test2	<amount> <type> <number> <expDate>	3000 VI 4457010200000247 1121	<response> <message>	851 MCC 9311 requires taxType element

## 2.5.12 Testing Convenience Fees

You include Convenience Fees through the use of the `secondaryAmount` element.

To test the use of Convenience Fees submit the transactions detailed below:

1. Submit `authorization` or `sale` transactions for the first five transactions of [Table 2-21](#) using the values provided in Supplied Data Elements columns.
2. Verify that the response values match those shown in Key Response Elements section of [Table 2-21](#) for those transactions and that your systems parse the data correctly.
3. Submit `sale` transactions for Order Id `SaleWOSecondary` using the data provided.
4. After receiving an approval for the `sale` transaction, submit a `credit` transaction using the `littleTxId` from the `sale` transaction and including the `secondaryAmount` element with the value provided.
5. Verify that the response values match those shown in Key Response Elements section for the `credit` transaction using Order Id `SaleWOSecondary` and that your systems parse the data correctly.



**TABLE 2-21** Convenience Fee Test Data

orderId	Supplied Data Elements		Key Response Elements	
	Element	Value	Element	Value
Visa_secondary Amount	<amount> <type> <number> <expDate> <secondaryAmount>	10500 VI 4457010200000247 1121 10000	<response> <message>	000 Approved
SecondaryAmt_Higher	<amount> <type> <number> <expDate> <secondaryAmount>	2500 VI 4111111111111111 1230 3000	<response> <message>	380 Secondary Amount cannot exceed the sale amount
MOP_Unsupported	<amount> <type> <number> <expDate> <secondaryAmount>	6002 AX 375001010000003 0421 1100	<response> <message>	381 This method of payment does not support secondary amount
Negative_Secondary	<amount> <type> <number> <expDate> <secondaryAmount>	1000 VI 4457010200000247 1121 -500	<response> <message>	382 Secondary Amount cannot be less than zero
Partial_Not_Allowed	<amount> <type> <number> <expDate> <secondaryAmount> <allowPartialAuth>	2500 VI 4111111111111111 1230 3000 true	<response> <message>	383 Partial transaction is not supported when including a secondary amount
SaleWOSecondary (Sale TXN)	<amount> <type> <number> <expDate>	1000 MC 5112010140000004 1121	<response> <message>	000 Approved

**TABLE 2-21** Convenience Fee Test Data

orderId	Supplied Data Elements		Key Response Elements	
	Element	Value	Element	Value
SaleWOSecondary (Credit Txn)	<littleTxnId>	Value from previous transaction	<response>	000
	<amount>	1000	<message>	Approved
	<secondaryAmount>	400	Declined Transaction report result = 385 - Secondary amount not allowed on refund if not included on deposit	

### 2.5.13 Testing the Recycling Engine

The Certification test cases for the Recycling Engine serve two purposes. First, you use the test transactions to verify your handling of the responses you receive if you submit additional Authorization transactions for a declined auth being handled by the engine. Second, you can verify your process for retrieving and processing recycling completion files via sFTP.

There are three test scenarios you can use to test the Recycling Engine and your ability to parse the response messages and/or result Batches. The particular data sets and scenarios you use depends upon the version of cnpAPI you use, as well as your plans for retrieving the response messages. Use the following to determine which tests you should run:

- If you plan to retrieve recycling results via the results Batches posted daily to the FTP site, perform the tests in Scenario 1.
- If you are using cnpAPI schema version V8.6 or above, perform the tests in Scenario 2.

#### Scenario 1

To test your handling of the Recycling Results Session file:

1. Submit authorization (or sale) transactions using the values provided in the Supplied Data Elements column of [Table 2-22](#). Please use the same value for the orderId and if applicable, the recycleId elements.

---

**NOTE:** If your configuration is set for Vantiv to recycle by default, you can omit the <recycleBy> element.

---

2. Wait a minimum of 2 hours after submitting the last transaction. After 2 hours, retrieve the Results Session file from the FTP site.

**TABLE 2-22** Recycling Engine Test Data - Results Session File Pick-up

orderId or recycleId (replace XXX with your merchantId)	Supplied Data Elements		Key Response Elements	
	Element	Value	Element	Value
XXXCase1Order1	<amount> 10000 <type> VI <number> 4457012400000027 <expDate> 1220 <recycleBy> Litle		<b>Initial Response:</b> <response> 110 <message> Insufficient Funds <recyclingEngineActive> true <b>Final Response (in FTP Session File):</b> <response> 000 <message> Approved	
XXXCase1Order2	<amount> 10000 <type> MC <number> 5160124000000029 <expDate> 1220 <recycleBy> Litle		<b>Initial Response:</b> <response> 110 <message> Insufficient Funds <recyclingEngineActive> true <b>Final Response (in FTP Session File):</b> <response> 000 <message> Approved	
XXXCase1Order3	<amount> 10000 <type> VI <number> 4100200700000059 <expDate> 1220 <recycleBy> Litle		<b>Initial Response:</b> <response> 110 <message> Insufficient Funds <recyclingEngineActive> true <b>Final Response (in FTP Session File):</b> <response> 110 <message> Insufficient Funds	

**TABLE 2-22** Recycling Engine Test Data - Results Session File Pick-up

orderId or recycleId (replace XXX with your merchantId)	Supplied Data Elements		Key Response Elements	
	Element	Value	Element	Value
XXXCase1Order4	<amount> 10000 <type> MC <number> 5500010000000052 <expDate> 1220 <recycleBy> Litle	10000 MC 5500010000000052 1220 Litle	<b>Initial Response:</b> <response> 110 <message> Insufficient Funds <recyclingEngineActive> true <b>Final Response (in FTP Session File):</b> <response> 110 <message> Insufficient Funds	110 Insufficient Funds true
XXXCase1Order5	<amount> 10000 <type> VI <number> 4457032800000047 <expDate> 1220 <recycleBy> Litle	10000 VI 4457032800000047 1220 Litle	<b>Initial Response:</b> <response> 110 <message> Insufficient Funds <recyclingEngineActive> true <b>Final Response (in FTP Session File):</b> <response> 328 <message> Cardholder requests that recurring or installment payment be stopped	110 Insufficient Funds true 328 Cardholder requests that recurring or installment payment be stopped
XXXCase1Order6	<amount> 10000 <type> MC <number> 5160328000000042 <expDate> 1220 <recycleBy> Litle	10000 MC 5160328000000042 1220 Litle	<b>Initial Response:</b> <response> 110 <message> Insufficient Funds <recyclingEngineActive> true <b>Final Response (in FTP Session File):</b> <response> 120 <message> Call Issuer	110 Insufficient Funds true 120 Call Issuer

**TABLE 2-22** Recycling Engine Test Data - Results Session File Pick-up

orderId or recycleId (replace XXX with your merchantId)	Supplied Data Elements		Key Response Elements	
	Element	Value	Element	Value
XXXCase1Order7	<amount>	10000	<b>Initial Response:</b>	
	<type>	VI	<response>	302
	<number>	5160328000000042	<message>	Account Number Does Not Match Payment Type
	<expDate>	1220		
	<recycleBy>	Litle	<recyclingEngineActive>	false
			<b>Final Response (in FTP Session File):</b>	
			None - This type of decline is not recycled.	

## Scenario 2

To test your handling of the Intercept Response Codes/Messages, as well as the Recycling Results Session file and Normal Batch/Online responses:

1. Submit authorization (or sale) transactions using the values provided in the Supplied Data Elements column of [Table 2-23](#). Please use the same value for the orderId and if applicable, the recycleId elements.

---

**NOTE:** If your configuration is set for Vantiv to recycle by default, you can omit the <recycleBy> element.

---

2. If you are using schema version V8.6 or above, resubmit any of the first four transactions within 36 hours to receive a response message containing the intercept Response Reason Code 372 - Soft Decline - Auto Recycling In Progress. If you are using schema version 8.5 or below, you will receive a response message with the same Response Reason Code as in the initial response message.
3. Wait a minimum of 36 hours after submitting the last of the initial transactions. After 36 hours, you can retrieve the Results Session file from the FTP site and/or resubmit the transaction. The responses will contain the data shown for the Final Response.

**TABLE 2-23** Recycling Engine Test Data - Intercept and Online or Results Session File Pick-up

orderId or recycleId (replace XXX with your merchantId)	Supplied Data Elements		Key Response Elements	
	Element	Value	Element	Value
XXXCase3Order1	<amount>	20000	<b>Initial Response:</b>	
	<type>	DI	<response>	350
	<number>	6223012400000025	<message>	Generic Decline
	<expDate>	1220	<recyclingEngineActive>	true
	<recycleBy>	Litle	<b>Intermediate Attempts (V8.6):</b>	
			<response>	372
			<message>	Soft decline - Recycling In Progress
			<recyclingEngineActive>	true
			<b>Final Response (Online/Normal Batch, or in FTP Session File):</b>	
			<response>	000
			<message>	Approved

**TABLE 2-23** Recycling Engine Test Data - Intercept and Online or Results Session File Pick-up

orderId or recycleId (replace XXX with your merchantId)	Supplied Data Elements		Key Response Elements	
	Element	Value	Element	Value
XXXCase3Order2	<amount>	20000	<b>Initial Response:</b>	
	<type>	AX	<response>	350
	<number>	377201240000025	<message>	Generic Decline
	<expDate>	1220	<recyclingEngineActive>	true
	<recycleBy>	Litle	<b>Intermediate Attempts (V8.6):</b>	
			<response>	372
			<message>	Soft decline - Recycling In Progress
			<recyclingEngineActive>	true
			<b>Final Response (Online/Normal Batch, or in FTP Session File):</b>	
			<response>	000
			<message>	Approved

**TABLE 2-23** Recycling Engine Test Data - Intercept and Online or Results Session File Pick-up

orderId or recycleId (replace XXX with your merchantId)	Supplied Data Elements		Key Response Elements	
	Element	Value	Element	Value
XXXCase3Order3	<amount>	20000	<b>Initial Response:</b>	
	<type>	DI	<response>	350
	<number>	6223012400000033	<message>	Generic Decline
	<expDate>	1220	<recyclingEngineActive>	true
	<recycleBy>	Litle	<b>Intermediate Attempts (V8.6):</b>	
			<response>	372
			<message>	Soft decline - Recycling In Progress
			<recyclingEngineActive>	true
			<b>Final Response (Online/Normal Batch, or in FTP Session File):</b>	
			<response>	373
			<message>	Hard Decline - Auto Recycling Complete



**TABLE 2-23** Recycling Engine Test Data - Intercept and Online or Results Session File Pick-up

orderId or recycleId (replace XXX with your merchantId)	Supplied Data Elements		Key Response Elements	
	Element	Value	Element	Value
XXXCase3Order4	<amount> 20000 <type> DI <number> 6011002078551608 <expDate> 1220 <recycleBy> Litle	20000 DI 6011002078551608 1220 Litle	<b>Initial Response:</b> <response> 101 <message> Issuer Unavailable <recyclingEngineActive> true  <b>Intermediate Attempts (V8.6):</b> <response> 372 <message> Soft decline - Recycling In Progress <recyclingEngineActive> true  <b>Final Response (Online/Normal Batch, or in FTP Session File):</b> <response> 373 <message> Hard Decline - Auto Recycling Complete	101 Issuer Unavailable true  372 Soft decline - Recycling In Progress true  373 Hard Decline - Auto Recycling Complete
XXXCase3Order5	<amount> 20000 <type> VI <number> 377203280000048 <expDate> 1220 <recycleBy> Litle	20000 VI 377203280000048 1220 Litle	<b>Initial Response:</b> <response> 302 <message> Account Number Does Not Match Payment Type <recyclingEngineActive> false  <b>All Responses:</b> None - This type of decline is not recycled.	302 Account Number Does Not Match Payment Type false

### 2.5.13.1 Testing Recycling Engine Cancellation

You use an `authReversal` transaction to halt the automatic recycling of an authorization. For a sale transaction, use a `void` transaction to halt recycling.

---

---

**NOTE:** You can perform this test either after completing the Recycling Engine test or prior to starting that test.

---

---

To test recycling cancellation:

1. Submit a `sale` transaction using the values provided for `Case1Order1a` and an authorization transaction using the values provided for `Case1Order2a` in the Supplied Data Elements of [Table 2-24](#).
2. Two (2) hours after receiving the decline message, submit a `void` transaction using the `littleTxnId` returned in the response message for `Case1Order1a`. If you are not enabled for Auto-refunding an approved Sales on Void, the Declined transaction report will contain a response code of 362 - Transaction not Voided - Already Settled.

---

---

**NOTE:** If you submit the Void transaction (Step 2) within 2 hours of the initial transaction submission, you will receive a `voidResponse` with a response code of 000 - Approved.

---

---

3. After receiving the decline messages, submit an `authReversal` transaction using the `littleTxnId` returned in the response message for `Case1Order2a`. This will halt the recycling of the order.

**TABLE 2-24** Recycling Engine Cancellation Test Data

orderId or recycleId (replace XXX with your merchantId)	Supplied Data Elements		Key Response Elements	
	Element	Value	Element	Value
XXXCase1Order1a	<amount> 11000 <type> VI <number> 4457012400000027 <expDate> 1220 <recycleBy> Litle  <b>Submit Void using litleTxnId from Initial Response</b>		<b>Initial Response:</b> <response> 110 <message> Insufficient Funds <recyclingEngineActive> true  <b>Void Response (if enabled for Auto-Refund):</b> <response> 000 <message> Approved <creditLitleTxnId> (Random Value)  <b>Void Response (if not enabled for Auto-Refund):</b> <response> 000 <message> Approved  Declined Transaction report result = 362 - Transaction Not Voided - Already Settled	

**TABLE 2-24** Recycling Engine Cancellation Test Data

orderId or recycleId (replace XXX with your merchantId)	Supplied Data Elements		Key Response Elements	
	Element	Value	Element	Value
XXXCase1Order2a	<amount>	11000	<b>Initial Response:</b>	
	<type>	MC	<response>	110
	<number>	5160124000000029	<message>	Insufficient Funds
	<expDate>	1220	<recyclingEngineActive>	true
	<recycleBy>	Litle	<b>authReversalResponse:</b>	
	<b>Submit authReversal using litleTxnId from Initial Response</b>		<response>	000
			<message>	Approved

## 2.5.14 Testing Recurring Engine Transactions

Use the following Certification tests to verify transactions associated with the Recurring Engine functionality. For testing purposes, the Certification environment will process the first recurring transaction within 2 hours. The system cancels subsequent recurring transactions in the payment stream. For example, if you submitted an Authorization at 9:00 AM that set-up a subscription for twelve monthly payments, the Cert Recurring Engine would process the first payment by 11:00 AM and cancel the remaining eleven payments.

---

**IMPORTANT:** The test data supplied does not necessarily account for all data fields/xml elements in a particular request. Where test data is not supplied, you should provide appropriate information.

You should never override your own system to enter supplied data. If you are unable to enter the supplied data without overriding your system, please consult your Implementation Consultant concerning the test and how to proceed.

---

To test the Recurring Engine functionality using the data supplied in [Table 2-25](#):

1. Submit createPlan transactions for Order Ids R1.1, R1.2, R1.3, R1.4, R1.5, and R1.6. These transactions establish Plans used in the remaining tests, as well as verify your cnpAPI messages used to create Plans. You can use whatever values you wish for the <planCode>

- and <name> elements. Verify that each transaction receives an approval code in the response message.
2. Submit `createPlan` transactions for Order Id R1.7 using the same <planCode> value you used in R1.3. This transaction is declined, because the Plan Code already exists. Verify that the transaction receives a response code of 487 - Plan code already exists.
  3. Submit a `sale` transaction for Order Id R2.1. This transaction creates a subscription using the plan established in Order R1.1. The amount in the sale transaction represents a set-up fee and not the initial payment. Verify that the transaction receives an approval code in the response message.
  4. Submit an `authorization` transaction for Order Id R2.2. This transaction creates a subscription using the plan established in Order R1.1. Because the Authorization did not specify a start date, the Recurring Engine schedules the first payment for the current date. Verify that the transaction receives an approval code in the response message.

---

**NOTE:** The transaction specified in Order 2.2 is a \$0 Auth. If you include an amount when using an Auth to establish a subscription, you should plan on reversing the Auth to avoid a Misuse of Auth fee. The Recurring Engine obtains its own Auth for the first payment.

---

5. Submit an `updateSubscription` transaction for Order Id R2.3. This transaction updates the subscription initiated with Order Id 2.1, changing the Plan to the plan you created in R1.2.
6. Submit a `sale` transaction for Order Id R3.1. This transaction utilizes a Sale transaction to initialize a subscription based upon the plan created in R1.3, but overrides both the number of payments and the amount specified in the Plan. Verify that the transaction receives an approval code in the response message.
7. Submit an `authorization` transaction for Order Id R3.2. This transaction utilizes an Authorization transaction to initialize a subscription based upon the plan created in R1.3, but overrides both the number of payments and the amount specified in the Plan. Verify that the transaction receives an approval code in the response message.
8. Submit an `updateSubscription` transaction for Order Id R3.3. This transaction updates an existing subscription, changing the billing date.
9. Submit an `authorization` transaction for Order Id R4.1. This transaction utilizes an Authorization transaction to initialize a subscription that overrides the default amount in the Plan and has a trial period. Verify that the transaction receives an approval code in the response message.
10. Submit an `updateSubscription` transaction for Order Id R4.2. This transaction updates an existing subscription with a new credit card number.
11. Submit an `authorization` transaction for Order Id R5.1. This transaction utilizes an Authorization transaction to initialize a subscription based upon the SEMIANNUAL\_PLAN, but overrides the number of payments. Verify that the transaction receives an approval code in the response message.

12. Submit an `updateSubscription` transaction for Order Id R5.2. This transaction updates an existing subscription with new billing information.
13. Submit an `updateSubscription` transaction for Order Id R5.3. Since the transaction does not include any updated information, the Declined Transaction report will contain a response code of 484 - Insufficient data to update subscription. Verify the response code by accessing the Declined Transaction report in Vantiv iQ.
14. Submit an `updateSubscription` transaction for Order Id R5.4. Since the transaction specifies a new billing date in the past, the Declined Transaction report will contain a response code of 485 - Invalid billing date. Verify the response code by accessing the Declined Transaction report in Vantiv iQ.
15. Submit an `authorization` transaction for Order Id R6.1. The system declines this transaction, since it uses an invalid Plan Code. Verify that the transaction receives a response code of 472 - Invalid plan code.
16. Submit an `updateSubscription` transaction for Order Id R6.2. Since this order uses an invalid subscription Id, The system declines this transaction, the Declined Transaction report will contain a response code of 482 - Invalid start date. Verify the response code by accessing the Declined Transaction report in Vantiv iQ.
17. Submit an `authorization` transaction for Order Id R6.3. The system declines this transaction, since it uses a start date in the past. Verify that the transaction receives a response code of 475 - Invalid Subscription Id.
18. Submit an `authorization` transaction for Order Id R7.1. This transaction utilizes an Authorization transaction to initialize a subscription based upon the `PLAN_WITH_PROMOTIONS` Plan with an add On and a Discount applied. Verify that the transaction receives an approval code in the response message.
19. Submit an `updateSubscription` transaction for Order Id R7.2. This transaction attempts to update an existing subscription with a new Add On, but is declined because the Add On already exists. Verify that the Declined Transaction report contains a response code of 476 - Add On already exists.
20. Submit an `updateSubscription` transaction for Order Id R7.3. This transaction attempts to update an Add On for an existing subscription, but is declined because the specified Add On is not associated with the Subscription. Verify that the Declined Transaction report contains a response code of 478 - No matching Add On code for the subscription.
21. Submit an `updateSubscription` transaction for Order Id R7.4. This transaction attempts to update an Add On for an existing subscription, but is declined because the specified Add On is not associated with the Subscription. Verify that the Declined Transaction report contains a response code of 478 - No matching Add On code for the subscription.
22. Submit an `updateSubscription` transaction for Order Id R7.5. This transaction attempts to update a Discount for an existing subscription, but is declined because the specified Discount is not associated with the Subscription. Verify that the Declined Transaction report contains a response code of 480 - No matching Discount code for the subscription.
23. Submit an `authorization` transaction for Order Id R8.1. This transaction utilizes an Authorization transaction to initialize a subscription, but includes duplicate Add Ons. Verify that the transaction receives a response code of 477 - Duplicate add-on codes in request.

24. Submit an `authorization` transaction for Order Id R8.2. This transaction utilizes an Authorization transaction to initialize a subscription, but includes duplicate Discounts. Verify that the transaction receives a response code of 481 - Duplicate discount codes in request.
25. Submit an `authorization` transaction for Order Id R9.1. In this case the parent Authorization transaction is declined with a response code of 301 - Invalid Account Number. The response code associated with the recurring request is 471 - Parent transaction declined - Recurring subscription not created.PREMIUM\_MONTHLY
26. Submit an `cancelSubscription` transaction for Order Id R10.1. Verify that the transaction receives an approval code in the response message.
27. Submit an `updatePlan` transaction for Order Id R11.1. This transaction changes the Plan to an inactive state. Verify that the transaction receives an approval code in the response message.

**TABLE 2-25** Recurring Engine Test Data

orderId	Supplied Data Elements		Key Response Elements	
	Element	Value	Element	Value
R1.1	<code>&lt;createPlan&gt;</code> <code>&lt;planCode&gt;</code> <code>&lt;name&gt;</code> <code>&lt;description&gt;</code> <code>&lt;intervalType&gt;</code> <code>&lt;amount&gt;</code> <code>&lt;numberOfPayments&gt;</code>	<i>(parent element)</i> Your Value Your Value Basic monthly plan MONTHLY 5000 12	<code>&lt;response&gt;</code> <code>&lt;message&gt;</code> <code>&lt;planCode&gt;</code>	000 Approved Your Value
R1.2	<code>&lt;createPlan&gt;</code> <code>&lt;planCode&gt;</code> <code>&lt;name&gt;</code> <code>&lt;description&gt;</code> <code>&lt;intervalType&gt;</code> <code>&lt;amount&gt;</code> <code>&lt;numberOfPayments&gt;</code>	<i>(parent element)</i> Your Value Your Value Premium monthly plan MONTHLY 7000 12	<code>&lt;response&gt;</code> <code>&lt;message&gt;</code> <code>&lt;planCode&gt;</code>	000 Approved Your Value
R1.3	<code>&lt;createPlan&gt;</code> <code>&lt;planCode&gt;</code> <code>&lt;name&gt;</code> <code>&lt;description&gt;</code> <code>&lt;intervalType&gt;</code> <code>&lt;amount&gt;</code>	<i>(parent element)</i> Your Value Your Value An annual plan ANNUAL 14000	<code>&lt;response&gt;</code> <code>&lt;message&gt;</code> <code>&lt;planCode&gt;</code>	000 Approved Your Value

**TABLE 2-25** Recurring Engine Test Data

orderId	Supplied Data Elements		Key Response Elements	
	Element	Value	Element	Value
R1.4	<createPlan> <planCode> <name> <description> <intervalType> <amount> <trialIntervalType> <trialNumberOfIntervals>	(parent element) Your Value Your Value A monthly plan with trial period MONTHLY 5000 MONTH 2	<response> <message> <planCode>	000 Approved Your Value
R1.5	<createPlan> <planCode> <name> <description> <intervalType> <amount>	(parent element) Your Value Your Value A semi-annual plan SEMIANNUAL 7000	<response> <message> <planCode>	000 Approved Your Value
R1.6	<createPlan> <planCode> <name> <description> <intervalType> <amount>	(parent element) Your Value Your Value A plan with Add Ons and Discounts MONTHLY 5000	<response> <message> <planCode>	000 Approved Your Value
R1.7	<createPlan> <planCode> <name> <description> <intervalType> <amount>	(parent element) Value from R1.3 Value from R1.3 An annual plan ANNUAL 5000	<response> <message> <planCode>	487 Plan code already exists Value from R1.3



**TABLE 2-25** Recurring Engine Test Data

orderId	Supplied Data Elements		Key Response Elements	
	Element	Value	Element	Value
R2.1	<sale> <amount> <recurringRequest> <subscription> <planCode> <startDate>	(parent element) 1000 (parent element) (parent element) Value from R1.1 Use any date	<recurringResponse> <responseCode> <responseMessage>	(parent element) 470 Approved - Recurring subscription created
R2.2	<authorization> <amount> <recurringRequest> <subscription> <planCode>	(parent element) 000 (parent element) (parent element) Value from R1.1	<recurringResponse> <responseCode> <responseMessage>	(parent element) 470 Approved - Recurring subscription created
R2.3	<updateSubscription> <subscriptionId>  <planCode>	(parent element) Value returned in R2.1 response  Value from R1.2	<subscriptionId> <response> <message>	(parent element) 000 Approved
R3.1	<sale> <recurringRequest> <subscription> <planCode> <startDate>  <numberOfPayments> <amount>	(parent element) (parent element) (parent element) Value from R1.3 Use any valid date in the future.  6 4000	<recurringResponse> <responseCode> <responseMessage>	(parent element) 470 Approved - Recurring subscription created
R3.2	<authorization> <recurringRequest> <subscription> <planCode> <startDate>  <numberOfPayments> <amount>	(parent element) (parent element) (parent element) Value from R1.3 Use any valid date in the future.  6 4000	<recurringResponse> <responseCode> <responseMessage>	(parent element) 470 Approved - Recurring subscription created

**TABLE 2-25** Recurring Engine Test Data

orderId	Supplied Data Elements		Key Response Elements	
	Element	Value	Element	Value
R3.3	<updateSubscription> <subscriptionId>  <billingDate>	(parent element) Value returned in R3.1 response  Use any valid date in the future and different from date used in R3.1.	<response> <message>	000 Approved
R4.1	<authorization> <recurringRequest> <subscription> <planCode> <startDate>  <amount>	(parent element) (parent element) (parent element) Value from R1.4 Use any valid date in the future.  4000	<recurringResponse> <responseCode> <responseMessage>	(parent element) 470 Approved - Recurring subscription created
R4.2	<updateSubscription> <subscriptionId>  <card> <type> <number> <expDate>	(parent element) Value returned in R4.1 response  (parent element) VI 4457010000000009 1221	<response> <message>	000 Approved
R5.1	<authorization> <recurringRequest> <subscription> <planCode>  <startDate>  <numberOfPayments>	(parent element) (parent element) (parent element) Value from R1.5 Use any valid date in the future.  6	<recurringResponse> <responseCode> <responseMessage>	(parent element) 470 Approved - Recurring subscription created

**TABLE 2-25** Recurring Engine Test Data

orderId	Supplied Data Elements		Key Response Elements	
	Element	Value	Element	Value
R5.2	<updateSubscription> <subscriptionId> <billToAddress> <name> <addressLine1> <city> <state> <zip> <country> <email> <phone>	(parent element) Value returned in R5.1 response (parent element) John 900 Chelmsford St. Lowell MA 01781 US john@gmail.com 8559658965	<subscriptionId> <response> <message>	Value returned in R5.1 response 000 Approved
R5.3	<updateSubscription> <subscriptionId>	(parent element) Value returned in R5.1 response	<response> <message> Declined Transaction report result = 484 - Insufficient data to update subscription	000 Approved
R5.4	<updateSubscription> <subscriptionId> <billingDate>	(parent element) Value returned in R5.1 response 2000-10-01	<response> <message> Declined Transaction report result = 485 - Invalid billing date	000 Approved
R6.1	<authorization> <recurringRequest> <subscription> <planCode>	(parent element) (parent element) (parent element) INVALID_PLAN	<responseCode> <responseMessage>	472 Invalid plan code

**TABLE 2-25** Recurring Engine Test Data

orderId	Supplied Data Elements		Key Response Elements	
	Element	Value	Element	Value
R6.2	<updateSubscription> <subscriptionId> <billToAddress> <name> <addressLine1> <city> <state> <zip> <country> <email> <phone>	(parent element) 1111111111 (parent element) John 900 Chelmsford St. Lowell MA 01781 US john@gmail.com 8559658965	<response> <message> Declined Transaction report result = 475 - Invalid Subscription Id	000 Approved
R6.3	<authorization> <recurringRequest> <subscription> <planCode> <startDate>	(parent element) (parent element) (parent element) Value from R1.1 2000-04-04	<recurringResponse> <responseCode> <responseMessage>	(parent element) 482 Invalid start date

**TABLE 2-25** Recurring Engine Test Data

orderId	Supplied Data Elements		Key Response Elements	
	Element	Value	Element	Value
R7.1	<authorization> <recurringRequest> <subscription> <planCode> <createAddOn> <addOnCode> <name> <amount> <startDate> <endDate> <createDiscount> <discountCode> <name> <amount> <startDate> <endDate>	(parent element) (parent element) (parent element) Value from R1.6 (parent element) SSL_ADDON Additional Service 1000 2013-08-30 2050-08-30 (parent element) PROMO_DISCOUN T Special Offer 1000 2013-08-30 2050-08-30	<recurringResponse> <responseCode> <responseMessage>	(parent element) 470 Approved - Recurring Subscription Created
R7.2	<updateSubscription> <subscriptionId> <createAddOn> <addOnCode> <name> <amount> <startDate> <endDate>	(parent element) Value returned in R7.1 response (parent element) SSL_ADDON Additional Service 1000 2013-08-30 2050-08-30	<recurringResponse> <response> <message>	(parent element) 000 Approved Declined Transaction report result = 476 - Add-on code already exists

**TABLE 2-25** Recurring Engine Test Data

orderId	Supplied Data Elements		Key Response Elements	
	Element	Value	Element	Value
R7.3	<updateSubscription> <subscriptionId> <createDiscount> <discountCode> <name> <amount> <startDate> <endDate>	(parent element) Value returned in R7.1 response (parent element) PROMO_DISCOUN T Special Offer 1000 2013-08-30 2050-08-30	<response> <message> Declined Transaction report result = 486 - Discount code already exists	000 Approved
R7.4	<updateSubscription> <subscriptionId> <updateAddOn> <addOnCode> <name> <amount>	(parent element) Value returned in R7.1 response (parent element) INVALID_ADDON_C ODE Extra Features 1000	<response> <message> Declined Transaction report result = 478 - No matching Add-on code for the subscription	478 No matching Add-on code for the subscription
R7.5	<updateSubscription> <subscriptionId> <updateDiscount> <discountCode> <name> <amount> <startDate> <endDate>	(parent element) Value returned in R7.1 response (parent element) INVALID_DISCOUN T_CODE Special Offer 1000 2013-08-30 2050-08-30	<response> <message> Declined Transaction report result = 480 - No matching Discount code for the subscription	480 No matching Discount code for the subscription

**TABLE 2-25** Recurring Engine Test Data

orderId	Supplied Data Elements		Key Response Elements	
	Element	Value	Element	Value
R8.1	<authorization>	(parent element)	<recurringResponse>	(parent element)
	<recurringRequest>	(parent element)	<response>	477
	<subscription>	(parent element)	<message>	Duplicate Add-on codes in request
	<planCode>	Value from R1.6		
	<createAddOn>	(parent element)		
	<addOnCode>	SSL_ADDON		
	<name>	Additional Service		
	<amount>	1000		
	<startDate>	2013-08-30		
	<endDate>	2050-08-30		
	<createAddOn>	(parent element)		
	<addOnCode>	SSL_ADDON		
	<name>	Additional Service		
	<amount>	1000		
	<startDate>	2013-08-30		
	<endDate>	2050-08-30		

**TABLE 2-25** Recurring Engine Test Data

orderId	Supplied Data Elements		Key Response Elements	
	Element	Value	Element	Value
R8.2	<authorization> <recurringRequest> <subscription> <planCode> <createDiscount> <discountCode> <name> <amount> <startDate> <endDate> <createDiscount> <discountCode> <name> <amount> <startDate> <endDate>	(parent element) (parent element) (parent element) Value from R1.6 (parent element) PROMO_DISCOUN T Discount 1000 2013-08-30 2050-08-30 (parent element) PROMO_DISCOUN T Discount 1000 2013-08-30 2050-08-30	<recurringResponse> <responseCode> <responseMessage>	(parent element) 481 Duplicate discount codes in request
R9.1	<authorization> <card> <type> <number> <expDate> <recurringRequest> <subscription> <planCode>	(parent element) (parent element) MC 5112010100000002 0721 (parent element) (parent element) Value from R1.6	<recurringResponse> <responseCode> <responseMessage>	(parent element) 471 Parent transaction declined - Recurring subscription not created
R10.1	<cancelSubscription> <subscriptionId>	(parent element) Value returned in R7.1 response	<recurringResponse> <subscriptionId> <response> <message>	(parent element) Submitted value 000 Approved



**TABLE 2-25** Recurring Engine Test Data

orderId	Supplied Data Elements		Key Response Elements	
	Element	Value	Element	Value
R11.1	<updatePlan> <planCode> <active>	(parent element) Value from R1.2 false	<response> <message>	000 Approved

## 2.5.15 Testing Gift Card Transactions

Use the following Certification tests to verify transactions associated with the Private Label Gift Card functionality. The tests are designed so that you can verify your XML structure for each transaction type, as well as your ability to parse the response data.

To test the Gift Card functionality using the data supplied in [Table 2-26](#):

---

**NOTE:** When processing gift cards, many transactions response messages include the `refCode`, `sequenceNumber`, `systemTraceId`, and `txnTime` elements. You should always store these values for possible use in subsequent transactions. For example, to perform the `giftCardCapture` in test `GC2A`, you must include the values returned for these elements in the associated `authorization` transaction, `GC2`.

---

1. Submit an `activate` transaction for Order Id `GC1`. Verify that the data in the response message matches the Key Response Elements specified in the table.
2. Submit an `activate` transaction for Order Id `GC1A`. This transaction activates a Virtual Gift Card. Verify that the data in the response message matches the Key Response Elements specified in the table.
3. Submit an `authorization` transaction for Order Id `GC2`. Verify that the data in the response message matches the Key Response Elements specified in the table.
4. Submit a `giftCardCapture` transaction for Order Id `GC2A`. Verify that the data in the response message matches the Key Response Elements specified in the table.
5. Submit a `giftCardCredit` transaction for Order Id `GC2B`. Verify that the data in the response message matches the Key Response Elements specified in the table.
6. Submit a `deactivate` transaction for Order Id `GC3`. Verify that the data in the response message matches the Key Response Elements specified in the table.
7. Submit a `load` transaction for Order Id `GC4`. Verify that the data in the response message matches the Key Response Elements specified in the table.
8. Submit a `unload` transaction for Order Id `GC5`. Verify that the data in the response message matches the Key Response Elements specified in the table.

9. Submit a `balanceInquiry` transaction for Order Id GC6. Verify that the data in the response message matches the Key Response Elements specified in the table.
10. Submit an `activate` transaction for Order Id GC7. Verify that the data in the response message matches the Key Response Elements specified in the table.
11. Submit an `activateReversal` transaction for Order Id GC7A. Verify that the data in the response message matches the Key Response Elements specified in the table.
12. Submit an `activateReversal` transaction for Order Id GC1A. Verify that the data in the response message matches the Key Response Elements specified in the table.
13. Submit an `authorization` transaction for Order Id GC8. Verify that the data in the response message matches the Key Response Elements specified in the table.
14. Submit an `authorizationReversal` transaction for Order Id GC8A. Verify that the data in the response message matches the Key Response Elements specified in the table.
15. Submit a `sale` transaction for Order Id GC9. Verify that the data in the response message matches the Key Response Elements specified in the table.
16. Submit a `depositReversal` transaction for Order Id GC9A. Verify that the data in the response message matches the Key Response Elements specified in the table.
17. Submit a `sale` transaction for Order Id GC10. Verify that the data in the response message matches the Key Response Elements specified in the table.
18. Submit a `giftCardCredit` transaction for Order Id GC10A. Verify that the data in the response message matches the Key Response Elements specified in the table.
19. Submit a `refundReversal` transaction for Order Id GC10B. Verify that the data in the response message matches the Key Response Elements specified in the table.
20. Submit a `deactivate` transaction for Order Id GC11. Verify that the data in the response message matches the Key Response Elements specified in the table.
21. Submit a `loadReversal` transaction for Order Id GC12. Verify that the data in the response message matches the Key Response Elements specified in the table.
22. Submit an `unload` transaction for Order Id GC13. Verify that the data in the response message matches the Key Response Elements specified in the table.
23. Submit an `unloadReversal` transaction for Order Id GC13A. Verify that the data in the response message matches the Key Response Elements specified in the table.
24. Submit an `activate` transaction for Order Id GC14. This transaction is declined with a response code of 301 - Invalid Account Number. Verify that the data in the response message matches the Key Response Elements specified in the table.
25. Submit an `activate` transaction for Order Id GC15. This transaction is declined with a response code of 217 - Already active, because it attempts to activate the same card already activated in Order Id GC1. Verify that the data in the response message matches the Key Response Elements specified in the table.
26. Submit an `authorization` transaction for Order Id GC16. This transaction is declined with a response code of 110 - Insufficient Funds. Verify that the data in the response message matches the Key Response Elements specified in the table.

27. Submit an `authorization` transaction for Order Id GC17. This transaction is declined with a response code of 281 - Card not active. Verify that the data in the response message matches the Key Response Elements specified in the table.
28. Submit a `sale` transaction for Order Id GC19. Verify that the data in the response message matches the Key Response Elements specified in the table.
29. Submit a `giftCardCredit` transaction for Order Id GC19A. For this transaction the Declined Transaction report will contain response code of 304 - Lost/Stolen Card.
30. Submit a `balanceInquiry` transaction for Order Id GC20. This transaction is declined with a response code of 352 - Invalid CVV2. Verify that the data in the response message matches the Key Response Elements specified in the table.

**TABLE 2-26** Private Label Gift Card Test Data

orderId	Supplied Data Elements		Key Response Elements	
	Element	Value	Element	Value
GC1	<b>Activate:</b>  <amount> 15000 <type> GC <number> Supplied by Implementation Consultant <expDate> 1220 <cardValidationNum> 123		<b>Activate Response:</b>  <response> 000 <message> Approved <cardValidationResult> M <availableBalance> 15000	
GC1A	<b>Virtual Activate:</b>  <amount> 8000 <accountNumberLength> 16 <giftCardBin> Supplied by Implementation Consultant		<b>Activate Response:</b>  <response> 000 <message> Approved <availableBalance> 8000 <accountNumber> 603571xxxxxxxxxx	
GC2	<b>Authorization:</b>  <amount> 1500 <type> GC <number> Number from GC1 <expDate> 1220 <cardValidationNum> 123		<b>Authorization Response:</b>  <response> 000 <message> Approved <authCode> 11111 <cardValidationResult> M <availableBalance> 13500	

**TABLE 2-26** Private Label Gift Card Test Data

orderId	Supplied Data Elements		Key Response Elements	
	Element	Value	Element	Value
GC2A	<b>Gift Card Capture:</b> <tleTxnId> <captureAmount> <type> <number> <expDate> <cardValidationNum> <originalRefCode> <originalAmount> <originalTxnTime>	Value from GC2 resp. 1500 GC Number from GC2 1220 123 refCode from GC2 amount from GC2 txnTime from GC2	<b>Capture Response:</b> <response> <message>	000 Approved
GC2B	<b>Gift Card Credit:</b> <tleTxnId> <creditAmount> <type> <number> <expDate>	Value from GC2A resp. 500 GC Number from GC2 1220	<b>Credit Response:</b> <response> <message>	000 Approved
CG3	<b>Deactivate:</b> <type> <number>	GC Supplied by Implementation Consultant	<b>Deactivate Response:</b> <response> <message> <availableBalance>	000 Approved 0
GC4	<b>Load:</b> <amount> <type> <number> <expDate> <cardValidationNum>	5000 GC Supplied by Implementation Consultant 0121 123	<b>Load Response:</b> <response> <message> <cardValidationResult> <availableBalance>	000 Approved M 5000

**TABLE 2-26** Private Label Gift Card Test Data

orderId	Supplied Data Elements		Key Response Elements	
	Element	Value	Element	Value
GC5	<b>Unload:</b> <amount> 2500 <type> GC <number> Number from GC4 <expDate> 0121 <cardValidationNum> 123		<b>Unload Response:</b> <response> 000 <message> Approved <cardValidationResult> M <availableBalance> 2500	
GC6	<b>Balance Inquiry:</b> <type> GC <number> Number from GC1 <expDate> 0121 <cardValidationNum> 123		<b>Balance Inquiry Response:</b> <response> 000 <message> Approved <cardValidationResult> M <availableBalance> 2500	
GC7	<b>Activate:</b> <amount> 8000 <type> GC <number> Supplied by Implementation Consultant <expDate> 1215 <cardValidationNum> 123		<b>Activate Response:</b> <response> 000 <message> Approved <cardValidationResult> M <availableBalance> 8000	
GC7A	<b>Activate Reversal:</b> <littleTxnId> Value from GC7 resp. <type> from GC7 <number> from GC7 <expDate> from GC7 <originalRefCode> refCode from GC7 <originalAmount> amount from GC7 <originalSystemTraceId> systemTraceId from GC7 <originalSequenceNumber> sequenceNumber from GC7		<b>Activate Reversal Response:</b> <response> 000 <message> Approved	

**TABLE 2-26** Private Label Gift Card Test Data

orderId	Supplied Data Elements		Key Response Elements	
	Element	Value	Element	Value
GC7B	<b>Activate Reversal:</b> <littleTxnId> <type> <number> <expDate> <originalRefCode> <originalAmount> <originalSystemTraceId> <originalSequenceNumber>	Value from GC1A resp. from GC1 from GC1 from GC1 refCode from GC1A amount from GC1A systemTraceId from GC1A sequenceNumber from GC1A	<b>Activate Reversal Response:</b> <response> <message>	000 Approved
GC8	<b>Authorization:</b> <amount> <type> <number> <expDate> <cardValidationNumber>	2000 GC Supplied by Implementation Consultant 1220 123	<b>Authorization Response:</b> <response> <message> <authCode> <cardValidationResult> <availableBalance>	000 Approved 1111 M 4000
GC8A	<b>Gift Card Auth Reversal:</b> <littleTxnId> <type> <number> <expDate> <originalRefCode> <originalAmount> <originalSystemTraceId> <originalSequenceNumber>	Value from GC8 resp. from GC8 from GC8 from GC8 refCode from GC8 amount from GC8 systemTraceId from GC8 sequenceNumber from GC8	<b>Auth Reversal Response:</b> <response> <message>	000 Approved

**TABLE 2-26** Private Label Gift Card Test Data

orderId	Supplied Data Elements		Key Response Elements	
	Element	Value	Element	Value
GC9	<b>Sale:</b> <amount> 2000 <type> GC <number> Supplied by Implementation Consultant <expDate> 1220 <cardValidationNum> 123		<b>Sale Response:</b> <response> 000 <message> Approved <authCode> 11111 <cardValidationResult> M <availableBalance> 8000	
GC9A	<b>Deposit Reversal:</b> <littleTxnId> Value from GC9 resp. <type> from GC9 <number> from GC9 <expDate> from GC9 <originalRefCode> refCode from GC9 <originalAmount> amount from GC9 <originalSystemTraceId> systemTraceId from GC9 <originalSequenceNumber> sequenceNumber from GC9		<b>Deposit Reversal Response:</b> <response> 000 <message> Approved	
GC10	<b>Sale:</b> <amount> 2000 <type> GC <number> Number from GC9 <expDate> 1220 <cardValidationNum> 123		<b>Sale Response:</b> <response> 000 <message> Approved <authCode> 11111 <cardValidationResult> M <availableBalance> 8000	
GC10A	<b>Gift Card Credit:</b> <littleTxnId> Value from GC10 resp. <CreditAmount> 2000 <type> GC <number> Number from GC9 <expDate> 1220		<b>Credit Response:</b> <response> 000 <message> Approved	

**TABLE 2-26** Private Label Gift Card Test Data

orderId	Supplied Data Elements		Key Response Elements	
	Element	Value	Element	Value
GC10B	<b>Refund Reversal:</b> <littleTxnId> <type> <number> <expDate> <originalRefCode> <originalAmount> <originalSystemTracelId> <originalSequenceNumber>	Value from GC10A resp. from GC10 from GC10 from GC10 refCode from GC10A amount from GC10A systemTracelId from GC10A sequenceNumber from GC10A	<b>Refund Reversal Response:</b> <response> <message>	000 Approved
GC11	<b>Deactivate Reversal:</b> <littleTxnId> <type> <number> <expDate> <originalRefCode> <originalAmount> <originalSystemTracelId> <originalSequenceNumber>	Value from GC3 resp. from GC3 from GC3 from GC3 refCode from GC3 resp. amount from GC3 resp. systemTracelId from GC3 sequenceNumber from GC3 resp.	<b>Deactivate Reversal Response:</b> <response> <message>	000 Approved
GC12	<b>Load Reversal:</b> <littleTxnId> <type> <number> <expDate> <originalRefCode> <originalAmount> <originalSystemTracelId> <originalSequenceNumber>	Value from GC4 resp. from GC4 from GC4 from GC4 refCode from GC4 resp. amount from GC4 resp. systemTracelId from GC4 sequenceNumber from GC4 resp.	<b>Load Reversal Response:</b> <response> <message> <availableBalance>	000 Approved 0



**TABLE 2-26** Private Label Gift Card Test Data

orderId	Supplied Data Elements		Key Response Elements	
	Element	Value	Element	Value
GC13	<b>Unload:</b> <amount> 2500 <type> GC <number> Supplied by Implementation Consultant <expDate> 0121 <cardValidationNum> 123		<b>Unload Response:</b> <response> 000 <message> Approved <cardValidationResu lt> M <availableBalance> 1500	
GC13A	<b>Unload Reversal:</b> <littleTxnId> Value from GC13 resp. <type> from GC13 <number> from GC13 <expDate> from GC13 <originalRefCode> refCode from GC13 resp. <originalAmount> amount from GC13 resp. <originalSystemTraceId> systemTraceId from GC13 resp. <originalSequenceNumb er> sequenceNumber from GC13 resp.		<b>Unload Reversal                      Response:</b> <response> 000 <message> Approved	
GC14	<b>Activate:</b> <amount> 15000 <type> GC <number> Supplied by Implementation Consultant <expDate> 1221 <cardValidationNum> 123		<b>Activate Response:</b> <response> 301 <message> Invalid Account Number	
GC15	<b>Activate:</b> <amount> 10000 <type> GC <number> Number from GC1 <expDate> 1221 <cardValidationNum> 123		<b>Activate Response:</b> <response> 217 <message> Already active <availableBalance> 14000	

**TABLE 2-26** Private Label Gift Card Test Data

orderId	Supplied Data Elements		Key Response Elements	
	Element	Value	Element	Value
GC16	<b>Authorization:</b> <amount> 1500000 <type> GC <number> Number from GC1 <expDate> 1221 <cardValidationNum> 123		<b>Authorization Response:</b> <response> 352 <message> Decline CVV/CID Fail <cardValidationResult> M <availableBalance> 14000	
GC17	<b>Authorization:</b> <amount> 15000 <type> GC <number> Supplied by Implementation Consultant <expDate> 1221 <cardValidationNum> 123		<b>Authorization Response:</b> <response> 218 <message> Card not active	
GC19	<b>Sale:</b> <amount> 1000 <type> GC <number> Supplied by Implementation Consultant <expDate> 1220 <cardValidationNum> 123		<b>Sale Response:</b> <response> 000 <message> Approved <authCode> 11111 <cardValidationResult> M <availableBalance> 1500	
GC19A	<b>Gift Card Credit:</b> <littleTxnId> Value from GC19 resp. <creditAmount> 10000 <type> GC <number> Value from GC19 <expDate> 1220		<b>Credit Response:</b> <response> 000 <message> Approved Declined Transaction report result = 304 - Lost/Stolen Card	

**TABLE 2-26** Private Label Gift Card Test Data

orderId	Supplied Data Elements		Key Response Elements	
	Element	Value	Element	Value
GC20	<b>Balance Inquiry:</b>		<b>Balance Inquiry Response:</b>	
	<type>	GC	<response>	352
	<number>	Number from GC4	<message>	Invalid CVV2
	<expDate>	0121		
	<cardValidationNum>	476		

## 2.5.16 Testing MasterPass Transactions

If you are planning to support MasterPass transaction, in addition to other required certification testing, you should submit the following transactions to test the use of the additional cnpAPI elements required for a MasterPass transaction.

To test the MasterPass functionality using the data supplied in [Table 2-27](#):

1. Submit an Authorization transaction using the data supplied for Order Id MCWalletAuth. Verify that the response data matches the values for the Key Response Elements for that orderId.
2. Submit a Sale transaction using the data supplied for Order Id MCWalletSale. Verify that the response data matches the values for the Key Response Elements for that orderId.

**TABLE 2-27** MasterPass Test Data

orderId	Supplied Data Elements		Key Response Elements	
	Element	Value	Element	Value
MCWalletAuth	<wallet>	(parent element)	<response>	000
	<walletSourceType>	MasterPass	<message>	Approved
	<walletSourceTypeId>	102		
MCWalletSale	<wallet>	(parent element)	<response>	000
	<walletSourceType>	MasterPass	<message>	Approved
	<walletSourceTypeId>	102		

## 2.5.17 Testing Apple Pay Transaction Processing

The following Apple Pay tests allow you to verify your submission of valid XML for two Apple Pay scenarios. The first test scenario applies to the case where you decrypt the Apple Pay

PKPaymentToken, while the second scenario applies to the Vantiv decryption PKPaymentToken components submitted in a cnpAPI transaction.

---

**NOTE:** For information about testing the submission of the PKPaymentToken using the Mobile eProtect, please refer to the *Vantiv eProtect Integration Guide*.

---

### 2.5.17.1 Testing the Submission of the Decrypted PKPaymentToken in cnpAPI

To test the submission of an Apple Pay transaction in cnpAPI when you decrypt the PKPaymentToken, you must include the information listed in the table below in an Authorization or Sale transaction. Assuming you submit valid XML with appropriate values, the test environment will return an approved response message.

**TABLE 2-28** cnpAPI Elements for Merchant Decrypted PKPaymentToken

cnpAPI Element	Value
number	Use any valid (Mod-10 compliant) card number. You can find test numbers in Chapter 2 of the <i>Vantiv cnpAPI Reference Guide</i> .
expDate	Use any valid expiration date (i.e., a date in the future).
authenticationValue	Any Base-64 encoded value between 40 and 56 characters in length. This value simulates the cryptogram extracted from the PKPaymentToken.
orderSource	Set to applepay

### 2.5.17.2 Testing the Submission of PKPaymentToken in cnpAPI

When you receive a PKPaymentToken, you must parse (not decrypt) the component parts and use the data to populate the cnpAPI <applepay> child elements. This test is designed to allow you to verify your ability to parse the PKPaymentToken data and construct well formed cnpAPI messages. The test uses the data from the example PKPaymentToken shown below (data element names in bold red type) to construct an Authorization or Sale transaction (see [applepay](#)). The system returns a Response Code of 000 - Approved.

**Example: PKPaymentToken**

```
{ "version": "EC_v1", "data": "Ww9EI+10VVpyZrAb3nxu9c8PG4JEnIh4oTkDhZi4axj5QqC5WIir6
TJcFmk/3wkrNL/KaRXz3aan4WRO6cPL+cUTRpQU09ECqTBItmQbJxGbN42713TyI+y97k3msl7bd5rJO
MIOpkCtftp2ua+3lnBhjGFnUzdCxq+/K6eoIEwY1AEfX9Sdpjm+plVfvSK7vj0BQCcXoIdXGkNUKwKWA4
```

```
GYPUE3qwbuiQWcZwLxAEF43274pACV4LBmdv0HYgYpcgCY0+U6/YSVKdpPrhHLDeLOl07T4WwuiMHojs
KA/BknpPY1uJfP+YJxj1fYghaAOAR0tA5cYJft1WLXaV9lZu113Ns1rxColh4PR8wsuw81CdOruvoURG
NaNyX+hG1suQoHeE8ECzKIE6DlHEeVMcdxXySwFPY7hxEYlQKSSXw==", "signature": "MIAGCSqGSI
b3DQEHAqCAMIACAQExDzANBg1ghkgBZQMEAgEFADCABgkqhkiG9w0BBWEAAKCAMIICvzCCAmWgAwIBAg
IIQpCV6UIIb4owCgYIKoZiZj0EAwIweJEuMCwGALUEAwWlQXBwbGUgQXBwBGljYXRpb24gSW50ZWdyYX
Rpb24gQ0EgLSBHmzEmMCQGA1UECwwdQXBwBGUgQ2VydG1maWNhdGlvbiBBdXR0b3JpdHkxZARBgNVBA
oMCKFwcGx1IEluYy4xCzAJBgNVBAYTAlVTMB4XDTE0MDUwODAxMjMzOV0XDTE5MDUwNzAxMjMzOV0wXz
ElMCMGA1UEAwcZWNjLXNtcc1icm9rZXItc2lnb19VQzQtUFJPRDEUMBIGALUECwwLaU9TIFN5c3R1bX
MxEzARBgNVBAoMCKFwcGx1IEluYy4xCzAJBgNVBAYTAlVTMFkwEwYHKoZIzj0CAQYIKoZIzj0DAQcDQg
AEWhV37evWx7Ihj2jdcJChIY3HsL1vLc9hGCV2Ur0pUEbg0IO2BH2QH6DMx8cVMP36zIglrrV10/0ko
mJpNwPE60B7zCB7DBFBggrBgEFBQCBAQQ5MDcwNQYIKwYBBQUHMAGKWh0dHA6Ly9vY3NwLmFwcGx1Lm
NvbS9vY3NwMDQ0tYXBwbGVAwNhmZAxMB0GA1UdDgQWBBSUV9tv1XSbhomJdi9+V4UH55tYJDAMBgNVHR
MBAF8EAJAAMB8GA1UdIwQYMBaAFcPyScRpk+TvJ+be9ihsP6K7/S5LMDQGA1UdHwQtMCswKaAAnoCWGI2
h0dHA6Ly9jcmwYXBwBGUuY29tL2FwcGx1YwlljYTMuY3J3MA4GA1UdDwEB/wQEAwIHGDAPBkgqhkiG92
Nkhh0EAgUAMAoGCCqGSM49BAMCA0GAMEUCIQCFGdtAk+7wXrBV7jTwzCBLE+OcrVL15hjfif0reLjIPGg
IgxGHYYeXwrn02Zwc15TT1W8rIqK0QuIvOn01THCbkhVowggLuMIICdaADAgECAGhJbS+/OpjalzAKBg
gqhkiJOPQQAjBnMRswGQYDVQDDBJBCHBSZSBSb290IENBIC0gRzMXJjAKBgnVBASMHUFwcGx1IENlcn
RpZmljYXRpb24gQXV0aG9yaXR5MRMwEQYDVQKDApBCHBSZSBJbmMuMQswCQYDVQOGEwJVUzAeFw0xND
AlMDYyMzQ2MzBaFw0yOTA1MDYyMzQ2MzBaMHoxLjAsBgNVBAMMJUFwcGx1IEFwcGxpY2F0aW9uIEludG
VncmF0aW9uIENBIC0gRzMXJjAKBgnVBASMHUFwcGx1IENlcnRpZmljYXRpb24gQXV0aG9yaXR5MRMwEQ
YDVQKDApBCHBSZSBJbmMuMQswCQYDVQOGEwJVUzBZBMGByqGSM49AgEGCCqGSM49AwEHA0IABPAXEY
QZ12SF1RpeJYEHduiAou/ee65N4I38S5Phm1bVZ1s1r1LQ13YNIk57ugj9dhf0iMt2u2ZwvsjoKYT/VE
WjgfcwgfQwRgYIKwYBBQUHAQEEOja4MDYGCCSGAQUFBzABhipodHRwOi8vb2Nzc5hcHBsZS5jb20vb2
NzcDA0LWFwcGx1cm9vdGNhZzZmWmHqYDVR0OBByEFcPyScRpk+TvJ+be9ihsP6K7/S5LMA8GA1UdEwEB/w
QFMAMBAf8wHwYDVR0jBBgwFoAUu7DeoVgziJqkipnevr3rr9rLJKswNwYDVR0fBDAwLjAsocqgKIYmaH
R0cDovL2NybC5hcHBsZS5jb20vYXBwBGVyb290Y2FnMy5jcmwwDgYDVR0PAQH/BAQDAgEGMBAGCiqGSI
b3Y2QGAg4EAgUAMAoGCCqGSM49BAMCA2cAMGQCMdrPcoNRFpmxhvs1w1bKYr/0F+3ZD3VNoo6+8ZyBxk
K3ifiy95tZn5jVQQ2Pnenc/gIwMi3VRCGwowV3bF3zODuQZ/0XfCwhbZzPxnJpghJvVPh6fRuZy5sJiS
FhBpkPCZiDAAAaxggFMIIBWwIBATCBhjb6MS4wLAYDVQDDCVBCHBSZSBBCHBSaWNhdGlvbiBjbnRlZ3
JhdGlvbiBDQSAtIEczMSYwJAYDVQQLDB1BCHBSZSBDZXJ0aWZpY2F0aW9uIEF1dGhvcml0eTEETMBEGA1
UECwKQXBwBGUgSW5jLjELMAkGA1UEBhMCMVVMCCEKQlelCCG+KMA0GCWCGSFA1AwQCAQUAoGkwGAYJKo
ZIHvcNAQkDMQsGCSqGSIb3DQEHAATCBgkqhkiG9w0BCQUxDxcNMTQxMDAzMjE1NjQzWjAvBkgqhkiG9w
0BCQQxIgg8i4X6yRAU7AXS1lamCf02UIQlpUvNPToXUaamsFUT8wCgYIKoZIzj0EAwIERzBFAiBe17
NGTuuk+W901k3Oac4Z90PoMhN1qRqni9KNEb/XAIhALELZyDww0fQM8t0pX086gg9xXFz424rEMlJ01
TmlVxhAAAAA", "header": {"applicationData": "496461ea64b50527d2d792df7c38f301300
085dd463e347453ae72deb6f64d14", "transactionId": "f9b0d3cfbb64cd155249c691aca3c521
de03725720616b810d90341f97f347b7", "ephemeralPublicKey": "MFkwEwYHKoZIzj0CAQYIKoZI
zj0DAQcDQgAEarp8xOhLX9QliUPS9c54i3cqEfrJD37NG75ieNxcOeFLkjck", "publicKeyHash": "
jAMRQgg4nfHrXvfwRfbaEc11bk3QD3rv5K9xLqLgu0="}}
```

## 2.5.18 Testing Android Pay Transaction Processing

The certification testing you need to perform depends upon the integration method you implement. This section provides information about the required tests for the eProtect integration method.

### 2.5.18.1 Testing Android Pay using eProtect

In this integration method, your application submits information to the Google test environment, receives a low-value token, and then submits the low value token to Vantiv in a normal payment transaction.

The table below provides key data values you provide in the submitted transaction.

1. Perform an implicit token registration by submitting a Sale or Authorization transaction using the data shown for the androidpay\_1 (orderId) transaction in Table 1.
2. Verify the response message includes the key Response values shown.
3. Perform an explicit token registration by submitting a Register Token Request using the data shown for the androidpay\_2 (orderId) transaction in Table 1.
4. Verify the response message includes the key Response values shown.

**TABLE 2-29** Android Pay using eProtect Test Data

orderId	Supplied Data Elements		Key Response Elements	
	Element	Value	Element	Value
androidpay_1	<orderSource> <paypageRegistrationId>	androidpay Value returned from Google	<response> <message>	000 Approved
androidpay_2	<paypageRegistrationId>	Value returned from Google	<response> <message>	801 Account number was successfully registered <b>Note:</b> Under certain circumstances this test could return 820 - Account number was previously registered.

### Example: Implicit Token Registration via Authorization Transaction

```
<litleOnlineRequest version="10.2" xmlns="http://www.litle.com/schema"
  merchantId="100">
  <authentication>
    <user>User Name</user>
    <password>Password</password>
  </authentication>
  <authorization id="834262" reportGroup="ABC Division" customerId="038945">
    <orderId>androidpay_1</orderId>
    <amount>40000</amount>
    <orderSource>androidpay</orderSource>
    <paypage>
      <paypageRegistrationId>Low-Value Token</paypageRegistrationId>
    </paypage>
  </authorization>
</litleOnlineRequest>
```

### Example: Explicit Token Registration Transaction

```
<litleOnlineRequest version="10.2" xmlns="http://www.litle.com/schema"
  merchantId="100">
  <authentication>
    <user>User Name</user>
    <password>Password</password>
  </authentication>
  <registerTokenRequest id="99999" reportGroup="RG1">
    <orderId>androidpay_2</orderId>
    <paypageRegistrationId>Low-Value Token</paypageRegistrationId>
  </registerTokenRequest>
</litleOnlineRequest>
```

## 2.5.19 Testing checkoutId

The checkoutId element is a low value token issued by eProtect in replacement for the CVV value. You only need to perform these test if you use eProtect and plan to the checkoutId in place of the CVV.

To test the use of the checkoutId element, do the following:

The first test provides a response of a matching CVV, while the second and third test return checkoutId failure messages allowing you to verify your handling of these conditions. All tests

return as Approved, because the CVV check does not necessarily impact the approval/decline of a transaction.

1. Using your (test) Web site, the token value returned for orderId 1 (Table 2-1) and the CVV value shown for orderId 1 to initiate an eProtect transaction. Use the checkoutId value you receive for CVV to construct an Authorization transaction within 24 hours. Verify the response data matches the information shown for orderId chkoutId\_1 in Table 2-30.
2. Submit an Authorization using the same token value from Step 1 and the checkoutId value from the Supplied Data Elements for orderId chkoutId\_2. Verify that the response data matches the Key response Elements for orderId chkoutId\_2 in Table 2-30.
3. Submit an Authorization using the same token value from Step 1 and the checkoutId value from the Supplied Data Elements for orderId chkoutId\_3. Verify that the response data matches the Key response Elements for orderId chkoutId\_3 in Table 2-30.

**TABLE 2-30** checkoutId Test Data

orderId	Supplied Data Elements		Key Response Elements	
	Element	Value	Element	Value
chkoutId_1	<littleToken> <checkoutId>	value from orderId_1 value from eProtect	<response> <message> <cardValidationResult>	000 Approved M
chkoutId_2	<littleToken> <checkoutId>	value from orderId_1 A90999999999999999	<response> <message> <tokenResponseCode> <tokenMessage>	000 Approved 826 Checkout Id was invalid
chkoutId_3	<littleToken> <checkoutId>	value from orderId_1 201234567891234567	<response> <message> <tokenResponseCode> <tokenMessage>	000 Approved 827 Checkout Id was not found



## 2.5.20 Testing SEPA Direct Debit Transaction

Currently, the SEPA Direct Debit certification tests cover the Vantiv supplied Mandate scenario only. End-to-end testing involves simulating a consumer on your test site, who selects SEPA Direct Debit as the payment method and approves the Mandate.

To test the SEPA Direct Debit alternate payment method, do the following:

1. Construct a Sale transaction using the information provided for `orderId 1_sddSale`, and submit it to the Pre-Live environment. Ideally, you should do this using a test checkout page as a simulated consumer. Make sure you include all required fields, as well as the `name`, `email`, and `country` child elements of `billToAddress`.
2. Redirect the customer browser to the `redirectUrl` from the response message. Also, record the `redirectToken` and the `mandateReference` values.
3. As the customer, accept the Mandate. After redirecting the browser back to your checkout page, verify that the `redirectToken` parameter from the URL matches the `redirectToken` value from the response message.
4. To simulate a recurring (subsequent) payment, construct a Sale transaction using the information provided for `orderId 1a_sddSale`, including the `mandateReference` value returned in the `1_sddSale` response message.
5. Verify the approval of the transaction.
6. Construct a Sale transaction using the information provided for `orderId 15_sddSale`, and submit it to the Pre-Live environment.
7. Verify you receive a 904 response code and that you handle it appropriately. In a production environment you should prompt the consumer to reenter their IBAN.
8. Construct a Sale transaction using the information provided for `orderId 24_sddSale`, and submit it to the Pre-Live environment.
9. Verify you receive a 379 response code and that you handle it appropriately. In a production environment you should prompt the consumer to select a different payment method.
10. Construct a Sale transaction using the information provided for `orderId 2_sddSale`, and submit it to the Pre-Live environment.
11. Verify you receive a 386 response code and that you handle it appropriately. In a production environment you should retry submitting the transaction.

**TABLE 2-31** SEPA Direct Debit Test Data

orderId	Supplied Data Elements		Key Response Elements	
	Element	Value	Element	Value
1_sddSale	<name> <mandateProvider> <sequenceType> <iban>	David Berman Vantiv FirstRecurring DE7985050300310 0180568	<response> <message> <redirectUrl> <redirectToken> <mandateReference>	000 Approved Cert Mandate page Dynamically Generated Dynamically Generated
1a_sddSale	<name> <mandateProvider> <sequenceType> <mandateReference> <iban>	David Berman Vantiv SubsequentRecurri ng Value from 1_sddSale DE7985050300310 0180568	<response> <message>	000 Approved
15_sddSale	<name> <mandateProvider> <sequenceType> <iban>	David Berman Vantiv OneTime DE79850503A0310 0180568	<response> <message>	904 Invalid IBAN
24_sddSale	<name> <mandateProvider> <sequenceType> <iban>	girogateDecline Vantiv OneTime DE79850503A0310 0180568	<response> <message>	379 Transaction declined by the processing network
2_sddSale	<name> <mandateProvider> <sequenceType> <iban>	unknownError Vantiv OneTime DE7985050300310 0180568	<response> <message>	386 Processing Network Error

## 2.5.21 Testing iDEAL Transactions

iDEAL (Real-time Bank Transfers) is an international alternate payment method used in the Netherlands.

To test the iDEAL alternate payment method, do the following:

1. Construct a Sale transaction using the information provided for orderId p1\_idealSale and submit it to the Pre-Live environment. Ideally, you should do this using a test checkout page as a simulated consumer. Make sure you include all required fields and set the (billing) country to NL.
2. Redirect the customer browser to the `redirectUrl` from the response message. Also, record the `redirectToken`.
3. As the customer, accept the agreement. After redirecting the browser back to your checkout page, verify that the `redirectToken` parameter from the URL matches the `redirectToken` value from the response message.

---

**NOTE:** The agreement page presented by the Pre-Live simulator differs from the bank page that a consumer uses and may vary by bank. Although the mechanics of the consumer accepting the agreement may differ, any difference does not change the operations from the merchants standpoint.

---

4. Verify the approval of the agreement by comparing the `redirectToken` value to the `token_value` parameter returned in the URL.
5. Construct a Sale transaction using the information provided for orderId n10\_idealSale and submit it to the Pre-Live environment.
6. Verify that the transaction fails with a Response Code of 917 - Invalid Country and that your system handles the response correctly. All iDeal transaction must use NL as the (Billing) country.

**TABLE 2-32** iDEAL Test Data

orderId	Supplied Data Elements		Key Response Elements	
	Element	Value	Element	Value
p1_idealSale	<amount> <name> <country>	10011 David Berman NL	<response> <message> <redirectUrl> <redirectToken>	000 Approved Cert bank page Dynamically Generated
n10_idealSale	<amount> <name> <country>	20100 David Berman USA	<response> <message>	917 Invalid Billing Country

## 2.5.22 Testing Giropay Transactions

Giropay (Real-time Bank Transfers) is an international alternate payment method used in Germany.

To test the Giropay alternate payment method, do the following:

1. Construct a Sale transaction using the information provided for orderId p1\_giropaySale and submit it to the Pre-Live environment. Ideally, you should do this using a test checkout page as a simulated consumer. Make sure you include all required fields and set the (billing) country to NL.
2. Redirect the customer browser to the `redirectUrl` from the response message. Also, record the `redirectToken`.
3. As the customer, accept the agreement. After redirecting the browser back to your checkout page, verify that the `redirectToken` parameter from the URL matches the `redirectToken` value from the response message.

---

**NOTE:** The agreement page presented by the Pre-Live simulator differs from the bank page that a consumer uses and may vary by bank. Although the mechanics of the consumer accepting the agreement may differ, any difference does not change the operations from the merchants standpoint.

---

4. Verify the approval of the agreement by comparing the `redirectToken` value to the `token_value` parameter returned in the URL.
5. Construct a Sale transaction using the information provided for orderId n10\_giropaySale and submit it to the Pre-Live environment.
6. Verify that the transaction fails with a Response Code of 917 - Invalid Country and that your system handles the response correctly. All Giropay transaction must use DE as the (Billing) country.

**TABLE 2-33** Giropay Test Data

orderId	Supplied Data Elements		Key Response Elements	
	Element	Value	Element	Value
p1_giropaySale	<amount>	10011	<response>	000
	<name>	David Berman	<message>	Approved
	<country>	NL	<redirectUrl>	Cert bank page
			<redirectToken>	Dynamically Generated
n10_giropaySale	<amount>	20100	<response>	917
	<name>	David Berman	<message>	Invalid Billing Country
	<country>	USA		

## 2.5.23 Testing SOFORT Transactions

SOFORT (Real-time Bank Transfers) is an international alternate payment method used in several European countries.

To test the SOFORT alternate payment method, do the following:

1. Construct a Sale transaction using the information provided for orderId `p1_sofortSale` and submit it to the Pre-Live environment. Ideally, you should do this using a test checkout page as a simulated consumer. Make sure you include all required fields and set the (billing) country to NL.
2. Redirect the customer browser to the `redirectUrl` from the response message. Also, record the `redirectToken`.
3. As the customer, accept the agreement. After redirecting the browser back to your checkout page, verify that the `redirectToken` parameter from the URL matches the `redirectToken` value from the response message.

---

**NOTE:** The agreement page presented by the Pre-Live simulator differs from the bank page that a consumer uses and may vary by bank. Although the mechanics of the consumer accepting the agreement may differ, any difference does not change the operations from the merchants standpoint.

---

4. Verify the approval of the agreement by comparing the `redirectToken` value to the `token_value` parameter returned in the URL.
5. Construct a Sale transaction using the information provided for orderId `n10_sofortSale` and submit it to the Pre-Live environment.
6. Verify that the transaction fails with a Response Code of 917 - Invalid Country and that your system handles the response correctly. All SOFORT transaction must use one of the following as the (Billing) country: DE (Germany), AT (Austria), CH (Switzerland), BE (Belgium), FR (France), NL (the Netherlands), (the UK), IT (Italy), ES (Spain), PL (Poland), HU (Hungary), SK (Slovakia), CZ (Czech Republic)

---

**NOTE:** The list of countries (above) where SOFORT is available is accurate at the time of printing, but may change over time.

---

**TABLE 2-34** SOFORT Test Data

orderId	Supplied Data Elements		Key Response Elements	
	Element	Value	Element	Value
p1_sofortSale	<amount>	10011	<response>	000
	<name>	David Berman	<message>	Approved
	<country>	NL	<redirectUrl>	Cert bank page
			<redirectToken>	Dynamically Generated
n10_sofortSale	<amount>	20100	<response>	917
	<name>	David Berman	<message>	Invalid Billing Country
	<country>	USA		

### 2.5.24 Testing Transaction Volume Capacity

Volume testing is useful if you plan to send large files. This is an optional test you can perform during certification testing. Volume testing enables you to verify how many transactions (the number of requests and responses) you can process within a specific time frame.

Vantiv recommends you submit transactions for a 15-minute time interval. Submit the approximate number of transactions that you anticipate to be normal volume for any 15-minute period. You can send in any valid transaction data; the actual data you send will not be verified.

---

## CNPAPI TRANSACTION EXAMPLES

This chapter contains information and examples concerning the structure of cnpAPI transaction messages. Where differences exist between the structure of Batch and Online transactions, the sections present examples of both structures.

---

**NOTE:** In the cnpAPI, the order of the elements is enforced. Failure to adhere to the element order as defined in the schema will result in XML validation errors.

---

This chapter discusses the following topics:

- [Overview of Online and Batch Processing Formats](#)
- [Transaction Types and Examples](#)

---

**NOTE:** This chapter does not include examples of the PayFac Instruction-Based Dynamic Payout transaction types. For additional information about these transactions, please refer to [Appendix D, "PayFac™ Dynamic Payout"](#).

---

## 3.1 Overview of Online and Batch Processing Formats

There are two methods of submitting payment transactions using the cnpAPI format: Online (one transaction at a time), or Batch. This section provides a high level overview of the request and response structures used for each submission type.

### 3.1.1 Batch Process Format

We treat each Batch transmission you send to us as a single request. You can think of the entire Batch request as a session composed of one or more individual batches, each containing one or more transactions. You can also use a Batch as a retrieval request for the response to a previously processed session. We return a response transmission for each request.

Batch processing supports the following transaction types:

- Activate Transactions
- Authorization Transactions
- Authorization Reversal
- Balance Inquiry Transactions
- Cancel Subscription Transactions
- Capture Transactions
- Capture Given Auth Transactions
- Create Plan Transactions
- Credit Transactions
- Deactivate Transactions
- eCheck Credit Transactions
- eCheck Prenotification Credit
- eCheck Prenotification Sale
- eCheck Redeposit Transactions
- eCheck Sale Transactions
- eCheck Verification Transactions
- Force Capture Transactions
- Fraud Check Transaction
- Gift Card Auth Reversal Transaction
- Gift Card Capture Transaction
- Gift Card Credit Transaction
- Load Transactions
- Register Token Transactions
- RFR Batch Transactions (Batch Only)
- Sale Transactions
- Unload Transactions
- Update Card Validation Number Transactions
- Update Plan Transactions
- Update Subscription Transactions
- All PayFac Dynamic Payout Transactions

---

---

**NOTE:** For information and examples of Dynamic Payout Funding Instructions, please refer to [Appendix D, "PayFac™ Dynamic Payout"](#).

---

---



For more information about Batch processing, see [Batch Transaction Processing](#) on page 5.

### 3.1.1.1 Supported Communication Protocols

We supports the following communication protocols for Batch processing:

- Encrypted FTP (PGP or GPG key encryption)
- sFTP

For additional information concerning the recommended transmission methods, see [Transferring Session Files](#) on page 97.

### 3.1.1.2 Batch Processing Request Format

The Batch processing request is made up of the following elements:

- Header information - one `<littleRequest>` element
- Merchant authentication information - one `<authentication>` element
- Batch information - one or more `<batchRequest>` elements
- Payment transactions (for example, an Authorization, Capture, Credit, etc.) - at least one per `<batchRequest>` element

---

---

**NOTE:** Each of the `num` and `amount` attributes used in a `batchRequest` defaults to 0 (zero) if not specified in the request. In any of the `amount` fields (`authAmount`, `captureAmount`, etc.), the value is an implied decimal (for example `500=5.00`).

---

---

### 3.1.1.3 Batch Processing Response Format

The Batch processing response is composed of the following elements:

- Header information - one `<littleResponse>` element
- One or more `<batchResponse>` elements - contains payment transactions response.
- At least one payment transaction response (for example, an Authorization response, Capture response, Credit response, etc.).

---

---

**NOTE:** For information on the XML Validation response and message attributes, please refer to [XML Validation Error Messages](#) on page 864.

---

---

## 3.2 Online Processing Format

Each Online request you send to us is a single transaction. We process Online transactions upon receipt and return a response file.

Online processing supports the following transaction types:

- Activate Transactions
- Activate Reversal Transactions (Online Only)
- Authorization Transactions
- Authorization Reversal
- Balance Inquiry Transactions
- Cancel Subscription Transactions
- Capture Transactions
- Capture Given Auth Transactions
- Create Plan Transactions
- Credit Transactions
- Deactivate Transactions
- Deactivate Reversal Transactions (Online Only)
- Deposit Reversal Transactions (Online Only)
- Force Capture Transactions
- Load Transactions
- Load Reversal Transactions (Online Only)
- eCheck Sale Transactions
- eCheck Credit Transactions
- eCheck Redeposit Transactions
- eCheck Verification Transactions
- eCheck Void Transactions (Online Only)
- Refund Reversal Transactions (Online Only)
- Sale Transactions
- Status Query Transaction (Online Only)
- Unload Transactions
- Unload Reversal Transactions (Online Only)
- Update Card Validation Number Transactions
- Update Plan Transactions

- Update Subscription Transactions
- Void Transactions (Online Only)

### 3.2.1 Supported Communication Protocols

Vantiv supports the HTTPS POST communication protocol for Online processing.

For additional information concerning the recommended transmissions methods, see [Transferring Online Files](#) on page 98.

### 3.2.2 Online Processing Request Format

The Online processing request is made up of the following elements:

- Header information - one `<littleOnlineRequest>` element
- Merchant authentication information - one `<authentication>` element
- Payment transaction - one payment transaction

### 3.2.3 Online Processing Response Format

An Online processing response is composed of the following elements:

- Header information - one `<littleOnlineResponse>`
- Payment transaction - one payment transaction

---

---

**NOTE:** For information on the XML Validation response and message attributes, please refer to [XML Validation Error Messages](#) on page 864.

---

---

## 3.3 Transaction Types and Examples

This section presents structural information of each transaction type for both Online and Batch submission methods. The structural information is followed by one or more examples of the cnpAPI transaction. Each structural example shows the parent and all child elements, but does not show grandchildren. The cnpAPI examples do show child elements to multiple levels.

The element names in the structural examples provide links to the element definitions in Chapter 4.

---

---

**NOTE:** The XML examples in this section are intended to present typical cnpAPI transactions. The examples may not include every possible element for a particular transaction type. When coding your XML, always consult the cnpAPI schema files for information concerning all available elements.

---

---

This section contains examples of the following transaction types:

---

---

**NOTE:** In the cnpAPI, the order of the elements is enforced. Failure to adhere to the element order as defined in the schema will result in XML validation errors.

---

---

- [Authorization Transactions](#)
- [Authorization Reversal Transactions](#)
- [Activate Transactions](#) (Private Label Gift Card transaction)
- [Activate Reversal Transactions \(Online Only\)](#) (Private Label Gift Card transaction)
- [Balance Inquiry Transactions](#) (Private Label Gift Card transaction)
- [Cancel Subscription Transactions](#) (Recurring Engine transaction)
- [Capture Transactions](#)
- [Capture Given Auth Transactions](#)
- [Create Plan Transactions](#) (Recurring Engine transaction)
- [Credit Transactions](#)
- [Deactivate Transactions](#) (Private Label Gift Card transaction)
- [Deactivate Reversal Transactions \(Online Only\)](#) (Private Label Gift Card transaction)
- [Deposit Reversal Transactions \(Online Only\)](#) (Private Label Gift Card transaction)
- [eCheck Credit Transactions](#)
- [eCheck Prenotification Credit Transactions \(Batch Only\)](#)
- [eCheck Prenotification Sale Transactions \(Batch Only\)](#)

- [eCheck Redeposit Transactions](#)
- [eCheck Sale Transactions](#)
- [eCheck Verification Transactions](#)
- [eCheck Void Transactions \(Online Only\)](#)
- [Force Capture Transactions](#)
- [Fraud Check Transaction](#)
- [Gift Card Auth Reversal Transactions \(Private Label Gift Card transaction\)](#)
- [Gift Card Capture Transactions \(Private Label Gift Card transaction\)](#)
- [Gift Card Credit Transactions \(Private Label Gift Card transaction\)](#)
- [Load Transactions \(Private Label Gift Card transaction\)](#)
- [Load Reversal Transactions \(Online Only\) \(Private Label Gift Card transaction\)](#)
- [Status Query Transactions \(Online Only\)](#)
- [Refund Reversal Transactions \(Online Only\) \(Private Label Gift Card transaction\)](#)
- [Register Token Transactions](#)
- [RFR Transactions \(Batch Only\)](#)
- [Sale Transactions](#)
- [Unload Transactions \(Private Label Gift Card transaction\)](#)
- [Unload Reversal Transactions \(Online Only\) \(Private Label Gift Card transaction\)](#)
- [Update Plan Transactions \(Recurring Engine transaction\)](#)
- [Update Subscription Transactions \(Recurring Engine transaction\)](#)
- [Update Card Validation Number Transactions](#)
- [Void Transactions \(Online Only\)](#)

### 3.3.1 Authorization Transactions

The Authorization transaction enables you to confirm that a customer has submitted a valid payment method with their order and has sufficient funds to purchase the goods or services they ordered.

The lifespan of an authorization varies according to the payment type being used, as shown in [Table 3-1](#). During the lifespan, you can use a valid authorization multiple times as needed.

---

**NOTE:** To submit an AVS Only request, submit an Authorization request with the `<amount>` element set to 000. The response is identical to an Authorization response message.

---

**TABLE 3-1** Lifespan of a Payment Authorization

Payment Type	Lifespan of Authorization
American Express	7 days
Discover	10 days
MasterCard	7 days
PayPal	29 days total; Vantiv recommends three days. For more information about PayPal authorizations, see the <i>Vantiv PayPal Integration Guide</i> .
Visa	7 days

This section describes the format you must use for an Authorization request, as well as the format of the Authorization Response you receive from us.

#### 3.3.1.1 Authorization Request Structure

You must structure an Authorization request as shown in the following examples. The structure of an Authorization request is identical for either an Online or a Batch submission.

```
<authorization id="Authorization Id" reportGroup="iQ Report Group"
customerId="Customer Id">
  <orderId>Order Id</orderId>
  <amount>Authorization Amount</amount>
  <secondaryAmount>Secondary Amount</secondaryAmount>
  <orderSource>Order Entry Source</orderSource>
  <customerInfo>
  <billToAddress>
```

```

    <shipToAddress>
    [ <card> | <paypal> | <paypage> | <token> | <mpos> | <applepay> ]
    <billMeLaterRequest>
    <cardholderAuthentication>
    <processingInstructions>
    <pos>
    <customBilling>
    <taxType>payment or fee</taxType>
    <enhancedData>
    <amexAggregatorData>
    <allowPartialAuth>
    <healthcareIIAS>
    <filtering>
    <merchantData>
    <recyclingRequest> (for Recovery merchants using Recycling)
    <fraudFilterOverride>
    <recurringRequest> (for Recurring Engine merchants)
    <debtRepayment>true or false</debtRepayment>
    <advancedFraudChecks>
    <wallet>
    <processingType>processingType Enum</processingType>
    <originalNetworkTransactionId>Network Txn Value</originalNetworkTransactionId>
    <originalTransactionAmount>Amount from Orig Txn</originalTransactionAmount>
  </authorization>

```

### Example: Batch Authorization Request - Card Not Present

The example below shows a batch request with a single card-not-present Authorization request. If the batch included additional Authorization requests, each would have its own `<authorization>` element with all applicable attributes and child elements. Also, the `numAuths` attribute of the `<batchRequest>` element would increment for each additional `<authorization>` element and the `authAmount` attribute would increase by the new amounts from each authorization.

```

<littleRequest version="11.4" xmlns="http://www.little.com/schema"
  numBatchRequests = "1">
  <authentication>
    <user>userName</user>
    <password>password</password>

```

```
</authentication>
<batchRequest numAuths="1" authAmount="2500" merchantId="000902">
  <authorization id="test1" reportGroup="core" customerId="test1">
    <orderId>visa_test1</orderId>
    <amount>2500</amount>
    <orderSource>telephone</orderSource>
    <billToAddress>
      <name>John Doe</name>
      <addressLine1>15 Main Street</addressLine1>
      <city>San Jose</city>
      <state>CA</state>
      <zip>95032-1234</zip>
      <country>USA</country>
      <phone>9782750000</phone>
      <email>jdoe@vantiv.com</email>
    </billToAddress>
    <shipToAddress>
      <name>Jane Doe</name>
      <addressLine1>15 Main Street</addressLine1>
      <city>San Jose</city>
      <state>CA</state>
      <zip>95032-1234</zip>
      <country>USA</country>
      <phone>9782750000</phone>
      <email>jdoe@vantiv.com</email>
    </shipToAddress>
    <card>
      <type>VI</type>
      <number>4005550000081019</number>
      <expDate>1110</expDate>
    </card>
    <customBilling>
      <phone>8009990001</phone>
      <descriptor>bdi*001</descriptor>
    </customBilling>
    <allowPartialAuth>true</allowPartialAuth>
  </authorization>
</batchRequest>
</litleRequest>
```



**Example: Batch Authorization Request - Card Present**

The following example contains two Authorization requests, each defined in its own <authorization> element. The first is a card present transaction, which uses the <track> child of the <card> element.

```
<littleRequest version="11.4" xmlns="http://www.little.com/schema" id="123"
  numBatchRequests="1">
  <authentication>
    <user>userName</user>
    <password>password</password>
  </authentication>
  <batchRequest id="01234567" numAuths="2" authAmount="68336"
  merchantId="100">
    <authorization id="AX54321678" reportGroup="RG27">
      <orderId>12z58743y1</orderId>
      <amount>12522</amount>
      <orderSource>retail</orderSource>
      <billToAddress>
        <zip>95032</zip>
      </billToAddress>
      <card>
        <track>%B40000001^Doe/JohnP^06041...?;40001=0604101064200?</track>
      </card>
      <pos>
        <capability>magstripe</capability>
        <entryMode>completeread</entryMode>
        <cardholderId>signature</cardholderId>
      </pos>
    </authorization>
    <authorization id="AX54325432" reportGroup="RG12">
      <orderId>12z58743y7</orderId>
      <amount>55814</amount>
      <orderSource>retail</orderSource>
      <billToAddress>
        <zip>01854</zip>
      </billToAddress>
      <card>
        <type>VI</type>
        <number>4005550000081019</number>
        <expDate>0911</expDate>
      </card>
      <pos>
        <capability>keyedonly</capability>
      </pos>
    </authorization>
  </batchRequest>
</littleRequest>
```

```
<entryMode>keyed</entryMode>
<cardholderId>directmarket</cardholderId>
</pos>
<allowPartialAuth>true</allowPartialAuth>
</authorization>
</batchRequest>
</litleRequest>
```

### Example: Online Authorization Request

---

---

**NOTE:** The example below uses `3dsAuthenticated` as the `<orderSource>` value. If you submit the wrong `<orderSource>` value, we return the response code 370 - Internal System Error - Contact Litle.

Also, the values for the `<authenticationValue>` and `<authenticationTransactionId>` elements in the example below have been truncated.

---

---

```
<litleOnlineRequest version="11.4" xmlns="http://www.litle.com/schema"
merchantId="100">
  <authentication>
    <user>User Name</user>
    <password>Password</password>
  </authentication>
  <authorization id="834262" reportGroup="ABC Division" customerId="038945">
    <orderId>65347567</orderId>
    <amount>40000</amount>
    <orderSource>3dsAuthenticated</orderSource>
    <billToAddress>
      <name>John Smith</name>
      <addressLine1>100 Main St</addressLine1>
      <city>Boston</city>
      <state>MA</state>
      <zip>12345</zip>
      <email>jsmith@someaddress.com</email>
      <phone>555-123-4567</phone>
    </billToAddress>
    <card>
      <type>VI</type>
      <number>4000000000000002</number>
      <expDate>1209</expDate>
      <cardValidationNum>555</cardValidationNum>
```

```

</card>
<cardholderAuthentication>
  <authenticationValue>BwABBJQ1gJDUCAAAAAA=</authenticationValue>
  <authenticationTransactionId>gMV75TmjAgk=</authenticationTransactionId>
</cardholderAuthentication>
</authorization>
</litleOnlineRequest>

```

### Example: Authorization Request using token Element

The example below uses the following token related elements (click name to jump to element definition): [token](#) and [litleToken](#).

---

**NOTE:** When you submit the CVV2/CVC2/CID in a registerTokenRequest, the platform encrypts and stores the value on a temporary basis for later use in a tokenized Auth/Sale transaction submitted without the value. To use the store value when submitting an Auth/Sale transaction, set the cardValidationNum value to 000.

---

```

<authorization id="99999" customerId="444" reportGroup="RG1">
  <orderId>F12345</orderId>
  <amount>15000</amount>
  <orderSource>telephone</orderSource>
  <billToAddress>
    <name>John Doe</name>
    <addressLine1>15 Main Street</addressLine1>
    <city>San Jose</city>
    <state>CA</state>
    <zip>95032-1234</zip>
    <country>USA</country>
    <phone>9782750000</phone>
    <email>jdoe@vantiv.com</email>
  </billToAddress>
  <shipToAddress>
    <name>Jane Doe</name>
    <addressLine1>15 Main Street</addressLine1>
    <city>San Jose</city>
    <state>CA</state>
    <zip>95032-1234</zip>
    <country>USA</country>
    <phone>9782750000</phone>
    <email>jdoe@vantiv.com</email>

```

```
</shipToAddress>
<token>
  <cnpToken>1111000101039449</cnpToken>
  <expDate>1112</expDate>
  <cardValidationNum>987</cardValidationNum>
</token>
</authorization>
```

### Example: Authorization Request with Recurring Request

```
<littleOnlineRequest version="11.4" xmlns="http://www.little.com/schema"
  merchantId="100">
  <authentication>
    <user>User Name</user>
    <password>Password</password>
  </authentication>
  <authorization id="834262" reportGroup="ABC Division" customerId="038945">
    <orderId>65347567</orderId>
    <amount>40000</amount>
    <orderSource>3dsAuthenticated</orderSource>
    <billToAddress>
      <name>John Smith</name>
      <addressLine1>100 Main St</addressLine1>
      <city>Boston</city>
      <state>MA</state>
      <zip>12345</zip>
      <email>jsmith@someaddress.com</email>
      <phone>555-123-4567</phone>
    </billToAddress>
    <card>
      <type>VI</type>
      <number>4000000000000002</number>
      <expDate>1209</expDate>
      <cardValidationNum>555</cardValidationNum>
    </card>
    <cardholderAuthentication>
      <authenticationValue>BwABBJQ1gJDUCAAAAAA=</authenticationValue>
      <authenticationTransactionId>gMV75TmjAgk=</authenticationTransactionId>
    </cardholderAuthentication>
    <recurringRequest>
      <subscription>
        <planCode>Gold_Monthly_1</planCode>
        <numberOfPayments>12</numberOfRemianingPayments>
```

```

    <startDate>2016-07-21</startDate>
    <amount>1500</amount>
    <createDiscount>
      <discountCode>New_Customer_Discount_1</addOnCode>
      <name>New_Customer</name>
      <amount>750</amount>
      <startDate>2016-07-21</startDate>
      <endDate>2016-07-22</endDate>
    </createDiscount>
    <createAddOn>
      <addOnCode>Extra_Feature_1</addOnCode>
      <name>Extra_1</name>
      <amount>900</amount>
      <startDate>2016-08-21</startDate>
      <endDate>2016-07-21</endDate>
    </createAddOn>
  </subscription>
</recurringRequest>
</authorization>
</litleOnlineRequest>

```

### 3.3.1.2 Authorization Response Structure

An Authorization response has the following structure. The response message is identical for Online and Batch transactions except Online includes the <postDate> element.

```

<authorizationResponse id="Authorization Id" reportGroup="iQ Report
Group" customerId="Customer Id">
  <litleTxnId>Transaction Id</litleTxnId>
  <orderId>Order Id</orderId>
  <response>Response Code</response>
  <responseTime>Date and Time in GMT</responseTime>
  <postDate>Date transaction posted</postDate> (Online Only)
  <message>Response Message</message>
  <authCode>Approval Code</authCode>
  <approvedAmount>Approved amount for partial Auth<approvedAmount>
  <accountInformation>
  <accountUpdater>
  <fraudResult>

```

```
<billMeLaterResponseData>
<tokenResponse> (for Tokenized merchants submitting card data)
<enhancedAuthResponse>
<recycling> (included for declined Auths if feature is enabled)
<recurringResponse> (for Recurring Engine merchants)
<giftCardResponse> (included if Gift Card is Method of Payment)
<applepayResponse>
<cardSuffix>Card Last 4</cardSuffix> (included for ApplePay using VI or MC)
<androidpayResponse>
<networkTransactionId>Txn ID returned from network</networkTransactionId>
</authorizationResponse>
```

### Example: Batch Authorization Response

The example below shows a batch Authorization response that contains two transactions.

```
<littleResponse version="11.4" xmlns="http://www.little.com/schema" id="123"
response="0" message="Valid Format" cnpSessionId="987654321">
<batchResponse id="01234567" cnpBatchId="4455667788" merchantId="100">
  <authorizationResponse id="AX54321678" reportGroup="RG27">
    <cnpTxnId>84568456</cnpTxnId>
    <orderId>12z58743y1</orderId>
    <response>000</response>
    <responseTime>2011-03-01T10:24:31</responseTime>
    <message>Approved</message>
    <authCode>123456</authCode>
    <fraudResult>
      <avsResult>00</avsResult>
    </fraudResult>
  </authorizationResponse>
  <authorizationResponse id="AX54325432" reportGroup="RG12">
    <cnpTxnId>84568457</cnpTxnId>
    <orderId>12z58743y7</orderId>
    <response>000</response>
    <responseTime>2011-03-01T10:24:31</responseTime>
    <message>Approved</message>
    <authCode>123456</authCode>
    <fraudResult>
      <avsResult>00</avsResult>
      <authenticationResult>2</authenticationResult>
    </fraudResult>
  <enhancedAuthResponse>
```

```

    <fundingSource>
      <type>PREPAID</type>
      <availableBalance>5000</availableBalance>
      <reloadable>NO</reloadable>
      <prepaidCardType>GIFT</prepaidCardType>
    </fundingSource>
  </enhancedAuthResponse>
</authorizationResponse>
</batchResponse>
</litleResponse>

```

### Example: Online Authorization Response including Advanced Fraud Results

---

**NOTE:** The online response format contains a `<postDate>` element, which indicates the date the financial transaction will post.

---

```

<litleOnlineResponse version="11.4" xmlns="http://www.litle.com/schema"
  response="0" message="Valid Format">
  <authorizationResponse id="834262" reportGroup="ABC Division">
    <cnpTxnId>969506</cnpTxnId>
    <orderId>65347567</orderId>
    <response>000</response>
    <responseTime>2011-07-25T15:13:43</responseTime>
    <postDate>2011-07-25</postDate>
    <message>Approved</message>
    <authCode>123457</authCode>
    <fraudResult>
      <avsResult>00</avsResult>
      <cardValidationResult>N</cardValidationResult>
      <authenticationResult>2</authenticationResult>
      <advancedFraudResults>
        <deviceReviewStatus>pass</deviceReviewStatus>
        <deviceReputationScore>70</deviceReputationScore>
        <triggeredRule>FlashImagesCookiesDisabled</triggeredRule>
      </advancedFraudResults>
    </fraudResult>
    <enhancedAuthResponse>
      <fundingSource>
        <type>PREPAID</type>
        <availableBalance>0</availableBalance>
        <reloadable>YES</reloadable>
        <prepaidCardType>TEEN</prepaidCardType>
      </fundingSource>
    </enhancedAuthResponse>
  </authorizationResponse>
</litleOnlineResponse>

```

```
</fundingSource>  
</enhancedAuthResponse>  
</authorizationResponse>  
</litleOnlineResponse>
```

### Example: Authorization Response for Tokenized Merchant Sending Card Data

If a tokenized merchant submits card data in the Authorization request, the response includes the `tokenResponse` element. The example below is a response for an Online request (`litleOnlineResponse` element not shown); therefore, it includes the `postDate` element.

```
<authorizationResponse id="99999" reportGroup="RG1" customerId="444">  
  <cnpTxnId>21200000001108</cnpTxnId>  
  <orderId>F12345</orderId>  
  <response>000</response>  
  <responseTime>2011-10-08T21:38:32</responseTime>  
  <postDate>2011-10-08</postDate>  
  <message>Approved</message>  
  <authCode>270005</authCode>  
  <fraudResult>  
    <avsResult>11</avsResult>  
    <cardValidationResult>P</cardValidationResult>  
  </fraudResult>  
  <tokenResponse>  
    <cnpToken>1111100100240005</cnpToken>  
    <tokenResponseCode>801</tokenResponseCode>  
    <tokenMessage>Account number was successfully registered</tokenMessage>  
    <type>VI</type>  
    <bin>402410</bin>  
  </tokenResponse>  
</authorizationResponse>
```

### Example: Online Authorization Response with Account Updater Token Info

In this example, the `accountUpdater` contains both original and new card information as well as the `extendedCardResponse` element. This signifies that the card number changed from the original to the new and (from the extended response code) that the issuer reported the new account as closed. Although the Authorization was approved, this information allows you to make an informed decision about how to proceed with the sale.

```
<litleOnlineResponse version="11.4" xmlns="http://www.litle.com/schema"  
  response="0" message="Valid Format">  
  <authorizationResponse id="834262" reportGroup="ABC Division">  
    <cnpTxnId>969506</cnpTxnId>
```



```

<orderId>65347567</orderId>
<response>000</response>
<responseTime>2011-07-25T15:13:43</responseTime>
<postDate>2011-07-25</postDate>
<message>Approved</message>
<authCode>123457</authCode>
<accountUpdater>
  <originalCardTokenInfo>
    <cnpToken>1111100100240005</cnpToken>
    <type>VI</type>
    <expDate>1112</expDate>
    <bin>400555</bin>
  </originalCardTokenInfo>
  <newCardTokenInfo>
    <cnpToken>1111100100250017</cnpToken>
    <type>VI</type>
    <expDate>1114</expDate>
    <bin>400555</bin>
  </newCardTokenInfo>
  <extendedCardResponse>
    <code>501</code>
    <message>The account was closed</message>
  </extendedCardResponse>
</accountUpdater>
<fraudResult>
  <avsResult>00</avsResult>
  <cardValidationResult>N</cardValidationResult>
  <authenticationResult>2</authenticationResult>
</fraudResult>
</authorizationResponse>
</litleOnlineResponse>

```

### Example: Online Authorization Response with Recurring Response

```

<litleOnlineResponse version="11.4" xmlns="http://www.litle.com/schema"
  response="0" message="Valid Format">
  <authorizationResponse id="834262" reportGroup="ABC Division">
    <cnpTxnId>969506</cnpTxnId>
    <orderId>65347567</orderId>
    <response>000</response>
    <responseTime>2016-07-25T15:13:43</responseTime>
    <postDate>2016-07-25</postDate>
    <message>Approved</message>
  </authorizationResponse>
</litleOnlineResponse>

```

```

<authCode>123457</authCode>
<fraudResult>
  <avsResult>00</avsResult>
  <cardValidationResult>N</cardValidationResult>
  <authenticationResult>2</authenticationResult>
</fraudResult>
<recurringResponse>
  <subscriptionId>1234567890</subscriptionId>
  <responseCode>000</responseCode>
  <responseMessage>Approved</responseMessage>
</recurringResponse>
</authorizationResponse>
</litleOnlineResponse>
  
```

### 3.3.2 Authorization Reversal Transactions

The Authorization Reversal transaction enables you to remove the hold on any funds being held by an Authorization. The original Authorization transaction must have been processed within the system. For information on how to use the Authorization Reversal transaction, see [Notes on the Use of Authorization Reversal Transactions](#) on page 77. Also, if you use our Recycling Engine, you can use the `authReversal` transaction to halt the recycling of an authorization transaction.

---

**NOTE:** To reverse an Authorization on a Closed-loop Gift Card, submit a Gift Card Auth Reversal transaction, not an Authorization Reversal transaction. See [Gift Card Auth Reversal Transactions](#) on page 290 for additional information.

---

#### 3.3.2.1 Authorization Reversal Requests

You must structure an Authorization Reversal request as shown in the following examples. The structure of the request is identical for either an Online or a Batch submission.

```

<authReversal id="Authorization Id" reportGroup="iQ Report Group"
customerId="Customer Id">
  <litleTxnId>Transaction Id</litleTxnId>
  <amount>Authorization Amount to Reverse</amount>
  <actionReason>SUSPECT_FRAUD</actionReason>
</authReversal>
  
```

### Example: Batch Authorization Reversal Request

The following example contains three Authorization Reversal Requests.

```
<litleRequest version="11.4" xmlns="http://www.litle.com/schema"
  numBatchRequests="1">
  <authentication>
    <user>userName</user>
    <password>password</password>
  </authentication>
  <batchRequest numAuthReversals="3" authReversalAmount="3005"
  merchantId="000057">
    <authReversal id="ID" customerId="customerId" reportGroup="000057">
      <cnpTxnId>12345678</cnpTxnId>
      <amount>1002</amount>
    </authReversal>
    <authReversal id="ID" customerId="customerId" reportGroup="000057">
      <cnpTxnId>81234567</cnpTxnId>
      <amount>1003</amount>
    </authReversal>
    <authReversal id="ID" customerId="customerId" reportGroup="000057">
      <cnpTxnId>78123456</cnpTxnId>
      <amount>1000</amount>
    </authReversal>
  </batchRequest>
</litleRequest>
```

### Example: Online Authorization Reversal Request

```
<litleOnlineRequest version="11.4" xmlns="http://www.litle.com/schema"
  merchantId="100">
  <authentication>
    <user>User Name</user>
    <password>Password</password>
  </authentication>
  <authReversal id="12345" customerId="Customer Id" reportGroup="Auth
  Reversals">
    <cnpTxnId>12345678</cnpTxnId>
    <amount>2999</amount>
  </authReversal>
</litleOnlineRequest>
```

### 3.3.2.2 Authorization Reversal Responses

The basic structure of an Authorization Reversal response is identical for Batch and Online responses.

```
<authReversalResponse id="Authorization Id" reportGroup="iQ Report
Group" customerId="Customer Id">
  <littleTxnId>Transaction Id</littleTxnId>
  <response>Response Code</response>
  <responseTime>Date and Time in GMT</responseTime>
  <message>Response Message</message>
</authReversalResponse>
```

#### Example: Batch Authorization Reversal Response

This example shows a Batch Response containing three Authorization Reversal responses.

```
<littleResponse version="11.4" xmlns="http://www.little.com/schema"
response="0" message="ValidFormat" cnpSessionId="21500040809">
  <batchResponse cnpBatchId="21500040908" merchantId="000902">
    <authReversalResponse id="ID" reportGroup="core" customerId="Rev1">
      <cnpTxnId>21200000002700</cnpTxnId>
      <response>000</response>
      <responseTime>2011-10-14T13:15:43</responseTime>
      <message>Approved</message>
    </authReversalResponse>
    <authReversalResponse id="ID" reportGroup="core" customerId="viRev2">
      <cnpTxnId>21200000002809</cnpTxnId>
      <response>001</response>
      <responseTime>2011-10-14T13:15:43</responseTime>
      <message>Transaction received</message>
    </authReversalResponse>
    <authReversalResponse id="ID" reportGroup="core" customerId="mcRev3">
      <cnpTxnId>21200000002908</cnpTxnId>
      <response>001</response>
      <responseTime>2011-10-14T13:15:43</responseTime>
      <message>Transaction received</message>
    </authReversalResponse>
  </batchResponse>
</littleResponse>
```

### Example: Online Authorization Reversal Response

```
<littleOnlineResponse version="11.4" xmlns="http://www.little.com/schema"
  response="0" message="Valid Format">
  <authReversalResponse id="12345" customerId="Customer Id"
    reportGroup="Auth Reversals">
    <cnpTxnId>12345678</cnpTxnId>
    <response>000</response>
    <responseTime>2017-04-30T13:15:43</responseTime>
    <message>Approved</message>
  </authReversalResponse>
</littleOnlineResponse>
```

## 3.3.3 Activate Transactions

The Activate transaction changes the status of a (Closed Loop) Gift Card from inactive to active with a value as specified by the amount element. You can also use this transaction type to create a Virtual Gift Card.

---

---

**NOTE:** You must be enabled for (Closed Loop) Gift Card transactions to use this transaction type. Please consult your Relationship Manager for additional information about Gift Card transactions.

---

---

### 3.3.3.1 Activate Request

You must structure an Activate request as shown in the following examples. The structure of the request is identical for either an Online or a Batch submission.

```
<activate id="Activate Id" reportGroup="iQ Report Group" customerId="Customer
  Id">
  <orderId>Order Id</orderId>
  <amount>Activation Amount</amount>
  <orderSource>Order Entry Source</orderSource>
  [ <card> | <virtualGiftCard> ]
</activate>
```

#### Example: Activate Request - Gift Card

```
<littleOnlineRequest version="11.4" xmlns="http://www.little.com/schema"
  merchantId="100">
  <authentication>
  <user>User Name</user>
  <password>Password</password>
```

```
</authentication>
<activate id="834262" reportGroup="ABC Division" customerId="038945">
  <orderId>65347567</orderId>
  <amount>40000</amount>
  <orderSource>ecommerce</orderSource>
  <card>
    <type>GC</type>
    <number>9000000000000001</number>
  </card>
</activate>
</litleOnlineRequest>
```

### Example: Activate Request - Virtual Gift Card

```
<litleOnlineRequest version="11.4" xmlns="http://www.litle.com/schema"
  merchantId="100">
  <authentication>
    <user>User Name</user>
    <password>Password</password>
  </authentication>
  <activate id="834262" reportGroup="ABC Division" customerId="038945">
    <orderId>65347567</orderId>
    <amount>40000</amount>
    <orderSource>ecommerce</orderSource>
    <virtualGiftCard>
      <accountNumberLength>16</accountNumberLength>
      <giftCardBin>900000</giftCardBin>
    </virtualGiftCard>
  </activate>
</litleOnlineRequest>
```

### 3.3.3.2 Activate Response

An Activate response has the following structure. The response message is identical for Online and Batch transactions except Online includes the <postDate> element.

```
<activateResponse id="Activate Id" reportGroup="iQ Report Group"
  customerId="Customer Id">
  <litleTxnId>Transaction Id</litleTxnId>
  <response>Response Code</response>
  <responseTime>Date and Time in GMT</responseTime>
```

```
<postDate>Date transaction posted</postDate> (Online Only)
<message>Response Message</message>
<fraudResult>
<giftCardResponse>
<virtualGiftCardResponse>
</activateResponse>
```

### Example: Activate Response - Gift Card

```
<litleOnlineResponse version="11.4" xmlns="http://www.litle.com/schema"
  response="0" message="Valid Format">
  <activateResponse id="834262" reportGroup="ABC Division">
    <cnpTxnId>9695064321</cnpTxnId>
    <response>000</response>
    <responseTime>2017-01-25T15:13:43</responseTime>
    <postDate>2017-01-25</postDate>
    <message>Approved</message>
    <giftCardResponse>
      <txnTime>2016-11-25T15:13:38</txnTime>
      <refCode>123456</refCode>
      <systemTraceId>123456</systemTraceId>
      <sequenceNumber>123456</sequenceNumber>
      <availableBalance>5000</availableBalance>
    </giftCardResponse>
  </activateResponse>
</litleOnlineResponse>
```

### Example: Activate Response - Virtual Gift Card

```
<litleOnlineResponse version="11.4" xmlns="http://www.litle.com/schema"
  response="0" message="Valid Format">
  <activateResponse id="834262" reportGroup="ABC Division">
    <cnpTxnId>9695064321</cnpTxnId>
    <response>000</response>
    <responseTime>2017-01-25T15:13:43</responseTime>
    <postDate>2017-01-25</postDate>
    <message>Approved</message>
    <giftCardResponse>
      <txnTime>2017-01-25T15:13:38</txnTime>
      <refCode>123456</refCode>
      <systemTraceId>123456</systemTraceId>
      <sequenceNumber>123456</sequenceNumber>
      <availableBalance>5000</availableBalance>
    </giftCardResponse>
  </activateResponse>
</litleOnlineResponse>
```

```
</giftCardResponse>
<virtualGiftCardResponse>
  <accountNumber>9000000000000001</accountNumber>
  <cardValidationNum>978</cardValidationNum>
  <pin>1234</pin>
</virtualGiftCardResponse>
</activateResponse>
</littleOnlineResponse>
```

### 3.3.4 Activate Reversal Transactions (Online Only)

The Activate Reversal transaction changes the status of a newly activated Gift Card from active to inactive, thus reversing the operation of an Active transaction. The Activate Reversal references the associated Activate transaction by means of the `littleTxnId` element returned in the Activate response. This transaction type is available only for Online transactions.

---

---

**NOTE:** You must be enabled for (Closed Loop) Gift Card transactions to use this transaction type. Please consult your Relationship Manager for additional information about Gift Card transactions.

---

---

#### 3.3.4.1 Activate Reversal Request

You must structure an Activate Reversal request as shown in the following examples.

```
<activateReversal id="Activate Reversal Id" reportGroup="iQ Report Group"
customerId="Customer Id">
  <littleTxnId>Transaction Id from Activate Response</littleTxnId>
  <card>
  <virtualGiftCardBin>
  <originalRefCode>Reference Code from Activate Response</originalRefCode>
  <originalAmount>Amount from Activate Transaction</originalAmount>
  <originalTxnTime>Transaction Time from Activate Response</originalTxnTime>
  <originalSystemTraceId>Trace Id from Activate Response</originalSystemTraceId>
  <originalSequenceNumber>Seq Num from Activate Rsp</originalSequenceNumber>
</activateReversal>
```



**Example: Activate Reversal Request**

```

<littleOnlineRequest version="11.4" xmlns="http://www.little.com/schema"
  merchantId="100">
  <authentication>
    <user>User Name</user>
    <password>Password</password>
  </authentication>
  <activateReversal id="12345" customerId="Customer Id"
    reportGroup="Activate Reversals">
    <cnpTxnId>1234567890123456789</cnpTxnId>
    <card>
      <type>GC</type>
      <number>1234102000003558</number>
      <cardValidationNum>888</cardValidationNum>
      <pin>1234</pin>
    </card>
    <originalRefCode>123456</originalRefCode>
    <originalAmount>1900</originalAmount>
    <originalTxnTime>2017-03-21T10:02:46</originalTxnTime>
    <originalSystemTraceId>678901</originalSystemTraceId>
    <originalSequenceNumber>123456</originalSequenceNumber>
  </activateReversal>
</littleOnlineRequest>

```

**3.3.4.2 Activate Reversal Response**

An Activate Reversal response has the following structure.

```

<activateReversalResponse id="Activate Reversal Id" reportGroup="iQ
Report Group" customerId="Customer Id">
  <littleTxnId>Transaction Id</littleTxnId>
  <response>Response Code</response>
  <responseTime>Date and Time in GMT</responseTime>
  <postDate>Date transaction posted</postDate> (Online Only)
  <message>Response Message</message>
  <giftCardResponse>
</activateReversalResponse>

```

### Example: Activate Reversal Response

```
<littleOnlineResponse version="11.4" xmlns="http://www.little.com/schema"
  response="0" message="Valid Format">
  <activateReversalResponse id="834262" reportGroup="ABC Division">
    <cnpTxnId>9695064321</cnpTxnId>
    <response>000</response>
    <responseTime>2017-03-22T15:13:43</responseTime>
    <postDate>2017-03-22</postDate>
    <message>Approved</message>
    <giftCardResponse>
      <txnTime>2017-03-22T12:00:00</txnTime>
      <refCode>003558</refCode>
      <systemTraceId>834528</systemTraceId>
      <sequenceNumber>123456</sequenceNumber>
      <availableBalance>0</availableBalance>
    </giftCardResponse>
  </activateReversalResponse>
</littleOnlineResponse>
```

## 3.3.5 Balance Inquiry Transactions

A Balance Inquiry transaction returns the available balance of a Gift Card.

---

**NOTE:** You must be enabled for (Closed Loop) Gift Card transactions to use this transaction type. Please consult your Relationship Manager for additional information about Gift Card transactions.

---

### 3.3.5.1 Balance Inquiry Request

You must structure an Balance Inquiry request as shown in the following examples. The structure of the request is identical for either an Online or a Batch submission.

```
<balanceInquiry id="Balance Inquiry Id" reportGroup="iQ Report Group"
  customerId="Customer Id">
  <orderId>Order Id</orderId>
  <orderSource>Order Entry Source</orderSource>
  <card>
</balanceInquiry>
```

**Example: Balance Inquiry Request**

```

<litleOnlineRequest version="11.4" xmlns="http://www.litle.com/schema"
  merchantId="100">
  <authentication>
    <user>User Name</user>
    <password>Password</password>
  </authentication>
  <balanceInquiry id="834262" reportGroup="ABC Division"
    customerId="038945">
    <orderId>65347567</orderId>
    <orderSource>ecommerce</orderSource>
    <card>
      <type>GC</type>
      <number>9000000000000001</number>
      <pin>1234</pin>
    </card>
  </balanceInquiry>
</litleOnlineRequest>

```

**3.3.5.2 Balance Inquiry Response**

An Balance Inquiry response has the following structure. The response message is identical for Online and Batch transactions except Online includes the <postDate> element.

```

<balanceInquiryResponse id="Balance Inquiry Id" reportGroup="iQ
  Report Group" customerId="Customer Id">
  <litleTxnId>Transaction Id</litleTxnId>
  <orderId>Order Id</orderId>
  <response>Response Code</response>
  <responseTime>Date and Time in GMT</responseTime>
  <postDate>Date transaction posted</postDate> (Online Only)
  <message>Response Message</message>
  <fraudResult>
  <giftCardResponse>
</balanceInquiryResponse>

```

**Example: Balance Inquiry Response**

```

<litleOnlineResponse version="11.4" xmlns="http://www.litle.com/schema"
  response="0" message="Valid Format">
  <balanceInquiryResponse id="834262" reportGroup="ABC Division">
    <cnpTxnId>9695064321</cnpTxnId>

```

```
<orderId>65347567</orderId>
<response>000</response>
<responseTime>2017-03-21T15:13:43</responseTime>
<postDate>2017-03-21</postDate>
<message>Approved</message>
<fraudResult>
  <cardValidationResult>N</cardValidationResult>
</fraudResult>
<giftCardResponse>
  <availableBalance>2000</activateReversalResponse>
</litleOnlineResponse>
```

### 3.3.6 Cancel Subscription Transactions

The Cancel Subscription transaction cancels the specified subscription, removing the transaction stream managed by the Recurring Engine.

#### 3.3.6.1 Cancel Subscription Request

You must structure an Cancel Subscription request as shown in the following examples. The structure of the request is identical for either an Online or a Batch submission.

```
<cancelSubscription>
  <subscriptionId>ID of Subscription to Cancel</subscriptionId>
</cancelSubscription>
```

#### Example: Cancel Subscription Request

```
<litleOnlineRequest version="11.4" xmlns="http://www.litle.com/schema"
  merchantId="100">
  <authentication>
    <user>User Name</user>
    <password>password</password>
  </authentication>
  <cancelSubscription>
    <subscriptionId>1234</subscriptionId>
  </cancelSubscription>
</litleOnlineRequest>
```

### 3.3.6.2 Cancel Subscription Response

A Cancel Subscription response has the following structure. The response message is identical for Online and Batch transactions except Online includes the `<postDate>` element.

```
<cancelSubscriptionResponse>
  <littleTxnId>Transaction Id</littleTxnId>
  <response>Response Code</response>
  <message>Response Message</message>
  <responseTime>Date and Time in GMT</responseTime>
  <subscriptionId>ID of Subscription Canceled</subscriptionId>
</cancelSubscriptionResponse>
```

#### Example: Cancel Subscription Response

```
<littleOnlineResponse version="11.4" xmlns="http://www.little.com/schema"
  response="0" message="Valid Format">
  <cancelSubscriptionResponse>
    <cnpTxnId>1100030055</cnpTxnId>
    <response>000</response>
    <message>Approved</message>
    <responseTime>2017-04-11T14:48:46</responseTime>
    <subscriptionId>123457</subscriptionId>
  </cancelSubscriptionResponse>
</littleOnlineResponse>
```

### 3.3.7 Capture Transactions

The Capture transaction transfers funds from the customer to the merchant. The Capture references the associated Authorization by means of the `littleTxnId` element returned in the Authorization response.

---

**NOTE:** To perform a capture on a Closed-loop Gift Card, submit a Gift Card Capture transaction, not an Authorization transaction. See [Gift Card Capture Transactions](#) on page 292 for additional information.

---

You send a Capture after the order has been fulfilled. In some cases, it is not possible to fulfill a customer's entire order in one shipment (for example, if some items are backordered, or some shipped from an off-site DCS). In this situation, you can send a Partial Capture transaction by setting the `partial` attribute to `true`. A Partial Capture contains only the data relevant to the items that were actually shipped, enabling you to settle the funds related to those items.

---

**NOTE:** If you settle in a currency other than US or Canada, you cannot use partial captures.

---

### 3.3.7.1 Capture Request

You must structure a Capture request as shown in the following examples. The structure of the request is identical for either an Online or a Batch submission.

```
<capture id="Capture Id" reportGroup="iQ Report Group" customerId="Customer Id"
partial="false">
  <littleTxnId>Transaction Id</littleTxnId>
  <amount>Authorization Amount</amount>
  <surchargeAmount>Surcharge Amount</surchargeAmount>
  <enhancedData>
  <processingInstructions>
  <paypalOrderComplete>Set to true for final Capture</paypalOrderComplete>
  <pin>Gift Card Pin Number</pin>
</capture>
```

#### Example: Batch Capture Request - Full Capture

The following Capture example is for a full capture. Although the <capture> element includes an <amount> child, it is not required for a full Capture. If you omit the <amount> child element, the capture amount defaults to the full amount from the associated Authorization.

```
<littleRequest version="11.4" xmlns="http://www.little.com/schema" id="123"
numBatchRequests="1">
  <authentication>
    <user>userName</user>
    <password>password</password>
  </authentication>
  <batchRequest id="01234567" numAuths="0" authAmount="0" numCaptures="1"
captureAmount="55814" numCredits="0" creditAmount="0" numSales="0"
saleAmount="0" merchantId="100">
    <capture id="AX54325432" reportGroup="RG12" partial="false">
      <cnpTxnId>84568457</cnpTxnId>
      <amount>55814</amount>
      <enhancedData>
        <customerReference>P012346</customerReference>
        <salesTax>1500</salesTax>
        <taxExempt>>false</taxExempt>
        <discountAmount>0</discountAmount>
```

```
<shippingAmount>3714</shippingAmount>
<dutyAmount>0</dutyAmount>
<shipFromPostalCode>01851</shipFromPostalCode>
<destinationPostalCode>01851</destinationPostalCode>
<destinationCountryCode>USA</destinationCountryCode>
<invoiceReferenceNumber>123456</invoiceReferenceNumber>
<orderDate>2011-09-14</orderDate>
<detailTax>
  <taxIncludedInTotal>true</taxIncludedInTotal>
  <taxAmount>500</taxAmount>
  <taxRate>0.01667</taxRate>
  <taxTypeIdentifier>00</taxTypeIdentifier>
  <cardAcceptorTaxId>011234567</cardAcceptorTaxId>
</detailTax>
<lineItemData>
  <itemSequenceNumber>1</itemSequenceNumber>
  <itemDescription>table</itemDescription>
  <productCode>TB123</productCode>
  <quantity>1</quantity>
  <unitOfMeasure>EACH</unitOfMeasure>
  <taxAmount>1500</taxAmount>
  <lineItemTotal>30000</lineItemTotal>
  <lineItemTotalWithTax>31500</lineItemTotalWithTax>
  <itemDiscountAmount>0</itemDiscountAmount>
  <commodityCode>301</commodityCode>
  <unitCost>300.00</unitCost>
  <detailTax>
    <taxIncludedInTotal>true</taxIncludedInTotal>
    <taxAmount>500</taxAmount>
    <taxRate>0.01667</taxRate>
    <taxTypeIdentifier>03</taxTypeIdentifier>
    <cardAcceptorTaxId>011234567</cardAcceptorTaxId>
  </detailTax>
</lineItemData>
<lineItemData>
  <itemSequenceNumber>2</itemSequenceNumber>
  <itemDescription>chair</itemDescription>
  <productCode>CH123</productCode>
  <quantity>1</quantity>
  <unitOfMeasure>EACH</unitOfMeasure>
  <lineItemTotal>20000</lineItemTotal>
  <itemDiscountAmount>0</itemDiscountAmount>
  <commodityCode>301</commodityCode>
```

```
        <unitCost>200.00</unitCost>
    </lineItemData>
</enhancedData>
</capture>
</batchRequest>
</litleRequest>
```

### Example: Batch Capture Request - Partial Capture

A partial Capture has the `partial` attribute set to `true` and must include an amount child element.

```
<litleRequest version="11.4" xmlns="http://www.litle.com/schema" id="123"
numBatchRequests="1">
  <authentication>
    <user>userName</user>
    <password>password</password>
  </authentication>
  <batchRequest id="01234567" numAuths="0" authAmount="0" numCaptures="1"
captureAmount="45814" numCredits="0" creditAmount="0" numSales="0"
saleAmount="0" merchantId="100">
    <capture id="AX54325432" reportGroup="RG12" partial="true">
      <cnpTxnId>84568457</cnpTxnId>
      <amount>45814</amount>
      <enhancedData>
        <customerReference>P012346</customerReference>
        <salesTax>2100</salesTax>
        <taxExempt>>false</taxExempt>
        <discountAmount>0</discountAmount>
        <shippingAmount>3714</shippingAmount>
        <dutyAmount>0</dutyAmount>
        <shipFromPostalCode>01851</shipFromPostalCode>
        <destinationPostalCode>01851</destinationPostalCode>
        <destinationCountryCode>USA</destinationCountryCode>
        <invoiceReferenceNumber>123456</invoiceReferenceNumber>
        <orderDate>2016-09-14</orderDate>
        <detailTax>
          <taxIncludedInTotal>>true</taxIncludedInTotal>
          <taxAmount>500</taxAmount>
          <taxRate>0.01667</taxRate>
          <taxTypeIdentifier>00</taxTypeIdentifier>
          <cardAcceptorTaxId>011234567</cardAcceptorTaxId>
        </detailTax>
      </enhancedData>
    </capture>
  </batchRequest>
</litleRequest>
```



```

    <itemSequenceNumber>1</itemSequenceNumber>
    <itemDescription>table</itemDescription>
    <productCode>TB123</productCode>
    <quantity>1</quantity>
    <unitOfMeasure>EACH</unitOfMeasure>
    <taxAmount>1500</taxAmount>
    <lineItemTotal>30000</lineItemTotal>
    <lineItemTotalWithTax>31500</lineItemTotalWithTax>
    <itemDiscountAmount>0</itemDiscountAmount>
    <commodityCode>301</commodityCode>
    <unitCost>300.00</unitCost>
    <detailTax>
      <taxIncludedInTotal>true</taxIncludedInTotal>
      <taxAmount>500</taxAmount>
      <taxRate>0.01667</taxRate>
      <taxTypeIdentifier>03</taxTypeIdentifier>
      <cardAcceptorTaxId>011234567</cardAcceptorTaxId>
    </detailTax>
  </lineItemData>
  <lineItemData>
    <itemSequenceNumber>2</itemSequenceNumber>
    <itemDescription>chair</itemDescription>
    <productCode>CH123</productCode>
    <quantity>1</quantity>
    <unitOfMeasure>EACH</unitOfMeasure>
    <lineItemTotal>20000</lineItemTotal>
    <itemDiscountAmount>0</itemDiscountAmount>
    <commodityCode>301</commodityCode>
    <unitCost>200.00</unitCost>
  </lineItemData>
</enhancedData>
</capture>
</batchRequest>
</litleRequest>

```

### Example: Online Capture Request - Full Capture

The following Capture example is for a full capture. Although the <capture> element includes an <amount> child, it is not required for a full Capture. If you omit the <amount> child element, the capture amount defaults to the full amount from the associated Authorization.

```

<litleOnlineRequest version="11.4" xmlns="http://www.litle.com/schema"
  merchantId="100">

```

```
<authentication>
  <user>User Name</user>
  <password>password</password>
</authentication>
<capture id="2" reportGroup="ABC Division" customerId="038945"
partial="false">
  <cnpTxnId>13254123434</cnpTxnId>
  <enhancedData>
    <customerReference>P012345</customerReference>
    <salesTax>125</salesTax>
    <taxExempt>>false</taxExempt>
    <discountAmount>0</discountAmount>
    <shippingAmount>495</shippingAmount>
    <dutyAmount>0</dutyAmount>
    <shipFromPostalCode>01851</shipFromPostalCode>
    <destinationPostalCode>01851</destinationPostalCode>
    <destinationCountryCode>USA</destinationCountryCode>
    <invoiceReferenceNumber>123456</invoiceReferenceNumber>
    <orderDate>2011-08-14</orderDate>
    <detailTax>
      <taxIncludedInTotal>>true</taxIncludedInTotal>
      <taxAmount>55</taxAmount>
      <taxRate>0.0059</taxRate>
      <taxTypeIdentifier>00</taxTypeIdentifier>
      <cardAcceptorTaxId>011234567</cardAcceptorTaxId>
    </detailTax>
  <lineItemData>
    <itemSequenceNumber>1</itemSequenceNumber>
    <itemDescription>chair</itemDescription>
    <productCode>CH123</productCode>
    <quantity>1</quantity>
    <unitOfMeasure>EACH</unitOfMeasure>
    <taxAmount>125</taxAmount>
    <lineItemTotal>9380</lineItemTotal>
    <lineItemTotalWithTax>9505</lineItemTotalWithTax>
    <itemDiscountAmount>0</itemDiscountAmount>
    <commodityCode>300</commodityCode>
    <unitCost>93.80</unitCost>
    <detailTax>
      <taxIncludedInTotal>>true</taxIncludedInTotal>
      <taxAmount>55</taxAmount>
      <taxRate>0.0059</taxRate>
      <taxTypeIdentifier>03</taxTypeIdentifier>
    </detailTax>
  </lineItemData>
</capture>
```

```

        <cardAcceptorTaxId>011234567</cardAcceptorTaxId>
    </detailTax>
</lineItemData>
<lineItemData>
    <itemSequenceNumber>2</itemSequenceNumber>
    <itemDescription>table</itemDescription>
    <productCode>TB123</productCode>
    <quantity>1</quantity>
    <unitOfMeasure>EACH</unitOfMeasure>
    <lineItemTotal>30000</lineItemTotal>
    <itemDiscountAmount>0</itemDiscountAmount>
    <commodityCode>300</commodityCode>
    <unitCost>300.00</unitCost>
</lineItemData>
</enhancedData>
</capture>
</litleOnlineRequest>

```

### Example: Online Capture Request - Partial Capture

A partial Capture has the `partial` attribute set to **true** and must include an `<amount>` child element.

```

<litleOnlineRequest version="11.4" xmlns="http://www.litle.com/schema"
  merchantId="100">
  <authentication>
    <user>User Name</user>
    <password>password</password>
  </authentication>
  <capture id="2" reportGroup="ABC Division" customerId="038945"
    partial="true">
    <cnpTxnId>13254123434</cnpTxnId>
    <amount>100</amount>
    <enhancedData>
      <customerReference>PO12345</customerReference>
      <salesTax>125</salesTax>
      <taxExempt>>false</taxExempt>
      <discountAmount>0</discountAmount>
      <shippingAmount>495</shippingAmount>
      <dutyAmount>0</dutyAmount>
      <shipFromPostalCode>01851</shipFromPostalCode>
      <destinationPostalCode>01851</destinationPostalCode>
      <destinationCountryCode>USA</destinationCountryCode>
    </enhancedData>
  </capture>
</litleOnlineRequest>

```

```
<invoiceReferenceNumber>123456</invoiceReferenceNumber>
<orderDate>2011-08-14</orderDate>
<detailTax>
  <taxIncludedInTotal>true</taxIncludedInTotal>
  <taxAmount>55</taxAmount>
  <taxRate>0.0059</taxRate>
  <taxTypeIdentifier>00</taxTypeIdentifier>
  <cardAcceptorTaxId>011234567</cardAcceptorTaxId>
</detailTax>
<lineItemData>
  <itemSequenceNumber>1</itemSequenceNumber>
  <itemDescription>chair</itemDescription>
  <productCode>CH123</productCode>
  <quantity>1</quantity>
  <unitOfMeasure>EACH</unitOfMeasure>
  <taxAmount>125</taxAmount>
  <lineItemTotal>9380</lineItemTotal>
  <lineItemTotalWithTax>9505</lineItemTotalWithTax>
  <itemDiscountAmount>0</itemDiscountAmount>
  <commodityCode>300</commodityCode>
  <unitCost>93.80</unitCost>
  <detailTax>
    <taxIncludedInTotal>true</taxIncludedInTotal>
    <taxAmount>55</taxAmount>
    <taxRate>0.0059</taxRate>
    <taxTypeIdentifier>03</taxTypeIdentifier>
    <cardAcceptorTaxId>011234567</cardAcceptorTaxId>
  </detailTax>
</lineItemData>
<lineItemData>
  <itemSequenceNumber>2</itemSequenceNumber>
  <itemDescription>table</itemDescription>
  <productCode>TB123</productCode>
  <quantity>1</quantity>
  <unitOfMeasure>EACH</unitOfMeasure>
  <lineItemTotal>30000</lineItemTotal>
  <itemDiscountAmount>0</itemDiscountAmount>
  <commodityCode>300</commodityCode>
  <unitCost>300.00</unitCost>
</lineItemData>
</enhancedData>
</capture>
</littleOnlineRequest>
```

### 3.3.7.2 Capture Response

A Capture response has the following structure. The response message is identical for Online and Batch transactions except Batch always includes the <orderId> element, while Online includes the <postDate> element.

```
<captureResponse id="Authorization Id" reportGroup="iQ Report Group"
customerId="Customer Id">
  <littleTxnId>Transaction Id</littleTxnId>
  <response>Response Code</response>
  <responseTime>Date and Time in GMT</responseTime>
  <postDate>Date Of Posting</postDate> (Online Only)
  <message>Response Message</message>
  <accountUpdater>
</captureResponse>
```

#### Example: Batch Capture Response

```
<littleResponse version="11.4" xmlns="http://www.little.com/schema" id="123"
cnpSessionId="987654321" response="0" message="Valid Format">
  <batchResponse id="01234567" cnpBatchId="4455667788" merchantId="100">
    <captureResponse id="AX54321678" reportGroup="RG27">
      <cnpTxnId>84568456</cnpTxnId>
      <response>000</response>
      <responseTime>2017-04-01T10:24:31</responseTime>
      <message>Approved</message>
    </captureResponse>
    <captureResponse id="AX54325432" reportGroup="RG12">
      <cnpTxnId>84568457</cnpTxnId>
      <response>000</response>
      <responseTime>2017-04-01T10:24:31</responseTime>
      <message>message</message>
    </captureResponse>
  </batchResponse>
</littleResponse>
```

#### Example: Online Capture Response

```
<littleOnlineResponse version="11.4" xmlns="http://www.little.com/schema"
response="0" message="Valid Format">
  <captureResponse id="2" reportGroup="ABC Division" customerId="038945">
```

```
<cnpTxnId>1100030204</cnpTxnId>
<response>000</response>
<responseTime>2017-04-11T14:48:48</responseTime>
<postDate>2016-07-11</postDate>
<message>Approved</message>
</captureResponse>
</littleOnlineResponse>
```

### 3.3.8 Capture Given Auth Transactions

You typically use a Capture Given Auth transaction when the associated Authorization occurred outside of the system (for example, if you received a telephone Authorization). Another possible use for a Capture Given Auth transaction is if the Authorization transaction occurred within the system, but the `<littleTxnId>` is unknown by the submitting party (for example, if the Auth was submitted by a merchant, but a fulfiller submits a Capture Given Auth).

#### 3.3.8.1 Capture Given Auth Request

You must specify the Capture Given Auth request as follows. The structure of the request is identical for either an Online or a Batch submission.

```
<captureGivenAuth id="Capture Given Auth Id" reportGroup="iQ Report Group"
customerId="Customer Id">
  <orderId>Order Id</orderId>
  <authInformation>
  <amount>Authorization Amount</amount>
  <secondaryAmount>Secondary Amount</secondaryAmount>
  <orderSource>Order Entry Source</orderSource>
  <billToAddress>
  <shipToAddress>
  [ <card> | <token> | <paypage> | <mpos> ]
  <customBilling>
  <taxType>payment or fee</taxType>
  <billMeLaterRequest>
  <enhancedData>
  <processingInstructions>
  <pos>
  <amexAggregatorData>
```

```

    <merchantData>
    <debtRepayment>true or false</debtRepayment>
    <processingType>processingType Enum</processingType>
    <originalNetworkTransactionId>Network Txn Value</originalNetworkTransactionId>
    <originalTransactionAmount>Amount from Orig Txn</originalTransactionAmount>
  </captureGivenAuth>

```

### Example: Batch Capture Given Auth Request

The following example shows a single Capture Given Auth request. The example uses the <card> child element, but a tokenized merchant could use the <token> child element in its place.

```

<littleRequest version="11.4" xmlns="http://www.little.com/schema"
  numBatchRequests="1">
  <authentication>
    <user>User Name</user>
    <password>password</password>
  </authentication>
  <batchRequest id="batchId" numCaptureGivenAuths="1"
    captureGivenAuthAmount="10000" merchantId="100">
    <captureGivenAuth id="AX54321678" reportGroup="RG27">
      <orderId>orderId</orderId>
      <authInformation>
        <authDate>2016-09-21</authDate>
        <authCode>123456</authCode>
      </authInformation>
      <amount>10000</amount>
      <orderSource>ecommerce</orderSource>
      <card>
        <type>VI</type>
        <number>4005550000081019</number>
        <expDate>0910</expDate>
      </card>
      <enhancedData>
        <customerReference>P012345</customerReference>
        <salesTax>125</salesTax>
        <taxExempt>>false</taxExempt>
        <discountAmount>0</discountAmount>
        <shippingAmount>495</shippingAmount>
        <dutyAmount>0</dutyAmount>
        <shipFromPostalCode>01851</shipFromPostalCode>
        <destinationPostalCode>01851</destinationPostalCode>
      </enhancedData>
    </captureGivenAuth>
  </batchRequest>
</littleRequest>

```

```
<destinationCountryCode>USA</destinationCountryCode>
<invoiceReferenceNumber>123456</invoiceReferenceNumber>
<orderDate>2016-09-21</orderDate>
<detailTax>
  <taxIncludedInTotal>true</taxIncludedInTotal>
  <taxAmount>55</taxAmount>
  <taxRate>0.0055</taxRate>
  <taxTypeIdentifier>00</taxTypeIdentifier>
  <cardAcceptorTaxId>011234567</cardAcceptorTaxId>
</detailTax>
<lineItemData>
  <itemSequenceNumber>1</itemSequenceNumber>
  <itemDescription>chair</itemDescription>
  <productCode>CH123</productCode>
  <quantity>1</quantity>
  <unitOfMeasure>EACH</unitOfMeasure>
  <taxAmount>125</taxAmount>
  <lineItemTotal>9380</lineItemTotal>
  <lineItemTotalWithTax>9505</lineItemTotalWithTax>
  <itemDiscountAmount>0</itemDiscountAmount>
  <commodityCode>300</commodityCode>
  <unitCost>93.80</unitCost>
</lineItemData>
</enhancedData>
</captureGivenAuth>
</batchRequest>
</litleRequest>
```

### Example: Online Capture Given Auth Request

```
<litleOnlineRequest version="11.4" xmlns="http://www.litle.com/schema"
  merchantId="100">
  <authentication>
    <user>userName</user>
    <password>password</password>
  </authentication>
  <captureGivenAuth id="AX54321678" reportGroup="RG27">
    <orderId>orderId</orderId>
    <authInformation>
      <authDate>2016-08-24</authDate>
      <authCode>123456</authCode>
    </authInformation>
    <amount>10000</amount>
```



```
<orderSource>ecommerce</orderSource>
<card>
  <type>VI</type>
  <number>4005550000081019</number>
  <expDate>0910</expDate>
</card>
<enhancedData>
  <customerReference>P012345</customerReference>
  <salesTax>125</salesTax>
  <deliveryType>TBD</deliveryType>
  <taxExempt>>false</taxExempt>
  <discountAmount>0</discountAmount>
  <shippingAmount>495</shippingAmount>
  <dutyAmount>0</dutyAmount>
  <shipFromPostalCode>01851</shipFromPostalCode>
  <destinationPostalCode>01851</destinationPostalCode>
  <destinationCountryCode>USA</destinationCountryCode>
  <invoiceReferenceNumber>123456</invoiceReferenceNumber>
  <orderDate>2016-08-14</orderDate>
  <detailTax>
    <taxIncludedInTotal>>true</taxIncludedInTotal>
    <taxAmount>55</taxAmount>
    <taxRate>0.0059</taxRate>
    <taxTypeIdentifier>00</taxTypeIdentifier>
    <cardAcceptorTaxId>011234567</cardAcceptorTaxId>
  </detailTax>
  <lineItemData>
    <itemSequenceNumber>1</itemSequenceNumber>
    <itemDescription>chair</itemDescription>
    <productCode>CH123</productCode>
    <quantity>1</quantity>
    <unitOfMeasure>EACH</unitOfMeasure>
    <taxAmount>125</taxAmount>
    <lineItemTotal>9380</lineItemTotal>
    <lineItemTotalWithTax>9505</lineItemTotalWithTax>
    <itemDiscountAmount>0</itemDiscountAmount>
    <commodityCode>300</commodityCode>
    <unitCost>93.80</unitCost>
  </lineItemData>
</enhancedData>
</captureGivenAuth>
</litleOnlineRequest>
```

### Example: Capture Given Auth Request using token Element

The example below uses the following token related elements (click name to jump to element definition): [token](#) and [litleToken](#).

```
<captureGivenAuth id="99999" customerId="444" reportGroup="RG1" >
  <orderId>F12345</orderId>
  <authInformation>
    <authDate>2011-10-25</authDate>
    <authCode>500005</authCode>
  </authInformation>
  <amount>15000</amount>
  <orderSource>ecommerce</orderSource>
  <billToAddress>
    <name>John Doe</name>
    <addressLine1>10 Main Street</addressLine1>
    <city>San Jose</city>
    <state>CA</state>
    <zip>95032-1234</zip>
    <country>USA</country>
  </billToAddress>
  <token>
    <cnpToken>1112000100010085</cnpToken>
    <expDate>1112</expDate>
    <cardValidationNum>987</cardValidationNum>
  </token>
</captureGivenAuth>
```

### 3.3.8.2 Capture Given Auth Response

A Capture Given Auth response has the following structure. The response message is identical for Online and Batch transactions except Online includes the `<postDate>` element.

```
<captureGivenAuthResponse id="Capture Id" reportGroup="iQ Report Group"
  customerId="Customer Id">
  <litleTxnId>Transaction Id</litleTxnId>
  <response>Response Code</response>
  <responseTime>Date and Time in GMT</responseTime>
  <postDate>Date of Posting</postDate> (Online Only)
  <message>Response Message</message>
  <tokenResponse> (for Tokenized merchants submitting card data)
</captureGivenAuthResponse>
```

**Example: Batch Capture Given Auth Response**

```

<littleResponse version="11.4" xmlns="http://www.little.com/schema" id="123"
  cnpSessionId="987654321" response="0" message="Valid Format">
  <batchResponse id="01234567" cnpBatchId="4455667788" merchantId="100">
    <captureGivenAuthResponse id="AX54325432" reportGroup="RG12">
      <cnpTxnId>84568457</cnpTxnId>
      <response>000</response>
      <responseTime>2017-04-01T10:24:31</responseTime>
      <message>Approved</message>
    </captureGivenAuthResponse>
  </batchResponse>
</littleResponse>

```

**Example: Online Capture Given Auth Response**

```

<littleOnlineResponse version="11.4" xmlns="http://www.little.com/schema"
  response="0" message="Valid Format">
  <captureGivenAuthResponse id="2" reportGroup="ABC Division"
    customerId="038945">
    <cnpTxnId>1100030204</cnpTxnId>
    <response>000</response>
    <responseTime>2017-04-11T14:48:48</responseTime>
    <postDate>2017-04-11</postDate>
    <message>Approved</message>
  </captureGivenAuthResponse>
</littleOnlineResponse>

```

**Example: Capture Given Auth Response for Tokenized Merchant Sending Card Data**

```

<captureGivenAuthResponse id="99999" reportGroup="RG1" customerId="444">
  <cnpTxnId>21200000022005</cnpTxnId>
  <response>000</response>
  <responseTime>2017-04-25T04:00:00</responseTime>
  <postDate>2017-04-26</postDate>
  <message>Approved</message>
  <tokenResponse>
    <cnpToken>1111000100409510</cnpToken>
    <tokenResponseCode>801</tokenResponseCode>
    <tokenMessage>Account number was successfully registered</tokenMessage>
    <type>VI</type>
    <bin>432610</bin>
  </tokenResponse>

```

```
</captureGivenAuthResponse>
```

## 3.3.9 Create Plan Transactions

The Create Plan transaction allows you to define several attributes of a recurring payment schedule. Later, you can associate existing, active plans with subscriptions, which establishes a recurring payment schedule managed by the Recurring Engine.

### 3.3.9.1 Create Plan Request

You must specify the Create Plan transaction as follows. The structure of the request is identical for either an Online or a Batch submission.

```
<createPlan>
  <planCode>Plan Reference Code</planCode>
  <name>Name of Plan</name>
  <description>Description of Plan</description>
  <intervalType>The Type of Interval</intervalType>
  <amount>Amount of Recurring Payment</amount>
  <numberOfPayments>1 to 99</numberOfRemianingPayments>
  <trialNumberOfIntervals>Number of Trial Intervals</trialNumberOfIntervals>
  <trialIntervalType>Type of Trial Period Interval</trialIntervalType>
  <active>true or false</active>
</createPlan>
```

#### Example: Online Create Plan Request

```
<littleOnlineRequest version="11.4" xmlns="http://www.little.com/schema"
  merchantId="100">
  <authentication>
    <user>User Name</user>
    <password>password</password>
  </authentication>
  <createPlan>
    <planCode>Gold12</planCode>
    <name>Gold_Monthly</name>
    <description>Gold Level with Monthly Payments</description>
    <intervalType>MONTHLY</intervalType>
    <amount>5000</amount>
    <numberOfPayments>4</numberOfPayments>
```

```
<trialNumberOfIntervals>1</trialNumberOfIntervals>
<trialIntervalType>MONTH</trialIntervalType>
<active>>true</active>
</createPlan>
</litleOnlineRequest>
```

### 3.3.9.2 Create Plan Response

The Create Plan response message is identical for Online and Batch transactions.

```
<createPlanResponse>
  <litleTxnId>Transaction Id</litleTxnId>
  <response>Response Code</response>
  <message>Response Message</message>
  <responseTime>Date and Time in GMT</responseTime>
  <planCode>Plan Reference Code</subscriptionId>
</createPlanResponse>
```

#### Example: Online Create Plan Response

```
<litleOnlineResponse version="11.4" xmlns="http://www.litle.com/schema"
  response="0" message="Valid Format">
  <createPlanResponse>
    <cnpTxnId>1100030055</cnpTxnId>
    <response>000</response>
    <message>Approved</message>
    <responseTime>2016-07-11T14:48:46</responseTime>
    <planCode>Gold12</planCode>
  </createPlanResponse>
</litleOnlineResponse>
```

## 3.3.10 Credit Transactions

The Credit transaction enables you to refund money to a customer, even if the original transaction occurred outside of our system. You can submit refunds against any of the following payment transactions:

---

**NOTE:** To perform a credit on a Closed-loop Gift Card, submit a Gift Card Credit transaction, not an Credit transaction. See [Gift Card Credit Transactions](#) on page 294 for additional information.

---

- [Capture Transactions](#)
- [Capture Given Auth Transactions](#)
- [Force Capture Transactions](#)
- [Sale Transactions](#)
- External Sale or Capture Transactions

---

**NOTE:** Although there are two different scenarios for Credit requests, there is only one scenario for the Credit response.

---

### 3.3.10.1 Credit Request for a Vantiv Processed Transaction

You must specify the Credit request for a Vantiv processed transaction as follows. The structure of the request is identical for either an Online or a Batch submission.

```
<credit id="Credit Id" reportGroup="iQ Report Group" customerId="Customer Id">
  <littleTxnId>Transaction Id</littleTxnId>
  <amount>Authorization Amount</amount>
  <secondaryAmount>Secondary Amount</secondaryAmount>
  <customBilling>
  <enhancedData>
  <processingInstructions>
  <actionReason>SUSPECT_FRAUD</actionReason>
</credit>
```

#### **Example:** Batch Credit Request for a Vantiv Processed Transaction

To request a Credit against a sale settled by us, you only need to specify the `<littleTxnId>` element. The application uses the `<littleTxnId>` to look-up the Capture referenced and obtain all the necessary information including the amount.

---

**NOTE:** Although it is not required, if you choose to include `<amount>` elements in your Credit transaction, you must include the total amount in the `creditAmount` attribute of the `<batchrequest>`. If you do not specify amounts, set the `creditAmount` attribute to 0.

---

```
<litleRequest version="11.4" xmlns="http://www.litle.com/schema" id="123"
  numBatchRequests="1">
  <authentication>
    <user>userName</user>
    <password>password</password>
  </authentication>
  <batchRequest id="01234567" numAuths="0" authAmount="0" numCaptures="0"
    captureAmount="0" numCredits="1" creditAmount="10000" numSales="0"
    saleAmount="0" merchantId="100">
    <credit id="AX54321678" reportGroup="RG27">
      <cnpTxnId>84568456</cnpTxnId>
      <amount>10000</amount>
      <enhancedData>
        <customerReference>PO12345</customerReference>
        <salesTax>125</salesTax>
        <taxExempt>>false</taxExempt>
        <discountAmount>0</discountAmount>
        <shippingAmount>3017</shippingAmount>
        <dutyAmount>0</dutyAmount>
        <shipFromPostalCode>01851</shipFromPostalCode>
        <destinationPostalCode>01851</destinationPostalCode>
        <destinationCountryCode>USA</destinationCountryCode>
        <invoiceReferenceNumber>123456</invoiceReferenceNumber>
        <orderDate>2016-09-14</orderDate>
        <detailTax>
          <taxIncludedInTotal>>true</taxIncludedInTotal>
          <taxAmount>55</taxAmount>
          <taxRate>0.0059</taxRate>
          <taxTypeIdentifier>00</taxTypeIdentifier>
          <cardAcceptorTaxId>011234567</cardAcceptorTaxId>
        </detailTax>
        <lineItemData>
          <itemSequenceNumber>1</itemSequenceNumber>
          <itemDescription>chair</itemDescription>
          <productCode>CH123</productCode>
          <quantity>1</quantity>
          <unitOfMeasure>EACH</unitOfMeasure>
          <taxAmount>125</taxAmount>
          <lineItemTotal>9380</lineItemTotal>
          <lineItemTotalWithTax>9505</lineItemTotalWithTax>
          <itemDiscountAmount>0</itemDiscountAmount>
          <commodityCode>300</commodityCode>
          <unitCost>93.80</unitCost>
        </lineItemData>
      </enhancedData>
    </credit>
  </batchRequest>
</litleRequest>
```

```

    <detailTax>
      <taxIncludedInTotal>true</taxIncludedInTotal>
      <taxAmount>55</taxAmount>
      <taxRate>0.0059</taxRate>
      <taxTypeIdentifier>03</taxTypeIdentifier>
      <cardAcceptorTaxId>011234567</cardAcceptorTaxId>
    </detailTax>
  </lineItemData>
</enhancedData>
</credit>
</batchRequest>
</litleRequest>

```

### Example: Online Credit Request for a Vantiv Processed Transaction

To request a Credit against a sale settled by us, you need only specify the `<litleTxnId>` element. The application uses the `<litleTxnId>` to look up the Capture referenced and obtain all the necessary information including the amount. The example below includes the optional `<customBilling>` and `<enhancedData>` elements.

```

<litleOnlineRequest version="11.4" xmlns="http://www.litle.com/schema"
  merchantId="100">
  <authentication>
    <user>User Name</user>
    <password>password</password>
  </authentication>
  <credit id="2" reportGroup="ABC Division" customerId="038945">
    <cnpTxnId>13254123434</cnpTxnId>
    <customBilling>
      <phone>8888888888</phone>
      <descriptor>descriptor</descriptor>
    </customBilling>
    <enhancedData>
      <customerReference>PO12345</customerReference>
      <salesTax>125</salesTax>
      <taxExempt>>false</taxExempt>
      <discountAmount>0</discountAmount>
      <shippingAmount>495</shippingAmount>
      <dutyAmount>0</dutyAmount>
      <shipFromPostalCode>01851</shipFromPostalCode>
      <destinationPostalCode>01851</destinationPostalCode>
      <destinationCountryCode>USA</destinationCountryCode>
      <invoiceReferenceNumber>123456</invoiceReferenceNumber>
    </enhancedData>
  </credit>
</litleOnlineRequest>

```



```
<orderDate>2016-07-14</orderDate>
<detailTax>
  <taxIncludedInTotal>true</taxIncludedInTotal>
  <taxAmount>55</taxAmount>
  <taxRate>0.0059</taxRate>
  <taxTypeIdentifier>00</taxTypeIdentifier>
  <cardAcceptorTaxId>011234567</cardAcceptorTaxId>
</detailTax>
<lineItemData>
  <itemSequenceNumber>1</itemSequenceNumber>
  <itemDescription>chair</itemDescription>
  <productCode>CH123</productCode>
  <quantity>1</quantity>
  <unitOfMeasure>EACH</unitOfMeasure>
  <taxAmount>125</taxAmount>
  <lineItemTotal>9380</lineItemTotal>
  <lineItemTotalWithTax>9505</lineItemTotalWithTax>
  <itemDiscountAmount>0</itemDiscountAmount>
  <commodityCode>300</commodityCode>
  <unitCost>93.80</unitCost>
  <detailTax>
    <taxIncludedInTotal>true</taxIncludedInTotal>
    <taxAmount>55</taxAmount>
    <taxRate>0.0059</taxRate>
    <taxTypeIdentifier>03</taxTypeIdentifier>
    <cardAcceptorTaxId>011234567</cardAcceptorTaxId>
  </detailTax>
</lineItemData>
<lineItemData>
  <itemSequenceNumber>2</itemSequenceNumber>
  <itemDescription>table</itemDescription>
  <productCode>TB123</productCode>
  <quantity>1</quantity>
  <unitOfMeasure>EACH</unitOfMeasure>
  <lineItemTotal>30000</lineItemTotal>
  <itemDiscountAmount>0</itemDiscountAmount>
  <commodityCode>300</commodityCode>
  <unitCost>300.00</unitCost>
</lineItemData>
</enhancedData>
</credit>
</litleOnlineRequest>
```

### 3.3.10.2 Credit Request for a Non-Vantiv Processed Transaction

You must specify the Credit request for a Non-Vantiv processed transaction as follows. The structure of the request is identical for either an Online or a Batch submission.

---

**NOTE:** Although the schema shows `<paypal>` as an optional element for a Credit against a non-Vantiv processed transaction, refunds of this type are not supported for PayPal. If you need to refund non-Vantiv processed transactions and have not maintained a temporary relationship with your former processor for this purpose, please ask your Relationship Manager for alternative options.

---

```
<credit id="Credit Id" reportGroup="iQ Report Group" customerId="Customer Id">
  <orderId>Order Id</orderId>
  <amount>Authorization Amount</amount>
  <orderSource>Order Entry Source</orderSource>
  <billToAddress>
    [ <card> | <token> | <paypage> | <mpos> ]
  <customBilling>
  <taxType>payment or fee</taxType>
  <billMeLaterRequest>
  <enhancedData>
  <processingInstructions>
  <pos>
  <amexAggregatorData>
  <merchantData>
    <actionReason>SUSPECT_FRAUD</actionReason>
</credit>
```

#### Example: Batch Credit Request for a Non-Vantiv Processed Transaction

If the sale occurred outside of our system, you must specify the following elements in your Credit request: `<orderId>`, `<amount>`, and `<card>`, or `<token>` (`<paypal>` not supported for this transaction type).

```
<litleRequest version="11.4" xmlns="http://www.litle.com/schema" id="123"
  numBatchRequests="1">
  <authentication>
    <user>userName</user>
    <password>password</password>
  </authentication>
```

```
<batchRequest id="01234567" numCredits="1" creditAmount="10000"
merchantId="100">
  <credit id="AX54321678" reportGroup="RG27">
    <orderId>12z58743y1</orderId>
    <amount>10000</amount>
    <orderSource>ecommerce</orderSource>
    <billToAddress>
      <name>John Doe</name>
      <addressLine1>123 4th street</addressLine1>
      <addressLine2>Apt. 20</addressLine2>
      <addressLine3>second floor</addressLine3>
      <city>San Jose</city>
      <state>CA</state>
      <zip>95032</zip>
      <country>USA</country>
      <email>jdoe@isp.com</email>
      <phone>408-555-1212</phone>
    </billToAddress>
    <card>
      <type>MC</type>
      <number>5186005800001012</number>
      <expDate>1110</expDate>
    </card>
    <enhancedData>
      <customerReference>PO12345</customerReference>
      <salesTax>125</salesTax>
      <taxExempt>>false</taxExempt>
      <discountAmount>0</discountAmount>
      <shippingAmount>495</shippingAmount>
      <dutyAmount>0</dutyAmount>
      <shipFromPostalCode>01851</shipFromPostalCode>
      <destinationPostalCode>01851</destinationPostalCode>
      <destinationCountryCode>USA</destinationCountryCode>
      <invoiceReferenceNumber>123456</invoiceReferenceNumber>
      <orderDate>2016-09-14</orderDate>
      <detailTax>
        <taxIncludedInTotal>>true</taxIncludedInTotal>
        <taxAmount>55</taxAmount>
        <taxRate>0.0059</taxRate>
        <taxTypeIdentifier>00</taxTypeIdentifier>
        <cardAcceptorTaxId>011234567</cardAcceptorTaxId>
      </detailTax>
    </enhancedData>
  </credit>
</batchRequest>
```

```

    <itemSequenceNumber>1</itemSequenceNumber>
    <itemDescription>chair</itemDescription>
    <productCode>CH123</productCode>
    <quantity>1</quantity>
    <unitOfMeasure>EACH</unitOfMeasure>
    <taxAmount>125</taxAmount>
    <lineItemTotal>9380</lineItemTotal>
    <lineItemTotalWithTax>9505</lineItemTotalWithTax>
    <itemDiscountAmount>0</itemDiscountAmount>
    <commodityCode>300</commodityCode>
    <unitCost>93.80</unitCost>
  </lineItemData>
</enhancedData>
</credit>
</batchRequest>
</litleRequest>

```

### Example: Online Credit Request for a Non-Vantiv Processed Transaction

If the sale occurred outside of our system, you must specify the following elements in your Credit request: <orderId>, <amount>, and <card>, or <token> (<paypal> not supported for this transaction type).

```

<litleOnlineRequest version="11.4" xmlns="http://www.litle.com/schema"
  merchantId="100">
  <authentication>
    <user>User Name</user>
    <password>password</password>
  </authentication>
  <credit id="2" reportGroup="ABC Division" customerId="038945">
    <orderId>56789</orderId>
    <amount>10000</amount>
    <orderSource>ecommerce</orderSource>
    <billToAddress>
      <name>Mike J. Hammer</name>
      <addressLine1>Two Main Street</addressLine1>
      <addressLine2>Apartment 222</addressLine2>
      <addressLine3></addressLine3>
      <city>Riverside</city>
      <state>RI</state>
      <zip>02915</zip>
      <country>US</country>
      <email>mike@sample.com</email>
    </billToAddress>
  </credit>
</litleOnlineRequest>

```

```
<phone>5555555555</phone>
</billToAddress>
<card>
  <type>VI</type>
  <number>4005550000081019</number>
  <expDate>0907</expDate>
</card>
<customBilling>
  <phone>5555555555</phone>
  <descriptor>descriptor</descriptor>
</customBilling>
<enhancedData>
  <customerReference>P012345</customerReference>
  <salesTax>125</salesTax>
  <taxExempt>>false</taxExempt>
  <discountAmount>0</discountAmount>
  <shippingAmount>495</shippingAmount>
  <dutyAmount>0</dutyAmount>
  <shipFromPostalCode>01851</shipFromPostalCode>
  <destinationPostalCode>01851</destinationPostalCode>
  <destinationCountryCode>USA</destinationCountryCode>
  <invoiceReferenceNumber>123456</invoiceReferenceNumber>
  <orderDate>2011-08-14</orderDate>
  <detailTax>
    <taxIncludedInTotal>>true</taxIncludedInTotal>
    <taxAmount>55</taxAmount>
    <taxRate>0.0059</taxRate>
    <taxTypeIdentifier>00</taxTypeIdentifier>
    <cardAcceptorTaxId>011234567</cardAcceptorTaxId>
  </detailTax>
  <lineItemData>
    <itemSequenceNumber>1</itemSequenceNumber>
    <itemDescription>chair</itemDescription>
    <productCode>CH123</productCode>
    <quantity>1</quantity>
    <unitOfMeasure>EACH</unitOfMeasure>
    <taxAmount>125</taxAmount>
    <lineItemTotal>9380</lineItemTotal>
    <lineItemTotalWithTax>9505</lineItemTotalWithTax>
    <itemDiscountAmount>0</itemDiscountAmount>
    <commodityCode>300</commodityCode>
    <unitCost>93.80</unitCost>
  </lineItemData>
```

```

<lineItemData>
  <itemSequenceNumber>2</itemSequenceNumber>
  <itemDescription>table</itemDescription>
  <productCode>TB123</productCode>
  <quantity>1</quantity>
  <unitOfMeasure>EACH</unitOfMeasure>
  <lineItemTotal>30000</lineItemTotal>
  <itemDiscountAmount>0</itemDiscountAmount>
  <commodityCode>300</commodityCode>
  <unitCost>300.00</unitCost>
</lineItemData>
</enhancedData>
</credit>
</littleOnlineRequest>
  
```

### 3.3.10.3 Credit Response

The Credit response message is identical for Online and Batch transactions except Online includes the `postDate` element.

```

<creditResponse id="Credit Id" reportGroup="iQ Report Group"
customerId="Customer Id">
  <littleTxnId>Transaction Id</littleTxnId>
  <response>Response Code</response>
  <responseTime>Date and Time in GMT</responseTime>
  <postDate>Date of Posting</postDate> (Online Only)
  <message>Response Message</message>
  <tokenResponse> (for Tokenized merchants submitting card data)
</creditResponse>
  
```

#### Example: Credit Response

The example below illustrates a Batch Credit response. A response for an Online transaction uses a `littleOnlineResponse` element as the parent.

```

<littleResponse version="11.4" xmlns="http://www.little.com/schema" id="123"
cnpSessionId="987654321" response="0" message="Valid Format">
  <batchResponse id="01234567" cnpBatchId="4455667788" merchantId="100">
    <creditResponse id="AX54325432" reportGroup="RG12">
      <cnpTxnId>84568457</cnpTxnId>
      <response>000</response>
      <responseTime>2017-04-01T10:24:31</responseTime>
    </creditResponse>
  </batchResponse>
</littleResponse>
  
```

```
<message>Approved</message>
</creditResponse>
</batchResponse>
</litleResponse>
```

### Example: Credit Response for a Tokenized Merchant Sending Card Data

When a tokenized merchant submits card data in the Credit request, the response includes the tokenResponse element. The example below is a response for an Online request (<litleOnlineResponse> element not shown), so it includes the <postDate> element.

```
<creditResponse id="99999" reportGroup="RG1" customerId="444">
  <cnpTxnId>21200000473208</cnpTxnId>
  <response>000</response>
  <responseTime>2017-04-19T19:29:45</responseTime>
  <postDate>2017-04-19</postDate>
  <message>Approved</message>
  <tokenResponse>
    <cnpToken>1111102200202001</cnpToken>
    <tokenResponseCode>801</tokenResponseCode>
    <tokenMessage>Account number was successfully registered</tokenMessage>
    <type>VI</type>
    <bin>402410</bin>
  </tokenResponse>
</creditResponse>
```

## 3.3.11 Deactivate Transactions

The Deactivate transaction changes the status of a (Closed Loop) Gift Card from active to inactive.

---

---

**NOTE:** You must be enabled for (Closed Loop) Gift Card transactions to use this transaction type. Please consult your Relationship Manager for additional information about Gift Card transactions.

---

---

### 3.3.11.1 Deactivate Request

You must structure a Deactivate request as shown in the following examples. The structure of the request is identical for either an Online or a Batch submission.

```
<deactivate id="Activate Id" reportGroup="iQ Report Group" customerId="Customer
Id">
```

```
<orderId>Order Id</orderId>
<orderSource>Order Entry Source</orderSource>
<card>
</deactivate>
```

### Example: Online Deactivate Request

```
<littleOnlineRequest version="11.4" xmlns="http://www.little.com/schema"
  merchantId="100">
  <authentication>
    <user>User Name</user>
    <password>Password</password>
  </authentication>
  <deactivate id="834262" reportGroup="ABC Division" customerId="038945">
    <orderId>65347567</orderId>
    <orderSource>ecommerce</orderSource>
    <card>
      <type>GC</type>
      <number>9000000000000001</number>
      <pin>1234</pin>
    </card>
  </deactivate>
</littleOnlineRequest>
```

### 3.3.11.2 Deactivate Response

A Deactivate response has the following structure. The response message is identical for Online and Batch transactions except Online includes the <postDate> element.

```
<deactivateResponse id="Deactivate Id" reportGroup="iQ Report Group"
  customerId="Customer Id">
  <littleTxnId>Transaction Id</littleTxnId>
  <response>Response Code</response>
  <responseTime>Date and Time in GMT</responseTime>
  <postDate>Date transaction posted</postDate> (Online Only)
  <message>Response Message</message>
  <fraudResult>
  <approvedAmount>5000</approvedAmount>
  <giftCardResponse>
</deactivateResponse>
```



**Example: Online Deactivate Response**

```

<littleOnlineResponse version="11.4" xmlns="http://www.little.com/schema"
  response="0" message="Valid Format">
  <deactivateResponse id="834262" reportGroup="ABC Division">
    <cnpTxnId>9695064321</cnpTxnId>
    <response>000</response>
    <responseTime>2016-07-25T15:13:43</responseTime>
    <postDate>2016-07-25</postDate>
    <message>Approved</message>
    <approvedAmount>5000</approvedAmount>
    <giftCardResponse>
      <availableBalance>0</availableBalance>
      <beginningBalance>5000</beginningBalance>
      <endingBalance>0</endingBalance>
    </giftCardResponse>
  </deactivateResponse>
</littleOnlineResponse>

```

**3.3.12 Deactivate Reversal Transactions (Online Only)**

The Deactivate Reversal transaction changes the status of a newly deactivated Gift Card from inactive to active, thus reversing the operation of an Deactivate transaction. The Deactivate Reversal references the associated Deactivate transaction by means of the `littleTxnId` element returned in the Deactivate response. This transaction type is available only for Online transactions.

---

**NOTE:** You must be enabled for (Closed Loop) Gift Card transactions to use this transaction type. Please consult your Relationship Manager for additional information about Gift Card transactions.

---

**3.3.12.1 Deactivate Reversal Request**

You must structure an Deactivate Reversal request as shown in the following examples.

```

<deactivateReversal id="Deactivate Reversal Id" reportGroup="iQ Report Group"
  customerId="Customer Id">
  <littleTxnId>Transaction Id from Load Response</littleTxnId>
  <card>
    <originalRefCode>Reference Code from Deactivate Response</originalRefCode>
    <originalAmount>Amount from Deactivate Transaction</originalAmount>
  </card>
</deactivateReversal>

```

```
<originalTxnTime>Transaction Time from Deactivate Response</originalTxnTime>  
<originalSystemTraceId>Trace Id from Deactivate Resp</originalSystemTraceId>  
<originalSequenceNumber>Seq Num from Deactivate Resp</originalSequenceNumber>  
</deactivateReversal>
```

### Example: Deactivate Reversal Request

```
<litleOnlineRequest version="11.4" xmlns="http://www.litle.com/schema"  
  merchantId="100">  
  <authentication>  
    <user>User Name</user>  
    <password>Password</password>  
  </authentication>  
  <deactivateReversal id="12345" customerId="Customer Id"  
    reportGroup="Deactivate Reversals">  
    <cnpTxnId>1234567890123456789</cnpTxnId>  
    <card>  
      <type>GC</type>  
      <number>1234102000003558</number>  
      <cardValidationNum>888</cardValidationNum>  
      <pin>1234</pin>  
    </card>  
    <originalRefCode>123456</originalRefCode>  
    <originalAmount>1900</originalAmount>  
    <originalTxnTime>2017-03-21T10:02:46</originalTxnTime>  
    <originalSystemTraceId>678901</originalSystemTraceId>  
    <originalSequenceNumber>123456</originalSequenceNumber>  
  </deactivateReversal>  
</litleOnlineRequest>
```

### 3.3.12.2 Deactivate Reversal Response

An Deactivate Reversal response has the following structure.

```
<deactivateReversalResponse id="Deactivate Reversal Id" reportGroup="iQ  
Report Group" customerId="Customer Id">  
  <litleTxnId>Transaction Id</litleTxnId>  
  <response>Response Code</response>  
  <responseTime>Date and Time in GMT</responseTime>  
  <postDate>Date transaction posted</postDate>  
  <message>Response Message</message>
```

```
<giftCardResponse>  
</deactivateReversalResponse>
```

### Example: Online Deactivate Reversal Response

```
<littleOnlineResponse version="11.4" xmlns="http://www.little.com/schema"  
  response="0" message="Valid Format">  
  <deactivateReversalResponse id="834262" reportGroup="ABC Division">  
    <cnpTxnId>9695064321</cnpTxnId>  
    <response>000</response>  
    <responseTime>2017-03-22T15:13:43</responseTime>  
    <postDate>2017-03-22</postDate>  
    <message>Approved</message>  
    <giftCardResponse>  
      <txnTime>2017-03-22T12:00:00</txnTime>  
      <refCode>003558</refCode>  
      <systemTraceId>834528</systemTraceId>  
      <sequenceNumber>123456</sequenceNumber>  
      <availableBalance>5000</availableBalance>  
    </giftCardResponse>  
  </deactivateReversalResponse>  
</littleOnlineResponse>
```

## 3.3.13 Deposit Reversal Transactions (Online Only)

The Deposit Reversal transaction is a Gift Card transaction that reverses the deposit initiated by either a Capture or Sale transaction. The Deposit Reversal references the associated Capture/Sale transaction by means of the `littleTxnId` element returned in the Capture/Sale response. This transaction type is available only for Online transactions.

---

**NOTE:** You must be enabled for (Closed Loop) Gift Card transactions to use this transaction type. Please consult your Relationship Manager for additional information about Gift Card transactions.

---

### 3.3.13.1 Deposit Reversal Request

You must structure an Deposit Reversal request as shown in the following examples.

```
<depositReversal id="Deposit Reversal Id" reportGroup="iQ Report Group"  
  customerId="Customer Id">  
  <littleTxnId>Transaction Id from Load Response</littleTxnId>  
  <card>
```

```
<originalRefCode>Reference Code from Gift Card Capture Resp</originalRefCode>  
<originalAmount>Amount from Gift Card Capture Resp</originalAmount>  
<originalTxnTime>Transaction Time from GC Capture Response</originalTxnTime>  
<originalSystemTraceId>Trace Id from GC Capture Resp</originalSystemTraceId>  
<originalSequenceNumber>Seq Num from GC Capture Resp</originalSequenceNumber>  
</depositReversal>
```

### Example: Deposit Reversal Request

```
<litleOnlineRequest version="11.4" xmlns="http://www.litle.com/schema"  
  merchantId="100">  
  <authentication>  
    <user>User Name</user>  
    <password>Password</password>  
  </authentication>  
  <depositReversal id="12345" customerId="Customer Id" reportGroup="Deposit  
Reversals">  
    <cnpTxnId>1234567890123456789</cnpTxnId>  
    <card>  
      <type>GC</type>  
      <number>1234102000003558</number>  
      <cardValidationNum>888</cardValidationNum>  
    </card>  
    <originalRefCode>123456</originalRefCode>  
    <originalAmount>1900</originalAmount>  
    <originalTxnTime>2017-03-21T10:02:46</originalTxnTime>  
    <originalSystemTraceId>678901</originalSystemTraceId>  
    <originalSequenceNumber>123456</originalSequenceNumber>  
  </depositReversal>  
</litleOnlineRequest>
```

### 3.3.13.2 Deposit Reversal Response

An Deposit Reversal response has the following structure.

```
<depositReversalResponse id="Deactivate Reversal Id" reportGroup="iQ  
Report Group" customerId="Customer Id">  
  <litleTxnId>Transaction Id</litleTxnId>  
  <response>Response Code</response>  
  <responseTime>Date and Time in GMT</responseTime>  
  <postDate>Date transaction posted</postDate>
```

```

    <message>Response Message</message>
    <giftCardResponse>
</depositReversalResponse>

```

### Example: Online Deposit Reversal Response

```

<littleOnlineResponse version="11.4" xmlns="http://www.little.com/schema"
  response="0" message="Valid Format">
  <depositReversalResponse id="834262" reportGroup="ABC Division">
    <cnpTxnId>9695064321</cnpTxnId>
    <response>000</response>
    <responseTime>2017-03-22T15:13:43</responseTime>
    <postDate>2017-03-22</postDate>
    <message>Approved</message>
    <giftCardResponse>
      <txnTime>2017-03-22T12:00:00</txnTime>
      <refCode>003558</refCode>
      <systemTraceId>834528</systemTraceId>
      <sequenceNumber>123456</sequenceNumber>
      <availableBalance>5000</availableBalance>
    </giftCardResponse>
  </depositReversalResponse>
</littleOnlineResponse>

```

## 3.3.14 eCheck Credit Transactions

The eCheck Credit transaction enables you to refund a previous eCheck Sale. Merchants can submit an eCheck Credit transaction for a sale regardless of whether the original transaction was settled by our system, although the requests are structured differently. This section contains the following:

- [eCheck Credit Request Against a Vantiv Transaction](#)
- [eCheck Credit Request for a Non-Vantiv Processed Sale](#)
- [eCheck Credit Response](#)

---

**NOTE:** Although there are two different scenarios for eCheck Credit requests, the response message uses the same structure.

---

### 3.3.14.1 eCheck Credit Request Against a Vantiv Transaction

To request an eCheck Credit against an eCheck Sale that had been settled by us, you only need to specify the <littleTxnId> element. When you specify this element, the application uses the

<littleTxnId> to look up the referenced echeckSale transaction and obtain the necessary information. In this case, the <amount> element is optional, but should be included if the credit amount is less than the captured amount. If you do not include the <amount> element, the system assumes the credit to be for the total amount of the referenced transaction.

When requesting a echeckCredit against an echeckSale that occurred within our system, specify the Credit request as follows:

```
<echeckCredit id="Credit Id" reportGroup="iQ Report Group" customerId="Customer Id">
  <littleTxnId>Transaction Id</littleTxnId>
  <amount>Credit Amount</amount>
  <secondaryAmount>Secondary Amount</secondaryAmount>
  <customBilling> (Do not use)
  <customIdentifier>
</echeckCredit>
```

### Example: eCheck Credit Request

The eCheck Credit batch request shown below contains three <echeckCredit> elements. The first two use a Transaction Id as a reference. The third, which you would use for a sale occurring outside of our system, uses the <orderId>, <amount>, <billToAddress>, and <echeck> elements to provide the required information.

```
<littleRequest version="11.3" xmlns="http://www.little.com/schema"
  numBatchRequests="1">
  <authentication>
    <user>userName</user>
    <password>password</password>
  </authentication>
  <batchRequest id="xmlbat01" numEcheckCredit="3" echeckCreditAmount="12100"
  merchantId="000053">
    <echeckCredit id="credit1" reportGroup="new53" customerId="53">
      <cnpTxnId>4455667788</cnpTxnId>
      <amount>1000</amount>
    </echeckCredit>
    <echeckCredit reportGroup="new53">
      <cnpTxnId>4455667789</cnpTxnId>
      <amount>1100</amount>
    </echeckCredit>
    <echeckCredit reportGroup="new53">
      <orderId>12z58743y1</orderId>
      <amount>10000</amount>
      <orderSource>ecommerce</orderSource>
      <billToAddress>
```

```

    <name>John Doe</name>
    <addressLine1>123 4th street</addressLine1>
    <addressLine2>Apt. 20</addressLine2>
    <addressLine3>second floor</addressLine3>
    <city>San Jose</city>
    <state>CA</state>
    <zip>95032</zip>
    <country>USA</country>
    <email>jdoe@isp.com</email>
    <phone>408-555-1212</phone>
  </billToAddress>
  <echeck>
    <accType>Checking</accType>
    <accNum>5186005800001012</accNum>
    <routingNum>000010101</routingNum>
    <checkNum>1104</checkNum>
  </echeck>
</echeckCredit>
</batchRequest>
</litleRequest>

```

### 3.3.14.2 eCheck Credit Request for a Non-Vantiv Processed Sale

If the original eCheck Sale transaction was not processed via our system, or the if the `<litleTxnId>` for the original eCheck Sale transaction is not available, specify eCheck Credit request as follows:

```

  <echeckCredit id="eCheckCredit Id" reportGroup="iQ Report Group"
  customerId="Customer Id">
    <orderId>Order Id</orderId>
    <amount>Credit Amount</amount>
    <secondaryAmount>Secondary Amount</secondaryAmount>
    <orderSource>Order Entry Source</orderSource>
    <billToAddress>
    <echeck> or <echeckToken>
    <customBilling> (Do not use)
    <merchantData>
  </echeckCredit>

```

The third transaction shown in the [eCheck Credit Request](#) example on page 264 shows an example of a Credit request against a non-Vantiv processed transaction.

### 3.3.14.3 eCheck Credit Response

The eCheck Credit message is identical for either type of eCheck Credit request. The <accountUpdater> element is included only if you submit account information in the request transaction for which a NOC exists. In this case the system automatically updates the information sent to the ACH network and includes the change information in the response.

The eCheck Credit response has the following structure:

```
<echeckCreditResponse id="eCheck Credit Id" reportGroup="iQ Report Group"
customerId="Customer Id">
  <littleTxnId>Transaction Id</littleTxnId>
  <response>Response Code</response>
  <responseTime>Date and Time in GMT</responseTime>
  <message>Response Message</message>
  <postDate>Date of Posting</postDate> (Online Only)
  <accountUpdater>Account Change Info</accountUpdater>
  <tokenResponse> (for Tokenized merchants submitting account data)
</echeckCreditResponse>
```

#### Example: eCheck Credit Response

```
<littleResponse version="11.4" xmlns="http://www.little.com/schema" id="123"
response="0" message="Valid Format" cnpSessionId="987654321">
  <batchResponse id="01234567" cnpBatchId="4455667788" merchantId="100">
    <echeckCreditResponse id="AX54321678" reportGroup="RG27"
customerId="53">
      <cnpTxnId>84568456</cnpTxnId>
      <response>000</response>
      <responseTime>2017-04-01T10:24:31</responseTime>
      <message>Approved</message>
    </echeckCreditResponse>
  </batchResponse>
</littleResponse>
```

### 3.3.15 eCheck Prenotification Credit Transactions (Batch Only)

You use this non-monetary transaction to verify the consumer's account information prior to submitting an eCheck Credit transaction (also see [eCheck Prenotification](#) on page 49). This transaction type is only supported for US transactions.



### 3.3.15.1 eCheck Prenotification Credit Request

You must specify the eCheck Prenotification Credit request using the following format:

```
<echeckPreNoteCredit id="eCheck PreNote Id" reportGroup="iQ Report Group"
customerId="Customer Id">
  <orderId>Order Id</orderId>
  <orderSource>Order Entry Source</orderSource>
  <billToAddress>
  <echeck>
  <merchantData>
</echeckPreNoteCredit>
```

#### Example: eCheck Prenotification Credit Request

```
<littleRequest version="11.4" xmlns="http://www.little.com/schema" id="123"
numBatchRequests="1">
  <authentication>
    <user>userName</user>
    <password>password</password>
  </authentication>
  <batchRequest id="654321" numEcheckPreNoteCredit="1" merchantId="100">
    <echeckPreNoteCredit id="AX54321678" reportGroup="RG27" customerId="53">
      <orderId>12z58743y1</orderId>
      <orderSource>telephone</orderSource>
      <billToAddress>
        <firstName>John</firstName>
        <lastName>Doe</lastName>
        <addressLine1>123 4th street</addressLine1>
        <addressLine2>Apt. 20</addressLine2>
        <addressLine3>second floor</addressLine3>
        <city>San Jose</city>
        <state>CA</state>
        <zip>95032</zip>
        <country>USA</country>
        <email>jdoe@isp.com</email>
        <phone>408-555-1212</phone>
      </billToAddress>
      <echeck>
        <accType>Checking</accType>
        <accNum>5186005800001012</accNum>
        <routingNum>000010101</routingNum>
        <checkNum>1104</checkNum>
```

```
</echeck>
</echeckPreNoteCredit>
</batchRequest>
</litleRequest>
```

### 3.3.15.2 eCheck Prenotification Credit Response

The eCheck Prenotification Credit response has the following structure:

```
<echeckPreNoteCreditResponse id="eCheckSale Id" reportGroup="iQ Report Group"
customerId="Customer Id">
  <litleTxnId>Transaction Id</litleTxnId>
  <orderId>Order Id</orderId>
  <response>Response Code</response>
  <responseTime>Date and Time in GMT</responseTime>
  <message>Response Message</message>
</echeckPreNoteCreditResponse>
```

#### Example: eCheck Prenotification Credit Response

```
<litleResponse version="11.4" xmlns="http://www.litle.com/schema" id="123"
response="0" message="Valid Format" cnpSessionId="987654321">
  <batchResponse id="01234567" cnpBatchId="4455667788" merchantId="100">
    <echeckPreNoteCreditResponse id="AX54321678" reportGroup="RG27"
customerId="53">
      <cnpTxnId>84568456</cnpTxnId>
      <orderId>12z58743y1</orderId>
      <response>000</response>
      <responseTime>2017-03-01T10:24:31</responseTime>
      <message>Approved</message>
    </echeckPreNoteCreditResponse>
  <echeckPreNoteCreditResponse id="AX54325432" reportGroup="RG12">
    <cnpTxnId>84568457</cnpTxnId>
    <orderId>12z58743y7</orderId>
    <response>000</response>
    <responseTime>2017-03-01T10:24:31</responseTime>
    <message>Approved</message>
  </echeckPreNoteCreditResponse>
</batchResponse>
</litleResponse>
```

### 3.3.16 eCheck Prenotification Sale Transactions (Batch Only)

You use this non-monetary transaction to verify the consumer's account information prior to submitting an eCheck Sale transaction (also see [eCheck Prenotification](#) on page 49). This transaction type is only supported for US transactions.

#### 3.3.16.1 eCheck Prenotification Sale Request

You must specify the eCheck Prenotification Credit request using the following format:

```
<echeckPreNoteSale id="eCheck PreNote Id" reportGroup="iQ Report Group"
customerId="Customer Id">
  <orderId>Order Id</orderId>
  <orderSource>Order Entry Source</orderSource>
  <billToAddress>
  <echeck>
  <merchantData>
</echeckPreNotesale>
```

#### Example: eCheck Prenotification Sale Request

```
<littleRequest version="11.4" xmlns="http://www.little.com/schema" id="123"
numBatchRequests="1">
  <authentication>
    <user>userName</user>
    <password>password</password>
  </authentication>
  <batchRequest id="654321" numEcheckPreNoteSale="1" merchantId="100">
    <echeckPreNoteSale id="AX54321678" reportGroup="RG27" customerId="53">
      <orderId>12z58743y1</orderId>
      <orderSource>telephone</orderSource>
      <billToAddress>
        <firstName>John</firstName>
        <lastName>Doe</lastName>
        <addressLine1>123 4th street</addressLine1>
        <addressLine2>Apt. 20</addressLine2>
        <addressLine3>second floor</addressLine3>
        <city>San Jose</city>
        <state>CA</state>
        <zip>95032</zip>
        <country>USA</country>
        <email>jdoe@isp.com</email>
        <phone>408-555-1212</phone>
```

```

    </billToAddress>
    <echeck>
      <accType>Checking</accType>
      <accNum>5186005800001012</accNum>
      <routingNum>000010101</routingNum>
      <checkNum>1104</checkNum>
    </echeck>
  </echeckPreNoteSale>
</batchRequest>
</litleRequest>

```

### 3.3.16.2 eCheck Prenotification Sale Response

The eCheck Prenotification Sale response has the following structure:

```

<echeckPreNoteSaleResponse id="eCheckSale Id" reportGroup="iQ Report Group"
customerId="Customer Id">
  <litleTxnId>Transaction Id</litleTxnId>
  <orderId>Order Id</orderId>
  <response>Response Code</response>
  <responseTime>Date and Time in GMT</responseTime>
  <message>Response Message</message>
</echeckPreNoteSaleResponse>

```

#### Example: eCheck Prenotification Sale Response

```

<litleResponse version="11.4" xmlns="http://www.litle.com/schema" id="123"
response="0" message="Valid Format" cnpSessionId="987654321">
  <batchResponse id="01234567" cnpBatchId="4455667788" merchantId="100">
    <echeckPreNoteSaleResponse id="AX54321678" reportGroup="RG27"
customerId="53">
      <cnpTxnId>84568456</cnpTxnId>
      <orderId>12z58743y1</orderId>
      <response>000</response>
      <responseTime>2017-03-01T10:24:31</responseTime>
      <message>Approved</message>
    </echeckPreNoteCreditResponse>
  <echeckPreNoteCreditResponse id="AX54325432" reportGroup="RG12">
    <cnpTxnId>84568457</cnpTxnId>
    <orderId>12z58743y7</orderId>
    <response>000</response>
    <responseTime>2017-03-01T10:24:31</responseTime>
  </echeckPreNoteCreditResponse>
</batchResponse>
</litleResponse>

```

```

    <message>Approved</message>
  </echeckPreNoteSaleResponse>
</batchResponse>
</litleResponse>

```

### 3.3.17 eCheck Redeposit Transactions

You use this transaction type to manually attempt redeposits of eChecks returned for either Insufficient Funds or Uncollected Funds. You can use this element in either Batch or Online transactions.

---

**NOTE:** Do not use this transaction type if you are enabled for the Auto Redeposit feature. If you are enabled for the Auto Redeposit feature, the system will reject any `echeckRedeposit` transaction you submit.

---

#### 3.3.17.1 eCheck Redeposit Request

You must specify the eCheck Redeposit request using the following format:

```

<echeckRedeposit id="eCheck Redeposit Id" reportGroup="iQ Report Group"
customerId="Customer Id">
  <litleTxnId>Transaction Id</litleTxnId>
  <echeck> or <echeckToken>
  <merchantData>
  <customIdentifier>
</echeckredeposit>

```

---

**NOTE:** If you include the `echeck` element, the values submitted for `accType`, `accNum`, and `routingNum` children must match those submitted in the original `echeckSale` transaction.

---

#### Example: Online eCheck Redeposit Request

```

<litleOnlineRequest version="11.4" xmlns="http://www.litle.com/schema"
merchantId="81603">
  <authentication>
    <user>User Name</user>
    <password>password</password>
  </authentication>
  <echeckRedeposit reportGroup="001603">

```

```
<cnpTxnId>345454444</cnpTxnId>
<echeck>
  <accType>Checking</accType>
  <accNum>1099999903</accNum>
  <routingNum>114567895</routingNum>
</echeck>
<merchantData>
  <campaign>New Marketing Campaign</campaign>
</merchantData>
</echeckRedeposit>
</litleOnlineRequest>
```

### Example: Batch eCheck Redeposit Request

```
<litleRequest version="11.4" xmlns="http://www.litle.com/schema"
  numBatchRequests="1">
  <authentication>
    <user>User Name</user>
    <password>Password</password>
  </authentication>
  <batchRequest id="uniqueId" numEcheckRedeposit="4" merchantId="1603">
    <echeckRedeposit reportGroup="001603">
      <cnpTxnId>3456456444</cnpTxnId>
      <merchantdata>
        <affiliate>ABC Marketing</affiliate>
      </merchantdata>
    </echeckRedeposit>
    <echeckRedeposit reportGroup="001603">
      <cnpTxnId>3456456449</cnpTxnId>
      <echeck>
        <accType>Checking</accType>
        <accNum>1099999903</accNum>
        <routingNum>114567895</routingNum>
      </echeck>
      <merchantdata>
        <affiliate>ABC Marketing</affiliate>
      </merchantdata>
    </echeckRedeposit>
    <echeckRedeposit reportGroup="001603">
      <cnpTxnId>3456557123</cnpTxnId>
      <echeck>
        <accType>Savings</accType>
        <accNum>10999999444</accNum>
```

```
<routingNum>114567895</routingNum>
</echeck>
<merchantdata>
  <affiliate>ABC Marketing</affiliate>
</merchantdata>
</echeckRedeposit>
<echeckRedeposit reportGroup="001603">
  <cnpTxnId>123456789</cnpTxnId>
</echeckRedeposit>
</batchRequest>
</litleRequest>
```

### 3.3.17.2 eCheck Redeposit Response

The eCheck Redeposit response indicates that we have received your eCheck Redeposit request. This does not indicate when funds will be transferred. The <accountUpdater> element is included only if the account information submitted in the request transaction has changed (NOC exists). In this case the system automatically updates the information sent to the ACH network and includes the change information in the response.

The eCheck Sale response has the following structure:

```
<echeckRedepositResponse id="eCheckRedeposit Id" reportGroup="iQ Report Group"
customerId="Customer Id">
  <litleTxnId>Transaction Id</litleTxnId>
  <response>Response Code</response>
  <responseTime>Date and Time in GMT</responseTime>
  <message>Response Message</message>
  <postDate>Date of Posting</postDate> (Online Only)
  <accountUpdater>Account Change Info</accountUpdater>
</echeckRedepositResponse>
```

#### Example: Batch eCheck Redeposit Response

```
<litleResponse version="11.4" xmlns="http://www.litle.com/schema" id="123"
response="0" message="Valid Format" cnpSessionId="987654321">
  <batchResponse id="01234567" cnpBatchId="4455667788" merchantId="100">
    <echeckRedepositResponse id="AX54321678" reportGroup="RG27"
customerId="53">
      <cnpTxnId>84568456</cnpTxnId>
      <response>000</response>
      <responseTime>2017-06-01T10:24:31</responseTime>
      <message>Approved</message>
```

```
</echeckRedepositResponse>
<echeckRedepositResponse id="AX54325432" reportGroup="RG12">
  <cnpTxnId>84568457</cnpTxnId>
  <response>000</response>
  <responseTime>2017-06-01T10:24:31</responseTime>
  <message>Approved</message>
  <accountUpdater>
    <originalAccountInfo>
      <accType>Checking</accType>
      <accNum>5186005800001012</accNum>
      <routingNum>000010101</routingNum>
    </originalAccountInfo>
    <newAccountInfo>
      <accType>Checking</accType>
      <accNum>5499576040500006</accNum>
      <routingNum>000010102</routingNum>
    </newAccountInfo>
  </accountUpdater>
</echeckRedepositResponse>
</batchResponse>
</litleResponse>
```

### 3.3.18 eCheck Sale Transactions

You use the eCheck Sale transaction to capture funds from a customer paying via electronic checks. It is the eCheck equivalent of a Capture transaction. Setting the `<verify>` element to **true** triggers an eCheck Verification operation prior to the capture. If the verification fails, the system does not process the capture operation.

---

**NOTE:** To perform a verification you must include the following optional children of the `billToAddress` element in your request: `firstName`, `lastName`, `companyName` (if `accType = Corporate or Corp Savings`), `address1` (address 2 and 3 if needed), `city`, `state`, `zip`, and `phone`.

The value for the `orderSource` element must be one of the following: `telephone`, `ecommerce`, or `recurringtel`.

---

#### 3.3.18.1 eCheck Sale Request

You must specify the eCheck Sale request using the following format:

```
<echeckSale id="eCheckSale Id" reportGroup="iQ Report Group"
customerId="Customer Id">
```



```
<orderId>Order Id</orderId>
<verify>true or false</verify>
<amount>Authorization Amount</amount>
<secondaryAmount>Secondary Amount</secondaryAmount>
<orderSource>Order Entry Source</orderSource>
<billToAddress>
<shipToAddress>
<echeck> or <echeckToken>
<customBilling> (Do not use)
<merchantData>
<customIdentifier>
</echeckSale>
```

### Example: Batch eCheck Sale Request

```
<littleRequest version="11.4" xmlns="http://www.little.com/schema" id="123"
  numBatchRequests="1">
  <authentication>
    <user>userName</user>
    <password>password</password>
  </authentication>
  <batchRequest id="654321" numEcheckSales="1" echeckSalesAmount="10000"
    merchantId="100">
    <echeckSale id="AX54321678" reportGroup="RG27" customerId="53">
      <orderId>12z58743y1</orderId>
      <verify>true</verify>
      <amount>10000</amount>
      <orderSource>telephone</orderSource>
      <billToAddress>
        <firstName>John</firstName>
        <lastName>Doe</lastName>
        <addressLine1>123 4th street</addressLine1>
        <addressLine2>Apt. 20</addressLine2>
        <addressLine3>second floor</addressLine3>
        <city>San Jose</city>
        <state>CA</state>
        <zip>95032</zip>
        <country>USA</country>
        <email>jdoe@isp.com</email>
        <phone>408-555-1212</phone>
      </billToAddress>
```

```
<echeck>
  <accType>Checking</accType>
  <accNum>5186005800001012</accNum>
  <routingNum>000010101</routingNum>
  <checkNum>1104</checkNum>
</echeck>
</echeckSale>
</batchRequest>
</litleRequest>
```

### 3.3.18.2 eCheck Sale Response

The eCheck Sale response indicates that we have received your eCheck Sale request. This does not indicate when funds will be transferred. The `<accountUpdater>` element is included only if the account information submitted in the request transaction has changed (NOC exists). In this case the system automatically updates the information sent to the ACH network and includes the change information in the response.

---

---

**NOTE:** The schema for `echeckSalesResponse` includes a `verificationCode` child element. This element is not used at this time.

---

---

The eCheck Sale response has the following structure:

```
<echeckSalesResponse id="eCheckSale Id" reportGroup="iQ Report Group"
customerId="Customer Id">
  <litleTxnId>Transaction Id</litleTxnId>
  <response>Response Code</response>
  <responseTime>Date and Time in GMT</responseTime>
  <message>Response Message</message>
  <postDate>Date of Posting</postDate> (Online Only)
  <accountUpdater>Account Change Info</accountUpdater>
  <tokenResponse> (for Tokenized merchants submitting account data)
</echeckSaleResponse>
```

#### Example: Batch eCheck Sale Response

The response example below includes the `accountUpdater` element, which indicates that there is a NOC against the account and provides the new account information. If the request used a token, the `accountUpdater` element would have children providing the original and new token information.

```

<litleResponse version="11.4" xmlns="http://www.litle.com/schema" id="123"
  response="0" message="Valid Format" cnpSessionId="987654321">
  <batchResponse id="01234567" cnpBatchId="4455667788" merchantId="100">
    <echeckSalesResponse id="AX54321678" reportGroup="RG27" customerId="53">
      <cnpTxnId>84568456</cnpTxnId>
      <response>000</response>
      <responseTime>2016-09-01T10:24:31</responseTime>
      <message>Approved</message>
    </echeckSalesResponse>
    <echeckSalesResponse id="AX54325432" reportGroup="RG12">
      <cnpTxnId>84568457</cnpTxnId>
      <response>000</response>
      <responseTime>2016-09-01T10:24:31</responseTime>
      <message>Approved</message>
      <accountUpdater>
        <originalAccountInfo>
          <accType>Checking</accType>
          <accNum>5186005800001012</accNum>
          <routingNum>000010101</routingNum>
        </originalAccountInfo>
        <newAccountInfo>
          <accType>Checking</accType>
          <accNum>5499576040500006</accNum>
          <routingNum>000010102</routingNum>
        </newAccountInfo>
      </accountUpdater>
    </echeckSalesResponse>
  </batchResponse>
</litleResponse>

```

### 3.3.19 eCheck Verification Transactions

You use an eCheck Verification transaction to initiate a comparison to a database containing information about checking accounts. The database may include information as to whether the account has been closed, as well as whether there is a history of undesirable behavior associated with the account/account holder. This transaction type is only supported for US transactions.

---

**NOTE:** While eCheck Verification is a valuable tool that you can use to reduce possible fraud and loss, unlike a credit card authorization, it does not check for the availability of funds, nor does it place a hold on any funds.

---

### 3.3.19.1 eCheck Verification Request

You must specify the eCheck Verification request using the following format:

---

---

**IMPORTANT:** For an eCheckVerification transaction, you must submit the `firstName` and `lastName` elements instead of the `name` element (`middleInitial` is optional). For a corporate account you must include the `companyName` element in addition to the `firstName` and `lastName` elements. In both cases, you also must include the address, city, state, zip and phone information.

For a corporate account, if you do not have the name of the check issuer, you can use a value of "unavailable" for the `firstName` and `lastName` elements.

---

---

```
<echeckVerification id="echeckVerification Id" reportGroup="iQ Report Group"
customerId="Customer Id">
  <orderId>Order Id</orderId>
  <amount>Authorization Amount</amount>
  <orderSource>Order Entry Source</orderSource>
  <billToAddress>
  <echeck> or <echeckToken>
  <merchantData>
</echeckVerification>
```

#### Example: eCheck Verification Request - Personal Checking

```
<littleRequest version="11.4" xmlns="http://www.little.com/schema" id="123"
numBatchRequests="1">
  <authentication>
    <user>userName</user>
    <password>password</password>
  </authentication>
  <batchRequest id="654321" numEcheckVerification="1"
echeckVerificationAmount="10000" merchantId="100">
    <echeckVerification id="AX54321678" reportGroup="RG27" customerId="53">
      <orderId>12z58743y1</orderId>
      <amount>10000</amount>
      <orderSource>telephone</orderSource>
      <billToAddress>
        <firstName>John</firstName>
        <lastName>Doe</lastName>
        <addressLine1>123 4th street</addressLine1>
        <addressLine2>Apt. 20</addressLine2>
```

```

    <addressLine3>second floor</addressLine3>
    <city>San Jose</city>
    <state>CA</state>
    <zip>95032</zip>
    <country>USA</country>
    <email>jdoe@isp.com</email>
    <phone>408-555-1212</phone>
  </billToAddress>
  <echeck>
    <accType>Checking</accType>
    <accNum>5186005800001012</accNum>
    <routingNum>000010101</routingNum>
    <checkNum>1104</checkNum>
  </echeck>
  <merchantData>
    <campaign>New Campaign</campaign>
  </merchantData>
</echeckVerification>
</batchRequest>
</litleRequest>

```

### Example: eCheck Verification Request - Corporate Account

---

**NOTE:** If you do not have the name of the check issuer, you can use a value of "unavailable" for the `firstName` and `lastName` elements.

---

```

<litleRequest version="11.4" xmlns="http://www.litle.com/schema" id="123"
  numBatchRequests="1">
  <authentication>
    <user>userName</user>
    <password>password</password>
  </authentication>
  <batchRequest id="654321" numEcheckVerification="1"
  echeckVerificationAmount="10000" merchantId="100">
    <echeckVerification id="AX54321678" reportGroup="RG27" customerId="53">
      <orderId>12z58743y1</orderId>
      <amount>10000</amount>
      <orderSource>telephone</orderSource>
      <billToAddress>
        <firstName>Paul</firstName>
        <lastName>Jones</lastName>
        <companyName>Widget Company</companyName>
      </billToAddress>
    </echeckVerification>
  </batchRequest>
</litleRequest>

```

```
<addressLine1>123 4th street</addressLine1>
<addressLine2>Apt. 20</addressLine2>
<addressLine3>second floor</addressLine3>
<city>San Jose</city>
<state>CA</state>
<zip>95032</zip>
<country>USA</country>
<email>pjones@isp.com</email>
<phone>408-555-1212</phone>
</billToAddress>
<echeck>
  <accType>Corporate</accType>
  <accNum>5186005800001012</accNum>
  <routingNum>000010101</routingNum>
  <checkNum>1104</checkNum>
</echeck>
</echeckVerification>
</batchRequest>
</litleRequest>8.6
```

### 3.3.19.2 eCheck Verification Response

The `<accountUpdater>` element is included only if the account information submitted in the request transaction has changed (NOC exists). In this case the system automatically updates the information sent to the ACH network and includes the change information in the response.

The eCheck Verification response has the following structure:

```
<echeckVerificationResponse id="echeckVerification Id" reportGroup="iQ Report
Group" customerId="Customer Id">
  <litleTxnId>Transaction Id</litleTxnId>
  <response>Response Code</response>
  <responseTime>Date and Time in GMT</responseTime>
  <message>Response Message</message>
  <postDate>Date of Posting</postDate> (Online Only)
  <tokenResponse> (for Tokenized merchants submitting account data)
  <accountUpdater>Account Change Info</accountUpdater>
</echeckSaleResponse>
```

#### Example: eCheck Verification Response

```
<litleResponse version="11.4" xmlns="http://www.litle.com/schema" id="123"
```

```

response="0" message="Valid Format" cnpSessionId="987654321">
<batchResponse id="01234567" cnpBatchId="4455667788" merchantId="100">
  <echeckVerificationResponse id="AX54321678" reportGroup="RG27"
customerId="53">
    <cnpTxnId>84568456</cnpTxnId>
    <response>000</response>
    <responseTime>2016-09-01T10:24:31</responseTime>
    <message>Approved</message>
  </echeckVerificationResponse>
  <echeckVerificationResponse id="AX54325432" reportGroup="RG12">
    <cnpTxnId>84568457</cnpTxnId>
    <response>000</response>
    <responseTime>2016-09-01T10:24:31</responseTime>
    <message>Approved</message>
    <accountUpdater>
      <originalAccountInfo>
        <accType>Checking</accType>
        <accNum>5186005800001012</accNum>
        <routingNum>000010101</routingNum>
      </originalAccountInfo>
      <newAccountInfo>
        <accType>Checking</accType>
        <accNum>5499576040500006</accNum>
        <routingNum>000010102</routingNum>
      </newAccountInfo>
    </accountUpdater>
  </echeckVerificationResponse>
</batchResponse>
</littleResponse>

```

### 3.3.20 eCheck Void Transactions (Online Only)

You use an eCheck Void transaction to either halt automatic redeposit attempts of eChecks returned for either Insufficient Funds or Uncollected Funds, or cancel an eCheck Sale transaction, as long as the transaction has not yet settled. This also applies to merchant initiated redeposits. You can use this element only in Online transactions.

#### 3.3.20.1 eCheck Void Request

The eCheck Void request references the `<littleTxnId>` of the previously approved transaction. You must structure an eCheck Void request as follows.

```
<echeckVoid id = "echeckVoid Id" reportGroup="iQ Report Group">
  <littleTxnId>Transaction Id</littleTxnId>
</echeckVoid>
```

### Example: eCheck Void Request

```
<littleOnlineRequest version="11.4" xmlns="http://www.little.com/schema"
  merchantId="81601">
  <authentication>
    <user>User Name</user>
    <password>Password</password>
  </authentication>
  <echeckVoid id="101" reportGroup="001601">
    <cnpTxnId>345454444</cnpTxnId>
  </echeckVoid>
</littleOnlineRequest>
```

### 3.3.20.2 eCheck Void Response

The eCheck Void response has the following structure.

```
<echeckVoidResponse id="eCheck Void Id" reportGroup="iQ Report Group"
  numDeposits=>"1"
  <littleTxnId>Transaction Id</littleTxnId>
  <response>Response Code</response>
  <responseTime>Date and Time in GMT</responseTime>
  <postDate>Date of Posting</postDate>
  <message>Response Message</message>
</echeckVoidResponse>
```

### Example: Online eCheck Void Response

```
<littleOnlineResponse version="11.4" xmlns="http://www.little.com/schema"
  response="0" message="Valid Format">
  <echeckVoidResponse id="101" reportGroup="001601">
    <cnpTxnId>21200000026600</cnpTxnId>
    <response>000</response>
    <responseTime>2017-06-17T21:20:50</responseTime>
    <message>Approved</message>
    <postDate>2017-06-17</postDate>
  </echeckVoidResponse>
</littleOnlineResponse>
```



## 3.3.21 Force Capture Transactions

A Force Capture transaction is a Capture transaction used when you do not have a valid Authorization for the order, but have fulfilled the order and wish to transfer funds.

---

---

**CAUTION:** Merchants must be authorized by Vantiv before submitting transactions of this type. In some instances, using a Force Capture transaction can lead to chargebacks and fines.

---

---

### 3.3.21.1 Force Capture Request

You must specify the Force Capture request as follows. The structure of the request is identical for either an Online or a Batch submission.

```
<forceCapture id="Id" reportGroup="iQ Report Group" customerId="Customer Id">
  <orderId>Order Id</orderId>
  <amount>Force Capture Amount</amount>
  <secondaryAmount>Secondary Amount</secondaryAmount>
  <orderSource>Order Entry Source</orderSource>
  <billToAddress>
    [ <card | token> | <paypage> | <mpos> ]
  <customBilling>
  <taxType>payment or fee</taxType>
  <enhancedData>
  <processingInstructions>
  <pos>
  <amexAggregatorData>
  <merchantData>
  <debtRepayment>true or false</debtRepayment>
  <processingType>processingType Enum</processingType>
</forceCapture>
```

#### Example: Batch Force Capture Request

```
<littleRequest version="11.4" xmlns="http://www.little.com/schema" id="123"
  numBatchRequests="1">
  <authentication>
```

```
<user>userName</user>
<password>password</password>
</authentication>
<batchRequest id="01234567" numForceCaptures="1"
forceCaptureAmount="10000" merchantId="100">
  <forceCapture id="AX54321678" reportGroup="RG27" customerId="038945">
    <orderId>orderId</orderId>
    <amount>10000</amount>
    <orderSource>ecommerce</orderSource>
    <card>
      <type>VI</type>
      <number>4005550000081019</number>
      <expDate>0910</expDate>
    </card>
    <enhancedData>
      <customerReference>P012345</customerReference>
      <salesTax>125</salesTax>
      <taxExempt>>false</taxExempt>
      <discountAmount>0</discountAmount>
      <shippingAmount>495</shippingAmount>
      <dutyAmount>0</dutyAmount>
      <shipFromPostalCode>01851</shipFromPostalCode>
      <destinationPostalCode>01851</destinationPostalCode>
      <destinationCountryCode>USA</destinationCountryCode>
      <invoiceReferenceNumber>123456</invoiceReferenceNumber>
      <orderDate>2016-09-14</orderDate>
      <detailTax>
        <taxIncludedInTotal>>true</taxIncludedInTotal>
        <taxAmount>55</taxAmount>
        <taxRate>0.0059</taxRate>
        <taxTypeIdentifier>00</taxTypeIdentifier>
        <cardAcceptorTaxId>011234567</cardAcceptorTaxId>
      </detailTax>
      <lineItemData>
        <itemSequenceNumber>1</itemSequenceNumber>
        <itemDescription>chair</itemDescription>
        <productCode>CH123</productCode>
        <quantity>1</quantity>
        <unitOfMeasure>EACH</unitOfMeasure>
        <taxAmount>125</taxAmount>
        <lineItemTotal>9380</lineItemTotal>
        <lineItemTotalWithTax>9505</lineItemTotalWithTax>
        <itemDiscountAmount>0</itemDiscountAmount>
      </lineItemData>
    </forceCapture>
  </batchRequest>

```

```

    <commodityCode>300</commodityCode>
    <unitCost>93.80</unitCost>
    <detailTax>
      <taxIncludedInTotal>true</taxIncludedInTotal>
      <taxAmount>55</taxAmount>
      <taxRate>0.0059</taxRate>
      <taxTypeIdentifier>03</taxTypeIdentifier>
      <cardAcceptorTaxId>011234567</cardAcceptorTaxId>
    </detailTax>
  </lineItemData>
</enhancedData>
</forceCapture>
</batchRequest>
</litleRequest>

```

### Example: Online Force Capture Request

```

<litleOnlineRequest version="11.4" xmlns="http://www.litle.com/schema"
  merchantId="123">
  <authentication>
    <user>userName</user>
    <password>password</password>
  </authentication>
  <forceCapture id="AX54321678" reportGroup="RG27" customerId="038945">
    <orderId>orderId</orderId>
    <amount>10000</amount>
    <orderSource>ecommerce</orderSource>
    <card>
      <type>VI</type>
      <number>4005550000081019</number>
      <expDate>0907</expDate>
    </card>
    <enhancedData>
      <customerReference>PO12345</customerReference>
      <salesTax>125</salesTax>
      <taxExempt>>false</taxExempt>
      <discountAmount>0</discountAmount>
      <shippingAmount>495</shippingAmount>
      <dutyAmount>0</dutyAmount>
      <shipFromPostalCode>01851</shipFromPostalCode>
      <destinationPostalCode>01851</destinationPostalCode>
      <destinationCountryCode>USA</destinationCountryCode>
      <invoiceReferenceNumber>123456</invoiceReferenceNumber>
    </enhancedData>
  </forceCapture>
</litleOnlineRequest>

```

```

<orderDate>2016-08-14</orderDate>
<detailTax>
  <taxIncludedInTotal>true</taxIncludedInTotal>
  <taxAmount>55</taxAmount>
  <taxRate>0.0059</taxRate>
  <taxTypeIdentifier>00</taxTypeIdentifier>
  <cardAcceptorTaxId>011234567</cardAcceptorTaxId>
</detailTax>
<lineItemData>
  <itemSequenceNumber>1</itemSequenceNumber>
  <itemDescription>chair</itemDescription>
  <productCode>CH123</productCode>
  <quantity>1</quantity>
  <unitOfMeasure>EACH</unitOfMeasure>
  <taxAmount>125</taxAmount>
  <lineItemTotal>9380</lineItemTotal>
  <lineItemTotalWithTax>9505</lineItemTotalWithTax>
  <itemDiscountAmount>0</itemDiscountAmount>
  <commodityCode>300</commodityCode>
  <unitCost>93.80</unitCost>
</lineItemData>
</enhancedData>
</forceCapture>
</littleOnlineRequest>
  
```

### 3.3.21.2 Force Capture Response

The Force Capture response message is identical for Online and Batch transactions, except Online includes the <postDate> element. The Force Capture response has the following structure:

```

<forceCaptureResponse id="Capture Id" reportGroup="iQ Report Group"
customerId="Customer Id">
  <littleTxnId>Transaction Id</littleTxnId>
  <response>Response Code</response>
  <responseTime>Date and Time in GMT</responseTime>
  <postDate>Date of Posting</postDate> (Online Only)
  <message>Response Message</message>
  <tokenResponse> (for Tokenized merchants submitting card data)
  <accountUpdater>
</forceCaptureResponse>
  
```

**Example: Batch Force Capture Response**

```
<litleResponse version="11.4" xmlns="http://www.litle.com/schema" id="123"
  cnpSessionId="987654321" response="0" message="Valid Format">
  <batchResponse id="01234567" cnpBatchId="4455667788" merchantId="100">
    <forceCaptureResponse id="AX54325432" reportGroup="RG12"
      customerId="038945">
      <cnpTxnId>84568457</cnpTxnId>
      <response>000</response>
      <responseTime>2016-09-01T10:24:31</responseTime>
      <message>Approved</message>
    </forceCaptureResponse>
  </batchResponse>
</litleResponse>
```

**Example: Online Force Capture Response**

```
<litleOnlineResponse version="11.4" xmlns="http://www.litle.com/schema"
  response="0" message="Valid Format">
  <forceCaptureResponse id="2" reportGroup="ABC Division"
    customerId="038945">
    <cnpTxnId>1100030204</cnpTxnId>
    <response>000</response>
    <responseTime>2016-07-11T14:48:48</responseTime>
    <postDate>2016-07-11</postDate>
    <message>Approved</message>
  </forceCaptureResponse>
</litleOnlineResponse>
```

**Example: Force Capture Response for Tokenized Merchant Sending Card Data**

A tokenized merchant that includes card information in the request receives a response message that includes the token element. The example below is an Online response.

```
<forceCaptureResponse id="99999" reportGroup="RG1" customerId="444">
  <cnpTxnId>21200000039504</cnpTxnId>
  <response>000</response>
  <responseTime>2016-10-20T18:25:38</responseTime>
  <postDate>2016-10-20</postDate>
  <message>Approved</message>
  <tokenResponse>
    <cnpToken>111310880008000</cnpToken>
    <tokenResponseCode>801</tokenResponseCode>
    <tokenMessage>Account number was successfully registered</tokenMessage>
  </tokenResponse>
  <type>AX</type>
```

```
<bin></bin>  
</tokenResponse>  
</forceCaptureResponse>
```

## 3.3.22 Fraud Check Transaction

If you wish to retrieve the Advanced Fraud results without introducing a Authorization or Sale transactions, use a Fraud Check transaction, as shown in the example below. Fraud Check transactions are only supported as Online transactions.

### 3.3.22.1 Fraud Check Request

You must specify the Fraud Check request as follows.

```
<fraudCheck id="Fraud Check Id" reportGroup="iQ Report Group">  
  <advancedFraudChecks>  
    <billToAddress>  
    <shipToAddress>  
  </fraudCheck>
```

#### Example: Fraud Check Request

```
<cnpOnlineRequest version="12.0" xmlns="http://www.vantivcnp.com/schema"  
  merchantId="81601">  
  <authentication>  
    <user>User Name</user>  
    <password>password</password>  
  </authentication>  
  <fraudCheck id="002" reportGroup="001601">  
    <advancedFraudChecks>  
      <threatMetrixSessionId>ASDFG-AXXXXAB999</threatMetrixSessionId>  
      <customAttribute1>Attribute passed to ThreatMetrix</customAttribute1>  
      <customAttribute2>Attribute passed to ThreatMetrix</customAttribute2>  
      <customAttribute3>Attribute passed to ThreatMetrix</customAttribute3>  
      <customAttribute4>Attribute passed to ThreatMetrix</customAttribute4>  
      <customAttribute5>Attribute passed to ThreatMetrix</customAttribute5>  
    </advancedFraudChecks>  
    <billToAddress>  
      <name>John Doe</name>  
      <addressLine1>15 Main Street</addressLine1>  
      <city>San Jose</city>
```

```

    <state>CA</state>
    <zip>95032-1234</zip>
    <country>USA</country>
    <phone>9782750000</phone>
    <email>jdoe@vantiv.com</email>
  </billToAddress>
  <shipToAddress>
    <name>Jane Doe</name>
    <addressLine1>15 Main Street</addressLine1>
    <city>San Jose</city>
    <state>CA</state>
    <zip>95032-1234</zip>
    <country>USA</country>
    <phone>9782750000</phone>
    <email>jdoe@vantiv.com</email>
  </shipToAddress>
</fraudCheck>
</cnpOnlineRequest>

```

### 3.3.22.2 Fraud Check Response

A Fraud Check response has the following structure.

```

<fraudCheckResponse id="Fraud Check Id" reportGroup="iQ Report Group">
  <littleTxnId>Transaction Id</littleTxnId>
  <response>Response Code</response>
  <message>Response Message</message>
  <responseTime>Date and Time in GMT</responseTime>
  <advancedFraudResults>
</fraudCheckResponse>

```

#### Example: Fraud Check Response

```

<littleOnlineResponse version="11.1" xmlns="http://www.little.com/schema"
  response="0" message="Valid Format">
  <fraudCheckResponse id="002" reportGroup="001601">
    <littleTxnId>82823534116454639</littleTxnId>
    <response>000</response>
    <message>Approved</message>
    <responseTime>2016-11-08T21:36:50</responseTime>
    <advancedFraudResults>
      <deviceReviewStatus>pass</deviceReviewStatus>
    </advancedFraudResults>
  </fraudCheckResponse>
</littleOnlineResponse>

```

```
<deviceReputationScore>50</deviceReputationScore>
<triggeredRule>FlashImagesCookiesDisabled</triggeredRule>
</advancedFraudResults>
</fraudCheckResponse>
</litleOnlineResponse>
```

### 3.3.23 Gift Card Auth Reversal Transactions

The Gift Card Auth Reversal transaction allows you to reverse an authorization against a closed-loop gift card; thereby, removing the funds hold established by the authorization.

#### 3.3.23.1 Gift Card Auth Reversal Request

You must specify the Gift Card Auth Reversal request as follows. The structure of the request is identical for either an Online or a Batch submission.

```
<giftCardAuthReversal id="Id" reportGroup="iQ Report Group" customerId="Customer
Id">
  <litleTxnId>Transaction Id from Auth Response</litleTxnId>
  <card>
    <originalRefCode>Auth Code from Auth Response</originalRefCode>
    <originalAmount>Amount from Auth Response</originalAmount>
    <originalTxnTime>txnTime from Auth Response</originalTxnTime>
    <originalSystemTraceId>systemTraceId from Auth Rsp</originalSystemTraceId>
    <originalSequenceNumber>sequenceNumber from Auth Rsp</originalSequenceNumber>
  </giftCardAuthReversal>
```

#### Example: Online Gift Card Auth Reversal

```
<litleOnlineRequest version="11.1" xmlns="http://www.litle.com/schema"
merchantId="100">
  <authentication>
    <user>User Name</user>
    <password>Password</password>
  </authentication>
  <giftCardAuthReversal id="834262" reportGroup="ABC Division"
customerId="038945">
    <litleTxnId>82823534116454002</litleTxnId>
    <card>
      <type>GC</type>
      <number>9000000000000001</number>
```



```

    <PIN>1234</PIN>
  </card>
  <originalRefCode>123456</originalRefCode>
  <originalAmount>40000</originalAmount>
  <originalTxnTime>2016-07-25T15:13:43</originalTxnTime>
  <originalSystemTraceId>654321</originalSystemTraceId>
  <originalSequenceNumber>456789</originalSequenceNumber>
</giftCardAuthReversal>
</litleOnlineRequest>

```

### 3.3.23.2 Gift Card Auth Reversal Response

A Gift Card Auth Reversal response has the following structure. The response message is identical for Online and Batch transactions except Online includes the <postDate> element.

```

<giftCardAuthReversalResponse id="Load Id" reportGroup="iQ Report
Group" customerId="Customer Id">
  <litleTxnId>Transaction Id</litleTxnId>
  <response>Response Code</response>
  <responseTime>Date and Time in GMT</responseTime>
  <postDate>Date transaction posted</postDate> (Online Only)
  <message>Response Message</message>
  <giftCardResponse>
</giftCardAuthReversalResponse>

```

#### Example:

```

<litleOnlineResponse version="11.1" xmlns="http://www.litle.com/schema"
response="0" message="Valid Format">
  <giftCardAuthReversalResponse id="834262" reportGroup="ABC Division">
    <litleTxnId>9695064321</litleTxnId>
    <response>000</response>
    <responseTime>2017-03-25T15:13:43</responseTime>
    <postDate>2017-03-25</postDate>
    <message>Approved</message>
    <giftCardResponse>
      <txnTime>2017-03-25T15:13:38</txnTime>
      <refCode>123456</refCode>
      <systemTraceId>123456</systemTraceId>
      <sequenceNumber>123456</sequenceNumber>
      <availableBalance>5000</availableBalance>
    </giftCardResponse>
  </giftCardAuthReversalResponse>
</litleOnlineResponse>

```

```
</giftCardAuthReversalResponse>  
</litleOnlineResponse>
```

### 3.3.24 Gift Card Capture Transactions

The Gift Card Capture transaction allows you to capture (settle) funds previously authorized on a Closed-loop gift card. Unlike the Capture transaction used for a credit card transaction, a Gift Card Capture requires you to provide both the capture amount and the original (authorized) amount. If the transaction is a partial capture, the capture amount will be less than the original amount, with the remainder available for future capture.

#### 3.3.24.1 Gift Card Capture Request

You must specify the Gift Card Capture request as follows. The structure of the request is identical for either an Online or a Batch submission.

```
<giftCardCapture id="Id" reportGroup="iQ Report Group" customerId="Customer Id">  
  <litleTxnId>Transaction Id from Auth Response</litleTxnId>  
  <captureAmount>Amt of Capture</captureAmount>  
  <card>  
    <originalRefCode>Auth Code from Auth Response</originalRefCode>  
    <originalAmount>Amount from Auth Request</originalAmount>  
    <originalTxnTime>txnTime from Auth Response</originalTxnTime>  
  </card>  
</giftCardCapture>
```

#### Example: Gift Card Capture Request

```
<litleOnlineRequest version="11.1" xmlns="http://www.litle.com/schema"  
  merchantId="100">  
  <authentication>  
    <user>User Name</user>  
    <password>Password</password>  
  </authentication>  
  <giftCardCapture id="834262" reportGroup="ABC Division"  
    customerId="038945">  
    <litleTxnId>82823534116454002</litleTxnId>  
    <captureAmount>40000</captureAmount>  
    <card>  
      <type>GC</type>  
      <number>9000000000000001</number>  
    </card>  
  </giftCardCapture>  
</litleOnlineRequest>
```

```

    <originalRefCode>123456</originalRefCode>
    <originalAmount>40000</originalAmount>
    <originalTxnTime>2016-07-25T15:13:43</originalTxnTime>
  </giftCardCapture>
</litleOnlineRequest>

```

### 3.3.24.2 Gift Card Capture Response

A Gift Card Capture response has the following structure. The response message is identical for Online and Batch transactions except Online includes the `<postDate>` element.

```

<giftCardCaptureResponse id="Load Id" reportGroup="iQ Report Group"
customerId="Customer Id">
  <litleTxnId>Transaction Id</litleTxnId>
  <response>Response Code</response>
  <responseTime>Date and Time in GMT</responseTime>
  <postDate>Date transaction posted</postDate> (Online Only)
  <message>Response Message</message>
  <accountUpdater>
  <fraudResult>
  <giftCardResponse>
</giftCardCaptureResponse>

```

#### Example: Gift Card Capture Response

```

<litleOnlineResponse version="11.1" xmlns="http://www.litle.com/schema"
response="0" message="Valid Format">
  <giftCardCaptureResponse id="834262" reportGroup="ABC Division">
    <litleTxnId>9695064321</litleTxnId>
    <response>000</response>
    <responseTime>2017-03-25T15:13:43</responseTime>
    <postDate>2017-03-25</postDate>
    <message>Approved</message>
    <giftCardResponse>
      <txnTime>2017-03-25T15:13:38</txnTime>
      <refCode>123456</refCode>
      <systemTraceId>123456</systemTraceId>
      <sequenceNumber>123456</sequenceNumber>
      <availableBalance>5000</availableBalance>
    </giftCardResponse>
  </giftCardCaptureResponse>

```

```
</littleOnlineResponse>
```

### 3.3.25 Gift Card Credit Transactions

The Gift Card Credit transaction allows you to refund funds previously captured on a Closed-loop gift card.

#### 3.3.25.1 Gift Card Credit Request

You must specify the Gift Card Credit request as follows. There are two possible structures for this transaction type. You use the structure containing the `littleTxnId` element, when the Vantiv processed the capture transaction. You use the structure containing the `orderId`, when the processor of the capture transaction was not Vantiv. Typically, this occurs when you first migrate your processing to Vantiv. The structures of the requests are identical for either an Online or a Batch submission.

```
<giftCardCapture id="Id" reportGroup="iQ Report Group" customerId="Customer Id">
  <littleTxnId>Transaction Id from Auth Response</littleTxnId>
  <creditAmount>Amt of Credit</captureAmount>
  <card>
</giftCardCapture>
```

or

```
<giftCardCapture id="Id" reportGroup="iQ Report Group" customerId="Customer Id">
  <orderId>Order Id from Capture</littleTxnId>
  <creditAmount>Amt of Credit</captureAmount>
  <orderSource></orderSource>
  <card>
</giftCardCapture>
```

#### Example: Online Gift Card Credit Transaction (Vantiv Processed Capture)

```
<littleOnlineRequest version="11.1" xmlns="http://www.little.com/schema"
  merchantId="100">
  <authentication>
    <user>User Name</user>
    <password>Password</password>
  </authentication>
  <giftCardCredit id="834262" reportGroup="ABC Division"
  customerId="038945">
    <littleTxnId>82823534116454002</littleTxnId>
```

```

    <creditAmount>40000</creditAmount>
  <card>
    <type>GC</type>
    <number>9000000000000001</number>
  </card>
</giftCardCredit>
</litleOnlineRequest>

```

### Example: Online Gift Card Credit Transaction (Non-Vantiv Processed Capture)

```

<litleOnlineRequest version="11.1" xmlns="http://www.litle.com/schema"
  merchantId="100">
  <authentication>
    <user>User Name</user>
    <password>Password</password>
  </authentication>
  <giftCardCredit id="834262" reportGroup="ABC Division"
    customerId="038945">
    <orderId>116454002</orderId>
    <creditAmount>4000</creditAmount>
    <orderSource>ecommerce</orderSource>
    <card>
      <type>GC</type>
      <number>9000000000000001</number>
    </card>
  </giftCardCredit>
</litleOnlineRequest>

```

### 3.3.25.2 Gift Card Credit Response

A Gift Card Credit response has the following structure. The response message is identical for either request structure, as well as Online and Batch transactions except Online includes the <postDate> element.

```

<giftCardCaptureResponse id="Load Id" reportGroup="iQ Report Group"
  customerId="Customer Id">
  <litleTxnId>Transaction Id</litleTxnId>
  <response>Response Code</response>
  <responseTime>Date and Time in GMT</responseTime>
  <postDate>Date transaction posted</postDate> (Online Only)
  <message>Response Message</message>

```

```
<fraudResult>  
<giftCardResponse>  
</giftCardCaptureResponse>
```

### Example: Gift Card Credit Response

```
<littleOnlineResponse version="11.1" xmlns="http://www.little.com/schema"  
  response="0" message="Valid Format">  
  <giftCardCreditResponse id="834262" reportGroup="ABC Division">  
    <littleTxnId>9695064321</littleTxnId>  
    <response>000</response>  
    <responseTime>2017-03-22T15:13:43</responseTime>  
    <postDate>2017-03-22</postDate>  
    <message>Approved</message>  
    <giftCardResponse>  
      <txnTime>2017-03-22T12:00:00</txnTime>  
      <refCode>003558</refCode>  
      <systemTraceId>834528</systemTraceId>  
      <sequenceNumber>123456</sequenceNumber>  
      <availableBalance>0</availableBalance>  
    </giftCardResponse>  
  </giftCardCreditResponse>  
</littleOnlineResponse>
```

## 3.3.26 Load Transactions

The Load transaction adds funds to an active Gift Card. The load amount cannot exceed the maximum allowed amount for the Gift Card. If you attempt to load more than the maximum amount, the transaction will be declined with a response Code of 221 - Over Max Balance.

---

---

**NOTE:** You must be enabled for (Closed Loop) Gift Card transactions to use this transaction type. Please consult your Relationship Manager for additional information about Gift Card transactions.

---

---

### 3.3.26.1 Load Request

You must specify the Load request as follows. The structure of the request is identical for either an Online or a Batch submission.

```
<load id="Load Id" reportGroup="iQ Report Group" customerId="Customer Id">  
  <orderId>Order Id</orderId>
```

```
<amount>Amount to Load</amount>
<orderSource>Order Entry Source</orderSource>
<card>
</load>
```

### Example: Online Load Request

```
<litleOnlineRequest version="11.4" xmlns="http://www.litle.com/schema"
  merchantId="100">
  <authentication>
    <user>User Name</user>
    <password>Password</password>
  </authentication>
  <load id="834262" reportGroup="ABC Division" customerId="038945">
    <orderId>65347567</orderId>
    <amount>40000</amount>
    <orderSource>ecommerce</orderSource>
    <card>
      <type>GC</type>
      <number>9000000000000001</number>
      <cardValidationNum>888</cardValidationNum>
      <pin>1234</pin>
    </card>
  </load>
</litleOnlineRequest>
```

### 3.3.26.2 Load Response

A Load response has the following structure. The response message is identical for Online and Batch transactions except Online includes the <postDate> element.

```
<loadResponse id="Load Id" reportGroup="iQ Report Group"
  customerId="Customer Id">
  <litleTxnId>Transaction Id</litleTxnId>
  <response>Response Code</response>
  <responseTime>Date and Time in GMT</responseTime>
  <postDate>Date transaction posted</postDate> (Online Only)
  <message>Response Message</message>
  <fraudResult>
  <giftCardResponse>
```

```
</loadResponse>
```

### Example: Load Response

```
<littleOnlineResponse version="11.4" xmlns="http://www.little.com/schema"
  response="0" message="Valid Format">
  <loadResponse id="834262" reportGroup="ABC Division">
    <cnpTxnId>9695064321</cnpTxnId>
    <response>000</response>
    <responseTime>2017-03-22T15:13:43</responseTime>
    <postDate>2017-03-22</postDate>
    <message>Approved</message>
    <giftCardResponse>
      <txnTime>2017-03-22T15:13:38</txnTime>
      <refCode>123456</refCode>
      <systemTraceId>123456</systemTraceId>
      <sequenceNumber>123456</sequenceNumber>
      <availableBalance>5000</availableBalance>
    </giftCardResponse>
  </loadResponse>
</littleOnlineResponse>
```

## 3.3.27 Load Reversal Transactions (Online Only)

The Load Reversal transaction reverses the operation of a Load transaction, removing the newly loaded amount from the Gift Card. The Load Reversal references the associated Load transaction by means of the `littleTxnId` element returned in the Load response. You cannot perform a partial Load Reversal. This transaction always reverses the full amount of the referenced Load transaction. This transaction type is available only for Online transactions.

---

**NOTE:** You must be enabled for (Closed Loop) Gift Card transactions to use this transaction type. Please consult your Relationship Manager for additional information about Gift Card transactions.

---

### 3.3.27.1 Load Reversal Request

You must structure a Load Reversal request as shown in the following examples.

```
<loadReversal id="Load Reversal Id" reportGroup="iQ Report Group"
  customerId="Customer Id">
  <littleTxnId>Transaction Id from Load Response</littleTxnId>
```



```

<card>
  <originalRefCode>Reference Code from Load Response</originalRefCode>
  <originalAmount>Amount from Load Transaction</originalAmount>
  <originalTxnTime>Transaction Time from Load Response</originalTxnTime>
  <originalSystemTraceId>Trace Id from Load Response</originalSystemTraceId>
  <originalSequenceNumber>Seq Num from Load Rsp</originalSequenceNumber>
</loadReversal>

```

### Example: Online Load Reversal Request

```

<litleOnlineRequest version="11.4" xmlns="http://www.litle.com/schema"
  merchantId="100">
  <authentication>
    <user>User Name</user>
    <password>Password</password>
  </authentication>
  <loadReversal id="12345" customerId="Customer Id" reportGroup="Load
  Reversals">
    <cnpTxnId>1234567890123456789</cnpTxnId>
    <card>
      <type>GC</type>
      <number>1234102000003558</number>
      <cardValidationNum>888</cardValidationNum>
      <pin>1234</pin>
    </card>
    <originalRefCode>123456</originalRefCode>
    <originalAmount>1900</originalAmount>
    <originalTxnTime>2017-03-21T10:02:46</originalTxnTime>
    <originalSystemTraceId>678901</originalSystemTraceId>
    <originalSequenceNumber>123456</originalSequenceNumber>
  </loadReversal>
</litleOnlineRequest>

```

### 3.3.27.2 Load Reversal Response

An Load Reversal response has the following structure.

```

<loadReversalResponse id="Load Reversal Id" reportGroup="iQ Report
  Group" customerId="Customer Id">
  <litleTxnId>Transaction Id</litleTxnId>
  <response>Response Code</response>

```

```
<responseTime>Date and Time in GMT</responseTime>
<postDate>Date transaction posted</postDate>
<message>Response Message</message>
<giftCardResponse>
</loadReversalResponse>
```

### Example: Online Load Reversal Response

```
<litleOnlineResponse version="11.4" xmlns="http://www.litle.com/schema"
  response="0" message="Valid Format">
  <loadReversalResponse id="834262" reportGroup="ABC Division">
    <cnpTxnId>9695064321</cnpTxnId>
    <response>000</response>
    <responseTime>2017-03-22T15:13:43</responseTime>
    <postDate>2017-03-22</postDate>
    <message>Approved</message>
    <giftCardResponse>
      <txnTime>2017-03-22T12:00:00</txnTime>
      <refCode>003558</refCode>
      <systemTraceId>834528</systemTraceId>
      <sequenceNumber>123456</sequenceNumber>
      <availableBalance>0</availableBalance>
    </giftCardResponse>
  </loadReversalResponse>
</litleOnlineResponse>
```

## 3.3.28 Status Query Transactions (Online Only)

You use a Status Query Transaction to verify the status of an Online transaction submitted within the prior 24 hours. As search criteria, you must submit, at a minimum, the id (the `id` attribute) and transaction type (i.e., authorization, deposit, void, etc.) of the original transaction, but to narrow the search, you can also include the transaction id from the original transaction. This transaction type is available only for Online transactions.

---

---

**NOTE:** You must be specifically enabled to use this transaction type. Please speak to your Implementation Consultant or Relationship Manager for additional information.

---

---

### 3.3.28.1 Query Transaction Request

You must structure your Query request as shown below. The `origId` and `origActionType` elements are required.

---

**NOTE:** If submitting a query for an eCheck transaction, do not include the account number. Use the `origAccountNumber` element for Credit/Debit/Gift cards only.

---

```
<queryTransaction id="GCQueryAuth" reportGroup = "Mer5PM1" customerId="1">
  <origId>id Attribute for Original Transaction</origId>
  <origActionType>Code for type of Original Transaction</origActionType>
  <origLittleTxnId>littleTxnId from Original Transaction</origLittleTxnId>
</queryTransaction>
```

#### Example: Query Transaction Request

```
<littleOnlineRequest version="11.1" xmlns="http://www.little.com/schema"
  merchantId="100">
  <authentication>
    <user>User Name</user>
    <password>Password</password>
  </authentication>
  <queryTransaction id="query1" reportGroup="Some RG" customerId="038945">
    <origId>834262</origId>
    <origActionType>A</origActionType>
    <origLittleTxnId>9695061110103040608</origLittleTxnId>
  </queryTransaction>
</littleOnlineRequest>
```

### 3.3.28.2 Query Transaction Response

The structure of the Query Transaction response message can vary according to the results of the query. The results can include a single or multiple transactions that meet the query criteria, no results, if nothing was found, or a limited response, if a transaction was found, but processing was not complete. The structure of the response message will be as follows:

```
<queryTransactionResponse>
  <response>Response Code</response>
  <responseTime>Date and Time in GMT</responseTime>
  <message>Response Message</message>
```

```
<matchCount>Number of Matches Found</matchCount>
<results_Max10>
  <queryTransactionUnavailableResponse>
    or
    One or more (10 max) found transaction responses of type specified in the
    queryTransaction
  </results_Max10>
</queryTransactionResponse>
```

### Example: Query Transaction Response with One Found Transaction

```
<litleOnlineResponse version="11.1" xmlns="http://www.litle.com/schema"
response="0" message="Valid Format">
  <queryTransactionResponse id="GCQueryAuth" reportGroup="Mer5PM1"
customerId="1">
    <response>150</response>
    <responseTime>2017-04-06T16:40:24</responseTime>
    <message>Original transaction found</message>
    <matchCount>1</matchCount>
    <results_max10>
      <authorizationResponse id="GiftCardAuth" reportGroup="Mer5PM1"
customerId="1">
        <litleTxnId>82827170811986124</litleTxnId>
        <orderId>150330_GCAuth</orderId>
        <response>000</response>
        <responseTime>2017-04-06T16:40:04</responseTime>
        <postDate>2017-04-06</postDate>
        <message>Approved</message>
        <authCode>111115</authCode>
        <fraudResult>
          <avsResult>30</avsResult>
          <cardValidationResult>M</cardValidationResult>
        </fraudResult>
        <giftCardResponse>
          <availableBalance>125</availableBalance>
        </giftCardResponse>
      </authorizationResponse>
    </results_max10>
  </queryTransactionResponse>
</litleOnlineResponse>
```

**Example: Query Transaction Response with Multiple Found Transactions**

---

**NOTE:** This response only occurs if you fail to use unique values for the `id` attribute, when submitting transactions.

---

```
<litleOnlineResponse version="11.1" xmlns="http://www.litle.com/schema"
response="0" message="Valid Format">
  <queryTransactionResponse id="GCQueryAuth" reportGroup="Mer5PM1"
customerId="1">
    <response>150</response>
    <responseTime>2017-04-06T16:40:24</responseTime>
    <message>Original transaction found</message>
    <matchCount>2</matchCount>
    <results_max10>
      <authorizationResponse id="DupeId" reportGroup="Mer5PM1">
        <litleTxnId>82827170811986215</litleTxnId>
        <orderId>150331_DupeAuth2</orderId>
        <response>000</response>
        <responseTime>2017-04-06T16:40:12</responseTime>
        <postDate>2017-04-06</postDate>
        <message>Approved</message>
        <authCode>055858</authCode>
        <fraudResult>
          <avsResult>32</avsResult>
          <cardValidationResult>M</cardValidationResult>
        </fraudResult>
      </authorizationResponse>
      <authorizationResponse id="DupeId" reportGroup="Mer5PM1">
        <litleTxnId>82827170811986207</litleTxnId>
        <orderId>150331_DupeAuth1</orderId>
        <response>000</response>
        <responseTime>2017-04-06T16:40:11</responseTime>
        <postDate>2017-04-06</postDate>
        <message>Approved</message>
        <authCode>111111</authCode>
        <fraudResult>
          <avsResult>00</avsResult>
          <cardValidationResult>M</cardValidationResult>
        </fraudResult>
      </authorizationResponse>
    </results_max10>
  </queryTransactionResponse>
</litleOnlineResponse>
```

### Example: Query Transaction Response with No Found Transaction

```
<littleOnlineResponse version="11.1" xmlns="http://www.little.com/schema"
  response="0" message="Valid Format">
  <queryTransactionResponse id="AuthFromSale" reportGroup="Mer5PM1">
    <response>151</response>
    <responseTime>2017-04-06T16:40:30</responseTime>
    <message>Original transaction not found</message>
    <matchCount>0</matchCount>
    <results_max10></results_max10>
  </queryTransactionResponse>
</littleOnlineResponse>
```

### Example: Query Transaction Response with Transaction Found, but not Complete

```
<littleOnlineResponse version="11.1" xmlns="http://www.little.com/schema"
  response="0" message="Valid Format">
  <queryTransactionResponse id="someAuth" reportGroup="Mer5PM1">
    <response>152</response>
    <responseTime>2016-04-06T16:40:30</responseTime>
    <message>Original transaction found but response not yet
available</message>
    <matchCount>1</matchCount>
    <results_max10>
      <queryTransactionUnavailableResponse>
        <littleTxnId>82827170811986124</littleTxnId>
        <response>152</response>
        <message>Original transaction found but response not yet
available</message>
      </queryTransactionUnavailableResponse>
    </results_max10>
  </queryTransactionResponse>
</littleOnlineResponse>
```

## 3.3.29 Refund Reversal Transactions (Online Only)

The Refund Reversal transaction is a Gift Card only transaction that reverses the operation of a Refund transaction on the Gift Card. The Refund Reversal references the associated Credit transaction by means of the `littleTxnId` element returned in the Credit response. You cannot

perform a partial Refund Reversal. This transaction always reverses the full amount of the referenced Refund transaction. This transaction type is available only for Online transactions.

---

---

**NOTE:** You must be enabled for (Closed Loop) Gift Card transactions to use this transaction type. Please consult your Relationship Manager for additional information about Gift Card transactions.

---

---

### 3.3.29.1 Refund Reversal Request

You must structure a Refund Reversal request as shown in the following examples.

```
<refundReversal id="Refund Reversal Id" reportGroup="iQ Report Group"
customerId="Customer Id">
  <littleTxnId>Transaction Id from CGCredit Response</littleTxnId>
  <card>
    <originalRefCode>Reference Code from CGCredit Response</originalRefCode>
    <originalAmount>Amount from CGCredit Transaction</originalAmount>
    <originalTxnTime>Transaction Time from CGCredit Response</originalTxnTime>
    <originalSystemTraceId>Trace Id from CGCredit Response</originalSystemTraceId>
    <originalSequenceNumber>Seq Num from CGCredit Rsp</originalSequenceNumber>
  </card>
</refundReversal>
```

#### Example: Online Refund Reversal Request

```
<littleOnlineRequest version="11.4" xmlns="http://www.little.com/schema"
merchantId="100">
  <authentication>
    <user>User Name</user>
    <password>Password</password>
  </authentication>
  <refundReversal id="12345" customerId="Customer Id" reportGroup="Refund
Reversals">
    <cnpTxnId>1234567890123456789</cnpTxnId>
    <card>
      <type>GC</type>
      <number>1234102000003558</number>
      <cardValidationNum>888</cardValidationNum>
      <pin>1234</pin>
    </card>
    <originalRefCode>123456</originalRefCode>
```

```
<originalAmount>1900</originalAmount>
<originalTxnTime>2017-03-21T10:02:46</originalTxnTime>
<originalSystemTraceId>678901</originalSystemTraceId>
<originalSequenceNumber>123456</originalSequenceNumber>
</refundReversal>
</litleOnlineRequest>
```

### 3.3.29.2 Refund Reversal Response

An Refund Reversal response has the following structure.

```
<refundReversalResponse id="Refund Reversal Id" reportGroup="iQ Report
Group" customerId="Customer Id">
  <litleTxnId>Transaction Id</litleTxnId>
  <response>Response Code</response>
  <responseTime>Date and Time in GMT</responseTime>
  <postDate>Date transaction posted</postDate>
  <message>Response Message</message>
  <giftCardResponse>
</refundReversalResponse>
```

#### Example: Online Refund Reversal Response

```
<litleOnlineResponse version="11.4" xmlns="http://www.litle.com/schema"
response="0" message="Valid Format">
  <refundReversalResponse id="834262" reportGroup="ABC Division">
    <cnpTxnId>9695064321</cnpTxnId>
    <response>000</response>
    <responseTime>2017-03-22T15:13:43</responseTime>
    <postDate>2017-03-22</postDate>
    <message>Approved</message>
    <giftCardResponse>
      <txnTime>2017-03-22T12:00:00</txnTime>
      <refCode>003558</refCode>
      <systemTraceId>834528</systemTraceId>
      <sequenceNumber>123456</sequenceNumber>
      <availableBalance>0</availableBalance>
    </giftCardResponse>
  </refundReversalResponse>
</litleOnlineResponse>
```



### 3.3.30 Register Token Transactions

The Register Token transaction enables you to submit a credit card number, eCheck account number, or Registration Id to us and receive a token in return. While you can submit Register Token transactions at any time, typically, you would make use of this transactions when initially converting to the use of tokens. In this case you would submit large quantities of credit cards/eCheck account numbers in Batches and replace them in your database with the tokens returned.

---

---

**NOTE:** When initially tokenizing your customer database, Vantiv recommends that you collect all distinct credit card numbers and submit the information in one or more large Session files. When you receive the response file, parse the returned token information to your database, replacing the card numbers.

---

---

#### 3.3.30.1 Register Token Request

You must specify the Register Token request as follows. The structure of the request is identical for either an Online or a Batch submission. The child elements used differ depending upon whether you are registering a credit card account, an eCheck account, or submitting a Registration Id.

When you submit the CVV2/CVC2/CID in a `registerTokenRequest`, the platform encrypts and stores the value on a temporary basis for later use in a tokenized Auth/Sale transaction submitted without the value. This is done to accommodate merchant systems/workflows where the security code is available at the time of token registration, but not at the time of the Auth/Sale. If for some reason you need to change the value of the security code supplied at the time of the token registration, use an `updateCardValidationNumOnToken` transaction. To use the store value when submitting an Auth/Sale transaction, set the `cardValidationNum` value to 000.

---

---

**NOTE:** The use of the `cardValidationNum` element in the `registertokenRequest` only applies when you submit an `accountNumber` element.

---

---

For credit cards:

```
<registerTokenRequest id="Id" reportGroup="iQ Report Group">
  <orderId>Order Id</orderId>
  <accountNumber>Card Account Number</accountNumber>
  <cardValidationNum>CVV2/CVC2/CID</cardValidationNum>
</registerTokenRequest>
```

For eCheck accounts:

```
<registerTokenRequest id="Id" reportGroup="iQ Report Group">  
  <orderId>Order Id</orderId>  
  <echeckForToken>  
    <accNum>Account Number</accNum>  
    <routingNum>Routing Number</routingNum>  
  </echeckForToken>  
</registerTokenRequest>
```

For Registration Ids:

```
<registerTokenRequest id="Id" reportGroup="iQ Report Group">  
  <orderId>Order Id</orderId>  
  <paypageRegistrationId>  
</registerTokenRequest>
```

For Mobile POS transactions:

```
<registerTokenRequest id="Id" reportGroup="iQ Report Group">  
  <orderId>Order Id</orderId>  
  <mpos>  
    <ksn>Key Serial Number</ksn>  
    <formatId>Format of Encrypted Track</formatId>  
    <encryptedTrack>Encrypted Track Data</encryptedTrack>  
    <track1Status>Track Read Status - 0 or 1</track1Status>  
    <track2Status>Track Read Status - 0 or 1</track2Status>  
  </mpos>  
</registerTokenRequest>
```

For Apple Pay transactions:

```
<registerTokenRequest id="Id" reportGroup="iQ Report Group">  
  <orderId>Order Id</orderId>  
  <applepay>  
    <data>Encrypted Payment Data</data>  
    <header>  
      <applicationData>Hash of Application Data Property</applicationData>  
      <ephemeralPublicKey>Ephemeral Public Key</ephemeralPublicKey>  
      <publicKeyHash>Merchant Cert Encoded Public Key</publicKeyHash>
```

```

    <transactionId>Transaction Id from Device</transactionId>
  </header>
  <signature>Signature of Payment and Header Data</signature>
  <version>Payment Token Version</version>
</applepay>
</registerTokenRequest>

```

### Example: Batch Register Token Request - Credit Card

```

<litleRequest version="11.4" xmlns="http://www.litle.com/schema" id="123"
  numBatchRequests="1">
  <authentication>
    <user>userName</user>
    <password>password</password>
  </authentication>
  <batchRequest id="01234567" numTokenRegistrations="1" merchantId="000902">
    <registerTokenRequest id="99999" reportGroup="RG1">
      <orderId>F12345</orderId>
      <accountNumber>4005101001000002</accountNumber>
      <cardValidationNum>999</cardValidationNum>
    </registerTokenRequest>
  </batchRequest>
</litleRequest>

```

### Example: Batch Register Token Request - eCheck

```

<litleRequest version="11.4" xmlns="http://www.litle.com/schema" id="123"
  numBatchRequests="1">
  <authentication>
    <user>userName</user>
    <password>password</password>
  </authentication>
  <batchRequest id="01234567" numTokenRegistrations="1" merchantId="000902">
    <registerTokenRequest id="99999" reportGroup="RG1">
      <orderId>F12345</orderId>
      <echeckForToken>
        <accNum>12345678901234567</accNum>
        <routingNum>000010101</routingNum>
      </echeckForToken>
    </registerTokenRequest>
  </batchRequest>
</litleRequest>

```

### Example: Batch Register Token Request - `paypageRegistrationId`

```
<litleRequest version="11.4" xmlns="http://www.litle.com/schema" id="123"
  numBatchRequests="1">
  <authentication>
    <user>userName</user>
    <password>password</password>
  </authentication>
  <batchRequest id="01234567" numTokenRegistrations="1" merchantId="000902">
    <registerTokenRequest id="99999" reportGroup="RG1">
      <orderId>F12345</orderId>
      <paypageRegistrationId>12345678901234567</paypageRegistrationId>
    </registerTokenRequest>
  </batchRequest>
</litleRequest>
```

### 3.3.30.2 Register Token Response

There is no structural difference an Online and Batch response; however, some child elements change depending upon whether the token is for a credit card account or an eCheck account. The response will have one of the following structures.

Register Token response for Credit Cards:

```
<registerTokenResponse id="99999" reportGroup="RG1">
  <litleTxnId>Transaction Id</litleTxnId>
  <litleToken>Token</litleToken>
  <bin>BIN</bin>
  <type>Method of Payment</type>
  <response>Response Code</response>
  <message>Response Message</message>
  <responseTime>Response Time</responseTime>
</registerTokenResponse>
```

Register Token response for eChecks:

```
<registerTokenResponse id="99999" reportGroup="RG1">
  <litleTxnId>Transaction Id</litleTxnId>
  <litleToken>Token</litleToken>
  <type>Method of Payment</type>
```

```

    <eCheckAccountSuffix>Last 3 of Acct Number</eCheckAccountSuffix>
    <response>Response Code</response>
    <responseTime>Response Time</responseTime>
    <message>Response Message</message>
</registerTokenResponse>

```

#### Register Token response for ApplePay:

```

<registerTokenResponse id="99999" reportGroup="RG1">
  <littleTxnId>Transaction Id</littleTxnId>
  <littleToken>Token</littleToken>
  <type>Method of Payment</type>
  <response>Response Code</response>
  <responseTime>Response Time</responseTime>
  <message>Response Message</message>
  <applepayResponse>
    <applicationExpirationDate>App PAN Exp Date</applicationExpirationDate>
    <currencyCode>Currency Code</currencyCode>
    <transactionAmount>Amount of Transaction</transactionAmount>
    <cardholderName>Name of cardholder</cardholderName>
    <deviceManufacturerIdentifier>Device Mfr Id</deviceManufacturerIdentifier>
    <paymentDataType>Type of Payment Data</paymentDataType>
    <onlinePaymentCryptogram>Payment Cryptogram</onlinePaymentCryptogram>
    <eciIndicator>eCommerce Indicator</eciIndicator>
  </applepayResponse>
</registerTokenResponse>

```

#### Example: Batch Register Token Response - Credit Card

```

<littleResponse version="11.4" xmlns="http://www.little.com/schema" id="123"
  response="0" message="Valid Format" cnpSessionId="987654321">
  <batchResponse id="01234567" cnpBatchId="4455667788" merchantId="100">
    <registerTokenResponse id="99999" reportGroup="RG1">
      <cnpTxnId>21122700</cnpTxnId>
      <cnpToken>1111000100360002</cnpToken>
      <bin>400510</bin>
      <type>VI</type>
      <response>801</response>
      <responseTime>2016-10-26T17:21:51</responseTime>
      <message>Account number was successfully registered</message>
    </registerTokenResponse>
  </batchResponse>
</littleResponse>

```

```
</registerTokenResponse>  
</batchResponse>  
</litleResponse>
```

### Example: Batch Register Token Request - eCheck

```
<litleResponse version="11.1" xmlns="http://www.litle.com/schema" id="123"  
  response="0" message="Valid Format" litleSessionId="987654321">  
  <batchResponse id="01234567" litleBatchId="4455667788" merchantId="100">  
    <registerTokenResponse id="99999" reportGroup="RG1">  
      <litleTxnId>21122700</litleTxnId>  
      <litleToken>1111000100360002</litleToken>  
      <type>VI</type>  
      <eCheckAccountSuffix>511</eCheckAccountSuffix>  
      <response>801</response>  
      <responseTime>2016-10-26T17:21:51</responseTime>  
      <message>Account number was successfully registered</message>  
    </registerTokenResponse>  
  </batchResponse>  
</litleResponse>
```

## 3.3.31 RFR Transactions (Batch Only)

An RFR (Request For Response) transaction enables you to request a response file for a previously submitted Batch. You make the request by submitting either the `litleSessionId` of the Batch, or in the case of a request for an Account Updater file, the `accountUpdateFileRequestData` element.

---

---

**NOTE:** The use of RFR transactions for Account Updater files apply only to the legacy Account Updater solution.

---

---

### 3.3.31.1 RFR Request

You must specify the RFR request as follows.

```
<RFRRequest>  
  <litleSessionId | accNum>  
</RFRRequest>
```

### Example: RFR Request for Payment Transaction Batch

The following example shows an RFR request for the response, with 7766554321 as the value of the <littleSessionId> element.

```
<littleRequest version="11.4" xmlns="http://www.little.com/schema" id="123"
  numBatchRequests="0">
  <authentication>
    <user>userName</user>
    <password>password</password>
  </authentication>
  <RFRRequest>
    <cnpSessionId>7766554321</cnpSessionId>
  </RFRRequest>
</littleRequest>
```

### Example: RFR Request for an Account Updater File

```
<littleRequest version="11.4" xmlns="http://www.little.com/schema" id="123"
  numBatchRequests="0">
  <authentication>
    <user>userName</user>
    <password>password</password>
  </authentication>
  <RFRRequest>
    <merchantId>100</merchantId>
    <postDate>2017-01-15</postDate>
  </RFRRequest>
</littleRequest>
```

## 3.3.31.2 RFR Response

When using an RFR request to obtain the response file for a payment transaction Batch, the RFR response is exactly the same as the original session response associated with the <littleSessionId> you submitted in the RFR request. The session ID returned in the response will be the session ID of the original session.

When using an RFR request in an Account Updater scenario, you will receive either an Account Updater Completion response, if the file is ready, or an Account Updater RFR “not ready” response, as shown in the example below.

### Example: Account Updater RFR “not ready” Response

```
<littleResponse version="11.4" xmlns="http://www.little.com/schema">
  <RFRResponse response="1" message="The account update file is not ready
```

```
yet. Please try again later.">  
</RFRResponse>  
</litleResponse>
```

### 3.3.32 Sale Transactions

The Sale transaction enables you to both authorize fund availability and deposit those funds by means of a single transaction. The Sale transaction is also known as a conditional deposit, because the deposit takes place only if the authorization succeeds. If the authorization is declined, the deposit will not be processed.

---

**NOTE:** If the authorization succeeds, the deposit is processed automatically, regardless of the AVS, CVV2, CVC2, or CID response, except for American Express transactions. For American Express, a failure to match the security code (CID) results in a declined transaction with the Response Reason Code of 352 - Decline CVV2/CID Fail.

---

#### 3.3.32.1 Sale Request

You must specify the Sale request as follows. The structure of the request is identical for either an Online or a Batch submission.

---

**NOTE:** When you submit the CVV2/CVC2/CID in a registerTokenRequest, the platform encrypts and stores the value on a temporary basis for later use in a tokenized Auth/Sale transaction submitted without the value. To use the store value when submitting an Auth/Sale transaction, set the cardValidationNum value to 000.

---

```
<sale id="Sale Id" reportGroup="iQ Report Group" customerId="Customer Id">  
  <orderId>Order Id</orderId>  
  <amount>Authorization Amount</amount>  
  <secondaryAmount>Secondary Amount</secondaryAmount>  
  <orderSource>Order Entry Source</orderSource>  
  <customerInfo>  
  <billToAddress>  
  <shipToAddress>  
  [<card>|<paypal>|<token>|<paypal>|<mpos>|<applepay>|  
  <sepaDirectDebit>|<ideal>|<sofort>|<giropay>] (Choice)  
  <billMeLaterRequest>
```



```

    <cardholderAuthentication>
    <customBilling>
    <taxType>payment or fee</taxType>
    <enhancedData>
    <processingInstructions>
    <pos>
    <paypalOrderComplete>Send true in the final Sale</paypalOrderComplete>
    <amexAggregatorData>
    <allowPartialAuth>
    <healthcareIIAS>
    <filtering>
    <merchantData>
    <recyclingRequest> (for Recycling Engine merchants)
    <fraudFilterOverride>
    <recurringRequest> (for Recurring Engine merchants)
    <debtRepayment>true or false</debtRepayment>
    <advancedFraudChecks>
    <wallet>
    <processingType>processingType Enum</processingType>
    <originalNetworkTransactionId>Network Txn Value</originalNetworkTransactionId>
    <originalTransactionAmount>Amount from Orig Txn</originalTransactionAmount>
  </sale>

```

### Example: Batch Sale Request

```

<litleRequest version="11.4" xmlns="http://www.litle.com/schema" id="123"
  numBatchRequests="1">
  <authentication>
    <user>userName</user>
    <password>password</password>
  </authentication>
  <batchRequest id="01234567" numSales="1" saleAmount="12522"
  merchantId="100">
    <sale id="AX54321678" reportGroup="RG27">
      <orderId>12z58743y1</orderId>
      <amount>12522</amount>
      <orderSource>ecommerce</orderSource>
      <billToAddress>
        <name>John Doe</name>

```

```
<addressLine1>123 4th street</addressLine1>
<addressLine2>Apt. 20</addressLine2>
<addressLine3>second floor</addressLine3>
<city>San Jose</city>
<state>CA</state>
<zip>95032</zip>
<country>USA</country>
<email>jdoe@isp.com</email>
<phone>408-555-1212</phone>
</billToAddress>
<card>
  <type>MC</type>
  <number>5186005800001012</number>
  <expDate>1110</expDate>
</card>
</sale>
</batchRequest>
</litleRequest>
```

### Example: Online Sale Request

---

**NOTE:** The example below includes an `<orderSource>` value of `3dsAuthenticated` and includes the `<cardholderAuthentication>` information. Use this `<orderSource>` value only if you are a 3DS merchant and authenticated the cardholder.

Also, the values for the `<authenticationValue>` and `<authenticationTransactionId>` elements in the example below have been truncated.

---

```
<litleOnlineRequest version="11.4" xmlns="http://www.litle.com/schema"
  merchantId="100">
  <authentication>
    <user>User Name</user>
    <password>password</password>
  </authentication>
  <sale id="1" reportGroup="ABC Division" customerId="038945">
    <orderId>5234234</orderId>
    <amount>40000</amount>
    <orderSource>3dsAuthenticated</orderSource>
    <billToAddress>
      <name>John Smith</name>
      <addressLine1>100 Main St</addressLine1>
```

```
<addressLine2>100 Main St</addressLine2>
<addressLine3>100 Main St</addressLine3>
<city>Boston</city>
<state>MA</state>
<zip>12345</zip>
<country>US</country>
<email>jsmith@someaddress.com</email>
<phone>555-123-4567</phone>
</billToAddress>
<card>
  <type>VI</type>
  <number>4005550000081019</number>
  <expDate>1210</expDate>
  <cardValidationNum>555</cardValidationNum>
</card>
<cardholderAuthentication>
  <authenticationValue>BwABBJQ1AgJDUCAAAAAA= </authenticationValue>
  <authenticationTransactionId>gMV75TAgk= </authenticationTransactionId>
</cardholderAuthentication>
<customBilling>
  <phone>8888888888</phone>
  <descriptor>bdi*Vantiv Test</descriptor>
</customBilling>
<enhancedData>
  <customerReference>P012345</customerReference>
  <salesTax>125</salesTax>
  <taxExempt>>false</taxExempt>
  <discountAmount>0</discountAmount>
  <shippingAmount>495</shippingAmount>
  <dutyAmount>0</dutyAmount>
  <shipFromPostalCode>01851</shipFromPostalCode>
  <destinationPostalCode>01851</destinationPostalCode>
  <destinationCountryCode>USA</destinationCountryCode>
  <invoiceReferenceNumber>123456</invoiceReferenceNumber>
  <orderDate>2016-08-14</orderDate>
  <detailTax>
    <taxIncludedInTotal>>true</taxIncludedInTotal>
    <taxAmount>55</taxAmount>
    <taxRate>0.0059</taxRate>
    <taxTypeIdentifier>00</taxTypeIdentifier>
    <cardAcceptorTaxId>011234567</cardAcceptorTaxId>
  </detailTax>
  <lineItemData>
```

```
<itemSequenceNumber>1</itemSequenceNumber>
<itemDescription>chair</itemDescription>
<productCode>CH123</productCode>
<quantity>1</quantity>
<unitOfMeasure>EACH</unitOfMeasure>
<taxAmount>125</taxAmount>
<lineItemTotal>9380</lineItemTotal>
<lineItemTotalWithTax>9505</lineItemTotalWithTax>
<itemDiscountAmount>0</itemDiscountAmount>
<commodityCode>300</commodityCode>
<unitCost>93.80</unitCost>
<detailTax>
  <taxIncludedInTotal>true</taxIncludedInTotal>
  <taxAmount>55</taxAmount>
  <taxRate>0.0059</taxRate>
  <taxTypeIdentifier>03</taxTypeIdentifier>
  <cardAcceptorTaxId>011234567</cardAcceptorTaxId>
</detailTax>
</lineItemData>
<lineItemData>
  <itemSequenceNumber>2</itemSequenceNumber>
  <itemDescription>table</itemDescription>
  <productCode>TB123</productCode>
  <quantity>1</quantity>
  <unitOfMeasure>EACH</unitOfMeasure>
  <lineItemTotal>30000</lineItemTotal>
  <itemDiscountAmount>0</itemDiscountAmount>
  <commodityCode>300</commodityCode>
  <unitCost>300.00</unitCost>
</lineItemData>
</enhancedData>
</sale>
</litleOnlineRequest>
```

### Example: Online Sale Request - SEPA Direct Debit

```
<litleOnlineRequest version="11.1" xmlns="http://www.litle.com/schema"
  merchantId="100">
  <authentication>
    <user>User Name</user>
    <password>password</password>
  </authentication>
  <sale id="1" reportGroup="ABC Division" customerId="038945">
```

```

<orderId>5234234</orderId>
<amount>40000</amount>
<orderSource>3dsAuthenticated</orderSource>
<billToAddress>
  <name>John Smith</name>
  <addressLine1>100 Main St</addressLine1>
  <addressLine2>100 Main St</addressLine2>
  <addressLine3>100 Main St</addressLine3>
  <city>Boston</city>
  <state>MA</state>
  <zip>12345</zip>
  <country>US</country>
  <email>jsmith@someaddress.com</email>
  <phone>555-123-4567</phone>
</billToAddress>
<sepaDirectDebit>
  <mandateProvider>Vantiv</mandateProvider>
  <sequenceType>OneTime</sequenceType>
  <iban>DE89370400440532013000</iban>
  <preferredLanguage>DE</preferredLanguage>
</sepaDirectDebit>
</sale>
</litleOnlineRequest>

```

### 3.3.32.2 Sale Response

The Sale response message is identical for Online and Batch transactions except Online includes the postDate element. The Sale response has the following structure:

```

<saleResponse id="Sale Id" reportGroup="iQ Report Group" customerId="Customer
Id">
  <litleTxnId>Transaction Id</litleTxnId>
  <response>Response Code</response>
  <orderId>Order Id</orderId>
  <responseTime>Date and Time in GMT</responseTime>
  <postDate>Date of Posting</postDate> (Online Only)
  <message>Response Message</message>
  <authCode>Approval Code</authCode>
  <approvedAmount>Approved amount for partial Auth</approvedAmount>
  <accountInformation>

```

```
<fraudResult>
<billMeLaterResponseData>
<tokenResponse> (for Tokenized merchants submitting card data)
<enhancedAuthResponse>
<accountUpdater>
<recycling> (included for declined Auths if featrure is enabled)
<recurringResponse> (for Recurring Engine merchants)
<giftCardResponse> (included if Gift Card is Method of Payment)
<applepayResponse> (included if an ApplePay transaction)
<cardSuffix>Card Last 4</cardSuffix> (included for ApplePay using VI or MC)
<androidpayResponse>
<sepaDirectDebitResponse>
<networkTransactionId>Txn ID returned from network</networkTransactionId>
</saleResponse>
```

### Example: Batch Sale Response

```
<litleResponse version="11.4" xmlns="http://www.litle.com/schema" id="123"
response="0" message="Valid Format" cnpSessionId="987654321">
  <batchResponse id="01234567" cnpBatchId="4455667788" merchantId="100">
    <saleResponse id="AX54321678" reportGroup="RG27">
      <cnpTxnId>84568456</cnpTxnId>
      <response>000</response>
      <orderId>12z58743y1</orderId>
      <responseTime>2016-09-01T10:24:31</responseTime>
      <message>Approved</message>
      <authCode>123456</authCode>
      <fraudResult>
        <avsResult>00</avsResult>
      </fraudResult>
    </saleResponse>
    <saleResponse id="AX54325432" reportGroup="RG12">
      <cnpTxnId>84568457</cnpTxnId>
      <response>000</response>
      <orderId>12z58743y7</orderId>
      <responseTime>2016-09-01T10:24:31</responseTime>
      <message>Approved</message>
      <authCode>123456</authCode>
      <fraudResult>
        <avsResult>00</avsResult>
        <authenticationResult>2</authenticationResult>
      </fraudResult>
    </saleResponse>
  </batchResponse>
</litleResponse>
```

```
</fraudResult>  
</saleResponse>  
</batchResponse>  
</litleResponse>
```

### Example: Online Sale Response

```
<litleOnlineResponse version="11.4" xmlns="http://www.litle.com/schema"  
  response="0" message="Valid Format">  
  <saleResponse id="1" reportGroup="ABC Division" customerId="038945">  
    <cnpTxnId>1100030055</cnpTxnId>  
    <response>000</response>  
    <orderId>23423434</orderId>  
    <responseTime>2016-07-11T14:48:46</responseTime>  
    <postDate>2011-07-11</postDate>  
    <message>Approved</message>  
    <authCode>123457</authCode>  
    <fraudResult>  
      <avsResult>01</avsResult>  
      <cardValidationResult>U</cardValidationResult>  
      <authenticationResult>2</authenticationResult>  
    </fraudResult>  
  </saleResponse>  
</litleOnlineResponse>
```

### Example: Online Sale Response for Tokenized Merchant Sending Card Data

A tokenized merchant that includes card information in the request receives a response message that includes the token element. The example below is an Online response.

```
<saleResponse id="99999" reportGroup="RG1" customerId="444">  
  <cnpTxnId>21200000028606</cnpTxnId>  
  <response>000</response>  
  <orderId>F12345</orderId>  
  <responseTime>2016-10-26T17:30:00</responseTime>  
  <postDate>2011-10-26</postDate>  
  <message>Approved</message>  
  <authCode>089510</authCode>  
  <fraudResult>  
    <avsResult>11</avsResult>  
    <cardValidationResult>P</cardValidationResult>  
  </fraudResult>  
  <tokenResponse>
```

```
<cnpToken>1111000100329510</cnpToken>
<tokenResponseCode>801</tokenResponseCode>
<tokenMessage>Account number was successfully registered</tokenMessage>
<type>VI</type>
<bin>432610</bin>
</tokenResponse>
</saleResponse>
```

### Example: Online Sale Response with Account Updater Info

```
<littleOnlineResponse version="11.4" xmlns="http://www.little.com/schema"
  response="0" message="Valid Format">
  <saleResponse id="1" reportGroup="ABC Division" customerId="038945">
    <cnpTxnId>1100030055</cnpTxnId>
    <response>000</response>
    <orderId>23423434</orderId>
    <responseTime>2017-07-11T14:48:46</responseTime>
    <postDate>2011-07-11</postDate>
    <message>Approved</message>
    <authCode>123457</authCode>
    <accountUpdater>
      <originalCardInfo>
        <type>VI</type>
        <number>4234823492346234</number>
        <expDate>1112</expDate>
      </originalCardInfo>
      <newCardInfo>
        <type>VI</type>
        <number>4234823490005777</number>
        <expDate>1114</expDate>
      </newCardInfo>
    </accountUpdater>
    <fraudResult>
      <avsResult>01</avsResult>
      <cardValidationResult>U</cardValidationResult>
      <authenticationResult>2</authenticationResult>
    </fraudResult>
  </saleResponse>
</littleOnlineResponse>
```



**Example: Batch Sales Response with Recurring Info**

The following is an example of the Recurring Response file produced daily to provide information about the transactions submitted by the Recurring Engine. This file is delivered via sFTP.

```
<litleResponse version="11.1" xmlns="http://www.litle.com/schema"
  response="0" message="Valid Format" litleSessionId="82912082263408653">
  <batchResponse litleBatchId="82912082263408661" merchantId="101">
    <saleResponse reportGroup="Default Report Group">
      <litleTxnId>82912082263409610</litleTxnId>
      <response>000</response>
      <orderId>recurring_appr1</orderId>
      <responseTime>2017-01-30T20:15:51</responseTime>
      <message>Approved</message>
      <authCode>11111</authCode>
      <fraudResult>
        <avsResult>01</avsResult>
      </fraudResult>
      <recurringResponse>
        <subscriptionId>82912081866997773</subscriptionId>
        <responseCode>473</responseCode>
        <responseMessage>Scheduled recurring payment
processed</responseMessage>
        <recurringTxnId>211014241510</recurringTxnId>
      </recurringResponse>
    </saleResponse>
    <saleResponse reportGroup="Default Report Group">
      <litleTxnId>82912082263410311</litleTxnId>
      <response>000</response>
      <orderId>recurring_appr2</orderId>
      <responseTime>2017-01-30T20:15:55</responseTime>
      <message>Approved</message>
      <authCode>123457</authCode>
      <fraudResult>
        <avsResult>00</avsResult>
      </fraudResult>
      <recurringResponse>
        <subscriptionId>82912081866997799</subscriptionId>
        <responseCode>473</responseCode>
        <responseMessage>Scheduled recurring payment
processed</responseMessage>
        <recurringTxnId>211014245016</recurringTxnId>
      </recurringResponse>
    </saleResponse>
```

```
<saleResponse reportGroup="Default Report Group">
  <littleTxnId>82912082263410337</littleTxnId>
  <response>110</response>
  <orderId>recurring_decline1</orderId>
  <responseTime>2017-01-30T20:15:56</responseTime>
  <message>Insufficient Funds</message>
  <fraudResult>
    <avsResult>34</avsResult>
  </fraudResult>
  <recycling>
    <recycleEngineActive>true</recycleEngineActive>
  </recycling>
  <recurringResponse>
    <subscriptionId>82912081866997807</subscriptionId>
    <responseCode>473</responseCode>
    <responseMessage>Scheduled recurring payment
processed</responseMessage>
    <recurringTxnId>211014245115</recurringTxnId>
  </recurringResponse>
</saleResponse>
<saleResponse reportGroup="Default Report Group">
  <littleTxnId>82912082263410378</littleTxnId>
  <response>110</response>
  <orderId>recurring_decline3</orderId>
  <responseTime>2017-01-30T20:15:56</responseTime>
  <message>Insufficient Funds</message>
  <fraudResult>
    <avsResult>34</avsResult>
  </fraudResult>
  <recycling>
    <recycleEngineActive>true</recycleEngineActive>
  </recycling>
  <recurringResponse>
    <subscriptionId>82912081866997807</subscriptionId>
    <responseCode>473</responseCode>
    <responseMessage>Scheduled recurring payment
processed</responseMessage>
    <recurringTxnId>211014245313</recurringTxnId>
  </recurringResponse>
</saleResponse>
</batchResponse>
</littleResponse>
```

### 3.3.33 Unload Transactions

The Unload transaction removes funds from an active Gift Card. The unload amount cannot exceed the available balance on the Gift Card. If you attempt to unload more than the available balance, the transaction will be declined with a response Code of 209 - Invalid Amount.

---

**NOTE:** You must be enabled for (Closed Loop) Gift Card transactions to use this transaction type. Please consult your Relationship Manager for additional information about Gift Card transactions.

---

#### 3.3.33.1 Unload Request

You must specify the Unload request as follows. The structure of the request is identical for either an Online or a Batch submission.

```
<unload id="Unload Id" reportGroup="iQ Report Group" customerId="Customer Id">
  <orderId>Order Id</orderId>
  <amount>Amount to Load</amount>
  <orderSource>Order Entry Source</orderSource>
  <card>
</unload>
```

#### Example: Online Unload Request

```
<littleOnlineRequest version="11.4" xmlns="http://www.little.com/schema"
  merchantId="100">
  <authentication>
    <user>User Name</user>
    <password>Password</password>
  </authentication>
  <unload id="834262" reportGroup="ABC Division" customerId="038945">
    <orderId>65347567</orderId>
    <amount>40000</amount>
    <orderSource>ecommerce</orderSource>
    <card>
      <type>GC</type>
      <number>9000000000000001</number>
      <pin>1234</number>
    </card>
  </unload>
</littleOnlineRequest>
```

### 3.3.33.2 Unload Response

An Unload response has the following structure. The response message is identical for Online and Batch transactions except Online includes the <postDate> element.

```
<unloadResponse id="Unload Id" reportGroup="iQ Report Group"
customerId="Customer Id">
  <littleTxnId>Transaction Id</littleTxnId>
  <response>Response Code</response>
  <responseTime>Date and Time in GMT</responseTime>
  <postDate>Date transaction posted</postDate> (Online Only)
  <message>Response Message</message>
  <fraudResult>
  <giftCardResponse>
</unloadResponse>
```

#### Example: Unload Response

```
<littleOnlineResponse version="11.4" xmlns="http://www.little.com/schema"
response="0" message="Valid Format">
  <unloadResponse id="834262" reportGroup="ABC Division">
    <cnpTxnId>9695064321</cnpTxnId>
    <response>000</response>
    <responseTime>2017-03-22T15:13:43</responseTime>
    <postDate>2017-03-22</postDate>
    <message>Approved</message>
    <giftCardResponse>
      <txnTime>2017-03-22T12:00:00</txnTime>
      <refCode>003558</refCode>
      <systemTraceId>834528</systemTraceId>
      <sequenceNumber>123456</sequenceNumber>
      <availableBalance>0</availableBalance>
    </giftCardResponse>
  </unloadResponse>
</littleOnlineResponse>
```

### 3.3.34 Unload Reversal Transactions (Online Only)

The Unload Reversal transaction reverses the operation of a Unload transaction, returning the value removed from the Gift Card by the Unload transaction. The Unload Reversal references the associated Unload transaction by means of the littleTxnId element returned in the Unload response. You cannot perform a partial Unload Reversal. This transaction always reverses the full

amount of the referenced Unload transaction. This transaction type is available only for Online transactions.

---

---

**NOTE:** You must be enabled for (Closed Loop) Gift Card transactions to use this transaction type. Please consult your Relationship Manager for additional information about Gift Card transactions.

---

---

### 3.3.34.1 Unload Reversal Request

You must structure a Unload Reversal request as shown in the following examples.

```
<unloadReversal id="Unload Reversal Id" reportGroup="iQ Report Group"
customerId="Customer Id">
  <littleTxnId>Transaction Id from CGCredit Response</littleTxnId>
  <card>
    <originalRefCode>Reference Code from Unload Response</originalRefCode>
    <originalAmount>Amount from Unload Transaction</originalAmount>
    <originalTxnTime>Transaction Time from Unload Response</originalTxnTime>
    <originalSystemTraceId>Trace Id from Unload Response</originalSystemTraceId>
    <originalSequenceNumber>Seq Num from Unload Rsp</originalSequenceNumber>
  </card>
</unloadReversal>
```

#### Example: Online Unload Reversal Request

```
<littleOnlineRequest version="11.4" xmlns="http://www.little.com/schema"
merchantId="100">
  <authentication>
    <user>User Name</user>
    <password>Password</password>
  </authentication>
  <unloadReversal id="12345" customerId="Customer Id" reportGroup="Unload
Reversals">
    <cnpTxnId>1234567890123456789</cnpTxnId>
    <card>
      <type>GC</type>
      <number>1234102000003558</number>
      <cardValidationNum>888</cardValidationNum>
      <pin>1234</pin>
    </card>
    <originalRefCode>123456</originalRefCode>
    <originalAmount>1900</originalAmount>
    <originalTxnTime>2017-03-21T10:02:46</originalTxnTime>
```

```
<originalSystemTraceId>678901</originalSystemTraceId>
<originalSequenceNumber>123456</originalSequenceNumber>
</unloadReversal>
</litleOnlineRequest>
```

### 3.3.34.2 Unload Reversal Response

An Unload Reversal response has the following structure.

```
<unloadReversalResponse id="Unload Reversal Id" reportGroup="iQ Report
Group" customerId="Customer Id">
  <litleTxnId>Transaction Id</litleTxnId>
  <response>Response Code</response>
  <responseTime>Date and Time in GMT</responseTime>
  <postDate>Date transaction posted</postDate>
  <message>Response Message</message>
  <giftCardResponse>
</unloadReversalResponse>
```

#### Example: Online Unload Reversal Response

```
<litleOnlineResponse version="11.4" xmlns="http://www.litle.com/schema"
response="0" message="Valid Format">
  <unloadReversalResponse id="834262" reportGroup="ABC Division">
    <cnpTxnId>9695064321</cnpTxnId>
    <response>000</response>
    <responseTime>2017-03-22T15:13:43</responseTime>
    <postDate>2017-03-22</postDate>
    <message>Approved</message>
    <giftCardResponse>
      <txnTime>2017-03-22T12:00:00</txnTime>
      <refCode>003558</refCode>
      <systemTraceId>834528</systemTraceId>
      <sequenceNumber>123456</sequenceNumber>
      <availableBalance>0</availableBalance>
    </giftCardResponse>
  </unloadReversalResponse>
</litleOnlineResponse>
```

### 3.3.35 Update Plan Transactions

You use the Update Plan transaction to activate/deactivate Plans associated with recurring payments. When you deactivate a Plan, by setting the `active` flag to **false**, you can no longer reference that Plan for use with subscriptions. Existing subscriptions already using the deactivated Plan will continue to use the Plan until the subscription is either modified or completed. You can also reactivate a deactivated Plan by updating the Plan and setting the `active` flag to **true**.

#### 3.3.35.1 Update Plan Request

You must structure an Update Plan request as shown in the following examples. The structure of the request is identical for either an Online or a Batch submission.

```
<updatePlan>
  <planCode>Plan Reference Code</planCode>
  <active>true or false</active>
</updatePlan>
```

#### Example: Online Update Plan Request

```
<litleOnlineRequest version="11.4" xmlns="http://www.litle.com/schema"
  merchantId="100">
  <authentication>
    <user>User Name</user>
    <password>password</password>
  </authentication>
  <updatePlan>
    <planCode>Reference_Code</planCode>
    <active>>false</active>
  </updatePlan>
</litleOnlineRequest>
```

#### 3.3.35.2 Update Plan Response

An Update Plan response has the following structure. The response message is identical for Online and Batch transactions.

```
<updatePlanResponse>
  <litleTxnId>Transaction Id</litleTxnId>
  <response>Response Code</response>
  <message>Response Message</message>
  <responseTime>Date and Time in GMT</responseTime>
```

```
<planCode>Plan Reference Code</subscriptionId>
</updatePlanResponse>
```

### Example: Online Update Plan Response

```
<littleOnlineResponse version="11.4" xmlns="http://www.little.com/schema"
  response="0" message="Valid Format">
  <updatePlanResponse>
    <cnpTxnId>1100030055</cnpTxnId>
    <response>000</response>
    <message>Approved</message>
    <responseTime>2017-07-11T14:48:46</responseTime>
    <planCode>Reference_Code</planCode>
  </updatePlanResponse>
</littleOnlineResponse>
```

## 3.3.36 Update Subscription Transactions

The Update Subscription transaction allows you to change certain subscription information associated with a recurring payment. Using this transaction type you can change the plan, card, billing information, and/or billing date. You can also create, update, or delete a Discount and/or an Add On.

---



---

**NOTE:** You can include multiple create, update, and delete Discounts and Add On operations in a single updateSubscription transaction.

---



---

### 3.3.36.1 Update Subscription Request

You must structure an Update Subscription request as shown in the following examples. The structure of the request is identical for either an Online or a Batch submission.

```
<updateSubscription>
  <subscriptionId>Subscription Id</subscriptionId>
  <planCode>Plan Reference Code</subscriptionId>
  <billToAddress>
    [ <card> | <paypage> | <token> ]
  <billingDate>New Billing Date</billingDate>
  <createDiscount>
  <updateDiscount>
  <deleteDiscount>
```



```

    <createAddOn>
    <updateAddOn>
    <deleteAddOn>
  </updateSubscription

```

### Example: Online Update Subscription Request

```

<littleOnlineRequest version="11.4" xmlns="http://www.little.com/schema"
  merchantId="100">
  <authentication>
    <user>User Name</user>
    <password>password</password>
  </authentication>
  <updateSubscription>
    <subscriptionId>1234</subscriptionId>
    <planCode>Gold_Monthly</planCode>
    <billToAddress>
      <name>John Smith</name>
      <addressLine1>100 Main St</addressLine1>
      <city>Boston</city>
      <state>MA</state>
      <zip>12345</zip>
      <country>US</country>
      <email>jsmith@someaddress.com</email>
      <phone>555-123-4567</phone>
    </billToAddress>
    <card>
      <type>VI</type>
      <number>4005550000081019</number>
      <expDate>1210</expDate>
      <cardValidationNum>555</cardValidationNum>
    </card>
    <deleteDiscount>
      <discountCode>1GBExtra</discountCode>
    </deleteDiscount>
    <createAddOn>
      <addOnCode>1WF</addOnCode>
      <name>One_GB_Extra</name>
      <amount>500</amount>
      <startDate>2017-07-15</startDate>
      <endDate>2017-07-22</endDate>
    </createAddOn>
  </updateSubscription>

```

```
</litleOnlineRequest>
```

### 3.3.36.2 Update Subscription Response

An Update Subscription response has the following structure. The response message is identical for Online and Batch transactions.

```
<updateSubscriptionResponse>
  <litleTxnId>Transaction Id</litleTxnId>
  <response>Response Code</response>
  <message>Response Message</message>
  <responseTime>Date and Time in GMT</responseTime>
  <subscriptionId>ID of Subscription Canceled</subscriptionId>
  <tokenResponse> (For Tokenized Merchants submitting Card/Paypage)
</cancelSubscriptionResponse>
```

#### Example: Online Update Subscription Response

```
<litleOnlineResponse version="11.4" xmlns="http://www.litle.com/schema"
  response="0" message="Valid Format">
  <updateSubscriptionResponse>
    <cnpTxnId>1100030055</cnpTxnId>
    <response>000</response>
    <message>Approved</message>
    <responseTime>2017-06-11T14:48:46</responseTime>
    <subscriptionId>123457</subscriptionId>
  </updateSubscriptionResponse>
</litleOnlineResponse>
```

### 3.3.37 Update Card Validation Number Transactions

When you submit the CVV2/CVC2/CID in a `registerTokenRequest`, the platform encrypts and stores the value on a temporary basis for later use in a tokenized Auth/Sale transaction submitted without the value. This is done to accommodate merchant systems/workflows where the security code is available at the time of token registration, but not at the time of the Auth/Sale. If for some reason you need to change the value of the security code supplied at the time of the token registration, use an `updateCardValidationNumOntoken` transaction.

---

**NOTE:** You should only use this transaction type if you had previously submitted the account number and security code in a `registerTokenRequest` transaction and now need to change the CVV2/CVC2/CID value.

---

### 3.3.37.1 Update Card Validation Number Request

The `updateCardValidationNumOnToken` transaction has the following structure:

```
<updateCardValidationNumOnToken id = "Update Id" customerId="Customer Id"
reportGroup="iQ Report Group">
  <orderId>Order Id</orderId>
  <littleToken>Token</littleToken>
  <cardValidationNum>CVV2/CVC2/CID Value</cardValidationNum>
</updateCardValidationNumOnToken>
```

#### Example: Online Update Card Validation Number Request

```
<littleOnlineRequest version="11.4" xmlns="http://www.little.com/schema"
merchantId="100">
  <updateCardValidationNumOnToken id="99999" customerId="444"
reportGroup="RG1">
    <orderId>F12345</orderId>
    <cnpToken>1111000101039449</cnpToken>
    <cardValidationNum>987</cardValidationNum>
  </updateCardValidationNumOnToken>
</littleOnlineRequest>
```

### 3.3.37.2 Update Card Validation Number Response

The `updateCardValidationNumOnTokenResponse` transaction has the following structure:

```
<updateCardValidationNumOnTokenResponse id="Update Id" reportGroup="iQ Report
Group">
  <littleTxnId>Transaction Id</littleTxnId>
  <response>Response Code</response>
  <message>Response Message</message>
  <responseTime>Date and Time in GMT</responseTime>
</updateCardValidationNumOnTokenResponse>
```

**Example: Online Update Card Validation Number Response**

```
<littleOnlineResponse version="11.4" xmlns="http://www.little.com/schema"
  response="0" message="Valid Format">
  <updateCardValidationNumOnTokenResponse id="99999" customerId="444"
  reportGroup="RG1">
    <cnpTxnId>21122700</cnpTxnId>
    <response>803</response>
    <message>Card Validation Number Updated</message>
    <responseTime>2017-06-09T17:21:51</responseTime>
  </updateCardValidationNumOnTokenResponse>
</littleOnlineResponse>
```

**3.3.38 Void Transactions (Online Only)**

You use a Void transaction to cancel a transaction that occurred during the same business day. You can void Capture, Credit, and Sale transactions. Also, if you use Recycling Engine, you can use the void transaction to halt the recycling of a sale transaction. In this case the response may include the recycling element. (see [Using Void to Halt Recycling Engine](#) on page 86).

---

**NOTE:** Before submitting a Void, please allow a minimum of 60 seconds to elapse after submitting the transaction you wish to void. This timing ensures our system fully records the first (to be voided) transaction in our database.

Do not use Void transactions to void an Authorization. To remove an Authorization use an Authorization Reversal transaction (see [Authorization Reversal Transactions](#) on page 220.)

---

If you attempt to void a transaction after the cutoff time, the system returns a response code of **362** and the message, **Transaction Not Voided - Already Settled**. In this situation, you can cancel the original transaction by using its reverse transaction, as shown in [Table 3-2](#).

**TABLE 3-2** Cancelling a Transaction That Cannot Be Voided

If you had originally sent this transaction...	Cancel it by using this transaction...
Capture Transactions	Credit Transactions
Sale Transactions	Credit Transactions
Credit Transactions	Sale Transactions
Force Capture Transactions	Credit Transactions

### 3.3.38.1 Void Request

The Void request references the <littleTxnId> of the previously approved transaction. You must structure a Void request as follows.

```
<void id = "Void Id" reportGroup="iQ Report Group">
  <littleTxnId>Transaction Id</littleTxnId>
  <processingInstructions>
</void>
```

#### Example: Online Void Request

```
<littleOnlineRequest version="11.4" xmlns="http://www.little.com/schema"
  merchantId="100">
  <authentication>
    <user>User Name</user>
    <password>Password</password>
  </authentication>
  <void id="1" reportGroup="Void Division">
    <cnpTxnId>345454444</cnpTxnId>
  </void>
</littleOnlineRequest>
```

### 3.3.38.2 Void Response

The Void response has the following structure.

```
<voidResponse id="Void Id" reportGroup="iQ Report Group">
  <littleTxnId>Transaction Id</littleTxnId>
  <response>Response Code</response>
  <responseTime>Date and Time in GMT</responseTime>
  <postDate>Date of Posting</postDate>
  <message>Response Message</message>
  <recycling> (May be included if halting recycling.)
</voidResponse>
```

#### Example: Online Void Response

```
<littleOnlineResponse version="11.4" xmlns="http://www.little.com/schema"
  response="0" message="Valid Format">
  <voidResponse id="1" reportGroup="Void Division">
    <cnpTxnId>1100026202</cnpTxnId>
    <response>000</response>
```

```
<responseTime>2017-06-16T19:43:38</responseTime>
<postDate>2017-06-16</postDate>
<message>Approved</message>
</voidResponse>
</litleOnlineResponse>
```

### Example: Online Void Response with Recycling Element

When you use a Void transaction to halt recycling, the response may include the `recycling` element. (see [Using Void to Halt Recycling Engine](#) on page 86).

```
<litleOnlineResponse version="11.1" xmlns="http://www.litle.com/schema"
  response="0" message="Valid Format">
  <voidResponse id="1" reportGroup="Void Division">
    <litleTxnId>1100026202333456789</litleTxnId>
    <response>000</response>
    <responseTime>2017-06-16T19:43:38</responseTime>
    <postDate>2017-06-16</postDate>
    <message>Approved</message>
    <recycling>
      <creditLitleTxnId>1234567890123456789</message>
    </recycling>
  </voidResponse>
</litleOnlineResponse>
```

---

## CNPAPI ELEMENTS

This chapter provides definitions for the elements and attributes used by the cnpAPI. This information is intended to be used in combination with the various cnpAPI schema files to assist you as you build the code necessary to submit transactions to our transaction processing systems. Each section defines a particular element, its relationship to other elements (parents and children), as well as any attributes associated with the element.

For additional information on the structure of cnpAPI requests and responses using these elements, as well as XML examples, please refer to [Chapter 3, "cnpAPI Transaction Examples"](#).

The XML elements defined in this chapter are listed alphabetically.

## 4.1 accNum

The `accNum` element is a required child of the `echeck`, `originalAccountInfo`, and `newAccountInfo` elements defining the account number of the eCheck account.

**Type** = String; **minLength** = 1; **maxLength** = 17

**Parent Elements:**

`echeck`, `newAccountInfo`, `originalAccountInfo`, `accountInfo`

**Attributes:**

None

**Child Elements:**

None



## 4.2 accountInfo

The `accountInfo` element is a required child of the `submerchantCredit`, and `submerchantDebit` transactions. It contains child elements used to provide details concerning the Sub-merchant account.

### Parent Elements:

[submerchantCredit](#), [submerchantDebit](#), [vendorCredit](#), [vendorDebit](#)

### Attributes:

None

### Child Elements:

Required: [accType](#), [accNum](#), [routingNum](#)

Optional: [ccdPaymentInformation](#)

---

**NOTE:** Although shown as an optional element in the schema, the `checkNum` element should not be used as a child of `accountInfo`.

---

### Example: accountInfo Structure

```
<accountInfo>
  <accType>Account Type Abbreviation</accType>
  <accNum>Account Number</accNum>
  <routingNum>Routing Number</routingNum>
  <ccdPaymentInformation>Payment Description</ccdPaymentInformation>
</accountInfo>
```

## 4.3 accountInformation

The `accountInformation` element is an optional child of the `authorizationResponse` and `saleResponse` elements. It contains two children that define the card type and account number.

**Parent Elements:**

`authorizationResponse`, `saleResponse`

**Attributes:**

None

**Child Elements:**

Required: `type`

Optional: `number`

## 4.4 accountNumber

The `accountNumber` element is a required child of the `registerTokenRequest` element defining the account number for which you are requesting a token. It is also an optional child of the `virtualGiftCardResponse` element, where it defines the account number of the requested Virtual Gift Card.

**Type** = String; **minLength** = 13; **maxLength** = 25

**Parent Elements:**

[registerTokenRequest](#), [virtualGiftCardResponse](#)

**Attributes:**

None

**Child Elements:**

None

## 4.5 accountNumberLength

The `accountNumberLength` element is a required child of the `virtualGiftCard` element defining the requested length of the virtual Gift Card number you are requesting.

---

---

**NOTE:** In an early iteration of schema V8.22 issued in September of 2013 this element was defined as an optional child of the `virtualGiftCard` element. If you coded to the earlier version, be aware that this element is now required. If you do not include this element, the transaction will fail XML validation.

---

---

**Type** = Integer; **Allowed Values** between 13 and 25 inclusive.

---

---

**IMPORTANT:** Although the schema defines the allowed values as any integer between 13 and 25 inclusive, at this time you can only use a value of either 16 or 19.

---

---

**Parent Elements:**

[virtualGiftCard](#)

**Attributes:**

None

**Child Elements:**

None

## 4.6 accountUpdate

The `accountUpdate` element is the parent element for all Account Updater request transactions. You can use this only with Batch transactions.

### Parent Elements:

[batchRequest](#)

### Attributes:

Attribute Name	Type	Required?	Description
id	String	Yes	A unique identifier assigned by the presenter and mirrored back in the response. <b>minLength = 1    maxLength = 36</b>
customerId	String	No	A value assigned by the merchant to identify the consumer. <b>minLength = N/A    maxLength = 50</b>
reportGroup	String	Yes	Required attribute that defines the merchant sub-group in the user interface where this transaction will be displayed. Please refer to <a href="#">Coding for Report Groups</a> on page 10 for additional information. <b>minLength = 1    maxLength = 25</b>

### Child Elements: (all Required)

[orderId](#), [cardOrToken](#) (allows the substitution of either the `card` or `token` elements)

## 4.7 accountUpdateFileRequestData

The `accountUpdateFileRequestData` element is a child of the `RFRRequest` element, required when requesting the response file for an (legacy) Account Updater submission.

### Parent Elements:

[RFRRequest](#)

### Attributes:

None

### Child Elements:

Required: [merchantId](#)

Optional: [postDay](#)

### Example: accountUpdateFileRequestData Structure

```
<accountUpdateFileRequestData>
  <merchantId>Merchant ID</merchantId>
  <postDay>Post Date</postDay>
</accountUpdateFileRequestData>
```

## 4.8 accountUpdater

The `accountUpdater` element is an optional child of the `authorizationResponse`, `captureResponse`, `echeckSalesResponse`, `echeckCreditResponse`, `echeckVerificationResponse`, `forceCaptureResponse`, and `saleResponse` elements. This element is included in the response messages when the submitted account information has changed.

In the case of eCheck accounts, the system automatically updates the information sent to the ACH network and includes the original and updated information in the response. Similarly, if you use the Account Updater service (for credit cards), the system automatically repairs the card information sent to the card networks and depending upon the option you select, can return the info to you.

### Parent Elements:

[authorizationResponse](#), [captureResponse](#), [forceCaptureResponse](#), [echeckCreditResponse](#), [echeckRedepositResponse](#), [echeckSalesResponse](#), [saleResponse](#)

### Attributes:

None

### Child Elements:

Required: [extendedCardResponse](#), [newAccountInfo](#), [newCardInfo](#), [newCardTokenInfo](#), [newTokenInfo](#), [originalAccountInfo](#), [originalCardInfo](#), [originalCardTokenInfo](#), [originalTokenInfo](#)

---

**IMPORTANT:** When using Account Updater (any variation), you must always code to receive the `extendedCardResponse` element and its children. Vantiv always returns this information whenever applicable regardless of whether you receive other account updater information in the transaction response message.

---

### Example: accountUpdater Structure - Credit Cards without extendedCardResponse

```
<accountUpdater>
  <originalCardInfo>
    <type>Card Type</type>
    <number>Old Account Number</number>
    <expDate>Old Expiration Date</expDate>
  </originalCardInfo>
  <newCardInfo>
```

```
<type>Card Type</type>
<number>New Account Number</number>
<expDate>New Expiration Date</expDate>
</newCardInfo>
</accountUpdater>
```

**Example: accountUpdater Structure - Credit Cards with extendedCardResponse**

```
<accountUpdater>
  <originalCardInfo>
    <type>Card Type</type>
    <number>Old Account Number</number>
    <expDate>Old Expiration Date</expDate>
  </originalCardInfo>
  <newCardInfo>
    <type>Card Type</type>
    <number>New Account Number</number>
    <expDate>New Expiration Date</expDate>
  </newCardInfo>
  <extendedCardResponse>
    <message>Code Description</message>
    <code>Either 501 or 504</code>
  </extendedCardResponse>
</accountUpdater>
```

**Example: accountUpdater Structure - Credit Cards only extendedCardResponse**

```
<accountUpdater>
  <extendedCardResponse>
    <message>Code Description</message>
    <code>Either 501 or 504</code>
  </extendedCardResponse>
</accountUpdater>
```



**Example: accountUpdater Structure - Credit Cards (tokenized Merchant)**

---

**NOTE:** This structure can also include the <extendedCardResponse> element.

---

```

<accountUpdater>
  <originalCardTokenInfo>
    <littleToken>Old Token</littleToken>
    <type>Card Type</type>
    <expDate>Old Expiration Date</expDate>
    <bin>Old Card BIN</bin>
  </originalCardTokenInfo>
  <newCardTokenInfo>
    <littleToken>New Token</littleToken>
    <type>Card Type</type>
    <expDate>New Expiration Date</expDate>
    <bin>New Card BIN</bin>
  </newCardTokenInfo>
</accountUpdater>

```

**Example: accountUpdater Structure - eCheck (for non-Tokenized Merchant)**

```

<accountUpdater>
  <originalAccountInfo>
    <accType>Original Account Type</accType>
    <accNum>Original Account Number</accNum>
    <routingNum>Original Routing Number</routingNum>
  </originalAccountInfo>
  <newAccountInfo>
    <accType>New Account Type</accType>
    <accNum>New Account Number</accNum>
    <routingNum>New Routing Number</routingNum>
  </newAccountInfo>
</accountUpdateFileRequestData>

```

**Example: accountUpdater Structure - eCheck (for Tokenized Merchant)**

```

<accountUpdater>

```

```
<originalTokenInfo>
  <accType>Original Account Type</accType>
  <littleToken>Original Token</littleToken>
  <routingNum>Original Routing Number</routingNum>
</originalTokenInfo>
<newTokenInfo>
  <accType>New Account Type</accType>
  <littleToken>New Token</littleToken>
  <routingNum>New Routing Number</routingNum>
</newTokenInfo>
</accountUpdateFileRequestData>
```

## 4.9 accountUpdateResponse

The `accountUpdateResponse` element is the parent element for all Account Update responses transactions. You can use this only with Batch transactions.

### Parent Elements:

[batchResponse](#)

### Attributes:

Attribute Name	Type	Required?	Description
id	String	Yes	The response returns the same value submitted in the <code>accountUpdate</code> transaction. <b>minLength = 1    maxLength = 36</b>
customerId	String	No	The response returns the same value submitted in the <code>accountUpdate</code> transaction. <b>minLength = N/A    maxLength = 50</b>
reportGroup	String	Yes	The response returns the same value submitted in the <code>accountUpdate</code> transaction. <b>minLength = 1    maxLength = 25</b>

### Child Elements: (Required)

[littleTxnId](#), [orderId](#), [response](#), [responseTime](#), [message](#)

### Child Elements: (Optional)

[updatedCard](#), [originalCard](#), [originalToken](#), [updatedToken](#)

## 4.10 accType

The `accType` element is a required child of the `echeck`, `originalAccountInfo`, and `newAccountInfo` elements defining the type of eCheck account used in the transaction.

**Type** = Choice (Enum); **Enumerations** = Checking, Savings, Corporate, or Corp Savings

---

---

**NOTE:** Use Corporate for Corporate Checking accounts.

---

---

**Parent Elements:**

[echeck](#), [newAccountInfo](#), [originalAccountInfo](#), [originalTokenInfo](#), [newTokenInfo](#), [accountInfo](#)

**Attributes:**

None

**Child Elements:**

None

## 4.11 actionReason

The `actionReason` element is an optional child of the `authReversal` element defining if the reversal is due to suspected fraud.

**Type** = String (Enum); **Enumerations** = SUSPECT\_FRAUD

---

**NOTE:** When you include this optional element in an `authReversal` transaction, the information will be forwarded to MasterCard as part of the MasterCard eCommerce Fraud Alert program.

When you include this optional element in an `credit` transaction, the system uses the information to track potentially fraudulent transactions for future analysis.

---

### Parent Elements:

[authReversal](#), [credit](#)

### Attributes:

None

### Child Elements:

None

## 4.12 activate

The `activate` element is the parent element for the transaction type that activates a Gift Card.

### Parent Elements:

[littleOnlineRequest](#), [batchRequest](#)

### Attributes:

Attribute Name	Type	Required?	Description
id	String	Yes	A unique identifier assigned by the presenter and mirrored back in the response. <b>minLength = 1    maxLength = 36</b>
customerId	String	No	A value assigned by the merchant to identify the consumer. <b>minLength = N/A    maxLength = 50</b>
reportGroup	String	Yes	Required attribute that defines the merchant sub-group in the user interface where this transaction will be displayed. Please refer to <a href="#">Coding for Report Groups</a> on page 10 for additional information. <b>minLength = 1    maxLength = 25</b>

### Child Elements: (Required)

[orderId](#), [amount](#), [orderSource](#), [card](#), [virtualGiftCard](#)

## 4.13 activateResponse

The `activateResponse` element is the parent element for information returned to you in response to an **activate** transaction. You can use this element in either Online or Batch transactions.

### Parent Elements:

[litleOnlineResponse](#), [batchResponse](#)

### Attributes:

Attribute Name	Type	Required?	Description
id	String	Yes	The response returns the same value submitted in the Activate transaction. <b>minLength = 1    maxLength = 36</b>
customerId	String	No	The response returns the same value submitted in the Activate transaction. <b>minLength = N/A    maxLength = 50</b>
reportGroup	String	Yes	The response returns the same value submitted in the Activate transaction. <b>minLength = 1    maxLength = 25</b>

### Child Elements:

Required: [litleTxnId](#), [response](#), [responseTime](#), [message](#), [giftCardResponse](#)

Optional: [postDate](#), [fraudResult](#), [giftCardResponse](#), [virtualGiftCardResponse](#)

## 4.14 activateReversal

The `activateReversal` element is the parent element for the transaction type that reverses the activation of a Gift Card.

### Parent Elements:

[litleOnlineRequest](#)

### Attributes:

Attribute Name	Type	Required?	Description
id	String	Yes	A unique identifier assigned by the presenter and mirrored back in the response. <b>minLength = 1    maxLength = 36</b>
customerId	String	No	A value assigned by the merchant to identify the consumer. <b>minLength = N/A    maxLength = 50</b>
reportGroup	String	Yes	Required attribute that defines the merchant sub-group in the user interface where this transaction will be displayed. Please refer to <a href="#">Coding for Report Groups</a> on page 10 for additional information. <b>minLength = 1    maxLength = 25</b>

### Child Elements: (Required)

[card](#), [originalRefCode](#), [originalAmount](#), [originalTxnTime](#), [originalSystemTraceId](#), [originalSequenceNumber](#)

### Child Elements: (Optional)

[litleTxnId](#), [virtualGiftCardBin](#)



## 4.15 activateReversalResponse

The `activateReversalResponse` element is the parent element for information returned to you in response to an `activateReversal` transaction. You can use this element in either Online or Batch transactions.

### Parent Elements:

[litleOnlineResponse](#)

### Attributes:

Attribute Name	Type	Required?	Description
id	String	Yes	The response returns the same value submitted in the Activate Reversal transaction. <b>minLength = 1    maxLength = 36</b>
customerId	String	No	The response returns the same value submitted in the Activate Reversal transaction. <b>minLength = N/A    maxLength = 50</b>
reportGroup	String	Yes	The response returns the same value submitted in the Activate Reversal transaction. <b>minLength = 1    maxLength = 25</b>

### Child Elements:

Required: [litleTxnId](#), [response](#), [responseTime](#), [message](#), [giftCardResponse](#)

Optional: [postDate](#)

## 4.16 active

The `active` element is an optional child of both the `createPlan` and `updatePlan` elements. You use this flag to activate/deactivate a Plan. When you deactivate a Plan, you can no longer reference that Plan for use with subscriptions. Existing subscriptions making use of the deactivated Plan will continue to use the Plan until either modified or completed. You can also reactivate a deactivated Plan by updating the Plan and setting the `active` flag to true.

**Type** = Boolean; **Valid Values** = true or false

### Parent Elements:

[createPlan](#), [updatePlan](#)

### Attributes:

None

### Child Elements:

None

## 4.17 addOnCode

The `addOnCode` element is the identifier of a defined add on charge to a subscription. You use this element when creating, updating, and deleting an Add On applied to a subscription.

**Type** = String; **minLength** = N/A; **maxLength** = 25

**Parent Elements:**

[createAddOn](#), [updateAddOn](#), [deleteAddOn](#)

**Attributes:**

None

**Child Elements:**

None

## 4.18 addressIndicator

The `addressIndicator` element is an optional child of the `billMeLaterResponseData` element and indicates whether the shipping address is a commercial (**c**) or residential (**r**) shipping address.

**Type** = String; **minLength** = N/A; **maxLength** = 1

**Parent Elements:**

[billMeLaterResponseData](#)

**Attributes:**

None

**Child Elements:**

None

## 4.19 addressLine1, addressLine2, addressLine3

The elements `addressLine1`, `addressLine2`, and `addressLine3` define the address information in both the `billToAddress` and `shipToAddress` elements.

**Type** = String; **minLength** = N/A; **maxLength** = 35

**Parent Elements:**

[billToAddress](#), [shipToAddress](#)

**Attributes:**

None

**Child Elements:**

None

## 4.20 advancedAVSResult

The `advancedAVSResult` element is an optional child element of the `fraudResult` element. It defines the American Express Advanced AVS response codes that can be returned as verification of information supplied in the `<phone>` and/or `<email>` child elements of the `<billToAddress>` element. For a list of possible values, please refer to [AAVS Response Codes](#) on page 843.

---

---

**NOTE:** You must be specifically enabled to use the Advanced AVS feature. Please consult your Relationship Manager for additional information.

---

---

**Type** = String; **minLength** = N/A; **maxLength** = 3

**Parent Elements:**

[fraudResult](#)

**Attributes:**

None

**Child Elements:**

None

## 4.21 advancedFraudChecks

The advancedFraudChecks element is an optional child of both the authorization and sale elements and a required child of the fraudCheck element.

### Parent Elements:

[authorization](#), [sale](#), [fraudCheck](#)

### Attributes:

None

### Child Elements:

[threatMetrixSessionId](#), [customAttribute1](#) through [customAttribute5](#)

### Example: advancedFraudChecks Structure

```
<advancedFraudChecks>
  <threatMetrixSessionId>Session Id from Threat Metrix</threatMetrixSessionId>
  <customAttribute1>Some attribute passed to ThreatMetrix</customAttribute1>
  <customAttribute2>Some attribute passed to ThreatMetrix</customAttribute2>
  <customAttribute3>Some attribute passed to ThreatMetrix</customAttribute3>
  <customAttribute4>Some attribute passed to ThreatMetrix</customAttribute4>
  <customAttribute5>Some attribute passed to ThreatMetrix</customAttribute5>
</advancedFraudChecks>
```

## 4.22 advancedFraudResults

The `advancedFraudResults` element is an optional child of both the `fraudResult` and the `fraudCheckResponse` elements. Child elements return the results of advanced fraud checks performed by Threat Metrix, as well as a list of the rules triggered from the ThreatMetrix (merchant) Policy.

### Parent Elements:

[fraudResult](#), [fraudCheckResponse](#)

### Attributes:

None

### Child Elements: (Required)

[deviceReviewStatus](#), [deviceReputationScore](#), [triggeredRule](#)

### Example: advancedFraudChecks Structure

```
<advancedFraudResults>
  <deviceReviewStatus>pass, fail, review, or unavailable</deviceReviewStatus>
  <deviceReputationScore>Score Returned from ThreatMetix</deviceReputationScore>
  <triggeredRule>Triggered Rule #1</triggeredRule>
  .
  .
  .
  <triggeredRule>Triggered Rule #N</triggeredRule>
</advancedFraudResults>
```



## 4.23 affiliate

The `affiliate` element is an optional child element of the `merchantData` element. You can use it to track transactions associated with various affiliate organizations.

**Type** = String; **minLength** = N/A; **maxLength** = 25

**Parent Elements:**

[merchantData](#)

**Attributes:**

None

**Child Elements:**

None

## 4.24 affluence

The `affluence` element is an optional child of the `enhancedAuthResponse` element and defines whether the card used falls into one of the two defined affluent categories. If the card does not meet the definition of either category, the system does not return the `affluence` element.

---

**NOTE:** Please consult your Relationship Manager for additional information concerning this feature.

---

**Type** = String (enum); **minLength** = N/A; **maxLength** = N/A

### Parent Elements:

[enhancedAuthResponse](#)

### Attributes:

None

### Child Elements:

None

### Enumerations:

Enumeration	Description
MASS AFFLUENT	Returned for certain Visa and MasterCard cards indicating high income customers (>100K annual income).
AFFLUENT	Returned for certain Visa and MasterCard cards indicating high income customers with high spending patterns (>100K annual income and >40K in card usage).

---

**NOTE:** The Affluence indicator applies only to certain Visa and MasterCard cards. This indicator does not apply to American Express or Discover cards.

---

## 4.25 allowPartialAuth

The `allowPartialAuth` element is an optional child of both Authorization and Sale transactions, which allows you to specify whether to authorize a partial amount if the entire requested authorization amount exceeds available credit/balance.

---

---

**NOTE:** If you settle in a currency other than US or Canada, you cannot use partial authorizations.

When submitting transactions for private label gift cards (card type of GC), the use of partial authorizations is determined by a setting in the Merchant Profile (on or off globally). This flag has no effect.

---

---

Type = Boolean; Valid Values = true or false

**Parent Elements:**

[authorization](#), [sale](#)

**Attributes:**

None

**Child Elements:**

None

---

---

**NOTE:** For a Sale transaction, the deposit will be for the partial amount.

---

---

## 4.26 amexAggregatorData

The `amexAggregatorData` element defines Amex Aggregator specific information in the cnpAPI. The system does not use the information unless you are designated as an Aggregator by American Express.

### Parent Elements:

[authorization](#), [captureGivenAuth](#), [credit](#), [forceCapture](#), [sale](#)

### Attributes:

None

### Child Elements: (Required)

[sellerId](#), [sellerMerchantCategoryCode](#)

### Example: amexAggregatorData Structure

```
<amexAggregatorData>
  <sellerId>Seller Id</sellerId>
  <sellerMerchantCategoryCode>MerchantCategoryCode</sellerMerchantCategoryCode>
</amexAggregatorData>
```

## 4.27 amount

The `amount` element is a child of several elements. When used in a payment transaction this element defines the amount of the transaction. When `amount` is a child of the `subscription` element, it defines the amount of the recurring payment. As a child of the `activate`, `load`, or `unload` transactions, `amount` defines the initial value of a newly activated gift Card, the amount loaded onto a reloadable Gift Card, or the amount unloaded from a Gift Card, respectively. When used in an Instruction-Based Dynamic Payout transaction type, it specifies the amount of funds to transfer. Supply the value in cents without a decimal point. For example, a value of 1995 signifies \$19.95.

---

---

**NOTE:** For the following currencies, the value you submit is the amount without implied decimal: Burundian Franc, Chilean Peso, Comoro Franc, Djibouti Franc, Guinea Franc, Iceland Krona, Japanese Yen, South Korean Won, Vanuatu Vatu, Paraguayan Guarani, Rwanda Franc, Vietnamese Dong, Uganda Shilling, CFA Franc BEAC, CFA Franc BCEAO, and CFP Franc.

For example, if the currency is Japanese Yen, entering 2000 means 2000 Yen, NOT 20.00 Yen.

---

---

**Type** = Integer; **totalDigits** = 12

### Parent Elements:

The `amount` element is a required child of each of the following Parent Elements: `activate`, `authorization`, `credit` (required if original transaction was not processed by Vantiv), `captureGivenAuth`, `echeckCredit` (required if original transaction was not processed by Vantiv), `echeckSale`, `echeckVerification`, `forceCapture`, `fraudCheck`, `load`, `sale`, `unload`

This element is also a required child of the following Instruction-Based Dynamic Payout transaction types: `payFacCredit`, `payFacDebit`, `physicalCheckCredit`, `physicalCheckDebit`, `reserveCredit`, `reserveDebit`, `submerchantCredit`, `submerchantDebit`, `vendorCredit`, `vendorDebit`, `fastAccessFunding`

The `amount` element is an optional child of each of the following Parent Elements: `authReversal`, `capture`, `credit`, `echeckCredit`, `subscription`

---

---

**NOTE:** For all cases where the `amount` element is optional, except when a child of the `subscription` element, if you do not specify a value, the system uses the entire amount from the referenced (by `littleTxnId`) transaction. When `amount` is a child of the `subscription` element, if you do not specify a value, the amount defaults to the value defined in the referenced recurring plan (`planCode` element).

---

---

**Attributes:**

None

**Child Elements:**

None

## 4.28 androidpayResponse

The `androidpayResponse` element is an optional child of several transaction types and is returned in response messages, when the `orderSource` in the request is `androidpay`.

### Parent Elements:

[authorizationResponse](#), [registerTokenResponse](#), [saleResponse](#)

### Attributes:

None

### Child Elements (all optional):

[cryptogram](#), [expMonth](#), [expYear](#), [eciIndicator](#)

### Example: androidpayResponse Structure

```
<androidpayResponse>
  <cryptogram>Payment Cryptogram</cryptogram>
  <expMonth>Expiration Month</expMonth>
  <expYear>Expiration Year</expYear>
  <eciIndicator>eCommerece Indicator</eciIndicator>
</androidpayResponse>
```

## 4.29 applepay

The `applepay` element is an optional child of several transaction types and takes the place of the card element in Apple Pay transaction where the merchant does not decrypt the (Apple Pay) `PKPaymentToken` prior to submitting the transaction. It contains child elements for the component parts of the `PKPaymentToken`.

### Parent Elements:

[authorization](#), [registerTokenRequest](#), [sale](#)

### Attributes:

None

### Child Elements (all required):

[data](#), [header](#), [signature](#), [version](#)

### Example: applepay Structure

```
<applepay>
  <data>User Name</data>
  <header>
    <applicationData>Base64 Hash of App Data Property</applicationData>
    <ephemeralPublicKey>Base64 Encoded Ephemeral Public Key</ephemeralPublicKey>
    <publicKeyHash>Base64 Hash of Public Merchant Key Cert</publicKeyHash>
    <transactionId>Hex Transaction Id</transactionId>
  </header>
  <signature>Signature of Payment and Header Data</signature>
  <version>Payment Token Version Info</version>
</applepay>
```



## 4.30 applepayResponse

The `applepayResponse` element is an optional child of several transaction types and is returned in response messages, when the request includes the `applepay` element.

### Parent Elements:

[authorizationResponse](#), [registerTokenResponse](#), [saleResponse](#)

### Attributes:

None

### Child Elements:

[applicationPrimaryAccountNumber](#), [applicationExpirationDate](#), [currencyCode](#), [transactionAmount](#), [cardholderName](#), [deviceManufacturerIdentifier](#), [paymentDataType](#), [onlinePaymentCryptogram](#), [eciIndicator](#)

### Example: applepayResponse Structure

```
<applepayResponse>
  <applicationPrimaryAccountNumber>App PAN</applicationPrimaryAccountNumber>
  <applicationExpirationDate>App PAN Exp Date</applicationExpirationDate>
  <currencyCode>Currency Code</currencyCode>
  <transactionAmount>Amount of Transaction</transactionAmount>
  <cardholderName>Name of cardholder</cardholderName>
  <deviceManufacturerIdentifier>Id of Device Mfr</deviceManufacturerIdentifier>
  <paymentDataType>Type of Payment Data</paymentDataType>
  <onlinePaymentCryptogram>Payment Cryptogram</onlinePaymentCryptogram>
  <eciIndicator>eCommerece Indicator</eciIndicator>
</applepayResponse>
```

---

---

**IMPORTANT:** The system never returns the `applicationPrimaryAccountNumber` element in a `registerTokenresponse` message, since this transaction type includes a token replacing the application PAN.

---

---

## 4.31 applicationData

The `applicationData` element is an optional child of the `header` element and provides the SHA-256 hash, hex encoded string of the original `PKPaymentRequest` of the Apple Pay transaction.

**Type** = Hex Encoded String; **minLength** = N/A; **maxLength** = 10000

**Parent Elements:**

[header](#)

**Attributes:**

None

**Child Elements:**

None

## 4.32 applicationExpirationDate

The applicationExpirationDate element is an optional child of the applepayResponse element and defines expiration date of the application primary account number.

**Type** = String; **minLength** = N/A; **maxLength** = 20

**Parent Elements:**

[applepayResponse](#)

**Attributes:**

None

**Child Elements:**

None

## 4.33 applicationPrimaryAccountNumber

The `applicationPrimaryAccountNumber` element is an optional child of the `applepayResponse` element and defines the primary account number associated with the application.

**Type** = String; **minLength** = N/A; **maxLength** = 20

**Parent Elements:**

[applepayResponse](#)

**Attributes:**

None

**Child Elements:**

None

---

---

**IMPORTANT:** The system never returns the `applicationPrimaryAccountNumber` element (child of the `applepayResponse` element) in a `registerTokenresponse` message, since this transaction type includes a token replacing the application PAN.

---

---

## 4.34 approvedAmount

The `approvedAmount` element defines the dollar amount of the approval. It appears in an authorization or sale response only if the `allowPartialAuth` element is set to true in the request transaction. It can also appear as the child of a `deactivateResponse` message where it specifies the value of the Gift Card prior to deactivation.

**Type** = Integer; **totalDigits** = 8

**Parent Elements:**

[authorizationResponse](#), [saleResponse](#), [deactivateResponse](#)

**Attributes:**

None

**Child Elements:**

None

## 4.35 authAmount

The `authAmount` element is an optional child of the `authInformation` element and is used to define the dollar amount of the authorization for Capture Given Auth transactions.

**Type** = Integer; **totalDigits** = 8

**Parent Elements:**

[authInformation](#)

**Attributes:**

None

**Child Elements:**

None

## 4.36 authCode

The authCode element is an optional child of both the authorizationResponse and saleResponse elements. It is also a required child of the authInformation element (used in captureGivenAuth transactions), where it specifies the authorization code from the associated Authorization or Sale transaction.

**Type** = String; **minLength** = N/A; **maxLength** = 6

### Parent Elements:

[authInformation](#), [authorizationResponse](#), [saleResponse](#)

### Attributes:

None

### Child Elements:

None

## 4.37 authDate

The `authDate` element is a required child of the `authInformation` element and defines the date of the associated Authorization transaction.

**Type** = Date; **Format** = YYYY-MM-DD

**Parent Elements:**

[authInformation](#)

**Attributes:**

None

**Child Elements:**

None



## 4.38 authenticatedByMerchant

The `authenticatedByMerchant` element is an optional child element of the `cardholderAuthentication` element. This element indicates whether or not the customer has logged in to a secure web site or has been authenticated by the call center ANI.

**Type** = Boolean; **Valid Values** = true or false

**Parent Elements:**

[cardholderAuthentication](#)

**Attributes:**

None

**Child Elements:**

None

## 4.39 authentication

The `authentication` element is a required element of both the `litleOnlineRequest` and the `batchRequest` elements. It contains child elements used to authenticate that the XML message is from a valid user.

---

---

**NOTE:** The `authentication` element and its child elements, `user` and `password`, are used to identify the merchant submitting transactions. They do not provide other access to platform or to the iQ reporting system.

---

---

### Parent Elements:

[litleOnlineRequest](#), [litleRequest](#)

### Attributes:

None

### Child Elements:

Required: [user](#), [password](#)

### Example: authentication Structure

```
<authentication>
  <user>User Name</user>
  <password>Password</password>
</authentication>
```

## 4.40 authenticationResult

The `authenticationResult` element is an optional child element of the `fraudResult` element. It defines the 3DS results from either Verified by Visa, MasterCard SecureCode, or Discover ProtectBuy. For a list of possible values, please refer to [3DS Authentication Result Codes](#) on page 840.

**Type** = String; **minLength** = N/A; **maxLength** = 1

### Parent Elements:

[fraudResult](#)

### Attributes:

None

### Child Elements:

None

## 4.41 authenticationTransactionId

The `authenticationTransactionId` element is an optional child of the `cardholderAuthentication` element. This element defines the Verified by Visa Transaction Id or the Visa TAVV (Token Authentication Verification Value). This element is not used for Discover ProtectBuy transactions.

You must include this element for Visa transactions, when the `orderSource` element is set to **3dsAuthenticated**.

**Type** = Base 64 Encoded String; **minLength** = N/A; **maxLength** = 28

### Parent Elements:

[cardholderAuthentication](#)

### Attributes:

None

### Child Elements:

None

## 4.42 authenticationValue

The authenticationValue element is an optional child of the cardholderAuthentication element. This element defines either the Visa CAVV value (fixed length 28 characters) or the MasterCard UCAF value (variable length up to 32 characters).

You must include this element for Visa and MasterCard transactions, when the orderSource element is set to **3dsAuthenticated**, as well as MasterCard transactions if the orderSource element is set to **3dsAttempted**.

**Type** = Base 64 Encoded String; **minLength** = N/A; **maxLength** = 56

### Parent Elements:

[cardholderAuthentication](#)

### Attributes:

None

### Child Elements:

None

## 4.43 authInformation

The `authInformation` element is a required child of the `captureGivenAuth` element. It contains child elements used to provide details concerning the external (to the systems) Authorization.

### Parent Elements:

[captureGivenAuth](#)

### Attributes:

None

### Child Elements:

Required: [authDate](#), [authCode](#)

Optional: [fraudResult](#), [authAmount](#)

### Example: authInformation Structure

```
<authInformation>
  <authDate>Auth Date</authDate>
  <authCode>Approval Code</authCode>
  <fraudResult>
    <avsResult>AVS Verification Result Code</avsResult>
    <cardValidationResult>Validation Result Code</cardValidationResult>
    <authenticationResult>Verified by Visa Result Code</authenticationResult>
  </fraudResult>
  <authAmount>Amount of Authorization</authAmount>
</authInformation>
```

## 4.44 authorization

The `authorization` element is the parent element for all Authorization transactions. You can use this element in either Online or Batch transactions.

### Parent Elements:

[littleOnlineRequest](#), [batchRequest](#)

### Attributes:

Attribute Name	Type	Required?	Description
id	String	Yes	A unique identifier assigned by the presenter and mirrored back in the response. <b>minLength = 1    maxLength = 36</b>
customerId	String	No	A value assigned by the merchant to identify the consumer. <b>minLength = N/A    maxLength = 50</b>
reportGroup	String	Yes	Required attribute that defines the merchant sub-group in the user interface where this transaction will be displayed. Please refer to <a href="#">Coding for Report Groups</a> on page 10 for additional information. <b>minLength = 1    maxLength = 25</b>

### Child Elements:

Required: [orderId](#), [amount](#), [orderSource](#), (choice of) [card](#), [paypal](#), [paypage](#), [mpos](#), [token](#), or [applepay](#), [cardholderAuthentication](#)

---

**NOTE:**    **The `cardholderAuthentication` child element is required only for 3-D Secure transactions.**

---

Optional: [customerInfo](#), [billToAddress](#), [shipToAddress](#), [billMeLaterRequest](#), [processingInstructions](#), [pos](#), [customBilling](#), [taxType](#), [enhancedData](#), [amexAggregatorData](#), [allowPartialAuth](#), [healthcareIIAS](#), [merchantData](#), [recyclingRequest](#), [fraudFilterOverride](#), [surchargeAmount](#), [debtRepayment](#), [recurringRequest](#), [advancedFraudChecks](#), [secondaryAmount](#), [wallet](#), [processingType](#), [origOrderId](#), [password](#), [originalNetworkTransactionId](#), [originalTransactionAmount](#)

## 4.45 authorizationResponse

The `authorizationResponse` element is the parent element for information returned to you in response to an Authorization transaction. It can be a child of either a `littleOnlineResponse` element or a `batchResponse` element.

### Parent Elements:

[littleOnlineResponse](#), [batchResponse](#)

### Attributes:

Attribute Name	Type	Required?	Description
id	String	Yes	The response returns the same value submitted in the Authorization transaction. <b>minLength = 1    maxLength = 36</b>
customerId	String	No	The response returns the same value submitted in the Authorization transaction. <b>minLength = N/A    maxLength = 50</b>
reportGroup	String	Yes	The response returns the same value submitted in the Authorization transaction. <b>minLength = 1    maxLength = 25</b>

### Child Elements:

Required: [littleTxnId](#), [orderId](#), [response](#), [responseTime](#), [message](#)

Optional: [postDate](#), [cardProductId](#) (see Note below), [authCode](#), [authorizationResponseSubCode](#) (see Note below), [approvedAmount](#), [accountInformation](#), [fraudResult](#), [billMeLaterResponseData](#), [tokenResponse](#), [enhancedAuthResponse](#), [accountUpdater](#), [recycling](#), [recurringResponse](#), [giftCardResponse](#), [applepayResponse](#), [cardSuffix](#), [androidpayResponse](#), [networkTransactionId](#)

---

**NOTE:**    The `postDate` child element is returned only in responses to Online transactions.

              The `cardProductId` element returns a raw code referencing the card type. Please consult your Relationship Manager for additional information.

              The `authorizationResponseSubCode` element is not used at this time.

---



## 4.46 authorizationSourcePlatform

The `authorizationSourcePlatform` element is an optional child element of the `billMeLaterRequest` element. This element defines the physical platform that was used for submitting the authorization request (not the order). Specify as needed for auditing and re-authorization management purposes.

**Type** = String; **minLength** = N/A; **maxLength** = 1 (valid values below)

Value	Description
A	application processing
B	batch capture, recurring or mail order
C	call center
F	fulfillment/order management
K	kiosk
M	mobile device gateway
P	processor or gateway reauthorization
R	retail POS

**Parent Elements:**

[billMeLaterRequest](#)

**Attributes:**

None

**Child Elements:**

None

## 4.47 authReversal

The `authReversal` element is the parent element for all Authorization Reversal transactions. You can use this element in either Online or Batch transactions. Also see [Notes on the Use of Authorization Reversal Transactions](#) on page 77. Also, if you use the Recycling Engine, you can use the `authReversal` transaction to halt the recycling of an authorization transaction.

### Parent Elements:

[litleOnlineRequest](#), [batchRequest](#)

### Attributes:

Attribute Name	Type	Required?	Description
id	String	Yes	A unique identifier assigned by the presenter and mirrored back in the response. <b>minLength = 1    maxLength = 36</b>
customerId	String	No	A value assigned by the merchant to identify the consumer. <b>minLength = N/A    maxLength = 50</b>
reportGroup	String	Yes	Required attribute that defines the merchant sub-group in the user interface where this transaction will be displayed. Please refer to <a href="#">Coding for Report Groups</a> on page 10 for additional information. <b>minLength = 1    maxLength = 25</b>

### Child Elements:

Required: [litleTxnId](#)

Optional: [amount](#), [actionReason](#), [paypalNotes](#), [surchargeAmount](#)

---

**NOTE:**    If you do not specify an amount child element, the system reverses the full amount from the associated Authorization transaction.

---

## 4.48 authReversalResponse

The `authReversalResponse` element is the parent element for information returned to you in response to an Auth Reversal transaction. It can be a child of either a `litleOnlineResponse` element or a `batchResponse` element.

### Parent Elements:

[litleOnlineResponse](#), [batchResponse](#)

### Attributes:

Attribute Name	Type	Required?	Description
id	String	Yes	The response returns the same value submitted in the Authorization Reversal transaction. <b>minLength = 1    maxLength = 36</b>
customerId	String	No	The response returns the same value submitted in the Authorization Reversal transaction. <b>minLength = N/A    maxLength = 50</b>
reportGroup	String	Yes	The response returns the same value submitted in the Authorization Reversal transaction. <b>minLength = 1    maxLength = 25</b>

### Child Elements:

Required: [litleTxnId](#), [response](#), [responseTime](#), [message](#)

Optional: [postDate](#)

---

**NOTE:**    The `postDate` child element is returned only in responses to Online transactions.

---

## 4.49 availableBalance

The `availableBalance` element is a required child element of the `fundingSource` element and an optional child of the `giftCardResponse` element. It defines the outstanding available balance on the submitted prepaid or Gift Card. If the balance can not be determined, the element returns, “Not Available.”

**Type** = String; **minLength** = N/A; **maxLength** = 20

### Parent Elements:

[fundingSource](#), [giftCardResponse](#)

### Attributes:

None

### Child Elements:

None

---

---

**NOTE:** The `fundingSource` element and its child elements, `type` and `availableBalance` are associated with the Insights features (see [Issuer Insights](#) on page 24.)  
Please consult your Relationship Manager for additional information.

---

---

## 4.50 avsResult

The `avsResult` element is an optional child element of the `fraudResult` element. It defines the Address Verification response code returned by the networks. For a list of possible values, please refer to [AVS Response Codes](#) on page 842.

**Type** = String; **minLength** = N/A; **maxLength** = 2

### Parent Elements:

[fraudResult](#)

### Attributes:

None

### Child Elements:

None

## 4.51 balanceInquiry

The `balanceInquiry` element is the parent element for the transaction type that queries the available balance of a Gift Card.

### Parent Elements:

[littleOnlineRequest](#), [batchRequest](#)

### Attributes:

Attribute Name	Type	Required?	Description
id	String	Yes	A unique identifier assigned by the presenter and mirrored back in the response. <b>minLength = 1    maxLength = 36</b>
customerId	String	No	A value assigned by the merchant to identify the consumer. <b>minLength = N/A    maxLength = 50</b>
reportGroup	String	Yes	Required attribute that defines the merchant sub-group in the user interface where this transaction will be displayed. Please refer to <a href="#">Coding for Report Groups</a> on page 10 for additional information. <b>minLength = 1    maxLength = 25</b>

### Child Elements: (all Required)

[orderId](#), [orderSource](#), [card](#)

## 4.52 balanceInquiryResponse

The `balanceInquiryResponse` element is the parent element for information returned to you in response to a **balanceInquiry** transaction. It can be a child of either a `litleOnlineResponse` element or a `batchResponse` element.

### Parent Elements:

[litleOnlineResponse](#), [batchResponse](#)

### Attributes:

Attribute Name	Type	Required?	Description
id	String	Yes	The response returns the same value submitted in the Balance Inquiry transaction. <b>minLength = 1    maxLength = 36</b>
customerId	String	No	The response returns the same value submitted in the Balance Inquiry transaction. <b>minLength = N/A    maxLength = 50</b>
reportGroup	String	Yes	The response returns the same value submitted in the Balance Inquiry transaction. <b>minLength = 1    maxLength = 25</b>

### Child Elements:

Required: [litleTxnId](#), [orderId](#), [response](#), [responseTime](#), [message](#)

Optional: [postDate](#), [fraudResult](#), [giftCardResponse](#)

## 4.53 batchRequest

This is the root element for all cnpAPI Batch requests.

**Parent Elements:**

[litleRequest](#)

**Attributes:**

---

**NOTE:** Include the count and amount attributes for all transaction types included in the Batch. For example if you submit one Sale transaction of \$10, include numSales="1" and saleAmount="1000". You must always include an amount, if you include a count. Do not include corresponding attributes, if the Batch does not include the transaction type.

---

Attribute Name	Type	Required?	Description
id	String	No	A unique string to identify this batchRequest within the system. <b>minLength = N/A maxLength = 50</b>
numAuths	Integer	No	Defines the total count of Authorization transactions in the batchRequest. <b>minLength = N/A maxLength = N/A</b>
authAmount	Integer	No	Defines the total dollar amount of Authorization transactions in the batchRequest. The decimal point is implied. For example, you enter \$25.00 as 2500. <b>totalDigits = 10</b>
numAuthReversals	Integer	No	Defines the total count of AuthReversal transactions in the batchRequest. <b>minLength = N/A maxLength = N/A</b>
authReversalAmount	Integer	No	Defines the total dollar amount of AuthReversal transactions in the batchRequest. The decimal point is implied. For example, you enter \$25.00 as 2500. <b>totalDigits = 10</b>
numGiftCardAuthReversals	Integer	No	Defines the total count of giftCardAuthReversal transactions in the batchRequest. <b>minLength = N/A maxLength = N/A</b>



Attribute Name	Type	Required?	Description
giftCardAuthReversalOriginalAmount	Integer	No	Defines the total dollar amount of giftCardAuthReversal transactions in the <code>batchRequest</code> . The decimal point is implied. For example, you enter \$25.00 as 2500. <b>totalDigits = 10</b>
numCaptures	Integer	No	Defines the total count of Capture transactions in the <code>batchRequest</code> . <b>minLength = N/A maxLength = N/A</b>
captureAmount	Integer	No	Defines the total dollar amount of Capture transactions in the <code>batchRequest</code> . The decimal point is implied. For example, you enter \$25.00 as 2500. <b>totalDigits = 10</b>
numGiftCardCaptures	Integer	No	Defines the total count of giftCardCapture transactions in the <code>batchRequest</code> . <b>minLength = N/A maxLength = N/A</b>
giftCardCaptureAmount	Integer	No	Defines the total dollar amount of giftCardCapture transactions in the <code>batchRequest</code> . The decimal point is implied. For example, you enter \$25.00 as 2500. <b>totalDigits = 10</b>
numCredits	Integer	No	Defines the total count of Credit transactions in the <code>batchRequest</code> . <b>minLength = N/A maxLength = N/A</b>
creditAmount	Integer	No	Defines the total dollar amount of Credit transactions in the <code>batchRequest</code> . The decimal point is implied. For example, you enter \$25.00 as 2500. <b>totalDigits = 10</b>
numGiftCardCredits	Integer	No	Defines the total count of giftCardCredit transactions in the <code>batchRequest</code> . <b>minLength = N/A maxLength = N/A</b>
giftCardCreditAmount	Integer	No	Defines the total dollar amount of giftCardCredit transactions in the <code>batchRequest</code> . The decimal point is implied. For example, you enter \$25.00 as 2500. <b>totalDigits = 10</b>

Attribute Name	Type	Required?	Description
numForceCaptures	Integer	No	Defines the total count of Force Capture transactions in the <code>batchRequest</code> . <b>minLength</b> = N/A <b>maxLength</b> = N/A
forceCaptureAmount	Integer	No	Defines the total dollar amount of Force Capture transactions in the <code>batchRequest</code> . The decimal point is implied. For example, you enter \$25.00 as 2500. <b>totalDigits</b> = 10
numSales	Integer	No	Defines the total count of Sale transactions in the <code>batchRequest</code> . <b>minLength</b> = N/A <b>maxLength</b> = N/A
saleAmount	Integer	No	Defines the total dollar amount of Sale transactions in the <code>batchRequest</code> . The decimal point is implied. For example, you enter \$25.00 as 2500. <b>totalDigits</b> = 10
numCaptureGivenAuths	Integer	No	Defines the total count of Capture Given Auth transactions in the <code>batchRequest</code> . <b>minLength</b> = N/A <b>maxLength</b> = N/A
captureGivenAuthAmount	Integer	No	Defines the total dollar amount of Capture Given Auth transactions in the <code>batchRequest</code> . The decimal point is implied. For example, you enter \$25.00 as 2500. <b>totalDigits</b> = 10
numEcheckSales	Integer	No	Defines the total count of eCheck Sale transactions in the <code>batchRequest</code> . <b>minLength</b> = N/A <b>maxLength</b> = N/A
echeckSalesAmount	Integer	No	Defines the total dollar amount of eCheck Sale transactions in the <code>batchRequest</code> . The decimal point is implied. For example, you enter \$25.00 as 2500. <b>totalDigits</b> = 10
numEcheckCredit	Integer	No	Defines the total count of eCheck Credit transactions in the <code>batchRequest</code> . <b>minLength</b> = N/A <b>maxLength</b> = N/A

Attribute Name	Type	Required?	Description
echeckCreditAmount	Integer	No	Defines the total dollar amount of eCheck Credit transactions in the <code>batchRequest</code> . The decimal point is implied. For example, you enter \$25.00 as 2500. <b>totalDigits = 10</b>
numEcheckVerification	Integer	No	Defines the total count of eCheck Verification transactions in the <code>batchRequest</code> . <b>minLength = N/A maxLength = N/A</b>
echeckVerificationAmount	Integer	No	Defines the total dollar amount of eCheck Verification transactions in the <code>batchRequest</code> . The decimal point is implied. For example, you enter \$25.00 as 2500. <b>totalDigits = 10</b>
numEcheckRedeposit	Integer	No	Defines the total count of eCheck Redeposit transactions in the <code>batchRequest</code> . <b>minLength = N/A maxLength = N/A</b>
numEcheckPreNoteSale	Integer	No	Defines the total count of eCheck Prenotification Sale transactions in the <code>batchRequest</code> . <b>minLength = N/A maxLength = N/A</b>
numEcheckPreNoteCredit	Integer	No	Defines the total count of eCheck Prenotification Credit transactions in the <code>batchRequest</code> . <b>minLength = N/A maxLength = N/A</b>
numAccountUpdates	Integer	No	Defines the total count of Account Update transactions in the <code>batchRequest</code> . <b>minLength = N/A maxLength = N/A</b>
numTokenRegistrations	Integer	No	Defines the total count of Token Registration transactions in the <code>batchRequest</code> . <b>minLength = N/A maxLength = N/A</b>
numUpdateCardValidationNumOnTokens	Integer	No	Defines the total count of Update Card Validation Number request transactions in the <code>batchRequest</code> . <b>minLength = N/A maxLength = N/A</b>
numCancelSubscriptions	Integer	No	Defines the total count of Cancel Subscription transactions in the <code>batchRequest</code> . <b>minLength = N/A maxLength = N/A</b>
numUpdateSubscriptions	Integer	No	Defines the total count of Update Subscription transactions in the <code>batchRequest</code> . <b>minLength = N/A maxLength = N/A</b>

Attribute Name	Type	Required?	Description
numCreatePlans	Integer	No	Defines the total count of Create Plan transactions in the <code>batchRequest</code> . <b>minLength</b> = N/A <b>maxLength</b> = N/A
numUpdatePlans	Integer	No	Defines the total count of Update Plan transactions in the <code>batchRequest</code> . <b>minLength</b> = N/A <b>maxLength</b> = N/A
numActivates	Integer	No	Defines the total count of (Gift Card) Activate transactions in the <code>batchRequest</code> . <b>minLength</b> = N/A <b>maxLength</b> = N/A
numDeactivates	Integer	No	Defines the total count of (Gift Card) Deactivate transactions in the <code>batchRequest</code> . <b>minLength</b> = N/A <b>maxLength</b> = N/A
activateAmount	Integer	No	Defines the total dollar amount of (Gift Card) Activate transactions in the <code>batchRequest</code> . The decimal point is implied. For example, you enter \$25.00 as 2500. <b>totalDigits</b> = 10
numLoads	Integer	No	Defines the total count of (Gift Card) Load transactions in the <code>batchRequest</code> . <b>minLength</b> = N/A <b>maxLength</b> = N/A
loadAmount	Integer	No	Defines the total dollar amount of (Gift Card) Load transactions in the <code>batchRequest</code> . The decimal point is implied. For example, you enter \$25.00 as 2500. <b>totalDigits</b> = 10
numUnloads	Integer	No	Defines the total count of (Gift Card) Unload transactions in the <code>batchRequest</code> . <b>minLength</b> = N/A <b>maxLength</b> = N/A
unloadAmount	Integer	No	Defines the total dollar amount of (Gift Card) Unload transactions in the <code>batchRequest</code> . The decimal point is implied. For example, you enter \$25.00 as 2500. <b>totalDigits</b> = 10
numBalanceInquiries	Integer	No	Defines the total count of (Gift Card) Balance Inquiry transactions in the <code>batchRequest</code> . <b>minLength</b> = N/A <b>maxLength</b> = N/A

Attribute Name	Type	Required?	Description
numPayFacCredit	Integer	No	Defines the total count of PayFac Credit transactions in the <code>batchRequest</code> . <b>minLength = N/A maxLength = N/A</b>
numPayFacDebit	Integer	No	Defines the total count of PayFac Debit transactions in the <code>batchRequest</code> . <b>minLength = N/A maxLength = N/A</b>
numSubmerchantCredit	Integer	No	Defines the total count of Submerchant Credit transactions in the <code>batchRequest</code> . <b>minLength = N/A maxLength = N/A</b>
numSubmerchantDebit	Integer	No	Defines the total count of Submerchant Debit transactions in the <code>batchRequest</code> . <b>minLength = N/A maxLength = N/A</b>
numReserveCredit	Integer	No	Defines the total count of Reserve Credit transactions in the <code>batchRequest</code> . <b>minLength = N/A maxLength = N/A</b>
numReserveDebit	Integer	No	Defines the total count of Reserve Debit transactions in the <code>batchRequest</code> . <b>minLength = N/A maxLength = N/A</b>
numVendorCredit	Integer	No	Defines the total count of Vendor Credit transactions in the <code>batchRequest</code> . <b>minLength = N/A maxLength = N/A</b>
numVendorDebit	Integer	No	Defines the total count of Vendor Debit transactions in the <code>batchRequest</code> . <b>minLength = N/A maxLength = N/A</b>
numPhysicalCheckCredit	Integer	No	Defines the total count of Physical Check Credit transactions in the <code>batchRequest</code> . <b>minLength = N/A maxLength = N/A</b>
numPhysicalCheckDebit	Integer	No	Defines the total count of Physical Check Debit transactions in the <code>batchRequest</code> . <b>minLength = N/A maxLength = N/A</b>
numFundingInstructionVoid	Integer	No	Defines the total count of Funding Instruction Void transactions in the <code>batchRequest</code> . <b>minLength = N/A maxLength = N/A</b>

Attribute Name	Type	Required?	Description
payFacCreditAmount	Integer	No	Defines the total dollar amount of PayFac Credit transactions in the <code>batchRequest</code> . The decimal point is implied. For example, you enter \$25.00 as 2500. <b>totalDigits = 10</b>
payFacDebitAmount	Integer	No	Defines the total dollar amount of PayFac Debit transactions in the <code>batchRequest</code> . The decimal point is implied. For example, you enter \$25.00 as 2500. <b>totalDigits = 10</b>
submerchantCreditAmount	Integer	No	Defines the total dollar amount of Sub-merchant Credit transactions in the <code>batchRequest</code> . The decimal point is implied. For example, you enter \$25.00 as 2500. <b>totalDigits = 10</b>
submerchantDebitAmount	Integer	No	Defines the total dollar amount of Sub-merchant Debit transactions in the <code>batchRequest</code> . The decimal point is implied. For example, you enter \$25.00 as 2500. <b>totalDigits = 10</b>
reserveCreditAmount	Integer	No	Defines the total dollar amount of Reserve Credit transactions in the <code>batchRequest</code> . The decimal point is implied. For example, you enter \$25.00 as 2500. <b>totalDigits = 10</b>
reserveDebitAmount	Integer	No	Defines the total dollar amount of Reserve Debit transactions in the <code>batchRequest</code> . The decimal point is implied. For example, you enter \$25.00 as 2500. <b>totalDigits = 10</b>
vendorCreditAmount	Integer	No	Defines the total dollar amount of Vendor Credit transactions in the <code>batchRequest</code> . The decimal point is implied. For example, you enter \$25.00 as 2500. <b>totalDigits = 10</b>
vendorDebitAmount	Integer	No	Defines the total dollar amount of Vendor Debit transactions in the <code>batchRequest</code> . The decimal point is implied. For example, you enter \$25.00 as 2500. <b>totalDigits = 10</b>

Attribute Name	Type	Required?	Description
physicalCheckCreditAmount	Integer	No	Defines the total dollar amount of Physical Check Credit transactions in the <code>batchRequest</code> . The decimal point is implied. For example, you enter \$25.00 as 2500. <b>totalDigits = 10</b>
physicalCheckDebitAmount	Integer	No	Defines the total dollar amount of Physical Check Debit transactions in the <code>batchRequest</code> . The decimal point is implied. For example, you enter \$25.00 as 2500. <b>totalDigits = 10</b>
merchantId	String	Yes	A unique string to identify the merchant within the system. <b>minLength = N/A maxLength = 50</b> <b>Note: International currencies are supported on a per merchantId basis.</b>
sameDayFunding	Boolean	No	Used for Dynamic Payout Funding Instructions only. Set to <b>true</b> to mark this Batch of Funding Instructions for same day funding. Also, see <a href="#">Same Day Funding</a> on page 888.

### Child Elements:

At least one of the following required: [activate](#), [authorization](#), [authReversal](#), [balanceInquiry](#), [cancelSubscription](#), [capture](#), [captureGivenAuth](#), [createPlan](#), [credit](#), [deactivate](#), [echeckCredit](#), [echeckPreNoteSale](#), [echeckRedeposit](#), [echeckSale](#), [echeckVerification](#), [forceCapture](#), [giftCardAuthReversal](#), [giftCardCapture](#), [giftCardCredit](#), [load](#), [registerTokenRequest](#), [sale](#), [unload](#), [updateCardValidationNumOnToken](#), [updatePlan](#), [updateSubscription](#), [payFacCredit](#), [payFacDebit](#), [reserveCredit](#), [reserveDebit](#), [submerchantCredit](#), [submerchantDebit](#), [vendorCredit](#), [vendorDebit](#)

## 4.54 batchResponse

The `batchResponse` element is the parent element for information returned to you in response to a batch you submitted for processing. It is a child of a `littleResponse` element.

### Parent Elements:

[littleResponse](#)

### Attributes:

Attribute Name	Type	Required?	Description
id	String	No	The response returns the same value submitted in the Batch Request. <b>minLength</b> = N/A <b>maxLength</b> = 25
littleBatchId	Long	Yes	A unique value assigned by Vantiv to identify the batch. <b>minLength</b> = N/A <b>maxLength</b> = 19
merchantId	String	Yes	The response returns the same value submitted in the Batch Request. <b>minLength</b> = 1 <b>maxLength</b> = 50

### Child Elements:

Required: [accountUpdateResponse](#), [activateResponse](#), [authorizationResponse](#), [authReversalResponse](#), [captureResponse](#), [captureGivenAuthResponse](#), [createPlanResponse](#), [creditResponse](#), [deactivateResponse](#), [echeckCreditResponse](#), [echeckPreNoteCreditResponse](#), [echeckPreNoteSaleResponse](#), [echeckRedepositResponse](#), [echeckSalesResponse](#), [echeckVerificationResponse](#), [forceCaptureResponse](#), [giftCardAuthReversalResponse](#), [giftCardCaptureResponse](#), [giftCardCreditResponse](#), [loadResponse](#), [registerTokenResponse](#), [saleResponse](#), [unloadResponse](#), [updateCardValidationNumOnTokenResponse](#), [cancelSubscriptionResponse](#), [updatePlanResponse](#), [updateSubscriptionResponse](#), [payFacCreditResponse](#), [payFacDebitResponse](#), [physicalCheckCreditResponse](#), [physicalCheckDebitResponse](#), [reserveCreditResponse](#), [reserveDebitResponse](#), [submerchantCreditResponse](#), [submerchantDebitResponse](#), [vendorCreditResponse](#), [vendorDebitResponse](#)

---

**NOTE:** The `batchResponse` contains child elements corresponding to the requests submitted in the `batchRequest`. For example, if the `batchRequest` contained 10 `authorization` and 8 `capture` transactions, the `batchResponse` would contain 10 `authorizationResponse` and 8 `captureResponse` transactions.

---



## 4.55 beginningBalance

The `beginningBalance` element is an optional child of the `giftCardResponse` element. It defines the available balance on the submitted Gift Card prior to the requested operation.

---

---

**NOTE:** Although included in the schema, the `beginningBalance`, `endingBalance`, and `cashBackAmount` elements are not currently supported.

---

---

Type = String; minLength = N/A; maxLength = 20

**Parent Elements:**

[giftCardResponse](#)

**Attributes:**

None

**Child Elements:**

None

## 4.56 billingDate

The `billingDate` element is an optional child of the `updateSubscription` element that defines the new date for the recurring billing when the scheduled date need to be changed.

**Type** = Date; **Format** = YYYY-MM-DD

**Parent Elements:**

[updateSubscription](#)

**Attributes:**

None

**Child Elements:**

None

## 4.57 billMeLaterRequest

The `billMeLaterRequest` element is the parent of several child elements used to define merchant, product type, terms and conditions, and other items for PayPal Credit authorization transactions, or where you must reference an external (to Vantiv) BML transaction.

---

---

**NOTE:** As of September, 2016, the Vantiv eCommerce platform no longer supports PayPal Credit for new merchants or existing merchants not already using this payment method. Existing merchants already using PayPal Credit should consult their Vantiv Relationship Manager.

---

---

### Parent Elements:

[authorization](#), [captureGivenAuth](#), [credit](#), [sale](#)

### Attributes:

None

### Child Elements: (all optional)

[bmlMerchantId](#), [bmlProductType](#), [itemCategoryCode](#), [termsAndConditions](#), [preapprovalNumber](#), [virtualAuthenticationKeyPresenceIndicator](#), [virtualAuthenticationKeyData](#), [authorizationSourcePlatform](#)

---

---

**NOTE:** The following elements appear in the schema as children of the `billMeLaterRequest` element, but are not used at this time:

- `authorizationSourcePlatform`
  - `customerBillingAddressChanged`
  - `customerEmailChanged`
  - `customerPasswordChanged`
  - `customerPhoneChanged`
  - `merchantPromotionalCode`
  - `secretQuestionAnswer`
  - `secretQuestionCode`
- 
- 

### Example: billMeLaterRequest

```
<billMeLaterRequest>
  <bmlMerchantId>bmlMerchantId</bmlMerchantId>
  <bmlProductType>bmlProductType</bmlProductType>
  <termsAndConditions>termsAndConditions</termsAndConditions>
```

```
<preapprovalNumber>preapprovalNumber</preapprovalNumber>
<virtualAuthenticationKeyPresenceIndicator> Indicator
</virtualAuthenticationKeyPresenceIndicator>
<virtualAuthenticationKeyData> virtualAuthenticationKeyData
</virtualAuthenticationKeyData>
<itemCategoryCode>itemCategoryCode</itemCategoryCode>
<authorizationSourcePlatform>platformType</authorizationSourcePlatform>
</billMeLaterRequest>
```

## 4.58 billMeLaterResponseData

The `billMeLaterResponseData` element is the parent of several child elements used in the response XML for PayPal Credit authorization transactions.

---

---

**NOTE:** As of September, 2016, the Vantiv eCommerce platform no longer supports PayPal Credit for new merchants or existing merchants not already using this payment method. Existing merchants already using PayPal Credit should consult their Vantiv Relationship Manager.

---

---

### Parent Elements:

[authorizationResponse](#), [saleResponse](#)

### Attributes:

None

### Child Elements:

[bmlMerchantId](#), [creditLine](#), [addressIndicator](#)

---

---

**NOTE:** The following elements appear in the schema as children of the `billMeLaterResponseData` element, but are not used at this time:

- `approvedTermsCode`
  - `loanToValueEstimator`
  - `promotionalCodeOffer`
  - `riskEstimator`
  - `riskQueueAssignment`
- 
- 

### Example: billMeLaterResponseData Structure

```
<billMeLaterResponseData>
  <bmlMerchantId>bmlMerchantId</bmlMerchantId>
  <creditLine>creditLine</creditLine>
  <addressIndicator>addressIndicator</addressIndicator>
</billMeLaterResponseData>
```

## 4.59 billToAddress

The `billToAddress` element contains several child elements that define the postal mailing address (and telephone number) used for billing purposes. It also contains several elements used for the eCheck verification process.

### Parent Elements:

`authorization`, `captureGivenAuth`, `credit`, `echeckCredit` (required if original transaction was not processed by Vantiv), `echeckPreNoteCredit`, `echeckPreNoteSale`, `echeckSale`, `echeckVerification`, `forceCapture`, `fraudCheck`, `sale`, `updateSubscription`

### Attributes:

None

### Child Elements: (all optional)

`name`, `firstName`, `middleInitial`, `lastName`, `companyName`, `addressLine1`, `addressLine2`, `addressLine3`, `city`, `state`, `zip`, `country`, `email`, `phone`

---

**NOTE:** You must submit the `name` element for `echeckSale` and `echeckCredit` transactions. If you do not submit the customer name in these eCheck transactions, we return the response 709 - Invalid Data.

You must submit the `name`, `country`, and `email` elements in `sale` transactions using the `sepaDirectDebit` method of payment. Failure to include these elements results in a 901 - Missing Name Response Code, 903 - Missing Billing Country Code, or 905 - Missing Email Address respectively.

For an `echeckVerification` transaction, you must submit the `firstName` and `lastName` elements instead of the `name` element (`middleInitial` is optional). For a corporate account you must include the `companyName` element in addition to the `firstName` and `lastName` elements. In both cases, you also must include the address, city, state, zip and phone information.

For a corporate account, if you do not have the name of the check issuer, you can use a value of "unavailable" for the `firstName` and `lastName` elements.

---

### Example: billToAddress Structure

```
<billToAddress>
  <name>Customer's Full Name</name>
  <firstName>Customer's First Name</firstName>
  <middleInitial>Customer's Middle Initial</middleInitial>
  <lastName>Customer's Last Name</lastName>
```

```
<companyName>Company's Name</companyName> (include for echeckVerification of
corporate account)
<addressLine1>Address Line 1</addressLine1>
<addressLine2>Address Line 2</addressLine2>
<addressLine3>Address Line 3</addressLine3>
<city>City</city>
<state>State Abbreviation</state>
<zip>Postal Code</zip>
<country>Country Code</country>
<email>Email Address</email>
<phone>Telephone Number</phone>
</billToAddress>
```

## 4.60 bin

The `bin` element provides the 6-digit Bank (or Issuer) Identification Number of the Issuing Bank. The system returns this value in XML responses when issuing new tokens to replace Visa or MasterCard account numbers.

For Discover and American Express cards, this element is empty in a `registerTokenResponse`.

For Discover, when included with Account Updater information in a payment transaction response, the `bin` element will have a value of **discov**.

**Type** = String; **minLength** = 0; **maxLength** = 6

### Parent Elements:

The `bin` element is an optional child of each listed parent element.

[registerTokenResponse](#), [tokenResponse](#), [newCardTokenInfo](#), [originalCardTokenInfo](#), [originalToken](#), [updatedToken](#)

### Attributes:

None

### Child Elements:

None



## 4.61 bmlMerchantId

The `bmlMerchantId` element is a value assigned by PayPal Credit to identify the merchant within the PayPal Credit system.

---

---

**NOTE:** As of September, 2016, the Vantiv eCommerce platform no longer supports PayPal Credit for new merchants or existing merchants not already using this payment method. Existing merchants already using PayPal Credit should consult their Vantiv Relationship Manager.

---

---

**Type** = Long; **minLength** = N/A; **maxLength** = 19

### Parent Elements:

The `bmlMerchantId` element is an optional child of each listed parent element.

[billMeLaterRequest](#), [billMeLaterResponseData](#)

### Attributes:

None

### Child Elements:

None

## 4.62 bmlProductType

The `bmlProductType` element is a value assigned by PayPal Credit to identify the merchant account type within the PayPal Credit system.

---

---

**NOTE:** As of September, 2016, the Vantiv eCommerce platform no longer supports PayPal Credit for new merchants or existing merchants not already using this payment method. Existing merchants already using PayPal Credit should consult their Vantiv Relationship Manager.

---

---

Type = String; minLength = 2; maxLength = 2

### Parent Elements:

The `bmlProductType` element is an optional child of each listed parent element.

[billMeLaterRequest](#), [billMeLaterResponseData](#)

---

---

**NOTE:** At this time, the only valid value for this element is BL.

---

---

### Attributes:

None

### Child Elements:

None

## 4.63 bypassVelocityCheck

The `bypassVelocityCheck` element is an optional child of the `processingInstructions` element, which allows you to specify whether or not the system performs velocity checking on the transaction.

---

---

**NOTE:**      **Velocity Checking is not currently supported.**

---

---

**Type** = Boolean; **Valid Values** = true or false

**Parent Elements:**

[processingInstructions](#)

**Attributes:**

None

**Child Elements:**

None

## 4.64 campaign

The `campaign` element is an optional child element of the `merchantData` element. You can use it to track transactions associated with various marketing campaigns.

**Type** = String; **minLength** = N/A; **maxLength** = 25

**Parent Elements:**

[merchantData](#)

**Attributes:**

None

**Child Elements:**

None

## 4.65 cancelSubscription

The `cancelSubscription` element is the parent element for the transaction that cancels a subscription. You can use this element in either Online or Batch transactions.

**Parent Elements:**

[litleOnlineRequest](#), [batchRequest](#)

**Attributes:**

None

**Child Elements:**

Required: [subscriptionId](#)

## 4.66 cancelSubscriptionResponse

The `cancelSubscriptionResponse` element is the parent element for the response to a `cancelSubscription` transaction.

**Parent Elements:**

`litleOnlineResponse`, `batchResponse`

**Attributes:**

None

**Child Elements:**

Required: `subscriptionId`, `litleTxnId`, `response`, `message`, `responseTime`

## 4.67 capability

The `capability` element is a required child of the `pos` element, which describes the capability of the point of sale terminal.

**Type** = String (Enum); **minLength** = N/A; **maxLength** = N/A

### Parent Elements:

`pos`

### Attributes:

None

### Child Elements:

None

### Enumerations:

Enumeration	Description
notused	terminal not used
magstripe	magnetic stripe reader capability
keyedonly	keyed entry only capability

---

**NOTE:** For CAT (Cardholder Activated Terminal) transactions, the `capability` element must be set to `magstripe`, the `cardholderId` element must be set to `nopin`, and the `catLevel` element must be set to `self service`.

---

## 4.68 capture

The `capture` element is the parent element for all Capture (deposit) transactions. You can use this element in either Online or Batch transactions.

### Parent Elements:

[litleOnlineRequest](#), [batchRequest](#)

### Attributes:

Attribute Name	Type	Required?	Description
id	String	Yes	A unique identifier assigned by the presenter and mirrored back in the response. <b>minLength = 1    maxLength = 36</b>
customerId	String	No	A value assigned by the merchant to identify the consumer. <b>minLength = N/A    maxLength = 50</b>
reportGroup	String	Yes	Required attribute that defines the merchant sub-group in the user interface where this transaction will be displayed. Please refer to <a href="#">Coding for Report Groups</a> on page 10 for additional information. <b>minLength = 1    maxLength = 25</b>
partial	Boolean	No	If there is more than one capture that references the same <code>&lt;litleTxnId&gt;</code> , set this attribute to "true" for each of those partial captures. The default value is false. <b>Valid Values = true or false</b> <b>Note: If you settle in a currency other than US or Canada, you cannot use partial captures.</b>

### Child Elements:

Required: [litleTxnId](#), [paypalOrderComplete](#) (required only if closing a PayPal order)

Optional: [amount](#), [enhancedData](#), [paypalNotes](#), [pin](#), [processingInstructions](#), [secondaryAmount](#), [surchargeAmount](#)

---

**NOTE:**    If you do not specify an amount, the system uses the full amount from the associated Authorization transaction.

---



## 4.69 captureAmount

The `captureAmount` element is a required child of the `giftCardCapture` element and defines the amount of the capture (deposit). This value must be less than or equal to the value of the `originalAmount` element. Setting this element to a value less than the `originalAmount` implies that this is a partial capture.

**Type** = Integer; **totalDigits** = 12

**Parent Elements:**

[giftCardCapture](#)

**Attributes:**

None

**Child Elements:**

None

## 4.70 captureGivenAuth

The `captureGivenAuth` element is the parent element for all Capture Given Auth transactions. These are specialized Capture transactions used when the `littleTxnId` for the associated Authorization is unknown or when the Authorization occurred outside our system. You can use this element in either Online or Batch transactions.

### Parent Elements:

[littleOnlineRequest](#), [batchRequest](#)

### Attributes:

Attribute Name	Type	Required?	Description
id	String	Yes	A unique identifier assigned by the presenter and mirrored back in the response. <b>minLength = 1    maxLength = 36</b>
customerId	String	No	A value assigned by the merchant to identify the consumer. <b>minLength = N/A    maxLength = 50</b>
reportGroup	String	Yes	Required attribute that defines the merchant sub-group in the user interface where this transaction will be displayed. Please refer to <a href="#">Coding for Report Groups</a> on page 10 for additional information. <b>minLength = 1    maxLength = 25</b>

### Child Elements:

Required: [orderId](#), [authInformation](#), [amount](#), [orderSource](#), choice of [card](#), [token](#), [mpos](#), or [paypage](#)

Optional: [billToAddress](#), [shipToAddress](#), [customBilling](#), [taxType](#), [enhancedData](#), [processingInstructions](#), [pos](#), [amexAggregatorData](#), [merchantData](#), [secondaryAmount](#), [surchargeAmount](#), [debtRepayment](#), [processingType](#), [originalNetworkTransactionId](#), [originalTransactionAmount](#)

---

**NOTE:** If you do not specify an `amount` child element, the system uses the full amount from the associated Authorization transaction.

---

## 4.71 captureGivenAuthResponse

The `captureGivenAuthResponse` element is the parent element for information returned to you in response to a Capture Given Auth transaction. It can be a child of either a `litleOnlineResponse` element or a `batchResponse` element.

### Parent Elements:

[litleOnlineResponse](#), [batchResponse](#)

### Attributes:

Attribute Name	Type	Required?	Description
id	String	Yes	The response returns the same value submitted in the Capture Given Auth transaction. <b>minLength = 1    maxLength = 36</b>
customerId	String	No	The response returns the same value submitted in the Capture Given Auth transaction. <b>minLength = N/A    maxLength = 50</b>
reportGroup	String	Yes	The response returns the same value submitted in the Capture Given Auth transaction. <b>minLength = 1    maxLength = 25</b>

### Child Elements:

Required: [litleTxnId](#), [response](#), [responseTime](#), [message](#)

Optional: [postDate](#), [tokenResponse](#), [giftCardResponse](#)

---

---

**NOTE:**    The `postDate` child element is returned only in responses to Online transactions.

---

---

## 4.72 captureResponse

The `captureResponse` element is the parent element for information returned to you in response to a Capture transaction. It can be a child of either a `littleOnlineResponse` element or a `batchResponse` element.

### Parent Elements:

[littleOnlineResponse](#), [batchResponse](#)

### Attributes:

Attribute Name	Type	Required?	Description
id	String	Yes	The response returns the same value submitted in the capture transaction. <b>minLength = 1    maxLength = 36</b>
customerId	String	No	The response returns the same value submitted in the capture transaction. <b>minLength = N/A    maxLength = 50</b>
reportGroup	String	Yes	The response returns the same value submitted in the capture transaction. <b>minLength = 1    maxLength = 25</b>

### Child Elements:

Required: [littleTxnId](#), [response](#), [responseTime](#), [message](#)

Optional: [postDate](#), [accountUpdater](#), [giftCardResponse](#)

---

**NOTE:** The system returns the `postDate` child element in all Online transactions responses.

---

## 4.73 card

The `card` element defines payment card information. It is a required element for most transaction types unless the transaction uses an alternate payment method such as PayPal. It contains one or more child elements depending upon whether the transaction is a card-not-present or a card-present (face-to-face) transaction.

### Parent Elements:

[activate](#), [activateReversal](#), [accountUpdate](#), [authorization](#), [balanceInquiry](#), [captureGivenAuth](#), [credit](#), [deactivate](#), [deactivateReversal](#), [depositReversal](#), [forceCapture](#), [giftCardAuthReversal](#), [giftCardCapture](#), [giftCardCredit](#), [load](#), [loadReversal](#), [refundReversal](#), [sale](#), [unload](#), [unloadReversal](#), [updateSubscription](#), [fastAccessFunding](#)

### Attributes:

None

### Child Elements:

For card-not-present transactions (Required): [type](#), [number](#), [expDate](#)

For card-present transactions (Required): [track](#)

For both transactions types (Optional): [cardValidationNum](#)

For Gift Card transactions (Optional): [pin](#)

### Example: card Structure - Card-Not-Present

```
<card>
  <type>Card Type Abbreviation</type>
  <number>Account Number</number>
  <expDate>Expiration Date</expDate>
  <cardValidationNum>Card Validation Number</cardValidationNum>
</card>
```

### Example: card Structure - Card-Present

```
<card>
  <track>Magnetic Stripe Read</track>
</card>
```

### Example: card Structure - Gift Card (Card-Not-Present)

```
<card>
```

```
<type>GC</type>
<number>Account Number</number>
<expDate>Expiration Date</expDate>
<cardValidationNum>Card Validation Number</cardValidationNum>
<pin>Pin Number</pin>
</card>
```

## 4.74 cardAcceptorTaxId

The `cardAcceptorTaxId` element is an optional child of the `detailTax` element and defines the merchant's Tax Id. This ID is nine digits long if the merchant is domiciled in the U.S. If the card acceptor tax ID is unknown, do not include this element.

**Type** = String; **minLength** = 1; **maxLength** = 20

**Parent Elements:**

[detailTax](#)

**Attributes:**

None

**Child Elements:**

None

## 4.75 cardholderAuthentication

The `cardholderAuthentication` element is an optional child element of the Authorization and Sale transactions. The children of this element have two purposes. The first is to define Verified by Visa or MasterCard SecureCode data in the Authorization or Sale transactions (`authenticationValue`, `authenticationTransactionId`, and `authenticatedByMerchant` elements). The remaining child element, `customerIpAddress`, as well as the `authenticationTransactionId`, are used in PayPal Credit transactions. The `customerIpAddress` element can also be used to supply the customer IP Address by merchants enabled for American Express Advanced AVS services.

---

---

**NOTE:** As of September, 2016, the Vantiv eCommerce platform no longer supports PayPal Credit for new merchants or existing merchants not already using this payment method. Existing merchants already using PayPal Credit should consult their Vantiv Relationship Manager.

---

---

### Parent Elements:

[authorization](#), [sale](#)

### Attributes:

None

### Child Elements:

[authenticationValue](#), [authenticationTransactionId](#), [customerIpAddress](#), [authenticatedByMerchant](#)

### Example: cardholderAuthentication Structure

```
<cardholderAuthentication>
  <authenticationValue>BwABBJQ1AgAAAAAgJDUCAAAAAAA=</authenticationValue>
  <authenticationTransactionId>EaOMucALHQqLAEGAgk=</authenticationTransactionId>
  <customerIpAddress>Customer Ip</customerIpAddress>
  <authenticatedByMerchant>Boolean</authenticatedByMerchant>
</cardholderAuthentication>
```

---

---

**NOTE:** The values for the `<authenticationValue>` and `<authenticationTransactionId>` elements in the example above have been truncated.

---

---



## 4.76 cardholderId

The `cardholderId` element is a required child of the `pos` element, which describes the method used for cardholder identification at the point of sale.

**Type** = String (Enum); **minLength** = N/A; **maxLength** = N/A

### Parent Elements:

[pos](#)

### Attributes:

None

### Child Elements:

None

### Enumerations:

Enumeration	Description
signature	customer signature obtained
pin	PIN number
nopin	unattended terminal - no PIN pad
directmarket	mail, telephone, or online

---

**NOTE:** For CAT (Cardholder Activated Terminal) transactions, the `capability` element must be set to `magstripe`, the `cardholderId` element must be set to `nopin`, and the `catLevel` element must be set to `self service`.

---

## 4.77 cardholderName

The `cardholderName` element is an optional child of the `applepayResponse` element and provides the name of the cardholder whose card initiated the Apple Pay transaction.

**Type** = String; **minLength** = N/A; **maxLength** = 512

**Parent Elements:**

[applepayResponse](#)

**Child Elements:**

None

## 4.78 cardOrToken

The `cardOrToken` element is an abstract that allows the substitution of either the `card` or `token` element. You must specify one of the two substitution elements as a child of the `accountUpdate` element.

**Parent Elements:**

`accountUpdate`

**Substitution Options:**

`card`, `token`

## 4.79 cardProductType

The `cardProductType` element is an optional child of the `enhancedAuthResponse` element and whether the card used is commercial or consumer.

**Type** = String (enum); **minLength** = N/A; **maxLength** = N/A

### Parent Elements:

[enhancedAuthResponse](#)

### Attributes:

None

### Child Elements:

None

### Enumerations:

Enumeration	Description
COMMERCIAL	The card is a commercial card.
CONSUMER	The card is a consumer card.
UNKNOWN	The type of card is not known.

## 4.80 cardSuffix

The `cardSuffix` element is an optional child of both the `authorizationResponse` and `saleResponse` elements. It provides the last four digits of the actual PAN for Apple Pay transactions, when the underlying card is either Visa or MasterCard.

**Type** = String; **minLength** = 3; **maxLength** = 6

**Parent Elements:**

`authorizationResponse`, `saleResponse`

**Attributes:**

None

**Child Elements:**

None

## 4.81 cardValidationNum

The `cardValidationNum` element is an optional child of the `card` element, which you use to submit either the CVV2 (Visa), CVC2 (MasterCard), or CID (American Express and Discover) value.<sup>5</sup>

---

---

**NOTE:** Some American Express cards may have a 4-digit CID on the front of the card and/or a 3-digit CID on the back of the card. You can use either of the numbers for card validation, but not both.

---

---

When you submit the CVV2/CVC2/CID in a `registerTokenRequest`, the platform encrypts and stores the value on a temporary basis for later use in a tokenized Auth/Sale transaction submitted without the value. This is done to accommodate merchant systems/workflows where the security code is available at the time of token registration, but not at the time of the Auth/Sale. If for some reason you need to change the value of the security code supplied at the time of the token registration, use an `updateCardValidationNumOnToken` transaction. To use the stored value when submitting an Auth/Sale transaction, set the `cardValidationNum` value to 000.

The `cardValidationNum` element is an optional child of the `virtualGiftCardResponse` element, where it defines the value of the validation Number associated with the Virtual Gift Card requested.

---

---

**NOTE:** The use of the `cardValidationNum` element in the `registertokenRequest` only applies when you submit an `accountNumber` element.

---

---

**Type** = String; **minLength** = N/A; **maxLength** = 4

### Parent Elements:

[card](#), [paypage](#), [token](#), [registerTokenRequest](#), [updateCardValidationNumOnToken](#), [virtualGiftCardResponse](#)

### Attributes:

None

### Child Elements:

None

## 4.82 cardValidationResult

The `cardValidationResult` element is an optional child element of the `fraudResult` element. It defines the Card Validation response code returned by the networks. For a list of possible values, please refer to [Card Validation Response Codes](#) on page 846.

**Type** = String; **minLength** = N/A; **maxLength** = 2

### Parent Elements:

[fraudResult](#)

### Attributes:

None

### Child Elements:

None

## 4.83 cashBackAmount

The `cashBackAmount` element is an optional child of the `giftCardResponse` element. It defines the Cash Back amount provided to the Gift Card holder.

---

---

**NOTE:** Although included in the schema, the `beginningBalance`, `endingBalance`, and `cashBackAmount` elements are not currently supported.

---

---

Type = String; minLength = N/A; maxLength = 20

**Parent Elements:**

[giftCardResponse](#)

**Attributes:**

None

**Child Elements:**

None



## 4.84 catLevel

The `catLevel` element is an optional child of the `pos` element, which describes the capability of the Cardholder Activated Terminal. Although optional in the schema, it is required for all CAT transactions.

**Type** = String (Enum); **minLength** = N/A; **maxLength** = N/A

### Parent Elements:

[pos](#)

### Attributes:

None

### Child Elements:

None

### Enumerations:

Enumeration	Description
self service	Cardholder Activated Terminal level

## 4.85 ccdPaymentInformation

The `ccdPaymentInformation` element is an optional child of the `echeck` element. This element is intended for use by PayFacs using Instruction Based Dynamic Payout to submit a description of the transaction. The description will appear in the extended detail section of the receiver's bank statement, if that section is supported by the receiver's bank.

**Type** = String; **minLength** = N/A; **maxLength** = 80

### Parent Elements:

[accountInfo](#), [echeck](#)

### Attributes:

None

### Child Elements:

None

## 4.86 chargeback

The `chargeback` element is an optional child of the `filtering` element. To disable the chargeback filtering operation for a selected transaction include the `chargeback` element with a setting of `false`.

**Type** = Boolean; **Valid Value** = false

---

---

**NOTE:** Although included in the schema, the `<chargeback>` element is not supported. To override the chargeback filter for a selected transaction, use the `fraudFilterOverride` flag (see [fraudFilterOverride](#) on page 540). Please consult your Relationship Manager for additional information.

---

---

### Parent Elements:

[filtering](#)

### Attributes:

None

### Child Elements:

None

## 4.87 checkNum

The `checkNum` element is an optional child of the `echeck` element defining the check number of used in the transaction.

**Type** = String; **minLength** = N/A; **maxLength** = 15

**Parent Elements:**

[echeck](#)

**Attributes:**

None

**Child Elements:**

None

## 4.88 checkoutId

The `checkoutId` element is an optional child of the `token` element specifying the low value token replacing the CVV value. You use this feature when you already have the consumer's card (i.e., token) on file, but wish the consumer to supply the CVV value for a new transaction. This LVT remains valid for 24 hours from the time of issue.

---

---

**NOTE:** For additional information about this element, please refer to the *Vantiv Enterprise eProtect Integration Guide*.

---

---

Type = String; minLength = 18; maxLength = 18

### Parent Elements:

[token](#)

### Attributes:

None

### Child Elements:

None

## 4.89 city

The `city` element defines the customer's city name in the `billToAddress` and `shipToAddress` elements. In the `customBilling` element, `city` defines the location of the merchant for card-present transactions.

**Type** = String; **minLength** = N/A; **maxLength** = 35

**Parent Elements:**

[billToAddress](#), [shipFromPostalCode](#), [customBilling](#)

**Attributes:**

None

**Child Elements:**

None

## 4.90 clinicOtherAmount

The `clinicAmount` element is an optional child of the `healthcareAmounts` element and defines the healthcare amount used for the clinic/office visits. The decimal is implied. Example: 500 = \$5.00.

**Type** = Integer; **totalDigits** = 8

**Parent Elements:**

Optional: [healthcareAmounts](#)

**Attributes:**

None

**Child Elements:**

None

## 4.91 code

The `code` element is a required child of the `extendedCardResponse` element. The `code/message` combination can be either 501- The account was closed, or 504 - Contact the cardholder for updated information.

**Type** = String; **minLength** = N/A; **maxLength** = 3

**Parent Elements:**

[extendedCardResponse](#)

**Attributes:**

None

**Child Elements:**

None



## 4.92 commodityCode

The `commodityCode` element is an optional child of the `lineItemData` element, which specifies the Identifier assigned by the card acceptor that categorizes the purchased item. Although the schema defines it as an optional child of the `enhancedData` element, it is required by Visa for Level III interchange rates.

**Type** = String; **minLength** = 1; **maxLength** = 12

### Parent Elements:

[lineItemData](#)

### Attributes:

None

### Child Elements:

None

---

---

**NOTE:** A commodity code is a numeric code representing a particular product or service. The code can be 3, 5, 7, or 11 digits in length. The longer the code the more granular the description of the product/service. For example, code 045 is used for Appliances and Equipment, Household Type, while code 04506 represents the sub-set of Appliances, Small Electric.

The codes are issued by the NIGP (National Institute of Governmental Purchasing). Their site, [www.nigp.com](http://www.nigp.com), offers a subscription based code search engine, as well as downloadable lists for purchase.

You can also find many lists published online by performing a simple search on “Commodity Codes”.

---

---

## 4.93 companyName

The `companyName` element is an optional child of the `billToAddress` element, which specifies the name of the company associated with the corporate checking account. This element is required when performing an eCheck Verification of a check from a corporate account, as defined by the `<accType>` child of the `<echeck>` element.

**Type** = String; **minLength** = N/A; **maxLength** = 40

**Parent Elements:**

[billToAddress](#)

**Attributes:**

None

**Child Elements:**

None

## 4.94 country

The `country` element defines the country portion of the postal mailing address in both the `billToAddress` and `shipToAddress` elements.

**Type** = String (Enum); **minLength** = N/A; **maxLength** = 3

---

**NOTE:** The enumerations for this element are listed under `<countryTypeEnum>` in the cnpAPI Common XSD. The country names corresponding to the abbreviations can be found in the ISO 3166-1 standard.

All Country Codes are 2-character except for the United States, which accepts both US and USA.

The `country` element is required for `sale` transactions using the `sepaDirectDebit` method of payment. Failure to include the name element results in a 903 - Missing Billing Country Code Response Code.

---

### Parent Elements:

[billToAddress](#), [shipFromPostalCode](#)

### Attributes:

None

### Child Elements:

None

## 4.95 createAddOn

The `createAddOn` element is the parent of several child elements used to define an additional charge added to a new or existing subscription.

### Parent Elements:

[subscription](#), [updateSubscription](#)

### Attributes:

None

### Child Elements (all Required):

[addOnCode](#), [name](#), [amount](#), [startDate](#), [endDate](#)

### Example: customerInfo Structure

```
<createAddOn>
  <addOnCode>Add On Reference Code</addOnCode>
  <name>Name of Add On</name>
  <amount>Amount of Add On</amount>
  <startDate>Start Date of Add On Charge</startDate>
  <endDate>End Date of Add On Charge</endDate>
</createAddOn>
```

## 4.96 createDiscount

The `createDiscount` element is the parent of several child elements used to define a discount to be applied to a new or existing subscription.

### Parent Elements:

[subscription](#), [updateSubscription](#)

### Attributes:

None

### Child Elements (all Required):

[discountCode](#), [name](#), [amount](#), [startDate](#), [endDate](#)

### Example: customerInfo Structure

```
<createDiscount>
  <discountCode>Discount Reference Code</discountCode>
  <name>Name of Discount</name>
  <amount>Amount of Discount</amount>
  <startDate>Start Date of Discount</startDate>
  <endDate>End Date of Discount</endDate>
</createDiscount>
```

## 4.97 createPlan

The `createPlan` element is the parent of several child element that define the attributes of a recurring payment plan. You associate Plans with subscriptions to define the billing behavior for the recurring payment.

### Parent Elements:

[litleOnlineRequest](#), [batchRequest](#)

### Attributes:

None

### Child Elements:

[planCode](#), [name](#), [description](#), [intervalType](#), [amount](#), [numberOfPayments](#), [trialNumberOfIntervals](#), [trialIntervalType](#), [active](#)

### Example: createPlan Structure

```
<createPlan>
  <planCode>Plan Reference Code</planCode>
  <name>Name of Plan</name>
  <description>Description of Plan</description>
  <intervalType>The Type of Interval</intervalType>
  <amount>Amount of Recurring Payment</amount>
  <numberOfPayments>1 to 99</numberOfRemianingPayments>
  <trialNumberOfIntervals>Number of Trial Period
Intervals</trialNumberOfIntervals>
  <trialIntervalType>Type of Trial Period Interval</trialIntervalType>
  <active>true or false</active>
</createPlan>
```

## 4.98 createPlanResponse

The `createPlanResponse` element is the parent element for the response to a `createPlan` transaction.

**Parent Elements:**

[litleOnlineResponse](#), [batchResponse](#)

**Attributes:**

None

**Child Elements:**

[planCode](#), [litleTxnId](#), [response](#), [message](#), [responseTime](#)

## 4.99 credit

The `credit` element is the parent element for all Credit transactions. You can use this element in either Online or Batch transactions.

### Parent Elements:

[littleOnlineRequest](#), [batchRequest](#)

### Attributes:

Attribute Name	Type	Required?	Description
id	String	Yes	A unique identifier assigned by the presenter and mirrored back in the response. <b>minLength = 1    maxLength = 36</b>
customerId	String	No	A value assigned by the merchant to identify the consumer. <b>minLength = N/A    maxLength = 50</b>
reportGroup	String	Yes	Required attribute that defines the merchant sub-group in the user interface where this transaction will be displayed. Please refer to <a href="#">Coding for Report Groups</a> on page 10 for additional information. <b>minLength = 1    maxLength = 25</b>

### Child Elements:

For credits to transactions processed by Vantiv (Required): [littleTxnId](#)

For credits to transactions processed by Vantiv (Optional): [amount](#), [paypalNotes](#), [pin](#), [secondaryAmount](#), [surchargeAmount](#)

---

**NOTE:**    **If you do not specify an `amount`, the system uses the full amount from the associated settlement transaction.**  
**You must include the `amount` element for credits to transactions not processed by Vantiv**

---

For credits to transactions not processed by Vantiv (Required): [orderId](#), [amount](#), [orderSource](#), choice of [card](#), [token](#), [paypage](#), [mpos](#), [paypal](#), or [applepay](#)

For credits to transactions not processed by Vantiv (Optional): [billToAddress](#), [billMeLaterRequest](#), [amexAggregatorData](#)

For both transaction types (Optional): [customBilling](#), [taxType](#), [enhancedData](#), [processingInstructions](#), [merchantData](#), [actionReason](#), [pos](#)



## 4.100 creditAmount

The creditAmount element is a required child of the `giftCardCredit` transaction, where it specifies the amount of the refund. Supply the value in cents without a decimal point. For example, a value of 1995 signifies \$19.95.

**Type** = Integer; **totalDigits** = 12

**Parent Elements:**

[giftCardCredit](#)

**Attributes:**

None

**Child Elements:**

None

## 4.101 creditLine

The `creditLine` element is an optional child of the `billMeLaterResponseData` element and indicates the credit line of the customer. The amount is specified using a two-digit implied decimal.

**Type** = Integer; **totalDigits** = 8

**Parent Elements:**

[billMeLaterResponseData](#)

**Attributes:**

None

**Child Elements:**

None

## 4.102 creditLittleTxnId

The `creditLittleTxnId` element is the Transaction Id (`littleTxnId`) of a Credit transaction automatically submitted under the following conditions:

- You submitted a Void transaction to halt the recycling of a declined Sale transaction by the Recovery/Recycling Engine.
- The Sale transaction has already been approved and captured.
- Your Recovery/Recycling Engine configuration enables automatic refunds.
- The system has successfully submitted a Credit transaction on your behalf.

**Type** = Long; **minLength** = N/A; **maxLength** = 19

### Parent Elements:

[recycling](#)

### Attributes:

None

### Child Elements:

None

## 4.103 creditResponse

The `creditResponse` element is the parent element for information returned to you in response to a Credit transaction. It can be a child of either a `littleOnlineResponse` element or a `batchResponse` element.

### Parent Elements:

[littleOnlineResponse](#), [batchResponse](#)

### Attributes:

Attribute Name	Type	Required?	Description
id	String	Yes	The response returns the same value submitted in the credit transaction. <b>minLength = 1    maxLength = 36</b>
customerId	String	No	The response returns the same value submitted in the credit transaction. <b>minLength = N/A    maxLength = 50</b>
reportGroup	String	Yes	The response returns the same value submitted in the credit transaction. <b>minLength = 1    maxLength = 25</b>

### Child Elements:

Required: [littleTxnId](#), [response](#), [responseTime](#), [message](#)

Optional: [postDate](#), [tokenResponse](#), [giftCardResponse](#), [applepayResponse](#)

---

**NOTE:**    The `postDate` child element is returned only in responses to Online transactions.

---

## 4.104 cryptogram

The `cryptogram` element is an optional child of the `androidResponse` element and provides the BASE64 Encoded signature cryptogram associated with the Android Pay transaction.

**Type** = Base 64 Encoded String; **minLength** = N/A; **maxLength** = 56

### Parent Elements:

[androidpayResponse](#)

### Attributes:

None

### Child Elements:

None

## 4.105 currencyCode

The `currencyCode` element is an optional child of the `applepayResponse` element and provides the 3-character code for the currency used in the transaction.

**Type** = String; **minLength** = N/A; **maxLength** = 3

**Parent Elements:**

[applepayResponse](#)

**Attributes:**

None

**Child Elements:**

None

## 4.106 customAttribute1

The `customAttribute1` through `customAttribute5` elements are an optional children of the `advancedFraudChecks` element. These elements allow users of Advanced Fraud Tools with self-serve rules to submit additional custom data to ThreatMetrix for inclusion in the fraud evaluation process. For example, if you assigned a certain attribute to your customers for segmentation purposes, you might wish to submit the assigned value and also establish a ThreatMetrix rule so the value was included in the evaluation.

---

---

**NOTE:** Once you decide to use a particular custom attribute for a particular value set and establish a rule for its evaluation, you

---

---

Type = String; `minLength` = 1; `maxLength` = 200

**Parent Elements:**

[advancedFraudChecks](#)

**Attributes:**

None

**Child Elements:**

None

## 4.107 customBilling

The `customBilling` element allows you to specify custom billing descriptor information for the transaction. This billing descriptor is used instead of the descriptor defined as the default billing descriptor. If you do not define this element, the system uses the default.

---

---

**NOTE:** If you submit a `captureGivenAuth` transaction with a `customBilling` element and Vantiv finds a matching Authorization (see [Capture Given Auth Transaction](#) on page 79), the system uses the `customBilling` information from the Authorization and discards the information from the `captureGivenAuth`.

---

---

### Parent Elements:

[authorization](#), [captureGivenAuth](#), [credit](#), [echeckCredit](#), [echeckSale](#), [forceCapture](#), [sale](#)

---

---

**IMPORTANT:** Although the schema includes the `customBilling` element as a child of `echeckCredit` and `echeckSale`, Vantiv does not support its use in these instances.

---

---

### Attributes:

None

### Child Elements:

Please consult your Relationship Manager prior to using the `<url>` element. The contents of this element are discarded unless Vantiv specifically enables to use it in your `cnpAPI` submissions. Required for card-not-present transactions: [phone](#), or [url](#)

---

---

**NOTE:** Please consult your Relationship Manager prior to using the `<url>` element. The contents of this element are discarded unless Vantiv specifically enables the use it in your `cnpAPI` submissions.

---

---

Required for card present transactions: [city](#)

Optional for either: [descriptor](#)

### Example: customBilling Structure - Card-Not-Present (using phone child)

```
<customBilling>
  <phone>Telephone Number</phone>
  <descriptor>Billing Descriptor</descriptor>
```



```
</customBilling>
```

**Example: customBilling Structure - Card-Not-Present (using url child)**

```
<customBilling>  
  <url>retail.url</url>  
  <descriptor>www.retail.com</descriptor>  
</customBilling>
```

**Example: customBilling Structure - Card-Present**

```
<customBilling>  
  <city>City</city>  
  <descriptor>Billing Descriptor</descriptor>  
</customBilling>
```

## 4.108 customIdentifier

The `customIdentifier` element is an optional child of Sub-merchant funding instruction request transaction types, as well as eCheck Sale/Credit/Redeposit requests. PayFacs/Merchants can use this element to specify a Billing Descriptor to appear on the bank statements of the parties involved in the funds transfer or eCheck transaction.

---

---

**NOTE:** The information you provide in this element populates the Individual ID field of the ACH Record. The use of this field and its appearance on bank statements is at the discretion of the bank producing the statement.

---

---

**Type** = String; **minLength** = N/A; **maxLength** = 15

**Parent Elements:**

[echeckCredit](#), [echeckRedeposit](#), [echeckSale](#), [submerchantCredit](#), [submerchantDebit](#)

**Attributes:**

None

**Child Elements:**

None

## 4.109 customerInfo

The `customerInfo` element is the parent of several child elements use to define customer information for PayPal Credit transactions.

---

---

**NOTE:** As of September, 2016, the Vantiv eCommerce platform no longer supports PayPal Credit for new merchants or existing merchants not already using this payment method. Existing merchants already using PayPal Credit should consult their Vantiv Relationship Manager.

---

---

### Parent Elements:

[authorization](#), [sale](#)

### Attributes:

None

### Child Elements:

[ssn](#), [dob](#), [customerRegistrationDate](#), [customerType](#), [incomeAmount](#), [employerName](#), [customerWorkTelephone](#), [residenceStatus](#), [yearsAtResidence](#), [yearsAtEmployer](#)

---

---

**NOTE:** Under certain conditions PayPal Credit requires you to include `ssn`, `dob`, `customerType` and `customerRegistrationDate`.

---

---

### Example: customerInfo Structure

```
<customerInfo>
  <ssn>ssn</ssn>
  <dob>dob</dob>
  <customerRegistrationDate>customerRegistrationDate</customerRegistrationDate>
  <customerType>customerType</customerType>
  <incomeAmount>incomeAmount</incomeAmount>
  <incomeCurrency>incomeCurrency</incomeCurrency>
  <employerName>employerName</employerName>
  <customerWorkTelephone>customerWorkTelephone</customerWorkTelephone>
  <residenceStatus>residenceStatus</residenceStatus>
  <yearsAtResidence>yearsAtResidence</yearsAtResidence>
  <yearsAtEmployer>yearsAtEmployer</yearsAtEmployer>
</customerInfo>
```

## 4.110 customerIpAddress

The `customerIpAddress` element is an optional child element of the `cardholderAuthentication` element. This element defines the IP Address of the customer's system. This element is used either for PayPal Credit transactions or to supply the customer IP Address by merchants enabled for American Express Advanced AVS services.

---

---

**NOTE:** As of September, 2016, the Vantiv eCommerce platform no longer supports PayPal Credit for new merchants or existing merchants not already using this payment method. Existing merchants already using PayPal Credit should consult their Vantiv Relationship Manager.

---

---

**Type** = Ip Address; **Format** = nnn.nnn.nnn.nnn

---

---

**NOTE:** This element is required for BML ecommerce transactions to succeed.

---

---

### Parent Elements:

[cardholderAuthentication](#)

### Attributes:

None

### Child Elements:

None

## 4.111 customerReference

The `customerReference` element defines a reference string used by the customer for the purchase (for example, a Purchase Order Number). Although the schema defines it as an optional child of the `enhancedData` element, Vantiv recommends you include the element if a value is available/supplied and omit this element if it is blank.

**Type** = String; **minLength** = 1; **maxLength** = 17

### Parent Elements:

[enhancedData](#)

### Attributes:

None

### Child Elements:

None

## 4.112 customerRegistrationDate

The `customerRegistrationDate` element is an optional child of the `customerInfo` element defining the earliest date on file with this customer. The latest allowable date is the current date. It is used in combination with several other elements to provide required information for some PayPal Credit transactions.

---

---

**NOTE:** As of September, 2016, the Vantiv eCommerce platform no longer supports PayPal Credit for new merchants or existing merchants not already using this payment method. Existing merchants already using PayPal Credit should consult their Vantiv Relationship Manager.

---

---

**Type** = Date; **Format** = YYYY-MM-DD

---

---

**NOTE:** In order for a BML transaction to succeed, you must include this element if the customer does not have a BML account.

---

---

### Parent Elements:

[customerInfo](#)

### Attributes:

None

### Child Elements:

None

## 4.113 customerType

The `customerType` element is an optional child of the `customerInfo` element defining whether the customer is a new or existing customer. An existing customer is a customer in good standing that has been registered with the merchant for a minimum of 30 days and has made at least one purchase in the last 30 days. It is used in combination with several other elements to provide required information for some PayPal Credit transactions.

---

---

**NOTE:** As of September, 2016, the Vantiv eCommerce platform no longer supports PayPal Credit for new merchants or existing merchants not already using this payment method. Existing merchants already using PayPal Credit should consult their Vantiv Relationship Manager.

---

---

**Type** = Choice (Enum); **Enumerations** = New or Existing

---

---

**NOTE:** In order for a PayPal Credit transaction to succeed, you must include this element if the customer does not have a PayPal Credit account.

---

---

### Parent Elements:

[customerInfo](#)

### Attributes:

None

### Child Elements:

None

## 4.114 customerWorkTelephone

The `customerWorkTelephone` element is an optional child of the `customerInfo` element and defines the customer's work telephone number. It is used in combination with several other elements to provide information for some PayPal Credit transactions.

---

---

**NOTE:** As of September, 2016, the Vantiv eCommerce platform no longer supports PayPal Credit for new merchants or existing merchants not already using this payment method. Existing merchants already using PayPal Credit should consult their Vantiv Relationship Manager.

---

---

**Type** = String; **minLength** = N/A; **maxLength** = 20

**Parent Elements:**

[customerInfo](#)

**Attributes:**

None

**Child Elements:**

None



## 4.115 data

The `data` element is a required child of the `applepay` element. It is the payment data dictionary, BASE64 encoded string from the `PKPaymentToken`.

**Type** = String; **minLength** = N/A; **maxLength** = 2000

**Parent Elements:**

[applepay](#)

**Attributes:**

None

**Child Elements:**

None

## 4.116 deactivate

The `deactivate` element is the parent element for the transaction type that deactivate a Gift Card.

### Parent Elements:

[littleOnlineRequest](#), [batchRequest](#)

### Attributes:

Attribute Name	Type	Required?	Description
id	String	Yes	A unique identifier assigned by the presenter and mirrored back in the response. <b>minLength = 1    maxLength = 36</b>
customerId	String	No	A value assigned by the merchant to identify the consumer. <b>minLength = N/A    maxLength = 50</b>
reportGroup	String	Yes	Required attribute that defines the merchant sub-group in the user interface where this transaction will be displayed. Please refer to <a href="#">Coding for Report Groups</a> on page 10 for additional information. <b>minLength = 1    maxLength = 25</b>

### Child Elements: (all Required)

[orderId](#), [orderSource](#), [card](#)

## 4.117 deactivateResponse

The `deactivateResponse` element is the parent element for information returned to you in response to a **deactivate** transaction. It can be a child of either a `littleOnlineResponse` element or a `batchResponse` element.

### Parent Elements:

[littleOnlineResponse](#), [batchResponse](#)

### Attributes:

Attribute Name	Type	Required?	Description
id	String	Yes	The response returns the same value submitted in the Deactivate transaction. <b>minLength = 1    maxLength = 36</b>
customerId	String	No	The response returns the same value submitted in the Deactivate transaction. <b>minLength = N/A    maxLength = 50</b>
reportGroup	String	Yes	The response returns the same value submitted in the Deactivate transaction. <b>minLength = 1    maxLength = 25</b>

### Child Elements:

Required: [littleTxnId](#), [response](#), [responseTime](#), [message](#)

Optional: [postDate](#), [fraudResult](#), [giftCardResponse](#)

## 4.118 deactivateReversal

The `deactivateReversal` element is the parent element for the transaction type that reverses the deactivation of a Gift Card.

### Parent Elements:

[litleOnlineRequest](#)

### Attributes:

Attribute Name	Type	Required?	Description
id	String	Yes	A unique identifier assigned by the presenter and mirrored back in the response. <b>minLength = 1    maxLength = 36</b>
customerId	String	No	A value assigned by the merchant to identify the consumer. <b>minLength = N/A    maxLength = 50</b>
reportGroup	String	Yes	Required attribute that defines the merchant sub-group in the user interface where this transaction will be displayed. Please refer to <a href="#">Coding for Report Groups</a> on page 10 for additional information. <b>minLength = 1    maxLength = 25</b>

### Child Elements: (Required)

[card](#), [originalRefCode](#), [originalAmount](#), [originalTxnTime](#), [originalSystemTraceId](#), [originalSequenceNumber](#)

### Child Elements: (Optional)

[litleTxnId](#)

## 4.119 deactivateReversalResponse

The deactivateReversalResponse element is the parent element for information returned to you in response to an deactivateReversal transaction.

### Parent Elements:

[litleOnlineResponse](#)

### Attributes:

Attribute Name	Type	Required?	Description
id	String	Yes	The response returns the same value submitted in the Deactivate Reversal transaction. <b>minLength = 1    maxLength = 36</b>
customerId	String	No	The response returns the same value submitted in the Deactivate Reversal transaction. <b>minLength = N/A    maxLength = 50</b>
reportGroup	String	Yes	The response returns the same value submitted in the Deactivate Reversal transaction. <b>minLength = 1    maxLength = 25</b>

### Child Elements:

Required: [litleTxnId](#), [response](#), [responseTime](#), [message](#)

Optional: [postDate](#), [giftCardResponse](#)

## 4.120 debtRepayment

The `debtRepayment` element is an optional child of `authorization`, `captureGivenAuth`, `forceCapture`, and `sale` transactions. You use this flag only if the method of payment is Visa and the transaction is a for a debt repayment. Also, your MCC must be either 6012 or 6051. If you set this flag to true and you are not one of the allowed MCCs, the system declines the transaction with a Response Reason Code of 852 - Debt Repayment only allowed for VI transactions on MCCs 6012 and 6051.

**Type** = Boolean; **Valid Values** = true or false (default)

### Parent Elements:

[authorization](#), [captureGivenAuth](#), [forceCapture](#), [sale](#)

### Attributes:

None

### Child Elements:

None

## 4.121 deleteAddOn

The `deleteAddOn` element is the parent element used to define an Add On to be removed from an existing subscription.

**Parent Elements:**

[updateSubscription](#)

**Attributes:**

None

**Child Elements (all Required):**

[addOnCode](#)

**Example: deleteAddOn Structure**

```
<deleteAddOn>
  <addOnCode>Add On Reference Code</addOnCode>
</deleteAddOn>
```

## 4.122 deleteDiscount

The `deleteDiscount` element is the parent element used to define a discount to be removed from an existing subscription.

**Parent Elements:**

[updateSubscription](#)

**Attributes:**

None

**Child Elements (all Required):**

[discountCode](#)

**Example: deleteDiscount Structure**

```
<deleteDiscount>
  <discountCode>Discount Reference Code</discountCode>
</deleteDiscount>
```



## 4.123 deliveryType

The `deliveryType` element is an optional child of the `enhancedData` element and defines the shipping method used for delivery of the product.

**Type** = String (enum); **minLength** = N/A; **maxLength** = N/A

### Parent Elements:

[enhancedData](#)

### Attributes:

None

### Child Elements:

None

### Enumerations:

Enumeration	Description
CNC	Cash and Carry
DIG	Digital Delivery
PHY	Physical Delivery
SVC	Service Delivery
TBD (default)	To be determined.

## 4.124 dentalAmount

The `dentalAmount` element is an optional child of the `healthcareAmounts` element and defines the healthcare amount used for dental related purchases. The decimal is implied.

Example: 500 = \$5.00.

**Type** = Integer; **totalDigits** = 8

**Parent Elements:**

Optional: [healthcareAmounts](#)

**Attributes:**

None

**Child Elements:**

None

## 4.125 depositReversal

The `depositReversal` element is the parent element for a Gift Card specific transaction type that reverses a `giftCardCapture` or `sale` transaction.

### Parent Elements:

[litleOnlineRequest](#)

### Attributes:

Attribute Name	Type	Required?	Description
id	String	Yes	A unique identifier assigned by the presenter and mirrored back in the response. <b>minLength = 1    maxLength = 36</b>
customerId	String	No	A value assigned by the merchant to identify the consumer. <b>minLength = N/A    maxLength = 50</b>
reportGroup	String	Yes	Required attribute that defines the merchant sub-group in the user interface where this transaction will be displayed. Please refer to <a href="#">Coding for Report Groups</a> on page 10 for additional information. <b>minLength = 1    maxLength = 25</b>

### Child Elements: (Required)

[card](#), [originalRefCode](#), [originalAmount](#), [originalTxnTime](#), [originalSystemTraceId](#), [originalSequenceNumber](#)

### Child Elements: (Optional)

[litleTxnId](#)

## 4.126 depositReversalResponse

The `depositReversalResponse` element is the parent element for information returned to you in response to an `depositReversal` transaction.

### Parent Elements:

[litleOnlineResponse](#)

### Attributes:

Attribute Name	Type	Required?	Description
id	String	Yes	The response returns the same value submitted in the Deposit Reversal transaction. <b>minLength = 1    maxLength = 36</b>
customerId	String	No	The response returns the same value submitted in the Deposit Reversal transaction. <b>minLength = N/A    maxLength = 50</b>
reportGroup	String	Yes	The response returns the same value submitted in the Deposit Reversal transaction. <b>minLength = 1    maxLength = 25</b>

### Child Elements:

Required: [litleTxnId](#), [response](#), [responseTime](#), [message](#), [giftCardResponse](#)

Optional: [postDate](#)

## 4.127 description

The `description` element is an optional child of the `createPlan` element and provides a text description of the Plan.

**Type** = String; **minLength** = N/A; **maxLength** = 100

**Parent Elements:**

[createPlan](#)

**Attributes:**

None

**Child Elements:**

None

## 4.128 descriptor

The `descriptor` element is an optional child of the `customBilling` element. This element defines the text you wish to display on the customer bill, enabling the customer to better recognize the charge.

**Type** = String; **minLength** = 4; **maxLength** = 25

- 
- 
- NOTE:** If you include a prefix:
- the prefix must be either 3, 7, or 12 characters in length.
  - you must use an asterisk (\*) after the prefix as a separator, in one of the following positions: 4th, 8th, or 13th. Do not use an asterisk in more than one position.
  - Use only the following valid characters:
    - Numbers
    - Letters
    - Special characters as follows: ampersand, asterisk (Required; see note above), comma, dash, period, or pound sign.
- 
- 

### Parent Elements:

[customBilling](#)

### Attributes:

None

### Child Elements:

None

- 
- 
- NOTE:** When using a descriptor with eChecks, Vantiv maps the first 16 characters to the Company Name field of the ACH message and the last nine characters as the company phone number.
- 
-

## 4.129 destinationCountryCode

The `destinationCountryCode` element defines the country portion of the postal mailing address in the `enhancedData` element.

**Type** = String (Enum); **minLength** = N/A; **maxLength** = 3

---

---

**NOTE:** The enumerations for this element are listed under `<countryTypeEnum>` in the `cnpAPI Common XSD`. The country names corresponding to the abbreviations can be found in the ISO 3166-1 standard.

---

---

### Parent Elements:

[enhancedData](#)

### Attributes:

None

### Child Elements:

None

## 4.130 destinationPostalCode

The `destinationPostalCode` element defines the postal code of the destination in the `enhancedData` element.

**Type** = String; **minLength** = N/A; **maxLength** = 20

---

---

**NOTE:** Although the schema specifies the **maxLength** of the `<destinationPostalCode>` element as 20 characters, in practice you should never exceed 10 characters in your submissions.

---

---

### Parent Elements:

[enhancedData](#)

### Attributes:

None

### Child Elements:

None



## 4.131 detailTax

The `detailTax` element is an optional child of both the `enhancedData` and `lineItemData` elements, which you use to specify detailed tax information (for example, city or local tax). The total sum of the `detailTax` values should match either the `salesTax` value, if `detailTax` is a child of `enhancedData`, or the `taxAmount` element if `detailTax` is a child of `lineItemData`.

### Parent Elements:

[enhancedData](#), [lineItemData](#)

---

---

**NOTE:** The `detailTax` element can appear a maximum of six times as a child of either parent.

---

---

### Attributes:

None

### Child Elements:

Required: [taxAmount](#)

Optional: [taxIncludedInTotal](#), [taxRate](#), [taxTypeIdentifier](#), [cardAcceptorTaxId](#)

### Example: detailTax Structure

```
<detailTax>
  <taxIncludedInTotal>true or false</taxIncludedInTotal>
  <taxAmount>Additional Tax Amount</taxAmount>
  <taxRate>Tax Rate of This Tax Amount</taxRate>
  <taxTypeIdentifier>Tax Type Enum</taxTypeIdentifier>
  <cardAcceptorTaxId>Tax ID of Card Acceptor</cardAcceptorTaxId>
</detailTax>
```

## 4.132 deviceManufacturerIdentifier

The `deviceManufacturerIdentifier` element is an optional child of the `applepayResponse` element and defines the manufacturer of the device originating the transaction.

**Type** = String; **minLength** = N/A; **maxLength** = 20

**Parent Elements:**

[applepayResponse](#)

**Attributes:**

None

**Child Elements:**

None

## 4.133 deviceReputationScore

The `deviceReputationScore` element is an optional child of the `advancedFraudResults` element and specifies score resulting from the ThreatMetrix analysis of the customer device.

**Type** = Integer; **totalDigits** = 8

**Parent Elements:**

[advancedFraudResults](#)

**Attributes:**

None

**Child Elements:**

None

## 4.134 deviceReviewStatus

The `deviceReviewStatus` element is a required child of the `advancedFraudResults` element and specifies the results of the comparison of the `deviceReputationScore` against the threshold levels configured for the merchant. Typical values are: `pass`, `fail`, `review`, `unavailable`, and `invalid_session`.

---

---

**NOTE:** The system returns *invalid\_session* if you submitted a session Id using an invalid prefix.

---

---

**Type** = String; **minLength** = N/A; **maxLength** =

**Parent Elements:**

[advancedFraudResults](#)

**Attributes:**

None

**Child Elements:**

None

## 4.135 discountAmount

The `discountAmount` element defines the amount of the discount for the order. Although the schema defines it as an optional child of the `enhancedData` element, it is required by Visa for Level III interchange rates. The decimal is implied. Example: 500 = \$5.00.

**Type** = Integer; **totalDigits** = 8

**Parent Elements:**

[enhancedData](#)

**Attributes:**

None

**Child Elements:**

None

## 4.136 discountCode

The `discountCode` element is the identifier of a defined discount. You use this element when creating, updating, and deleting a discount applied to a subscription.

**Type** = String; **minLength** = N/A; **maxLength** = 25

**Parent Elements:**

[createDiscount](#), [updateDiscount](#), [deleteDiscount](#)

**Attributes:**

None

**Child Elements:**

None

## 4.137 dob

The `dob` element is an optional child of the `customerInfo` element. It is used in combination with several other elements to provide required information for some PayPal Credit transactions.

---

---

**NOTE:** As of September, 2016, the Vantiv eCommerce platform no longer supports PayPal Credit for new merchants or existing merchants not already using this payment method. Existing merchants already using PayPal Credit should consult their Vantiv Relationship Manager.

---

---

**Type** = Date; **Format** = YYYY-MM-DD

---

---

**NOTE:** In order for a PayPal Credit transaction to succeed, you must include this element if:

- the customer does not have a PayPal Credit account

or

- the customer has a PayPal Credit account, but the account has not been authenticated.

You do not need to include this element if the PayPal Credit account has been authenticated.

---

---

### Parent Elements:

[customerInfo](#)

### Attributes:

None

### Child Elements:

None

## 4.138 dutyAmount

The `dutyAmount` element defines duty on the total purchased amount for the order. Although the schema defines it as an optional child of the `enhancedData` element, it is required by Visa for Level III interchange rates. The decimal is implied. Example: 500 = \$5.00.

**Type** = Integer; **totalDigits** = 8

**Parent Elements:**

[enhancedData](#)

**Attributes:**

None

**Child Elements:**

None



## 4.139 echeck

The `echeck` element is a required child of the `echeckSale`, `echeckVerification`, and `echeckCredit` (when the credit is against a transaction not originally processed through our system) elements. It contains child elements used to provide details concerning the eCheck account.

### Parent Elements:

[echeckCredit](#), [echeckPreNoteCredit](#), [echeckPreNoteSale](#), [echeckSale](#), [echeckVerification](#)

### Attributes:

None

### Child Elements:

Required: [accType](#), [accNum](#), [routingNum](#)

Optional: [checkNum](#), [ccdPaymentInformation](#)

### Example: echeck Structure

```
<echeck>
  <accType>Account Type Abbreviation</accType>
  <accNum>Account Number</accNum>
  <routingNum>Routing Number</routingNum>
  <checkNum>Check Number</checkNum>
  <ccdPaymentInformation>Payment Description</ccdPaymentInformation>
</echeck>
```

## 4.140 eCheckAccountSuffix

The `eCheckAccountSuffix` element is an optional child of the `tokenResponse` element that provides the last three characters of the eCheck account number.

**Type** = String; **minLength** = 3; **maxLength** = 3

**Parent Elements:**

`registerTokenResponse`, `tokenResponse`

**Attributes:**

None

**Child Elements:**

None

## 4.141 echeckCredit

The `echeckCredit` element is the parent element for all eCheck Credit transactions. You can use this element in either Batch or Online transactions.

---

**IMPORTANT:** Although the schema includes the `customBilling` element as a child of `echeckCredit` and `echeckSale`, Vantiv does not support its use in these instances.

---

### Parent Elements:

[batchRequest](#), [litleOnlineRequest](#)

### Attributes:

Attribute Name	Type	Required?	Description
id	String	Yes	A unique identifier assigned by the presenter and mirrored back in the response. <b>minLength = 1    maxLength = 36</b>
customerId	String	No	A value assigned by the merchant to identify the consumer. <b>minLength = N/A    maxLength = 50</b>
reportGroup	String	Yes	Required attribute that defines the merchant sub-group in the user interface where this transaction will be displayed. Please refer to <a href="#">Coding for Report Groups</a> on page 10 for additional information. <b>minLength = 1    maxLength = 25</b>

### Child Elements:

For credits to transactions processed by Vantiv (Required): [litleTxnId](#)

For credits to transactions processed by Vantiv (Optional): [amount](#)

---

**NOTE:** Omit the `amount` child element, to use the full amount from the `echeckSale`.

---

For credits to transactions not processed by Vantiv (Required): [orderId](#), [amount](#), [orderSource](#), [billToAddress](#), [echeckOrEcheckToken](#) (allows the substitution of either the `echeck` or `echeckToken` elements)

For credits to transactions not processed by Vantiv (Optional): [merchantData](#)

For both (Optional): [customBilling](#), [secondaryAmount](#), [customIdentifier](#)

## 4.142 echeckCreditResponse

The `echeckCreditResponse` element is the parent element for information returned to you in response to an `echeckCredit` transaction.

### Parent Elements:

[batchResponse](#), [litleOnlineResponse](#)

### Attributes:

Attribute Name	Type	Required?	Description
id	String	Yes	The response returns the same value submitted in the <code>echeckCredit</code> transaction. <b>minLength = 1    maxLength = 36</b>
customerId	String	No	The response returns the same value submitted in the <code>echeckCredit</code> transaction. <b>minLength = N/A    maxLength = 50</b>
reportGroup	String	Yes	The response returns the same value submitted in the <code>echeckCredit</code> transaction. <b>minLength = 1    maxLength = 25</b>

### Child Elements: (all Required)

[litleTxnId](#), [response](#), [responseTime](#), [message](#)

Optional: [postDate](#), [accountUpdater](#)

---

**NOTE:**    The `postDate` child element is returned only in responses to Online transactions.

---

## 4.143 echeckForToken

The `echeckForToken` element is a child of the `registerTokenRequest` element. It contains the routing and account number of the eCheck account which the system uses to generate a token.

### Parent Elements:

[registerTokenRequest](#)

### Attributes:

None

### Child Elements:

Required: [accNum](#), [routingNum](#)

### Example: echeck Structure

```
<echeckForToken>
  <accNum>Account Number</accNum>
  <routingNum>Routing Number</routingNum>
</echeckForToken>
```

## 4.144 echeckOrEcheckToken

The `echeckOrEcheckToken` element is an abstract that allows the substitution of either the `echeck` or `echeckToken` element. In eCheck transactions, except `echeckVoid`, you must specify one of the two substitution elements as a child.

**Parent Elements:**

[echeckCredit](#), [echeckRedeposit](#), [echeckSale](#), [echeckVerification](#)

**Substitution Options:**

[echeck](#), [echeckToken](#)

## 4.145 echeckPreNoteCredit

The `echeckPreNoteCredit` element is the parent element for all eCheck Prenotification Credit transactions. You use this transaction type to perform an eCheck Prenotification, when the subsequent eCheck transaction will be an eCheck Credit transaction. You can use this element only in Batch transactions. This transaction type is only supported for US transactions.

### Parent Elements:

[batchRequest](#)

### Attributes:

Attribute Name	Type	Required?	Description
id	String	Yes	A unique identifier assigned by the presenter and mirrored back in the response. <b>minLength = 1    maxLength = 36</b>
customerId	String	No	A value assigned by the merchant to identify the consumer. <b>minLength = N/A    maxLength = 50</b>
reportGroup	String	Yes	Required attribute that defines the merchant sub-group in the user interface where this transaction will be displayed. Please refer to <a href="#">Coding for Report Groups</a> on page 10 for additional information. <b>minLength = 1    maxLength = 25</b>

### Child Elements:

Required: [orderId](#), [orderSource](#), [billToAddress](#), [echeck](#)

Optional: [merchantData](#)

## 4.146 echeckPreNoteCreditResponse

The echeckPreNoteCreditResponse element is the parent element for information returned to you in response to an echeckPreNoteCredit transaction.

### Parent Elements:

[batchResponse](#)

### Attributes:

Attribute Name	Type	Required?	Description
id	String	Yes	The response returns the same value submitted in the echeckCredit transaction. <b>minLength = 1    maxLength = 36</b>
customerId	String	No	The response returns the same value submitted in the echeckCredit transaction. <b>minLength = N/A    maxLength = 50</b>
reportGroup	String	Yes	The response returns the same value submitted in the echeckCredit transaction. <b>minLength = 1    maxLength = 25</b>

### Child Elements: (all Required)

[litleTxnId](#), [response](#), [responseTime](#), [message](#)



## 4.147 echeckPreNoteSale

The `echeckPreNoteSale` element is the parent element for all eCheck Prenotification Sale transactions. You use this transaction type to perform an eCheck Prenotification, when the subsequent eCheck transaction will be an eCheck Sale transaction. You can use this element only in Batch transactions. This transaction type is only supported for US transactions.

### Parent Elements:

[batchRequest](#)

### Attributes:

Attribute Name	Type	Required?	Description
id	String	Yes	A unique identifier assigned by the presenter and mirrored back in the response. <b>minLength = 1    maxLength = 36</b>
customerId	String	No	A value assigned by the merchant to identify the consumer. <b>minLength = N/A    maxLength = 50</b>
reportGroup	String	Yes	Required attribute that defines the merchant sub-group in the user interface where this transaction will be displayed. Please refer to <a href="#">Coding for Report Groups</a> on page 10 for additional information. <b>minLength = 1    maxLength = 25</b>

### Child Elements:

Required: [orderId](#), [orderSource](#), [billToAddress](#), [echeck](#)

Optional: [merchantData](#)

## 4.148 echeckPreNoteSaleResponse

The echeckPreNoteSaleResponse element is the parent element for information returned to you in response to an echeckPreNoteSale transaction.

### Parent Elements:

[batchResponse](#)

### Attributes:

Attribute Name	Type	Required?	Description
id	String	Yes	The response returns the same value submitted in the echeckCredit transaction. <b>minLength = 1    maxLength = 36</b>
customerId	String	No	The response returns the same value submitted in the echeckCredit transaction. <b>minLength = N/A    maxLength = 50</b>
reportGroup	String	Yes	The response returns the same value submitted in the echeckCredit transaction. <b>minLength = 1    maxLength = 25</b>

### Child Elements: (all Required)

[litleTxnId](#), [response](#), [responseTime](#), [message](#)

## 4.149 echeckRedeposit

The `echeckRedeposit` element is the parent element for all eCheck Redeposit transactions. You use this transaction type to manually attempt redeposits of eChecks returned for either Insufficient Funds or Uncollected Funds. You can use this element in either Batch or Online transactions.

---

**NOTE:** Do not use this transaction type if you are enabled for the Auto Redeposit feature. If you are enabled for the Auto Redeposit feature, the system will reject any `echeckRedeposit` transaction you submit.

---

### Parent Elements:

[batchRequest](#), [litleOnlineRequest](#)

### Attributes:

Attribute Name	Type	Required?	Description
id	String	Yes	A unique identifier assigned by the presenter and mirrored back in the response. <b>minLength = 1    maxLength = 36</b>
customerId	String	No	A value assigned by the merchant to identify the consumer. <b>minLength = N/A    maxLength = 50</b>
reportGroup	String	Yes	Required attribute that defines the merchant sub-group in the user interface where this transaction will be displayed. Please refer to <a href="#">Coding for Report Groups</a> on page 10 for additional information. <b>minLength = 1    maxLength = 25</b>

### Child Elements:

Required: [litleTxnId](#)

Optional: [echeckOrEcheckToken](#) (allows the substitution of either the `echeck` or `echeckToken` elements), [merchantData](#), [customIdentifier](#)

## 4.150 echeckRedepositResponse

The `echeckRedepositResponse` element is the parent element for information returned to you in response to an `echeckRedeposit` transaction.

### Parent Elements:

[batchResponse](#), [litleOnlineResponse](#)

### Attributes:

Attribute Name	Type	Required?	Description
id	String	Yes	The response returns the same value submitted in the <code>echeckSale</code> transaction. <b>minLength = 1    maxLength = 36</b>
customerId	String	No	The response returns the same value submitted in the <code>echeckSale</code> transaction. <b>minLength = N/A    maxLength = 50</b>
reportGroup	String	Yes	The response returns the same value submitted in the <code>echeckSale</code> transaction. <b>minLength = 1    maxLength = 25</b>

### Child Elements:

Required: [litleTxnId](#), [response](#), [responseTime](#), [message](#)

Optional: [postDate](#), [accountUpdater](#)

---

**NOTE:**    The `postDate` child element is returned only in responses to Online transactions.

---

## 4.151 echeckSale

The echeckSale element is the parent element for all eCheck Sale transactions. You can use this element in either Batch or Online transactions.

### Parent Elements:

[batchRequest](#), [litleOnlineRequest](#)

### Attributes:

Attribute Name	Type	Required?	Description
id	String	Yes	A unique identifier assigned by the presenter and mirrored back in the response. <b>minLength = 1    maxLength = 36</b>
customerId	String	No	A value assigned by the merchant to identify the consumer. <b>minLength = N/A    maxLength = 50</b>
reportGroup	String	Yes	Required attribute that defines the merchant sub-group in the user interface where this transaction will be displayed. Please refer to <a href="#">Coding for Report Groups</a> on page 10 for additional information. <b>minLength = 1    maxLength = 25</b>

### Child Elements:

Required: [orderId](#), [amount](#), [orderSource](#), [billToAddress](#), [echeckOrEcheckToken](#) (allows the substitution of either the [echeck](#) or [echeckToken](#) elements)

---

**NOTE:** You must use one of the following values for the [orderSource](#) element: [telephone](#), [ecommerce](#), [recurringtel](#), or [echeckppd](#).

---

Optional: [shipToAddress](#), [verify](#), [customBilling](#), [merchantData](#), [secondaryAmount](#), [customIdentifier](#)

---

**IMPORTANT:** Although the schema includes the [customBilling](#) element as a child of [echeckCredit](#) and [echeckSale](#), Vantiv does not support its use in these instances.

---

## 4.152 echeckSalesResponse

The `echeckSalesResponse` element is the parent element for information returned to you in response to an `echeckSale` transaction.

### Parent Elements:

[batchResponse](#), [litleOnlineResponse](#)

### Attributes:

Attribute Name	Type	Required?	Description
id	String	Yes	The response returns the same value submitted in the <code>echeckSale</code> transaction. <b>minLength = 1    maxLength = 36</b>
customerId	String	No	The response returns the same value submitted in the <code>echeckSale</code> transaction. <b>minLength = N/A    maxLength = 50</b>
reportGroup	String	Yes	The response returns the same value submitted in the <code>echeckSale</code> transaction. <b>minLength = 1    maxLength = 25</b>

### Child Elements:

Required: [litleTxnId](#), [response](#), [responseTime](#), [message](#)

Optional: [postDate](#), [accountUpdater](#), [tokenResponse](#)

---

**NOTE:**    The `postDate` child element is returned only in responses to Online transactions.

---

## 4.153 echeckToken

The `echeckToken` element replaces the `echeck` element in tokenized eCheck transactions and defines the tokenized account information.

### Parent Elements:

`echeckCredit`, `echeckRedeposit`, `echeckSale`, `echeckVerification`

### Attributes:

None

### Child Elements:

Required: `litleToken`, `routingNum`, `accType`

Optional: `checkNum`

### Example: echeck Structure

```
<echeckToken>
  <litleToken>Token</litleToken>
  <routingNum>Routing Number</routingNum>
  <accType>Account Type Abbreviation</accType>
  <checkNum>Check Number</checkNum>
</echeckToken>
```

## 4.154 echeckVerification

The `echeckVerification` element is the parent element for all eCheck Verification transactions. You use this transaction type to initiate a comparison of the consumer's account information against positive/negative databases. You can use this element in either Batch or Online transactions. This transaction type is only supported for US transactions.

### Parent Elements:

[batchRequest](#), [litleOnlineRequest](#)

### Attributes:

Attribute Name	Type	Required?	Description
id	String	Yes	A unique identifier assigned by the presenter and mirrored back in the response. <b>minLength = 1    maxLength = 36</b>
customerId	String	No	A value assigned by the merchant to identify the consumer. <b>minLength = N/A    maxLength = 50</b>
reportGroup	String	Yes	Required attribute that defines the merchant sub-group in the user interface where this transaction will be displayed. Please refer to <a href="#">Coding for Report Groups</a> on page 10 for additional information. <b>minLength = 1    maxLength = 25</b>

### Child Elements:

Required: [orderId](#), [amount](#), [orderSource](#), [billToAddress](#), [echeckOrEcheckToken](#) (allows the substitution of either the `echeck` or `echeckToken` elements)

Optional: [merchantData](#)



## 4.155 echeckVerificationResponse

The `echeckVerificationResponse` element is the parent element for information returned to you in response to a eCheck Verification transaction.

### Parent Elements:

[batchResponse](#), [litleOnlineResponse](#)

### Attributes:

Attribute Name	Type	Required?	Description
id	String	Yes	The response returns the same value submitted in the capture transaction. <b>minLength = 1    maxLength = 36</b>
customerId	String	No	The response returns the same value submitted in the capture transaction. <b>minLength = N/A    maxLength = 50</b>
reportGroup	String	Yes	The response returns the same value submitted in the capture transaction. <b>minLength = 1    maxLength = 25</b>

### Child Elements:

Required: [litleTxnId](#), [response](#), [responseTime](#), [message](#)

Optional: [postDate](#)

---

---

**NOTE:**    The `postDate` child element is returned only in responses to Online transactions.

---

---

## 4.156 echeckVoid

The `echeckVoid` element is the parent element for all eCheck Void transactions. You use this transaction type to either cancel an eCheck Sale transaction, as long as the transaction has not yet settled, or halt automatic redeposit attempts of eChecks returned for either Insufficient Funds or Uncollected Funds. You can use this element only in Online transactions.

### Parent Elements:

[litleOnlineRequest](#)

### Attributes:

Attribute Name	Type	Required?	Description
id	String	Yes	A unique identifier assigned by the presenter and mirrored back in the response. <b>minLength = 1    maxLength = 36</b>
customerId	String	No	A value assigned by the merchant to identify the consumer. <b>minLength = N/A    maxLength = 50</b>
reportGroup	String	Yes	Required attribute that defines the merchant sub-group in the user interface where this transaction will be displayed. Please refer to <a href="#">Coding for Report Groups</a> on page 10 for additional information. <b>minLength = 1    maxLength = 25</b>

### Child Elements:

Required: [litleTxnId](#)

## 4.157 echeckVoidResponse

The `echeckVoidResponse` element is the parent element for information returned to you in response to an eCheck Void transaction.

### Parent Elements:

[litleOnlineResponse](#)

### Attributes:

Attribute Name	Type	Required?	Description
id	String	Yes	The response returns the same value submitted in the void transaction. <b>minLength = 1    maxLength = 36</b>
customerId	String	No	The response returns the same value submitted in the void transaction. <b>minLength = N/A    maxLength = 50</b>
reportGroup	String	Yes	The response returns the same value submitted in the void transaction. <b>minLength = 1    maxLength = 25</b>

### Child Elements: (all Required)

[litleTxnId](#), [response](#), [responseTime](#), [message](#), [postDate](#)

## 4.158 eciIndicator

The `eciIndicator` element is an optional child of the `applepayResponse` and `androidpayResponse` elements and specifies electronic commerce indicator associated with an Apple Pay/Android Pay transaction.

**Type** = String; **minLength** = N/A; **maxLength** = 2

**Parent Elements:**

[applepayResponse](#), [androidpayResponse](#)

**Attributes:**

None

**Child Elements:**

None

## 4.159 email

The `email` element defines the email address of the customer in both the `billToAddress` and `shipToAddress` elements.

---

---

**NOTE:** The `email` element is required for `sale` transactions using the `sepaDirectDebit` method of payment. Failure to include the name element results in a 905 - Missing Email Address Response Code.

---

---

**Type** = String; **minLength** = N/A; **maxLength** = 100

**Parent Elements:**

[billToAddress](#), [shipToAddress](#)

**Attributes:**

None

**Child Elements:**

None

## 4.160 employerName

The `employerName` element is an optional child of the `customerInfo` element and defines the name of the customer's place of employment. It is used in combination with several other elements to provide information for some PayPal Credit transactions.

---

---

**NOTE:** As of September, 2016, the Vantiv eCommerce platform no longer supports PayPal Credit for new merchants or existing merchants not already using this payment method. Existing merchants already using PayPal Credit should consult their Vantiv Relationship Manager.

---

---

Type = String; minLength = N/A; maxLength = 20

### Parent Elements:

[customerInfo](#)

### Attributes:

None

### Child Elements:

## 4.161 encryptedTrack

The `encryptedTrack` element is a required child of the `mpos` element. This element provides the encrypted track data resulting from a card swipe using a ROAM device.

**Type** = String; **minLength** = 1; **maxLength** = 1028

**Parent Elements:**

[mpos](#)

**Attributes:**

None

**Child Elements:**

None

## 4.162 endDate

The endDate element is an optional child of both the createAddOn and createDiscount element, where it specifies either the ending date of the Add On charge or the ending date of the discount.

**Type** = Date; **Format** = YYYY-MM-DD

**Parent Elements:**

[createAddOn](#), [createDiscount](#)

**Attributes:**

None

**Child Elements:**

None



## 4.163 endingBalance

The endingBalance element is an optional child of the giftCardResponse element. It defines the available balance on the submitted Gift Card after the requested operation.

---

---

**NOTE:** Although included in the schema, the beginningBalance, endingBalance, and cashBackAmount elements are not currently supported.

---

---

Type = String; minLength = N/A; maxLength = 20

**Parent Elements:**

[giftCardResponse](#)

**Attributes:**

None

**Child Elements:**

None

## 4.164 endpoint

The `endpoint` element is a required child of the `networkResponse` element. It defines the card network (i.e., Visa, MasterCard, Discover, or American Express) acting as an endpoint for the submitted transaction.

**Type** = String; **minLength** = N/A; **maxLength** = 256

**Parent Elements:**

[networkResponse](#)

**Attributes:**

None

**Child Elements:**

None

## 4.165 enhancedAuthResponse

The `enhancedAuthResponse` element is an optional child of both the `authorizationResponse` and `saleResponse` elements. Through its child elements, it can provide information concerning whether the card used for the transaction is Prepaid and if so, the available balance. Depending upon the card used, other elements can indicate affluence, card product type, prepaid card type, reloadability and whether or not it is a virtual account number.

### Parent Elements:

[authorizationResponse](#), [saleResponse](#)

### Attributes:

None

### Child Elements: (all Optional)

[fundingSource](#), [affluence](#), [issuerCountry](#), [cardProductType](#), [virtualAccountNumber](#), [networkResponse](#)

### Example: enhancedAuthResponse - with fundingSource

```
<enhancedAuthResponse>
  <fundingSource>
    <type>PREPAID</type>
    <availableBalance>0</availableBalance>
    <reloadable>YES|NO|UNKNOWN</reloadable>
    <prepaidCardType>GIFT</prepaidCardType>
  </fundingSource>
</enhancedAuthResponse>
```

### Example: enhancedAuthResponse - with affluence

```
<enhancedAuthResponse>
  <affluence>AFFLUENT</affluence>
</enhancedAuthResponse>
```

### Example: enhancedAuthResponse - with issuerCountry

```
<enhancedAuthResponse>
  <issuerCountry>MEX</issuerCountry>
</enhancedAuthResponse>
```

**Example: enhancedAuthResponse - with cardProductType**

```
<enhancedAuthResponse>
  <cardProductType>CONSUMER</cardProductType>
</enhancedAuthResponse>
```

**Example: enhancedAuthResponse - with virtualAccountNumber**

```
<enhancedAuthResponse>
  <virtualAccountNumber>true or false</virtualAccountNumber>
</enhancedAuthResponse>
```

**Example: enhancedAuthResponse - with networkResponse**

```
<enhancedAuthResponse>
  <networkResponse>
    <endpoint>VISA</endpoint>
    <networkField fieldNumber="4" fieldName="Transaction Amount">
      <fieldValue>000000000962</fieldValue>
    </networkField>
    <networkField fieldNumber="44" fieldName="Additional Response Data">
      <networkSubField fieldNumber="0">
        <fieldValue></fieldValue>
      </networkSubField>
      <networkSubField fieldNumber="1">
        <fieldValue>5</fieldValue>
      </networkSubField>
    </networkField>
  </networkResponse>
</enhancedAuthResponse>
```

## 4.166 enhancedData

The `enhancedData` element allows you to specify extra information concerning a transaction in order to qualify for certain purchasing interchange rates. The following tables provide information about required elements you must submit to achieve Level 2 or Level 3 Interchange rates for Visa and MasterCard.

- For MasterCard:
  - The transaction must be taxable.
  - The tax charged must be between 0.1% and 30% of the transaction amount, except as noted below.
  - For Level 3, the transaction must use a corporate, business, or purchasing card.

---

**NOTE:** You can qualify for MasterCard Level 2 rates without submitting the total tax amount (submit 0) if your MCC is one of the following: 4111, 4131, 4215, 4784, 8211, 8220, 8398, 8661, 9211, 9222, 9311, 9399, 9402.

This also applies to Level 3, regardless of your MCC (i.e., submission of 0 allowed).

---

- You must include at least one line item with amount, description, and quantity defined.

**TABLE 4-1** MasterCard Level 2/Level 3 Data Requirements

MasterCard Level 2 Data	MasterCard Level 3 Data	cnpAPI Element (child of enhancedData unless noted)
Customer Code (if supplied by customer)	Customer Code (if supplied by customer)	<b>customerReference</b>
Card Acceptor Tax ID	Card Acceptor Tax ID	<b>cardAcceptorTaxId</b> (child of detailTax)
Total Tax Amount	Total Tax Amount	<b>salesTax</b>
	Product Code	<b>productCode</b> (child of lineItemData)
	Item Description	<b>itemDescription</b> (child of lineItemData)
	Item Quantity	<b>quantity</b> (child of lineItemData)
	Item Unit of Measure	<b>unitOfMeasure</b> (child of lineItemData)

**TABLE 4-1** MasterCard Level 2/Level 3 Data Requirements

MasterCard Level 2 Data	MasterCard Level 3 Data	cnpAPI Element (child of enhancedData unless noted)
	Extended Item Amount	<b>lineItemTotal</b> (child of lineItemData) or <b>lineItemTotalWithTax</b> (child of lineItemData)

In addition to the requirements below, please be aware of the following:

- For Visa:
  - The transaction must be taxable.
  - The tax charged must be between 0.1% and 22% of the transaction amount, except as noted.
  - For Level 3, the transaction must use a corporate or purchasing card.

---

**NOTE:** Sales Tax is no longer required for Level 3. In this case omit the <salesTax > element entirely.

---

**TABLE 4-2** Visa Level 2/Level 3 Data Requirements

Visa Level 2 Data	Visa Level 3 Data	cnpAPI Element (child of enhancedData unless noted)
Sales Tax	Sales Tax*	<b>salesTax</b>
	Discount Amount	<b>discountAmount</b>
	Freight/Shipping Amount	<b>shippingAmount</b>
	Duty Amount	<b>dutyAmount</b>
	Item Sequence Number	<b>itemSequenceNumber</b> (child of lineItemData)
	Item Commodity Code	<b>commodityCode</b> (child of lineItemData)
	Item Description	<b>itemDescription</b> (child of lineItemData)
	Product Code	<b>productCode</b> (child of lineItemData)
	Quantity	<b>quantity</b> (child of lineItemData)

**TABLE 4-2** Visa Level 2/Level 3 Data Requirements

Visa Level 2 Data	Visa Level 3 Data	cnpAPI Element (child of enhancedData unless noted)
	Unit of Measure	<b>unitOfMeasure</b> (child of lineItemData)
	unit Cost	<b>unitCost</b> (child of lineItemData)
	Discount per Line Item	<b>itemDiscountAmount</b> (child of lineItemData)
	Line Item Total	<b>lineItemTotal</b> (child of lineItemData)

\* Sales Tax is no longer required for Level 3. In this case omit the <salesTax > element entirely.

---

**NOTE:** We always attempts to qualify your transactions for the optimal Interchange Rate. Although in some instances your transaction may qualify for either Level 2 or Level 3 rates without submitting all recommended fields, for the most consistent results, Vantiv strongly recommends that you adhere to the guidelines detailed above.

For Discover transactions, the interchange rate is not impacted by the presence of Level 2 or Level 3 data.

---

**Parent Elements:**

[authorization](#), [capture](#), [captureGivenAuth](#), [credit](#), [forceCapture](#), [sale](#)

**Child Elements: (all Optional)**

[customerReference](#), [salesTax](#), [deliveryType](#), [taxExempt](#), [discountAmount](#), [shippingAmount](#), [dutyAmount](#), [shipFromPostalCode](#), [destinationPostalCode](#), [destinationCountryCode](#), [invoiceReferenceNumber](#), [orderDate](#), [detailTax](#), [lineItemData](#)

**Example: enhancedData Structure**

```
<enhancedData>
  <customerReference>Customer Reference</customerReference>
  <salesTax>Amount of Sales Tax Included in Transaction</salesTax>
  <deliveryType>TBD</deliveryType>
  <taxExempt>true or false</taxExempt>
  <discountAmount>Discount Amount Applied to Order</discountAmount>
  <shippingAmount>Amount to Transport Order</shippingAmount>
  <dutyAmount>Duty on Total Purchase Amount</dutyAmount>
  <shipFromPostalCode>Ship From Postal Code</shipFromPostalCode>
  <destinationPostalCode>Ship To Postal Code</destinationPostalCode>
```

```
<destinationCountryCode>Ship To ISO Country Code</destinationCountryCode>
<invoiceReferenceNumber>Merchant Invoice Number</invoiceReferenceNumber>
<orderDate>Date Order Placed</orderDate>
<detailTax>
  <taxIncludedInTotal>true or false</taxIncludedInTotal>
  <taxAmount>Additional Tax Amount</taxAmount>
  <taxRate>Tax Rate of This Tax Amount</taxRate>
  <taxTypeIdentifier>Tax Type Enum</taxTypeIdentifier>
  <cardAcceptorTaxId>Tax ID of Card Acceptor</cardAcceptorTaxId>
</detailTax>
<lineItemData>
  <itemSequenceNumber>Line Item Number within Order</itemSequenceNumber>
  <itemDescription>Description of Item</itemDescription>
  <productCode>Product Code of Item</productCode>
  <quantity>Quantity of Item</quantity>
  <unitOfMeasure>Unit of Measurement Code</unitOfMeasure>
  <taxAmount>Sales Tax or VAT of Item</taxAmount>
  <lineItemTotal>Total Amount of Line Item</lineItemTotal>
  <lineItemTotalWithTax>taxAmount + lineItemTotal</lineItemTotalWithTax>
  <itemDiscountAmount>Discount Amount</itemDiscountAmount>
  <commodityCode>Card Acceptor Commodity Code for Item</commodityCode>
  <unitCost>Price for One Unit of Item</unitCost>
</lineItemData>
</enhancedData>
```



## 4.167 entryMode

The `entryMode` element is a required child of the `pos` element, which describes the method used for card data entry at the point of sale.

**Type** = String (Enum); **minLength** = N/A; **maxLength** = N/A

### Parent Elements:

[pos](#)

### Attributes:

None

### Child Elements:

None

### Enumerations:

Enumeration	Description
notused	terminal not used
keyed	card number manually entered
track1	track 1 read
track2	magnetic stripe read (track 2 when known or when the terminal makes no distinction between tracks 1 and 2.)
completeread	complete magnetic stripe read and transmitted

## 4.168 ephemeralPublicKey

The `ephemeralPublicKey` element is a required child of the `header` element and provides the BASE64 Encoded string of the ephemeral public key bytes from the Apple Pay transaction.

**Type** = Base 64 Encoded String; **minLength** = N/A; **maxLength** = 400

### Parent Elements:

[header](#)

### Attributes:

None

### Child Elements:

None

## 4.169 expDate

The `expDate` element is a child of the `card`, `token`, `paypage` elements, which specifies the expiration date of the card (format: `mmyy`) and is required for card-not-present transactions.

---

---

**NOTE:** Although the schema defines the `expDate` element as an optional child of the `card`, `token` and `paypage` elements, you must submit a value for card-not-present transactions.

---

---

**Type** = String; **minLength** = 4; **maxLength** = 4

### Parent Elements:

[card](#), [newCardInfo](#), [newCardTokenInfo](#), [originalCard](#), [originalCardInfo](#), [originalCardTokenInfo](#), [originalToken](#), [paypage](#), [token](#), [updatedCard](#), [updatedToken](#)

### Attributes:

None

### Child Elements:

None

---

---

**NOTE:** You should submit whatever expiration date you have on file, regardless of whether or not it is expired/stale.

We recommend all merchant with recurring and/or installment payments participate in the Account Updater program.

---

---

## 4.170 expMonth

The `expMonth` element is an optional child of the `androidpayResponse` element, which specifies the month of expiration of the network token (format: mm).

**Type** = String; **minLength** = 2; **maxLength** = 2

**Parent Elements:**

[androidpayResponse](#)

**Attributes:**

None

**Child Elements:**

None

## 4.171 expYear

The `expYear` element is an optional child of the `androidpayResponse` element, which specifies the year of expiration of the network token (format: yyyy).

**Type** = String; **minLength** = 4; **maxLength** = 4

**Parent Elements:**

[androidpayResponse](#)

**Attributes:**

None

**Child Elements:**

None

## 4.172 extendedCardResponse

The `extendedCardResponse` element is an optional child of the `accountUpdater` element, which contains two child elements, `code` and `message`. The codes/messages can be either “501 - The Account Was Closed.” or “504 - Contact the cardholder for updated information.”

---

---

**IMPORTANT:** When using Account Updater (any variation), you must always code to receive the `extendedCardResponse` element and its children. We always return this information whenever applicable regardless of whether you receive other account updater information in the transaction response message.

---

---

### Parent Elements:

[accountUpdater](#)

### Attributes:

None

### Child Elements:

[code](#), [message](#)

### Example: newCardInfo Structure

```
<extendedCardResponse>
  <message>Message for Code</message>
  <code>Either 501 or 504</code>
</extendedCardResponse>
```

## 4.173 fastAccessFunding

The `fastAccessFunding` element is the parent element for the transaction type that a PayFac uses to move funds to a sub-merchant held debit card. The transfer of funds occurs within 30 minutes.

---

**NOTE:** For additional information about PayFac Instruction-Based Dynamic Payout and the use of this transaction type, please refer to the *PayFac Instruction-Based Dynamic Payout* document.

---

### Parent Elements:

[littleOnlineRequest](#)

### Attributes:

Attribute Name	Type	Required?	Description
id	String	Yes	A unique identifier assigned by the presenter and mirrored back in the response. <b>minLength = 1    maxLength = 36</b>
customerId	String	No	A value assigned by the merchant to identify the consumer. <b>minLength = N/A    maxLength = 50</b>
reportGroup	String	Yes	For PayFacs, this attribute does not segregate transactions in iQ. This field does appear in various SSR reports. <b>minLength = 1    maxLength = 25</b>

### Child Elements:

Required: [amount](#), [fundingSubmerchantId](#), [fundsTransferId](#), [submerchantName](#), (choice of) [card](#), [paypage](#), or [token](#)

## 4.174 fastAccessFundingResponse

The `fastAccessFundingResponse` element is the parent element for information returned to you in response to a `fastAccessFunding` transaction.

### Parent Elements:

[litleOnlineResponse](#)

### Attributes:

Attribute Name	Type	Required?	Description
id	String	Yes	The response returns the same value submitted in the <code>payFacCredit</code> transaction. <b>minLength = 1    maxLength = 36</b>
customerId	String	No	The response returns the same value submitted in the <code>payFacCredit</code> transaction. <b>minLength = N/A    maxLength = 50</b>
reportGroup	String	Yes	The response returns the same value submitted in the <code>submerchantCredit</code> transaction. <b>minLength = 1    maxLength = 25</b>
duplicate	boolean	No	If the request is a duplicate, the response includes the duplicate flag set to <b>true</b> and the entire original response. <b>Note:</b> This attribute applies only to Online Dynamic Payout Funding Instruction responses.

### Child Elements:

Required: [litleTxnId](#), [fundsTransferId](#), [response](#), [responseTime](#), [message](#), [postDate](#)



## 4.175 fieldValue

The `fieldValue` element is a child of both the `networkField` and `networkSubField` elements. The `fieldValue` element is required when a child of the `networkField` element and no subfield exists. This element is always required when used as a child of the `networkSubField` element. It provides the raw data for the designated field, extracted from the network ISO 8583 response message.

**Type** = String; **minLength** = N/A; **maxLength** = 9999

### Parent Elements:

[networkField](#), [networkSubField](#)

### Attributes:

None

### Child Elements:

None

## 4.176 filtering

The `filtering` element is an optional child of either the Authorization or Sale request transaction. You use its child elements to selectively enable/disable the various Basic Fraud toolkit features. Setting either the `<international>` or `<chargeback>` child element to **false** disables that filtering feature for the transaction. The `<prepaid>` child can be set to **true** to enable the feature selectively, or set to **false** to disable the feature for the transaction, if you elected to use the **filter all** prepaid configuration option.

### Parent Elements:

[authorization](#), [sale](#)

### Attributes:

None

### Child Elements:

Optional: [prepaid](#), [international](#), [chargeback](#)

---

---

**NOTE:** Although included in the schema and shown in the example below, the `<chargeback>` element is not supported. To override the chargeback filter for a selected transaction, use the `fraudFilterOverride` flag (see [fraudFilterOverride](#) on page 540). Please consult your Relationship Manager for additional information.

---

---

### Example: filtering Structure

```
<filtering>
  <prepaid>true or false</prepaid>
  <international>>false</international>
  <chargeback>>false</chargeback>
</filtering>
```

## 4.177 finalPayment

The finalPayment element is a required child of the litleInternalRecurringRequestType. A value of **true** indicates that this is the final payment of the subscription. Since this element is used only in internally generated transaction, you do not need to code for its use.

**Type** = Boolean; **Valid Values** = true or false

### Parent Elements:

[litleInternalRecurringRequest](#)

### Attributes:

None

### Child Elements:

None

## 4.178 firstName

The `firstName` element is a child of the `billtoAddress` element, which specifies the first name of the account holder and is required for `echeckVerification` transactions.

---

---

**NOTE:** When performing an eCheck Verification for a corporate account, you must include values for the `firstName` and `lastName` elements. If you do not have the name of the check issuer, you can use a value of “unavailable” for both elements.

---

---

**Type** = String; **minLength** = N/A; **maxLength** = 25

**Parent Elements:**

[billToAddress](#)

**Attributes:**

None

**Child Elements:**

None

## 4.179 forceCapture

The `forceCapture` element is the parent element for all Force Capture transactions. These are specialized Capture transactions used when you do not have a valid Authorization for the order, but have fulfilled the order and wish to transfer funds. You can use this element in either Online or Batch transactions.

---

**CAUTION:** You must be authorized by Vantiv before processing this transaction type. In some instances, using a Force Capture transaction can lead to chargebacks and fines.

---

### Parent Elements:

[littleOnlineRequest](#), [batchRequest](#)

### Attributes:

Attribute Name	Type	Required?	Description
id	String	Yes	A unique identifier assigned by the presenter and mirrored back in the response. <b>minLength = 1    maxLength = 36</b>
customerId	String	No	A value assigned by the merchant to identify the consumer. <b>minLength = N/A    maxLength = 50</b>
reportGroup	String	Yes	Required attribute that defines the merchant sub-group in the user interface where this transaction will be displayed. Please refer to <a href="#">Coding for Report Groups</a> on page 10 for additional information. <b>minLength = 1    maxLength = 25</b>

### Child Elements:

Required: `orderId`, `amount`, `orderSource`, choice of `card`, `token`, `mpos`, `paypage`, or `applepay`

Optional: `billToAddress`, `customBilling`, `taxType`, `enhancedData`, `processingInstructions`, `pos`, `amexAggregatorData`, `merchantData`, `productCode`, `secondaryAmount`, `surchargeAmount`, `debtRepayment`, `processingType`

## 4.180 forceCaptureResponse

The `forceCaptureResponse` element is the parent element for information returned to you in response to a Force Capture transaction. It can be a child of either a `littleOnlineResponse` element or a `batchResponse` element.

### Parent Elements:

[littleOnlineResponse](#), [batchResponse](#)

### Attributes:

Attribute Name	Type	Required?	Description
id	String	Yes	The response returns the same value submitted in the Force Capture transaction. <b>minLength = 1    maxLength = 36</b>
customerId	String	No	The response returns the same value submitted in the Force Capture transaction. <b>minLength = N/A    maxLength = 50</b>
reportGroup	String	Yes	The response returns the same value submitted in the Force Capture transaction. <b>minLength = 1    maxLength = 25</b>

### Child Elements:

Required: [littleTxnId](#), [response](#), [responseTime](#), [message](#)

Optional: [postDate](#), [tokenResponse](#), [accountUpdater](#), [giftCardResponse](#), [applepayResponse](#)

---

**NOTE:**    The `postDate` child element is returned only in responses to Online transactions.

---

## 4.181 formatId

The `formatId` element is a required child of the `mpos` element. This element identifies the format of the encrypted track submitted from the device.

**Type** = String; **minLength** = 1; **maxLength** = 1028

**Parent Elements:**

[mpos](#)

**Attributes:**

None

**Child Elements:**

None

## 4.182 fraudCheck

The `fraudCheck` element is the parent element for the standalone Advanced Fraud Check transaction. You use this transaction type to retrieve the results of the Advanced Fraud Check tool without submitting an Authorization or Sale transaction. You can use this element only in Online transactions.

### Parent Elements:

[litleOnlineRequest](#)

### Attributes:

Attribute Name	Type	Required?	Description
id	String	Yes	A unique identifier assigned by the presenter and mirrored back in the response. <b>minLength = 1    maxLength = 36</b>
customerId	String	No	A value assigned by the merchant to identify the consumer. <b>minLength = N/A    maxLength = 50</b>
reportGroup	String	Yes	Required attribute that defines the merchant sub-group in the user interface where this transaction will be displayed. Please refer to <a href="#">Coding for Report Groups</a> on page 10 for additional information. <b>minLength = 1    maxLength = 25</b>

### Child Elements:

Required: [advancedFraudChecks](#)

Optional: [billToAddress](#), [shipToAddress](#), [amount](#)



## 4.183 fraudCheckResponse

The `fraudCheckResponse` element is the parent element for information returned to you in response to a standalone Fraud Check transaction.

### Parent Elements:

[litleOnlineResponse](#)

### Attributes:

Attribute Name	Type	Required?	Description
id	String	Yes	The response returns the same value submitted in the Force Capture transaction. <b>minLength = 1    maxLength = 36</b>
customerId	String	No	The response returns the same value submitted in the Force Capture transaction. <b>minLength = N/A    maxLength = 50</b>
reportGroup	String	Yes	The response returns the same value submitted in the Force Capture transaction. <b>minLength = 1    maxLength = 25</b>

### Child Elements:

Required: [litleTxnId](#), [response](#), [responseTime](#), [message](#)

Optional: [advancedFraudResults](#)

## 4.184 fraudFilterOverride

The `fraudFilterOverride` element is an optional child of both the `authorization` and the `sale` elements. A setting of **true** will override (disable) all fraud filters for the submitted transaction.

**Type** = Boolean; **Valid Values** = true or false

**Parent Elements:**

[authorization](#), [sale](#)

**Attributes:**

None

**Child Elements:**

None

## 4.185 fraudResult

The `fraudResult` element is an optional child of the `authorizationResponse`, the `saleResponse` and the `authInformation` elements. It contains child elements defining any fraud checking results.

### Parent Elements:

[activateResponse](#), [authorizationResponse](#), [deactivateResponse](#), [loadResponse](#), [saleResponse](#), [unloadResponse](#), [authInformation](#)

### Attributes:

None

### Child Elements: (All Optional)

[authenticationResult](#), [avsResult](#), [cardValidationResult](#), [advancedAVSResult](#), [advancedFraudResults](#)

### Example: fraudResult Structure

```
<fraudResult>
  <avsResult>00</avsResult>
  <cardValidationResult>N</cardValidationResult>
  <authenticationResult>2</authenticationResult>
  <advancedAVSResult>011</advancedAVSResult>
  <advancedFraudResults>
    <deviceReviewStatus>pass, fail, review, or unavailable</deviceReviewStatus>
    <deviceReputationScore>Score from ThreatMetix</deviceReputationScore>
    <triggeredRule>Triggered Rule_may occur multiple times</triggeredRule>
  </advancedFraudResults>
</fraudResult>
```

---

**NOTE:** The `<advancedAVSResults>` element applies only to American Express transactions. Also, you must be enabled specifically to use the Advanced AVS feature. Please consult your Relationship Manager for additional information.

---

## 4.186 fundingInstructionVoid

The `fundingInstructionVoid` element is the parent element for the transaction type that a PayFac uses to void a submitted, but not yet processed funding instruction. You must submit the `fundingInstructionVoid` transaction prior to your cutoff time on the same day you submitted the instruction to be voided. This rule also applies to funding instructions submitted on weekends.

### Parent Elements:

[batchRequest](#)

### Attributes:

Attribute Name	Type	Required?	Description
id	String	Yes	A unique identifier assigned by the presenter and mirrored back in the response. <b>minLength = 1    maxLength = 36</b>
customerId	String	No	A value assigned by the merchant to identify the consumer. <b>minLength = N/A    maxLength = 50</b>
reportGroup	String	Yes	For PayFacs, this attribute does not segregate transactions in iQ. This field does appear in various SSR reports. <b>minLength = 1    maxLength = 25</b>

### Child Elements:

Required: [litleTxnId](#)

## 4.187 fundingInstructionVoidResponse

The `fundingInstructionVoidResponse` element is the parent element for information returned to you in response to a `fundingInstructionVoid` transaction.

### Parent Elements:

[batchResponse](#)

### Attributes:

Attribute Name	Type	Required?	Description
id	String	Yes	The response returns the same value submitted in the credit transaction. <b>minLength = 1    maxLength = 36</b>
customerId	String	No	The response returns the same value submitted in the credit transaction. <b>minLength = N/A    maxLength = 50</b>
reportGroup	String	Yes	The response returns the same value submitted in the credit transaction. <b>minLength = 1    maxLength = 25</b>

### Child Elements:

Required: [litleTxnId](#), [response](#), [responseTime](#), [message](#)

## 4.188 fundingSource

The `fundingSource` element is an optional child of the `enhancedAuthResponse` element. Through its child elements, it provides information concerning whether the card used for the transaction is Prepaid, Credit, Debit, or FSA and if Prepaid, the available balance, the type of prepaid card, and whether it is reloadable.

### Parent Elements:

[enhancedAuthResponse](#)

### Attributes:

None

### Child Elements:

Required: [type](#), [availableBalance](#), [reloadable](#), [prepaidCardType](#)

### Example: fundingSource Structure

```
<fundingSource>
  <type>PREPAID</type>
  <availableBalance>0</availableBalance>
  <reloadable>YES|NO|UNKNOWN</reloadable>
  <prepaidCardType>GIFT</prepaidCardType>
</fundingSource>
```

---

**NOTE:** The `fundingSource` element and its child elements, `type` and `availableBalance` are associated with the Insights features (see [Issuer Insights](#) on page 24.)

Please consult your Relationship Manager for additional information.

---

## 4.189 fundingSubmerchantId

The `fundingSubmerchantId` element is a required child of each funding instruction request transaction type, where it specifies the identifier of the sub-merchant whose funds the instruction moves.

---

**NOTE:** If you process transactions solely on the Vantiv platform or on both the Vantiv and Vantiv eCommerce platforms, use the Vantiv-supplied Sub-merchant Merchant Id as the value of the `fundingSubmerchantId` element.

If you process solely on the Vantiv eCommerce platform, use the eCommerce-supplied value obtained, after creating the Sub-merchant, by submitting a Sub-Merchant Retrieval Request via the Merchant Provisioner API as the value of the `fundingSubmerchantId` element.

Please refer to the *Vantiv PayFac API Reference Guide* for additional information.

---

**Type** = String; **minLength** = N/A; **maxLength** = 50

### Parent Elements:

[payFacCredit](#), [payFacDebit](#), [physicalCheckCredit](#), [physicalCheckDebit](#), [reserveCredit](#), [reserveDebit](#), [submerchantCredit](#), [submerchantDebit](#), [vendorCredit](#), [vendorDebit](#), [fastAccessFunding](#), [fastAccessFundingResponse](#)

### Attributes:

None

### Child Elements:

None

## 4.190 fundsTransferId

The `fundingTransferId` element is a required child of each funding instruction request/response transaction type, where it specifies the PayFac assigned identifier for the transaction. You must use unique values for each transaction across your entire organization. The system mirrors this identifier back in the response messages.

**Type** = String; **minLength** = N/A; **maxLength** = 36 (for all except `fastAccessFunding` and `fastAccessFundingResponse`)

**Type** = String; **minLength** = N/A; **maxLength** = 16 (for `fastAccessFunding` and `fastAccessFundingResponse`)

### Parent Elements:

`payFacCredit`, `payFacCreditResponse`, `payFacDebit`, `payFacDebitResponse`, `physicalCheckCredit`, `physicalCheckCreditResponse`, `physicalCheckDebit`, `physicalCheckDebitResponse`, `reserveCredit`, `reserveCreditResponse`, `reserveDebit`, `reserveDebitResponse`, `submerchantCredit`, `submerchantCreditResponse`, `submerchantDebit`, `submerchantDebitResponse`, `vendorCredit`, `vendorCreditResponse`, `vendorDebit`, `vendorDebitResponse`, `fastAccessFunding`, `fastAccessFundingResponse`

### Attributes:

None

### Child Elements:

None



## 4.191 giftCardAuthReversal

The `giftCradAuthReversal` element is the parent element for the transaction type that reverses an authorization on a Gift Card.

### Parent Elements:

[litleOnlineRequest](#), [litleRequest](#)

### Attributes:

Attribute Name	Type	Required?	Description
id	String	Yes	A unique identifier assigned by the presenter and mirrored back in the response. <b>minLength = 1    maxLength = 36</b>
customerId	String	No	A value assigned by the merchant to identify the consumer. <b>minLength = N/A    maxLength = 50</b>
reportGroup	String	Yes	Required attribute that defines the merchant sub-group in the user interface where this transaction will be displayed. Please refer to <a href="#">Coding for Report Groups</a> on page 10 for additional information. <b>minLength = 1    maxLength = 25</b>

### Child Elements: (Required)

[card](#), [originalRefCode](#), [originalAmount](#), [originalTxnTime](#), [originalSystemTraceId](#), [originalSequenceNumber](#)

### Child Elements: (Optional)

[litleTxnId](#)

## 4.192 giftCardAuthReversalResponse

The `giftCardAuthReversalResponse` element is the parent element for information returned to you in response to a Gift Card Auth Reversal transaction.

### Parent Elements:

[litleOnlineResponse](#), [litleResponse](#)

### Attributes:

Attribute Name	Type	Required?	Description
id	String	Yes	The response returns the same value submitted in the Force Capture transaction. <b>minLength = 1    maxLength = 36</b>
customerId	String	No	The response returns the same value submitted in the Force Capture transaction. <b>minLength = N/A    maxLength = 50</b>
reportGroup	String	Yes	The response returns the same value submitted in the Force Capture transaction. <b>minLength = 1    maxLength = 25</b>

### Child Elements:

Required: [litleTxnId](#), [response](#), [responseTime](#), [message](#), [giftCardResponse](#)

Optional: [postDate](#) (returned for online transactions only)

## 4.193 giftCardBin

The `giftCardBin` element is a required child of the `virtualGiftCard` element defining the requested BIN of the virtual Gift Card number requested.

---

---

**NOTE:** In an early iteration of schema V8.22 issued in September of 2013 this element was defined as an optional child of the `virtualGiftCard` element. If you coded to the earlier version, be aware that this element is now required. If you do not include this element, the transaction will fail XML validation.

---

---

Type = String; minLength = N/A; maxLength = 10

**Parent Elements:**

[virtualGiftCard](#)

**Attributes:**

None

**Child Elements:**

None

## 4.194 giftCardCapture

The `giftCardCapture` element is the parent element for the transaction type that captures funds previously authorized on a Gift Card.

### Parent Elements:

[litleOnlineRequest](#), [litleRequest](#)

### Attributes:

Attribute Name	Type	Required?	Description
id	String	Yes	A unique identifier assigned by the presenter and mirrored back in the response. <b>minLength = 1    maxLength = 36</b>
customerId	String	No	A value assigned by the merchant to identify the consumer. <b>minLength = N/A    maxLength = 50</b>
reportGroup	String	Yes	Required attribute that defines the merchant sub-group in the user interface where this transaction will be displayed. Please refer to <a href="#">Coding for Report Groups</a> on page 10 for additional information. <b>minLength = 1    maxLength = 25</b>

### Child Elements: (Required)

[card](#), [captureAmount](#), [originalRefCode](#), [originalAmount](#), [originalTxnTime](#),

### Child Elements: (Optional)

[litleTxnId](#)

## 4.195 giftCardCaptureResponse

The `giftCardCaptureResponse` element is the parent element for information returned to you in response to a Gift Card Capture transaction.

**Parent Elements:**

[litleOnlineResponse](#), [litleResponse](#)

**Attributes:**

Attribute Name	Type	Required?	Description
id	String	Yes	The response returns the same value submitted in the Force Capture transaction. <b>minLength = 1    maxLength = 36</b>
customerId	String	No	The response returns the same value submitted in the Force Capture transaction. <b>minLength = N/A    maxLength = 50</b>
reportGroup	String	Yes	The response returns the same value submitted in the Force Capture transaction. <b>minLength = 1    maxLength = 25</b>

**Child Elements:**

Required: [litleTxnId](#), [response](#), [responseTime](#), [message](#), [giftCardResponse](#)

Optional: [fraudResult](#), [postDate](#) (returned for online transactions only)

## 4.196 giftCardCredit

The `giftCardCredit` element is the parent element for all Gift Card Credit transactions. There are two possible structures for this message type. You use the first structure for credit transactions against captures/sales processed by Vantiv. The alternate structure applies to credits against captures/sales not processed by Vantiv. You can use this transaction type in either Online or Batch submissions.

### Parent Elements:

[litleOnlineRequest](#), [batchRequest](#)

### Attributes:

Attribute Name	Type	Required?	Description
id	String	Yes	A unique identifier assigned by the presenter and mirrored back in the response. <b>minLength = 1    maxLength = 36</b>
customerId	String	No	A value assigned by the merchant to identify the consumer. <b>minLength = N/A    maxLength = 50</b>
reportGroup	String	Yes	Required attribute that defines the merchant sub-group in the user interface where this transaction will be displayed. Please refer to <a href="#">Coding for Report Groups</a> on page 10 for additional information. <b>minLength = 1    maxLength = 25</b>

### Child Elements:

For credits to transactions processed by Vantiv (Required): [creditAmount](#), [card](#)

For credits to transactions processed by Vantiv (Optional): [litleTxnId](#)

For credits to transactions not processed by Vantiv (Required): [orderId](#), [creditAmount](#), [orderSource](#), [card](#)

## 4.197 giftCardCreditResponse

The `giftCardCreditResponse` element is the parent element for information returned to you in response to a Gift Card Credit transaction.

### Parent Elements:

[litleOnlineResponse](#), [litleResponse](#)

### Attributes:

Attribute Name	Type	Required?	Description
id	String	Yes	The response returns the same value submitted in the Force Capture transaction. <b>minLength = 1    maxLength = 36</b>
customerId	String	No	The response returns the same value submitted in the Force Capture transaction. <b>minLength = N/A    maxLength = 50</b>
reportGroup	String	Yes	The response returns the same value submitted in the Force Capture transaction. <b>minLength = 1    maxLength = 25</b>

### Child Elements:

Required: [litleTxnId](#), [response](#), [responseTime](#), [message](#), [giftCardResponse](#)

Optional: [fraudResult](#), [postDate](#) (returned for online transactions only)

## 4.198 giftCardResponse

The `giftCardResponse` element is a required child of several transaction types and optional for several others. Through its child elements, it provides details about the available balance on a Gift Card, as well as additional reference items used in subsequent, related transactions. For example, in a `giftCardAuthReversal` transaction, you must include values of the `refCode`, `systemTraceId`, and `sequenceNumber` from the `authorizationResponse` in the `originalRefCode`, `originalSystemTraceId`, and `originalSequenceNumber` elements respectively.

### Parent Elements:

Required: [activateResponse](#), [activateReversalResponse](#), [giftCardAuthReversalResponse](#), [balanceInquiryResponse](#), [giftCardCaptureResponse](#), [giftCardCreditResponse](#), [deactivateResponse](#), [deactivateReversalResponse](#), [depositReversalResponse](#), [loadResponse](#), [loadReversalResponse](#), [refundReversalResponse](#), [unloadResponse](#), [unloadReversalResponse](#)

Optional (per schema, but always returned for Gift Card Transactions): [authorizationResponse](#), [captureGivenAuthResponse](#), [forceCaptureResponse](#), [saleResponse](#)

### Attributes:

None

### Child Elements (All Optional, but must contain at least one child):

Optional: [txnTime](#), [refCode](#), [systemTraceId](#), [sequenceNumber](#), [availableBalance](#), [beginningBalance](#), [endingBalance](#), [cashBackAmount](#)

---

---

**NOTE:** Although included in the schema, the `beginningBalance`, `endingBalance`, and `cashBackAmount` elements are not currently supported.

---

---

### Example: giftCardResponse Structure

```
<giftCardResponse>
  <txnTime>2016-11-15T12:00:00</txnTime>
  <refCode>abc123</refCode>
  <systemTraceId>123456</systemTraceId>
  <sequenceNumber>123456</sequenceNumber>
  <availableBalance>Balance Available on Gift Card</availableBalance>
</giftCardResponse>
```



## 4.199 giropay

The `giropay` element is a child of the `sale` transaction that, through its child elements, defines information needed to process an Giropay (Real-time Bank Transfer) transaction. At this time, you can use the iDeal method of payment in Online transactions only.

### Parent Elements:

[sale](#)

### Attributes:

None

### Child Elements:

Optional: [preferredLanguage](#)

### Example: giropay Structure

```
<giropay>
  <preferredLanguage>Country Code of Language</preferredLanguage>
</giropay>
```

## 4.200 giropayResponse

The `giropayResponse` element is a child of the `saleResponse` transaction when the method of payment in the request is `giropay`. It contains child elements that you should store for future use/reference.

### Parent Elements:

[saleResponse](#)

### Attributes:

None

### Child Elements (all Optional):

[paymentPurpose](#), [redirectUrl](#), [redirectToken](#)

### Example: giropayResponse Structure

```
<giropayResponse>
  <redirectUrl>URL of Vantiv Supplied Mandate</redirectUrl>
  <redirectToken>Map Mandate to littleTxnId</redirectToken>
  <paymentPurpose>Reference Number + Billing Descrptor</paymentPurpose>
</giropayResponse>
```

## 4.201 header

The `header` element is a required child of the `applepay` element. Its child elements provides information required to process the Apple Pay transaction.

**Type** = String; **minLength** = N/A; **maxLength** = 10000

### Parent Elements:

[applepay](#)

### Attributes:

None

### Child Elements (All Optional, but must contain at least one child):

Optional: [applicationData](#), [ephemeralPublicKey](#), [publicKeyHash](#), [transactionId](#)

### Example: header Structure

```
<header>Password</header>
  <applicationData>SHA-256 Hash Hex Encoded of App Data
  Property</applicationData>
  <ephemeralPublicKey>Base64 Encoded Ephemeral Public Key</ephemeralPublicKey>
  <publicKeyHash>Base64 Hash of Public Key Bytes from Merchant
  Certificate</publicKeyHash>
  <transactionId>Hex Transaction Id</transactionId>
</header>
```

## 4.202 healthcareAmounts

The `healthcareAmount` element is a required child of the `healthcareIIAS` element. Through its child elements, it provides details about the dollar amount and type of IIAS qualified items purchased using Healthcare Prepaid cards.

The value used for the `totalHealthcareAmount` child must be the sum of the values applied to the following elements: `RxAmount`, `visionAmount`, `clinicOtherAmount`, and `dentalAmount`.

### Parent Elements:

[healthcareIIAS](#)

### Attributes:

None

### Child Elements:

Required: [totalHealthcareAmount](#)

Optional: [RxAmount](#), [visionAmount](#), [clinicOtherAmount](#), [dentalAmount](#)

### Example: fundingSource Structure

```
<healthcareAmounts>
  <totalHealthcareAmount>Total of Healthcare Items</totalHealthcareAmount>
  <RxAmount>Amount for Medications</RxAmount>
  <visionAmount>Amount for Vision Items</visionAmount>
  <clinicOtherAmount>Amount for Clinic Charges</clinicOtherAmount>
  <dentalAmount>Amount for Dental Charges</dentalAmount>
</healthcareAmounts>
```

## 4.203 healthcareIIAS

The `healthcareIIAS` element is an optional child of Authorization and Sale transactions. Through its child elements, it provides information about IIAS qualified items purchased using Healthcare Prepaid cards.

### Parent Elements:

[authorization](#), [sale](#)

### Attributes:

None

### Child Elements:

Required: [healthcareAmounts](#), [IIASFlag](#)

### Example: fundingSource Structure

```
<healthcareIIAS>
  <healthcareAmounts>
    <totalHealthcareAmount>Total of Healthcare Items</totalHealthcareAmount>
    <RxAmount>Amount for Medications</RxAmount>
    <visionAmount>Amount for Vision Items</visionAmount>
    <clinicOtherAmount>Amount for Clinic Charges</clinicOtherAmount>
    <dentalAmount>Amount for Dental Charges</dentalAmount>
  </healthcareAmounts>
  <IIASFlag>Y</IIASFlag>
</healthcareIIAS>
```

## 4.204 iban

The `iban` element is a required child of the `sepaDirectDebit` element. It defines the International Bank Account Number of the customer.

**Type** = String; **minLength** = 15; **maxLength** = 34

**Parent Elements:**

[sepaDirectDebit](#)

**Attributes:**

None

**Child Elements:**

None

## 4.205 ideal

The `ideal` element is a child of the `sale` transaction that, through its child elements, defines information needed to process an iDEAL (Real-time Bank Transfers) transaction. At this time, you can use the iDEAL method of payment in Online transactions only.

### Parent Elements:

[sale](#)

### Attributes:

None

### Child Elements:

Optional: [preferredLanguage](#)

### Example: ideal Structure

```
<ideal>
  <preferredLanguage>Country Code of Language</preferredLanguage>
</ideal>
```

## 4.206 idealResponse

The `idealResponse` element is a child of the `saleResponse` transaction when the method of payment in the request is `ideal`. It contains child elements that you should store for future use/reference.

### Parent Elements:

[saleResponse](#)

### Attributes:

None

### Child Elements (all Optional):

[paymentPurpose](#), [redirectUrl](#), [redirectToken](#)

### Example: idealResponse Structure

```
<idealResponse>
  <redirectUrl>URL of Vantiv Supplied Mandate</redirectUrl>
  <redirectToken>Map Mandate to littleTxnId</redirectToken>
  <paymentPurpose>Reference Number + Billing Descrptor</paymentPurpose>
</idealResponse>
```



## 4.207 IIASFlag

The `IIASFlag` element is a required child of the `healthcareIIAS` element. This element only supports a value of **Y**.

**Type** = String (enum); **minLength** = N/A; **maxLength** = 1; **Valid Value** = Y

**Parent Elements:**

[healthcareIIAS](#)

**Child Elements:**

None

## 4.208 incomeAmount

The `incomeAmount` element is an optional child of the `customerInfo` element and defines the yearly income of the customer. It is used in combination with several other elements to provide information for some PayPal Credit transactions.

---

---

**NOTE:** As of September, 2016, the Vantiv eCommerce platform no longer supports PayPal Credit for new merchants or existing merchants not already using this payment method. Existing merchants already using PayPal Credit should consult their Vantiv Relationship Manager.

---

---

Type = Long; minLength = N/A; maxLength = N/A

### Parent Elements:

[customerInfo](#)

### Attributes:

None

### Child Elements:

None

## 4.209 incomeCurrency

The `incomeCurrency` element is an optional child of the `customerInfo` element and defines the currency of the `incomeAmount` element. The default value is USD (United States Dollars). It is used in combination with several other elements to provide information for some PayPal Credit transactions.

---

**NOTE:** As of September, 2016, the Vantiv eCommerce platform no longer supports PayPal Credit for new merchants or existing merchants not already using this payment method. Existing merchants already using PayPal Credit should consult their Vantiv Relationship Manager.

---

**Type** = String (Enum); **minLength** = N/A; **maxLength** = N/A

### Parent Elements:

[customerInfo](#)

### Attributes:

None

### Child Elements:

None

### Enumerations:

Enumeration	Description
AUD	Australian Dollar
CAD	Canadian Dollar
CHF	Swiss Francs
DKK	Denmark Kroner
EUR	Euro
GBP	United Kingdom Pound
HKD	Hong Kong Dollar
JPY	Japanese Yen
NOK	Norwegian Krone
NZD	New Zealand Dollar

<b>Enumeration</b>	<b>Description</b>
SEK	Swedish Kronor
SGD	Singapore Dollar
USD (default)	United States Dollar

## 4.210 international

The `international` element is an optional child of the `filtering` element. To disable the filtering operation for a selected transaction include the `international` element with a setting of **false**.

**Type** = Boolean; **Valid Value** = false

**Parent Elements:**

[filtering](#)

**Attributes:**

None

**Child Elements:**

None

## 4.211 intervalType

The `intervalType` element is a required child of the `createPlan` element and defines the billing period associated with the Plan.

**Type** = String (enum); **minLength** = N/A; **maxLength** = N/A

### Parent Elements:

[createPlan](#)

### Attributes:

None

### Child Elements:

None

### Enumerations:

Enumeration	Description
ANNUAL	The billing period is once per year.
SEMIANNUAL	The billing period is twice per year.
QUARTERLY	The billing period is every three months.
MONTHLY	The billing period is every month.
WEEKLY	The billing period is every week.

## 4.212 invoiceReferenceNumber

The `invoiceReferenceNumber` element is an optional child of the `enhancedData` element, which specifies the merchant's invoice number. If you do not know the invoice number, do not include this element.

**Type** = String; **minLength** = 1; **maxLength** = 15

**Parent Elements:**

[enhancedData](#)

**Attributes:**

None

**Child Elements:**

None

## 4.213 issuerCountry

The `issuerCountry` element is an optional child of the `enhancedAuthResponse` element, which defines the country of the bank that issued the card submitted in the Authorization or Sale transaction.

**Type** = String; **minLength** = N/A; **maxLength** = 3

**Parent Elements:**

[enhancedAuthResponse](#)

**Attributes:**

None

**Child Elements:**

None



## 4.214 itemCategoryCode

The `itemCategoryCode` element is an optional child of the `billMeLaterRequest` element and defines the PayPal Credit item category for the type of product sold.

---

---

**NOTE:** As of September, 2016, the Vantiv eCommerce platform no longer supports PayPal Credit for new merchants or existing merchants not already using this payment method. Existing merchants already using PayPal Credit should consult their Vantiv Relationship Manager.

---

---

**Type** = Integer; **totalDigits** = 4

**Parent Elements:**

[billMeLaterRequest](#)

**Attributes:**

None

**Child Elements:**

None

## 4.215 itemDescription

The `itemDescription` element is a required child of the `lineItemData` element, which provides a brief text description of the item purchased.

**Type** = String; **minLength** = N/A; **maxLength** = 26

**Parent Elements:**

[lineItemData](#)

**Attributes:**

None

**Child Elements:**

None

## 4.216 itemDiscountAmount

The `itemDiscountAmount` element is an optional child of the `lineItemData` element, which specifies the item discount amount. Although an optional element, it is required by Visa for Level III Interchange rates. The value must be greater than or equal to 0. The decimal is implied.

Example: 500 = \$5.00.

**Type** = Integer; **totalDigits** = 8

**Parent Elements:**

[lineItemData](#)

**Attributes:**

None

**Child Elements:**

None

## 4.217 itemSequenceNumber

The `itemSequenceNumber` element is an optional child of the `lineItemData` element (required for Visa transactions). When providing line item data, you must number each item sequentially starting with 1.

**Type** = Integer; **minInclusive value** = 1, **maxInclusive value** = 99

**Parent Elements:**

[lineItemData](#)

**Attributes:**

None

**Child Elements:**

None

## 4.218 ksn

The `ksn` element is a required child of the `mpos` element. This element defines the Key serial Number returned from the encrypting device. It is created automatically from the unique identifier of the device and an internal transaction counter.

**Type** = String; **minLength** = 1; **maxLength** = 1028

### Parent Elements:

[mpos](#)

### Attributes:

None

### Child Elements:

None

## 4.219 lastName

The `lastName` element is a child of the `billToAddress` element, which specifies the last name of the account holder and is required for `echeckVerification` transactions.

---

---

**NOTE:** When performing an eCheck Verification for a corporate account, you must include values for the `firstName` and `lastName` element. If you do not have the name of the check issuer, you can use a value of “unavailable” for both elements.

---

---

Type = String; minLength = N/A; maxLength = 25

**Parent Elements:**

[billToAddress](#)

**Attributes:**

None

**Child Elements:**

None

## 4.220 lineItemData

The `lineItemData` element contains several child elements used to define information concerning individual items in the order. Although the schema defines it as an optional child of the `enhancedData` element, it is required for Level III interchange rates.

---

**NOTE:** MasterCard and Visa allow up to 99 instances of this element in a transaction. American Express allows a maximum of 4 instances of this element in a transaction.

---

### Parent Elements:

[enhancedData](#)

### Attributes:

None

### Child Elements:

Required: [itemDescription](#)

Optional: [itemSequenceNumber](#), [productCode](#), [quantity](#), [unitOfMeasure](#), [taxAmount](#), [lineItemTotal](#), [lineItemTotalWithTax](#), [itemDiscountAmount](#), [commodityCode](#), [unitCost](#), [detailTax](#)

---

**NOTE:** When including the `lineItemData` element, please be aware of the following rules for its child elements:

- `itemSequenceNumber` is required by Visa
  - `productCode`, `quantity`, `unitOfMeasure`, and `lineItemTotal` are required by Visa and MasterCard
  - `itemDiscountAmount`, `commodityCode`, and `unitCost` are required by Visa for Level III Interchange rates
- 

### Example: lineItemData Structure

```
<lineItemData>
  <itemSequenceNumber>Line Item Number within Order</itemSequenceNumber>
  <itemDescription>Description of Item</itemDescription>
  <productCode>Product Code of Item</productCode>
  <quantity>Quantity of Item</quantity>
  <unitOfMeasure>Unit of Measurement Code</unitOfMeasure>
  <taxAmount>Sales Tax or VAT of Item</taxAmount>
```

```
<lineItemTotal>Total Amount of Line Item</lineItemTotal>
<lineItemTotalWithTax>taxAmount + lineItemTotal</lineItemTotalWithTax>
<itemDiscountAmount>Discount Amount</itemDiscountAmount>
<commodityCode>Card Acceptor Commodity Code for Item</commodityCode>
<unitCost>Price for One Unit of Item</unitCost>
<detailTax>
  <taxIncludedInTotal>true or false</taxIncludedInTotal>
  <taxAmount>Additional Tax Amount</taxAmount>
  <taxRate>Tax Rate of This Tax Amount</taxRate>
  <taxTypeIdentifier>Tax Type Enum</taxTypeIdentifier>
  <cardAcceptorTaxId>Tax ID of Card Acceptor</cardAcceptorTaxId>
</detailTax>
</lineItemData>
```



## 4.221 lineItemTotal

The `lineItemTotal` element is an optional child of the `lineItemData` element, which specifies the total cost of the line items purchased, not including tax. For example, if the order was for 500 pencils at \$1.00 each, the `lineItemTotal` would be \$500. Although an optional element, it is required by Visa and MasterCard when specifying line item data. The decimal is implied. Example: 500 = \$5.00.

**Type** = Integer; **totalDigits** = 8

### Parent Elements:

[lineItemData](#)

### Attributes:

None

### Child Elements:

None

## 4.222 lineItemTotalWithTax

The `lineItemTotalWithTax` element is an optional child of the `lineItemData` element, which specifies the total cost of the line items purchased including tax. If the tax is not known, do not include this element. The decimal is implied. Example: 500 = \$5.00.

**Type** = Integer; **totalDigits** = 8

### Parent Elements:

[lineItemData](#)

### Attributes:

None

### Child Elements:

None

## 4.223 litleInternalRecurringRequest

The `litleInternalRecurringRequest` element and its children is an element structure that exists solely for internally (to system) generated transactions associated with recurring payments managed by the Recurring engine. You do not need to code for this structure.

**Parent Elements:**

[sale](#)

**Attributes:**

None

**Child Elements:**

[subscriptionId](#), [recurringTxnId](#), [finalPayment](#)

## 4.224 litleOnlineRequest

This is the root element for all cnpAPI Online requests.

### Parent Elements:

None

### Attributes:

Attribute Name	Type	Required?	Description
version	String	Yes	Defines the cnpAPI schema version against which the XML is validated. <b>minLength</b> = N/A <b>maxLength</b> = 10
xmlns	String	Yes	Defines the URI of the schema definition. This is a fixed location and must be specified as: <a href="http://www.litle.com/schema">http://www.litle.com/schema</a> . <b>minLength</b> = N/A <b>maxLength</b> = 38
merchantId	String	Yes	A unique string used to identify the merchant within the system. <b>minLength</b> = N/A <b>maxLength</b> = 50 <b>Note: International currencies are supported on a per merchantId basis.</b>
loggedInUser	String	No	<b>Internal Use Only</b>
sameDayFunding	Boolean	No	Used for Dynamic Payout Funding Instructions only. Set to <b>true</b> to mark this Funding Instructions for same day funding. Also, see <a href="#">Same Day Funding on page 888</a> .

### Child Elements:

Required: [authentication](#)

One of the following required: [activate](#), [activateReversal](#), [authorization](#), [authReversal](#), [balanceInquiry](#), [cancelSubscription](#), [capture](#), [captureGivenAuth](#), [createPlan](#), [credit](#), [deactivate](#), [deactivateReversal](#), [depositReversal](#), [echeckCredit](#), [echeckRedeposit](#), [echeckSale](#), [echeckVerification](#), [echeckVoid](#), [forceCapture](#), [fraudCheck](#), [giftCardAuthReversal](#), [giftCardCapture](#), [giftCardCredit](#), [load](#), [loadReversal](#), [registerTokenRequest](#), [refundReversal](#), [sale](#), [unload](#), [updateCardValidationNumOnToken](#), [updatePlan](#), [updateSubscription](#), [unloadReversal](#), [void](#), [fastAccessFunding](#), [payFacCredit](#), [payFacDebit](#), [physicalCheckCredit](#), [physicalCheckDebit](#), [reserveCredit](#), [reserveDebit](#), [submerchantCredit](#), [submerchantDebit](#), [vendorCredit](#), [vendorDebit](#)

## 4.225 litleOnlineResponse

This is the root element for all cnpAPI Online responses.

### Parent Elements:

None

### Attributes:

Attribute Name	Type	Required?	Description
version	String	Yes	Defines the cnpAPI schema version against which the XML is validated. <b>minLength</b> = N/A <b>maxLength</b> = 10
xmlns	String	Yes	Defines the URI of the schema definition. This is a fixed location and must be specified as: <a href="http://www.litle.com/schema">http://www.litle.com/schema</a> . <b>minLength</b> = N/A <b>maxLength</b> = 38
response	String	Yes	Indicates whether your XML syntax passed validation. Expected values are as follows: 0 - XML validation succeeded. 1 - XML validation failed. See the message attribute for more details. 2 - Indicates that the submitted content was either improperly formatted XML or non-XML content. 3 - Indicates that the submission contains empty or invalid credentials (user and password). 4 - Indicates that the merchant has reached the maximum number of concurrent connections. 5 - Indicates that systems may have detected message content that violates certain restrictions. <b>minLength</b> = N/A <b>maxLength</b> = 3

Attribute Name	Type	Required?	Description
message	String	Yes	<p>XML validation error message. Expected values are as follows:</p> <ul style="list-style-type: none"> <li>If the response attribute returns 0, the message attribute returns the text "Valid Format."</li> <li>If the response attribute returns 1, the message attribute returns an error message that helps you to identify and troubleshoot the syntax problem. See <a href="#">XML Validation Error Messages</a> on page 864 for example messages.</li> <li>If the response attribute returns 2, the message attribute is "System Error - Call Litle &amp; Co."</li> <li>If the response attribute returns a value of 3, 4, or 5, the message attribute is "There is a problem with the system. Contact eCommerceSupport@vantiv.com."</li> </ul> <p><b>minLength</b> = N/A <b>maxLength</b> = 512</p>

### Child Elements:

One of the following required: [activateResponse](#), [activateReversalResponse](#), [authorizationResponse](#), [authReversalResponse](#), [balanceInquiryResponse](#), [cancelSubscriptionResponse](#), [captureGivenAuthResponse](#), [captureResponse](#), [createPlanResponse](#), [deactivateResponse](#), [deactivateReversalResponse](#), [depositReversalResponse](#), [creditResponse](#), [echeckCreditResponse](#), [echeckRedepositResponse](#), [echeckSalesResponse](#), [echeckVerificationResponse](#), [forceCaptureResponse](#), [giftCardAuthReversalResponse](#), [giftCardCaptureResponse](#), [giftCardCreditResponse](#), [loadResponse](#), [loadReversalResponse](#), [refundReversalResponse](#), [registerTokenResponse](#), [saleResponse](#), [unloadResponse](#), [unloadReversalResponse](#), [updateCardValidationNumOnTokenResponse](#), [voidResponse](#), [updatePlanResponse](#), [updateSubscriptionResponse](#), [fastAccessFundingResponse](#), [payFacCreditResponse](#), [payFacDebitResponse](#), [physicalCheckCreditResponse](#), [physicalCheckDebitResponse](#), [reserveCreditResponse](#), [reserveDebitResponse](#), [submerchantCreditResponse](#), [submerchantDebitResponse](#), [vendorCreditResponse](#), [vendorDebitResponse](#)

## 4.226 litleRequest

This is the root element for all cnpAPI Batch requests.

### Parent Elements:

None

### Attributes:

Attribute Name	Type	Required?	Description
version	String	Yes	Defines the cnpAPI schema version against which the XML is validated. <b>minLength</b> = N/A <b>maxLength</b> = 10
xmlns	String	Yes	Defines the URI of the schema definition. This is a fixed location and must be specified as: <a href="http://www.litle.com/schema">http://www.litle.com/schema</a> . <b>minLength</b> = N/A <b>maxLength</b> = 38
id	String	No	A unique string to identify the session within the system. <b>minLength</b> = N/A <b>maxLength</b> = 25
numBatchRequests	Integer	Yes	Defines the total number of batchRequest children included in the litleRequest. If the litleRequest contains only an RFRRequest, then set this attribute to "0".

### Child Elements:

Required: [authentication](#)

One of the following required: [batchRequest](#), [RFRRequest](#)

## 4.227 litleResponse

This is the root element for all cnpAPI Batch responses.

### Parent Elements:

None

### Attributes:

Attribute Name	Type	Required?	Description
version	String	Yes	Defines the cnpAPI schema version against which the XML is validated. <b>minLength</b> = N/A <b>maxLength</b> = 10
xmlns	String	Yes	Defines the URI of the schema definition. This is a fixed location and must be specified as: <a href="http://www.litle.com/schema">http://www.litle.com/schema</a> . <b>minLength</b> = N/A <b>maxLength</b> = 38
id	String	No	The response returns the same value submitted in the Litle Request. <b>minLength</b> = N/A <b>maxLength</b> = 25
response	String	Yes	Indicates whether your XML syntax passed validation. Expected values are as follows: 0 - XML validation succeeded. 1 - XML validation failed. See the message attribute for more details. 2 - Indicates that the submitted content was either improperly formatted XML or non-XML content. 3 - Indicates that the submission contains empty or invalid credentials (user and password). 4 - Indicates that the merchant has reached the maximum number of concurrent connections. 5 - Indicates that systems may have detected message content that violates certain restrictions. <b>minLength</b> = N/A <b>maxLength</b> = 3



Attribute Name	Type	Required?	Description
message	String	Yes	<p>XML validation error message. Expected values are as follows:</p> <ul style="list-style-type: none"> <li>If the response attribute returns 0, the message attribute returns the text "Valid Format."</li> <li>If the response attribute returns 1, the message attribute returns an error message that helps you to identify and troubleshoot the syntax problem. See <a href="#">XML Validation Error Messages</a> on page 864 for example messages.</li> <li>If the response attribute returns 2, the message attribute is "System Error - Call Litle &amp; Co."</li> <li>If the response attribute returns a value of 3, 4, or 5, the message attribute is "There is a problem with the system. Contact eCommerceSupport@vantiv.com."</li> </ul> <p><b>minLength</b> = N/A <b>maxLength</b> = 512</p>
litleSessionId	Long	Yes	<p>A unique value assigned by Vantiv to identify the session.</p> <p><b>minLength</b> = N/A <b>maxLength</b> = 19</p>

**Child Elements:**

One of the following required: [batchResponse](#), [RFRResponse](#)

## 4.228 littleSessionId

The `littleSessionId` element is a child of the `RFRRequest` element used to request the response from a previously submitted Batch. The value of the `littleSessionId` must be the same as the value returned in the corresponding attribute of the `littleResponse`.

**Type** = Long; **minLength** = N/A; **maxLength** = 19

### Parent Elements:

[RFRRequest](#)

### Attributes:

None

### Child Elements:

None

## 4.229 litleToken

The `litleToken` element defines the value of the token. The system returns this value in XML responses when issuing new tokens to replace account numbers. The length of the token is the same as the length of the submitted account number for credit card tokens or a fixed length of seventeen (17) characters for eCheck account tokens.

**Type** = String; **minLength** = 13; **maxLength** = 25

### Parent Elements:

The `litleToken` element is an optional child of each listed parent element.

[registerTokenResponse](#), [tokenResponse](#), [newCardTokenInfo](#), [originalCardTokenInfo](#), [originalToken](#), [originalTokenInfo](#), [newTokenInfo](#), [updatedToken](#), [token](#), [echeckToken](#)

### Attributes:

None

### Child Elements:

None

## 4.230 littleTxnId

The `littleTxnId` element is used to identify transactions in the system. The system returns this element in XML responses. You use it in various requests to reference the original transaction. For example, when you submit a Capture transaction, you include the `littleTxnId` for the associated Authorization.

**Type** = Long; **minLength** = N/A; **maxLength** = 19

### Parent Elements:

This element is a required child of the following: `accountUpdateResponse`, `activateResponse`, `activateReversalResponse`, `authorizationResponse`, `authReversalResponse`, `capture`, `captureResponse`, `credit`, `creditResponse`, `captureGivenAuthResponse`, `deactivateResponse`, `deactivateReversalResponse`, `depositReversalResponse`, `echeckCredit`, `echeckCreditResponse`, `echeckPreNoteCreditResponse`, `echeckPreNoteSaleResponse`, `echeckRedeposit`, `echeckRedepositResponse`, `echeckSalesResponse`, `echeckVerificationResponse`, `echeckVoid`, `echeckVoidResponse`, `fastAccessFundingResponse`, `forceCapture`, `forceCaptureResponse`, `fraudCheckResponse`, `fundingInstructionVoid`, `fundingInstructionVoidResponse`, `giftCardAuthReversalResponse`, `giftCardCaptureResponse`, `giftCardCreditResponse`, `loadResponse`, `loadReversalResponse`, `payFacCreditResponse`, `payFacDebitResponse`, `physicalCheckCreditResponse`, `physicalCheckDebitResponse`, `refundReversalResponse`, `saleResponse`, `unloadResponse`, `void`, `voidResponse`, `cancelSubscriptionResponse`, `updatePlanResponse`, `updateSubscriptionResponse`, `unloadReversalResponse`, `submerchantCreditResponse`, `submerchantDebitResponse`, `vendorCreditResponse`, `vendorDebitResponse`

---

**NOTE:** While the `littleTxnId` is optional in the transaction types listed below, Vantiv recommends you include it whenever possible. Failure to include the `littleTxnId` results in missing information in the Associated Transaction Stream section of the Transaction Detail screen in iQ.

---

This element is an optional child of the following: `activateReversal`, `deactivateReversal`, `depositReversal`, `giftCardAuthReversal`, `giftCardCapture`, `giftCardCredit`, `loadReversal`, `refundReversal`, `unloadReversal`

---

**NOTE:** Although the schema shows the `littleTxnId` element as an optional child of the `authorization`, `echeckSale`, and `sale` transactions, under normal circumstances, merchants would never use this option.

---

### Attributes:

None

**Child Elements:**

None

## 4.231 load

The `load` element is the parent element for the transaction type that adds funds to a reloadable Gift Card.

### Parent Elements:

[littleOnlineRequest](#), [batchRequest](#)

### Attributes:

Attribute Name	Type	Required?	Description
id	String	Yes	A unique identifier assigned by the presenter and mirrored back in the response. <b>minLength = 1    maxLength = 36</b>
customerId	String	No	A value assigned by the merchant to identify the consumer. <b>minLength = N/A    maxLength = 50</b>
reportGroup	String	Yes	Required attribute that defines the merchant sub-group in the user interface where this transaction will be displayed. Please refer to <a href="#">Coding for Report Groups</a> on page 10 for additional information. <b>minLength = 1    maxLength = 25</b>

### Child Elements: (all Required)

[orderId](#), [amount](#), [orderSource](#), [card](#)

## 4.232 loadResponse

The `loadResponse` element is the parent element for information returned to you in response to a `load` transaction. It can be a child of either a `littleOnlineResponse` element or a `batchResponse` element.

### Parent Elements:

[littleOnlineResponse](#), [batchResponse](#)

### Attributes:

Attribute Name	Type	Required?	Description
id	String	Yes	The response returns the same value submitted in the Load transaction. <b>minLength = 1    maxLength = 36</b>
customerId	String	No	The response returns the same value submitted in the Load transaction. <b>minLength = N/A    maxLength = 50</b>
reportGroup	String	Yes	The response returns the same value submitted in the Load transaction. <b>minLength = 1    maxLength = 25</b>

### Child Elements:

Required: [littleTxnId](#), [response](#), [responseTime](#), [message](#)

Optional: [postDate](#), [fraudResult](#), [giftCardResponse](#)

## 4.233 loadReversal

The `loadReversal` element is the parent element for the transaction type that reverses the loading of a Gift Card.

### Parent Elements:

[litleOnlineRequest](#)

### Attributes:

Attribute Name	Type	Required?	Description
id	String	Yes	A unique identifier assigned by the presenter and mirrored back in the response. <b>minLength = 1    maxLength = 36</b>
customerId	String	No	A value assigned by the merchant to identify the consumer. <b>minLength = N/A    maxLength = 50</b>
reportGroup	String	Yes	Required attribute that defines the merchant sub-group in the user interface where this transaction will be displayed. Please refer to <a href="#">Coding for Report Groups</a> on page 10 for additional information. <b>minLength = 1    maxLength = 25</b>

### Child Elements: (Required)

[card](#), [originalRefCode](#), [originalAmount](#), [originalTxnTime](#), [originalSystemTraceId](#), [originalSequenceNumber](#)

### Child Elements: (Optional)

[litleTxnId](#)



## 4.234 loadReversalResponse

The loadReversalResponse element is the parent element for information returned to you in response to an loadReversal transaction.

### Parent Elements:

[litleOnlineResponse](#)

### Attributes:

Attribute Name	Type	Required?	Description
id	String	Yes	The response returns the same value submitted in the Load Reversal transaction. <b>minLength = 1    maxLength = 36</b>
customerId	String	No	The response returns the same value submitted in the Load Reversal transaction. <b>minLength = N/A    maxLength = 50</b>
reportGroup	String	Yes	The response returns the same value submitted in the Load Reversal transaction. <b>minLength = 1    maxLength = 25</b>

### Child Elements:

Required: [litleTxnId](#), [response](#), [responseTime](#), [message](#)

Optional: [postDate](#), [giftCardResponse](#)

## 4.235 mandateProvider

The `mandateProvider` element is a required child of the `sepaDirectDebit` element and defines whether the Merchant or Vantiv provides the mandate for customer approval.

**Type** = String (Enum); **Allowed Values** = Merchant or Vantiv

**Parent Elements:**

[sepaDirectDebit](#)

**Attributes:**

None

**Child Elements:**

None

## 4.236 mandateReference

The `mandateReference` element is an optional child of both the `sepaDirectDebit` element and the `sepaDirectDebitResponse` element. You use this element for recurring payments (after the initial transaction) to provide the reference number that links subsequent payments in a recurring stream to the mandate agreed to at the time of the initial payment. Vantiv returns this value in the `sepaDirectDebitResponse` associated with the initial payment. It is not returned for subsequent payments in a recurring stream.

**Type** = String; **minLength** = N/A; **maxLength** = 256

### Parent Elements:

[sepaDirectDebit](#), [sepaDirectDebitResponse](#)

### Attributes:

None

### Child Elements:

None

## 4.237 mandateSignatureDate

The `mandateSignatureDate` element is an optional child of the `sepaDirectDebit` element and defines the date the consumer agreed to the mandate allowing the merchant to debit their account. Although optional, you should always provide this information when the value for the `mandateProvider` element is `Merchant`.

**Type** = Date; **Format** = YYYY-MM-DD

**Parent Elements:**

[sepaDirectDebit](#)

**Attributes:**

None

**Child Elements:**

None

## 4.238 mandateURL

The `mandateUrl` element is an optional child of the `sepaDirectDebit` element and defines the URL of the mandate to which the consumer agreed, allowing the merchant to debit their account. Although optional, you should always provide this information when the value for the `mandateProvider` element is `Merchant`.

**Type** = String; **minLength** = 1; **maxLength** = 2000

**Parent Elements:**

[sepaDirectDebit](#)

**Attributes:**

None

**Child Elements:**

None

## 4.239 matchCount

The `matchCount` element is a required child of the `queryTransactionResponse` element and defines the number of found transactions that matched the criteria submitted in the `queryTransaction`.

**Type** = Integer; **totalDigits** = 2

**Parent Elements:**

[queryTransactionResponse](#)

**Attributes:**

None

**Child Elements:**

None

## 4.240 merchantData

The merchantData element is an optional child element of several transaction types. You can use its children to track transactions based upon marketing campaigns, affiliates, or other user defined parameter.

**Parent Elements:**

[authorization](#), [captureGivenAuth](#), [credit](#), [echeckCredit](#), [echeckPreNoteCredit](#), [echeckPreNoteSale](#), [echeckRedeposit](#), [echeckSale](#), [echeckVerification](#), [forceCapture](#), [sale](#)

**Attributes:**

None

**Child Elements (all optional):**

[affiliate](#), [campaign](#), [merchantGroupingId](#)

## 4.241 merchantGroupingId

The merchantGroupingId element is an optional child element of the merchantData element. You can use it to track transactions based upon this user defined parameter.

**Type** = String; **minLength** = N/A; **maxLength** = 25

**Parent Elements:**

[merchantData](#)

**Attributes:**

None

**Child Elements:**

None



## 4.242 merchantId

The merchantId element is a child of the accountUpdateFileRequestData element used when you request an Account Update file. This value is a unique string used to identify the merchant within the system.

**Type** = String; **minLength** = N/A; **maxLength** = 50

**Parent Elements:**

[accountUpdateFileRequestData](#)

**Attributes:**

None

**Child Elements:**

None

---

---

**NOTE:** Several elements use merchantId as an attribute, including batchRequest, batchResponse, and litleOnlineRequest.

---

---

## 4.243 message

The `message` element contains a brief definition of the response code returned for the transaction.

When it is a child of the `extendedCardResponse` element, the only values allowed are either "The account was closed," or "Contact the cardholder for updated information."

For a complete list of response codes and associated messages, please refer to [Appendix A](#).

**Type** = String; **minLength** = N/A; **maxLength** = 512

### Parent Elements:

`activateResponse`, `activateReversalResponse`, `authorizationResponse`, `captureResponse`, `captureGivenAuthResponse`, `creditResponse`, `deactivateResponse`, `deactivateReversalResponse`, `depositReversalResponse`, `echeckCreditResponse`, `echeckPreNoteCreditResponse`, `echeckPreNoteSaleResponse`, `echeckRedepositResponse`, `echeckSalesResponse`, `echeckVerificationResponse`, `echeckVoidResponse`, `extendedCardResponse`, `forceCaptureResponse`, `fraudCheckResponse`, `loadResponse`, `loadReversalResponse`, `queryTransactionResponse`, `queryTransactionUnavailableResponse`, `refundReversalResponse`, `saleResponse`, `unloadResponse`, `unloadReversalResponse`, `voidResponse`, `cancelSubscriptionResponse`, `updatePlanResponse`, `updateSubscriptionResponse`, `payFacCreditResponse`, `payFacDebitResponse`, `physicalCheckCreditResponse`, `physicalCheckDebitResponse`, `reserveCreditResponse`, `reserveDebitResponse`, `submerchantCreditResponse`, `submerchantDebitResponse`, `vendorCreditResponse`, `vendorDebitResponse`

### Attributes:

None

### Child Elements:

None

## 4.244 middleInitial

The `middleInitial` element is a child of the `billtoAddress` element, which specifies the middle initial of the account holder. It is an optional element used for `echeckVerification` transactions.

**Type** = String; **minLength** = N/A; **maxLength** = 1

**Parent Elements:**

[billToAddress](#)

**Attributes:**

None

**Child Elements:**

None

## 4.245 mpos

The `mpos` element defines payment card information when the transaction originates with a ROAM device.

### Parent Elements:

[authorization](#), [captureGivenAuth](#), [credit](#), [forceCapture](#), [sale](#), [registerTokenRequest](#)

### Attributes:

None

### Child Elements: (all Required)

[ksn](#), [formatId](#), [encryptedTrack](#), [track1Status](#), [track2Status](#)

### Example: mpos Structure

```
<mpos>
  <ksn>Key Serial Number</ksn>
  <formatId>Format of Encrypted Track</formatId>
  <encryptedTrack>Encrypted Track Data</encryptedTrack>
  <track1Status>Card Validation Number</track1Status>
  <track2Status>Card Validation Number</track2Status>
</mpos>
```

## 4.246 name

The `name` element defines the customer name in both the `billToAddress` and `shipToAddress` elements. When used as a child of one of the Recurring Engine associated parents (i.e., `createAddOn`, `updateAddOn`, `createDiscount`, `updateDiscount`, or `createPlan`), the `name` element specifies the name of the parent item being created/updated.

**Type** = String; **minLength** = N/A; **maxLength** = 100

### Parent Elements:

[billToAddress](#), [shipToAddress](#), [createAddOn](#), [updateAddOn](#), [createDiscount](#), [updateDiscount](#), [createPlan](#)

---

**NOTE:** The `name` element is required for Echeck transactions. If you do not submit the customer name in an Echeck transaction, we return Response Code 330 - Invalid Payment Type.

The `name` element is required for `sale` transactions using the `sepaDirectDebit` method of payment and must be a minimum of two characters. Failure to include the `name` element results in a 901 - Missing Name Response Code. If the value is not at least two characters, the transaction declines with a response code of 902 - Invalid Name

---

### Attributes:

None

### Child Elements:

None

## 4.247 networkField

The `networkField` element is an optional child of the `networkResponse` element. Its attributes and child elements define the Field Number, Field Name, (Raw) Field Value, as well as any Sub-fields, if applicable.

### Parent Elements:

[networkResponse](#)

### Attributes:

Attribute Name	Type	Required?	Description
fieldName	String	Yes	<p>This attribute defines the name of the ISO 8583 field containing the information returned.</p> <p><b>Type</b> = Enum</p> <p><b>Allowed Values:</b></p> <ul style="list-style-type: none"> <li>• Transaction Amount</li> <li>• Settlement Date</li> <li>• Authorization Identification Response</li> <li>• Response Code</li> <li>• Additional Response Data</li> <li>• Private Use Additional Data</li> <li>• Settlement Currency Code</li> <li>• Cardholder Billing Currency Code</li> <li>• Additional Amounts</li> <li>• Reserved Private</li> <li>• Transaction Description</li> <li>• Reserved For National Use</li> <li>• Reserved For Private Use</li> </ul>
fieldNumber	Integer	Yes	<p>This attribute defines the number of the ISO 8583 field containing the information returned. Different card networks may use different Field Numbers for the same information.</p> <p><b>minLength</b> = 1    <b>maxLength</b> = N/A</p>

### Child Elements:

[fieldValue](#), [networkSubField](#)

**Example: networkField Structure with fieldValue**

```
<networkField fieldNumber="4" fieldName="Transaction Amount">  
  <fieldValue>00000001111</fieldValue>  
</networkField>
```

**Example: networkField Structure with networkSubField**

```
<networkField fieldNumber="44" fieldName="Additional Response Data">  
  <networkSubField fieldNumber="1">  
    <fieldValue>7</fieldValue>  
  </networkSubField>  
  <networkSubField fieldNumber="2">  
    <fieldValue>W</fieldValue>  
  </networkSubField>  
</networkField>
```

## 4.248 networkResponse

The `networkResponse` element is an optional child of the `enhancedAuthResponse` element. Its child elements provide a number of data points returned by the card networks in their ISO 8583 response messages.

### Parent Elements:

[enhancedAuthResponse](#)

### Attributes:

None

### Child Elements:

[endpoint](#), [networkField](#)

### Example: networkResponse Structure

```
<networkResponse>
  <endpoint>VISA</endpoint>
  <networkField fieldNumber="4" fieldName="Transaction Amount">
    <fieldValue>000000000962</fieldValue>
  </networkField>
  <networkField fieldNumber="44" fieldName="Additional Response Data">
    <networkSubField fieldNumber="1">
      <fieldValue>7</fieldValue>
    </networkSubField>
    <networkSubField fieldNumber="2">
      <fieldValue>W</fieldValue>
    </networkSubField>
  </networkField>
</networkResponse>
```



## 4.249 networkSubField

The `networkSubField` element is a required child of the `networkField` element, when a subfield exists. Its child element provides the raw subfield data returned by the card networks in their ISO 8583 response messages.

### Parent Elements:

[networkField](#)

### Attributes:

Attribute Name	Type	Required?	Description
fieldNumber	Integer	Yes	This attribute defines the number of the ISO 8583 field or subfield containing the information returned. Different card networks may use different Field Numbers for the same information. <b>minLength</b> = 1 <b>maxLength</b> = N/A

### Child Elements:

[fieldValue](#)

## 4.250 networkTransactionId

The `networkTransactionId` element is an optional child of the `authorizationResponse`, and `saleResponse` transactions, returned for Visa and Discover transactions. Visa and Discover use this value to link subsequent payments in a recurring/installment stream back to the initial transaction. You must include this value in the request message (`originalNetworkTransactionId` element) for subsequent recurring payments, if the payment method is either Visa or Discover.

**Type** = String; **minLength** = N/A; **maxLength** = 30

---

---

**NOTE:** In the initial transaction of the recurring/installment stream, you must set the `processingType` element to either `initialRecurring` or `initialInstallment`, as applicable.

---

---

### Parent Elements:

[authorizationResponse](#), [saleResponse](#)

### Attributes:

None

### Child Elements:

None

## 4.251 newAccountInfo

The `newAccountInfo` element is an optional child of the `accountUpdater` element, which contains child elements providing the updated information for the submitted account.

### Parent Elements:

[accountUpdater](#)

### Attributes:

None

### Child Elements:

[accType](#), [accNum](#), [routingNum](#)

### Example: newAccountInfo Structure

```
<newAccountInfo>
  <accType>Account Type</accType>
  <accNum>New Account Number</accNum>
  <routingNum>New Routing Number</routingNum>
</newAccountInfo>
```

## 4.252 newCardInfo

The `newCardInfo` element is an optional child of the `accountUpdater` element, which contains child elements providing the updated information for the submitted card.

### Parent Elements:

[accountUpdater](#)

### Attributes:

None

### Child Elements:

[type](#), [number](#), [expDate](#)

### Example: newCardInfo Structure

```
<newCardInfo>
  <type>Card Type</type>
  <number>New Account Number</number>
  <expDate>New Expiration Date</expDate>
</newCardInfo>
```

## 4.253 newCardTokenInfo

The `newCardTokenInfo` element is an optional child of the `accountUpdater` element, which contains child elements providing the updated token information for the submitted token.

### Parent Elements:

[accountUpdater](#)

### Attributes:

None

### Child Elements:

[littleToken](#), [type](#), [expDate](#), [bin](#)

### Example: newCardInfo Structure

```
<newCardTokenInfo>
  <littleToken>New Token</littleToken>
  <type>Card Type</type>
  <expDate>New Expiration Date</expDate>
  <bin>New Card BIN</bin>
</newCardTokenInfo>
```

## 4.254 newTokenInfo

The `newTokenInfo` element is an optional child of the `accountUpdater` element, which contains child elements providing the updated information for the submitted account. The system returns this information when processing a tokenized eCheck transactions and a change (NOC) is found against the account.

### Parent Elements:

[accountUpdater](#)

### Attributes:

None

### Child Elements:

[accType](#), [litleToken](#), [routingNum](#)

### Example: newAccountInfo Structure

```
<newTokenInfo>
  <accType>Account Type</accType>
  <litleToken>New Token Number</litleToken>
  <routingNum>New Routing Number</routingNum>
</newTokenInfo>
```

## 4.255 nextRecycleTime

---

---

**NOTE:** The recycling Advice feature is no longer supported.

---

---

The nextRecycleTime element is an optional child of the recycleAdvice element, which specifies the date and time (in GMT) recommended for the next recycle of the declined Authorization/Sale transaction. The format of the element is YYYY-MM-DDTHH:MM:SSZ. For example, 2011-04-21T11:00:00Z.

---

---

**NOTE:** Per the ISO8601 standard, the Z appended to the end of the date/time stamp indicates the time is GMT.

---

---

**Type** = dateTime; **minLength** = N/A; **maxLength** = 20

**Parent Elements:**

[recycleAdvice](#)

**Attributes:**

None

**Child Elements:**

None

## 4.256 number

The `number` element defines the account number associated with the transaction or the new/old account number associated with an update. This is a required child of the `card` element for card-not-present transactions.

**Type** = String; **minLength** = 13; **maxLength** = 25

### Parent Elements:

[accountInformation](#), [card](#), [newCardInfo](#), [originalCardInfo](#)

### Attributes:

None

### Child Elements:

None



## 4.257 numberOfPayments

The `numberOfPayments` element is defines the number of payments in a recurring billing plan including the initial payment. The timing of subsequent charges is defined by the `planCode` element. This element is an optional child of both the `subscription`, and `createPlan` elements. When submitted as a child of the `subscription` element, the value overrides the default value defined in the Plan.

---

---

**NOTE:** For an open-ended Plan, please omit the optional `numberOfPayments` element in `createPlan`.  
For an open-ended subscription, please omit the optional `numberOfPayments` element in `subscription` and reference an open-ended Plan.

---

---

Type = Integer; `minLength` = 1; `maxLength` = 99

### Parent Elements:

[subscription](#), [createPlan](#)

### Attributes:

None

### Child Elements:

None

## 4.258 onlinePaymentCryptogram

The `onlinePaymentCryptogram` element is an optional child of the `applepayResponse` element and provides the BASE64 Encoded signature cryptogram associated with the Apple Pay transaction.

**Type** = Base 64 Encoded String; **minLength** = N/A; **maxLength** = 56

**Parent Elements:**

[applepayResponse](#)

**Attributes:**

None

**Child Elements:**

None

## 4.259 orderDate

The `orderDate` element is an optional child of the `enhancedData` element, which specifies the date the order was placed. If you do not know the order date, do not include this element.

**Type** = Date; **Format** = YYYY-MM-DD

**Parent Elements:**

[enhancedData](#)

**Attributes:**

None

**Child Elements:**

None

## 4.260 orderId

The `orderId` element is a required child of several transaction types and defines a merchant-assigned value representing the order in the merchant's system.

**Type** = String; **minLength** = N/A; **maxLength** = 25

---

---

**NOTE:** If you are using the `orderId` element as the transaction signature for the Recycling Engine, do not use the pipe character ("`|`") in the `orderId`. Use of the pipe character in this scenario will cause recycling errors.

---

---

### Parent Elements:

`accountUpdate`, `accountUpdateResponse`, `activate`, `authorization`, `authorizationResponse`, `balanceInquiry`, `credit`, `captureGivenAuth`, `deactivate`, `echeckCredit`, `echeckPreNoteCredit`, `echeckPreNoteSale`, `echeckSale`, `echeckVerification`, `forceCapture`, `giftCardCredit`, `load`, `registerTokenRequest`, `sale`, `saleResponse`, `unload`, `updateCardValidationNumOnToken`

### Attributes:

None

### Child Elements:

None

## 4.261 orderSource

The `orderSource` element defines the order entry source for the type of transaction.

**Type** = Choice (enum); **minLength** = N/A; **maxLength** = N/A

### Parent Elements:

[activate](#), [authorization](#), [balanceInquiry](#), [captureGivenAuth](#), [credit](#), [deactivate](#), [echeckCredit](#), [echeckPreNoteCredit](#), [echeckPreNoteSale](#), [echeckSale](#), [echeckVerification](#) [forceCapture](#), [load](#), [sale](#), [unload](#)

### Attributes:

None

### Child Elements:

None

### Enumerations:

---

**NOTE:** If you submit the wrong `orderSource` value, we return the response code 370 - Internal System Error - Contact Litle.

**eCheckSale transactions must use an `orderSource` of one of the following: `telephone`, `ecommerce`, `echeckppd`, or `recurringtel`.**

---

Enumeration	Description
3dsAuthenticated	Use this value only if you authenticated the cardholder via an approved 3DS system such as Visa Verified By Visa and MasterCard SecureCode. This value applies to Visa and MasterCard transactions only.  <b>NOTE: Your Merchant Profile must be configured to process 3DS type payments and accept this value.</b>
3dsAttempted	Use this value only if you attempted to authenticate the cardholder via an approved 3DS system such as Visa VerifiedByVisa and MasterCard SecureCode, but either the Issuer or cardholder is not participating in the 3DS program. This value applies to Visa and MasterCard transactions only. If this is a MasterCard transaction, you must include the <code>authenticationValue</code> returned by MasterCard.  <b>NOTE: Your Merchant Profile must be configured to process 3DS type payments and accept this value.</b>

Enumeration	Description
echeckppd	<b>(eCheck only)</b> Use this value for eCheck PPD transactions (Prearranged Payment and Deposit Entries). This type of transaction occurs when a merchant receives a written authorization, including a voided paper check, from a consumer so that the merchant can debit the consumer account. These transactions can be single entry or recurring debits to a consumer's account.
ecommerce	The transaction is an Internet or electronic commerce transaction.
installment	The transaction is an installment payment.
mailorder	The transaction is for a single mail order transaction.
recurring	The transaction is a recurring transaction. For Visa transactions, you can use this value for all transactions in a recurring stream including the initial transaction.
retail	The transaction is a Swiped or Keyed Entered retail purchase transaction.
telephone	The transaction is for a single telephone order.
recurringtel	<b>(eCheck only)</b> The transaction is a recurring eCheck transaction initiated via telephone
applepay	The transaction uses the Apple Pay service.
androidpay	The transaction uses the Android Pay service.

## 4.262 originalAccountInfo

The `originalAccountInfo` element is an optional child of the `accountUpdater` element, which contains child elements providing the original information for the submitted account.

### Parent Elements:

[accountUpdater](#)

### Attributes:

None

### Child Elements:

[accType](#), [accNum](#), [routingNum](#)

### Example: originalAccountInfo Structure

```
<originalAccountInfo>
  <accType>Account Type</accType>
  <litleToken>Original Token Number</litleToken>
  <routingNum>Original Routing Number</routingNum>
</originalAccountInfo>
```

## 4.263 origAccountNumber

The `origAccountNumber` element is an optional child of the `queryTransaction` element and defines the account number of the credit/debit/gift card used in the original transaction.

---

---

**NOTE:** If you are performing a query for an eCheck transaction, do not use this element to designate the checking/savings account number. You should use this element for Credit/Debit/Gift card account numbers only.

---

---

Type = String; minLength = 13; maxLength = 25

**Parent Elements:**

[queryTransaction](#)

**Attributes:**

None

**Child Elements:**

None



## 4.264 origActionType

The `origActionType` element is a required child of the `queryTransaction` element and defines the transaction type of original transaction.

**Type** = String (Enum); **minLength** = 1; **maxLength** = 2 (Valid values shown below)

**Parent Elements:**

[queryTransaction](#)

**Attributes:**

None

**Child Elements:**

None

**Enumerations:**

Enumeration	Transaction Type
A	authorization
AR	activateReversal
D	deposit or sale
G	activate
I	unload
J	deactivate
L	load
LR	loadReversal
P	authReversal
R	credit
RR	refundReversal
S	echeckSale
T	echeckCredit
UR	unloadReversal
V	void
W	depositReversal

Enumeration	Transaction Type
X	echeckVoid

## 4.265 origId

The `origId` element is a required child of the `queryTransaction` element and defines the `id` attribute used in the original transaction.

**Type** = String; **minLength** = N/A; **maxLength** = 25

**Parent Elements:**

[queryTransaction](#)

**Attributes:**

None

**Child Elements:**

None

## 4.266 originalAmount

The `originalAmount` element is a required child of several gift card reversal transactions, as well as the `giftCardCapture` transaction, where it specifies the amount of the original gift card transaction. In the case of the `giftCardCapture` transaction, this is the amount associated with the authorization. In the case of a reversal transaction, it is the amount from the transaction you want to reverse. For example, for an `loadReversal` it specifies the amount from the `load` transaction.

**Type** = Integer; **totalDigits** = 6

### Parent Elements:

[activateReversal](#), [deactivateReversal](#), [depositReversal](#), [giftCardAuthReversal](#), [giftCardCapture](#), [loadReversal](#), [refundReversal](#), [unloadReversal](#)

### Attributes:

None

### Child Elements:

None

## 4.267 originalCard

The `originalCard` element is an optional child of the `accountUpdateResponse` element, which contains child elements providing the original information for the submitted card.

### Parent Elements:

[accountUpdateResponse](#)

### Attributes:

None

### Child Elements:

[type](#), [number](#), [expDate](#)

### Example: originalCard Structure

```
<originalCard>
  <type>Card Type</type>
  <number>Old Account Number</number>
  <expDate>Old Expiration Date</expDate>
</originalCard>
```

## 4.268 originalCardInfo

The `originalCardInfo` element is an optional child of the `accountUpdater` element, which contains child elements providing the original information for the submitted card.

### Parent Elements:

[accountUpdater](#)

### Attributes:

None

### Child Elements:

[type](#), [number](#), [expDate](#)

### Example: originalCard Structure

```
<originalCardInfo>
  <type>Card Type</type>
  <number>Old Account Number</number>
  <expDate>Old Expiration Date</expDate>
</originalCardInfo>
```

## 4.269 originalCardTokenInfo

The `originalCardTokenInfo` element is an optional child of the `accountUpdater` element, which contains child elements providing the original information for the submitted token.

### Parent Elements:

[accountUpdater](#)

### Attributes:

None

### Child Elements:

[littleToken](#), [type](#), [expDate](#), [bin](#)

### Example: originalCard Structure

```
<originalCardTokenInfo>
  <littleToken>Old Token</littleToken>
  <type>Card Type</type>
  <expDate>Old Expiration Date</expDate>
  <bin>Old Card BIN</bin>
</originalCardTokenInfo>
```

## 4.270 originalNetworkTransactionId

The `originalNetworkTransactionId` element is an optional child of the `authorization`, `captureGivenAuth`, and `sale` transactions. It defines the `networkTransactionId` returned in the response messages for Visa and Discover Auth/Sale transactions. You must include this element and the original value returned for subsequent (after the initial) Visa or Discover recurring/installment payments.

**Type** = String; **minLength** = N/A; **maxLength** = 30

---

---

**NOTE:** In the initial transaction of the recurring/installment stream, you must set the `processingType` element to either `initialRecurring` or `initialInstallment`, as applicable.

As of April 2017, if you fail to include this element/value for a recurring/installment Visa or Discover transaction, the card network rejects the transaction.

---

---

### Parent Elements:

[authorization](#), [captureGivenAuth](#), [sale](#)

### Attributes:

None

### Child Elements:

None



## 4.271 originalRefCode

The `originalRefCode` element is a required child of several gift card transactions, where it specifies the value returned in the `refCode` element of the associated `giftCardResponse` element of the response messages.

**Type** = String; **minLength** = N/A; **maxLength** = 6

### Parent Elements:

[activateReversal](#), [deactivateReversal](#), [depositReversal](#), [giftCardAuthReversal](#), [giftCardCapture](#), [loadReversal](#), [refundReversal](#), [unloadReversal](#),

### Attributes:

None

### Child Elements:

None

## 4.272 originalSequenceNumber

The `originalSequenceNumber` element is a required child of several gift card reversal transactions, where it specifies the value returned in the `sequenceNumber` element of the associated `giftCardResponse` element of the response messages.

**Type** = String; **totalDigits** = 6; **Allowed Characters**: 0 - 9

### Parent Elements:

[activateReversal](#), [deactivateReversal](#), [depositReversal](#), [giftCardAuthReversal](#), [loadReversal](#), [refundReversal](#), [unloadReversal](#),

### Attributes:

None

### Child Elements:

None

## 4.273 originalSystemTraceId

The `originalSystemTraceId` element is a required child of several gift card reversal transactions, where it specifies the value returned in the `systemTraceId` element of the associated `giftCardResponse` element from the response messages of the transaction you wish to reverse. For example, for a `loadReversal` transaction, you use the value returned in the `loadResponse` message.

**Type** = Integer; **totalDigits** = 6

### Parent Elements:

[activateReversal](#), [deactivateReversal](#), [depositReversal](#), [giftCardAuthReversal](#), [loadReversal](#), [refundReversal](#), [unloadReversal](#)

### Attributes:

None

### Child Elements:

None

## 4.274 originalToken

The `originalToken` element is an optional child of the `accountUpdateResponse` element, which contains child elements providing the original information for the submitted token.

### Parent Elements:

[accountUpdateResponse](#)

### Attributes:

None

### Child Elements:

[type](#), [number](#), [expDate](#), [bin](#)

### Example: originalCard Structure

```
<originalToken>
  <littleToken>Old Token Number</littleToken>
  <expDate>Old Expiration Date</expDate>
  <type>Card Type</type>
  <bin>Card BIN</bin>
</originalToken>
```

## 4.275 originalTokenInfo

The `originalTokenInfo` element is an optional child of the `accountUpdater` element, which contains child elements providing the original token information for the submitted account. The system returns this information when processing a tokenized eCheck transactions and a change (NOC) is found against the account.

### Parent Elements:

[accountUpdater](#)

### Attributes:

None

### Child Elements:

[accType](#), [litleToken](#), [routingNum](#)

### Example: originalAccountInfo Structure

```
<originalTokenInfo>
  <accType>Account Type</accType>
  <litletoken>Old Account Number</litletoken>
  <routingNum>Old Routing Number</routingNum>
</originalTokenInfo>
```

## 4.276 originalTransactionAmount

The `originalTransactionAmount` element is an optional child of the `authorization`, `captureGivenAuth`, and `sale` transactions. It defines the amount from the initial transaction in a recurring/installment stream. You must include this element and the original amount in subsequent (after the initial) recurring/installment payments, if the payment method is Discover. You must also include the `originalNetworkTransactionId` element using the value from the `networkTransactionId` element returned in the initial transaction of the stream.

---

---

**NOTE:** In the initial transaction of the recurring/installment stream, you must set the `processingType` element to either `initialRecurring` or `initialInstallment`, as applicable.

As of April 2017, if you fail to include this element/value for a recurring/installment Discover transaction, the card network rejects the transaction.

---

---

**Type** = Integer; **totalDigits** = 12

**Parent Elements:**

[authorization](#), [captureGivenAuth](#), [sale](#)

**Attributes:**

None

**Child Elements:**

None

## 4.277 originalTxnTime

The `originalTxnTime` element is a required child of several gift card transactions, which specifies the date and time the original transaction was processed by Vantiv. The system returns this value in the `txnTime` child of the `giftCardResponse` element. The format of the element is YYYY-MM-DDTHH:MM:SS. For example, 2016-11-21T11:00:00.

**Type** = dateTime; **minLength** = N/A; **maxLength** = 20

### Parent Elements:

[activateReversal](#), [deactivateReversal](#), [depositReversal](#), [giftCardAuthReversal](#), [giftCardCapture](#), [loadReversal](#), [refundReversal](#), [unloadReversal](#)

### Attributes:

None

### Child Elements:

None

## 4.278 origLittleTxnId

The `origLittleTxnId` element is an optional child of the `queryTransaction` element and defines the value of the `littleTxnId` element assigned to the original transaction and returned in the response message.

**Type** = Long; **minLength** = N/A; **maxLength** = 19

### Parent Elements:

[queryTransaction](#)

### Attributes:

None

### Child Elements:

None



## 4.279 origOrderId

The `origOrderId` element is an optional child of the `queryTransaction` element and defines the merchant-assigned value for the `orderId` element submitted in the original transaction.

**Type** = String; **minLength** = N/A; **maxLength** = 25

**Parent Elements:**

[queryTransaction](#)

**Attributes:**

None

**Child Elements:**

None

## 4.280 password

The `password` element is a required child of the `authentication` element. It is used in combination with the `user` element to authenticate that the message is from a valid source.

**Type** = String; **minLength** = N/A; **maxLength** = 20

**Parent Elements:**

[authentication](#)

**Attributes:**

None

**Child Elements:**

None

## 4.281 payerId

The `payerId` element is a required child of the `paypal` element for all cases except for an Online Credit transaction, where you can choose between this element and the `payerEmail` element. This element specifies the Payer Id returned from PayPal.

---

---

**NOTE:** The value of the `<payerId>` element must match the PAYERID value returned by the `GetExpressCheckout` call operation to PayPal.

---

---

Type = String; minLength = 1; maxLength = 17

### Parent Elements:

[paypal](#)

### Attributes:

None

### Child Elements:

None

## 4.282 payFacCredit

The `payFacCredit` element is the parent element for the transaction type that a PayFac uses to distribute funds to themselves (i.e., from the PayFac Settlement Account to the PayFac Operating Account). If you use V11.3 or above, you can submit this transaction type either in a Batch or Online.

---

**NOTE:** You can submit funding instructions either Online or via Batch files, but not both. The two methodologies are mutually exclusive for funding instruction submissions.

---

### Parent Elements:

[batchRequest](#), [litleOnlineRequest](#)

### Attributes:

Attribute Name	Type	Required?	Description
id	String	Yes	A unique identifier assigned by the presenter and mirrored back in the response. <b>minLength = 1    maxLength = 36</b>
customerId	String	No	A value assigned by the merchant to identify the consumer. <b>minLength = N/A    maxLength = 50</b>
reportGroup	String	Yes	For PayFacs, this attribute does not segregate transactions in iQ. This field does appear in various SSR reports. <b>minLength = 1    maxLength = 25</b>
duplicate	boolean	No	If the request is a duplicate, the response includes the duplicate flag set to <b>true</b> and the entire original response. <b>Note:</b> This attribute applies only to Online Dynamic Payout Funding Instruction responses.

### Child Elements:

Required: [amount](#), [fundingSubmerchantId](#), [fundsTransferId](#)

## 4.283 payFacCreditResponse

The `payFacCreditResponse` element is the parent element for information returned to you in response to a `payFacCredit` transaction.

### Parent Elements:

[batchResponse](#), [litleOnlineResponse](#)

### Attributes:

Attribute Name	Type	Required?	Description
id	String	Yes	The response returns the same value submitted in the <code>payFacCredit</code> transaction. <b>minLength = 1    maxLength = 36</b>
customerId	String	No	The response returns the same value submitted in the <code>payFacCredit</code> transaction. <b>minLength = N/A    maxLength = 50</b>
reportGroup	String	Yes	The response returns the same value submitted in the <code>payFacCredit</code> transaction. <b>minLength = 1    maxLength = 25</b>

### Child Elements:

Required: [litleTxnId](#), [fundsTransferId](#), [response](#), [responseTime](#), [message](#)

Required (Online): [postDate](#)

## 4.284 payFacDebit

The `payFacDebit` element is the parent element for the transaction type that a PayFac uses to move funds from the PayFac Operating Account back to the PayFac Settlement Account. If you use V11.3 or above, you can submit this transaction type either in a Batch or Online.

---

**NOTE:** You can submit funding instructions either Online or via Batch files, but not both. The two methodologies are mutually exclusive for funding instruction submissions.

---

### Parent Elements:

[batchRequest](#), [litleOnlineRequest](#)

### Attributes:

Attribute Name	Type	Required?	Description
id	String	Yes	A unique identifier assigned by the presenter and mirrored back in the response. <b>minLength = 1    maxLength = 36</b>
customerId	String	No	A value assigned by the merchant to identify the consumer. <b>minLength = N/A    maxLength = 50</b>
reportGroup	String	Yes	For PayFacs, this attribute does not segregate transactions in iQ. This field does appear in various SSR reports. <b>minLength = 1    maxLength = 25</b>
duplicate	boolean	No	If the request is a duplicate, the response includes the duplicate flag set to <b>true</b> and the entire original response. <b>Note:</b> This attribute applies only to Online Dynamic Payout Funding Instruction responses.

### Child Elements:

Required: [amount](#), [fundingSubmerchantId](#), [fundsTransferId](#)

## 4.285 payFacDebitResponse

The `payFacDebitResponse` element is the parent element for information returned to you in response to a `payFacDebit` transaction.

### Parent Elements:

[batchRequest](#), [litleOnlineResponse](#)

### Attributes:

Attribute Name	Type	Required?	Description
id	String	Yes	The response returns the same value submitted in the <code>payFacCredit</code> transaction. <b>minLength = 1    maxLength = 36</b>
customerId	String	No	The response returns the same value submitted in the <code>payFacDebit</code> transaction. <b>minLength = N/A    maxLength = 50</b>
reportGroup	String	Yes	The response returns the same value submitted in the <code>payFacCredit</code> transaction. <b>minLength = 1    maxLength = 25</b>

### Child Elements:

Required: [litleTxnId](#), [fundsTransferId](#), [response](#), [responseTime](#), [message](#)

Required (Online): [postDate](#)

## 4.286 paymentDataType

The `paymentDataType` element is an optional child of the `applepayResponse` element and specifies data type of the payment data associated with an Apple Pay transaction.

**Type** = String; **minLength** = N/A; **maxLength** = 20

**Parent Elements:**

[applepayResponse](#)

**Attributes:**

None

**Child Elements:**

None



## 4.287 paymentPurpose

The `paymentPurpose` element is an optional child of the `idealResponse` and `giropayResponse` elements where it specifies information (equivalent of Bill Descriptor for a credit card transaction) that appears on the consumer bank statement along with a reference string representing the transaction. The value has two components. The first part is a reference number assigned to the transaction. The second part is a default merchant descriptor established during implementation.

**Type** = String; **minLength** = N/A; **maxLength** = 256

### Parent Elements:

[idealResponse](#), [giropayResponse](#)

### Attributes:

None

### Child Elements:

None

## 4.288 paypage

The `paypage` element defines eProtect account information. It replaces the `card` or `token` elements in transactions using the eProtect feature of the Vault solution. When you submit the `paypage` element in a request, response messages will include token information.

### Parent Elements:

[authorization](#), [captureGivenAuth](#), [credit](#), [forceCapture](#), [sale](#), [updateSubscription](#), [fastAccessFunding](#)

### Attributes:

None

### Child Elements:

Required: [paypageRegistrationId](#)

Optional: [expDate](#), [cardValidationNum](#), [type](#)

---

**NOTE:** Although the schema defines the `expDate` element as an optional child of the `paypage` element, you must submit a value for card-not-present transactions.

---

### Example: Example: paypage Structure

```
<paypage>
  <paypageRegistrationId>Registration ID from eProtect</paypageRegistrationId>
  <expDate>Expiration Date</expDate>
  <cardValidationNum>Card Validation Number</cardValidationNum>
  <type>Method of Payment</type>
</paypage>
```

## 4.289 paypageRegistrationId

The `paypageRegistrationId` element is a required child of the `paypage` element, and specifies the Registration ID generated by `securepaypage.little.com` (eProtect). You can also use it in a Register Token Request to obtain a token based on eProtect activity prior to submitting an Authorization or Sale transaction.

**Type** = String; **minLength** = N/A; **maxLength** = 512

### Parent Elements:

[paypage](#), [registerTokenRequest](#)

### Attributes:

None

### Child Elements:

None

## 4.290 paypal

The `paypal` element defines paypal account information. It replaces the card or token elements in transactions using PayPal as a payment method.

### Parent Elements:

[authorization](#), [sale](#)

### Attributes:

None

### Child Elements:

Required: [payerId](#), [transactionId](#)

Optional: [token](#)

### Example: paypal Structure

```
<paypal>
  <payerId>PayPal Customer Identifier</payerId>
  <token>Token Value Returned</token>
  <transactionId>PayPal Transaction ID</transactionId>
</paypal>
```

## 4.291 payPalNotes

The `payPalNotes` element is an optional child of multiple transaction types. You use this field to record additional information about the PayPal transaction.

**Type** = String; **Type** = String; **minLength** = N/A; **maxLength** = 255

**Parent Elements:**

[authReversal](#), [capture](#), [credit](#), [sale](#)

**Attributes:**

None

**Child Elements:**

None

## 4.292 paypalOrderComplete

The `paypalOrderComplete` element is an optional child of both the `capture` and `sale` elements, but is required to close a PayPal order. Set the value to **true** to close the order, when you have fulfilled the order and do not need to send any further auths or deposits against it. Set the value to **false** to keep the order open for additional auths or deposits.

**Type** = Boolean; **Valid values** = true or false

### Parent Elements:

[capture](#), [sale](#)

### Attributes:

None

### Child Elements:

None

## 4.293 phone

The `phone` element has two different uses in cnpAPI depending upon the parent element. When used as a child of either the `billToAddress` or `shipToAddress` elements, it defines the customer's phone number. When used as a child of the `customBilling` element, it defines the phone number of the merchant.

### 4.293.0.1 phone as a child of `billToAddress` and `shipToAddress`

The `phone` element defines the customer's phone number in both the `billToAddress` and `shipToAddress` elements.

---

---

**NOTE:** When submitting an eCheck Verification, the string can only contain numbers (0 through 9). Letters and special characters are not allowed.

---

---

**Type** = String; **minLength** = N/A; **maxLength** = 20

**Parent Elements:**

[billToAddress](#), [shipFromPostalCode](#)

**Attributes:**

None

**Child Elements:**

None

### 4.293.0.2 phone as a child of `customBilling`

The `phone` element defines the merchant's phone number. The string can only contain numbers (0 through 9). Letters and special characters are not allowed.

**Type** = String; **minLength** = N/A; **maxLength** = 13

**Parent Elements:**

[customBilling](#)

**Attributes:**

None

**Child Elements:** None

## 4.294 physicalCheckCredit

The `physicalCheckCredit` element is the parent element for the transaction type that a PayFac uses to distribute funds to a third party who issues physical checks on the PayFacs behalf. (i.e., from the PayFac Settlement Account to the Third Party Account). If you use V11.3 or above, you can submit this transaction type either in a Batch or Online.

---

**NOTE:** You can submit funding instructions either Online or via Batch files, but not both. The two methodologies are mutually exclusive for funding instruction submissions.

---

### Parent Elements:

[batchRequest](#), [litleOnlineRequest](#)

### Attributes:

Attribute Name	Type	Required?	Description
id	String	Yes	A unique identifier assigned by the presenter and mirrored back in the response. <b>minLength = 1    maxLength = 36</b>
customerId	String	No	A value assigned by the merchant to identify the consumer. <b>minLength = N/A    maxLength = 50</b>
reportGroup	String	Yes	For PayFacs, this attribute does not segregate transactions in iQ. This field does appear in various SSR reports. <b>minLength = 1    maxLength = 25</b>
duplicate	boolean	No	If the request is a duplicate, the response includes the duplicate flag set to <b>true</b> and the entire original response. <b>Note:</b> This attribute applies only to Online Dynamic Payout Funding Instruction responses.

### Child Elements:

Required: [amount](#), [fundingSubmerchantId](#), [fundsTransferId](#)



## 4.295 physicalCheckCreditResponse

The `physicalCheckCreditResponse` element is the parent element for information returned to you in response to a `physicalCheckCredit` transaction.

### Parent Elements:

[batchResponse](#), [litleOnlineResponse](#)

### Attributes:

Attribute Name	Type	Required?	Description
id	String	Yes	The response returns the same value submitted in the <code>physicalCheckCredit</code> transaction. <b>minLength = 1    maxLength = 36</b>
customerId	String	No	The response returns the same value submitted in the <code>physicalCheckCredit</code> transaction. <b>minLength = N/A    maxLength = 50</b>
reportGroup	String	Yes	The response returns the same value submitted in the <code>physicalCheckCredit</code> transaction. <b>minLength = 1    maxLength = 25</b>

### Child Elements:

Required: [litleTxnId](#), [fundsTransferId](#), [response](#), [responseTime](#), [message](#)

Required (Online): [postDate](#)

## 4.296 physicalCheckDebit

The `physicalCheckDebit` element is the parent element for the transaction type that a PayFac uses to move funds from a third party who issues physical checks on the PayFac's behalf. (i.e., from the Third Party Account to the PayFac Settlement Account). If you use V11.3 or above, you can submit this transaction type either in a Batch or Online.

---

**NOTE:** You can submit funding instructions either Online or via Batch files, but not both. The two methodologies are mutually exclusive for funding instruction submissions.

---

### Parent Elements:

[batchRequest](#), [litleOnlineRequest](#)

### Attributes:

Attribute Name	Type	Required?	Description
id	String	Yes	A unique identifier assigned by the presenter and mirrored back in the response. <b>minLength = 1    maxLength = 36</b>
customerId	String	No	A value assigned by the merchant to identify the consumer. <b>minLength = N/A    maxLength = 50</b>
reportGroup	String	Yes	For PayFacs, this attribute does not segregate transactions in iQ. This field does appear in various SSR reports. <b>minLength = 1    maxLength = 25</b>
duplicate	boolean	No	If the request is a duplicate, the response includes the duplicate flag set to <b>true</b> and the entire original response. <b>Note:</b> This attribute applies only to Online Dynamic Payout Funding Instruction responses.

### Child Elements:

Required: [amount](#), [fundingSubmerchantId](#), [fundsTransferId](#)

## 4.297 physicalCheckDebitResponse

The `physicalCheckDebitResponse` element is the parent element for information returned to you in response to a `physicalCheckDebit` transaction.

### Parent Elements:

[batchResponse](#), [litleOnlineResponse](#)

### Attributes:

Attribute Name	Type	Required?	Description
id	String	Yes	The response returns the same value submitted in the <code>physicalCheckDebit</code> transaction. <b>minLength = 1    maxLength = 36</b>
customerId	String	No	The response returns the same value submitted in the <code>physicalCheckDebit</code> transaction. <b>minLength = N/A    maxLength = 50</b>
reportGroup	String	Yes	The response returns the same value submitted in the <code>physicalCheckDebit</code> transaction. <b>minLength = 1    maxLength = 25</b>

### Child Elements:

Required: [litleTxnId](#), [fundsTransferId](#), [response](#), [responseTime](#), [message](#)

Required (Online): [postDate](#)

## 4.298 pin

The `pin` element is an optional child of the several transaction types, as well as the `card` element. It only applies to transactions involving closed-loop Gift Cards and defines the pin number associated with the Gift Card.

**Type** = String; **minLength** = 4; **maxLength** = 12

**Parent Elements:**

`capture`, `card`, `credit`, `virtualGiftCardResponse`

**Attributes:**

None

**Child Elements:**

None

## 4.299 planCode

The `planCode` element is the identifier of a defined recurring payment plan. You use it to specify the payment plan when submitting a recurring transaction to the Recurring Engine. For example, there could be a define plan called **Monthly** that instructs the Recurring Engine to bill the consumer the same amount every month for the number of months defined by the `numberOfPayments` element. This element is a required child of the `subscription` element.

**Type** = String; **minLength** = N/A; **maxLength** = 25

### Parent Elements:

[subscription](#), [updateSubscription](#), [createPlan](#), [updatePlan](#), [updatePlanResponse](#)

### Attributes:

None

### Child Elements:

None

## 4.300 pos

The `pos` element contains child elements used to specify information required when submitting authorization, `captureGivenAuth`, `credit`, `forceCapture`, and `sale` transactions from point of sale terminals.

### Parent Elements:

[authorization](#), [captureGivenAuth](#), [credit](#), [forceCapture](#), [sale](#)

### Attributes:

None

### Child Elements:

[capability](#), [entryMode](#), [cardholderId](#), [terminalId](#), [catLevel](#)

### Example: pos Structure

```
<pos>
  <capability>Capabilty Enumeration</capability>
  <entryMode>Entry Mode Enumeration</entryMode>
  <cardholderId>Cardholder ID Enumeration</cardholderId>
  <terminalId>1234567890</terminalId>
  <catLevel>Capabilty of CAT Terminal</catLevel>
</pos>
```

---

---

**NOTE:** For CAT (Cardholder Activated Terminal) transactions, the `capability` element must be set to `magstripe`, the `cardholderId` element must be set to `nopin`, and the `catLevel` element must be set to `self service`.

---

---

## 4.301 postDate

The `postDate` element defines the date the transaction was posted. The format is YYYY-MM-DD. It occurs only in response to Online transactions.

---

---

**NOTE:** Although the schema defines this element as optional in most response messages, the system returns it in the response for all Online transactions.

---

---

**Type** = Date; **minLength** = N/A; **maxLength** = 10

### Parent Elements:

[activateResponse](#), [activateReversalResponse](#), [authorizationResponse](#), [authReversalResponse](#), [captureResponse](#), [captureGivenAuthResponse](#), [creditResponse](#), [deactivateResponse](#), [deactivateReversalResponse](#), [depositReversalResponse](#), [echeckCreditResponse](#), [echeckSalesResponse](#), [echeckVerificationResponse](#), [forceCaptureResponse](#), [loadResponse](#), [loadReversalResponse](#), [refundReversalResponse](#), [saleResponse](#), [unloadResponse](#), [unloadReversalResponse](#), [voidResponse](#), [fastAccessFundingResponse](#), [payFacCreditResponse](#), [payFacDebitResponse](#), [physicalCheckCreditResponse](#), [physicalCheckDebitResponse](#), [reserveCreditResponse](#), [reserveDebitResponse](#), [submerchantCreditResponse](#), [submerchantDebitResponse](#), [vendorCreditResponse](#), [vendorDebitResponse](#)

### Attributes:

None

### Child Elements:

None

## 4.302 postDay

The `postDay` element is an optional child of the `accountUpdateFileRequestData` element that defines the date you submitted the Account Updater request. The format is YYYY-MM-DD.

---

---

**NOTE:** This is also the same date that the system created the Account Updater acknowledgment file.

---

---

**Type** = Date; **minLength** = N/A; **maxLength** = 10

**Parent Elements:**

[accountUpdateFileRequestData](#)

**Attributes:**

None

**Child Elements:**

None



## 4.303 preapprovalNumber

The `preapprovalNumber` element is an optional child of the `billMeLaterRequest` element, which you use to specify the pre-approval number issued by PayPal Credit. If you include this element, the value must be 16 digits in length. Do not include this element to indicate there is no pre-approval. Internal pre-approval is indicated by using 1 as the first digit.

---

---

**NOTE:** As of September, 2016, the Vantiv eCommerce platform no longer supports PayPal Credit for new merchants or existing merchants not already using this payment method. Existing merchants already using PayPal Credit should consult their Vantiv Relationship Manager.

---

---

Type = String; minLength = 13; maxLength = 25

### Parent Elements:

[billMeLaterRequest](#)

### Attributes:

None

### Child Elements:

None

## 4.304 preferredLanguage

The `preferredLanguage` element is an optional child of the `sepaDirectDebit` element. This defines the language in which the merchant prefers the mandate to appear. While the merchant could be able to select any language, the mandate may not be available in the selected language. If the selected language is not available, the mandate appears in English. If you do not include this element, the preferred language defaults to the language indicated by the country of the IBAN, unless it is not available, in which case the language defaults to English.

**Type** = String (Enum); **minLength** = N/A; **maxLength** = 3

---

---

**NOTE:** The enumerations for this element are listed under `<countryTypeEnum>` in the cnpAPI Common XSD. The country names corresponding to the abbreviations can be found in the ISO 3166-1 standard.

All Country Codes are 2-character except for the United States, which accepts both US and USA.

---

---

### Parent Elements:

[sepaDirectDebit](#), [ideal](#), [giropay](#)

### Attributes:

None

### Child Elements:

None

## 4.305 prepaid

The `prepaid` element is an optional child of the `filtering` element. How you choose to implement the Prepaid Filtering feature determines the use of the `prepaid` element. If your configuration filters all prepaid card transactions, you can disable the feature on selected transactions by including the `prepaid` element with a setting of **false**. If your configuration filters prepaid card transactions on a per transaction basis, you enable the filtering on a selected transaction by including the `prepaid` element with a setting of **true**.

**Type** = Boolean; **Valid Values** = true or false

### Parent Elements:

[filtering](#)

### Attributes:

None

### Child Elements:

None

## 4.306 prepaidCardType

The `prepaidCardType` element is an optional child of the `enhancedAuthResponse` element, which specifies the type of prepaid card submitted in the Authorization or Sale transaction. For example, a few of the possible values are: GIFT, PAYROLL, and GENERAL\_PREPAID

**Type** = String; **minLength** = N/A; **maxLength** = 50

**Parent Elements:**

[fundingSource](#)

**Attributes:**

None

**Child Elements:**

None

## 4.307 processingInstructions

The `processingInstructions` element contains a child element that allows you to specify whether or not the system performs velocity checking on the transaction.

### Parent Elements: (optional for all)

[authorization](#), [capture](#), [captureGivenAuth](#), [credit](#), [forceCapture](#), [sale](#), [void](#)

### Attributes:

None

### Child Elements:

[bypassVelocityCheck](#)

---

---

**NOTE:** Please consult your Relationship Manager for additional information concerning Velocity Checking.

---

---

### Example: processingInstructions Structure

```
<processingInstructions>
  <bypassVelocityCheck>true or false</bypassVelocityCheck>
</processingInstructions>
```

## 4.308 processingType

The `processingType` element is an optional child of several transaction types. You use this element to define a Visa transaction is intended to fund a host-based prepaid product, a brokerage account, or an escrow account. For Visa and Discover transactions, you also use it to define the initial transaction in a recurring or installment stream, or the initial, merchant initiated, or cardholder initiated Card on file transaction. For these cases, you must store the value of the `networkTransactionId` element returned in the response message. You use this value to populate the `originalNetworkTransactionId` element in subsequent recurring/installment or CoF transactions, so the networks can tie back to the original approval.

**Type** = String (Enum); **minLength** = N/A; **maxLength** = N/A

### Parent Elements:

[authorization](#), [captureGivenAuth](#), [forceCapture](#), [sale](#)

### Attributes:

None

### Child Elements:

None

### Enumerations:

Enum	Description
accountFunding	Use this value to define a Visa transaction is intended to fund a host-based prepaid product, a brokerage account, or an escrow account.
initialRecurring	Use this value to specify the first in a series of recurring payments for Visa or Discover transactions.
initialInstallment	Use this value to specify the first in a series of installment payments for Visa or Discover transactions.
initialCOF	Use this value to specify an initial Card on File transaction. (Used for Visa only at this time.)
merchantInitiated COF	Use this value to specify a merchant initiated Card on File transaction after the initial CoF transaction. (Used for Visa only at this time.)
cardholderInitiated COF	Use this value to specify a cardholder initiated Card on File transaction after the initial CoF transaction. (Used for Visa only at this time.)

## 4.309 productCode

The `productCode` element is an optional child of the `lineItemData` element, which specifies the product code of the purchased item. This value is a merchant defined description code of the product/service. This could be an inventory number, UPC, catalog number, or some other value that the merchant uses to define the specific product. Although an optional element, it is required by Visa and MasterCard when specifying line item data.

**Type** = String; **minLength** = 1; **maxLength** = 12

### Parent Elements:

[lineItemData](#)

### Attributes:

None

### Child Elements:

None

## 4.310 publicKeyHash

The `publicKeyHash` element is a required child of the `header` element and provides the BASE64 Encoded string that is a hash of the merchant's certificate public key bytes associated with the Apple Pay transaction.

**Type** = Base 64 Encoded String; **minLength** = N/A; **maxLength** = 200

### Parent Elements:

[header](#)

### Attributes:

None

### Child Elements:

None



## 4.311 quantity

The `quantity` element is an optional child of the `lineItemData` element, which specifies the number of items purchased. Although an optional element, it is required by Visa and MasterCard when specifying line item data. The value must be greater than zero, but no more than 12 digits not including the decimal point.

---

---

**NOTE:** If you accidentally omit the `quantity` element, our system will submit the transaction using a default value of 1.

---

---

**Type** = Decimal; **minInclusive** = 0; **totalDigits** = 12

**Parent Elements:**

[lineItemData](#)

**Attributes:**

None

**Child Elements:**

None

## 4.312 queryTransaction

The `queryTransaction` element is the parent element for Query transactions. You use this transaction type to determine the status of a previously submitted transaction. You can submit this element only as an Online transaction.

### Parent Elements:

[litleOnlineRequest](#)

### Attributes:

Attribute Name	Type	Required?	Description
id	String	Yes	A unique identifier assigned by the presenter and mirrored back in the response. <b>minLength = 1    maxLength = 36</b>
customerId	String	No	A value assigned by the merchant to identify the consumer. <b>minLength = N/A    maxLength = 50</b>
reportGroup	String	Yes	Required attribute that defines the merchant sub-group in the user interface where this transaction will be displayed. Please refer to <a href="#">Coding for Report Groups</a> on page 10 for additional information. <b>minLength = 1    maxLength = 25</b>

### Child Elements:

Required: [origId](#), [origActionType](#)

Optional: [origLitleTxnId](#), [origOrderId](#), [origAccountNumber](#)

## 4.313 queryTransactionResponse

The `queryTransactionResponse` element is the parent element for the response to `queryTransaction` requests.

### Parent Elements:

[litleOnlineResponse](#)

### Attributes:

Attribute Name	Type	Required?	Description
id	String	Yes	The response returns the same value submitted in the capture transaction. <b>minLength = 1    maxLength = 36</b>
customerId	String	No	The response returns the same value submitted in the capture transaction. <b>minLength = N/A    maxLength = 50</b>
reportGroup	String	Yes	The response returns the same value submitted in the capture transaction. <b>minLength = 1    maxLength = 25</b>

### Child Elements:

All Required: [response](#), [responseTime](#), [message](#), [matchCount](#), [results\\_Max10](#)

## 4.314 queryTransactionUnavailableResponse

The `queryTransactionUnavailableResponse` element is an optional child of the `results_Max10` element. If the query results is a response code of 152 - Transaction found, but response not yet available, the `results_Max10` element will contain at least one `queryTransactionUnavailableResponse` child (see example *results\_Max10 Element for 152 Response Code*).

**Parent Elements:**

[results\\_Max10](#)

**Attributes:**

None

**Child Elements:**

All Required: [litleTxnId](#), [response](#), [message](#)

## 4.315 recurringRequest

The `recurringRequest` element is the parent of several child element that define the number of payments and plan type of recurring transaction to be handled by the Recurring Engine. It is an optional child of the Authorization and Sale transactions.

### Parent Elements:

[authorization](#), [sale](#)

### Attributes:

None

### Child Elements:

[subscription](#)

### Example: recurringRequest Structure

```
<recurringRequest>
  <subscription>
    <planCode>Plan Reference Code</planCode>
    <numberOfPayments>1 to 99</numberOfRemianingPayments>
    <startDate>Start Date of Recurring Cycle</startDate>
    <amount>Amount of Recurring Payment</amount>
  </subscription>
</recurringRequest>
```

## 4.316 recurringResponse

The `recurringResponse` element is the parent element for the `subscriptionId`, `responseCode`, `responseMessage`, and `recurringTxnId` elements associated with a requested recurring payment. The system returns this element only when the `sale` transaction includes a `recurringRequest` element.

### Parent Elements:

[authorizationResponse](#), [saleResponse](#)

### Attributes:

None

### Child Elements:

[subscriptionId](#), [responseCode](#), [responseMessage](#), [recurringTxnId](#)

### Example: recurringResponse Structure

```
<recurringResponse>
  <subscriptionId>1234567890</subscriptionId>
  <responseCode>Response Code</responseCode>
  <responseMessage>Response Message</responseMessage>
</recurringResponse>
```

## 4.317 recurringTxnId

The `recurringTxnId` element is an optional child of the `recurringResponse` element used to identify the record of recurring, scheduled transactions.

**Type** = Long; **minLength** = N/A; **maxLength** = 19

### Parent Elements:

[recurringResponse](#), [littleInternalRecurringRequest](#)

---

---

**NOTE:** Although the element is an optional child of the `recurringResponse` element, it will never be returned in the response to a merchant initiated transaction.

---

---

### Attributes:

None

### Child Elements:

None

## 4.318 recycleAdvice

---

---

**NOTE:** The recycling Advice feature is no longer supported.

---

---

The `recyclingAdvice` element contains a two child elements that either specifies the date and time (in GMT) recommended for the next recycle of the declined Authorization/Sale transaction or indicates that there is no additional recycling advice. The two children are mutually exclusive.

### Parent Elements: (optional for all)

[recycling](#)

### Attributes:

None

### Child Elements:

[nextRecycleTime](#), [recycleAdviceEnd](#)

---

---

**NOTE:** The `recycleAdvice` element contains either a `nextRecycleTime` or `recycleAdviceEnd` element, but not both.

---

---

### Example: recycleAdvice Structure - with recommended Date:Time

```
<recycleAdvice>
  <nextRecycleTime>2016-11-15T12:00:00</nextRecycleTime>
</recycleAdvice>
```

### Example: recycleAdvice Structure - with end message

```
<recycleAdvice>
  <recycleAdviceEnd>End of Advice</recycleAdviceEnd>
</recycleAdvice>
```



## 4.319 recycleAdviceEnd

---

---

**NOTE:** The recycling Advice feature is no longer supported.

---

---

The recycleAdviceEnd element is an optional child of the recycleAdvice element and signifies that no further recycling recommendations are available.

**Type** = String; **minLength** = N/A; **maxLength** = 20

**Parent Elements:**

[recycleAdvice](#)

**Attributes:**

None

**Child Elements:**

None

## 4.320 recycleBy

The `recycleBy` element is an optional child of the `recyclingRequest` element and determines the use of the Recycling Engine. The default setting is `Little`, so omitting this element is the same as submitting a value of `Little`.

---

**NOTE:** Also, if your Merchant Profile includes a preset percentage split of transactions between merchant and Vantiv controlled, then settings of `Merchant` and `Little` are ignored; you can still use a setting of `None` to exclude the transaction.

Also, although the default setting is normally `Little`, it can be altered in your merchant profile to a setting of `Merchant`.

---

Type = String (Enum); `minLength` = N/A; `maxLength` = N/A

### Parent Elements:

[recyclingRequest](#)

### Attributes:

None

### Child Elements:

None

### Enumerations:

Enum	Description
Merchant	This setting indicates that the merchant controls the recycling of the transaction. For A/B comparison testing, transactions using this setting will be counted as merchant controlled. After setting this value in the initial transaction, subsequent transactions should have same value. Any different value will be ignored.
Little	This setting indicates either that the Recycling Engine controls the recycling of the transaction. For A/B comparison testing, transactions using this setting will be counted as Vantiv controlled. After setting this value in the initial transaction, subsequent transactions should have same value. Any different value will be ignored.
None	For A/B comparison testing, transactions using this setting are excluded from all counts. These transactions will not be counted as either merchant or Vantiv controlled.

## 4.321 recycleEngineActive

The `recycleEngineActive` element is an optional child of the `recycling` element that indicates whether or not the engine is recycling the declined transaction. This element is returned only if you are using the Recycling Engine.

**Type** = Boolean; **Valid values** = true or false

**Parent Elements:**

[recycling](#)

**Attributes:**

None

**Child Elements:**

None

## 4.322 recycleId

The `recycleId` element is an optional child of the `recyclingRequest` element. Merchants can use this identifier as part of the transaction signature used to track the recycling of a transaction. This element is an alternative to using the `orderId` element as part of the transaction signature.

**Type** = String; **minLength** = N/A; **maxLength** = 25

### Parent Elements:

[recyclingRequest](#)

### Attributes:

None

### Child Elements:

None

## 4.323 recycling

The `recycling` element has two uses in the cnpAPI depending upon the parent. When used as a child of either the `authorizationResponse` or `saleResponse` elements, the `recycling` element contains a child element that specifies whether or not the engine is recycling the declined transaction.

When used as a child of the `voidResponse`, the `recycling` element contains a child providing the Transaction Id of the Credit transaction issued. This occurs only if a Void transaction is used to halt the recycling of a transaction by the recycling engine and the transaction has already been approved and captured (see [Using Void to Halt Recycling Engine](#) on page 86).

### 4.323.1 recycling Element as a Child of `authorizationResponse` or `saleResponse`

The `recycling` element contains child elements indicating that the Recycling Engine is active.

**Parent Elements:**

[authorizationResponse](#), [saleResponse](#)

**Attributes:**

None

**Child Elements:**

[recycleAdvice](#), [recycleEngineActive](#)

---

---

**NOTE:** The recycling Advice feature is no longer supported.

---

---

**Example:** recycling Structure - with engine active flag

```
<recycling>
  <recycleEngineActive>true or false</recycleEngineActive>
</recycling>
```

### 4.323.2 recycling Element as a Child of `voidResponse`

The `recycling` element in an optional child of the `voidResponse` element and contains a child providing the Transaction Id of the Credit transaction issued. This element is present in the Void response only under the following circumstances (see [Using Void to Halt Recycling Engine](#) on page 86):

- You submitted a Void transaction to halt the recycling of a declined Sale transaction by the Recovery/Recycling Engine.
- The Sale transaction has already been approved and captured.
- Your Recovery/Recycling Engine configuration enables automatic refunds.
- The system has successfully submitted a Credit transaction on your behalf.

**Parent Elements:**[voidResponse](#)**Attributes:**

None

**Child Elements:**[creditLittleTxnId](#)**Example: recycling Structure - child of voidResponse**

```
<recycling>
  <creditLittleTxnId>1234567890123456789</creditLittleTxnId>
</recycling>
```

## 4.324 recyclingRequest

The `recyclingrequest` element is an optional child of the `authorization` and `sale` transactions, which contains a child element that specifies who is responsible for recycling the transaction. It also contains an optional element for an identifier assigned by the merchant to track the recycling of the transaction. This element only applies to merchants using the Recycling Engine.

### Parent Elements:

[authorization](#), [sale](#)

### Attributes:

None

### Child Elements:

[recycleBy](#), [recycleId](#)

### Example: recyclingRequest Structure

```
<recyclingRequest>
  <recycleBy>Merchant or Little or None</recycleBy>
  <recycleId>abcdef1234567890</recycleId>
</recyclingRequest>
```

## 4.325 redirectToken

The `redirectToken` element is an optional child of the `sepaDirectDebitResponse`, `idealResponse`, and `giropayResponse` elements. It allows you to verify that the consumer accepted the Mandate by comparing it to the `token_value` parameter returned in the URL upon redirect from the Mandate site.

**Type** = String; **minLength** = N/A; **maxLength** = 128

**Parent Elements:**

[sepaDirectDebitResponse](#), [idealResponse](#), [giropayResponse](#)

**Attributes:**

None

**Child Elements:**

None



## 4.326 redirectUrl

The `redirectUrl` element is an optional child of the `sepaDirectDebit` element and defines the URL that hosts the mandate, when Vantiv supplies the mandate. If you supply the mandate (`<mandateProvider>Merchant</mandateProvider>`), this element will not appear in the response.

**Type** = String; **minLength** = N/A; **maxLength** = 256

### Parent Elements:

[sepaDirectDebitResponse](#), [idealResponse](#), [giropayResponse](#)

### Attributes:

None

### Child Elements:

None

## 4.327 refCode

The `refCode` element is an optional child of the `giftCardResponse` element, where it specifies the authorization code of the gift card transaction.

**Type** = String; **minLength** = N/A; **maxLength** = 6

**Parent Elements:**

[giftCardResponse](#)

**Attributes:**

None

**Child Elements:**

None

## 4.328 refundReversal

The `refundReversal` element is the parent element for a Gift Card specific transaction type that reverses the a refund associated with a Gift Card.

### Parent Elements:

[litleOnlineRequest](#)

### Attributes:

Attribute Name	Type	Required?	Description
id	String	Yes	A unique identifier assigned by the presenter and mirrored back in the response. <b>minLength = 1    maxLength = 36</b>
customerId	String	No	A value assigned by the merchant to identify the consumer. <b>minLength = N/A    maxLength = 50</b>
reportGroup	String	Yes	Required attribute that defines the merchant sub-group in the user interface where this transaction will be displayed. Please refer to <a href="#">Coding for Report Groups</a> on page 10 for additional information. <b>minLength = 1    maxLength = 25</b>

### Child Elements: (Required)

[card](#), [originalRefCode](#), [originalAmount](#), [originalTxnTime](#), [originalSystemTraceId](#), [originalSequenceNumber](#)

### Child Elements: (Optional)

[litleTxnId](#)

## 4.329 refundReversalResponse

The `refundReversalResponse` element is the parent element for information returned to you in response to an `refundReversal` transaction.

### Parent Elements:

[litleOnlineResponse](#)

### Attributes:

Attribute Name	Type	Required?	Description
id	String	Yes	The response returns the same value submitted in the Refund Reversal transaction. <b>minLength = 1    maxLength = 36</b>
customerId	String	No	The response returns the same value submitted in the Refund Reversal transaction. <b>minLength = N/A    maxLength = 50</b>
reportGroup	String	Yes	The response returns the same value submitted in the Refund Reversal transaction. <b>minLength = 1    maxLength = 25</b>

### Child Elements:

Required: [litleTxnId](#), [response](#), [responseTime](#), [message](#), [giftCardResponse](#)

Optional: [postDate](#)

## 4.330 registerTokenRequest

The registerTokenRequest element is the parent element for the Register Token transaction. You use this transaction type when you wish to submit an account number for tokenization, but there is no associated payment transaction.

You can use this element in either Online or Batch transactions.

---

**NOTE:** When submitting registerTokenRequest elements in a batchRequest, you must also include a numTokenRegistrations= attribute in the batchRequest element.

---

### Parent Elements:

[litleOnlineRequest](#), [batchRequest](#)

### Attributes:

Attribute Name	Type	Required?	Description
id	String	Yes	A unique identifier assigned by the presenter and mirrored back in the response. <b>minLength = 1    maxLength = 36</b>
customerId	String	No	A value assigned by the merchant to identify the consumer. <b>minLength = N/A    maxLength = 50</b>
reportGroup	String	Yes	Required attribute defining the merchant sub-group in the user interface where this transaction displays. Also see <a href="#">Coding for Report Groups</a> on page 10 for information. <b>minLength = 1    maxLength = 25</b>

### Child Elements:

Required: either [accountNumber](#), [echeckForToken](#), [mpos](#), [paypageRegistrationId](#), or [applepay](#)

Optional: [orderId](#), [cardValidationNum](#)

---

**NOTE:** The use of the cardValidationNum element in the registertokenRequest only applies when you submit an accountNumber element.

---

## 4.331 registerTokenResponse

The `registerTokenResponse` element is the parent element for the response to `registerTokenRequest` transactions. You receive this transaction type in response to the submission of an account number for tokenization in a `registerTokenRequest` transaction.

### Parent Elements:

[litleOnlineResponse](#), [batchResponse](#)

### Attributes:

Attribute Name	Type	Required?	Description
id	String	Yes	The response returns the same value submitted in the <code>registerTokenRequest</code> transaction. <b>minLength = 1    maxLength = 36</b>
customerId	String	No	The response returns the same value submitted in the <code>registerTokenRequest</code> transaction. <b>minLength = N/A    maxLength = 50</b>
reportGroup	String	Yes	The response returns the same value submitted in the <code>registerTokenRequest</code> transaction. <b>minLength = 1    maxLength = 25</b>

### Child Elements:

Required: [litleTxnId](#), [response](#), [message](#), [responseTime](#)

Optional: [eCheckAccountSuffix](#), [litleToken](#), [bin](#), [type](#), [applepayResponse](#), [androidpayResponse](#)

## 4.332 reloadable

The `reloadable` element is an optional child of the `fundingSource` element and defines whether the prepaid card is reloadable.

---

---

**NOTE:** This element is never returned for American Express card transaction.

---

---

**Type** = String (Enum); **Enumerations** = YES, NO, or UNKNOWN

**Parent Elements:**

[fundingSource](#)

**Attributes:**

None

**Child Elements:**

None

## 4.333 reserveCredit

The `reserveCredit` element is the parent element for the transaction type that a PayFac uses to move funds from the PayFac Settlement Account to the PayFac Reserve Account. If you use V11.3 or above, you can submit this transaction type either in a Batch or Online.

---

**NOTE:** You can submit funding instructions either Online or via Batch files, but not both. The two methodologies are mutually exclusive for funding instruction submissions.

---

### Parent Elements:

[batchRequest](#), [litleOnlineRequest](#)

### Attributes:

Attribute Name	Type	Required?	Description
id	String	Yes	A unique identifier assigned by the presenter and mirrored back in the response. <b>minLength = 1    maxLength = 36</b>
customerId	String	No	A value assigned by the merchant to identify the consumer. <b>minLength = N/A    maxLength = 50</b>
reportGroup	String	Yes	For PayFacs, this attribute does not segregate transactions in iQ. This field does appear in various SSR reports. <b>minLength = 1    maxLength = 25</b>

### Child Elements:

Required: [amount](#), [fundingSubmerchantId](#), [fundsTransferId](#)



## 4.334 reserveCreditResponse

The `reserveCreditResponse` element is the parent element for information returned to you in response to a `reserveCredit` transaction.

### Parent Elements:

[batchResponse](#), [litleOnlineResponse](#)

### Attributes:

Attribute Name	Type	Required?	Description
id	String	Yes	The response returns the same value submitted in the <code>payFacCredit</code> transaction. <b>minLength = 1    maxLength = 36</b>
customerId	String	No	The response returns the same value submitted in the <code>payFacCredit</code> transaction. <b>minLength = N/A    maxLength = 50</b>
reportGroup	String	Yes	The response returns the same value submitted in the <code>reserveCredit</code> transaction. <b>minLength = 1    maxLength = 25</b>
duplicate	boolean	No	If the request is a duplicate, the response includes the duplicate flag set to <b>true</b> and the entire original response. <b>Note:</b> This attribute applies only to Online Dynamic Payout Funding Instruction responses.

### Child Elements:

Required: [litleTxnId](#), [fundsTransferId](#), [response](#), [responseTime](#), [message](#)

Required (Online): [postDate](#)

## 4.335 reserveDebit

The `reserveDebit` element is the parent element for the transaction type that a PayFac uses to move funds from the PayFac Reserve Account to the PayFac Settlement Account. If you use V11.3 or above, you can submit this transaction type either in a Batch or Online.

---

**NOTE:** You can submit funding instructions either Online or via Batch files, but not both. The two methodologies are mutually exclusive for funding instruction submissions.

---

### Parent Elements:

[batchRequest](#), [litleOnlineRequest](#)

### Attributes:

Attribute Name	Type	Required?	Description
id	String	Yes	A unique identifier assigned by the presenter and mirrored back in the response. <b>minLength = 1    maxLength = 36</b>
customerId	String	No	A value assigned by the merchant to identify the consumer. <b>minLength = N/A    maxLength = 50</b>
reportGroup	String	Yes	For PayFacs, this attribute does not segregate transactions in iQ. This field does appear in various SSR reports. <b>minLength = 1    maxLength = 25</b>

### Child Elements:

Required: [amount](#), [fundingSubmerchantId](#), [fundsTransferId](#)

## 4.336 reserveDebitResponse

The `reserveDebitResponse` element is the parent element for information returned to you in response to a `reserveDebit` transaction.

### Parent Elements:

[batchResponse](#), [litleOnlineResponse](#)

### Attributes:

Attribute Name	Type	Required?	Description
id	String	Yes	The response returns the same value submitted in the <code>payFacCredit</code> transaction. <b>minLength = 1    maxLength = 36</b>
customerId	String	No	The response returns the same value submitted in the <code>payFacCredit</code> transaction. <b>minLength = N/A    maxLength = 50</b>
reportGroup	String	Yes	The response returns the same value submitted in the <code>reserveDebit</code> transaction. <b>minLength = 1    maxLength = 25</b>
duplicate	boolean	No	If the request is a duplicate, the response includes the duplicate flag set to <b>true</b> and the entire original response. <b>Note:</b> This attribute applies only to Online Dynamic Payout Funding Instruction responses.

### Child Elements:

Required: [litleTxnId](#), [fundsTransferId](#), [response](#), [responseTime](#), [message](#)

Required (Online): [postDate](#)

## 4.337 residenceStatus

The `residenceStatus` element is an optional child of the `customerInfo` element and defines the type of domicile in which the customer resides. It is used in combination with several other elements to provide required information for some PayPal Credit transactions.

---

---

**NOTE:** As of September, 2016, the Vantiv eCommerce platform no longer supports PayPal Credit for new merchants or existing merchants not already using this payment method. Existing merchants already using PayPal Credit should consult their Vantiv Relationship Manager.

---

---

**Type** = String (Enum); **Enumerations** = Own, Rent, or Other

**Parent Elements:**

[customerInfo](#)

**Attributes:**

None

**Child Elements:**

None

## 4.338 response

The `response` element contains a three digit numeric code which specifies either that the transaction is approved (000 code) or declined. The `message` element provides a brief definition of the response code.

For a complete list of response codes and associated messages, please refer to [Payment Transaction Response Codes](#) on page 816.

**Type** = String; **minLength** = N/A; **maxLength** = 3

### Parent Elements:

[activateResponse](#), [activateReversalResponse](#), [authorizationResponse](#), [authReversalResponse](#), [captureResponse](#), [captureGivenAuthResponse](#), [creditResponse](#), [deactivateResponse](#), [deactivateReversalResponse](#), [depositReversalResponse](#), [echeckCreditResponse](#), [echeckPreNoteCreditResponse](#), [echeckPreNoteSaleResponse](#), [echeckRedepositResponse](#), [echeckSalesResponse](#), [echeckVerificationResponse](#), [echeckVoidResponse](#), [forceCaptureResponse](#), [fraudCheckResponse](#), [loadResponse](#), [loadReversalResponse](#), [queryTransactionResponse](#), [queryTransactionUnavailableResponse](#), [registerTokenResponse](#), [refundReversalResponse](#), [saleResponse](#), [voidResponse](#), [cancelSubscriptionResponse](#), [unloadResponse](#), [updatePlanResponse](#), [updateSubscriptionResponse](#), [unloadReversalResponse](#), [payFacCreditResponse](#), [payFacDebitResponse](#), [physicalCheckCreditResponse](#), [physicalCheckDebitResponse](#), [submerchantCreditResponse](#), [reserveCreditResponse](#), [reserveDebitResponse](#), [submerchantDebitResponse](#), [vendorCreditResponse](#), [vendorDebitResponse](#)

### Attributes:

None

### Child Elements:

None

## 4.339 responseCode

The `responseCode` element contains a three digit numeric code which along with the `responseMessage` element specifies either acceptance by the Recurring Engine or the reason the recurring Engine was unable to schedule subsequent payments.

**Type** = String; **minLength** = N/A; **maxLength** = 3

**Parent Elements:**

[recurringResponse](#)

**Attributes:**

None

**Child Elements:**

None

## 4.340 responseMessage

The `responseMessage` element contains a brief definition of the **responseCode** returned for the recurring transaction.

**Type** = String; **minLength** = N/A; **maxLength** = 512

**Parent Elements:**

[recurringResponse](#)

**Attributes:**

None

**Child Elements:**

None

## 4.341 responseTime

The `responseTime` element provides a date/time stamp of the response. The format of the element is YYYY-MM-DDTHH:MM:SS. For example, 2009-12-21T11:37:04.

**Type** = dateTime; **minLength** = N/A; **maxLength** = 19

### Parent Elements:

activateResponse, activateReversalResponse, authorizationResponse, authReversalResponse, captureResponse, captureGivenAuthResponse, creditResponse, deactivateResponse, deactivateReversalResponse, depositReversalResponse, echeckCreditResponse, echeckPreNoteCreditResponse, echeckPreNoteSaleResponse, echeckRedepositResponse, echeckSalesResponse, echeckVerificationResponse, echeckVoidResponse, forceCaptureResponse, fraudCheckResponse, loadResponse, loadReversalResponse, queryTransactionResponse, registerTokenResponse, refundReversalResponse, saleResponse, voidResponse, cancelSubscriptionResponse, unloadResponse, unloadReversalResponse, updatePlanResponse, updateSubscriptionResponse, payFacCreditResponse, payFacDebitResponse, physicalCheckCreditResponse, physicalCheckDebitResponse, reserveCreditResponse, reserveDebitResponse, submerchantCreditResponse, submerchantDebitResponse, vendorCreditResponse, vendorDebitResponse

### Attributes:

None

### Child Elements:

None



## 4.342 results\_Max10

The `results_Max10` element is a required child of the `queryTransactionResponse`. Any original transaction responses that match the criteria submitted in the `queryTransaction` appear as children of this element in the response. The system can return a maximum of ten responses as children of the `results_Max10` element. The value for the `matchCount` element reflects the number of found transactions.

If the system does not find any transactions matching the query criteria, the `results_Max10` element will be empty.

If the query results is a response code of 152 - Transaction found, but response not yet available, the `results_Max10` element will contain at least one `queryTransactionUnavailableResponse` child and may contain other found responses.

### Parent Elements:

[queryTransactionResponse](#)

### Attributes:

None

### Child Elements:

All Optional: [activateResponse](#), [activateReversalResponse](#), [authorizationResponse](#), [captureResponse](#), [creditResponse](#), [deactivateResponse](#), [depositReversalResponse](#), [echeckCreditResponse](#), [echeckSalesResponse](#), [loadResponse](#), [loadReversalResponse](#), [refundReversalResponse](#), [saleResponse](#), [unloadResponse](#), [unloadReversalResponse](#), [voidResponse](#), [queryTransactionUnavailableResponse](#)

### Example: results\_Max10 Element with One Found Transaction

```
<results_max10>
  <authorizationResponse id="GiftCardAuth" reportGroup="Mer5PM1" customerId="1">
    <littleTxnId>82827170811986124</littleTxnId>
    <orderId>150330_GCAuth</orderId>
    <response>000</response>
    responseTime>2015-04-06T16:40:04</responseTime>
    <postDate>2015-04-06</postDate>
    <message>Approved</message>
    <authCode>111115</authCode>
    <fraudResult>
      <avsResult>30</avsResult>
    </fraudResult>
  </authorizationResponse>
</results_max10>
```

```
    <cardValidationResult>M</cardValidationResult>
  </fraudResult>
</giftCardResponse>
  <availableBalance>125</availableBalance>
</giftCardResponse>
</authorizationResponse>
</results_max10>
```

**Example: results\_Max10 Element with Multiple Found Transactions**

```
<results_max10>
  <authorizationResponse id="DupeId" reportGroup="Mer5PM1">
    <littleTxnId>82827170811986215</littleTxnId>
    <orderId>150331_DupeAuth2</orderId>
    <response>000</response>
    <responseTime>2015-04-06T16:40:12</responseTime>
    <postDate>2015-04-06</postDate>
    <message>Approved</message>
    <authCode>055858</authCode>
    <fraudResult>
      <avsResult>32</avsResult>
      <cardValidationResult>M</cardValidationResult>
    </fraudResult>
  </authorizationResponse>
  <authorizationResponse id="DupeId" reportGroup="Mer5PM1">
    <littleTxnId>82827170811986207</littleTxnId>
    <orderId>150331_DupeAuth1</orderId>
    <response>000</response>
    <responseTime>2015-04-06T16:40:11</responseTime>
    <postDate>2015-04-06</postDate>
    <message>Approved</message>
    <authCode>111111</authCode>
    <fraudResult>
      <avsResult>00</avsResult>
      <cardValidationResult>M</cardValidationResult>
    </fraudResult>
```

```
</authorizationResponse>  
</results_max10>
```

**Example: results\_Max10 Element for 152 Response Code**

```
<results_max10>  
  <queryTransactionUnavailableResponse>  
    <littleTxnId>82827170811986124</littleTxnId>  
    <response>152</response>  
    <message>Original transaction found but response not yet available</message>  
  </queryTransactionUnavailableResponse>  
</results_max10>
```

## 4.343 RFRRequest

The RFRRequest element is an optional child of a littleRequest element. You can use this type of request in one of two ways.

- To request a session response from a previously processed littleRequest, include the littleSessionId child. The resulting RFR response will duplicate the original session response (Authorization, Credit, Capture, or Sale response) associated with the littleSessionId. The session ID returned in the response will be the session ID of the original session.
- To request an Account Updater completion response file, include the accountUpdateFileRequestData element. If the completion file is ready, it is returned. If the completion file is not ready, you receive an RFRResponse message with the response attribute set to 1 and the message attribute reading, “The account Update file is not ready yet. Please try again later.”

### Parent Elements:

[littleRequest](#)

### Attributes:

None

### Child Elements: (Choice of)

[littleSessionId](#) or [accountUpdateFileRequestData](#)

### Example: RFRRequest Structure - Batch

```
<RFRRequest>
  <littleSessionId>Session ID</littleSessionId>
</RFRRequest>
```

### Example: RFRRequest Structure - Account Updater

```
<RFRRequest>
  <accountUpdateFileRequestData>
    <merchantId>Merchant ID</merchantId>
    <postDay>Post Date</postDay>
  </accountUpdateFileRequestData>
</RFRRequest>
```

## 4.344 RFRResponse

The RFRResponse element is an optional child of a litleResponse element returned in response to a RFRRequest.

### Parent Elements:

[litleResponse](#)

### Attributes:

Attribute Name	Type	Required?	Description
response	String	Yes	The RFR Response Code indicating the result of the RFR request. <b>minLength</b> = N/A <b>maxLength</b> = 3
message	String	Yes	A brief definition of the response code returned for this transaction. <b>minLength</b> = N/A <b>maxLength</b> = 512

### Child Elements:

None

## 4.345 routingNum

The `routingNum` element is a required child of the `echeck`, `originalAccountInfo`, and `newAccountInfo` elements defining the routing number of the Echeck account.

**Type** = String; **minLength** = 8; **maxLength** = 9

**Parent Elements:**

[echeck](#), [newAccountInfo](#), [originalAccountInfo](#), [newTokenInfo](#), [originalTokenInfo](#), [accountInfo](#)

**Attributes:**

None

**Child Elements:**

None

---

---

**NOTE:** If you submit an invalid routing number, we return the XML Response Code 900 - Invalid Bank Routing Number.

---

---

## 4.346 RxAmount

The RxAmount element is an optional child of the healthcareAmounts element and defines the healthcare amount used for the purchased medications. The decimal is implied. Example: 500 = \$5.00.

**Type** = Integer; **totalDigits** = 8

**Parent Elements:**

Optional: [healthcareAmounts](#)

**Attributes:**

None

**Child Elements:**

None

## 4.347 sale

The `sale` element is the parent element for all Sale transactions. A Sale transaction is a combination Authorization and Capture transaction. You can use this element in either Online or Batch transactions.

### Parent Elements:

[litleOnlineRequest](#), [batchRequest](#)

### Attributes:

Attribute Name	Type	Required?	Description
id	String	Yes	A unique identifier assigned by the presenter and mirrored back in the response. <b>minLength = 1    maxLength = 36</b>
customerId	String	No	A value assigned by the merchant to identify the consumer. <b>minLength = N/A    maxLength = 50</b>
reportGroup	String	Yes	Required attribute that defines the merchant sub-group in the user interface where this transaction will be displayed. Please refer to <a href="#">Coding for Report Groups</a> on page 10 for additional information. <b>minLength = 1    maxLength = 25</b>

### Child Elements:

Required: [orderId](#), [amount](#), [orderSource](#), (choice of) [card](#), [paypal](#), [paypage](#), [mpos](#), [token](#), [applepay](#), [ideal](#), [sepaDirectDebit](#), [giropay](#), or [sofort](#)

---

**NOTE:**    **The `cardholderAuthentication` child element is required only for 3-D Secure transactions and for BML ecommerce transactions.**  
**The `fraudCheck` element has been deprecated; use the `cardholderAuthentication` element instead.**

---

Optional: [litleTxnId](#), [customerInfo](#), [billToAddress](#), [shipToAddress](#), [billMeLaterRequest](#), [cardholderAuthentication](#), [customBilling](#), [taxType](#), [enhancedData](#), [processingInstructions](#), [pos](#), [paypalNotes](#), [paypalOrderComplete](#), [amexAggregatorData](#), [allowPartialAuth](#), [healthcareIIAS](#), [merchantData](#), [recyclingRequest](#), [fraudFilterOverride](#), [secondaryAmount](#), [surchargeAmount](#), [recurringRequest](#), [litleInternalRecurringRequest](#), [debtRepayment](#), [advancedFraudChecks](#), [wallet](#), [processingType](#), [origOrderId](#), [password](#), [originalNetworkTransactionId](#), [originalTransactionAmount](#)



## 4.348 saleResponse

The `saleResponse` element is the parent element for information returned in response to a Sale transaction. It can be a child of either a `litleOnlineResponse` element or a `batchResponse` element.

### Parent Elements:

[litleOnlineResponse](#), [batchResponse](#)

### Attributes:

Attribute Name	Type	Required?	Description
id	String	Yes	The response returns the same value submitted in the Sale transaction. <b>minLength = 1    maxLength = 36</b>
customerId	String	No	The response returns the same value submitted in the Sale transaction. <b>minLength = N/A    maxLength = 50</b>
reportGroup	String	Yes	The response returns the same value submitted in the Sale transaction. <b>minLength = 1    maxLength = 25</b>

### Child Elements:

Required: [litleTxnId](#), [orderId](#), [response](#), [responseTime](#), [message](#)

Optional: [postDate](#), [cardProductId](#) (see Note below), [authCode](#), [authorizationResponseSubCode](#) (see Note below), [approvedAmount](#), [accountInformation](#), [fraudResult](#), [billMeLaterResponseData](#), [tokenResponse](#), [enhancedAuthResponse](#), [accountUpdater](#), [recycling](#), [recurringResponse](#), [giftCardResponse](#), [applepayResponse](#), [cardSuffix](#), [androidpayResponse](#), [sepaDirectDebitResponse](#), [networkTransactionId](#), [idealResponse](#), [giropayResponse](#), [sofortResponse](#)

---

**NOTE:**    The `postDate` child element is returned only in responses to Online transactions.

              The `cardProductId` element returns a raw code referencing the card type. Please consult your Relationship Manager for additional information.

              The `authorizationResponseSubCode` element is not used at this time.

---

## 4.349 salesTax

The `salesTax` element defines the amount of sales tax included in the transaction amount. Although the schema defines it as an optional child of the `enhancedData` element, it is required to receive the best interchange rate for Level II and Level III corporate purchases. The decimal is implied. Example: 500 = \$5.00.

---

---

**NOTE:** For a non-taxable transaction, use 0 as the value. In this case you must also set the `taxExempt` element to true.

If you provide `detailTax` data, the `salesTax` should be the sum of the `detailTax`.

---

---

Type = Integer; totalDigits = 8

### Parent Elements:

[enhancedData](#)

### Attributes:

None

### Child Elements:

None

## 4.350 secondaryAmount

The `secondaryAmount` element defines the principal portion of the total amount when a convenience fee applied to the transaction by the merchant. for example, if the total charge is \$105, with the principal amount being \$100 and the convenience fee being \$5, you must use \$100 as the value for the `secondaryAmount` element. Supply the value in cents without a decimal point. For example, a value of 400 signifies \$4.00.

**Type** = Integer; **totalDigits** = 12

### Parent Elements:

[authorization](#), [capture](#), [credit](#), [captureGivenAuth](#), [echeckCredit](#), [echeckSale](#), [forceCapture](#), [sale](#)

### Attributes:

None

### Child Elements:

None

## 4.351 sellerId

The `sellerId` element is a required child of the `amexAggregatorData` element, which defines the Seller Id as assigned by American Express.

**Type** = String; **minLength** = 1; **maxLength** = 16

**Parent Elements:**

[amexAggregatorData](#)

**Attributes:**

None

**Child Elements:**

None

## 4.352 sellerMerchantCategoryCode

The sellerMerchantCategoryCode element is a required child of the amexAggregatorData element, which defines the Merchant Category Code as assigned by American Express.

**Type** = String; **minLength** = 1; **maxLength** = 4

**Parent Elements:**

[amexAggregatorData](#)

**Attributes:**

None

**Child Elements:**

None

## 4.353 sepaDirectDebit

The `sepaDirectDebit` element is a child of the `sale` transaction that, through its child elements, defines information needed to process a SEPA Direct Debit transaction. At this time, you can use the SEPA Direct Debit method of payment in Online transactions only.

### Parent Elements:

[sale](#)

### Attributes:

None

### Child Elements:

Required: [iban](#), [mandateProvider](#), [sequenceType](#)

Optional: [mandateReference](#), [mandateURL](#), [mandateSignatureDate](#), [preferredLanguage](#)

### Example: sepaDirectDebit Structure

```
<sepaDirectDebit>
  <mandateProvider>Merchant or Vantiv</mandateProvider>
  <sequenceType>One Time or Type of Recurring</sequenceType>
  <mandateReference>Ref to First Payment of Recurring Stream</mandateReference>
  <mandateUrl>URL of Merchant Hosted Mandtae</mandateUrl>
  <mandateSignatureDate>2016-06-12</mandateSignatureDate>
  <iban>Consumer Account Number</iban>
  <preferredLanguage>Country Code of Language</preferredLanguage>
</sepaDirectDebit>
```

## 4.354 sepaDirectDebitResponse

The `sepaDirectDebitResponse` element is a child of the `saleResponse` transaction when the method of payment in the request is `sepaDirectDebit`. It contains child elements that you should store for future use/reference.

### Parent Elements:

[saleResponse](#)

### Attributes:

None

### Child Elements (all Optional):

[mandateReference](#), [redirectUrl](#), [redirectToken](#)

### Example: sepaDirectDebitResponse Structure

```
<sepaDirectDebitResponse>
  <redirectUrl>URL of Vantiv Supplied Mandate</redirectUrl>
  <redirectToken>Map Mandate to littleTxnId</redirectToken>
  <mandateReference>Ref Number for Subsequent Payments</mandateReference>
</sepaDirectDebit>
```

## 4.355 sequenceNumber

The `sequenceNumber` element is an optional child of the `giftCardResponse` element, which specifies a Vantiv generated sequence number associated with the transaction in our systems. You should retain this value for possible future use in gift card reversal transactions.

**Type** = String; **totalDigits** = 6; **Allowed Characters**: 0 - 9

**Parent Elements:**

[giftCardResponse](#)

**Attributes:**

None

**Child Elements:**

None



## 4.356 sequenceType

The `sequenceType` element is a required child of the `sepaDirectDebit` element and defines the purchase in terms of a one-time buy or a member of a recurring stream of debits. If the value of this element is either **SubsequentRecurring**, or **FinalRecurring**, you must include the `mandateReference` element in the request, specifying the value returned in the initial `sepaDirectDebitResponse`.

**Type** = String (Enum); **minLength** = N/A; **maxLength** = N/A

### Parent Elements:

[sepaDirectDebit](#)

### Attributes:

None

### Child Elements:

None

### Enumerations:

Enumeration	Description
OneTime	The purchase is a one-time buy (i.e., not part of a recurring stream).
FirstRecurring	This purchase is the initial buy of a recurring stream.
SubsequentRecurring	This purchase is part of a recurring stream of purchases, but not the first or last in the stream.
FinalRecurring	This purchase is the final buy of a recurring stream.

## 4.357 shipFromPostalCode

The `shipFromPostalCode` element defines the postal code from which the product ships in the `enhancedData` element.

**Type** = String; **minLength** = N/A; **maxLength** = 20

---

---

**NOTE:** Although the schema specifies the **maxLength** of the `<shipFromPostalCode>` element as 20 characters, in practice you should never exceed 10 characters in your submissions.

---

---

### Parent Elements:

[enhancedData](#)

### Attributes:

None

### Child Elements:

None

## 4.358 shippingAmount

The `shippingAmount` element defines shipping cost for the order. Although the schema defines it as an optional child of the `enhancedData` element, it is required by Visa for Level III interchange rates. The decimal is implied. Example: 500 = \$5.00.

**Type** = Integer; **totalDigits** = 8

**Parent Elements:**

[enhancedData](#)

**Attributes:**

None

**Child Elements:**

None

## 4.359 shipToAddress

The `shipToAddress` element contains several child elements that define the postal mailing address (and telephone number) used for shipping purposes.

### Parent Elements:

[authorization](#), [captureGivenAuth](#), [fraudCheck](#), [sale](#)

### Attributes:

None

### Child Elements: (all Optional)

[name](#), [addressLine1](#), [addressLine2](#), [addressLine3](#), [city](#), [state](#), [zip](#), [country](#), [email](#), [phone](#)

### Example: shipToAddress Structure

```
<shipToAddress>
  <name>Customer's Full Name</name>
  <addressLine1>Address Line 1</addressLine1>
  <addressLine2>Address Line 2</addressLine2>
  <addressLine3>Address Line 3</addressLine3>
  <city>City</city>
  <state>State Abbreviation</state>
  <zip>ZIP Code</zip>
  <country>Country Code</country>
  <email>Email Address</email>
  <phone>Telephone Number</phone>
</shipToAddress>
```

## 4.360 signature

The `signature` element is a required child of the `applepay` element. It is the BASE64 encoded string signature of the payment and header data from the `PKPaymentToken`.

**Type** = String; **minLength** = N/A; **maxLength** = 10000

**Parent Elements:**

[applepay](#)

**Attributes:**

None

**Child Elements:**

None

## 4.361 sofort

The `sofort` element is a child of the `sale` transaction that, through its child elements, defines information needed to process an SOFORT (Real-time Bank Transfer) transaction. At this time, you can use the iDeal method of payment in Online transactions only.

### Parent Elements:

[sale](#)

### Attributes:

None

### Child Elements:

Optional: [preferredLanguage](#)

### Example: `sofort` Structure

```
<sofort>
  <preferredLanguage>Country Code of Language</preferredLanguage>
</sofort>
```

## 4.362 sofortResponse

The `sofortResponse` element is a child of the `saleResponse` transaction when the method of payment in the request is `sofort`. It contains child elements that you should store for future use/reference.

### Parent Elements:

[saleResponse](#)

### Attributes:

None

### Child Elements (all Optional):

[paymentPurpose](#), [redirectUrl](#), [redirectToken](#)

### Example: sofortResponse Structure

```
<sofortResponse>
  <redirectUrl>URL of Vantiv Supplied Mandate</redirectUrl>
  <redirectToken>Map Mandate to litleTxnId</redirectToken>
  <paymentPurpose>Reference Number + Billing Descrptor</paymentPurpose>
</sofortResponse>
```

## 4.363 ssn

The `ssn` element is an optional child of the `customerInfo` element. It is used in combination with several other elements to provide required information for some PayPal Credit transactions.

---

---

**NOTE:** As of September, 2016, the Vantiv eCommerce platform no longer supports PayPal Credit for new merchants or existing merchants not already using this payment method. Existing merchants already using PayPal Credit should consult their Vantiv Relationship Manager.

---

---

**Type** = Pattern; **minLength** = 4 (last four digits of SSN); **maxLength** = 9 (full SSN)

---

---

**NOTE:** In order for a BML transaction to succeed, you must include this element if:

- the customer does not have a BML account

or

- the customer has a BML account, but the account has not been authenticated.

You do not need to include this element if the BML account has been authenticated.

---

---

### Parent Elements:

[customerInfo](#)

### Attributes:

None

### Child Elements:

None



## 4.364 startDate

The `startDate` element is an optional child of the `subscription` element, which specifies the date the recurring billing should begin. It is also an optional child of both the `createAddOn` and `createDiscount` element, where it specifies either the starting date of the Add On charge or the starting date of the discount.

**Type** = Date; **Format** = YYYY-MM-DD

### Parent Elements:

[subscription](#), [createAddOn](#), [createDiscount](#), [updateAddOn](#), [updateDiscount](#)

### Attributes:

None

### Child Elements:

None

## 4.365 state

The `state` element defines the customer's state name in the `billToAddress`, `shipToAddress`, `taxBilling` and elements.

**Type** = String; **minLength** = N/A; **maxLength** = 2

---

---

**NOTE:** Although the schema defines the **maxLength** for this element as 30, the best practice is to use the 2 character abbreviation. When submitting an eCheck Verification transaction, you must use the 2 character abbreviation or the transaction will be rejected with a 370 reason code.

---

---

### Parent Elements:

[billToAddress](#), [shipToAddress](#), [taxExempt](#)

### Attributes:

None

### Child Elements:

None

## 4.366 submerchantCredit

The `submerchantCredit` element is the parent element for the transaction type that a PayFac uses to move funds from the PayFac Settlement Account to the Sub-merchant Account. If you use V11.3 or above, you can submit this transaction type either in a Batch or Online.

---

**NOTE:** You can submit funding instructions either Online or via Batch files, but not both. The two methodologies are mutually exclusive for funding instruction submissions.

---

### Parent Elements:

[batchRequest](#), [litleOnlineRequest](#)

### Attributes:

Attribute Name	Type	Required?	Description
id	String	Yes	A unique identifier assigned by the presenter and mirrored back in the response. <b>minLength = 1    maxLength = 36</b>
customerId	String	No	A value assigned by the merchant to identify the consumer. <b>minLength = N/A    maxLength = 50</b>
reportGroup	String	Yes	For PayFacs, this attribute does not segregate transactions in iQ. This field does appear in various SSR reports. <b>minLength = 1    maxLength = 25</b>

### Child Elements:

Required: [accountInfo](#), [amount](#), [fundingSubmerchantId](#), [fundsTransferId](#), [submerchantName](#), [customIdentifier](#)

## 4.367 submerchantCreditResponse

The `submerchantCreditResponse` element is the parent element for information returned to you in response to a `submerchantCredit` transaction.

### Parent Elements:

[batchResponse](#), [litleOnlineResponse](#)

### Attributes:

Attribute Name	Type	Required?	Description
id	String	Yes	The response returns the same value submitted in the <code>payFacCredit</code> transaction. <b>minLength = 1    maxLength = 36</b>
customerId	String	No	The response returns the same value submitted in the <code>payFacCredit</code> transaction. <b>minLength = N/A    maxLength = 50</b>
reportGroup	String	Yes	The response returns the same value submitted in the <code>submerchantCredit</code> transaction. <b>minLength = 1    maxLength = 25</b>
duplicate	boolean	No	If the request is a duplicate, the response includes the duplicate flag set to <b>true</b> and the entire original response. <b>Note:</b> This attribute applies only to Online Dynamic Payout Funding Instruction responses.

### Child Elements:

Required: [litleTxnId](#), [fundsTransferId](#), [response](#), [responseTime](#), [message](#)

Required (Online): [postDate](#)

## 4.368 submerchantDebit

The `submerchantDebit` element is the parent element for the transaction type that a PayFac uses to move funds from the Sub-merchant Account to the PayFac Settlement Account. If you use V11.3 or above, you can submit this transaction type either in a Batch or Online.

---

**NOTE:** You can submit funding instructions either Online or via Batch files, but not both. The two methodologies are mutually exclusive for funding instruction submissions.

---

### Parent Elements:

[batchRequest](#), [litleOnlineRequest](#)

### Attributes:

Attribute Name	Type	Required?	Description
id	String	Yes	A unique identifier assigned by the presenter and mirrored back in the response. <b>minLength = 1    maxLength = 36</b>
customerId	String	No	A value assigned by the merchant to identify the consumer. <b>minLength = N/A    maxLength = 50</b>
reportGroup	String	Yes	For PayFacs, this attribute does not segregate transactions in iQ. This field does appear in various SSR reports. <b>minLength = 1    maxLength = 25</b>

### Child Elements:

Required: [accountInfo](#), [amount](#), [fundingSubmerchantId](#), [fundsTransferId](#), [submerchantName](#), [customIdentifier](#)

## 4.369 submerchantDebitResponse

The `submerchantDebitResponse` element is the parent element for information returned to you in response to a `submerchantDebit` transaction.

### Parent Elements:

[batchResponse](#), [litleOnlineResponse](#)

### Attributes:

Attribute Name	Type	Required?	Description
id	String	Yes	The response returns the same value submitted in the <code>payFacCredit</code> transaction. <b>minLength = 1    maxLength = 36</b>
customerId	String	No	The response returns the same value submitted in the <code>payFacCredit</code> transaction. <b>minLength = N/A    maxLength = 50</b>
reportGroup	String	Yes	The response returns the same value submitted in the <code>submerchantDebit</code> transaction. <b>minLength = 1    maxLength = 25</b>
duplicate	boolean	No	If the request is a duplicate, the response includes the duplicate flag set to <b>true</b> and the entire original response. <b>Note:</b> This attribute applies only to Online Dynamic Payout Funding Instruction responses.

### Child Elements:

Required: [litleTxnId](#), [fundsTransferId](#), [response](#), [responseTime](#), [message](#)

Required (Online): [postDate](#)

## 4.370 submerchantName

The submerchantName element is a required child of the submerchantCredit element and specifies the name of the Sub-merchant.

**Type** = String; **minLength** = 1; **maxLength** = 256

**Parent Elements:**

[submerchantCredit](#), [submerchantDebit](#), [fastAccessFunding](#)

**Attributes:**

None

**Child Elements:**

None

## 4.371 subscription

The `subscription` element is a required child of the `recurringRequest` element and the parent of several child element that define information about the recurring transaction stream to be handled by the Recurring Engine.

### Parent Elements:

[recurringRequest](#)

### Attributes:

None

### Child Elements (required):

[planCode](#)

### Child Elements (optional):

[numberOfPayments](#), [startDate](#), [amount](#), [createDiscount](#), [createAddOn](#)

---

---

**NOTE:** If you include the `numberOfPayments` child element, the value submitted overrides the default value defined in the Plan.

---

---

### Example: subscription Structure

```
<subscription>
  <planCode>Plan Reference Code</planCode>
  <numberOfPayments>1 to 99</numberOfRemianingPayments>
  <startDate>Start Date of recurring Cycle</startDate>
  <amount>Amount of Recurring Payment</amount>
  <createDiscount>
    <discountCode>Discount Reference Code</addOnCode>
    <name>Name of Discount</name>
    <amount>Amount of Discount</amount>
    <startDate>Start Date of Discount</startDate>
    <endDate>End Date of Discount</endDate>
  </createDiscount>
  <createAddOn>
    <addOnCode>Add On Reference Code</addOnCode>
```



```
<name>Name of Add On</name>
<amount>Amount of Add On</amount>
<startDate>Start Date of Add On Charge</startDate>
<endDate>End Date of Add On Charge</endDate>
</createAddOn>
</subscription>
```

## 4.372 subscriptionId

The `subscriptionId` element is a required child of the `recurringResponse` element and defines the assigned identifier for the sequence of recurring billing transactions. You also use this element in the `updateSubscription` and `cancelSubscription` transactions to identify the subscription for changes/cancellation.

**Type** = Long; **minLength** = N/A; **maxLength** = 19

### Parent Elements:

[recurringResponse](#), [litleInternalRecurringRequest](#), [cancelSubscription](#), [updateSubscription](#), [updateSubscriptionResponse](#), [cancelSubscriptionResponse](#)

### Attributes:

None

### Child Elements:

None

## 4.373 surchargeAmount

The `surchargeAmount` element defines the amount of the surcharge applied to the transaction by the merchant. Supply the value in cents without a decimal point. For example, a value of 400 signifies \$4.00.

**Type** = Integer; **totalDigits** = 12

---

---

**NOTE:** Use of the `surchargeAmount` element applies to Visa or MasterCard credit card payments only. Also, you are required to notify the card networks and us of your intent to applying surcharges at least 30 days prior to implementing the surcharges. Please consult your Relationship Manager if you have additional questions.

---

---

### Parent Elements:

[authorization](#), [authReversal](#), [capture](#), [credit](#), [captureGivenAuth](#), [forceCapture](#), [sale](#)

### Attributes:

None

### Child Elements:

None

## 4.374 systemTraceId

The `systemTraceId` element is an optional child of the `giftCardResponse` element, which specifies a Vantiv generated identifier associated with the transaction in our systems. You should retain this value for possible future use in gift card reversal transactions.

**Type** = Integer; **totalDigits** = 6

**Parent Elements:**

[giftCardResponse](#)

**Attributes:**

None

**Child Elements:**

None

## 4.375 taxAmount

The `taxAmount` element is a required child of the `detailTax` element and an optional child of the `lineItemData` element and defines the detail tax amount on the purchased good or service. The decimal is implied. Example: 500 = \$5.00.

**Type** = Integer; **totalDigits** = 8

### Parent Elements:

Required: [detailTax](#)

Optional: [lineItemData](#)

---

---

**NOTE:** If you include `taxAmount` as a child of `lineItemData` along with `detailTax`, the `lineItemData taxAmount` should be the sum of the `taxAmount` children from `detailTax` children.

---

---

### Attributes:

None

### Child Elements:

None

## 4.376 taxExempt

The `taxExempt` element is an optional child of the `enhancedData` element and specifies whether or not the transaction is exempt from sales tax. If you do not include this element, the value defaults to **false**.

---

---

**NOTE:** You must set this element to true, if you set the `salesTax` element to 0.

---

---

**Type** = Boolean; **Valid values** = true or false

**Parent Elements:**

[enhancedData](#)

**Attributes:**

None

**Child Elements:**

None

## 4.377 taxIncludedInTotal

The `taxIncludedInTotal` element is an optional child of the `detailTax` element and defines whether or not the tax is included in the total purchase amount.

**Type** = Boolean; **Valid Values** = true or false

### Parent Elements:

[detailTax](#)

### Attributes:

None

### Child Elements:

None

## 4.378 taxRate

The `taxRate` element is an optional child of the `detailTax` element and defines the tax rate applied to this specific taxable amount.

**Type** = Decimal; **totalDigits** = 5

**Parent Elements:**

[detailTax](#)

**Attributes:**

None

**Child Elements:**

None



## 4.379 taxType

The `taxType` element is an optional child of several transaction types that designates the transaction as either a convenience fee or tax payment for merchants using the Visa Tax Payment Program or the MasterCard Convenience Fee Program.

**Type** = String (enum); **minLength** = N/A; **maxLength** = 1; **Valid Values** = payment or fee

### Parent Elements:

[authorization](#), [captureGivenAuth](#), [credit](#), [forceCapture](#), [sale](#)

### Attributes:

None

### Child Elements:

None

## 4.380 taxTypeIdentifier

The `taxTypeIdentifier` element is an optional child of the `detailTax` element and defines the type of tax collected on this specific tax amount. If the tax type identifier is unknown, do not include this element.

**Type** = String (Enum); **minLength** = N/A; **maxLength** = 2

### Parent Elements:

[detailTax](#)

### Attributes:

None

### Child Elements:

None

### Enumerations:

Enumeration	Description
00	Unknown
01	Federal/National Sales Tax
02	State Sales Tax
03	City Sales Tax
04	Local Sales Tax
05	Municipal Sales Tax
06	Other Tax
10	Value Added Tax (VAT)
11	Goods and Services Tax (GST)
12	Provincial Sales Tax (PST)
13	Harmonized Sales Tax (HST)
14	Quebec Sales Tax (QST)
20	Room Tax
21	Occupancy Tax
22	Energy Tax

## 4.381 terminalId

The `terminalId` element is an optional child of the `pos` element and defines the identifier of the terminal used at the point of sale.

---

---

**NOTE:** The `terminalId` element is required for MasterCard POS transactions.

---

---

**Type** = String; **minLength** = N/A; **maxLength** = 8 (No special characters allowed.)

**Parent Elements:**

[pos](#)

**Attributes:**

None

**Child Elements:**

None

## 4.382 termsAndConditions

The `termsAndConditions` element is an optional child of the `billMeLaterRequest` element and defines the specific lending terms of the PayPal Credit account.

---

---

**NOTE:** As of September, 2016, the Vantiv eCommerce platform no longer supports PayPal Credit for new merchants or existing merchants not already using this payment method. Existing merchants already using PayPal Credit should consult their Vantiv Relationship Manager.

---

---

**Type** = Integer; **totalDigits** = 5

**Parent Elements:**

[billMeLaterRequest](#)

**Attributes:**

None

**Child Elements:**

None

## 4.383 threatMetrixSessionId

The `threatMetrixSessionId` element is an optional child of the `advancedFraudChecks` element.

**Type** = String; **Allowed Characters** = a-z, A-Z, 0-9, -, \_ ; **minLength** = 1; **maxLength** = 128

---

---

**NOTE:** While generated by you at the time the consumer accesses your page, each `threatMetrixSessionId` must include a 5-character prefix, supplied by your Implementation Consultant, followed by a dash ("-"). The remainder of the Id must be unique for each instance of the customer accessing your page.

---

---

### Parent Elements:

[advancedFraudChecks](#)

### Attributes:

None

### Child Elements:

None

## 4.384 token

The `token` element has two uses depending upon whether the element concerns a Vantiv generated token (for tokenized merchants) or a PayPal generated token.

### 4.384.1 token (Vantiv generated card number replacement)

In this case, the `token` element replaces the `card` element in tokenized card transactions or the `echeck` element in eCheck transactions, and defines the tokenized payment card/account information.

#### Parent Elements:

[authorization](#), [captureGivenAuth](#), [credit](#), [forceCapture](#), [sale](#), [accountUpdate](#), [updateSubscription](#), [fastAccessFunding](#)

#### Attributes:

None

---

---

**IMPORTANT:** Although not a required element, Vantiv recommends you include the `expDate` element. If you converted PAN information to tokens using the `registerTokenRequest` transaction, we do not have the `expDate` value stored, so cannot add it to the transaction. Transactions without `expDate` have a high likelihood of decline.

---

---

#### Child Elements:

Required: [litleToken](#)

Optional: [expDate](#), [cardValidationNum](#), [type](#), [checkoutId](#)

#### Example: token Structure with CVV

```
<token>
  <litleToken>Token</litleToken>
  <expDate>Card Expiration Date</expDate>
  <cardValidationNum>Card Validation Number</cardValidationNum>
  <type>Method of Payment</type>
</token>
```

**Example: token Structure with checkoutId instead of CVV**

```
<token>
  <littleToken>Token</littleToken>
  <expDate>Card Expiration Date</expDate>
  <type>Method of Payment</type>
  <checkoutId>Low Value Token for CVV</checkoutId>
</token>
```

**4.384.2 token (PayPal generated)**

In this case, the token element is the token generated by PayPal.

**Type** = String; **minLength** = N/A; **maxLength** = N/A

**Parent Elements:**

[paypal](#)

**Attributes:**

None

**Child Elements:**

None

## 4.385 tokenMessage

The tokenMessage element provides a short, human-readable explanation of the tokenResponseCode (see [Table 4-3](#)).

**Type** = String; **minLength** = N/A; **maxLength** = N/A

**Parent Elements:**

[tokenResponse](#)

**Attributes:**

None

**Child Elements:**

None



## 4.386 tokenResponse

The `tokenResponse` element is the parent element for several children defining the registered token, as well the either card type and BIN, or last three characters of the account number in the case of eChecks. This element appears in the response only if a tokenized merchant submits card or eCheck account information in the transaction request.

### Parent Elements:

[authorizationResponse](#), [captureGivenAuthResponse](#), [creditResponse](#), [echeckCreditResponse](#), [echeckRedepositResponse](#), [echeckSalesResponse](#), [echeckVerificationResponse](#), [forceCaptureResponse](#), [saleResponse](#), [updateSubscriptionResponse](#)

### Attributes:

None

### Child Elements:

Required: [tokenResponseCode](#), [tokenMessage](#)

Optional: [litleToken](#), [type](#), [bin](#), [eCheckAccountSuffix](#)

### Example: tokenResponse Structure

```
<tokenResponse>
  <litleToken>Token</litleToken>
  <tokenResponseCode>Response Code</tokenResponseCode>
  <tokenMessage>Response Message</tokenMessage>
  <type>Method of Payment</type>
  <bin>BIN</bin>
  <eCheckAccountSuffix>Last 3 of Account Number</eCheckAccountSuffix> (returned
for eCheck account tokens)
</tokenResponse>
```

## 4.387 tokenResponseCode

The `tokenResponseCode` element provides a 3-digit code (see [Table 4-3](#)) indicating the results of a transaction involving the conversion or attempted conversion of an account number to a token. The `tokenMessage` element contains a short, human-readable explanation of the `tokenResponseCode`.

**Type** = String; **minLength** = N/A; **maxLength** = 3

### Parent Elements:

[tokenResponse](#)

### Attributes:

None

### Child Elements:

None

**TABLE 4-3** tokenResponseCode and tokenMessage Values

Code	Message
801	Account number was successfully registered
802	Account number was previously registered
820	Credit card number was invalid
821	Merchant is not authorized for tokens
822	Token was not found
823	Token was Invalid
898	Generic token registration error
899	Generic token use error

## 4.388 totalHealthcareAmount

The totalHealthcareAmount element is a required child of the healthcareAmounts element and defines the total amount of healthcare related purchases. This value must be the greater than or equal to the sum of the values applied to the following elements: RxAmount, visionAmount, clinicOtherAmount, and dentalAmount. The decimal is implied. Example: 500 = \$5.00.

**Type** = Integer; **totalDigits** = 8

### Parent Elements:

Optional: [healthcareAmounts](#)

### Attributes:

None

### Child Elements:

None

## 4.389 track

The `track` element is child of the `card` element, which is required for card-present transactions. The contents of the `track` element is the data read from the magnetic stripe.

**Type** = String; **minLength** = 1; **maxLength** = 256

### Parent Elements:

[card](#)

### Attributes:

None

### Child Elements:

None

## 4.390 track1Status

The `track1Status` element is a required child of the `mpos` element. This element indicates whether the device read track 1 from the magnetic stripe. A value of 0 indicates a successful read, while a value of 1 indicates a failure.

**Type** = Integer; **minInclusive** = 0; **maxInclusive** = 1028

### Parent Elements:

[mpos](#)

### Attributes:

None

### Child Elements:

None

## 4.391 track2Status

The `track2Status` element is a required child of the `mpos` element. This element indicates whether the device read track 2 from the magnetic stripe. A value of 0 indicates a successful read, while a value of 1 indicates a failure.

**Type** = Integer; **minInclusive** = 0; **maxInclusive** = 1028

### Parent Elements:

[mpos](#)

### Attributes:

None

### Child Elements:

None

## 4.392 transactionAmount

The `transactionAmount` element is an optional child of the `applepayResponse` element and specifies the amount of the transaction. The decimal is implied. Example: 500 = \$5.00.

**Type** = Integer; **totalDigits** = 12

**Parent Elements:**

[applepayResponse](#)

**Attributes:**

None

**Child Elements:**

None

## 4.393 transactionId

The `transactionId` element is used in two locations: in PayPal transactions, as a child of the `paypal` element and in Apple Pay transactions as a child of the `header` element.

### 4.393.1 transactionId as a Child of the paypal element

The `transactionId` element is a required child of the `paypal` element, specifying the transaction Id returned from PayPal.

---

**NOTE:** The value of the `<transactionId>` element must match the `TRANSACTIONID` value returned by the `DoExpressCheckoutPayment` call operation to PayPal.

---

**Type** = String; **minLength** = N/A; **maxLength** = N/A

**Parent Elements:**

[paypal](#)

**Attributes:**

None

**Child Elements:**

None

### 4.393.2 transactionId as a Child of the header element

The `transactionId` element is a required child of the `header` element and provides the hexadecimal transaction identifier generated on the device for an Apple Pay transaction.

**Type** = Hex Encoded String; **minLength** = N/A; **maxLength** = 250

**Parent Elements:**

[header](#)

**Attributes:**

None



**Child Elements:**

None

## 4.394 trialIntervalType

The `trialIntervalType` element is an optional child of the `createPlan` element and defines the interval period of a trial associated with the Plan. The overall length of a trial period is defined by the `trialIntervalType` combined with the `trialNumberOfIntervals` element.

**Type** = String (enum); **minLength** = N/A; **maxLength** = N/A

### Parent Elements:

[createPlan](#)

### Attributes:

None

### Child Elements:

None

### Enumerations:

Enumeration	Description
MONTH	The trial interval one month.
DAY	The trial interval one day.

## 4.395 trialNumberOfIntervals

The `trialNumberOfIntervals` element is an optional child of the `createPlan` element and defines the number of trial intervals (`trialIntervalType`) associated with the Plan. The overall length of a trial period is defined by the `trialIntervalType` combined with the `trialNumberOfIntervals` element.

**Type** = Integer; **minLength** = 1; **maxLength** = 99

### Parent Elements:

[createPlan](#)

### Attributes:

None

### Child Elements:

None

## 4.396 triggeredRule

The `triggeredRule` element is an optional child of the `advancedFraudResult` element. It can appear multiple times in the response, once for each triggered rule from the ThreatMetrix policy. A triggered rule is one where the threshold is exceeded.

**Type** = String; **minLength** = N/A; **maxLength** = 64

### Parent Elements:

[advancedFraudResults](#)

### Attributes:

None

### Child Elements:

None

## 4.397 txnTime

The `txnTime` element is an optional child of the `giftCardResponse` element, which specifies the date and time the transaction was processed by Vantiv. You should retain this value for possible future use in other gift card transactions, such as `giftCardCapture` and most reversal transactions. The format of the element is YYYY-MM-DDTHH:MM:SS. For example, 2016-11-21T11:00:00.

**Type** = dateTime; **minLength** = N/A; **maxLength** = 20

### Parent Elements:

[giftCardResponse](#)

### Attributes:

None

### Child Elements:

None

## 4.398 type

The `type` element has two uses in the `cnpAPI` depending upon the parent. In one case it defines the type of account used in the transaction in terms of association, company, PayPal, or eCheck. When used as a child of the `fundingSource` element, it defines the card type in terms of prepaid, credit, debit, FSA, or unknown.

### 4.398.1 type Element as a Child of the parent elements listed below

This `type` element defines the type of account used in the transaction in terms of card association, card company, PayPal, or eCheck.

**Type** = String (Enum); **minLength** = N/A; **maxLength** = 2

#### Parent Elements:

[accountInformation](#), [newCardInfo](#), [newCardTokenInfo](#), [originalCard](#), [originalCardInfo](#), [originalCardTokenInfo](#), [originalToken](#), [updatedCard](#), [updatedToken](#), [registerTokenResponse](#), [tokenResponse](#), [card](#), [paypage](#), [token](#)

#### Attributes:

None

#### Child Elements:

None

#### Enumerations:

Enumeration	Description
MC	MasterCard
VI	Visa
AX	American Express
DC	Diner's Club (see <a href="#">Table B-1</a> )
DI	Discover
PP	PayPal
JC	JCB (Japanese Credit Bureau)
BL	PayPal Credit
EC	eCheck

Enumeration	Description
GC	Gift Card
"" (empty)	Card type unknown or undefined

#### 4.398.2 type Element as a Child of fundingSource

This `type` element defines the card type in terms of prepaid, credit, debit, FSA, or unknown.

**Type** = String (Enum); **minLength** = N/A; **maxLength** = N/A

##### Parent Elements:

[fundingSource](#)

##### Attributes:

None

##### Child Elements:

None

##### Enumerations:

Enumeration	Description
UNKNOWN	The card type can not be determined.
PREPAID	This is a prepaid card.
CREDIT	This is a credit card.
DEBIT	This is a debit card.
FSA	This is a Flexible Spending Account card. Cards of this type can be used only for IRS-approved healthcare items.

---

**NOTE:** The `fundingSource` element and its child elements, `type` and `availableBalance` are associated with the Insights features (see [Issuer Insights](#) on page 24.)

Please consult your Relationship Manager for additional information.

---

## 4.399 unitCost

The `unitCost` element is an optional child of the `lineItemData` element, which specifies the price of one unit of the item purchased. Although the schema defines it as an optional child of the `enhancedData` element, it is required by Visa for Level III interchange rates. The value must be greater than or equal to 0.

**Type** = Decimal; **minInclusive value** = 0, **totalDigits** = 12

### Parent Elements:

[lineItemData](#)

### Attributes:

None

### Child Elements:

None



## 4.400 unitOfMeasure

The `unitOfMeasure` element is an optional child of the `lineItemData` element, which specifies the unit of measure of the purchased item. For example, each, kit, pair, gallon, and month would all be valid values. Although an optional element, it is required by Visa and MasterCard when specifying line item data.

**Type** = String; **minLength** = 1; **maxLength** = 12

### Parent Elements:

[lineItemData](#)

### Attributes:

None

### Child Elements:

None

## 4.401 unload

The `unload` element is the parent element for the transaction type that removes funds from a Gift Card.

### Parent Elements:

[littleOnlineRequest](#), [batchRequest](#)

### Attributes:

Attribute Name	Type	Required?	Description
id	String	Yes	A unique identifier assigned by the presenter and mirrored back in the response. <b>minLength = 1    maxLength = 36</b>
customerId	String	No	A value assigned by the merchant to identify the consumer. <b>minLength = N/A    maxLength = 50</b>
reportGroup	String	Yes	Required attribute that defines the merchant sub-group in the user interface where this transaction will be displayed. Please refer to <a href="#">Coding for Report Groups</a> on page 10 for additional information. <b>minLength = 1    maxLength = 25</b>

### Child Elements: (all Required)

[amount](#), [orderSource](#), [card](#)

## 4.402 unloadResponse

The `unloadResponse` element is the parent element for information returned to you in response to an `unload` transaction. It can be a child of either a `littleOnlineResponse` element or a `batchResponse` element.

### Parent Elements:

[littleOnlineResponse](#), [batchResponse](#)

### Attributes:

Attribute Name	Type	Required?	Description
id	String	Yes	The response returns the same value submitted in the Unload transaction. <b>minLength = 1    maxLength = 36</b>
customerId	String	No	The response returns the same value submitted in the Unload transaction. <b>minLength = N/A    maxLength = 50</b>
reportGroup	String	Yes	The response returns the same value submitted in the Unload transaction. <b>minLength = 1    maxLength = 25</b>

### Child Elements:

Required: [littleTxnId](#), [response](#), [responseTime](#), [message](#)

Optional: [postDate](#), [fraudResult](#), [giftCardResponse](#)

## 4.403 unloadReversal

The `unloadReversal` element is the parent element for the transaction type that reverses the unloading of a Gift Card.

### Parent Elements:

[litleOnlineRequest](#)

### Attributes:

Attribute Name	Type	Required?	Description
id	String	Yes	A unique identifier assigned by the presenter and mirrored back in the response. <b>minLength = 1    maxLength = 36</b>
customerId	String	No	A value assigned by the merchant to identify the consumer. <b>minLength = N/A    maxLength = 50</b>
reportGroup	String	Yes	Required attribute that defines the merchant sub-group in the user interface where this transaction will be displayed. Please refer to <a href="#">Coding for Report Groups</a> on page 10 for additional information. <b>minLength = 1    maxLength = 25</b>

### Child Elements: (Required)

[card](#), [originalRefCode](#), [originalAmount](#), [originalTxnTime](#), [originalSystemTraceId](#), [originalSequenceNumber](#)

### Child Elements: (Optional)

[litleTxnId](#)

## 4.404 unloadReversalResponse

The `unloadReversalResponse` element is the parent element for information returned to you in response to an `unloadReversal` transaction.

### Parent Elements:

[litleOnlineResponse](#)

### Attributes:

Attribute Name	Type	Required?	Description
id	String	Yes	The response returns the same value submitted in the Unload Reversal transaction. <b>minLength = 1    maxLength = 36</b>
customerId	String	No	The response returns the same value submitted in the Unload Reversal transaction. <b>minLength = N/A    maxLength = 50</b>
reportGroup	String	Yes	The response returns the same value submitted in the Unload Reversal transaction. <b>minLength = 1    maxLength = 25</b>

### Child Elements:

Required: [litleTxnId](#), [response](#), [responseTime](#), [message](#)

Optional: [postDate](#), [giftCardResponse](#)

## 4.405 updateAddOn

The `updateAddOn` element is the parent of several child elements used to modify an additional charge added to an existing subscription.

### Parent Elements:

[updateSubscription](#)

### Attributes:

None

### Child Elements (all Required):

[addOnCode](#), [name](#), [amount](#), [startDate](#), [endDate](#)

### Example: updateAddOn Structure

```
<updateAddOn>
  <addOnCode>Add On Reference Code</addOnCode>
  <name>Name of Add On</name>
  <amount>Amount of Add On</amount>
  <startDate>Start Date of Add On Charge</startDate>
  <endDate>End Date of Add On Charge</endDate>
</updateAddOn>
```

## 4.406 updatedCard

The updatedCard element is an optional child of the accountUpdateResponse element, which contains child elements providing the updated information for the submitted card.

### Parent Elements:

[accountUpdateResponse](#)

### Attributes:

None

### Child Elements:

[type](#), [number](#), [expDate](#)

### Example: updatedCard Structure

```
<updatedCard>
  <type>Card Type</type>
  <number>New Account Number</number>
  <expDate>New Expiration Date</expDate>
</updatedCard>
```

## 4.407 updateCardValidationNumOnToken

The `updateCardValidationNumOnToken` element is the parent element for the transaction type used to update a CVV2/CVC2/CID code stored temporarily on the platform. You should only use this transaction type if you had previously submitted the account number and security code in a `registerTokenRequest` transaction and now need to change the CVV2/CVC2/CID value.

### Parent Elements:

[litleOnlineRequest](#), [batchRequest](#)

### Attributes:

Attribute Name	Type	Required?	Description
id	String	Yes	A unique identifier assigned by the presenter and mirrored back in the response. <b>minLength = 1    maxLength = 36</b>
customerId	String	No	A value assigned by the merchant to identify the consumer. <b>minLength = N/A    maxLength = 50</b>
reportGroup	String	Yes	Required attribute that defines the merchant sub-group in the user interface where this transaction will be displayed. Please refer to <a href="#">Coding for Report Groups</a> on page 10 for additional information. <b>minLength = 1    maxLength = 25</b>

### Child Elements:

Required: [litleToken](#), [cardValidationNum](#)

Optional: [orderId](#)



## 4.408 updateCardValidationNumOnTokenResponse

The updateCardValidationOnTokenResponse element is the parent element for the response to updateCardValidationNumOnToken transactions.

**Parent Elements:**

[litleOnlineResponse](#), [batchResponse](#)

**Attributes:**

Attribute Name	Type	Required?	Description
id	String	Yes	The response returns the same value submitted in the updateCardValidationOnToken transaction. <b>minLength = 1    maxLength = 36</b>
customerId	String	No	The response returns the same value submitted in the updateCardValidationOnToken transaction. <b>minLength = N/A    maxLength = 50</b>
reportGroup	String	Yes	The response returns the same value submitted in the updateCardValidationOnToken transaction. <b>minLength = 1    maxLength = 25</b>

**Child Elements:**

Required: [litleTxnId](#), [response](#), [message](#), [responseTime](#)

## 4.409 updateDiscount

The `updateDiscount` element is the parent of several child elements used to define updates to a discount applied to an existing subscription.

### Parent Elements:

[updateSubscription](#)

### Attributes:

None

### Child Elements (all Required):

[discountCode](#), [name](#), [amount](#), [startDate](#), [endDate](#)

### Example: customerInfo Structure

```
<updateDiscount>
  <discountCode>Discount Reference Code</discountCode>
  <name>Name of Discount</name>
  <amount>Amount of Discount</amount>
  <startDate>Start Date of Discount</startDate>
  <endDate>End Date of Discount</endDate>
</updateDiscount>
```

## 4.410 updatePlan

The `updatePlan` element is the parent of the transaction used to activate/deactivate Plans associated with recurring payments. When you deactivate a Plan, you can no longer reference that Plan for use with subscriptions. Existing subscriptions making use of the deactivated Plan will continue to use the Plan until either modified or completed. You can also reactivate a deactivated Plan by updating the Plan and setting the `active` flag to true.

### Parent Elements:

[litleOnlineRequest](#), [litleRequest](#)

### Attributes:

None

### Child Elements:

[planCode](#), [active](#)

### Example: createPlan Structure

```
<updatePlan>
  <planCode>Plan Reference Code</planCode>
  <active>true or false</active>
</updatePlan>
```

## 4.411 updatePlanResponse

The `updatePlanResponse` element is the parent of the response message to the `updatePlan` transaction used to deactivate Plans associated with recurring payments.

### Parent Elements:

[littleOnlineResponse](#), [batchResponse](#)

### Attributes:

None

### Child Elements:

[littleTxnId](#), [response](#), [message](#), [responseTime](#), [planCode](#)

### Example: updatePlan Structure

```
<updatePlan>
  <littleTxnId>Transaction ID</littleTxnId>
  <response>Response Reason Code</response>
  <message>Response Message</message>
  <responseTime>Date and Time in GMT</responseTime>
  <planCode>Plan Reference Code</planCode>
</updatePlan>
```

## 4.412 updateSubscription

The `updateSubscription` element is the parent element for the transaction that updates the subscription information associated with a recurring payment. Using this transaction type you can change the plan, card, billing information, and/or billing date. You can also create, update, or delete a Discount and/or an Add On.

### Parent Elements:

`litleOnlineRequest`, `batchRequest`

### Attributes:

None

### Child Elements:

Required: `subscriptionId`

Optional: `planCode`, `billToAddress`, (choice of) `card`, `paypage`, or `token`, `billingDate`, `createDiscount`, `deleteDiscount`, `updateDiscount`, `createAddOn`, `updateAddOn`, `deleteAddOn`

### Example: updateSubscription - Change Plan

```
<updateSubscription>
  <subscriptionId>Subscription Id</subscriptionId>
  <planCode>New Plan Code</planCode>
</updateSubscription>
```

### Example: updateSubscription - Change Card

```
<updateSubscription>
  <subscriptionId>Subscription Id</subscriptionId>
  <card>
    <type>Card Type Abbreviation</type>
    <number>Account Number</number>
    <expDate>Expiration Date</expDate>
  </card>
</updateSubscription>
```

### Example: updateSubscription - Change Billing Date

```
<updateSubscription>
  <subscriptionId>Subscription Id</subscriptionId>
```

```
<billingDate>New Billing Date</billingDate>
</updateSubscription>
```

**Example: updateSubscription - Change Billing Info**

```
<updateSubscription>
  <subscriptionId>Subscription Id</subscriptionId>
  <billToAddress>
    <name>Customer's Full Name</name>
    <companyName>Company's Name</companyName>
    <addressLine1>Address Line 1</addressLine1>
    <addressLine2>Address Line 2</addressLine2>
    <addressLine3>Address Line 3</addressLine3>
    <city>City</city>
    <state>State Abbreviation</state>
    <zip>Postal Code</zip>
    <country>Country Code</country>
    <email>Email Address</email>
    <phone>Telephone Number</phone>
  </billToAddress>
</updateSubscription>
```

**Example: updateSubscription - Create Discount**

```
<updateSubscription>
  <subscriptionId>Subscription Id</subscriptionId>
  <createDiscount>
    <discountCode>Discount Reference Code</discountCode>
    <name>Name of Discount</name>
    <amount>Amount of Discount</amount>
    <startDate>Start Date of Discount</startDate>
    <endDate>End Date of Discount</endDate>
  </createDiscount>
</updateSubscription>
```

**Example: updateSubscription - Create Add On**

```
<updateSubscription>
  <subscriptionId>Subscription Id</subscriptionId>
```

```
<createAddOn>
  <addOnCode>Add On Reference Code</addOnCode>
  <name>Name of Add On</name>
  <amount>Amount of Add On</amount>
  <startDate>Start Date of Add On Charge</startDate>
  <endDate>End Date of Add On Charge</endDate>
</createAddOn>
</updateSubscription>
```

**Example: updateSubscription - Update Discount**

```
<updateSubscription>
  <subscriptionId>Subscription Id</subscriptionId>
  <updateDiscount>
    <discountCode>Discount Reference Code</discountCode>
    <name>Name of Discount</name>
    <amount>Amount of Discount</amount>
    <startDate>Start Date of Discount</startDate>
    <endDate>End Date of Discount</endDate>
  </updateDiscount>
</updateSubscription>
```

**Example: updateSubscription - Update Add On**

```
<updateSubscription>
  <subscriptionId>Subscription Id</subscriptionId>
  <updateAddOn>
    <addOnCode>Add On Reference Code</addOnCode>
    <name>Name of Add On</name>
    <amount>Amount of Add On</amount>
    <startDate>Start Date of Add On Charge</startDate>
    <endDate>End Date of Add On Charge</endDate>
  </updateAddOn>
</updateSubscription>
```

**Example: updateSubscription - Delete Discount**

```
<updateSubscription>
  <subscriptionId>Subscription Id</subscriptionId>
```

```
<deleteDiscount>
  <discountCode>Discount Reference Code</discountCode>
</deleteDiscount>
</updateSubscription>
```

**Example: updateSubscription - Delete Add On**

```
<updateSubscription>
  <subscriptionId>Subscription Id</subscriptionId>
  <deleteAddOn>
    <addOnCode>Add On Reference Code</addOnCode>
  </deleteAddOn>
</updateSubscription>
```



## 4.413 updateSubscriptionResponse

The updateSubscriptionResponse element is the parent element for the response to an updateSubscription transaction.

**Parent Elements:**

littleOnlineResponse, batchResponse

**Attributes:**

None

**Child Elements:**

subscriptionId, littleTxnId, response, message, responseTime, tokenResponse

## 4.414 updatedToken

The updatedToken element is an optional child of the accountUpdateResponse element, which contains child elements providing the updated information for the submitted token.

### Parent Elements:

[accountUpdateResponse](#)

### Attributes:

None

### Child Elements:

[type](#), [number](#), [expDate](#), [bin](#)

### Example: originalCard Structure

```
<updatedToken>
  <littleToken>New Token Number</littleToken>
  <expDate>New Expiration Date</expDate>
  <type>Card Type</type>
  <bin>Card BIN</bin>
</updatedToken>
```

## 4.415 url

The `url` element is an optional child of the `customBilling` element. You use it to designate your customer service web site instead of providing a customer service phone number. This element may include any of the following characters: A-Z, a-z, 0-9, /, \, -, ., or \_.

**Type** = String; **minLength** = N/A; **maxLength** = 13

---

---

**NOTE:** Please consult your Relationship Manager prior to attempting to use the `<url>` element. This contents of this element are discarded unless you are specifically enabled to use in your cnpAPI submissions.

---

---

### Parent Elements:

[customBilling](#)

### Attributes:

None

### Child Elements:

None

## 4.416 user

The `user` element is a required child of the `authentication` element. It is a unique identifier of the user/merchant used to authenticate that the message is from a valid source.

**Type** = String; **minLength** = N/A; **maxLength** = 20

**Parent Elements:**

[authentication](#)

**Attributes:**

None

**Child Elements:**

None

## 4.417 vendorCredit

The `vendorCredit` element is the parent element for the transaction type that a PayFac uses to move funds from the PayFac Settlement Account the Vendor Account. If you use V11.3 or above, you can submit this transaction type either in a Batch or Online.

---

**NOTE:** You can submit funding instructions either Online or via Batch files, but not both. The two methodologies are mutually exclusive for funding instruction submissions.

---

### Parent Elements:

[batchRequest](#), [litleOnlineRequest](#)

### Attributes:

Attribute Name	Type	Required?	Description
id	String	Yes	A unique identifier assigned by the presenter and mirrored back in the response. <b>minLength = 1    maxLength = 36</b>
customerId	String	No	A value assigned by the merchant to identify the consumer. <b>minLength = N/A    maxLength = 50</b>
reportGroup	String	Yes	For PayFacs, this attribute does not segregate transactions in iQ. This field does appear in various SSR reports. <b>minLength = 1    maxLength = 25</b>

### Child Elements:

Required: [accountInfo](#), [amount](#), [fundingSubmerchantId](#), [fundsTransferId](#), [vendorName](#)

## 4.418 vendorCreditResponse

The `vendorCreditResponse` element is the parent element for information returned to you in response to a `vendorCredit` transaction.

### Parent Elements:

[batchResponse](#), [litleOnlineResponse](#)

### Attributes:

Attribute Name	Type	Required?	Description
id	String	Yes	The response returns the same value submitted in the <code>payFacCredit</code> transaction. <b>minLength = 1    maxLength = 36</b>
customerId	String	No	The response returns the same value submitted in the <code>payFacCredit</code> transaction. <b>minLength = N/A    maxLength = 50</b>
reportGroup	String	Yes	The response returns the same value submitted in the <code>submerchantCredit</code> transaction. <b>minLength = 1    maxLength = 25</b>
duplicate	boolean	No	If the request is a duplicate, the response includes the duplicate flag set to <b>true</b> and the entire original response. <b>Note:</b> This attribute applies only to Online Dynamic Payout Funding Instruction responses.

### Child Elements:

Required: [litleTxnId](#), [fundsTransferId](#), [response](#), [responseTime](#), [message](#)

Required (Online): [postDate](#)

## 4.419 vendorDebit

The `vendorDebit` element is the parent element for the transaction type that a PayFac uses to move funds from the Vendor Account to the PayFac Settlement Account. If you use V11.3 or above, you can submit this transaction type either in a Batch or Online.

---

**NOTE:** You can submit funding instructions either Online or via Batch files, but not both. The two methodologies are mutually exclusive for funding instruction submissions.

---

### Parent Elements:

[batchRequest](#), [litleOnlineRequest](#)

### Attributes:

Attribute Name	Type	Required?	Description
id	String	Yes	A unique identifier assigned by the presenter and mirrored back in the response. <b>minLength = 1    maxLength = 36</b>
customerId	String	No	A value assigned by the merchant to identify the consumer. <b>minLength = N/A    maxLength = 50</b>
reportGroup	String	Yes	For PayFacs, this attribute does not segregate transactions in iQ. This field does appear in various SSR reports. <b>minLength = 1    maxLength = 25</b>

### Child Elements:

Required: [accountInfo](#), [amount](#), [fundingSubmerchantId](#), [fundsTransferId](#), [vendorName](#)

## 4.420 vendorDebitResponse

The `vendorDebitResponse` element is the parent element for information returned to you in response to a `vendorDebit` transaction.

### Parent Elements:

[batchResponse](#), [litleOnlineResponse](#)

### Attributes:

Attribute Name	Type	Required?	Description
id	String	Yes	The response returns the same value submitted in the <code>payFacCredit</code> transaction. <b>minLength = 1    maxLength = 36</b>
customerId	String	No	The response returns the same value submitted in the <code>payFacCredit</code> transaction. <b>minLength = N/A    maxLength = 50</b>
reportGroup	String	Yes	The response returns the same value submitted in the <code>submerchantCredit</code> transaction. <b>minLength = 1    maxLength = 25</b>
duplicate	boolean	No	If the request is a duplicate, the response includes the duplicate flag set to <b>true</b> and the entire original response. <b>Note:</b> This attribute applies only to Online Dynamic Payout Funding Instruction responses.

### Child Elements:

Required: [litleTxnId](#), [fundsTransferId](#), [response](#), [responseTime](#), [message](#)

Required (Online): [postDate](#)



## 4.421 vendorName

The vendorName element is a required child of both the vendorCredit and vendorDebit elements and specifies the name of the vendor involved in the funding instructions.

**Type** = String; **minLength** = 1; **maxLength** = 256

**Parent Elements:**

vendorCredit, vendorDebit

**Attributes:**

None

**Child Elements:**

None

## 4.422 verificationCode

---

---

**NOTE:** This element is not used at this time.

---

---

The `verificationCode` element is an optional child of the `echeckSaleResponse` element. It specifies the verification code from the associated eCheck Sale transaction.

**Type** = String; **minLength** = N/A; **maxLength** = 6

**Parent Elements:**

[echeckSalesResponse](#)

**Attributes:**

None

**Child Elements:**

None

## 4.423 verify

The `verify` element is an optional child of the `echeckSale` element, which allows you to specify to perform an eCheck Verification prior to processing the sale. If the account fails the verification operation, the system does not process the sale.

**Type** = Boolean; **Valid Values** = true or false

**Parent Elements:**

[echeckSale](#)

**Attributes:**

None

**Child Elements:**

None

## 4.424 version

The `version` element is a required child of the `applepay` element and provides version information about the payment token.

**Type** = String; **minLength** = 5; **maxLength** = 20

**Parent Elements:**

[applepay](#)

**Attributes:**

None

**Child Elements:**

None

## 4.425 virtualAccountNumber

The `virtualAccountNumber` element is an optional child of the `enhancedAuthResponse` element and indicates if the card number used for the transaction corresponds to a virtual account number.

**Type** = Boolean; **Valid Values** = true or false

**Parent Elements:**

[enhancedAuthResponse](#)

**Attributes:**

None

**Child Elements:**

None

## 4.426 virtualAuthenticationKeyData

The virtualAuthenticationKeyData is an optional child of the billMeLaterRequest element.

**Type** = String; **minLength** = N/A; **maxLength** = 4

**Parent Elements:**

[billMeLaterRequest](#)

**Attributes:**

None

**Child Elements:**

None

## 4.427 virtualAuthenticationKeyPresenceIndicator

The `virtualAuthenticationKeyPresenceIndicator` is an optional child of the `billMeLaterRequest` element.

**Type** = String; **minLength** = N/A; **maxLength** = 1

### Parent Elements:

[batchRequest](#)

### Attributes:

None

### Child Elements:

None

## 4.428 virtualGiftCard

The `virtualGiftCard` element is an optional child of the `activate` transaction. You include this element when you are requesting a Virtual Gift Card.

---

---

**NOTE:** In an early iteration of schema V8.22 issued in September of 2013 the `accountNumberLength` and `giftCardBin` child elements were defined as optional. If you coded to the earlier version, be aware that these elements are now required children of `virtualGiftCard`. If you do not include these elements, the transaction will fail XML validation.

---

---

### Parent Elements:

[activate](#)

### Attributes:

None

### Child Elements (all required):

[accountNumberLength](#), [giftCardBin](#)

### Example: virtualGiftCard Structure

```
<virtualGiftCard>
  <accountNumberLength>Length of Virtual Card Number</accountNumberLength>
  <giftCardBin>Requested BIN of Virtual Gift Card</giftCardBin>
</virtualGiftCard>
```



## 4.429 virtualGiftCardBin

The `VirtualGiftCardBin` element is an optional child of the `activateReversal` element defining the BIN of the virtual Gift Card.

**Type** = String; **minLength** = N/A; **maxLength** = 10

**Parent Elements:**

[activateReversal](#)

**Attributes:**

None

**Child Elements:**

None

## 4.430 virtualGiftCardResponse

The `virtualGiftCardResponse` element is an optional child of the `activateResponse` transaction. This element is returned when you request a Virtual Gift Card number via an `activate` transaction and through its children, defines the virtual gift Card number, as well as the Card Validation number.

### Parent Elements:

[activateResponse](#)

### Attributes:

None

### Child Elements (all optional):

[accountNumber](#), [cardValidationNum](#), [pin](#)

### Example: virtualGiftCardResponse Structure

```
<virtualGiftCardResponse>
  <accountNumber>Virtual Card Number</accountNumber>
  <cardValidationNum>Validation Number</cardValidationNum>
  <pin>Pin Number</pin>
</virtualGiftCardResponse>
```

## 4.431 visionAmount

The `visionAmount` element is an optional child of the `healthcareAmounts` element and defines the healthcare amount used for vision related purchases. The decimal is implied.

Example: 500 = \$5.00.

**Type** = Integer; **totalDigits** = 8

### Parent Elements:

Optional: [healthcareAmounts](#)

### Attributes:

None

### Child Elements:

None

## 4.432 void

The `void` element is the parent element for all Void transactions. You can use this element only in Online transactions. If you use this Recycling Engine, you can use the `void` transaction to halt the recycling of a `sale` transaction.

---

**NOTE:** Before submitting a Void, please allow a minimum of 60 seconds to elapse after submitting the transaction you wish to void. This timing ensures our system fully records the first (to be voided) transaction in our database.

---

### Parent Elements:

[litleOnlineRequest](#)

### Attributes:

Attribute Name	Type	Required?	Description
id	String	Yes	A unique identifier assigned by the presenter and mirrored back in the response. <b>minLength = 1    maxLength = 36</b>
customerId	String	No	A value assigned by the merchant to identify the consumer. <b>minLength = N/A    maxLength = 50</b>
reportGroup	String	Yes	Required attribute that defines the merchant sub-group in the user interface where this transaction will be displayed. Please refer to <a href="#">Coding for Report Groups</a> on page 10 for additional information. <b>minLength = 1    maxLength = 25</b>

### Child Elements:

Required: [litleTxnId](#)

Optional: [processingInstructions](#)

## 4.433 voidResponse

The `voidResponse` element is the parent element for information returned to you in response to a Void transaction.

### Parent Elements:

[littleOnlineResponse](#)

### Attributes:

Attribute Name	Type	Required?	Description
id	String	Yes	The response returns the same value submitted in the void transaction. <b>minLength = 1    maxLength = 36</b>
customerId	String	No	The response returns the same value submitted in the void transaction. <b>minLength = N/A    maxLength = 50</b>
reportGroup	String	Yes	The response returns the same value submitted in the void transaction. <b>minLength = 1    maxLength = 25</b>

### Child Elements: (Required)

[littleTxnId](#), [response](#), [responseTime](#), [message](#), [postDate](#)

### Child Elements: (Optional)

[recycling](#)

## 4.434 wallet

The `wallet` element is an optional child of the of both the `authorization` and `sale` transactions. You must use this element along with its child elements, when the consumer uses MasterPass or Visa Checkout to make a purchase.

**Parent Elements:**

[authorization](#), [sale](#)

**Attributes:**

None

**Child Elements:**

[walletSourceType](#), [walletSourceTypeId](#)

**Example: wallet Structure**

```
<wallet>
  <walletSourceType>MasterPass or VisaCheckout</walletSourceType>
  <walletSourceTypeId>MasterPass ID or VCIND</walletSourceTypeId>
</wallet>
```

## 4.435 walletSourceType

The `walletSourceType` element is a required child of the `wallet` element, which defines the source of the transaction information. You must submitted this element with the transaction when the consumer uses MasterPass or Visa Checkout.

**Type** = String (Enum); **minLength** = N/A; **maxLength** = N/A

### Parent Elements:

[wallet](#)

### Attributes:

None

### Child Elements:

None

### Enumerations:

Enumeration	Description
MasterPass	The origin of the information used in the transaction is from MasterPass.
VisaCheckout	The origin of the information used in the transaction is from Visa Checkout.

## 4.436 walletSourceTypeId

The `walletSourceTypeId` element is a required child of the `wallet` element. For MasterPass transactions, the value of this element is returned from MasterPass. For Visa Checkout transactions, set this value to VCIND.

**Type** = String; **minLength** = N/A; **maxLength** = N/A

### Parent Elements:

[wallet](#)

### Attributes:

None

### Child Elements:

None



## 4.437 yearsAtEmployer

The `yearsAtEmployer` element is an optional child of the `customerInfo` element and defines the number of years the customer has worked for their current employer. It is used in combination with several other elements to provide required information for some PayPal Credit transactions.

---

---

**NOTE:** As of September, 2016, the Vantiv eCommerce platform no longer supports PayPal Credit for new merchants or existing merchants not already using this payment method. Existing merchants already using PayPal Credit should consult their Vantiv Relationship Manager.

---

---

**Type** = Integer; **totalDigits** = 2

**Parent Elements:**

[customerInfo](#)

**Attributes:**

None

**Child Elements:**

None

## 4.438 yearsAtResidence

The `yearsAtResidence` element is an optional child of the `customerInfo` element and defines the number of years the customer has resided in their current domicile. It is used in combination with several other elements to provide required information for some PayPal Credit transactions.

---

---

**NOTE:** As of September, 2016, the Vantiv eCommerce platform no longer supports PayPal Credit for new merchants or existing merchants not already using this payment method. Existing merchants already using PayPal Credit should consult their Vantiv Relationship Manager.

---

---

Type = Integer; totalDigits = 2

### Parent Elements:

[customerInfo](#)

### Attributes:

None

### Child Elements:

None

## 4.439 zip

The `zip` element defines the customer's postal code in both the `billToAddress` and `shipToAddress` elements.

**Type** = String; **minLength** = N/A; **maxLength** = 20

---

**NOTE:** Although the schema specifies the **maxLength** of the `zip` element as 20 characters, in practice you should never exceed 10 characters in your submissions.

If including the `zip` element for eCheck Verification, do not exceed 9 characters and do not use dashes.

---

### Parent Elements:

[billToAddress](#), [shipToAddress](#)

### Attributes:

None

### Child Elements:

None



---

## PAYMENT TRANSACTION RESPONSE CODES

This appendix provides reference material regarding the codes that are returned in a cnpAPI response for a payment transaction. This appendix contains the following sections:

- [Payment Transaction Response Codes](#)
- [3DS Authentication Result Codes](#)
- [AVS Response Codes](#)
- [AAVS Response Codes](#)
- [Card Validation Response Codes](#)
- [Advanced Fraud Tools Triggered Rules](#)
- [XML Validation Error Messages](#)
- [Additional Response Header Error Messages](#)
- [ACH Return Reason Codes](#)
- [ACH NoC Change Codes](#)
- [Canadian eCheck Return Codes](#)

## A.1 Payment Transaction Response Codes

This section contains a list of codes and messages that the system can return in the response message for a payment transaction.

---

**NOTE:** For information concerning Chargeback Response Code, see the *Chargeback API Reference Guide*.

---

Table A-1 shows all possible values for the <response> and <message> elements. You should code appropriately to handle all codes applicable to the transactions you use.

- The Response Code value appears in the <response> element.
- The Response Message value appears in the <message> element.

**TABLE A-1** Valid Values for the Response and Message Elements

Response Code	Response Message	Response Type	Description
001	Transaction Received	Info	This is sent to acknowledge that the submitted transaction has been received.
000	Approved	Approved	No action required.
010	Partially Approved	Approved	The authorized amount is less than the requested amount.
011	Offline Approval	Approved	Offline approval issued while the terminal is unable to communicate with the issuer.
013	Offline Approval (unable to go online)	Approved	Offline approval issued while the terminal is unable to communicate with the issuer.
100	Processing Network Unavailable	Soft Decline	There is a problem with the card network. Contact the network for more information.
101	Issuer Unavailable	Soft Decline	There is a problem with the issuer network. Please contact the issuing bank.
102	Re-submit Transaction	Soft Decline	There is a temporary problem with your submission. Please re-submit the transaction.

**TABLE A-1** Valid Values for the Response and Message Elements (Continued)

Response Code	Response Message	Response Type	Description
108	Try again later	Soft	Returned if the eProtect token is not immediately available, when submitting an Auth or Sale transaction.
110	Insufficient Funds	Soft Decline	The card does not have enough funds to cover the transaction.
111	<b>Authorization amount has already been depleted</b>	<b>Hard Decline</b>	<b>The total amount of the original Authorization has been used.</b> Appears in Declined Transaction report.
120	Call Issuer	Referral or Soft Decline	There is an unspecified problem, contact the issuing bank.
121	Call AMEX	Referral	There is an unspecified problem; contact AMEX.
122	Call Diners Club	Referral	There is an unspecified problem; contact Diners Club.
123	Call Discover	Referral	There is an unspecified problem; contact Discover.
124	Call JBS	Referral	There is an unspecified problem; contact JBS.
125	Call Visa/MasterCard	Referral	There is an unspecified problem; contact Visa or MasterCard.
126	Call Issuer - Update Cardholder Data	Referral	Some data is out of date; contact the issuer to update this information.
127	<b>Exceeds Approval Amount Limit</b>	<b>Hard Decline</b>	<b>This transaction exceeds the daily approval limit for the card.</b>
130	Call Indicated Number	Referral	There is an unspecified problem; contact the phone number provided.
140	Update Cardholder Data	Referral	Cardholder data is incorrect; contact the issuing bank.
150	Original transaction found.	Info	A Query transaction response indicating that the original transaction was found.
151	Original transaction not found.	Info	A Query transaction response indicating that the original transaction was not found.

**TABLE A-1** Valid Values for the Response and Message Elements (Continued)

Response Code	Response Message	Response Type	Description
152	Original transaction found, but response not yet available.	Info	A Query transaction response indicating that the original transaction was found, but the final response information is not yet available.
153	Query transaction not enabled.	Info	A Query transaction response indicating that you are not enabled for use of the Query transaction.
191	The merchant is not registered in the update program.	N/A	This is an Account Updater response indicating a set-up problem that must be resolved prior to submitting another request file. Escalate this to your Relationship Manager.
<b>192</b>	<b>Merchant not certified/enabled for IIAS</b>	<b>Hard Decline</b>	<b>Your organization is not certified or enabled for IIAS/FSA transactions.</b>
206	Issuer Generated Error	Soft Decline	An unspecified error was returned by the issuer. Please retry the transaction and if the problem persist, contact the issuing bank.
<b>207</b>	<b>Pickup card - Other than Lost/Stolen</b>	<b>Hard Decline</b>	<b>The issuer indicated that the gift card should be removed from use.</b>
<b>209</b>	<b>Invalid Amount</b>	<b>Hard Decline</b>	<b>The specified amount is invalid for this transaction.</b>
<b>211</b>	<b>Reversal Unsuccessful</b>	<b>Hard Decline</b>	<b>The reversal transaction was unsuccessful.</b>
<b>212</b>	<b>Missing Data</b>	<b>Hard Decline</b>	<b>Contact your Relationship Manager.</b>
<b>213</b>	<b>Pickup Card - Lost Card</b>	<b>Hard Decline</b>	<b>The submitted card was reported as lost and should be removed from use.</b>
<b>214</b>	<b>Pickup Card - Stolen Card</b>	<b>Hard Decline</b>	<b>The submitted card was reported as stolen and should be removed from use.</b>
<b>215</b>	<b>Restricted Card</b>	<b>Hard Decline</b>	<b>The specified Gift Card is not available for use.</b>



**TABLE A-1** Valid Values for the Response and Message Elements (Continued)

<b>Response Code</b>	<b>Response Message</b>	<b>Response Type</b>	<b>Description</b>
216	Invalid Deactivate	Hard Decline	The Deactivate transaction is invalid for the specified card.
217	Card Already Active	Hard Decline	The submitted card is already active.
218	Card Not Active	Hard Decline	The submitted card has not been activated.
219	Card Already Deactivate	Hard Decline	The submitted card has already been deactivated.
221	Over Max Balance	Hard Decline	The activate or load amount exceeds the maximum allowed for the specified gift Card.
222	Invalid Activate	Hard Decline	The activate transaction is not valid or can no longer be reversed.
223	No transaction Found for Reversal	Hard Decline	The transaction referenced in the reversal transaction does not exist.
226	Incorrect CVV	Hard Decline	The transaction was declined because it was submitted with the incorrect security code.
229	Illegal Transaction	Hard Decline	The transaction would violate the law.
251	Duplicate Transaction	Hard Decline	The transaction is a duplicate of a previously submitted transaction. Appears in Declined Transaction report.
252	System Error	Hard Decline	Contact your Relationship Manager.
253	Deconverted BIN	Hard Decline	The BIN is no longer valid.
254	Merchant Depleted	Hard Decline	No balance remains on gift Card.
255	Gift Card Escheated	Hard Decline	The Gift Card has been seized by the government while resolving an estate.

**TABLE A-1** Valid Values for the Response and Message Elements (Continued)

Response Code	Response Message	Response Type	Description
256	<b>Invalid Reversal Type for Credit Card Transaction</b>	<b>Hard Decline</b>	You attempted to use a <b>Closed Loop Gift Card</b> reversal transaction to reverse a credit card transaction. For example, you cannot use a <b>Deposit Reversal</b> transaction to reverse a <b>Capture</b> . To reverse a credit card <b>Capture</b> transaction, use a <b>Credit</b> transaction.
257	<b>System Error (message format error)</b>	<b>Hard Decline</b>	Issuer reported message format is incorrect. Contact your <b>Relationship Manager</b> .
258	<b>System Error (cannot process)</b>	<b>Hard Decline</b>	Issuer reported transaction could not be processed. Contact your <b>Relationship Manager</b> .
271	Refund rejected due to pending deposit status	Soft Decline	The refund is tied to a deposit that is still in pending state or the state is in doubt. You can retry the refund at a later time.
272	<b>Refund rejected due to declined deposit status</b>	<b>Hard Decline</b>	The refund is tied to a deposit that failed.
273	Refund rejected by the processing network	Soft Decline	The refund is tied to a deposit that succeeded, but was declined by PayPro.
284	<b>Capture, Credit and AuthReversal tags cannot be used for Gift Card Transactions</b>	<b>Hard Decline</b>	You must use the <b>Gift Card</b> version of these transactions for <b>Gift Cards</b> (i.e., <b>giftCardCapture</b> , <b>giftCardCredit</b> , and <b>giftCardAuthReversal</b> ).
301	<b>Invalid Account Number</b>	<b>Hard Decline</b>	The account number is not valid; contact the cardholder to confirm information or inquire about another form of payment.
302	<b>Account Number Does Not Match Payment Type</b>	<b>Hard Decline</b>	The payment type was selected as one card type (e.g. <b>Visa</b> ), but the card number indicates a different card type (e.g. <b>MasterCard</b> ).

**TABLE A-1** Valid Values for the Response and Message Elements (Continued)

Response Code	Response Message	Response Type	Description
303	Pick Up Card	Hard Decline	This is a card present response, but in a card not present environment. Do not process the transaction and contact the issuing bank.
304	Lost/Stolen Card	Hard Decline	The card has been designated as lost or stolen; contact the issuing bank.
305	Expired Card	Hard Decline	The card is expired.
306	Authorization has expired; no need to reverse	Hard Decline	The original Authorization is no longer valid, because it has expired. You can not perform an Authorization Reversal for an expired Authorization.  Appears in Declined Transaction report.
307	Restricted Card	Hard Decline	The card has a restriction preventing approval for this transaction. Please contact the issuing bank for a specific reason.  You may also receive this code if the transaction was declined due to Prior Fraud Advice Filtering and you are using a schema version V8.10 or older.
308	Restricted Card - Chargeback	Hard Decline	This transaction is being declined due the operation of the Prior Chargeback Card Filtering Service or the card has a restriction preventing approval if there are any chargebacks against it.
309	Restricted Card - Prepaid Card Filtering Service	Hard Decline	This transaction is being declined due the operation of the Prepaid Card Filtering service.
310	Invalid track data	Hard Decline	The track data is not valid.

**TABLE A-1** Valid Values for the Response and Message Elements (Continued)

Response Code	Response Message	Response Type	Description
311	Deposit is already referenced by a chargeback	Hard Decline	The deposit is already referenced by a chargeback; therefore, a refund cannot be processed against the original transaction. Appears in Declined Transaction report.
312	Restricted Card - International Card Filtering Service	Hard Decline	This transaction is being declined due the operation of the International Card Filtering Service.
313	International filtering for issuing card country <country> (where <country> is the 3-character country code)	Hard Decline	This is returned when the transaction involves a US based merchant processing Canadian transactions has a transaction that uses a US card.
315	Restricted Card - Auth Fraud Velocity Filtering Service	Hard Decline	This transaction is being declined due the operation of the Auth Fraud Velocity Filtering Service.
316	Automatic Refund Already Issued	Hard Decline	This refund transaction is a duplicate for one already processed automatically by the Fraud Chargeback Prevention Service (FCPS). Appears in Declined Transaction report.
318	Restricted Card - Auth Fraud Advice Filtering Service	Hard Decline	This transaction is being declined due the operation of the Auth Fraud Advice Filtering Service.
319	Restricted Card - Fraud AVS Filtering Service	Hard Decline	This transaction is being declined due the operation of the Auth Fraud AVS Filtering Service.
320	Invalid Expiration Date	Hard Decline	The expiration date is invalid
321	Invalid Merchant	Hard Decline	The card is not allowed to make purchases from this merchant (e.g. a Travel only card trying to purchase electronics).

**TABLE A-1** Valid Values for the Response and Message Elements (Continued)

Response Code	Response Message	Response Type	Description
322	<b>Invalid Transaction</b> <b>Note:</b> If you are enabled for Transaction Filtering, but have not upgraded to use schema version 8.3 or above, the system returns this code for transactions filtered by the Prepaid or International Card Filtering Service. If you are enabled for Velocity Fraud Filtering, but have not upgraded to V8.9, you will receive this code for filtered transactions. If you are enabled for AVS Fraud Filtering, but have not upgraded to V8.13, you will receive this code for filtered transactions.	Hard Decline	The transaction is not permitted; contact the issuing bank.
323	No such issuer	Hard Decline	The card number references an issuer that does not exist. Do not process the transaction.
324	Invalid Pin	Hard Decline	The PIN provided is invalid. Appears in Declined Transaction report
325	Transaction not allowed at terminal	Hard Decline	The transaction is not permitted; contact the issuing bank.
326	Exceeds number of PIN entries	Hard Decline	(Referring to a debit card) The incorrect PIN has been entered excessively and the card is locked.
327	Cardholder transaction not permitted	Hard Decline	Merchant does not allow that card type or specific transaction.
328	Cardholder requested that recurring or installment payment be stopped	Hard Decline	Recurring/Installment Payments no longer accepted by the card issuing bank.
330	Invalid Payment Type	Hard Decline	This payment type is not accepted by the issuer.
331	Invalid POS Capability for Cardholder Authorized Terminal Transaction	Hard Decline	For a Cardholder Authorized Terminal Transaction the POS capability must be set to magstripe.

**TABLE A-1** Valid Values for the Response and Message Elements (Continued)

Response Code	Response Message	Response Type	Description
332	Invalid POS Cardholder ID for Cardholder Authorized Terminal Transaction	Hard Decline	For a Cardholder Authorized Terminal Transaction the POS Cardholder ID must be set to nopin.
335	This method of payment does not support authorization reversals	Hard Decline	You can not perform an Authorization Reversal transaction for this payment type.
336	Reversal amount does not match Authorization amount.	Hard Decline	For a merchant initiated reversal against an American Express authorization, the reversal amount must match the authorization amount exactly.
337	Transaction did not convert to Pinless	Soft Decline	Retry the transaction.
340	Invalid Amount	Hard Decline	The transaction amount is invalid (too high or too low). For example, less than 0 for an authorization, or less than .01 for other payment types.
341	Invalid Healthcare Amounts	Hard Decline	The amount submitted with this FSA/Healthcare transaction is invalid. The FSA amount must be greater than 0, and cannot be greater than the transaction amount.
346	Invalid billing descriptor prefix	Hard Decline	The billing descriptor prefix submitted is not valid. Appears in Declined Transaction report.
347	Invalid billing descriptor	Hard Decline	The billing descriptor is not valid because you are not authorized to send transactions with custom billing fields. Appears in Declined Transaction report.

**TABLE A-1** Valid Values for the Response and Message Elements (Continued)

Response Code	Response Message	Response Type	Description
348	Invalid Report Group	Hard Decline	The Report Group specified in the transaction is invalid, because it is either not in the defined list of acceptable Report Groups or there is a mis-match between the Report Group and the defined Billing Descriptor.
349	Do Not Honor	Soft Decline	The issuing bank has put a temporary hold on the card.
350	Generic Decline	Soft or Hard Decline	There is an unspecified problem; contact the issuing bank for more details. <b>Note:</b> This code can be a hard or soft decline, depending on the method of payment, and other variables.
351	Decline - Request Positive ID	Hard Decline	Card Present transaction that requires a picture ID match.
352	Decline CVV2/CID Fail	Hard Decline	The CVV2/CID is invalid.
354	3-D Secure transaction not supported by merchant	Hard Decline	You are not certified to submit 3-D Secure transactions.
356	Invalid purchase level III, the transaction contained bad or missing data	Soft Decline	Submitted Level III data is bad or missing.
357	Missing healthcareIIAS tag for an FSA transaction	Hard Decline	The FSA Transactions submitted does not contain the <healthcareIIAS> data element.
358	Restricted by Vantiv due to security code mismatch.	Hard Decline	The transaction was declined due to the security code (CVV2, CID, etc) not matching.
360	No transaction found with specified Transaction Id	Hard Decline	There were no transactions found with the specified Transaction Id. Appears in Declined Transaction report.

**TABLE A-1** Valid Values for the Response and Message Elements (Continued)

Response Code	Response Message	Response Type	Description
361	Authorization no longer available	Hard Decline	<b>The authorization for this transaction is no longer available. Either the authorization has already been consumed by another capture, or the authorization has expired.</b>  Appears in Declined Transaction report.
362	Transaction Not Voided - Already Settled	Hard Decline	<b>This transaction cannot be voided; it has already been delivered.</b>  Appears in Declined Transaction report.
363	Auto-void on refund	Hard Decline	<b>This transaction (both capture and refund) has been voided.</b>  Appears in Declined Transaction report.
364	Invalid Account Number - original or NOC updated eCheck account required	Hard Decline	<b>The submitted account number is invalid. Confirm the original account number or check NOC for new account number.</b>
365	Total credit amount exceeds capture amount	Hard Decline	<b>The amount of the credit is greater than the capture, or the amount of this credit plus other credits already referencing this capture are greater than the capture amount.</b>  Appears in Declined Transaction report.
366	Exceed the threshold for sending redeposits	Hard Decline	<b>NACHA rules allow two redeposit attempts within 180 days of the settlement date of the initial deposit attempt. This threshold has been exceeded.</b>  Appears in Declined Transaction report.



**TABLE A-1** Valid Values for the Response and Message Elements (Continued)

Response Code	Response Message	Response Type	Description
367	<b>Deposit has not been returned for insufficient/non-sufficient funds</b>	<b>Hard Decline</b>	<b>NACHA rules only allow redeposit attempts against deposits returned for Insufficient or Uncollected Funds.</b> Appears in Declined Transaction report.
368	Invalid check number	Soft Decline	The check number is invalid.
369	<b>Redeposit against invalid transaction type</b>	<b>Hard Decline</b>	<b>The redeposit attempted against an invalid transaction type.</b> Appears in Declined Transaction report.
370	<b>Internal System Error - Call Vantiv</b>	<b>Hard Decline</b>	<b>There is a problem with the system. Contact eCommerceSupport@vantiv.com.</b>
371	<b>Original Transaction has been Processed - Future Redeposits Canceled</b>	<b>Hard Decline</b>	<b>Do not send additional redeposit transactions, since the original transaction was processed.</b> Appears in Declined Transaction report.
372	Soft Decline - Auto Recycling In Progress	Soft Decline	The transaction was intercepted because it is being auto recycled by the Recycling Engine.
373	<b>Hard Decline - Auto Recycling Complete</b>	<b>Hard Decline</b>	<b>The transaction was intercepted because auto recycling has completed with a final decline.</b>
375	<b>Merchant is not enabled for surcharging</b>	<b>Hard Decline</b>	<b>The submitted transaction contained a surcharge and the merchant is not enabled for surcharging.</b>
376	<b>This method of payment does not support surcharging</b>	<b>Hard Decline</b>	<b>The use of a surcharge is only allowed for Visa and MasterCard methods of payment.</b>
377	<b>Surcharge is not valid for debit or prepaid cards</b>	<b>Hard Decline</b>	<b>You cannot apply a surcharge to a transaction using a debit or prepaid card.</b>

**TABLE A-1** Valid Values for the Response and Message Elements (Continued)

Response Code	Response Message	Response Type	Description
378	Surcharge cannot exceed 4% of the sale amount	Hard Decline	The surcharge in the submitted transaction exceeded 4% maximum allowed for a surcharge.
380	Secondary amount cannot exceed the sale amount	Hard Decline	The secondary amount exceeded the sale amount in the submitted transaction.
381	This method of payment does not support secondary amount	Hard Decline	The submitted method of payment does not allow the use of Convenience Fees.
382	Secondary amount cannot be less than zero	Hard Decline	The secondary amount must be a positive integer.
383	Partial transaction is not supported when including a secondary amount	Hard Decline	Transactions set to allow partial authorizations cannot include a secondary amount.
384	Secondary amount required on partial refund when used on deposit	Hard Decline	If the associated sale or capture transaction included a secondary amount, an associated partial refund must include a secondary amount.
385	Secondary amount not allowed on refund if not included on deposit	Hard Decline	If the associated sale or capture transaction did not include a secondary amount, you cannot include a secondary amount on an associated refund.
401	Invalid E-mail	Hard Decline	The e-mail address provided is not valid. Verify that it was entered correctly.
469	Invalid Recurring Request - See Recurring Response for Details	Hard Decline	The Recurring Request was invalid, which invalidated the transaction. The Response Code and Message in the Recurring Response contains additional information.
470	Approved - Recurring Subscription Created	Approved	The recurring request was processed successfully.

**TABLE A-1** Valid Values for the Response and Message Elements (Continued)

Response Code	Response Message	Response Type	Description
471	<b>Parent Transaction Declined - Recurring Subscription Not Created</b>	<b>Hard Decline</b>	<b>The original payment transaction was declined, so the recurring payments have not been scheduled.</b> Appears in Declined Transaction report.
472	<b>Invalid Plan Code</b>	<b>Hard Decline</b>	<b>The plan specified in the recurring request was invalid.</b>
473	Scheduled Recurring Payment Processed	Approved	The scheduled recurring payment has been processed successfully.
475	<b>Invalid Subscription Id</b>	<b>Hard Decline</b>	<b>The referenced subscription Id does not exist.</b> Appears in Declined Transaction report.
476	<b>Add On Code Already Exists</b>	<b>Hard Decline</b>	<b>The specified Add On code already exists.</b> Appears in Declined Transaction report.
477	<b>Duplicate Add On Codes in Requests</b>	<b>Hard Decline</b>	<b>Multiple createAddOn requests submitted with the same Add On Code.</b>
478	<b>No Matching Add On Code for the Subscription</b>	<b>Hard Decline</b>	<b>The Add On code specified does not exist.</b> Appears in Declined Transaction report.
480	<b>No Matching Discount Code for the Subscription</b>	<b>Hard Decline</b>	<b>The Discount Code supplied in the updateDiscount or deleteDiscount transaction does not exist.</b> Appears in Declined Transaction report.
481	<b>Duplicate Discount Codes in Request</b>	<b>Hard Decline</b>	<b>Multiple createDiscount requests submitted with the same Discount Code.</b>
482	<b>Invalid Start Date</b>	<b>Hard Decline</b>	<b>The supplied Start Date is invalid.</b>
483	<b>Merchant Not Registered for Recurring Engine</b>	<b>Hard Decline</b>	<b>You are not registered for the use of the Recurring Engine.</b>

**TABLE A-1** Valid Values for the Response and Message Elements (Continued)

Response Code	Response Message	Response Type	Description
500	The account number was changed	Hard Decline	An Account Updater response indicating the Account Number changed from the original number.
501	The account was closed	Hard Decline	An Account Updater response indicating the account was closed. Contact the cardholder directly for updated information.
502	The expiration date was changed	N/A	An Account Updater response indicating the Expiration date for the card has changed.
503	The issuing bank does not participate in the update program	N/A	An Account Updater response indicating the issuing bank does not participate in the update program
504	Contact the cardholder for updated information	N/A	An Account Updater response indicating you should contact the cardholder directly for updated information.
505	No match found	N/A	An Account Updater response indicating no match was found in the updated information.
506	No changes found	N/A	An Account Updater response indicating there have been no changes to the account information.
521	Soft Decline - Card reader decryption service is not available	Soft Decline	The connection to the decryption service is currently unavailable. Please retry the transaction and/or contact your Relationship Manager.
523	Soft Decline - Decryption failed	Soft Decline	Our attempt to decrypt the card information failed. Please retry the transaction.
524	Hard Decline - Input data is invalid.	Hard Decline	The submitted data is invalid.
530	Apple Pay Key Mismatch	Hard Decline	The submitted publicKeyHash element does not match any configured entries. Contact your Implementation Consultant.
531	Apple Pay Decryption Failed	Hard Decline	Vantiv was unable to decrypt the submitted information.

**TABLE A-1** Valid Values for the Response and Message Elements (Continued)

Response Code	Response Message	Response Type	Description
550	Restricted Device or IP - ThreatMetrix Fraud Score Below Threshold	Hard Decline	The transaction was declined because the resulting ThreatMetrix Fraud Score was below the acceptable threshold set in the merchant's policy.
601	Soft Decline - Primary Funding Source Failed	Soft Decline	A PayPal response indicating the transaction failed due to an issue with primary funding source (e.g. expired Card, insufficient funds, etc.).
<b>NOTE:</b> The Response Message associated with Response Code 602 is inaccurate due to a remapping of PayPal Response Codes. Please read the Description below for the recommended action when receiving Response Code 602.			
602	Soft Decline - Buyer has alternate funding source	Soft Decline	<p>The transaction could not be completed for one of the following reasons:</p> <ul style="list-style-type: none"> <li>The billing address associated with the financial Instrument could not be confirmed.</li> <li>The transaction exceeds the card limit.</li> <li>The transaction was denied by the card issuer.</li> </ul> <p>You should establish error handling logic that directs the customer to contact PayPal to resolve the issue with their account.</p>
610	Hard Decline - Invalid Billing Agreement Id	Hard Decline	A PayPal response indicating the Billing Agreement ID is invalid.
611	Hard Decline - Primary Funding Source Failed	Hard Decline	A PayPal response indicating the issuer is unavailable.
612	Hard Decline - Issue with Paypal Account	Hard Decline	A PayPal response indicating the transaction failed due to an issue with the buyer account.
613	Hard Decline - PayPal authorization ID missing	Hard Decline	A PayPal response indicating the need to correct the authorization ID before resubmitting.

**TABLE A-1** Valid Values for the Response and Message Elements (Continued)

Response Code	Response Message	Response Type	Description
614	Hard Decline - confirmed email address is not available	Hard Decline	A PayPal response indicating your account is configured to decline transactions without a confirmed address. request another payment method or contact eCommerceSupport@vantiv.com to modify your account settings.
615	Hard Decline - PayPal buyer account denied	Hard Decline	A PayPal response indicating account unauthorized payment risk.
616	Hard Decline - PayPal buyer account restricted	Hard Decline	A PayPal response indicating PayPal is unable to process the payment. Buyer should contact PayPal with questions.
617	Hard Decline - PayPal order has been voided, expired, or completed	Hard Decline	A PayPal response indicating no further authorizations/captures can be processed against this order. A new order must be created.
618	Hard Decline - issue with PayPal refund	Hard Decline	A PayPal response indicating one of these potential refund related issues: duplicate partial refund must be less than or equal to original or remaining amount, past time limit, not allowed for transaction type, consumer account locked/inactive, or complaint exists - only a full refund of total/remaining amount allowed. Contact eCommerceSupport@vantiv.com for specific details.
619	Hard Decline - PayPal credentials issue	Hard Decline	A PayPal response indicating you do not have permissions to make this API call.
620	Hard Decline - PayPal authorization voided or expired	Hard Decline	A PayPal response indicating you cannot capture against this authorization. You need to perform a brand new authorization for the transaction.

**TABLE A-1** Valid Values for the Response and Message Elements (Continued)

Response Code	Response Message	Response Type	Description
621	Hard Decline - required PayPal parameter missing	Hard Decline	A PayPal response indicating missing parameters are required. Contact <a href="mailto:eCommerceSupport@vantiv.com">eCommerceSupport@vantiv.com</a> for specific details.
622	Hard Decline - PayPal transaction ID or auth ID is invalid	Hard Decline	A PayPal response indicating the need to check the validity of the authorization ID prior to reattempting the transaction.
623	Hard Decline - Exceeded maximum number of PayPal authorization attempts	Hard Decline	A PayPal response indicating you should capture against a previous authorization.
624	Hard Decline - Transaction amount exceeds merchant's PayPal account limit.	Hard Decline	A PayPal response indicating the transaction amount exceeds the merchant's account limit. Contact <a href="mailto:eCommerceSupport@vantiv.com">eCommerceSupport@vantiv.com</a> to modify your account settings.
625	Hard Decline - PayPal funding sources unavailable.	Hard Decline	A PayPal response indicating the buyer needs to add another funding sources to their account.
626	Hard Decline - issue with PayPal primary funding source.	Hard Decline	A PayPal response indicating there are issues with the buyer's primary funding source.
627	Hard Decline - PayPal profile does not allow this transaction type.	Hard Decline	Contact your Relationship Manager to adjust your PayPal merchant profile preferences.
628	Internal System Error with PayPal - Contact Vantiv	Hard Decline	There is a problem with your username and password. Contact <a href="mailto:eCommerceSupport@vantiv.com">eCommerceSupport@vantiv.com</a> .
629	Hard Decline - Contact PayPal consumer for another payment method	Hard Decline	A PayPal response indicating you should contact the consumer for another payment method.
637	Invalid terminal Id	Hard Decline	The terminal Id submitted with the POS transaction is invalid.
701	Under 18 years old	Hard Decline	A PayPal Credit response indicating the customer is under 18 years of age based upon the date of birth.

**TABLE A-1** Valid Values for the Response and Message Elements (Continued)

Response Code	Response Message	Response Type	Description
702	Bill to outside USA	Hard Decline	A PayPal Credit response indicating the billing address is outside the United States.
703	Bill to address is not equal to ship to address	Hard Decline	A PayPal Credit response indicating that the billing address does not match the shipping address.
704	Declined, foreign currency, must be USD	Hard Decline	A PayPal Credit response indicating the transaction is declined, because it is not in US dollars.
705	On negative file	Hard Decline	A PayPal Credit response indicating the account is on the negative file.
706	Blocked agreement	Hard Decline	A PayPal Credit response indicating a blocked agreement account status.
707	Insufficient buying power	Other	A PayPal Credit response indicating that the account holder does not have sufficient credit available for the transaction amount.
708	Invalid Data	Hard Decline	A PayPal Credit response indicating that there are one or more problems with the submitted data.
709	Invalid Data - data elements missing	Hard Decline	A PayPal Credit response indicating one or more required data elements are missing.  Also, returned for an eCheck transaction that is missing a required data element. For example, failure to include the name element in an echeckSale or echeckCredit transaction would result in this code being returned.
710	Invalid Data - data format error	Hard Decline	A PayPal Credit response indicating that some data was formatted incorrectly.



**TABLE A-1** Valid Values for the Response and Message Elements (Continued)

Response Code	Response Message	Response Type	Description
711	Invalid Data - Invalid T&C version	Hard Decline	A PayPal Credit response indicating the T&C version is invalid.
712	Duplicate transaction	Hard Decline-	A PayPal Credit response indicating that the transaction is a duplicate.
713	Verify billing address	Hard Decline	A PayPal Credit response indicating that you should verify the billing address.
714	Inactive Account	Hard Decline	A PayPal Credit response indicating the customer account is inactive.
716	Invalid Auth	Hard Decline	A PayPal Credit response indicating that the referenced authorization is invalid.
717	Authorization already exists for the order	Hard Decline	A PayPal Credit response indicating that an authorization already exists for the transaction.
801	Account number was successfully registered	Approved	The card number was successfully registered and a token number was returned.
802	Account number was previously registered	Approved	The card number was previously registered for tokenization.
805	Card Validation Number Updated	Approved	The stored value for CVV2/CVC2/CID has been successfully updated.
820	Credit card number was invalid	Hard Decline	The card number submitted for tokenization is invalid.
821	Merchant is not authorized for tokens	Hard Decline	Your organization is not authorized to use tokens.
822	Token was not found	Hard Decline	The token number submitted with this transaction was not found.
823	Token Invalid	Hard Decline	The submitted token is invalid.
825	Merchant not authorized for eCheck tokens	Hard Decline	Your organization is not authorized for eCheck tokenization.

**TABLE A-1** Valid Values for the Response and Message Elements (Continued)

Response Code	Response Message	Response Type	Description
826	Checkout Id was invalid	Soft Decline	The submitted checkoutId is invalid.
827	Checkout Id was not found	Soft Decline	The submitted checkoutId was not found. The low value token is only good for 24 hours and may have expired.
828	Generic Checkout Id error	Soft Decline	An unknown error caused the use of checkoutId to fail.
<b>835</b>	<b>Capture amount can not be more than authorized amount</b>	<b>Hard Decline</b>	<b>The amount in the submitted Capture exceeds 115% of the authorized amount.</b> Appears in Declined Transaction report.
850	Tax Billing only allowed for MCC 9311	Hard Decline	Tax Billing elements are allowed only for MCC 9311.
851	MCC 9311 requires taxType element	Hard Decline	Missing taxType element
852	Debt Repayment only allowed for VI transactions on MCCs 6012 and 6051	Hard Decline	You must be either MCC 6012 or 6051 to designate a Visa transaction as Debt Repayment (debtRepayment element set to true).
861	Routing Number did not match one on file for token	Soft Decline	The routing number submitted does not match the number submitted when the token was created. Verify the routing number and resubmit the transaction.
877	Invalid Pay Page Registration Id	Hard Decline	An eProtect response indicating that the Registration ID submitted is invalid.
878	Expired Pay Page Registration Id	Hard Decline	An eProtect response indicating that the Registration ID has expired (Registration IDs expire 24 hours after being issued).
879	Merchant is not authorized for Pay Page	Hard Decline	Your organization is not authorized to use eProtect.
898	Generic token registration error	Soft Decline	There is an unspecified token registration error; contact your Relationship Manager

**TABLE A-1** Valid Values for the Response and Message Elements (Continued)

Response Code	Response Message	Response Type	Description
899	Generic token use error	Soft Decline	There is an unspecified token use error; contact your Relationship Manager.
<b>900</b>	<b>Invalid Bank Routing Number</b>	<b>Hard Decline</b>	<b>The eCheck routing number submitted with this transaction has failed validation.</b>
<b>901</b>	<b>Missing Name</b>	<b>Hard Decline</b>	<b>The customer name is required for SEPA transactions.</b>
<b>902</b>	<b>Invalid Name</b>	<b>Hard Decline</b>	<b>The customer name must be a minimum of two characters for SEPA transactions.</b>
<b>903</b>	<b>Missing Billing Country Code</b>	<b>Hard Decline</b>	<b>The Billing Country code is required for SEPA transactions.</b>
<b>904</b>	<b>Invalid IBAN</b>	<b>Hard Decline</b>	The submitted International Bank Account number is invalid. Please correct the number and resubmit the transaction.
<b>905</b>	<b>Missing Email Address</b>	<b>Hard Decline</b>	<b>The customer email address is required for SEPA transactions.</b>
940	This Funding Instruction results in a negative account balance	Soft Decline	There are insufficient funds in the FBO Settlement Account to cover the Funding Instruction. Wait for additional funds to settle to the account and then resubmit the transaction.
941	Account balance information unavailable at this time.	Soft Decline	Typically, this response occurs only for new FBO Settlement accounts that do not yet have any settled transactions and were not pre-funded (i.e., no balance yet recorded for the account). Wait for additional funds to settle to the account or pre-fund the account and then resubmit the transaction.
<b>917</b>	<b>Invalid Billing Country</b>	<b>Hard Decline</b>	<b>Some of the alternative payment methods restrict the allowed consumer's billing country codes. For example, iDEAL only allows country code NL.</b>

**TABLE A-1** Valid Values for the Response and Message Elements (Continued)

<b>Response Code</b>	<b>Response Message</b>	<b>Response Type</b>	<b>Description</b>
950	Decline - Negative Information on File	Hard Decline	An eCheck response indicating the account is on the negative file.
951	Absolute Decline	Hard Decline	An eCheck response indicating that this transaction was declined.
952	The Merchant Profile does not allow the requested operation	Hard Decline	An eCheck response indicating that your Merchant Profile does not allow the requested operation. Contact your Relationship Manager for additional information.
953	The account cannot accept ACH transactions	Hard Decline	An eCheck response indicating the customer's checking account does not accept ACH transactions.
954	The account cannot accept ACH transactions or site drafts	Hard Decline	An eCheck response indicating the customer's checking account does not accept ACH transactions or site drafts.
955	Amount greater than limit specified in the Merchant Profile	Hard Decline	An eCheck response indicating that the dollar amount of this transaction exceeds the maximum amount specified in your Merchant Profile. Contact your Relationship Manager for additional information.
956	Merchant is not authorized to perform eCheck Verification transactions	Hard Decline	An eCheck response indicating that your organization is not authorized to perform eCheck verifications. Contact your Relationship Manager for additional information.
957	First Name and Last Name required for eCheck Verifications	Hard Decline	An eCheck response indicating that the first and last name of the customer is required for eCheck verifications.
958	Company Name required for corporate account for eCheck Verifications	Hard Decline	An eCheck response indicating that the company name is required for verifications on corporate accounts.

**TABLE A-1** Valid Values for the Response and Message Elements (Continued)

<b>Response Code</b>	<b>Response Message</b>	<b>Response Type</b>	<b>Description</b>
<b>959</b>	<b>Phone number required for eCheck Verifications</b>	<b>Hard Decline</b>	<b>An eCheck response indicating that the phone number of the customer is required for eCheck verifications.</b>
<b>961</b>	<b>Card Brand token not supported</b>	<b>Hard Decline</b>	<b>This code is returned if the merchant submits a Visa generated token.</b>
<b>962</b>	<b>Private Label Card not supported</b>	<b>Hard Decline</b>	<b>This code is returned if the transaction involves a Visa Private Label card.</b>

## A.2 3DS Authentication Result Codes

Table A-2 contains a list of valid authentication result codes returned by Visa for the Verified by Visa service or MasterCard for the MasterCard SecureCode service. It specifies which authentication result values apply to which order sources.

---

**NOTE:** The Discover ProtectBuy service only returns one of the following Authentication Result Codes: 0, 1, or 2.

---

**TABLE A-2** Authentication Result Codes

Authentication Result Code	Description
Order Source - Ecommerce	
Blank	Standard ecommerce or non-ecommerce transactions, not an authentication or attempted authentication. CAVV not present
Order Source - any	
B	CAVV passed verification, but no liability shift because a) ECI was not 5 or 6 or b) the card type is an excluded (e.g., Commercial Card)
Order Source - 3DSAuthenticated or 3DSAttempted	
0	CAVV data field not properly formatted; verification cannot be performed. or (for MasterCard) Downgrade to non-3DS transaction, Missing or base64 encoded AAV does not start with j (AAV is invalid for 3dsAuthenticated transaction)
6	CAVV not verified because Issuer has requested no verification. VisaNet processes as if CAVV is valid.
Order Source - 3DSAuthenticated	
1	CAVV failed verification or (for Visa) TAVV (token authentication verification value) cryptogram failed validation or (for MasterCard) Downgrade to 3DS Attempted transaction, AAV starts with h and not j
2	CAVV passed verification or (for Visa) TAVV cryptogram passed validation

**TABLE A-2** Authentication Result Codes (Continued)

<b>Authentication Result Code</b>	<b>Description</b>
D	Issuer elected to return CAVV verification results and Field 44.13 blank. Value is set by VisaNet; means CAVV Results are valid.
Order Source - 3DSAttempted	
3	CAVV passed verification or (for Visa) DTVV (dynamic token verification value) or Visa-defined format cryptogram failed validation
4	CAVV failed verification or (for Visa) DTVV or Visa-defined format cryptogram passed validation
5	Not used
7	CAVV failed verification
8	CAVV passed verification
9	CAVV failed verification; Visa generated CAVV because Issuer ACS was not available.
A	CAVV passed verification; Visa generated CAVV because Issuer Access Control Server (ACS) was not available.
B	CAVV passed verification but no liability shift because a) ECI was not 5 or 6 or b) the card type is an excluded (e.g., Commercial Card)
C	Issuer elected to return CAVV verification results and Field 44.13 blank. Value is set by VisaNet; means CAVV Results are valid

## A.3 AVS Response Codes

Table A-3 contains a list of AVS response codes that can be returned in the response for a payment transaction. There are some codes that you may never receive. Code your system to expect codes from this list. The description is not included in the response.

**TABLE A-3** AVS Response Codes

AVS Response Code	Description
00	5-Digit zip and address match
01	9-Digit zip and address match
02	Postal code and address match
10	5-Digit zip matches, address does not match
11	9-Digit zip matches, address does not match
12	Zip does not match, address matches
13	Postal code does not match, address matches
14	Postal code matches, address not verified
20	Neither zip nor address match
30	AVS service not supported by issuer
31	AVS system not available
32	Address unavailable
33	General error
34	AVS not performed
40	Address failed Vantiv edit checks



## A.4 AAVS Response Codes

Table A-4 contains a list of American Express Advanced AVS response codes that can be returned as verification of information supplied in the <name>, <phone> and/or <email> child elements of the <billToAddress> element. The system returns the AAVS response code in the <advancedAVSResult> child of the <fraudResult> element.

The code returned has the following format:

- **1st position** - name match
- **2nd position** - phone match
- **3rd position** - email match
- Each position can have one of the following values:
  - **0** - No Match (failure)
  - **1** - Match
  - **2** - Not Sent
  - **3** - No Response (unchecked, retry, or service not allowed)

For example, a code of 210 would indicate that the name was not sent, the phone matches, and the email does not match.

You should code your system to parse all codes from this list. The description is not included in the response.

**TABLE A-4** Advances AVS Response Codes

AAVS Response Code	Description
000	No Match
001	Email matches, name and phone do not match
002	Name and phone do not match, email not sent
003	Name and phone do not match, no response for email
010	Phone matches, name and email do not match
011	Phone and email match, name does not match
012	Phone matches, name does not match, email not sent
013	Phone matches, name does not match, no response for email
020	Name and email do not match, phone not sent

**TABLE A-4** Advances AVS Response Codes

<b>AAVS Response Code</b>	<b>Description</b>
021	Email matches, name does not match, phone not sent
030	Name and email do not match, no response for phone
031	Email matches, name does not match, no response for phone
033	Name does not match, no response for phone or email
100	Name matches, phone and email do not match
101	Name and email match, phone does not match
102	Name matches, phone does not match, email not sent
103	Name matches, phone does not match, no response for email
110	Name and phone match, no match for email
111	Full match
112	Name and phone match, email not sent
113	Name and phone match, no response for email
120	Name matches, email does not match, phone not sent
121	Name and email match, phone not sent
130	Name matches, email does not match, no response for phone
131	Name and email match, no response for phone
133	Name matches, no response for phone or email
200	Name not sent, phone and email do not match
201	Email matches, phone does not match, name not sent
202	Phone does not match, name and email not sent
203	Phone does not match, name not sent, no response for email
210	Phone matches, email does not match, name not sent
211	Phone and email match, name not sent
212	Phone matches, name and email not sent
213	Phone matches, name not sent, no response for email
220	Email does not match, name and phone not sent

**TABLE A-4** Advances AVS Response Codes

<b>AAVS Response Code</b>	<b>Description</b>
221	Email matches, name and phone not sent
230	Email does not match, name not sent, no response for phone
231	Email matches, name not sent, no response for phone
233	Name not sent, no response for phone and email
300	Phone and email do not match, no response for name
301	Email matches, phone does not match, no response for name
302	Phone does not match, no response for name, email not sent
303	Phone does not match, no response for name and email
310	Phone matches, email does not match, no response for name
311	Phone and email match, no response for name
312	Phone matches, email not sent, no response for name
313	Phone matches, no response for name and email
320	Email does not match, phone not sent, no response for name
321	Email matches, phone not sent, no response for name
330	Email does not match, no response for name and phone
331	Email matches, no response for name and phone
333	No response

## A.5 Card Validation Response Codes

Table A-5 contains a normalized list of response codes that can be returned when requesting a card validation check.

- CVV2
- CVC2
- CID

The description is not included in the response.

---

---

**NOTE:** For American Express transactions, if the submitted security code does not match, the transaction is declined with a Response Reason Code of 352 - Decline CVV2/CID Fail.

---

---

**TABLE A-5** Card Validation Response Codes

CVV2/CVC2/CID Response Code	Description
M	Match
N	No Match
P	Not Processed
S	CVV2/CVC2/CID should be on the card, but the merchant has indicated CVV2/CVC2/CID is not present
U	Issuer is not certified for CVV2/CVC2/CID processing
"" (empty response)	Check was not done for an unspecified reason

## A.6 Advanced Fraud Tools Triggered Rules

This section provides definitions of the triggered rules returned in the Advanced Fraud Results (`advancedFraudResults` element) section of the response message (see Example below). ThreatMetrix uses the rules triggered by each advanced fraud check to determine the device reputation score, which in turn determines the final review status: Pass, Review, or Fail.

---

**NOTE:** The rules/descriptions in this document reflect those used in the generic merchant policy. Depending upon the policy configured in your merchant profile, some rules may not apply to you, or additional rules, not defined here, may appear in your results.

---

### Example: advancedFraudResults Structure

```
<advancedFraudResults>
  <deviceReviewStatus>pass, fail, review, etc.</deviceReviewStatus>
  <deviceReputationScore>Score Returned from
  ThreatMetrix</deviceReputationScore>
  <triggeredRule>Triggered Rule #1</triggeredRule>
  .
  .
  .
  <triggeredRule>Triggered Rule #N</triggeredRule>
</advancedFraudResults>
```

**TABLE A-6** Triggered Rules Definitions

Triggered Rule Name	Description
10PaymentsOnDeviceLocalDay	This device submitted 10 or more payments in the previous 24 hours. This is atypical and may be an indicator of misuse.
10PaymentsOnDeviceLocalHour	This device has submitted 10 or more payments in the previous hour. This is atypical and may be an indicator of misuse.
10PaymentsOnFuzzyDeviceLocalDay	This device appears to have submitted 10 or more payments in the previous 24 hours. This is atypical and may be an indicator of misuse.
10PaymentsOnFuzzyDeviceLocalHour	This device appears to have submitted 10 or more payments in the previous hour. This is atypical and may be an indicator of misuse.

**TABLE A-6** Triggered Rules Definitions

Triggered Rule Name	Description
10PaymentsOnTrueIPLocalDay	This True IP submitted 10 or more payments in the previous day. This is atypical and may be an indicator of misuse.
10PaymentsOnTrueIPLocalHour	This True IP submitted 10 or more payments in the previous hour. This is atypical and may be an indicator of misuse.
10PaymentsWithEmailAddressLocalDay	This email address submitted 10 or more payments in the previous day. This is atypical and may be an indicator of misuse.
15PaymentsWithCustomerIDLocalDay	This customer ID submitted 15 or more payments in the previous day. This is atypical and may be an indicator of misuse.
15PaymentsWithPaymentCardLocalDay	This payment card submitted 15 or more payments in the previous day. This is atypical and may be an indicator of misuse.
100PaymentsOnDeviceLocalMonth	This device submitted 100 or more payments in the previous month. This is atypical and may be an indicator of misuse.
100PaymentsOnFuzzyDeviceLocalMonth	This device appears to have submitted 100 or more payments in the previous month. This is atypical and may be an indicator of misuse.
100PaymentsOnTrueIPLocalMonth	This True IP submitted 100 or more payments in the previous month. This is atypical and may be an indicator of misuse.
2ScreenResolutionsPerDeviceGlobalDay	This device used 2 or more screen resolutions in the past day. This is atypical and may indicate misuse.
20PaymentsOnDeviceLocalDay	This device submitted 20 or more payments in the previous 24 hours. This is atypical and may be an indicator of misuse.
20PaymentsOnFuzzyDeviceLocalDay	This device appears to have submitted 20 or more payments in the previous 24 hours. This is atypical and may be an indicator of misuse.
20PaymentsOnTrueIPLocalDay	This True IP submitted 20 or more payments in the previous day. This is atypical and may be an indicator of misuse.

**TABLE A-6** Triggered Rules Definitions

Triggered Rule Name	Description
20PaymentsWithCustomerIDLocalWeek	This customer ID submitted 20 or more payments in the previous week. This is atypical and may be an indicator of misuse.
20PaymentsWithPaymentCardLocalWeek	This payment card submitted 20 or more payments in the previous week. This is atypical and may be an indicator of misuse.
3CustomerIDsPerDeviceLocalDay	This device submitted transactions using 3 or more distinct customer IDs in the previous 24 hours. This is abnormal and may be an indicator of a card-testing attack or free-trial abuse.
3CustomerIDsPerDeviceLocalWeek	This device submitted transactions using 3 or more distinct customer IDs in the previous 7 days. This is abnormal and may be an indicator of a card-testing attack or free-trial abuse.
3DevicesPerCustomerIDLocalDay	Three or more devices have been used to submit transactions with this customer ID in the previous 24 hours. This may be an indicator of misuse.
3DevicesPerCustomerIDLocalWeek	Three or more devices have been used to submit transactions with this customer ID in the previous 7 days. This may be an indicator of misuse.
3DevicesPerEmailGlobalDay	Three or more devices have been used to submit transactions with this email address in the previous 24 hours. This may be an indicator of misuse.
3DevicesPerEmailGlobalWeek	Three or more devices have been used to submit transactions with this email address in the previous 7 days. This may be an indicator of misuse.
3DevicesPerPaymentCardGlobalDay	Three or more devices have been used to submit transactions with this payment card in the previous 24 hours. This may be an indicator of misuse.
3DevicesPerPaymentCardGlobalWeek	Three or more devices have been used to submit transactions with this payment card in the previous 7 days. This may be an indicator of misuse.

**TABLE A-6** Triggered Rules Definitions

Triggered Rule Name	Description
3EmailsPerDeviceGlobalDay	This device has submitted transactions using 3 or more distinct email addresses in the previous 24 hours. This is abnormal and may be an indicator of a card-testing attack or free-trial abuse.
3EmailsPerDeviceGlobalWeek	This device has submitted transactions using 3 or more distinct email addresses in the previous 7 days. This is abnormal and may be an indicator of a card-testing attack or free-trial abuse.
3EmailsPerFuzzyDeviceLocalHour	This device appears to have submitted transactions using 3 or more distinct email addresses in the previous 60 minutes. This is abnormal and may be an indicator of a card-testing attack or free-trial abuse.
3PaymentCardsPerDeviceGlobalDay	This device has submitted transactions using 3 or more distinct payment cards in the previous 24 hours. This is abnormal and may be an indicator of a card-testing attack or free-trial abuse.
3PaymentCardsPerDeviceGlobalWeek	This device has submitted transactions using 3 or more distinct payment cards in the previous 7 days. This is abnormal and may be an indicator of a card-testing attack or free-trial abuse.
3PaymentsOnDeviceLocalHour	This device has submitted 3 or more payments in the previous hour. This is atypical and may be an indicator of misuse.
3PaymentsOnFuzzyDeviceLocalHour	This device appears to have submitted 3 or more payments in the previous hour. This is atypical and may be an indicator of misuse.
3PaymentsOnTrueIPLocalHour	This True IP submitted 3 or more payments in the previous hour. This is atypical and may be an indicator of misuse.
3ProxiesPerDeviceGlobalDay	This device submitted transactions through 3 or more distinct IP proxies in the previous 24 hours. This is atypical and may be an indicator of misuse.
4ScreenResolutionsPerDeviceGlobalDay	This device has used 4 or more screen resolutions in the past day. This is atypical and may indicate misuse.



**TABLE A-6** Triggered Rules Definitions

Triggered Rule Name	Description
5PaymentsOnDeviceLocalDay	This device has submitted 5 or more payments in the previous 24 hours. This is atypical and may be an indicator of misuse.
5PaymentsOnDeviceLocalHour	This device has submitted 5 or more payments in the previous hour. This is atypical and may be an indicator of misuse.
5PaymentsOnFuzzyDeviceLocalDay	This device appears to have submitted 5 or more payments in the previous 24 hours. This is atypical and may be an indicator of misuse.
5PaymentsOnFuzzyDeviceLocalHour	This device appears to have submitted 5 or more payments in the previous hour. This is atypical and may be an indicator of misuse.
5PaymentsOnTrueIPLocalDay	This True IP has submitted 5 or more payments in the previous day. This is atypical and may be an indicator of misuse.
5PaymentsOnTrueIPLocalHour	This True IP submitted 5 or more payments in the previous hour. This is atypical and may be an indicator of misuse.
5PaymentsWithCustomerIDLocalHour	This customer ID submitted 5 or more payments in the previous hour. This is atypical and may be an indicator of misuse.
5PaymentsWithEmailAddressLocalHour	This email address has submitted 5 or more payments in the previous hour. This is atypical and may be an indicator of misuse.
5PaymentsWithPaymentCardLocalHour	This payment card submitted 5 or more payments in the previous hour. This is atypical and may be an indicator of misuse.
50PaymentsOnDeviceLocalWeek	This device has submitted 50 or more payments in the previous week. This is atypical and may be an indicator of misuse.
50PaymentsOnFuzzyDeviceLocalWeek	This device appears to have submitted 50 or more payments in the previous week. This is atypical and may be an indicator of misuse.
50PaymentsOnTrueIPLocalMonth	This True IP has submitted 50 or more payments in the previous month. This is atypical and may be an indicator of misuse.

**TABLE A-6** Triggered Rules Definitions

Triggered Rule Name	Description
20PaymentsWithCustomerIDLocalMonth	This customer ID submitted 20 or more payments in the previous month. This is atypical and may be an indicator of misuse.
20PaymentsWithPaymentCardLocalWeek	This payment card submitted 20 or more payments in the previous week. This is atypical and may be an indicator of misuse.
AnonymousProxy	This transaction was submitted through an anonymous web proxy, a method that is sometimes employed when trying to cloak one's identity.
AnonymousProxyIP	This transaction was submitted through an anonymous proxy IP Address, a method that is sometimes employed when trying to cloak one's identity.
BINCustomerAddressGeolocationMismatch	The customer's bill-to address country does not match that of the payment card's issuing bank. This may be an indicator of a fraud attack.
ComputerGeneratedEmail	This email address may have been automatically generated by a computer. Fraudsters frequently employ automated bots that create email addresses programmatically to enable their fraud attacks.
CookiesDisabled	The browser used to submit this transaction has disabled cookies. This is common to fraud attacks and may be an indicator of misuse.
CookiesJavascriptDisabled	The browser used to submit this transaction has disabled cookies and JavaScript. This is common to fraud attacks and may be an indicator of misuse.
CustomAttribute1OnLocalBlacklist	Custom attribute 1 for this transaction is on Vantiv's ThreatMetrix-hosted blacklist.
CustomAttribute1OnLocalWhitelist	Custom attribute 1 for this transaction is on Vantiv's ThreatMetrix-hosted whitelist.
CustomAttribute2OnLocalBlacklist	Custom attribute 2 for this transaction is on Vantiv's ThreatMetrix-hosted blacklist.
CustomAttribute2OnLocalWhitelist	Custom attribute 2 for this transaction is on Vantiv's ThreatMetrix-hosted whitelist.

**TABLE A-6** Triggered Rules Definitions

Triggered Rule Name	Description
CustomAttribute3OnLocalBlacklist	Custom attribute 3 for this transaction is on Vantiv's ThreatMetrix-hosted blacklist.
CustomAttribute3OnLocalWhitelist	Custom attribute 3 for this transaction is on Vantiv's ThreatMetrix-hosted whitelist.
CustomAttribute4OnLocalBlacklist	Custom attribute 4 for this transaction is on Vantiv's ThreatMetrix-hosted blacklist.
CustomAttribute4OnLocalWhitelist	Custom attribute 4 for this transaction is on Vantiv's ThreatMetrix-hosted whitelist.
CustomAttribute5OnLocalBlacklist	Custom attribute 5 for this transaction is on Vantiv's ThreatMetrix-hosted blacklist.
CustomAttribute5OnLocalWhitelist	Custom attribute 5 for this transaction is on Vantiv's ThreatMetrix-hosted whitelist.
CustomerIDOnLocalBlacklist	The customer ID for this transaction is on Vantiv's ThreatMetrix-hosted blacklist.
CustomerIDOnLocalWhitelist	The customer ID for this transaction is on Vantiv's ThreatMetrix-hosted whitelist.
CustomerNameOnLocalBlacklist	The customer name for this transaction is on Vantiv's ThreatMetrix-hosted blacklist.
CustomerNameOnLocalWhitelist	The customer name for this transaction is on Vantiv's ThreatMetrix-hosted whitelist.
DeviceCountriesNotAllowed	This transaction originated from an IP address located in a country on ThreatMetrix-hosted blacklist.
DeviceIDOnThreatMetrixGlobalBlacklist	The originating device is on the ThreatMetrix global blacklist.
DeviceGlobalAgeLessThanOneHour	The originating device was first seen across the entire ThreatMetrix global network within the past hour. This is uncommon and may point to a fraudster simulating a new device through advanced techniques in an attempt to avoid detection.
DeviceLocalAgeLessThanOneHour	The originating device was first seen by Vantiv within the past hour. This may point to a fraudster simulating a new device through advanced techniques in an attempt to avoid detection.

**TABLE A-6** Triggered Rules Definitions

Triggered Rule Name	Description
DeviceNotFingerprinted	ThreatMetrix could not fingerprint the originating device. This is atypical and may indicate a deliberate attempt by the user to cloak his or her identity.
DeviceOnLocalBlacklist	The originating device is on ThreatMetrix-hosted blacklist.
DeviceOnLocalWhitelist	The originating device is on ThreatMetrix-hosted whitelist.
DeviceOnThreatMetrixGlobalBlacklist	The originating device is on the ThreatMetrix global blacklist.
DeviceRejectedByNetwork10Times	The originating device has been rejected by one of ThreatMetrix's customers and/or partners 10 or more times on the suspicion of fraud.
DeviceRejectedByNetwork25Times	The originating device has been rejected by one of ThreatMetrix's customers and/or partners 25 or more times on the suspicion of fraud.
DeviceRejectedByNetwork5Times	The originating device has been rejected by one of ThreatMetrix's customers and/or partners 5 or more times on the suspicion of fraud.
DeviceRejectedByNetworkInLastWeek	The originating device has been rejected by one of ThreatMetrix's customers and/or partners in the last week on the suspicion of fraud.
DeviceReviewedByNetwork5Times	The originating device has been reviewed by one of ThreatMetrix's customers and/or partners 5 or more times on the suspicion of fraud.
DeviceReviewedByNetwork10Times	The originating device has been reviewed by one of ThreatMetrix's customers and/or partners 10 or more times on the suspicion of fraud.
DeviceReviewedByNetwork25Times	The originating device has been reviewed by one of ThreatMetrix's customers and/or partners 25 or more times on the suspicion of fraud.
EmailDistanceTraveled	This email address has been associated with transactions originating from locations at least 1,000 miles apart in the last hour. This is a red flag and warrants caution.

**TABLE A-6** Triggered Rules Definitions

Triggered Rule Name	Description
EmailHostnameTooLong	The hostname portion (i.e. to the right of "@") of this email address exceeds 30 characters. Email addresses associated with suspicious domain names are often used as part of attacks. Overly long hostnames are a common marker of such domains.
EmailHostnameWithNonLetters	The hostname portion (i.e. to the right of "@") of this email address contains non-letter characters (e.g. numbers and special characters). Email addresses associated with suspicious domain names are often used as part of attacks. Hostnames with non-letter characters are a common marker of such domains.
EmailOnLocalBlacklist	The customer email address for this transaction is on Vantiv's ThreatMetrix-hosted blacklist.
EmailOnLocalWhitelist	The customer email address for this transaction is on Vantiv's ThreatMetrix-hosted whitelist.
EmailOnThreatMetrixGlobalBlacklist	This email address is on the ThreatMetrix global blacklist.
EmailRejectedByNetwork10TimesInLastDay	The associated email address has been rejected by one of ThreatMetrix's customers and/or partners 10 or more times in the last day on the suspicion of fraud.
EmailRejectedByNetworkInLastWeek	A transaction using this email address has been rejected by one of ThreatMetrix's customers and/or partners in the last week on the suspicion of fraud.
EmailUsernameTooLong	The name portion (i.e. to the left of "@") of this email address exceeds 30 characters. Email addresses associated with suspicious user names are often used as part of attacks. Overly long user names are a common marker of such domains.

**TABLE A-6** Triggered Rules Definitions

Triggered Rule Name	Description
EmailUsernameWithNonLetters	The name portion (i.e. to the left of "@") of this email address contains non-letter characters (e.g. numbers and special characters). Email addresses associated with suspicious usernames are often used as part of attacks. Usernames with non-letter characters are a common marker of such domains.
ExcessivePaymentsOnDeviceHour	An abnormally high number of transactions have been submitted from this device in the last hour. This is a common indicator of fraudulent payment.
ExcessivePaymentsOnDeviceDay	An abnormally high number of transactions have been submitted from this device in the last 24 hours. This is a common indicator of fraudulent payment.
ExcessivePaymentsOnFuzzyDeviceHour	An abnormally high number of transactions appear to have been submitted from this device in the last hour. This is a common indicator of fraudulent payment.
ExcessivePaymentsOnFuzzyDeviceDay	An abnormally high number of transactions appear to have been submitted from this device in the last 24 hours. This is a common indicator of fraudulent payment.
FlashBrowserLanguageMismatch	The language used by the web browser used to submit this transaction does not match the language used by the Flash plug-in. This is atypical and may be an indicator of misuse.
FlashCook1esJavascriptDisabled	The browser used to submit this transaction has disabled Flash objects, cookies, and JavaScript. This is common to fraud attacks and may be an indicator of misuse.
FlashCookiesDisabled	The browser used to submit this transaction has disabled Flash objects and cookies. This is common to fraud attacks and may be an indicator of misuse.
FlashDisabled	The browser used to submit this transaction has disabled Flash objects. This is common to fraud attacks and may be an indicator of misuse.

**TABLE A-6** Triggered Rules Definitions

Triggered Rule Name	Description
FlashImagesCookiesDisabled	The browser used to submit this transaction has disabled Flash objects, images, and cookies. This is common to fraud attacks and may be an indicator of misuse.
FlashImagesCookiesJavascriptDisabled	The browser used to submit this transaction has disabled Flash objects, images, cookies, and JavaScript. This is common to fraud attacks and may be an indicator of misuse.
FlashImagesDisabled	The browser used to submit this transaction has disabled Flash objects and images. This is common to fraud attacks and may be an indicator of misuse.
FlashImagesJavascriptDisabled	The browser used to submit this transaction has disabled Flash objects, images, and JavaScript. This is common to fraud attacks and may be an indicator of misuse.
FlashJavascriptDisabled	The browser used to submit this transaction has disabled Flash objects and JavaScript. This is common to fraud attacks and may be an indicator of misuse.
FuzzyDeviceLocalAgeLessThanOneHour	The originating device appears to have been seen by Vantiv for the first time within the past hour. This may point to a fraudster simulating a new device through advanced techniques in an attempt to avoid detection.
FuzzyDeviceOnLocalBlacklist	The originating device appears to be on Vantiv's ThreatMetrix-hosted blacklist.
FuzzyDeviceOnLocalWhitelist	The originating device appears to be on Vantiv's ThreatMetrix-hosted whitelist.
FuzzyDeviceOnThreatMetrixGlobalBlacklist	The originating device appears to be on the ThreatMetrix global blacklist.
FuzzyDeviceRejectedByNetworkInLastWeek	The originating device appears to have been rejected by one of ThreatMetrix's customers and/or partners in the last week on the suspicion of fraud.
GeolocationLanguageMismatch	The language detected from the originating web browser is not appropriate for the location. This is atypical and may be an indicator of misuse.

**TABLE A-6** Triggered Rules Definitions

Triggered Rule Name	Description
HiddenProxy	This transaction was submitted through a hidden web proxy, a method that is sometimes employed when trying to cloak one's identity.
ImagesCookiesDisabled	The browser used to submit this transaction has disabled images and cookies. This is common to fraud attacks and may be an indicator of misuse.
ImagesCookiesJavascriptDisabled	The browser used to submit this transaction has disabled images, cookies, and JavaScript. This is common to fraud attacks and may be an indicator of misuse.
ImagesDisabled	The browser used to submit this transaction has disabled images. This is common to fraud attacks and may be an indicator of misuse.
ImagesJavascriptDisabled	The browser used to submit this transaction has disabled images and JavaScript. This is common to fraud attacks and may be an indicator of misuse.
IPHasNegativeReputation	The originating IP address is a potential threat based upon analysis of its activity across the ThreatMetrix network.
IPOnLocalBlacklist	The originating IP address is on ThreatMetrix-hosted blacklist.
IPOnLocalWhitelist	The originating IP address is on ThreatMetrix-hosted whitelist.
IPOnThreatMetrixGlobalBlacklist	The originating IP address is on the ThreatMetrix global blacklist.
IPRejectedByNetwork10Times	The originating IP address has been rejected by one of ThreatMetrix's customers and/or partners 10 or more times on the suspicion of fraud.
IPRejectedByNetwork25Times	The originating IP address has been rejected by one of ThreatMetrix's customers and/or partners 25 or more times on the suspicion of fraud.
IPRejectedByNetwork5Times	The originating IP address has been rejected by one of ThreatMetrix's customers and/or partners 5 or more times on the suspicion of fraud.



**TABLE A-6** Triggered Rules Definitions

Triggered Rule Name	Description
JavascriptDisabled	The browser used to submit this transaction has disabled JavaScript. This is common to fraud attacks and may be an indicator of misuse.
KnownVPNISP	This transaction was submitted through a known Virtual Private Network (VPN), a method that is sometimes employed when trying to cloak one's identity.
MalwareDetectedOnDevice	The originating device appears have to been infected with malware.
OpenProxy	This transaction was submitted through an open web proxy, a method that is sometimes employed when trying to cloak one's identity.
PaymentCardBINShippingAddressGeolocationMismatch	The customer's ship-to address country does not match that of the payment card's issuing bank. This may be an indicator of a fraud attack.
PaymentCardBINTrueIPGeolocationMismatch	The geolocation of the True IP address does not match that of the payment card's issuing bank. This may be an indicator of a fraud attack.
PaymentCardDistanceTraveled	This payment card has been associated with transactions originating from locations at least 1,000 miles apart in the last hour. This is a red flag and warrants caution.
PaymentCardOnThreatMetrixGlobalBlacklist	This payment card is on the ThreatMetrix global blacklist.
PaymentCardRejectedByNetworkInLastWeek	A transaction using this payment card has been rejected by one of ThreatMetrix's customers and/or partners in the last week on the suspicion of fraud.
PhoneNumberOnLocalBlacklist	The customer telephone number for this transaction is on Vantiv's ThreatMetrix-hosted blacklist.
PhoneNumberOnLocalWhitelist	The customer telephone number for this transaction is on Vantiv's ThreatMetrix-hosted whitelist.

**TABLE A-6** Triggered Rules Definitions

Triggered Rule Name	Description
PossibleCookieWipingDay	The user appears to have cleared his or her browser's cookies 3 or more times in the last day. This is common to fraud attacks and may be an indicator of misuse.
PossibleCookieWipingHour	The user appears to have cleared his or her browser's cookies 3 or more times in the last hour. This is common to fraud attacks and may be an indicator of misuse.
PossibleCookieWipingWeek	The user appears to have cleared his or her browser's cookies 3 or more times in the last week. This is common to fraud attacks and may be an indicator of misuse.
PossibleVPNOrTunnel	This transaction may have been submitted through a Virtual Private Network (VPN), a method that is sometimes employed when trying to cloak one's identity.
PossibleVPNConnection	This transaction may have been submitted through a Virtual Private Network (VPN), a method that is sometimes employed when trying to cloak one's identity.
PotentialVirtualMachine	This transaction may have been submitted using a Virtual Machine, a method that is sometimes employed when trying to cloak one's identity.
ProxyHasNegativeReputation	The originating IP proxy is a potential threat based upon an analysis of its activity across the ThreatMetrix network.
ProxyIPHasNegativeReputation	The originating IP address is a potential threat based upon analysis of its activity across the ThreatMetrix network.
ProxyIPOnLocalBlacklist	The originating proxy IP address is on Vantiv's ThreatMetrix-hosted blacklist.
ProxyIPOnLocalWhitelist	The originating proxy IP address is on Vantiv's ThreatMetrix-hosted whitelist.
ProxyIPOnThreatMetrixGlobalBlacklist	The originating proxy IP address is on the ThreatMetrix global blacklist.

**TABLE A-6** Triggered Rules Definitions

Triggered Rule Name	Description
SatelliteISP	This transaction was submitted through a Satellite Internet Service Provider, a method that is sometimes employed when trying to cloak one's identity.
SatelliteProxyISP	This transaction was submitted through a Satellite Proxy Internet Service Provider, a method that is sometimes employed when trying to cloak one's identity.
SessionAnomaly	Characteristics of the originating device appear to have been modified during the course of the user's web session. This is atypical and may indicate misuse.
ShippingAddressTrueIPGeolocationMismatch	The shipping address country does not match that of the True IP address. This may be an indicator of a package redirection/interception/forwarding or re-shipping fraudster attack.
SuspectedSessionCloaking	The characteristics of the originating browser are consistent with common fraud attacks, and may be an indicator of a fraudster's deliberate attempt to cloak his or her identity.
SuspectedTORNetwork	This transactions appears to have originated from a TOR network, a common source of fraud attacks.
SystemStateAnomaly	The system state of the originating device has changed two or more times within the past hour. This is atypical and may indicate misuse.
TimeZoneTrueGeolocationMismatch	The time zone setting on the originating device does not match to the true geolocation of the customer. This is atypical and may be an indicator of misuse.
TransparentProxy	This transaction was submitted through a transparent web proxy, a method that is most often used in corporate environments, though also employed when trying to cloak one's identity.

**TABLE A-6** Triggered Rules Definitions

Triggered Rule Name	Description
TrueIPDNSGeolocationMismatch	The geolocation of the True IP address does not match that of the DNS provider. This may be an indicator of a fraudster's attempt to cloak his or her identity.
TrueIPHasNegativeReputation	The originating IP address is a potential threat based upon analysis of its activity across the ThreatMetrix network.
TrueIPOnLocalBlacklist	The originating true IP address is on Vantiv's ThreatMetrix-hosted blacklist.
TrueIPOnLocalWhitelist	The originating true IP address is on Vantiv's ThreatMetrix-hosted whitelist.
TrueIPOnThreatMetrixGlobalBlacklist	The originating true IP address is on the ThreatMetrix global blacklist.
TrueIPProxyIPCityMismatch	The city of the True IP address does not match that of the Proxy IP address. This may be an indicator of a fraudster's attempt to cloak his or her identity.
TrueIPProxyIPGeolocationMismatch	The geolocation of the True IP address does not match that of the Proxy IP address. This may be an indicator of a fraudster's attempt to cloak his or her identity.
TrueIPProxyIPISPMismatch	The Internet Service Provider of the True IP address does not match that of the Proxy IP address. This may be an indicator of a fraudster's attempt to cloak his or her identity.
TrueIPProxyIPOrganizationMismatch	The organization of the True IP address does not match that of the Proxy IP address. This may be an indicator of a fraudster's attempt to cloak his or her identity.
TrueIPProxyIPRegionMismatch	The region of the True IP address does not match that of the Proxy IP address. This may be an indicator of a fraudster's attempt to cloak his or her identity.
TrueIPRejectedByNetwork10TimesInLast Day	The originating IP address has been rejected by one of ThreatMetrix's customers and/or partners 10 or more times in the last day on the suspicion of fraud.

**TABLE A-6** Triggered Rules Definitions

Triggered Rule Name	Description
TrueIPRejectedByNetworkInLastWeek	The originating true IP has been rejected by one of ThreatMetrix's customers and/or partners in the last week on the suspicion of fraud.
UnusualProxyAttributes	This web proxy used to submit the transaction has unusual attributes (e.g. dialup), which may indicate an attempt to cloak one's identity.

## A.7 XML Validation Error Messages

Table A-7 provides examples of XML Validation Error Messages. These messages are the value associated with the message attribute of either a `litleResponse` or `litleOnlineResponse`, when the `response="1"` (the response attribute).

---

**NOTE:** If `response="0"`, the associated `message="Valid Format"`.  
 For information about response values 2 through 5, please refer to [Additional Response Header Error Messages](#) on page 866.

---

**TABLE A-7** Response Header Error Message Examples

Example Message (message attribute of <code>litleOnlineResponse</code> )	Description (line numbers will vary according to the location of the error)
Error validating xml data against the schema on line 13. The length of the value is 3, but the required minimum is 4.	The value on line 13 does not meet the minimum length requirement for the element as specified in the schema. For example, if you specified 812 as a value for the <code>&lt;expDate&gt;</code> element, which has a <code>minLength</code> of 4, the system returns this error message.
Error validating xml data against the schema on line 18. The length of the value is 6, but the required maximum is 4.	The value on line 18 exceeds the maximum length requirement for the element as specified in the schema. For example, if you specified 082012 as a value for the <code>&lt;expDate&gt;</code> element, which has a <code>maxLength</code> of 4, the system returns this error message.
Error validating xml data against the schema on line 11. The value is not a member of the enumeration.	The value on line 11 is not a valid enumeration for the specified element. For example, The <code>&lt;type&gt;</code> element allows values of VI, MC, DI, AX, DC, JC, PP and BL. If you submitted a value of VISA, the system returns this error message.
Error validating xml data against the schema on line 8. Content of element <code>&amp;quot;amount&amp;quot;</code> is incomplete.	The <code>&lt;amount&gt;</code> element does not contains a valid value. For example, if you submitted a <code>captureGivenAuth</code> request and included the <code>amount</code> element without specifying a value, the system returns this error message.
Error validating xml data against the schema on line 6 tag name <code>&amp;quot;echeckSale&amp;quot;</code> is not allowed. Possible tag names are: <code>&amp;lt;authorization&amp;gt;</code> , <code>&amp;lt;capture&amp;gt;</code> , <code>&amp;lt;credit&amp;gt;</code> , <code>&amp;lt;sale&amp;gt;</code> , <code>&amp;lt;void&amp;gt;</code> ;	The submitted transaction failed validation against the schema, because an element name was out of sequence or not allowed in the transaction. The error message specifies the invalid element ( <code>&lt;echeckSale&gt;</code> in the example), as well as the possible valid elements.

**TABLE A-7** Response Header Error Message Examples (Continued)

Example Message (message attribute of <code>litleOnlineResponse</code> )	Description (line numbers will vary according to the location of the error)
System Error - Call Vantiv	<p>Typically, the system returns this error if there was a problem with authentication due to an error in the submitted Merchant Id, user, and/or password.</p> <p>The problem may also be due to the use of single quotes around the attribute (<code>merchantId</code>) value.</p>
Error validating xml data against the schema on line 1. Probably namespace URI of tag <code>&lt;litleOnlineRequest&gt;</code> is wrong (correct one is <code>&lt;http://www.litle.com/schema&gt;</code> ;) )	<p>The URI named in the <code>xmlns=</code> attribute is incorrect. The problem may also be due to the use of single quotes around the attribute value.</p> <p><b>Note:</b> The URI may differ based upon the version of cnpAPI you are using.</p>
Error validating xml data against the schema on line 12786. The entity name must immediately follow the <code>&amp; amp;</code> in the entity reference.	<p>The <code>'&amp;</code> symbol is used in XML to designate certain special characters. The error indicates that the symbol was submitted without an entity name (for example, <code>&amp;quot;</code>; or <code>&amp; amp;</code>;) ).</p> <p>Typically, the error occurs when the name or one of the address lines of the <code>billToAddress</code> element includes the symbol instead of the entity reference. For example, “John &amp; Mary Smith” should be sent as “John &amp; amp; Mary Smith” or “John and Mary Smith”).</p>
Error validating xml data against the schema on line 1. Content is not allowed in prolog.	<p>This error is usually an indication of extraneous characters appearing in front of the first XML element. For example, the <code>“?”</code> before the <code>“&lt;”</code> symbol in the following line would cause this error to be returned:</p> <pre data-bbox="824 1272 1349 1297">?&lt;?xml version="1.0" encoding="utf-8"&gt;</pre>
Duplicate Batch (Batch ID: 28292109643, session sequence: 1, unique ID:) not processed - 29 duplicate transactions (57 total) in a row found. Duplicate Batch (Batch ID: 23829210964, session sequence: 1, unique ID:) not processed - 96.49% of the transactions (57 total) in the batch are duplicates.	<p><b>(Batch only)</b> The system has determined that the Batch is a duplicate and therefore not processed.</p> <p>The first part of the message provides the count of the greatest number of consecutive duplicate transaction in the batch (29 in the example). The second part of the message the overall percentage of duplicates in the batch (96.49% in the example).</p> <p>The limits are more than 10 consecutive duplicate transactions detected and/or more than 25% of all transaction in the batch detected as duplicates.</p>

## A.8 Additional Response Header Error Messages

When submitting transactions via Open Access, there are additional HTTP responses and validation errors that may occur. The table below provides information about these responses/error messages, as well as some additional errors you may encounter during Online transaction processing.

---

**NOTE:** The response value and message in the table represent the values for the response and message attributes of either a `littleResponse` or `littleOnlineResponse`.

If Resubmit? = No, you must debug and modify the submitted message prior to resubmission in order to have any chance of success. Resubmitting the same message will result in the same failure.

---

**TABLE A-8** HTTP Status Message and Validation Errors

response value	message	HTTP Status Code/Message	Description	Resubmit?
2	Invalid XML. Contact eCommerceSupport@vantiv.com.	200 OK	The submission is not valid XML containing the <code>user</code> and <code>password</code> elements.	No - debug or contact Vantiv Support
3	Invalid credentials. Contact eCommerceSupport@vantiv.com.	200 OK	The submission contains empty or invalid credentials ( <code>user</code> and <code>password</code> ).	Maybe - verify credentials
4	Connection limit exceeded. Contact eCommerceSupport@vantiv.com.	200 OK	The merchant has exceeded the maximum number of concurrent connections.	Yes
5	Objectionable content detected. Contact eCommerceSupport@vantiv.com.	200 OK	The system has determined that the submission may contain objectionable content.	No - debug or contact Vantiv Support
N/A	N/A	403 Method Not Allowed	The merchant has exceeded the maximum number of concurrent connections.	Yes
N/A	N/A	405 Method Not Allowed	Only HTTP POST method is allowed.	No - debug or contact Vantiv Support



**TABLE A-8** HTTP Status Message and Validation Errors

response value	message	HTTP Status Code/Message	Description	Resubmit?
N/A	N/A	404 Not Found	An invalid URI was used. Verify the URI you are using is correct and that you have not appended any parameters to the URI.	No - debug or contact Vantiv Support
N/A	N/A	417 Expectation Failed	An HTTP <b>Expect</b> header was included in the HTTP POST, which is not allowed.	No - debug or contact Vantiv Support

## A.9 ACH Return Reason Codes

Table A-9 is a list of ACH Return Reason Codes, which can apply to either eCheck transactions, or Dynamic Payout funding instructions. These codes are not returned in the cnpAPI response messages, but are visible in iQ on the eCheck Returns Received report, as well as the Payment Detail screen and the Funding Instruction Detail screen.

---

**NOTE:** If an eCheck is returned for reason Code R01 or R09, it is eligible for redeposit.

---

**TABLE A-9** eCheck Return Reason Codes

ACH Return Reason Code	Description
R01	Insufficient funds in account
R02	Account is closed
R03	No account on file
R04	Invalid account number
R05	Unauthorized debit to consumer account
R06	Returned at request of ODFI
R07	Authorization revoked by customer
R08	Payment stopped
R09	Insufficient collected funds in account being charged
R10	Customer advises not Authorized, notice not provided, improper source document, or amount of entry not accurately obtained from source document
R11	Check truncation return
R12	Account sold to another financial institution
R13	Invalid ACH routing number
R14	Representative payee is deceased or cannot continue in that capacity
R15	Beneficiary or account holder other than representative payee deceased
R16	Account funds have been frozen

**TABLE A-9** eCheck Return Reason Codes

<b>ACH Return Reason Code</b>	<b>Description</b>
R17	Item returned because of invalid data; refer to addenda fro information
R18	Improper effective date
R19	Amount error
R20	Account does not allow ACH transactions or limit for transactions has been exceeded
R21	Invalid company identification
R22	Invalid individual ID
R23	Credit entry refused by receiver
R24	Duplicate entry
R25	Addenda record error
R26	Mandatory field error
R27	Trace number error
R28	Routing/transit number check digit error
R29	Corporate customer advised not authorized
R30	RDFI not participant in check truncation program
R31	Permissible return entry
R32	RDFI non-settlement
R33	Return of item
R34	Limited participation ODFI
R35	Return of improper debit entry
R36	Return of improper credit entry
R37	Source document presented for payment
R38	Stop payment on source document
R39	Improper source document
R40	Return of item by government agency
R41	Invalid Transaction Code
R42	Routing/transit number check digit error
R43	Invalid account number

**TABLE A-9** eCheck Return Reason Codes

<b>ACH Return Reason Code</b>	<b>Description</b>
R44	Invalid individual ID
R45	Invalid individual name or company name
R46	Invalid representative payee indicator code
R47	Duplicate enrollment
R50	State law affecting RCK acceptance
R51	Item is ineligible, notice not provided, signature not genuine, or original item altered for adjustment entry
R52	Stop payment on item
R53	Item and ACH entry presented for payment
R61	Misrouted return - RDFI for original entry has placed incorrect routing/transit number in RDFI identification field
R67	Duplicate return
R68	Untimely return - return was not sent within the established time frame
R69	Field errors
R70	Permissible return entry not accepted
R71	Misrouted dishonored return -incorrect routing/transit number in RDFI identification field
R72	Untimely return - dishonored return was not sent within the established time frame
R73	Timely original return - RDFI certifies the original return entry was sent within established time frame for original returns
R74	Corrected return - RDFI is correcting a previous return entry that was dishonored because it contained incomplete or incorrect information
R75	Original return not a duplicate
R76	No errors found
R80	Cross-border payment coding error
R81	Non-participant in cross-border program
R82	Invalid foreign RDFI identification
R83	Foreign RDFI unable to settle
R84	Cross-border entry not processed by originating gateway operator

## A.10 ACH NoC Change Codes

Table A-10 is a list of ACH NOC Change Codes. These codes are included in the daily NOC report made available to you via sFTP.

**TABLE A-10** eCheck NOC Change Codes

<b>ACH NOC Change Code</b>	<b>Description</b>
C01	Incorrect account number
C02	Incorrect routing/transit number
C03	Incorrect routing/transit number and incorrect account number
C04	Incorrect account name
C05	Incorrect transaction code
C06	Incorrect account number and transaction code
C07	Incorrect routing/transit number, account number and transaction code
C08	Incorrect foreign RDFI identification
C09	Incorrect individual ID
C13	Addenda format error
C61	Misrouted NOC
C62	Incorrect trace number
C63	Incorrect company ID
C64	Incorrect individual ID
C65	Incorrectly formatted correct data
C66	Incorrect discretionary data
C67	Routing/transit number not from original entry
C68	Account number not from original entry
C69	Incorrect transaction code
C96	Administrative return dishonor (dollar amount will be zero)
C99	Converted to MICR draft (check conversion items)

## A.11 Canadian eCheck Return Codes

Table A-9 is a list of Canadian eCheck Return Reason Codes. These codes are not returned in the cnpAPI response messages, but are visible in iQ on the eCheck Returns Received report, as well as the Payment Detail screen and the Funding Instruction Detail screen.

---

**NOTE:** Return Reason Codes R901 or R908 are eligible for redeposit. Similarly, Code R900-xx are Edit rejects, which you can resubmit with corrected information.

---

**TABLE A-11** Canadian eCheck Return Reason Codes

Canadian eCheck Return Reason Code	Description
R900-07	Institution ID Invalid
R900-08	Account Number Invalid
R900-16	Institution ID for Return Invalid
R900-17	Account Number for Return Invalid
R900-D2	Destination Institute is Not Defined on FIF
R900-E1	Destination Account Number Invalid
R900-L2	Institution for Return Not Defined on FIF
R900-L3	Institution for Return Cross Reference Invalid
R900-M1	Account for Return Invalid
R901	NFS (Debit Only)
R902	Cannot Trace
R903	Payment Stopped/Recalled
R904	Post/Stale Dated
R905	Account Closed
R907	No Debit Allowed
R908	Funds Not Cleared
R909	Currency/Account Mismatch
R910	Payor/Payee Deceased
R911	Account Frozen

**TABLE A-11** Canadian eCheck Return Reason Codes

<b>Canadian eCheck Return Reason Code</b>	<b>Description</b>
R912	Invalid/Incorrect Account Number
R914	Incorrect Payor/Payee Name
R915	PAD No Agreement Existed - Business/Personal
R916	PAD Not According to Agreement - Personal
R917	PAD Agreement Revoked - Personal
R918	PAD No Confirmation/Pre-Notification - Personal
R919	PAD Not According to Agreement - Business
R920	PAD Agreement Revoked - Business
R921	PAD No Confirmation/Pre-Notification - Business
R922	Customer Initiated Return - CREDIT only
R990	Institution in Default





## CREDIT CARD NUMBER FORMATS

This appendix has two parts. The first provides basic information about card numbers, such as length, prefixes, and validation numbers. The second part provides information about the Luhn Mod-10 algorithm used to validate account numbers.

### Credit Card Number Formats:

Table B-1 provides information on number formats for various credit card types.

---

**CAUTION:** The data presented here is for informational purposes only and is subject to change by the Credit Card Associations/Companies. You should verify the information using additional sources prior to using it to create or alter any of your business systems, processes, or procedures.

---

**TABLE B-1** Card Number Formats

Card Type	Card Number Prefix/Range	Number Length	Card Validation Number Length	Comments
American Express	34 and 37	15 digits	4 digits	
Diners Club International	36	14 digits	3 digits	Account Numbers starting with 36 should be submitted as Discover.
Diners Club (US and Canada)	54 and 55	16 digits	3 digits	These are processed through the MasterCard network and must be submitted as MasterCard.

Card Type	Card Number Prefix/Range	Number Length	Card Validation Number Length	Comments
Discover	30000000-30599999 30950000-30959999 35280000-35899999 36 38 39 64 65 6011 62212600-62699999 62400000-62699999 62820000-62889999	14 digits or 16 digits	3 digits	
JCB	35 (except 352800-358999)	16 digits	3 digits	Account numbers 352800-358999 are processed through the Discover network
MasterCard	51-55 222100 - 272099	16 digits or 19 digits	3 digits	The 222100 - 272099 BIN range will be active as of October 2016. Merchants must support this BIN range no later than January 1, 2017.
Visa	4	16 digits or 19 digits	3 digits	

### Luhn Mod-10 Algorithm for Card Number Validation:

The Luhn Mod-10 algorithm was invented in 1954 by IBM scientist Hans Peter Luhn and is a relatively simple formula used in numerous applications to validate identification numbers, including credit cards. The algorithm detects all single digit errors in an account number, as well as most transpositions of adjacent numbers.

Use the following method to determine if an account number is Mod-10 compliant:

1. Working from the right, double every other number. If the result of any doubling is a 2-digit number, treat them as individual digits for step 2. For example,  $2 * 9 = 18$ , should be treated as a 1 and an 8.

2. Add all the numbers together, including those you did not double. Remember to treat any 2-digit numbers as individual numbers.
3. If the result of step 2 is a multiple of 10, the account number is Mod-10 compliant.

**Example: Mod-10 Algorithm**

For the account number 4005550000081019, the computations are shown in the table below.

4	0	0	5	5	5	0	0	0	0	0	8	1	0	1	9
x2		x2		x2		x2		x2		x2		x2		x2	
8	0	0	5	10	5	0	0	0	0	0	8	2	0	2	9
8+	0+	0+	5+	1+0+	5+	0+	0+	0+	0+	0+	8+	2+	0+	2+	9

The result is 40, which is a multiple of 10 and therefore compliant.



# TEST CARD NUMBERS

The following table provides a list of credit card numbers you can use in our Certification environment to construct your own transactions beyond what is required for certification. These account numbers are extracted from the Certification tests of Chapter 2 and the transaction examples of Chapter 3. Never use these account numbers in the live, production environment.

---



---

**IMPORTANT:** Per PCI DSS Requirements and Security Assessment Procedure, Section 6.4.3, "Production data (live PANs) are not used for testing or development."

---



---

**TABLE C-1** Test Card Numbers

Account Number	Card Type	CVV2/CID
4457010000000009	Visa	349
4457010100000008	Visa	992
4457010140000141	Visa	N/A
4457010200000247	Visa	N/A
4100200300011001	Visa	463
4100200300012009	Visa	N/A
4100200300013007	Visa	N/A
4100200310000002	Visa	N/A
4024720001231239	Visa	N/A
4457012400000001	Visa	N/A
4457013200000001	Visa	N/A
4457119922390123	Visa	N/A

**TABLE C-1** Test Card Numbers

Account Number	Card Type	CVV2/CID
4457000300000007	Visa	N/A
4457000100000009	Visa	N/A
4457003100000003	Visa	N/A
4457000400000006	Visa	N/A
4457000200000008	Visa	N/A
4457000800000002	Visa	N/A
4457000900000001	Visa	N/A
4457001000000008	Visa	N/A
4005550000081019	Visa	N/A
4000000000000002	Visa	555
2223000148400010	MasterCard	001
2223000048400011	MasterCard	001
2223280062080010	MasterCard	001
2222630061560019	MasterCard	001
2222470061880012	MasterCard	001
2222400061240016	MasterCard	001
2222400041240011	MasterCard	001
2223520063560019	MasterCard	001
2223520043560014	MasterCard	001
2222420040560011	MasterCard	001
2222410040360017	MasterCard	001
2223020040760014	MasterCard	001
5112000100000003	MasterCard	N/A
5112002100000009	MasterCard	N/A
5112002200000008	MasterCard	N/A
5112000200000002	MasterCard	N/A
5112000300000001	MasterCard	N/A
5112000400000000	MasterCard	N/A
5112010400000009	MasterCard	N/A

**TABLE C-1** Test Card Numbers

Account Number	Card Type	CVV2/CID
5112000600000008	MasterCard	N/A
5112010000000003	MasterCard	261
5112010100000002	MasterCard	251
5112010140000004	MasterCard	N/A
5154605300000121	MasterCard	N/A
5167001020236549	MasterCard	N/A
5500000254444445	MasterCard	N/A
5592106621450897	MasterCard	N/A
5590409551104142	MasterCard	N/A
5587755665222179	MasterCard	N/A
5445840176552850	MasterCard	N/A
5390016478904678	MasterCard	N/A
5112010201000109	MasterCard	N/A
5112010202000108	MasterCard	N/A
5194560012341234	MasterCard	N/A
5435101234510196	MasterCard	987
5407102010000018	MasterCard	N/A
5112000900000005	MasterCard	N/A
6011010000000003	Discover	758
6011010100000002	Discover	184
6011010140000004	Discover	N/A
375000026600004	American Express	N/A
375001000000005	American Express	N/A
375001010000003	American Express	0421
375001014000009	American Express	N/A
341234567890127	American Express	N/A





---

## PAYFAC™ DYNAMIC PAYOUT

This appendix discusses the Vantiv Instruction-Based Dynamic Payout option provided for use by PayFacs (Payment Facilitators).

Topics covered in this document include:

- [Advantages of Using Dynamic Payout](#)
- [Overview of Dynamic Payout](#)
- [Example of Funding Instructions](#)
- [Funding Instruction Certification Testing](#)
- [SSR Reports](#)
- [Tax ID Validation Process](#)

---

**NOTE:** Please also refer to the *PayFac Dynamic Payout FAQ* document, which contains answers to numerous topics including payout timing, split platform processing, report availability, and general process items.

---

## D.1 Advantages of Using Dynamic Payout

Dynamic Payout is a solution platform that controls the distribution of funds using flexible, customized instructions defined by the PayFac. The solution provides a closed-loop transaction life cycle from payment to payout. With one connection for payments and payouts, our solution reduces a PayFac's dependency on other vendors, minimizing cost associated with PCI and reducing scope.

Dynamic Payout is dependent upon the PayFac submitting instructions each time a payout is required. A PayFac can fund merchants on a fixed schedule, such as daily, weekly or monthly, or irregular schedule. PayFacs may even choose to delay funding based on contractual or risk related issues.

The Dynamic Payout funding solution has the following capabilities and benefits:

### Capabilities:

- Execute payouts for all card brands, including American Express, as early as the next day.
- Determine when to payout.
- Calculate the fees to charge sub-merchants for rendering service. You can use a complex formula or a tiered billing structure.
- Charge fees at a transaction level, not just MID level.
- Maintain a reserve on your sub-merchants.
- Fund a sub-merchant that needs funds split across multiple bank accounts. You can fund multiple bank accounts per sub-merchant.

## D.2 Overview of Dynamic Payout

Dynamic Payout is a method of distributing funds to your sub-merchants, physical check (writing) services, other third party vendors (in the payment flow), and yourself via the ACH network. With Dynamic Payout, you board sub-merchants and submit transactions normally. Funds from settled transactions accumulate in a FBO (For Benefit Of) account. You distribute the funds to your sub-merchants by submitting a Batch file containing Funds Transfer Instructions (see [Example of Funding Instructions](#)), or Online by submitting individual instruction. You submit these instructions based upon your payout agreements with your sub-merchants (daily, weekly, monthly, etc.). Vantiv processes the instructions and moves the funds from the holding account to the sub-merchants. Funding can take place as early as the next day after settlement or on the same day if you utilize Same Day Funding.

**FIGURE D-1** Overview of Instruction-Based Funding

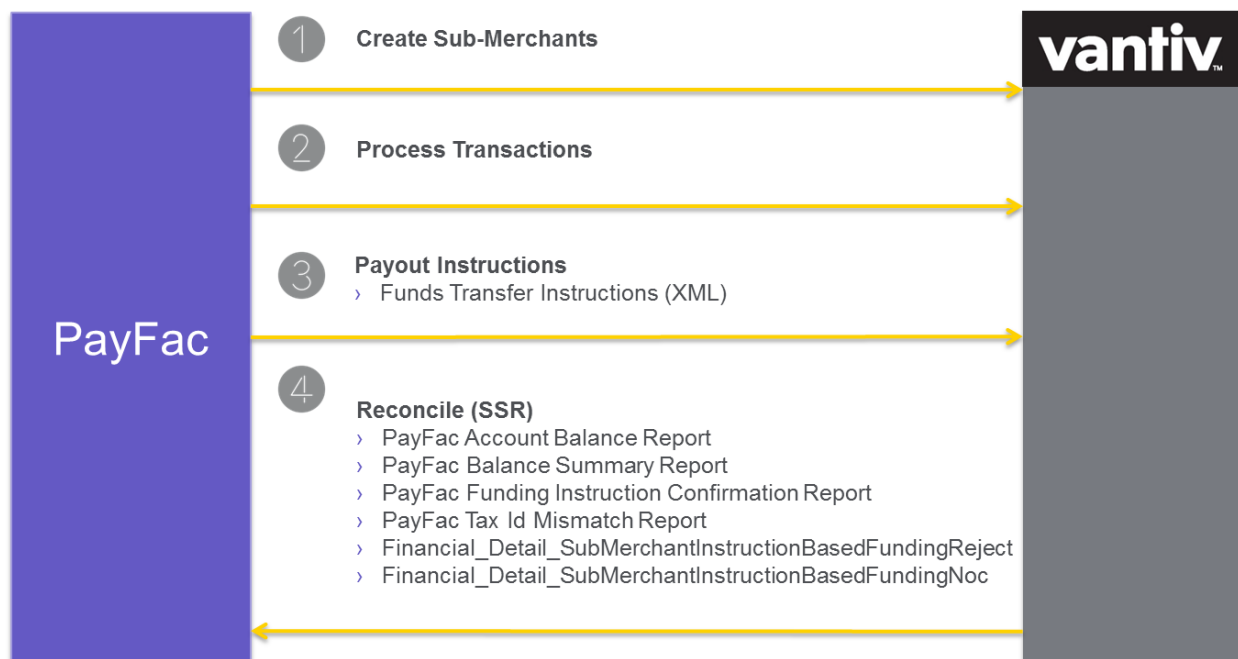

## D.2.1 Timing of Transactions, Reports, and Money Movement

The diagram below illustrates the typical timing and flow of transactions, reports, and money movement. In the diagram, the process begins with the delivery of transactions on Monday morning from the Sub-merchants to the PayFac and completes on Wednesday morning with the final money movement.

**NOTE:** The diagram below does not reflect the Same Day Funding or FastAccess Funding™ options.

**FIGURE D-2** Transaction, Reports, and Money Movement

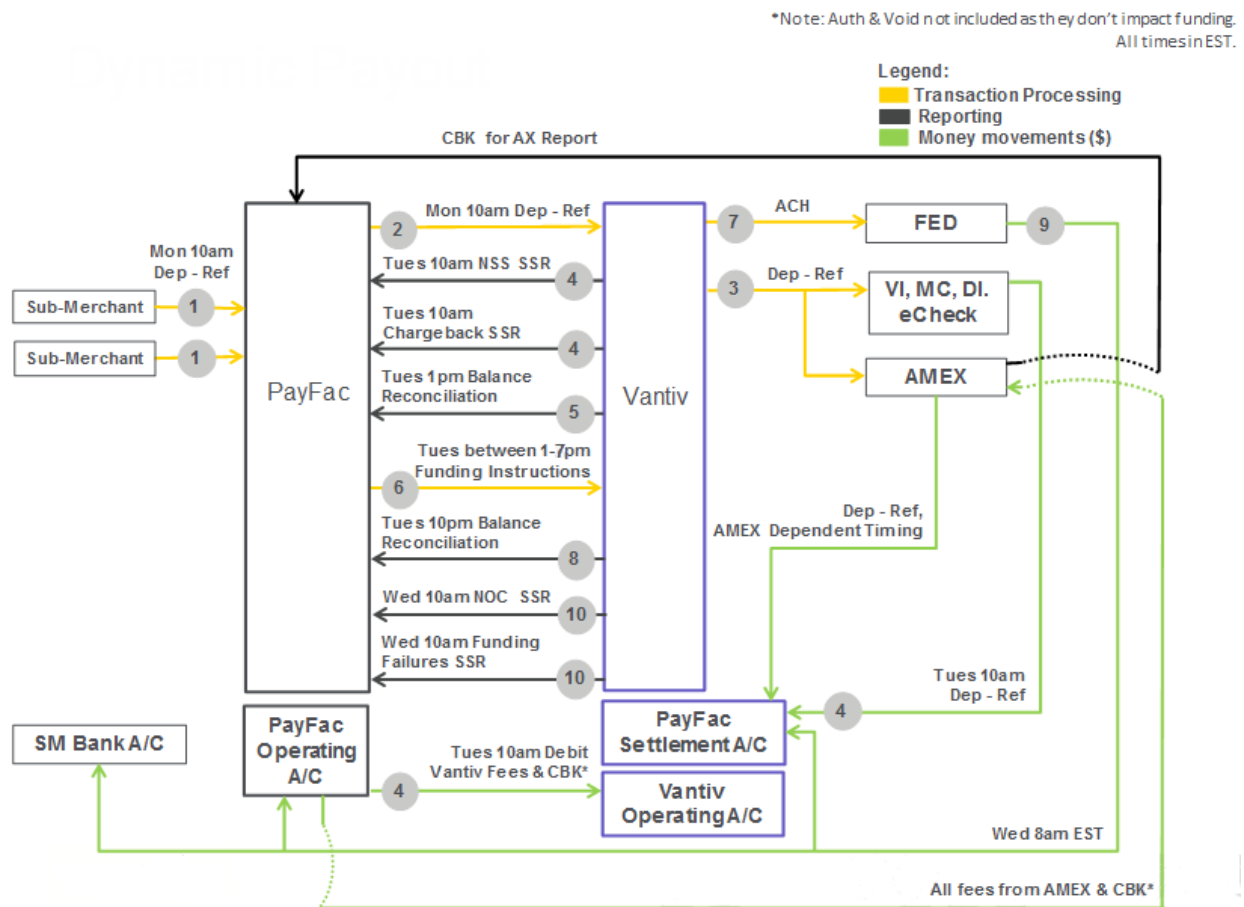

**NOTE:** The money movement into the PayFac Settlement account from card and eCheck transactions is the Net Settled Sales (i.e., Deposits - Refunds). The funds debited from the PayFac Operating account is the total of Interchange + Chargebacks + Assessments + Vantiv Fees for PayFacs processing on the eComm platform or just Vantiv fees, if processing on the Vantiv Core platform.

## D.2.2 Money Movement and Accounts

Figure D-3 below illustrates the various possible accounts, as well as the funding instructions associated with moving the funds between the accounts.

---

**IMPORTANT:** Vantiv performs a check on the net (deposits - refunds) money movement between accounts for each Batch of funding instructions. If there are insufficient funds in any account impacted by the funding instructions, Vantiv rejects the entire Batch without processing any instructions. The returned error message provides information about which account lacks the necessary funds.

---

FIGURE D-3 Dynamic Payout Accounts

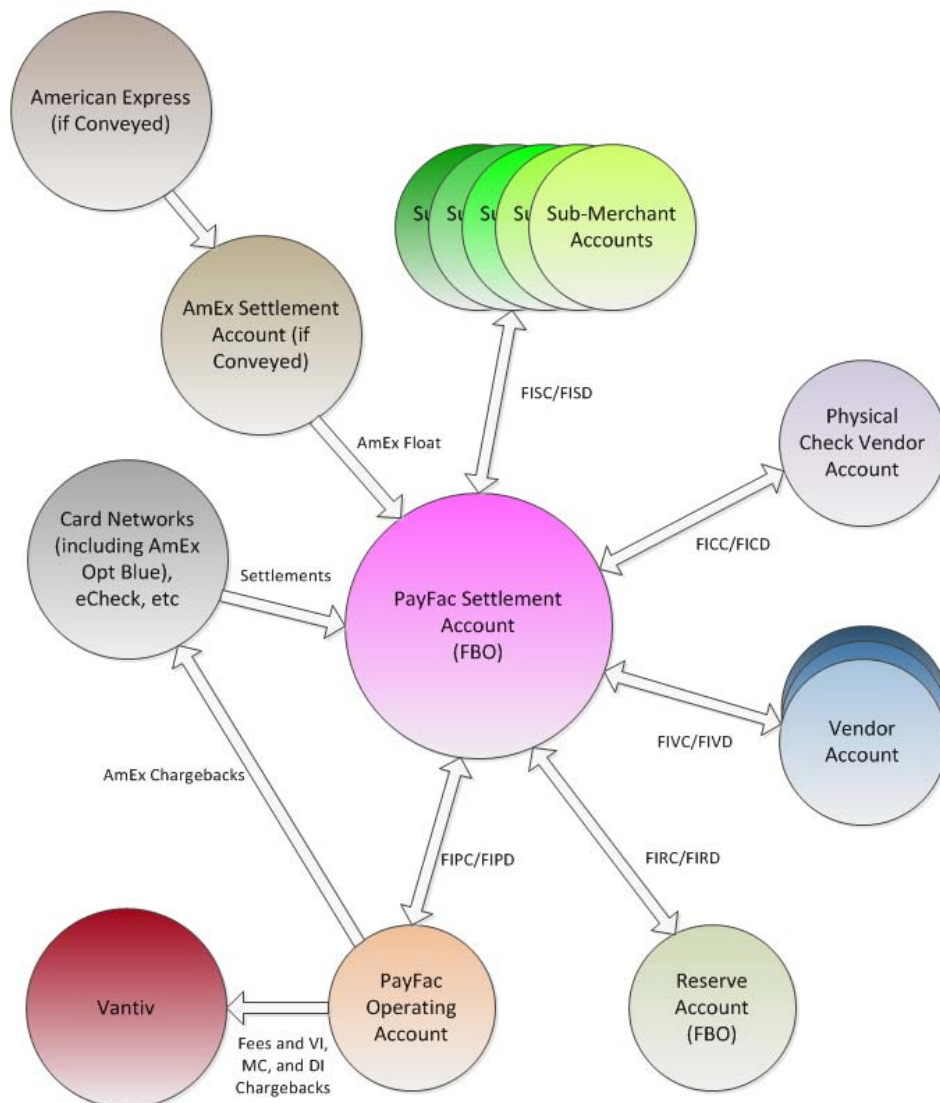

The cnpAPI file shown in [Example of Funding Instructions](#) on page 891 provides examples of the transactions used for each type of money movement. The following transaction type are available for your use:

- **Funding Instruction PayFac Credit (FIPC)** - used to move funds from the PayFac Settlement account to the PayFac Operating account.
- **Funding Instruction PayFac Debit (FIPD)** - used to move funds from the PayFac Operating account to the PayFac Settlement account.
- **Funding Instruction Reserve Credit (FIRC)** - used to move funds from the PayFac Settlement account to the PayFac Reserve account.
- **Funding Instruction Reserve Debit (FIRD)** - used to move funds from the PayFac Reserve account to the PayFac Settlement account.
- **Funding Instruction Sub-merchant Credit (FISC)** - used to move funds from the PayFac Settlement account to the sub-merchant Operating account.
- **Funding Instruction Sub-merchant Debit (FISD)** - used to move funds from the sub-merchant Operating account to the PayFac Settlement account.
- **Funding Instruction Vendor Credit (FIVC)** - used to move funds from the PayFac Settlement account to the Vendor account.
- **Funding Instruction Vendor Debit (FIVD)** - used to move funds from the Vendor account to the PayFac Settlement account.
- **Funding Instruction Physical Check Credit (FICC)** - used to move funds from the PayFac Settlement account to the Physical Check account.
- **Funding Instruction Physical Check Debit (FICD)** - used to move funds from the Physical Check account to the PayFac Settlement.
- **Funding Instruction Void** - used to void a submitted, but unsettled funding instruction. (See [Funding Instruction Void Transactions](#) on page 895.)
- **FastAccess Funding™** - used to transfer funds to certain eligible MasterCard or Visa debit cards. Transfer of funds takes place within 30 minutes. (See [FastAccess Funding™](#) on page 889.)

### D.2.2.1 Same Day Funding

Starting with V11.1, Vantiv provides an additional funding instruction submission window that adds the capability of same day funding. This means you can submit a funding instruction files (Batch or Online) before 12:00 PM ET and the funds move the same day. Submissions must also meet the following conditions for same day processing.

- All transactions, Batch or Online must be for less than \$25,000 (single transaction limit).

---

**NOTE:** If you include a transaction over \$25,000, we mark the transactions as same day, but processing takes place next day. Because you set the `sameDayFunding` flag to `true`, we assess fees for same day funding. To avoid excess fees, do not attempt to use same day funding for these transactions.

---

- We only process same day funding batch submissions on non-holiday weekdays (i.e., no weekends or holidays).
- Batch or Online instructions submitted outside the allowed window are processed as next day funding instructions.
- You must set the `sameDayFunding` attribute (of the `batchRequest` or `littleOnlineRequest`) to **true**.

If you miss the submission window with a batch or online file marked for same day funding, we process it as a normal, next day funded batch and apply only the normal next day funding fee.

### D.2.2.2 FastAccess Funding™

The FastAccess Funding feature allows you to fund a sub-merchant within 30 minutes of submitting the `fastAccessFunding` transaction by pushing the funds to certain MasterCard or Visa cards held by your sub-merchant.

The example below uses the `token` structure to designate the card to which you are pushing the funds. This transaction type also allows the use of the `card` structure or the `paypage` structure in place of the `token` structure.

#### Example: FastAccess Funding Request (using a token)

```
<cnpOnlineRequest version="12.0" xmlns="http://www.vantivcnp.com/schema"
  merchantId="100">
  <authentication>
    <user>User Name</user>
    <password>Password</password>
  </authentication>
  <fastAccessFunding id="A123456" reportGroup="FastPayment">
    <fundingSubmerchantId>SomeSubMerchant</fundingSubmerchantId>
    <submerchantName>Some Merchant Inc.</submerchantName>
    <fundsTransferId>123e4567e89b12d3</fundsTransferId>
    <amount>3000</amount>
    <token>
      <cnpToken>1111000101039449</cnpToken>
      <expDate>1112</expDate>
      <cardValidationNum>987</cardValidationNum>
      <type>VI</type>
    </token>
  </fastAccessFunding>
</cnpOnlineRequest>
```

```
</token>  
</fastAccessFunding>  
</cnpOnlineRequest>
```

### Example: FastAccess Funding Response

```
<litleOnlineResponse version="11.3" xmlns="http://www.litle.com/schema"  
  response="0" message="Valid Format">  
  <fastAccessFundingResponse id="A123456" reportGroup="Fasy Payment">  
    <litleTxnId>82823972759879805</litleTxnId>  
    <fundsTransferId>123e4567e89b12d3</fundsTransferId>  
    <response>000</response>  
    <responseTime>2017-09-09T20:28:32</responseTime>  
    <postDate>2017-09-09</postDate>  
    <message>Approved</message>  
  </fastAccessFundingResponse>  
</litleOnlineResponse>
```

### D.2.2.3 Account Balance Verifications

Vantiv performs a front-end check on each Funding Instruction Batch, as well as Online instructions, verifying sufficient account balances to cover the net money movement from each account. If system detects insufficient funds in any account impacted by the funding instructions, Vantiv rejects the entire Batch or the individual Online instruction. The returned error message provides information about the account lacking funds.

---

---

**NOTE:** To avoid possible account balance verification issues, Vantiv recommends you submit debit transactions first, in a separate Batch from the credit transactions.

---

---

For example, you submit a Batch of funding instructions that include a number of `reserveCredit` and `reserveDebit` transactions, such that the net funds movement (credits - debits) results in \$200,000 being moved from the PayFac Reserve Account to the PayFac Settlement Account. If the current balance in the Reserve account is less than \$200,000, The front-end checks detect this situation and reject the entire Batch with a reject message similar to:

```
<litleResponse version="11.3" xmlns="http://www.litle.com/schema" id="691"  
  response="1" message="Over Balance (Litle ID: 819812345678357001, session  
  sequence: 2, unique ID: null) not processed - The specified Funding Instructions  
  would result in a negative balance in your Reserve Account"  
  litleSessionId="810123456789357102"></litleResponse>
```



## D.3 Example of Funding Instructions

To use Instruction-Based Funding, you must code to cnpAPI V9.0 or above for Batch, or V11.3 or above for Online. The example below shows a Batch containing the various funding instruction you can use. Do not mix other transaction types in a Batch containing funding instructions.

---

**NOTE:** You can submit funding instructions either Online or via Batch files, but not both. The two methodologies are mutually exclusive for funding instruction submissions.

---

### Example: cnpAPI Funding Instructions

```
<littleRequest version="11.3" xmlns="http://www.little.com/schema"
  numBatchRequests="1">
  <authentication>
    <user>username</user>
    <password>password</password>
  </authentication>
  <batchRequest merchantId="01601" numPayFacCredit="1"
    payFacCreditAmount="1000" numPayFacDebit="1" payFacDebitAmount="2000"
    numSubmerchantCredit="1" submerchantCreditAmount="3000"
    numSubmerchantDebit="1" submerchantDebitAmount="4000" numReserveCredit="1"
    reserveCreditAmount="5000" numReserveDebit="1" reserveDebitAmount="6000"
    numVendorCredit="1" vendorCreditAmount="7000" numVendorDebit="1"
    vendorDebitAmount="8000" numPhysicalCheckCredit="1"
    physicalCheckCreditAmount="9000" numPhysicalCheckDebit="1"
    physicalCheckDebitAmount="10000" sameDayFunding="true">
    <!-- Example of PayFac funding themselves. Funds move from the PayFac
    Settlement Account to the PayFac Operating Account. -->
    <payFacCredit id="abc12345" reportGroup="CollectedFees">
    <!-- ID of Submerchant associated with fee - NOT Payfac ID -->
    <fundingSubmerchantId>SomeSubMerchant</fundingSubmerchantId>
    <!-- Your internal tracking number for fund transfer -->
    <fundsTransferId>123e4567-e89b-12d3-a456-426655440000</fundsTransferId>
    <amount>1000</amount>
    </payFacCredit>
    <!-- Example of PayFac returning money to the settlement account. Funds
    move from the PayFac Operating Account to the PayFac Settlement Account.
    -->
    <payFacDebit id="abc12346" reportGroup="MiscRefunds">
    <fundingSubmerchantId>SomeSubMerchant</fundingSubmerchantId>
    <fundsTransferId>123e4567-e89b-12d3-a456-426655440001</fundsTransferId>
    <amount>2000</amount>
    </payFacDebit>
    <!-- Example of PayFac funding the Submerchant. Funds move from the PayFac
```

```
Settlement Account to the Submerchant Account. -->
<submerchantCredit id="abc12347" reportGroup="SubMerchantPayment">
  <fundingSubmerchantId>SomeSubMerchant</fundingSubmerchantId>
  <submerchantName>Some Merchant Inc.</submerchantName>
  <fundsTransferId>123e4567-e89b-12d3-a456-426655440002</fundsTransferId>
  <amount>3000</amount>
  <accountInfo>
    <accType>Checking</accType>
    <accNum>123456789012</accNum>
    <routingNum>114567895</routingNum>
  </accountInfo>
  <customIdentifier>Co_Descriptor</customIdentifier>
</submerchantCredit>
<!-- Example of PayFac debiting the Submerchant. Funds move from the
Submerchant Account to the PayFac Settlement Account. -->
<submerchantDebit id="abc12348" reportGroup="SubMerchantRefund">
  <fundingSubmerchantId>SomeSubMerchant</fundingSubmerchantId>
  <submerchantName>Some Merchant Inc.</submerchantName>
  <fundsTransferId>123e4567-e89b-12d3-a456-426655440003</fundsTransferId>
  <amount>4000</amount>
  <accountInfo>
    <accType>Checking</accType>
    <accNum>123456789012</accNum>
    <routingNum>114567895</routingNum>
  </accountInfo>
  <customIdentifier>Co_Descriptor</customIdentifier>
</submerchantDebit>
<!-- Example of PayFac adding money into reserves. Funds move from the
PayFac Settlement Account to the Reserve Account. -->
<reserveCredit id="abc12349" reportGroup="Reserve">
  <fundingSubmerchantId>SomeSubMerchant</fundingSubmerchantId>
  <fundsTransferId>123e4567-e89b-12d3-a456-426655440004</fundsTransferId>
  <amount>5000</amount>
</reserveCredit>
<!-- Example of PayFac getting money from Reserves. Funds move from the
Reserve Account to the PayFac Settlement Account. -->
<reserveDebit id="abc12350" reportGroup="SubMerchantRefund">
  <fundingSubmerchantId>SomeSubMerchant</fundingSubmerchantId>
  <fundsTransferId>123e4567-e89b-12d3-a456-426655440005</fundsTransferId>
  <amount>6000</amount>
</reserveDebit>
<!-- Example of PayFac funding the vendor. Funds move from the PayFac
Settlement Account to the Vendor Account. -->
<vendorCredit id="abc12351" reportGroup="vendorPayment">
```

```
<fundingSubmerchantId>SomeVendor</fundingSubmerchantId>
<vendorName>Some Vendor Inc.</vendorName>
<fundsTransferId>123e4567-e89b-12d3-a456-426655440006</fundsTransferId>
<amount>7000</amount>
<accountInfo>
  <accType>Checking</accType>
  <accNum>123456789012</accNum>
  <routingNum>114567895</routingNum>
</accountInfo>
</vendorCredit>
<!-- Example of PayFac debiting the vendor account. Funds move from the
Vendor Account to the Payfac Settlement Account. -->
<vendorDebit id="abc12352" reportGroup="vendorReturn">
  <fundingSubmerchantId>SomeVendor</fundingSubmerchantId>
  <vendorName>Some Vendor Inc.</vendorName>
  <fundsTransferId>123e4567-e89b-12d3-a456-426655440007</fundsTransferId>
  <amount>8000</amount>
  <accountInfo>
    <accType>Checking</accType>
    <accNum>123456789014</accNum>
    <routingNum>114567895</routingNum>
  </accountInfo>
</vendorDebit>
<!-- Example of PayFac funding the Physical Check Account. Funds move from
the PayFac Settlement Account to the Physical Check Account -->
<physicalCheckCredit id="abc12353" reportGroup="physicalCheck">
  <fundingSubmerchantId>SomeSubMerchant</fundingSubmerchantId>
  <fundsTransferId>123e4567-e89b-12d3-a456-426655440008</fundsTransferId>
  <amount>9000</amount>
</physicalCheckCredit>
<!-- Example of PayFac debiting the Physical Check account. Funds move
from the Physical Check Account to the PayFac Settlement Account-->
<physicalCheckDebit id="abc12354" reportGroup="physicalCheckDebit">
  <fundingSubmerchantId>SomeSubMerchant</fundingSubmerchantId>
  <fundsTransferId>123e4567-e89b-12d3-a456-426655440009</fundsTransferId>
  <amount>10000</amount>
</physicalCheckDebit>
</batchRequest>
</litleRequest>
```

Online Funding Instructions have the same structure as Batch transactions, except the parent element is `litleOnlineRequest` as shown in the example below.

### Example: Online Sub-merchant Credit Request

```
<cnpOnlineRequest version="12.0" xmlns="http://www.vantivcnp.com/schema"
  merchantId="100" sameDayFunding="true">
  <authentication>
    <user>User Name</user>
    <password>Password</password>
  </authentication>
  <!-- Example of PayFac funding the Submerchant. Funds move from the PayFac
  Settlement Account to the Submerchant Account. -->
  <submerchantCredit id="A123456" reportGroup="SubMerchantPayment">
    <fundingSubmerchantId>SomeSubMerchant</fundingSubmerchantId>
    <submerchantName>Some Merchant Inc.</submerchantName>
    <fundsTransferId>123e4567-e89b-12d3-a456-426655440002</fundsTransferId>
    <amount>3000</amount>
    <accountInfo>
      <accType>Checking</accType>
      <accNum>123456789012</accNum>
      <routingNum>114567895</routingNum>
    </accountInfo>
    <customIdentifier>Co_Descriptor</customIdentifier>
  </submerchantCredit>
</cnpOnlineRequest>
```

All Funding Instruction responses, except the Void response, have the identical structure other than the parent element. The example shown below, for a `payFacCreditResponse` illustrates all response structures.

### Example: Funding Instruction Response

```
<payFacCreditResponse id="asdf12345" reportGroup="CollectedFees">
  <litleTxnId>82823972759879805</litleTxnId>
  <fundsTransferId>123e4567-e89b-12d3-a456-426655440000</fundsTransferId>
  <response>000</response>
  <responseTime>2014-01-09T20:28:32</responseTime>
  <message>Approved</message>
</payFacCreditResponse>
```

## D.3.1 Funding Instruction Void Transactions

You can use the Funding Instruction Void transaction type to void/remove a designated instruction from a submitted batch of instructions provided the following conditions are met:

- You must be coded to XML V10.1 or above.
- Submit the Funding Instruction Void transaction prior to your cutoff time.
- You must submit the funding instruction void the same day as the funding instruction you wish to void, or in the case of same day funding, before the intra-day cutoff times. This rule also applies to weekends.

---

**NOTE:** When you issue a Finding Instruction Void, allow 30 minutes for the system to add the amount of the void back to your Settlement Account.

---

### Example: Online Funding Instruction Void Request

```
<litleOnlineRequest version="11.3" xmlns="http://www.litle.com/schema"
  merchantId="100" sameDayFunding="false">
  <authentication>
    <user>User Name</user>
    <password>Password</password>
  </authentication>
  <!-- Example of Funding Instruction Void. -->
  <fundingInstructionVoid id="A123456" reportGroup="void" id="1">
    <litleTxnId>82828656962104521</litleTxnId>
  </fundingInstructionVoid>
</litleOnlineRequest>
```

### Example: Online Funding Instruction Void Response

```
<litleOnlineResponse version="11.3" xmlns="http://www.litle.com/schema"
  response="0" message="Valid Format">
  <fundingInstructionVoidResponse id="1" reportGroup="void">
    <litleTxnId>82828656962109465</litleTxnId>
    <response>000</response>
    <responseTime>2017-09-02T15:51:54</responseTime>
    <message>Approved</message>
  </fundingInstructionVoidResponse>
</litleOnlineResponse>
```

## D.4 Funding Instruction Certification Testing

In order to validate of your cnpAPI structure for Instruction-Based transaction types, submit two Batches, one containing credit transaction and one containing debit transactions, using the data supplied in [Table D-1](#).

---

**NOTE:** All test transactions result in approved responses. They are intended only to allow you to verify that your XML messages will pass validation.

Although the tests separate debit and credit transactions, there are no system requirements to do so when constructing your Batches.

For required field without supplied data, submit any value valid for the element.

---

**TABLE D-1** Funding Instruction Test Data

Transaction Type	Supplied Data Elements		Key Response Elements	
	Element	Value	Element	Value
<b>First Batch Containing Credit Transactions:</b>				
payFacCredit	<fundsTransferId> <amount>	00001 1000	<fundsTransferId> <response> <message>	00001 000 Approved
submerchantCredit	<fundsTransferId> <amount>	00003 3000	<fundsTransferId> <response> <message>	00003 000 Approved
reserveCredit	<fundsTransferId> <amount>	00005 5000	<fundsTransferId> <response> <message>	00005 000 Approved
vendorCredit	<fundsTransferId> <amount>	00007 7000	<fundsTransferId> <response> <message>	00007 000 Approved
physicalCheckCredit	<fundsTransferId> <amount>	00009 9000	<fundsTransferId> <response> <message>	00009 000 Approved
<b>Second Batch Containing Debit Transactions:</b>				

**TABLE D-1** Funding Instruction Test Data

Transaction Type	Supplied Data Elements		Key Response Elements	
	Element	Value	Element	Value
payFacDebit	<fundsTransferId> <amount>	00002 2000	<fundsTransferId> <response> <message>	00002 000 Approved
submerchantDebit	<fundsTransferId> <amount>	00004 4000	<fundsTransferId> <response> <message>	00004 000 Approved
reserveDebit	<fundsTransferId> <amount>	00006 6000	<fundsTransferId> <response> <message>	00006 000 Approved
vendorDebit	<fundsTransferId> <amount>	00008 8000	<fundsTransferId> <response> <message>	00008 000 Approved
physicalCheckDebit	<fundsTransferId> <amount>	00010 10000	<fundsTransferId> <response> <message>	00010 000 Approved

## D.5 SSR Reports

You are required to receive the following Scheduled Secure Reports when using the Dynamic Payout feature:

- **Failed Fund Transfer Report** - contains data about failures to transfers funds to Sub-merchants accounts. The report is produced daily.
- **NoC Report** - contains NoC data detailing changes in Sub-merchants accounts discovered during funds transfer operations. The report is produced daily and removed after 24 hours.
- **Account Balance Report**- contains data about balances in various accounts used by this solution. The report is produced daily.
- **TIN Validation Report** - contains data about Legal Entity Tax Identification Numbers validation failures. The report is produced daily.
- **Funding Instruction Discrepancy Report** - provides data about each funding instruction, between 30 to 60 days old, that does not reconcile with submitted Funds In/Out reports.
- **Activity Discrepancy Report** - provides data reconciling the Finds In/Out report, settlement activity, and Net Sales per Source by activity day.
- **Funding Instruction ACH Summary Report** - provides counts of all funding instruction types, as well as counts of NOCs and fund transfer failures for the previous month
- **Funding Instruction Confirmation Report** - provides data about all settled funding instructions from the previous day.
- **Balance Summary Report** - provides a summary of the balance in the PayFac account for the previous day.

In addition to the required reports listed above, you can use the SSR to track transactional data, chargebacks, and to assist in reconciliation operations. Some of these reports are:

- **Net Settled Sales by Transaction Report** - includes all settled and conveyed transactions (deposits and refunds), including echeck transactions. The report can be scheduled based upon either Activity (post) or Settlement (funds transfer) day.
- **Session Report** - includes all transactions for a particular activity post day and allows reconciliation against submitted transactions.
- **Transaction Summary Report** - includes summarized deposits and refunds (both settled and conveyed) submitted by the merchant and broken down by purchase currency, reporting groups, and payment type for a particular activity post day.
- **Activity Report** - includes summarized financial data for transactions (deposits and refunds) based upon activity post date and broken down by Reporting Group and payment type.
- **Settlement Report** - includes summarized financial data for settled transactions (deposits and refunds) based upon settlement (funds transfer) date and broken down by Reporting Group and payment type.



- **Chargeback Financial Report** - includes detailed information about financial impacting chargeback activities for a given activity (post) or fund transfer (settlement) date.
- **Chargeback Status Report** - provides details of all chargeback activities for a designated activity (post day) date or date range in the case of a monthly report. This report is run daily or monthly.
- **Fee Report** - provides a detailed breakdown of all Vantiv and Passthrough (Interchange) fees associated with transactions for a given activity (post) or fund transfer (settlement) date.
- **Visa Fixed Acquirer Network Fee Report** - a PayFac report that provides details of Visa FANF fees assessed (by Legal Entity). Vantiv produces the report on the 8th of each month. Each report contains data for the prior month.
- **MasterCard per Location Fee Report** - a PayFac report that provides details of location fees assessed by Legal Entity and Sub-merchant. Vantiv produces the report on the 15th of each month. Each report contains data for the prior month.

---

---

**NOTE:** For additional information about these and other reports, please refer to the latest version of the *Vantiv Scheduled Secure Reports Reference Guide*.

---

---

## D.6 Tax ID Validation Process

The Internal Revenue Service requires that “a payment settlement entity (PSE) must file Form 1099-K, *Payment Card and Third Party Network Transactions*, for payments made in settlement of reportable payment transactions for each calendar year.”

Vantiv issues 1099-Ks to e-commerce merchants, PayFacs, and sub-merchants who are enabled for Dynamic Payout. Prior to issuing 1099-Ks, it is the responsibility of the PayFac to provide and validate sub-merchant Tax ID information to ensure that the validation process performed by Vantiv through IRS.gov is successful.

If the Tax ID validation fails, it is indicated in the Legal Entity Background Check Results panel of the PayFac Portal. You can also view the **PayFac Tax Id Validation Report**, available through the Scheduled Secure Report (SSR) service, to determine if a Legal Entity Tax ID Validation has failed. This report only applies to legal entities that have a sub-merchant funded through our platform, and is produced daily.

You can re-submit the sub-merchant request when certain Tax ID validation errors occur using the **Edit** button at the top of the View Sub-merchant page of the PayFac Portal to edit and re-submit Tax ID information.

---

# Index

---

## Numerics

---

3DS response certification testing, 2–142

## A

---

AAVS Response Codes, A–843  
accNum, 4–338  
Account Updater, 1–14  
accountInfo, 4–339  
accountInformation, 4–340  
accountNumber, 4–341  
accountNumberLength, 4–342  
accountUpdate, 4–343  
accountUpdateFileRequestData, 4–344  
accountUpdater, 4–345  
accountUpdateResponse, 4–349  
accType, 4–350  
actionReason, 4–351  
activate, 4–352  
activateResponse, 4–353  
activateReversal, 4–354  
activateReversalResponse, 4–355  
active, 4–356  
addOnCode, 4–357  
address response certification testing, 2–136  
addressIndicator, 4–358  
addressLine1, 4–359  
Advanced AVS Response Codes, A–843  
advancedAVSResult, 4–360  
advancedFraudChecks, 4–361  
advancedFraudResults, 4–362  
affiliate, 4–363  
affluence, 4–364  
Affluence Indicator Feature, 1–25  
allowPartialAuth, 4–365  
American Express  
    Authorization lifespan, 3–208  
amexAggregatorData, 4–366  
amount, 4–367  
androidpayResponse, 4–369  
applepay, 4–370  
applepayResponse, 4–371  
applicationData, 4–372  
applicationExpirationDate, 4–373

applicationPrimaryAccountNumber, 4–374  
approvedAmount, 4–375  
authAmount, 4–376  
authCode, 4–377  
authDate, 4–378  
authenticatedByMerchant, 4–379  
authentication, 4–380  
authenticationResult, 4–381  
authenticationTransactionId, 4–382  
authenticationValue, 4–383  
authInformation, 4–384  
authorization, 4–385  
Authorization lifespan, 3–208  
    American Express, 1–76  
    Discover, 1–76  
    MasterCard, 1–75  
    PayPal, 1–76  
    Visa, 1–75  
Authorization Reversal transactions  
    certification testing, 2–116  
authorizationResponse, 4–386  
authorizationSourcePlatform, 4–387  
authReversal, 4–388  
authReversalResponse, 4–389  
availableBalance, 4–390  
AVS Filtering, 1–32  
AVS response code testing, 2–135  
AVS Response Codes, A–842  
avsResult, 4–391

## B

---

balanceInquiry, 4–392  
balanceInquiryResponse, 4–393  
Basic Fraud Tools  
    AVS Filtering, 1–32  
    Fraud Velocity Filtering, 1–32  
    Prepaid Card Filtering, 1–30  
    Prior Chargeback Filtering, 1–31  
    Prior Fraud Filtering, 1–32  
    Security Code No-match Filtering, 1–31  
Basic Fraud tools  
    International Card Filtering, 1–31  
batchRequest, 4–394  
batchResponse, 4–402

beginningBalance, 4-403  
 billingDate, 4-404  
 billMeLaterRequest, 4-405  
 billMeLaterResponseData, 4-407  
 billToAddress, 4-408  
 bin, 4-410  
 bmlMerchantId, 4-411  
 bmlProductType, 4-412  
 bypassVelocityCheck, 4-413

## C

campaign, 4-414  
 cancelSubscription, 4-415  
 cancelSubscriptionResponse, 4-415, 4-416  
 capability, 4-417  
 capture, 4-418  
 captureGivenAuth, 4-420  
 captureGivenAuthResponse, 4-421  
 captureResponse, 4-422  
 card, 4-423  
 cardAcceptorTaxId, 4-425  
 Cardholder Type Indicator Feature, 1-26  
 cardholderAuthentication, 4-426  
 cardholderId, 4-427  
 cardholderName, 4-428  
 cardOrToken, 4-429  
 cardProductType, 4-430  
 cardSuffix, 4-431  
 cardValidationNum, 4-432  
 cardValidationResult, 4-433  
 cashBackAmount, 4-434  
 catLevel, 4-435  
 ccdPaymentInformation, 4-436  
 certification testing
 

- 3DS responses, 2-142
- address responses, 2-136
- Authorization Reversal transactions, 2-116
- AVS response codes, 2-135
- response codes and messages, 2-139
- volume testing, 2-200

 chargeback, 4-437  
 checkNum, 4-438  
 checkoutId, 4-439  
 city, 4-440  
 clinicOtherAmount, 4-441  
 code, 4-442  
 commodityCode, 4-443

companyName, 4-444  
 country, 4-445  
 createAddOn, 4-446  
 createDiscount, 4-447  
 createPlan, 4-448  
 createPlanResponse, 4-449  
 credit, 4-450  
 creditLine, 4-452  
 creditLitleTxnId, 4-453  
 creditResponse, 4-454  
 cryptogram, 4-455  
 currencyCode, 4-456  
 customAttribute1, 4-457  
 customBilling, 4-458  
 customerInfo, 4-461  
 customerIpAddress, 4-462  
 customerReference, 4-463  
 customerRegistrationDate, 4-464  
 customerType, 4-465  
 customerWorkTelephone, 4-466  
 customIdentifier, 4-460

## D

data, 4-467  
 deactivate, 4-468  
 deactivateResponse, 4-469  
 deactivateReversal, 4-470  
 deactivateReversalResponse, 4-471  
 debtRepayment, 4-472  
 Decline Notice
 

- eCheck Verification, 1-47

 deleteAddOn, 4-473  
 deleteDiscount, 4-474  
 deliveryType, 4-475  
 dentalAmount, 4-476  
 depositReversal, 4-477  
 depositReversalResponse, 4-478  
 description, 4-479  
 descriptor, 4-480  
 destinationCountryCode, 4-481  
 destinationPostalCode, 4-482  
 detailTax, 4-483  
 deviceManufacturerIdentifier, 4-484  
 deviceReputationScore, 4-485  
 deviceReviewStatus, 4-486  
 discountAmount, 4-487  
 discountCode, 4-488

**Discover**

- Authorization lifespan, 3–208
- dob, 4–489
- Duplicate Transaction Detection Feature, 1–7
- dutyAmount, 4–490
- Dynamic Payout
  - Account Balance Verification, D–890
  - Certification Testing, D–896
  - FastAccess Funding, D–889
  - Funding Instruction Void, D–895
  - Funding Instructions, D–891
  - Money Movement and Accounts, D–887
  - Overview, D–885
  - Same Day Funding, D–888
  - Tax Id Validation, D–900

**E**

- echeck, 4–491
- eCheck Auto Redeposit Feature, 1–48
- eCheck NoC Update Feature, 1–48
- eCheck Processing Feature, 1–46
- eCheck Validation Feature, 1–46
- eCheck Verification
  - Decline Notice, 1–47
- eCheck Verification Feature, 1–46
- eCheckAccountSuffix, 4–492
- echeckCredit, 4–493
- echeckCreditResponse, 4–494
- echeckForToken, 4–495
- echeckOrEcheckToken, 4–496
- echeckPreNoteCredit, 4–497
- echeckPreNoteCreditResponse, 4–498
- echeckPreNoteSale, 4–499
- echeckPreNoteSaleResponse, 4–500
- echeckRedeposit, 4–501
- echeckRedepositResponse, 4–502
- echeckSale, 4–503
- echeckSalesResponse, 4–504
- echeckToken, 4–505
- echeckVerification, 4–506
- echeckVerificationResponse, 4–507
- echeckVoid, 4–508
- echeckVoidResponse, 4–509
- eciIndicator, 4–510
- email, 4–511
- employerName, 4–512
- encryptedTrack, 4–513

- endDate, 4–514
- endingBalance, 4–515
- endpoint, 4–516
- enhancedAuthResponse, 4–517
- enhancedData, 4–519
- entryMode, 4–523
- ephemeralPublicKey, 4–524
- error messages
  - response Header, A–866
  - XML validation, A–864
- expDate, 4–525
- expMonth, 4–526
- expYear, 4–527
- extendedCardResponse, 4–528

**F**

- FastAccess Funding, D–889
- fastAccessFunding, 4–529
- fastAccessFundingResponse, 4–530
- Features
  - Account Updater, 1–14
  - Affluence Indicator, 1–25
  - Cardholder Type Indicator, 1–26
  - Duplicate Transaction Detection, 1–7
  - eCheck Auto Redeposit, 1–48
  - eCheck NoC Update, 1–48
  - eCheck Processing, 1–46
  - eCheck Validation, 1–46
  - eCheck Verification, 1–46
  - Issuer Country Indicator, 1–26
  - Prepaid Indicator, 1–24
  - Recovery, 1–12
  - Recurring Engine, 1–18
  - Recycling Engine, 1–12
  - Report Groups, 1–10
  - Tokenization, 1–40
- fieldValue, 4–531
- filtering, 4–532
- Filtering Rules, 1–34
- finalPayment, 4–533
- firstName, 4–534
- forceCapture, 4–535
- forceCaptureResponse, 4–536
- formatId, 4–537
- Fraud Check transaction, 1–39
- Fraud Filtering
  - Filtering Rules, 1–34

Fraud Toolkit, 1–29  
 Fraud Velocity Filtering, 1–32  
 fraudCheck, 4–538, 4–714  
 fraudCheckResponse, 4–539  
 fraudFilterOverride, 4–540  
 fraudResult, 4–541  
 Funding Instruction Void, D–895  
 Funding Instructions, D–891  
 fundingInstructionVoid, 4–542  
 fundingInstructionVoidResponse, 4–543  
 fundingSource, 4–544  
 fundingSubmerchantId, 4–545  
 fundsTransferId, 4–546

## G

---

giftCardBin, 4–549  
 giftCardResponse, 4–554  
 GiroPay, 1–57

## H

---

header, 4–557  
 healthcareIIAS, 4–559

## I

---

iban, 4–560  
 iDEAL, 1–57  
 idle time timeout, 2–101  
 IIASFlag, 4–563  
 incomeAmount, 4–564  
 incomeCurrency, 4–565  
 Instruction-Based Dynamic Payout, 1–87  
 international, 4–567  
 International Alternate Payment Methods
 

- GiroPay, 1–57
- iDEAL, 1–57
- SEPA, 1–51
- SOFORT, 1–57

 International Card Filtering, 1–31  
 intervalType, 4–568  
 invoiceReferenceNumber, 4–569  
 Issuer Country Indicator Feature, 1–26  
 Issuer Insights, 1–24  
 issuerCountry, 4–570  
 itemCategoryCode, 4–571  
 itemDescription, 4–572  
 itemDiscountAmount, 4–573

itemSequenceNumber, 4–574

## K

---

kns, 4–575

## L

---

lastName, 4–576  
 lineItemData, 4–577  
 lineItemTotal, 4–579  
 lineItemTotalWithTax, 4–580  
 litleInternalRecurringRequest, 4–581  
 litleOnlineRequest, 4–582  
 litleOnlineResponse, 4–583  
 litleRequest, 4–585  
 litleResponse, 4–586  
 litleSessionId, 4–588  
 litleToken, 4–589  
 litleTxnId, 4–590  
 load, 4–592  
 loadResponse, 4–593  
 loadReversal, 4–594  
 loadReversalResponse, 4–595

## M

---

mandateProvider, 4–596  
 mandateReference, 4–597  
 mandateSignatureDate, 4–598  
 mandateUrl, 4–599  
 MasterCard
 

- Authorization lifespan, 3–208

 merchantData, 4–601  
 merchantGroupingId, 4–602  
 merchantId, 4–603  
 message, 4–604  
 middleInitial, 4–605  
 mpos, 4–606

## N

---

name, 4–607  
 networkField, 4–608  
 networkResponse, 4–610  
 networkSubField, 4–611  
 networkTransactionId, 4–612  
 newAccountInfo, 4–613  
 newCardInfo, 4–614

newCardTokenInfo, 4-615  
 newTokenInfo, 4-616  
 nextRecycleTime, 4-617  
 number, 4-618  
 numberOfPayments, 4-619

## O

onlinePaymentCryptogram, 4-620  
 optional certification tests  
   3DS responses, 2-142  
   address responses, 2-136  
   AVS response codes, 2-135  
   response codes and messages, 2-139  
   volume testing, 2-200  
 orderDate, 4-621  
 orderId, 4-622  
 orderSource, 4-623  
 origAccountNumber, 4-626  
 origActionType, 4-627  
 origId, 4-629  
 originalAccountInfo, 4-625  
 originalCard, 4-631  
 originalCardInfo, 4-632  
 originalCardTokenInfo, 4-633  
 originalNetworkTransactionId, 4-634  
 originalToken, 4-638  
 originalTokenInfo, 4-639  
 originalTransactionAmount, 4-640  
 origLitleTxnId, 4-642  
 origOrderId, 4-643

## P

password, 4-644  
 payerId, 4-645  
 payFacCredit, 4-646  
 payFacCreditResponse, 4-647  
 payFacDebit, 4-648  
 payFacDebitResponse, 4-649  
 paymentDataType, 4-650  
 paypage, 4-652  
 paypageRegistrationId, 4-653  
 PayPal  
   Authorization lifespan, 3-208  
 paypal, 4-654  
 paypalNotes, 4-655  
 paypalOrderComplete, 4-656

persistent connection timeout, 2-101  
 phone, 4-657  
 physicalCheckCredit, 4-658  
 physicalCheckCreditResponse, 4-659  
 physicalCheckDebit, 4-660  
 physicalCheckDebitResponse, 4-661  
 pin, 4-662  
 planCode, 4-663  
 pos, 4-664  
 postDate, 4-665  
 postDay, 4-666  
 preapprovalNumber, 4-667  
 preferredLanguage, 4-668  
 prepaid, 4-669  
 Prepaid Card Filtering, 1-30  
 Prepaid Indicator Feature, 1-24  
 prepaidCardType, 4-670  
 Prior Chargeback Filtering, 1-31  
 Prior Fraud Filtering, 1-32  
 processingInstructions, 4-671  
 processingType, 4-672  
 productCode, 4-673  
 publicKeyHash, 4-674

## Q

quantity, 4-675  
 Query Transaction, 1-84, 3-300  
 queryTransaction, 4-676  
 queryTransactionResponse, 4-677  
 queryTransactionUnavailableResponse, 4-678

## R

Recovery, 1-12  
 Recurring Engine, 1-18  
 recurringRequest, 4-679  
 recurringResponse, 4-679, 4-680  
 recurringTxnId, 4-681  
 recycleAdvice, 4-682  
 recycleAdviceEnd, 4-683  
 recycleBy, 4-684  
 recycleEngineActive, 4-685  
 recycleId, 4-686  
 recycling, 4-687  
 Recycling Engine, 1-12  
 Recycling Engine and Auth Reversal, 1-78, 1-86  
 recyclingRequest, 4-689

redirectToken, 4-690  
 redirectUrl, 4-691  
 refundReversal, 4-693  
 refundReversalResponse, 4-694  
 registerTokenRequest, 4-695  
 registerTokenResponse, 4-696  
 reloadable, 4-697  
 Report Group Feature, 1-10  
 reserveCredit, 4-698  
 reserveCreditResponse, 4-699  
 reserveDebit, 4-700  
 reserveDebitResponse, 4-701  
 residenceStatus, 4-702  
 response, 4-703  
 response codes and messages testing, 2-139  
 Response Header error messages, A-866  
 responseCode, 4-704  
 responseMessage, 4-705  
 responseTime, 4-706  
 results\_Max10, 4-707  
 RFRRequest, 4-710  
 RFRResponse, 4-711  
 routingNum, 4-712  
 RxAmount, 4-713

## S

sale, 4-714  
 saleResponse, 4-715  
 salesTax, 4-716  
 Same Day Funding, D-888  
 secondaryAmount, 4-717  
 Security Code No-match Filtering, 1-31  
 sellerId, 4-718  
 sellerMerchantCategoryCode, 4-719  
 SEPA, 1-51  
 sepaDirectDebit, 4-720  
 sepaDirectDebitResponse, 4-721  
 sequenceType, 4-723  
 shipFromPostalCode, 4-724  
 shippingAmount, 4-725  
 shipToAddress, 4-726  
 signature, 4-727  
 SOFORT, 1-57  
 ssn, 4-730  
 startDate, 4-731  
 state, 4-732  
 Status Query Transaction, 1-84, 3-300

stopping auto-recycling, 1-78, 1-86  
 submerchantCredit, 4-733  
 submerchantCreditResponse, 4-734  
 submerchantDebit, 4-735  
 submerchantDebitResponse, 4-736  
 submerchantName, 4-737  
 subscription, 4-738  
 subscriptionId, 4-740  
 surchargeAmount, 4-741

## T

Tagging Transactions, 1-11  
 taxAmount, 4-743  
 taxExempt, 4-744  
 taxIncludedInTotal, 4-745  
 taxRate, 4-746  
 taxType, 4-747  
 taxTypeIdentifier, 4-748  
 terminalId, 4-749  
 termsAndConditions, 4-750  
 testing
 

- Authorization Reversal transactions, 2-116
- optional certification tests
  - 3DS responses, 2-142
  - address responses, 2-136
  - AVS response codes, 2-135
  - response codes and messages, 2-139
  - volume testing, 2-200

 threatMetrixSessionId, 4-751  
 timeout
 

- persistent connection, 2-101

 Timeout settings, 2-101  
 token, 4-752  
 Tokenization Feature, 1-40  
 tokenMessage, 4-754  
 tokenResponse, 4-755  
 tokenResponseCode, 4-756  
 totalHealthcareAmount, 4-757  
 track, 4-758  
 track1Status, 4-759  
 track2Status, 4-760  
 transactionAmount, 4-761  
 transactionId, 4-762  
 trialIntervalType, 4-764  
 trialNumberOfIntervals, 4-765  
 triggeredRule, 4-766  
 type, 4-768



**U**

unitCost, 4-770  
 unitOfMeasure, 4-771  
 unload, 4-772  
 unloadResponse, 4-773  
 unloadReversal, 4-774  
 unloadReversalResponse, 4-775  
 updateAddOn, 4-776  
 updateCardValidationNumOnToken, 4-778  
 updateCardValidationNumOnTokenResponse, 4-779  
 updatedCard, 4-777  
 updateDiscount, 4-780  
 updatedToken, 4-788  
 updatePlan, 4-781  
 updatePlanResponse, 4-782  
 updateSubscription, 4-783  
 updateSubscriptionResponse, 4-787  
 url, 4-789  
 user, 4-790

**V**

Value Added Services
 

- Fraud Toolkit, 1-29
- Issuer Insights, 1-24

 vendorCredit, 4-791  
 vendorCreditResponse, 4-792  
 vendorDebit, 4-793  
 vendorDebitResponse, 4-794  
 vendorName, 4-795  
 verificationCode, 4-796  
 verify, 4-797  
 version, 4-798  
 virtualAccountNumber, 4-799  
 virtualAuthenticationKeyData, 4-800  
 virtualAuthenticationKeyPresenceIndicator, 4-801  
 virtualGiftCard, 4-802  
 virtualGiftCardBin, 4-803  
 virtualGiftCardResponse, 4-804  
 Visa
 

- Authorization lifespan, 3-208

 visionAmount, 4-805  
 void, 4-806  
 voidResponse, 4-807  
 volume certification testing, 2-200

**W**

wallet, 4-808  
 walletSourceType, 4-809  
 walletSourceTypeId, 4-810

**X**

## XML elements

accNum, 4-338  
 accountInfo, 4-339  
 accountInformation, 4-340  
 accountNumber, 4-341  
 accountNumberLength, 4-342  
 accountUpdate, 4-343  
 accountUpdateFileRequestData, 4-344  
 accountUpdater, 4-345  
 accountUpdateResponse, 4-349  
 accType, 4-350  
 actionReason, 4-351  
 activate, 4-352  
 activateResponse, 4-353  
 activateReversal, 4-354  
 activateReversalResponse, 4-355  
 active, 4-356  
 addOnCode, 4-357  
 addressIndicator, 4-358  
 addressLine1, 4-359  
 advancedAVSResult, 4-360  
 advancedFraudChecks, 4-361  
 advancedFraudResults, 4-362  
 affiliate, 4-363  
 affluence, 4-364  
 allowPartialAuth, 4-365  
 amexAggregatorData, 4-366  
 amount, 4-367  
 androidpayResponse, 4-369  
 applepay, 4-370  
 applepayResponse, 4-371  
 applicationData, 4-372  
 applicationExpirationDate, 4-373  
 applicationPrimaryAccountNumber, 4-374  
 approvedAmount, 4-375  
 authAmount, 4-376  
 authCode, 4-377  
 authDate, 4-378  
 authenticatedByMerchant, 4-379  
 authentication, 4-380

authenticationResult, 4–381  
authenticationTransactionId, 4–382  
authenticationValue, 4–383  
authInformation, 4–384  
authorization, 4–385  
authorizationResponse, 4–386  
authorizationSourcePlatform, 4–387  
authReversal, 4–388  
authReversalResponse, 4–389  
availableBalance, 4–390  
avsResult, 4–391  
balanceInquiry, 4–392  
balanceInquiryResponse, 4–393  
batchRequest, 4–394  
batchResponse, 4–402  
beginningBalance, 4–403  
billingDate, 4–404  
billMeLaterRequest, 4–405  
billMeLaterResponseData, 4–407  
billToAddress, 4–408  
bin, 4–410  
bmlMerchantId, 4–411  
bmlProductType, 4–412  
bypassVelocityCheck, 4–413  
campaign, 4–414  
cancelSubscription, 4–415  
cancelSubscriptionResponse, 4–415, 4–416  
capability, 4–417  
capture, 4–418  
captureGivenAuth, 4–420  
captureGivenAuthResponse, 4–421  
captureResponse, 4–422  
card, 4–423  
cardAcceptorTaxId, 4–425  
cardholderAuthentication, 4–426  
cardholderId, 4–427  
cardholderName, 4–428  
cardOrToken, 4–429  
cardProductType, 4–430  
cardSuffix, 4–431  
cardValidationNum, 4–432  
cardValidationResult, 4–433  
cashBackAmount, 4–434  
catLevel, 4–435  
ccdPaymentInformation, 4–436  
chargeback, 4–437  
checkNum, 4–438  
checkoutId, 4–439  
city, 4–440  
clinicOtherAmount, 4–441  
code, 4–442  
commodityCode, 4–443  
companyName, 4–444  
country, 4–445  
createAddOn, 4–446  
createDiscount, 4–447  
createPlan, 4–448  
createPlanResponse, 4–449  
credit, 4–450  
creditLine, 4–452  
creditLitleTxnId, 4–453  
creditResponse, 4–454  
cryptogram, 4–455  
currencyCode, 4–456  
customAttribute1, 4–457  
customBilling, 4–458  
customerInfo, 4–461  
customerIpAddress, 4–462  
customerReference, 4–463  
customerRegistrationDate, 4–464  
customerType, 4–465  
customerWorkTelephone, 4–466  
customIdentifier, 4–460  
data, 4–467  
deactivate, 4–468  
deactivateResponse, 4–469  
deactivateReversal, 4–470  
deactivateReversalResponse, 4–471  
debtRepayment, 4–472  
deleteAddOn, 4–473  
deleteDiscount, 4–474  
deliveryType, 4–475  
dentalAmount, 4–476  
depositReversal, 4–477  
depositReversalResponse, 4–478  
description, 4–479  
descriptor, 4–480  
destinationCountryCode, 4–481  
destinationPostalCode, 4–482  
detailTax, 4–483  
deviceManufacturerIdentifier, 4–484  
deviceReputationScore, 4–485  
deviceReviewStatus, 4–486  
discountAmount, 4–487  
discountCode, 4–488  
dob, 4–489

dutyAmount, 4-490  
echeck, 4-491  
eCheckAccountSuffix, 4-492  
echeckCredit, 4-493  
echeckCreditResponse, 4-494  
echeckForToken, 4-495  
echeckOrEcheckToken, 4-496  
echeckPreNoteCredit, 4-497  
echeckPreNoteCreditResponse, 4-498  
echeckPreNoteSale, 4-499  
echeckPreNoteSaleResponse, 4-500  
echeckRedeposit, 4-501  
echeckRedepositResponse, 4-502  
echeckSale, 4-503  
echeckSalesResponse, 4-504  
echeckToken, 4-505  
echeckVerification, 4-506  
echeckVerificationResponse, 4-507  
echeckVoid, 4-508  
echeckVoidResponse, 4-509  
eciIndicator, 4-510  
email, 4-511  
employerName, 4-512  
encryptedTrack, 4-513  
endDate, 4-514  
endingBalance, 4-515  
endpoint, 4-516  
enhancedAuthResponse, 4-517  
enhancedData, 4-519  
entryMode, 4-523  
ephemeralPublicKey, 4-524  
expDate, 4-525  
expMonth, 4-526  
expYear, 4-527  
extendedCardResponse, 4-528  
fastAccessFunding, 4-529  
fastAccessFundingResponse, 4-530  
fieldValue, 4-531  
filtering, 4-532  
finalPayment, 4-533  
firstName, 4-534  
forceCapture, 4-535  
forceCaptureResponse, 4-536  
formatId, 4-537  
fraudCheck, 4-538, 4-714  
fraudCheckResponse, 4-539  
fraudFilterOverride, 4-540  
fraudResult, 4-541  
fundingInstructionVoid, 4-542  
fundingInstructionVoidResponse, 4-543  
fundingSource, 4-544  
fundingSubmerchantId, 4-545  
fundsTransferId, 4-546  
giftCardBin, 4-549  
giftCardResponse, 4-554  
header, 4-557  
healthcareIIAS, 4-559  
iban, 4-560  
IIASFlag, 4-563  
incomeAmount, 4-564  
incomeCurrency, 4-565  
international, 4-567  
intervalType, 4-568  
invoiceReferenceNumber, 4-569  
issuerCountry, 4-570  
itemCategoryCode, 4-571  
itemDescription, 4-572  
itemDiscountAmount, 4-573  
itemSequenceNumber, 4-574  
ksn, 4-575  
lastName, 4-576  
lineItemData, 4-577  
lineItemTotal, 4-579  
lineItemTotalWithTax, 4-580  
litleInternalRecurringRequest, 4-581  
litleOnlineRequest, 4-582  
litleOnlineResponse, 4-583  
litleRequest, 4-585  
litleResponse, 4-586  
litleSessionId, 4-588  
litleToken, 4-589  
litleTxnId, 4-590  
load, 4-592  
loadResponse, 4-593  
loadReversal, 4-594  
loadReversalResponse, 4-595  
mandateProvider, 4-596  
mandateReference, 4-597  
mandateSignatureDate, 4-598  
mandateUrl, 4-599  
merchantData, 4-601  
merchantGroupId, 4-602  
merchantId, 4-603  
message, 4-604

middleInitial, 4-605  
mpos, 4-606  
name, 4-607  
networkField, 4-608  
networkResponse, 4-610  
networkSubField, 4-611  
networkTransactionId, 4-612  
newAccountInfo, 4-613  
newCardInfo, 4-614  
newCardTokenInfo, 4-615  
newTokenInfo, 4-616  
nextRecycleTime, 4-617  
number, 4-618  
numberOfPayments, 4-619  
onlinePaymentCryptogram, 4-620  
orderDate, 4-621  
orderId, 4-622  
orderSource, 4-623  
origAccountNumber, 4-626  
origActionType, 4-627  
origId, 4-629  
originalAccountInfo, 4-625  
originalCard, 4-631  
originalCardInfo, 4-632  
originalCardTokenInfo, 4-633  
originalNetworkTransactionId, 4-634  
originalToken, 4-638  
originalTokenInfo, 4-639  
originalTransactionAmount, 4-640  
origLitleTxnId, 4-642  
origOrderId, 4-643  
password, 4-644  
payerId, 4-645  
payFacCredit, 4-646  
payFacCreditResponse, 4-647  
payFacDebit, 4-648  
payFacDebitResponse, 4-649  
paymentDataType, 4-650  
paypage, 4-652  
paypageRegistrationId, 4-653  
paypal, 4-654  
payPalNotes, 4-655  
payPalOrderComplete, 4-656  
phone, 4-657  
physicalCheckCredit, 4-658  
physicalCheckCreditResponse, 4-659  
physicalCheckDebit, 4-660  
physicalCheckDebitResponse, 4-661

pin, 4-662  
planCode, 4-663  
pos, 4-664  
postDate, 4-665  
postDay, 4-666  
preapprovalNumber, 4-667  
preferredLanguage, 4-668  
prepaid, 4-669  
prepaidCardType, 4-670  
processingInstructions, 4-671  
processingType, 4-672  
productCode, 4-673  
publicKeyHash, 4-674  
quantity, 4-675  
queryTransaction, 4-676  
queryTransactionResponse, 4-677  
queryTransactionUnavailableResponse, 4-678  
recurringRequest, 4-679  
recurringResponse, 4-679, 4-680  
recurringTxnId, 4-681  
recycleAdvice, 4-682  
recycleAdviceEnd, 4-683  
recycleBy, 4-684  
recycleEngineActive, 4-685  
recycleId, 4-686  
recycling, 4-687  
recyclingRequest, 4-689  
redirectToken, 4-690  
redirectUrl, 4-691  
refundReversal, 4-693  
refundReversalResponse, 4-694  
registerTokenRequest, 4-695  
registerTokenResponse, 4-696  
reloadable, 4-697  
reserveCredit, 4-698  
reserveCreditResponse, 4-699  
reserveDebit, 4-700  
reserveDebitResponse, 4-701  
residenceStatus, 4-702  
response, 4-703  
responseCode, 4-704  
responseMessage, 4-705  
responseTime, 4-706  
results\_Max10, 4-707  
RFRRequest, 4-710  
RFRResponse, 4-711  
routingNum, 4-712  
RxAmount, 4-713

sale, 4-714  
saleResponse, 4-715  
salesTax, 4-716  
secondaryAmount, 4-717  
sellerId, 4-718  
sellerMerchantCategoryCode, 4-719  
sepaDirectDebit, 4-720  
sepaDirectDebitResponse, 4-721  
sequenceType, 4-723  
shipFromPostalCode, 4-724  
shippingAmount, 4-725  
shipToAddress, 4-726  
signature, 4-727  
ssn, 4-730  
startDate, 4-731  
state, 4-732  
submerchantCredit, 4-733  
submerchantCreditResponse, 4-734  
submerchantDebit, 4-735  
submerchantDebitResponse, 4-736  
submerchantName, 4-737  
subscription, 4-738  
subscriptionId, 4-740  
surchargeAmount, 4-741  
taxAmount, 4-743  
taxExempt, 4-744  
taxIncludedInTotal, 4-745  
taxRate, 4-746  
taxType, 4-747  
taxTypeIdentifier, 4-748  
terminalId, 4-749  
termsAndConditions, 4-750  
threatMetrixSessionId, 4-751  
token, 4-752  
tokenMessage, 4-754  
tokenResponse, 4-755  
tokenResponseCode, 4-756  
totalHealthcareAmount, 4-757  
track, 4-758  
track1Status, 4-759  
track2Status, 4-760  
transactionAmount, 4-761  
transactionId, 4-762  
trialIntervalType, 4-764  
trialNumberOfIntervals, 4-765  
triggeredRule, 4-766  
type, 4-768  
unitCost, 4-770

unitOfMeasure, 4-771  
unload, 4-772  
unloadResponse, 4-773  
unloadReversal, 4-774  
unloadReversalResponse, 4-775  
updateAddOn, 4-776  
updateCardValidationNumOnToken, 4-778  
updateCardValidationNumOnTokenResponse, 4-779  
updatedCard, 4-777  
updateDiscount, 4-780  
updatedToken, 4-788  
updatePlan, 4-781  
updatePlanResponse, 4-782  
updateSubscription, 4-783  
updateSubscriptionResponse, 4-787  
url, 4-789  
user, 4-790  
vendorCredit, 4-791  
vendorCreditResponse, 4-792  
vendorDebit, 4-793  
vendorDebitResponse, 4-794  
vendorName, 4-795  
verificationCode, 4-796  
verify, 4-797  
version, 4-798  
virtualAccountNumber, 4-799  
virtualAuthenticationKeyData, 4-800  
virtualAuthenticationKeyPresenceIndicator, 4-801  
virtualGiftCard, 4-802  
virtualGiftCardBin, 4-803  
virtualGiftCardResponse, 4-804  
visionAmount, 4-805  
void, 4-806  
voidResponse, 4-807  
wallet, 4-808  
walletSourceType, 4-809  
walletSourceTypeId, 4-810  
yearsAtEmployer, 4-811  
yearsAtResidence, 4-812  
zip, 4-813

## Y

yearsAtEmployer, 4-811  
yearsAtResidence, 4-812

## Z

---

zip, 4–813