



PORTATONE *EZ-250i*

Owner's Manual



KEYBOARDMANIA
Yamaha Edition

Let's play the KEYBOARDMANIA !

Install KEYBOARDMANIA to your computer (see page 3 and 60) and connect it to the EZ-250i by an USB cable – then play musical games and learn songs.



SPECIAL MESSAGE SECTION

This product utilizes batteries or an external power supply (adapter). DO NOT connect this product to any power supply or adapter other than one described in the manual, on the name plate, or specifically recommended by Yamaha.

This product should be used only with the components supplied or; a cart, rack, or stand that is recommended by Yamaha. If a cart, etc., is used, please observe all safety markings and instructions that accompany the accessory product.

SPECIFICATIONS SUBJECT TO CHANGE:

The information contained in this manual is believed to be correct at the time of printing. However, Yamaha reserves the right to change or modify any of the specifications without notice or obligation to update existing units.

This product, either alone or in combination with an amplifier and headphones or speaker/s, may be capable of producing sound levels that could cause permanent hearing loss. DO NOT operate for long periods of time at a high volume level or at a level that is uncomfortable. If you experience any hearing loss or ringing in the ears, you should consult an audiologist.

IMPORTANT: The louder the sound, the shorter the time period before damage occurs.

NOTICE:

Service charges incurred due to a lack of knowledge relating to how a function or effect works (when the unit is operating as designed) are not covered by the manufacturer's warranty, and are therefore the owners responsibility. Please study this manual carefully and consult your dealer before requesting service.

ENVIRONMENTAL ISSUES:

Yamaha strives to produce products that are both user safe and environmentally friendly. We sincerely believe that our products and the production methods used to produce them, meet these goals. In keeping with both the letter and the spirit of the law, we want you to be aware of the following:

Battery Notice:

This product MAY contain a small non-rechargeable battery which (if applicable) is soldered in place. The average life span of this type of battery is approximately five years. When replacement becomes necessary, contact a qualified service representative to perform the replacement.

This product may also use "household" type batteries. Some of these may be rechargeable. Make sure that the battery being charged is a rechargeable type and that the charger is intended for the battery being charged.

When installing batteries, do not mix batteries with new, or with batteries of a different type. Batteries MUST be installed correctly. Mismatches or incorrect installation may result in overheating and battery case rupture.

Warning:

Do not attempt to disassemble, or incinerate any battery. Keep all batteries away from children. Dispose of used batteries promptly and as regulated by the laws in your area. Note: Check with any retailer of household type batteries in your area for battery disposal information.

Disposal Notice:

Should this product become damaged beyond repair, or for some reason its useful life is considered to be at an end, please observe all local, state, and federal regulations that relate to the disposal of products that contain lead, batteries, plastics, etc. If your dealer is unable to assist you, please contact Yamaha directly.

NAME PLATE LOCATION:

The name plate is located on the bottom of the product. The model number, serial number, power requirements, etc., are located on this plate. You should record the model number, serial number, and the date of purchase in the spaces provided below and retain this manual as a permanent record of your purchase.

Model _____

Serial No. _____

Purchase Date _____

PLEASE KEEP THIS MANUAL

92-BP (bottom)

FCC INFORMATION (U.S.A.)

1. IMPORTANT NOTICE: DO NOT MODIFY THIS UNIT!

This product, when installed as indicated in the instructions contained in this manual, meets FCC requirements. Modifications not expressly approved by Yamaha may void your authority, granted by the FCC, to use the product.

2. IMPORTANT: When connecting this product to accessories and/or another product use only high quality shielded cables. Cable/s supplied with this product MUST be used. Follow all installation instructions. Failure to follow instructions could void your FCC authorization to use this product in the USA.

3. NOTE: This product has been tested and found to comply with the requirements listed in FCC Regulations, Part 15 for Class "B" digital devices. Compliance with these requirements provides a reasonable level of assurance that your use of this product in a residential environment will not result in harmful interference with other electronic devices. This equipment generates/uses radio frequencies and, if not installed and used according to the instructions found in the users manual, may cause interference harmful to the operation of other electronic devices. Compliance

with FCC regulations does not guarantee that interference will not occur in all installations. If this product is found to be the source of interference, which can be determined by turning the unit "OFF" and "ON", please try to eliminate the problem by using one of the following measures:

Relocate either this product or the device that is being affected by the interference.

Utilize power outlets that are on different branch (circuit breaker or fuse) circuits or install AC line filter/s.

In the case of radio or TV interference, relocate/reorient the antenna. If the antenna lead-in is 300 ohm ribbon lead, change the lead-in to co-axial type cable.

If these corrective measures do not produce satisfactory results, please contact the local retailer authorized to distribute this type of product. If you can not locate the appropriate retailer, please contact Yamaha Corporation of America, Electronic Service Division, 6600 Orangethorpe Ave, Buena Park, CA90620

The above statements apply ONLY to those products distributed by Yamaha Corporation of America or its subsidiaries.

* This applies only to products distributed by YAMAHA CORPORATION OF AMERICA.

(class B)

OBSERVERA!

Apparaten kopplas inte ur växelströmskällan (nätet) så länge som den är ansluten till vägguttaget, även om själva apparaten har stängts av.

ADVARSSEL: Netspændingen til dette apparat er IKKE afbrudt, så længe netledningen sidder i en stikkontakt, som er t endt — også selvom der er slukket på apparatets afbryder.

VAROITUS: Laitteen toisiopiiriin kytketty käyttökytkin ei irroita koko laitetta verkosta.

(standby)

Entsorgung leerer Batterien (nur innerhalb Deutschlands)

Leisten Sie einen Beitrag zum Umweltschutz. Verbrauchte Batterien oder Akkumulatoren dürfen nicht in den Hausmüll. Sie können bei einer Sammelstelle für Altbatterien bzw. Sondermüll abgegeben werden. Informieren Sie sich bei Ihrer Kommune.

(battery)

Software License Agreement

Yamaha Corporation (Yamaha) permits you use the Keyboardmania Yamaha Edition (Software) conditioned on your acceptance of this agreement. The Software includes all associated contents, all printed materials and all electronic documentation. Use of this Software will be taken to mean acceptance of this agreement, so please read the following terms carefully before you use the Software.

1. Copyright and permission for use

Yamaha grants you as an individual the right to use the Software on only one computer at any single time. The ownership of the disk on which the Software is recorded belongs to you, but the ownership and copyright of the Program itself belongs to Yamaha and Yamaha's Licensor(s).

2. Prohibitions and restrictions

You may not reverse-compile, disassemble, reverse-engineer, or use any other method to convert the Software into a human-readable form, nor may you allow another person to do so. The Software may not be duplicated, corrected, modified, lent, leased, sold, distributed, licensed or disposed of in any other way in part or in whole. The creation of derivative works based on the content of the Software is also prohibited. The Software may not be transmitted over a network to another

computer without written authorization from Yamaha. Your rights regarding the Software may be transferred to a third party only if this is done for non-commercial purposes and if the Software and all associated documentation including this agreement are included, and if the third party accepts this agreement.

3. Limitations of Liability

The Software was developed at, and is copyrighted by, Yamaha and Yamaha's Licensor(s). The Software is offered "AS IS" and Yamaha makes no warranty as to its use or performance. YAMAHA AND ITS SUPPLIERS DO NOT AND CANNOT WARRANT THE PERFORMANCE OR RESULTS YOU MAY OBTAIN BY USING THE SOFTWARE OR DOCUMENTATION. YAMAHA AND ITS SUPPLIERS MAKE NO WARRANTIES, EXPRESS OR IMPLIED, AS TO NONINFRINGEMENT OF THIRD PARTY RIGHTS, MERCHANTABILITY, OR FITNESS FOR ANY PARTICULAR PURPOSE. IN NO EVENT WILL YAMAHA OR ITS SUPPLIERS BE LIABLE TO YOU FOR ANY CONSEQUENTIAL, INCIDENTAL OR SPECIAL DAMAGES, INCLUDING ANY LOST PROFITS OR LOST SAVINGS, EVEN IF AN YAMAHA REPRESENTATIVE HAS BEEN ADVISED OF THE POSSIBILITY OF SUCH DAMAGES, OR FOR ANY CLAIM BY ANY THIRD PARTY.

● COPYRIGHT NOTICE

① Six of the demo-songs (or compositions) included in this keyboard are as follows:

A Hard Day's Night

- Words and Music by John Lennon and Paul McCartney
- Copyright © 1964 Sony/ATV Songs LLC
- Copyright Renewed
- All Rights Administered by Sony/ATV Music Publishing, 8 Music Square West, Nashville, TN37203
- International Copyright Secured All Rights Reserved

Can't Help Falling In Love

- Words and Music by George David Weiss, Hugo Peretti and Luigi Creatore
- Copyright © 1961 by Gladys Music, Inc.
- Copyright Renewed and Assigned to Gladys Music
- All Rights Administered by Cherry Lane Music Publishing Company, Inc. and Chrysalis Music
- International Copyright Secured All Rights Reserved

Stella By Starlight

- from the Paramount Picture THE UNINVITED
- Words by Ned Washington
- Music by Victor Young
- Copyright © 1946 (Renewed 1973, 1974) by Famous Music Corporation
- International Copyright Secured All Rights Reserved

Hey Jude

- Words and Music by John Lennon and Paul McCartney
- Copyright © 1968 Sony/ATV Songs LLC
- Copyright Renewed
- All Rights Administered by Sony/ATV Music Publishing, 8 Music Square West, Nashville, TN37203
- International Copyright Secured All Rights Reserved

Edelweiss

- Lyrics by Oscar Hammerstein II
- Music by Richard Rodgers
- Copyright © 1959 by Richard Rodgers and Oscar Hammerstein II
- Copyright Renewed
- WILLIAMSON MUSIC owner of publication and allied rights throughout the world
- International Copyright Secured All Rights Reserved

Linus And Lucy

- By Vince Guaraldi
- Copyright © 1965 LEE MENDELSON FILM PRODUCTIONS, INC.
- Copyright Renewed
- International Copyright Secured All Rights Reserved

② Four of the demo-songs (or compositions) included in this keyboard are as follows:

Composition Title : An Englishman In New York
Composer's Name : Sumner 0590545
Copyright Owner's Name: G M SUMNER LTD

Composition Title : Against All Odds
Composer's Name : Collins 0007403
Copyright Owner's Name: EMI MUSIC PUBLISHING LTD / HIT & RUN MUSIC LTD

Composition Title : Just The Way You Are
Composer's Name : Joel 0273671
Copyright Owner's Name: EMI MUSIC PUBLISHING LTD

Composition Title : Look Of Love
Composer's Name : Bacharach/David 0093316
Copyright Owner's Name: Screen Gems - EMI Music Ltd

CAUTION: All Rights Reserved, Unauthorized copying, public performance and broadcasting are strictly prohibited regarding the above ten demo-songs.

COPYRIGHT NOTICE This product incorporates and bundles computer programs and contents in which Yamaha owns copyrights or with respect to which it has license to use others' copyrights. Such copyrighted materials include, without limitation, all computer software, styles files, MIDI files, WAVE data and sound recordings. Any unauthorized use of such programs and contents outside of personal use is not permitted under relevant laws. Any violation of copyright has legal consequences. **DON'T MAKE, DISTRIBUTE OR USE ILLEGAL COPIES.**

PRECAUTIONS

PLEASE READ CAREFULLY BEFORE PROCEEDING

* Please keep this manual in a safe place for future reference.



WARNING

Always follow the basic precautions listed below to avoid the possibility of serious injury or even death from electrical shock, short-circuiting, damages, fire or other hazards. These precautions include, but are not limited to, the following:

Power supply/AC power adaptor

- Only use the voltage specified as correct for the instrument. The required voltage is printed on the name plate of the instrument.
- Use the specified adaptor (PA-3C or PA-3B or an equivalent recommended by Yamaha) only. Using the wrong adaptor can result in damage to the instrument or overheating.
- Check the electric plug periodically and remove any dirt or dust which may have accumulated on it.
- Do not place the AC adaptor cord near heat sources such as heaters or radiators, and do not excessively bend or otherwise damage the cord, place heavy objects on it, or place it in a position where anyone could walk on, trip over, or roll anything over it.

Do not open

- Do not open the instrument or attempt to disassemble the internal parts or modify them in any way. The instrument contains no user-serviceable parts. If it should appear to be malfunctioning, discontinue use immediately and have it inspected by qualified Yamaha service personnel.

Water warning

- Do not expose the instrument to rain, use it near water or in damp or wet conditions, or place containers on it containing liquids which might spill into any openings.
- Never insert or remove an electric plug with wet hands.

Fire warning

- Do not put burning items, such as candles, on the unit.
A burning item may fall over and cause a fire.

If you notice any abnormality

- If the AC adaptor cord or plug becomes frayed or damaged, or if there is a sudden loss of sound during use of the instrument, or if any unusual smells or smoke should appear to be caused by it, immediately turn off the power switch, disconnect the adaptor plug from the outlet, and have the instrument inspected by qualified Yamaha service personnel.



CAUTION

Always follow the basic precautions listed below to avoid the possibility of physical injury to you or others, or damage to the instrument or other property. These precautions include, but are not limited to, the following:

Power supply/AC power adaptor

- When removing the electric plug from the instrument or an outlet, always hold the plug itself and not the cord.
- Unplug the AC power adaptor when not using the instrument, or during electrical storms.
- Do not connect the instrument to an electrical outlet using a multiple-connector. Doing so can result in lower sound quality, or possibly cause overheating in the outlet.

Battery

- Always make sure all batteries are inserted in conformity with the +/- polarity markings. Failure to do so might result in overheating, fire, or battery fluid leakage.
- Always replace all batteries at the same time. Do not use new batteries together with old ones. Also, do not mix battery types, such as alkaline batteries with manganese batteries, or batteries from different makers, or different types of batteries from the same maker, since this can cause overheating, fire, or battery fluid leakage.
- Do not dispose of batteries in fire.

- Do not attempt to recharge batteries that are not intended to be charged.
- When the batteries run out, or if the instrument is not to be used for a long time, remove the batteries from the instrument to prevent possible leakage of the battery fluid.
- Keep batteries away from children.
- If the batteries do leak, avoid contact with the leaked fluid. If the battery fluid should come in contact with your eyes, mouth, or skin, wash immediately with water and consult a doctor. Battery fluid is corrosive and may possibly cause loss of sight or chemical burns.

Location

- Do not expose the instrument to excessive dust or vibrations, or extreme cold or heat (such as in direct sunlight, near a heater, or in a car during the day) to prevent the possibility of panel disfiguration or damage to the internal components.
- Do not use the instrument in the vicinity of a TV, radio, stereo equipment, mobile phone, or other electric devices. Otherwise, the instrument, TV, or radio may generate noise.

- Do not place the instrument in an unstable position where it might accidentally fall over.
- Before moving the instrument, remove all connected adaptor and other cables.
- Use only the stand specified for the instrument. When attaching the stand or rack, use the provided screws only. Failure to do so could cause damage to the internal components or result in the instrument falling over.

Connections

- Before connecting the instrument to other electronic components, turn off the power for all components. Before turning the power on or off for all components, set all volume levels to minimum. Also, be sure to set the volumes of all components at their minimum levels and gradually raise the volume controls while playing the instrument to set the desired listening level.

Maintenance

- When cleaning the instrument, use a soft, dry cloth. Do not use paint thinners, solvents, cleaning fluids, or chemical-impregnated wiping cloths.

Handling caution

- Do not insert a finger or hand in any gaps on the instrument.
- Never insert or drop paper, metallic, or other objects into the gaps on the panel or keyboard. If this happens, turn off the power immediately and unplug the power cord from the AC outlet. Then have the instrument inspected by qualified Yamaha service personnel.
- Do not place vinyl, plastic or rubber objects on the instrument, since this might discolor the panel or keyboard.
- Do not rest your weight on, or place heavy objects on the instrument, and do not use excessive force on the buttons, switches or connectors.
- Do not operate the instrument for a long period of time at a high or uncomfortable volume level, since this can cause permanent hearing loss. If you experience any hearing loss or ringing in the ears, consult a physician.

Saving data

Saving and backing up your data

- Saved data may be lost due to malfunction or incorrect operation. Save important data to external media.

Yamaha cannot be held responsible for damage caused by improper use or modifications to the instrument, or data that is lost or destroyed.

Always turn the power off when the instrument is not in use.

When using a power adaptor, even when the power switch is in the "STANDBY" position, electricity is still flowing to the instrument at the minimum level. When you are not using the instrument for a long time, make sure you unplug the AC power adaptor from the wall AC outlet.

Make sure to discard used batteries according to local regulations.

The illustrations and LCD screens as shown in this owner's manual are for instructional purposes only, and may be different from the ones on your instrument.

● Trademarks

- Apple and Macintosh are trademarks of Apple Computer, Inc., registered in the U.S. and other countries.
- Windows is the registered trademark of Microsoft® Corporation.

All other trademarks are the property of their respective holders.

Congratulations on your purchase of the Yamaha EZ-250i PortaTone!

You now own a portable keyboard that combines advanced functions, great sound and exceptional ease-of-use in a highly compact package. Its outstanding features also make it a remarkably expressive and versatile instrument.

Read this Owner's Manual carefully while playing your new EZ-250i in order to take full advantage of its various features.

Main Features

The EZ-250i is a sophisticated yet easy-to-use keyboard with the following features and functions:



■ Keyboard Mania..... page 3, 60

Included with the instrument (on CD-ROM) is the fun software program Keyboard Mania. Simply install it to your computer (Windows only) and connect the instrument via USB cable — and play musical games and learn songs the fun way.



■ Stereo Sampled Piano page 21

The EZ-250i has a special Portable Grand Piano Voice — created by state-of-the-art stereo sampling technology and using Yamaha's sophisticated AWM (Advanced Wave Memory) tone generation system.



■ Touch Response page 27

The exceptionally natural Touch Response feature, with a convenient front panel on/off switch, gives you maximum expressive level control over the voices. It also works in conjunction with the Dynamic Filter, which dynamically adjusts the timbre or tone of a voice according to your playing strength — just a like a real musical instrument!



■ Yamaha Education Suite pages 40, 42, 49

The EZ-250i features the new Yamaha Education Suite — a set of learning tools that utilize the latest technology to make studying and practicing music more fun and fulfilling than ever before!



■ One Touch Setting page 25

One Touch Setting (OTS), for automatically calling up an appropriate voice for playing with the selected Style and Song.



■ Powerful Speaker System

The built-in stereo amplifier/speaker system of the EZ-250i — with a special Bass Boost feature — provides exceptionally powerful, high-quality sound, letting you hear the full dynamic range of the EZ-250i's authentic voices.



■ USB..... page 56

This enables you to connect the instrument directly to a computer, for recording your performances and playing song data with the computer.

■ Flash Memory page 58

The internal flash memory of the instrument lets you save song data from a computer. The songs saved to the memory can then be used for playing and practice in the same way as the preset songs.



■ GM System Level 1

“GM System Level 1” is an addition to the MIDI standard which ensures that any GM-compatible music data can be accurately played by any GM-compatible tone generator, regardless of manufacturer. The GM mark is affixed to all software and hardware products that support GM System Level.



■ XGlite

As its name implies, “XGlite” is a simplified version of Yamaha's high-quality XG tone generation format. Naturally, you can play back any XG song data using an XGlite tone generator. However, keep in mind that some songs may play back differently compared to the original data, due to the reduced set of control parameters and effects.

Contents

Panel Controls and Terminals	8	Song Lesson	49
Setting Up	10	• Using the Lesson Feature	49
• Power Requirements	10	• Select the Lesson Track.....	51
• Turning On the Power.....	11	• Lesson 1 — Timing	51
• Accessory Jacks	11	• Lesson 2 — Waiting	52
		• Lesson 3 — Minus One.....	52
		• Lesson 4 — Both Hands	53
		• Grade	53
Quick Guide	12	MIDI Functions	54
Step 1 Voices	12	• What Is MIDI?	54
Step 2 Songs	14	• Connecting to a Personal Computer	56
Step 3 Style	16	• Local Control	57
		• External Clock	57
		• Using Initial Setup Send with a Sequencer	57
		• PC Mode	58
		• Loading a Song into EZ-250i's Flash Memory	58
Basic Operation and LCD Display	18	Accessory CD-ROM Installation Guide	60
Portable Grand	21	• Contents of CD-ROM	60
• Playing the Portable Grand.....	21	• CD-ROM Installation Procedure.....	60
• Using the Metronome	21	• Minimum System Requirements	61
		• For Windows Users	61
Playing Voices	23	• For Macintosh Users	63
• Playing a Voice	23	• Setting up OMS	64
• #000 OTS	25	Function	66
• Dual Voice	25	• Using the Function parameters	66
• Split Voice.....	26	Data Backup	68
• Setting the Split Point	26	Troubleshooting	69
• Touch and Touch Sensitivity.....	27	Voice List	70
• Transpose and Tuning.....	28	Style List	75
• Light Guide On and Off.....	28	Drum Kit List	76
		MIDI Implementation Chart	78
Effects	29	Effect map	80
• Harmony	29	Specifications	81
• Reverb	29	Index	82
• Chorus	30		
• Sustain.....	30		
Selecting and Playing Styles	33		
• Selecting a Style	33		
• Playing the Styles	34		
• Changing the Tempo	38		
• Accompaniment Sections (Main A/B and Fill-ins)	39		
• Adjusting the Style Volume	39		
• Using Auto Accompaniment — Multi Fingering	40		
• Dictionary	42		
Selecting and Playing Songs	45		
• Selecting a Song.....	45		
• Playing the Songs.....	46		
• A-B Repeat	47		
• Melody Voice Change.....	48		
• Adjusting the Song Volume	48		



Panel Controls and Terminals

■ Front Panel

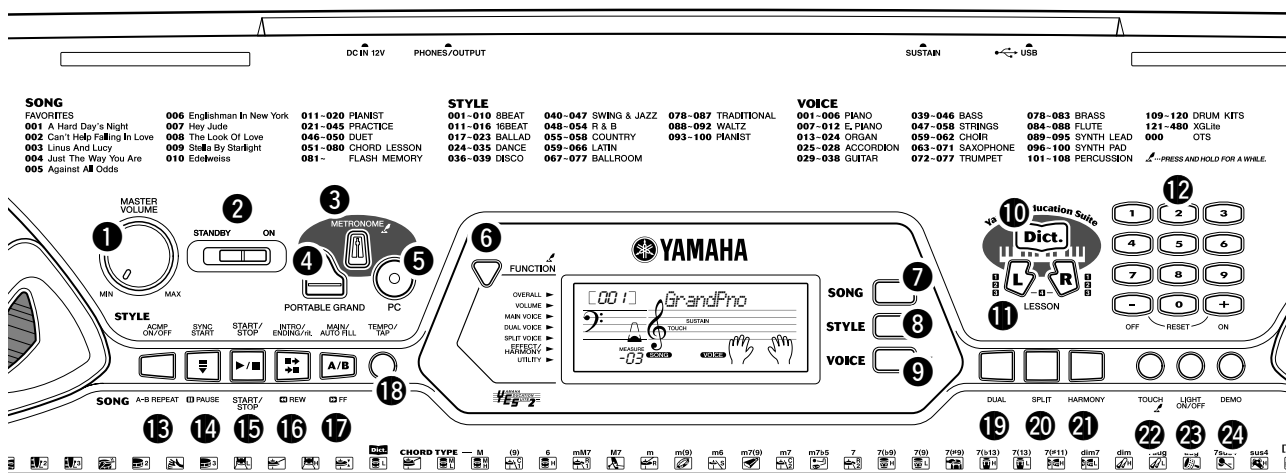

① [MASTER VOLUME] dial

This determines the overall volume of the EZ-250i.

② Power switch ([STANDBY/ON])

③ [METRONOME] button

This turns the metronome on and off. (See page 21.) Holding down this button calls up the Time Signet settings.

④ [PORTABLE GRAND] button

This instantly calls up the Grand Piano voice. (See page 21.)

⑤ [PC] button

This convenient control lets you instantly call up the specified MIDI settings for optimum use with a connected computer. (See page 58.)

⑥ [FUNCTION] button

This calls up the Function mode and stores the specified panel setting to the flash memory (See pages 66, 68).

⑦ [SONG] button

This is for enabling song selection. (See page 45.)

⑧ [STYLE] button

This is for enabling style selection. (See page 33.)

⑨ [VOICE] button

This is for enabling voice selection. (See page 23.) Holding down this button calls up the Melody Voice Change function. (See page 48.)

⑩ [Dict.] button

This calls up the Dictionary function (See page 42).

⑪ LESSON [L] (Left) and [R] (Right) buttons

These call up the Lesson exercises for the corresponding hand (left or right) for the selected song. (See page 49.)

⑫ Numeric keypad, [+ / ON] and [- / OFF] buttons

These are used for selecting songs, voices, and styles. (See pages 19.) They are also used for adjusting certain settings and answering certain display prompts.

⑬ [ACMP ON/OFF] / [A-B REPEAT] button

When the Style mode is selected, this turns the auto accompaniment on and off. (See page 34.) In the Song mode, this calls up the A-B Repeat function. (See page 47.)

⑭ [SYNC START] / [PAUSE] button

This turns the Sync Start function on and off. (See page 35.) In the Song mode, it is used to temporarily pause song playback. (See page 46.)

⑮ [START/STOP] button

When the Style mode is selected, this alternately starts and stops the style. (See page 34.) In the Song mode, this alternately starts and stops song playback. (See page 46.)

16 [INTRO/ENDING/rit.] / [REW] button

When the Style mode is selected, this is used to control the Intro and Ending functions. (See page 34.)

When the Song mode is selected, this is used as a “rewind” control, or move the song playback point back toward the beginning.

17 [MAIN/AUTO FILL] / [FF] button

When the Style mode is selected, this is used to change auto accompaniment sections and control the Auto Fill function. (See page 39.) When the Song mode is selected, this is used as a “fast forward” control, or move the song playback point toward the end.

18 [TEMPO/TAP] button

This button is used to call up the Tempo setting, letting you set the Tempo with the numeric keypad or [+]/[-] buttons. (See page 21.) It also allows you to tap out the tempo and automatically start a selected song or style at that tapped speed. (See page 35.)

19 [DUAL] button

This turns the Dual voice on or off. (See page 25.)

20 [SPLIT] button

This turns the Split voice on and off. (See page 26.)

21 [HARMONY] button

This turns the Harmony effect on and off. (See page 29.)

22 [TOUCH] button

This turns the Touch function on and off. (See page 27.) Holding down this button calls up the Touch Sensitivity settings.

23 [LIGHT ON/OFF] button

This turns the Light Guide on or off. (See page 28.)

24 [DEMO] button

This is used to play the Demo songs. (See page 14.)

■ Rear Panel

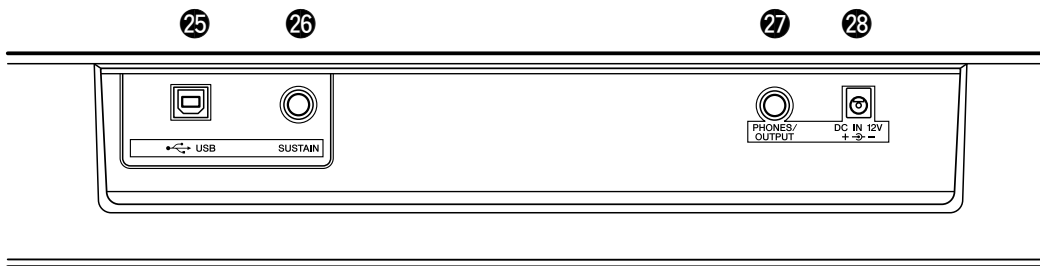

25 USB terminals

This is for connection to a computer. (See page 56.)

26 SUSTAIN jack

This is for connection to an optional FC4 or FC5 Footswitch for control over sustain, just like the damper pedal on a piano. (See page 11.)

27 PHONES/OUTPUT jack

This is for connection to a set of stereo headphones or to an external amplifier/speaker system. (See page 11.)

28 DC IN 12V jack

This is for connection to a PA-3C or PA-3B AC power adaptor. (See page 10.)



Setting Up

This section contains information about setting up your EZ-250i for playing. Make sure to read this section carefully before using the instrument.

Power Requirements

Although the EZ-250i will run either from an optional AC adaptor or batteries, Yamaha recommends use of an AC adaptor whenever possible. An AC adaptor is more environmentally friendly than batteries and does not deplete resources.

■ Using an AC Power Adaptor

- ① Make sure that the [STANDBY/ON] switch of the EZ-250i is set to STANDBY.
- ② Connect the AC adaptor (PA-3C, PA-3B, or other adaptor specifically recommended by Yamaha) to the DC IN 12V jack.
- ③ Plug the AC adaptor into an AC outlet.

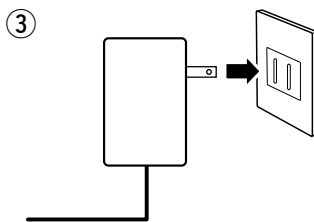
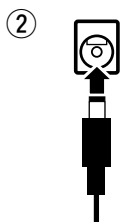

⚠ WARNING

- Use ONLY a Yamaha PA-3C or PA-3B AC Power Adaptor (or other adaptor specifically recommended by Yamaha) to power your instrument from the AC mains. The use of other adaptors may result in irreparable damage to both the adaptor and the EZ-250i.
- Unplug the AC Power Adaptor when not using the EZ-250i, or during electrical storms.

■ Using Batteries

For battery operation the EZ-250i requires six 1.5V “D” size, LR20 or equivalent batteries. When the batteries need to be replaced, the volume may be reduced, the sound may be distorted, and other problems may occur. When this happens, turn the power off and replace the batteries, as described below

- ① Open the battery compartment cover located on the instrument’s bottom panel.
- ② Insert the six new batteries, being careful to follow the polarity markings in the compartment cover.
- ③ Replace the compartment cover, making sure that it locks firmly in place.

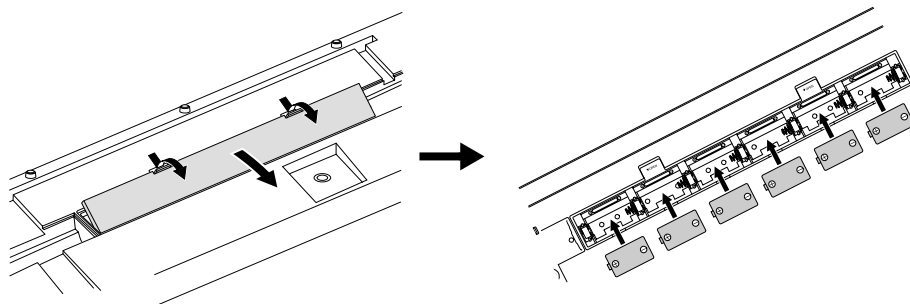

⚠ CAUTION

- Use only manganese or alkaline batteries for this instrument. Other types of batteries (including rechargeable batteries) may have sudden drops of power when battery power becomes low, possibly resulting in loss of data in the flash memory and the need to initialize the flash memory.
- When the batteries run down, replace them with a complete set of six new batteries. NEVER mix old and new batteries.
- Do not use different kinds of batteries (e.g. alkaline and manganese) at the same time.
- If the instrument is not to be in use for a long time, remove the batteries from it, in order to prevent possible fluid leakage from the battery.
- The effective life of rechargeable batteries may shorter than that of conventional batteries.

Turning On the Power

With the AC power adaptor connected or with batteries installed, simply move the power switch until it is set to the ON position. When the instrument is not in use, be sure to turn the power off.

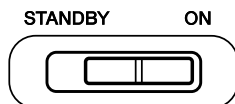

CAUTION

- Even when the switch is in the “STANDBY” position, electricity is still flowing to the instrument at the minimum level. When you are not using the EZ-250i for a long time, make sure you unplug the AC power adaptor from the wall AC outlet, and/or remove the batteries from the instrument.
- Never attempt to turn the power off when data is being transferred from a computer. Doing so can damage the internal flash memory and result in loss of data.

Accessory Jacks

■ Using Headphones

For private practicing and playing without disturbing others, connect a set of stereo headphones to the rear panel PHONES/OUTPUT jack. Sound from the built-in speaker system is automatically cut off when you insert a headphone plug into this jack.

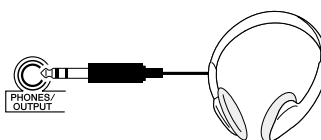

■ Connecting a Keyboard Amplifier or Stereo System

Though the EZ-250i is equipped with a built-in speaker system, you can also play it through an external amplifier/speaker system. First, make sure the EZ-250i and any external devices are turned off, then connect one end of a stereo audio cable to the LINE IN or AUX IN jack(s) of the other device and the other end to the rear panel PHONES/OUTPUT jack on the EZ-250i.

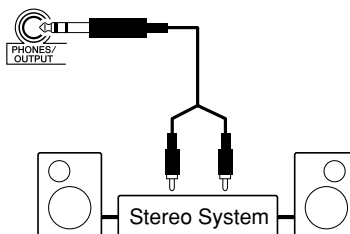

CAUTION

- To prevent damage to the speakers, set the volume of the external devices at the minimum setting before connecting them. Failure to observe these cautions may result in electric shock or equipment damage. Also, be sure to set the volumes of all devices at their minimum levels and gradually raise the volume controls while playing the instrument to set the desired listening level.

■ Using a Footswitch

This feature lets you use an optional footswitch (Yamaha FC4 or FC5) to sustain the sound of the voices. The footswitch functions the same way as a damper pedal on an acoustic piano — press and hold down the footswitch as you play the keyboard to sustain the sound.

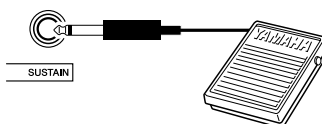

NOTE

- Make sure that the footswitch plug is properly connected to the SUSTAIN jack before turning on the power.
- Do not press the footswitch while turning the power on. Doing this changes the recognized polarity of the footswitch, resulting in reversed footswitch operation.

■ Connecting to a computer (USB terminal)

By connecting the USB terminal of this instrument to the USB terminal of a computer, you can transfer performance data and song files between the instrument. (See page 56.)

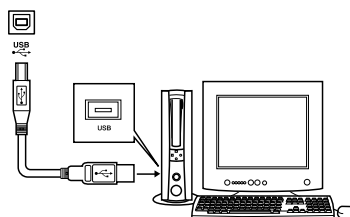

NOTE

- Make sure to purchase a quality USB cable at a musical instrument store, computer store or electrical appliance store.

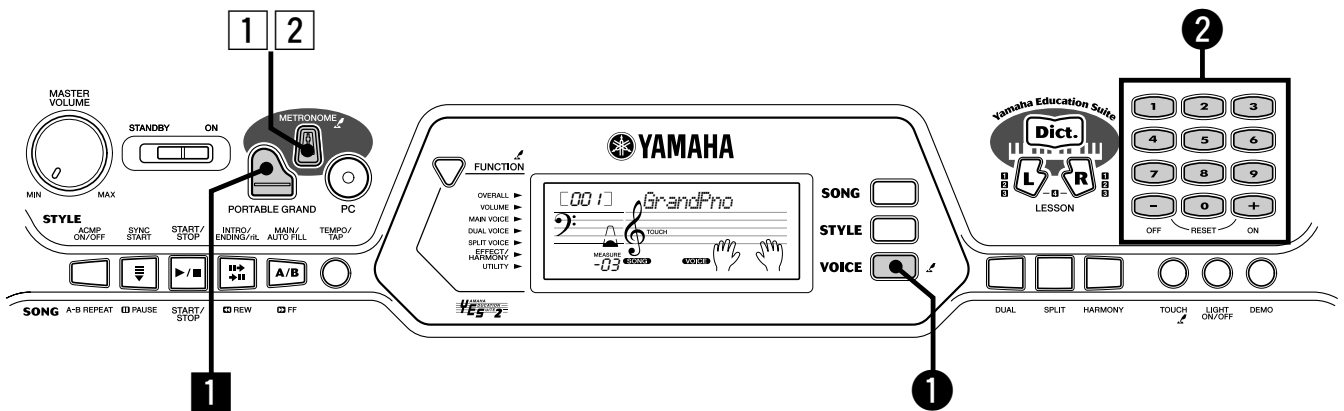

Playing the Piano

Simply by pressing the [PORTABLE GRAND] button, you can automatically select the Grand Piano voice.

- 1 Press the [PORTABLE GRAND] button.

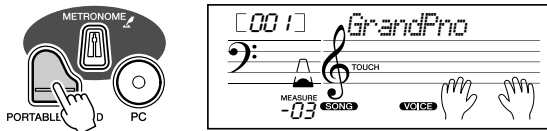

- 2 Play the keyboard.

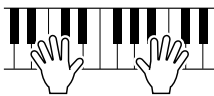

Want to find out more? See page 21.

Playing along with the Metronome

- 1 Press the [METRONOME] button.

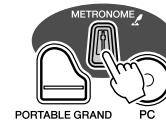

- 2 Stop the Metronome.

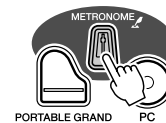

Want to find out more? See page 21.

Selecting and Playing Other Voices

The EZ-250i has a huge total of 480 dynamic and realistic instrument voices. Let's try a few of them out now...

① Press the [VOICE] button.

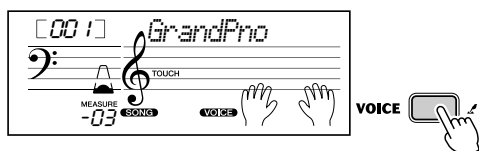

② Select a voice.

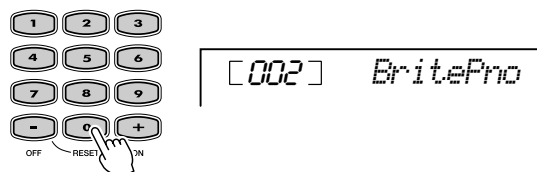

③ Play the keyboard.



Want to find out more? See page 23.

● Panel Voice List

No.	Voice Name
PIANO	
001	Grand Piano
002	Bright Piano
003	Honky-tonk Piano
004	MIDI Grand Piano
005	CP 80
006	Harpsichord
E.PIANO	
007	Galaxy EP
008	Funky Electric Piano
009	DX Modern Elec. Piano
010	Hyper Tines
011	Venus Electric Piano
012	Clavi
ORGAN	
013	Jazz Organ 1
014	Jazz Organ 2
015	Click Organ
016	Bright Organ
017	Rock Organ
018	Purple Organ
019	16'+2' Organ
020	16'+4' Organ
021	Theater Organ
022	Church Organ
023	Chapel Organ
024	Reed Organ
ACCORDION	
025	Traditional Accordion
026	Musette Accordion
027	Bandoneon
028	Harmonica
GUITAR	
029	Classical Guitar

No.	Voice Name
030	Folk Guitar
031	12Strings Guitar
032	Jazz Guitar
033	Octave Guitar
034	Clean Guitar
035	60's Clean Guitar
036	Muted Guitar
037	Overdriven Guitar
038	Distortion Guitar
BASS	
039	Acoustic Bass
040	Finger Bass
041	Pick Bass
042	Fretless Bass
043	Slap Bass
044	Synth Bass
045	Hi-Q Bass
046	Dance Bass
STRINGS	
047	String Ensemble
048	Chamber Strings
049	Synth Strings
050	Slow Strings
051	Tremolo Strings
052	Pizzicato Strings
053	Orchestra Hit
054	Violin
055	Cello
056	Contrabass
057	Banjo
058	Harp
CHOIR	
059	Choir
060	Vocal Ensemble

No.	Voice Name
061	Vox Humana
062	Air Choir
SAXOPHONE	
063	Soprano Sax
064	Alto Sax
065	Tenor Sax
066	Breathy Tenor
067	Baritone Sax
068	Oboe
069	English Horn
070	Bassoon
071	Clarinet
TRUMPET	
072	Trumpet
073	Muted Trumpet
074	Trombone
075	Trombone Section
076	French Horn
077	Tuba
BRASS	
078	Brass Section
079	Big Band Brass
080	Mellow Horns
081	Synth Brass
082	Jump Brass
083	Techno Brass
FLUTE	
084	Flute
085	Piccolo
086	Pan Flute
087	Recorder
088	Ocarina
SYNTH LEAD	
089	Square Lead

No.	Voice Name
090	Sawtooth Lead
091	Voice Lead
092	Star Dust
093	Brightness
094	Analogon
095	Fargo
SYNTH PAD	
096	Fantasia
097	Bell Pad
098	Xenon Pad
099	Equinox
100	Dark Moon
PERCUSSION	
101	Vibraphone
102	Marimba
103	Xylophone
104	Steel Drums
105	Celesta
106	Tubular Bells
107	Timpani
108	Music Box
DRUM KITS	
109	Standard Kit 1
110	Standard Kit 2
111	Room Kit
112	Rock Kit
113	Electronic Kit
114	Analog Kit
115	Dance Kit
116	Jazz Kit
117	Brush Kit
118	Symphony Kit
119	SFX Kit 1
120	SFX Kit 2

* This list includes only a portion of the total available voices.

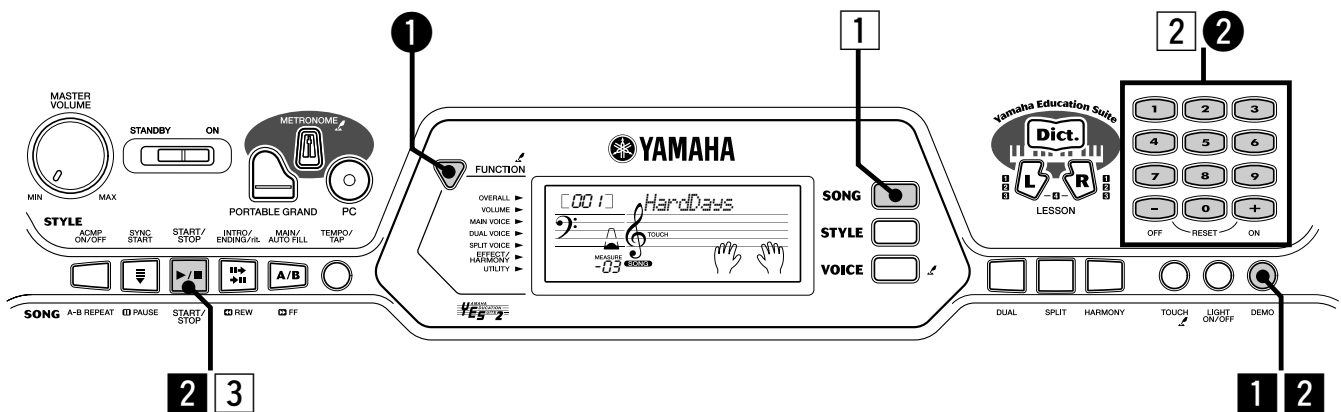

Playing the Songs

The EZ-250i is packed with a total of 80 songs, including 10 Demo songs — which has been specially created to showcase the rich and dynamic sounds of the instrument. There are also 70 additional songs, designed to be used with the educational Lesson feature.

You can also play songs loaded to the instrument via USB. The songs can be stored to the song numbers 081-180.

Playing the Demo song

Let's play the Demo song now.

- 1 Start the Demo song.

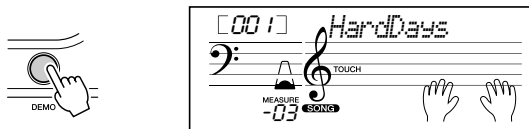

You can also play back songs of other categories. Simply select the appropriate number of the desired song during playback.

- 2 Stop the Demo song.

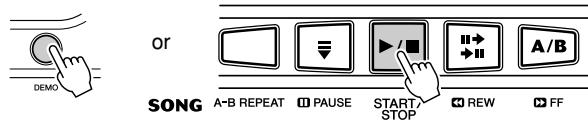

NOTE

- The EZ-250i also has a Demo Cancel function that allows you to disable Demo song function. Set Demo Cancel in the *Function mode* (page 67).

Playing a single song

Naturally, you can also individually select and play back the EZ-250i's songs.

- 1 Press the [SONG] button.

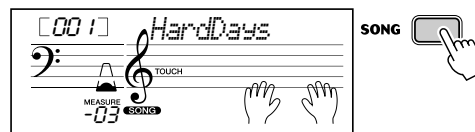

- 2 Select a song.

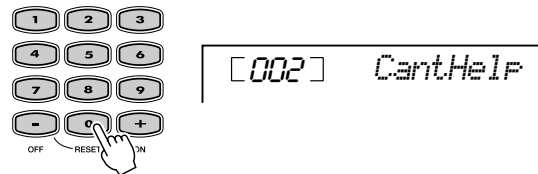

- 3 Start (and stop) the song.

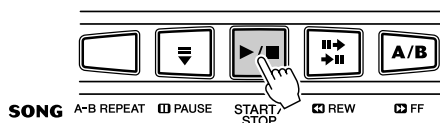

Want to find out more? See page 45.

Changing the volume of the song

This lets you adjust the volume balance between the song and your keyboard performance.

- 1 Press the [FUNCTION] button, until SongVol is indicated in the display.

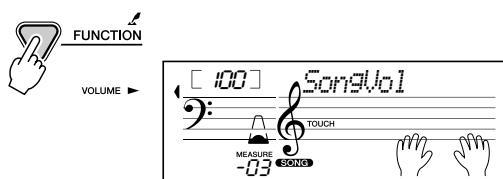

- 2 Use the [+]/[-] buttons to adjust the song volume.

You can also use the numeric keypad to directly enter the value.

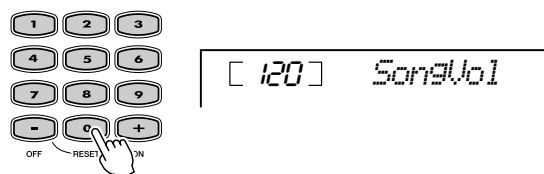

Want to find out more? See page 48.

Song List

No.	Song Name (Composers)
FAVORITES	
001	A Hard Day's Night
002	Can't Help Falling In Love
003	Linus And Lucy
004	Just The Way You Are
005	Against All Odds
006	Englishman In New York
007	Hey Jude
008	The Look Of Love
009	Stella By Starlight
010	Edelweiss
PIANIST	
011	Arabesque (J.F.Burgmüller)
012	Innocence (J.F.Burgmüller)
013	Etude op.10-3 "Chanson De L'adieu" (F.Chopin)
014	Menuett (L. Boccherini)
015	Nocturne op.9-2 (F. Chopin)
016	Moments Musicaux op.94-3 (F. Schubert)
017	The Entertainer (S. Joplin)
018	Prelude (Wohltemperierte Klavier 1-1) (J.S. Bach)
019	La Violette (Streabbog)
020	Für Elise (L.v. Beethoven)
PRACTICE	
021	America The Beautiful (S.A. Ward)
022	Londonderry Air (Traditional)
023	Ring De Banjo (S.C. Foster)
024	Wenn Ich Ein Vöglein Wär ? (Traditional)
025	Die Lorelei (F. Silcher)
026	Funiculi-Funicula (L. Denza)
027	Turkey In The Straw (Traditional)
028	Old Folks At Home (S.C. Foster)
029	Jingle Bells (J.S. Pierpont)
030	Muss I Denn (F. Silcher)
031	Liebesträume Nr.3 (F. Liszt)
032	Jesu, Joy Of Man's Desiring (J.S. Bach)
033	Symphonie Nr.9 (L.v. Beethoven)
034	Song Of The Pearl Fisher (G. Bizet)
035	Gavotte (F.J. Gossec)
036	String Quartet No.17 2nd mov. "Serenade" (F.J. Haydn)
037	Menuett (J.S. Bach)
038	Canon (J. Pachelbel)
039	From "The Magic Flute" (W.A. Mozart)
040	Piano Sonate op.27-2 "Mondschein" (L.v. Beethoven)
041	"The Surprise" Symphony (F.J. Haydn)
042	To A Wild Rose (E.A. MacDowell)
043	Air de Toréador "Carmen" (G. Bizet)
044	O Mio Babbino Caro (From "Gian-ni Schicchi") (G. Puccini)
045	Frühlingslied (F. Mendelssohn)

No.	Song Name (Composers)
DUET	
046	Row Row Row Your Boat (Traditional)
047	We Wish You A Merry Christmas (Traditional)
048	Ten Little Indians (Septimus Winner)
049	O Du Lieber Augustin (Traditional)
050	London Bridge (Traditional)
CHORD LESSON	
051	Bill Bailey (Won't You Please Come Home) (H. Cannon)
052	Down By The Riverside (Traditional)
053	Camptown Races (S.C. Foster)
054	Little Brown Jug (Joseph Winner)
055	Loch Lomond (Traditional)
056	Oh! Susanna (S.C. Foster)
057	Greensleeves (Traditional)
058	Aura Lee (G. Poulton)
059	Silent Night (F. Gruber)
060	The Danube Waves (I. Ivanovici)
061	Twinkle Twinkle Little Star (Traditional)
062	Close Your Hands, Open Your Hands (J.J. Rousseau)
063	The Cuckoo (Traditional)
064	O Du Lieber Augustin (Traditional)
065	London Bridge (Traditional)
066	American Patrol (F.W. Meacham)
067	Beautiful Dreamer (S.C. Foster)
068	Battle Hymn Of The Republic (Traditional)
069	Home Sweet Home (H. Bishop)
070	Valse Des Fleurs (From "The Nutcracker") (P.I. Tchaikovsky)
071	Aloha Oe (Traditional)
072	I've Been Working On The Railroad (Traditional)
073	My Darling Clementine (Traditional)
074	Auld Lang Syne (Traditional)
075	Grandfather's Clock (H.C. Work)
076	Amazing Grace (Traditional)
077	My Bonnie (H.J. Fulmer)
078	Yankee Doodle (Traditional)
079	Joy To The World (G.F. Händel)
080	Ave Maria (F.Schubert)
081-	FLASH MEMORY

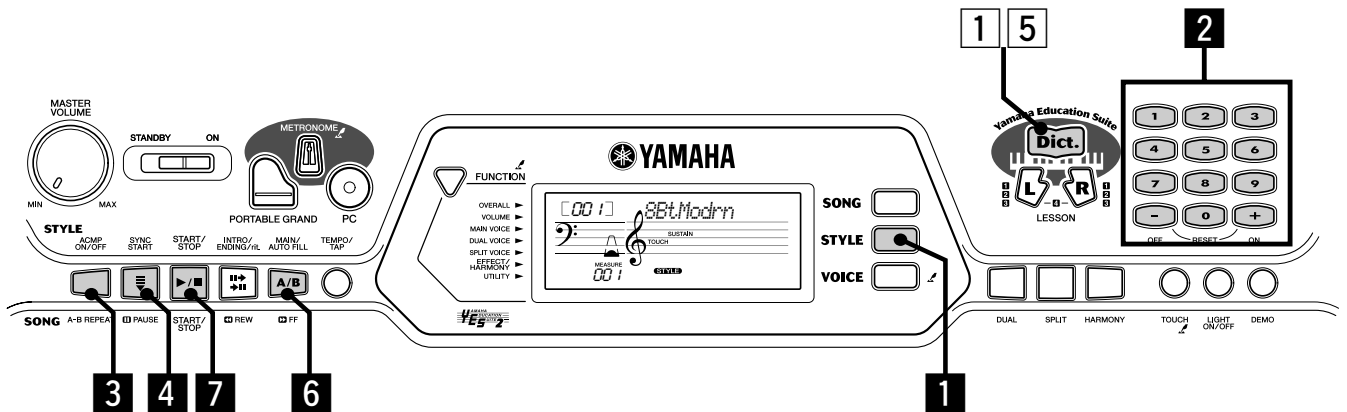

Using the Style

The powerful yet easy-to-use Style features give you professional instrumental backing for your performances. Simply play chords with your left hand — and the EZ-250i automatically produces appropriate bass, chord and rhythm backing. Use your right hand to play melodies, and you'll sound like an entire band!

NOTE

- For more information on playing proper chords for the auto accompaniment, see "Using Auto Accompaniment — Multi Fingering" on page 40 and "Dictionary" on page 42.

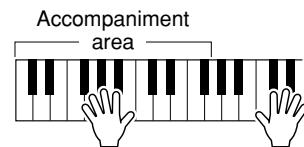

Left hand + Right hand

Auto accompaniment
(for example, bass + guitar + drums)

Melody
(for example, piano)

1 Press the [STYLE] button.



2 Select a style.

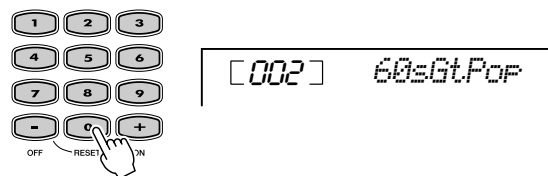

3 Turn the auto accompaniment on.

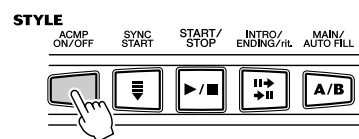

Looking up Chords in the Dictionary

The convenient Dictionary function teaches you how to play chords by showing you the individual notes. In the example below, we'll learn how to play a GM7 chord...

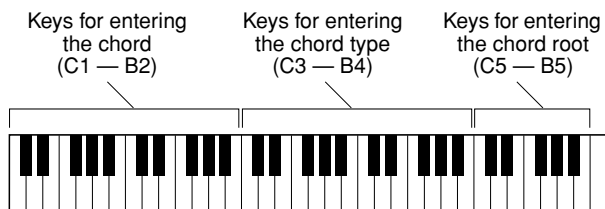

Learning how to play a specific chord

Example: **G M7**
 Root note Chord type

1 Press the [Dict.] button.

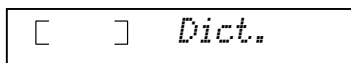

2 Specify the root note of the chord (in this case, G).

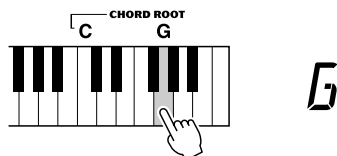

3 Specify the chord type of the chord (in this case, M7).

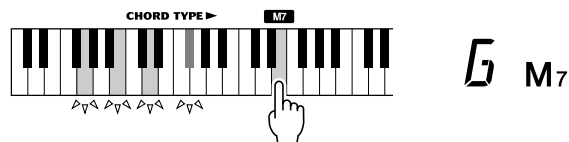

4 Play the notes of the chord according to the Light Guide. The "Congratulation" melody plays when the chord is played properly

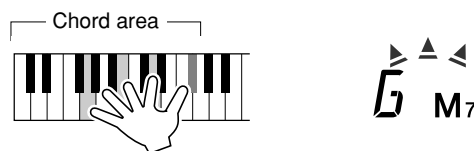

The keys light to show you how to play the chord. You can also play chord inversions, as described in the note on page 40 (Fingered Chords).

5 To leave the Dictionary function, press the [Dict.] button again.



Want to find out more? See page 42.

4 Turn the Sync Start function on.

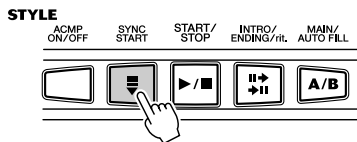

5 Play a chord with your left hand.

The style starts as soon as you play the keyboard. For more on chords, see "Looking up Chords in the Dictionary" above.

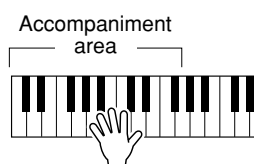

6 Select a section.

The auto accompaniment has four sections: Intro, Main A/B, and Ending.

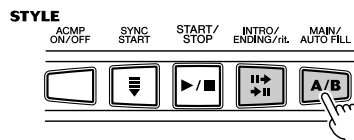

7 Stop the style.

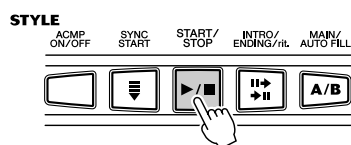

Want to find out more? See page 34.



Basic Operation and LCD Display

Adjusting the Volume

Turn the [MASTER VOLUME] dial.

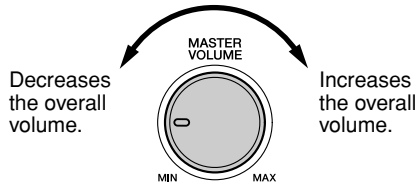

Name and Number indication (Song/Style/Voice)

Currently selected name and number (Song, Style or Voice) appear here.

For example, when song is selected:

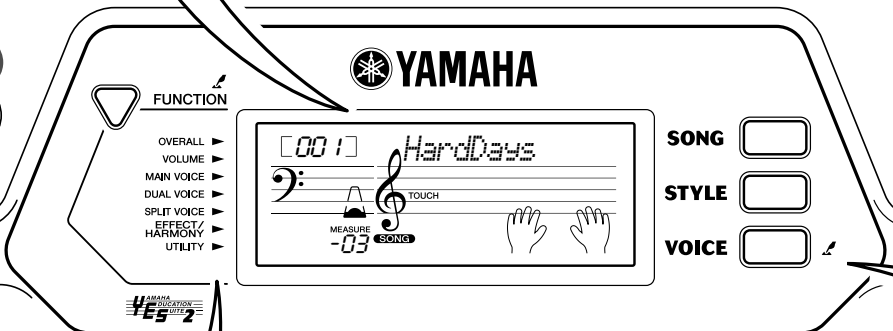
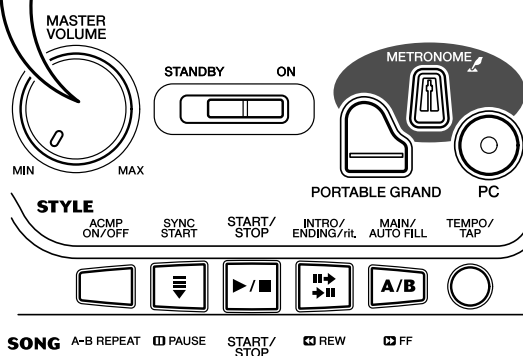
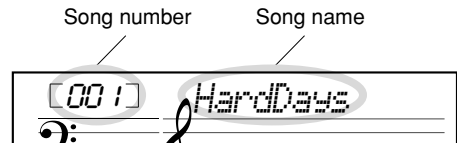

Function settings and indications

This button lets you call up the various function settings.



- OVERALL ▶ See page 66
- VOLUME ▶ See page 67
- MAIN VOICE ▶ See page 23, 67
- DUAL VOICE ▶ See page 25, 67
- SPLIT VOICE ▶ See page 26, 67
- EFFECT/HARMONY ▶ See page 29, 67
- UTILITY ▶ See page 67

Note that the function bar in the LCD indicates the function category (Overall, Volume, etc.) when you select each function, and the currently selected function name and value appears in the LCD.

For example, when Transpose is selected:

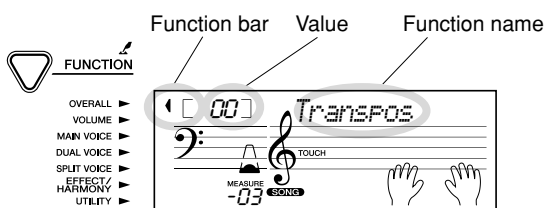

Setting values

- Use the numeric [0]-[9] buttons or [+]/[-] buttons.

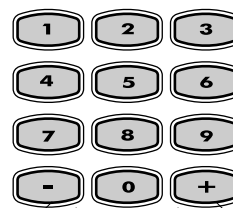

Decreases the number by one step.

Increases the number by one step.

To continuously change the number up or down, press and hold the appropriate [+]/[-] button. To input a negative value, simultaneously hold the [-] button and enter the number.

Entering one of the modes (Song, Style or Voice)

- Pressing one of the buttons below calls up the appropriate mode — Song, Style or Voice, and the indicator in the display appears the currently selected mode.

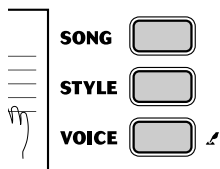

SONG **STYLE** **VOICE**

Song

Select the desired song.

Style

Select the desired style.

Voice

Select the desired voice.

- The following indications appear when you press the [VOICE] button in the Song or Style mode.

- For selecting a voice in the Song mode.

SONG **VOICE**

- For selecting a voice in the Style mode.

STYLE **VOICE**

Entering numbers

- Use the [+]/[-] buttons when you want to change the number in single steps.

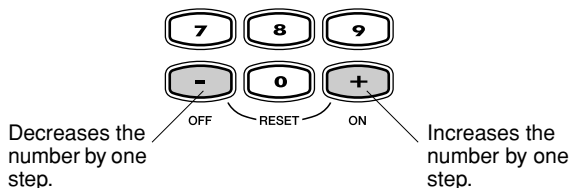

To continuously change the number up or down, press and hold the appropriate [+]/[-] button.

- To directly enter the desired number, use numeric buttons [0]-[9].

Ex. Voice number 109: Standard Kit 1

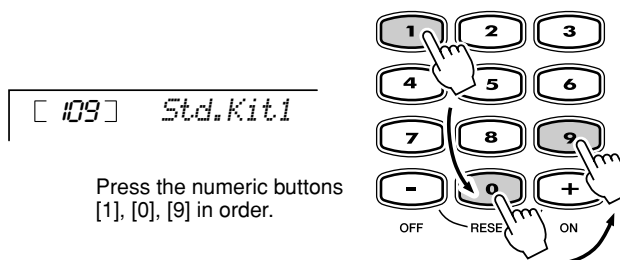

NOTE

- If the first digit or first two digits of the number are "0," (ex., 074 or 005), pressing the [0] button is unnecessary. However, pressing the [0] button is necessary if "0" is part of the number (ex., 105).

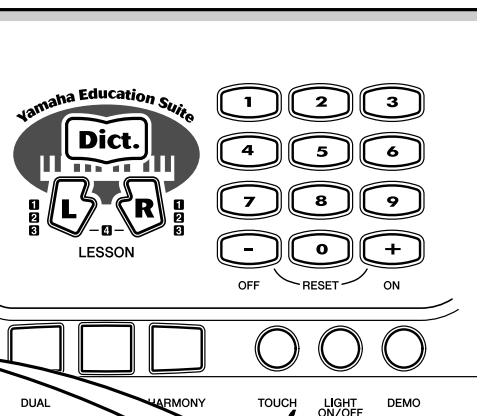

[PRESS AND HOLD FOR A WHILE] indication



Buttons having this indication can be used to call up an alternate function when the relevant button is pressed and held.

Hold down this button until the function calls up.

Music Rest

Insert the bottom edge of the included music rest into the slot located at the top rear of the EZ-250i control panel.

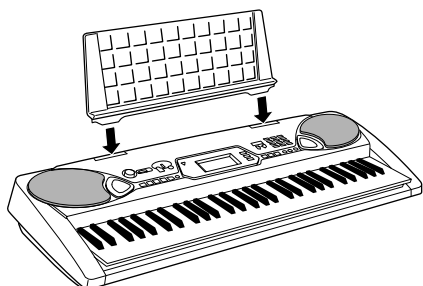

Basic Operation and LCD Display

NOTATION

Normally, these indicate which keys or notes are played, or which keys to play when using the Dictionary function.

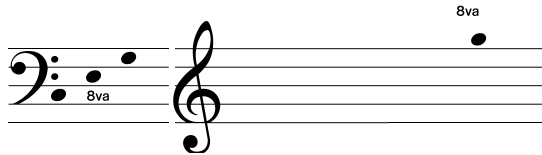

NOTE

- Any notes occurring below or above the staff are indicated by "8va" in the notation.
- In certain cases, a note may not be fully shown in the display.

DUAL

Indicates that the Dual Voice feature is turned on.

DUAL

SPLIT

Indicates that the Split feature is turned on.

SPLIT

HARMONY

Indicates that the Harmony feature is turned on.

HARMONY

TOUCH

Indicates that Touch is turned on.

TOUCH

SUSTAIN

Indicates that Sustain is turned on.

SUSTAIN

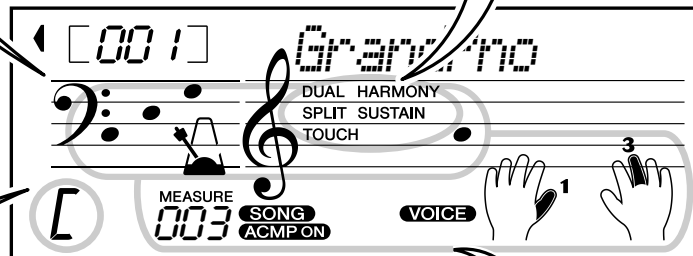

CHORD

Indicates the chord name when playing in the style or song (only chord type song) mode.



MEASURE number

Indicates the current measure number of the song or style.

MEASURE
003

Accompaniment On (ACMP ON)

Indicates when accompaniment is on.

ACMP ON

Fingering guide

During the Lesson, this guide suggests a fingering for playing the song.





Portable Grand

This convenient function lets you instantly call up the Grand Piano voice.

Playing the Portable Grand

Press the [PORTABLE GRAND] button.

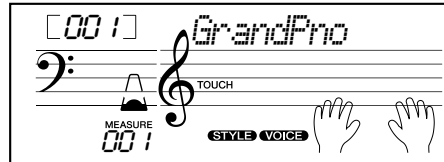
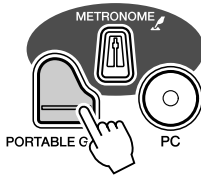

Doing this automatically selects the special “Stereo Sampled Piano” Grand Piano voice.

Using the Metronome

1 Call up the Tempo setting.

Press the [TEMPO/TAP] button.

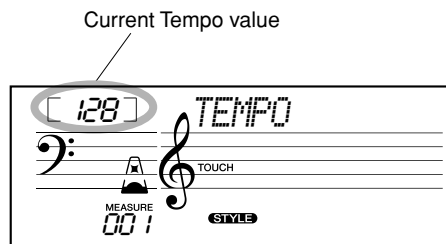
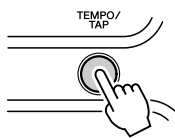

2 Change the value.

Use the numeric keypad to set the desired Tempo value, or use the [+]/[-] buttons to increase or decrease the value.

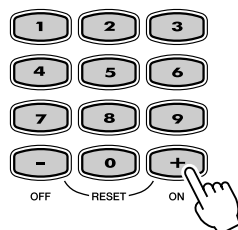

Restoring the Default Tempo Value

Each song and style has been given a default or standard Tempo setting. If you've changed the Tempo, you can instantly restore the default setting by pressing both [+]/[-] buttons simultaneously (when Tempo is selected).

3 Turn on the Metronome.

Press the [METRONOME] button.

The metronome is indicated as follows (for a time signature of 4/4):

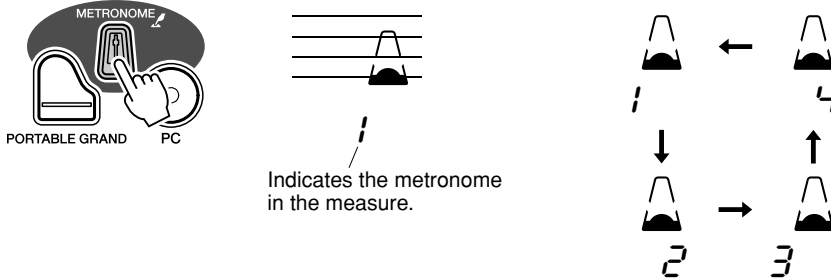

To turn the Metronome off, press the [METRONOME] button again.

Setting the Metronome Time Signature

The time signature of the Metronome can be set to various quarter-note based meters.

Press and hold the [METRONOME] button (until "TimeSig" appears in the display), then press the button on the numeric keypad or [+]/[-] buttons that corresponds to the desired time signature (see chart right).

The Time Signature also can be set in the Function mode (page 67).

NOTE

- The time signature changes automatically when a style or song is selected.

Numeric keypad	Time signature
0	Plays no "1" beats (all low clicks)
01	1/4 — Plays only "1" beats (all high clicks)
02	2/4
03	3/4
04	4/4
:	:
15	15/4

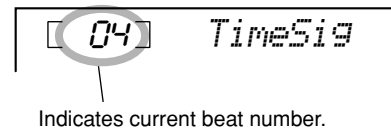

Adjusting the Metronome Volume

You can adjust the volume of the Metronome sound in the *Function mode* (page 67). The volume range is 000 - 127.



Playing Voices

The EZ-250i features a total of 480 authentic voices — all of which have been created with Yamaha’s sophisticated AWM (Advanced Wave Memory) tone generation system. These include 360 XG Lite voices and drum kits.

The EZ-250i also has a Dual Voice or Split Voice function that lets you combine two different voices in a layer, or play from separate areas of the keyboard, play the two together across the keyboard.

Playing a Voice

1 Press the [VOICE] button.

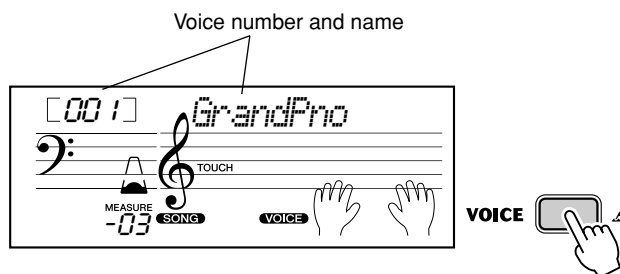

2 Select the desired voice number.

The categories of each voice and their numbers are shown on the panel. A complete voice list of the available voices is given on page 70.

NOTE

- Selecting the #000 OTS voice — calls up a convenient feature — automatically selecting an appropriate voice to best match the current style or song.

VOICE

001~006 PIANO	039~046 BASS	078~083 BRASS	109~120 DRUM KITS
007~012 E. PIANO	047~058 STRINGS	084~088 FLUTE	121~480 XGLite
013~024 ORGAN	059~062 CHOIR	089~095 SYNTH LEAD	000 OTS
025~028 ACCORDION	063~071 SAXOPHONE	096~100 SYNTH PAD	
029~038 GUITAR	072~077 TRUMPET	101~108 PERCUSSION	

3 Play the selected voice.

Since either the Style or Song mode is active in the background, you can also play styles or songs, respectively, in the Voice mode by simply pressing the [START/STOP] button. The last selected style, or song will be played.

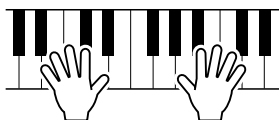

The following parameteres can be set in the Function mode (page 67).

CATEGORY	SELECT
Main Voice	Volume
	Octave
	Reverb Send Level
	Chorus Send Level

Drum Kit Voice List (voices 109-120)

When one of the 12 Drum Kit voices is selected, you can play different drum and percussion instrument sounds from the keyboard.



• For more details, see page 76.

No.	Name	LCD
109	Standard Kit 1	Std.Kit1
110	Standard Kit 2	Std.Kit2
111	Room Kit	Room Kit
112	Rock Kit	Rock Kit
113	Electronic Kit	Elct.Kit
114	Analog Kit	AnlogKit
115	Dance Kit	DanceKit
116	Jazz Kit	Jazz Kit
117	Brush Kit	BrushKit
118	Symphony Kit	SymphKit
119	SFX Kit 1	SFX Kit1
120	SFX Kit 2	SFX Kit2

● For example, when 109 “Standard Kit 1” is selected:

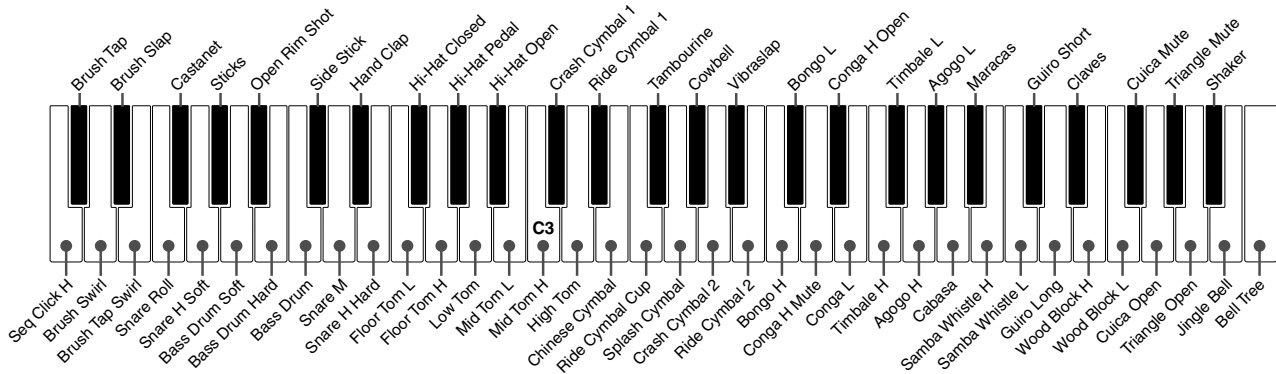

#000 OTS

This special “voice” is actually a convenient feature which automatically selects a suitable voice for you when you select a style or a song. The voice is selected to best match the style or song you’ve called up.

Select voice #000 (OTS).

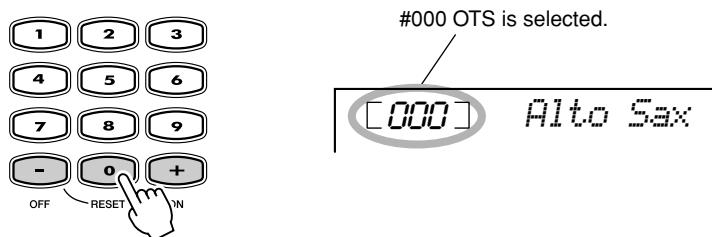

Dual Voice

The Dual Voice function lets you combine two different voices in a layer — one the Main voice, which is selected normally, and the other the Dual voice, which is selected in the *Function mode (page 67)*. You can also set various parameters independently for these voices, such as giving them separate volume, octave, Reverb, and Chorus settings. This lets you create an optimum mix for the voices, and enhance the way they blend together.

The following parameters can be set in the Function mode (page 67).

CATEGORY	SELECT
Dual Voice	Voice
	Volume
	Octave
	Reverb Send Level
	Chorus Send Level

To turn the Dual Voice on or off, press the [DUAL] button.

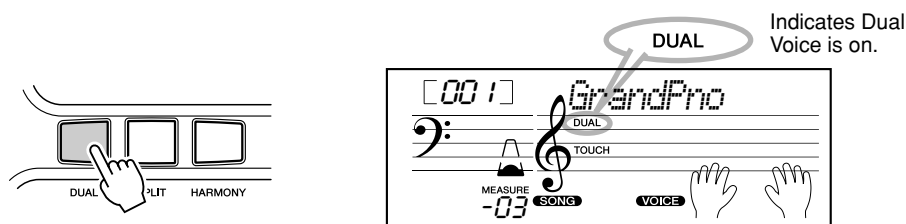

Split Voice

The Split Voice function lets you assign two different Voices to opposite areas of the keyboard, and play one Voice with your left hand while your right plays another.

For example, you could play bass with the left hand and play piano with the right. The right-hand (or upper) Voice is selected in the Main Voice mode (page 23), and the left-hand (or lower) Voice is selected in the *Function mode* (page 67), along with the other Split Voice parameters shown below.

The following parameters can be set in the Function mode (page 67).

CATEGORY	SELECT
Split Voice	Voice
	Volume
	Octave
	Reverb Send Level
	Chorus Send Level

To turn the Split Voice on or off, press the [SPLIT] button.

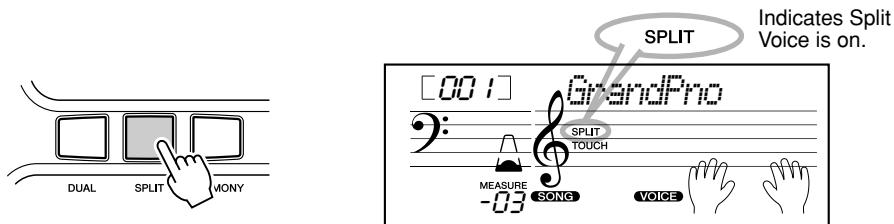

Setting the Split Point

The Split Point determines the highest key for the split voice and sets the split point.

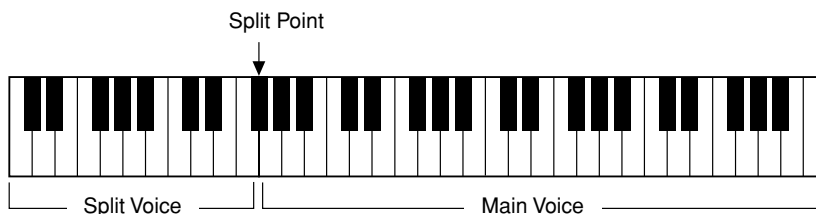

NOTE

- This setting also affects the split point for the accompaniment area.

Split Point can be set in the Function mode (page 66).

Touch and Touch Sensitivity

The EZ-250i features a Touch Response function that gives you dynamic, expressive control over the volume of the voices. The Touch Sensitivity parameter lets you set the degree of Touch Response.

- 1 Turn the Touch function on or off as desired by pressing the [TOUCH] button.

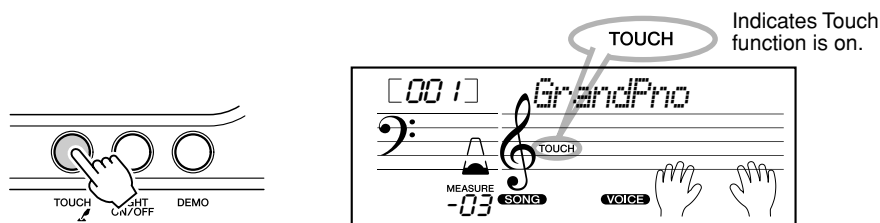

- 2 Changing the Touch Sensitivity Value.

Press and hold down the [TOUCH] button, then press the appropriate numbered button on the numeric keypad: 1, 2, 3, or [+]/[-].

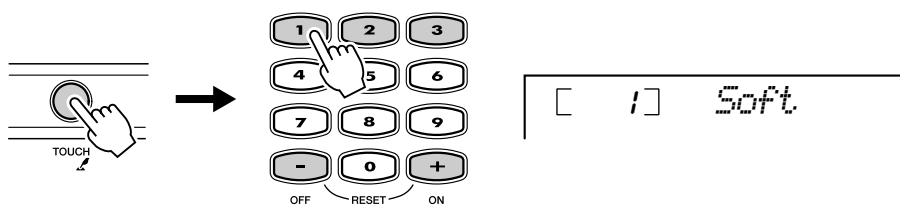

Sensitivity can also be set in the Function mode (page 66).

● Settings:

1 (Soft)	This results in limited touch response, and produces a relatively narrow dynamic range, no matter how lightly or strongly you play the keys.
2 (Medium)	This lets you play over a normal dynamic range (soft to loud).
3 (Hard)	This is designed for playing very soft passages, giving you slightly more detailed control in the soft volume range.

When Touch is turned off, a constant volume (corresponding to a velocity value of 80) is produced.

Restoring the Default Touch Sensitivity Value

The default Touch Sensitivity is 2 (Medium). To restore the default value, press both [+]/[-] buttons simultaneously (when Touch Sensitivity is selected).

Transpose and Tuning

You can also adjust the tuning and change the transposition (key) of the entire EZ-250i sound with the Transpose and Tuning functions.

■ Transpose

Transpose determines the key of both the main voice and the bass/chord accompaniment. It also determines the pitch of the songs. This allows you to easily match the pitch of the EZ-250i to other instruments or singers, or play in a different key without changing your fingering. The Transpose settings can be adjusted over a range of ± 12 semitones (± 1 octave).

NOTE

- The Transpose function has no effect on the Drum Kits voices (#109 - #120).

Transpose can be set in the Function mode (page 66).

■ Tuning

Tuning determines the fine pitch setting of both the main voice and the bass/chord accompaniment. It also determines the pitch of the songs. This allows you to accurately match the tuning with that of other instruments. The Tuning settings can be adjusted over a range of ± 100 (approx. ± 1 semitone).

NOTE

- The Tuning settings have no effect on the Drum Kit voices (#109 - #120).

Tuning can be set in the Function mode (page 66).

Light Guide On and Off

You can switch the Light Guide on or off. The Light Guide can be used as a keyboard guide during song playback, while you are using the Lesson or the Dictionary function.

Turn the Light Guide ON or OFF.

Press the [LIGHT ON/OFF] button.

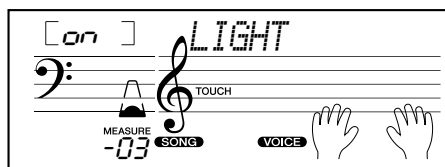
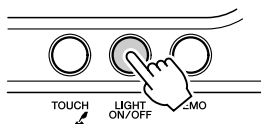

CAUTION

- Playing while looking at the lights for a long period of time may cause eyestrain or stiffness in your neck and shoulders. For your health and comfort, we recommend that you take a ten-minute break after every hour of playing.



The EZ-250i is equipped with a wide variety of effects that can be used to enhance the sound of the voices. The EZ-250i has three separate effect systems — Harmony, Reverb and Chorus — and each has many different effect types to choose from.

Harmony

The Harmony section features a variety of performance effects that enhance the melodies you play when using the accompaniment styles of the EZ-250i. A total of twenty-six Harmony types are available. (See page 31.)

Tremolo, Trill and Echo effects can be used even if accompaniment is off. There are five different Harmony Types that automatically create harmony parts (for notes played in the upper area of the keyboard) to match the accompaniment chords.

Turn on/off the Harmony effect.

Press the [HARMONY] button.

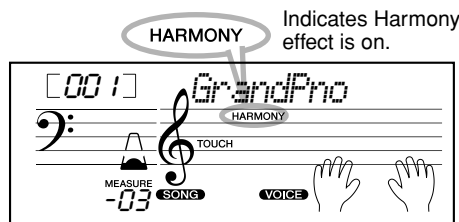
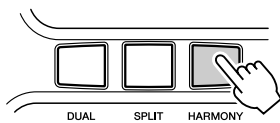

IMPORTANT

- For the first five Harmony Types (Duet, Trio, Block, Country, and Octave), chords must be played in the Accompaniment area of the keyboard. The Harmony voice(s) change in pitch to best match the chords you play.
- The speed of the Trill, Tremolo, and Echo effects depends on the Tempo setting (page 31).

NOTE

- Each voice of the EZ-250i has its own independent Harmony setting.

Harmony type and Harmony Volume (when Harmony Type 1 - 5 is selected) can be set in the Function mode (page 67).

Reverb

The Reverb effect reproduces the natural ambient “wash” of sound that occurs when an instrument is played in a room or concert hall. A total of nine different Reverb types simulating various different performance environments are available. (See page 32.)

The following parameters can be set in the Function mode (pages 67).

CATEGORY	SELECT
Effect	Reverb Type
Main Voice	Reverb Send Level
Dual Voice	Reverb Send Level
Split Voice	Reverb Send Level

NOTE

- Nine additional Reverb Types are available when controlling the EZ-250i from a MIDI device. (For details, See page 80.)
- Each style of the EZ-250i has its own independent Reverb setting.

Chorus

The Chorus effect lets you enhance the sound of the voices with the use of pitch modulation. Two basic types are provided: Chorus and Flanger. Chorus produces a thicker, warmer, and more animated sound, whereas Flanger creates a swirling, metallic effect. A total of four Chorus types are available. (See page 32.)

The following parameters can be set in the Function mode (pages 67).

CATEGORY	SELECT
Effect	Chorus Type
Main Voice	Chorus Send Level
Dual Voice	Chorus Send Level
Split Voice	Chorus Send Level

Sustain

The Sustain effect automatically adds a slow, natural decay to the voice sound when the keys are released.

Sustain on/off can be set in the Function mode (page 66).

■ Effect Types

● Harmony Types

No.	Harmony Type	Display Name		Description
1	Duet	Duet		Harmony types 1 - 5 are pitch-based and add one-, two- or three-note harmonies to the single-note melody played in the right hand. These types only sound when chords are played in the auto accompaniment area of the keyboard.
2	Trio	Trio		
3	Block	Block		
4	Country	Country		
5	Octave	Octave		
6	Trill 1/4 note	Tril1/4		<p>Types 6 - 26 are rhythm-based effects and add embellishments or delayed repeats in time with the auto accompaniment. These types sound whether the auto accompaniment is on or not; however, the actual speed of the effect depends on the Tempo setting (page 38). The individual note values in each type let you synchronize the effect precisely to the rhythm. Triplet settings are also available: 1/6 = quarter-note triplets, 1/12 = eighth-note triplets, 1/24 = sixteenth-note triplets.</p> <ul style="list-style-type: none"> • The Trill effect Types (6 - 12) create two-note trills (alternating notes) when two notes are held. • The Tremolo effect Types (13 - 19) repeat all held notes (up to four). • The Echo effect Types (20 - 26) create delayed repeats of each note played.
7	Trill 1/6 note	Tril1/6		
8	Trill 1/8 note	Tril1/8		
9	Trill 1/12 note	Tril1/12		
10	Trill 1/16 note	Tril1/16		
11	Trill 1/24 note	Tril1/24		
12	Trill 1/32 note	Tril1/32		
13	Tremolo 1/4 note	Trem1/4		
14	Tremolo 1/6 note	Trem1/6		
15	Tremolo 1/8 note	Trem1/8		
16	Tremolo 1/12 note	Trem1/12		
17	Tremolo 1/16 note	Trem1/16		
18	Tremolo 1/24 note	Trem1/24		
19	Tremolo 1/32 note	Trem1/32		
20	Echo 1/4 note	Echo1/4		
21	Echo 1/6 note	Echo1/6		
22	Echo 1/8 note	Echo1/8		
23	Echo 1/12 note	Echo1/12		
24	Echo 1/16 note	Echo1/16		
25	Echo 1/24 note	Echo1/24		
26	Echo 1/32 note	Echo1/32		

Effects

● Reverb Types

No.	Reverb Type	Display Name	Description
1	Hall 1	Hall1	Concert hall reverb.
2	Hall 2	Hall2	
3	Hall 3	Hall3	
4	Room 1	Room1	Small room reverb.
5	Room 2	Room2	
6	Stage 1	Stage1	Reverb for solo instruments.
7	Stage 2	Stage2	
8	Plate 1	Plate1	Simulated steel plate reverb.
9	Plate 2	Plate2	
10	Off	Off	No effect.

● Chorus Types

No.	Chorus Type	Display Name	Description
1	Chorus 1	Chorus1	Conventional chorus program with rich, warm chorusing.
2	Chorus 2	Chorus2	
3	Flanger 1	Flanger1	Pronounced three-phase modulation with a slight metallic sound.
4	Flanger 2	Flanger2	
5	Off	Off	No effect.



Selecting and Playing Styles

The EZ-250i provides dynamic rhythm/accompaniment patterns (styles) — as well as voice settings appropriate for each style — for various popular musical categories.

A total of 100 different styles are available, in several different categories. Each style is made up of separate “sections” — Intro, Main A and B, and Ending — letting you call up different accompaniment sections as you perform.

The auto accompaniment features that are built into the rhythms add the excitement of instrumental backing to your performance, letting you control the accompaniment by the chords you play. Auto accompaniment effectively splits the keyboard into two areas: The upper is used for playing a melody line, and the lower (set by default to keys F#2 and lower) is for the auto accompaniment function.

The EZ-250i also features the convenient Dictionary function (page 42). Dictionary provides you with a built-in “chord encyclopedia” that teaches you how to play any chord you specify by showing you the appropriate notes in the display.

Selecting a Style

1 Press the [STYLE] button.

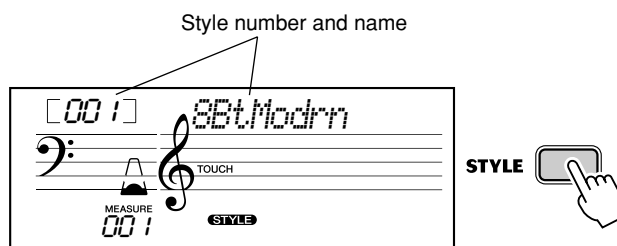

2 Select the desired style number.

The categories of each styles and their numbers are shown on the panel. A complete style list of the available styles is given on page 75.

STYLE

001~010 8BEAT	040~047 SWING & JAZZ	078~087 TRADITIONAL
011~016 16BEAT	048~054 R & B	088~092 WALTZ
017~023 BALLAD	055~058 COUNTRY	093~100 PIANIST
024~035 DANCE	059~066 LATIN	
036~039 DISCO	067~077 BALLROOM	

Selecting and Playing Styles

■ Use the numeric keypad.

Style numbers can be selected in the same way as with the voices (page 19). You can use the numeric keypad to directly enter the style number, or use the [+] / [-] buttons to step up and down through the styles.

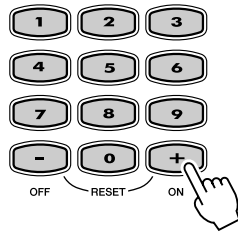

NOTE

- Rhythm sounds and fill-in sections are not available when one of the Pianist styles (#093 - #100) are selected.

Playing the Styles

The panel buttons below function as style controls.

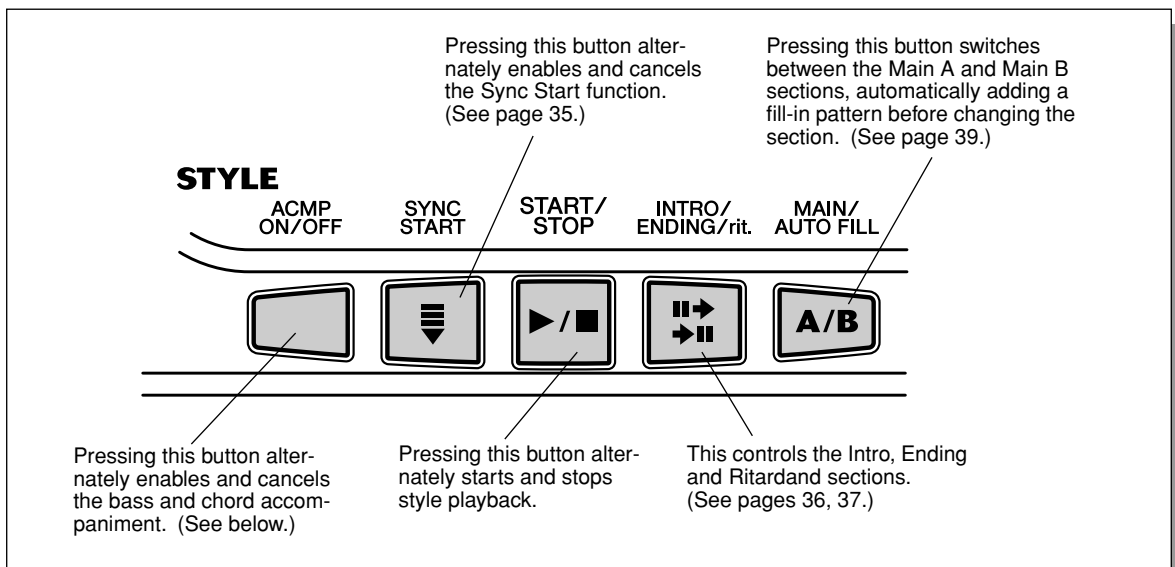

1 Turn on the auto accompaniment.

Press the [ACMP ON/OFF] button to turn on (enable) the auto accompaniment.

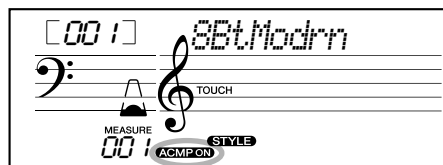
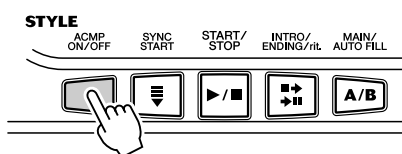

Indicates that auto accompaniment is on.

2 Start the style.

You can do this in one of the following ways:

■ Pressing the [START/STOP] button

The rhythm starts playing immediately without bass and chord accompaniment. The currently selected Main A or B section will play.

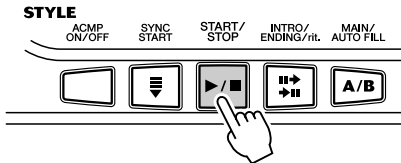

You can select the Main A or B section by pressing the appropriate button — [MAIN A/B] — before pressing the [START/STOP] button. (The display shows the letter of the selected section: “MAIN A” or “MAIN B.”)

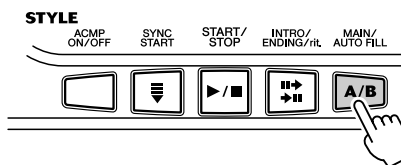

Indicates selected section (Main A or B).



■ Using Tap Tempo to Start

This useful feature lets you tap out the speed (tempo) of the style and automatically start the style at that tapped speed.

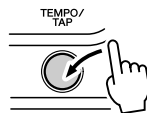

Simply tap the [TEMPO/TAP] button four times (or three times for a 3/4 time style), and the style starts automatically at the tempo you tapped. You can also change the tempo while the style is playing by tapping the [TEMPO/TAP] button twice at the desired tempo.

■ Using Sync Start

The EZ-250i also has a Sync Start function that allows you to start the style by simply pressing a key on the keyboard. To use Sync Start, first press the [SYNC START] button (the beat mark flashes to indicate Sync Start standby), then press any key on the keyboard. (When auto accompaniment is on, play a key or chord in the auto accompaniment area of the keyboard.)

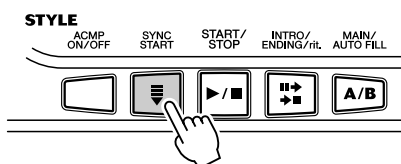

Auto accompaniment area



Selecting and Playing Styles

Starting with an Intro section

Each style has its own two- or four-measure Intro section. When used with the auto accompaniment, many of the Intro sections also include special chord changes and embellishments to enhance your performance.

To start with an Intro section:

- 1) Press the [MAIN/AUTO FILL] button — to select which section (A or B) is to follow the Intro.

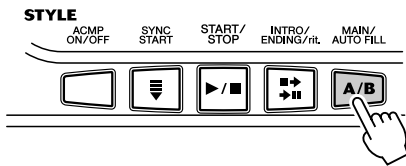

Indicates selected section (Main A or B).



- 2) Press the [INTRO/ENDING/rit.] button.

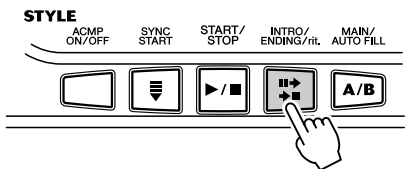

Indicates Intro standby.

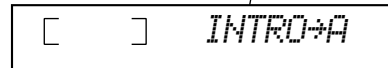

To actually start the Intro section, press the [START/STOP] button.

Using Sync Start with an Intro section

You can also use the Sync Start function with the special Intro section of the selected style.

To use Sync Start with an Intro section:

- 1) Press the [MAIN/AUTO FILL] button — to select which section (A or B) is to follow the Intro.

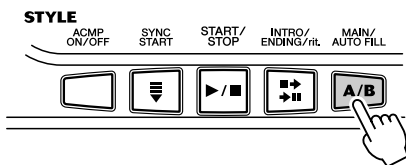

Indicates selected section (Main A or B).



- 2) Press the [INTRO/ENDING/rit.] button.

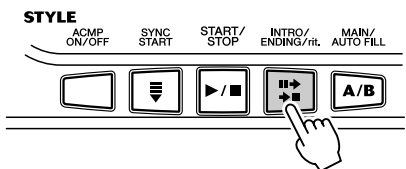

Indicates Intro standby.

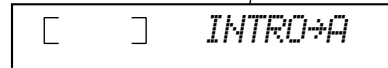

- 3) Press the [SYNC START] button to enable Sync Start, and start the Intro section and accompaniment by playing any key on the keyboard. (When auto accompaniment is on, play a key or chord in the auto accompaniment area of the keyboard.)

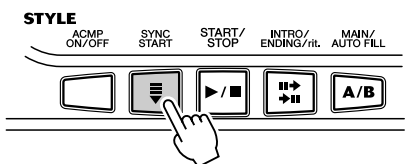

Auto accompaniment area

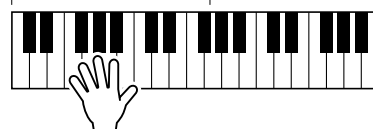

3 Change chords using the auto accompaniment feature.

Try playing a few successive chords with your left hand, and notice how the bass and chord accompaniment change with each chord you play. (Refer to page 40 for more information on how to use auto accompaniment.)

HINT

- The [ACMP ON/OFF] button can also be used to turn off and on the bass/chord accompaniment while playing — allowing you to create dynamic rhythmic breaks in your performance.

NOTE

- Chords played in the auto accompaniment area of the keyboard are also detected and played when the style is stopped. In effect, this gives you a “split keyboard,” with bass and chords in the left hand and the normally selected voice in the right.

4 Stop the style.

You can do this in one of three ways:

■ Pressing the [START/STOP] button

The style stops playing immediately.

■ Using an Ending section

Press the [INTRO/ENDING/rit.] button. The style stops after the Ending section is finished.

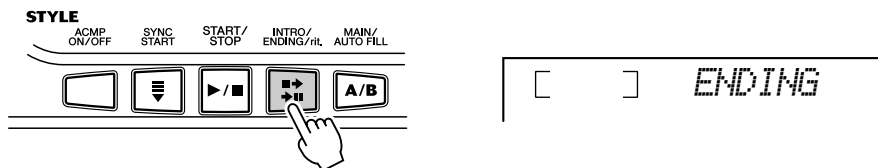

■ Pressing the [SYNC START] button

This immediately stops the style and automatically enables Sync Start, letting you restart the style by simply playing a chord or key in the auto accompaniment area of the keyboard.

To have the Ending section gradually slow down (ritardando) as it is playing, press the [INTRO/ENDING/rit.] button twice quickly.

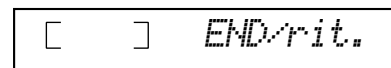

Changing the Tempo

The tempo of style playback can be adjusted over a range of 32 - 280 bpm (beats per minute).

1 Call up the Tempo setting.

Press the [TEMPO/TAP] button.

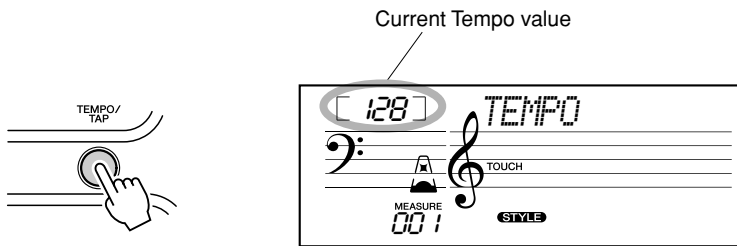

NOTE

- When style playback is stopped and a different style is selected, the tempo returns to the default setting of the new style. When switching styles during playback, the last tempo setting is maintained. (This allows you to keep the same tempo, even when changing styles.)

2 Change the value.

Use the numeric keypad to set the desired Tempo value, or use the [+]/[-] buttons to increase or decrease the value.

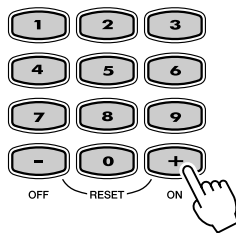

Restoring the Default Tempo Value

Each song and style has been given a default or standard Tempo setting. If you've changed the Tempo, you can instantly restore the default setting by pressing both [+]/[-] buttons simultaneously (when Tempo is selected).

HINT

- You can also use the convenient Tap Tempo function to change the tempo by "tapping" a new one in real time. (See page 35.)

About the Beat Display

This section of the display provides a convenient, easy-to-understand indication of the rhythm — for song and style playback. The flashing “metronome” icons indicate both the downbeats and upbeats of a measure as follows:

	Indicates the first beat of the measure (downbeat)
	Indicates an upbeat
	Indicates a downbeat (other than the first beat)

Accompaniment Sections (Main A/B and Fill-ins)

While the style is playing, you can add variation in the rhythm/accompaniment by pressing the [MAIN/AUTO FILL] button. This switches between the Main A and Main B sections, automatically playing a fill-in pattern to smoothly lead into the next section. For example, if the Main A section is currently playing, pressing this button automatically plays a fill-in pattern, followed by the Main B section. (See illustration below.)

You can also select either the Main A or B section to start by pressing the [MAIN/AUTO FILL] button before starting the style.

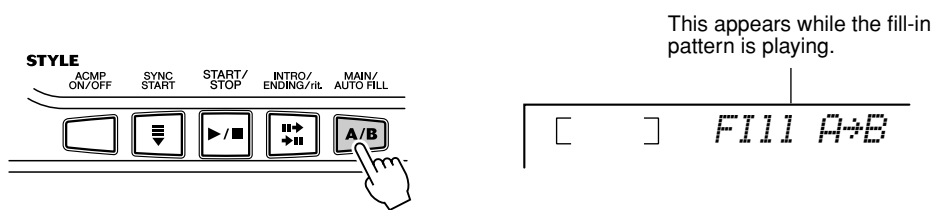

About the Fill-in Patterns

If you press the [MAIN/AUTO FILL] button before beat 4...

...a fill-in pattern plays immediately until the end of the measure...

...and the Main A or B section begins here.

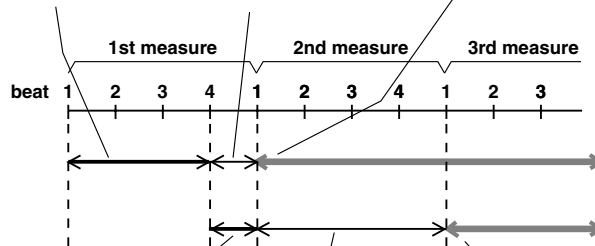

If you press the [MAIN/AUTO FILL] button here, after beat 4...

...a fill-in pattern plays from here...

...and the Main A or B section begins here.

Adjusting the Style Volume

The playback volume of the style can be adjusted in the *Function mode* (page 67). This volume control affects only the Style volume. The volume range is 000 - 127.



- Style Volume cannot be changed unless the Style mode is active.

Chord Name/[Abbreviation]	Normal Voicing	Chord (C)	Display
Major [M]	1 - 3 - 5	C	C
Add ninth [(9)]	1 - 2 - 3 - 5	C(9)	C(9)
Sixth [6]	1 - (3) - 5 - 6	C6	C6
Sixth ninth [6(9)]	1 - 2 - 3 - (5) - 6	C6(9)	C6(9)
Major seventh [M7]	1 - 3 - (5) - 7 or 1 - (3) - 5 - 7	CM7	CM7
Major seventh ninth [M7(9)]	1 - 2 - 3 - (5) - 7	CM7(9)	CM7(9)
Major seventh add sharp eleventh [M7(#11)]	1 - (2) - 3 - #4 - 5 - 7 or 1 - 2 - 3 - #4 - (5) - 7	CM7(#11)	CM7(#11)
Flatted fifth [(b5)]	1 - 3 - b5	C(b5)	Cb5
Major seventh flatted fifth [M7b5]	1 - 3 - b5 - 7	CM7b5	CM7b5
Suspended fourth [sus4]	1 - 4 - 5	Csus4	Csus4
Augmented [aug]	1 - 3 - #5	Caug	Caug
Major seventh augmented [M7aug]	1 - (3) - #5 - 7	CM7aug	CM7aug
Minor [m]	1 - b3 - 5	Cm	Cm
Minor add ninth [m(9)]	1 - 2 - b3 - 5	Cm(9)	Cm(9)
Minor sixth [m6]	1 - b3 - 5 - 6	Cm6	Cm6
Minor seventh [m7]	1 - b3 - (5) - b7	Cm7	Cm7
Minor seventh ninth [m7(9)]	1 - 2 - b3 - (5) - b7	Cm7(9)	Cm7(9)
Minor seventh add eleventh [m7(11)]	1 - (2) - b3 - 4 - 5 - (b7)	Cm7(11)	Cm7(11)
Minor major seventh [mM7]	1 - b3 - (5) - 7	CmM7	CmM7
Minor major seventh ninth [mM7(9)]	1 - 2 - b3 - (5) - 7	CmM7(9)	CmM7(9)
Minor seventh flatted fifth [m7b5]	1 - b3 - b5 - b7	Cm7b5	Cm7b5
Minor major seventh flatted fifth [mM7b5]	1 - b3 - b5 - 7	CmM7b5	CmM7b5
Diminished [dim]	1 - b3 - b5	Cdim	Cdim
Diminished seventh [dim7]	1 - b3 - b5 - 6	Cdim7	Cdim7
Seventh [7]	1 - 3 - (5) - b7 or 1 - (3) - 5 - b7	C7	C7
Seventh flatted ninth [7(b9)]	1 - b2 - 3 - (5) - b7	C7(b9)	C7(b9)
Seventh add flatted thirteenth [7(b13)]	1 - 3 - 5 - b6 - b7	C7(b13)	C7(b13)
Seventh ninth [7(9)]	1 - 2 - 3 - (5) - b7	C7(9)	C7(9)
Seventh add sharp eleventh [7(#11)]	1 - (2) - 3 - #4 - 5 - b7 or 1 - 2 - 3 - #4 - (5) - b7	C7(#11)	C7(#11)
Seventh add thirteenth [7(13)]	1 - 3 - (5) - 6 - b7	C7(13)	C7(13)
Seventh sharp ninth [7(#9)]	1 - #2 - 3 - (5) - b7	C7(#9)	C7(#9)
Seventh flatted fifth [7b5]	1 - 3 - b5 - b7	C7b5	C7b5
Seventh augmented [7aug]	1 - 3 - #5 - b7	C7aug	C7aug
Seventh suspended fourth [7sus4]	1 - 4 - (5) - b7	C7sus4	C7sus4
One plus two plus five [1+2+5]	1 - 2 - 5	C1+2+5	C

NOTE

- Notes in parentheses can be omitted.
- Playing two same root keys in the adjacent octaves produces accompaniment based only on the root.
- A perfect fifth (1 + 5) produces accompaniment based only on the root and fifth which can be used with both major and minor chords.
- The chord fingerings listed are all in "root" position, but other inversions can be used — with the following exceptions:
m7, m7b5, 6, m6, sus4, aug, dim7, 7b5, 6(9), 1+2+5.
- Inversion of the 7sus4 and m7(11) chords are not recognized if the notes shown in parentheses are omitted.
- The auto accompaniment will sometimes not change when related chords are played in sequence (e.g. some minor chords followed by the minor seventh).
- Two-note fingerings will produce a chord based on the previously played chord.

Selecting and Playing Styles

Dictionary

The Dictionary function is essentially a built-in “chord book” that shows you the individual notes of chords. It is ideal when you know the name of a certain chord and want to quickly learn how to play it.

1 Press the [Dict.] button.

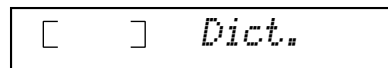

NOTE

- Make sure to turn on the Light Guide function when using the Dictionary function.

2 Specify the root of the chord.

Press the key on the keyboard that corresponds to the desired chord root (as printed on the panel).

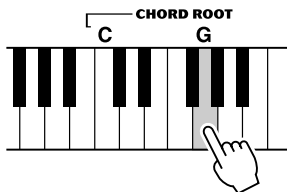

Pressing this key selects the root G.

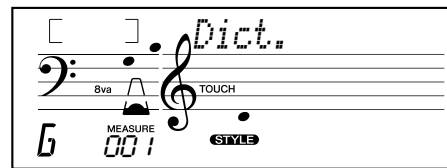

3 Specify the type of the chord (major, minor, seventh, etc.).

Press the key on the keyboard that corresponds to the desired chord type (as printed on the panel).

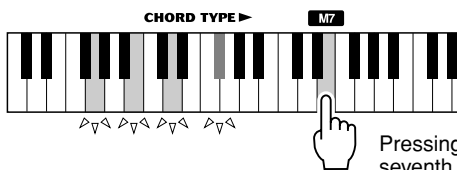

Pressing this key selects the major seventh chord type (M7).

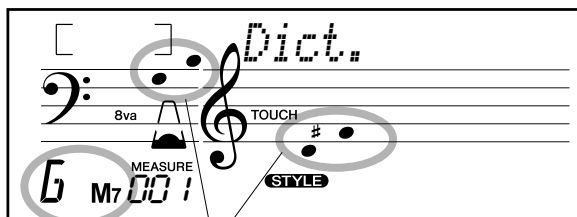

Notation of chord
Chord name (root and type)

NOTE

- For a few specific chords, not all notes may be shown in the notation section of the display. This is due to space limitations in the display.
- You can also show the inversion of chord when using [+]/[-] button.

4 Play the chord.

Play the chord by pressing the keys that light in the ACMP area of the keyboard. The chord name flashes in the display when the correct notes are held down. (Inversions for many of the chords are also recognized.)

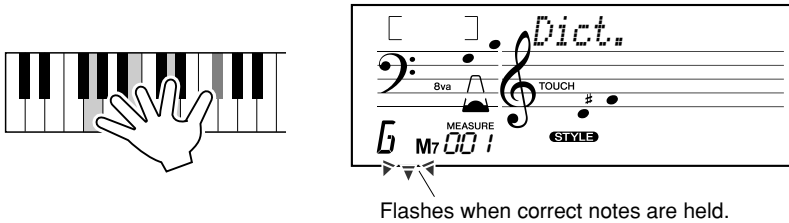

To leave the Dictionary function, press the [Dict.] button again.

..... What is a Chord?

The simple answer: Three or more notes played simultaneously is a chord. (Two notes played together is an “interval” — an interval being the distance between two different notes. This is also referred to as a “harmony.”) Depending on the intervals between the three or more notes, a chord can sound beautiful or muddy and dissonant.

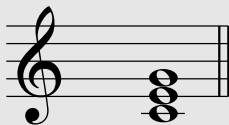

The organization of notes in the example at left — a triad chord — produces a pleasant, harmonious sound. Triads are made up of three notes and are the most basic and common chords in most music.

In this triad, the lowest note is the “root.” The root is the most important note in the chord, because it anchors the sound harmonically by determining its “key” and forms the basis for how we hear the other notes of the chord.

The second note of this chord is four semitones higher than the first, and the third is three semitones higher than the second. Keeping our root note fixed and changing these notes by a semitone up or down (sharp or flat), we can create four different chords.

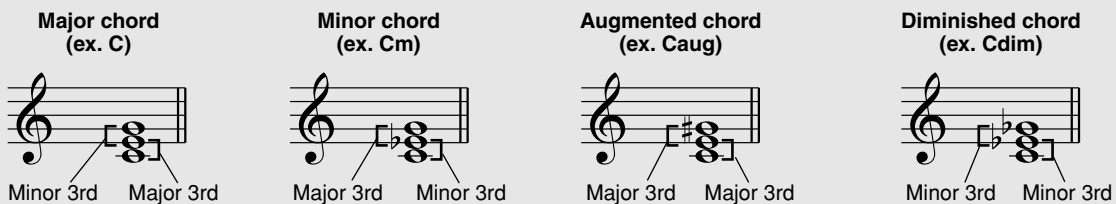

Keep in mind that we can also change the “voicing” of a chord — for example, change the order of the notes (called “inversions”), or play the same notes in different octaves — without changing the basic nature of the chord itself.

Inversion examples for the key of C



Selecting and Playing Styles

Beautiful sounding harmonies can be built in this manner. The use of intervals and chords is one of the most important elements in music. A wide variety of emotions and feelings can be created depending on the types of chords used and the order in which they are arranged.

..... Writing Chord Names

Knowing how to read and write chord names is an easy yet invaluable skill. Chords are often written in a kind of shorthand that makes them instantly recognizable (and gives you the freedom to play them with the voicing or inversion that you prefer). Once you understand the basic principles of harmony and chords, it's very simple to use this shorthand to write out the chords of a song.

First, write the root note of the chord in an uppercase letter. If you need to specify sharp or flat, indicate that to the right of the root. The chord type should be indicated to the right as well. Examples for the key of C are shown below.

Major chord	Minor chord	Augmented chord	Diminished chord
C	Cm	Caug	Cdim

For simple major chords, the type is omitted.

One important point: Chords are made up of notes “stacked” on top of each other, and the stacked notes are indicated in the chord name of the chord type as a number — the number being the distance of the note from the root. (See the keyboard diagram below.) For example, the minor 6th chord includes the 6th note of the scale, the major 7th chord has the 7th note of the scale, etc.

The Intervals of the Scale

To better understand the intervals and the numbers used to represent them in the chord name, study this diagram of the C major scale:

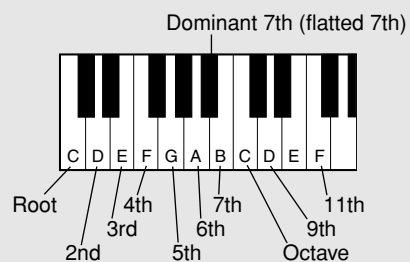

Other Chords

Csus4 5th 4th	C7 Dominant 7th Major chord	Cm7 Dominant 7th Minor chord	CM7 7th Major chord
Cm7b5 Dominant 7th Diminished chord	Cm6 Minor chord 6th	C(9) 9th	Cdim7 Diminished 7th (double flatted 7th) Diminished chord

* Bbb = A



Selecting and Playing Songs

The Song mode features 80 special songs that have been created using the rich and dynamic sounds of the EZ-250i.

The songs are generally for your listening enjoyment; however, you can also play along with them on the keyboard. The songs of the EZ-250i can also be used with the powerful Lesson feature (page 49), a convenient tool that makes learning songs fun and easy.

You can also transfer song data from your computer to the EZ-250i for playback. For details, see page 58.

Selecting a Song

1 Press the [SONG] button.

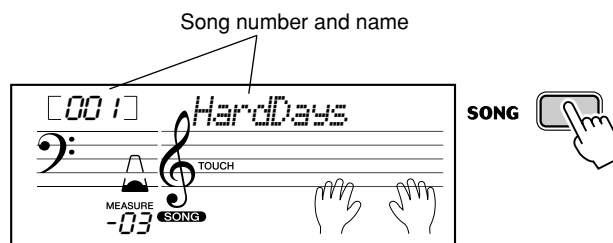

2 Select the desired song number.

The categories of each song and their numbers are shown on the panel. A complete list of the available songs is given on page 15.

SONG

FAVORITES

- 001 A Hard Day's Night
- 002 Can't Help Falling In Love
- 003 Linus And Lucy
- 004 Just The Way You Are
- 005 Against All Odds

- 006 Englishman In New York
- 007 Hey Jude
- 008 The Look Of Love
- 009 Stella By Starlight
- 010 Edelweiss

- 011~020 PIANIST
- 021~045 PRACTICE
- 046~050 DUET
- 051~080 CHORD LESSON
- 081~ FLASH MEMORY

■ Use the numeric keypad.

Song numbers can be selected in the same way as with the voices (page 19). You can use the numeric keypad to directly enter the song number, or use the [+]/[-] buttons to step up and down through the song.

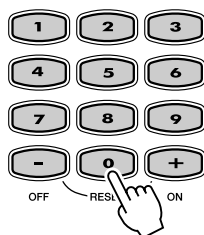

Playing the Songs

The Panel buttons below function as Song controls.

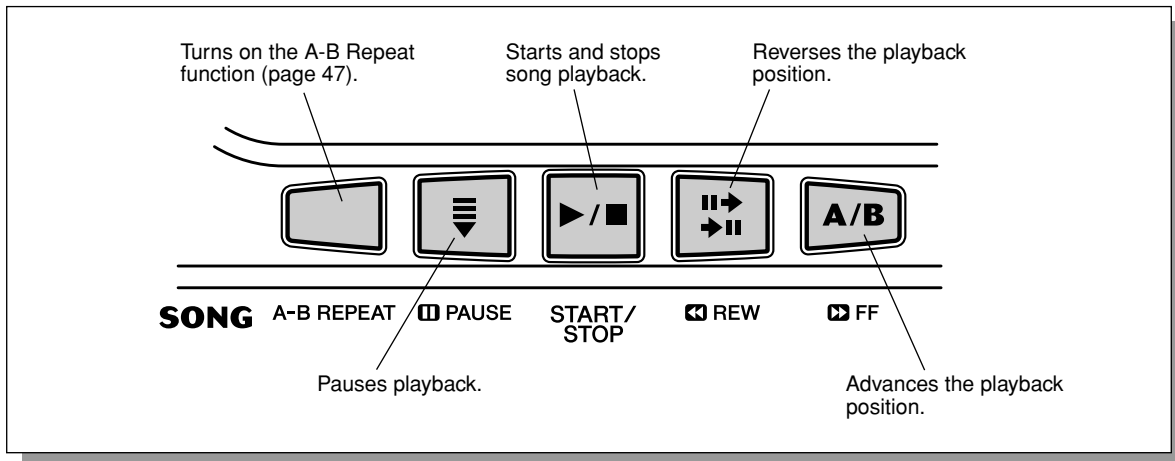

1 Start the selected song.

Press the [START/STOP] button. As the song plays back, the measure number and playing keys are shown in the display.

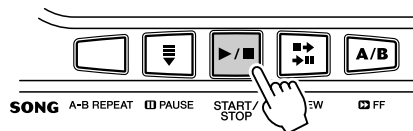

NOTE

- You can play along with the song using the currently selected voice, or even select a different voice for playing along. Simply call up the Voice mode while the song is playing back and select the desired voice. (See page 23.)

2 Stop the song.

Press the [START/STOP] button. If playback was started by pressing the [START/STOP] button, the selected song stops automatically.

Playing the Flash Memory Song

The EZ-250i can play a song loaded into its internal flash memory. To do this, you'll need to connect the EZ-250i to a personal computer, and use the "Song Filer" software to transmit the song from the computer. For more information on Flash songs and Song Filer, refer to page 58.

Select the song number 081-180 using numeric keypad in the same way as preset songs.

A-B Repeat

The convenient A-B Repeat function is an ideal aid for practicing and learning. It allows you to specify a phrase of a song (between point A and point B) and repeat it — while you play or practice along with it.

1 While playing a song, set point A (the start point).

During playback, press the [A-B REPEAT] button once, at the beginning point to be repeated.

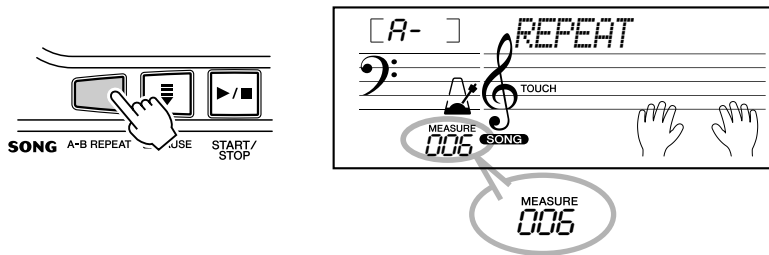

NOTE

- The A and B points can only be specified at the beginning of a measure (beat 1), and not at any point in the middle of a measure.
- To set the A point to the beginning of a song, press the [A-B REPEAT] button before starting playback.

2 Set point B (the end point).

As the song continues playing, press the [A-B REPEAT] button once again, at the ending point to be repeated. The selected phrase repeats indefinitely until stopped.

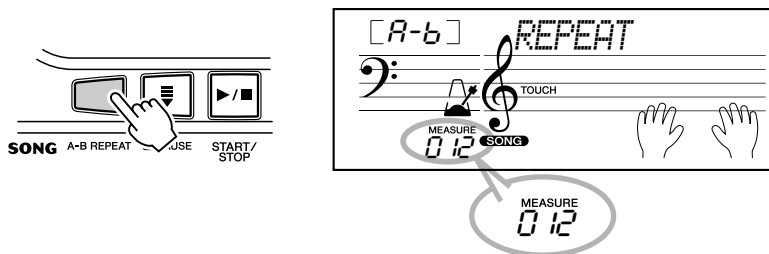

HINT

- If you're repeat practicing a particularly difficult section, try slowing down the Tempo to an appropriate speed to make it easier to play and master the part. You may also want to slow down the Tempo while setting the A and B points; this makes it easier to accurately set the points.
- You can also set the A-B Repeat function when the song is stopped. Simply use the [REW] and [FF] buttons to select the desired measures, pressing the [A-B REPEAT] button for each point, then start playback.

3 Pause or stop playback as needed.

Use the [PAUSE] button or [START/STOP] button. Stopping playback does not cancel the set A/B points or the A-B Repeat function.

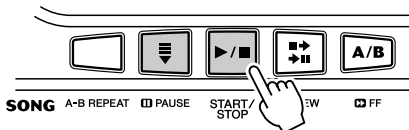

4 Turn off the A-B Repeat function.

Press the [A-B REPEAT] button.

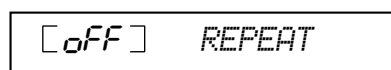

Melody Voice Change

The EZ-250i lets you play a melody on the keyboard along with each of the songs, either with the original melody voice or one of your own selection. The convenient Melody Voice Change feature takes this one step further — it lets you replace the original voice used for the melody of the song with the panel voice of your own selection. For example, if the current voice selected on the panel is piano but the song's melody is being played by a flute voice, using Melody Voice Change will change the flute melody voice to piano.

1 Select the desired song.

Press the [SONG] button, then use the numeric keypad or [+]/[-] buttons to select the desired song. (See page 45.)

2 Select the desired voice.

Press the [VOICE] button, then use the numeric keypad or [+]/[-] buttons to select the desired voice. (See page 23.)

3 Press and hold down the [VOICE] button for at least one second.

“MELODY VOICE CHANGE” appears in the display, indicating that the selected panel voice has replaced the song's original melody voice.

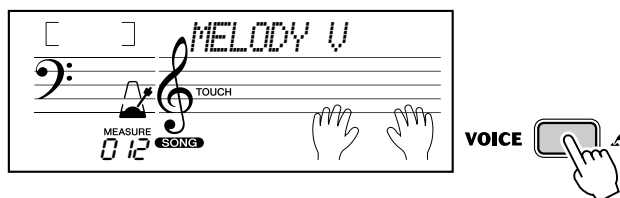

NOTE

- Playing a voice which is selected by the melody voice change may differ from the original voice, since the voice is added as an effect for the selected song.

Adjusting the Song Volume

The playback volume of the song can be adjusted in the *Function mode* (page 67). This volume control affects only the Song volume. The volume range is 000 - 127.

NOTE

- Song Volume cannot be changed unless the Song mode is active. (This function becomes Style Volume when the Style mode is active.)



Song Lesson

The Lesson feature provides an exceptionally fun and easy-to-use way to learn how to play the keyboard. Lesson lets you practice the left- and right-hand parts of each song independently, step by step, until you've mastered them and are ready to practice with both hands together. These practices are divided into four Lesson steps, as described below. Lessons 1 - 3 apply to each hand; press the appropriate button, L (left) or R (right) to select the desired part for practice. Try practicing with the Lessons, following the Light Guide.

■ Lesson 1 — Timing

This lesson step lets you practice just the timing of the notes — any note can be used, as long as you play in rhythm.

■ Lesson 2 — Waiting

In this lesson step, the EZ-250i waits for you to play the correct notes before continuing playback of the song.

■ Lesson 3 — Minus One

This lesson step plays back the song with one part muted, letting you play and master the missing part (following the Light Guide) yourself — in rhythm and at the proper tempo.

■ Lesson 4 — Both Hands

Lesson 4 is a “Minus One” practice essentially the same as Lesson 3, except that both the left- and right-hand parts are muted — letting you play and master both hands at the same time.

Using the Lesson Feature

1 Select one of the Lesson songs.

Press the [SONG] button, then use the numeric keypad or [+] / [-] buttons to select the desired song.

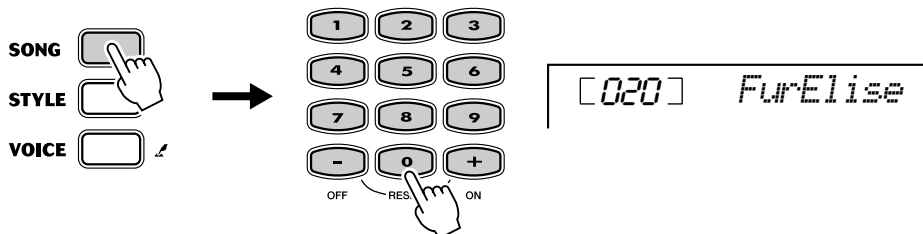

2 Select the part you wish to work on (left or right) and the Lesson step.

If you want to work on the right-hand part, press the [R] button; to work on the left, press the [L] button. Pressing either button repeatedly cycles through the available Lesson steps in order: Lesson 1 → Lesson 2 → Lesson 3 → Off → Lesson 1, etc. The selected Lesson step is indicated in the display.

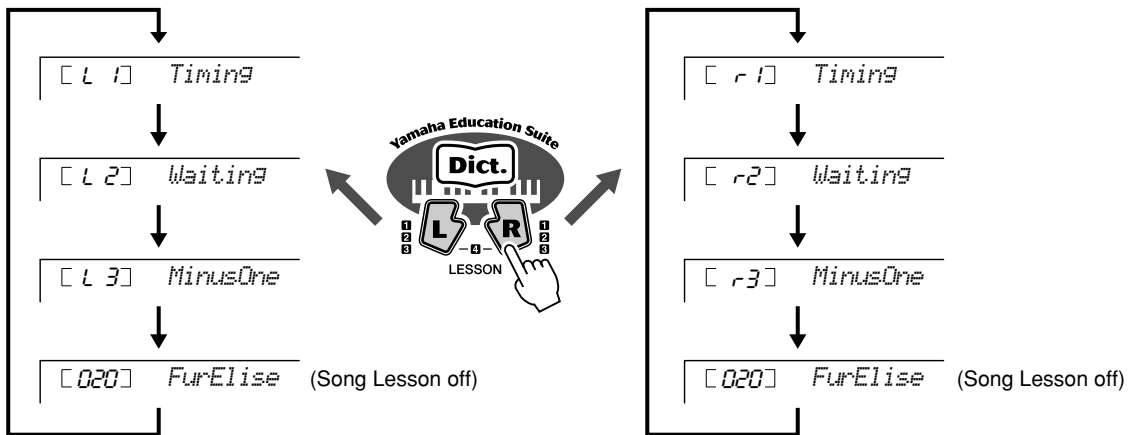

To select Lesson 4, press both [L] and [R] buttons simultaneously.

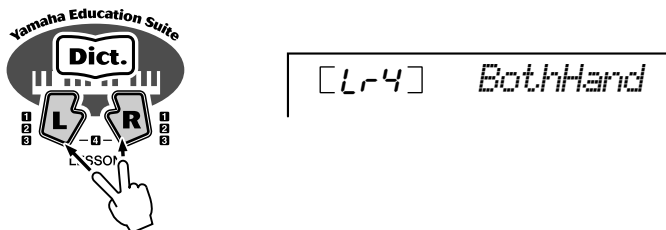

3 Start the Lesson.

The Lesson and song playback start automatically (following a lead-in count) as soon as the Lesson step is selected. When the Lesson is finished, your performance “grade” is shown in the display. After a short pause, the Lesson begins again automatically.

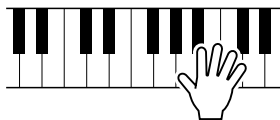

4 Press the [START/STOP] button to stop the Lesson.

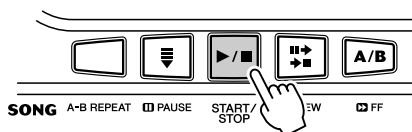

The EZ-250i exits from the Lesson feature automatically when the [START/STOP] button is pressed.

Select the Lesson Track

This function allows you to select the track number of a loaded song from computer (only SMF format 0).

The track number of the song can be specified in the Function mode (page 67)

Lesson 1 — Timing

This lesson step lets you practice just the timing of the notes — any note can be used, as long as you play in rhythm. Pick a note to play. For the left hand, use a note in the auto accompaniment area or play the appropriate left-hand note; for the right, play a note above F#2. Simply concentrate on playing each note in time with the rhythmic accompaniment.

NOTE

- The melody note does not sound unless your playing is in time with the rhythm.
- Make sure to turn on the Light Guide function when using the Lesson.

1 Select one of the Lesson songs.

2 Select Lesson 1.

Press the [L] or [R] button (repeatedly, if necessary) until Lesson 1 is indicated.

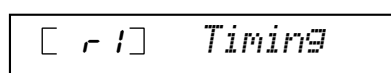

3 Play the appropriate melody or chord with the song.

After the lead-in, the song starts automatically, and the appropriate notes appear in the display. In Lesson 1, simply play one note repeatedly in time with the music.

Regarding chords and the use of the left hand, the EZ-250i actually has two different types of songs: 1) songs with normal left-hand chords, and 2) songs in which the left hand plays arpeggios or melodic figures in combination with the right.

In the case of the first type, play the chords with your left hand in the auto accompaniment area of the keyboard.

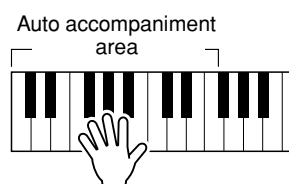

Lesson 2 — Waiting

In this lesson step, the EZ-250i waits for you to play the correct notes before continuing playback of the song. This lets you practice reading the music at your own pace. The notes to be played are shown in the display, one after another, as you play them correctly. The Light Guide shows you which keys to play.

NOTE

- Make sure to turn on the Light Guide function when using the Lesson.

1 Select one of the Lesson songs.

2 Select Lesson 2.

Press the [L] or [R] button (repeatedly, if necessary) until Lesson 2 is indicated.



[r2] Waiting

NOTE

- Depending on the selected song, the rhythm part may be muted for Lesson 2.

3 Play the appropriate melody or chord with the song.

After the lead-in, the song starts automatically, and the Light Guide shows you which keys to play. In Lesson 2, play the correct notes at your own pace, until you can master playing them in rhythm.

Lesson 3 — Minus One

This lesson step lets you practice one part of the song in rhythm at the proper tempo. The EZ-250i plays back the song with one part muted (either the left part or the right)—letting you play and master the missing part yourself. The notes you are to play are shown continuously in the display and Light Guide as the song plays back.

1 Select one of the Lesson songs.

2 Select Lesson 3.

Press the [L] or [R] button (repeatedly, if necessary) until Lesson 3 is indicated.



[r3] MinusOne

3 Play the appropriate part with the song.

After the lead-in, the song starts automatically, and the Light Guide shows you which keys to play. In Lesson 3, listen carefully to the un-muted part, and play the muted part yourself.

Lesson 4 — Both Hands

Lesson 4 is a “Minus One” practice essentially the same as Lesson 3, except that both the left- and right-hand parts are muted — letting you play and master both hands at the same time. Go on to this lesson step after you’ve mastered each hand’s part in the previous three lesson steps. Practice both hands in time with the rhythm along with the notation and Light Guide.

1 Select one of the Lesson songs.

2 Select Lesson 4.

Press the [L] and [R] buttons simultaneously, so that Lesson 4 is indicated.



[L-R] BothHand

3 Play both the left- and right-hand parts with the song.

After the lead-in, the song starts automatically, and the Light Guide shows you which keys to play. In Lesson 4, both parts (left and right) are muted, letting you play the entire song by yourself.

Grade

The Lesson feature has a built-in evaluation function that monitors your practicing of the Lesson songs, and just like a real teacher, it indicates how well you did each exercise. Four grades are assigned, depending on your performance: “Try Again,” “Good,” “Very Good!,” and “Excellent!”



MIDI Functions

Nearly all of the electronic musical instruments made today-particularly synthesizers, sequencers and computer music related devices-use MIDI. MIDI is a worldwide standard that allows these devices to send and receive performance and setting data. Naturally, this instrument lets you send your keyboard performance as MIDI data, as well as that of the styles and panel settings. The potential MIDI holds for your live performance and music creation/production is enormous-simply by connecting this instrument to a computer and transmitting MIDI data. In this section, you'll learn the basics of MIDI and the particular MIDI functions of this instrument.

What Is MIDI?

No doubt you have heard the terms "acoustic instrument" and "digital instrument." In the world today, these are the two main categories of instruments. Let's consider an acoustic piano and a classical guitar as representative acoustic instruments. They are easy to understand. With the piano, you strike a key, and a hammer inside hits some strings and plays a note. With the guitar, you directly pluck a string and the note sounds. But how does a digital instrument go about playing a note?

Acoustic guitar note production

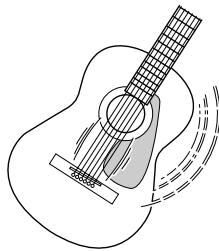

Pluck a string and the body resonates the sound.

Digital instrument note production

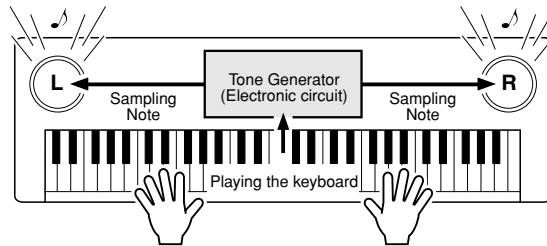

Based on playing information from the keyboard, a sampling note stored in the tone generator is played through the speakers.

As shown in the illustration above, in an electronic instrument the sampling note (previously recorded note) stored in the tone generator section (electronic circuit) is played based on information received from the keyboard. So then what is the information from the keyboard that becomes the basis for note production?

For example, let's say you play a "C" quarter note using the grand piano sound on the instrument. Unlike an acoustic instrument that puts out a resonated note, the electronic instrument puts out information from the keyboard such as "with what voice," "with which key," "about how strong," "when was it pressed," and "when was it released." Then each piece of information is changed into a number value and sent to the tone generator. Using these numbers as a basis, the tone generator plays the stored sampling note.

● Example of Keyboard Information

Voice number (with what voice)	01 (grand piano)
Note number (with which key)	60 (C3)
Note on (when was it pressed) and note off (when was it released)	Timing expressed numerically (quarter note)
Velocity (about how strong)	120 (strong)

Your keyboard performance and all panel operations of this instrument are processed as MIDI data. The auto accompaniment patterns (styles) are also made up of MIDI data. MIDI is an acronym that stands for Musical Instrument Digital Interface and it allows different musical instruments and devices to instantly communicate with each other, via digital data. The MIDI standard is used all over the world and was designed to transmit performance data between electronic musical instruments. (and computers). MIDI messages can be divided into two groups: Channel messages and System messages.

GM System Level 1

“GM System Level 1” is an addition to the MIDI standard which ensures that any GM-compatible music data can be accurately played by any GM-compatible tone generator, regardless of manufacturer. The GM mark is affixed to all software and hardware products that support GM System Level 1. The EZ-250i supports GM System Level 1.



● Channel Messages

This instrument is capable of handling 16 MIDI channels simultaneously—meaning it can play up to sixteen different instruments at the same time. Channel messages transmit information such as Note ON/OFF, Program Change, for each of the 16 channels.

Message Name	EZ-250i Operation/Panel Setting
Note ON/OFF	Messages which are generated when the keyboard is played. Each message includes a specific note number which corresponds to the key which is pressed, plus a velocity value based on how hard the key is struck.
Program Change	Voice number (along with corresponding bank select MSB/LSB settings, if necessary).
Control Change	Messages that are used to change some aspect of the sound (volume, etc.).

● System Messages

This is data that is used in common by the entire MIDI system. System messages include messages like Exclusive Messages that transmit data unique to each instrument manufacturer and Realtime Messages that control the MIDI device.

Message Name	EZ-250i Operation/Panel Setting
Exclusive Message	Reverb setting, etc.
Realtime Messages	Clock, Start/stop operations

The messages transmitted/received by the EZ-250i are shown in the MIDI Implementation Chart on page 78.

Connecting to a Personal Computer

Connecting this instrument to a computer enables a wide range of powerful and useful musical possibilities. You can transfer MIDI data back and forth with your computer for music recording/playback, and with the special Song Filer software (contained in the included CD-ROM), you can copy data from your computer to memory card.

Connect one end of a USB cable to the USB terminal on the rear panel of this instrument to the USB terminal on your computer. You'll also need to install the USB-MIDI driver (also in the included CD-ROM) to your computer. For details, see the "CD-ROM Installation Guide".

NOTE

Viewing the Notation for MIDI Channel 1

- The EZ-250i has a special function that lets you view the notes of the MIDI data (channel 1 only) on the display.

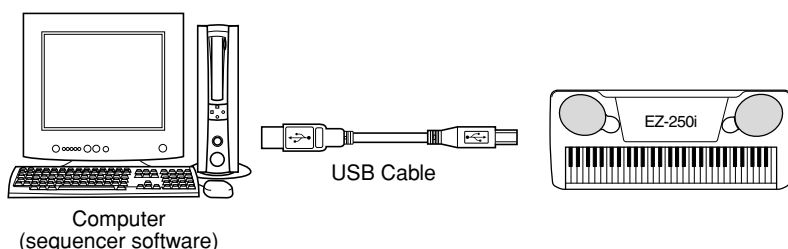

MIDI LSB Receive Cancel

Determines whether the LSB data of Bank Select is received or not. Press and hold the lowest key and turn on the power to change the setting (LSB is ignored).

To restore MIDI LSB Receive Cancel to normal (LSB is recognized), turn on the power again normally.

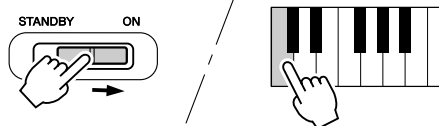

Local Control

This function lets you enable or disable keyboard control over the EZ-250i's voices in the *Function mode* (page 67). This would come in handy, for example, when recording notes to MIDI sequencer. If you are using the sequencer to play back the voices of the EZ-250i, you would want to set this to “off” — in order to avoid getting “double” notes, both from the keyboard and from the sequencer. Normally, when playing the EZ-250i by itself, this should be set to “on.”

CAUTION

- No sound is output from the EZ-250i when Local ON/OFF is set to OFF.

External Clock

This determines whether the style and song playback functions are controlled by the PortaTone's internal clock (off) or by MIDI clock data from an external sequencer or computer (on).

This should be set to on when you want to have style or song playback follow the external device (such as a rhythm machine or a sequencer). The default setting is off.

These settings can be made in the Function mode (page 67).

CAUTION

- If External Clock is set to ON, style or song playback will not start unless external clock are received.

Using Initial Setup Send with a Sequencer

The most common use for the Initial Setup Send function is in recording a song on a sequencer that is intended for playback with the EZ-250i. Essentially, this takes a “snapshot” of the EZ-250i settings and sends that data to the sequencer. By recording this “snapshot” at the start of the song (before any actual performance data), you can instantly restore the necessary settings on the EZ-250i in the *Function mode* (page 67). Provided there is a pause in the song, you could also do this in the middle of a song — for example, completely changing the EZ-250i settings for the next section of the song.

NOTE

- When the Initial Setup Send operation is completed, the EZ-250i automatically returns to the previous panel condition.

PC Mode

The PC Mode lets you instantly reconfigure the MIDI control settings for use with a computer or MIDI device.

	PC mode is on	PC mode is off
LOCAL ON/OFF	OFF	ON

CAUTION

- No sound is output from the EZ-250i when Local ON/OFF is set to OFF.

NOTE

- A "Can't Set" message appears in the display when the USB terminal is not connected to another device.

■ To turn the PC mode on or off:

Press the [PC] button and then press the appropriate [+]/[-] button. This switches between the PC Mode on/off settings.

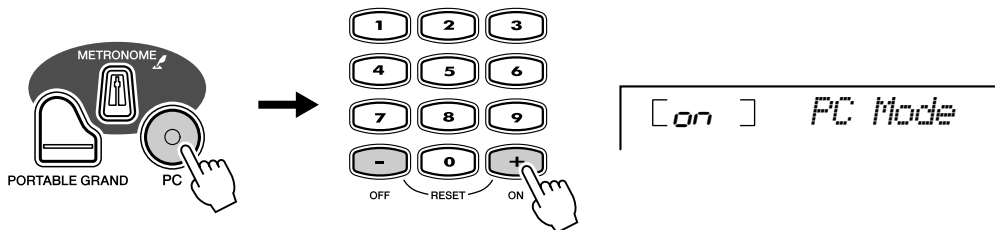

Loading a Song into EZ-250i's Flash Memory

The EZ-250i's internal flash memory enables you to save song data transmitted from a connected personal computer. You can play or practice Flash songs (saved in flash memory) in the same way as preset songs.

To transmit song data from a personal computer to the EZ-250i, you first need to install the "Song Filer" application to your computer.

Song data that can be saved in flash memory:

- The number of songs: max. 100 songs (Song #081–#180)
- Available memory: 448 KB
- Data format: SMF format 0

The total number of songs that can be loaded will depend on the data size of the songs. As an example, about 20, 20-kilobyte songs can be loaded.

■ Installing Song Filer

You can install the "Song Filer" application from the included CD-ROM (see page 60).

NOTE

- Visit the Yamaha PK CLUB website for more information on the latest version of Song Filer (version 2.0.0 or higher) and how to install it.

Yamaha PK CLUB (Portable Keyboard Home Page)
<http://www.yamahaPKclub.com/>

System requirements for Song Filer:

[Windows]

OS: Windows 95/98/Me/2000/XP
 CPU: Pentium/100MHz or faster
 Available Memory: 8MB or more
 Free space in Hard Disk: 2MB or more
 Display: 800 x 600, 256 colors or more

[Macintosh]

OS: Mac OS 7.5 through 9.2.2
 (OSX and Mac Classic environments are not supported)
 CPU: Power PC or upper
 Available Memory: 8MB or more
 Free space in Hard Disk: 2MB or more
 Display: 800 x 600, 256 colors or more

■ Song Filer

After you install Song Filer and connect the EZ-250i to the computer, you can use the two functions described below.

● Transmit Files

You can transmit song files from your computer to your EZ-250i's Flash Memory.

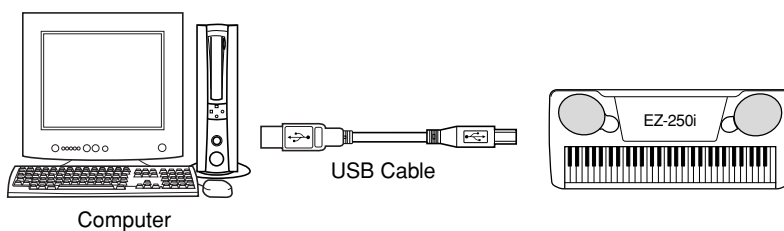

● Manage Files on Flash Memory

You can delete and rename files in your EZ-250i's Flash Memory from your computer.

NOTE

- Refer to page 56 for information on connecting the EZ-250i to a computer.
- You cannot use the Song Filer's "Receive Files" function with the EZ-250i.
- For more information on using Song Filer, refer to the PDF manual included in the Song Filer application.

CAUTION

- Never attempt to turn the power off while transmitting song data. Doing so will not only result in failure to save the data, but also make the internal flash memory unstable. It may also clear all the data residing in the flash memory when turning the power on and off.
- Saved data in the instrument may be lost due to malfunction or incorrect operation. Retain important data to your computer or floppy disk.

Selecting a right & left hand guide track

You can select a track in the *Function mode* (page 67) to guide your right and left hand fingering during the Lesson (page 51).

This function is available only when you select a flash memory song (SMF format 0).



Accessory CD-ROM Installation Guide

SPECIAL NOTICES

- The software and this Installation Guide are exclusive copyrights of Yamaha Corporation.
- Use of the software and this guide is governed by the SOFTWARE LICENSING AGREEMENT which the purchaser fully agrees to upon breaking the seal of the software packaging. (Please read carefully the AGREEMENT on pages 3 and 65 before installing the application.)
- Copying of the software or reproduction of this guide in whole or in part by any means is expressly forbidden without the written consent of the manufacturer.
- Yamaha makes no representations or warranties with regard to the use of the software and documentation and cannot be held responsible for the results of the use of this guide and the software.
- This disc is a CD-ROM. Do not attempt to play the disc on an audio CD player. Doing so may result in irreparable damage to your audio CD player.
- Copying of the commercially available music data is strictly prohibited except for your personal use.
- The company names and product names in this Installation Guide are the trademarks or registered trademarks of their respective companies.
- Future upgrades of application and system software and any changes in specifications and functions will be announced separately.
- Depending on the version of your operating system, the screen shots and messages shown in this guide may differ to those that you see on your computer screen.

Contents of CD-ROM

The applications in this CD-ROM are provided in versions for both Windows and Macintosh operating systems. The installation procedure and the applications themselves differ depending on the operating system that you are using.

CAUTION

- *Never attempt to play back the included CD-ROM on an audio CD player. Doing so may result in damage to your hearing as well as to your CD player/audio speakers.*

For Windows

Application/Data Name	Folder Name	Contents
Song Filer ^{*1 *2}	SongFiler	Enables control/organization of the instrument's song data on the computer.
USB Driver for Windows 98/Me	USBdrv_	Enables communication between the MIDI instrument and your computer via a USB connection (for the indicated version of Windows).
USB Driver for Windows 2000/XP	USBdrv2k_	
YMIA Introduction HTML	SampleSongs	Enables you to take advantage (via the Internet) of the most up to date music software and tools, enhancing your MIDI instrument experience.
Acrobat Reader ^{*2 *3}	Acroread_	PDF (Portable Document Format) viewer. Enables you to view each PDF manual for the applications.
KEYBOARDMANIA	KMYE	Enables playing the game or lesson.

For Macintosh

Application/Data Name	Folder Name	Contents
Song Filer ^{*1 *2}	SongFiler	Enables control/organization of the instrument's song data on the computer.
Open Music System (OMS) ^{*2}	OMS_	Enables you to use several MIDI applications on the Mac OS.
OMS Setup for YAMAHA ^{*2}		Contains the OMS setup files for the Yamaha MIDI instrument.
USB Driver	USBdrv_	Enables your computer to communicate with the MIDI instrument when your computer and the MIDI instrument are connected using a USB cable.
YMIA Introduction HTML	SampleSongs	Enables you to take advantage (via the Internet) of the most up to date music software and tools, enhancing your MIDI instrument experience.
Acrobat Reader ^{*2 *3}	Acroread_	PDF (Portable Document Format) viewer. Enables you to view each PDF manual for the applications.

*1 Song Filer cannot be used with the instrument when the instrument is in one of the following conditions. • Demo song mode

*2 The applications are supplied with online/PDF manuals.

*3 Unfortunately, Yamaha makes no guarantee concerning the stability of these programs nor can it offer user support for them.

CD-ROM Installation Procedure

The following steps are the same for both Windows and Macintosh.

- 1 Verify that your system meets the operating requirements of the software (Song Filer, driver, etc.)
See the Minimum System Requirements.
- 2 Insert the CD-ROM to your computer.
- 3 Click the "cancel" dialog in initial display (Windows only).
- 4 Connect the instrument to your computer.
Refer to page 56 for details on connections.
- 7 Install the software (KEYBOARDMANIA (Windows only), Song Filer, etc.).
Acrobat Reader/YAMAHA USB MIDI Driver:
See page 61 (Windows) or page 63 (Macintosh).
- 8 Insert the CD-ROM.
- 9 Click the "install" dialog of KEYBOARDMANIA or Song Filer (Windows only). Refer to "Installing Song Filer" for Macintosh on page 64

NOTE

- Depending on the computer system you are using, some types of connections may not be possible.

- 5 Install the appropriate driver to your computer, and make the necessary settings.
See page 61 (Windows) or page 63 (Macintosh).

- 6 Eject the CD-ROM.
EZ-250i Owner's Manual

For subsequent operations, refer to the owner's manual for each software program (online help/PDF manual).

NOTE

- In order to view PDF files, you will need to install Acrobat Reader in your computer.
See page 61 (Windows) or page 63 (Macintosh).

Minimum System Requirements

For Windows

Data Name	OS	CPU	Memory	Hard Disk	Display	Other
Song Filer	Windows 95/98/98SE/Me/2000/XP Home Edition/XP Professional	100 MHz or higher; Intel® Pentium®/Celeron® processor family	8 MB or more	2 MB or more	800 x 600, 256 colors or more	—
USB Driver for Windows 98/Me	Windows 98/98SE/Me	166 MHz or higher; Intel® Pentium®/Celeron® processor family	32 MB or more		—	—
USB Driver for Windows 2000/XP	Windows 2000/XP Home Edition/XP Professional		32 MB or more		—	—
KEYBOARDMANIA	Windows 98/Me/2000/XP Home Edition/XP Professional	266 MHz or higher; Pentium®/Celeron®	32 MB or more	500 MB or more	640 x 480 High Color (16bit)	—

For Macintosh

Data Name	OS	CPU	Memory	Hard Disk	Display	Other
Song Filer	Mac OS 7.5 through OS 9.22 (The Mac OS X and Mac Classic environments are not supported)	A Macintosh computer with a PowerPC or later CPU.	8 MB or more	2 MB or more	800 x 600, 256 colors or more	—
USB Driver	Mac OS 8.6 through OS 9.22 (The Mac OS X and Mac Classic environments are not supported)		64 MB or more (128 MB or more is recommended)		—	OMS 2.3.3 or later (included in the CD-ROM in the package)

For Windows Users

■ Software Installation ●●●●●●●●●●

NOTE

- For details about the application software which has no installation guide described below, refer to the online manual of each software.

Uninstall (Removing the installed application)

You can remove the installed application software.

Windows 98/ME

Select [START] → [Settings] → [Control Panel] → [Add/Remove Programs] → [Install/Uninstall], then select the application to be removed and click [Add/Remove...]. Follow the on-screen instructions to uninstall the application.

NOTE

- The button names or menus may differ depending on the computer OS.

Windows 2000/XP

Select [START] → [Control Panel] → [Add/Remove Programs], then select the application to be removed and click [Remove]. Follow the on-screen instructions to uninstall the application.

● Acrobat Reader

In order to view the electronic (PDF) manuals included with each application, you'll need to install Acrobat Reader.

NOTE

- If an older version of Acrobat Reader is installed on your PC, you'll need to uninstall it before proceeding.

- Double-click on the "Acroread_" folder. Four different language folders will be displayed.

- Select the language you want to use and double-click on its folder. The file "ar***.exe" file will be displayed. ("***" indicates the selected language.)
- Double-click on "ar***.exe". Acrobat Reader Setup Dialog box will be displayed.
- Execute the installation by following the on-screen directions.

After installation is complete, the Acrobat folder appears on your PC (in Program Files, as the default).

For information on using the Acrobat Reader, refer to the Reader Guide in the Help menu.

● USB MIDI Driver

To operate the MIDI instrument from your computer via USB, you'll need to install the appropriate driver software. The USB-MIDI driver is software that transfers MIDI data back and forth between sequence software and the MIDI instrument via a USB cable.

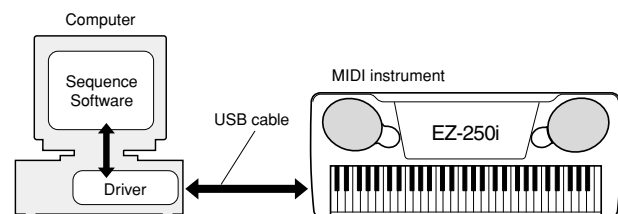

NOTE

- Before you install the USB MIDI driver, you can minimize the possibility of problems by putting your computer in the following state.
 - Close all applications and windows that you are not using.
 - Disconnect all cables from the MIDI instrument except for the cable whose driver you are installing.

Installation for Windows 98/Me/2000/XP

1 Start the computer.

For **Windows 2000/XP** execute the following steps after the computer is started.

In **Windows 2000**, use the “Administrator” account to log in, then select [My Computer] → [Control Panel] → [System] → [Hardware] → [Driver Signing] → [File Signature Verification]. Check the radio button next to “Ignore — Install all files, regardless of file signature,” then click “OK.”

In **Windows XP**, select [Start] → [Control Panel]. (If the control panel appears as shown below, click “Switch to Classic View” at the upper left of the window to display all Control Panel icons.) Next, go to [System] → [Hardware] → [Driver Signing] → [File Signature Verification] and check the radio button next to “Ignore — Install software, not want to check (I),” then click “OK.” Click “OK” to close System Properties, then close the Control Panel by clicking the close box [X] at the top right of the display.

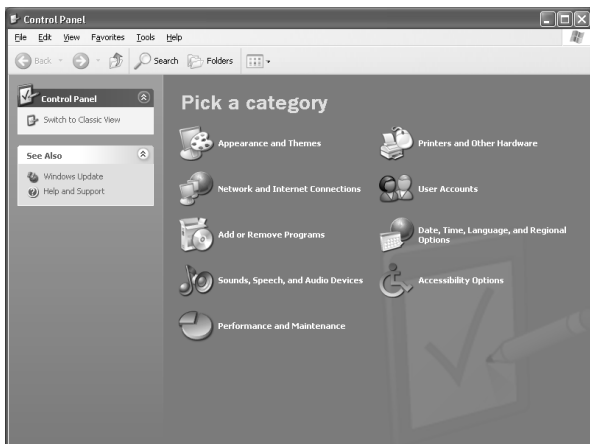

2 Insert the included CD-ROM in the CD-ROM drive and click the “Cancel” dialog on the display.

3 Check that the instrument is turned off, then connect the USB terminal of the computer to the USB terminal of the instrument with a standard USB cable. Turn on the instrument, and the message “Add New Hardware Wizard” (**Windows 98/Me/2000**) or “Found New Hardware Wizard” (**Windows XP**) automatically appears.

NOTE

- On some computers, it may take about ten seconds or so for this display to appear after the instrument is turned on.

In **Windows Me**, check the radio button next to “Automatic search for a better driver (Recommended)” of the Add New Hardware Wizard, then click [Next]. The system searches for the proper driver and installation starts automatically. Unless you are manually installing a driver, skip directly to **step 8** below. If a proper driver is not found, select “Specify the location of the driver (Advanced)” and specify the “USBdrv_” folder on the CD-ROM

In **Windows XP**, check the radio button next to “Install the software automatically (Recommended)” of the Found New Hardware Wizard, then click [Next]. The system searches for the proper driver and installation starts automatically. Unless you are manually installing a driver, skip directly to **step 8** below.

4 Click [Next].

From the window that appears, you can select the method of searching for the driver.

5 Check the radio button next to “Search for a suitable driver for your device. (Recommended),” then click [Next].

From this window, you can specify the location of the driver.

6 In **Windows 98**, check the “Specify a location” box, click “Browse..”, then specify the “USBdrv_” directory of the CD-ROM drive (such as D:\USBdrv_) and continue the installation. In **Windows 2000**, check “CD-ROM drive” and make sure all other items are unchecked.

Click [Next]. The system searches for the driver in the CD-ROM and prepares to install.

NOTE

- In some cases, the system may ask you to insert a Windows CD-ROM while it checks for the driver. If this happens, specify the “USBdrv_” directory of the CD-ROM drive (for example, D:\USBdrv_) in Windows 98, or the “USBdrv2k_” directory (for example, D:\USBdrv2k_) in Windows 2000, and continue the installation.

7 After confirming that “YAMAHA USB MIDI Driver” is shown in the driver search window, click [Next]. Installation starts.

NOTE

- The exact pathname or location of the driver may differ depending on the particular instrument and other variables.

8 When the installation is complete and a message appears to indicate completion, click [Finish].

NOTE

- On some computers, it may take about ten seconds or so for this message to appear after installation is complete.

In **Windows 2000/XP**, the computer is restarted.

The driver has been properly installed.

● Installing KEYBOARDMANIA or Song Filer

1 Insert the CD-ROM to your computer.

2 Click the “install” dialog of KEYBOARDMANIA or Song Filer.

For instructions and operation details of KEYBOARDMANIA, refer to the PDF manuals in the “manual” folder in the CD-ROM.

To view the documentation, you’ll need to:

Click [Cancel] to exit from the Install display.

Double-click [My Computer], then RIGHT-click on [CD-ROM].

Select [OPEN], then double-click [KMYE] and double-click [manual].

For instruction and operation detail of Song Filer, refer to the online help and PDF manual.

* For the latest version of Song Filer, go to the following website.

<http://www.yamahapclub.com/english/download/songfiler/songfiler.htm>

When using KEYBOARDMANIA, set the MIDI port to USB according to the instructions in the manual (see the file KM_manual.pdf, pages 7 and 8) contained in the CD-ROM. **When using Song Filer, follow the steps below to set the MIDI port to USB.**

1 Connect the instrument to your computer with a USB cable.

2 First, turn on your computer, then the instrument, and finally, start Song Filer.

3 Open the “MIDI Port Setting” from the Song Filer menu bar, and select “USB.”

For Macintosh Users

■ Software Installation •••••

● Acrobat Reader

In order to view the electronic (PDF) manuals included with each application, you'll need to install Acrobat Reader.

- 1 Double-click on the "Acroread_" folder.
Four different language folders will be displayed: English, German, French and Spanish.
- 2 Select the language you want to use and double-click on its folder.
"Reader Installer" will be displayed.
The Installer name may differ depending on the language you select.
- 3 Double-click on the "Reader Installer."
Acrobat Reader Setup Dialog will be displayed.
- 4 Execute the installation by following the directions appearing on the screen.
After installation is complete, the Acrobat folder appears on your computer (in Hard Disk, as the default).
For information on using the Acrobat Reader, refer to the Reader Guide in the Help menu.

● Open Music System (OMS)

OMS allows you to use several MIDI applications on the Mac OS at the same time.

- 1 Double-click on the "OMS_" folder (English version only).
"Install OMS *****" will be displayed.
- 2 Double-click on "Install OMS *****"
OMS Setup Dialog will be displayed.
- 3 Execute the installation by following the on-screen directions.
After the installation, select "Restart."

NOTE

• After the installation is complete, you may possibly encounter an error message warning that the installer did not close. In this case, go to the "File" menu and select "Quit" to close the installer. Then reboot the computer.

After restarting the Macintosh, you will find the "Opcode"/"OMS Applications" folder on your computer (Hard Disk, as the default).

- 4 Copy the "OMS_***_Mac.pdf" in the CD-ROM to the "OMS Applications" folder (drag-and-drop it to the folder).
Refer to the "OMS_***_Mac.pdf" (English version only) how to use the application.
- 5 Copy the "OMS Setup for YAMAHA" in the CD-ROM to the "OMS Applications" folder (drag-and-drop it to the folder).
In the "OMS Setup for YAMAHA" folder you will find the OMS Setup files for the Yamaha tone generators, which can be used as templates.

● USB MIDI Driver

To operate the MIDI instrument from your computer via USB, you'll need to install the appropriate driver software. The USB-MIDI driver is software that transfers MIDI data back and forth between sequence software and the MIDI instrument via a USB cable.

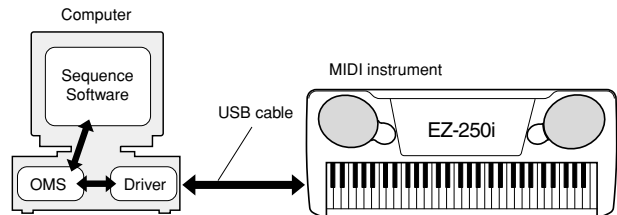

First install OMS before you install the USB-MIDI driver. Also, after installing the driver, you will need to set up OMS (see page 64).

- 1 Start the computer.
- 2 Insert the included CD-ROM into the CD-ROM drive. The system displays the CD-ROM icon on the desktop.
- 3 Double-click the CD-ROM icon and double-click the "Install USB Driver" icon in the "USBdrv_" folder to display the following installation screen.



- 4 The "Install Location" box displays the destination of the installation. If you wish to change the destination disk or folder, use the [Switch Disk] button and the pop-up menu to specify the desired destination.

NOTE

• This box usually displays the start-up disk as the destination.

- 5 Click the [Install] button. The system displays the following message: "This installation requires your computer to restart after installing this software. Click Continue to automatically quit all other running applications." Click [Continue].

NOTE

• To cancel the installation, click [Cancel].

Accessory CD-ROM Installation Guide

- 6 The installation starts. If the driver has already been installed, the following message appears. To return to step 3, press [Continue]. To complete the installation, click [Quit].



- 7 When the installation is complete, the system displays the following message: "Installation was successful. You have installed software which requires you to restart your computer." Click [Restart]. The computer automatically restarts. You can locate the installed files in the following locations:

- [System Folder] → [Control Panels] → [YAMAHA USB MIDI Patch]
- [System Folder] → [Extensions] → [USB YAMAHA MIDI Driver]
- [System Folder] → [OMS Folder] → [YAMAHA USB MIDI OMS Driver]

■ Installing Song Filer

- 1 Double-click on the "SongFiler_" folder in the CD-ROM. "Install Song Filer" file will be displayed.
- 2 Double-click on the "Install Song Filer" file. The Song Filer installation dialog will be displayed. Execute the installation by following the on-screen directions.



• Select "Custom Installation" if you want to access PDF manuals in languages other than English.

- 3 After installing, restart the computer.

For instructions and operation details, refer to the online help and PDF manual.

* For the latest version of Song Filer, go to the following web-site.

<http://www.yamahapkclub.com/english/download/songfiler/songfiler.htm>

Setting up OMS

The OMS studio setup file for the MIDI instrument is contained in the included CD-ROM. This studio setup file is used for setting up OMS.



• Before performing the following procedure, the OMS and USB MIDI Driver should be installed (see page 63).

- 1 Use a USB cable to connect the USB terminal of the computer (or the USB hub) to the USB terminal of the MIDI instrument and turn the MIDI instrument's power on.
- 2 Start the computer.
- 3 Insert the included CD-ROM into the CD-ROM drive of your Macintosh computer. The CD-ROM icon appears on the desktop.
- 4 Double-click on the CD-ROM icon, "OMS_", and "OMS Setup for YAMAHA." The file "*****-USB" appears. ("*****" indicates the product name, etc.) Copy this to the hard disk on your computer.
- 5 Double-click on the "*****-USB" file to start the OMS Setup.
- 6 After starting the OMS Setup, the Studio setup file double-clicked in step 5 opens.

Indicates this setup is available

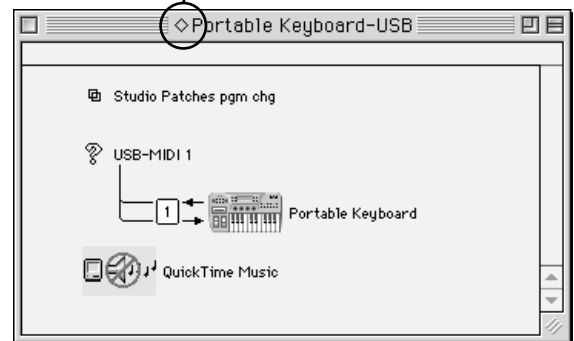

• If "◇" is not indicated at the left of the setup file name, select "Make Current" from the "File" menu and execute the save operation.

The OMS studio setup has been completed.



• After the OMS studio setup above has been completed, your computer will recognize only the MIDI instrument as a MIDI instrument. If you use another MIDI instrument in addition to the MIDI instrument or you add a second MIDI instrument to the existing system, you should create an original Studio Setup file. For details, refer to the on-line manual supplied with the OMS.

Depending on the Macintosh and operating system version that you are using, the included studio setup file for the MIDI instrument still may not work even after you have performed the above steps. (MIDI transmission and reception will not be possible even if the setup is valid.)

In this case, use the following procedure to re-create the setup file.

- 1 Connect the MIDI instrument and Macintosh via USB cable, and turn on the power of the MIDI instrument.
- 2 Start up OMS Setup, and from the "File" menu, choose "New setup."
- 3 The OMS driver search dialog box will appear. Uncheck both [Modem] and [Printer] if you are using a USB connection.
- 4 Click the [Find] button to search for the device. When a device has been found, the OMS Driver Setting dialog box will display "USB-MIDI."
 - If the device was found correctly, click the [OK] button to proceed.
 - If the device was not found, re-check that the cable connections are correct, and repeat the procedure from step 1.
- 5 Make sure that the port is shown below the device that was found. (This will be a name such as USB-MIDI.) Check the check box for the port, and then click the [OK] button.
- 6 A dialog box will appear, allowing you to name the file that will be saved. Input the desired filename, and click [Save]. This completes the OMS setup.
- 7 From the "Studio" menu, choose "Test," and click the port icon. If a channel sounds on the MIDI instrument, the system is operating correctly.

For details on using OMS, refer to "OMS_***_Mac.pdf," included with OMS.

SOFTWARE LICENSING AGREEMENT

The following is a legal agreement between you, the end user, and Yamaha Corporation ("Yamaha"). The enclosed Yamaha software program is licensed by Yamaha to the original purchaser for use only on the terms set forth herein. Please read this licensing agreement with care. Opening this package indicates that you accept all terms outlined herein. If you do not agree to the terms, return this package unopened to Yamaha for a full refund. In the event that you obtained the enclosed Yamaha software program(s) as a part of a software package or software bundled with a hardware product, you may not return the enclosed Yamaha software program(s) to Yamaha.

1. GRANT OF LICENSE AND COPYRIGHT

Yamaha grants you, the original purchaser, the right to use one copy of the enclosed software program and data ("SOFTWARE") on a single-user computer system. You may not use it on more than one computer or computer terminal. The SOFTWARE is owned by Yamaha and is protected by Japanese copyright laws and all applicable international treaty provisions. You are entitled to claim ownership of the media in which the SOFTWARE is included. Therefore, you must treat the SOFTWARE like any other copyrighted materials.

2. RESTRICTIONS

The SOFTWARE program is copyrighted. You may not engage in reverse engineering or reproduction of the SOFTWARE by other conceivable methods. You may not reproduce, modify, change, rent, lease, resell, or distribute the SOFTWARE in whole or in part, or create derivative works from the SOFTWARE. You may not transmit or network the SOFTWARE with other computers. You may transfer ownership of the SOFTWARE and the accompanying written materials on a permanent basis provided that you retain no copies and the recipient agrees to the terms of the licensing agreement.

3. TERMINATION

The licensing condition of the software program becomes effective on the day that you receive the SOFTWARE. If any one of the copyright laws or clauses of the licensing conditions is violated, the licensing agreement shall be terminated automatically without notice from Yamaha. In this case, you must destroy the licensed SOFTWARE and its copies immediately.

4. PRODUCT WARRANTY

Yamaha warrants to the original purchaser that if the SOFTWARE, when used in normal conditions, will not perform the functions described in the manual provided by Yamaha, the sole remedy will be that Yamaha will replace any media which proves defective in materials or workmanship on an exchange basis without charge. Except as expressly set forth above, the SOFTWARE is provided "as is," and no other warranties, either expressed or implied, are made with respect to this software, including, without limitation the implied warranties of merchantability and fitness for a particular purpose.

5. LIMITED LIABILITY

Your sole remedies and Yamaha's entire liability are as set forth above. In no event will Yamaha be liable to you or any other person for any damages, including without limitation any incidental or consequential damages, expenses, lost profits, lost savings or other damages arising out of the use or inability to use such SOFTWARE even if Yamaha or an authorized dealer has been advised of the possibility of such damages, or for any claim by any other party.

6. GENERAL

This license agreement shall be interpreted according to and governed by Japanese laws.



Function

The EZ-250i has a variety of settings in the Function parameters. These give you detailed control over many of the EZ-250i's features.

Using the Function parameters

1 Select a Function name.

Press the [FUNCTION] button, repeatedly if necessary, until appropriate Function name is appear in the display.

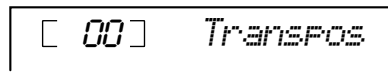
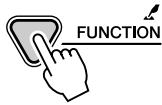

NOTE

- To save the Function parameters and the Touch on/off status to internal memory (flash memory), press and hold the [FUNCTION] button. (See page 68.)

2 Input the appropriate value or use the [+]/[-] buttons to set the selected Function.

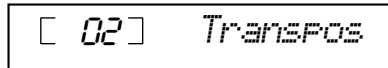
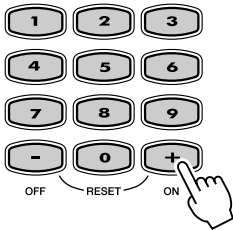

NOTE

- To input a negative value, simultaneously hold the [-] button and enter the number.

● Function parameters

CATEGORY	SELECT	Display	Range/Settings	Description
Overall	Transpose	<i>TransPos</i>	-12-12	This determines the transposition of the entire EZ-250i sound. *
	Tuning	<i>Tuning</i>	-100-100	This determines the pitch of the entire EZ-250i sound. *
	Split Point	<i>SPlitPnt</i>	000-127	This determines the highest key for the Split voice and sets the Split "point" — in other words, the key that separates the Split (lower) and Main (upper) voices. (The Split voice sounds up to and including the Split Point key.) The default Split Point is 054 (F#2). The Split Point setting and Accompaniment Split Point setting are automatically set to the same value. *
	Touch Sensitivity	<i>TouchSns</i>	1-3	A setting of "1" results in limited touch response; this setting produces a relatively narrow dynamic range, no matter how lightly or strongly you play the keys. "2" lets you play over a normal dynamic range (soft to loud), while "3" is designed for playing very soft passages, giving you slightly more detailed control in the soft volume range. When Touch is turned off (page 27), a constant velocity value of 80 is produced (total velocity range = 0-127). *
	Sustain On/Off	<i>Sustain</i>	On/Off	This determines the Sustain on or off. Press the [+]/[-] buttons to set Sustain to on or off. *

CATEGORY	SELECT	Display	Range/ Settings	Description	
Volume	Style Volume	<i>StyleVol</i>	0-127	This determines the volume of the style, letting you create an optimum mix with your performance.	*
	Song Volume	<i>SongVol</i>	0-127	This determines the volume of the Song.	*
	Metronome Volume	<i>MtrVol</i>	0-127	This determines the volume of the Metronome.	*
	Metronome Time Signature	<i>TimeSig</i>	0-15	This determines the time signature of the Metronome.	*
Main Voice	Volume	<i>M.Vol</i>	0-127	This determines the volume of the Main voice, letting you create an optimum mix with the Dual or Split voice.	*
	Octave	<i>M.Octave</i>	-2-2 (octave)	This determines the octave range for the Main voice. Use this to set the most suitable range for the Main voice.	*
	Reverb Send Level	<i>M.RevLvl</i>	0-127	This determines how much of the Main voice's signal is sent to the Reverb effect. Higher values result in a louder Reverb effect.	*
	Chorus Send Level	<i>M.ChoLvl</i>	0-127	This determines how much of the Main voice's signal is sent to the Chorus effect. Higher values result in a louder Chorus effect.	*
Dual Voice	Voice	<i>D.Voice</i>	1-480	This select the dual voice.	
	Volume	<i>D.Volume</i>	0-127	This determines the volume of the Dual voice, letting you create an optimum mix with the Main voice.	*
	Octave	<i>D.Octave</i>	-2-2 (octave)	This determines the octave range for the Dual voice. Use this to create an octave layer for the Dual voice.	*
	Reverb Send Level	<i>D.RevLvl</i>	0-127	This determines how much of the Dual voice's signal is sent to the Reverb effect. Higher values result in a louder Reverb effect for the Dual voice.	*
	Chorus Send Level	<i>D.ChoLvl</i>	0-127	This determines how much of the Dual voice's signal is sent to the Chorus effect. Higher values result in a louder Chorus effect for the Dual voice.	*
Split Voice	Voice	<i>S.Voice</i>	1-480	This select the split voice.	
	Volume	<i>S.Volume</i>	0-127	This determines the volume of the Split voice, letting you create an optimum mix with the Main voice.	*
	Octave	<i>S.Octave</i>	-2-2 (octave)	This determines the octave range for the Split voice. Use this to set the most suitable range for the Split (lower) voice.	*
	Reverb Send Level	<i>S.RevLvl</i>	0-127	This determines how much of the Split voice's signal is sent to the Reverb effect. Higher values result in a louder Reverb effect for the Split voice.	*
	Chorus Send Level	<i>S.ChoLvl</i>	0-127	This determines how much of the Split voice's signal is sent to the Chorus effect. Higher values result in a louder Chorus effect for the Split voice.	*
Effect/ Harmony	Reverb Type	<i>Reverb</i>	1-10	This determines the Reverb type (See the list on page 32).	*
	Chorus Type	<i>Chorus</i>	1-5	This determines the Chorus type, including "off" (See the list on page 32).	*
	Harmony Type	<i>HarmType</i>	1-26	This determines the Harmony type (See the list on page 31).	*
	Harmony Volume	<i>HarmVol</i>	0-127	This determines the level of the Harmony effect when Harmony type 1-5 is selected, letting you create the optimum mix with the original melody note.	*
Utility	Local On/Off	<i>Local</i>	On/Off	This determines the Local on or off. Press the [+]/[-] buttons to set Local Control to on or off.	*
	External Clock	<i>ExtClock</i>	On/Off	This determines the External clock or Internal clock. Press the [+]/[-] buttons to set External clock or Internal clock.	*
	Initial Setup Send	<i>InitSend</i>	YES/NO	This lets you save PortaTone initial data to another device (such as a sequencer, computer, or MIDI data filer). Use the [+]/[ON] button to transmit the data.	
	Lesson Track (R)	<i>R-Part</i>	1-16	This determines the track number for your right hand lesson. This setting is effective only loaded song.	*
	Lesson Track (L)	<i>L-Part</i>	1-16	This determines the track number for your left hand lesson. This setting is effective only loaded song.	*
	Demo Cancel	<i>D-Cancel</i>	On/Off	This determines the Demo Cancel is enabled or not. Press the [+]/[-] buttons to set Demo Cancel to on or off.	
	Backup Clear	<i>BkupClr?</i>	YES/NO	This determines the Internal Flash Memory is initialized or not.	

* The "*" mark indicates that the setting can be restored to default value by pressing both [+]/[-] buttons simultaneously.



Data Backup

■ Data Backup

The following data can be stored to internal flash memory as data backup.

Group	Parameter
SONG	User Song Data
FUNCTION	Tuning Split Point Touch Sensitivity Sustain On/Off Style Volume Song Volume Metronome Volume Demo Cancel On/Off
Touch	Touch On/Off

⚠ CAUTION

- Never attempt to turn the power off when data is being transferred from a computer. Doing so can damage the internal flash memory and result in loss of data.

● About the Internal Flash Memory

The Song data is stored when data is transferred from a computer. Function and touch On/Off are stored when Pressing and Holding the [FUNCTION] button.

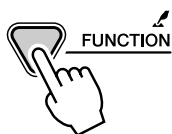

■ Data Initialization

● All Data Initialization (including loaded song data)

All data can be initialized by turning on the power while holding the highest (rightmost) white key (C6) and nearest A key (A5) on the keyboard. “CLr All Mem” will appear briefly on the display. You can also execute this setting in the Utility mode (see page 67.)

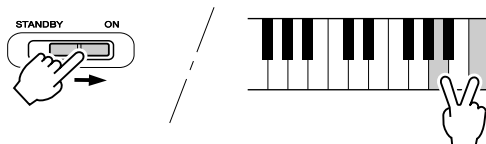

⚠ CAUTION

- All data listed above, plus loaded song data, will be erased and/or changed when the All Data Initialization procedure is carried out.
- Carrying out the data initialization procedure will usually restore normal operation if the EZ-250i freezes or begins to act erratically for any reason.

● All data Initialization (excluding song data)

All data except for loaded song data can be initialized by turning on the power while holding the highest (rightmost) white key on the keyboard.

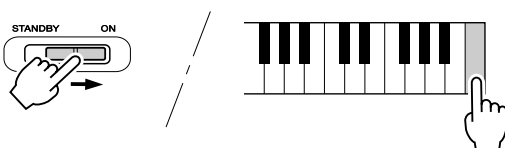



Troubleshooting

Problem	Possible Cause and Solution
When the EZ-250i is turned on or off, a popping sound is temporarily produced.	This is normal and indicates that the EZ-250i is receiving electrical power.
When using a mobile phone, noise is produced.	Using a mobile phone in close proximity to the EZ-250i may produce interference. To prevent this, turn off the mobile phone or use it further away from the EZ-250i.
There is no sound even when the keyboard is played or when a song is being played back.	Check that nothing is connected to the PHONES/OUTPUT jack on the rear panel. When a set of headphones is plugged into this jack, no sound is output.
	Check the Local Control on/off or PC Mode on/off. (See page 57, 58.)
Playing keys in the right hand area of the keyboard does not produce any sound.	When using the Dictionary function (page 42), the keys in the right hand area are used only for entering the chord root and type.
The sound of the voices or rhythms seems unusual or strange.	The battery power is too low. Replace the batteries. (See page 10.)
The auto accompaniment doesn't turn on, even when pressing the [ACMP ON/OFF] button.	Make sure the Style mode is active before using the auto accompaniment. Press the [STYLE] button to enable style operations.
The style or song does not play back even when pressing the [START/STOP] button.	Check the External Clock on/off. (See page 57.)
The style or song does not sound properly.	Make sure that the Style Volume or Song Volume (page 39) is set to an appropriate level.
When playing back one of the Pianist styles (#93 - #100), the rhythm cannot be heard.	This is normal. The Pianist styles have no drums or bass — only piano accompaniment. The accompaniment of the style can only be heard when accompaniment is set to ON and keys are played in the auto accompaniment area of the keyboard.
Not all of the voices seem to sound, or the sound seems to be cut off.	The EZ-250i is polyphonic up to a maximum of 32 notes. If the Dual voice or Split voice is being used and a style or song is playing back at the same time, some notes/sounds may be omitted (or "stolen") from the accompaniment or song.
A strange "flanging" or "doubling" sound occurs when using the EZ-250i with a sequencer. (This may also sound like a "dual" layered sound of two voices, even when Dual is turned off.)	When using the style with a sequencer, set MIDI Echo (or the relevant control) to "off." (Refer to the owner's manual of your particular device and/or software for details.)
The footswitch (for sustain) seems to produce the opposite effect. For example, pressing the footswitch cuts off the sound and releasing it sustains the sounds.	The polarity of the footswitch is reversed. Make sure that the footswitch plug is properly connected to the SUSTAIN jack before turning on the power.
The sound of the voice changes from note to note.	The AWM tone generation method uses multiple recordings (samples) of an instrument across the range of the keyboard; thus, the actual sound of the voice may be slightly different from note to note.

Voice No.	Bank Select		MIDI Program Change#	Voice Name
	MSB	LSB		
087	0	112	74	Recorder
088	0	112	79	Ocarina
SYNTH LEAD				
089	0	112	80	Square Lead
090	0	112	81	Sawtooth Lead
091	0	112	85	Voice Lead
092	0	112	98	Star Dust
093	0	112	100	Brightness
094	0	115	81	Analogon
095	0	119	81	Fargo
SYNTH PAD				
096	0	112	88	Fantasia
097	0	113	100	Bell Pad
098	0	112	91	Xenon Pad
099	0	112	94	Equinox
100	0	113	89	Dark Moon
PERCUSSION				
101	0	112	11	Vibraphone
102	0	112	12	Marimba
103	0	112	13	Xylophone
104	0	112	114	Steel Drums
105	0	112	8	Celesta
106	0	112	14	Tubular Bells
107	0	112	47	Timpani
108	0	112	10	Music Box
DRUM KITS				
109	127	0	0	Standard Kit 1
110	127	0	1	Standard Kit 2
111	127	0	8	Room Kit
112	127	0	16	Rock Kit
113	127	0	24	Electronic Kit
114	127	0	25	Analog Kit
115	127	0	27	Dance Kit
116	127	0	32	Jazz Kit
117	127	0	40	Brush Kit
118	127	0	48	Symphony Kit
119	126	0	0	SFX Kit 1
120	126	0	1	SFX Kit 2

● XGlite Voice List

Voice No.	Bank Select		MIDI Program Change#	Voice Name
	MSB	LSB		
PIANO				
121	0	0	0	Grand Piano
122	0	1	0	Grand Piano KSP
123	0	40	0	Piano Strings
124	0	41	0	Dream
125	0	0	1	Bright Piano
126	0	1	1	Bright Piano KSP
127	0	0	2	Electric Grand Piano
128	0	1	2	Electric Grand Piano KSP
129	0	32	2	Detuned CP80
130	0	0	3	Honky-tonk Piano
131	0	1	3	Honky-tonk Piano KSP
132	0	0	4	Electric Piano 1
133	0	1	4	Electric Piano 1 KSP
134	0	32	4	Chorus Electric Piano 1
135	0	0	5	Electric Piano 2
136	0	1	5	Electric Piano 2 KSP
137	0	32	5	Chorus Electric Piano 2
138	0	41	5	DX + Analog Electric Piano
139	0	0	6	Harpsichord
140	0	1	6	Harpsichord KSP
141	0	35	6	Harpsichord 3
142	0	0	7	Clavi
143	0	1	7	Clavi KSP
CHROMATIC				
144	0	0	8	Celesta
145	0	0	9	Glockenspiel
146	0	0	10	Music Box
147	0	64	10	Orgel
148	0	0	11	Vibraphone
149	0	1	11	Vibraphone KSP
150	0	0	12	Marimba
151	0	1	12	Marimba KSP
152	0	64	12	Sine Marimba
153	0	97	12	Balimba
154	0	98	12	Log Drums
155	0	0	13	Xylophone
156	0	0	14	Tubular Bells
157	0	96	14	Church Bells
158	0	97	14	Carillon
159	0	0	15	Dulcimer
160	0	35	15	Dulcimer 2
161	0	96	15	Cimbalom
162	0	97	15	Santur
ORGAN				
163	0	0	16	DrawOrg
164	0	32	16	Detuned DrawOrg
165	0	33	16	60's DrawOrg 1
166	0	34	16	60's DrawOrg 2
167	0	35	16	70's DrawOrg 1
168	0	37	16	60's DrawOrg 3
169	0	40	16	16+2"2/3
170	0	64	16	Organ Bass
171	0	65	16	70's DrawOrg 2
172	0	66	16	Cheezy Organ
173	0	67	16	DrawOrg 3
174	0	0	17	Percussive Organ
175	0	24	17	70's Percussive Organ
176	0	32	17	Detuned Percussive Organ
177	0	33	17	Light Organ
178	0	37	17	Percussive Organ 2
179	0	0	18	Rock Organ
180	0	64	18	Rotary Organ
181	0	65	18	Slow Rotary
182	0	66	18	Fast Rotary

Voice List

Voice No.	Bank Select		MIDI Program Change#	Voice Name
	MSB	LSB		
183	0	0	19	Church Organ
184	0	32	19	Church Organ 3
185	0	35	19	Church Organ 2
186	0	40	19	Notre Dame
187	0	64	19	Organ Flute
188	0	65	19	Tremolo Organ Flute
189	0	0	20	Reed Organ
190	0	40	20	Puff Organ
191	0	0	21	Accordion
192	0	0	22	Harmonica
193	0	32	22	Harmonica 2
194	0	0	23	Tango Accordion
195	0	64	23	Tango Accordion 2
GUITAR				
196	0	0	24	Nylon Guitar
197	0	96	24	Ukulele
198	0	0	25	Steel Guitar
199	0	35	25	12-string Guitar
200	0	40	25	Nylon & Steel Guitar
201	0	41	25	Steel Guitar with Body Sound
202	0	96	25	Mandolin
203	0	0	26	Jazz Guitar
204	0	32	26	Jazz Amp
205	0	0	27	Clean Guitar
206	0	32	27	Chorus Guitar
207	0	0	28	Muted Guitar
208	0	40	28	Funk Guitar 1
209	0	41	28	Muted Steel Guitar
210	0	45	28	Jazz Man
211	0	0	29	Overdriven Guitar
212	0	43	29	Guitar Pinch
213	0	0	30	Distortion Guitar
214	0	40	30	Feedback Guitar
215	0	41	30	Feedback Guitar 2
216	0	0	31	Guitar Harmonics
217	0	65	31	Guitar Feedback
218	0	66	31	Guitar Harmonics 2
BASS				
219	0	0	32	Acoustic Bass
220	0	40	32	Jazz Rhythm
221	0	45	32	Velocity Crossfade Upright Bass
222	0	0	33	Finger Bass
223	0	18	33	Finger Dark
224	0	40	33	Bass & Distorted Electric Guitar
225	0	43	33	Finger Slap Bass
226	0	45	33	Finger Bass 2
227	0	65	33	Modulated Bass
228	0	0	34	Pick Bass
229	0	28	34	Muted Pick Bass
230	0	0	35	Fretless Bass
231	0	32	35	Fretless Bass 2
232	0	33	35	Fretless Bass 3
233	0	34	35	Fretless Bass 4
234	0	0	36	Slap Bass 1
235	0	32	36	Punch Thumb Bass
236	0	0	37	Slap Bass 2
237	0	43	37	Velocity Switch Slap
238	0	0	38	Synth Bass 1
239	0	40	38	Techno Synth Bass
240	0	0	39	Synth Bass 2
241	0	6	39	Mellow Synth Bass
242	0	12	39	Sequenced Bass
243	0	18	39	Click Synth Bass
244	0	19	39	Synth Bass 2 Dark
245	0	40	39	Modular Synth Bass
246	0	41	39	DX Bass

Voice No.	Bank Select		MIDI Program Change#	Voice Name
	MSB	LSB		
STRING				
247	0	0	40	Violin
248	0	8	40	Slow Violin
249	0	0	41	Viola
250	0	0	42	Cello
251	0	0	43	Contrabass
252	0	0	44	Tremolo Strings
253	0	8	44	Slow Tremolo Strings
254	0	40	44	Suspense Strings
255	0	0	45	Pizzicato Strings
256	0	0	46	Orchestral Harp
257	0	40	46	Yang Chin
258	0	0	47	Timpani
ENSEMBLE				
259	0	0	48	Strings 1
260	0	3	48	Stereo Strings
261	0	8	48	Slow Strings
262	0	35	48	60's Strings
263	0	40	48	Orchestra
264	0	41	48	Orchestra 2
265	0	42	48	Tremolo Orchestra
266	0	45	48	Velocity Strings
267	0	0	49	Strings 2
268	0	3	49	Stereo Slow Strings
269	0	8	49	Legato Strings
270	0	40	49	Warm Strings
271	0	41	49	Kingdom
272	0	0	50	Synth Strings 1
273	0	0	51	Synth Strings 2
274	0	0	52	Choir Aahs
275	0	3	52	Stereo Choir
276	0	32	52	Mellow Choir
277	0	40	52	Choir Strings
278	0	0	53	Voice Oohs
279	0	0	54	Synth Voice
280	0	40	54	Synth Voice 2
281	0	41	54	Choral
282	0	64	54	Analog Voice
283	0	0	55	Orchestra Hit
284	0	35	55	Orchestra Hit 2
285	0	64	55	Impact
BRASS				
286	0	0	56	Trumpet
287	0	32	56	Warm Trumpet
288	0	0	57	Trombone
289	0	18	57	Trombone 2
290	0	0	58	Tuba
291	0	0	59	Muted Trumpet
292	0	0	60	French Horn
293	0	6	60	French Horn Solo
294	0	32	60	French Horn 2
295	0	37	60	Horn Orchestra
296	0	0	61	Brass Section
297	0	35	61	Trumpet & Trombone Section
298	0	0	62	Synth Brass 1
299	0	20	62	Resonant Synth Brass
300	0	0	63	Synth Brass 2
301	0	18	63	Soft Brass
302	0	41	63	Choir Brass
REED				
303	0	0	64	Soprano Sax
304	0	0	65	Alto Sax
305	0	40	65	Sax Section
306	0	0	66	Tenor Sax
307	0	40	66	Breathy Tenor Sax
308	0	0	67	Baritone Sax

Voice No.	Bank Select		MIDI Program Change#	Voice Name
	MSB	LSB		
309	0	0	68	Oboe
310	0	0	69	English Horn
311	0	0	70	Bassoon
312	0	0	71	Clarinet
PIPE				
313	0	0	72	Piccolo
314	0	0	73	Flute
315	0	0	74	Recorder
316	0	0	75	Pan Flute
317	0	0	76	Blown Bottle
318	0	0	77	Shakuhachi
319	0	0	78	Whistle
320	0	0	79	Ocarina
SYNTH LEAD				
321	0	0	80	Square Lead
322	0	6	80	Square Lead 2
323	0	8	80	LM Square
324	0	18	80	Hollow
325	0	19	80	Shroud
326	0	64	80	Mellow
327	0	65	80	Solo Sine
328	0	66	80	Sine Lead
329	0	0	81	Sawtooth Lead
330	0	6	81	Sawtooth Lead 2
331	0	8	81	Thick Sawtooth
332	0	18	81	Dynamic Sawtooth
333	0	19	81	Digital Sawtooth
334	0	20	81	Big Lead
335	0	96	81	Sequenced Analog
336	0	0	82	Calliope Lead
337	0	65	82	Pure Pad
338	0	0	83	Chiff Lead
339	0	0	84	Charang Lead
340	0	64	84	Distorted Lead
341	0	0	85	Voice Lead
342	0	0	86	Fifths Lead
343	0	35	86	Big Five
344	0	0	87	Bass & Lead
345	0	16	87	Big & Low
346	0	64	87	Fat & Perky
347	0	65	87	Soft Whirl
SYNTH PAD				
348	0	0	88	New Age Pad
349	0	64	88	Fantasy
350	0	0	89	Warm Pad
351	0	0	90	Poly Synth Pad
352	0	0	91	Choir Pad
353	0	66	91	Itopia
354	0	0	92	Bowed Pad
355	0	0	93	Metallic Pad
356	0	0	94	Halo Pad
357	0	0	95	Sweep Pad
SYNTH EFFECTS				
358	0	0	96	Rain
359	0	65	96	African Wind
360	0	66	96	Carib
361	0	0	97	Sound Track
362	0	27	97	Prologue
363	0	0	98	Crystal
364	0	12	98	Synth Drum Comp
365	0	14	98	Popcorn
366	0	18	98	Tiny Bells
367	0	35	98	Round Glockenspiel
368	0	40	98	Glockenspiel Chimes
369	0	41	98	Clear Bells
370	0	42	98	Chorus Bells
371	0	65	98	Soft Crystal

Voice No.	Bank Select		MIDI Program Change#	Voice Name
	MSB	LSB		
372	0	70	98	Air Bells
373	0	71	98	Bell Harp
374	0	72	98	Gamelimba
375	0	0	99	Atmosphere
376	0	18	99	Warm Atmosphere
377	0	19	99	Hollow Release
378	0	40	99	Nylon Electric Piano
379	0	64	99	Nylon Harp
380	0	65	99	Harp Vox
381	0	66	99	Atmosphere Pad
382	0	0	100	Brightness
383	0	0	101	Goblins
384	0	64	101	Goblins Synth
385	0	65	101	Creeper
386	0	67	101	Ritual
387	0	68	101	To Heaven
388	0	70	101	Night
389	0	71	101	Glisten
390	0	96	101	Bell Choir
391	0	0	102	Echoes
392	0	0	103	Sci-Fi
WORLD				
393	0	0	104	Sitar
394	0	32	104	Detuned Sitar
395	0	35	104	Sitar 2
396	0	97	104	Tamboura
397	0	0	105	Banjo
398	0	28	105	Muted Banjo
399	0	96	105	Rabab
400	0	97	105	Gopichant
401	0	98	105	Oud
402	0	0	106	Shamisen
403	0	0	107	Koto
404	0	96	107	Taisho-kin
405	0	97	107	Kanoon
406	0	0	108	Kalimba
407	0	0	109	Bagpipe
408	0	0	110	Fiddle
409	0	0	111	Shanai
PERCUSSIVE				
410	0	0	112	Tinkle Bell
411	0	96	112	Bonang
412	0	97	112	Altair
413	0	98	112	Gamelan Gongs
414	0	99	112	Stereo Gamelan Gongs
415	0	100	112	Rama Cymbal
416	0	0	113	Agogo
417	0	0	114	Steel Drums
418	0	97	114	Glass Percussion
419	0	98	114	Thai Bells
420	0	0	115	Woodblock
421	0	96	115	Castanets
422	0	0	116	Taiko Drum
423	0	96	116	Gran Cassa
424	0	0	117	Melodic Tom
425	0	64	117	Melodic Tom 2
426	0	65	117	Real Tom
427	0	66	117	Rock Tom
428	0	0	118	Synth Drum
429	0	64	118	Analog Tom
430	0	65	118	Electronic Percussion
431	0	0	119	Reverse Cymbal
SOUND EFFECTS				
432	0	0	120	Fret Noise
433	0	0	121	Breath Noise
434	0	0	122	Seashore
435	0	0	123	Bird Tweet

Voice List

Voice No.	Bank Select		MIDI Program Change#	Voice Name
	MSB	LSB		
436	0	0	124	Telephone Ring
437	0	0	125	Helicopter
438	0	0	126	Applause
439	0	0	127	Gunshot
440	64	0	0	Cutting Noise
441	64	0	1	Cutting Noise 2
442	64	0	3	String Slap
443	64	0	16	Flute Key Click
444	64	0	32	Shower
445	64	0	33	Thunder
446	64	0	34	Wind
447	64	0	35	Stream
448	64	0	36	Bubble
449	64	0	37	Feed
450	64	0	48	Dog
451	64	0	49	Horse
452	64	0	50	Bird Tweet 2
453	64	0	55	Maou
454	64	0	64	Phone Call
455	64	0	65	Door Squeak
456	64	0	66	Door Slam
457	64	0	67	Scratch Cut
458	64	0	68	Scratch Split
459	64	0	69	Wind Chime
460	64	0	70	Telephone Ring 2
461	64	0	80	Car Engine Ignition
462	64	0	81	Car Tires Squeal
463	64	0	82	Car Passing
464	64	0	83	Car Crash
465	64	0	84	Siren
466	64	0	85	Train
467	64	0	86	Jet Plane
468	64	0	87	Starship
469	64	0	88	Burst
470	64	0	89	Roller Coaster
471	64	0	90	Submarine
472	64	0	96	Laugh
473	64	0	97	Scream
474	64	0	98	Punch
475	64	0	99	Heartbeat
476	64	0	100	Footsteps
477	64	0	112	Machine Gun
478	64	0	113	Laser Gun
479	64	0	114	Explosion
480	64	0	115	Firework

Style List

Style No.	Style Name
8BEAT	
001	8BeatModern
002	60'sGtrPop
003	8BeatAdria
004	60's8Beat
005	8Beat
006	OffBeat
007	60'sRock
008	HardRock
009	RockShuffle
010	8BeatRock
16BEAT	
011	16Beat
012	PopShuffle
013	GuitarPop
014	16BtUptempo
015	KoolShuffle
016	HipHopLight
BALLAD	
017	PianoBallad
018	LoveSong
019	6/8ModernEP
020	6/8SlowRock
021	OrganBallad
022	PopBallad
023	16BeatBallad
DANCE	
024	EuroTrance
025	Ibiza
026	SwingHouse
027	Clubdance
028	ClubLatin
029	Garage1
030	Garage2
031	TechnoParty
032	UKPop
033	HipHopGroove
034	HipShuffle
035	HipHopPop
DISCO	
036	70'sDisco
037	LatinDisco
038	SaturdayNight
039	DiscoHands
SWING & JAZZ	
040	BigBandFast
041	BigBandBallad
042	JazzClub
043	Swing1
044	Swing2
045	Five/Four
046	Dixieland
047	Ragtime
R & B	
048	Soul
049	DetroitPop
050	6/8Soul
051	CrocoTwist
052	Rock&Roll
053	ComboBoogie
054	6/8Blues

Style No.	Style Name
COUNTRY	
055	CountryPop
056	CountrySwing
057	Country2/4
058	Bluegrass
LATIN	
059	BrazilianSamba
060	BossaNova
061	Tijuana
062	DiscoLatin
063	Mambo
064	Salsa
065	Beguine
066	Reggae
BALLROOM	
067	VienneseWaltz
068	EnglishWaltz
069	Slowfox
070	Foxtrot
071	Quickstep
072	Tango
073	Pasodoble
074	Samba
075	ChaChaCha
076	Rumba
077	Jive
TRADITIONAL	
078	USMarch
079	6/8March
080	GermanMarch
081	PolkaPop
082	OberPolka
083	Tarantella
084	Showtune
085	ChristmasSwing
086	ChristmasWaltz
087	ScottishReel
WALTZ	
088	SwingWaltz
089	JazzWaltz
090	CountryWaltz
091	OberWalzer
092	Musette
PIANIST	
093	Stride
094	PianoSwing
095	Arpeggio
096	Habanera
097	SlowRock
098	8BeatPianoBallad
099	6/8PianoMarch
100	PianoWaltz

Drum Kit List

- “ ” indicates that the drum sound is the same as “Standard Kit 1”.
- Each percussion voice uses one note.
- The MIDI Note # and Note are actually one octave lower than keyboard Note # and Note. For example, in “109: Standard Kit 1”, the “Seq Click H” (Note# 36/Note C1) corresponds to (Note# 24/Note C0).
- Key Off: Keys marked “O” stop sounding the instant they are released.
- Voices with the same Alternate Note Number (*1 – 4) cannot be played simultaneously. (They are designed to be played alternately with each other.)

		Voice No.					109	110	111	112	113	114	
		MSB/LSB/PC					127/000/000	127/000/001	127/000/008	127/000/016	127/000/024	127/000/025	
		Keyboard		MIDI		Key Off	Alternate assign	Standard Kit 1	Standard Kit 2	Room Kit	Rock Kit	Electronic Kit	Analog Kit
Note#	Note	Note#	Note	Note#	Note								
		25	C# 0	13	C# -1		3	Surdo Mute					
		26	D 0	14	D -1		3	Surdo Open					
		27	D# 0	15	D# -1			Hi Q					
		28	E 0	16	E -1			Whip Slap					
		29	F 0	17	F -1		4	Scratch Push					
		30	F# 0	18	F# -1		4	Scratch Pull					
		31	G 0	19	G -1			Finger Snap					
		32	G# 0	20	G# -1			Click Noise					
		33	A 0	21	A -1			Metronome Click					
		34	A# 0	22	A# -1			Metronome Bell					
		35	B 0	23	B -1			Seq Click L					
		36	C 1	24	C 0			Seq Click H					
C1	C#1	37	C# 1	25	C# 0			Brush Tap					
D1	D#1	38	D 1	26	D 0	O		Brush Swirl					
E1	E#1	39	D# 1	27	D# 0			Brush Slap					
F1	F#1	40	E 1	28	E 0	O		Brush Tap Swirl			Reverse Cymbal	Reverse Cymbal	
G1	G#1	41	F 1	29	F 0	O		Snare Roll					
A1	A#1	42	F# 1	30	F# 0			Castanet			Hi Q 2	Hi Q 2	
B1	B#1	43	G 1	31	G 0			Snare H Soft	Snare H Soft 2		SD Rock H	Snare L	SD Rock H
C2	C#2	44	G# 1	32	G# 0			Sticks					
D2	D#2	45	A 1	33	A 0			Bass Drum Soft				Bass Drum H	Bass Drum H
E2	E#2	46	A# 1	34	A# 0			Open Rim Shot	Open Rim Shot 2				
F2	F#2	47	B 1	35	B 0			Bass Drum Hard			Bass Drum H	BD Rock	BD Analog L
G2	G#2	48	C 2	36	C 1			Bass Drum	Bass Drum 2		BD Rock	BD Gate	BD Analog H
A2	A#2	49	C# 2	37	C# 1			Side Stick					Analog Side Stick
B2	B#2	50	D 2	38	D 1			Snare M	Snare M 2	SD Room L	SD Rock L	SD Rock L	Analog Snare 1
C3	C#3	51	D# 2	39	D# 1			Hand Clap					
D3	D#3	52	E 2	40	E 1			Snare H Hard	Snare H Hard 2	SD Room H	SD Rock Rim	SD Rock H	Analog Snare 2
E3	E#3	53	F 2	41	F 1			Floor Tom L		Room Tom 1	Rock Tom 1	E Tom 1	Analog Tom 1
F3	F#3	54	F# 2	42	F# 1	1		Hi-Hat Closed					Analog HH Closed 1
G3	G#3	55	G 2	43	G 1			Floor Tom H		Room Tom 2	Rock Tom 2	E Tom 2	Analog Tom 2
A3	A#3	56	G# 2	44	G# 1	1		Hi-Hat Pedal					Analog HH Closed 2
B3	B#3	57	A 2	45	A 1			Low Tom		Room Tom 3	Rock Tom 3	E Tom 3	Analog Tom 3
C4	C#4	58	A# 2	46	A# 1	1		Hi-Hat Open					Analog HH Open
D4	D#4	59	B 2	47	B 1			Mid Tom L		Room Tom 4	Rock Tom 4	E Tom 4	Analog Tom 4
E4	E#4	60	C 3	48	C 2			Mid Tom H		Room Tom 5	Rock Tom 5	E Tom 5	Analog Tom 5
F4	F#4	61	C# 3	49	C# 2			Crash Cymbal 1					Analog Cymbal
G4	G#4	62	D 3	50	D 2			High Tom		Room Tom 6	Rock Tom 6	E Tom 6	Analog Tom 6
A4	A#4	63	D# 3	51	D# 2			Ride Cymbal 1					
B4	B#4	64	E 3	52	E 2			Chinese Cymbal					
C5	C#5	65	F 3	53	F 2			Ride Cymbal Cup					
D5	D#5	66	F# 3	54	F# 2			Tambourine					
E5	E#5	67	G 3	55	G 2			Splash Cymbal					
F5	F#5	68	G# 3	56	G# 2			Cowbell					Analog Cowbell
G5	G#5	69	A 3	57	A 2			Crash Cymbal 2					
A5	A#5	70	A# 3	58	A# 2			Vibraslap					
B5	B#5	71	B 3	59	B 2			Ride Cymbal 2					
C6	C#6	72	C 4	60	C 3			Bongo H					
D6	D#6	73	C# 4	61	C# 3			Bongo L					
E6	E#6	74	D 4	62	D 3			Conga H Mute					Analog Conga H
F6	F#6	75	D# 4	63	D# 3			Conga H Open					Analog Conga M
G6	G#6	76	E 4	64	E 3			Conga L					Analog Conga L
A6	A#6	77	F 4	65	F 3			Timbale H					
B6	B#6	78	F# 4	66	F# 3			Timbale L					
C7	C#7	79	G 4	67	G 3			Agogo H					
D7	D#7	80	G# 4	68	G# 3			Agogo L					
E7	E#7	81	A 4	69	A 3			Cabasa					
F7	F#7	82	A# 4	70	A# 3			Maracas					Analog Maracas
G7	G#7	83	B 4	71	B 3	O		Samba Whistle H					
A7	A#7	84	C 5	72	C 4	O		Samba Whistle L					
B7	B#7	85	C# 5	73	C# 4			Guiro Short					
C8	C#8	86	D 5	74	D 4	O		Guiro Long					
D8	D#8	87	D# 5	75	D# 4			Claves					Analog Claves
E8	E#8	88	E 5	76	E 4			Wood Block H					
F8	F#8	89	F 5	77	F 4			Wood Block L					
G8	G#8	90	F# 5	78	F# 4			Cuica Mute			Scratch Push	Scratch Push	
A8	A#8	91	G 5	79	G 4			Cuica Open			Scratch Pull	Scratch Pull	
B8	B#8	92	G# 5	80	G# 4		2	Triangle Mute					
C9	C#9	93	A 5	81	A 4		2	Triangle Open					
D9	D#9	94	A# 5	82	A# 4			Shaker					
E9	E#9	95	B 5	83	B 4			Jingle Bell					
F9	F#9	96	C 6	84	C 5			Bell Tree					
G9	G#9	97	C# 6	85	C# 5								
A9	A#9	98	D 6	86	D 5								
B9	B#9	99	D# 6	87	D# 5								
C10	C#10	100	E 6	88	E 5								
D10	D#10	101	F 6	89	F 5								
E10	E#10	102	F# 6	90	F# 5								
F10	F#10	103	G 6	91	G 5								

Prog Change : True #	0 0 - 127 *****	0 0 - 127
System Exclusive	0 *3	*3
: Song Pos.	x	x
: Song Sel.	x	x
: Tune	x	x
System : Clock	0	0
Real Time : Commands	0 *4	*4
Aux : All Sound OFF	0	0 (120, 126, 127)
: Reset All Cntrls	x	0 (121)
: Local ON/OFF	x	0 (122)
: All Notes OFF	x	0 (123-125)
Mes- : Active Sense	0	0
sages: Reset	x	x

O : Yes
X : No

Mode 1 : OMNI ON , POLY
Mode 2 : OMNI ON , MONO
Mode 3 : OMNI OFF, POLY
Mode 4 : OMNI OFF, MONO

NOTE:

*1 By default (factory settings) the EZ-250i ordinarily functions as a 16-channel multi-timbral tone generator, and incoming data does not affect the panel voices or panel settings. However, the MIDI messages listed below do affect the panel voices, auto accompaniment, and songs.

- MIDI Master Tuning
- System exclusive messages for changing the Reverb Type and Chorus Type.

*2 Messages for these control change numbers cannot be transmitted from the EZ-250i itself. However, they may be transmitted when playing the accompaniment, song or using the Harmony effect.

*3 Exclusive

<GM System ON> F0H, 7EH, 7FH, 09H, 01H, F7H

- This message automatically restores all default settings for the instrument, with the exception of MIDI Master Tuning.

<MIDI Master Volume> F0H, 7FH, 7FH, 04H, 01H, II, mm, F7H

- This message allows the volume of all channels to be changed simultaneously (Universal System Exclusive).
- The values of "mm" is used for MIDI Master Tuning. (Values for "II" are ignored.)

<MIDI Master Tuning> F0H, 43H, 1nH, 27H, 30H, 00H, 00H, mm, II, cc, F7H

- This message simultaneously changes the tuning value of all channels.
- The values of "mm" and "II" are used for MIDI Master Tuning.
- The default value of "mm" and "II" are 08H and 00H, respectively. Any values can be used for "n" and "cc."

<Reverb Type> F0H, 43H, 1nH, 4CH, 02H, 01H, 00H, mmH, IIH, F7H

- mm : Reverb Type MSB
- II : Reverb Type LSB

Refer to the Effect Map (page 80) for details.

<Chorus Type> F0H, 43H, 1nH, 4CH, 02H, 01H, 20H, mmH, IIH, F7H

- mm : Chorus Type MSB
- II : Chorus Type LSB

Refer to the Effect Map (page 80) for details.

*4 When the accompaniment is started, an FAH message is transmitted. When accompaniment is stopped, an FCH message is transmitted. When the clock is set to External, both FAH (accompaniment start) and FCH (accompaniment stop) are recognized.

*5 Local ON/OFF

<Local ON> Bn, 7A, 7F

<Local OFF> Bn, 7A, 00

Value for "n" is ignored.

MIDI Implementation Chart

■ Effect map

- * If the received value does not contain an effect type in the TYPE LSB, the LSB will be directed to TYPE 0.
- * The numbers in parentheses in front of the Effect Type names correspond to the number indicated in the display..
- * By using an external sequencer, which is capable of editing and transmitting the system exclusive messages and parameter changes, you can select the Reverb, Chorus and DSP effect types which are not accessible from the EZ-250i panel itself. When one of the effects is selected by the external sequencer, " - " will be shown on the display.

● REVERB

TYPE MSB	TYPE LSB								
	00	01	02	08	16	17	18	19	20
000	No Effect								
001	(1)Hall1				(2)Hall2	(3)Hall3			
002	Room					(4)Room1		(5)Room2	
003	Stage				(6)Stage1	(7)Stage2			
004	Plate				(8)Plate1	(9)Plate2			
005 – 127	No Effect								

● CHORUS

TYPE MSB	TYPE LSB								
	00	01	02	08	16	17	18	19	20
000 – 063	No Effect								
064	Thru								
065	Chorus		(2)Chorus2						
066	Celeste					(1)Chorus1			
067	Flanger			(3)Flanger1		(4)Flanger2			
068 – 127	No Effect								

Specifications

Keyboards

- 61 standard-size keys (C1 - C6), with Touch Response.

Display

- Large multi-function LCD display (backlit)

Setup

- STANDBY/ON
- MASTER VOLUME : MIN - MAX

Panel Controls

- SONG, STYLE, VOICE, Dict., PC, LESSON L, R, METRONOME, PORTABLE GRAND, DEMO, FUNCTION, TOUCH, DUAL, SPLIT, HARMONY, TEMPO/TAP, [0]-[9], [+](YES), [-](NO)

Voice

- 108 panel voices + 12 drum kits + 360 XG Lite voices
- Polyphony : 32

Style

- 100 styles
- Style Control : ACMP ON/OFF, SYNC START, START/STOP, INTRO/ENDING/rit., MAIN/AUTO FILL
- Fingering : Multi fingering
- Style Volume

Yamaha Educational Suite

- Dictionary
- Lesson 1-4

Function

- Overall : Transpose, Tuning, Split Point, Touch Sensitivity, Sustain
- Volume : Style Volume, Song Volume, Metronome Volume, Metronome Time Signature
- Main Voice : Volume, Octave, Reverb Send Level, Chorus Send Level
- Dual Voice : Voice, Volume, Octave, Reverb Send Level, Chorus Send Level
- Split Voice : Voice, Volume, Octave, Reverb Send Level, Chorus Send Level
- Effect/Harmony : Reverb Type, Chorus Type, Harmony Type, Harmony Volume
- Utility : Local On/Off, External Clock, Initial Setup Send, Lesson Track R, Lesson Track L, Demo Cancel, Backup Clear

Effects

- Reverb : 9 types
- Chorus : 4 types
- Harmony : 26 types

Song

- 80 Songs
- Song Volume

MIDI

- Local On/Off
- Initial Setup Send
- External Clock

Auxiliary jacks

- PHONES/OUTPUT, DC IN 12V, USB, SUSTAIN

Amplifier (when using PA-3C power adaptor)

- 2.5W + 2.5W

Speakers

- 12cm x 2

Power Consumption (when using PA-3C power adaptor)

- 13W

Power Supply

- Adaptor : Yamaha PA-3C AC power adaptor
- Batteries : Six "D" size, R20P (LR20) or equivalent batteries

Dimensions (W x D x H)

- 931 x 348.8 x 127.9 mm (36-2/3" x 13-3/4" x 5-1/16")

Weight

- 5.0 kg (11 lbs.)

Supplied Accessories

- Music Rest
- Owner's Manual
- Song Book
- CD-ROM
- USB Cable

Optional Accessories

- Headphones : HPE-150
- AC power adaptor : PA-3B/3C
- Footswitch : FC4, FC5
- Keyboard stand : L-2C, L-2L

* Specifications and descriptions in this owner's manual are for information purposes only. Yamaha Corp. reserves the right to change or modify products or specifications at any time without prior notice. Since specifications, equipment or options may not be the same in every locale, please check with your Yamaha dealer.

Panel controls and terminals

+/-	8, 19
A-B REPEAT	8, 46
ACMP ON/OFF	8, 34
DC IN 12V	9, 10
DEMO	9, 14
Dict.	8, 42
DUAL	9, 25
FF	9, 46
FUNCTION	8, 18, 66
HARMONY	9, 29
INTRO/ENDING/rit.	9, 34
LESSON	8, 50
LIGHT ON/OFF	9, 28
MAIN/AUTO FILL	9, 34
MASTER VOLUME	8, 18
METRONOME	8, 21
Numeric keypad	8, 19
OFF	8
ON	8
PAUSE	8, 46
PC	8, 58
PHONES/OUTPUT	9, 11
PORTABLE GRAND	8, 21
REW	9, 46
SONG	8, 45, 49
SPLIT	9, 26
STANDBY/ON	8, 11
START/STOP	8, 34, 46
STYLE	8, 33
SUSTAIN	11, 30
SYNC START	8, 34
TEMPO/TAP	9, 21, 38
TOUCH	9, 27
USB	9, 56
VOICE	8, 23

Misc.

#000 OTS	25
----------	----

A

A-B repeat	47
AC Power adaptor	10
accessory jacks	11
accompaniment sections	39
Accompaniment Split Point	26

B

Batteries	10
Beat display	38

C

Chord Names	44
Chord Type	44
Chords, About	43
Chords, Fingered	40
Chords, Single Finger	40
Chorus	30

D

DEMO Cancel	14
Demo song	14
Dictionary	42
Drum Kit Voice Chart	76
Dual Voice	25

E

Effects	29
Ending	37
External Clock	57

F

Fill-in	39
Fingered chords	40
Flash Memory	58
Footswitch	11
Function	18, 66

G

GM System Level 1	55
Grade	53

H

Harmony	29
Headphones	11

I

Indicator	20
Initial Setup Send	57
Intro	36

L

Left	50
Lesson	49
Lesson Track	51
Level, chorus send	30
Level, reverb send	29
Light Guide	28
LIGHT ON/OFF	28
Local on/off	57

M

Main A/B	39
Main Voice	23
Master Volume	18
Melody Voice Change	48
Metronome	21
MIDI	54
MIDI channels	55
MIDI Implementation Chart	78
MIDI LSB Receive cancel	56
Multi Fingering	40
Music Rest	19

N

Notation	20
----------	----

O

Octave	20
Octave, dual	25
Octave, main	23
Octave, split	26

P

PC	58
Portable Grand	21

Q

Quick Guide	12
-------------	----

R

Reverb	29
Right	50
Ritardando	37
Root	43

S

sections (accompaniment)	39
Single Finger chords	40
Song Volume	48
songs, playing	46
songs, selecting	45
Specifications	81
Split Point	26

Split Voice.....26
 Style Volume.....39
 styles, playing.....34
 styles, selecting.....33
 Sustain30
 Sync Start.....35

T

Tap35
 Tempo 21, 38
 Time Signature22
 Touch Sensitivity27
 Transpose.....28
 Troubleshooting.....69
 Tuning.....28

V

Voice List.....70
 voices, Drum Kit76
 voices, selecting and playing.....23
 voices, XG Lite.....71
 Volume, dual.....25
 Volume, harmony.....29
 Volume, main.....23
 Volume, Metronome22
 Volume, Song48
 Volume, split.....26
 Volume, Style39

X

XG Lite Voice List.....71

Limited Warranty

90 DAYS LABOR

1 YEAR PARTS

Yamaha Corporation of America, hereafter referred to as Yamaha, warrants to the original consumer of a product included in the categories listed below, that the product will be free of defects in materials and/or workmanship for the periods indicated. This warranty is applicable to all models included in the following series of products:

EZ SERIES OF ELECTRONIC KEYBOARDS

If during the first 90 days that immediately follows the purchase date, your new Yamaha product covered by this warranty is found to have a defect in material and/or workmanship, Yamaha and/or its authorized representative will repair such defect without charge for parts or labor.

If parts should be required after this 90 day period but within the one year period that immediately follows the purchase date, Yamaha will, subject to the terms of this warranty, supply these parts without charge. However, charges for labor, and/or any miscellaneous expenses incurred are the consumers responsibility. Yamaha reserves the right to utilize reconditioned parts in repairing these products and/or to use reconditioned units as warranty replacements.

THIS WARRANTY IS THE ONLY EXPRESS WARRANTY WHICH YAMAHA MAKES IN CONNECTION WITH THESE PRODUCTS. ANY IMPLIED WARRANTY APPLICABLE TO THE PRODUCT, INCLUDING THE WARRANTY OF MERCHANTABILITY IS LIMITED TO THE DURATION OF THE EXPRESS WARRANTY. YAMAHA EXCLUDES AND SHALL NOT BE LIABLE IN ANY EVENT FOR INCIDENTAL OR CONSEQUENTIAL DAMAGES.

Some states do not allow limitations that relate to implied warranties and/or the exclusion of incidental or consequential damages. Therefore, these limitations and exclusions may not apply to you.

This warranty gives you specific legal rights. You may also have other rights which vary from state to state.

CONSUMERS RESPONSIBILITIES

If warranty service should be required, it is necessary that the consumer assume certain responsibilities:

1. Contact the Customer Service Department of the retailer selling the product, or any retail outlet authorized by Yamaha to sell the product for assistance. You may also contact Yamaha directly at the address provided below.
2. Deliver the unit to be serviced under warranty to: the retailer selling the product, an authorized service center, or to Yamaha with an explanation of the problem. Please be prepared to provide proof purchase date (sales receipt, credit card copy, etc.) when requesting service and/or parts under warranty.
3. Shipping and/or insurance costs are the consumers responsibility.* Units shipped for service should be packed securely.

*Repaired units will be returned PREPAID if warranty service is required within the first 90 days.

IMPORTANT: Do NOT ship anything to ANY location without prior authorization. A Return Authorization (RA) will be issued that has a tracking number assigned that will expedite the servicing of your unit and provide a tracking system if needed.

4. Your owners manual contains important safety and operating instructions. It is your responsibility to be aware of the contents of this manual and to follow all safety precautions.

EXCLUSIONS

This warranty does not apply to units whose trade name, trademark, and/or ID numbers have been altered, defaced, exchanged removed, or to failures and/or damages that may occur as a result of:

1. Neglect, abuse, abnormal strain, modification or exposure to extremes in temperature or humidity.
2. Improper repair or maintenance by any person who is not a service representative of a retail outlet authorized by Yamaha to sell the product, an authorized service center, or an authorized service representative of Yamaha.
3. This warranty is applicable only to units sold by retailers authorized by Yamaha to sell these products in the U.S.A., the District of Columbia, and Puerto Rico. This warranty is not applicable in other possessions or territories of the U.S.A. or in any other country.

Please record the model and serial number of the product you have purchased in the spaces provided below.

Model _____ Serial # _____ Sales Slip # _____

Purchased from _____ Date _____
(Retailer)

YAMAHA CORPORATION OF AMERICA
Electronic Service Division
6600 Orangethorpe Avenue
Buena Park, CA 90620

KEEP THIS DOCUMENT FOR YOUR RECORDS. DO NOT MAIL!

For details of products, please contact your nearest Yamaha representative or the authorized distributor listed below.

Pour plus de détails sur les produits, veuillez-vous adresser à Yamaha ou au distributeur le plus proche de vous figurant dans la liste suivante.

Die Einzelheiten zu Produkten sind bei Ihrer unten aufgeführten Niederlassung und bei Yamaha Vertragshändlern in den jeweiligen Bestimmungsländern erhältlich.

Para detalles sobre productos, contacte su tienda Yamaha más cercana o el distribuidor autorizado que se lista debajo.

NORTH AMERICA

CANADA

Yamaha Canada Music Ltd.
135 Milner Avenue, Scarborough, Ontario,
M1S 3R1, Canada
Tel: 416-298-1311

U.S.A.

Yamaha Corporation of America
6600 Orangethorpe Ave., Buena Park, Calif. 90620,
U.S.A.
Tel: 714-522-9011

CENTRAL & SOUTH AMERICA

MEXICO

**Yamaha de Mexico S.A. De C.V.,
Departamento de ventas**
Javier Rojo Gomez No.1149, Col. Gpe Del
Moral, Deleg. Iztapalapa, 09300 Mexico, D.F.
Tel: 686-00-33

BRAZIL

Yamaha Musical do Brasil LTDA.
Av. Rebouças 2636, São Paulo, Brasil
Tel: 011-853-1377

ARGENTINA

Yamaha de Panamá S.A. Sucursal de Argentina
Viamonte 1145 Piso 2-B 1053,
Buenos Aires, Argentina
Tel: 1-4371-7021

PANAMA AND OTHER LATIN AMERICAN COUNTRIES/ CARIBBEAN COUNTRIES

Yamaha de Panamá S.A.
Torre Banco General, Piso 7, Urbanización Marbella,
Calle 47 y Aquilino de la Guardia,
Ciudad de Panamá, Panamá
Tel: +507-269-5311

EUROPE

THE UNITED KINGDOM

Yamaha-Kemble Music (U.K.) Ltd.
Sherbourne Drive, Tilbrook, Milton Keynes,
MK7 8BL, England
Tel: 01908-366700

IRELAND

Danfay Ltd.
61D, Sallynoggin Road, Dun Laoghaire, Co. Dublin
Tel: 01-2859177

GERMANY

Yamaha Music Central Europe GmbH
Siemensstraße 22-34, 25462 Rellingen, Germany
Tel: 04101-3030

SWITZERLAND/LIECHTENSTEIN

**Yamaha Music Central Europe GmbH,
Branch Switzerland**
Seefeldstrasse 94, 8008 Zürich, Switzerland
Tel: 01-383 3990

AUSTRIA

**Yamaha Music Central Europe GmbH,
Branch Austria**
Schleiergasse 20, A-1100 Wien, Austria
Tel: 01-60203900

THE NETHERLANDS

**Yamaha Music Central Europe,
Branch Nederland**
Clarissenhof 5-b, 4133 AB Vianen, The Netherlands
Tel: 0347-358 040

BELGIUM/LUXEMBOURG

**Yamaha Music Central Europe GmbH,
Branch Belgium**
Rue de Geneve (Genevstraat) 10, 1140 - Brussels,
Belgium
Tel: 02-726 6032

FRANCE

**Yamaha Musique France, S.A.
Division Professionnelle**
BP 70-77312 Marne-la-Vallée Cedex 2, France
Tel: 01-64-61-4000

ITALY

**Yamaha Musica Italia S.P.A.
Combo Division**
Viale Italia 88, 20020 Lainate (Milano), Italy
Tel: 02-935-771

SPAIN/PORTUGAL

Yamaha-Hazen Música, S.A.
Ctra. de la Coruna km. 17, 200, 28230
Las Rozas (Madrid), Spain
Tel: 91-639-8888

GREECE

Philippos Nakas S.A. The Music House
147 Skiathou Street, 112-55 Athens, Greece
Tel: 01-228 2160

SWEDEN

Yamaha Scandinavia AB
J. A. Wettergrens Gata 1
Box 30053
S-400 43 Göteborg, Sweden
Tel: 031 89 34 00

DENMARK

YS Copenhagen Liaison Office
Generatorvej 8B
DK-2730 Herlev, Denmark
Tel: 44 92 49 00

FINLAND

F-Musiikki Oy
Kluuvikatu 6, P.O. Box 260,
SF-00101 Helsinki, Finland
Tel: 09 618511

NORWAY

Norsk filial av Yamaha Scandinavia AB
Grini Næringspark 1
N-1345 Østerås, Norway
Tel: 67 16 77 70

ICELAND

Skifan HF
Skeifan 17 P.O. Box 8120
IS-128 Reykjavik, Iceland
Tel: 525 5000

OTHER EUROPEAN COUNTRIES

Yamaha Music Central Europe GmbH
Siemensstraße 22-34, 25462 Rellingen, Germany
Tel: +49-4101-3030

AFRICA

**Yamaha Corporation,
Asia-Pacific Music Marketing Group**
Nakazawa-cho 10-1, Hamamatsu, Japan 430-8650
Tel: +81-53-460-2312

MIDDLE EAST

TURKEY/CYPRUS

Yamaha Music Central Europe GmbH
Siemensstraße 22-34, 25462 Rellingen, Germany
Tel: 04101-3030

OTHER COUNTRIES

Yamaha Music Gulf FZE
LB21-128 Jebel Ali Freezone
P.O.Box 17328, Dubai, U.A.E.
Tel: +971-4-881-5868

ASIA

HONG KONG

Tom Lee Music Co., Ltd.
11/F., Silvercord Tower 1, 30 Canton Road,
Tsimshatsui, Kowloon, Hong Kong
Tel: 2737-7688

INDONESIA

**PT. Yamaha Music Indonesia (Distributor)
PT. Nusantik**
Gedung Yamaha Music Center, Jalan Jend. Gatot
Subroto Kav. 4, Jakarta 12930, Indonesia
Tel: 21-520-2577

KOREA

Yamaha Music Korea Ltd.
Tong-Yang Securities Bldg. 16F 23-8 Yoido-dong,
Youngdungpo-ku, Seoul, Korea
Tel: 02-3770-0661

MALAYSIA

Yamaha Music Malaysia, Sdn., Bhd.
Lot 8, Jalan Perbandaran, 47301 Kelana Jaya,
Petaling Jaya, Selangor, Malaysia
Tel: 3-703-0900

PHILIPPINES

Yupangco Music Corporation
339 Gil J. Puyat Avenue, P.O. Box 885 MCPO,
Makati, Metro Manila, Philippines
Tel: 819-7551

SINGAPORE

Yamaha Music Asia Pte., Ltd.
11 Ubi Road #06-00, Meiban Industrial Building,
Singapore
Tel: 65-747-4374

TAIWAN

Yamaha KHS Music Co., Ltd.
3F, #6, Sec.2, Nan Jing E. Rd. Taipei.
Taiwan 104, R.O.C.
Tel: 02-2511-8688

THAILAND

Siam Music Yamaha Co., Ltd.
121/60-61 RS Tower 17th Floor,
Ratchadaphisek RD., Dindaeng,
Bangkok 10320, Thailand
Tel: 02-641-2951

THE PEOPLE'S REPUBLIC OF CHINA AND OTHER ASIAN COUNTRIES

**Yamaha Corporation,
Asia-Pacific Music Marketing Group**
Nakazawa-cho 10-1, Hamamatsu, Japan 430-8650
Tel: +81-53-460-2317

OCEANIA

AUSTRALIA

Yamaha Music Australia Pty. Ltd.
Level 1, 99 Queensbridge Street, Southbank,
Victoria 3006, Australia
Tel: 3-9693-5111

NEW ZEALAND

Music Houses of N.Z. Ltd.
146/148 Captain Springs Road, Te Papapa,
Auckland, New Zealand
Tel: 9-634-0099

COUNTRIES AND TRUST TERRITORIES IN PACIFIC OCEAN

**Yamaha Corporation,
Asia-Pacific Music Marketing Group**
Nakazawa-cho 10-1, Hamamatsu, Japan 430-8650
Tel: +81-53-460-2312

HEAD OFFICE Yamaha Corporation, Pro Audio & Digital Musical Instrument Division
Nakazawa-cho 10-1, Hamamatsu, Japan 430-8650
Tel: +81-53-460-3273



Yamaha PK CLUB (Portable Keyboard Home Page, English only)
<http://www.yamahaPKclub.com/>

Yamaha Manual Library
<http://www2.yamaha.co.jp/manual/english/>

M.D.G., Pro Audio & Digital Musical Instrument Division, Yamaha Corporation
© 2003 Yamaha Corporation

WA07130 ???PO???.?-03C0 Printed in China