

Roland ED



SOUND Canvas SC-8820

Owner's Manual

Before using this unit, carefully read the sections entitled: "USING THE UNIT SAFELY" and "IMPORTANT NOTES" (p. 3; p. 5). These sections provide important information concerning the proper operation of the unit. Additionally, in order to feel assured that you have gained a good grasp of every feature provided by your new unit, Owner's manual should be read in its entirety. The manual should be saved and kept on hand as a convenient reference.

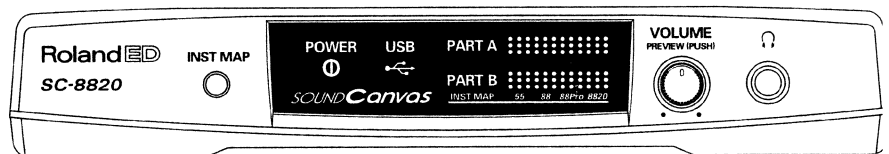

Copyright © 1999 ROLAND CORPORATION

All rights reserved. No part of this publication may be reproduced in any form without the written permission of ROLAND CORPORATION.

USING THE UNIT SAFELY

INSTRUCTIONS FOR THE PREVENTION OF FIRE, ELECTRIC SHOCK, OR INJURY TO PERSONS

About ⚠ WARNING and ⚠ CAUTION Notices







⚠ WARNING	Used for instructions intended to alert the user to the risk of death or severe injury should the unit be used improperly.
⚠ CAUTION	Used for instructions intended to alert the user to the risk of injury or material damage should the unit be used improperly. * Material damage refers to damage or other adverse effects caused with respect to the home and all its furnishings, as well to domestic animals or pets.







About the Symbols

⚠	The ⚠ symbol alerts the user to important instructions or warnings. The specific meaning of the symbol is determined by the design contained within the triangle. In the case of the symbol at left, it is used for general cautions, warnings, or alerts to danger.
⊘	The ⊘ symbol alerts the user to items that must never be carried out (are forbidden). The specific thing that must not be done is indicated by the design contained within the circle. In the case of the symbol at left, it means that the unit must never be disassembled.
⦿	The ⦿ symbol alerts the user to things that must be carried out. The specific thing that must be done is indicated by the design contained within the circle. In the case of the symbol at left, it means that the power-cord plug must be unplugged from the outlet.

ALWAYS OBSERVE THE FOLLOWING

⚠ WARNING

- Before using this unit, make sure to read the instructions below, and the Owner's Manual. 
- Do not open (or modify in any way) the unit or its AC adaptor. 
- Do not attempt to repair the unit, or replace parts within it (except when this manual provides specific instructions directing you to do so). Refer all servicing to your retailer, the nearest Roland Service Center, or an authorized Roland distributor, as listed on the "Information" page. 
- Never use or store the unit in places that are:
 - Subject to temperature extremes (e.g., direct sunlight in an enclosed vehicle, near a heating duct, on top of heat-generating equipment); or are 
 - Damp (e.g., baths, washrooms, on wet floors); or are 
 - Humid; or are
 - Exposed to rain; or are
 - Dusty; or are
 - Subject to high levels of vibration.
- Make sure you always have the unit placed so it is level and sure to remain stable. Never place it on stands that could wobble, or on inclined surfaces. 

- Be sure to use only the AC adaptor supplied with the unit. Also, make sure the line voltage at the installation matches the input voltage specified on the AC adaptor's body. Other AC adaptors may use a different polarity, or be designed for a different voltage, so their use could result in damage, malfunction, or electric shock. 

- Avoid damaging the power cord. Do not bend it excessively, step on it, place heavy objects on it, etc. A damaged cord can easily become a shock or fire hazard. Never use a power cord after it has been damaged. 
- This unit, either alone or in combination with an amplifier and headphones or speakers, may be capable of producing sound levels that could cause permanent hearing loss. Do not operate for a long period of time at a high volume level, or at a level that is uncomfortable. If you experience any hearing loss or ringing in the ears, you should immediately stop using the unit, and consult an audiologist. 
- Do not allow any objects (e.g., flammable material, coins, pins); or liquids of any kind (water, soft drinks, etc.) to penetrate the unit. 

- Immediately turn the power off, remove the AC adaptor from the outlet, and request servicing by your retailer, the nearest Roland Service Center, or an authorized Roland distributor, as listed on the "Information" page when:
 - The AC adaptor or the power-supply cord has been damaged; or
 - Objects have fallen into, or liquid has been spilled onto the unit; or
 - The unit has been exposed to rain (or otherwise has become wet); or
 - The unit does not appear to operate normally or exhibits a marked change in performance.

- In households with small children, an adult should provide supervision until the child is capable of following all the rules essential for the safe operation of the unit.

- Protect the unit from strong impact. (Do not drop it!)

- Do not force the unit's power-supply cord to share an outlet with an unreasonable number of other devices. Be especially careful when using extension cords—the total power used by all devices you have connected to the extension cord's outlet must never exceed the power rating (watts/ amperes) for the extension cord. Excessive loads can cause the insulation on the cord to heat up and eventually melt through.

- Before using the unit in a foreign country, consult with your retailer, the nearest Roland Service Center, or an authorized Roland distributor, as listed on the "Information" page.

- DO NOT play a CD-ROM disc on a conventional audio CD player. The resulting sound may be of a level that could cause permanent hearing loss. Damage to speakers or other system components may result.



CAUTION

- The unit and the AC adaptor should be located so their location or position does not interfere with their proper ventilation.

- Always grasp only the plug or the body of the AC adaptor when plugging into, or unplugging from, an outlet or this unit.

- Whenever the unit is to remain unused for an extended period of time, disconnect the AC adaptor.

- Try to prevent cords and cables from becoming entangled. Also, all cords and cables should be placed so they are out of the reach of children.

- Never climb on top of, nor place heavy objects on the unit.

- Never handle the AC adaptor body, or its plugs, with wet hands when plugging into, or unplugging from, an outlet or this unit.

- Before moving the unit, disconnect the AC adaptor and all cords coming from external devices.

- Before cleaning the unit, turn off the power and unplug the AC adaptor from the outlet (P.18).

- Whenever you suspect the possibility of lightning in your area, disconnect the AC adaptor from the outlet.



IMPORTANT NOTES

In addition to the items listed under "USING THE UNIT SAFELY" on Page 3, please read and observe the following:

Power Supply

- Do not use this unit on the same power circuit with any device that will generate line noise (such as an electric motor or variable lighting system).
- The AC adaptor will begin to generate heat after long hours of consecutive use. This is normal, and is not a cause for concern.
- Before connecting this unit to other devices, turn off the power to all units. This will help prevent malfunctions and/or damage to speakers or other devices.

Placement

- Using the unit near power amplifiers (or other equipment containing large power transformers) may induce hum. To alleviate the problem, change the orientation of this unit; or move it farther away from the source of interference.
- This device may interfere with radio and television reception. Do not use this device in the vicinity of such receivers.
- Do not expose the unit to direct sunlight, place it near devices that radiate heat, leave it inside an enclosed vehicle, or otherwise subject it to temperature extremes. Excessive heat can deform or discolor the unit.
- To avoid possible breakdown, do not use the unit in a wet area, such as an area exposed to rain or other moisture.

Maintenance

- For everyday cleaning wipe the unit with a soft, dry cloth or one that has been slightly dampened with water. To remove stubborn dirt, use a cloth impregnated with a mild, non-abrasive detergent. Afterwards, be sure to wipe the unit thoroughly with a soft, dry cloth.
- Never use benzine, thinners, alcohol or solvents of any kind, to avoid the possibility of discoloration and/or deformation.

Additional Precautions

- Use a reasonable amount of care when using the unit's buttons, sliders, or other controls; and when using its jacks and connectors. Rough handling can lead to malfunctions.
- When connecting / disconnecting all cables, grasp the connector itself—never pull on the cable. This way you will avoid causing shorts, or damage to the cable's internal elements.
- To avoid disturbing your neighbors, try to keep the unit's volume at reasonable levels. You may prefer to use headphones, so you do not need to be concerned about those around you (especially when it is late at night).
- When you need to transport the unit, package it in the box (including padding) that it came in, if possible. Otherwise, you will need to use equivalent packaging materials.
- Use a cable from Roland to make the connection. If using some other make of connection cable, please note the following precautions.
 - Some connection cables contain resistors. Do not use cables that incorporate resistors for connecting to this unit. The use of such cables can cause the sound level to be extremely low, or impossible to hear. For information on cable specifications, contact the manufacturer of the cable.

Handling CD-ROMs

- Avoid touching or scratching the shiny underside (encoded surface) of the disc. Damaged or dirty CD-ROM discs may not be read properly. Keep your discs clean using a commercially available CD cleaner.

Main Features

Supports GM (General MIDI) / GM 2 (General MIDI 2) / GS Format

This unit is a sound module compatible with the General MIDI and 2. It can be used to play back any song data (General MIDI scores) bearing the General MIDI logo. This unit is also compatible with the Roland GS format. It can be used to play back any song data bearing the GS logo.

32-Part/64-Voice Multitimbral

The SC-8820 is a 32-part, 64-voice multitimbral sound module. A single unit can produce the sounds of a large ensemble. It is a sound module for use with computers or sequencers.

* This is only when the USB connector or serial connector is used. When the MIDI connectors are used, a maximum of 16 parts are available.

High-Quality Sounds

A high-quality and versatile range of 1,608 sounds and 63 drum sets are provided. These include the same sounds as the SC-55/55mkl, SC-88 and SC-88Pro, so that you will be able to enjoy existing performance data or commercially available music data (*1) (p.25).

Furthermore, the sounds that have been newly added on the SC-8820 are organized in a manner that is compatible with the top-of-the-line SC-8850. This means that music data that was produced for the SC-8850 can be played back using essentially the same instrumentation(*2).

*1 The performance may differ slightly depending on the data.

*2 Although the arrangement of sounds in the SC-8850 map and the SC-8820 map are identical, differences in the waveform data that is used, the number of voices used by each sound, and the maximum polyphony of each device may mean that the reproduction may not be perfect.

A complete selection of effects

The effects provided by the SC-8820 include 64 different Insertion effects, which can be applied to specific parts; 8 types of reverb, 8 types of chorus, 10 types of delay, and 2-band equalization. In addition, you can adjust parameters for each of these effects to modify the sound to your taste. (p.40, p.47)

User Sounds

By editing sound parameters such as vibrato, filter and envelope, you can modify sounds to your taste.

USB connector provided

A USB connector and a Serial connector are provided for direct connection to an Apple Macintosh computer or a PC. Using sequencing software, you can play back and edit song data. (p.10, p.12)

Bus power supply is also supported, so that you can enjoy simple setup even without an AC adaptor.

* Depending on how your computer supplies power to USB connector, the unit may not be able to operate on bus power supply. If this is the case, use it with the AC adaptor connected.

Connecting with Other Devices

Audio input jacks allow you to connect another sound source, and output it from the audio output jacks mixed with the SC-8820's own sound. (p.16)

You will need a few other things

The SC-8820 has only the minimum buttons and controls required for operation. This means that in order to perform operations such as selecting sounds, you will need to connect a computer or keyboard that has a MIDI interface. Also, you will need a set of headphones or a stereo system to listen to the sound.

GM (General MIDI)

General MIDI is a set of recommendations which seeks to provide a way to go beyond the limitations of proprietary designs, and standardize the MIDI capabilities of sound generating devices. Sound generating devices and music files that meet the General MIDI standard bear the General MIDI logo ().

Music files bearing the General MIDI logo can be played back using any General MIDI sound generating unit to produce essentially the same musical performance.

GM 2 (General MIDI 2)

The upwardly compatible General MIDI 2 () recommendations pick up where the original General MIDI left off, offering enhanced expressive capabilities, and even greater compatibility.

Issues that were not covered by the original General MIDI recommendations, such as how sounds are to be edited, and how effects should be handled, have now been precisely defined. Moreover, the available sounds have been expanded.

General MIDI 2 compliant sound generators are capable of reliably playing back music files that carry either the General MIDI or General MIDI 2 logo.

In some cases, the conventional form of General MIDI, which does not include the new enhancements, is referred to as "General MIDI 1" as a way of distinguishing it from General MIDI 2.

GS format

The GS Format () is Roland's set of specifications for standardizing the performance of sound generating devices. In addition to including support for everything defined by the General MIDI, the highly compatible GS Format additionally offers an expanded number of sounds,

provides for the editing of sounds, and spells out many details for a wide range of extra features, including effects such as reverb and chorus.

Designed with the future in mind, the GS Format can readily include new sounds and support new hardware features when they arrive.

* GS () is a registered trademark of Roland Corporation.

* Microsoft, Windows, and Windows NT are registered trademarks of Microsoft Corporation.

* Apple is a registered trademark of Apple Computer, Inc.

* Macintosh is a registered trademark of Apple Computer, Inc.

* PC-9800 Series is a trademark of NEC Corporation.

* All product names mentioned in this document are trademarks or registered trademarks of their respective owners.

Contents

USING THE UNIT SAFELY	3
IMPORTANT NOTES	5
Main Features	6
Panel Descriptions	9
Front Panel	9
Rear Panel	9
Connecting to Your Computer/MIDI Keyboard ..	10
Connecting to a Computer	10
Connecting to a Computer via the USB Connector	10
Connecting to a Computer via the Serial Connector	12
Connecting to a Computer via the MIDI Connectors	13
How MIDI Messages Are Exchanged with a Computer	14
Do You Hear Sound?	15
Connecting to Headphones	16
Connecting to an Audio Input Jacks	16
Connecting to a MIDI Keyboard	17
Making Connections	17
Turning the Power ON/OFF	18
Do you Hear Sound?	18
Connecting Another MIDI Sound Source to the SC-8820	19
Making Connections	19
Parts and Sounds	20
Switching the Sound of Each Part	20
Types of Part	20
Which MIDI IN Will be Used by Each Part?	20
Selecting Basic Sounds (Normal Part)	21
Using MIDI Messages to Select Instruments from Other Devices or Sequencing Software	22
Selecting Drum Sets (Drum Part)	24
Using MIDI Messages to Select Drum Sets from Other Devices or Sequencing Software	25
Selecting the Same Sounds As the SC-88Pro/SC-88/SC-55	25
Legato-enabled Sounds	26
How the Number of Simultaneous Notes and Voices Are Related	26
Parameters	27
Part Parameters for Performance	27
What Each Parameter Does	27
Part Parameters for Sound Editing	33
The Function of Each Parameter	33
Parameters Common to All Parts	36
What Each Parameter Does	36
Effects	39
System Effects	39
Insertion Effects (EFX)	39
System Effects	40
Reverb Parameters and Their Functions	40
Chorus Parameters and Their Functions	42
Delay Parameters and Their Functions	44
Equalizer Parameters	46
Insertion Effects	47
Insertion Effect Parameters and their functions	47
Insertion Effect Types	48
Appendices	89
Troubleshooting	89
About MIDI	95
What's MIDI?	95
What is General MIDI 2?	96
MIDI Messages That Can Be Received by the SC-8820	98
Computer Cable Wiring Diagrams	106
Instrument List	107
Drum Set List	127
GM 2 Instrument List	153
GM 2 Drum Set List	155
Insertion Effect List	156
Effect Parameter Value Conversion Table	164
MIDI Implementation	166
Specifications	186
Index	187
Operations via MIDI	190

Panel Descriptions

■ Front Panel

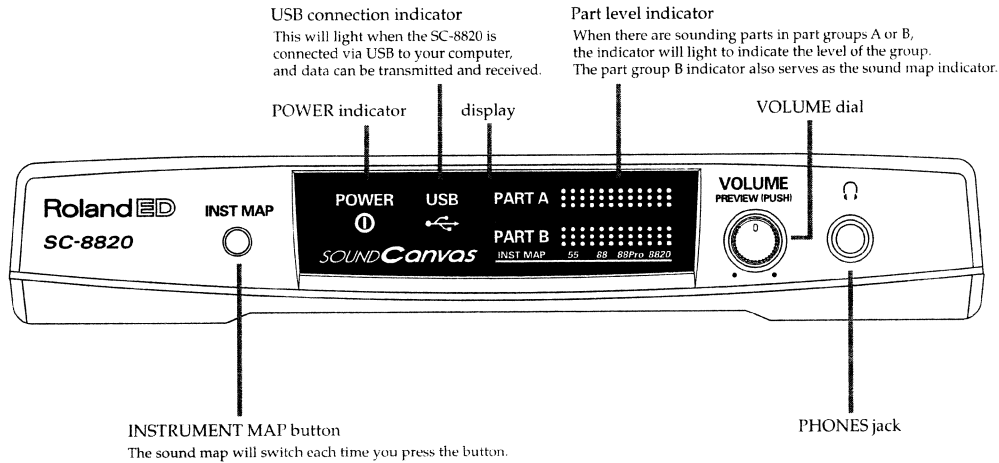

■ Rear Panel

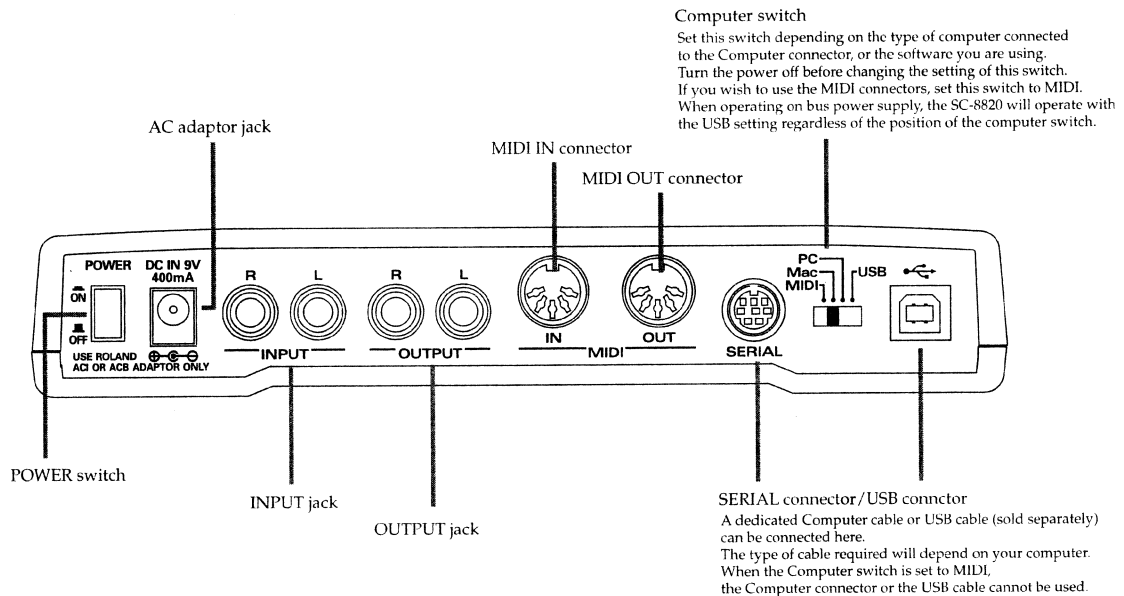

Connecting to Your Computer/MIDI Keyboard

Connecting to a Computer

There are three ways to connect the SC-8820 to your computer; using the **USB connectors**, the **MIDI connectors** or the **Serial connector**. You can use up to 32 parts if you use the USB connectors or the Serial connectors, and up to 16 parts if you use the MIDI connectors. And if you use the MIDI connectors, you will need to obtain a computer interface board (adaptor) that has MIDI connectors (such as the Roland Super MPU II, etc.). If you use the USB connectors or the Serial connectors, you can use a special cable to connect the SC-8820 directly with the computer, but your software must be able to correspond to the USB port or the Serial port. (Refer to the **How MIDI Messages Are Exchanged with a Computer** p.14)



To prevent malfunction and/or damage to speakers or other devices, always turn down the volume, and turn off the power on all devices before making any connections.



When connecting your computer to the SC-8820 via a USB cable, it is not necessary to turn off the power of your computer.

■ Connecting to a Computer via the USB Connector

USB stands for Universal Serial Bus, and is a new interface used for connecting various peripherals to a computer.

USB allows you to use a single USB cable to connect numerous peripheral devices, and allows data to be transferred faster than previous serial ports.

Also, peripheral devices can be connected or disconnected while the power is still turned on, and the computer will detect this automatically. (For some peripherals, settings or other operations may be required.)

The SC-8820 is supplied with power from its connected AC adaptor, but it also supports bus power supply. Power can be supplied simply by connecting a USB cable, so that an AC adaptor need not be connected. Before disconnecting the AC adaptor, please turn the power switch OFF.

* For the most stable operation, we recommend that you use it with the AC adaptor connected.

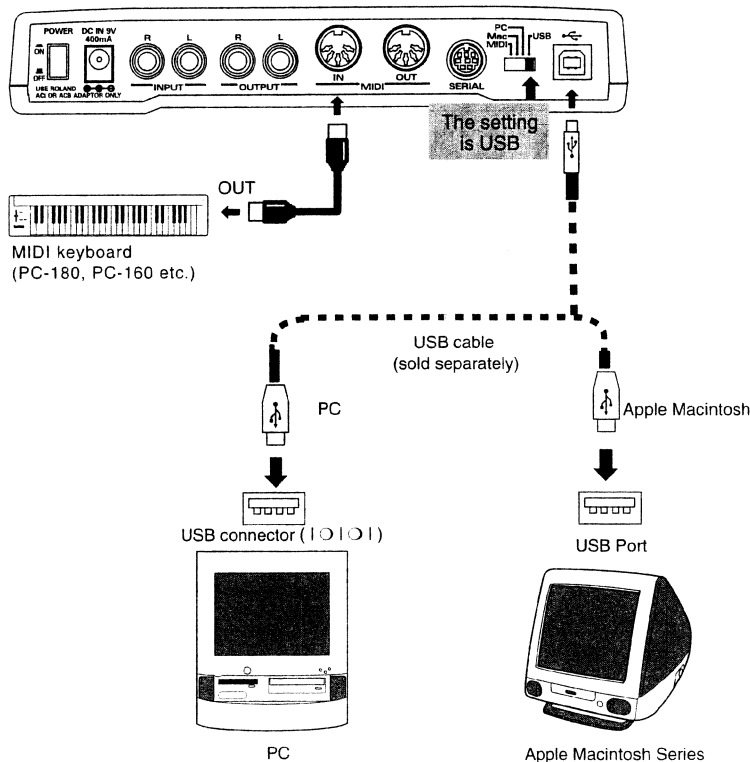

Depending on the power supply conditions of your computer or USB hub, the SC-8820 may not operate on bus power supply. If this is the case, please use it with the AC adaptor connected.

- 1** Turn off the power of the SC-8820 and set the COMPUTER switch to [USB].

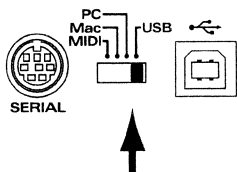

* When operating on bus power supply, the SC-8820 will operate with the USB setting regardless of the position of the computer switch.

- 2** Connect the USB cable to the USB connector or USB port of your computer.

- 3** Connect the other end of the USB cable to the SC-8820's USB connector.

Installing the USB Driver

In order to connect your computer to the SC-8820 via a USB cable, you must first install the USB driver (MIDI driver). The USB driver is contained in the included CD-ROM.

The USB driver is software that passes data between your computer application (sequencer software etc.) and the SC-8820 when your computer is connected via a USB cable to the SC-8820.

The USB driver passes data from the application program to the SC-8820, and passes MIDI messages from the SC-8820 to the application program.

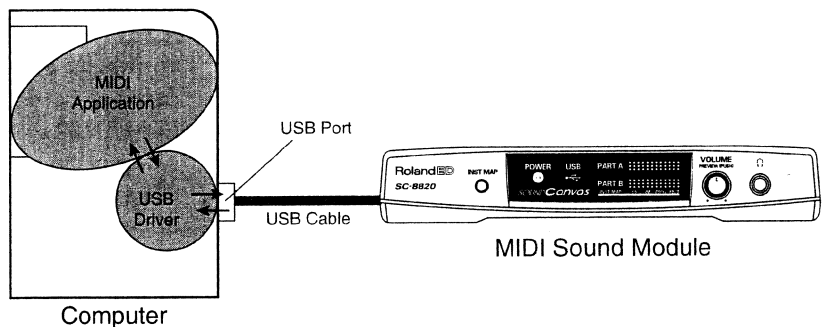

For details on installing the USB driver, refer to the booklet for the included **Software Library for SC-8820**.

Cautions when using a USB connection
 Even if the SC-8820's USB connector is connected to your computer, it will not operate correctly unless the driver supports your computer. Be sure to use a computer for which operation has been verified.

NOTE

Turn off the power before changing the setting of the COMPUTER switch. The setting of this switch takes effect when the power is turned on.

MEMO

When connecting the SC-8820 and the PC via the USB cable, you can use only Windows 98 compatible machines.

MEMO

You may need to make various settings on your computer, so carefully read the owner's manual for your software, and make the appropriate settings before use.

Connecting to Your Computer/MIDI Keyboard

■ Connecting to a Computer via the Serial Connector

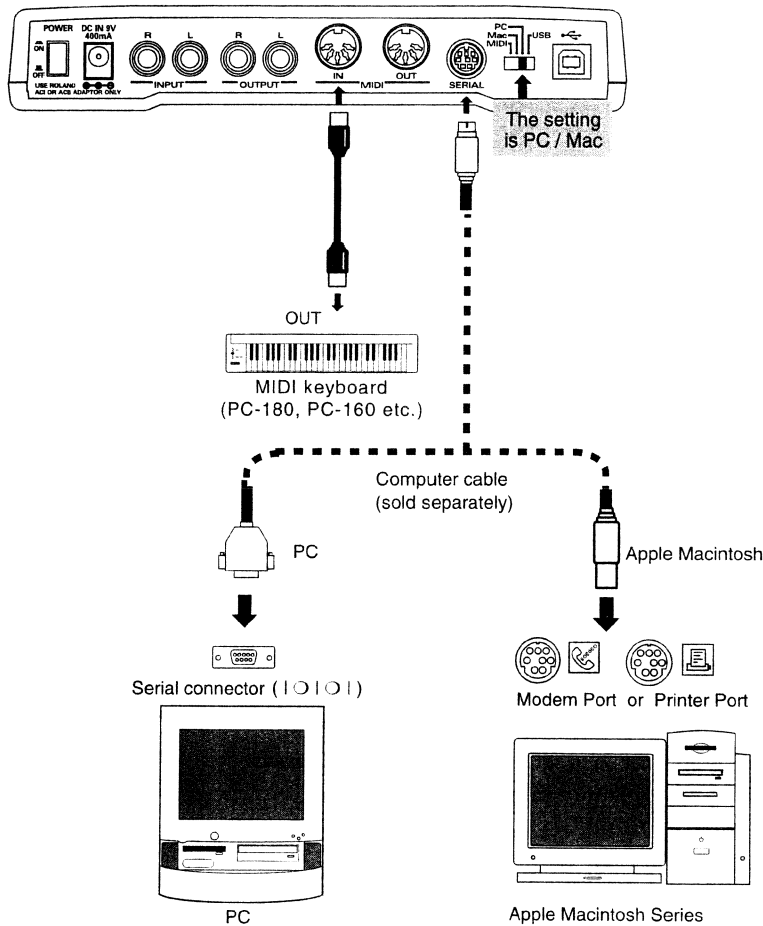

Before making connections to other devices, it is very important to turn down the volume and turn off the power in order to prevent malfunctions or speaker damage.



If you are using the serial connector to make connections, you must also connect the AC adaptor.



Turn off the power before changing the setting of the COMPUTER switch. The setting of this switch takes effect when the power is turned on.



Be aware that the appropriate setting of the COMPUTER switch may differ, depending on the type of computer.



You will need to have a Computer cable (sold separately) that is appropriate for the computer that you are using. Refer to **Computer Cable Wiring Diagrams** (p. 106).

1

Turn off the power of the SC-8820, then set the COMPUTER switch, which is located on the back of the SC-8820.

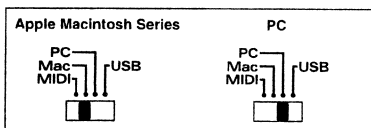

Select the "Mac" position if you are using an Apple Macintosh computer, or select the "PC" position if you are using a PC.

The PC baud rate is 38.4 Kbps.

* This cannot be used on computers whose baud rate can be set only to 31.25 Kbps.

2

Connect the Computer cable to the Serial port (PC), or the Modem or Printer port (Apple Macintosh series computer) on the back of your computer.

3

Connect the other end of the Computer cable to the Serial connector (SERIAL) of the SC-8820.

Installing the Serial MIDI Driver

In order to connect your computer to the SC-8820 via a computer cable, you must first install the Serial MIDI driver (MIDI driver). The Serial MIDI driver is contained in the included CD-ROM.

The Serial MIDI driver is software that passes data between your computer application (sequencer software etc.) and the SC-8820 when your computer is connected via a computer cable to the SC-8820.

The Serial MIDI driver passes data from the application program to the SC-8820, and passes MIDI messages from the SC-8820 to the application program.

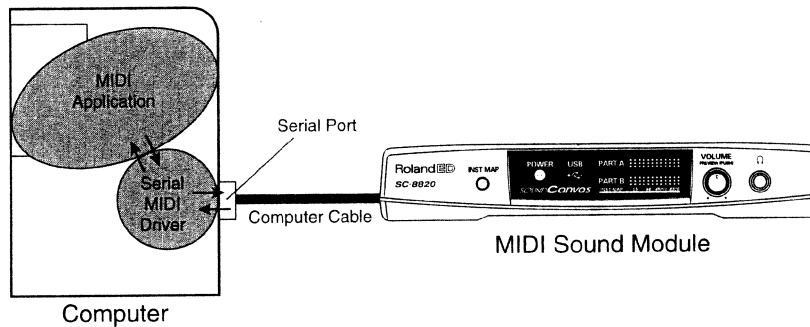

For details on installing the Serial MIDI driver, refer to the booklet for the included Software Library for SC-8820.

■ Connecting to a Computer via the MIDI Connectors

If you use the MIDI connectors, you will need to obtain a computer interface board (adaptor) that has MIDI connectors (such as the Roland Super MPU II, etc.).

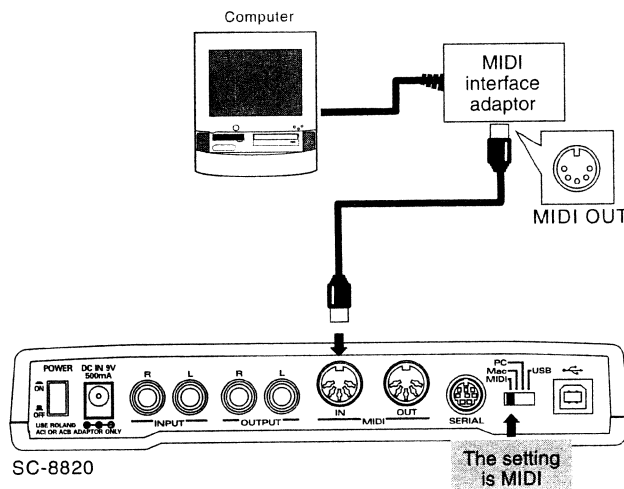

* Set the COMPUTER switch located on the back of the SC-8820 to [MIDI]. If you use MIDI cables, the SC-8820 will be limited to a maximum of 16 parts. If you wish to perform using more than 17 parts, use either a USB cable or a computer cable.

MEMO

In some cases, you will need to make settings on your computer, so carefully read the owner's manual for the software that you wish to use, and make the appropriate settings before use.

NOTE

If you are using the serial connector to make connections, you must also connect the AC adaptor.

NOTE

Before making connections to other devices, it is very important to turn down the volume and turn off the power in order to prevent malfunctions or speaker damage.

NOTE

Turn off the power before changing the setting of the COMPUTER switch. The setting of this switch takes effect when the power is turned on.

■ How MIDI Messages Are Exchanged with a Computer

Depending on the setting of the COMPUTER switch, MIDI data flow will be different as follows.

When the COMPUTER switch is set to USB

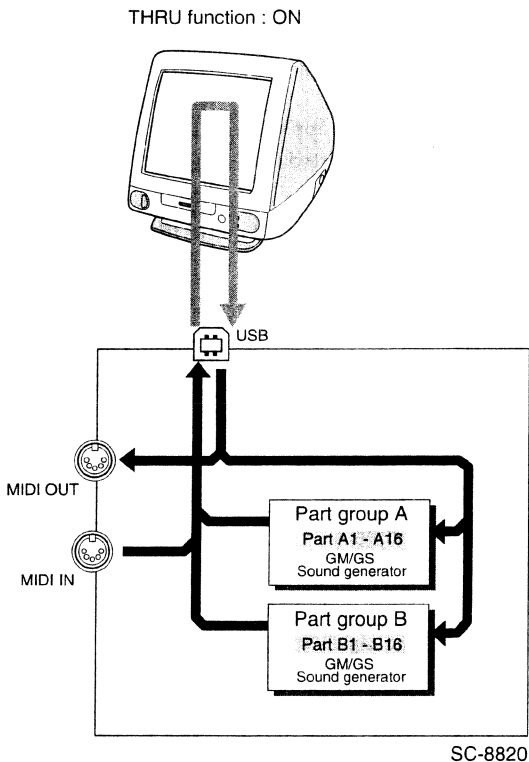

MEMO

The number of sound generator Parts that can be controlled using the USB connector or the Serial connector will depend on the software you are using. This means that if you are using the USB connector or the Serial connector, you will not necessarily be able to play 32 Parts. Carefully read the owner's manual for your software.

When the COMPUTER switch is set to SERIAL (PC or Mac)

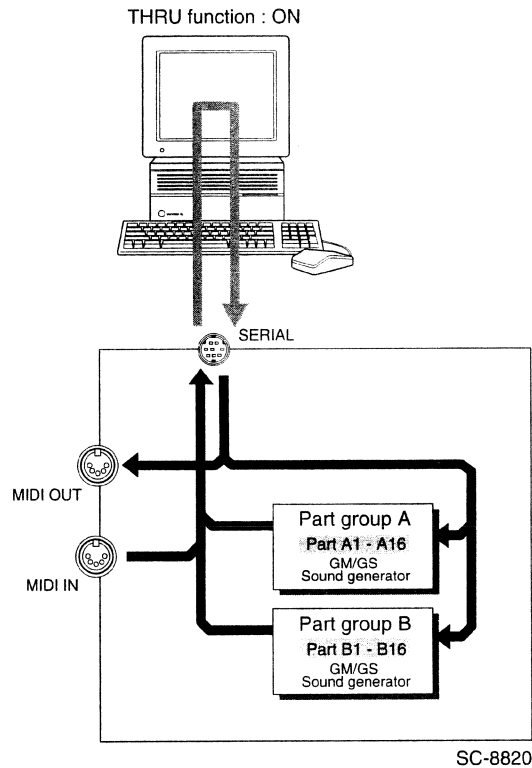

The Thru function of the computer software

In order for data received at MIDI IN to be sent to the sound generator section, the Thru function of the computer software must be turned on. When Thru function is turned on, the data received at MIDI IN will pass through the computer and be played by the sound generator section.

MEMO

For details on how to turn on the Thru function, refer to the owner's manual for the software that you are using.

■ Do You Hear Sound?

If the SC-8820 is connected to your computer but you do not hear any sound, this may be due to a variety of reasons. A flow chart has been provided to help you determine the problem. In the **Appendices**, please refer to **No sound** (p. 90).

Connecting to Headphones

Use headphones of 8 – 150 ohms impedance. Sound will be output from the audio output jacks even when headphones are connected.

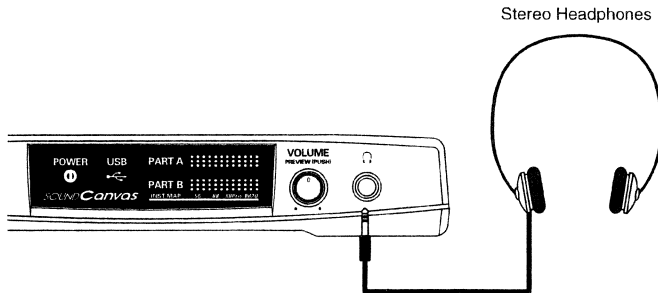

NOTE

Even with headphones connected, the output from the audio output jacks will not be muted.

Connecting to an Audio Input Jacks

You can connect the output jacks of other MIDI sound sources to these jacks. The audio signal that is input here will be mixed with this unit's sound and output from the audio output jacks.

Audio (Sound Card, CD player etc)

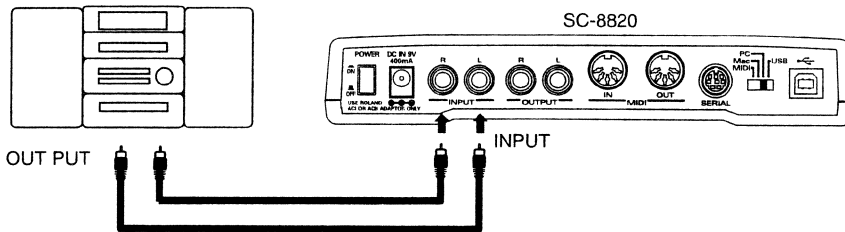

MEMO

To adjust the level of the audio input, make adjustments on your audio device.

Connecting to a MIDI Keyboard

■ Making Connections

This section explains how to connect this unit to a MIDI keyboard and play the sounds. If you wish to connect a sequencer or personal computer to this unit, refer to p.10.

Set the COMPUTER switch located on the back of this unit to **MIDI**.

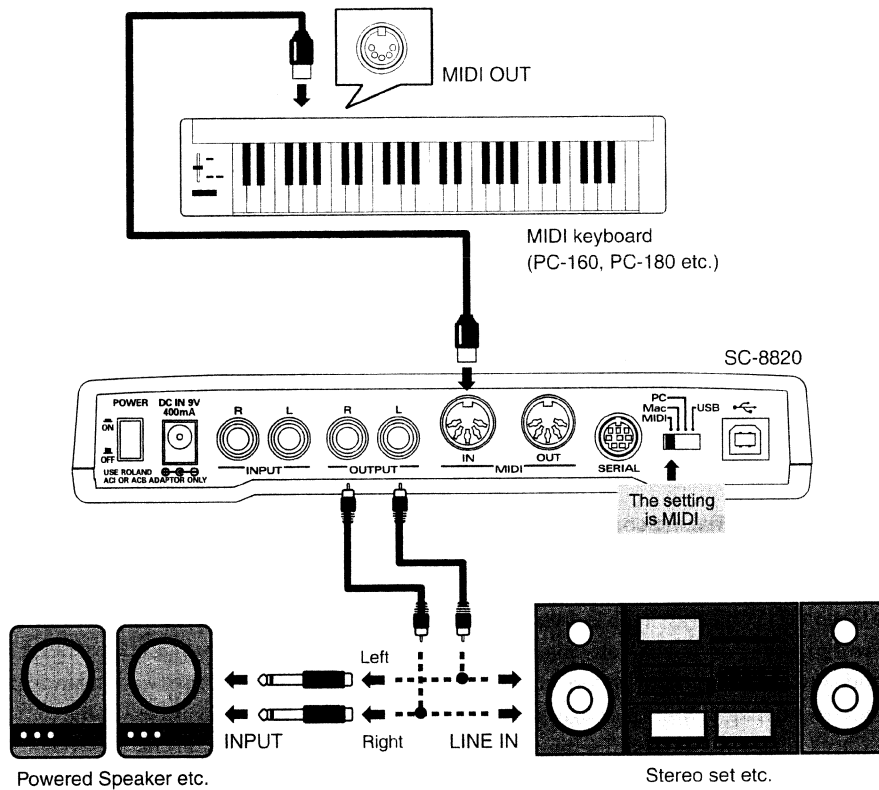

NOTE

To prevent malfunction and/or damage to speakers or other devices, always turn down the volume, and turn off the power on all devices before making any connections.

NOTE

The new setting of the COMPUTER switch will take effect when the power is turned on. Turn off the power before changing the setting of the COMPUTER switch.

MEMO

Be sure to match the L/R Output jacks of the SC-8820 with the L/R input jacks on your audio equipment. If you get them reversed, the sounds you play will be reversed too.

■ Turning the Power ON/OFF

Once the connections have been completed, turn on power to your various devices in the order specified.

Here we will explain how to connect the SC-8820 to an audio reproduction system (stereo set or amplified speakers). If you are using headphones, you may skip the explanations regarding operation of your audio reproduction system.

Turning the Power On

- 1** Before you turn the power on, turn down the volume of the SC-8820 and audio playback devices (your amp/speaker system).
- 2** Push the Power switch to turn on the SC-8820.
- 3** Turn on the power of your audio system.
- 4** Set the volume of each device to an appropriate setting.

■ Do you Hear Sound?

After making connections as explained in **Making connections**, turn the power on, and gradually raise the volume while playing the keyboard. Do the part level indicators of the SC-8820 light? If they light, the SC-8820 is receiving MIDI messages. This unit will sound a note when the [VOLUME] knob is pressed (the Preview function). If playing your keyboard produces no sound, you can use this function to see whether the amp volume and speaker connections are correct. If this unit part level indicator does not light, MIDI messages are not being received from your MIDI keyboard. Check your MIDI keyboard settings and MIDI cable connections.

Turning the Power Off

- 1** Before you turn the power off, turn down the volume of SC-8820 and audio playback devices (your amp/speaker system).
- 2** Turn off audio devices, and then turn off the SC-8820.



By turning on devices in the wrong order, you risk causing malfunction and/or damage to speakers and other devices.



When connecting the SC-8820 to your speaker system, excessive volumes can damage your speaker system. Please be aware that speakers used in conventional stereo systems are more vulnerable to being damaged by high volume levels than are speakers designed for musical instruments.



This unit is equipped with a protection circuit. A brief interval (a few seconds) after power up is required before the unit will operate normally.



At the factory settings, this unit will produce sound in response to any channel 1 – 16, regardless of the transmit channel your keyboard is set to (p.96). This is because each Part is assigned to the correspondingly numbered MIDI channel.

Connecting Another MIDI Sound Source to the SC-8820

■ Making Connections

Use a MIDI cable (sold separately) to connect the SC-8820's MIDI OUT connector to the MIDI IN connector of the other MIDI sound source.

When the **COMPUTER** switch is set to [SERIAL (PC, Mac)] or [USB]

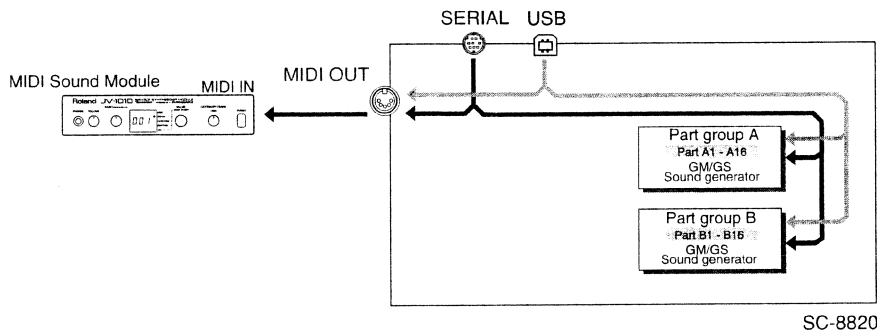

When the **COMPUTER** switch is set to [MIDI]

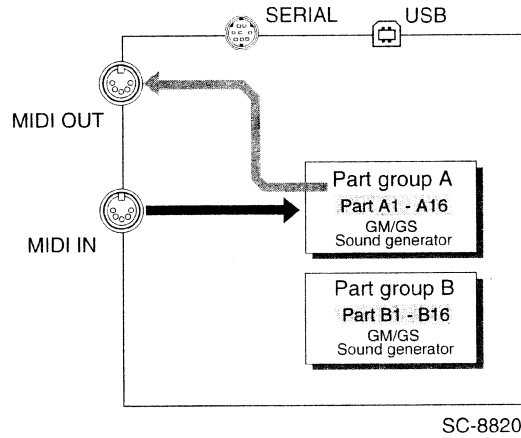

* If you connect this unit using MIDI cable, you cannot use the Part B.

MEMO

MIDI messages will be transmitted from MIDI OUT to the connected device. If you set track output to **MIDI OUT** on your sequencer software, the performance will be transmitted from MIDI OUT without being played by the SC-8820, allowing you to play a performance together with a different sound module. (It is not possible for the data of the same track to simultaneously be output to both the SC-8820 and MIDI OUT.)

NOTE

Be aware that when the **COMPUTER** switch located on the back of the SC-8820 is set to MIDI, data will not be exchanged via the USB or the Serial connector.

Parts and Sounds

The SC-8820 is able to produce 32 different sounds at once. (Used with the USB connector and the Serial connector only.) An instrument such as the SC-8820, which can simultaneously produce many sounds from a single unit is called a **multitimbral sound generator**. A timbre is an instrumental sound. Being able to simultaneously play 32 sounds means that you can use 32 different instruments at once. In other words, you can create an orchestra-like ensemble of 32 musical parts. In the SC-8820, the sound selected for each Part is called an **Instrument**. (Instrument List, p.107) You can assign the sounds you want to each of 32 Parts to create your own ensemble.

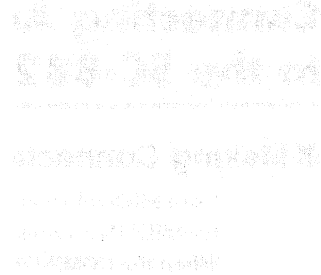

Switching the Sound of Each Part

■ Types of Part

The SC-8820 has 32 Parts. Parts are classified into Group A (A01-A16), Group B (B01-B16) with sixteen in each group.

There are two types of Parts: **Normal Parts** and **Drum Parts**. We refer to this difference as the Part Mode. Normal Parts are used for playing melody or bass lines. Drum Parts are used for playing percussion instruments.

With the initial settings (when the power is turned on), each part is set to the following part mode.

Normal Part: A01-A09, A11-A16, B01-B09, B11-B16
Drum Part: A10, B10



You can change the Part Mode settings. For more information, refer to **Part Mode** (p.28).

■ Which MIDI IN Will be Used by Each Part?

When playing the SC-8820 via the MIDI connector, group A will correspond to MIDI IN. Normally, MIDI IN is used to play parts A01 through A16.

At the factory settings, group A correspond to the SC-8820's MIDI IN connector.

In other words, MIDI messages received at MIDI IN is sent to the Group A Parts. For example, MIDI messages on channel 5 received at MIDI IN will sound Part 5 of Group A (A05) (at the factory settings).

It is not possible to sound the parts of group B when using the MIDI IN connector to play the SC-8820.

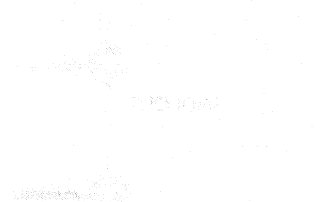
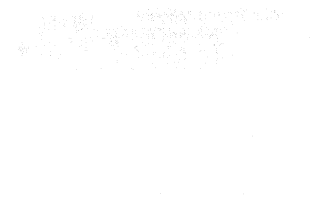

■ Selecting Basic Sounds (Normal Part)

How to Use the Instrument List

Sounds (Instruments) contained in the SC-8820 are in the **Instrument List** (p.107).

Each sound (Instrument) of the SC-8820 has two numbers; an **Instrument number** and a **Variation number**. Sounds with Variation number 000 are Capitals, and the sounds with numbers other than 000 are Variations.

In the **Instrument List**, you can check both the Instrument number and the Variation number.

<Example>

CC00	PC	SC-8820 Map	Voices	SC-88Pro Map	Voices	SC-88 Map	Voices	SC-55 Map	Voices
000	093	Bowed Glass	2 [Pro]	Bowed Glass	2 [88]	Bowed Glass	2 [55]	Bowed Glass	2
001		SoftBellPad	2 [Pro]	SoftBellPad	2	----	2	----	
002		JP8 Sqr Pad	2 [Pro]	JP8 Sqr Pad	2	----	2	----	
003		7thBelPad	2 [Pro]	7thBelPad	2	----	2	----	
004		Steel Glass	2	----		----		----	
005		Bottle Stack	2	----		----		----	

CC00 Variation number (value of Controller number 0)
Capital sounds with Variation number 0 are shown in boldface.

PC Instrument number (Program Number)

SC-8820 Map sounds of SC-8820

SC-88Pro Map sounds of SC-88Pro

SC-88 Map sounds of SC-88 map

SC-55 Map sounds of SC-55 map

---- no sound in the Variation number

Voices number of voices used by the Instrument

Remark : legato-enabled sounds

Remark [Pro] same sounds as SC-88Pro map

Remark [88] same sounds as SC-88 map

Remark [55] same sounds as SC-55 map

Remark + percussive sounds which cannot be played melodically.



Voices (p.26)



Legato-enabled sounds (p.26)

■ Using MIDI Messages to Select Instruments from Other Devices or Sequencing Software

You can use sequencing software on your computer to select the SC-8820's sounds. You can specify sounds by inputting the **Variation number** and the **Instrument number** (p.21) into your sequencing program, but depending on your software the way in which numbers are displayed may differ, so be aware of this. On the SC-8820, Variation numbers begin with 0, and Instrument numbers begin with 1. Variation numbers correspond to **MIDI Bank numbers**, and Instrument numbers correspond to **MIDI Program numbers**.

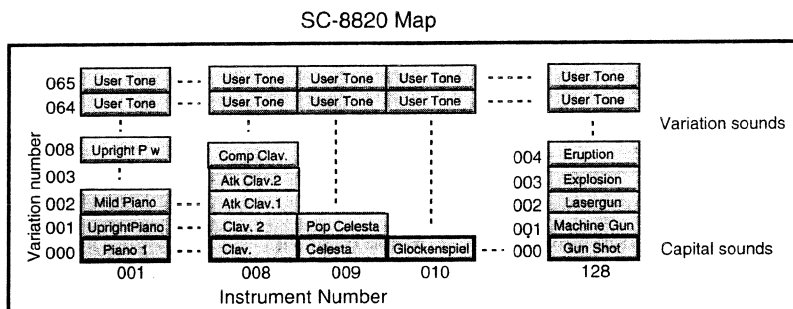

MEMO

MIDI Bank numbers have an upper (MSB) and lower (LSB) part. Each can specify a number 0-127, allowing you to specify $128 \times 128 = 16384$ banks. The upper part of the Bank number corresponds to the SC-8820 Variation number. The lower part switches between SC-55 map, SC-88 map, SC-88Pro map, and SC-8820 map. (MIDI Implementation, p.166).

MEMO

If you specify an Instrument number that the SC-8820 does not have, a sound will not change. Refer to **Instrument List** on p.107 when selecting sounds.

NOTE

Note that the data actually transmitted as the Program number will be one less than the Program number.

Actual MIDI Messages

When creating MIDI messages on a sequencing program and transmitting them, use the following procedure.

- [1] The value of Control Change 0: MIDI Bank number (upper) (the SC-8820's Variation number)
- [2] The value of Control Change 32: MIDI Bank number (lower) (0: map setting on the panel, 1: SC-55 map, 2: SC-88 map, 3: SC-88Pro map, 4: SC-8820 map)
- [3] Program Change value: MIDI Program number (the SC-8820's Instrument number)

* For details, refer to the following section **Bank Select LSB**.

[1] and [2] are the Bank Select message. Bank Select messages are a type of Control Change message (p.99), and the Bank Select processing will be suspended until a Program Change message is received.

For example, if you wish to select the Instrument (Piano3w) with Variation number 8, Instrument number 3, you would transmit the following data to the SC-8820. (Expressed in decimal notation.)

- [1] The value of Control Change 0: 008 (Bank number (upper) 8; Variation number 8)
- [2] The value of Control Change 32: 0
- [3] Program Change value: 002 (Program number 3: Instrument number 3)

Bank Select LSB

The SC-8820 processes the lower part of the Bank Select message (LSB) as follows (p.99).

Least significant byte (LSB)

- | | |
|---|---|
| 0 | The INST MAP settings shown on the panel of the SC-8820 will be used. Press the INST MAP button on the panel. When the Inst Map indicator lights to indicate "55," the SC-55 map is selected; "88" indicates the SC-88 map, "88Pro" indicates the SC-88Pro map, and "8820" indicates the SC-8820 map. |
| 1 | The SC-55 map will be selected. |
| 2 | The SC-88 map will be selected. |
| 3 | The SC-88Pro map will be selected. |
| 4 | The SC-8820 map will be selected. |

Operation via MIDI

How to change the sound of a part using MIDI messages

<Example> Setting the sound of Part 2 to the SC-88 map 017 Organ 1 (Variation 000)

MIDI CH =	02	
CC#00	000	Selects Variation number 000
CC#32	002	Selects the SC-88 map
PC#	017	Selects Instrument number 017

Operation via MIDI

How to change the variation sound of a part using MIDI messages

<Example> Setting the sound of Part 1 to the SC-8820 map 006 Detuned EP3 (Variation 009)

MIDI CH =	01	
CC#00	009	Selects Variation number 009
CC#32	004	Selects the SC-8820 map
PC#	006	Selects Instrument number 006

Operation via MIDI

How to change the map and variation sound of a part using MIDI messages

<Example> Setting the sound of Part 3 to the SC-88Pro map 039 Acid Bass (Variation 008)

MIDI CH =	03	
CC#00	008	Selects Variation number 008
CC#32	003	Selects the SC-88Pro map
PC#	039	Selects Instrument number 039

■ Selecting Drum Sets (Drum Part)

How to Use the Drum Set List

Each drum sound (Drum Instrument) is assigned to a different note of the Drum set. The Drum Sets of the SC-8820 are listed in the **Drum Set List** (p.127), which gives the number and name of each sound in each Drum set.

P.128 and the following provide lists of the SC-8820 Sets, SC-8820 Drum Sets, SC-88 Drum Sets, and SC-55 Drum Sets, giving the number and name of each sound.

<Example>

	PC1 STANDARD 1	PC2 STANDARD 2	PC3 STANDARD L/R	PC9 ROOM
C1	22 MC-500 Beep 1	<-	<-	<-
23	MC-500 Beep 2	<-	<-	<-
24	Concert SD	<-	<-	<-
25	Snare Roll	<-	<-	<-
26	Finger Snap 2	Finger Snap	<-	Finger Snap
27	High Q	<-	<-	<-
28	Slap	<-	<-	<-
29	Scratch Push [EXC7]	<-	<-	<-
30	Scratch Pull [EXC7]	<-	<-	<-
31	Sticks	<-	<-	<-
32				
33				
34				
35				

- PC Drum Set number (Program number)
- Keys Note Number
- <- Same as the percussion sound of **STANDARD 1** Set (PC1).
- No sound
- [Pro] Same as the percussion sound of SC-88Pro
- [88] Same as the percussion sound of SC-88
- [55] Same as the percussion sound of SC-55
- [EXC] Percussion sound of the same number will not be heard at the same time.
- * Tones that are created using two voices

■ Using MIDI Messages to Select Drum Sets from Other Devices or Sequencing Software

You can select Drum Sets by transmitting MIDI messages from a sequencing program, in the same way as you can select Instruments. When a Program Change message is received, the Drum Set will change. Transmit a Program Change message on the channel being received by the Drum Part. At the factory settings, Part 10 is the Drum Part (MIDI receive channel:10). On the SC-8820, Drum Set numbers (displayed under **INST.**) correspond to Program numbers (p.127).

Set the note numbers of the rhythm data being played back to match the note numbers of the SC-8820 Drum Set you are using (p.128).

Drum Set name and Drum Set number (Program number)

STANDARD 1	---	ROOM	---	TR-808	---	User Set	User Set
001		009		026		065	066

Operation via MIDI

How to change the drum set of a part using MIDI messages

<Example> Setting the sound of Part 10 to the SC-8820 map 013 ROOM L/R

MIDI CH = 10

CC#00 000 Selects Variation number 000

CC#32 004 Selects the SC-8820 map

PC# 013 Selects Instrument number 013

■ Selecting the Same Sounds As the SC-88Pro/SC-88/SC-55

The SC-8820 has four maps: an SC-8820 map, which contains original sounds; an SC-88Pro map, which contains the same sounds as the SC-88Pro; an SC-88 map, which contains the same sounds as the SC-88; and an SC-55 map, which contains almost the same sounds as the SC-55/SC-55mkII. If you wish to use the same sounds as the SC-88Pro, SC-88, or SC-55, change the map.

* Part blocks A and B will both be switched.

Each time you subsequently press [INST MAP], the SC-8820, SC-88Pro, SC-88, and SC-55 instrument maps will be selected in succession, and the corresponding Inst Map indicator will light.

After making this change, wait for a short time, and the input map indicator will return to the part group B level indicator display.

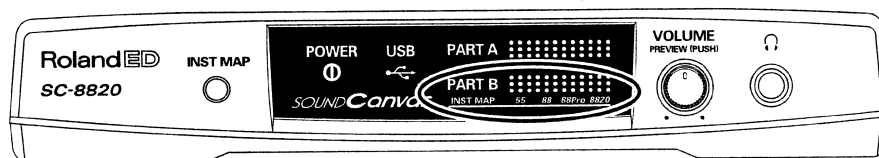

■ Legato-enabled Sounds

The SC-8820 provides legato-enabled sounds, which are ideally suited to legato playing, and can realistically simulate this instrumental performance technique. To understand this feature, consider how most string instruments produce sound. Usually, a brief attack-like sound will be heard only at the very instant the string is made to vibrate. After that a much mellower, attack-free sound continues to emanate during the string's vibration. The legato-enabled sounds simulate such variable attack-portion characteristics of string sounds by switching on or off certain special voices within an Instrument according to the way the keyboard is played. Try out one of these sounds to hear how it works. Play a note and keep your finger on that key while playing another note. You should hear a distinct attack portion with the first note you play, while the second one contains almost no attack components, and sounds much smoother.

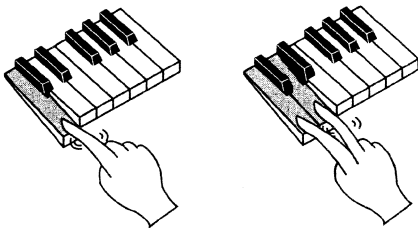

If you want to sound the attack portion each time, simply release your finger from a key before playing the next note.

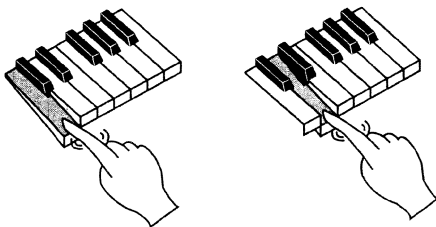

How the Number of Simultaneous Notes and Voices Are Related

On the SC-8820, the sounds are made up of **voices**, the smallest unit of sound generation. There is a limit to how many of these Voices can sound at once, and in the case of the SC-8820, up to 64 simultaneous voices can be used. Some sounds (Instruments) use 1 voice and others use more (Instrument List, p.107). The main reason for using more than 2 voices is to allow different timbres to be produced by different velocity values, or to produce richer textures by layering the multiple sounds. If more than 64 voices are used at once, later-sounded notes will be given priority, and notes sounded previously will be turned off, starting from the oldest. If you use only single-voice Instruments, you will be able to play 64 notes simultaneously, but if some of the Instruments are more than 2-voice ones, you won't be able to play 64 simultaneous notes. Even if a MIDI Note Off message (p.99) is received, voices will be used for as long as the sound is heard. Be aware of this especially in the case of sound with a long release (p.35).

MEMO

Legato control cannot be switched on and off on an Instrument basis. You should choose and edit an Instrument that meets your intended usage.

MEMO

If song data created with 64 voice playback in mind is played back on a sound generator with fewer voices, some notes will drop out, and the musical result will not be as it should. The SC-8820, the SC-88Pro and SC-88 has 64 voices, the SC-55 has 24 voices, and the SC-55mkII has 28 voices.

Parameters

In this chapter, we provide a general description of each of the parameters. A “parameter” is something that affects the sound. The process of modifying parameter values is called “editing.” Although it is not possible to modify the values of parameters by operating the SC-8820 itself, you can modify parameter values by using the editing functionality of your computer software or sequencer. For instructions on how to make settings, please refer to the MIDI Implementation (p.166). The range shown in this chapter is the same as that shown in the “Description” column of the MIDI Implementation.

Part Parameters for Performance

These parameters determine how each Part behaves when it receives MIDI messages. The way in which the sound changes in response to messages such as velocity, pitch bend, modulation and aftertouch will be determined by the settings of these parameters.

■ What Each Parameter Does

The following parameters determine how each Part behaves when it receives MIDI messages.

■ EFFECT

REVERB SEND LEVEL (Reverb Send Level) 0–40–127
set the Reverb Send Level of each Instrument

CHORUS SEND LEVEL (Chorus Send Level) 0–127
set the Chorus Send Level of each Instrument

DELAY SEND LEVEL (Delay Send Level) 0–127
set the Delay Send Level of each Instrument

EQ ON/OFF (Part Equalizer) Off/On
Equalizer on/off can be set for individual Parts. Part equalizer will be on, and the equalizer will be applied to the sounds of Parts. Part equalizer will be off, and the equalizer will not be applied to the sounds of Parts. At the factory settings, equalizer gain is set at 0. This means that the equalizer will have no effect even if the Part EQ is on.

PART EFX ASSIGN (Insertion Effects) Off/On
Set the Insertion Effects ON/Off.

■ EDIT

PART LEVEL 0–100–127
Adjusts the volume of an individual Part. Raising the value will increase the volume. The basic volume of the entire SC-8820 is adjusted by the [VOLUME] knob. If the [VOLUME] knob is at minimum position, there will be no sound even if this LEVEL setting is raised.

PART PANPOT Rnd, L63–0–R63
Pan sets the stereo position of the sound when a stereo playback system is used. For example, the drum set and bass might be placed in the center, the guitar at right, and the keyboard at left. (If you are listening to the SC-8820 in mono, pan settings will have no effect.) As the L-value increases the sound will be placed further left, and as the R-value increases the sound will be placed further right. To place a sound in the center, set the Pan value to 0. If you continue pressing PAN [◀] when setting for each Part, **Rnd** (random) will be selected, and each note will be placed at a random stereo position.

MEMO

For the procedure of changing the Part EQ On/Off using MIDI messages, refer to p.37.

MEMO

For details on insertion effects, refer to **Insertion Effects (EFX)** (p.39), or to **Insertion Effects** (p.47).

MEMO

In the case of a Drum Set, the pan position has been fixed for each percussion instrument. Adjusting the pan of a Drum Set will shift the overall set to left or right.

MEMO

For some Instruments, a bit of sound may be heard from the opposite speaker even if pan has been set fully left or right.

□ Rx. CHANNEL (MIDI channel)

Specify the MIDI channel that will be assigned to each part. Parts that are set to OFF will ignore all MIDI messages other than system exclusive messages, meaning that they will not produce sound.

□ USE FOR RHYTHM PART

Normal/Drum1/Drum2

For Parts that are playing conventional instrument sounds, select Normal (Normal mode). For Parts that are playing percussion or drums, select Drum1 or Drum2. Drum Parts play a different sound (Instrument) for each different MIDI note number (p.99). In other words, a single Part can play many different percussion instrument sounds (**Drum Set List** p.127).

Each Part 1–16 can be used either for normal sounds (Normal Part) or for a Drum Set (Drum Part).

The mode of a Drum Part can be either Drum1 or Drum2. Since the same Drum Set will automatically be selected for Parts that have the same Part Mode, this means that up to 2 types of Drum Set can be used simultaneously.

For example, if you set the Part Mode of Part 10 and Part 11 respectively to Drum1 and Drum2, you could select STANDARD1 for Part 10 and JAZZ for Part 11. If the Part Mode of both Parts 10 and 11 were set to Drum1, selecting STANDARD1 for Part 10 would automatically select STANDARD1 for Part 11 as well.

□ MONO/POLY MODE (Mono/Poly Mode)

Mono/Poly

If a Part is set to Mono (Mono Mode), that Part will play only one note at a time. It is effective to select Mono Mode for Parts that are playing a naturally monophonic instrument such as a trumpet or sax. Select Poly (Poly Mode) for Parts that are playing chords.

□ PITCH KEY SHIFT

-24-±0-+24

Key Shift adjusts the pitch of the sound in semitone steps. For example, if you were playing back song data from a sequencing program, you could use the Key Shift parameter to change the key of the song without changing the settings for the sequencing program. Or, if you are singing along with sequence data, you can adjust Key Shift to move the song to the key most comfortable for your voice. As the displayed value rises (falls) one step, the pitch will rise (fall) one semitone. This means that 12 steps equal one octave. With a setting of 0 the pitch will not be affected.

□ PITCH FINE TUNE

-100.0-0.0-+100.0 cents

Use this parameter when you wish to make fine adjustments to the tuning of a Part. Positive (+) settings will raise the pitch, and negative (-) settings will lower the pitch. If two or more Parts are set to the same MIDI channel and the same sound and spread their Fine Tuning settings apart, you can add rich depth and breath to the sound.

□ BEND PITCH CONTROL

±0-+2-+24

This parameter specifies the way in which the sound will change when the Pitch Bend messages are received. At the factory settings, this parameter modifies the pitch. A setting of 12 allows 1 octave of change, and a setting of 24 allows 2 octaves of change. With a setting of 0, there will be no pitch change.

* Bend Range is the same parameter as Bnd Range accessed by pressing [BEND] ([F3]) (p.31). Whichever parameter you set, the parameter set last will be valid.

□ MOD LFO1 PITCH DEPTH (Modulation Depth)

0-10-127

This parameter applies vibrato to the sound when the Modulation messages are received. Higher values allow the modulation effect to be increased.

* Mod Depth is the same parameter as Mod LFO Pitch accessed by pressing [MOD] ([F2]) (p.31). Whichever parameter you set, the parameter set last will be valid.



For the procedure of changing the Part Mode using MIDI messages, refer to p.38.



For a Drum Part, changing the Mono/Poly Mode setting will not affect the sound.



Even if you adjust Key Shift for all Parts, the pitch of the Drum Part will not be affected.



To shift the pitch of all Parts, use M. Key Shift. (p.36)



To adjust the pitch of all Parts, use the Master Tune parameter (p.36).



For some sounds, the pitch may not rise as high as specified by the Range setting.

- **VELOCITY SENSE DEPTH (Velocity Sensitivity Depth)** 0-64-127
- **VELOCITY SENSE OFFSET (Velocity Sensitivity Offset)** 0-64-127

The force with which you play a note on MIDI keyboard is transmitted as MIDI Velocity data. Strongly played notes will have a higher velocity value. The Velo Depth and Velo Offset parameters determine the relation between the force of the keyboard playing and the loudness of the sound that results.

If Velo Depth is increased, small differences in your playing dynamics will make a large difference in the loudness of the sound (Fig.3). If Velo Depth is decreased, even large differences in your playing dynamics will make only a small difference in the loudness of the sound (Fig.2).

If Velo Offset is set higher than 64, even softly played notes (i.e., notes with a low velocity) will be sounded loudly (Fig.5). If Velo Offset is set lower than 64, even strongly played notes (i.e., notes with a high velocity) will be sounded softly (Fig.4).

MEMO

For some settings, there may be no sound. If so, increase Velo Depth or Velo Offset.

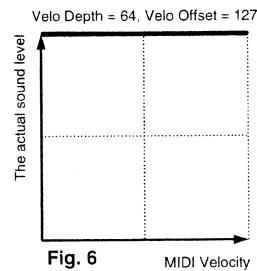
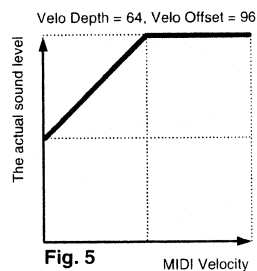
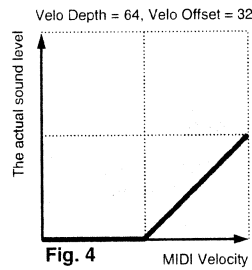
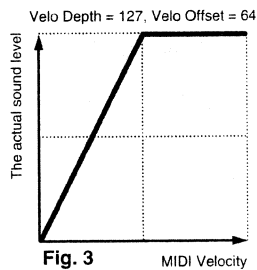
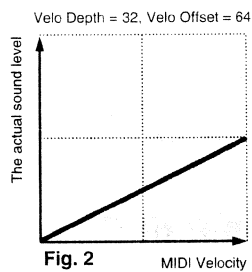
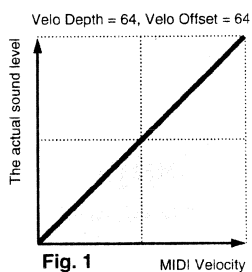

Parameters

- KEYBOARD RANGE LOW (Keyboard Range Low)** C-1–G9
- KEYBOARD RANGE HIGH (Keyboard Range High)** C-1–G9

The Key Range parameters determine the pitch range over which the instrument will be sounded. Keyboard Range Low (the lowest note) and Keyboard Range High (the highest note) will determine the range of notes that will sound. These values are displayed as key names. You can specify a value between C-1 and G9 (0–127), and middle C is C4 (60).

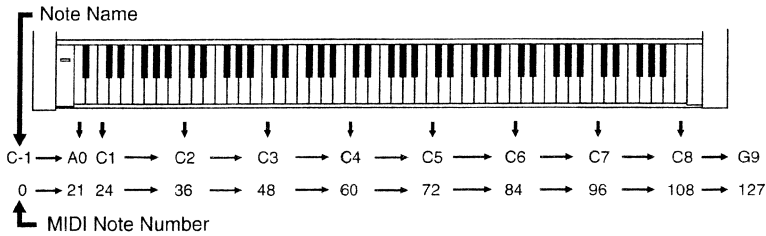

For example, if you assign two Parts to the same MIDI channel and set the Keyboard Range of one to C-1–B3 and the other to C4–G9. Then you could assign different sounds to each Part, and play two different sounds on either side of C4. Or, you could set the keyboard ranges of two Parts to overlap, and layer the two sounds.

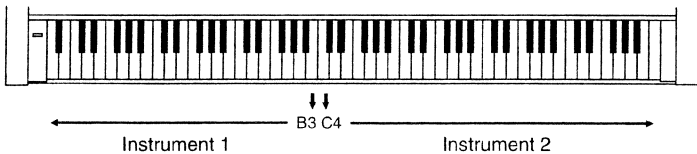

- CC1 CONTROLLER NUMBER (CC1 Controller Number)** 0–16–95
- Set the Controller number that will control the CC1 parameters (p.32) via MIDI. For example, if you set CC1 C.Number to 16, the value of an incoming MIDI Controller number 16 message will affect the sound as specified by the setting of the CC1 parameter.

MEMO

Be aware that if Keyboard Range High is set to a note name lower than Keyboard Range Low, there will be no sound.

■ MODIFY

* For details on the **MODIFY** parameters, refer to **The Function of Each Parameter** (p.33).

■ SCALE TUNING C-B

□ SCALE TUNING C-B

-64-±0-+63

Scale Tuning is a parameter which makes fine adjustments to the pitch of each note in the octave. These settings are for one octave of notes, and will simultaneously adjust the pitch of that note in all octaves. By using Scale Tuning, you can perform using a variety of temperaments other than equal temperament. Here we will give three settings as examples.

< Equal Temperament >

This tuning divides the octave into 12 equal parts, and is the most widely used method of temperament used in Western music. The default setting of the SC-8820's Scale Tune function is Equal Temperament.

< Just Intonation (Tonic of C) >

Compared with equal temperament, the principle triads sound pure in this tuning. However, this effect is achieved only in one key, and the triads will become ambiguous if you transpose. Here is an example of the settings for a tonic of C.

< Arabian-style Scale >

A variety of ethnic tunings can be achieved by using the Scale Tuning function. Here are settings for a tuning representative of Arabian-style scales.

Example settings (values are in units of cents)

Note name	Equal temperament	Just intonation (tonic of C)	Arabian-style Scale
C	0	0	-6
C#	0	-8	+45
D	0	+4	-2
D#	0	+16	-12
E	0	-14	-51
F	0	-2	-8
F#	0	-10	+43
G	0	+2	-4
G#	0	+14	+47
A	0	-16	0
A#	0	+14	-10
B	0	-12	-49

■ MOD/BEND/ CAf / CC1

The following explains the two parts that go together to make up a parameter name.

<The front half of the parameter name>

□ MOD ~ (Modulation ~)

When you move the modulation lever or modulation wheel of a MIDI keyboard, modulation messages are transmitted, modifying the sound. The Mod ~ parameters specify the way in which the sound will change when these messages are received. At the factory settings of these parameters, vibrato will be applied to the sound.

□ BEND ~ (Bend ~)

When you move the pitch bend lever or pitch wheel of a MIDI keyboard, pitch bend messages are transmitted, modifying the sound. The Bend ~ parameters specify the way in which the sound will change when these messages are received. At the factory settings of these parameters, the pitch will be modified.

□ CAf ~ (Channel aftertouch ~)

Some MIDI keyboards transmit messages known as aftertouch when pressure is applied to the keyboard after playing a note. Channel aftertouch (also known as channel pressure) transmits only one data value even if two or more notes are being pressed. When a sound generator receives this message, it can modify the sound in various ways. The CAf~ parameters specifies how the sound will change when the message is received. At the factory settings, no change will occur when this messages is received.

* Check whether your MIDI keyboard is able to transmit aftertouch messages.

□ CC1 ~

Some MIDI keyboards allow controller numbers to be assigned to the sliders. When these sliders are moved, messages of the specified controller number are transmitted, causing the sound to be modified. The CC1~ parameters specifies how the sound will change when messages of the corresponding control number are received.

First use the CC1 Controller Number parameter (p.30) to select the controller number that you are assigning.

<The latter half of the parameter name>

* When these settings are at 0, there will be no effect.

□ ~ PITCH CONTROL -24→+24 (Bend Range is +/-0→+24)

These parameters specify the maximum pitch change that will occur when the corresponding message is received. A setting of 12 allows 1 octave of change, and a setting of 24 allows 2 octaves of change. With a setting of 0, there will be no pitch change.

□ ~ TVF CUTOFF CONTROL (~Cutoff frequency)-64→+63

These parameters specify how the cutoff frequency will change when the corresponding message is received. Higher values will cause the cutoff frequency to rise. Positive (+) settings allow the sound to be made brighter, and negative (-) settings allow the sound to be made more mellow.

□ ~ AMPLITUDE CONTROL (~Amplitude) -64→+63

These parameters specify the way in which the sound will change when the corresponding message is received. Higher values allow a greater increase in volume.

□ ~ LFO RATE CONTROL -64→+63

These parameters specify the way in which the LFO frequency will change when the corresponding message is received, adjusting the speed at which the sound is modulated or varied. Higher values allow the modulation or variation to be speeded up.

□ ~ LF1 PITCH DEPTH 0→10→127

These parameters specify the way in which the depth of the vibrato effect (cyclic modulation of pitch) will change when the corresponding message is received. Higher values allow the modulation effect to be increased.

□ ~ LFO TVF DEPTH 0→127

These parameters specify the way in which the depth of the growl effect (cyclic modulation of tone) will change when the corresponding message is received. Higher values allow the growl effect to be increased.

□ ~ LFO TVA DEPTH 0→127

These parameters specify the way in which the depth of the tremolo effect (cyclic modulation of volume) will change when the corresponding message is received. Higher values allow the tremolo effect to be increased.

■ U.INST

For details on the U.INST parameters, refer to **The Function of Each Parameter** (p.33).



For some sounds, the pitch may not rise as high as specified by the Range setting.

Part Parameters for Sound Editing

On the SC-8820, you can modify the values of a variety of parameters in order to create the sound most suitable for your playing. Sound parameters affect the volume, timbre and pitch of the sound.

■ The Function of Each Parameter

On the SC-8820, parameter settings are made for each Part. In other words, parameter values belong to Parts, and not to sounds (Instruments). For example, if you set Vibrato Rate to +20 and then select a different sound for that Part, the Vibrato Rate of +20 will apply to the newly selected sound (not the initial value of +/-0). In this way, parameters belonging to Parts are called **Part parameters**.

Vibrato

Vibrato is an effect created by modulating the pitch. Applying vibrato makes the sound more expressive.

■ Vib Rate (Vibrato Rate) -64-0-+63

This parameter adjusts the speed (frequency) of the pitch modulation. Positive (+) settings make the pitch modulation faster, and negative (-) settings make it slower.

■ Vib Depth (Vibrato Depth) -64-0-+63

This parameter adjusts the depth of the pitch modulation. Positive (+) settings make the pitch modulation deeper, and negative (-) settings make it shallower.

■ Vib Delay (Vibrato Delay) -64-0-+63

This parameter adjusts the time required for the vibrato effect to begin. Positive (+) settings increase the time before vibrato will begin, and negative (-) settings shorten the time.

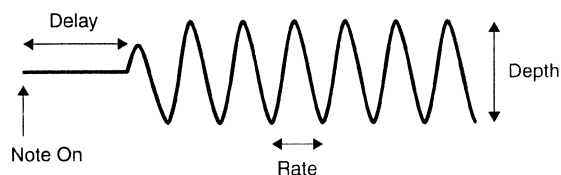

Filter

By modifying the filter settings, you can control the timbre (tone) of the sound. The type of filters in the SC-8820 are called Low Pass Filters, and allow only frequencies lower than a specified frequency to pass. This frequency is called the Cutoff Frequency. By modifying the setting of the Cutoff Frequency you can make the sound brighter or darker. The Cutoff Frequency can change over time, controlled by the envelope. By adjusting the filter and envelope settings, you can create sounds that have movement and expression.

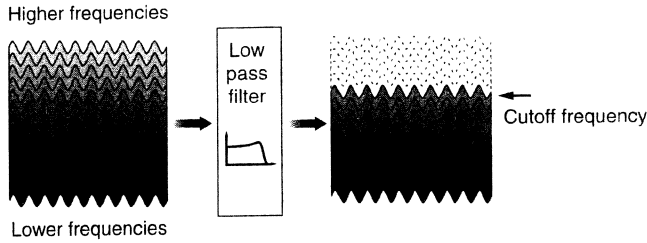

■ Cutoff Freq (Cutoff Frequency)

-64-0-+63

Positive settings of Cutoff Freq will raise the cutoff frequency. Negative settings will lower the cutoff frequency. As you set this value higher in the positive direction, more overtones will be allowed to pass, and the sound will become harder (brighter). The further this value is set in the negative direction, the fewer overtones will be allowed to pass, and the sound will become softer (darker).

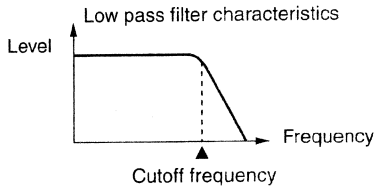

■ Resonance

-64-0-+63

When the Resonance value is increased, the overtones in the area of the cutoff frequency will be emphasized, creating a sound with a strong character.

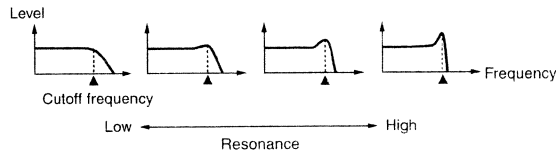

MEMO

For some sounds, positive (+) settings of Cutoff Freq will cause no noticeable change in the sound.

MEMO

For some sounds, negative (-) settings of Resonance will cause no noticeable change in the sound.

Envelope

The volume of an instrument changes with time, from the moment the note begins to sound to when it disappears. This change can be indicated on a graph as shown in the following diagram. This shape is unique to each instrument, and is an important element in how we distinguish sounds we hear. This shape is called the envelope.

The envelopes of musical instrument sounds can change depending on how the instrument is played. For example, if a trumpet is played sharply and strongly, the attack will be quick and the sound will be sharp. But if a trumpet is played lightly and softly, the attack will be softer. In order to adjust the attack of a sound, we can modify the Attack Time of the envelope. By modifying the values of the envelope we can simulate the characteristics of many different instruments.

The envelope shape that we create in this way will also affect the way in which the cutoff frequency changes. If the cutoff frequency had been lowered, it will rise as the envelope rises, and will fall as the envelope falls.

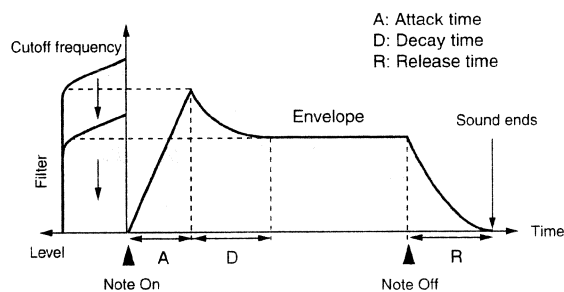

■ Attack Time -64-0-+63

This parameter adjusts the sharpness of the beginning of the sound.

■ Decay Time -64-0-+63

This parameter adjusts the time over which the sound will fall from the highest point of the attack down to the sustain level (Fig.1).

■ Release Time -64-0-+63

This parameter adjusts the time over which the sound will decay after the note is released until it is no longer heard. The cutoff frequency will also fall according to this.

Fig. 1

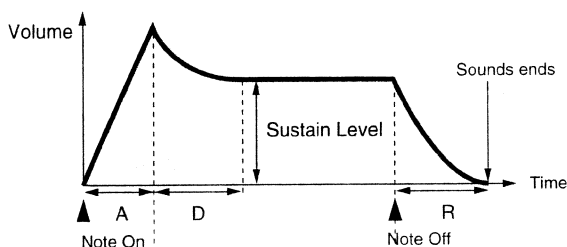
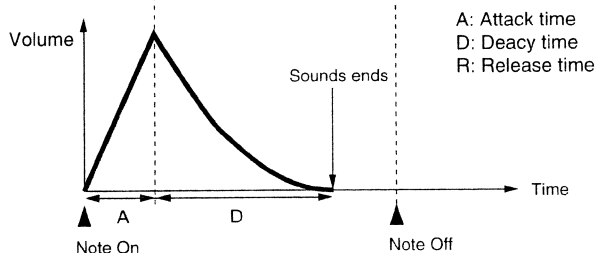

Fig. 2



Some sounds have a sustain level of 0 (Fig.2). Piano and guitar sounds are in this category.



For some sounds, modifying the various Time settings of the envelope will cause no noticeable change in the sound.

Parameters Common to All Parts

Here's how to make settings for parameters that are common to all Parts.

■ What Each Parameter Does

The settings for the following parameters made here apply to all Parts.

■ MASTER VOLUME

0–127

Adjusts the volume of all Parts. Raising the value will increase the volume.

The basic volume of the entire SC-8820 is adjusted by the [VOLUME] knob. If the [VOLUME] knob is at minimum position, there will be no sound even if this LEVEL setting is raised.

■ MASTER PAN

L63–0–R63

Master Pan sets the stereo position of the sound for all Parts. (If you are listening to the SC-8820 in mono, pan settings will have no effect.) As the L-value increases the sound will be placed further left, and as the R-value increases the sound will be placed further right. To place a sound in the center, set the Pan value to 0.

■ MASTER KEY-SHIFT (Master Key Shift)

-24–±0–+24, 2 octaves

Key Shift adjusts the pitch of the sound in semitone steps. For example, if you were playing back song data from a sequencing program, you could use the Key Shift parameter to change the key of the song without changing the settings for the sequencing program. Or, if you are singing along with sequence data, you can adjust Key Shift to move the song to the key most comfortable for your voice. As the displayed value rises (falls) one step, the pitch will rise (fall) one semitone. This means that 12 steps equal one octave. With a setting of 0 the pitch will not be affected.

■ MASTER TUNE (Master Tune)

415.3–440.0–466.2Hz

When you are playing in an ensemble with other instruments or need to set the SC-8820 to match the pitch of another instrument, adjust the Master Tune setting in the range of 415.3–466.2 Hz. The displayed value (e.g., 440.0 Hz) indicates the frequency of the A4 note's pitch (note number 69).



For some Instruments, a bit of sound may be heard from the opposite speaker even if pan has been set fully left or right.



Even if you adjust Key Shift for all Parts, the pitch of the Drum Part will not be affected.



To adjust the pitch of a single Part, use Key Shift. (p.28)

Operation via MIDI

How to change the level of a part using MIDI messages

<Example> Setting the level of Part 1 to 110

MIDI CH = 01
CC#07 110

Operation via MIDI

How to change the pan of a part using MIDI messages

<Example> Setting the pan of Part 2 to L30

MIDI CH = 02
CC#10 34

Since L63 is far left, 0 is center, and R63 is far right, it is calculated like this: $64 - 30 = 34$

Operation via MIDI

How to change the pan of a part to Random using MIDI messages

<Example> Setting the pan of Part 1 to be random

If you set the pan to be random, you cannot use Control Change message like the above example.

Transmit the following System Exclusive Message

address	data	checksum
F0 41 10 42 12 [40 11 1C] [00] [13] F7		
↑	↑	↑
Part 1	random	checksum

Operation via MIDI

To turn off the Equalizer of a Part using MIDI messages, transmit the following System Exclusive Message.

address	data	checksum
F0 41 10 42 12 [40 4x 20] [..] [..] F7		

Address: 40 4x 20 (EQ ON/OFF)

x: Part Number

Data 00-01

00 = OFF, 01 = ON

Checksum: Refer to **How to calculate the checksum** (p.184).

<Example> Setting the equalizer of Part 3 to be off

Transmit the following System Exclusive Message

address	data	checksum
F0 41 10 42 12 [40 43 20] [00] [5D] F7		
↑	↑	↑
Part 3	EQ OFF	checksum

If you want to set the equalizer to be on, change the value of the Data to **01**.

MEMO

Also refer to **MIDI Implementation** (p.179).

MEMO

In the MIDI implementation, the **part number** is described as the **block number**. For the correspondence between the part number and the block number, refer to p.176.

MEMO

At the factory settings, the equalizer of each Part is set to on.

 **Operation via MIDI**

To change a Normal Part to a Drum Part using MIDI messages, transmit the following System Exclusive Message.

address data checksum
 F0 41 10 42 12 [40 1x 15] [..] [..] F7

- Address: 40 1x 15 (USE FOR RHYTHM PART)
- x: Part Number
- Data: 00-02
 00 = Normal, 01 = Drum1, 02 = Drum2
- Checksum: Refer to **How to calculate the checksum** (p.184).

<Example> Setting the Part Mode of Part 11 to Drum2

Transmit the following System Exclusive Message.

address data checksum
 F0 41 10 42 12 [40 1A 15] [02] [0F] F7

↑ ↑ ↑
 Part 11 Drum2 checksum

To select a drum set after setting the part mode, transmit a program change to part 11.



Also refer to **MIDI Implementation** (p.177).

Effects

The effects of the SC-8820 can be categorized into **System effects** (p.40) and **Insertion effects** (p.47).

As System effects, the SC-8820 provides 8 types of reverb to add reverberation to the sound, 8 types of chorus to add depth, 10 types of delay to add echo-like effects, and a 2-band equalizer to modify the tonal character by boosting or cutting the frequency ranges of the sound.

As Insertion effects, the SC-8820 provides 64 diverse kinds of effects, which allow you to distort or modulate the sound, or even to combine multiple effects.

The System effects and Insertion effects differ not only in the type of effects, but also in the output routing of the effect sound.



It is not possible to modify the effect settings by operating the SC-8820.

However, you can impose effect settings by using the editing functionality of your computer software or sequencer, and transmitting the data to the SC-8820.

System Effects

Of the System effects, the reverb/chorus/delay effects take part of the sound from each Part to create a new effected sound (reverberance, etc.), and then add this to the original sound.

For these effects, you can specify the amount of the sound for each Part sent to the effect unit (Send Level). Higher settings will increase the level of the signal that is sent to the effect unit, causing the effect sound that is produced to be louder. The result is that the effect becomes deeper.

For the equalizer of System effects, on the other hand, you can select whether the sound of the Part will pass through the equalizer or not; i.e., make an on/off setting to modify the sound.

Insertion Effects (EFX)

Insertion effects are effects that modify the sound itself, and are able to give it a completely different character. SC-8820 provides 64 types of effects.

As shown in the diagram below, you can select one Insertion effect, and specify for each Part whether or not the sound will be routed through the effect (on/off).

Since only one type of Insertion effect can be applied at a time, turning it on for two or more Parts will cause the sound of these Parts to be mixed. If a System effect is applied to a Part for which the Insertion effect is turned on, the Insertion effect Send Level will be used instead of the Send Level of the Part itself (p.47).

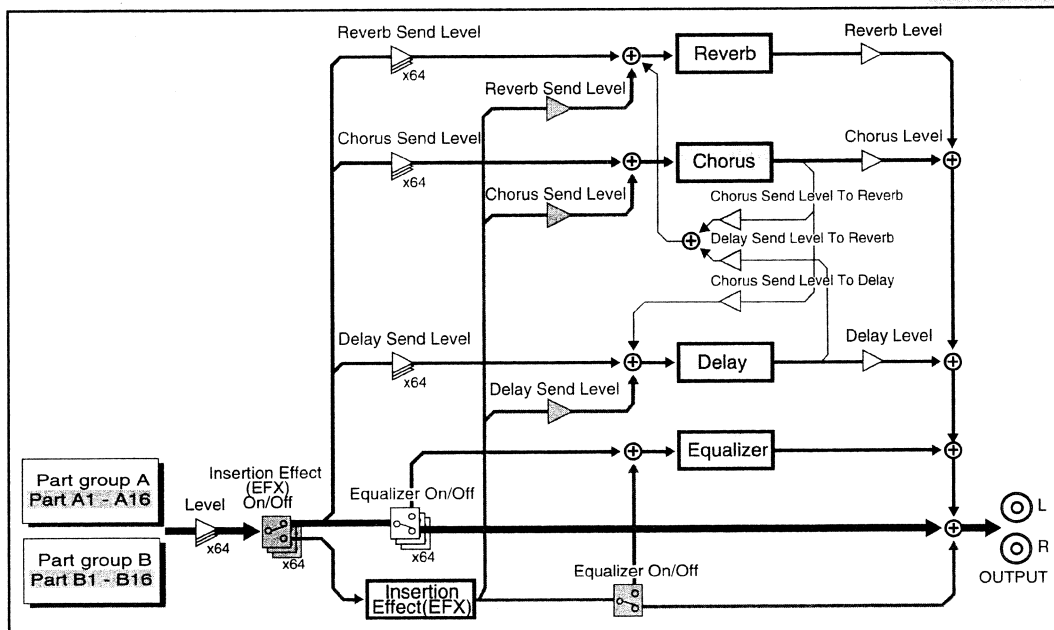

System Effects

The System effects of the SC-8820 include 8 types of reverb and chorus, and 10 types of delay. In addition, for each of these effects you can specify parameter values such as character, depth, rate, and time. For these effects, you can set the overall level for all Parts and also individual levels for each Part.

Reverb

Reverb is an effect that adds reverberation to a sound, as you would hear in a concert hall.

Chorus

Chorus broadens the spatial image of the sound, adding depth and richness.

Delay

Delay creates echoes. It is also possible to give depth and width to a sound by adding a short delay to the original sound.

Equalizer

An equalizer lets you boost or cut specified frequency ranges of a sound to adjust the tone. The SC-8820 has a two-band equalizer (high range, low range). For each range, high and low, you can specify the frequency and the amount of boost or cut (gain).

■ Reverb Parameters and Their Functions

■ REVERB MACRO (Reverb Macro)

You can choose from 8 types of reverb.

Room1 Room2 Room3

These reverbs simulate the reverberation of a room. They provide a well-defined spacious reverberation.

Hall1 Hall2

These reverbs simulate the reverberation of a concert hall. They provide a deeper reverberation than the Room reverbs.

Plate

This simulates a plate reverb (a studio device using a metal plate).

Delay

This is a conventional delay that produces echo effects.

Panning Delay

This is a special delay in which the delayed sounds move left and right. It is effective when you are listening in stereo.

■ REVERB LEVEL (Reverb Level)

0-64-127

This parameter sets the amount of the reverberant sound. Higher values result in louder reverberation.

■ REVERB CHARACTER (Reverb Character)

0-4-7

This parameter selects the type of reverb. 0-5 are reverb effects, and 6 and 7 are delay effects.

■ REVERB PRE-LPF (Reverb Pre-LPF)

0-7

A low pass filter can be applied to the sound coming into the reverb to cut the high frequency range. Higher values will cut more of the high frequencies, resulting in a more mellow reverberation.



For settings for each Part, this will be the Send Level.



For the procedure of setting the Equalizer on/off, refer to **Part EQ (Part Equalizer)** (p.27)



When you change the Reverb Type, the following parameter values will automatically change. For details, refer to **About Reverb Type** (p.41).



To apply the reverb effect to a part, you have to set the send level for the part. (p.27)

- **REVERB TIME (Reverb Time)** 0-64-127
 This parameter sets the time over which the reverberation will continue. Higher values result in longer reverberation.
- **REVERB DELAY FEEDBACK (Reverb Delay Feedback)** 0-127
 This parameter is used when the Reverb Character is set to 6 or 7, or the Reverb Type is set to Delay or Panning Delay (Rev Charac.6, 7). It sets the way in which delays repeat. Higher values result in more delay repeats.
- **REVERB PREDELAY TIME (Reverb Pre-Delay Time)** 0-127 ms
 This parameter sets the delay time until the reverberant sound is heard. Higher values result in a longer pre-delay time, simulating a larger reverberant space.

About Reverb Macro

When you change the Reverb Macro, the six reverb parameters (including Reverb Character) will be automatically adjusted to the optimal values. Rather than individually adjusting each reverb parameter, it is easier to first set the Reverb Macro (listed in the MIDI implementation as p.174), and then modify only those parameters that you wish to modify. In particular when using MIDI Exclusive messages, this method of making settings will minimize the amount of data.

	Room1	Room2	Room3	Hall1	Hall2	Plate	Delay	PanDelay
Rev Level	64	64	64	64	64	64	64	64
Rev Character	0	1	2	3	4	5	6	7
Rev Pre-LPF	3	4	0	4	0	0	0	0
Rev Time	80	56	64	72	64	88	32	64
Rev Dly Fb	0	0	0	0	0	0	40	32
Rev PreDlyTm	0	0	0	0	0	0	0	0



Operation via MIDI

To change the reverb type using MIDI messages, transmit the following System Exclusive Message.

DELAY: address data checksum
 F0 41 10 42 12 [40 01 30] [..] [..] F7

Address: 40 01 30 (REVERB MACRO)

Data: 00-07

00 = Room 1, 01 = Room 2, 02 = Room 3, 03 = Hall 1, 04 = Hall 2, 05 = Plate, 06 = Delay, 07 = Panning Delay

Checksum: Refer to **How to calculate the checksum** (p.184).

<Example> Setting the reverb type to Room 3

Transmit the following System Exclusive Message.

address data checksum
 F0 41 10 42 12 [40 01 30] [02] [0D] F7
↑ ↑ ↑
 REVERB MACRO Room3 checksum

MEMO

Also refer to **MIDI Implementation** (p.174).

■ Chorus Parameters and Their Functions

■ CHORUS MACRO (Chorus Macro)

You can choose from 8 types of chorus.

Chorus1 Chorus2 **Chorus3** Chorus4

These are conventional chorus effects that add spaciousness and depth to the sound.

Feedback Chorus

This is a chorus with a flanger-like effect and a soft sound.

Flanger

This is an effect sounding somewhat like a jet airplane taking off and landing.

Short Delay

This is a delay with a short delay time.

Short Delay (FB)

This is a short delay with many repeats.

■ CHORUS LEVEL (Chorus Level)

0–64–127

This parameter sets the amount of the chorus sound.

■ CHORUS PRE-LPF (Chorus Pre-LPF)

0–7

A low-pass filter can be applied to the sound coming into the chorus to cut the high frequency range. Higher values will cut more of the high frequencies, resulting in a more mellow chorus sound.

■ CHORUS FEEDBACK (Chorus Feedback)

0–8–127

This parameter sets the level at which the chorus sound is re-input (fed back) into the chorus. By using feedback, a denser chorus sound can be created. Higher values result in a greater feedback level.

■ CHORUS DELAY (Chorus Delay Time)

0–80–127

This parameter sets the delay time of the chorus effect.

■ CHORUS RATE (Chorus Rate)

0–3–127

This parameter sets the speed (frequency) at which the chorus sound is modulated. Higher values result in faster modulation.

■ CHORUS DEPTH (Chorus Depth)

0–19–127

This parameter sets the depth at which the chorus sound is modulated. Higher values result in deeper modulation.

■ CHORUS SEND LEVEL TO REVERB (Chorus Send Level To Reverb)

0–127

This parameter sets the amount of chorus sound that will be sent to the reverb. Higher values result in more sound being sent.

■ CHORUS SEND LEVEL TO DELAY (Chorus Send Level To Delay)

0–127

This parameter sets the amount of chorus sound that will be sent to the delay. Higher values result in more sound being sent.

MEMO

When you change the Chorus Type, the following parameter values will automatically change. For details, refer to **About Chorus Type** (p.43).

MEMO

To apply the chorus effect to a part, you have to set the send level for the part. (p.27)

About Chorus Macro

When you change the Chorus Macro, the eight chorus parameters will be automatically adjusted to the optimal values. Rather than individually adjusting each chorus parameter, it is easier to first set the Chorus Macro (listed in the MIDI implementation as p.175), and then modify only those parameters that you wish to modify. In particular when using MIDI Exclusive messages, this method of making settings will minimize the amount of data.

	Chorus1	Chorus2	Chorus3	Chorus4	FbChorus	Flanger	SDelay	SDelayFb
Cho Level	64	64	64	64	64	64	64	64
Cho Pre-LPF	0	0	0	0	0	0	0	0
Cho Feedback	0	5	8	16	64	112	0	80
Cho Delay	112	80	80	64	127	127	127	127
Cho Rate	3	9	3	9	2	1	0	0
Cho Depth	5	19	19	16	24	5	127	127
Cho To Rev	0	0	0	0	0	0	0	0
Cho To Dly	0	0	0	0	0	0	0	0



Operation via MIDI

To change the chorus type using MIDI messages, transmit the following System Exclusive Message.

```
DELAY:          address  data  checksum
                40 01 38 [ 00-07 ] [ .. ] [ .. ] F7
```

Address: 40 01 38 (CHORUS MACRO)

Data: 00-07

00 = Chorus1, 01 = Chorus 2, 02 = Chorus 3, 03 = Chorus 4, 04 = Feedback Chorus, 05 = Flanger, 06 = Short Delay, 07 = Short Delay (FB)

Checksum: Refer to **How to calculate the checksum** (p.184).

<Example> Setting the chorus type to Chorus4

Transmit the following System Exclusive Message.

```

                address  data  checksum
F0 41 10 42 12 [ 40 01 38 ] [ 03 ] [ 04 ] F7
                ↑         ↑         ↑
                CHORUS MACRO Chorus 4  checksum
```



Also refer to **MIDI Implementation** (p.175).

■ Delay Parameters and Their Functions

■ DELAY MACRO

You can choose from 10 types of delay.

Delay1 Delay2 Delay3

These are conventional delays. 1, 2 and 3 have progressively longer delay times.

Delay4

This is a delay with a rather short delay time.

Pan Delay1 Pan Delay2 Pan Delay3

The delay sound moves between left and right. This is effective when listening in stereo. 1, 2 and 3 have progressively longer delay times.

Pan Delay4

This is a rather short delay with the delayed sound moving between left and right. It is effective when listening in stereo.

Dly To Rev

Reverb is added to the delay sound, which moves between left and right. It is effective when listening in stereo.

PanRepeat

The delay sound moves between left and right, but the pan positioning is different than the effects listed above. It is effective when listening in stereo.

■ DELAY LEVEL (Delay Level) 0–64–127

This parameter sets the overall volume of the three delays (center, left and right). Higher values result in a louder overall delay.

■ DELAY PRE-LPF (Delay Pre-LPF) 0–7

A low-pass filter can be applied to the sound coming into the delay to cut the high frequency range. Higher values will cut more of the high frequencies, resulting in a more mellow delay sound.

■ DELAY TIME CENTER (Delay Time Center) 0.1ms–340ms–1.0s

The delay effect of the SC-8820 allow you to set three delay times; center, left and right (when listening in stereo). Delay Time Center sets the delay time of the delay located at the center.

■ DELAY TIME RATIO LEFT (Delay Time Ratio Left) 4%–500%

This parameter sets the delay time of the delay located at the left as a percentage of the Delay Time Center (up to a max. of 1.0 s).

■ DELAY TIME RATIO RIGHT (Delay Time Ratio Right) 4%–500%

This parameter sets the delay time of the delay located at the right as a percentage of the Delay Time Center (up to a max. of 1.0 s).

■ DELAY LEVEL CENTER (Delay Level Center) 0–127

This parameter sets the volume of the central delay. Higher values result in a louder center delay.

■ DELAY LEVEL LEFT (Delay Level Left) 0–127

This parameter sets the volume of the left delay. Higher values result in a louder left delay.

■ DELAY LEVEL RIGHT (Delay Level Right) 0–127

This parameter sets the volume of the right delay. Higher values result in a louder right delay.

■ DELAY FEEDBACK (Delay Feedback) -64–+16–+63

This parameter affects the number of times the delay will repeat. With a value of 0, the delay will not repeat. With higher values there will be more repeats. With negative (-) values, the center delay will be fed back with inverted phase. Negative values are effective with short delay times.

MEMO

When you change the Delay Type, the following parameter values will automatically change. For details, refer to **About Delay Type** (p.45).

MEMO

To apply the delay effect to a part, you have to set the send level for the part. (p.27)

■ **DELAY SEND LEVEL TO REVERB (Delay Send Level To Reverb) 0-127**

This parameter sets the amount of delay sound that is sent to the reverb. Higher values result in more sound being sent.

About Delay Macro

When you change the Delay Macro, the above-listed ten Delay parameters will be automatically adjusted to the optimal values. Rather than individually adjusting each delay parameter, it is easier to first set the Delay Macro (listed in the MIDI implementation as p.175), and then modify only those parameters that you wish to modify. In particular when using MIDI Exclusive messages, this method of making settings will minimize the amount of data.

	Delay				PanDelay			Dly To		Pan
	1	2	3	4	1	2	3	4	Rev	Repeat
Dly Level	64	64	64	64	64	64	64	64	64	64
Dly Pre-LPF	0	0	0	0	0	0	0	0	0	0
Dly Time C	340ms	550ms	1sec	130ms	500ms	700ms	1sec	260ms	700ms	750ms
DlyTmRatioL	4%	4%	4%	4%	50%	50%	50%	50%	50%	88%
DlyTmRatioR	4%	4%	4%	4%	100%	100%	100%	100%	100%	133%
Dly Level C	127	127	127	127	0	0	0	0	0	97
Dly Level L	0	0	0	0	125	125	120	120	114	127
Dly Level R	0	0	0	0	60	60	64	64	60	67
Dly Feedback	+16	+16	+8	+8	+10	+7	+9	+8	-3	-24
Dly To Rev	0	0	0	0	0	0	0	0	36	0

 **Operation via MIDI**

To change the delay type using MIDI messages, transmit the following System Exclusive Message.

DELAY: address data checksum
 F0 41 10 42 12 [40 01 50] [..] [..] F7

Address: 40 01 50 (DELAY MACRO)

Data: 00-09

00 = Delay 1, 01 = Delay 2, 02 = Delay 3, 03 = Delay 4, 04 = Pan Delay 1, 05 = Pan Delay 2, 06 = Pan Delay 3, 07 = Pan Delay 4, 08 = Delay to Reverb, 09 = Pan Repeat

Checksum: Refer to **How to calculate the checksum** (p.184).

<Example> Setting the reverb type to Delay 3

Transmit the following System Exclusive Message.

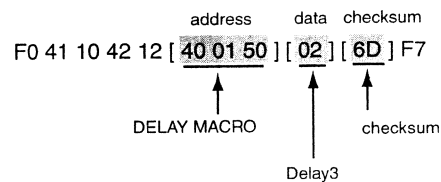

Also refer to **MIDI Implementation** (p.175).

■ Equalizer Parameters

- **EQ LOW FREQ** (Equalizer Low Frequency) 200/400 Hz
- **EQ LOW GAIN** (Equalizer Low Gain) -12-0+12 dB
- **EQ HIGH FREQ** (Equalizer High Frequency) 3/6 kHz

These parameters set the cutoff frequencies of the ranges boosted or cut by the equalizer.

- **EQ HIGH GAIN** (Equalizer High Gain) -12-0+12 dB
- Specify the amount of boost or cut (gain) for the high frequency range (high) and the low frequency range (low). Positive (+) settings will boost, and negative (-) settings will cut.

Operation via MIDI

To change the Equalizer Low Gain using MIDI messages, transmit the following System Exclusive Message.

```

address  data  checksum
F0 41 10 42 12 [ 40 02 01 ] [ .. ] [ .. ] F7

```

Address: EQ LOW GAIN

Data: 34H-40H-4CH (-12-±0-+12dB)

Checksum: Refer to **How to calculate the checksum** (p.184).

<Example> Setting the Equalizer Low Gain to +6

Transmit the following System Exclusive Message.

```

address  data  checksum
F0 41 10 42 12 [ 40 02 01 ] [ 46 ] [ 77 ] F7

```

↑ ↑ ↑
 EQ LOW GAIN checksum
 ±0=40 → +6=46

MEMO

The settings of the Equalizer Gain are common to all Parts. They cannot be set independently for individual Parts.

MEMO

With a gain setting of 0, the equalizer will have no effect

MEMO

Also refer to **MIDI Implementation** (p.175).

Insertion Effects

Insertion effects provide 64 effect types. Since appropriate parameters are provided for each effects, you can make fine adjustments to the sound for professional-level control.

* For details on System effects and Insertion effects, and on the effect structure of the SC-88ST Pro, refer top.39

Insertion effects can be applied independently to an individual Part.

■ Insertion Effect Parameters and their functions

- **EFX TYPE (Effect Type)** 0-64
 Choose the type of the insertion effects.
 For details about effect types, refer to p.48.
- **EFX PARAMETER (Effect Parameter)**
 If you change the EFX type, the parameters of that effect are displayed.
 For details about effect parameters, refer to p.48.
- **EFX SEND LEVEL TO REVERB** 0-40-127
 Adjust the send level of the sound that comes after the insertion effect to Reverb.
- **EFX SEND LEVEL TO CHORUS** 0-127
 Adjust the send level of the sound that comes after the insertion effect to Chorus.
- **EFX SEND LEVEL TO DELAY** 0-127
 Adjust the send level of the sound that comes after the insertion effect to Delay



It takes moment until the sound can be heard after you change the insertion effects. When **00 : Thru** is selected, the insertion effect will not be applied.

Pan Settings When Using Insertion Effects

Whether the Pan setting will have effect or not changes depending on whether the Insertion effect is stereo or monaural.

If a monaural Insertion effect is turned on, the settings for Part Pan (p.27) and Master Pan (p.36) will be ignored.

<Example of Monaural Insertion effects> 02: Spectrum, 35: OD → Chorus, etc.

In the case of stereo Insertion effects, however, the settings for Part Pan (p.27) and Master Pan (p.36) will be effective when the Insertion effect is on.

<Example of Stereo Insertion effects> 01: Stereo-EQ, 16: Hexa Chorus, etc.

The diagram for each effect shows whether the Insertion effect is monaural or stereo. Effects that have discrete signal paths, from input to output, for L and R are stereo; those that do not are monaural.



System effect settings cannot be made independently for a part that uses an insertion effect. If a system effect is applied, the level will be common to all parts for which an insertion effect is turned on, and cannot be set independently for individual parts.

System Effect Settings When Using Insertion Effects

If the Insertion effect is turned on for two or more Parts, the sound of each Part will be mixed, and the common settings are applied to these Parts. It will not be possible to set reverb/chorus/delay/equalizer independently for these Parts. (Refer to the figures on p.39)

For Parts for which the Insertion effect is Off, System effect settings can be made independently for each Part.

Insertion Effect Types

Effect types can be broadly grouped into the following categories.

Effects that modify the tone color	(filter type)	(1–4)
Effects that distort the sound	(distortion type)	(5–6)
Effects that modulate the sound	(modulation type)	(7–13)
Effects that affect the level	(compressor type)	(14–15)
Effects that broaden the sound	(chorus type)	(16–20)
Effects that reverberate the sound	(delay/reverb type)	(21–28)
Effects that modify the pitch	(pitch shift type)	(29–30)
Others		(31–34)
Effects that connect two types of effect in series	(series 2)	(35–46)
Effects that connect three or more types of effect in series	(series 3/series 4/series 5)	(47–55)
Effects that connect two types of effect in parallel	(parallel 2)	(56–64)

In the explanations that follow, the hexadecimal values used when making settings via Exclusive messages are given at the end of the effect type line. The parameter number is given in decimal form at the end of the Effect Parameter line. Use these values when you use MIDI messages to set parameters. For details on using Exclusive messages, refer to page 86, 173.

< Example >

01: Stereo-EQ

[01H, 00H]

This means that the value for Address corresponding to EFX 40H 03H 00H is MSB:01H, LSB:00H.

Low Freq 200/40 [1 (40 03 03)]

[1] describes that it's the first parameter.

(40 03 03) describes that it's the parameter's address for [1].

For example, if you wish to set the effect type to 01:Stereo-EQ (stereo equalizer) and set Low Freq (low frequency) to 400, transmit the following Exclusive message.

1. Set the effect type to 1:Stereo-EQ.

```
F0 41 10 42 12 40 03 00 01 00 3C F7
                address  Value set for
                for EFX   Stereo EQ
```

2. Select the Low Freq.

```
F0 41 10 42 12 40 03 03 01 39 F7
                address  Value to select
                corresponding to [1] +400
```

- * See the Insertion Effect List on page 156 for the correspondence of Parameter to Value.
- * See page 176 for the correspondence of Parameter number to Address.
- * Parameters with + or # symbols allow you to modify their value using a specified controller, such as pitch bend lever and sliders, or with control change messages (p.176).

00: Thru [00H, 00H]

No effect will be applied. When a GM1 System On, GM2 System On or GS Reset messages (p.102) is received, 00 Thru will be selected for Insertion Effect.

Effects that modify the tone color (filter type)**01: Stereo-EQ (Stereo Equalizer)** [01H, 00H]

This is a four-band stereo equalizer (low, mid x 2, high).

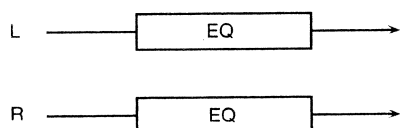
**Low Freq (Low Frequency)** 200/400 [1 (40 03 03)]

Selects the frequency of the low range (200 Hz/400 Hz).

Low Gain -12--+12 [2 (40 03 04)]

Adjusts the gain of the low frequency.

Hi Freq (High Frequency) 4k/8k [3 (40 03 05)]

Selects the frequency of the high range (4kHz/8kHz).

Hi Gain -12--+12 [4 (40 03 06)]

Adjusts the gain of the high frequency.

M1 Freq (Mid 1 Frequency) 200-6.3k [5 (40 03 07)]

Adjusts the frequency of Mid 1 (mid range1).

M1 Q (Mid 1 Q) 0.5/1.0/2.0/4.0/9.0 [6 (40 03 08)]

This parameter adjusts the width of the area around the M1 Freq parameter that will be affected by the Gain setting. Higher values of Q will result in a narrower area being affected.

M1 Gain (Mid 1 Gain) -12--+12 [7 (40 03 09)]

Adjusts the gain for the area specified by the M1 Freq parameter and M1 Q parameter settings.

M2 Freq (Mid 2 Frequency) 200-6.3k [8 (40 03 0A)]

Adjusts the frequency of Mid 2 (midrange2).

M2 Q (Mid 2 Q) 0.5/1.0/2.0/4.0/9.0 [9 (40 03 0B)]

This parameter adjusts the width of the area around the M2 Freq parameter that will be affected by the Gain setting. Higher values of Q will result in a narrower area being affected.

M2 Gain (Mid 2 Gain) -12--+12 [10 (40 03 0C)]

Adjusts the gain for the area specified by the M2 Freq parameter and M2 Q parameter settings.

+Level (Output Level) 0-127 [20 (40 03 16)]

Adjusts the output level.

02: Spectrum [01H, 01H]

Spectrum is a type of filter which modifies the timbre by boosting or cutting the level at specific frequencies. It is similar to an equalizer, but has 8 frequency points fixed at locations most suitable for adding character to the sound.

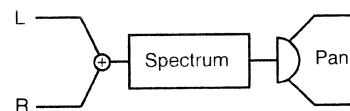
**Band 1 (Band 1 Gain)** -12--+12 [1 (40 03 03)]

Adjusts the 250 Hz level.

Band 2 (Band 2 Gain) -12--+12 [2 (40 03 04)]

Adjusts the 500 Hz level.

Band 3 (Band 3 Gain) -12--+12 [3 (40 03 05)]

Adjusts the 1000 Hz level.

Band 4 (Band 4 Gain) -12--+12 [4 (40 03 06)]

Adjusts the 1250 Hz level.

Band 5 (Band 5 Gain) -12--+12 [5 (40 03 07)]

Adjusts the 2000 Hz level.

Band 6 (Band 6 Gain) -12--+12 [6 (40 03 08)]

Adjusts the 3150 Hz level.

Band 7 (Band 7 Gain) -12--+12 [7 (40 03 09)]

Adjusts the 4000 Hz level.

Band 8 (Band 8 Gain) -12--+12 [8 (40 03 0A)]

Adjusts the 8000 Hz level.

Width (Band Width) 0.5/1.0/2.0/4.0/9.0 [9 (40 03 0B)]

Adjusts the width of the frequency bands whose gain is being modified (common to all bands). Higher settings will make the frequency band narrower.

+Pan (Output Pan) L63-0-R63 [19 (40 03 15)]

Adjusts the stereo location of the output sound. L63 is far left, 0 is center, and R63 is far right.

#Level (Output Level) 0-127 [20 (40 03 16)]

Adjusts the output level.

Effects

03: Enhancer [01H, 02H]

The Enhancer controls the overtone structure of the high frequencies, adding sparkle and tightness to the sound.

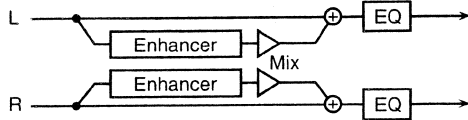

+Sens (Sensitivity) 0–127 [1 (40 03 03)]

Adjusts the sensitivity of the enhancer.

#Mix (Mix Level) 0–127 [2 (40 03 04)]

Adjusts the proportion by which the overtones generated by the enhancer are combined with the direct sound.

Low Gain -12–+12 [17 (40 03 13)]

Adjusts the gain of the low frequency range.

Hi Gain (High Gain) -12–+12 [18 (40 03 14)]

Adjusts the gain of the high frequency range.

Level (Output Level) 0–127 [20 (40 03 16)]

Adjusts the output level.

04: Humanizer [01H, 03H]

This adds a vowel character to the sound, making it similar to a human voice.

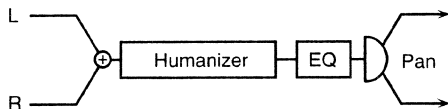

Drive 0–127 [1 (40 03 03)]

Adjusts the depth of distortion.

Drive Sw (Drive Switch) Off/On [2 (40 03 04)]

Turns Drive on/off.

+Vowel a/i/u/e/o [3 (40 03 05)]

Selects the vowel.

Accel 0–15 [4 (40 03 06)]

Adjusts the time over which the sound will move to the specified Vowel. Smaller values will require more time.

Low Gain -12–+12 [17 (40 03 13)]

Adjusts the low frequency gain.

Hi Gain (High Gain) -12–+12 [18 (40 03 14)]

Adjusts the high frequency gain.

Pan (Output Pan) L63–0–R63 [19 (40 03 15)]

Adjusts the stereo position of the output sound. L63 is far left, 0 is center, and R63 is far right.

#Level (Output Level) 0–127 [20 (40 03 16)]

Adjusts the output volume.

Effects that distort the sound (distortion type)

05: Overdrive [01H, 10H]

This effect creates a soft distortion similar to that produced by tube amplifiers.

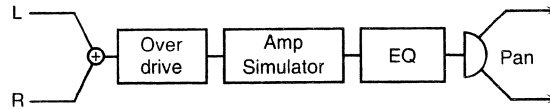

+Drive 0–127 [1 (40 03 03)]

Adjusts the degree of distortion.

Amp Type (Amp Simulator Type)

Small/Bltn/2-Stk/3-Stk [2 (40 03 04)]

Select the type of guitar amp.

Small: small amp

Bltn: single-unit type amp

2-Stk: large double stack amp

3-Stk: large triple stack amp

Amp Sw (Amp Switch) Off/On [3 (40 03 05)]

Turns the Amp Type on/off.

Low Gain -12–+12 [17 (40 03 13)]

Adjusts the gain of the low frequency range.

Hi Gain (High Gain) -12–+12 [18 (40 03 14)]

Adjusts the gain of the high frequency range.

#Pan (Output Pan) L63–0–R63 [19 (40 03 15)]

Adjusts the stereo location of the output sound. L63 is far left, 0 is center, and R63 is far right.

Level (Output Level) 0–127 [20 (40 03 16)]

Adjusts the output level.

06: Distortion [01H, 11H]

This effect produces a more intense distortion than Overdrive.

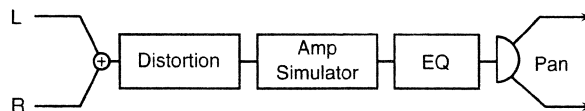

+Drive 0–127 [1 (40 03 03)]

Adjusts the degree of distortion.

Amp Type (Amp Simulator Type)

Small/Bltn/2-Stk/3-Stk [2 (40 03 04)]

Selects the type of guitar amp.

Small: small amp

Bltn: single-unit type amp

2-Stk: large double stack amp

3-Stk: large triple stack amp

Amp Sw (Amp Switch) Off/On [3 (40 03 05)]

Turns the Amp Type on/off.

Low Gain -12--+12 [17 (40 03 13)]

Adjusts the gain of the low frequency range.

Hi Gain (High Gain) -12--+12 [18 (40 03 14)]

Adjusts the gain of the high frequency range.

#Pan (Output Pan) L63-0-R63 [19 (40 03 15)]

Adjusts the stereo location of the output sound. L63 is far left, 0 is center, and R63 is far right.

Level (Output Level) 0-127 [20 (40 03 16)]

Adjusts the output level.

Effects that modulate the sound (modulation type)**07: Phaser** [01H, 20H]

A phaser adds a phase-shifted sound to the original sound, producing a twisting modulation that creates spaciousness and depth.

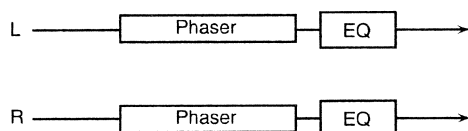
**+Manual** 100-8.0k [1 (40 03 03)]

Adjusts the basic frequency from which the sound will be modulated.

#Rate 0.05-10.0 [2 (40 03 04)]

Adjusts the frequency (period) of modulation.

Depth 0-127 [3 (40 03 05)]

Adjusts the depth of modulation.

Reso (Resonance) 0-127 [4 (40 03 06)]

Adjusts the amount of emphasis added to the frequency range surrounding the basic frequency determined by the Manual parameter setting.

Mix (Mix Level) 0-127 [5 (40 03 07)]

Adjusts the proportion by which the phase-shifted sound is combined with the direct sound.

Low Gain -12--+12 [17 (40 03 13)]

Adjusts the gain of the low frequency range.

Hi Gain (High Gain) -12--+12 [18 (40 03 14)]

Adjusts the gain of the high frequency range.

Level (Output Level) 0-127 [20 (40 03 16)]

Adjusts the output level.

08: Auto Wah [01H, 21H]

The Auto Wah cyclically controls a filter to create cyclic change in timbre.

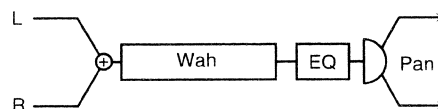
**Fil Type (Filter Type)** LPF/BPF [1 (40 03 03)]

Selects the type of filter.

LPF: The wah effect will be applied over a wide frequency range.

BPF: The wah effect will be applied over a narrow frequency range.

Sens (Sensitivity) 0-127 [2 (40 03 04)]

Adjusts the sensitivity with which the filter is controlled. If this value is increased, the filter frequency will change more readily in response to the input level.

+Manual 0-127 [3 (40 03 05)]

Adjusts the center frequency from which the effect is applied.

Peak 0-127 [4 (40 03 06)]

Adjusts the amount of the wah effect that will occur in the area of the center frequency. Lower settings will cause the effect to be applied in a broad area around the center frequency. Higher settings will cause the effect to be applied in a more narrow range. In the case of LPF, decreasing the value will cause the wah effect to change less.

#Rate 0.05-10.0 [5 (40 03 07)]

Adjusts the speed of the modulation.

Depth 0-127 [6 (40 03 08)]

Adjusts the depth of the modulation.

Polarity Down/Up [7 (40 03 09)]

Sets the direction in which the frequency will change when the filter is modulated. With a setting of Up, the filter will change toward a higher frequency. With a setting of Down it will change toward a lower frequency.

Low Gain -12--+12 [17 (40 03 13)]

Adjusts the gain of the low frequency range for EQ.

Hi Gain (High Gain) -12--+12 [18 (40 03 14)]

Adjusts the gain of the high frequency range for EQ.

Pan (Output Pan) L63-0-R63 [19 (40 03 15)]

Adjusts the stereo location of the output sound. L63 is far left, 0 is center, and R63 is far right.

Level (Output Level) 0-127 [20 (40 03 16)]

Adjusts the output level.

09: Rotary [01H, 22H]

The Rotary effect simulates the sound of a classic rotary speakers. Since the movement of the high range and low range rotors can be set independently, the unique modulation characteristics of these speakers can be simulated quite reliably. This effect is most suitable for electric organ.

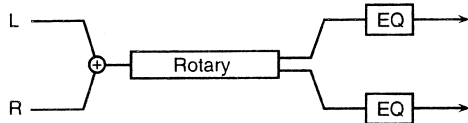

Low Slow (Low Frequency Slow Rate) 0.05–10.0 [1 (40 03 03)]

Adjusts the slow speed of the low frequency rotor.

Low Fast (Low Frequency Fast Rate) 0.05–10.0 [2 (40 03 04)]

Adjusts the fast speed of the low frequency rotor.

Low Accl (Low Frequency Acceleration) 0–15 [3 (40 03 05)]

Adjusts the time it takes for the low frequency rotor to reach the newly selected speed when switching from fast to slow (or slow to fast) speed. Lower values will require longer times.

Low Level (Low Frequency Level) 0–127 [4 (40 03 06)]

Adjusts the volume of the low frequency rotor.

Hi Slow (High Frequency Slow Rate) 0.05–10.0 [5 (40 03 07)]

Adjusts the slow speed of the high frequency rotor.

Hi Fast (High Frequency Fast Rate) 0.05–10.0 [6 (40 03 08)]

Adjusts the fast speed of the high frequency rotor.

Hi Accl (High Frequency Acceleration) 0–15 [7 (40 03 09)]

Adjusts the time it takes for the high frequency rotor to reach the newly selected speed when switching from fast to slow (or slow to fast) speed. Lower values will require longer times.

Hi Level (High Frequency Level) 0–127 [8 (40 03 0A)]

Adjusts the volume of the high frequency rotor.

Separate (Separation) 0–127 [9 (40 03 0B)]

Adjusts the spatial dispersion of the sound.

+Speed Slow/Fast [11 (40 03 0D)]

Simultaneously switches the rotational speed of the low frequency rotor and high frequency rotor.

Slow: Slows down the rotation to the specified speed (the Low Slow parameter/Hi Slow parameter values).

Fast: Speeds up the rotation to the specified speed (the Low Fast parameter/Hi Fast parameter values).

Low Gain -12→+12 [17 (40 03 13)]

Adjusts the gain of the low frequency range for EQ.

Hi Gain (High Gain) -12→+12 [18 (40 03 14)]

Adjusts the gain of the high frequency range for EQ.

#Level (Output Level) 0–127 [20 (40 03 16)]

Adjusts the output level.

10: Stereo Flanger [01H, 23H]

This is a stereo flanger. It produces a metallic resonance that rises and falls like a jet airplane taking off or landing. A filter is provided so that you can adjust the timbre of the flanged sound.

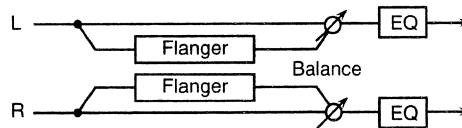

Pre Filter (Pre Filter Type) Off/LPF/HPF [1 (40 03 03)]

Selects the type of filter.

Off: a filter will not be used

LPF: cut the frequency range above the Cutoff parameter

HPF: cut the frequency range below the Cutoff parameter

Cutoff (Cutoff Frequency) 250–8k [2 (40 03 04)]

Adjusts the basic frequency of the filter.

Pre Dly (Pre Delay Time) 0–100ms [3 (40 03 05)]

Adjusts the time delay from when the direct sound begins until the processed sound is heard.

+Rate 0.05–10.0 [4 (40 03 06)]

Adjusts the rate of modulation.

Depth 0–127 [5 (40 03 07)]

Adjusts the depth of modulation.

#Feedback (Feedback Level) -98%→+98% [6 (40 03 08)]

Adjusts the amount (%) of the processed sound that is returned (fed back) into the input. Negative (-) settings will invert the phase.

Phase 0–180 [7 (40 03 09)]

Adjusts the spatial spread of the sound.

Balance (Effect Balance) D>0E–D0<E [16 (40 03 12)]

Adjusts the volume balance between the direct and the processed sound.

“D” or “E” on the display respectively means D (direct sound) or E (effect sound) values of 100.

Low Gain -12→+12 [17 (40 03 13)]

Adjusts the gain of the low frequency range.

Hi Gain (High Gain) -12→+12 [18 (40 03 14)]

Adjusts the gain of the high frequency range.

Level (Output Level) 0–127 [20 (40 03 16)]

Adjusts the output level.

11: Step Flanger [01H, 24H]

The Step Flanger is an effect in which the flanger pitch changes in steps.

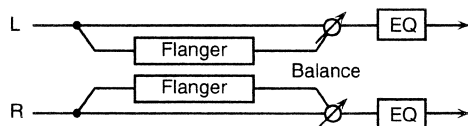

Pre Dly (Pre Delay Time) 0–100ms [1 (40 03 03)]

Adjusts the time delay from when the direct sound begins until the processed sound is heard.

Rate 0.05–10.0 [2 (40 03 04)]

Adjusts the rate of modulation.

Depth 0–127 [3 (40 03 05)]

Adjusts the depth of modulation.

+Feedback (Feedback Level) -98%–+98% [4 (40 03 06)]

Adjusts the amount (%) of the processed sound that is returned (fed back) into the input. Negative (-) settings will invert the phase.

Phase 0–180 [5 (40 03 07)]

Adjusts the spatial spread of the sound.

#Step Rate 0.05–10.0 [6 (40 03 08)]

Adjusts the rate (period) of pitch change.

Balance (Effect Balance) D>0E–D0<E [16 (40 03 12)]

Adjusts the volume balance between the direct and the processed sound.

“D” or “E” on the display respectively means D (direct sound) or E (effect sound) values of 100.

Low Gain -12–+12 [17 (40 03 13)]

Adjusts the gain of the low frequency range.

Hi Gain (High Gain) -12–+12 [18 (40 03 14)]

Adjusts the gain of the high frequency range.

Level (Output Level) 0–127 [20 (40 03 16)]

Adjusts the output level.

12: Tremolo [01H, 25H]

Tremolo cyclically modulates the volume to add tremolo effect to the sound.

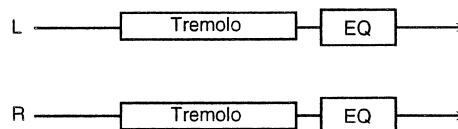

Mod Wave (Modulation Wave)

Tri/Sqr/Sin/Saw1/Saw2 [1 (40 03 03)]

Selects the type of modulation.

Tri: The sound will be modulated like a triangle wave.

Sqr: The sound will be modulated like a square wave.

Sin: The sound will be modulated like a sine wave.

Saw1,2: The sound will be modulated like a sawtooth wave. The **teeth** in Saw1 and Saw2 point at opposite directions.



+Mod Rate (Modulation Rate) 0.05–10.0 [2 (40 03 04)]

Adjusts the speed of modulation.

#Mod Depth (Modulation Depth) 0–127 [3 (40 03 05)]

Adjusts the depth of modulation.

Low Gain -12–+12 [17 (40 03 13)]

Adjusts the gain of the low frequency range.

Hi Gain (High Gain) -12–+12 [18 (40 03 14)]

Adjusts the gain of the high frequency range.

Level (Output Level) 0–127 [20 (40 03 16)]

Adjusts the output level.

13: Auto Pan [01H, 26H]

The Auto Pan effect cyclically modulates the stereo location of the sound.

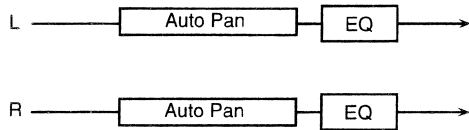

Mod Wave (Modulation Wave)

Tri/Sqr/Sin/Saw1/Saw2 [1 (40 03 03)]

Selects the type of modulation.

- Tri: The sound will be modulated like a triangle wave.
- Sqr: The sound will be modulated like a square wave.
- Sin: The sound will be modulated like a sine wave.
- Saw1,2: The sound will be modulated like a sawtooth wave. The **teeth** in Saw1 and Saw2 point at opposite direction.



+Mod Rate (Modulation Rate) 0.05–10.0 [2 (40 03 04)]

Adjusts the frequency of modulation.

#Mod Depth (Modulation Depth) 0–127 [3 (40 03 05)]

Adjusts the depth of modulation.

Low Gain -12–+12 [17 (40 03 13)]

Adjusts the gain of the low frequency range.

Hi Gain (High Gain) -12–+12 [18 (40 03 14)]

Adjusts the gain of the high frequency range.

Level (Output Level) 0–127 [20 (40 03 16)]

Adjusts the output level.

Effects that affect the level (compressor type)

14: Compressor [01H, 30H]

The Compressor flattens out high levels and boosts low levels, smoothing out unevenness in volume.

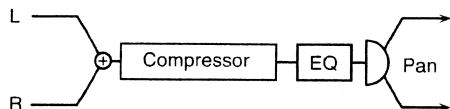

Attack 0–127 [1 (40 03 03)]

Adjusts the attack time of an input sound.

Sustain 0–127 [2 (40 03 04)]

Adjusts the time over which low level sounds are boosted until they reach the specified volume.

Increasing the value will shorten the time. When the value is modified, the level will also change.

Post Gain 0/+6/+12/+18 [3 (40 03 05)]

Adjusts the output gain.

Low Gain -12–+12 [17 (40 03 13)]

Adjusts the low frequency gain.

Hi Gain (High Gain) -12–+12 [18 (40 03 14)]

Adjusts the high frequency gain.

+Pan (Output Pan) L63–0–R63 [19 (40 03 15)]

Adjusts the stereo location of the output sound. L63 is far left, 0 is center, and R63 is far right.

#Level (Output Level) 0–127 [20 (40 03 16)]

Adjusts the output level.

15: Limiter [01H, 31H]

The Limiter compresses signals that exceed a specified volume level, preventing distortion from occurring.

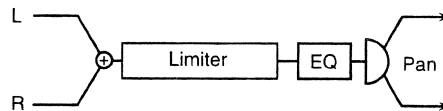

Threshold (Threshold Level) 0–127 [1 (40 03 03)]

Adjusts the volume at which compression will begin.

Ratio (Compression Ratio) 1/1.5, 1/2, 1/4, 1/100 [2 (40 03 04)]

This adjusts the compression ratio for signals that are louder than the Threshold Level. 1/100 is the highest compression ratio, and the output level will decrease.

Release (Release Time) 0–127 [3 (40 03 05)]

Adjusts the time from when the volume falls below the Threshold Level until compression is no longer applied.

Post Gain 0/+6/+12/+18 [4 (40 03 06)]

Adjusts the output gain.

Low Gain -12–+12 [17 (40 03 13)]

Adjusts the low frequency gain.

Hi Gain (High Gain) -12–+12 [18 (40 03 14)]

Adjusts the high frequency gain.

+Pan (Output Pan) L63–0–R63 [19 (40 03 15)]

Adjusts the stereo location of the output sound. L63 is far left, 0 is center, and R63 is far right.

#Level (Output Level) 0–127 [20 (40 03 16)]

Adjusts the output level.

Effects that broaden the sound (chorus type)

16: Hexa Chorus [01H, 40H]

Hexa-chorus uses a six-phase chorus (six layers of chorused sound) to give richness and spatial spread to the sound.

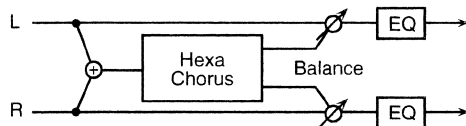

Pre Dly (Pre Delay Time) 0–100ms [1 (40 03 03)]

Adjusts the time delay from when the direct sound begins until the processed sound is heard.

+Rate 0.05–10.0 [2 (40 03 04)]

Adjusts the rate of modulation.

Depth 0–127 [3 (40 03 05)]

Adjusts the depth of modulation.

Pre Dly Dev (Pre Delay Deviation) 0–20 [4 (40 03 06)]

The Pre Delay is the time from when the original sound begins until when the chorus sound is heard. This adjusts the difference in Pre Delay between each of the six phases of chorus sound.

Depth Dev (Depth Deviation) -20–+20 [5 (40 03 07)]

Adjusts the difference in modulation depth between each of the six phases of chorus sound.

Pan Dev (Pan Deviation) 0–20 [6 (40 03 08)]

Adjusts the difference in stereo position between each of the six phases of chorus sound. With a setting of 0, all the chorus sound will be located in the center. With a setting of 20, each chorus sound will be placed in 30 degree intervals relative to the center position.

#Balance (Effect Balance) $D > 0E - D0 < E$ [16 (40 03 12)]

Adjusts the volume balance between the direct and the processed sound.

“D” or “E” on the display respectively means D (direct sound) or E (effect sound) values of 100.

Low Gain -12–+12 [17 (40 03 13)]

Adjusts the low frequency gain.

Hi Gain (High Gain) -12–+12 [18 (40 03 14)]

Adjusts the high frequency gain.

Level (Output Level) 0–127 [20 (40 03 16)]

Adjusts the output level.

17: Tremolo Chorus [01H, 41H]

Tremolo Chorus is a chorus effect with added Tremolo (cyclic modulation of volume).

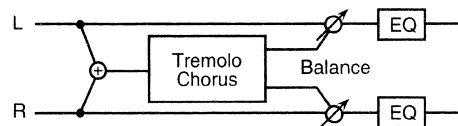

Pre Dly (Pre Delay Time) 0–100ms [1 (40 03 03)]

Adjusts the time delay from when the direct sound begins until the chorus sound is heard.

Cho Rate (Chorus Rate) 0.05–10.0 [2 (40 03 04)]

Adjusts the modulation speed of the chorus effect.

Cho Depth (Chorus Depth) 0–127 [3 (40 03 05)]

Adjusts the modulation depth of the chorus effect.

Trem Phase (Tremolo Phase) 0–180 [4 (40 03 06)]

Adjusts the width of the tremolo sound.

+Trem Rate (Tremolo Rate) 0.05–10.0 [5 (40 03 07)]

Adjusts the modulation speed of the tremolo effect.

Trem Sep (Tremolo Separation) 0–127 [6 (40 03 08)]

Adjusts the spatial spread of the tremolo effect.

#Balance (Effect Balance) $D > 0E - D0 < E$ [16 (40 03 12)]

Adjusts the volume balance between the direct and the processed sound.

“D” or “E” on the display respectively means D (direct sound) or E (effect sound) values of 100.

Low Gain -12–+12 [17 (40 03 13)]

Adjusts the low frequency gain.

Hi Gain (High Gain) -12–+12 [18 (40 03 14)]

Adjusts the high frequency gain.

Level (Output Level) 0–127 [20 (40 03 16)]

Adjusts the output level.

18: Stereo Chorus [01H, 42H]

This is a stereo chorus. A filter is provided so that you can adjust the timbre of the chorus sound.

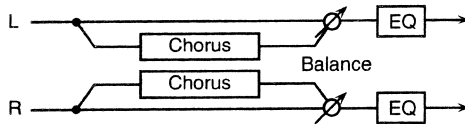

Pre Filter (Pre Filter Type) Off/LPF/HPF [1 (40 03 03)]

Selects the type of filter.

- Off: a filter will not be used
- LPF: cut the frequency range above the cutoff
- HPF: cut the frequency range below the cutoff

Cutoff (Cutoff Frequency) 250–8k [2 (40 03 04)]

Adjusts the center frequency of the filter for the chorus sound.

Pre Dly (Pre Delay Time) 0–100ms [3 (40 03 05)]

Adjusts the time delay from when the direct sound begins until the processed sound is heard.

+Rate 0.05–10.0 [4 (40 03 06)]

Adjusts the rate of modulation.

Depth 0–127 [5 (40 03 07)]

Adjusts the depth of modulation.

Phase 0–180 [7 (40 03 09)]

Adjusts the spatial spread of the sound.

#Balance (Effect Balance) D>0E–D0<E [16 (40 03 12)]

Adjusts the volume balance between the direct and the processed sound.

“D” or “E” on the display respectively means D (direct sound) or E (effect sound) values of 100.

Low Gain -12–+12 [17 (40 03 13)]

Adjusts the gain of the low frequency range.

Hi Gain (High Gain) -12–+12 [18 (40 03 14)]

Adjusts the gain of the high frequency range.

Level (Output Level) 0–127 [20 (40 03 16)]

Adjusts the output level.

19: Space D [01H, 43H]

Space-D is a multiple chorus that applies two-phase modulation in stereo. It gives no impression of modulation, but produces a transparent chorus effect.

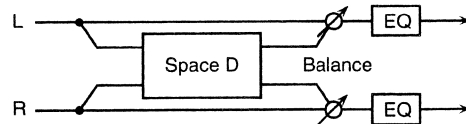

Pre Dly (Pre Delay Time) 0–100ms [1 (40 03 03)]

Adjusts the time delay from when the direct sound begins until the processed sound is heard.

+Rate 0.05–10.0 [2 (40 03 04)]

Adjusts the rate of modulation.

Depth 0–127 [3 (40 03 05)]

Adjusts the depth of modulation.

Phase 0–180 [4 (40 03 06)]

Adjusts the spatial spread of the sound.

#Balance (Effect Balance) D>0E–D0<E [16 (40 03 12)]

Adjusts the volume balance between the direct and the processed sound.

“D” or “E” on the display respectively means D (direct sound) or E (effect sound) values of 100.

Low Gain -12–+12 [17 (40 03 13)]

Adjusts the gain of the low frequency range.

Hi Gain (High Gain) -12–+12 [18 (40 03 14)]

Adjusts the gain of the high frequency range.

Level (Output Level) 0–127 [20 (40 03 16)]

Adjusts the output level.

20: 3D Chorus [01H, 44H]

This applies a 3D effect to the chorus sound. The chorus sound will be positioned 90 degrees left and 90 degrees right.

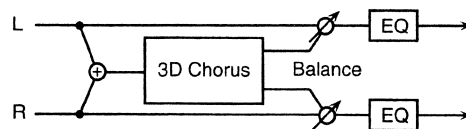

Pre Dly (Pre Delay Time) 0–100ms [1 (40 03 03)]

Adjusts the time delay from when the direct sound begins until the processed sound is heard.

+Cho Rate (Chorus Rate) 0.05–10.0 [2 (40 03 04)]

Adjusts the modulation speed of the chorus sound.

Cho Depth (Chorus Depth) 0–127 [3 (40 03 05)]

Adjusts the modulation depth of the chorus sound.

Out (Output Mode) Speaker/Phones [15 (40 03 11)]

Specifies the method that will be used to hear the sound that is output to the OUTPUT jacks. The optimal 3D effect will be achieved if you select Speaker when using speakers, or Phones when using headphones (p.84).

#Balance (Effect Balance) D>0E-D0<E [16 (40 03 12)]

Adjusts the volume balance between the direct and the processed sound.

"D" or "E" on the display respectively means D (direct sound) or E (effect sound) values of 100.

Low Gain -12--+12 [17 (40 03 13)]

Adjusts the gain of the low frequency range.

Hi Gain (High Gain) -12--+12 [18 (40 03 14)]

Adjusts the gain of the high frequency range.

Level (Output Level) 0-127 [20 (40 03 16)]

Adjusts the output level.

Effects that reverberate the sound (delay/reverb type)

21: Stereo Delay [01H, 50H]

This is a stereo delay.

Fb Mode is Norm:

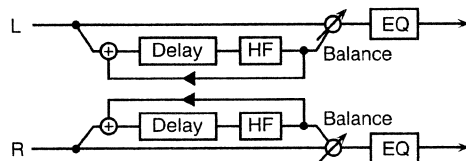

Fb Mode is Cross:

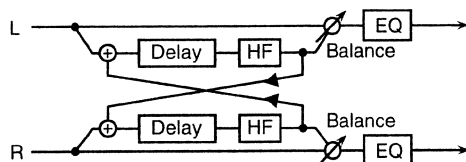

Dly Tm L (Delay Time Left) 0-500ms [1 (40 03 03)]

Adjusts the time from the original sound until when the left delay sound is heard.

Dly Tm R (Delay Time Right) 0-500ms [2 (40 03 04)]

Adjusts the time from the original sound until when the right delay sound is heard.

+Feedback (Feedback Level) -98%--+98% [3 (40 03 05)]

Adjusts the proportion (%) of the processed sound that is fed back into the effect. Negative (-) settings will invert the phase.

Fb Mode (Feedback Mode) Norm/Cross [4 (40 03 06)]

Selects the way in which processed sound is fed back into the effect.

Norm: The left delay sound will be fed back into the left delay, and the right delay sound into the right delay.

Cross: The left delay sound will be fed back into the right delay, and the right delay sound into the left delay.

Phase L (Phase Left) Norm/Invert [5 (40 03 07)]

Selects the phase of the left delay sound.

Norm: Phase will not be changed.

Invert: Phase will be inverted.

Phase R (Phase Right) Norm/Invert [6 (40 03 08)]

Selects the phase of the right delay sound.

Norm: Phase will not be changed.

Invert: Phase will be inverted.

HF Damp 315-8k/Bypass [8 (40 03 0A)]

Adjusts the frequency above which sound fed back to the effect will be cut. If you do not want to cut the high frequencies of the feedback, set this parameter to Bypass.

#Balance (Effect Balance) D>0E-D0<E [16 (40 03 12)]

Adjusts the volume balance between the direct and the processed sound.

"D" or "E" on the display respectively means D (direct sound) or E (effect sound) values of 100.

Low Gain -12--+12 [17 (40 03 13)]

Adjusts the gain of the low frequency range.

Hi Gain (High Gain) -12--+12 [18 (40 03 14)]

Adjusts the gain of the high frequency range.

Level (Output Level) 0-127 [20 (40 03 16)]

Adjusts the output level.

22: Mod Delay (Modulation Delay) [01H, 51H]

This effect adds modulation to the delayed sound, producing an effect similar to a flanger.

Fb Mode is Norm:

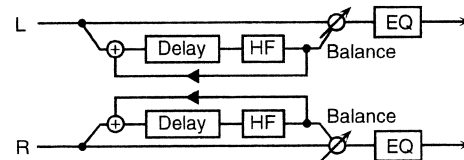

Fb Mode is Cross:

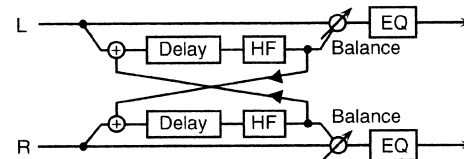

Dly Tm L (Delay Time Left) 0–500ms [1 (40 03 03)]

Adjusts the time from the original sound until when the left delay sound is heard.

Dly Tm R (Delay Time Right) 0–500ms [2 (40 03 04)]

Adjusts the time from the original sound until when the right delay sound is heard.

Feedback (Feedback Level) -98%–+98% [3 (40 03 05)]

Adjusts the proportion (%) of the processed sound that is fed back into the effect. Negative (-) settings will invert the phase.

Fb Mode (Feedback Mode) Norm/Cross [4 (40 03 06)]

Selects the way in which processed sound is fed back into the effect.

Norm: The left delay sound will be fed back into the left delay, and the right delay sound into the right delay.

Cross: The left delay sound will be fed back into the right delay, and the right delay sound into the left delay.

+Mod Rate (Modulation Rate) 0.05–10.0 [5 (40 03 07)]

Adjusts the speed of the modulation.

Mod Depth (Modulation Depth) 0–127 [6 (40 03 08)]

Adjusts the depth of the modulation.

Mod Phase (Modulation Phase) 0–180 [7 (40 03 09)]

Adjusts the spatial spread of the sound.

HF Damp 315–8k/Bypass [8 (40 03 0A)]

Adjusts the frequency above which sound fed back to the effect will be cut. If you do not wish to cut the high frequencies of the feedback, set this parameter to Bypass.

#Balance (Effect Balance) D>0E–D0<E [16 (40 03 12)]

Adjusts the volume balance between the direct and the processed sound.

“D” or “E” on the display respectively means D (direct sound) or E (effect sound) values of 100.

Low Gain -12–+12 [17 (40 03 13)]

Adjusts the gain of the low frequency range.

Hi Gain (High Gain) -12–+12 [18 (40 03 14)]

Adjusts the gain of the high frequency range.

Level (Output Level) 0–127 [20 (40 03 16)]

Adjusts the output level.

23: 3 Tap Delay (Triple Tap Delay) [01H, 52H]

The Triple Tap Delay produces three delay sounds; center, left and right.

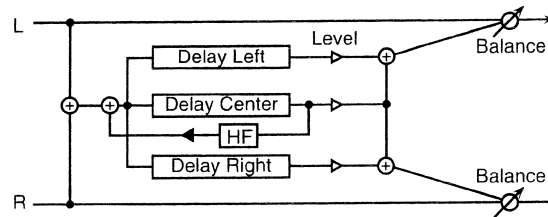

Dly Tm C (Delay Time Center)

200–990ms/1sec [1 (40 03 03)]

Adjusts the time delay from the direct sound until when the center delay sound is heard.

Dly Tm L (Delay Time Left) 200–990ms/1sec [2 (40 03 04)]

Adjusts the time delay from the direct sound until when the left delay sound is heard.

Dly Tm R (Delay Time Right)

200–990ms/1sec [3 (40 03 05)]

Adjusts the time delay from the direct sound until when the right delay sound is heard.

+Feedback (Feedback Level) -98%–+98% [4 (40 03 06)]

Adjusts the proportion (%) of the Center Delay sound that is fed back into the effect. Negative (-) settings will invert the phase.

Dly Lev C (Delay Level Center) 0–127 [5 (40 03 07)]

Adjusts the volume of Center Delay sound.

Dly Lev L (Delay Level Left) 0–127 [6 (40 03 08)]

Adjusts the volume of Left Delay sound.

Dly Lev R (Delay Level Right) 0–127 [7 (40 03 09)]

Adjusts the volume of Right Delay sound.

HF Damp 315–8k/Bypass [8 (40 03 0A)]

This adjusts the frequency at which the high range is cut when the Center Delay sound is returned to the input. If you do not wish to cut the high range, set this to Bypass.

#Balance (Effect Balance) D>0E–D0<E [16 (40 03 12)]

Adjusts the volume balance between the direct and the processed sound.

“D” or “E” on the display respectively means D (direct sound) or E (effect sound) values of 100.

Low Gain -12–+12 [17 (40 03 13)]

Adjusts the gain of the low frequency range.

Hi Gain (High Gain) -12–+12 [18 (40 03 14)]

Adjusts the gain of the high frequency range.

Level (Output Level) 0–127 [20 (40 03 16)]

Adjusts the output level.

24: 4 Tap Delay (Quadruple Tap Delay) [01H, 53H]

The Quadruple Tap Delay has four delays.

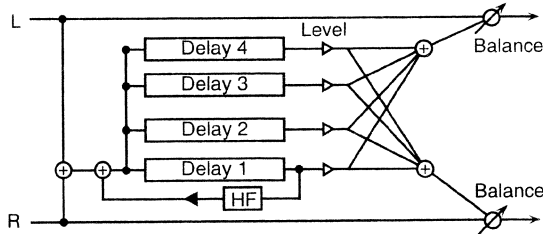
**Dly Tm 1 (Delay Time 1) 200–990ms/1sec [1 (40 03 03)]**

Adjusts the time delay from the direct sound until when the Delay 1 sound is heard.

Dly Tm 2 (Delay Time 2) 200–990ms/1sec [2 (40 03 04)]

Adjusts the time delay from the direct sound until when the Delay 2 sound is heard.

Dly Tm 3 (Delay Time 3) 200–990ms/1sec [3 (40 03 05)]

Adjusts the time delay from the direct sound until when the Delay 3 sound is heard.

Dly Tm 4 (Delay Time 4) 200–990ms/1sec [4 (40 03 06)]

Adjusts the time delay from the direct sound until when the Delay 4 sound is heard.

Dly Lev 1 (Delay Level 1) 0–127 [5 (40 03 07)]

Adjusts the volume of the Delay 1 sound.

Dly Lev 2 (Delay Level 2) 0–127 [6 (40 03 08)]

Adjusts the volume of the Delay 2 sound.

Dly Lev 3 (Delay Level 3) 0–127 [7 (40 03 09)]

Adjusts the volume of the Delay 3 sound.

Dly Lev 4 (Delay Level 4) 0–127 [8 (40 03 0A)]

Adjusts the volume of the Delay 4 sound.

+Feedback (Feedback Level) -98%–+98% [9 (40 03 0B)]

Adjusts the proportion (%) of the Delay 1 sound that is fed back into the effect. Negative (-) settings will invert the phase.

HF Damp 315–8k/Bypass [10 (40 03 0C)]

This adjusts the frequency at which the high range is cut when the Delay 1 sound is returned to the input. If you do not wish to cut the high range, set this to Bypass.

#Balance (Effect Balance) D>0E–D0<E [16 (40 03 12)]

Adjusts the volume balance between the direct and the processed sound.

“D” or “E” on the display respectively means D (direct sound) or E (effect sound) values of 100.

Low Gain -12–+12 [17 (40 03 13)]

Adjusts the gain of the low frequency range.

Hi Gain (High Gain) -12–+12 [18 (40 03 14)]

Adjusts the gain of the high frequency range.

Level (Output Level) 0–127 [20 (40 03 16)]

Adjusts the output level.

25: Tm Ctrl Delay (Time Control Delay) [01H, 54H]

This effect allows you to use a specified controller (the controller selected in EFX C.Src (p.176)) to control the delay time and pitch in real time. Lengthening the delay time will lower the pitch, and shortening it will raise the pitch.

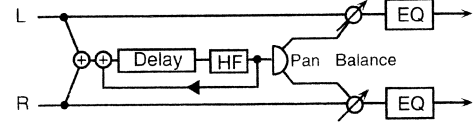
**+Dly Time (Delay Time) 200–990ms/1sec [1 (40 03 03)]**

Adjusts the time delay from the direct sound until when each delay sound is heard.

Accel (Acceleration) 0–15 [2 (40 03 04)]

This parameter adjusts the speed over which the Delay Time will change from the current setting to a newly specified setting. The rate of change for the Delay Time directly affects the rate of pitch change.

#Feedback (Feedback Level) -98%–+98% [3 (40 03 05)]

Adjusts the proportion (%) of the processed sound that is fed back into the effect. Negative (-) settings will invert the phase.

HF Damp 315–8k/Bypass [4 (40 03 06)]

Adjusts the frequency above which sound fed back to the effect will be cut. If you do not wish to cut the high frequencies of the feedback, set this parameter to Bypass.

EFX Pan (Effect Output Pan) L63–0–R63 [5 (40 03 07)]

Adjusts the stereo location of the processed sound. L63 is far left, 0 is center, and R63 is far right.

Balance (Effect Balance) D>0E–D0<E [16 (40 03 12)]

Adjusts the volume balance between the direct and the processed sound.

“D” or “E” on the display respectively means D (direct sound) or E (effect sound) values of 100.

Low Gain -12–+12 [17 (40 03 13)]

Adjusts the gain of the low frequency range.

Hi Gain (High Gain) -12–+12 [18 (40 03 14)]

Adjusts the gain of the high frequency range.

Level (Output Level) 0–127 [20 (40 03 16)]

Adjusts the output level.

26: Reverb [01H, 55H]

The Reverb effect adds reverberation to the sound, simulating an acoustic space.

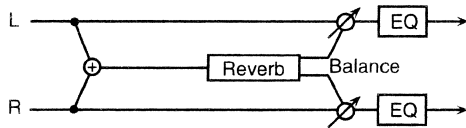

Type (ReverbType)

Room1/2/Stage1/2/Hall1/2 [1 (40 03 03)]

Selects the type of Reverb effect.

- Room1: dense reverb with short decay
- Room2: sparse reverb with short decay
- Stage1: reverb with greater late reverberation
- Stage2: reverb with strong early reflections
- Hall1: reverb with clear reverberance
- Hall2: reverb with rich reverberance

Pre Dly (Pre Delay Time) 0–100ms [2 (40 03 04)]

Adjusts the time delay from when the direct sound begins until the reverb sound is heard.

+Time (Reverb Time) 0–127 [3 (40 03 05)]

Adjusts the time length of reverberation.

HF Damp 315–8k/Bypass [4 (40 03 06)]

Adjusts the frequency above which the reverberant sound will be cut. As the frequency is set lower, more of the high frequencies will be cut, resulting in a softer and more muted reverberance. If you do not want the high frequencies to be cut, set this parameter to Bypass.

#Balance (Effect Balance) D>0E–D0<E [16 (40 03 12)]

Adjusts the volume balance between the direct and the processed sound.

“D” or “E” on the display respectively means D (direct sound) or E (effect sound) values of 100.

Low Gain -12–+12 [17 (40 03 13)]

Adjusts the gain of the low frequency range.

Hi Gain (High Gain) -12–+12 [18 (40 03 14)]

Adjusts the gain of the high frequency range.

Level (Output Level) 0–127 [20 (40 03 16)]

Adjusts the output level.

27: Gate Reverb [01H, 56H]

Gate Reverb is a special type of reverb in which the reverberant sound is cut off before its natural length.

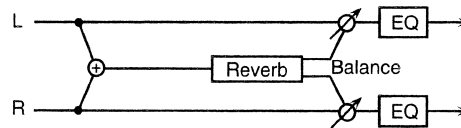

Type (Gate Reverb Type)

Norm/Reverse/Sweep1/2 [1 (40 03 03)]

Selects the type of reverb.

- Norm: conventional gate reverb
- Reverse: backwards reverb
- Sweep1: the reverberant sound moves from right to left
- Sweep2: the reverberant sound moves from left to right

Pre Dly (Pre Delay Time) 0–100ms [2 (40 03 04)]

Adjusts the time delay from when the direct sound begins until the reverb sound is heard.

Gate Time 5–500ms [3 (40 03 05)]

Adjusts the time from when the reverb is heard until when it disappears.

+Balance (Effect Balance) D>0E–D0<E [16 (40 03 12)]

Adjusts the volume balance between the direct and the processed sound.

“D” or “E” on the display respectively means D (direct sound) or E (effect sound) values of 100.

Low Gain -12–+12 [17 (40 03 13)]

Adjusts the gain of the low frequency range.

Hi Gain (High Gain) -12–+12 [18 (40 03 14)]

Adjusts the gain of the high frequency range.

#Level (Output Level) 0–127 [20 (40 03 16)]

Adjusts the output level.

28: 3D Delay [01H, 57H]

This applies a 3D effect to the delay sound. The delay sound will be positioned 90 degrees left and 90 degrees right.

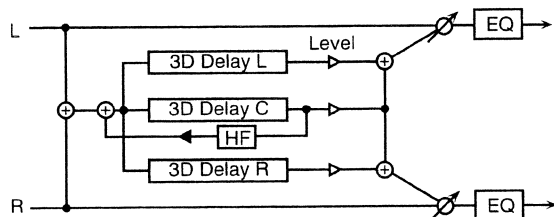
**Dly Tm C (Delay Time Center)** 0–500ms [1 (40 03 03)]

Adjusts the time from the original sound until when the center delay sound begins.

Dly Tm L (Delay Time Left) 0–500ms [2 (40 03 04)]

Adjusts the time from the original sound until when the left delay sound begins.

Dly Tm R (Delay Time Right) 0–500ms [3 (40 03 05)]

Adjusts the time from the original sound until when the right delay sound begins.

+Feedback (Delay Feedback) -98%–+98% [4 (40 03 06)]

Adjusts the amount (%) of the center delay sound that will be returned to the input. With negative (-) settings, the phase will be inverted.

Dly Lev C (Delay Level Center) 0–127 [5 (40 03 07)]

Adjusts the volume of the Center Delay sound.

Dly Lev L (Delay Level Left) 0–127 [6 (40 03 08)]

Adjusts the volume of the Left Delay sound.

Dly Lev R (Delay Level Right) 0–127 [7 (40 03 09)]

Adjusts the volume of the Right Delay sound.

HF Damp 315–8k/Bypass [8 (40 03 0A)]

This adjusts the frequency at which the high range is cut when the Center Delay sound is returned to the input. If you do not wish to cut the high range, set this to Bypass.

Out (Output Mode) Speaker/Phones [15 (40 03 11)]

Specifies the method that will be used to hear the sound that is output to the OUTPUT jacks. The optimal 3D effect will be achieved if you select Speaker when using speakers, or Phones when using headphones (p.84).

#Balance (Effect Balance) D>0E–D0<E [16 (40 03 12)]

Adjusts the volume balance between the direct and the processed sound.

“D” or “E” on the display respectively means D (direct sound) or E (effect sound) values of 100.

Low Gain -12–+12 [17 (40 03 13)]

Adjusts the gain of the low frequency range.

Hi Gain (High Gain) -12–+12 [18 (40 03 14)]

Adjusts the gain of the high frequency range.

Level (Output Level) 0–127 [20 (40 03 16)]

Adjusts the output level.

Effects that modify the pitch (pitch shift type)**29: 2 Pitch Shifter (2-Voice Pitch Shifter)** [01H, 60H]

A Pitch Shifter shifts the pitch of the original sound. This 2-voice pitch shifter has two pitch shifters, and can add two pitch shifted sounds to the original sound.

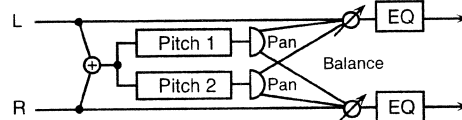
**+Coarse 1 (Coarse Pitch 1)** -24–0–+12 [1 (40 03 03)]

Adjusts the pitch of Pitch Shift 1 in semitone steps (-2–+1 octaves).

Fine 1 (Fine Pitch 1) -100–0–+100 [2 (40 03 04)]

Make fine adjustments to the pitch of Pitch Shift 1 in 2-cent steps (-100–+100 cents).

Pre Dly 1 (Pre Delay Time 1) 0–100ms [3 (40 03 05)]

Adjusts the time delay from when the direct sound begins until the Pitch Shift 1 sound is heard.

EFX Pan 1 (Effect Output Pan 1) L63–0–R63 [4 (40 03 06)]

Adjusts the stereo location of the Pitch Shift 1 sound. L63 is far left, 0 is center, and R63 is far right.

#Coarse 2 (Coarse Pitch 2) -24–0–+12 [5 (40 03 07)]

Adjusts the pitch of Pitch Shift 2 in semitone steps (-2–+1 octaves).

Fine 2 (Fine Pitch 2) -100–0–+100 [6 (40 03 08)]

Make fine adjustments to the pitch of Pitch Shift 2 in 2-cent steps (-100–+100 cents).

Pre Dly 2 (Pre Delay Time 2) 0–100ms [7 (40 03 09)]

Adjusts the time delay from when the direct sound begins until the Pitch Shift 2 sound is heard.

EFX Pan 2 (Effect Output Pan 2) L63–0–R63 [8 (40 03 0A)]

Adjusts the stereo location of the Pitch Shift 2 sound. L63 is far left, 0 is center, and R63 is far right.

Shift Mode (Pitch Shifter Mode) 1–5 [9 (40 03 0B)]

Higher settings of this parameter will result in slower response, but steadier pitch.

L.Bal (Level Balance) A> 0B–A0<B [10 (40 03 0C)]

Adjusts the volume balance between the Pitch Shift 1 and the Pitch Shift 2 sounds.

Balance (Effect Balance) D>0E–D0<E [16 (40 03 12)]

Adjusts the volume balance between the direct and the processed sound.

“D” or “E” on the display respectively means D (direct sound) or E (effect sound) values of 100.

Low Gain -12–+12 [17 (40 03 13)]

Adjusts the gain of the low frequency range.

Hi Gain (High Gain) -12–+12 [18 (40 03 14)]

Adjusts the gain of the high frequency range.

Level (Output Level) 0–127 [20 (40 03 16)]

Adjusts the output level.

30: Fb P.Shifter (Feedback Pitch Shifter) [01H, 61H]

This pitch shifter allows the pitch shifted sound to be returned into the effect.

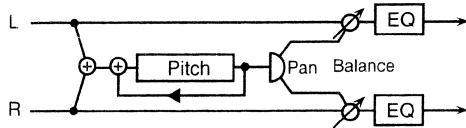

+P.Coarse (Coarse Pitch) -24-0-+12 [1 (40 03 03)]

Adjusts the pitch of the pitch shifted sound in semitone steps (-2-+1 octaves).

P.Fine (Fine Pitch) -100-0-+100 [2 (40 03 04)]

Make fine adjustments to the pitch of the pitch shifted sound in 2-cent steps (-100-+100 cents).

#Feedback (Feedback Level) -98%-+98% [3 (40 03 05)]

Adjusts the proportion (%) of the processed sound that is fed back into the effect. Negative (-) settings will invert the phase.

Pre Dly (Pre Delay Time) 0-100ms [4 (40 03 06)]

Adjusts the time delay from when the direct sound begins until the pitch shifted sound is heard.

Mode (Pitch Shifter Mode) 1-5 [5 (40 03 07)]

Higher settings for this parameter will result in slower response, but steadier pitch.

EFX Pan (Effect Output Pan) L63-0-R63 [6 (40 03 08)]

Adjusts the stereo location of the pitch shifted sound. L63 is far left, 0 is center, and R63 is far right.

Balance (Effect Balance) D>0E-D0<E [16 (40 03 12)]

Adjusts the volume balance between the direct and the processed sound.

"D" or "E" on the display respectively means D (direct sound) or E (effect sound) values of 100.

Low Gain -12-+12 [17 (40 03 13)]

Adjusts the gain of the low frequency range.

Hi Gain (High Gain) -12-+12 [18 (40 03 14)]

Adjusts the gain of the high frequency range.

Level (Output Level) 0-127 [20 (40 03 16)]

Adjusts the output level.

Others

31: 3D Auto [01H, 70H]

The 3D Auto effect rotates the location of the sound.

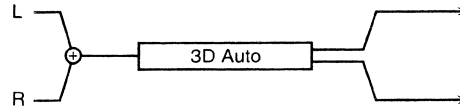

Azimuth 180/L168-0-R168 [1 (40 03 03)]

Sets the location at which the sound will stop when rotation is stopped.

A setting of 0 positions the sound in the center.

+Speed 0.05-10.0 [2 (40 03 04)]

Sets the speed of rotation.

Clockwise -/+ [3 (40 03 05)]

Sets the direction of rotation. A setting of - is counter-clockwise, and + is clockwise.

#Turn Off/On [4 (40 03 06)]

This stops or starts the rotation. When this is turned On, the sound will rotate. When turned Off, rotation will stop at the location specified by Azimuth.

Out (Output Mode) Speaker/Phones [15 (40 03 11)]

Specifies the method that will be used to hear the sound that is output to the OUTPUT jacks. The optimal 3D effect will be achieved if you select Speaker when using speakers, or Phones when using headphones (p.84).

Level (Output Level) 0-127 [20 (40 03 16)]

Adjusts the output level.

32: 3D Manual

[01H, 71H]

This places the 3D effect at a desired location.

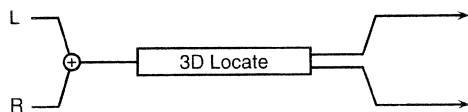

+Azimuth 180/L168–0–R168 [1 (40 03 03)]

Specifies the location. A setting of 0 positions the sound in the center.

Out (Output Mode) Speaker/Phones [15 (40 03 11)]

Specifies the method that will be used to hear the sound that is output to the OUTPUT jacks. The optimal 3D effect will be achieved if you select Speaker when using speakers, or Phones when using headphones (p.84).

#Level (Output Level) 0–127 [20 (40 03 16)]

Adjusts the output level.

33: Lo-Fi 1

[01H, 72H]

Lo-Fi 1 is an effect that intentionally degrades the sound quality.

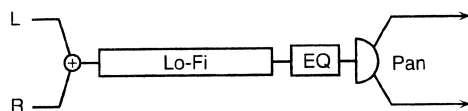

Pre Filter (Pre Filter Type) 1–6 [1 (40 03 03)]

Specifies the type of filter that will be applied before the sound passes through the Lo-Fi effect.

Lo-Fi Type 1–9 [2 (40 03 04)]

Degrades the sound quality. The sound quality will become poorer as this value is increased.

Post Filter (Post Filter Type) 1–6 [3 (40 03 05)]

Specifies the type of filter that will be applied after the sound passes through the Lo-Fi effect.

+Balance (Effect Balance) D>0E–D0<E [16 (40 03 12)]

Adjusts the volume balance between the direct and the processed sound.

“D” or “E” on the display respectively means D (direct sound) or E (effect sound) values of 100.

Low Gain –12–+12 [17 (40 03 13)]

Adjusts the gain of the low frequency range.

Hi Gain (High Gain) –12–+12 [18 (40 03 14)]

Adjusts the gain of the high frequency range.

#Pan (Output Pan) L63–0–R63 [19 (40 03 15)]

Adjusts the stereo location of the output sound. L63 is far left, 0 is center, and R63 is far right.

Level (Output Level) 0–127 [20 (40 03 16)]

Adjusts the output level.

34: Lo-Fi 2

[01H, 73H]

Lo-Fi 2 is an effect that intentionally degrades the sound quality and allows a variety of noise to be added.

* If the R.Detune (Radio Detune), W/P Level (White/Pink Noise Level), Disc Nz Lev (Disc Noise Level), or Hum Level settings are raised, there will be noise even when the input sound is silent.

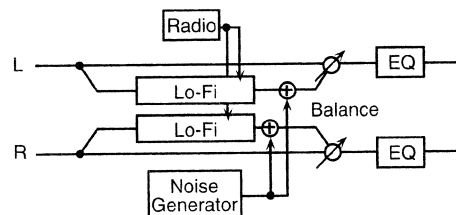

Lo-Fi Type 1–6 [1 (40 03 03)]

Degrades the sound quality. The sound quality will become poorer as this value is increased.

Filter Type (Filter Type) Off/LPF/HPF [2 (40 03 04)]

Specifies the type of filter that is applied after the sound passes through the Lo-Fi effect.

Cutoff (Cutoff Frequency) 250–8 k [3 (40 03 05)]

Specifies the cutoff frequency of the filter that is applied after the sound passes through the Lo-Fi effect.

+R.Detune (Radio Detune) 0–127 [4 (40 03 06)]

This simulates the tuning noise of a radio. As this value is raised, the tuning will drift further.

R.Nz Lev (Radio Noise Level) 0–127 [5 (40 03 07)]

Adjusts the volume of the radio noise.

W/P Sel (White/Pink Noise Select) White/Pink [6 (40 03 08)]

Selects either white noise or pink noise.

W/P LPF (White/Pink Noise LPF) 250–6.3 k/Bypass [7 (40 03 09)]

Specifies the cutoff frequency of the low pass filter that is applied to the white noise or pink noise.

W/P Level (White/Pink Noise Level) 0–127 [8 (40 03 0A)]

Specifies the volume of the white noise or pink noise.

Disc Type (Disc Noise Type) LP/EP/SP/RND [9 (40 03 0B)]

Selects the type of record noise. The frequency at which the noise is heard will depend on the selected type.

Disc LPF (Disc Noise LPF) 250–6.3 k/Bypass [10 (40 03 0C)]

Specifies the cutoff frequency of the low pass filter that is applied to the record noise.

Disc Nz Lev (Disc Noise Level) 0–127 [11 (40 03 0D)]

Specifies the volume of the record noise.

Hum Type (Hum Noise Type) 50/60 Hz [12 (40 03 0E)]

Selects the type of hum noise.

Hum LPF (Hum Noise LPF)

250–6.3 k/Bypass [13 (40 03 0F)]

Specifies the cutoff frequency of the low pass filter that is applied to the hum noise.

Hum Level (Hum Noise Level) 0–127 [14 (40 03 10)]

Specifies the volume of the hum noise.

M/S (Mono/Stereo Switch) Mono/Stereo [15 (40 03 11)]

Selects whether the effect sound will be monaural or stereo.

#Balance (Effect Balance) D>0E–D0<E [16 (40 03 12)]

Adjusts the volume balance between the direct and the effect sound.

“D” or “E” on the display respectively means D (direct sound) or E (effect sound) values of 100.

Low Gain -12→+12 [17 (40 03 13)]

Adjusts the gain of the low frequency range.

HI Gain (High Gain) -12→+12 [18 (40 03 14)]

Adjusts the gain of the high frequency range.

Pan (Mono) (Output Pan (Mono))

L63–0–R63 [19 (40 03 15)]

When Mono mode is used, adjust the stereo location of the output sound. L63 is far left, 0 is center, and R63 is far right.

Level (Output Level) 0–127 [20 (40 03 16)]

Adjusts the output level.

Effects that connect two types of effect in series (series 2)

35: OD → Chorus (Overdrive → Chorus) [02H, 00H]

This effect connects an overdrive and a chorus in series.

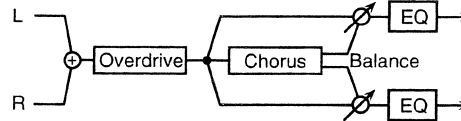

OD Drive (Overdrive Drive) 0–127 [1 (40 03 03)]

Adjusts the degree of overdrive distortion. The volume will change together with the degree of distortion.

+OD Pan (Overdrive Drive Output Pan)

L63–0–R63 [2 (40 03 04)]

Adjusts the stereo location of the overdrive sound. L63 is far left, 0 is center, and R63 is far right.

OD Amp (Overdrive Amp Simulator Type)

Small/BltIn/2-Stk/3-Stk [3 (40 03 05)]

Selects the type of guitar amp.

Small: small amp

BltIn: single-unit type amp

2-Stk: large double stack amp

3-Stk: large triple stack amp

OD Amp Sw (Overdrive Amp Switch)

Off/On [4 (40 03 06)]

Turns OD Amp on/off.

Cho Dly (Chorus Pre Delay) 0–100ms [6 (40 03 08)]

Adjusts the time delay from when the direct sound begins until the chorus sound is heard.

Cho Rate (Chorus Rate) 0.05–10.0 [7 (40 03 09)]

Adjusts the modulation speed of the chorus effect.

Cho Depth (Chorus Depth) 0–127 [8 (40 03 0A)]

Adjusts the modulation depth of the chorus effect.

#Cho Bal (Chorus Balance) D>0E–D0<E [10 (40 03 0C)]

Adjusts the volume balance between the sound that passes through the chorus and the sound that does not. With a setting of D>0E, only the overdrive sound will be output, and with a setting of D0<E, the overdrive sound that passes through the chorus will be output.

“D” or “E” on the display respectively means D (direct sound) or E (effect sound) values of 100.

Low Gain -12→+12 [17 (40 03 13)]

Adjusts the low frequency gain.

Hi Gain (High Gain) -12→+12 [18 (40 03 14)]

Adjusts the high frequency gain

Level (Output Level) 0–127 [20 (40 03 16)]

Adjusts the output level.

36: OD → Flanger (Overdrive → Flanger) [02H, 01H]

This effect connects an overdrive and a flanger in series.

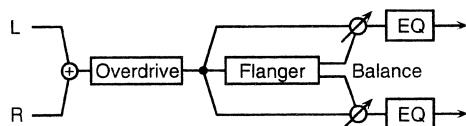
**OD Drive (Overdrive Drive) 0–127 [1 (40 03 03)]**

Adjusts the degree of overdrive distortion. The volume will change together with the degree of distortion.

+OD Pan (Overdrive Output Pan) L63–0–R63 [2 (40 03 04)]

Adjusts the stereo location of the overdrive sound. L63 is far left, 0 is center, and R63 is far right.

OD Amp (Overdrive Amp Simulator Type)

Small/BltIn/2-Stk/3-Stk [3 (40 03 05)]

Selects the type of guitar amp.

Small: small amp

BltIn: single-unit type amp

2-Stk: large double stack amp

3-Stk: large triple stack amp

OD Amp Sw (Overdrive Amp Switch)

Off/On [4 (40 03 06)]

Turns OD Amp on/off.

FL Dly (Flanger Pre Delay) 0–100ms [6 (40 03 08)]

Adjusts the time delay from when the direct sound begins until the flanger sound is heard.

FL Rate (Flanger Rate) 0.05–10.0 [7 (40 03 09)]

Adjusts the modulation speed of the flanger effect.

FL Depth (Flanger Depth) 0–127 [8 (40 03 0A)]

Adjusts the modulation depth of the flanger effect.

FL Fb (Flanger Feedback Level) -98%–+98% [9 (40 03 0B)]

Adjusts the proportion (%) of the flanger sound that is fed back into the effect. Negative (-) settings will invert the phase.

#FL Bal (Flanger Balance) D>0E–D0<E [10 (40 03 0C)]

Adjusts the volume balance between the sound that passes through the flanger and the sound that does not. With a setting of D>0E, only the overdrive sound will be output, and with a setting of D0<E, the overdrive sound that passes through the flanger will be output.

“D” or “E” on the display respectively means D (direct sound) or E (effect sound) values of 100.

Low Gain -12–+12 [17 (40 03 13)]

Adjusts the low frequency gain.

Hi Gain (High Gain) -12–+12 [18 (40 03 14)]

Adjusts the high frequency gain.

Level (Output Level) 0–127 [20 (40 03 16)]

Adjusts the output level.

37: OD → Delay (Overdrive → Delay) [02H, 02H]

This effect connects an overdrive and a delay in series.

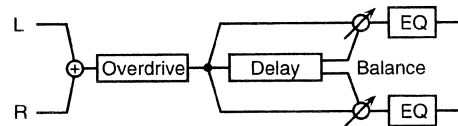
**OD Drive (Overdrive Drive) 0–127 [1 (40 03 03)]**

Adjusts the degree of overdrive distortion. The volume will change together with the degree of distortion.

+OD Pan (Overdrive Output Pan) L63–0–R63 [2 (40 03 04)]

Adjusts the stereo location of the overdrive sound. L63 is far left, 0 is center, and R63 is far right.

OD Amp (Overdrive Amp Simulator Type)

Small/BltIn/2-Stk/3-Stk [3 (40 03 05)]

Selects the type of guitar amp.

Small: small amp

BltIn: single-unit type amp

2-Stk: large double stack amp

3-Stk: large triple stack amp

OD Amp Sw (Overdrive Amp Switch)

Off/On [4 (40 03 06)]

Turns OD Amp on/off.

Dly Time (Delay Time) 0–500ms [6 (40 03 08)]

Adjusts the time delay from when the direct sound begins until the delay sound is heard.

Dly Fb (Delay Feedback Level) -98%–+98% [7 (40 03 09)]

Adjusts the proportion (%) of the delay sound that is fed back into the effect. Negative (-) settings will invert the phase.

Dly HF (Delay HF Damp) 315–8k/Bypass [8 (40 03 0A)]

Adjusts the frequency above which delayed sound fed back to the effect will be cut. If you do not wish to cut the high frequencies of the feedback, set this parameter to Bypass.

#Dly Bal (Delay Balance) D>0E–D0<E [10 (40 03 0C)]

Adjusts the volume balance between the sound that passes through the delay and the sound that does not. With a setting of D>0E, only the overdrive sound will be output, and with a setting of D0<E, the overdrive sound that passes through the delay will be output.

“D” or “E” on the display respectively means D (direct sound) or E (effect sound) values of 100.

Low Gain -12–+12 [17 (40 03 13)]

Adjusts the low frequency gain.

Hi Gain (High Gain) -12–+12 [18 (40 03 14)]

Adjusts the high frequency gain.

Level (Output Level) 0–127 [20 (40 03 16)]

Adjusts the output level.

38: DS → Chorus (Distortion → Chorus) [02H, 03H]

This effect connects a distortion and a chorus in series.

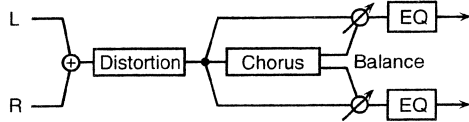

DS Drive (Distortion Drive) 0–127 [1 (40 03 03)]

Adjusts the degree of distortion. The volume will change together with the degree of distortion.

+DS Pan (Distortion Output Pan) L63–0–R63 [2 (40 03 04)]

Adjusts the stereo location of the distortion sound. L63 is far left, 0 is center, and R63 is far right.

DS Amp (Distortion Amp Simulator Type) Small/BltIn/2-Stk/3-Stk [3 (40 03 05)]

Selects the type of guitar amp.

- Small: small amp
- BltIn: single-unit type amp
- 2-Stk: large double stack amp
- 3-Stk: large triple stack amp

DS Amp Sw (Distortion Amp Switch) Off/On [4 (40 03 06)]

Turns DS Amp on/off.

Cho Dly (Chorus Pre Delay) 0–100ms [6 (40 03 08)]

Adjusts the time delay from when the direct sound begins until the chorus sound is heard.

Cho Rate (Chorus Rate) 0.05–10.0 [7 (40 03 09)]

Adjusts the modulation speed of the chorus effect.

Cho Depth (Chorus Depth) 0–127 [8 (40 03 0A)]

Adjusts the modulation depth of the chorus effect.

#Cho Bal (Chorus Balance) D>0E–D0<E [10 (40 03 0C)]

Adjusts the volume balance between the sound that passes through the chorus and the sound that does not. With a setting of D>0E, only the distortion sound will be output, and with a setting of D0<E, the distortion sound that passes through the chorus will be output.

“D” or “E” on the display respectively means D (direct sound) or E (effect sound) values of 100.

Low Gain -12→+12 [17 (40 03 13)]

Adjusts the low frequency gain.

Hi Gain (High Gain) -12→+12 [18 (40 03 14)]

Adjusts the high frequency gain.

Level (Output Level) 0–127 [20 (40 03 16)]

Adjusts the output level.

39: DS → Flanger (Distortion → Flanger) [02H, 04H]

This effect connects a distortion and a flanger in series.

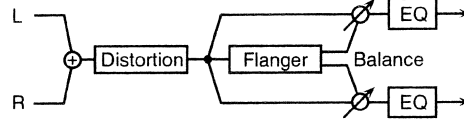

DS Drive (Distortion Drive) 0–127 [1 (40 03 03)]

Adjusts the degree of distortion. The volume will change together with the degree of distortion.

+DS Pan (Distortion Output Pan) L63–0–R63 [2 (40 03 04)]

Adjusts the stereo location of the distortion sound. L63 is far left, 0 is center, and R63 is far right.

DS Amp (Distortion Amp Simulator Type) Small/BltIn/2-Stk/3-Stk [3 (40 03 05)]

Selects the type of guitar amp.

- Small: small amp
- BltIn: single-unit type amp
- 2-Stk: large double stack amp
- 3-Stk: large triple stack amp

DS Amp Sw (Distortion Amp Switch) Off/On [4 (40 03 06)]

Turns DS Amp on/off.

FL Dly (Flanger Pre Delay) 0–100ms [6 (40 03 08)]

Adjusts the time delay from when the direct sound begins until the flanger sound is heard.

FL Rate (Flanger Rate) 0.05–10.0 [7 (40 03 09)]

Adjusts the modulation speed of the flanger effect.

FL Depth (Flanger Depth) 0–127 [8 (40 03 0A)]

Adjusts the modulation depth of the flanger effect.

FL Fb (Flanger Feedback Level) -98%→+98% [9 (40 03 0B)]

Adjusts the proportion (%) of the flanger sound that is fed back into the effect. Negative (-) settings will invert the phase

#FL Bal (Flanger Balance) D>0E–D0<E [10 (40 03 0C)]

Adjusts the volume balance between the sound that passes through the flanger and the sound that does not. With a setting of D>0E, only the distortion sound will be output, and with a setting of D0<E, the distortion sound that passes through the flanger will be output.

“D” or “E” on the display respectively means D (direct sound) or E (effect sound) values of 100.

Low Gain -12→+12 [17 (40 03 13)]

Adjusts the low frequency gain.

Hi Gain (High Gain) -12→+12 [18 (40 03 14)]

Adjusts the high frequency gain.

Level (Output Level) 0–127 [20 (40 03 16)]

Adjusts the output level.

40: DS → Delay (Distortion → Delay) [02H, 05H]

This effect connects a distortion and a delay in series.

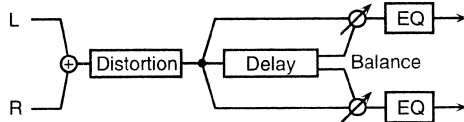
**DS Drive (Distortion Drive) 0–127 [1 (40 03 03)]**

Adjusts the degree of distortion. The volume will change together with the degree of distortion.

+DS Pan (Distortion Output Pan) L63–0–R63 [2 (40 03 04)]

Adjusts the stereo location of the distortion sound. L63 is far left, 0 is center, and R63 is far right.

DS Amp (Distortion Amp Simulator Type)

Small/BltIn/2-Stk/3-Stk [3 (40 03 05)]

Selects the type of guitar amp.

- Small: small amp
- BltIn: single-unit type amp
- 2-Stk: large double stack amp
- 3-Stk: large triple stack amp

DS Amp Sw (Distortion Amp Switch) Off/On [4 (40 03 06)]

Turns DS Amp on/off.

Dly Time (Delay Time) 0–500ms [6 (40 03 08)]

Adjusts the time delay from when the direct sound begins until the delay sound is heard.

Dly Fb (Delay Feedback Level) -98%–+98% [7 (40 03 09)]

Adjusts the proportion (%) of the delay sound that is fed back into the effect. Negative (-) settings will invert the phase.

Dly HF (Delay HF Damp) 315–8k/Bypass [8 (40 03 0A)]

Adjusts the frequency above which delayed sound fed back to the effect will be cut. If you do not wish to cut the high frequencies of the feedback, set this parameter to Bypass.

#Dly Bal (Delay Balance) D>0E–D0<E [10 (40 03 0C)]

Adjusts the volume balance between the sound that passes through the delay and the sound that does not. With a setting of D>0E, only the distortion sound will be output, and with a setting of D0<E, the distortion sound that passes through the delay will be output.

“D” or “E” on the display respectively means D (direct sound) or E (effect sound) values of 100.

Low Gain -12–+12 [17 (40 03 13)]

Adjusts the low frequency gain.

Hi Gain (High Gain) -12–+12 [18 (40 03 14)]

Adjusts the high frequency gain.

Level (Output Level) 0–127 [20 (40 03 16)]

Adjusts the output level.

41: EH → Chorus (Enhancer → Chorus) [02H, 06H]

This effect connects an enhancer and a chorus in series.

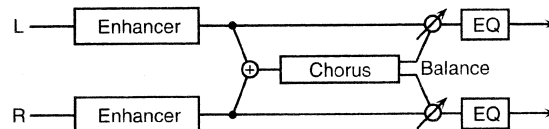
**+EH Sens (Enhancer Sensitivity) 0–127 [1 (40 03 03)]**

Adjusts the sensitivity of the enhancer.

EH Mix (Enhancer Mix Level) 0–127 [2 (40 03 04)]

Adjusts the proportion by which the overtones generated by the enhancer are combined with the direct sound.

Cho Dly (Chorus Pre Delay) 0–100ms [6 (40 03 08)]

Adjusts the time delay from when the direct sound begins until the chorus sound is heard.

Cho Rate (Chorus Rate) 0.05–10.0 [7 (40 03 09)]

Adjusts the modulation speed of the chorus effect.

Cho Depth (Chorus Depth) 0–127 [8 (40 03 0A)]

Adjusts the modulation depth of the chorus effect.

#Cho Bal (Chorus Balance) D>0E–D0<E [10 (40 03 0C)]

Adjusts the volume balance between the sound that passes through the chorus and the sound that does not. With a setting of D>0E, only the enhancer sound will be output, and with a setting of D0<E, the enhancer sound that passes through the chorus will be output.

“D” or “E” on the display respectively means D (direct sound) or E (effect sound) values of 100.

Low Gain -12–+12 [17 (40 03 13)]

Adjusts the low frequency gain.

Hi Gain (High Gain) -12–+12 [18 (40 03 14)]

Adjusts the high frequency gain.

Level (Output Level) 0–127 [20 (40 03 16)]

Adjusts the output level.

42: EH → Flanger (Enhancer → Flanger) [02H, 07H]

This effect connects an enhancer and a flanger in series.

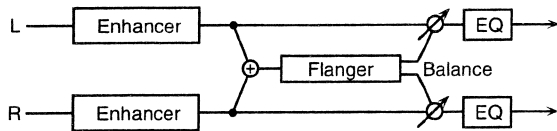

+EH Sens (Enhancer Sensitivity) 0–127 [1 (40 03 03)]
Adjusts the sensitivity of the enhancer.

EH Mix (Enhancer Mix Level) 0–127 [2 (40 03 04)]
Adjusts the proportion by which the overtones generated by the enhancer are combined with the direct sound.

FL Diy (Flanger Pre Delay) 0–100ms [6 (40 03 08)]
Adjusts the time delay from when the direct sound begins until the flanger sound is heard.

FL Rate (Flanger Rate) 0.05–10.0 [7 (40 03 09)]
Adjusts the modulation speed of the flanger effect.

FL Depth (Flanger Depth) 0–127 [8 (40 03 0A)]
Adjusts the modulation depth of the flanger effect.

FL Fb (Flanger Feedback Level) -98%–+98% [9 (40 03 0B)]
Adjusts the proportion (%) of the flanger sound that is fed back into the effect. Negative (-) settings will invert the phase.

#FL Bal (Flanger Balance) D>0E–D0<E [10 (40 03 0C)]
Adjusts the volume balance between the sound that passes through the flanger and the sound that does not. With a setting of D>0E, only the enhancer sound will be output, and with a setting of D0<E, the enhancer sound that passes through the flanger will be output.
“D” or “E” on the display respectively means D (direct sound) or E (effect sound) values of 100.

Low Gain -12–+12 [17 (40 03 13)]
Adjusts the low frequency gain.

Hi Gain (High Gain) -12–+12 [18 (40 03 14)]
Adjusts the high frequency gain.

Level (Output Level) 0–127 [20 (40 03 16)]
Adjusts the output level.

43: EH → Delay (Enhancer → Delay) [02H, 08H]

This effect connects an enhancer and a delay in series.

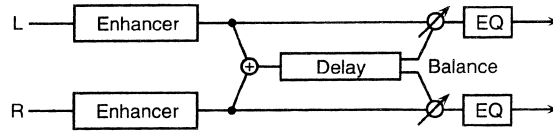

+EH Sens (Enhancer Sensitivity) 0–127 [1 (40 03 03)]
Adjusts the sensitivity of the enhancer.

EH Mix (Enhancer Mix Level) 0–127 [2 (40 03 04)]
Adjusts the proportion by which the overtones generated by the enhancer are combined with the direct sound.

Diy Time (Delay Time) 0–500ms [6 (40 03 08)]
Adjusts the time delay from when the direct sound begins until the delay sound is heard.

Diy Fb (Delay Feedback Level) -98%–+98% [7 (40 03 09)]
Adjusts the proportion (%) of the delay sound that is fed back into the delay input. Negative (-) settings will invert the phase.

Diy HF (Delay HF Damp) 315–8k/Bypass [8 (40 03 0A)]
Adjusts the frequency above which delayed sound fed back to the delay input will be cut. If you do not wish to cut the high frequencies of the delay feedback, set this parameter to Bypass.

#Diy Bal (Delay Balance) D>0E–D0<E [10 (40 03 0C)]
Adjusts the volume balance between the sound that passes through the delay and the sound that does not. With a setting of D>0E, only the enhancer sound will be output, and with a setting of D0<E, the enhancer sound that passes through the delay will be output.
“D” or “E” on the display respectively means D (direct sound) or E (effect sound) values of 100.

Low Gain -12–+12 [17 (40 03 13)]
Adjusts the low frequency gain.

Hi Gain (High Gain) -12–+12 [18 (40 03 14)]
Adjusts the high frequency gain.

Level (Output Level) 0–127 [20 (40 03 16)]
Adjusts the output level.

44: Cho → Delay (Chorus → Delay) [02H, 09H]

This effect connects a chorus and a delay unit in series.

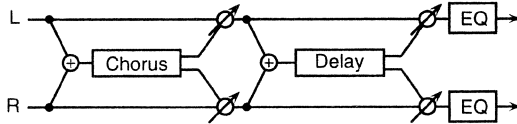
**Cho Dly (Chorus Pre Delay) 0–100ms [1 (40 03 03)]**

Adjusts the time delay from when the direct sound begins until the chorus sound is heard.

Cho Rate (Chorus Rate) 0.05–10.0 [2 (40 03 04)]

Adjusts the modulation speed of the chorus effect.

Cho Depth (Chorus Depth) 0–127 [3 (40 03 05)]

Adjusts the modulation depth of the chorus effect.

+Cho Bal (Chorus Balance) D>0E–D0<E [5 (40 03 07)]

Adjusts the volume balance between the direct sound and the chorus sound. With a setting of D>0E, only the direct sound will be output. With a setting of D0<E, only the chorus sound will be output.

“D” or “E” on the display respectively means D (direct sound) or E (effect sound) values of 100.

Dly Time (Delay Time) 0–500ms [6 (40 03 08)]

Adjusts the time delay from when the direct sound begins until the delay sound is heard.

Dly Fb (Delay Feedback Level) -98%–+98% [7 (40 03 09)]

Adjusts the proportion (%) of the delay sound that is fed back into the delay input. Negative (-) settings will invert the phase.

Dly HF (Delay HF Damp) 315–8k/Bypass [8 (40 03 0A)]

Adjusts the frequency above which delayed sound fed back to the delay input will be cut. If you do not wish to cut the high frequencies of the feedback, set this parameter to Bypass.

#Dly Bal (Delay Balance) D>0E–D0<E [10 (40 03 0C)]

Adjusts the volume balance between the sound that passes through the delay and the sound that does not. With a setting of D>0E, only the chorus sound will be output, and with a setting of D0<E, the chorus sound that passes through the delay will be output.

“D” or “E” on the display respectively means D (direct sound) or E (effect sound) values of 100.

Low Gain -12–+12 [17 (40 03 13)]

Adjusts the low frequency gain.

Hi Gain (High Gain) -12–+12 [18 (40 03 14)]

Adjusts the high frequency gain.

Level (Output Level) 0–127 [20 (40 03 16)]

Adjusts the output level.

45: FL → Delay (Flanger → Delay) [02H, 0AH]

This effect connects a flanger and a delay in series.

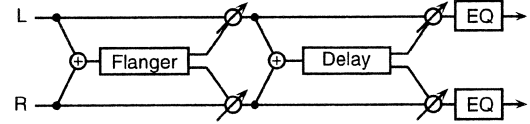
**FL Dly (Flanger Pre Delay) 0–100ms [1 (40 03 03)]**

Adjusts the time delay from when the direct sound begins until the flanger sound is heard.

FL Rate (Flanger Rate) 0.05–10.0 [2 (40 03 04)]

Adjusts the modulation speed of the flanger effect.

FL Depth (Flanger Depth) 0–127 [3 (40 03 05)]

Adjusts the modulation depth of the flanger effect.

+FL Fb (Flanger Feedback Level) -98%–+98% [4 (40 03 06)]

Adjusts the proportion (%) of the flanger sound that is fed back into the effect. Negative (-) settings will invert the phase.

FL Bal (Flanger Balance) D>0E–D0<E [5 (40 03 07)]

Adjusts the volume balance between the direct sound and the flanger sound. With a setting of D>0E, only the direct sound will be output. With a setting of D0<E, only the flanger sound will be output.

“D” or “E” on the display respectively means D (direct sound) or E (effect sound) values of 100.

Dly Time (Delay Time) 0–500ms [6 (40 03 08)]

Adjusts the time delay from when the direct sound begins until the delay sound is heard.

Dly Fb (Delay Feedback Level) -98%–+98% [7 (40 03 09)]

Adjusts the proportion (%) of the delay sound that is fed back into the delay input. Negative (-) settings will invert the phase.

Dly HF (Delay HF Damp) 315–8k/Bypass [8 (40 03 0A)]

Adjusts the frequency above which delayed sound fed back to the delay input will be cut. If you do not wish to cut the high frequencies of the delay feedback, set this parameter to Bypass.

#Dly Bal (Delay Balance) D>0E–D0<E [10 (40 03 0C)]

Adjusts the volume balance between the sound that passes through the delay and the sound that does not. With a setting of D>0E, only the flanger sound will be output, and with a setting of D0<E, the flanger sound that passes through the delay will be output.

“D” or “E” on the display respectively means D (direct sound) or E (effect sound) values of 100.

Low Gain -12–+12 [17 (40 03 13)]

Adjusts the low frequency gain.

Hi Gain (High Gain) -12–+12 [18 (40 03 14)]

Adjusts the high frequency gain.

Level (Output Level) 0–127 [20 (40 03 16)]

Adjusts the output level.

46: Cho → Flanger (Chorus → Flanger) [02H, 0BH]

This effect connects a chorus and a flanger in series.

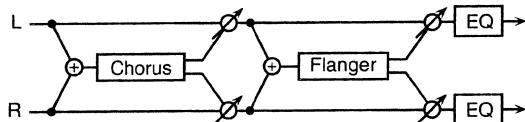

Cho Dly (Chorus Pre Delay) 0–100ms [1 (40 03 03)]

Adjusts the time delay from when the direct sound begins until the chorus sound is heard.

Cho Rate (Chorus Rate) 0.05–10.0 [2 (40 03 04)]

Adjusts the modulation speed of the chorus effect.

Cho Depth (Chorus Depth) 0–127 [3 (40 03 05)]

Adjusts the modulation depth of the chorus effect.

+Cho Bal (Chorus Balance) D>0E–D0<E [5 (40 03 07)]

Adjusts the volume balance between the direct sound and the chorus sound. With a setting of D>0E, only the direct sound will be output. With a setting of D0<E, only the chorus sound will be output.

“D” or “E” on the display respectively means D (direct sound) or E (effect sound) values of 100.

FL Dly (Flanger Pre Delay Time) 0–100ms [6 (40 03 08)]

Adjusts the time delay from when the direct sound begins until the flanger sound is heard.

FL Rate (Flanger Rate) 0.05–10.0 [7 (40 03 09)]

Adjusts the modulation speed of the flanger effect.

FL Depth (Flanger Depth) 0–127 [8 (40 03 0A)]

Adjusts the modulation depth of the flanger effect.

FL Fb (Flanger Feedback Level) -98%–+98% [9 (40 03 0B)]

Adjusts the proportion (%) of the flanger sound that is fed back into the effect. Negative (-) settings will invert the phase.

#FL Bal (Flanger Balance) D>0E–D0<E [10 (40 03 0C)]

Adjusts the volume balance between the sound that passes through the flanger and the sound that does not. With a setting of D>0E, only the chorus sound will be output, and with a setting of D0<E, the chorus sound that passes through the flanger will be output.

“D” or “E” on the display respectively means D (direct sound) or E (effect sound) values of 100.

Low Gain -12–+12 [17 (40 03 13)]

Adjusts the low frequency gain.

Hi Gain (High Gain) -12–+12 [18 (40 03 14)]

Adjusts the high frequency gain.

Level (Output Level) 0–127 [20 (40 03 16)]

Adjusts the output level.

Effects that connect three or more types of effect in series (series 3/series 4/series 5)

47: Rotary Multi [03H, 00H]

This connects Overdrive (OD), 3-band equalizer (EQ), and Rotary (RT) effects in series.

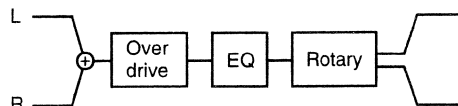

● **OD (Overdrive)**

+OD Drive 0–127 [1 (40 03 03)]

Adjusts the degree of distortion. The volume will change together with the degree of distortion.

OD Sw (Overdrive Switch) Off/On [2 (40 03 04)]

Turns the Overdrive effect on/off.

● **EQ (Equalizer)**

EQ L Gain (EQ Low Gain) -12–+12 [3 (40 03 05)]

Adjusts the low range gain of the equalizer.

EQ M Fq (EQ Mid Frequency) 200–6.3k [4 (40 03 06)]

Sets the center frequency for the equalizer mid-range.

EQ M Q (EQ Mid Q) 0.5/1.0/2.0/4.0/9.0 [5 (40 03 07)]

Adjusts the width of the area centered at the EQ M Fq setting in which the gain will be affected. The area affected will become narrower as this value is increased.

EQ M Gain (EQ Mid Gain) -12–+12 [6 (40 03 08)]

Adjusts the gain of the area specified by the EQ M Fq parameter and the EQ M Q parameter.

EQ H Gain (EQ High Gain) -12–+12 [7 (40 03 09)]

Adjusts the high-range gain of the equalizer.

● **RT (Rotary)**

RT L Slow (RT Low Frequency Slow Rate) 0.05–10.0 [8 (40 03 0A)]

Adjusts the speed of the low-range rotor for the slow-speed setting.

RT L Fast (RT Low Frequency Fast Rate) 0.05–10.0 [9 (40 03 0B)]

Adjusts the speed of the low-range rotor for the fast-speed setting.

RT Lo Accl (RT Low Frequency Acceleration) 0–15 [10 (40 03 0C)]

Adjusts the time over which the rotation speed of the low-range rotor will change from slow-speed to fast-speed (or fast-speed to slow-speed) rotation. Smaller values will require greater time to reach the new rotational speed.

RT Lo Lev (RT Low Frequency Level) 0–127 [11 (40 03 0D)]

Adjusts the volume of the low-range rotor.

RT H Slow (RT High Frequency Slow Rate)
0.05–10.0 [12 (40 03 0E)]

Adjusts the speed of the high-range rotor for the slow-speed setting.

RT H Fast (RT High Frequency Fast Rate)
0.05–10.0 [13 (40 03 0F)]

Adjusts the speed of the high-range rotor for the fast-speed setting.

RT Hi Accl (RT High Frequency Acceleration)
0–15 [14 (40 03 10)]

Adjusts the time over which the rotation speed of the high-range rotor will change from slow-speed to fast-speed (or fast-speed to slow-speed) rotation. Smaller values will require greater time to reach the new rotational speed.

RT Hi Lev (RT High Frequency Level)
0–127 [15 (40 03 11)]

Adjusts the volume of the high-range rotor.

RT Sept (RT Separation) 0–127 [16 (40 03 12)]

Adjusts the spatial spread of the rotary sound.

#RT Speed Slow/Fast [17 (40 03 13)]

Simultaneously switch the rotational speed of both the low-range and the high-range rotors.

Slow: Slow down the rotation to the specified speeds (RT L Slow parameter/RT H Slow parameter values).

Fast: Speed up the rotation to the specified speeds (RT L Fast parameter/RT H Fast parameter values).

Level (Output Level) 0–127 [20 (40 03 16)]

Adjusts the output level.

48: GTR Multi 1 (Guitar Multi 1) [04H, 00H]

Guitar Multi 1 connects Compressor (Cmp), Overdrive or Distortion (OD), Chorus or Flanger (CF), and Delay (Dly) effects in series.

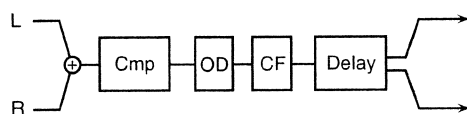

● Cmp (Compressor)

Cmp Atck (Compressor Attack) 0–127 [1 (40 03 03)]

Adjusts the time over which the sound will rise after input.

Cmp Sus (Compressor Sustain) 0–127 [2 (40 03 04)]

Adjusts the time over which low-level sounds are boosted until they reach a specified volume. Increasing the value will shorten the time. When the value is modified, the level will also change.

Cmp Level (Compressor Level) 0–127 [3 (40 03 05)]

Adjusts the volume of the compressor sound.

Cmp Sw (Compressor Switch) Off/On [4 (40 03 06)]

Turns the compressor on/off.

● OD (Overdrive/Distortion)

OD Sel (OD Select) Odrv/Dist [5 (40 03 07)]

Selects either Overdrive or Distortion.

+OD Drive 0–127 [6 (40 03 08)]

Adjusts the depth of distortion. The volume will change together with the depth of distortion.

OD Amp (OD Amp Simulator Type)
Small/Bltn/2-Stk/3-Stk [7 (40 03 09)]

Selects the type of guitar amp.

Small: small amp

Bltn: single-unit type amp

2-Stk: large double stack amp

3-Stk: large triple stack amp

OD Amp Sw (OD Amp Switch) Off/On [8 (40 03 0A)]

Turns OD Amp on/off.

OD L Gain (OD Low Gain) -12→+12 [9 (40 03 0B)]

Adjusts the low-range gain.

OD H Gain (OD High Gain) -12→+12 [10 (40 03 0C)]

Adjusts the high-range gain.

OD Sw (OD Switch) Off/On [11 (40 03 0D)]

Turns Overdrive or Distortion on/off.

● CF (Chorus/Flanger)

CF Sel (CF Select) Chorus/Flangr [12 (40 03 0E)]

Selects either Chorus or Flanger.

CF Rate 0.05–6.40 [13 (40 03 0F)]

Adjusts the speed of modulation.

CF Depth 0–127 [14 (40 03 10)]

Adjusts the depth of modulation.

CF Fb (CF Feedback) -98%→+98% [15 (40 03 11)]

Adjusts the amount (%) of the flanger sound that is returned to the input. Negative (-) values will invert the phase.

* In the case of Chorus, this will have no effect.

CF Mix 0–127 [16 (40 03 12)]

Adjusts the volume of the chorus or flanger sound.

● Dly (Delay)

Dly Time (Delay Time) 0–635ms [17 (40 03 13)]

Adjusts the time from the original sound until when the delay sound is heard.

Dly Fb (Delay Feedback Level) 0–127 [18 (40 03 14)]

Adjusts the amount of the delay sound that is returned to the input.

#Dly Mix (Delay Mix) 0–127 [19 (40 03 15)]

Adjusts the volume of the delay sound.

Level (Output Level) 0–127 [20 (40 03 16)]

Adjusts the output level.

49: GTR Multi 2 (Guitar Multi 2) [04H, 01H]

Guitar Multi 2 provides Compressor (Cmp), Overdrive or Distortion (OD), Equalizer (EQ), and Chorus or Flanger (CF) effects connected in series.

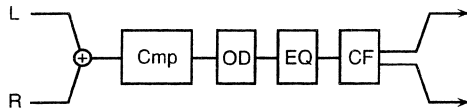

● **Cmp (Compressor)**

Cmp Atck (Compressor Attack) 0–127 [1 (40 03 03)]

Adjusts the time over which the sound will rise after it is input.

Cmp Sus (Compressor Sustain) 0–127 [2 (40 03 04)]

Adjusts the time over which low-level sounds are boosted until they reach a specified volume.

Increasing the value will shorten the time. When the value is modified, the level will also change.

Cmp Level (Compressor Level) 0–127 [3 (40 03 05)]

Adjusts the volume of the compressor sound.

Cmp Sw (Compressor Switch) Off/On [4 (40 03 06)]

Turns the compressor on/off.

● **OD (Overdrive/Distortion)**

OD Sel (OD Select) Odrv/Dist [5 (40 03 07)]

Selects either Overdrive or Distortion.

+OD Drive (OD Drive) 0–127 [6 (40 03 08)]

Adjusts the degree of distortion. The volume will change together with the degree of distortion.

OD Amp (Overdrive Amp Simulator Type) Small/BitIn/2-Stk/3-Stk [7 (40 03 09)]

Selects the type of guitar amp

Small: small amp

BitIn: single-unit type amp

2-Stk: large double stack amp

3-Stk: large triple stack amp

OD Amp Sw (OD Amp Switch) Off/On [8 (40 03 0A)]

Turns OD Amp on/off.

OD Sw (OD Switch) Off/On [9 (40 03 0B)]

Turns Overdrive or Distortion on/off.

● **EQ (Equalizer)**

EQ L Gain (EQ Low Gain) -12–+12 [10 (40 03 0C)]

Adjusts the low-range gain of the equalizer.

EQ M Fq (EQ Mid Frequency) 200–6.3k [11 (40 03 0D)]

Sets the center frequency for the equalizer mid-range.

EQ M Q (EQ Mid Q) 0.5/1.0/2.0/4.0/9.0 [12 (40 03 0E)]

Adjusts the width of the area centered at the EQ M Fq setting in which the gain will be affected. The area affected will become narrower as this value is increased.

EQ M Gain (EQ Mid Gain) -12–+12 [13 (40 03 0F)]

Adjusts the gain of the area specified by the EQ M Fq parameter and the EQ M Q parameter.

EQ H Gain (EQ High Gain) -12–+12 [14 (40 03 10)]

Adjusts the high-range gain of the equalizer.

● **CF (Chorus/Flanger)**

CF Sel (CF Select) Chorus/Flangr [15 (40 03 11)]

Selects either Chorus or Flanger.

CF Rate 0.05–6.40 [16 (40 03 12)]

Adjusts the speed of modulation for the chorus or flanger.

CF Depth 0–127 [17 (40 03 13)]

Adjusts the depth of modulation for the chorus or flanger.

CF Fb (CF Feedback) -98%–+98% [18 (40 03 14)]

Adjusts the amount (%) of the flanger sound that will be returned to the input. Negative (-) values will invert the phase.

* In the case of Chorus, this will have no effect.

#CF Mix (CF Mix) 0–127 [19 (40 03 15)]

Adjusts the volume of the chorus or flanger sound.

Level (Output Level) 0–127 [20 (40 03 16)]

Adjusts the output level.

50: GTR Multi 3 (Guitar Multi 3) [04H, 02H]

Guitar Multi 3 connects Wah (Wah), Overdrive or Distortion (OD), Chorus or Flanger (CF), and Delay (Dly) effects in series.

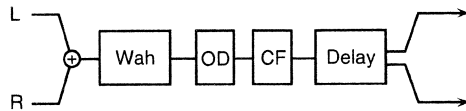

● Wah

Wah Fil (Wah Filter Type) LPF/BPF [1 (40 03 03)]

Selects the type of filter.

LPF: The wah effect will be produced over a broad frequency range.

BPF: The wah effect will be produced in a narrow frequency range.

+Wah Man (Wah Manual) 0-127 [2 (40 03 04)]

Sets the center frequency at which the effect will be produced.

Wah Peak 0-127 [3 (40 03 05)]

Adjusts the way in which the wah effect will be applied to the region of the center frequency. Lower settings will produce a wah effect in a broad area around the center frequency, and higher settings will produce a wah effect in a narrower area around the center frequency.

Wah Sw (Wah Switch) Off/On [4 (40 03 06)]

Turns Wah on/off.

● OD (Overdrive/Distortion)

OD Sel (OD Select) Odrv/Dist [5 (40 03 07)]

Selects either Overdrive or Distortion.

#OD Drive (Overdrive Drive) 0-127 [6 (40 03 08)]

Adjusts the depth of distortion. The volume will change together with the depth of distortion.

OD Amp (Overdrive Amp Simulator Type) Small/Bltn/2-Stk/3-Stk [7 (40 03 09)]

Selects the type of guitar amp

Small: small amp

Bltn: single-unit type amp

2-Stk: large double stack amp

3-Stk: large triple stack amp

OD Amp Sw (OD Amp Switch) Off/On [8 (40 03 0A)]

Turns OD Amp on/off.

OD L Gain (OD Low Gain) -12-+12 [9 (40 03 0B)]

Adjusts the low-range gain for the overdrive (or distortion) sound.

OD H Gain (OD High Gain) -12-+12 [10 (40 03 0C)]

Adjusts the high-range gain for the overdrive (or distortion) sound.

OD Sw (OD Switch) Off/On [11 (40 03 0D)]

Turns overdrive or distortion on/off.

● CF (Chorus/Flanger)

CF Sel (CF Select) Chorus/Flangr [12 (40 03 0E)]

Selects either Chorus or Flanger.

CF Rate 0.05-6.40 [13 (40 03 0F)]

Adjusts the modulation speed for the chorus or flanger.

CF Depth 0-127 [14 (40 03 10)]

Adjusts the modulation depth for the chorus or flanger.

CF Fb (CF Feedback) -98%-+98% [15 (40 03 11)]

Adjusts the amount (%) of the flanger sound that is returned to the input. Negative (-) values will invert the phase.

* In the case of Chorus, this will have no effect.

CF Mix 0-127 [16 (40 03 12)]

Adjusts the volume of the chorus or flanger sound.

● Dly (Delay)

Dly Time (Delay Time) 0-635ms [17 (40 03 13)]

Adjusts the time from the original sound until when the delay sound is heard.

Dly Fb (Delay Feedback Level) 0-127 [18 (40 03 14)]

Adjusts the amount of the delay sound that is returned to the input.

Dly Mix (Delay Mix) 0-127 [19 (40 03 15)]

Adjusts the volume of the delay sound.

Level (Output Level) 0-127 [20 (40 03 16)]

Adjusts the output level.

51: Clean Gt Multi1 (Clean Guitar Multi 1) [04H, 03H]

Clean Guitar Multi 1 connects Compressor (Cmp), Equalizer (EQ), Chorus or Flanger (CF), and Delay (Dly) effects in series.

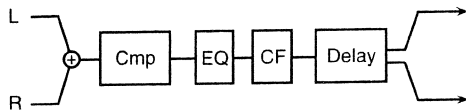

● **Cmp (Compressor)**

Cmp Atck (Compressor Attack) 0–127 [1 (40 03 03)]

Adjusts the time over which the sound will rise after it is input.

Cmp Sus (Compressor Sustain) 0–127 [2 (40 03 04)]

Adjusts the time over which low-level sounds are boosted until they reach a specified volume. Increasing the value will shorten the time. When the value is modified, the level will also change.

Cmp Level (Compressor Level) 0–127 [3 (40 03 05)]

Adjusts the volume of the compressor sound.

Cmp Sw (Compressor Switch) Off/On [4 (40 03 06)]

Turns the compressor on/off.

● **EQ (Equalizer)**

EQ L Gain (EQ Low Gain) -12→+12 [5 (40 03 07)]

Adjusts the low-range gain of the equalizer.

EQ M Fq (EQ Mid Frequency) 200–6.3k [6 (40 03 08)]

Sets the center frequency for the equalizer mid-range.

EQ M Q (EQ Mid Q) 0.5/1.0/2.0/4.0/9.0 [7 (40 03 09)]

Adjusts the width of the area centered at the EQ M Fq setting in which the gain will be affected. The area affected will become narrower as this value is increased.

EQ M Gain (EQ Mid Gain) -12→+12 [8 (40 03 0A)]

Adjusts the gain of the area specified by the EQ M Fq parameter and the EQ M Q parameter.

EQ H Gain (EQ High Gain) -12→+12 [9 (40 03 0B)]

Adjusts the high-range gain of the equalizer.

● **CF (Chorus/Flanger)**

CF Sel (CF Select) Chorus/Flangr [10 (40 03 0C)]

Selects either Chorus or Flanger.

CF Rate 0.05–6.40 [11 (40 03 0D)]

Adjusts the speed of modulation for the chorus or flanger.

CF Depth 0–127 [12 (40 03 0E)]

Adjusts the depth of modulation for the chorus or flanger.

CF Fb (CF Feedback) -98%→+98% [13 (40 03 0F)]

Adjusts the amount (%) of the flanger sound that will be returned to the input. Negative (-) values will invert the phase.

* In the case of Chorus, this will have no effect.

+CF Mix (CF Mix) 0–127 [14 (40 03 10)]

Adjusts the volume of the chorus or flanger sound.

● **Dly (Delay)**

Dly Time (Delay Time) 0–635ms [15 (40 03 11)]

Adjusts the time from the original sound until when the delay sound is heard.

Dly Fb (Delay Feedback Level) 0–127 [16 (40 03 12)]

Adjusts the amount of the delay sound that is returned to the input.

Dly HF (Delay HF Dump) 315-8k/Bypass [17 (40 03 13)]

Adjusts the frequency at which the high range will be cut from the delay sound that is returned to the input. If you do not wish to cut the high range of the returned sound, select Bypass.

#Dly Mix (Delay Mix) 0–127 [18 (40 03 14)]

Adjusts the volume of the delay sound.

Level (Output Level) 0–127 [20 (40 03 16)]

Adjusts the output level.

52: Clean Gt Multi2 (Clean Guitar Multi 2) [04H, 04H]

Clean Guitar Multi 2 provides Auto-wah (AW), Equalizer (EQ), Chorus or Flanger (CF), and Delay (Dly) effects connected in series.

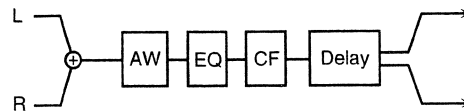

● **AW (Auto-wah)**

AW Filter (Auto-wah Filter Type) LPF/BPF [1 (40 03 03)]

Selects the type of filter for the Auto-wah.

LPF: The wah effect will be produced over a broad frequency range.

BPF: The wah effect will be produced over a narrow frequency range.

+AW Man (Auto-wah Manual) 0–127 [2 (40 03 04)]

Sets the center frequency at which the auto-wah effect will be produced.

AW Peak (Auto-wah Peak) 0–127 [3 (40 03 05)]

Adjusts the way in which the wah effect will be applied to the region of the center frequency. Lower settings will produce a wah effect in a broad area around the center frequency, and higher settings will produce a wah effect in a narrower area around the center frequency.

AW Rate (Auto-wah Rate) 0.05–6.40 [4 (40 03 06)]

Adjusts the modulation speed of the Auto-wah.

AW Depth (Auto-wah Depth) 0–127 [5 (40 03 07)]

Adjusts the modulation depth of the Auto-wah.

AW Sw (Auto-wah Switch) Off/On [6 (40 03 08)]

Turns Auto-wah on/off.

● EQ (Equalizer)

EQ L Gain (EQ Low Gain) -12—+12 [7 (40 03 09)]

Adjusts the low-range gain of the equalizer.

EQ M Fq (EQ Mid Frequency) 200—6.3k [8 (40 03 0A)]

Sets the center frequency for the equalizer mid-range.

EQ M Q (EQ Mid Q) 0.5/1.0/2.0/4.0/9.0 [9 (40 03 0B)]

Adjusts the width of the area centered at the EQ M Fq setting in which the gain will be affected. The area affected will become narrower as this value is increased.

EQ M Gain (EQ Mid Gain) -12—+12 [10 (40 03 0C)]

Adjusts the gain of the area specified by the EQ M Fq parameter and the EQ M Q parameter.

EQ H Gain (EQ High Gain) -12—+12 [11 (40 03 0D)]

Adjusts the high-range gain of the equalizer.

● CF (Chorus/Flanger)

CF Sel (CF Select) Chorus/Flangr [12 (40 03 0E)]

Selects either Chorus or Flanger.

CF Rate 0.05—6.40 [13 (40 03 0F)]

Adjusts the speed of modulation for the chorus or flanger.

CF Depth 0—127 [14 (40 03 10)]

Adjusts the depth of modulation for the chorus or flanger.

CF Fb (CF Feedback) -98%—+98% [15 (40 03 11)]

Adjusts the amount (%) of the flanger sound that will be returned to the input. Negative (-) values will invert the phase.

* In the case of Chorus, this will have no effect.

CF Mix 0—127 [16 (40 03 12)]

Adjusts the volume of the chorus or flanger sound.

● Dly (Delay)

Dly Time (Delay Time) 0—635ms [17 (40 03 13)]

Adjusts the time from the original sound until when the delay sound is heard.

Dly Fb (Delay Feedback Level) 0—127 [18 (40 03 14)]

Adjusts the amount of the delay sound that is returned to the input.

#Dly Mix (Delay Mix) 0—127 [19 (40 03 15)]

Adjusts the volume of the delay sound.

Level (Output Level) 0—127 [20 (40 03 16)]

Adjusts the output level.

53: Bass Multi

[04H, 05H]

Bass Multi provides Compressor (Cmp), Overdrive or Distortion (OD), Equalizer (EQ), and Chorus or Flanger (CF) effects connected in series.

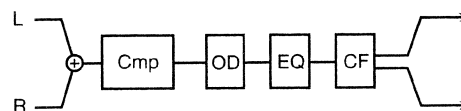

● Cmp (Compressor)

Cmp Atck (Compressor Attack) 0—127 [1 (40 03 03)]

Adjusts the time over which the sound will rise after it is input.

Cmp Sus (Compressor Sustain) 0—127 [2 (40 03 04)]

Adjusts the time over which low-level sounds are boosted until they reach a specified volume.

Increasing the value will shorten the time. When the value is modified, the level will also change.

Cmp Level (Compressor Level) 0—127 [3 (40 03 05)]

Adjusts the volume of the compressor sound.

Cmp Sw (Compressor Switch) Off/On [4 (40 03 06)]

Turns the compressor on/off.

● OD (Overdrive/Distortion)

OD Sel (OD Select) Odrv/Dist [5 (40 03 07)]

Selects either bass guitar Overdrive or Distortion.

+OD Drive (OD Drive) 0—127 [6 (40 03 08)]

Adjusts the depth of distortion. The volume will change together with the depth of distortion.

OD Amp (Overdrive Amp simulation Type)

Small/Bltn/2-Stk [7 (40 03 09)]

Selects the type of bass amp

Small: small amp

Bltn: single-unit type amp

2-Stk: large double stack amp

OD Amp Sw (OD Amp Switch) Off/On [8 (40 03 0A)]

Turns OD Amp on/off.

OD Sw (OD Switch) Off/On [9 (40 03 0B)]

Turns Overdrive/Distortion on/off.

● EQ (Equalizer)

EQ L Gain (EQ Low Gain) -12→+12 [10 (40 03 0C)]

Adjusts the low-range gain of the equalizer.

EQ M Fq (EQ Mid Frequency) 200–6.3k [11 (40 03 0D)]

Sets the center frequency for the equalizer mid-range.

EQ M Q (EQ Mid Q) 0.5/1.0/2.0/4.0/9.0 [12 (40 03 0E)]

Adjusts the width of the area centered at the EQ M Fq setting in which the gain will be affected. The area affected will become narrower as this value is increased.

EQ M Gain (EQ Mid Gain) -12→+12 [13 (40 03 0F)]

Adjusts the gain of the area specified by the EQ M Fq parameter and the EQ M Q parameter.

EQ H Gain (EQ High Gain) -12→+12 [14 (40 03 10)]

Adjusts the high-range gain of the equalizer.

● CF (Chorus/Flanger)

CF Sel (CF Select) Chorus/Flangr [15 (40 03 11)]

Selects either Chorus or Flanger.

CF Rate 0.05–6.40 [16 (40 03 12)]

Adjusts the speed of modulation for the chorus or flanger.

CF Depth 0–127 [17 (40 03 13)]

Adjusts the depth of modulation for the chorus or flanger.

CF Fb (CF Feedback Level) -98%→+98% [18 (40 03 14)]

Adjusts the amount (%) of the flanger sound that will be returned to the input. Negative (-) values will invert the phase.

* In the case of Chorus, this will have no effect.

#CF Mix 0–127 [19 (40 03 15)]

Adjusts the volume of the chorus or flanger sound.

Level (Output Level) 0–127 [20 (40 03 16)]

Adjusts the output level.

54: Rhodes Multi [04H, 06H]

Rhodes Multi provides Enhancer (EH), Phaser (PH), Chorus or Flanger (CF), and Tremolo or Pan (TP) effects connected in series.

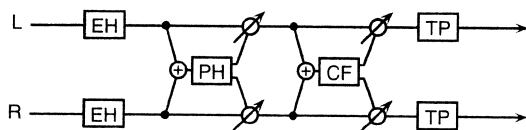

● EH (Enhancer)

EH Sens (Enhancer Sensitivity) 0–127 [1 (40 03 03)]

Adjusts the sensitivity of the enhancer.

EH Mix (Enhancer Mix Level) 0–127 [2 (40 03 04)]

Adjusts the level at which the overtones generated by the enhancer will be mixed with the direct sound.

● PH (Phaser)

PH Man (Phaser Manual) 100–8.0k [3 (40 03 05)]

Adjusts the center frequency at which the sound will be modulated.

PH Rate (Phaser Rate) 0.05–6.40 [4 (40 03 06)]

Adjusts the modulation speed.

PH Depth (Phaser Depth) 0–127 [5 (40 03 07)]

Adjusts the modulation depth.

PH Reso (Phaser Resonance) 0–127 [6 (40 03 08)]

Adjusts the emphasis for the region around the center frequency specified by the PH Man parameter.

PH Mix (Phaser Mix) 0–127 [7 (40 03 09)]

Adjusts the proportion of the phase-shifted sound that will be mixed with the direct sound.

● CF (Chorus/Flanger)

CF Sel (CF Select) Chorus/Flangr [8 (40 03 0A)]

Selects either Chorus or Flanger.

CF LPF (CF Low Pass Filter) 250–6.3k/Bypass [9 (40 03 0B)]

Cuts the high frequency range of the chorus or flanger sound.

CF Dly (CF Pre Delay) 0–100ms [10 (40 03 0C)]

Adjusts the time from the direct sound until when the chorus or flanger sound is heard.

CF Rate 0.05–6.40 [11 (40 03 0D)]

Adjusts the modulation speed.

CF Depth 0–127 [12 (40 03 0E)]

Adjusts the modulation depth.

CF Fb (CF Feedback Level) -98%→+98% [13 (40 03 0F)]

Adjusts the amount (%) of the flanger sound that will be returned to the input. Negative (-) values will invert the phase.

* In the case of Chorus, this will have no effect.

CF Mix 0–127 [14 (40 03 10)]

Adjusts the volume of the chorus or flanger sound.

● TP (Tremolo/Pan)

TP Sel (TP Select) Trem/Pan [15 (40 03 11)]

Selects either Tremolo or Pan.

TP Mod WV (TP Modulation Wave) Tri/Sqr/Sin/Saw1/Saw2 [16 (40 03 12)]

Selects the way in which tremolo or pan will be modulated.

Tri: The sound will be modulated like a triangle wave.

Sqr: The sound will be modulated like a square wave.

Sin: The sound will be modulated like a sine wave.

Saw1,2: The sound will be modulated like a sawtooth wave.

The **teeth** in Saw1 and Saw2 point in opposite directions.



+TP Mod RT (TP Modulation Rate) 0.05–6.40 [17 (40 03 13)]

Adjusts the modulation speed.

#TP Mod Dep (TP Modulation Depth) 0–127 [18 (40 03 14)]

Adjusts the modulation depth.

TP Sw (TP Switch) Off/On [19 (40 03 15)]

Turns tremolo or pan on/off.

Level (Output Level) 0–127 [20 (40 03 16)]

Adjusts the output level.

55: Keyboard Multi [05H, 00H]

Keyboard Multi provides Ring Modulator (RM), Equalizer (EQ), Pitch Shifter (PS), Phaser (PH) and Delay (Dly) effects connected in series.

Ring Modulator is an effect which applies amplitude modulation (AM) to the input signal, producing bell-like sounds.

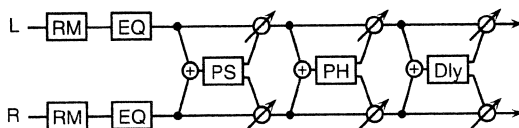

● RM (Ring Modulator)

+RM Mod Freq (RM Modulation Frequency) 0–127 [1 (40 03 03)]

Sets the frequency at which modulation will be applied.

#RM Bal (RM Balance) D>0E–D0<E [2 (40 03 04)]

Adjusts the balance between the direct and the ring modulated sound.

“D” or “E” on the display respectively means D (direct sound) or E (effect sound) values of 100.

● EQ (Equalizer)

EQ L Gain (EQ Low Gain) -12→+12 [3 (40 03 05)]
Adjusts the low range gain of the equalizer.

EQ M Fq (EQ Mid Frequency) 200–6.3k [4 (40 03 06)]
Sets the center frequency for the equalizer mid-range.

EQ M Q (EQ Mid Q) 0.5/1.0/2.0/4.0/9.0 [5 (40 03 07)]
Adjusts the width of the area centered at the EQ M Fq setting in which the gain will be affected. The area affected will become narrower as this value is increased.

EQ M Gain (EQ Mid Gain) -12→+12 [6 (40 03 08)]
Adjusts the gain of the area specified by the EQ M Fq parameter and the EQ M Q parameter.

EQ H Gain (EQ High Gain) -12→+12 [7 (40 03 09)]
Adjusts the high-range gain of the equalizer.

● PS (Pitch Shifter)

PS Coarse (PS Coarse Pitch) -24–0→+12 [8 (40 03 0A)]
Adjusts the amount of pitch shift in semitone steps (-2 to +1 octaves).

PS Fine (PS Fine Pitch) -100–0→+100 [9 (40 03 0B)]
Makes fine adjustments to the pitch shift in 2-cent steps (-100 to +100 cents).

PS Mode (PS Shifter Mode) 1–5 [10 (40 03 0C)]
As this value is increased, the response will become slower but the sound will be more stable.

PS Bal (PS Balance) D>0E–D0<E [11 (40 03 0D)]
Adjusts the volume balance between the direct and the pitch shifted sound.
“D” or “E” on the display respectively means D (direct sound) or E (effect sound) values of 100.

● PH (Phaser)

PH Man (Phaser Manual) 100–8.0k [12 (40 03 0E)]
Sets the center frequency at which the phaser sound will be modulated.

PH Rate (Phaser Rate) 0.05–6.40 [13 (40 03 0F)]
Adjusts the modulation speed of the phaser.

PH Depth (Phaser Depth) 0–127 [14 (40 03 10)]
Adjusts the modulation depth of the phaser.

PH Reso (Phaser Resonance) 0–127 [15 (40 03 11)]
Adjusts the emphasis for the region in the area of the center frequency specified by the PH Man parameter.

PH Mix (Phaser Mix) 0–127 [16 (40 03 12)]
Adjusts the proportion at which the phase-shifted sound will be mixed with the original sound.

● Dly (Delay)

Dly Time (Delay Time) 0–635ms [17 (40 03 13)]
Adjusts the time from the original sound until when the delay sound is heard.

Dly Fb (Delay Feedback Level) 0–127 [18 (40 03 14)]
Adjusts the amount of the delay sound that is returned to the input.

Dly Mix (Delay Mix Level) 0–127 [19 (40 03 15)]
Adjusts the proportion at which the delay sound is mixed with the direct sound.

Level (Output Level) 0–127 [20 (40 03 16)]
Adjusts the output level.

Effects that connect two types of effect in parallel (parallel 2)

Effect types in which two different effects are connected in parallel allow you to apply different effects to L and R independently. By using parallel effects for the sound of two Parts, you can achieve a result as if two separate effect units were used.

For example, you might select a guitar sound for Part 1 and an organ sound for Part 2. Then set the pan setting to L63 (far left) for Part 1, and to R63 (far right) for Part 2. Apply the effect **60: OD/Rotary** to both Parts 1 and 2. By then making appropriate settings for the **OD Pan** and **RT Pan** effect parameters, you can apply Overdrive to the guitar sound and Rotary to the organ sound, effectively allowing you to use two separate effects at once.

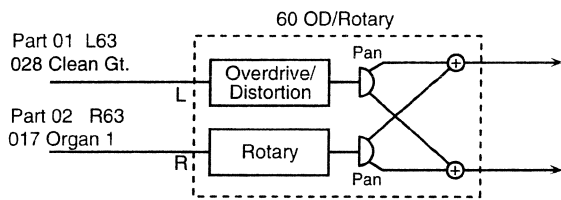

56: Cho/Delay (Chorus/Delay) [11H, 00H]

This effect connects a chorus and a delay in parallel.

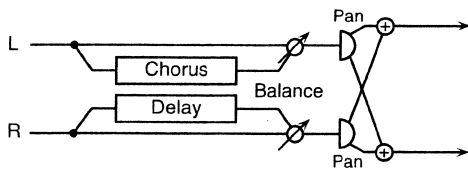

Cho Dly (Chorus Pre Delay) 0–100ms [1 (40 03 03)]

Adjusts the time delay from when the direct sound begins until the chorus sound is heard.

Cho Rate (Chorus Rate) 0.05–10.0 [2 (40 03 04)]

Adjusts the modulation speed of the chorus effect.

Cho Depth (Chorus Depth) 0–127 [3 (40 03 05)]

Adjusts the modulation depth of the chorus effect.

+Cho Bal (Chorus Balance) D>0E–D0<E [5 (40 03 07)]

Adjusts the volume balance between the direct and the chorus sound.

“D” or “E” on the display respectively means D (direct sound) or E (effect sound) values of 100.

Cho Pan (Chorus Output Pan) L63–0–R63 [16 (40 03 12)]

Adjusts the stereo position of the chorus sound. L63 is far left, 0 is center, and R63 is far right.

Cho Level (Chorus Level) 0–127 [17 (40 03 13)]

Adjusts the volume of the chorus sound.

Dly Time (Delay Time) 0–500ms [6 (40 03 08)]

Adjusts the time delay from when the direct sound begins until the delay sound is heard.

Dly Fb (Delay Feedback Level) -98%→98% [7 (40 03 09)]

Adjusts the proportion (%) of the delay sound that is fed back into the delay input. Negative (-) settings will invert the phase.

Dly HF (Delay HF Damp) 315–8k/Bypass [8 (40 03 0A)]

Adjusts the frequency above which delayed sound fed back to the delay input will be cut. If you do not wish to cut the high frequencies of the feedback, set this parameter to Bypass.

#Dly Bal (Delay Balance) D>0E–D0<E [10 (40 03 0C)]

Adjusts the volume balance between the direct and the delay sound.

“D” or “E” on the display respectively means D (direct sound) or E (effect sound) values of 100.

Dly Pan (Delay Output Pan) L63–0–R63 [18 (40 03 14)]

Adjusts the stereo position of the delay sound. L63 is far left, 0 is center, and R63 is far right.

Dly Level (Delay Level) 0–127 [19 (40 03 15)]

Adjusts the volume of the delay sound.

Level (Output Level) 0–127 [20 (40 03 16)]

Adjusts the output level.

57: FL/Delay (Flanger/Delay) [11H, 01H]

This effect connects a flanger and a delay in parallel.

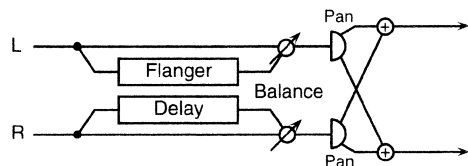
**FL Dly (Flanger Pre Delay) 0–100ms [1 (40 03 03)]**

Adjusts the time delay from when the direct sound begins until the flanger sound is heard.

FL Rate (Flanger Rate) 0.05–10.0 [2 (40 03 04)]

Adjusts the modulation speed of the flanger effect.

FL Depth (Flanger Depth) 0–127 [3 (40 03 05)]

Adjusts the modulation depth of the flanger effect.

FL Fb (Flanger Feedback Level) -98%–+98% [4 (40 03 06)]

Adjusts the proportion (%) of the flanger sound that is fed back into the effect. Negative (-) settings will invert the phase.

+FL Bal (Flanger Balance) D>0E–D0<E [5 (40 03 07)]

Adjusts the volume balance between the direct sound and the flanger sound.

“D” or “E” on the display respectively means D (direct sound) or E (effect sound) values of 100.

FL Pan (Flanger Output Pan) L63–0–R63 [16 (40 03 12)]

Adjusts the stereo position of the flanger sound. L63 is far left, 0 is center, and R63 is far right.

FL Level (Flanger Level) 0–127 [17 (40 03 13)]

Adjusts the volume of the flanger sound.

Dly Time (Delay Time) 0–500ms [6 (40 03 08)]

Adjusts the time delay from when the direct sound begins until the delay sound is heard.

Dly Fb (Delay Feedback Level) -98%–+98% [7 (40 03 09)]

Adjusts the proportion (%) of the delay sound that is fed back into the delay input. Negative (-) settings will invert the phase.

Dly HF (Delay HF Damp) 315–8k/Bypass [8 (40 03 0A)]

Adjusts the frequency above which delayed sound fed back to the delay input will be cut. If you do not want to cut the high frequencies of the delay feedback, set this parameter to Bypass.

#Dly Bal (Delay Balance) D>0E–D0<E [10 (40 03 0C)]

Adjusts the volume balance between the direct and the delay sound.

“D” or “E” on the display respectively means D (direct sound) or E (effect sound) values of 100.

Dly Pan (Delay Output Pan) L63–0–R63 [18 (40 03 14)]

Adjusts the stereo position of the delay sound. L63 is far left, 0 is center, and R63 is far right.

Dly Level (Delay Level) 0–127 [19 (40 03 15)]

Adjusts the volume of the delay sound.

Level (Output Level) 0–127 [20 (40 03 16)]

Adjusts the output level.

58: Cho/Flanger (Chorus/Flanger) [11H, 02H]

This effect connects a chorus and a flanger in parallel.

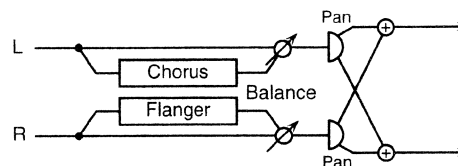
**Cho Dly (Chorus Pre Delay) 0–100ms [1 (40 03 03)]**

Adjusts the time delay from when the direct sound begins until the chorus sound is heard.

Cho Rate (Chorus Rate) 0.05–10.0 [2 (40 03 04)]

Adjusts the modulation speed of the chorus effect.

Cho Depth (Chorus Depth) 0–127 [3 (40 03 05)]

Adjusts the modulation depth of the chorus effect.

+Cho Bal (Chorus Balance) D>0E–D0<E [5 (40 03 07)]

Adjusts the volume balance between the direct and the chorus sound.

“D” or “E” on the display respectively means D (direct sound) or E (effect sound) values of 100.

Cho Pan (Chorus Output Pan) L63–0–R63 [16 (40 03 12)]

Adjusts the stereo position of the chorus sound. L63 is far left, 0 is center, and R63 is far right.

Cho Level (Chorus Level) 0–127 [17 (40 03 13)]

Adjusts the volume of the chorus sound.

FL Dly (Flanger Pre Delay) 0–100ms [6 (40 03 08)]

Adjusts the time delay from when the direct sound begins until the flanger sound is heard.

FL Rate (Flanger Rate) 0.05–10.0 [7 (40 03 09)]

Adjusts the modulation speed of the flanger effect.

FL Depth (Flanger Depth) 0–127 [8 (40 03 0A)]

Adjusts the modulation depth of the flanger effect.

FL Fb (Flanger Feedback Level) -98%–+98% [9 (40 03 0B)]

Adjusts the proportion (%) of the flanger sound that is fed back into the effect. Negative (-) settings will invert the phase.

#FL Bal (Flanger Balance) D>0E–D0<E [10 (40 03 0C)]

Adjusts the volume balance between the direct sound and the flanger sound.

“D” or “E” on the display respectively means D (direct sound) or E (effect sound) values of 100.

FL Pan (Flanger Output Pan) L63–0–R63 [18 (40 03 14)]

Adjusts the stereo position of the flanger sound. L63 is far left, 0 is center, and R63 is far right.

FL Level (Flanger Level) 0–127 [19 (40 03 15)]

Adjusts the volume of the flanger sound.

Level (Output Level) 0–127 [20 (40 03 16)]

Adjusts the output level.

59: OD1/OD2 (Overdrive/Distortion 1, 2) [11H, 03H]

This connects two effect units in parallel, each of which allows you to select Overdrive or Distortion.

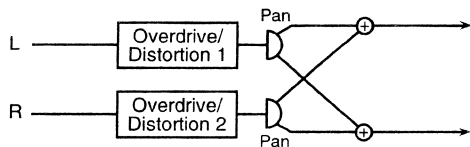

● **OD1 (Overdrive/Distortion 1)**

OD1 Sel (OD1 Select) Odrv/Dist [1 (40 03 03)]

Selects either Overdrive or Distortion for set 1.

+OD1 Drive (OD1 Drive) 0–127 [2 (40 03 04)]

Adjusts the degree of distortion for set 1. The volume will change together with the degree of distortion.

OD1 Amp (OD1 Amp Simulator Type) Small/Bltn/2-Stk/3-Stk [3 (40 03 05)]

Selects the type of guitar amp for set 1.

- Small: small amp
- Bltn: single-unit type amp
- 2-Stk: large double stack amp
- 3-Stk: large triple stack amp

OD1 Amp Sw (OD1 Amp Switch) Off/On [4 (40 03 06)]

Turns OD1 Amp on/off.

OD1 Pan (OD1 Output Pan) L63–0–R63 [16 (40 03 12)]

Sets the stereo location of the overdrive or distortion sound for set 1. L63 is far left, 0 is center, and R63 is far right.

OD1 Level 0–127 [17 (40 03 13)]

Adjusts the overdrive or distortion volume for set 1.

● **OD2 (Overdrive/Distortion 2)**

OD2 Sel (OD2 Select) Odrv/Dist [6 (40 03 08)]

Selects either Overdrive or Distortion for set 2.

#OD2 Drive (OD2 Drive) 0–127 [7 (40 03 09)]

Adjusts the degree of distortion for set 2. The volume will change together with the degree of distortion.

OD2 Amp (OD2 Amp Simulator Type) Small/Bltn/2-Stk/3-Stk [8 (40 03 0A)]

Selects the type of guitar amp for set 2.

- Small: small amp
- Bltn: single-unit type amp
- 2-Stk: large double stack amp
- 3-Stk: large triple stack amp

OD2 Amp Sw (OD2 Amp Switch) Off/On [9 (40 03 0B)]

Turns OD2 Amp on/off.

OD2 Pan (OD2 Output Pan) L63–0–R63 [18 (40 03 14)]

Sets the stereo location of the overdrive or distortion sound for set 2. L63 is far left, 0 is center, and R63 is far right.

OD2 Level 0–127 [19 (40 03 15)]

Adjusts the overdrive or distortion volume for set 2.

Level (Output Level) 0–127 [20 (40 03 16)]

Adjusts the output level.

60: OD/Rotary (Overdrive/Distortion, Rotary) [11H, 04H]

This connects Overdrive or Distortion in parallel with Rotary.

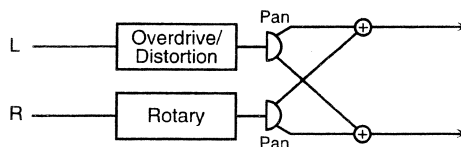

● **OD (Overdrive/Distortion)**

OD Sel (OD Select) Odrv/Dist [1 (40 03 03)]

Selects either Overdrive or Distortion.

+OD Drive (OD Drive) 0–127 [2 (40 03 04)]

Adjusts the depth of overdrive or distortion. The volume will change together with the depth of distortion.

OD Amp (OD Amp Simulator Type) Small/Bltn/2-Stk/3-Stk [3 (40 03 05)]

Select the type of guitar amp for overdrive or distortion.

- Small: small amp
- Bltn: single-unit type amp
- 2-Stk: large double stack amp
- 3-Stk: large triple stack amp

OD Amp Sw (OD Amp Switch) Off/On [4 (40 03 06)]

Turns the OD Amp parameter on/off.

OD Pan (OD Output Pan) L63–0–R63 [16 (40 03 12)]

Sets the stereo location of the overdrive or distortion sound. L63 is far left, 0 is center, and R63 is far right.

OD Level 0–127 [17 (40 03 13)]

Adjusts the volume of the overdrive or distortion sound.

● **RT (Rotary)**

RT L Slow (RT Low Frequency Slow Rate) 0.05–10.0 [6 (40 03 08)]

Adjusts the speed of the low-range rotor for the slow-speed setting.

RT L Fast (RT Low Frequency Fast Rate) 0.05–10.0 [7 (40 03 09)]

Adjusts the speed of the low-range rotor for the fast-speed setting.

RT Lo Accl (RT Low Frequency Acceleration) 0–15 [8 (40 03 0A)]

Adjusts the time over which the rotation speed of the low-range rotor will change from low-speed to high-speed (or high-speed to low-speed) rotation. Smaller values will require greater time to reach the new rotational speed.

RT Lo Lev (RT Low Frequency Level) 0–127 [9 (40 03 0B)]

Adjusts the volume of the low-range rotor.

RT H Slow (RT High Frequency Slow Rate)

0.05–10.0 [10 (40 03 0C)]

Adjusts the speed of the high-range rotor for the slow-speed setting.

RT H Fast (RT High Frequency Fast Rate)

0.05–10.0 [11 (40 03 0D)]

Adjusts the speed of the high-range rotor for the fast-speed setting.

RT Hi Accl (RT High Frequency Acceleration)

0–15 [12 (40 03 0E)]

Adjusts the time over which the rotation speed of the high-range rotor will change from slow-speed to fast-speed (or fast-speed to slow-speed) rotation. Smaller values will require greater time to reach the new rotational speed.

RT Hi Lev (RT High Frequency Level)

0–127 [13 (40 03 0F)]

Adjusts the volume of the high-range rotor.

RT Sept (RT Separation)

0–127 [14 (40 03 10)]

Adjusts the spatial spread of the rotary sound.

#RT Speed Slow/Fast [15 (40 03 11)]

Simultaneously switch the rotational speed of both the low-range and the high-range rotors.

Slow: Slow down the rotation to the specified speeds (RT L Slow parameter/RT H Slow parameter values).

Fast: Speed up the rotation to the specified speeds (RT L Fast parameter/RT H Fast parameter values).

RT Pan (RT Output Pan) L63–0–R63 [18 (40 03 14)]

Adjusts the stereo position of the rotary sound. L63 is far left, 0 is center, and R63 is far right.

RT Level 0–127 [19 (40 03 15)]

Adjusts the volume of the rotary sound.

Level (Output Level) 0–127 [20 (40 03 16)]

Adjusts the output level.

61: OD/Phaser (Overdrive/Distortion, Phaser) [11H, 05H]

This connects an overdrive or distortion in parallel with a phaser.

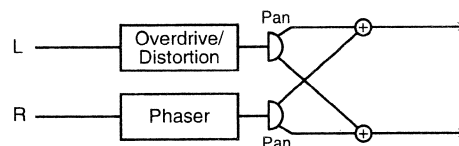
**● OD (Overdrive/Distortion)****OD Sel (OD Select)**

Odrv/Dist [1 (40 03 03)]

Selects either Overdrive or Distortion.

+OD Drive (OD Drive)

0–127 [2 (40 03 04)]

Adjusts the degree of distortion. The volume will change together with the degree of distortion.

OD Amp (Overdrive Amp Simulator Type)

Smal/Bltn/2-Stk/3-Stk [3 (40 03 05)]

Selects the type of guitar amp.

Small: small amp

Bltn: single-unit type amp

2-Stk: large double stack amp

3-Stk: large triple stack amp

OD Amp Sw (OD Amp Switch)

Off/On [4 (40 03 06)]

Turns the OD Amp parameter on/off.

OD Pan (OD Output Pan)

L63–0–R63 [16 (40 03 12)]

Sets the stereo location of the overdrive or distortion sound. L63 is far left, 0 is center, and R63 is far right.

OD Level

0–127 [17 (40 03 13)]

Adjusts the overdrive or distortion volume.

● PH (Phaser)**PH Man (Phaser Manual)**

100–8.0k [6 (40 03 08)]

Adjusts the center frequency at which the sound will be modulated.

#PH Rate (Phaser Rate)

0.05–10.0 [7 (40 03 09)]

Adjusts the modulation speed.

PH Depth (Phaser Depth)

0–127 [8 (40 03 0A)]

Adjusts the modulation depth.

PH Reso (Phaser Resonance)

0–127 [9 (40 03 0B)]

Adjusts the emphasis for the region around the center frequency specified by the PH Man parameter.

PH Mix (Phaser Mix Level)

0–127 [10 (40 03 0C)]

Adjusts the proportion of the phase-shifted sound that will be mixed with the direct sound.

PH Pan (Phaser Output Pan)

L63–0–R63 [18 (40 03 14)]

Sets the stereo location of the phaser sound. L63 is far left, 0 is center, and R63 is far right.

PH Level

0–127 [19 (40 03 15)]

Adjusts the volume of the phaser sound.

Level (Output Level)

0–127 [20 (40 03 16)]

Adjusts the output level.

62: OD/Auto Wah (Overdrive/Distortion, Auto-wah)[11H, 06H]

This connects an Overdrive or Distortion in parallel with an Auto-wah.

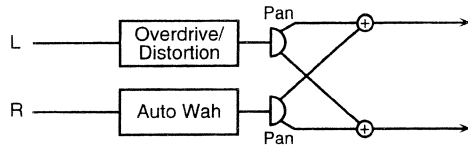

● **OD (Overdrive/Distortion)**

OD Sel (OD Select) Odrv/Dist [1 (40 03 03)]

Selects either Overdrive or Distortion.

+OD Drive (OD Drive) 0–127 [2 (40 03 04)]

Adjusts the degree of overdrive or distortion. The volume will change together with the degree of distortion.

OD Amp (Overdrive Amp Simulator Type)
Small/Bltn/2-Stk/3-Stk [3 (40 03 05)]

Selects the type of guitar amp for overdrive or distortion.

- Small: small amp
- Bltn: single-unit type amp
- 2-Stk: large double stack amp
- 3-Stk: large triple stack amp

OD Amp Sw (OD Amp Switch) Off/On [4 (40 03 06)]

Turns the OD Amp parameter on/off.

OD Pan (OD Output Pan) L63–0–R63 [16 (40 03 12)]

Sets the stereo location of the overdrive or distortion sound. L63 is far left, 0 is center, and R63 is far right.

OD Level 0–127 [17 (40 03 13)]

Adjusts the volume of the overdrive or distortion sound.

● **AW (Auto-wah)**

AW Filter (Auto-wah Filter Type) LPF/BPF [6 (40 03 08)]

Selects the type of filter for the auto-wah.

LPF: The wah effect will be produced over a broad frequency range.

BPF: The wah effect will be produced over a narrow frequency range.

AW Sens (Auto-wah Sensitivity) 0–127 [7 (40 03 09)]

Adjusts the sensitivity with which the auto-wah filter will be controlled.

#AW Man (Auto-wah Manual) 0–127 [8 (40 03 0A)]

Sets the center frequency at which the auto-wah effect will be produced.

AW Peak (Auto-wah Peak) 0–127 [9 (40 03 0B)]

Adjusts the way in which the wah effect will be applied to the region of the center frequency. Lower settings will produce a wah effect in a broad area around the center frequency, and higher settings will produce a wah effect in a narrower area around the center frequency.

AW Rate (Auto-wah Rate) 0.05–10.0 [10 (40 03 0C)]

Adjusts the modulation speed of the auto-wah.

AW Depth (Auto-wah Depth) 0–127 [11 (40 03 0D)]

Adjusts the modulation depth of the auto-wah.

AW Pol (Auto-wah Polarity) Down/Up [12 (40 03 0E)]

Sets the direction in which the frequency will change when the auto-wah filter is modulated. With a setting of Up, the filter will change toward a higher frequency. With a setting of Down, it will change toward a lower frequency.

AW Pan (Auto-wah Output Pan)L63–0–R63 [18 (40 03 14)]

Adjusts the stereo position of the auto-wah sound. L63 is far left, 0 is center, and R63 is far right.

AW Level (Auto-wah Level) 0–127 [19 (40 03 15)]

Adjusts the volume of the auto-wah sound.

Level (Output Level) 0–127 [20 (40 03 16)]

Adjusts the output level.

63: PH/Rotary (Phaser, Rotary) [11H, 07H]

This connects a Phaser effect in parallel with a Rotary effect.

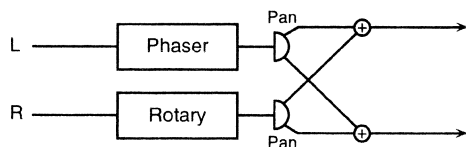

● PH (Phaser)

PH Man (Phaser Manual) 100–8.0k [1 (40 03 03)]

Adjusts the center frequency at which the sound will be modulated.

+PH Rate (Phaser Rate) 0.05–10.0 [2 (40 03 04)]

Adjusts the modulation speed of the phaser.

PH Depth (Phaser Depth) 0–127 [3 (40 03 05)]

Adjusts the modulation depth of the phaser.

PH Reso (Phaser Resonance) 0–127 [4 (40 03 06)]

Adjusts the emphasis for the region around the center frequency specified by the PH Man parameter.

PH Mix (Phaser Mix Level) 0–127 [5 (40 03 07)]

Adjusts the proportion of the phase-shifted sound that will be mixed with the direct sound.

PH Pan (Phaser Output Pan) L63–0–R63 [16 (40 03 12)]

Sets the stereo location of the phaser sound. L63 is far left, 0 is center, and R63 is far right.

PH Level (Phaser Level) 0–127 [17 (40 03 13)]

Adjusts the volume of the phaser sound.

● RT (Rotary)

RT L Slow (RT Low Frequency Slow Rate)
0.05–10.0 [6 (40 03 08)]

Adjusts the speed of the low-range rotor for the slow-speed setting.

RT L Fast (RT Low Frequency Fast Rate)
0.05–10.0 [7 (40 03 09)]

Adjusts the speed of the low-range rotor for the fast-speed setting.

RT Lo Accl (RT Low Frequency Acceleration)
0–15 [8 (40 03 0A)]

Adjusts the time over which the rotation speed of the low-range rotor will change from slow-speed to fast-speed (or fast-speed to slow-speed) rotation. Smaller values will require greater time to reach the new rotational speed.

RT Lo Lev (RT Low Frequency Level) 0–127 [9 (40 03 0B)]

Adjusts the volume of the low-range rotor.

RT H Slow (RT High Frequency Slow Rate)
0.05–10.0 [10 (40 03 0C)]

Adjusts the speed of the high-range rotor for the slow-speed setting.

RT H Fast (RT High Frequency Fast Rate)

0.05–10.0 [11 (40 03 0D)]

Adjusts the speed of the high-range rotor for the fast-speed setting.

RT Hi Accl (RT High Frequency Acceleration)

0–15 [12 (40 03 0E)]

Adjusts the time over which the rotation speed of the high-range rotor will change from slow-speed to fast-speed (or fast-speed to slow-speed) rotation. Smaller values will require greater time to reach the new rotational speed.

RT Hi Lev (RT High Frequency Level)

0–127 [13 (40 03 0F)]

Adjusts the volume of the high-range rotor.

RT Sept (RT Separation) 0–127 [14 (40 03 10)]

Adjusts the spread of the rotary sound.

#RT Speed Slow/Fast [15 (40 03 11)]

Simultaneously switch the rotational speed of both the low-range and the high-range rotors.

Slow: Slow down the rotation to the specified speeds (RT L Slow parameter/RT H Slow parameter values).

Fast: Speed up the rotation to the specified speeds (RT L Fast parameter/RT H Fast parameter values).

RT Pan (RT Output Pan) L63–0–R63 [18 (40 03 14)]

Adjusts the stereo position of the rotary sound. L63 is far left, 0 is center, and R63 is far right.

RT Level 0–127 [19 (40 03 15)]

Adjusts the volume of the rotary sound.

Level (Output Level) 0–127 [20 (40 03 16)]

Adjusts the output level.

64: PH/Auto Wah (Phaser, Auto-wah) [11H, 08H]

This connects a Phaser effect and an Auto-wah effect in parallel.

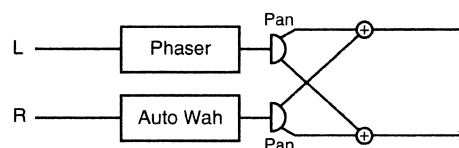

● PH (Phaser)

PH Man (Phaser Manual) 100–8.0k [1 (40 03 03)]

Adjusts the center frequency at which the phaser sound will be modulated.

+PH Rate (Phaser Rate) 0.05–10.0 [2 (40 03 04)]

Adjusts the modulation speed of the phaser.

PH Depth (Phaser Depth) 0–127 [3 (40 03 05)]

Adjusts the modulation depth of the phaser.

Effects

PH Reso (Phaser Resonance) 0–127 [4 (40 03 06)]

Adjusts the emphasis for the region around the center frequency specified by the PH Man parameter.

PH Mix (Phaser Mix Level) 0–127 [5 (40 03 07)]

Adjusts the proportion of the phase-shifted sound that will be mixed with the direct sound.

PH Pan (Phaser Output Pan) L63–0–R63 [16 (40 03 12)]

Sets the stereo location of the phaser sound. L63 is far left, 0 is center, and R63 is far right.

PH Level (Phaser Level) 0–127 [17 (40 03 13)]

Adjusts the volume of the phaser sound.

● **AW (Auto-wah)**

AW Filter (Auto-wah Filter Type) LPF/BPF [6 (40 03 08)]

Selects the type of filter for the auto-wah.

LPF: The wah effect will be produced over a broad frequency range.

BPF: The wah effect will be produced over a narrow frequency range.

AW Sens (Auto-wah Sensitivity) 0–127 [7 (40 03 09)]

Adjusts the sensitivity with which the auto-wah filter will be modulated.

#AW Man (Auto-wah Manual) 0–127 [8 (40 03 0A)]

Sets the center frequency at which the auto-wah effect will be produced.

AW Peak (Auto-wah Peak) 0–127 [9 (40 03 0B)]

Adjusts the way in which the wah effect will be applied to the region of the center frequency. Lower settings will produce a wah effect in a broad area around the center frequency, and higher settings will produce a wah effect in a narrower area around the center frequency.

AW Rate (Auto-wah Rate) 0.05–10.0 [10 (40 03 0C)]

Adjusts the modulation speed of the auto-wah.

AW Depth (Auto-wah Depth) 0–127 [11 (40 03 0D)]

Adjusts the modulation depth of the auto-wah.

AW Pol (Auto-wah Polarity) Down/Up [12 (40 03 0E)]

Sets the direction in which the frequency will change when the auto-wah filter is modulated. With a setting of Up, the filter will change toward a higher frequency. With a setting of Down it will change toward a lower frequency.

AW Pan (Auto-wah Output Pan) L63–0–R63 [18 (40 03 14)]

Adjusts the stereo position of the auto-wah sound. L63 is far left, 0 is center, and R63 is far right.

AW Level (Auto-wah Level) 0–127 [19 (40 03 15)]

Adjusts the volume of the auto-wah sound.

Level (Output Level) 0–127 [20 (40 03 16)]

Adjusts the output level.

When using 3D effects

The following four 3D effects utilize RSS (Roland Sound Space) technology to create a spaciousness that cannot be produced by delay, reverb, chorus, etc.

20: 3DChorus

28: 3DDelay

31: 3DAuto

32: 3DManual

When using these effects, we recommend that you place your speakers as follows. Also, make sure that the speakers are at a sufficient distance from the walls on either side.

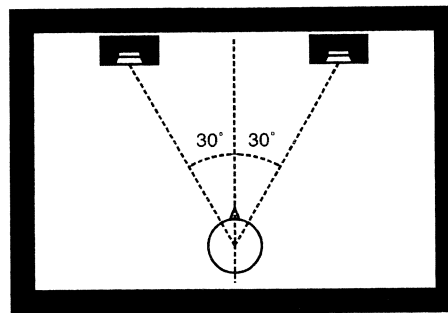

If the left and right speakers are too far apart, or if there is too much reverberation, the full 3D effect may not appear.

Each of these effects has an **Out (Output Mode)** parameter. If the sound from the OUTPUT jacks is to be heard through speakers, set this parameter to Speaker. If the sound is to be heard through headphones, set it to Phones. This will ensure that the optimal 3D effect will be heard. If this parameter is not set correctly, the full 3D effect may not appear.

Operation via MIDI

To apply an Insertion Effect to a certain Part using MIDI messages, transmit the following System Exclusive Messages in turn.

- | | address | data | checksum |
|----|----------------|--------------|--------------------|
| 1. | F0 41 10 42 12 | [40 03 00] | [...] [...] F7 |
| 2. | F0 41 10 42 12 | [40 03 03] | [...] [...] F7 |
| | | [40 03 20] | |
| 3. | F0 41 10 42 12 | [40 4x 22] | [...] [...] F7 |

- Address 1: EFX TYPE
 Data 1: Use the two values MSB and LSB to specify the effect type. For details on the effect type, refer to **Insertion Effect Types** (p.48) and to **Insertion Effect List** (p.156).
 Address 2: EFX PARAMETER 1 (- 20)
 For details on the parameters, refer to **Insertion Effect Types** (p.48) and to **Insertion Effect List** (p.156).
 Data 2: Specify the parameter value in the range of 00 - 7F (0 - 127).
 Checksum: Refer to **How to calculate the checksum** (p.184).
 Address 3: PART EFX ASSIGN
 x: Part Number (In the MIDI implementation, the part number is described as the block number. For more about the correspondence between part numbers and block numbers, refer to p.176.)
 Data 3: 00 - 01
 00 = BYPASS (Effect Off), 01 = EFX (Effect On)

<Example> Applying Insertion Effect 06:Distortion to Part 1

Transmit the following System Exclusive Messages in turn.

Firstly, set the effect type to 06:Distortion by transmitting EFX TYPE.

	address	data	checksum
F0 41 10 42 12	[40 03 00]	[01 11]	[2B] F7
	↑	↑	↑
	Effect Type	Distortion	checksum

Secondly, sets the effect parameter Drive to 127 by transmitting EFX PARAMETER 1.

	address	data	checksum
F0 41 10 42 12	[40 03 03]	[7F]	[3B] F7
	↑	↑	↑
	Drive	7F (=127)	checksum

Finally, turn on the effect for Part 1 by transmitting PART EFX ASSIGN.

	address	data	checksum
F0 41 10 42 12	[40 41 22]	[01]	[5C] F7
	↑	↑	↑
	Part 1	EFX on	checksum



Also refer to **MIDI Implementation** (p.176).



For details about decimal and hexadecimal, refer to **Decimal and Hexadecimal table** (p.183).



For details about the type of effects, refer to **Insertion Effect Types** (p.48), or **Insertion Effect List** (p.156).



For details about checksum, refer to **How to calculate the checksum** (p.184), and about decimal and hexadecimal, refer to **Decimal and Hexadecimal table** (p.183).

Examples of Using Effect Controllers

Here are some examples of how effect controllers can be used.

In these examples MIDI messages are used to modify the settings.

Hexadecimal values in the < Settings > sections denote Exclusive messages, and hexadecimal values in the < Modifying the value > sections denote control change messages. The Exclusive messages are given with device ID 17 (10H) (the factory setting). After the settings in < Settings > have been made, the control change messages described in < Modifying the value > can be transmitted to modify the parameters to the desired value.

For the correspondence between the hexadecimal values and the parameter values, refer to p.173.

■ Using Control Change 16 to modify the Drive value of **06: Distortion**

< Settings >

- 1** Turn EFX (address: 40H 41H 22H) on for Part 1.
F0 41 10 42 12 40 41 22 01 5C F7
- 2** Set the effect type to **6: Distortion** (value: 01H 11H)
F0 41 10 42 12 40 03 00 01 11 2B F7
- 3** Set Drive (address: 40H 03H 03H) to 0 (00H).
F0 41 10 42 12 40 03 03 00 3A F7
- 4** Set Effect Control Source 1 (address: 40H 03H 1BH) to CC16 (10H).
F0 41 10 42 12 40 03 1B 10 12 F7
- 5** Set Effect Control Depth 1 (address: 40H 03H 1CH) to +100% (7FH).
F0 41 10 42 12 40 03 1C 7F 22 F7

< Modifying the value >

CC#16	0	Drive	→	0
	1	Drive	→	1
	:			:
	126	Drive	→	126
	127	Drive	→	127

■ Using Control Change 16 to modify the Speed value of **09: Rotary**

< Settings >

- 1** Turn EFX (address: 40H 41H 22H) on for Part 1.
F0 41 10 42 12 40 41 22 01 5C F7
- 2** Set the effect type to **9: Rotary** (value: 01H 22H)
F0 41 10 42 12 40 03 00 01 22 1A F7
- 3** Set Speed (address: 40H 03H 0DH) to Slow (00H).
F0 41 10 42 12 40 03 0D 00 30 F7
- 4** Set Effect Control Source 1 (address: 40H 03H 1BH) to CC16 (10H).
F0 41 10 42 12 40 03 1B 10 12 F7
- 5** Set Effect Control Depth 1 (address: 40H 03H 1CH) to +100% (7FH).
F0 41 10 42 12 40 03 1C 7F 22 F7

< Modifying values >

Since the Speed parameter has only two values, Slow and Fast, the lower half of the range (0–63) will select Slow, and the upper half (64–127) will select Fast.

CC#16	0	Speed	→	Slow
	:			:
	63	Speed	→	Slow
	64	Speed	→	Fast
	:			:
	127	Speed	→	Fast

■ Using Control Change 16 to modify the Wah Man value of **50:GTR Multi3**

< Settings >

1 Turn EFX on for Part 1.

F0 41 10 42 12 40 41 22 01 5C F7

2 Set the effect type to **50: GTR Multi 3** (value: 04H 02H)

F0 41 10 42 12 40 03 00 04 02 37 F7

3 Set Wah Man (address: 40H 03H 04H) to 0 (00H).

F0 41 10 42 12 40 03 04 00 39 F7

4 Set Effect Control Source 1 (address: 40H 03H 1BH) to CC16 (10H).

F0 41 10 42 12 40 03 1B 10 12 F7

5 Set Effect Control Depth 1 (address: 40H 03H 1CH) to +100% (7FH).

F0 41 10 42 12 40 03 1C 7F 22 F7

< Modifying the value >

CC#16	0	Wah Man	→	0
	1	Wah Man	→	1
	:			:
	126	Wah Man	→	126
	127	Wah Man	→	127

■ Using Control Change 17 to modify the Feedback value of **10: Stereo Flanger**

Example 1: When Effect Control Depth is set to +100

< Settings >

1 Turn EFX on for Part 1.

F0 41 10 42 12 40 41 22 01 5C F7

2 Set the effect type to **10: Stereo Flanger** (value: 01H 23H)

F0 41 10 42 12 40 03 00 01 23 19 F7

3 Set Feedback (address: 40H 03H 08H) to -98% (00H).

F0 41 10 42 12 40 03 08 00 35 F7

4 Set Effect Control Source 2 (address: 40H 03H 1DH) to CC17 (11H).

F0 41 10 42 12 40 03 1D 11 0F F7

5 Set Effect Control Depth 2 (address: 40H 03H 1EH) to +100% (7FH).

F0 41 10 42 12 40 03 1E 7F 20 F7

< Modifying the value >

The Feedback parameter changes in 2% steps, with 64 as the center.

CC#17	0	Feedback	→	-98%
	:			:
	15	Feedback	→	-98%
	16	Feedback	→	-96%
	:			:
	62	Feedback	→	-4%
	63	Feedback	→	-2%
	64	Feedback	→	+/-0%
	65	Feedback	→	+2%
	66	Feedback	→	+4%
	:			:
	112	Feedback	→	+96%
	113	Feedback	→	+98%
	:			:
	127	Feedback	→	+98%

MEMO

For details about the hexadecimal values and their corresponding parameter value, refer to **Effect Parameter Value Conversion Table** (p.164).

■ Using Control Change 17 to modify the Feedback value of **10: Stereo Flanger**

Example 2: When Effect Control Depth is set to -100

< Settings >

- 1 Turn EFX on for Part 1.
F0 41 10 42 12 40 41 22 01 5C F7
- 2 Set the effect type to **10: Stereo Flanger** (value: 01H 23H)
F0 41 10 42 12 40 03 00 01 23 19 F7
- 3 Set Feedback (address: 40H 03H 08H) to +98% (7FH).
F0 41 10 42 12 40 03 08 7F 36 F7
- 4 Set Effect Control Source 2 (address: 40H 03H 1DH) to CC17 (11H).
F0 41 10 42 12 40 03 1D 11 0F F7
- 5 Set Effect Control Depth 2 (address: 40H 03H 1EH) to -100% (00H).
F0 41 10 42 12 40 03 1E 00 1F F7

< Modifying the value >

The Feedback parameter changes in 2% steps, with 40H as the center. Since Effect Control Depth is set to -100%, increasing control change values will cause the value of the Feedback parameter to decrease.

CC#17	0	Feedback	→	+98%
	:		:	
	14	Feedback	→	+98%
	15	Feedback	→	+96%
	:		:	
	61	Feedback	→	+4%
	62	Feedback	→	+2%
	63	Feedback	→	+/-0%
	64	Feedback	→	-2%
	65	Feedback	→	-4%
	:		:	
	111	Feedback	→	-96%
	112	Feedback	→	-98%
	:		:	
	127	Feedback	→	-98%

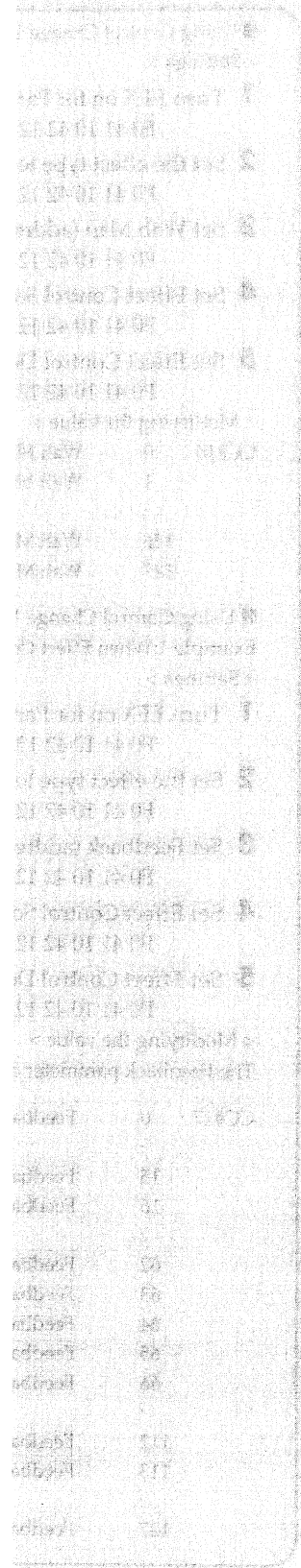

Appendices

Troubleshooting

If the SC-8820 does not function in the way you expect, first check the following points. If this does not resolve the problem, consult your dealer or a nearby Roland Service Station (listed at the end of this manual).

Cannot turn the power on

- Is the AC adaptor correctly plugged into an outlet and the SC-8820?

Does not operate on USB bus power supply

Depending on how power is supplied to the USB connector of your computer, the SC-8820 may not be able to operate on bus power. If this is the case, use it with the AC adaptor connected.

The volume level of the instrument connected to Audio output/input jacks is too low.

- Could you be using a connection cable that contains a resistor?
Use a connection cable that does not contain a resistor.

A specific Part does not sound

- Is the volume level of the Part turned down? (p.177)
- Does the MIDI Receive channel of the Part match the MIDI Transmit channel of the connected MIDI device? (p.95)

Do not sound when you press the [VOLUME] knob

- Make sure that the part level has not been lowered. (p.18)

A specific keyboard area does not sound

- Has the Keyboard Range been set? (p.30)

Cannot select the desired sound

- Are you sending an incorrect Program Change number? (p.22)
- Are you setting the SC-8820 to SC-55 Map, SC-88 Map, or SC-88Pro Map? (p.25)

No sound

If you do not hear any sound, the reason is often more complex and can have more potential causes than most other problems. However in most cases, the problem is due to incorrect connections between devices, or incorrect settings in the driver or software.

How to read the flow chart

- ▭ ... Read in sequence, following the instructions.
- ◇ ... Answer the questions.

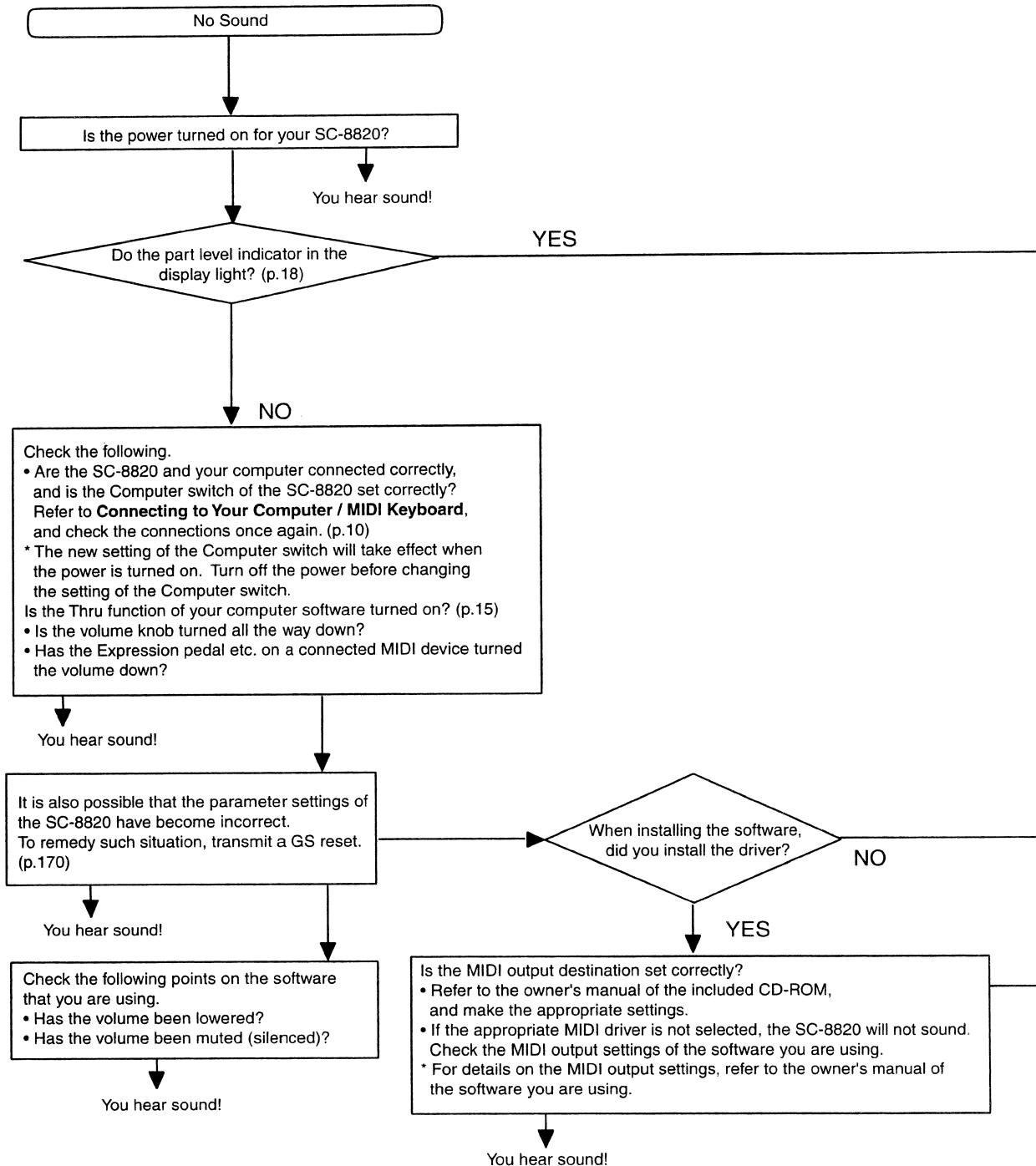

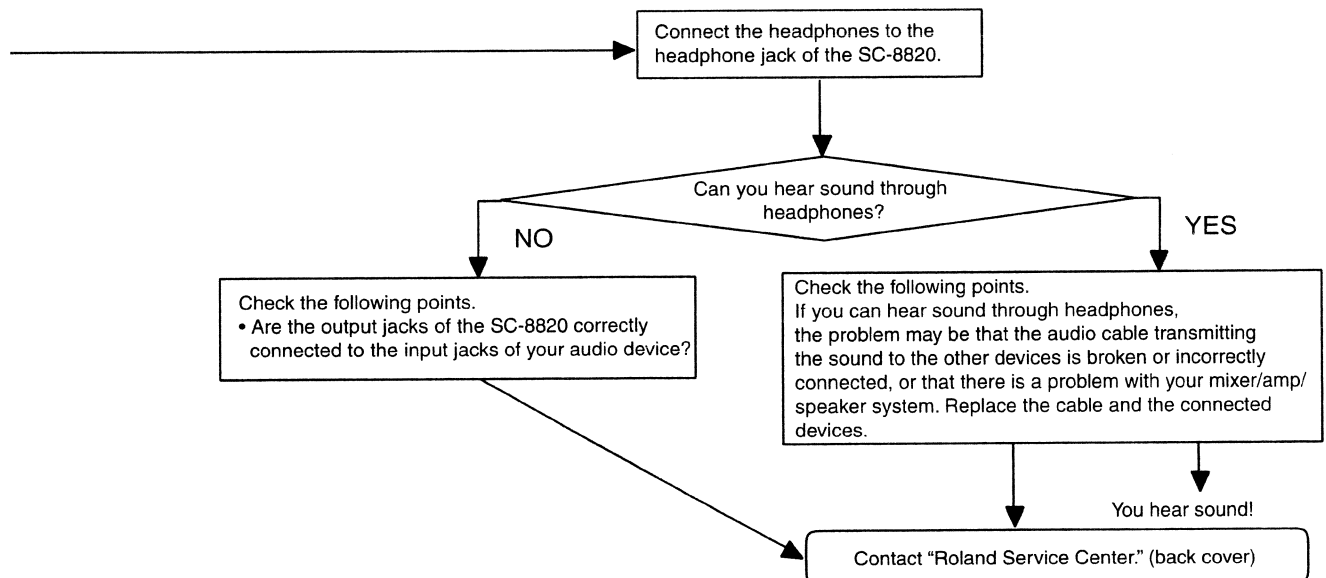

If the driver is not installed, the SC-8820 will not sound. Refer to the owner's manual of the included CD-ROM, and install the USB driver or serial MIDI driver.

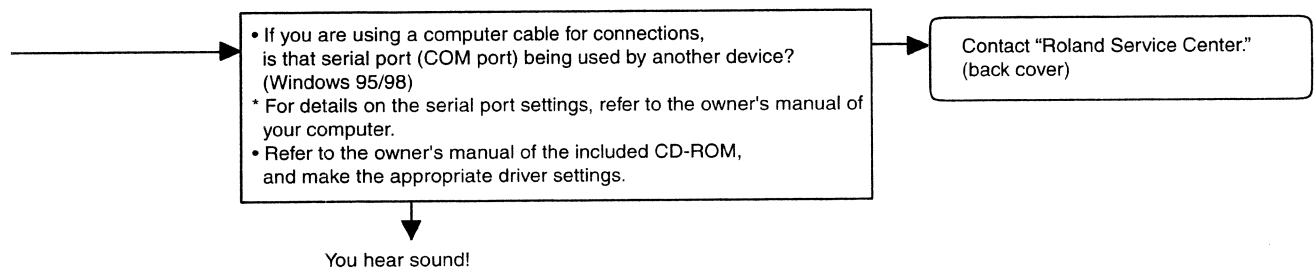

Can't install the SC-8820 USB driver (Windows 98)

● Is USB enabled?

Enable USB on your computer.

If an unknown device is not detected when you first connect the SC-8820 to your computer via a USB cable, it is possible that the USB interface itself is disabled. Use the following procedure to check whether the USB interface is enabled.

- 1 Click the Windows [Start] button, and from [Settings], choose [Control Panel]. In [Control Panel], double-click the [System] icon.
- 2 Click the [Device Manager] tab, and make sure that there are no yellow "!" marks or "x" marks displayed beside [Universal serial bus controller] or [USB Root Hub] below it.
If a yellow "!" mark or "x" mark is displayed, the USB is currently disabled. Refer to the owner's manual for your computer, and enable the USB.

● Has an unknown device been registered?

If the SC-8820 USB driver installation is interrupted for some reason (such as because a cable was pulled out) an unknown device could be registered to the computer, and it may no longer be possible to install the driver over again. If this occurs, use the following procedure to delete the unknown device, and install the driver once again.

- 1 Click the Windows [Start] button, and from [Settings], choose the [Control panel]. In [Control panel], double-click the [System] icon.
- 2 Click the [Device manager] tab, and with [View devices by type] selected, make sure that there is no [Other devices]. If there is, double-click it, and if there are any [Unknown devices] below it, click to select them and then click the [Remove] button to delete them.
- 3 Disconnect the USB cable from the SC-8820, and then re-connect the cable. If the computer recognizes the SC-8820, perform the driver installation from the beginning.



When checking USB-related operation, operate the SC-8820 with the AC adaptor connected.

USB connections cannot be made correctly (Windows 98)

● Has the SC-8820 been recognized?

Disconnect the USB cable, and then re-connect it.

It is possible that the computer has failed to recognize or initialize the SC-8820.

Leave the USB cable connected to the SC-8820, and restart Windows. If connection still does not occur, exit Windows, and turn off the power of your computer.

Then turn on the power of your computer and start Windows.

If you are using a bus power supply connection, disconnect the USB cable, connect the AC adapter, and then reconnect the USB cable.

Sound is distorted

- Is an effect which distorts the sound being applied? (p.50)
- If a specific sound or Part is distorted, lower the volume level of that Part. (p.177)
- If all sounds are distorted, lower the overall volume level of all Parts (p.36).

Pitch is incorrect

- Is the pitch of a specific Part or all Parts incorrect? (p.36, p.28)
- Has the Fine Tune setting set to a specific Part? (p.28)
- Has a MIDI Pitch Bend message been received to change the pitch?

Sound won't stop sounding

- With some sequencing programs, sound may continue to sound if you change the recording tracks while playing the keyboard.

Sound is wrong

- Have you selected another sound after modifying sound parameter settings (filter, etc.)?
Restore all sound parameter settings to a value of 0. (p.33)
- On occasion, you may find that the SC-8820's parameter settings have gone awry.
To remedy such situation, transmit a GS reset. (p.170)



Even if the SC-8820 is transmitted a GS reset, the System parameter settings will not be affected.

Sounds are interrupted

- If you play more than 64 voices at once, sounds will be interrupted. (p.26)

Can't playback more than 16 parts

- The SC-8820 can play more than 16 parts only when connected via the USB connector or the serial connector.
When the SC-8820 is connected via the MIDI connectors, it can play a maximum of 16 parts.

Exclusive messages are not received

- Does the Device ID number of the transmitted Exclusive message match the Device ID number (17) of the SC-8820?

The SC-8820 does not transmit MIDI data

- If you wish to transmit this unit data via the USB connector or the Serial connector, set the Computer switch to USB, PC, or Mac, depending on your computer. (p.10, p.12)
- When the Computer switch of the SC-8820 is set to MIDI, the SC-8820 will not transmit data from the USB connector or the Serial connector.

MIDI sound generators connected to the SC-8820 are not played from a computer or sequencer

- Performance data received at the SC-8820's USB connector or serial connector will be transmitted from the MIDI OUT connector for tracks whose track output is set to MIDI OUT.
Make the correct settings on your sequencer software and driver.

When using an insertion effect, the panpot of a part has no effect — the sound is located in the center

- Depending on the algorithm, this may have no effect.
The insertion effects are designed to be inserted after the part pan. Use the pan of the insertion effects.

I want to apply delay to a drum part, but cannot do so

- **With the initial settings, the Delay Send Level of all drum instruments is set to 0.**
Set the Delay Send Level for each instrument. (p.177)
Since the initial setting of the Delay Level for the drum part is also 0, raise the Delay Send Level. (p.27)

When I turn on an insertion effect, the system effect settings (reverb etc.) I had made are all initialized

- **When you turn on an insertion effect, it will no longer be possible to use control changes to set the send level for the system effects.**
This means that when you turn on an insertion effect, you will need to use a different route to send the signal to the system effects.
You can set the send level (common to the insertion effect) to the system effect when the **EFX TO Rev (Cho, Dly)** (p.47, p.176) is used to turn EFX ON.

Is there a way to automatically initialize every time?

- **The SC-8820 will start up in a GS reset condition when the power is turned on.**
- **If an exclusive message that transmits a GS Reset is included at the beginning of a song, the SC-8820 will automatically be reset when a song starts.**

Can play only 16 parts when connected via a computer cable

- **The Windows MIDI Mapper generally supports only 16 parts.**
If you wish to use 17 or more parts, you will need application software that has MIDI devices for two ports.

Since a bulk dump is too much data, is it possible to transmit only individual parameter data to the computer (sequencer)?

- **In addition to the bulk dump function that transmits a group of parameters, the SC-8820 also allows you to transmit data for individual parameters. You can use this individual data transmission capability to transmit only the data that you wish.**
Transmits individual data does not require you to look up the actual system exclusive data format, and is an efficient way of creating data (p.173).

The volume level of the instrument connected to an Audio Input jack is too low

- **Could you be using a connection cable that contains a resistor?**
Use a connection cable that does not contain a resistor.

About MIDI

■ What's MIDI?

MIDI stands for Musical Instrument Digital Interface. MIDI devices can transmit musically related data such as performance data or data to select sounds. Since MIDI is a world-wide standard, musical data can be sent and received between devices even if they are of different types and were made by different manufacturers. In the MIDI standard, data describing a musical performance such as "play a note" or "press the pedal" are transmitted as MIDI messages.

As long as you are using the this unit to simply play commercially available music data or to provide sound for game software, it is not necessary to know about MIDI. Simply follow the instructions in the manual for your music data playback device (MIDI player) or your software.

The explanation that follows will help you use MIDI to control this unit in greater detail.

How MIDI Messages are Transmitted and Received

First, we will briefly explain how MIDI messages are transmitted and received.

MIDI Connectors

MIDI messages are transmitted and received using two types of connector on the SC-8820. Connect MIDI cables to these connectors as appropriate for your setup.

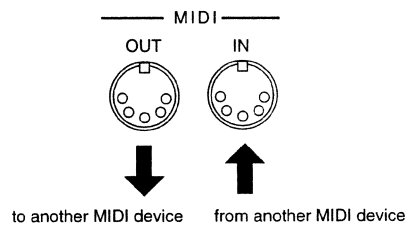

MIDI IN: This connector receives messages from another MIDI device.
 MIDI OUT: This connector transmits messages from this unit.

MIDI Channels and Multitimbral Sound Modules

MIDI transmits a wide variety of performance data over a single MIDI cable. This is made possible by MIDI channels. MIDI channels allow specific data to be selected out of a large amount of data. The concept is similar to the idea of TV channels. By changing the channel on a TV receiver you can view the programs of different stations. By setting the channel of the receiver to match the channel of the transmitter, you can receive only the program you wish to watch. In the same way, MIDI allows you to receive data only when the channel of the receiver matches the channel of the transmitter.

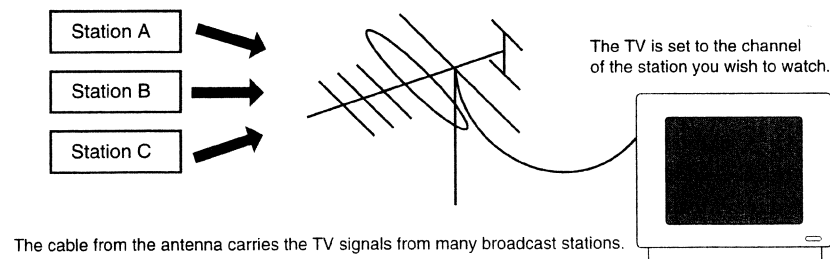

The SC-8820 is not equipped with MIDI THRU connector.

MIDI uses sixteen channels, numbered 1–16. Music data is received when the transmit channel of the transmitting device matches the receive channel of the receiving device. If you make the MIDI channel settings shown in Fig.1, only sound module B will sound when you play the keyboard, and sound module A will not sound. This is because sound module B matches the transmit channel of the keyboard, but sound module A's channel does not match.

Conversely, if you set the transmit channel of the keyboard to match sound module A, sound module A will sound (Fig.2).

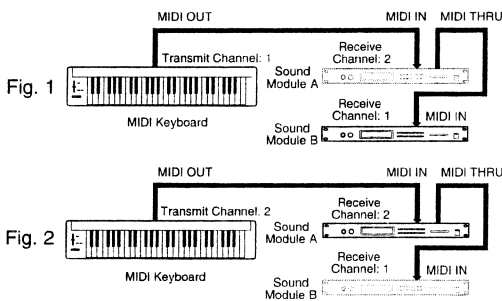

Since this unit has MIDI IN connector, it can receive a total of 16 channels simultaneously. By using 16 channels you can play ensembles that use 16 Parts. Sound module such as this unit, which are able to simultaneously play many parts, are called “multitimbral” sound modules. Timbre is a word meaning sound.

This unit has two types of Parts: Normal Parts and Drum Parts (p.28). Normal Parts are used to play melody or bass lines. On General MIDI/GS sound modules, the Drum Part uses channel 10.

■ What is General MIDI 2?

The General MIDI 2 is a set of recommended specifications that provide detailed definitions for functionality such as sound editing and effects that had not been defined in the GM (General MIDI) (*), and extend the sound map to allow a higher degree of performance expression and compatibility.

* The GM (General MIDI) was defined in 1991 as a recommended practice of the MIDI specification, to provide a standard for the MIDI functionality of sound modules that would allow certain types of compatibility between manufacturers. It defines basic sound module specifications such as the number of parts, polyphony, and the sound map.

Principle differences between General MIDI 2 and the GS Format (SC-8820)

- Initialization message for sound source parameters
 [GS] GS Reset F0 41 10 42 12 40 00 7F 00 41 F7
 [General MIDI 2] GM2 System On F0 7E 7F 09 03 F7

- Sound selection
 [GS] Use bank select MSB and program change.
 Bank select LSB is used to change the sound map.
 00H: specify INST MAP
 01H: SC-55 Map
 02H: SC-88 Map
 03H: SC-88Pro Map
 04H: SC-8820 Map

To set a part other than part 10 as the drum part, use a system exclusive message. (p.38)

<Example> Setting the Part 11 to a Drum Part (Room Set).
 F0 41 10 42 12 40 1A 15 02 0F F7
 MIDI CH = 11
 CC#00 000
 CC#32 4
 PC# 009

[General MIDI 2] Use bank select LSB and program change.
 Bank select MSB is 121. Use 120 to set as the drum part.

<Example> Setting the Part 11 to a Drum Part (Room Set).
 MIDI CH = 11
 CC#00 120
 CC#32 0
 PC# 009

* The General MIDI 2 sound map differs from the GS format. The SC-8820 will normally operate in the GS format, but if a GM2 System On message is received, it will enter General MIDI 2 mode, and will use the special sound map. In this state, it will not be possible to select the SC-8820's own sounds.



General MIDI 2 Sound map
 (p.153)

Items newly defined in General MIDI 2

- Polyphony 32 (General MIDI is 24)
- Number of sounds 256 sounds / 9 drum sets (General MIDI is 128 sounds / 1 drum set)
- Messages that must be received (* indicates those added by General MIDI 2)

Note ON/OFF

Program Change

Control Change

Bank Select	(Controllers 0 & 32)
Modulation Depth	(Controller 1)
Portamento Time*	(Controller 5)
Channel Volume	(Controller 7)
Pan	(Controller 10)
Expression	(Controller 11)
Hold 1	(Controller 64)
Portamento ON/OFF*	(Controller 65)
Sostenuto*	(Controller 66)
Soft*	(Controller 67)
Harmonic Content*	(Controller 71)
Release Time*	(Controller 72)
Attack Time*	(Controller 73)
Brightness*	(Controller 74)
Decay Time*	(Controller 75)
Vibrato Rate*	(Controller 76)
Vibrato Depth*	(Controller 77)
Vibrato Delay*	(Controller 78)
Reverb Send Level*	(Controller 91)
Chorus Send Level*	(Controller 93)
Data Entry	(Controllers 6 & 38)
RPN LSB/MSB	(Controller 100 & 101)

RPN

Pitch Bend Sensitivity
 Fine Tune
 Coarse Tune
 Modulation Sensitivity*
 RPN Null

- Channel Mode Message
 - All Sound Off
 - Reset All Controllers
 - All Notes OFF
 - Mono Mode ON*
 - Poly Mode ON*
- Pitch Bend
- Channel Pressure
- GM System Message
 - GM2 System ON*
 - GM1 System ON
 - GM System OFF
- Universal System Exclusive Message
 - Master Volume*
 - Master Fine Tuning*
 - Master Coarse Tuning*
 - Reverb Parameters*
 - Reverb Type*
 - Reverb Time*
 - Chorus Parameters*
 - Chorus Type*
 - Modulation Rate*
 - Modulation Depth*
 - Feedback*
 - Reverb Send Level*
 - Controller Settings*
 - Channel Pressure*
 - Control Change*
 - Scale/Octave Tuning*
 - Keybased Controller*
 - Level*
 - Pan*
 - Reverb Send Level*
 - Chorus Send Level*
- Active Sensing

■ MIDI Messages That Can Be Received by the SC-8820

MIDI uses many different types of message to transmit musical performance data, and there are many types of MIDI message. For example, information indicating “which key was played how strongly” is transmitted as a Note message.

The way that a device responds when it receives each type of MIDI message (such as how it produces sound) will depend on the specifications of that device. This means that if the receiving device is not able to perform the function requested by the incoming message, the musical result will not be what you expected.

The main types of MIDI message received by this unit are as follows.

* MIDI messages for which reception capability is required by the General MIDI are marked by a ☆ sign.

Note messages ☆

These messages convey notes played on the keyboard. They include the following information.

- Note number: a number indicating the note (key) that was pressed or released
 - Note on: data indicating that the note (key) was pressed
 - Note off: data indicating that the note (key) was released
 - Velocity: a number indicating how strongly the note (key) was pressed
- Note numbers are a number from 0 to 127 which indicate the keyboard key position, with middle C (C4) as note number 60.

Pitch Bend ☆

This is used to transmit message about the operation of the pitch bend wheel (or level) usually found on synthesizers. Pitch benders can continuously change the pitch of a note over a wide range.

Program Change ☆

These messages are used to select sounds. Sounds are selected by a Program numbers 1–128. On the SC-8820, these messages will select sounds (Instruments). By using Bank Select messages (which are a type of Control Change message), an even wider variety of sounds can be selected (p.22).

Control Change ☆

These messages control parameters such as modulation and pan. The function of the message is determined by its Control Change number.

Bank Select (control change number 0/32)

The tone is changed when used with a Program Change message. The tone is selected with a Program Change message after selecting the Bank Select message. The sound will not change when only a Bank Select message is received.

Modulation (control change number 1) ☆

This message controls vibrato.

Volume (control change number 7) ☆

This message controls the volume of a Part. When this message is received the volume of a Part will change.

Expression (control change number 11) ☆

This message conveys volume changes. It can be used to add expression during a song.

Using Volume and Expression

It is convenient to use Volume and Expression in distinct ways, as follows.

- Volume: Adjust the volume balance between Parts.
- Expression: Create volume changes during a song (crescendo, decrescendo, etc.)

The reason for this differentiation is that if you use only Volume messages to create volume changes during the song, you will have to modify all of the Volume data in the song if you later decide to adjust the volume balance between the Parts. However, if you use only Volume at the beginning of the song, and use only Expression during the song, it will be easy to adjust the volume balance between Parts for the entire song simply by modifying the Volume data at the beginning of the song, and the data for changes in dynamics during the song can remain as it was. This is very convenient when, for example, you decide to make a slight change in the balance between the piano and bass when the song is nearly completed.

MEMO

On some MIDI sequencers, control change data located at the same step (timing) is transmitted in ascending order of controller number. If you are using this type of MIDI sequencer, you must adjust the timing of the bank select data so that it is always transmitted in the correct order of Bank Select → Program Change.

NOTE

The volume of a Part will be affected both by Volume messages (control change 7) and by Expression messages (control change 11). If a value of 0 is received for either of these messages, the Part volume will be 0 and will not rise even if the other message is sent with a higher value. Be aware of this.

Pan (control change number 10) ☆

This message controls the stereo position of a Part. (p.27)

Hold (1) (control change number 64) ☆

This message conveys the up/down movements of the damper pedal, causing the currently sounding notes to be sustained. When a Hold On message is received, notes will be sustained. In the case of decay-type instruments such as a piano, the sound will decay gradually until a Hold Off message is received. In the case of sustain-type instruments such as an organ, the sound will continue sustaining until a Hold Off message is received.

Sostenuto (control change number 66)

The sostenuto pedal on a piano sustains only the notes which were already sounding at the moment the pedal was pressed. The Sostenuto message conveys the movement of this pedal. When Sostenuto On is received, only the notes which were already on at that moment will be sustained. In the case of decay-type instruments such as a piano, the sound will decay gradually until a Sostenuto Off message is received. In the case of sustain-type instruments such as an organ, the sound will continue sustaining until a Sostenuto Off message is received.

Soft (control change number 67)

The soft pedal on a piano softens the tone during the time the pedal is pressed. The Soft message conveys the movement of this pedal. When Soft On is received, the cut-off frequency will be lowered, causing a softer sound. When Soft Off is received, the previous sound will return.

Reverb Send Level (control change number 91)

This message adds a reverb effect to the Part. (Reverb Level p.40)

Chorus Send Level (control change number 93)

This message adds a chorus effect to the Part. (Chorus Level p.42)

Delay Send Level (control change number 94)

This message adds a delay effect to the Part. (Delay Level p.44)

Portamento (control change number 65)

Portamento Time (control change number 5)

Portamento Control (control change number 84)

Portamento is an effect that creates a smooth change in pitch between the previously played note and the newly played note. When a Portamento message is received, the portamento effect will be turned on or off. Portamento Time controls the speed of the pitch change. Portamento Control specifies the Source Note number (the previously played note).

RPN LSB, MSB (control change numbers 100 & 101) ☆

Data Entry (control change numbers 6 & 38) ☆

Since the function of the RPN (Registered Parameter Number) is defined in the MIDI specification, this message can be used between devices of different types. The RPN MSB and LSB messages specify the parameter which is to be modified, and then Data Entry messages can be used to modify the value of that parameter. RPN can be used to adjust Pitch Bend Sensitivity, Master Coarse Tune, and Master Fine Tune.

NRPN LSB, MSB (control change numbers 98 & 99)

Data Entry (control change numbers 6 & 38)

NRPN (Non-registered Parameter Number) messages can be used to modify the values of sound parameters unique to a particular device. The NRPN MSB and LSB messages specify the parameter that is to be modified, and then Data Entry messages can be used to modify the value of that parameter.

Since the GS format defines the function of several NRPN messages, GS compatible application programs can use NRPN messages to modify sound data parameters for Vibrato, Cutoff Frequency, Resonance, and Envelope values.

Aftertouch (Channel Pressure only) ☆

Aftertouch is a message which conveys the pressure applied to the keyboard after playing a note, so that this information can be used to control various aspects of the sound.

There are two types of aftertouch message: Polyphonic Key Pressure, which is transmitted separately for each note: and Channel Key Pressure, which is transmitted as one value that affects all notes on the specified MIDI channel.

All Sounds Off

This message completely turns off the sound of all currently sounding notes. The sound of the specified channel will be forcibly turned off.

All Notes Off ☆

This message causes a Note Off to be sent to each note of the specified channel that is currently on. However, if Hold 1 or Sostenuto are on, the sound will continue until these are turned off.

MEMO

The values modified using RPN messages will not be initialized even if Program Change messages, etc. are received to select other sounds.

MEMO

After a GS Reset message is received, NRPN messages will be received.

MEMO

For details about how to use NRPN with GS sound modules, refer to **Using NRPNs with GS Sound Modules** (p.104).

MEMO

With the initial settings, Aftertouch messages will have no effect when received by the SC-8820. In order for Aftertouch messages to do something, you need to set Aftertouch-related parameters. (p.32)

Reset All Controllers ☆

This message returns controller values to their initial settings. The following controller values for the specified channel will be reset to their initial values.

Controller	Initial value
Pitch Bend	0 (center)
Polyphonic Key Pressure	0 (minimum)
Channel Pressure	0 (minimum)
Modulation	0 (minimum)
Expression	127 (maximum)
Hold	0 (off)
Portamento	0 (off)
Soft	0 (off)
Sostenuto	0 (off)
RPN	number unset
NRPN	number unset

Active Sensing

This message is used to check for broken MIDI connections, such as MIDI connectors that have been pulled out, or MIDI cables that have been broken. The SC-8820 transmits Active Sensing messages from MIDI OUT at specific intervals. Once an Active Sensing message is received at MIDI IN, Active Sensing monitoring will begin, and if an Active Sensing message fails to arrive for more than 420 [msec], it is assumed that the cable has been disconnected. If this happens, all currently sounding notes will be turned off, the same procedure will be executed as if a Reset All Controllers message was received, and Active Sensing monitoring will stop.

System Exclusive messages

Exclusive messages are used to control functions which are unique to specific devices. Although Universal System Exclusive messages can be used even between devices of different manufacturers, most Exclusive messages cannot be used between devices of different types or different manufacturers.

In order to recognize the device for which the data is intended, Roland Exclusive messages contain a manufacturer ID, device ID and model ID.

The SC-8820 manufacturer's ID is 41H. The device ID is 10H. The model ID is 42H.

GM1 System On ☆

(Universal System Exclusive)

When GM1 System On is received, the SC-8820 will be set to the basic General MIDI settings. Also, NRPN Bank Select messages will no longer be received after GM1 System On is received. The beginning of song data bearing the GM logo contains a GM1 System On message. This means that if you play back the data from the beginning, the sound generator device will be automatically initialized to the basic settings.

GM2 System On

(Universal System Exclusive)

When GM2 System On is received, the SC-8820 will be set to the basic General MIDI 2 settings. Refer to p.96.

MEMO

Parameter values that were modified using RPN or NRPN will not change even when a Reset All Controller message is received.

GS Reset

(GS Format System Exclusive)

When a GS Reset is received, the SC-8820 will be set to the basic GS settings. Also, NRPN messages defined by the GS format are recognized after a GS Reset has been received. A GS System Reset message is located at the beginning of song data bearing the GS logo. This means that if you play back the data from the beginning, the sound generating device will automatically be initialized to the basic settings.

Master Volume

(Universal System Exclusive)

This is an Exclusive message common to all MIDI devices that controls the master volume of all Parts.

Other Exclusive messages

The SC-8820 can receive GS format Exclusive messages (model ID 42H) that are common to all GS sound generators. Exclusive messages can be used to store the SC-8820 settings or to make fine adjustments to parameters.

For details of the Exclusive message transmitted and received by the SC-8820, refer to the explanation on p.169 and following.

About MIDI Implementation Charts

MIDI has made it possible for a wide variety of devices to exchange information, but it is not always true that all types of MIDI messages can be exchanged between all types of devices. For example, if you use a synthesizer as a master device to control a digital piano, the pitch bender (the lever or wheel that modifies the pitch) of the synthesizer will have no effect on the sound of the piano.

The important thing to keep in mind when using MIDI is that the slave device must be able to understand what the master is saying. In other words, the MIDI messages must be common to both master and slave.

To help you quickly determine what types of MIDI messages can be exchanged between master and slave, the Operation Manual of each MIDI device includes a **MIDI Implementation chart** (p.185). By looking at this chart, you can quickly see what messages the device is able to transmit and receive. The left side of the chart lists the names of a variety of MIDI messages, and the Transmitted and Recognized columns use "o" and "x" marks to indicate whether or not each of these messages can be transmitted or received. This means that a specific MIDI message can be exchanged only if there is an "o" in both the Transmitted column of the master and the Recognized column of the slave device. MIDI implementation charts are standardized, so you can fold the charts from two manuals together to see at a glance how the two devices will communicate.

A detailed explanation concerning the data format used for Exclusive messages, and the implementation of MIDI used on the SC-8820 can be found starting on p.166.

Using NRPNs with GS Sound Modules

Included within the various types of Control Changes (often abbreviated as **CC**) is an extended range known as NRPNs (non-registered parameter numbers). The NRPNs can be used with GS sound modules to alter various sound parameters, such as those for the vibrato, filters, and envelopes. There are distinct advantages to using Control Changes rather than Exclusive messages when wishing to modify sounds. They are not as complicated, they are easier to handle, and they do not require a large amount of data (p.99, p.166). Such Control Change messages include a number (the Control Number) which specifies the type of function that is to be controlled.

The MIDI specifications do not define any specific functions which can be set using NRPNs. This is because the NRPNs are intended to serve as a flexible range of controls which can be assigned whatever parameters are required for a specific device in order to achieve the desired changes in its sounds, or enhance its expressive capabilities. In contrast, there is another type of extended form of control known as an RPN (registered parameter number). As their name suggests, RPN functions are all defined (registered) within the MIDI specifications (p.168).

When using an NRPN, the function (sound parameter) being dealt with needs to be specified by means of the numeric values that are supplied for the NRPN MSB (Controller No. 99) and NRPN LSB (Controller No. 98). By then sending the appropriate value for Data Entry (Controller No. 6), the change in the specified sound parameter is accomplished.

Note that instead of the hexadecimal notation that is used within the **MIDI Implementation** (p.168), the numbers for the combinations of values for NRPNs that appear in the chart below have all been converted to decimal.

NRPN MSB	NRPN LSB	Range	Function
1	8	0-64-127	Vibrato Rate *1 (p.33)
1	9	0-64-127	Vibrato Depth *1 (p.33)
1	10	0-64-127	Vibrato Delay *1 (p.33)
1	32	0-64-127	TVF Cutoff Frequency *1 (p.34)
1	33	0-64-127	TVF Resonance *1 (p.34)
1	99	0-64-127	TVF&TVA Envelope Attack Time *1 (p.35)
1	100	0-64-127	TVF&TVA Envelope Decay Time *1 (p.35)
1	102	0-64-127	TVF&TVA Envelope Release Time *1 (p.35)
24	rr	0-64-127	Drum Instrument Pitch Coarse *1 Alters the pitch of individual percussion instruments in the drum Part.
26	rr	0-127	Drum Instrument TVA Level Alters the volume of individual percussion instruments in the drum Part.
28	rr	0,1-64-127	Drum Instrument Pan Alters the panning for individual percussion instruments in the Drum Part. A setting of 0 provides random panning, while 1 selects the leftmost position, 64 the center, and 127 places it at the rightmost position.
29	rr	0-127	Drum Instrument Reverb Send Level Sets the reverb depth for individual percussion instruments in the Drum Part.
30	rr	0-127	Drum Instrument Chorus Send Level Sets the chorus depth for individual percussion instruments in the Drum Part.
31	rr	0-127	Drum Instrument Delay Send Level Determines the amount of delay for individual percussion instruments in the Drum Part (SC-88/SC-88 Pro/SC-8820 only)

For example, let's say that you want to alter the TVF Cutoff Frequency. First, you need to assert that it is the TVF Cutoff Frequency that you wish to control by sending the appropriate NRPN MSB and NRPN LSB combination. The value for Controller No. 99 is the NRPN MSB, and that for Controller No. 98 is the NRPN LSB. So, you would transmit these values:

Controller No. 99: 1
Controller No. 98: 32

The SC-8820 has thus been made aware that it is the TVF Cutoff Frequency that you are going to change. To go ahead and make the actual change, you would then use the Data Entry Control Change message to supply the new value (xx) for the TVF Cutoff Frequency.

Thus, you would send:

Controller No. 6: xx

As a result of transmitting the above three controller values, the TVF Cutoff Frequency will have been altered, and the timbre of the instrument selected for that Part should sound differently.

After altering sound parameters using an NRPN, we recommend that you make a habit of asserting a **null** by sending the RPN values shown below. This will tell the SC-8820 that you are finished working with the parameter that has been specified, and that it should stop waiting for any further new values for that parameter. (It cancels the standing request for change in a particular NRPN or RPN.) This way you can avoid having unexpected changes made if any unintended Data Entry values get sent afterwards.

Controller No. 101: 127
 Controller No. 100: 127

For the **NRPN LSB rr** value, you need to supply the value which corresponds to the note number of the particular percussion instrument that you want to address (these numbers can be found in the Drum Set List on p.127).

For example, let's say that you want to set the High Bongo so that no reverb will be applied to it. This instrument is assigned note number 60 (middle C), and is contained in the Standard Set 1 Drum Set.

To accomplish this you would transmit these values:

Controller No. 99: 29
 Controller No. 98: 60
 Controller No. 6: 0

Note that these MIDI messages need to be sent in the order listed above.

Parameters marked with *1 in the chart at left can be altered in a relative manner from the default value. Depending on the particular sound you are working with, the type of change available will be different (in some cases you may not even notice any change). Also, the range of change will vary.

You may need to consult the manual that came with your equipment or software for details on how to properly input and transmit Control Change messages. Note, though, that some devices may only allow you to work with a limited range of controller numbers.

Make sure that you always follow the order shown above when transmitting RPN, NRPN, and Data Entry data. Be careful, since if you insert a multiple number of MIDI messages at the same point in time (or in very close range of each other) when using some types of music software, the messages can sometimes be sent out in an order different than originally intended. To avoid problems, always allow sufficient space between adjacent messages (at least 1 tick at 96 TPQN, and 5 ticks at 480 TPQN).

 **Operation via MIDI**

How to change the value of the cutoff frequency of a Part

<Example> Setting the Part 3 cutoff frequency to -25

MIDI CH = 03
 CC#99 01 Cutoff frequency
 CC#98 32 Cutoff frequency
 CC#06 39 Since 64 is 0, we obtain: 64 - 25 = 39.

 **Operation via MIDI**

How to change the pitch of a drum instrument

<Example> Raising the pitch of note number 48 of the Part 10 Drum Set to +5 higher than the original pitch

MIDI CH = 10
 CC#99 24 Drum Instrument pitch coarse
 CC#98 48 Note number
 CC#06 69 Since 64 is the original pitch, we obtain: 64 + 5 = 69.

MEMO

Any value that has been imposed by means of an NRPN will not be initialized even when a different sound is changed to in compliance with a received Program Change. Settings that have been made using NRPNs can only be initialized by sending a GS Reset (p.170).

MEMO

TPQN: Ticks Per Quarter Note

MEMO

After a GS Reset message is received, NRPN messages will be received.

Computer Cable Wiring Diagrams

For Apple Macintosh (Sold separately: RSC-15APL)

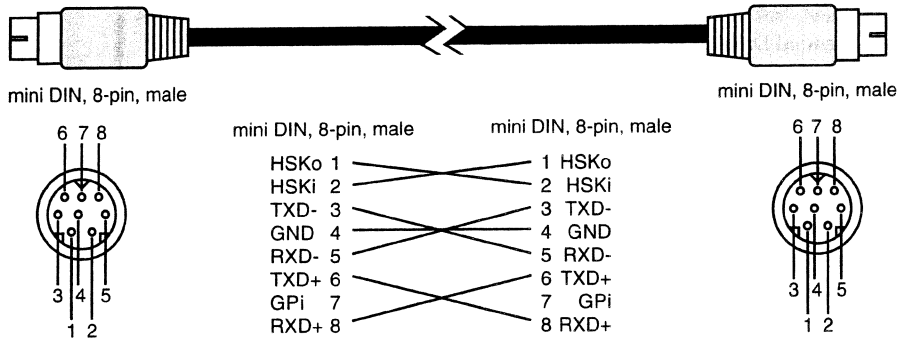

For PC (9-pin) (Sold separately: RSC-15AT)

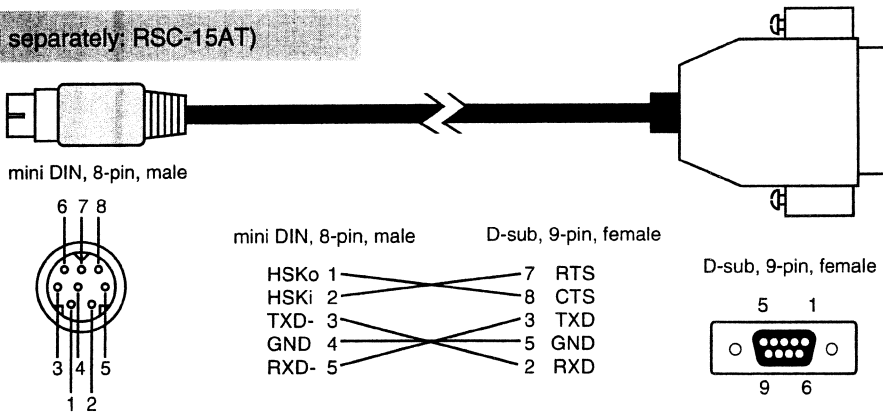

For PC (25-pin)

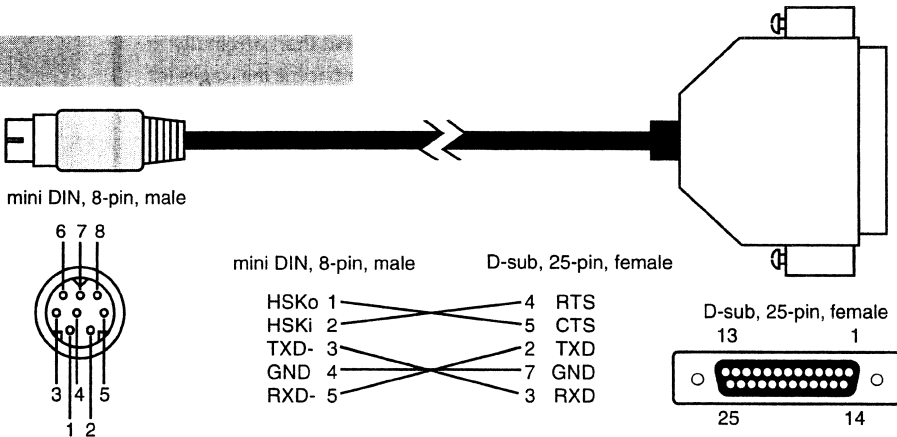

Instrument List

Piano

CC00	PC	SC-8820 Map	Voices	SC-88Pro Map	Voices	SC-88 Map	Voices	SC-55 Map	Voices
000	001	Piano 1	1 [Pro]	Piano 1	1	Piano 1	1	Piano 1	1
001		UprightPiano	1	----		----		----	
002		Mild Piano	1	----		----		----	
008		Upright P w	1	Piano 1w	1	Piano 1w	1	Piano 1w	1
009		Mild Piano w	1	----		----		----	
016		European Pf	1 [Pro]	European Pf	1	Piano 1d	1	Piano 1d	1
024		Piano + Str.	2 [Pro]	Piano + Str.	2	----		----	
025		Piano + Str2	2	----		----		----	
026		Piano+Choir1	2	----		----		----	
027		Piano+Choir2	2	----		----		----	
000	002	Piano 2	2 [Pro]	Piano 2	2	Piano 2	1	Piano 2	1
001		Pop Piano	2	----		----		----	
002		Rock Piano	2	----		----		----	
008		Pop Piano w	2	Piano 2w	2	Piano 2w	1	Piano 2w	1
009		Rock Piano w	2	----		----		----	
016		Dance Piano	2 [Pro]	Dance Piano	2	----		----	
000	003	Piano 3	2 [Pro]	Piano 3	2	Piano 3	1	Piano 3	1
001		EG+Rhodes 1	2 [Pro]	EG+Rhodes 1	2	EG+Rhodes 1	2	----	
002		EG+Rhodes 2	2 [Pro]	EG+Rhodes 2	2 [88]	EG+Rhodes 2	2	----	
008		Piano 3w	2 [Pro]	Piano 3w	2	Piano 3w	1	Piano 3w	1
000	004	Honky-tonk	2 [Pro]	Honky-tonk	2	Honky-tonk	2	Honky-tonk	2
008		Honky-tonk 2	2 [Pro]	Honky-tonk 2	2	Old Upright	2	HonkyTonk w	2
000	005	E.Piano 1	1 [Pro]	E.Piano 1	1	E.Piano 1	2	E.Piano 1	1
008		St.Soft EP	2 [Pro]	St.Soft EP	2 [88]	St.Soft EP	2	Detuned EP1	2
009		Cho. E.Piano	2 [Pro]	Cho. E.Piano	2	----		----	
010		SilentRhodes	2 [Pro]	SilentRhodes	2	----		----	
016		FM+SA EP	2 [Pro]	FM+SA EP	2 [88]	FM+SA EP	2	E.Piano 1v	2
017		Dist E.Piano	2 [Pro]	Dist E.Piano	2	----		----	
024		Wurly	2 [Pro]	Wurly	2	60'sE.Piano	1	60s E.Piano	1
025		Hard Rhodes	2 [Pro]	Hard Rhodes	2 [88]	Hard Rhodes	2	----	
026		MellowRhodes	2 [Pro]	MellowRhodes	2 [88]	MellwRhodes	2	----	
000	006	E.Piano 2	2 [Pro]	E.Piano 2	2 [88]	E.Piano 2	2	E.Piano 2	1
001		E.Piano 3	2	----		----		----	
008		Detuned EP 2	2 [Pro]	Detuned EP 2	2 [88]	Detuned EP2	2	Detuned EP2	2
009		Detuned EP 3	2	----		----		----	
010		EP Legend	2	----		----		----	
016		St.FM EP	2 [Pro]	St.FM EP	2 [88]	St.FM EP	2	E.Piano 2v	2
024		Hard FM EP	2 [Pro]	Hard FM EP	2 [88]	Hard FM EP	2	----	
032		EP Phase	2	----		----		----	
000	007	Harpsichord	1 [Pro]	Harpsichord	1 [88]	Harpsichord	1	Harpsichord	1
001		Harpsichord2	2 [Pro]	Harpsichord2	2	----		----	
002		Harpsichord3	2	----		----		----	
008		Coupled Hps.	2 [Pro]	Coupled Hps.	2 [88]	Coupled Hps	2 [55]	Coupled Hps	2
016		Harpsi.w	1 [Pro]	Harpsi.w	1 [88]	Harpsi.w	1	Harpsi.w	1
024		Harpsi.o	2 [Pro]	Harpsi.o	2 [88]	Harpsi.o	2	Harpsi.o	2
032		Synth Harpsi	2 [Pro]	Synth Harpsi	2	----		----	
000	008	Clav.	1 [Pro]	Clav.	1 [88]	Clav.	1	Clav.	1
001		Clav. 2	2	----		----		----	
002		Atk Clav.1	2	----		----		----	
003		Atk Clav.2	2	----		----		----	
008		Comp Clav.	1 [Pro]	Comp Clav.	1	----		----	
016		Reso Clav.	1 [Pro]	Reso Clav.	1	----		----	
017		Phase Clav	1	----		----		----	
024		Clav.o	2 [Pro]	Clav.o	2	----		----	
032		Analog Clav.	2 [Pro]	Analog Clav.	2	----		----	
033		JP8 Clav. 1	1 [Pro]	JP8 Clav. 1	1	----		----	
035		JP8 Clav. 2	1 [Pro]	JP8 Clav. 2	1	----		----	
036		SynRingClav.	2	----		----		----	
037		SynDistClav.	1	----		----		----	
038		JP8000 Clav.	1	----		----		----	
039		Pulse Clav	1	----		----		----	

Appendices

PC : program number(Instrument number)
 CC00 : value of controller number 0
 (Bank number, Variation number)
 : legato-enabled sounds
 Voices : number of voices used by the Instrument
 Remark [Pro] : same sound as SC-88Pro map
 Remark [88] : same sounds as SC-88 map
 Remark [55] : same sound as SC-55 map
 Remark + : a percussive sound which cannot be played melodically.
 Use near C4 (note number 60).

Chromatic percussion

CC00	PC	SC-8820 Map	Voices	SC-88Pro Map	Voices	SC-88 Map	Voices	SC-55 Map	Voices
000	009	Celesta	1 [Pro]	Celesta	1 [88]	Celesta	1 [55]	Celesta	1
001		Pop Celesta	2 [Pro]	Pop Celesta	2	-----		-----	
000	010	Glockenspiel	1 [Pro]	Glockenspiel	1 [88]	Glockenspiel	1	Glockenspl	1
000	011	Music Box	1 [Pro]	Music Box	1 [88]	Music Box	1	Music Box	1
001		Music Box 2	2	-----		-----		-----	
008		St.Music Box	2	-----		-----		-----	
000	012	Vibraphone	1 [Pro]	Vibraphone	1	Vibraphone	1	Vibraphone	1
001		Pop Vibe.	2 [Pro]	Pop Vibe.	2	Hard Vibe	2	-----	
008		Vibraphone w	1 [Pro]	Vibraphone w	1	Vib.w	1 [55]	Vib.w	1
009		Vibraphones	2 [Pro]	Vibraphones	2	-----		-----	
000	013	Marimba	1 [Pro]	Marimba	1 [88]	Marimba	1	Marimba	1
008		Marimba w	1 [Pro]	Marimba w	1 [88]	Marimba w	1	Marimba w	1
016		Barafon	1 [Pro]	Barafon	1 [88]	Barafon	1	-----	
017		Barafon 2	1 [Pro]	Barafon 2	1 [88]	Barafon 2	1	-----	
024		Log drum	1 [Pro]	Log drum	1 [88]	Log drum	1	-----	
000	014	Xylophone	1 [Pro]	Xylophone	1 [88]	Xylophone	1	Xylophone	1
008		Xylophone w	1	-----		-----		-----	
000	015	Tubular-bell	1 [Pro]	Tubular-bell	1 [88]	Tubularbell	1 [55]	Tubularbell	1
008		Church Bell	1 [Pro]	Church Bell	1 [88]	Church Bell	1 [55]	Church Bell	1
009		Carillon	1 [Pro]	Carillon	1 [88]	Carillon	1 [55]	Carillon	1
010		Church Bell2	2	-----		-----		-----	
016		Tubularbellw	1	-----		-----		-----	
000	016	Santur	1 [Pro]	Santur	1 [88]	Santur	1 [55]	Santur	1
001		Santur 2	2 [Pro]	Santur 2	2 [88]	Santur 2	2	-----	
002		Santur 3	2	-----		-----		-----	
008		Cimbalom	2 [Pro]	Cimbalom	2 [88]	Cimbalom	2	-----	
016		Zither 1	1 [Pro]	Zither 1	1	-----		-----	
017		Zither 2	2 [Pro]	Zither 2	2	-----		-----	
024		Dulcimer	2 [Pro]	Dulcimer	2	-----		-----	

Organ

CC00	PC	SC-8820 Map	Voices	SC-88Pro Map	Voices	SC-88 Map	Voices	SC-55 Map	Voices
000	017	Organ 1	2 [Pro]	Organ 1	2	Organ 1	1	Organ 1	1
001		Organ 101	2 [Pro]	Organ 101	2	Organ 101	2	-----	
002		Ful Organ 1	2	-----		-----		-----	
003		Ful Organ 2	2	-----		-----		-----	
004		Ful Organ 3	2	-----		-----		-----	
005		Ful Organ 4	2	-----		-----		-----	
006		Ful Organ 5	2	-----		-----		-----	
007		Ful Organ 6	2	-----		-----		-----	
008		Trem. Organ	2 [Pro]	Trem. Organ	2	DetunedOr.1	2	Detuned Or1	2
009		Organ o	2 [Pro]	Organ o	2	Organ 109	2	-----	
010		Ful Organ 7	2	-----		-----		-----	
011		Ful Organ 8	2	-----		-----		-----	
012		Ful Organ 9	2	-----		-----		-----	
016		60's Organ 1	1 [Pro]	60's Organ 1	1	60'sOrgan 1	1	60's Organ1	1
017		60's Organ 2	1 [Pro]	60's Organ 2	1	60'sOrgan 2	1	-----	
018		60's Organ 3	1 [Pro]	60's Organ 3	1	60'sOrgan 3	1	-----	
019		Farf Organ	1 [Pro]	Farf Organ	1	-----		-----	
024		Cheese Organ	1 [Pro]	Cheese Organ	1 [88]	CheeseOrgan	1	-----	
025		D-50 Organ	2 [Pro]	D-50 Organ	2	-----		-----	
026		JUNO Organ	2 [Pro]	JUNO Organ	2	-----		-----	
027		Hybrid Organ	2 [Pro]	Hybrid Organ	2	-----		-----	
028		VS Organ	2 [Pro]	VS Organ	2	-----		-----	
029		Digi Church	2 [Pro]	Digi Church	2	-----		-----	
030		JX-8P Organ	2	-----		-----		-----	
031		FM Organ	2	-----		-----		-----	
032		70's E.Organ	2 [Pro]	70's E.Organ	2	Organ 4	1	Organ 4	2
033		Even Bar	2 [Pro]	Even Bar	2 [88]	Even Bar	2	-----	
040		Organ Bass	1 [Pro]	Organ Bass	1 [88]	Organ Bass	1	-----	
048		5th Organ	2 [Pro]	5th Organ	2	-----		-----	
000	018	Organ 2	2 [Pro]	Organ 2	2	Organ 2	1	Organ 2	1
001		Jazz Organ	2 [Pro]	Jazz Organ	2	Organ 201	2	-----	
002		E.Organ 16+2	2 [Pro]	E.Organ 16+2	2	-----		-----	
003		Jazz Organ 2	2	-----		-----		-----	
004		Jazz Organ 3	2	-----		-----		-----	
005		Jazz Organ 4	2	-----		-----		-----	
006		Jazz Organ 5	2	-----		-----		-----	
007		Jazz Organ 6	2	-----		-----		-----	
008		Chorus Or.2	2 [Pro]	Chorus Or.2	2	DetunedOr.2	2	Detuned Or2	2
009		Octave Organ	2 [Pro]	Octave Organ	2	-----		-----	
032		Perc. Organ	2 [Pro]	Perc. Organ	2	Organ 5	2	Organ 5	2
033		Perc.Organ 2	2	-----		-----		-----	
034		Perc.Organ 3	2	-----		-----		-----	
035		Perc.Organ 4	2	-----		-----		-----	
000	019	Organ 3	2 [Pro]	Organ 3	2 [88]	Organ 3	2 [55]	Organ 3	2
008		Rotary Org.	1 [Pro]	Rotary Org.	1 [88]	Rotary Org.	1	-----	
016		Rotary Org.S	1 [Pro]	Rotary Org.S	1 [88]	RotaryOrg.S	1	-----	
017		Rock Organ 1	2 [Pro]	Rock Organ 1	2	-----		-----	
018		Rock Organ 2	2 [Pro]	Rock Organ 2	2	-----		-----	
024		Rotary Org.F	1 [Pro]	Rotary Org.F	1 [88]	RotaryOrg.F	1	-----	
000	020	Church Org.1	1 [Pro]	Church Org.1	1 [88]	ChurchOrg.1	1	Church Org1	1
008		Church Org.2	2 [Pro]	Church Org.2	2 [88]	ChurchOrg.2	2	Church Org2	2
016		Church Org.3	2 [Pro]	Church Org.3	2 [88]	ChurchOrg.3	2	Church Org3	2
024		Organ Flute	1 [Pro]	Organ Flute	1 [88]	Organ Flute	1	-----	
032		Trem.Flute	2 [Pro]	Trem.Flute	2 [88]	Trem.Flute	2	-----	
033		Theater Org.	2 [Pro]	Theater Org.	2	-----		-----	
000	021	Reed Organ	1 [Pro]	Reed Organ	1 [88]	Reed Organ	1 [55]	Reed Organ	1
008		Wind Organ	2 [Pro]	Wind Organ	2	-----		-----	
016		Puff Organ	2	-----		-----		-----	
000	022	Accordion Fr	1 [Pro]	Accordion Fr	1	AccordionFr	1	Accordion F	2
008		Accordion It	1 [Pro]	Accordion It	1	AccordionIt	2	Accordion I	2
009		Dist. Accord	2 [Pro]	Dist. Accord	2	-----		-----	
016		Cho. Accord	2 [Pro]	Cho. Accord	2	-----		-----	
024		Hard Accord	2 [Pro]	Hard Accord	2	-----		-----	
025		Soft Accord	2 [Pro]	Soft Accord	2	-----		-----	
000	023	Harmonica	1 [Pro]	Harmonica	1	Harmonica	1	Harmonica	1
001		Harmonica 2	1 [Pro]	Harmonica 2	1	Harmonica 2	2	-----	
008		B.Harp Basic	1	-----		-----		-----	
009		B.Harp Suppl	1	-----		-----		-----	
000	024	Bandoneon	2 [Pro]	Bandoneon	2	Bandoneon	1	Bandoneon	2
008		Bandoneon 2	2 [Pro]	Bandoneon 2	2	-----		-----	
016		Bandoneon 3	2 [Pro]	Bandoneon 3	2	-----		-----	

Appendices

PC : program number(Instrument number)
 CC00 : value of controller number 0
 (Bank number, Variation number)
 : legato-enabled sounds
 Voices : number of voices used by the Instrument
 Remark [Pro] : same sound as SC-88Pro map
 Remark [88] : same sounds as SC-88 map
 Remark [55] : same sound as SC-55 map
 Remark + : a percussive sound which cannot be played melodically.
 Use near C4 (note number 60).

Guitar

CC00	PC	SC-8820 Map	Voices	SC-88Pro Map	Voices	SC-88 Map	Voices	SC-55 Map	Voices
000	025	Nylon-str.Gt	2 [Pro]	Nylon-str.Gt	2	Nylonstr.Gt	1	Nylon Gt.	1
008		Ukulele	1 [Pro]	Ukulele	1 [88]	Ukulele	1	Ukulele	1
016		Nylon Gt.o	2 [Pro]	Nylon Gt.o	2	Nylon Gt.o	2	Nylon Gt.o	2
024		Velo Harmnix	1 [Pro]	Velo Harmnix	1 [88]	VeloHarmnix	1	-----	
032		Nylon Gt.2	1 [Pro]	Nylon Gt.2	1	Nylon Gt.2	1	Nylon Gt.2	1
040		Lequint Gt.	1 [Pro]	Lequint Gt.	1 [88]	Lequint Gt.	1	-----	
000	026	Steel-str.Gt	1 [Pro]	Steel-str.Gt	1	Steelstr.Gt	1	Steel Gt.	1
008		12-str.Gt	2 [Pro]	12-str.Gt	2	12-str.Gt	2	12-str.Gt	2
009		Nylon+Steel	2 [Pro]	Nylon+Steel	2	Nylon+Steel	2	-----	
010		Atk Steel Gt	2	-----		-----		-----	
016		Mandolin	2 [Pro]	Mandolin	2 [88]	Mandolin	2	Mandolin	1
017		Mandolin 2	2 [Pro]	Mandolin 2	2	-----		-----	
018		MandolinTrem	2 [Pro]	MandolinTrem	2	-----		-----	
032		Steel Gt.2	1 [Pro]	Steel Gt.2	1 [88]	Steel Gt.2	1	-----	
033		Steel + Body	2	-----		-----		-----	
000	027	Jazz Gt.	1 [Pro]	Jazz Gt.	1	Jazz Gt.	1 [55]	Jazz Gt.	1
001		Mellow Gt.	2 [Pro]	Mellow Gt.	2 [88]	Mellow Gt.	2	-----	
008		Pedal Steel	1 [Pro]	Pedal Steel	1 [88]	Pedal Steel	1	Hawaiian Gt	1
000	028	Clean Gt.	1 [Pro]	Clean Gt.	1	Clean Gt.	1	Clean Gt.	1
001		Clean Half	1 [Pro]	Clean Half	1	-----		-----	
002		Open Hard 1	2 [Pro]	Open Hard 1	2	-----		-----	
003		Open Hard 2	1 [Pro]	Open Hard 2	1	-----		-----	
004		JC Clean Gt.	1 [Pro]	JC Clean Gt.	1	-----		-----	
005		Atk CleanGt.	2	-----		-----		-----	
008		Chorus Gt.	2 [Pro]	Chorus Gt.	2	Chorus Gt.	2	Chorus Gt.	2
009		JC Chorus Gt	2 [Pro]	JC Chorus Gt	2	-----		-----	
016		TC FrontPick	1 [Pro]	TC FrontPick	1	-----		-----	
017		TC Rear Pick	1 [Pro]	TC Rear Pick	1	-----		-----	
018		TC Clean ff	2 [Pro]	TC Clean ff	2	-----		-----	
019		TC Clean 2:	2 [Pro]	TC Clean 2:	2	-----		-----	
020		LP Rear Pick	1	-----		-----		-----	
021		LP Rear 2	2	-----		-----		-----	
022		LP RearAtack	2	-----		-----		-----	
023		Mid Tone GTR	1	-----		-----		-----	
024		Chung Ruan	1	-----		-----		-----	
025		Chung Ruan 2	2	-----		-----		-----	
000	029	Muted Gt.	1 [Pro]	Muted Gt.	1	Muted Gt.	1	Muted Gt.	1
001		Muted Dis.Gt	1 [Pro]	Muted Dis.Gt	1 [88]	MutedDis.Gt	1	-----	
002		TC Muted Gt.	2 [Pro]	TC Muted Gt.	2	-----		-----	
008		Funk Pop	1 [Pro]	Funk Pop	1 [88]	Funk Pop	1	Funk Gt.	1
016		Funk Gt.2	1 [Pro]	Funk Gt.2	1 [88]	Funk Gt.2	1	Funk Gt.2	1
024		Jazz Man	2	-----		-----		-----	
000	030	Overdrive Gt	2 [Pro]	Overdrive Gt	2	OverdriveGt	1	OverdriveGt	1
001		Overdrive 2	2 [Pro]	Overdrive 2	2	-----		-----	
002		Overdrive 3	2 [Pro]	Overdrive 3	2	-----		-----	
003		More Drive	2 [Pro]	More Drive	2	-----		-----	
004		Guitar Pinch	1	-----		-----		-----	
005		Attack Drive	2	-----		-----		-----	
008		LP OverDrvGt	2 [Pro]	LP OverDrvGt	2	-----		-----	
009		LP OverDrv:	2 [Pro]	LP OverDrv:	2	-----		-----	
010		LP Half Drv	2	-----		-----		-----	
011		LP Half Drv2	2	-----		-----		-----	
012		LP Chorus	2	-----		-----		-----	
000	031	DistortionGt	2 [Pro]	DistortionGt	2	DistortionGt	1	Dist.Gt.	1
001		Dist. Gt2 :	2 [Pro]	Dist. Gt2 :	2	Dist. Gt2	2	-----	
002		Dazed Guitar	2 [Pro]	Dazed Guitar	2 [88]	DazedGuitar	2	-----	
003		Distortion:	2 [Pro]	Distortion:	2	-----		-----	
004		Dist. Fast :	2 [Pro]	Dist. Fast :	2	-----		-----	
005		Attack Dist	2	-----		-----		-----	
008		Feedback Gt.	2 [Pro]	Feedback Gt.	2 [88]	FeedbackGt.	2	Feedback Gt	2
009		Feedback Gt2	2 [Pro]	Feedback Gt2	2 [88]	FeedbackGt2	2	-----	
016		Power Guitar	2 [Pro]	Power Guitar	2 [88]	PowerGuitar	2	-----	
017		Power Gt.2	2 [Pro]	Power Gt.2	2	Power Gt.2	2	-----	
018		5th Dist.	2 [Pro]	5th Dist.	2 [88]	5th Dist.	2	-----	
024		Rock Rhythm	2 [Pro]	Rock Rhythm	2 [88]	Rock Rhythm	2	-----	
025		Rock Rhythm2	2 [Pro]	Rock Rhythm2	2 [88]	RockRhythm2	2	-----	
026		Dist Rtm GTR	1	-----		-----		-----	
000	032	Gt.Harmonics	1 [Pro]	Gt.Harmonics	1 [88]	Gt.Harmonix	1 [55]	Gt.Harmonix	1
008		Gt. Feedback	1 [Pro]	Gt. Feedback	1 [88]	Gt.Feedback	1 [55]	Gt.Feedback	1
009		Gt.Feedback2	2 [Pro]	Gt. Feedback2	2	-----		-----	
016		Ac.Gt.Harmnx	1 [Pro]	Ac.Gt.Harmnx	1 [88]	Ac.Gt.Harm.	1	-----	
024		E.Bass Harm.	1 [Pro]	E.Bass Harm.	1	-----		-----	

Bass

CC00	PC	SC-8820 Map	Voices	SC-88Pro Map	Voices	SC-88 Map	Voices	SC-55 Map	Voices
000	033	Acoustic Bs.	1	Acoustic Bs.	1	AcousticBs.	2	Acoustic Bs	1
001		Rockabilly	2 [Pro]	Rockabilly	2	-----		-----	
008		Wild A.Bass	2 [Pro]	Wild A.Bass	2	-----		-----	
009		Atk A.Bass	2	-----		-----		-----	
016		Bass + OHH	2 [Pro]	Bass + OHH	2	-----		-----	
000	034	Fingered Bs.	1 [Pro]	Fingered Bs.	1	FingeredBs.	1	Fingered Bs	1
001		Fingered Bs2	2 [Pro]	Fingered Bs2	2	FingeredBs2	2	-----	
002		Jazz Bass	1 [Pro]	Jazz Bass	1 [88]	Jazz Bass	1	-----	
003		Jazz Bass 2	2 [Pro]	Jazz Bass 2	2	-----		-----	
004		Rock Bass	2 [Pro]	Rock Bass	2	-----		-----	
005		Heart Bass	1	-----		-----		-----	
006		AttackFinger	2	-----		-----		-----	
007		Finger Slap	2	-----		-----		-----	
008		ChorusJazzBs	2 [Pro]	ChorusJazzBs	2	-----		-----	
016		F.Bass/Harm.	1 [Pro]	F.Bass/Harm.	1	-----		-----	
000	035	Picked Bass	1 [Pro]	Picked Bass	1	Picked Bass	1	Picked Bass	1
001		Picked Bass2	2 [Pro]	Picked Bass2	2	-----		-----	
002		Picked Bass3	2 [Pro]	Picked Bass3	2	-----		-----	
003		Picked Bass4	2 [Pro]	Picked Bass4	2	-----		-----	
004		Double Pick	2	-----		-----		-----	
008		Muted PickBs	1 [Pro]	Muted PickBs	1	MutePickBs.	1	-----	
016		P.Bass/Harm.	1 [Pro]	P.Bass/Harm.	1	-----		-----	
000	036	Fretless Bs.	1 [Pro]	Fretless Bs.	1 [88]	FretlessBs.	1	Fretless Bs	1
001		Fretless Bs2	2 [Pro]	Fretless Bs2	2	FretlessBs2	2	-----	
002		Fretless Bs3	2 [Pro]	Fretless Bs3	2 [88]	FretlessBs3	2	-----	
003		Fretless Bs4	2 [Pro]	Fretless Bs4	2 [88]	FretlessBs4	2	-----	
004		Syn Fretless	2 [Pro]	Syn Fretless	2 [88]	SynFretless	2	-----	
005		Mr.Smooth	2 [Pro]	Mr.Smooth	2 [88]	Mr.Smooth	2	-----	
008		Wood+FlessBs	2 [Pro]	Wood+FlessBs	2	-----		-----	
000	037	Slap Bass 1	1 [Pro]	Slap Bass 1	1 [88]	Slap Bass 1	1	Slap Bass 1	1
001		Slap Pop	1 [Pro]	Slap Pop	1	-----		-----	
008		Reso Slap	1 [Pro]	Reso Slap	1 [88]	Reso Slap	1	-----	
009		Unison Slap	2 [Pro]	Unison Slap	2	-----		-----	
000	038	Slap Bass 2	2 [Pro]	Slap Bass 2	2 [88]	Slap Bass 2	2	Slap Bass 2	1
001		Slap Bass 3	2	-----		-----		-----	
008		FM Slap	2 [Pro]	FM Slap	2	-----		-----	
000	039	Synth Bass 1	2 [Pro]	Synth Bass 1	2 [88]	SynthBass 1	2	Syn.Bass 1	1
001		SynthBass101	1 [Pro]	SynthBass101	1 [88]	Syn.Bass101	1 [55]	Syn.Bass101	1
002		CS Bass	2 [Pro]	CS Bass	2	-----		-----	
003		JP-4 Bass	1 [Pro]	JP-4 Bass	1	-----		-----	
004		JP-8 Bass	2 [Pro]	JP-8 Bass	2	-----		-----	
005		P5 Bass	1 [Pro]	P5 Bass	1	-----		-----	
006		JPMG Bass	2 [Pro]	JPMG Bass	2	-----		-----	
008		Acid Bass	1 [Pro]	Acid Bass	1 [88]	Acid Bass	1	Syn.Bass 3	1
009		TB303 Bass	1 [Pro]	TB303 Bass	1 [88]	TB303 Bass	1	-----	
010		Tekno Bass	2 [Pro]	Tekno Bass	2 [88]	Tekno Bass	2	-----	
011		TB303 Bass 2	1 [Pro]	TB303 Bass 2	1	-----		-----	
012		Kicked TB303	2 [Pro]	Kicked TB303	2	-----		-----	
013		TB303 Saw Bs	1 [Pro]	TB303 Saw Bs	1	-----		-----	
014		Rubber303 Bs	1 [Pro]	Rubber303 Bs	1	-----		-----	
015		Reso 303 Bs	1 [Pro]	Reso 303 Bs	1	-----		-----	
016		Reso SH Bass	1 [Pro]	Reso SH Bass	1 [88]	Reso SHBass	1	-----	
017		TB303 Sqr Bs	1 [Pro]	TB303 Sqr Bs	1	-----		-----	
018		TB303 DistBs	1 [Pro]	TB303 DistBs	1	-----		-----	
019		Clavi Bass	2	-----		-----		-----	
020		Hammer	2	-----		-----		-----	
021		Jungle Bass	1	-----		-----		-----	
022		Square Bass	2	-----		-----		-----	
023		Square Bass2	2	-----		-----		-----	
024		Arpeggio Bs	1 [Pro]	Arpeggio Bs	1	-----		-----	
032		Hit&Saw Bass	2	-----		-----		-----	
033		Ring Bass	2	-----		-----		-----	
034		AtkSineBass	2	-----		-----		-----	
035		OB sine Bass	2	-----		-----		-----	
036		Auxiliary Bs	2	-----		-----		-----	
040		303SqDistBs	1	-----		-----		-----	
041		303SqDistBs2	2	-----		-----		-----	
042		303SqDistBs3	1	-----		-----		-----	
043		303Sqr_Rev	1	-----		-----		-----	
044		TeeBee	1	-----		-----		-----	

Appendices

PC : program number(Instrument number)
 CC00 : value of controller number 0
 (Bank number, Variation number)
 : legato-enabled sounds
 Voices : number of voices used by the Instrument
 Remark [Pro] : same sound as SC-88Pro map
 Remark [88] : same sounds as SC-88 map
 Remark [55] : same sound as SC-55 map
 Remark + : a percussive sound which cannot be played melodically.
 Use near C4 (note number 60).

CC00	PC	SC-8820 Map	Voices	SC-88Pro Map	Voices	SC-88 Map	Voices	SC-55 Map	Voices
000	040	Synth Bass 2	2 [Pro]	Synth Bass 2	2 [88]	SynthBass 2	2	Syn.Bass 2	2
001		SynthBass201	2 [Pro]	SynthBass201	2 [88]	Syn.Bass201	2	-----	
002		Modular Bass	2 [Pro]	Modular Bass	2 [88]	ModularBass	2	-----	
003		Seq Bass	2 [Pro]	Seq Bass	2 [88]	Seq Bass	2	-----	
004		MG Bass	1 [Pro]	MG Bass	1	-----		-----	
005		Mg Oct Bass1	2 [Pro]	Mg Oct Bass1	2	-----		-----	
006		MG Oct Bass2	2 [Pro]	MG Oct Bass2	2	-----		-----	
007		MG Blip Bs:	2 [Pro]	MG Blip Bs:	2	-----		-----	
008		Beef FM Bass	2 [Pro]	Beef FM Bass	2 [88]	Beef FMBass	2	Syn.Bass 4	2
009		Dly Bass	2 [Pro]	Dly Bass	2	X Wire Bass	2	-----	
010		X Wire Bass	2 [Pro]	X Wire Bass	2 [88]	-----		-----	
011		WireStr Bass	2 [Pro]	WireStr Bass	2	-----		-----	
012		Blip Bass :	2 [Pro]	Blip Bass :	2	-----		-----	
013		RubberBass 1	2 [Pro]	RubberBass 1	2	-----		-----	
014		Syn Bell Bs	2	-----		-----		-----	
015		Odd Bass	2	-----		-----		-----	
016		RubberBass 2	2 [Pro]	RubberBass 2	2	Rubber Bass	2 [55]	Rubber Bass	2
017		SH101 Bass 1	1 [Pro]	SH101 Bass 1	1 [88]	SH101Bass 1	1	-----	
018		SH101 Bass 2	1 [Pro]	SH101 Bass 2	1 [88]	SH101Bass 2	1	-----	
019		Smooth Bass	2 [Pro]	Smooth Bass	2 [88]	Smooth Bass	2	-----	
020		SH101 Bass 3	1 [Pro]	SH101 Bass 3	1	-----		-----	
021		Spike Bass	1 [Pro]	Spike Bass	1	-----		-----	
022		House Bass:	2 [Pro]	House Bass:	2	-----		-----	
023		KG Bass	2 [Pro]	KG Bass	2	-----		-----	
024		Sync Bass	2 [Pro]	Sync Bass	2	-----		-----	
025		MG 5th Bass	2 [Pro]	MG 5th Bass	2	-----		-----	
026		RND Bass	2 [Pro]	RND Bass	2	-----		-----	
027		WowMG Bass	2 [Pro]	WowMG Bass	2	-----		-----	
028		Bubble Bass	2 [Pro]	Bubble Bass	2	-----		-----	
029		Attack Pulse	1	-----		-----		-----	
030		Sync Bass 2	2	-----		-----		-----	
031		Pulse Mix Bs	2	-----		-----		-----	
032		MG Dist Bass	2	-----		-----		-----	
033		Seq Bass 2	2	-----		-----		-----	
034		3rd Bass	2	-----		-----		-----	
035		MG Oct Bass	2	-----		-----		-----	
036		SlowEnvBass	2	-----		-----		-----	
037		Mild Bass	2	-----		-----		-----	
038		DistEnvBass	2	-----		-----		-----	
039		MG LightBass	2	-----		-----		-----	
040		DistSynBass	2	-----		-----		-----	
041		Rise Bass	2	-----		-----		-----	
042		Cyber Bass	2	-----		-----		-----	

Strings/orchestra

CC00	PC	SC-8820 Map	Voices	SC-88Pro Map	Voices	SC-88 Map	Voices	SC-55 Map	Voices
000	041	Violin :	2 [Pro]	Violin :	2	Violin	1	Violin	1
001		Violin Atk:	2 [Pro]	Violin Atk:	2	-----		-----	
008		Slow Violin	1 [Pro]	Slow Violin	1	Slow Violin	1	Slow Violin	1
000	042	Viola :	2 [Pro]	Viola :	2	Viola	1	Viola	1
001		Viola Atk.:	2 [Pro]	Viola Atk.:	2	-----		-----	
000	043	Cello :	2	Cello :	2	Cello	1	Cello	1
001		Cello Atk.:	2	Cello Atk.:	2	-----		-----	
000	044	Contrabass	1	Contrabass	1	Contrabass	1	Contrabass	1
000	045	Tremolo Str	1 [Pro]	Tremolo Str	1 [88]	Tremolo Str	1	Tremolo Str	1
002		Trem Str.St.	2	-----		-----		-----	
008		Slow Tremolo	1 [Pro]	Slow Tremolo	1 [88]	SlowTremolo	1	-----	
009		Suspense Str	2 [Pro]	Suspense Str	2 [88]	SuspenseStr	2	-----	
010		SuspenseStr2	2	-----		-----		-----	
000	046	PizzicatoStr	1 [Pro]	PizzicatoStr	1 [88]	Pizz. Str.	1	Pizzicato	1
001		Vcs&Cbs Pizz	2 [Pro]	Vcs&Cbs Pizz	2	-----		-----	
002		Chamber Pizz	2 [Pro]	Chamber Pizz	2	-----		-----	
003		St.Pizzicato	2 [Pro]	St. Pizzicato	2	-----		-----	
008		Solo Pizz.	1 [Pro]	Solo Pizz.	1	-----		-----	
016		Solo Spic.	1 [Pro]	Solo Spic.	1	-----		-----	
017		StringsSpic.	2	-----		-----		-----	
000	047	Harp	1 [Pro]	Harp	1 [88]	Harp	1	Harp	1
001		Harp&Strings	2	-----		-----		-----	
002		Harp St.	2	-----		-----		-----	
008		Uilleann Harp	2	-----		-----		-----	
016		Synth Harp	1 [Pro]	Synth Harp	1	-----		-----	
024		Yang Qin	2	-----		-----		-----	
025		Yang Qin 2	2	-----		-----		-----	
026		SynthYangQin	2	-----		-----		-----	
000	048	Timpani	1 [Pro]	Timpani	1 [88]	Timpani	1	Timpani	1

Ensemble

CC00	PC	SC-8820 Map	Voices	SC-88Pro Map	Voices	SC-88 Map	Voices	SC-55 Map	Voices
000	049	Strings :	2 [Pro]	Strings :	2	Strings	1	Strings	1
001		Bright Str:	1 [Pro]	Bright Str:	1	Strings 2	1	-----	
002		ChamberStr :	2 [Pro]	ChamberStr :	2	-----		-----	
003		Cello sect.	1 [Pro]	Cello sect.	1	-----		-----	
004		Bright Str.2	2	-----		-----		-----	
005		Bright Str.3	2	-----		-----		-----	
006		Quad Strings	2	-----		-----		-----	
007		Mild Strings	2	-----		-----		-----	
008		Orchestra	2 [Pro]	Orchestra	2	Orchestra	2	Orchestra	2
009		Orchestra 2	2 [Pro]	Orchestra 2	2	Orchestra 2	2	-----	
010		Tremolo Orch	2 [Pro]	Tremolo Orch	2 [88]	TremoloOrch	2	-----	
011		Choir Str.	2 [Pro]	Choir Str.	2	Choir Str.	2	-----	
012		Strings+Horn	2 [Pro]	Strings+Horn	2	-----		-----	
013		Str.+Flute	2	-----		-----		-----	
014		Choir Str.2	2	-----		-----		-----	
015		Choir Str.3	2	-----		-----		-----	
016		St. Strings	2 [Pro]	St. Strings	2	St.Strings	2	-----	
017		St.Strings 2	2	-----		-----		-----	
018		St.Strings 3	2	-----		-----		-----	
019		Orchestra 3	2	-----		-----		-----	
020		Orchestra 4	2	-----		-----		-----	
024		Velo Strings	2 [Pro]	Velo Strings	2 [88]	VeloStrings	2	-----	
032		Oct Strings1	2 [Pro]	Oct Strings1	2	-----		-----	
033		Oct Strings2	2 [Pro]	Oct Strings2	2	-----		-----	
034		ContraBsSect	2	-----		-----		-----	
040		60s Strings	2	-----		-----		-----	
000	050	Slow Strings	1 [Pro]	Slow Strings	1	SlowStrings	1	SlowStrings	1
001		SlowStrings2	1 [Pro]	SlowStrings2	1	Slow Str. 2	1	-----	
002		SlowStrings3	2	-----		-----		-----	
008		Legato Str.	2 [Pro]	Legato Str.	2 [88]	Legato Str.	2	-----	
009		Warm Strings	2 [Pro]	Warm Strings	2 [88]	WarmStrings	2	-----	
010		St.Slow Str.	2 [Pro]	St.Slow Str.	2	St.SlowStr.	2	-----	
011		St.Slow Str2	2	-----		-----		-----	
012		S.Str+Choir	2	-----		-----		-----	
013		S.Str+Choir2	2	-----		-----		-----	
000	051	Syn.Strings1	2 [Pro]	Syn.Strings1	2	SynStrings1	2	SynStrings1	1
001		OB Strings	2 [Pro]	OB Strings	2	OB Strings	2	-----	
002		StackStrings	2 [Pro]	StackStrings	2	-----		-----	
003		JP Strings	2 [Pro]	JP Strings	2	-----		-----	
004		Chorus Str.	2	-----		-----		-----	
008		Syn.Strings3	2 [Pro]	Syn.Strings3	2 [88]	SynStrings3	2 [55]	SynStrings3	2
009		Syn.Strings4	2 [Pro]	Syn.Strings4	2	-----		-----	
010		Syn.Strings6	2	-----		-----		-----	
011		Syn.Strings7	2	-----		-----		-----	
012		LoFi Strings	2	-----		-----		-----	
016		High Strings	2 [Pro]	High Strings	2	-----		-----	
017		Hybrid Str.	2 [Pro]	Hybrid Str.	2	-----		-----	
024		Tron Strings	2 [Pro]	Tron Strings	2	-----		-----	
025		Noiz Strings	2 [Pro]	Noiz Strings	2	-----		-----	
000	052	Syn.Strings2	2 [Pro]	Syn.Strings2	2 [88]	SynStrings2	2 [55]	SynStrings2	2
001		Syn.Strings5	2 [Pro]	Syn.Strings5	2	-----		-----	
002		JUNO Strings	2 [Pro]	JUNO Strings	2	-----		-----	
003		FilteredOrch	2	-----		-----		-----	
004		JP Saw Str.	2	-----		-----		-----	
005		Hybrid Str.2	2	-----		-----		-----	
006		DistStrings	2	-----		-----		-----	
007		JUNOFullStr.	2	-----		-----		-----	
008		Air Strings	2 [Pro]	Air Strings	2	-----		-----	
009		Atk Syn Str.	2	-----		-----		-----	
010		StraightStr.	2	-----		-----		-----	
000	053	Choir Aahs	1 [Pro]	Choir Aahs	1	Choir Aahs	1	Choir Aahs	1
008		St.ChoirAahs	2 [Pro]	St.ChoirAahs	2	St.Choir	2	-----	
009		Melted Choir	2 [Pro]	Melted Choir	2	Mello Choir	2	-----	
010		Church Choir	2 [Pro]	Church Choir	2	-----		-----	
011		Boys Choir 1	1	-----		-----		-----	
012		Boys Choir 2	2	-----		-----		-----	
013		St.BoysChoir	2	-----		-----		-----	
014		Rich Choir	2	-----		-----		-----	
016		Choir Hahs	1 [Pro]	Choir Hahs	1	-----		-----	
024		Chorus Lahs	1 [Pro]	Chorus Lahs	1	-----		-----	
032		Chorus Aahs	2 [Pro]	Chorus Aahs	2	ChoirAahs 2	1 [55]	Choir Aahs2	1
033		Male Aah+Str	2 [Pro]	Male Aah+Str	2	-----		-----	

Appendices

PC : program number(Instrument number)
 CC00 : value of controller number 0
 (Bank number, Variation number)
 : legato-enabled sounds
 Voices : number of voices used by the Instrument
 Remark [Pro] : same sound as SC-88Pro map
 Remark [88] : same sounds as SC-88 map
 Remark [55] : same sound as SC-55 map
 Remark + : a percussive sound which cannot be played melodically.
 Use near C4 (note number 60).

CC00	PC	SC-8820 Map	Voices	SC-88Pro Map	Voices	SC-88 Map	Voices	SC-55 Map	Voices
000	054	Voice Oohs	1	Voice Oohs	1 [88]	Voice Oohs	1 [55]	Voice Oohs	1
001		Chorus Oohs	2	-----		-----		-----	
002		Voice Oohs 2	2	-----		-----		-----	
003		Chorus Oohs2	2	-----		-----		-----	
004		OohsCodeMaj7	1	-----		-----		-----	
005		OohsCodeSus4	1	-----		-----		-----	
006		Jazz Scat	1	-----		-----		-----	
008		Voice Dahs	1 [Pro]	Voice Dahs	1	-----		-----	
009		JzVoice Dat	1	-----		-----		-----	
010		JzVoice Bap	1	-----		-----		-----	
011		JzVoice Dow	1	-----		-----		-----	
012		JzVoice Thum	1	-----		-----		-----	
016		VoiceLah Fem	1	-----		-----		-----	
017		ChorusLahFem	2	-----		-----		-----	
018		VoiceLuh Fem	1	-----		-----		-----	
019		ChorusLuhFem	2	-----		-----		-----	
020		VoiceLan Fem	1	-----		-----		-----	
021		ChorusLanFem	2	-----		-----		-----	
022		VoiceAah Fem	1	-----		-----		-----	
023		VoiceUuh Fem	1	-----		-----		-----	
024		Fem Lah&Lan	1	-----		-----		-----	
032		VoiceWah Mal	1	-----		-----		-----	
033		ChorusWahMal	2	-----		-----		-----	
034		VoiceWoh Mal	1	-----		-----		-----	
035		ChorusWohMal	2	-----		-----		-----	
036		VoiceAah Mal	1	-----		-----		-----	
037		VoiceOoh Mal	1	-----		-----		-----	
040		Humming	2	-----		-----		-----	
000	055	SynVox	1 [Pro]	SynVox	1 [88]	SynVox	1 [55]	SynVox	1
001		SynVox 2	2	-----		-----		-----	
002		SynVox 3	2	-----		-----		-----	
008		Syn.Voice	2 [Pro]	Syn.Voice	2 [88]	Syn.Voice	2	-----	
009		Silent Night	2 [Pro]	Silent Night	2	-----		-----	
010		Syn.Voice 2	2	-----		-----		-----	
016		VP330 Choir	1 [Pro]	VP330 Choir	1	-----		-----	
017		Vinyl Choir	2 [Pro]	Vinyl Choir	2	-----		-----	
018		JX8P Vox	2	-----		-----		-----	
019		Analog Voice	1	-----		-----		-----	
000	056	OrchestraHit	2 [Pro]	OrchestraHit	2 [88]	Orch. Hit	2	Orchest.Hit	2
001		Bass Hit	2	-----		-----		-----	
002		6th Hit	2	-----		-----		-----	
003		Euro Hit	2	-----		-----		-----	
008		Impact Hit	2 [Pro]	Impact Hit	2 [88]	Impact Hit	2	-----	
009		Philly Hit	2 [Pro]	Philly Hit	2 [88]	Philly Hit	2	-----	
010		Double Hit	2 [Pro]	Double Hit	2 [88]	Double Hit	2	-----	
011		Perc. Hit	1 [Pro]	Perc. Hit	1	-----		-----	
012		Shock Wave	2 [Pro]	Shock Wave	2	-----		-----	
013		Bounce Hit	1	-----		-----		-----	
014		Drill Hit	1	-----		-----		-----	
015		Thrill Hit	1	-----		-----		-----	
016		Lo Fi Rave	2 [Pro]	Lo Fi Rave	2 [88]	Lo Fi Rave	2	-----	
017		Techno Hit	1 [Pro]	Techno Hit	1	-----		-----	
018		Dist. Hit	1 [Pro]	Dist. Hit	1	-----		-----	
019		Bam Hit	1 [Pro]	Bam Hit	1	-----		-----	
020		Bit Hit	1 [Pro]	Bit Hit	1	-----		-----	
021		Bim Hit	1 [Pro]	Bim Hit	1	-----		-----	
022		Technorg Hit	1 [Pro]	Technorg Hit	1	-----		-----	
023		Rave Hit	2 [Pro]	Rave Hit	2	-----		-----	
024		Strings Hit	2 [Pro]	Strings Hit	2	-----		-----	
025		Stack Hit	2 [Pro]	Stack Hit	2	-----		-----	
026		Industry Hit	1	-----		-----		-----	
027		Clap Hit	1	-----		-----		-----	

Brass

CC00	PC	SC-8820 Map	Voices	SC-88Pro Map	Voices	SC-88 Map	Voices	SC-55 Map	Voices
000	057	Trumpet	1 [Pro]	Trumpet	1	Trumpet	1	Trumpet	1
001		Trumpet 2	1 [Pro]	Trumpet 2	1 [88]	Trumpet 2	1	-----	
002		Trumpet :	1 [Pro]	Trumpet :	1	-----		-----	
003		Dark Trumpet	1	-----		-----		-----	
004		Trumpet & Nz	2	-----		-----		-----	
008		Flugel Horn	1 [Pro]	Flugel Horn	1 [88]	Flugel Horn	1	-----	
016		4th Trumpets	2 [Pro]	4th Trumpets	2	-----		-----	
024		Bright Tp.	2 [Pro]	Bright Tp.	2	Bright Tp.	2	-----	
025		Warm Tp.	2 [Pro]	Warm Tp.	2 [88]	Warm Tp.	2	-----	
026		Warm Tp.2	2	-----		-----		-----	
027		Twin Tp.	2	-----		-----		-----	
032		Syn. Trumpet	1 [Pro]	Syn. Trumpet	1	-----		-----	
000	058	Trombone	1 [Pro]	Trombone	1	Trombone	1	Trombone	1
001		Trombone 2	1 [Pro]	Trombone 2	1	Trombone 2	2 [55]	Trombone 2	2
002		Twin bones	2 [Pro]	Twin bones	2	-----		-----	
003		Bones & Tuba	2	-----		-----		-----	
004		Bright Tb	1	-----		-----		-----	
008		Bs. Trombone	1 [Pro]	Bs. Trombone	1	-----		-----	
016		Euphonium	2	-----		-----		-----	
000	059	Tuba	1 [Pro]	Tuba	1 [88]	Tuba	1	Tuba	1
001		Tuba 2	1 [Pro]	Tuba 2	1 [88]	Tuba 2	1	-----	
008		Tuba + Horn	2	-----		-----		-----	
000	060	MutedTrumpet	1 [Pro]	MutedTrumpet	1 [88]	Muted Tp.	1	MuteTrumpet	1
001		Cup Mute Tp	1	-----		-----		-----	
002		MuteTrumpet2	1	-----		-----		-----	
003		MuteTrumpet3	2	-----		-----		-----	
008		Muted Horns	1 [Pro]	Muted Horns	1	-----		-----	
000	061	French Horns	1 [Pro]	French Horns	1 [88]	FrenchHorns	1	French Horn	2
001		Fr.Horn 2	2 [Pro]	Fr.Horn 2	2 [88]	Fr.Horn 2	2 [55]	Fr.Horn 2	2
002		Horn + Orche	2 [Pro]	Horn + Orche	2	-----		-----	
003		Wide FreHrns	2 [Pro]	Wide FreHrns	2	-----		-----	
008		F.Hrn Slow:	1 [Pro]	F.Hrn Slow:	1	Fr.HornSolo	1	-----	
009		Dual Horns	2 [Pro]	Dual Horns	2	-----		-----	
016		Synth Horn	2 [Pro]	Synth Horn	2	Horn Orch	2	-----	
024		F.Horn Rip	1 [Pro]	F.Horn Rip	1	-----		-----	
000	062	Brass 1	2 [Pro]	Brass 1	2	Brass 1	1 [55]	Brass 1	1
001		Brass ff	1 [Pro]	Brass ff	1	-----		-----	
002		Bones Sect.	1 [Pro]	Bones Sect.	1	-----		-----	
003		St. Brass ff	2	-----		-----		-----	
004		Quad Brass1	2	-----		-----		-----	
005		Quad Brass2	2	-----		-----		-----	
008		Brass 2	2 [Pro]	Brass 2	2	Brass 2	2	Brass 2	2
009		Brass 3	2 [Pro]	Brass 3	2	-----		-----	
010		Brass sfz	2 [Pro]	Brass sfz	2	-----		-----	
012		Brass sfz 2	2	-----		-----		-----	
014		FatPop Brass	2	-----		-----		-----	
016		Brass Fall	1 [Pro]	Brass Fall	1 [88]	Brass Fall	1	-----	
017		Trumpet Fall	1 [Pro]	Trumpet Fall	1	-----		-----	
024		Octave Brass	2 [Pro]	Octave Brass	2	-----		-----	
025		Brass + Reed	2 [Pro]	Brass + Reed	2	-----		-----	
026		Fat + Reed	2	-----		-----		-----	
032		Orch Brass	2	-----		-----		-----	
033		Orch Brass 2	2	-----		-----		-----	
035		St.FatPopBrs	2	-----		-----		-----	
036		St.Orch Brs	2	-----		-----		-----	
037		St.Orch Brs2	2	-----		-----		-----	
038		St.Orch Brs3	2	-----		-----		-----	
000	063	Synth Brass1	2 [Pro]	Synth Brass1	2	SynthBrass1	2	Syn.Brass 1	2
001		JUNO Brass	2 [Pro]	JUNO Brass	2	Poly Brass	2	-----	
002		Stack Brass	2 [Pro]	Stack Brass	2	-----		-----	
003		SH-5 Brass	2 [Pro]	SH-5 Brass	2	-----		-----	
004		MKS Brass	2 [Pro]	MKS Brass	2	-----		-----	
005		Jump Brass	1	-----		-----		-----	
008		Pro Brass	2 [Pro]	Pro Brass	2	Syn.Brass 3	2 [55]	Syn.Brass 3	2
009		P5 Brass	2 [Pro]	P5 Brass	2	Quack Brass	2	-----	
010		OrchSynBrass	2	-----		-----		-----	
016		Oct SynBrass	2 [Pro]	Oct SynBrass	2	OctaveBrass	2	Analog Brs1	2
017		Hybrid Brass	2 [Pro]	Hybrid Brass	2	-----		-----	
018		OctSynBrass2	2	-----		-----		-----	
019		BPF Brass	2	-----		-----		-----	

Appendices

PC : program number(Instrument number)
 CC00 : value of controller number 0
 (Bank number, Variation number)
 : legato-enabled sounds
 Voices : number of voices used by the Instrument
 Remark [Pro] : same sound as SC-88Pro map
 Remark [88] : same sounds as SC-88 map
 Remark [55] : same sound as SC-55 map
 Remark + : a percussive sound which cannot be played melodically.
 Use near C4 (note number 60).

CC00	PC	SC-8820 Map	Voices	SC-88Pro Map	Voices	SC-88 Map	Voices	SC-55 Map	Voices
000	064	Synth Brass2	2 [Pro]	Synth Brass 2	2	Syn.Brass 2	2 [55]	Syn.Brass 2	2
001		Soft Brass	2 [Pro]	Soft Brass	2	Soft Brass	2	-----	
002		Warm Brass	2 [Pro]	Warm Brass	2	-----		-----	
003		Synth Brass3	2	-----		-----		-----	
004		Sync Brass	2	-----		-----		-----	
005		Fat SynBrass	2	-----		-----		-----	
006		DeepSynBrass	2	-----		-----		-----	
008		SynBrass sfz	1 [Pro]	SynBrass sfz	1	Syn.Brass 4	1 [55]	Syn.Brass 4	1
009		OB Brass	2 [Pro]	OB Brass	2	-----		-----	
010		Reso Brass	2 [Pro]	Reso Brass	2	-----		-----	
011		DistSqrBrass	2	-----		-----		-----	
012		JP8000SawBrs	2	-----		-----		-----	
016		Velo Brass 1	2 [Pro]	Velo Brass 1	2 [88]	VeloBrass 1	2	Analog Brs2	2
017		Transbrass	2 [Pro]	Transbrass	2	VeloBrass 2	2	-----	

Reed

CC00	PC	SC-8820 Map	Voices	SC-88Pro Map	Voices	SC-88 Map	Voices	SC-55 Map	Voices
000	065	Soprano Sax	1 [Pro]	Soprano Sax	1	Soprano Sax	1	Soprano Sax	1
008		Soprano Exp.	1 [Pro]	Soprano Exp.	1	-----		-----	
000	066	Alto Sax	1 [Pro]	Alto Sax	1	Alto Sax	1	Alto Sax	1
008		AltoSax Exp.	1 [Pro]	AltoSax Exp.	1	Hyper Alto	1	-----	
009		Grow Sax	1 [Pro]	Grow Sax	1	-----		-----	
016		AltoSax + Tp	2 [Pro]	AltoSax + Tp	2	-----		-----	
017		Sax Section	2	-----		-----		-----	
000	067	Tenor Sax	2 [Pro]	Tenor Sax	2	Tenor Sax	2	Tenor Sax	1
001		Tenor Sax :	2 [Pro]	Tenor Sax :	2	-----		-----	
008		BreathyTn.:	1 [Pro]	BreathyTn.:	1	BreathyTnr.	1	-----	
009		St.Tenor Sax	2 [Pro]	St. Tenor Sax	2	-----		-----	
000	068	Baritone Sax	2 [Pro]	Baritone Sax	2	BaritoneSax	1	BaritoneSax	1
001		Bari. Sax :	2 [Pro]	Bari. Sax :	2	-----		-----	
008		Bari & Tenor	2	-----		-----		-----	
000	069	Oboe	1 [Pro]	Oboe	1	Oboe	1	Oboe	1
008		Oboe Exp.	1 [Pro]	Oboe Exp.	1	-----		-----	
016		Multi Reed	1 [Pro]	Multi Reed	1	-----		-----	
000	070	English Horn	1 [Pro]	English Horn	1 [88]	EnglishHorn	1	EnglishHorn	1
000	071	Bassoon	1 [Pro]	Bassoon	1 [88]	Bassoon	1	Bassoon	1
000	072	Clarinet	1 [Pro]	Clarinet	1	Clarinet	1	Clarinet	1
008		Bs Clarinet	1 [Pro]	Bs Clarinet	1 [88]	Bs Clarinet	1	-----	
016		Multi Wind	1 [Pro]	Multi Wind	1	-----		-----	
017		Quad Wind	2	-----		-----		-----	

Pipe

CC00	PC	SC-8820 Map	Voices	SC-88Pro Map	Voices	SC-88 Map	Voices	SC-55 Map	Voices
000	073	Piccolo	1 [Pro]	Piccolo	1 [88]	Piccolo	1	Piccolo	1
001		Piccolo :	1 [Pro]	Piccolo :	1	----		----	
008		Nay	2 [Pro]	Nay	2	----		----	
009		Nay Tremolo	2 [Pro]	Nay Tremolo	2	----		----	
016		Di	2 [Pro]	Di	2	----		----	
000	074	Flute	1 [Pro]	Flute	1 [88]	Flute	1	Flute	1
001		Flute 2 :	1 [Pro]	Flute 2 :	1	----		----	
002		Flute Exp.	1 [Pro]	Flute Exp.	1	----		----	
003		Fit Travelso	2 [Pro]	Fit Travelso	2	----		----	
008		Flute + Vln	2 [Pro]	Flute + Vln	2	----		----	
009		Pipe & Reed	2	----		----		----	
016		Tron Flute	1 [Pro]	Tron Flute	1	----		----	
017		Indian Flute	1	----		----		----	
000	075	Recorder	1 [Pro]	Recorder	1 [88]	Recorder	1 [55]	Recorder	1
000	076	Pan Flute	2 [Pro]	Pan Flute	2 [88]	Pan Flute	2	Pan Flute	1
008		Kawala	2 [Pro]	Kawala	2 [88]	Kawala	2	----	
016		Zampona	2 [Pro]	Zampona	2	----		----	
017		Zampona Atk	1 [Pro]	Zampona Atk	1	----		----	
024		Tin Whistle	1	----		----		----	
025		TinWhistle Nm	1	----		----		----	
026		TinWhistle Or	1	----		----		----	
000	077	Bottle Blow	2 [Pro]	Bottle Blow	2 [88]	Bottle Blow	2	Bottle Blow	2
000	078	Shakuhachi	2 [Pro]	Shakuhachi	2 [88]	Shakuhachi	2 [55]	Shakuhachi	2
001		Shakuhachi:	2 [Pro]	Shakuhachi:	2	----		----	
000	079	Whistle	1 [Pro]	Whistle	1 [88]	Whistle	1 [55]	Whistle	1
001		Whistle 2	2 [Pro]	Whistle 2	2	----		----	
000	080	Ocarina	1 [Pro]	Ocarina	1 [88]	Ocarina	1 [55]	Ocarina	1

Synth lead

CC00	PC	SC-8820 Map	Voices	SC-88Pro Map	Voices	SC-88 Map	Voices	SC-55 Map	Voices
000	081	Square Wave	2 [Pro]	Square Wave	2	Square Wave	2 [55]	Square Wave	2
001		MG Square	1 [Pro]	MG Square	1	Square	1 [55]	Square	1
002		Hollow Mini	1 [Pro]	Hollow Mini	1 [88]	Hollow Mini	1	----	
003		Mellow FM	2 [Pro]	Mellow FM	2 [88]	Mellow FM	2	----	
004		CC Solo	2 [Pro]	CC Solo	2 [88]	CC Solo	2	----	
005		Shmoog	2 [Pro]	Shmoog	2 [88]	Shmoog	2	----	
006		LM Square	2 [Pro]	LM Square	2 [88]	LM Square	2	----	
007		JP8000 TWM	2	----		----		----	
008		2600 Sine	1 [Pro]	2600 Sine	1	Sine Wave	1 [55]	Sine Wave	1
009		Sine Lead	1 [Pro]	Sine Lead	1	----		----	
010		KG Lead	1 [Pro]	KG Lead	1	----		----	
011		Twin Sine	2	----		----		----	
016		P5 Square	1 [Pro]	P5 Square	1	----		----	
017		OB Square	1 [Pro]	OB Square	1	----		----	
018		JP-8 Square	1 [Pro]	JP-8 Square	1	----		----	
019		Dist Square	1	----		----		----	
020		303SquarDst1	1	----		----		----	
021		303SquarDst2	1	----		----		----	
022		303 Mix Sqr	2	----		----		----	
023		Dual Sqr&Saw	2	----		----		----	
024		Pulse Lead	2 [Pro]	Pulse Lead	2	----		----	
025		JP8 PulseLd1	2 [Pro]	JP8 PulseLd1	2	----		----	
026		JP8 PulseLd2	1 [Pro]	JP8 PulseLd2	1	----		----	
027		MG Reso. Pls	1 [Pro]	MG Reso. Pls	1	----		----	
028		JP8 PulseLd3	2	----		----		----	
029		260RingLead	2	----		----		----	
030		303DistLead	2	----		----		----	
031		JP8000DistLd	2	----		----		----	
032		HipHop SinLd	1	----		----		----	
033		HipHop SqrLd	1	----		----		----	
034		HipHop PlsLd	1	----		----		----	
035		Flux Pulse	2	----		----		----	

Appendices

PC : program number(Instrument number)
 CC00 : value of controller number 0
 (Bank number, Variation number)
 : legato-enabled sounds
 Voices : number of voices used by the Instrument
 Remark [Pro] : same sound as SC-88Pro map
 Remark [88] : same sounds as SC-88 map
 Remark [55] : same sound as SC-55 map
 Remark + : a percussive sound which cannot be played melodically.
 Use near C4 (note number 60).

CC00	PC	SC-8820 Map	Voices	SC-88Pro Map	Voices	SC-88 Map	Voices	SC-55 Map	Voices
000	082	Saw Wave	2 [Pro]	Saw Wave	2	Saw Wave	2 [55]	Saw Wave	2
001		OB2 Saw	1 [Pro]	OB2 Saw	1	Saw	1 [55]	Saw	1
002		Pulse Saw	2 [Pro]	Pulse Saw	2 [88]	Pulse Saw	2	-----	
003		Feline GR	2 [Pro]	Feline GR	2 [88]	Feline GR	2	-----	
004		Big Lead	2 [Pro]	Big Lead	2 [88]	Big Lead	2	-----	
005		Velo Lead	2 [Pro]	Velo Lead	2 [88]	Velo Lead	2	-----	
006		GR-300	2 [Pro]	GR-300	2 [88]	GR-300	2	-----	
007		LA Saw	1 [Pro]	LA Saw	1 [88]	LA Saw	1	-----	
008		Doctor Solo	2 [Pro]	Doctor Solo	2 [88]	Doctor Solo	2 [55]	Doctor Solo	2
009		Fat Saw Lead	2 [Pro]	Fat Saw Lead	2	-----		-----	
010		JP8000 Saw	1	-----		-----		-----	
011		D-50 Fat Saw	2 [Pro]	D-50 Fat Saw	2	-----		-----	
012		OB DoubleSaw	2	-----		-----		-----	
013		JP DoubleSaw	2	-----		-----		-----	
014		FatSawLead 2	2	-----		-----		-----	
015		JP SuperSaw	2	-----		-----		-----	
016		Waspy Synth	2 [Pro]	Waspy Synth	2 [88]	Waspy Synth	2	-----	
017		PM Lead	1 [Pro]	PM Lead	1	-----		-----	
018		CS Saw Lead	1 [Pro]	CS Saw Lead	1	-----		-----	
024		MG Saw 1	1 [Pro]	MG Saw 1	1	-----		-----	
025		MG Saw 2	1 [Pro]	MG Saw 2	1	-----		-----	
026		OB Saw 1	1 [Pro]	OB Saw 1	1	-----		-----	
027		OB Saw 2	1 [Pro]	OB Saw 2	1	-----		-----	
028		D-50 Saw	1 [Pro]	D-50 Saw	1	-----		-----	
029		SH-101 Saw	1 [Pro]	SH-101 Saw	1	-----		-----	
030		CS Saw	1 [Pro]	CS Saw	1	-----		-----	
031		MG Saw Lead	1 [Pro]	MG Saw Lead	1	-----		-----	
032		OB Saw Lead	1 [Pro]	OB Saw Lead	1	-----		-----	
033		P5 Saw Lead	2 [Pro]	P5 Saw Lead	2	-----		-----	
034		MG unison	2 [Pro]	MG unison	2	-----		-----	
035		Oct Saw Lead	2 [Pro]	Oct Saw Lead	2	-----		-----	
036		Natural Lead	2	-----		-----		-----	
040		SequenceSaw1	2	SequenceSaw1	2	-----		-----	
041		SequenceSaw2	1 [Pro]	SequenceSaw2	1	-----		-----	
042		Reso Saw	1 [Pro]	Reso Saw	1	-----		-----	
043		Cheese Saw 1	1 [Pro]	Cheese Saw 1	1	-----		-----	
044		Cheese Saw 2	1 [Pro]	Cheese Saw 2	1	-----		-----	
045		Rhythmic Saw	2 [Pro]	Rhythmic Saw	2	-----		-----	
046		SequencedSaw	2	-----		-----		-----	
047		Techno Saw	2	-----		-----		-----	
000	083	Syn.Calliope	2 [Pro]	Syn.Calliope	2 [88]	SynCalliope	2 [55]	SynCalliope	2
001		Vent Synth	2 [Pro]	Vent Synth	2 [88]	Vent Synth	2	-----	
002		Pure PanLead	2 [Pro]	Pure PanLead	2 [88]	PurePanLead	2	-----	
008		LM Pure Lead	2	-----		-----		-----	
009		LM Blow Lead	2	-----		-----		-----	
000	084	Chiffer Lead	2 [Pro]	Chiffer Lead	2 [88]	ChifferLead	2 [55]	ChifferLead	2
001		TB Lead	2 [Pro]	TB Lead	2	-----		-----	
002		Hybrid Lead	2	-----		-----		-----	
003		Unison SqrLd	2	-----		-----		-----	
004		FatSolo Lead	2	-----		-----		-----	
005		ForcefullLead	2	-----		-----		-----	
006		Oct.UnisonLd	2	-----		-----		-----	
007		Unison SawLd	2	-----		-----		-----	
008		Mad Lead	2 [Pro]	Mad Lead	2	-----		-----	
009		CrowdingLead	2	-----		-----		-----	
010		Double Sqr.	2	-----		-----		-----	
000	085	Charang	2 [Pro]	Charang	2 [88]	Charang	2 [55]	Charang	2
001		Wire Lead	2	-----		-----		-----	
002		FB.Charang	2	-----		-----		-----	
003		Fat GR Lead	2	-----		-----		-----	
004		Windy GR Ld	2	-----		-----		-----	
005		Mellow GR Ld	2	-----		-----		-----	
006		GR & Pulse	2	-----		-----		-----	
008		Dist.Lead	2 [Pro]	Dist.Lead	2 [88]	Dist.Lead	2	-----	
009		Acid Guitar1	2 [Pro]	Acid Guitar1	2	-----		-----	
010		Acid Guitar2	2 [Pro]	Acid Guitar2	2	-----		-----	
011		Dance Dst.Gt	2	-----		-----		-----	
012		DanceDst.Gt2	2	-----		-----		-----	
016		P5 Sync Lead	1 [Pro]	P5 Sync Lead	1	-----		-----	
017		Fat SyncLead	2 [Pro]	Fat Sync Lead	2	-----		-----	
018		Rock Lead	2 [Pro]	Rock Lead	2	-----		-----	
019		5th DecaSync	2 [Pro]	5th DecaSync	2	-----		-----	
020		Dirty Sync	1 [Pro]	Dirty Sync	1	-----		-----	
021		DualSyncLead	2	-----		-----		-----	
022		LA Brass Ld	2	-----		-----		-----	
024		JUNO Sub Osc	1 [Pro]	JUNO Sub Osc	1	-----		-----	
025		2600 Sub Osc	1	-----		-----		-----	
026		JP8000Fd Osc	1	-----		-----		-----	

CC00	PC	SC-8820 Map	Voices	SC-88Pro Map	Voices	SC-88 Map	Voices	SC-55 Map	Voices
000	086	Solo Vox	2 [Pro]	Solo Vox	2 [88]	Solo Vox	2 [55]	Solo Vox	2
001		Solo Vox 2	2	-----		-----		-----	
008		Vox Lead	2 [Pro]	Vox Lead	2	-----		-----	
009		LFO Vox	2 [Pro]	LFO Vox	2	-----		-----	
010		Vox Lead 2	2	-----		-----		-----	
000	087	5th Saw Wave	2 [Pro]	5th Saw Wave	2 [88]	5th Saw	2 [55]	5th Saw	2
001		Big Fives	2 [Pro]	Big Fives	2 [88]	Big Fives	2	-----	
002		5th Lead	2 [Pro]	5th Lead	2	-----		-----	
003		5th Ana.Clav	2 [Pro]	5th Ana.Clav	2	-----		-----	
004		5th Pulse	2	-----		-----		-----	
005		JP 5th Saw	2	-----		-----		-----	
006		JP8000 5thFB	2	-----		-----		-----	
008		4th Lead	2 [Pro]	4th Lead	2	-----		-----	
000	088	Bass & Lead	2 [Pro]	Bass & Lead	2 [88]	Bass & Lead	2 [55]	Bass & Lead	2
001		Big & Raw	2 [Pro]	Big & Raw	2 [88]	Big & Raw	2	-----	
002		Fat & Perky	2 [Pro]	Fat & Perky	2 [88]	Fat & Perky	2	-----	
003		JUNO Rave	1 [Pro]	JUNO Rave	1	-----		-----	
004		JP8 BsLead 1	1 [Pro]	JP8 BsLead 1	1	-----		-----	
005		JP8 BsLead 2	2 [Pro]	JP8 BsLead 2	2	-----		-----	
006		SH-5 Bs.Lead	2 [Pro]	SH-5 Bs.Lead	2	-----		-----	
007		Delayed Lead	2	-----		-----		-----	

Synth pad, etc

CC00	PC	SC-8820 Map	Voices	SC-88Pro Map	Voices	SC-88 Map	Voices	SC-55 Map	Voices
000	089	Fantasia	2 [Pro]	Fantasia	2 [88]	Fantasia	2 [55]	Fantasia	2
001		Fantasia 2	2 [Pro]	Fantasia 2	2 [88]	Fantasia 2	2	-----	
002		New Age Pad	2 [Pro]	New Age Pad	2	-----		-----	
003		Bell Heaven	2 [Pro]	Bell Heaven	2	-----		-----	
004		Fantasia 3	2	-----		-----		-----	
005		Fantasia 4	2	-----		-----		-----	
006		After D !	2	-----		-----		-----	
007		260HarmPad	2	-----		-----		-----	
000	090	Warm Pad	1 [Pro]	Warm Pad	1 [88]	Warm Pad	1 [55]	Warm Pad	1
001		Thick Matrix	2 [Pro]	Thick Matrix	2	Thick Pad	2	-----	
002		Horn Pad	2 [Pro]	Horn Pad	2 [88]	Horn Pad	2	-----	
003		Rotary Strng	2 [Pro]	Rotary Strng	2 [88]	RotaryStrng	2	-----	
004		OB Soft Pad	2 [Pro]	OB Soft Pad	2	Soft Pad	2	-----	
005		Sine Pad	2	-----		-----		-----	
006		OB Soft Pad2	2	-----		-----		-----	
008		Octave Pad	2 [Pro]	Octave Pad	2	-----		-----	
009		Stack Pad	2 [Pro]	Stack Pad	2	-----		-----	
010		Human Pad	2	-----		-----		-----	
011		Sync Brs.Pad	2	-----		-----		-----	
012		Oct.PWM Pad	2	-----		-----		-----	
013		JP Soft Pad	2	-----		-----		-----	
000	091	Polysynth	2 [Pro]	Polysynth	2 [88]	Polysynth	2 [55]	Polysynth	2
001		80's PolySyn	2 [Pro]	80's PolySyn	2 [88]	80'sPolySyn	2	-----	
002		Polysynth 2	2 [Pro]	Polysynth 2	2	-----		-----	
003		Poly King	2 [Pro]	Poly King	2	-----		-----	
004		Super Poly	2	-----		-----		-----	
008		Power Stack	2 [Pro]	Power Stack	2	-----		-----	
009		Octave Stack	2 [Pro]	Octave Stack	2	-----		-----	
010		Reso Stack	1 [Pro]	Reso Stack	1	-----		-----	
011		Techno Stack	2 [Pro]	Techno Stack	2	-----		-----	
012		Pulse Stack	2	-----		-----		-----	
013		TwinOct.Rave	2	-----		-----		-----	
014		Oct.Rave	2	-----		-----		-----	
015		Happy Synth	2	-----		-----		-----	
016		ForwardSweep	2	-----		-----		-----	
017		ReverseSweep	2	-----		-----		-----	
024		Minor Rave	2	-----		-----		-----	
000	092	Space Voice	1 [Pro]	Space Voice	1 [88]	Space Voice	1 [55]	Space Voice	1
001		Heaven II	2 [Pro]	Heaven II	2 [88]	Heaven II	2	-----	
002		SC Heaven	2 [Pro]	SC Heaven	2	-----		-----	
003		Itopia	2	-----		-----		-----	
004		Water Space	2	-----		-----		-----	
005		Cold Space	2	-----		-----		-----	
006		Noise Peaker	1	-----		-----		-----	
007		Bamboo Hit	1	-----		-----		-----	
008		Cosmic Voice	2 [Pro]	Cosmic Voice	2	-----		-----	
009		Auh Vox	1 [Pro]	Auh Vox	1	-----		-----	
010		AuhAuh	2 [Pro]	AuhAuh	2	-----		-----	
011		Vocoderman	2 [Pro]	Vocoderman	2	-----		-----	
012		Holy Voices	2	-----		-----		-----	

Appendices

PC : program number(Instrument number)
 CC00 : value of controller number 0
 (Bank number, Variation number)
 : legato-enabled sounds
 Voices : number of voices used by the Instrument
 Remark [Pro] : same sound as SC-88Pro map
 Remark [88] : same sounds as SC-88 map
 Remark [55] : same sound as SC-55 map
 Remark + : a percussive sound which cannot be played melodically.
 Use near C4 (note number 60).

CC00	PC	SC-8820 Map	Voices	SC-88Pro Map	Voices	SC-88 Map	Voices	SC-55 Map	Voices
000	093	Bowed Glass	2 [Pro]	Bowed Glass	2 [88]	Bowed Glass	2 [55]	Bowed Glass	2
001		SoftBellPad	2 [Pro]	SoftBellPad	2	-----	-----	-----	-----
002		JP8 Sqr Pad	2 [Pro]	JP8 Sqr Pad	2	-----	-----	-----	-----
003		7thBelPad	2 [Pro]	7thBelPad	2	-----	-----	-----	-----
004		Steel Glass	2	-----	-----	-----	-----	-----	-----
005		Bottle Stack	2	-----	-----	-----	-----	-----	-----
000	094	Metal Pad	2 [Pro]	Metal Pad	2 [88]	Metal Pad	2 [55]	Metal Pad	2
001		Tine Pad	2 [Pro]	Tine Pad	2 [88]	Tine Pad	2	-----	-----
002		Panner Pad	2 [Pro]	Panner Pad	2 [88]	Panner Pad	2	-----	-----
003		Steel Pad	2	-----	-----	-----	-----	-----	-----
004		Special Rave	2	-----	-----	-----	-----	-----	-----
005		Metal Pad 2	2	-----	-----	-----	-----	-----	-----
000	095	Halo Pad	2 [Pro]	Halo Pad	2 [88]	Halo Pad	2 [55]	Halo Pad	2
001		Vox Pad	2 [Pro]	Vox Pad	2	-----	-----	-----	-----
002		Vox Sweep	2 [Pro]	Vox Sweep	2	-----	-----	-----	-----
008		Horror Pad	2 [Pro]	Horror Pad	2	-----	-----	-----	-----
009		SynVox Pad	2	-----	-----	-----	-----	-----	-----
010		SynVox Pad 2	2	-----	-----	-----	-----	-----	-----
011		Breath&Rise	2	-----	-----	-----	-----	-----	-----
012		Tears Voices	2	-----	-----	-----	-----	-----	-----
000	096	Sweep Pad	1 [Pro]	Sweep Pad	1 [88]	Sweep Pad	1 [55]	Sweep Pad	1
001		Polar Pad	1 [Pro]	Polar Pad	1 [88]	Polar Pad	1	-----	-----
002		Ambient BPF	2	-----	-----	-----	-----	-----	-----
003		Sync Pad	2	-----	-----	-----	-----	-----	-----
004		Warriors	2	-----	-----	-----	-----	-----	-----
008		Converge	1 [Pro]	Converge	1 [88]	Converge	1	-----	-----
009		Shwimmer	2 [Pro]	Shwimmer	2 [88]	Shwimmer	2	-----	-----
010		Celestial Pd	2 [Pro]	Celestial Pd	2 [88]	CelestialPd	2	-----	-----
011		Bag Sweep	2 [Pro]	Bag Sweep	2	-----	-----	-----	-----
012		Sweep Pipe	2	-----	-----	-----	-----	-----	-----
013		Sweep Stack	2	-----	-----	-----	-----	-----	-----
014		Deep Sweep	2	-----	-----	-----	-----	-----	-----
015		Stray Pad	2	-----	-----	-----	-----	-----	-----

Synth SFX

CC00	PC	SC-8820 Map	Voices	SC-88Pro Map	Voices	SC-88 Map	Voices	SC-55 Map	Voices
000	097	Ice Rain	2 [Pro]	Ice Rain	2 [88]	Ice Rain	2 [55]	Ice Rain	2
001		Harmo Rain	2 [Pro]	Harmo Rain	2 [88]	Harmo Rain	2	-----	-----
002		African wood	2 [Pro]	African wood	2 [88]	AfricanWood	2	-----	-----
003		Anklung Pad	2 [Pro]	Anklung Pad	2	-----	-----	-----	-----
004		Rattle Pad	2 [Pro]	Rattle Pad	2	-----	-----	-----	-----
005		Saw Impulse	2	-----	-----	-----	-----	-----	-----
006		Strange Str.	2	-----	-----	-----	-----	-----	-----
007		FastFWD Pad	2	-----	-----	-----	-----	-----	-----
008		Clavi Pad	2 [Pro]	Clavi Pad	2 [88]	Clavi Pad	2	-----	-----
009		EP Pad	2	-----	-----	-----	-----	-----	-----
010		Tambra Pad	2	-----	-----	-----	-----	-----	-----
011		CP Pad	2	-----	-----	-----	-----	-----	-----
000	098	Soundtrack	2 [Pro]	Soundtrack	2 [88]	Soundtrack	2 [55]	Soundtrack	2
001		Ancestral	2 [Pro]	Ancestral	2 [88]	Ancestral	2	-----	-----
002		Prologue	2 [Pro]	Prologue	2 [88]	Prologue	2	-----	-----
003		Prologue 2	2 [Pro]	Prologue 2	2	-----	-----	-----	-----
004		Hols Strings	2 [Pro]	Hols Strings	2	-----	-----	-----	-----
005		HistoryWave	2	-----	-----	-----	-----	-----	-----
008		Rave	2 [Pro]	Rave	2 [88]	Rave	2	-----	-----
000	099	Crystal	2 [Pro]	Crystal	2 [88]	Crystal	2 [55]	Crystal	2
001		Syn Mallet	1 [Pro]	Syn Mallet	1 [88]	Syn Mallet	1 [55]	Syn Mallet	1
002		Soft Crystal	2 [Pro]	Soft Crystal	2 [88]	SoftCrystal	2	-----	-----
003		Round Glock	2 [Pro]	Round Glock	2 [88]	Round Glock	2	-----	-----
004		Loud Glock	2 [Pro]	Loud Glock	2 [88]	Loud Glock	2	-----	-----
005		GlockenChime	2 [Pro]	GlockenChime	2 [88]	GlocknChime	2	-----	-----
006		Clear Bells	2 [Pro]	Clear Bells	2 [88]	Clear Bells	2	-----	-----
007		ChristmasBel	2 [Pro]	ChristmasBel	2 [88]	X'mas Bell	2	-----	-----
008		Vibra Bells	2 [Pro]	Vibra Bells	2 [88]	Vibra Bells	2	-----	-----
009		Digi Bells	2 [Pro]	Digi Bells	2 [88]	Digi Bells	2	-----	-----
010		Music Bell	2 [Pro]	Music Bell	2	-----	-----	-----	-----
011		Analog Bell	1 [Pro]	Analog Bell	1	-----	-----	-----	-----
012		Blow Bell	2	-----	-----	-----	-----	-----	-----
013		Hyper Bell	2	-----	-----	-----	-----	-----	-----
016		Choral Bells	2 [Pro]	Choral Bells	2 [88]	ChoralBells	2	-----	-----
017		Air Bells	2 [Pro]	Air Bells	2 [88]	Air Bells	2	-----	-----
018		Bell Harp	2 [Pro]	Bell Harp	2 [88]	Bell Harp	2	-----	-----
019		Gamelimba	2 [Pro]	Gamelimba	2 [88]	Gamelimba	2	-----	-----
020		JUNO Bell	2 [Pro]	JUNO Bell	2	-----	-----	-----	-----
021		JP Bell	2	-----	-----	-----	-----	-----	-----
022		Pizz Bell	2	-----	-----	-----	-----	-----	-----
023		Bottom Bell	2	-----	-----	-----	-----	-----	-----

CC00	PC	SC-8820 Map	Voices	SC-88Pro Map	Voices	SC-88 Map	Voices	SC-55 Map	Voices
000	100	Atmosphere	2 [Pro]	Atmosphere	2 [88]	Atmosphere	2 [55]	Atmosphere	2
001		Warm Atmos	2 [Pro]	Warm Atmos	2 [88]	Warm Atmos	2	-----	
002		Nylon Harp	2 [Pro]	Nylon Harp	2 [88]	Nylon Harp	2	-----	
003		Harpvox	2 [Pro]	Harpvox	2 [88]	Harpvox	2	-----	
004		HollowReleas	2 [Pro]	HollowReleas	2 [88]	HollowReleas	2	-----	
005		Nylon+Rhodes	2 [Pro]	Nylon+Rhodes	2 [88]	NylonRhodes	2	-----	
006		Ambient Pad	2 [Pro]	Ambient Pad	2 [88]	Ambient Pad	2	-----	
007		Invisible	2 [Pro]	Invisible	2	-----		-----	
008		Pulsey Key	2 [Pro]	Pulsey Key	2	-----		-----	
009		Noise Piano	2 [Pro]	Noise Piano	2	-----		-----	
010		Heaven Atmos	2	-----		-----		-----	
011		Tambra Atmos	2	-----		-----		-----	
000	101	Brightness	2 [Pro]	Brightness	2 [88]	Brightness	2 [55]	Brightness	2
001		Shining Star	2 [Pro]	Shining Star	2	-----		-----	
002		OB Stab	1 [Pro]	OB Stab	1	-----		-----	
003		Brass Star	2	-----		-----		-----	
004		Choir Stab	2	-----		-----		-----	
005		D-50 Retour	2	-----		-----		-----	
006		SouthernWind	2	-----		-----		-----	
007		SymbolicBell	2	-----		-----		-----	
008		Org Bell	2 [Pro]	Org Bell	2	-----		-----	
000	102	Goblin	2 [Pro]	Goblin	2 [88]	Goblin	2 [55]	Goblin	2
001		Goblinson	2 [Pro]	Goblinson	2 [88]	Goblinson	2	-----	
002		50's Sci-Fi	2 [Pro]	50's Sci-Fi	2 [88]	50's Sci-Fi	2	-----	
003		Abduction	2 [Pro]	Abduction	2	-----		-----	
004		Auhbient	2 [Pro]	Auhbient	2	-----		-----	
005		LFO Pad	2 [Pro]	LFO Pad	2	-----		-----	
006		Random Str	2 [Pro]	Random Str	2	-----		-----	
007		Random Pad	2 [Pro]	Random Pad	2	-----		-----	
008		LowBirds Pad	2 [Pro]	LowBirds Pad	2	-----		-----	
009		Falling Down	2 [Pro]	Falling Down	2	-----		-----	
010		LFO RAVE	2 [Pro]	LFO RAVE	2	-----		-----	
011		LFO Horror	2 [Pro]	LFO Horror	2	-----		-----	
012		LFO Techno	2 [Pro]	LFO Techno	2	-----		-----	
013		Alternative	2 [Pro]	Alternative	2	-----		-----	
014		UFO FX	2 [Pro]	UFO FX	2	-----		-----	
015		Gargle Man	1 [Pro]	Gargle Man	1	-----		-----	
016		Sweep FX	1 [Pro]	Sweep FX	1	-----		-----	
017		LM Has Come	2	-----		-----		-----	
018		FallInsect	2	-----		-----		-----	
019		LFO Oct.Rave	2	-----		-----		-----	
020		Just Before	2	-----		-----		-----	
021		RND Fl.Chord	2	-----		-----		-----	
022		RandomEnding	2	-----		-----		-----	
023		Random Sine	2	-----		-----		-----	
024		EatingFilter	2	-----		-----		-----	
025		Noise&SawHit	2	-----		-----		-----	
026		Pour Magic	2	-----		-----		-----	
027		DancingDrill	2	-----		-----		-----	
028		Dirty Stack	2	-----		-----		-----	
029		Big Blue	2	-----		-----		-----	
030		Static Hit	2	-----		-----		-----	
031		Atl.Mod.FX	2	-----		-----		-----	
032		Acid Copter	2	-----		-----		-----	
000	103	Echo Drops	1 [Pro]	Echo Drops	1 [88]	Echo Drops	1 [55]	Echo Drops	1
001		Echo Bell	2 [Pro]	Echo Bell	2 [88]	Echo Bell	2 [55]	Echo Bell	2
002		Echo Pan	2 [Pro]	Echo Pan	2 [88]	Echo Pan	2 [55]	Echo Pan	2
003		Echo Pan 2	2 [Pro]	Echo Pan 2	2 [88]	Echo Pan 2	2	-----	
004		Big Panner	2 [Pro]	Big Panner	2 [88]	Big Panner	2	-----	
005		Reso Panner	2 [Pro]	Reso Panner	2 [88]	Reso Panner	2	-----	
006		Water Piano	2 [Pro]	Water Piano	2 [88]	Water Piano	2	-----	
007		Echo SynBass	2	-----		-----		-----	
008		Pan Sequence	2 [Pro]	Pan Sequence	2	-----		-----	
009		Aqua	2 [Pro]	Aqua	2	-----		-----	
010		Panning Lead	2	-----		-----		-----	
011		PanningBrass	2	-----		-----		-----	
000	104	Star Theme	2 [Pro]	Star Theme	2 [88]	Star Theme	2 [55]	Star Theme	2
001		Star Theme 2	2 [Pro]	Star Theme 2	2 [88]	StarTheme 2	2	-----	
002		Star Mind	2	-----		-----		-----	
003		Star Dust	2	-----		-----		-----	
004		Rep.Trance	2	-----		-----		-----	
005		Etherality	2	-----		-----		-----	
006		Mystic Pad	2	-----		-----		-----	
008		Dream Pad	2 [Pro]	Dream Pad	2	-----		-----	
009		Silky Pad	2 [Pro]	Silky Pad	2	-----		-----	
010		Dream Pad 2	2	-----		-----		-----	
011		Silky Pad 2	2	-----		-----		-----	
016		New Century	1 [Pro]	New Century	1	-----		-----	
017		7th Atmos.	2 [Pro]	7th Atmos.	2	-----		-----	
018		Galaxy Way	2 [Pro]	Galaxy Way	2	-----		-----	
019		Rising OSC.	2	-----		-----		-----	

Appendices

PC : program number(Instrument number)
 CC00 : value of controller number 0
 (Bank number, Variation number)
 : legato-enabled sounds
 Voices : number of voices used by the Instrument
 Remark [Pro] : same sound as SC-88Pro map
 Remark [88] : same sounds as SC-88 map
 Remark [55] : same sound as SC-55 map
 Remark + : a percussive sound which cannot be played melodically.
 Use near C4 (note number 60).

Ethnic, etc

CC00	PC	SC-8820 Map	Voices	SC-88Pro Map	Voices	SC-88 Map	Voices	SC-55 Map	Voices
000	105	Sitar	1 [Pro]	Sitar	1 [88]	Sitar	1 [55]	Sitar	1
001		Sitar 2	2 [Pro]	Sitar 2	2 [88]	Sitar 2	2 [55]	Sitar 2	2
002		Detune Sitar	2 [Pro]	Detune Sitar	2 [88]	DetuneSitar	2	-----	-----
003		Sitar 3	2 [Pro]	Sitar 3	2	-----	-----	-----	-----
004		Sitar/Drone	1	-----	-----	-----	-----	-----	-----
005		Sitar 4	2	-----	-----	-----	-----	-----	-----
008		Tambra	1 [Pro]	Tambra	1 [88]	Tambra	1	-----	-----
016		Tamboura	2 [Pro]	Tamboura	2 [88]	Tamboura	2	-----	-----
000	106	Banjo	1 [Pro]	Banjo	1 [88]	Banjo	1	Banjo	1
001		Muted Banjo	1 [Pro]	Muted Banjo	1 [88]	Muted Banjo	1	-----	-----
008		Rabab	2 [Pro]	Rabab	2 [88]	Rabab	2	-----	-----
009		San Xian	2 [Pro]	San Xian	2	-----	-----	-----	-----
016		Gopichant	2 [Pro]	Gopichant	2 [88]	Gopichant	2	-----	-----
024		Oud	2 [Pro]	Oud	2 [88]	Oud	2	-----	-----
028		Oud+Strings	2 [Pro]	Oud+Strings	2	-----	-----	-----	-----
032		Pi Pa	1 [Pro]	Pi Pa	1	-----	-----	-----	-----
000	107	Shamisen	1 [Pro]	Shamisen	1 [88]	Shamisen	1 [55]	Shamisen	1
001		Tsugaru	2 [Pro]	Tsugaru	2 [88]	Tsugaru	2	-----	-----
008		Syn Shamisen	2 [Pro]	Syn Shamisen	2	-----	-----	-----	-----
000	108	Koto	2 [Pro]	Koto	2	Koto	1 [55]	Koto	1
001		Gu Zheng	2 [Pro]	Gu Zheng	2	-----	-----	-----	-----
008		Taisho Koto	1 [Pro]	Taisho Koto	1 [88]	Taisho Koto	1	Taisho Koto	2
016		Kanoon	2 [Pro]	Kanoon	2 [88]	Kanoon	2	-----	-----
019		Kanoon+Choir	2 [Pro]	Kanoon+Choir	2	-----	-----	-----	-----
024		Oct Harp	1 [Pro]	Oct Harp	1	-----	-----	-----	-----
000	109	Kalimba	1 [Pro]	Kalimba	1	Kalimba	1	Kalimba	1
008		Sanza	2 [Pro]	Sanza	2	-----	-----	-----	-----
009		Bodhran	1	-----	-----	-----	-----	-----	-----
010		Bodhran Mute	1	-----	-----	-----	-----	-----	-----
000	110	Bagpipe	1 [Pro]	Bagpipe	1 [88]	Bagpipe	1	Bagpipe	1
008		Didgeridoo	1 [Pro]	Didgeridoo	1 +	-----	-----	-----	-----
009		Uilleann Pipe	1	-----	-----	-----	-----	-----	-----
010		UilinPipe Nm	1	-----	-----	-----	-----	-----	-----
011		UilinPipe Or	1	-----	-----	-----	-----	-----	-----
000	111	Fiddle	1 [Pro]	Fiddle	1 [88]	Fiddle	1 [55]	Fiddle	1
008		Er Hu	1 [Pro]	Er Hu	1	-----	-----	-----	-----
009		Gao Hu	1 [Pro]	Gao Hu	1	-----	-----	-----	-----
000	112	Shanai	1 [Pro]	Shanai	1 [88]	Shanai	1 [55]	Shanai	1
001		Shanai 2	1 [Pro]	Shanai 2	1 [88]	Shanai 2	1	-----	-----
008		Pungi	1 [Pro]	Pungi	1 [88]	Pungi	1	-----	-----
016		Hichiriki	2 [Pro]	Hichiriki	2 [88]	Hichiriki	2	-----	-----
024		Mizmar	1 [Pro]	Mizmar	1	-----	-----	-----	-----
032		Suona 1	1 [Pro]	Suona 1	1	-----	-----	-----	-----
033		Suona 2	1 [Pro]	Suona 2	1	-----	-----	-----	-----

Percussive

CC00	PC	SC-8820 Map	Voices	SC-88Pro Map	Voices	SC-88 Map	Voices	SC-55 Map	Voices
000	113	Tinkle Bell	1 [Pro]	Tinkle Bell	1 [88]	Tinkle Bell	1 [55]	Tinkle Bell	1
008		Bonang	1 [Pro]	Bonang	1 [88]	Bonang	1	-----	-----
009		Gender	1 [Pro]	Gender	1 [88]	Gender	1	-----	-----
010		Gamelan Gong	1 [Pro]	Gamelan Gong	1 [88]	GamelanGong	1	-----	-----
011		St.Gamelan	2 [Pro]	St.Gamelan	2 [88]	St.Gamelan	2	-----	-----
012		Jang Gu	2 [Pro]	Jang Gu	2	-----	-----	-----	-----
013		Jegogan	2	-----	-----	-----	-----	-----	-----
014		Jublag	1	-----	-----	-----	-----	-----	-----
015		Pemade	1	-----	-----	-----	-----	-----	-----
016		RAMA Cymbal	1 [Pro]	RAMA Cymbal	1 [88]	RAMA Cymbal	1	-----	-----
017		Kajar	1	-----	-----	-----	-----	-----	-----
018		Kelontuk	1	-----	-----	-----	-----	-----	-----
019		Kelontuk Mt	1	-----	-----	-----	-----	-----	-----
020		Kelontuk Sid	1	-----	-----	-----	-----	-----	-----
021		Kopyak Op	1 +	-----	-----	-----	-----	-----	-----
022		Kopyak Mt	1 +	-----	-----	-----	-----	-----	-----
023		Ceng Ceng	2 +	-----	-----	-----	-----	-----	-----
024		Reyoung	2	-----	-----	-----	-----	-----	-----
025		Kempur	2	-----	-----	-----	-----	-----	-----
032		Jngl Crash	1 +	-----	-----	-----	-----	-----	-----
040		Crash Menu	1	-----	-----	-----	-----	-----	-----
041		RideCym Menu	1	-----	-----	-----	-----	-----	-----
042		RideBellMenu	1	-----	-----	-----	-----	-----	-----

CC00	PC	SC-8820 Map	Voices	SC-88Pro Map	Voices	SC-88 Map	Voices	SC-55 Map	Voices
000	114	Agogo	1 [Pro]	Agogo	1 [88]	Agogo	1	Agogo	1
008		Atarigane	1 [Pro]	Atarigane	1 [88]	Atarigane	1	-----	
016		Tambourine	1 [Pro] +	Tambourine	1 +	-----		-----	
000	115	Steel Drums	1 [Pro]	Steel Drums	1 [88]	Steel Drums	1 [55]	Steel Drums	1
001		Island Mlt	2 [Pro]	Island Mlt	2	-----		-----	
000	116	Woodblock	1 [Pro] +	Woodblock	1 [88] +	Woodblock	1 [55] +	Woodblock	1 +
008		Castanets	1 [Pro] +	Castanets	1 [88] +	Castanets	1 [55] +	Castanets	1 +
016		Angklung	1 [Pro]	Angklung	1	-----		-----	
017		Angkl Rhythm	2 [Pro]	Angkl Rhythm	2	-----		-----	
024		Finger Snaps	1 [Pro] +	Finger Snaps	1 +	-----		-----	
032		909 HandClap	1 [Pro] +	909 HandClap	1 +	-----		-----	
040		HandClapMenu	1	-----		-----		-----	
000	117	Taiko	1 [Pro] +	Taiko	1 [88] +	Taiko	1 [55] +	Taiko	1 +
001		Small Taiko	1 [Pro] +	Small Taiko	1 +	-----		-----	
008		Concert BD	1 [Pro] +	Concert BD	1 [88] +	Concert BD	1 [55] +	Concert BD	1 +
009		ConcertBD Mt	1 +	-----		-----		-----	
016		Jungle BD	1 [Pro] +	Jungle BD	1 +	-----		-----	
017		Techno BD	1 [Pro] +	Techno BD	1 +	-----		-----	
018		Bounce	1 [Pro] +	Bounce	1 +	-----		-----	
024		KendangWadon	1 +	-----		-----		-----	
025		Bebarongan	1 +	-----		-----		-----	
026		Pelegongan	1 +	-----		-----		-----	
027		Dholak 1	1 +	-----		-----		-----	
028		Dholak 2	1 +	-----		-----		-----	
032		Jngl BD Roll	1 +	-----		-----		-----	
040		Kick Menu 1	1	-----		-----		-----	
041		Kick Menu 2	1	-----		-----		-----	
042		Kick Menu 3	1	-----		-----		-----	
043		Kick Menu 4	1	-----		-----		-----	
000	118	Melo. Tom 1	1 [Pro] +	Melo. Tom 1	1 [88] +	Melo. Tom 1	1 [55] +	Melo. Tom 1	1 +
001		Real Tom	2 [Pro] +	Real Tom	2 [88] +	Real Tom	2 +	-----	
002		Real Tom 2	2 +	-----		-----		-----	
003		Jazz Tom	2 +	-----		-----		-----	
004		Brush Tom	2 +	-----		-----		-----	
008		Melo. Tom 2	1 [Pro] +	Melo. Tom 2	1 [88] +	Melo. Tom 2	1 [55] +	Melo. Tom 2	1 +
009		Rock Tom	2 [Pro] +	Rock Tom	2 [88] +	Rock Tom	2 +	-----	
016		Rash SD	1 [Pro] +	Rash SD	1 +	-----		-----	
017		House SD	1 [Pro] +	House SD	1 +	-----		-----	
018		Jungle SD	1 [Pro] +	Jungle SD	1 +	-----		-----	
019		909 SD	1 [Pro] +	909 SD	1 +	-----		-----	
024		Jngl SD Roll	1 +	-----		-----		-----	
040		SD Menu 1	1	-----		-----		-----	
041		SD Menu 2	1	-----		-----		-----	
042		SD Menu 3	1	-----		-----		-----	
043		SD Menu 4	1	-----		-----		-----	
044		SD Menu 5	1	-----		-----		-----	
000	119	Synth Drum	1 [Pro] +	Synth Drum	1 [88] +	Synth Drum	1 [55] +	Synth Drum	1 +
008		808 Tom	2 [Pro] +	808 Tom	2 [88] +	808 Tom	2 +	808 Tom	1 +
009		Elec Perc	1 [Pro] +	Elec Perc	1 [88] +	Elec Perc	1 [55] +	Elec Perc	1 +
010		Sine Perc.	1 [Pro]	Sine Perc.	1	-----		-----	
011		606 Tom	1 [Pro] +	606 Tom	1 +	-----		-----	
012		909 Tom	1 [Pro] +	909 Tom	1 +	-----		-----	
013		606 Dist.Tom	1 +	-----		-----		-----	
000	120	Reverse Cym.	1 [Pro] +	Reverse Cym.	1 [88] +	Reverse Cym	1 [55] +	Reverse Cym	1 +
001		Reverse Cym2	1 [Pro] +	Reverse Cym2	1 [88] +	ReverseCym2	1 +	-----	
002		Reverse Cym3	1 [Pro] +	Reverse Cym3	1 +	-----		-----	
003		Reverse Cym4	2 +	-----		-----		-----	
008		Rev.Snare 1	1 [Pro] +	Rev.Snare 1	1 [88] +	Rev.Snare 1	1 +	-----	
009		Rev.Snare 2	1 [Pro] +	Rev.Snare 2	1 [88] +	Rev.Snare 2	1 +	-----	
016		Rev.Kick 1	1 [Pro] +	Rev.Kick 1	1 [88] +	Rev.Kick 1	1 +	-----	
017		Rev.ConBD	1 [Pro] +	Rev.ConBD	1 [88] +	Rev.ConBD	1 +	-----	
024		Rev.Tom 1	1 [Pro] +	Rev.Tom 1	1 [88] +	Rev.Tom 1	1 +	-----	
025		Rev.Tom 2	1 [Pro] +	Rev.Tom 2	1 [88] +	Rev.Tom 2	1 +	-----	
026		Rev.Tom 3	1 +	-----		-----		-----	
027		Rev.Tom 4	1 +	-----		-----		-----	
040		Rev.SD Menu1	1	-----		-----		-----	
041		Rev.SD Menu2	1	-----		-----		-----	
042		Rev.SD Menu3	1	-----		-----		-----	
043		Rev.BD Menu1	1	-----		-----		-----	
044		Rev.BD Menu2	1	-----		-----		-----	
045		Rev.BD Menu3	1	-----		-----		-----	
046		Rev.ClapMenu	1	-----		-----		-----	

Appendices

PC : program number(Instrument number)
 CC00 : value of controller number 0
 (Bank number, Variation number)
 : legato-enabled sounds
 Voices : number of voices used by the Instrument
 Remark [Pro] : same sound as SC-88Pro map
 Remark [88] : same sounds as SC-88 map
 Remark [55] : same sound as SC-55 map
 Remark + : a percussive sound which cannot be played melodically.
 Use near C4 (note number 60).

SFX

CC00	PC	SC-8820 Map	Voices	SC-88Pro Map	Voices	SC-88 Map	Voices	SC-55 Map	Voices
000	121	Gt.FretNoise	1 [Pro]	Gt.FretNoise	1 [88]	Gt.FretNoiz	1 [55]	Gt.FretNoiz	1
001		Gt.Cut Noise	1 [Pro] +	Gt.Cut Noise	1 [88] +	Gt.CutNoise	1 [55] +	Gt.CutNoise	1 +
002		String Slap	1 [Pro] +	String Slap	1 [88] +	String Slap	1 [55] +	String Slap	1 +
003		Gt.CutNoise2	1 [Pro] +	Gt.CutNoise2	1 [88] +	Gt.CutNz. 2	1 +	-----	-----
004		Dist.CutNoiz	1 [Pro] +	Dist.CutNoiz	1 [88] +	Dist.CutNz.	1 +	-----	-----
005		Bass Slide	1 [Pro] +	Bass Slide	1 [88] +	Bass Slide	1 +	-----	-----
006		Pick Scrape	1 [Pro] +	Pick Scrape	1 [88] +	Pick Scrape	1 +	-----	-----
008		Gt. FX Menu	1 [Pro]	Gt. FX Menu	1	-----	-----	-----	-----
009		Bartok Pizz.	1 [Pro]	Bartok Pizz.	1	-----	-----	-----	-----
010		Guitar Slap	1 [Pro] +	Guitar Slap	1 +	-----	-----	-----	-----
011		Chord Stroke	1 [Pro]	Chord Stroke	1	-----	-----	-----	-----
012		Biwa Stroke	1 [Pro] +	Biwa Stroke	1 +	-----	-----	-----	-----
013		Biwa Tremolo	1 [Pro] +	Biwa Tremolo	1 +	-----	-----	-----	-----
016		A.Bs.Nz Menu	1	-----	-----	-----	-----	-----	-----
017		D.Gt.Nz Menu	1	-----	-----	-----	-----	-----	-----
018		E.Gt.NzMenu1	1	-----	-----	-----	-----	-----	-----
019		E.Gt.NzMenu2	1	-----	-----	-----	-----	-----	-----
020		G.StrokeMenu	1	-----	-----	-----	-----	-----	-----
021		Gt.SlideMenu	1	-----	-----	-----	-----	-----	-----
022		A.Bs.Mute Nz	1 +	-----	-----	-----	-----	-----	-----
023		A.Bs.TouchNz	1 +	-----	-----	-----	-----	-----	-----
024		A.Bs.AtackNz	1 +	-----	-----	-----	-----	-----	-----
025		TC Up Nz	1 +	-----	-----	-----	-----	-----	-----
026		TC DownMt.Nz	1 +	-----	-----	-----	-----	-----	-----
027		TC UpMt.Nz	1 +	-----	-----	-----	-----	-----	-----
028		TC Down Nz	1 +	-----	-----	-----	-----	-----	-----
029		DstGT.Up Nz	1 +	-----	-----	-----	-----	-----	-----
030		DstGT.DwnNz1	1 +	-----	-----	-----	-----	-----	-----
031		DstGT.DwnNz2	1 +	-----	-----	-----	-----	-----	-----
032		DstGT.MuteNz	1 +	-----	-----	-----	-----	-----	-----
034		Gt.StrokeNz5	1 +	-----	-----	-----	-----	-----	-----
035		StiGt.SldNz1	1 +	-----	-----	-----	-----	-----	-----
036		StiGt.SldNz2	1 +	-----	-----	-----	-----	-----	-----
037		StiGt.SldNz3	1 +	-----	-----	-----	-----	-----	-----
038		StiGt.SldNz4	1 +	-----	-----	-----	-----	-----	-----
039		Gt.StrokeNz1	1 +	-----	-----	-----	-----	-----	-----
040		Gt.StrokeNz2	1 +	-----	-----	-----	-----	-----	-----
041		Gt.StrokeNz3	1 +	-----	-----	-----	-----	-----	-----
042		Gt.StrokeNz4	1 +	-----	-----	-----	-----	-----	-----
000	122	Breath Noise	1 [Pro]	Breath Noise	1 [88]	BreathNoise	1 [55]	BreathNoise	1
001		Fl.Key Click	1 [Pro] +	Fl.Key Click	1 [88] +	Fl.KeyClick	1 [55] +	Fl.KeyClick	1 +
002		Brth Nz Menu	1	-----	-----	-----	-----	-----	-----
003		Fl.Breath 1	1 +	-----	-----	-----	-----	-----	-----
004		Fl.Breath 2	1 +	-----	-----	-----	-----	-----	-----
005		Fl.Breath 3	1 +	-----	-----	-----	-----	-----	-----
006		Vox Breath 1	1 +	-----	-----	-----	-----	-----	-----
007		Vox Breath 2	1 +	-----	-----	-----	-----	-----	-----
008		Trombone Nz	1 +	-----	-----	-----	-----	-----	-----
009		Trumpet Nz	1 +	-----	-----	-----	-----	-----	-----
000	123	Seashore	1 [Pro] +	Seashore	1 [88] +	Seashore	1 [55] +	Seashore	1 +
001		Rain	1 [Pro] +	Rain	1 [88] +	Rain	1 [55] +	Rain	1 +
002		Thunder	1 [Pro] +	Thunder	1 [88] +	Thunder	1 [55] +	Thunder	1 +
003		Wind	1 [Pro] +	Wind	1 [88] +	Wind	1 [55] +	Wind	1 +
004		Stream	2 [Pro] +	Stream	2 [88] +	Stream	2 [55] +	Stream	2 +
005		Bubble	2 [Pro] +	Bubble	2 [88] +	Bubble	2 [55] +	Bubble	2 +
006		Wind 2	1 [Pro] +	Wind 2	1 +	-----	-----	-----	-----
007		Cricket	1 +	-----	-----	-----	-----	-----	-----
016		Pink Noise	1 [Pro]	Pink Noise	1	-----	-----	-----	-----
017		White Noise	1 [Pro]	White Noise	1	-----	-----	-----	-----
000	124	Bird	2 [Pro] +	Bird	2 [88] +	Bird	2 [55] +	Bird	2 +
001		Dog	1 [Pro] +	Dog	1 [88] +	Dog	1 [55] +	Dog	1 +
002		Horse-Gallop	1 [Pro] +	Horse-Gallop	1 [88] +	HorseGallop	1 [55] +	HorseGallop	1 +
003		Bird 2	1 [Pro] +	Bird 2	1 [88] +	Bird 2	1 [55] +	Bird 2	1 +
004		Kitty	1 [Pro] +	Kitty	1 [88] +	Kitty	1 +	-----	-----
005		Growl	1 [Pro] +	Growl	1 [88] +	Growl	1 +	-----	-----
006		Growl 2	1 +	-----	-----	-----	-----	-----	-----
007		Fancy Animal	1 +	-----	-----	-----	-----	-----	-----
008		Seal	1 +	-----	-----	-----	-----	-----	-----

CC00	PC	SC-8820 Map	Voices	SC-88Pro Map	Voices	SC-88 Map	Voices	SC-55 Map	Voices
000	125	Telephone 1	1 [Pro] +	Telephone 1	1 [88] +	Telephone 1	1 [55] +	Telephone 1	1 +
001		Telephone 2	1 [Pro] +	Telephone 2	1 [88] +	Telephone 2	1 [55] +	Telephone 2	1 +
002		DoorCreaking	1 [Pro] +	DoorCreaking	1 [88] +	Creaking	1 [55] +	Creaking	1 +
003		Door	1 [Pro] +	Door	1 [88] +	Door	1 [55] +	Door	1 +
004		Scratch	1 [Pro] +	Scratch	1 [88] +	Scratch	1 [55] +	Scratch	1 +
005		Wind Chimes	2 [Pro] +	Wind Chimes	2 [88] +	Wind Chimes	2 [55] +	Wind Chimes	2 +
007		Scratch 2	1 [Pro] +	Scratch 2	1 [88] +	Scratch 2	1 +	-----	
008		ScratchKey	2 [Pro] +	ScratchKey	2 +	-----		-----	
009		TapeRewind	1 [Pro] +	TapeRewind	1 +	-----		-----	
010		Phono Noise	1 [Pro] +	Phono Noise	1 +	-----		-----	
011		MC-500 Beep	1 [Pro]	MC-500 Beep	1	-----		-----	
012		Scratch 3	1 +	-----		-----		-----	
013		Scratch 4	1 +	-----		-----		-----	
014		Scratch 5	1 +	-----		-----		-----	
015		Scratch 6	1 +	-----		-----		-----	
016		Scratch 7	1 +	-----		-----		-----	
000	126	Helicopter	1 [Pro] +	Helicopter	1 [88] +	Helicopter	1 [55] +	Helicopter	1 +
001		Car-Engine	1 [Pro] +	Car-Engine	1 [88] +	Car-Engine	1 [55] +	Car-Engine	1 +
002		Car-Stop	1 [Pro] +	Car-Stop	1 [88] +	Car-Stop	1 [55] +	Car-Stop	1 +
003		Car-Pass	1 [Pro] +	Car-Pass	1 [88] +	Car-Pass	1 [55] +	Car-Pass	1 +
004		Car-Crash	2 [Pro] +	Car-Crash	2 [88] +	Car-Crash	2 [55] +	Car-Crash	2 +
005		Siren	1 [Pro] +	Siren	1 [88] +	Siren	1 [55] +	Siren	1 +
006		Train	1 [Pro] +	Train	1 [88] +	Train	1 [55] +	Train	1 +
007		Jetplane	2 [Pro] +	Jetplane	2 [88] +	Jetplane	2 [55] +	Jetplane	2 +
008		Starship	2 [Pro] +	Starship	2 [88] +	Starship	2 [55] +	Starship	2 +
009		Burst Noise	2 [Pro] +	Burst Noise	2 [88] +	Burst Noise	2 [55] +	Burst Noise	2 +
010		Calculating	2 [Pro] +	Calculating	2 +	-----		-----	
011		Perc. Bang	2 [Pro] +	Perc. Bang	2 +	-----		-----	
012		Burner	2 +	-----		-----		-----	
013		Glass & Glam	1 +	-----		-----		-----	
014		Ice Ring	1 +	-----		-----		-----	
015		Over Blow	2 +	-----		-----		-----	
016		Crack Bottle	1 +	-----		-----		-----	
017		Pour Bottle	1 +	-----		-----		-----	
018		Soda	1 +	-----		-----		-----	
019		Open CD Tray	1 +	-----		-----		-----	
020		Audio Switch	1 +	-----		-----		-----	
021		Key Typing	1	-----		-----		-----	
022		SL 1	1 +	-----		-----		-----	
023		SL 2	1 +	-----		-----		-----	
024		Car Engine 2	1 +	-----		-----		-----	
025		Car Horn	1 +	-----		-----		-----	
026		Boeeseen	1 +	-----		-----		-----	
027		R. Crossing	1 +	-----		-----		-----	
028		Compressor	1 +	-----		-----		-----	
029		Sword Boom!	1 +	-----		-----		-----	
030		Sword Cross	1 +	-----		-----		-----	
031		Stab! 1	1 +	-----		-----		-----	
032		Stab! 2	1 +	-----		-----		-----	
000	127	Applause	2 [Pro] +	Applause	2 [88] +	Applause	2 [55] +	Applause	2 +
001		Laughing	1 [Pro] +	Laughing	1 [88] +	Laughing	1 [55] +	Laughing	1 +
002		Screaming	1 [Pro] +	Screaming	1 [88] +	Screaming	1 [55] +	Screaming	1 +
003		Punch	1 [Pro] +	Punch	1 [88] +	Punch	1 [55] +	Punch	1 +
004		Heart Beat	1 [Pro] +	Heart Beat	1 [88] +	Heart Beat	1 [55] +	Heart Beat	1 +
005		Footsteps	1 [Pro] +	Footsteps	1 [88] +	Footsteps	1 [55] +	Footsteps	1 +
006		Applause 2	2 [Pro] +	Applause 2	2 [88] +	Applause 2	2 +	-----	
007		Small Club	2 [Pro] +	Small Club	2 +	-----		-----	
008		ApplauseWave	2 [Pro] +	ApplauseWave	2 +	-----		-----	
009		BabyLaughing	1 +	-----		-----		-----	
016		Voice One	1 [Pro] +	Voice One	1 +	-----		-----	
017		Voice Two	1 [Pro] +	Voice Two	1 +	-----		-----	
018		Voice Three	1 [Pro] +	Voice Three	1 +	-----		-----	
019		Voice Tah	1 [Pro] +	Voice Tah	1 +	-----		-----	
020		Voice Whey	1 [Pro] +	Voice Whey	1 +	-----		-----	
022		Voice Kikit	1 +	-----		-----		-----	
023		Voice ComeOn	1 +	-----		-----		-----	
024		Voice Aou	1 +	-----		-----		-----	
025		Voice Oou	1 +	-----		-----		-----	
026		Voice Hie	1 +	-----		-----		-----	
000	128	Gun Shot	1 [Pro] +	Gun Shot	1 [88] +	Gun Shot	1 [55] +	Gun Shot	1 +
001		Machine Gun	1 [Pro] +	Machine Gun	1 [88] +	Machine Gun	1 [55] +	Machine Gun	1 +
002		Lasergun	1 [Pro] +	Lasergun	1 [88] +	Lasergun	1 [55] +	Lasergun	1 +
003		Explosion	2 [Pro] +	Explosion	2 [88] +	Explosion	2 [55] +	Explosion	2 +
004		Eruption	1 [Pro] +	Eruption	1 +	-----		-----	
005		Big Shot	2 [Pro] +	Big Shot	2 +	-----		-----	
006		Explosion 2	2 +	-----		-----		-----	

Appendices

PC : program number(Instrument number)
 CC00 : value of controller number 0
 (Bank number, Variation number)
 : legato-enabled sounds
 Voices : number of voices used by the Instrument
 Remark [88] : same sounds as SC-88 map
 Remark [55] : same sound as SC-55 map
 Remark + : a percussive sound which cannot be played melodically.
 Use near C4 (note number 60).

SC-55 Map (CM-64 Sound Map)

CM-64 (PCM)

CM-64 (LA)

PC	CC00	Instrument	Voices	PC	CC00	Instrument	Voices	PC	CC00	Instrument	Voices
001	126	Piano 2	1	001	127	Acou Piano1	1	065	127	Acou Bass 1	1
002	126	Piano 2	1	002	127	Acou Piano2	1	066	127	Acou Bass 2	1
003	126	Piano 2	1	003	127	Acou Piano3	1	067	127	Elec Bass 1	1
004	126	Honky-tonk	2	004	127	Elec Piano1	1	068	127	Elec Bass 2	1
005	126	Piano 1	1	005	127	Elec Piano2	1	069	127	Slap Bass 1	1
006	126	Piano 2	1	006	127	Elec Piano3	1	070	127	Slap Bass 2	1
007	126	Piano 2	1	007	127	Elec Piano4	1	071	127	Fretless 1	1
008	126	E.Piano 1	1	008	127	Honkytonk	2	072	127	Fretless 2	1
009	126	Detuned EP1	2	009	127	Elec Org 1	1	073	127	Flute 1	1
010	126	E.Piano 2	1	010	127	Elec Org 2	2	074	127	Flute 2	1
011	126	Steel Gt.	1	011	127	Elec Org 3	1	075	127	Piccolo 1	1
012	126	Steel Gt.	1	012	127	Elec Org 4	1	076	127	Piccolo 2	2
013	126	12-str.Gt	2	013	127	Pipe Org 1	2	077	127	Recorder	1
014	126	Funk Gt.	1	014	127	Pipe Org 2	2	078	127	Pan Pipes	1
015	126	Muted Gt.	1	015	127	Pipe Org 3	2	079	127	Sax 1	1
016	126	Slap Bass 1	1	016	127	Accordion	2	080	127	Sax 2	1
017	126	Slap Bass 1	1	017	127	Harpsi 1	1	081	127	Sax 3	1
018	126	Slap Bass 1	1	018	127	Harpsi 2	2	082	127	Sax 4	1
019	126	Slap Bass 1	1	019	127	Harpsi 3	1	083	127	Clarinet 1	1
020	126	Slap Bass 2	1	020	127	Clavi 1	1	084	127	Clarinet 2	1
021	126	Slap Bass 2	1	021	127	Clavi 2	1	085	127	Oboe	1
022	126	Slap Bass 2	1	022	127	Clavi 3	1	086	127	Engl Horn	1
023	126	Slap Bass 2	1	023	127	Celesta 1	1	087	127	Bassoon	1
024	126	Fingered Bs	1	024	127	Celesta 2	1	088	127	Harmonica	1
025	126	Fingered Bs	1	025	127	Syn Brass 1	2	089	127	Trumpet 1	1
026	126	Picked Bass	1	026	127	Syn Brass 2	2	090	127	Trumpet 2	1
027	126	Picked Bass	1	027	127	Syn Brass 3	2	091	127	Trombone 1	2
028	126	Fretless Bs	1	028	127	Syn Brass 4	2	092	127	Trombone 2	2
029	126	Acoustic Bs	1	029	127	Syn Bass 1	1	093	127	Fr Horn 1	2
030	126	Choir Aahs	1	030	127	Syn Bass 2	2	094	127	Fr Horn 2	2
031	126	Choir Aahs	1	031	127	Syn Bass 3	2	095	127	Tuba	1
032	126	Choir Aahs	1	032	127	Syn Bass 4	1	096	127	Brs Sect 1	1
033	126	Choir Aahs	1	033	127	Fantasy	2	097	127	Brs Sect 2	2
034	126	SlowStrings	1	034	127	Harmo Pan	2	098	127	Vibe 1	1
035	126	Strings	1	035	127	Chorale	1	099	127	Vibe 2	1
036	126	SynStrings3	2	036	127	Glasses	2	100	127	Syn Mallet	1
037	126	SynStrings3	2	037	127	Soundtrack	2	101	127	Windbell	2
038	126	Organ 1	1	038	127	Atmosphere	2	102	127	Glock	1
039	126	Organ 1	1	039	127	Warm Bell	2	103	127	Tube Bell	1
040	126	Organ 1	1	040	127	Funny Vox	1	104	127	Xylophone	1
041	126	Organ 2	1	041	127	Echo Bell	2	105	127	Marimba	1
042	126	Organ 1	1	042	127	Ice Rain	2	106	127	Koto	1
043	126	Organ 1	1	043	127	Oboe 2001	2	107	127	Sho	2
044	126	Organ 2	1	044	127	Echo Pan	2	108	127	Shakuhachi	2
045	126	Organ 2	1	045	127	Doctor Solo	2	109	127	Whistle 1	2
046	126	Organ 2	1	046	127	School Daze	1	110	127	Whistle 2	1
047	126	Trumpet	1	047	127	Bellsinger	1	111	127	Bottleblow	2
048	126	Trumpet	1	048	127	Square Wave	2	112	127	Breathpipe	1
049	126	Trombone	1	049	127	Str Sect 1	1	113	127	Timpani	1
050	126	Trombone	1	050	127	Str Sect 2	1	114	127	Melodic Tom	1
051	126	Trombone	1	051	127	Str Sect 3	1	115	127	Deep Snare	1 +
052	126	Trombone	1	052	127	Pizzicato	1	116	127	Elec Perc 1	1 +
053	126	Trombone	1	053	127	Violin 1	1	117	127	Elec Perc 2	1 +
054	126	Trombone	1	054	127	Violin 2	1	118	127	Taiko	1 +
055	126	Alto Sax	1	055	127	Cello 1	1	119	127	Taiko Rim	1
056	126	Tenor Sax	1	056	127	Cello 2	1	120	127	Cymbal	1
057	126	BaritoneSax	1	057	127	Contrabass	1	121	127	Castanets	1 +
058	126	Alto Sax	1	058	127	Harp 1	1	122	127	Triangle	1 +
059	126	Brass 1	1	059	127	Harp 2	1	123	127	Orche Hit	1
060	126	Brass 1	1	060	127	Guitar 1	1	124	127	Telephone	1 +
061	126	Brass 2	2	061	127	Guitar 2	1	125	127	Bird Tweet	1 +
062	126	Brass 2	2	062	127	Elec Gtr 1	1	126	127	OneNote Jam	1 +
063	126	Brass 1	1	063	127	Elec Gtr 2	1	127	127	Water Bell	2
064	126	Orchest.Hit	2	064	127	Sitar	2	128	127	Jungle Tune	2

Drum Set List

The drum sets of this unit are organized as follows.

The SC-8820 map has 37 types, the SC-88Pro map has 25 types, the SC-88 map has 14 types, the SC-55 map has 10 types.

PC	SC-8820 map	SC-88Pro map	SC-88 map	SC-55 map
001	STANDARD 1	STANDARD 1	STANDARD 1	STANDARD
002	STANDARD 2 [Pro]	STANDARD 2 [88]	STANDARD 2	---
003	STANDARD L/R	STANDARD 3	---	---
009	ROOM	ROOM [88]	ROOM	ROOM
010	HIP HOP	HIP HOP	---	---
011	JUNGLE	JUNGLE	---	---
012	TECHNO	TECHNO	---	---
013	ROOM L/R	---	---	---
014	HOUSE	---	---	---
017	POWER [Pro]	POWER	POWER	POWER
025	ELECTRONIC [Pro]	ELECTRONIC [88]	ELECTRONIC	ELECTRONIC
026	TR-808 [Pro]	TR-808	TR-808/909	TR-808
027	DANCE	DANCE	DANCE	---
028	CR-78 [Pro]	CR-78	---	---
029	TR-606 [Pro]	TR-606	---	---
030	TR-707 [Pro]	TR-707	---	---
031	TR-909 [Pro]	TR-909	---	---
033	JAZZ	JAZZ	JAZZ	JAZZ
034	JAZZ L/R	---	---	---
041	BRUSH [Pro]	BRUSH	BRUSH	BRUSH
042	BRUSH 2	---	---	---
043	BRUSH 2 L/R	---	---	---
049	ORCHESTRA [Pro]	ORCHESTRA [88]	ORCHESTRA	ORCHESTRA
050	ETHNIC [Pro]	ETHNIC [88]	ETHNIC	---
051	KICK & SNARE [Pro]	KICK & SNARE [88]	KICK & SNARE	---
052	KICK & SNARE 2	---	---	---
053	ASIA	ASIA	---	---
054	CYMBAL&CLAPS [Pro]	CYMBAL&CLAPS	---	---
055	GAMELAN 1	---	---	---
056	GAMELAN 2	---	---	---
057	SFX [Pro]	SFX	SFX	SFX
058	RHYTHM FX [Pro]	RHYTHM FX [88]	RHYTHM FX	---
059	RHYTHM FX 2 [Pro]	RHYTHM FX 2	---	---
060	RHYTHM FX 3	---	---	---
061	SFX 2	---	---	---
062	VOICE	---	---	---
063	CYM&CLAPS 2	---	---	---
128	---	---	---	CM-64/32L

PC : Program Number (Drum Set Number)

[88] : Same as the SC-88 map drum sets

[Pro] : Same as the SC-88Pro map drum sets

* Sounds in such as the drum set of STANDARD L/R and STANDARD 3 etc. that have "RND" appended to their name (such as Kick, Snare, and Hi-Hat) in the list on the next page are sounds which will change randomly with each note played (these changes affect the timbre and timing). The purpose of this is to create a more natural sounding performance—even if all note messages for percussive instruments are sent with absolute precision, subtle fluctuations will be applied so the performance sounds less mechanical. Note, however, that you may not always be able to obtain the desired effect, depending on the circumstances.

Appendices

[Pro] : Same as the percussion sound of SC-8820
 [88] : Same as the percussion sound of SC-88
 [55] : Same as the percussion sound of SC-55
 [EXC] : Percussion sound of the same number will not be heard at the same time.

PC : Program Number (Drum Set Number)
 <- : Same as the percussion sound of "STANDARD1"(PC1).
 --- : No sound
 * : Tones which are created using two voices

SC-8820 Drum Set (1)

* About Notes 0-21, and 95-127, refer to p.136.

	PC1 STANDARD 1	PC2 STANDARD 2	[Pro]	PC3 STANDARD L/R	PC9 ROOM	PC10 HIP HOP
22	MC-500 Beep 1	<-		<-	<-	<-
	MC-500 Beep 2	<-		<-	<-	<-
C1 23	Concert SD	<-		<-	<-	<-
	Snare Roll	<-		<-	<-	<-
24	Finger Snap 2	Finger Snap		<-	Finger Snap	<-
25	High Q	<-		<-	<-	<-
26	Slap	<-		<-	<-	<-
27	Scratch Push	[EXC7] <-		<-	<-	Scratch Push 2 [EXC7]
28	Scratch Pull	[EXC7] <-		<-	<-	Scratch Pull 2 [EXC7]
29	Sticks	<-		<-	<-	<-
30	Square Click	<-		<-	<-	<-
31	Metronome Click	<-		<-	<-	<-
32	Metronome Bell	<-		<-	<-	<-
33	Standard 1 Kick 2	Standard 2 Kick 2		[RND] Standard Kick 2	Room Kick 2	Hip-Hop Kick 2
34	Standard 1 Kick 1	Standard 2 Kick 1		[RND] Standard Kick 1	Room Kick 1	Hip-Hop Kick 1
C2 35	Side Stick	<-		<-	<-	TR-808 Rim Shot
36	Standard 1 Snare 1	Standard 2 Snare 1		[RND] Standard Snare 1	Room Snare 1	LoFi Snare 1
37	TR-909 Hand Clap	Hand Clap		<-	Hand Clap	TR-707 Claps
38	Standard 1 Snare 2	Standard 2 Snare 2		[RND] Standard Snare 2	Room Snare 2	LoFi Snare 2
39	Low Tom 2	<-		[RND] Low Tom 2	Room Low Tom 2	Jazz Low Tom 2
40	Closed Hi-Hat 1	[EXC1] Closed Hi-Hat	[EXC1]	[RND] Closed Hi-Hat [EXC1]	Room Closed Hi-Hat 3 [EXC1]	Room Closed Hi-Hat [EXC1]
41	Low Tom 1	<-		<-	Room Low Tom 1	Jazz Low Tom 1
42	Pedal Hi-Hat	[EXC1] Pedal Hi-Hat	[EXC1]	<-	[EXC1] Pedal Hi-Hat	[EXC1] Pedal Hi-Hat [EXC1]
43	Mid Tom 2	<-		<-	Room Mid Tom 2	Jazz Mid Tom 2
44	Open Hi-Hat 1	[EXC1] Open Hi-Hat	[EXC1]	[RND] Open Hi-Hat [EXC1]	Room Open Hi-Hat 3 [EXC1]	Room Open Hi-Hat [EXC1]
45	Mid Tom 1	<-		<-	Room Mid Tom 1	Jazz Mid Tom 1
C3 46	High Tom 2	<-		<-	Room High Tom 2	Jazz High Tom 2
47	Crash Cymbal 1	<-		[RND] Crash Cymbal	Room Crash Cymbal	TR-909 Crash Cymbal
48	High Tom 1	<-		<-	Room High Tom 1	Jazz High Tom 1
49	Ride Cymbal 1	<-		[RND] Ride Cymbal 1	Room Ride Cymbal	<-
50	Chinese Cymbal	<-		<-	<-	Reverse Cymbal
51	Ride Bell	<-		[RND] Ride Bell 1	Room Ride Bell	Ride Bell
52	Tambourine	<-		<-	<-	Shake Tambourine
53	Splash Cymbal	<-		<-	<-	<-
54	Cowbell	<-		<-	<-	TR-808 Cowbell
55	Crash Cymbal 2	<-		<-	<-	<-
56	Vibra-slap	<-		<-	<-	<-
57	Ride Cymbal 2	<-		<-	<-	<-
C4 58	High Bongo	<-		<-	<-	<-
59	Low Bongo	<-		<-	<-	<-
60	Mute High Conga	<-		<-	<-	<-
61	Open High Conga	<-		<-	<-	<-
62	Low Conga	<-		<-	<-	<-
63	High Timbale	<-		<-	<-	<-
64	Low Timbale	<-		<-	<-	<-
65	High Agogo	<-		<-	<-	<-
66	Low Agogo	<-		<-	<-	<-
67	Cabasa	<-		<-	<-	<-
68	Maracas	<-		<-	<-	TR-808 Maracas
69	Short High Whistle	[EXC2] <-		<-	<-	<-
C5 70	Long Low Whistle	[EXC2] <-		<-	<-	<-
71	Short Guiro	[EXC3] <-		<-	<-	<-
72	Long Guiro	[EXC3] <-		<-	<-	CR-78 Guiro [EXC3]
73	Claves	<-		<-	<-	TR-808 Claves
74	High Wood Block	<-		<-	<-	<-
75	Low Wood Block	<-		<-	<-	<-
76	Mute Cuica	[EXC4] <-		<-	<-	High Hoo [EXC4]
77	Open Cuica	[EXC4] <-		<-	<-	Low Hoo [EXC4]
78	Mute Triangle	[EXC5] <-		<-	<-	Electric Mute Triangle [EXC5]
79	Open Triangle	[EXC5] <-		<-	<-	Electric Open Triangle [EXC5]
80	Shaker	<-		<-	<-	Shaker 2
81	Jingle Bell	<-		<-	<-	<-
82	Bell Tree	Bar Chimes		<-	<-	<-
C6 83	Castanets	<-		<-	<-	<-
84	Mute Surdo	[EXC6] <-		<-	<-	[EXC6]
85	Open Surdo	[EXC6] <-		<-	<-	[EXC6]
86	Applause 2	<-		<-	<-	Small Club 1
87	---	---		---	---	Hip-Hop Snare 2
88	---	---		---	---	LoFi Snare Rim
89	---	---		---	---	Hip-Hop Claps
90	---	---		---	---	Standard 1 Snare 1
91	---	---		---	---	Standard 1 Snare 2
92	---	---		---	---	Room Snare 1
93	---	---		---	---	Room Snare 2
94	Room Snare 1	---		[L] Standard Kick 2	Standard 1 Snare 1	Room Snare 1
C7 95	Room Snare 2	---		[L] Standard Kick 1	Standard 1 Snare 2	Dance Snare

SC-8820 Drum Set (2)

* About Notes 0-21, and 95-127, refer to p.137.

	PC 11 JUNGLE	PC 12 TECHNO	PC 13 ROOM L/R	PC 14 HOUSE	PC 17 POWER	[Pro]
22	<-	<-	<-	<-	<-	
23	<-	<-	<-	<-	<-	
C124	<-	<-	<-	<-	<-	
25	<-	<-	<-	<-	<-	
26	<-	<-	Finger Snap	<-	<-	
27	<-	<-	<-	<-	<-	
28	<-	<-	<-	<-	<-	
29	Scratch Push 2 [EXC7]	Scratch Push 2 [EXC7]	<-	[EXC7] Scratch Push 2	[EXC7] <-	[EXC7]
30	Scratch Pull 2 [EXC7]	Scratch Pull 2 [EXC7]	<-	[EXC7] Scratch Pull 2	[EXC7] <-	[EXC7]
31	<-	<-	<-	<-	<-	
32	<-	<-	<-	<-	<-	
33	<-	<-	<-	<-	<-	
34	<-	<-	<-	<-	<-	
35	Jungle Kick 2	TR-808 Kick	[RND] Room Kick 2	TR-909 Kick 2	Power Kick 2	
C236	Jungle Kick 1	TR-909 Kick 1	[RND] Room Kick 1	TR-909 Kick 1	Power Kick 1	
37	Jungle Snare Rim	TR-909 Snare Rim	<-	House Snare Rim	<-	
38	HipHop Snare 1	TR-606 Snare 2	[RND] Room Snare 1	House Snare 1	Power Snare 1	
39	R&B Claps	TR-909 Claps	Hand Clap	TR-909 Claps	Hand Clap	
40	Jungle Snare	Techno Snare	[RND] Room Snare 2	House Snare 2	Power Snare 2	
41	TR-909 Low Tom 2	TR-606 Low Tom 2	Room Low Tom 2	TR-909 Low Tom 2	Power Low Tom 2	*
42	TR-606 Closed Hi-Hat [EXC1]	TR-707 Closed Hi-Hat [EXC1]	[RND] Room Closed Hi-Hat [EXC1]	Room Closed Hi-Hat [EXC1]	<-	
43	TR-909 Low Tom 1	TR-606 Low Tom 1	Room Low Tom 1	TR-909 Low Tom 1	Power Low Tom 1	*
44	Jungle Hi-Hat [EXC1]	CR-78 Closed Hi-Hat [EXC1]	Pedal Hi-Hat [EXC1]	Pedal Hi-Hat [EXC1]	<-	
45	TR-909 Mid Tom 2	TR-606 Mid Tom 2	Room Mid Tom 2	TR-909 Mid Tom 2	Power Mid Tom 2	*
46	TR-606 Open Hi-Hat [EXC1]	TR-909 Open Hi-Hat [EXC1]	[RND] Room Open Hi-Hat [EXC1]	Room Open Hi-Hat [EXC1]	<-	
47	TR-909 Mid Tom 1	TR-606 Mid Tom 1	Room Mid Tom 1	TR-909 Mid Tom 1	Power Mid Tom 1	*
C348	TR-909 High Tom 2	TR-606 High Tom 2	Room High Tom 2	TR-909 High Tom 2	Power High Tom 2	*
49	Jungle Crash	TR-909 Crash Cymbal	[RND] Room Crash Cymbal	TR-909 Crash Cymbal	<-	
50	TR-909 High Tom 1	TR-606 High Tom 1	Room High Tom 1	TR-909 High Tom 1	Power High Tom 1	*
51	Ride Cymbal 1	Ride Cymbal 1	[RND] Room Ride Cymbal	TR-909 Ride Cymbal	<-	
52	Reverse Cymbal	Reverse Cymbal	<-	Reverse Cymbal	<-	
53	Ride Bell	Ride Bell	[RND] Room Ride Bell	Ride Bell	<-	
54	Shake Tambourine	Shake Tambourine	<-	Shake Tambourine	<-	
55	<-	<-	Splash Cymbal	<-	<-	
56	TR-808 Cowbell	TR-808 Cowbell	<-	TR-808 Cowbell	<-	
57	<-	TR-909 Crash Cymbal	<-	TR-909 Crash Cymbal	<-	
58	<-	<-	<-	<-	<-	
59	<-	<-	<-	<-	<-	
C460	<-	CR-78 High Bongo	<-	CR-78 High Bongo	<-	
61	<-	CR-78 Low Bongo	<-	CR-78 Low Bongo	<-	
62	<-	TR-808 High Conga	<-	TR-808 High Conga	<-	
63	<-	TR-808 Mute Conga	<-	TR-808 Mute Conga	<-	
64	<-	TR-808 Low Conga	<-	TR-808 Low Conga	<-	
65	<-	<-	<-	<-	<-	
66	<-	<-	<-	<-	<-	
67	<-	<-	<-	<-	<-	
68	<-	<-	<-	<-	<-	
69	<-	<-	<-	<-	<-	
70	TR-808 Maracas	TR-808 Maracas	<-	TR-808 Maracas	<-	
71	<-	<-	<-	<-	<-	
C572	<-	<-	<-	<-	<-	
73	<-	<-	<-	<-	<-	
74	CR-78 Guiro [EXC3]	CR-78 Guiro [EXC3]	<-	CR-78 Guiro [EXC3]	<-	
75	TR-808 Claves	TR-808 Claves	<-	TR-808 Claves	<-	
76	<-	<-	<-	<-	<-	
77	<-	<-	<-	<-	<-	
78	High Hoo [EXC4]	High Hoo [EXC4]	<-	High Hoo [EXC4]	<-	
79	Low Hoo [EXC4]	Low Hoo [EXC4]	<-	Low Hoo [EXC4]	<-	
80	Electric Mute Triangle [EXC5]	Electric Mute Triangle [EXC5]	<-	Electric Mute Triangle [EXC5]	<-	
81	Electric Open Triangle [EXC5]	Electric Open Triangle [EXC5]	<-	Electric Open Triangle [EXC5]	<-	
82	Jungle Shaker	TR-626 Shaker	<-	TR-626 Shaker	<-	
83	<-	<-	<-	<-	<-	
C684	<-	<-	<-	<-	<-	
85	<-	<-	<-	<-	<-	
86	<-	<-	<-	<-	<-	
87	<-	<-	<-	<-	<-	
88	Small Club 1	<-	<-	Small Club 1	<-	
89	Jungle Kick Roll	Dance Snare	---	TR-606 Snare 2	---	
90	Jungle Snare Roll	House Snare	---	Dance Snare	---	
91	TR-606 Snare 2	Rock Snare Dry	---	Techno Snare	---	
92	Dance Snare	Jungle Snare	---	Rock Snare Dry	---	
93	Techno Snare	LoFi Snare 1	---	Hip-Hop Snare 1	---	
94	House Snare	LoFi Snare 2	---	LoFi Snare 1	---	
95	Rock Snare Dry	HipHop Snare 1	[L] Room Kick 2	LoFi Snare 2	---	
C796	LoFi Snare 1	HipHop Snare 2	[L] Room Kick 1	Jungle Snare	---	

Appendices

[Pro] : Same as the percussion sound of SC-8820 PC : Program Number (Drum Set Number)
 [88] : Same as the percussion sound of SC-88 <- : Same as the percussion sound of
 [55] : Same as the percussion sound of SC-55 "STANDARD1"(PC1).
 [EXC] : Percussion sound of the same number --- : No sound
 * : Tones which are created using two voices

SC-8820 Drum Set (3)

* About Notes 0-21, and 95-127, refer to p.137, p.138.

	PC 25 ELECTRONIC	[Pro]	PC 26 TR-808	[Pro]	PC 27 DANCE	PC 28 CR-78	[Pro]	PC 29 TR-606	[Pro]	
22	<-		<-		<-			<-		
23	<-		<-		<-			<-		
C1 24	<-		<-		<-			<-		
25	<-		<-		<-			<-		
26	Finger Snap 2		<-		Finger Snap 2			<-		
27	<-		<-		<-			<-		
28	<-		<-		<-			<-		
29	Scratch Push 2	[EXC7]	Scratch Push 2	[EXC7]	Scratch Push 2	[EXC7]	Scratch Push 2	[EXC7]	Scratch Push 2	[EXC7]
30	Scratch Pull 2	[EXC7]	Scratch Pull 2	[EXC7]	Scratch Pull 2	[EXC7]	Scratch Pull 2	[EXC7]	Scratch Pull 2	[EXC7]
31	<-		<-		<-			<-		
32	<-		<-		<-			<-		
33	<-		<-		<-			<-		
34	<-		<-		<-			<-		
35	Electric Kick 2		TR-808 Kick 2		Fat Kick		CR-78 Kick 2		CR-78 Kick 2	
C2 36	Electric Kick 1	*	TR-808 Kick 1		Dance Kick		CR-78 Kick 1		TR-606 Kick 1	
37	<-		TR-808 Rim Shot		Dance Rim Shot		CR-78 Rim Shot		CR-78 Rim Shot	
38	Electric Snare 1		TR-808 Snare 1		Dance Snare		CR-78 Snare 1		TR-606 Snare 1	
39	Hand Clap		Hand Clap		Comp Claps 2		TR-707 Hand Clap		TR-707 Hand Clap	
40	Electric Snare 2		TR-808 Snare 2		Rock SD Dry		CR-78 Snare 2		TR-606 Snare 2	
41	Electric Low Tom 2	*	TR-808 Low Tom 2	*	Electric Low Tom 2	*	CR-78 Low Tom 2	*	TR-606 Low Tom 2	
42	Closed Hi-Hat 2	[EXC1]	TR-808 Closed Hi-Hat 2	[EXC1]	CR-78 Closed Hi-Hat	[EXC1]	CR-78 Closed Hi-Hat	[EXC1]	TR-606 Closed Hi-Hat	[EXC1]
43	Electric Low Tom 1	*	TR-808 Low Tom 1	*	Electric Low Tom 1	*	CR-78 Low Tom 1	*	TR-606 Low Tom 1	
44	Pedal Hi-Hat	[EXC1]	TR-808 Closed Hi-Hat	[EXC1]	TR-808 Closed Hi-Hat 2	[EXC1]	TR-606 Closed Hi-Hat	[EXC1]	TR-606 Closed Hi-Hat	[EXC1]
45	Electric Mid Tom 2	*	TR-808 Mid Tom 2	*	Electric Mid Tom 2	*	CR-78 Mid Tom 2	*	TR-606 Mid Tom 2	
46	Open Hi-Hat 2	[EXC1]	TR-808 Open Hi-Hat	[EXC1]	CR-78 Open Hi-Hat	[EXC1]	CR-78 Open Hi-Hat	[EXC1]	TR-606 Open Hi-Hat	[EXC1]
47	Electric Mid Tom 1	*	TR-808 Mid Tom 1	*	Electric Mid Tom 1	*	CR-78 Mid Tom 1	*	TR-606 Mid Tom 1	
C3 48	Electric High Tom 2	*	TR-808 High Tom 2	*	Electric High Tom 2	*	CR-78 High Tom 2	*	TR-606 High Tom 2	
49	<-		TR-808 Crash Cymbal		TR-808 Crash Cymbal		TR-808 Crash Cymbal		TR-808 Crash Cymbal	
50	Electric High Tom 1	*	TR-808 High Tom 1	*	Electric High Tom 1	*	CR-78 High Tom 1	*	TR-606 High Tom 1	
51	<-		TR-606 Ride Cymbal		TR-606 Ride Cymbal		TR-606 Ride Cymbal		TR-606 Ride Cymbal	
52	Reverse Cymbal		<-		Reverse Cymbal		<-		<-	
53	<-		<-		Ride Bell		<-		<-	
54	<-		CR-78 Tambourine		Shake Tambourine		CR-78 Tambourine		CR-78 Tambourine	
55	<-		<-		<-		<-		<-	
56	<-		TR-808 Cowbell		TR-808 Cowbell		CR-78 Cowbell		CR-78 Cowbell	
57	<-		TR-909 Crash Cymbal		<-		TR-909 Crash Cymbal		TR-909 Crash Cymbal	
58	<-		<-		<-		<-		<-	
59	<-		Ride Cymbal 2		<-		Ride Cymbal Edge		Ride Cymbal Edge	
C4 60	<-		CR-78 High Bongo		<-		CR-78 High Bongo		CR-78 High Bongo	
61	<-		CR-78 Low Bongo		<-		CR-78 Low Bongo		CR-78 Low Bongo	
62	<-		TR-808 High Conga		<-		TR-808 High Conga		TR-808 High Conga	
63	<-		TR-808 Mute Conga		<-		TR-808 Mute Conga		TR-808 Mute Conga	
64	<-		TR-808 Low Conga		<-		TR-808 Low Conga		TR-808 Low Conga	
65	<-		<-		<-		<-		<-	
66	<-		<-		<-		<-		<-	
67	<-		<-		<-		<-		<-	
68	<-		<-		<-		<-		<-	
69	<-		<-		<-		<-		<-	
70	<-		TR-808 Maracas		<-		CR-78 Maracas		CR-78 Maracas	
71	<-		<-		<-		<-		<-	
C5 72	<-		<-		<-		<-		<-	
73	<-		<-		<-		<-		<-	
74	<-		CR-78 Guiro	[EXC3]	<-		CR-78 Guiro	[EXC3]	CR-78 Guiro	[EXC3]
75	<-		TR-808 Claves		<-		CR-78 Claves		CR-78 Claves	
76	<-		<-		<-		<-		<-	
77	<-		<-		<-		<-		<-	
78	<-		High Hoo	[EXC4]	High Hoo	[EXC4]	High Hoo	[EXC4]	High Hoo	[EXC4]
79	<-		Low Hoo	[EXC4]	Low Hoo	[EXC4]	Low Hoo	[EXC4]	Low Hoo	[EXC4]
80	<-		Electric Mute Triangle		Electric Mute Triangle	[EXC5]	CR-78 Metallic Beat 1	[EXC5]	CR-78 Metallic Beat 1	[EXC5]
81	<-		Electric Open Triangle		Electric Open Triangle	[EXC5]	CR-78 Metallic Beat 2	[EXC5]	CR-78 Metallic Beat 2	[EXC5]
82	<-		TR-626 Shaker		TR-626 Shaker		TR-626 Shaker		TR-626 Shaker	
83	<-		<-		<-		<-		<-	
C6 84	<-		<-		<-		<-		<-	
85	<-		<-		<-		<-		<-	
86	<-		<-		<-		<-		<-	
87	<-		<-		<-		<-		<-	
88	Small Club 1	*	Small Club 1	*	Small Club 1	*	Small Club 1	*	Small Club 1	*
89	---		---		TR-606 Snare 2		---		---	
90	---		---		Techno Snare		---		---	
91	---		---		House Snare		---		---	
92	---		---		Jungle Snare		---		---	
93	---		---		LoFi Snare 1		---		---	
94	---		---		LoFi Snare 2		---		---	
95	---		---		HipHop Snare 1		---		---	
C7 96	---		---		Hip-Hop Snare 2		---		---	

SC-8820 Drum Set (4)

* About Notes 0-21, and 95-127, refer to p.138.

	PC 30 TR-707	[Pro]	PC 31 TR-909	[Pro]	PC 33 JAZZ	PC 34 JAZZ L/R	PC 41 BRUSH	[Pro]
22	<-		<-		<-	<-	<-	
23	<-		<-		<-	<-	<-	
C24	<-		<-		<-	<-	<-	
25	<-		<-		<-	<-	<-	
26	<-		<-		Finger Snap 2	Finger Snap 2	Finger Snap 2	
27	<-		<-		<-	<-	<-	
28	<-		<-		<-	<-	<-	
29	Scratch Push 2	[EXC7]	Scratch Push 2	[EXC7]	<-	<-	<-	
30	Scratch Pull 2	[EXC7]	Scratch Pull 2	[EXC7]	<-	<-	<-	
31	<-		<-		<-	<-	<-	
32	<-		<-		<-	<-	<-	
33	<-		<-		<-	<-	<-	
34	<-		<-		<-	<-	<-	
35	TR-707 Kick 2		TR-909 Kick 2		Jazz Kick 2	[RND] Jazz Kick 2	Jazz Kick 2	
C36	TR-707 Kick 1		TR-909 Kick 1		Jazz Kick 1	[RND] Jazz Kick 1	Jazz Kick 1	
37	TR-707 Rim Shot		TR-909 Rim		<-	<-	<-	
38	TR-707 Snare 1		TR-909 Snare 1		Jazz Snare 1	[RND] Jazz Snare 1	Brush Tap 1	
39	TR-707 Hand Clap		<-		Hand Clap 2	Hand Clap 2	Brush Slap 1	
40	TR-707 Snare 2		TR-909 Snare2		Jazz Snare 2	[RND] Jazz Snare 2	Brush Swirl 1	
41	TR-707 Low Tom 2	*	TR-909 Low Tom 2		Jazz Low Tom 2	<-	Brush Low Tom 2	*
42	TR-707 Closed Hi-Hat	[EXC1]	TR-707 Closed Hi-Hat	[EXC1]	Closed Hi-Hat 2	[EXC1] [RND] Jazz Closed Hi-Hat	[EXC1] Brush Closed Hi-Hat	[EXC1]
43	TR-707 Low Tom 1	*	TR-909 Low Tom 1		Jazz Low Tom 1	<-	Brush Low Tom 1	*
44	TR-707 Closed Hi-Hat	[EXC1]	TR-707 Closed Hi-Hat	[EXC1]	Pedal Hi-Hat	[EXC1] Pedal Hi-Hat	[EXC1] Pedal Hi-Hat	[EXC1]
45	TR-707 Mid Tom 2	*	TR-909 Mid Tom 2		Jazz Mid Tom 2	<-	Brush Mid Tom 2	*
46	TR-707 Open Hi-Hat	[EXC1]	TR-909 Open Hi-Hat	[EXC1]	Open Hi-Hat 2	[EXC1] [RND] Jazz Open Hi-Hat	[EXC1] Brush Open Hi-Hat	[EXC1]
47	TR-707 Mid Tom 1	*	TR-909 Mid Tom 1		Jazz Mid Tom 1	<-	Brush Mid Tom 1	*
C38	TR-707 High Tom 2	*	TR-909 High Tom 2		Jazz High Tom 2	<-	Brush High Tom 2	*
49	TR-909 Crash Cymbal		TR-909 Crash Cymbal		Jazz Crash Cymbal	[RND] Jazz Crash Cymbal	Brush Crash Cymbal	
50	TR-707 High Tom 1	*	TR-909 High Tom 1		Jazz High Tom 1	<-	Brush High Tom 1	*
51	TR-909 Ride Cymbal	*	TR-909 Ride Cymbal	*	Jazz Ride Cymbal	[RND] JAZZ Ride Cymbal	Ride Cymbal Inner	
52	<-		<-		<-	<-	<-	
53	<-		<-		Jazz Ride Bell	[RND] Jazz Ride Bell	Brush Ride Bell	
54	Tambourine 2		Tambourine 2		<-	<-	<-	
55	<-		<-		<-	<-	<-	
56	TR-808 Cowbell		TR-808 Cowbell		<-	<-	<-	
57	<-		<-		<-	<-	<-	
58	<-		<-		<-	<-	<-	
59	Ride Cymbal Edge		Ride Cymbal Edge		Ride Cymbal Edge	Ride Cymbal Edge	Ride Cymbal Edge	
C40	<-		<-		<-	<-	<-	
61	<-		<-		<-	<-	<-	
62	<-		<-		<-	<-	<-	
63	<-		<-		<-	<-	<-	
64	<-		<-		<-	<-	<-	
65	<-		<-		<-	<-	<-	
66	<-		<-		<-	<-	<-	
67	<-		<-		<-	<-	<-	
68	<-		<-		<-	<-	<-	
69	<-		<-		<-	<-	<-	
70	TR-808 Maracas		TR-808 Maracas		<-	<-	<-	
71	<-		<-		<-	<-	<-	
C52	<-		<-		<-	<-	<-	
72	<-		<-		<-	<-	<-	
73	<-		<-		<-	<-	<-	
74	<-		CR-78 Guiro	[EXC3]	<-	<-	<-	
75	<-		TR-808 Claves		<-	<-	<-	
76	<-		<-		<-	<-	<-	
77	<-		<-		<-	<-	<-	
78	High Hoo	[EXC4]	High Hoo	[EXC4]	<-	<-	<-	
79	Low Hoo	[EXC4]	Low Hoo	[EXC4]	<-	<-	<-	
80	Electric Mute Triangle		Electric Mute Triangle		<-	<-	<-	
81	Electric Open Triangle		Electric Open Triangle		<-	<-	<-	
82	TR-626 Shaker		TR-626 Shaker		<-	<-	<-	
83	<-		<-		<-	<-	<-	
C64	<-		<-		<-	<-	<-	
85	<-		<-		<-	<-	<-	
86	<-		<-		<-	<-	<-	
87	<-		<-		<-	<-	<-	
88	Small Club 1	*	<-		Applause	Applause	Applause	*
89	---		---		---	---	---	
90	---		---		---	---	---	
91	---		---		---	---	---	
92	---		---		---	---	---	
93	---		---		---	---	---	
94	---		---		---	---	---	
95	---		---		---	[L] Jazz Kick 2	---	
C796	---		---		---	[L] Jazz Kick 1	---	

Appendices

[Pro] : Same as the percussion sound of SC-8820 PC : Program Number (Drum Set Number)
 [88] : Same as the percussion sound of SC-88 <- : Same as the percussion sound of
 [55] : Same as the percussion sound of SC-55 "STANDARD1"(PC1)
 [EXC] : Percussion sound of the same number --- : No sound
 * : Tones which are created using two voices

SC-8820 Drum Set (5)

* About Notes 0-21, and 95-127, refer to p.139.

	PC 42 BRUSH 2	PC 43 BRUSH 2 L/R	PC 49 ORCHESTRA	[Pro]	PC 50 ETHNIC	[Pro]	PC 51 KICK & SNARE	[Pro]
22	<-	<-	<-		---		---	
23	<-	<-	<-		---		---	
C1 24	<-	<-	<-		---		---	
25	<-	<-	<-		---		---	
26	Finger Snap 2	Finger Snap 2	Finger Snap		Finger Snap		CR-78 Kick 1	
27	<-	<-	<-		Tambourine		CR-78 Kick 2	
28	<-	<-	Closed Hi-Hat 2	[EXC1]	Castanets		TR-606 Kick	
29	<-	<-	Pedal Hi-Hat	[EXC1]	Crash Cymbal 1		TR-707 Kick	
30	<-	<-	Open Hi-Hat 2	[EXC1]	Snare Roll		TR-808 Kick 1	
31	<-	<-	Ride Cymbal 1		Concert SD		TR-909 Kick 1	
32	<-	<-	<-		Concert Cymbal		TR-909 Kick 2	
33	<-	<-	<-		Concert BD 1		Hip-Hop Kick 2	
34	<-	<-	<-		Jingle Bell		Hip-Hop Kick 1	
35	Brush Kick 2	[RND] Brush Kick 2	Jazz Kick 1		Bell Tree		Jungle Kick 2	
C2 36	Brush Kick 1	[RND] Brush Kick 1	Concert BD 1		Bar Chimes		Jungle Kick 1	
37	<-	<-	<-		Wadaiko	*	Techno Kick 2	
38	Brush Tap 2	[RND] Brush Tap 2	Concert SD		Wadaiko Rim	*	Techno Kick 1	
39	Brush Slap 2	[RND] Brush Slap 2	Castanets		Shime Taiko		Standard 1 Kick 2	
40	Brush Swirl 1	Brush Swirl 1	Concert SD		Atarigane		Standard 1 Kick 1	
41	Brush Low Tom 2	<-	Timpani F		Hyoushigi		[88] Standard 1 Kick 1	
42	Brush Closed Hi-Hat	[EXC1] [RND] Brush Closed Hi-Hat	[EXC1] Timpani F#		Onkawa		[88] Standard 1 Kick 2	
43	Brush Low Tom 1	<-	Timpani G		High Kotsuzumi		[88] Standard 2 Kick 1	
44	Pedal Hi-Hat	[EXC1] Pedal Hi-Hat	[EXC1] Timpani G#		Low Kotsuzumi		[88] Standard 2 Kick 2	
45	Brush Mid Tom 2	Brush Mid Tom 2	Timpani A		Ban Gu		[55] Kick Drum 1	
46	Brush Open Hi-Hat	[EXC1] [RND] Brush Open Hi-Hat	[EXC1] Timpani A#		Big Gong		[55] Kick Drum 2	
47	Brush Mid Tom 1	<-	Timpani B		Small Gong		[88] Soft Kick	
C3 48	Brush High Tom 2	<-	Timpani c		Bend Gong		[88] Jazz Kick 1	
49	Brush Crash Cymbal	[RND] Brush Crash Cymbal	Timpani c#		Thai Gong		[88] Jazz Kick 2	
50	Brush High Tom 1	<-	Timpani d		Rama Cymbal		[55] Concert BD 1	
51	Brush Ride Cymbal	[RND] Brush Ride Cymbal	Timpani d#		Gamelan Gong		[88] Room Kick 1	
52	<-	<-	Timpani e		Udo Short	[EXC1]	[88] Room Kick 2	
53	Brush Ride Bell	[RND] Brush Ride Bell	Timpani f		Udo Long	[EXC1]	[88] Power Kick1	*
54	<-	<-	<-		Udo Slap		[88] Power Kick2	
55	<-	<-	<-		Bendir		[88] Electric Kick 2	
56	<-	<-	<-		Req Dum		[88] Electric Kick 1	
57	<-	<-	Concert Cymbal 2		Req Tik		[55] Electric Kick	
58	<-	<-	<-		Tabla Te		[88] TR-808 Kick	
59	Ride Cymbal Edge	Ride Cymbal Edge	Concert Cymbal 1		Tabla Na		[88] TR-909 Kick	
C4 60	<-	<-	<-		Tabla Tun		[88] Dance Kick	
61	<-	<-	<-		Tabla Ge		[88] Standard 1 Snare 1	
62	<-	<-	<-		Tabla Ge Hi		[88] Standard 1 Snare 2	
63	<-	<-	<-		Talking Drum	*	[88] Standard 2 Snare 1	
64	<-	<-	<-		Bend Talking Drum	*	[88] Standard 2 Snare 2	
65	<-	<-	<-		Caxixi		[55] Tight Snare	
66	<-	<-	<-		Djembe		[55] Concert Snare	
67	<-	<-	<-		Djembe Rim		[88] Jazz Snare 1	
68	<-	<-	<-		Timbales Low		[88] Jazz Snare 2	
69	<-	<-	<-		Timbales Paila		[88] Room Snare 1	
70	<-	<-	<-		Timbales High		[88] Room Snare 2	
71	<-	<-	<-		Cowbell		[88] Power Snare 1	
C5 72	<-	<-	<-		High Bongo		[88] Power Snare 2	
73	<-	<-	<-		Low Bongo		[55] Gated Snare	
74	<-	<-	<-		Mute High Conga		[88] Dance Snare 1	
75	<-	<-	<-		Open High Conga		[88] Dance Snare 2	*
76	<-	<-	<-		Mute Low Conga		[88] Disco Snare	
77	<-	<-	<-		Conga Slap		[88] Electric Snare 2	*
78	<-	<-	<-		Open Low Conga		[88] House Snare	
79	<-	<-	<-		Conga Slide	*	[55] Electric Snare 1	*
80	<-	<-	<-		Mute Pandiero		[88] Electric Snare 3	
81	<-	<-	<-		Open Pandiero		[88] TR-808 Snare 1	
82	<-	<-	<-		Open Surdo	[EXC2]	[88] TR-808 Snare 2	
83	<-	<-	<-		Mute Surdo	[EXC2]	[88] TR-909 Snare 1	
C6 84	<-	<-	<-		Tamborim		[88] TR-909 Snare 2	
85	<-	<-	<-		High Agogo		[88] Brush Tap 1	
86	<-	<-	<-		Low Agogo		[88] Brush Tap 2	
87	<-	<-	<-		Shaker		[88] Brush Slap 1	
88	Applause	Applause	Applause		High Whistle	[EXC3]	[88] Brush Slap 2	
89	---	---	---		Low Whistle	[EXC3]	[88] Brush Slap 3	
90	---	---	---		Mute Cuica	[EXC4]	[88] Brush Swirl 1	
91	---	---	---		Open Cuica	[EXC4]	[88] Brush Swirl 2	
92	---	---	---		Mute Triangle	[EXC5]	[88] Brush Long Swirl	
93	---	---	---		Open Triangle	[EXC5]	Standard 1 Snare 1	
94	---	---	---		Short Guiro	[EXC6]	Standard 1 Snare 2	
95	---	[L] Brush Kick 2	---		Long Guiro	[EXC6]	Standard 1 Snare 3	
C7 96	---	[L] Brush Kick 1	---		Cabasa Up		Rap Snare	
					Cabasa Down		Hip-Hop Snare 2	

SC-8820 Drum Set (6)

* About Notes 0-21, and 95-127, refer to p.139.

	PC 52 KICK & SNARE 2	PC 53 ASIA	PC 54 CYMBAL&CLAPS	[Pro]	PC55 GAMELAN 1	PC56 GAMELAN 2
	22	---	---	---	---	---
	23	---	---	---	---	---
	24	---	---	---	---	---
C1	25	[Pro] CR-78 Kick 1	Gamelan Gong 1	---	---	---
	26	[Pro] CR-78 Kick 2	Gamelan Gong 2	---	---	---
	27	[Pro] TR-606 Kick	Gamelan Gong 3	---	---	---
	28	[Pro] TR-707 Kick	Gamelan Gong 4	---	---	---
	29	[Pro] TR-808 Kick 1	Gamelan Gong 5	---	---	---
	30	[Pro] TR-909 Kick 1	Gamelan Gong 6	---	---	---
	31	[Pro] TR-909 Kick 2	Gamelan Gong 7	---	---	---
	32	[Pro] Hip-Hop Kick 2	Gamelan Gong 8	Reverse Open Hi-Hat	---	---
	33	[Pro] Hip-Hop Kick 1	Gamelan Gong 9	Reverse Closed Hi-Hat 1	---	---
	34	[Pro] Jungle Kick 2	Gamelan Gong 10	Reverse Closed Hi-Hat 2	---	---
	35	[Pro] Jungle Kick 1	Gender 1	Jungle Hi-Hat	[EXC1] ---	---
	36	[Pro] Techno Kick 2	Gender 2	[55] Closed Hi-Hat	[EXC1] Kendang Wadon	Kendang Wadon
C2	37	[Pro] Techno Kick 1	Gender 3	[88] Closed Hi-Hat 2	[EXC1] Kendang Lanang	Kendang Lanang
	38	[Pro] Standard 1 Kick 2	Gender 4	[88] Closed Hi-Hat 3	[EXC1] Bebarongan	Bebarongan
	39	[Pro] Standard 1 Kick 1	Gender 5	Closed Hi-Hat 4	[EXC1] Pelegongan	Pelegongan
	40	Standard 1 Kick 2	Bonang 1	Closed Hi-Hat	[EXC1] Kelontuk	[EXC1] Kelontuk [EXC1]
	41	Standard 1 Kick 1	Bonang 2	TR-707 Closed Hi-Hat	[EXC1] Kelontuk Mute	[EXC1] Kelontuk Mute [EXC1]
	42	Brush Kick 2	Bonang 3	TR-806 Closed Hi-Hat	[EXC1] Kelontuk Side	[EXC1] Kelontuk Side [EXC1]
	43	Brush Kick 1	Bonang 4	[88] TR-808 Closed Hi-Hat	[EXC1] Gamelan Gong Wadon	Gamelan Gong Wadon
	44	Jazz Kick 2	Bonang 5	TR-808 Closed Hi-Hat	[EXC1] Gamelan Gong Lanang	Gamelan Gong Lanang
	45	Jazz Kick 1	Rama Cymbal Low	CR-78 Closed Hi-Hat	[EXC1] Ceng-Ceng	Ceng-Ceng
	46	Hip-Hop Kick 2	Rama Cymbal High	[55] Pedal Hi-Hat	[EXC1] Kopyak Open	[EXC2] Kopyak Open [EXC2]
	47	Hip-Hop Kick 1	Sagat Open	[EXC7] [88] Pedal Hi-Hat	[EXC1] Kopyak Mute	[EXC2] Kopyak Mute [EXC2]
	48	Concert BD 1 Mute	[EXC1] Sagat Closed	[EXC7] Pedal Hi-Hat	[EXC1] Kajar	Kajar
C3	49	[55] Concert BD 1	[EXC1] Jaws Harp	Half-Open Hi-Hat 1	[EXC1] Kempur	Kempur
	50	Room Kick 2	Wadaiko	Half-Open Hi-Hat 2	[EXC1] Jegogan	Jegogan
	51	Room Kick 1	Wadaiko Rim	[55] Open Hi-Hat	[EXC1] Jegogan	Jegogan
	52	Jungle Kick 2	Small Taiko	[88] Open Hi-Hat 2	[EXC1] Jegogan	Jegogan
	53	Jungle Kick 1	Shimetaiko	[88] Open Hi-Hat 3	[EXC1] Jegogan	Jegogan
	54	Jungle Kick Roll	Atarigane	Open Hi-Hat 2	[EXC1] Jegogan	Jegogan
	55	Fat Kick	Hycushigi	TR-909 Open Hi-Hat	[EXC1] Jublag	Jublag
	56	Dance Kick	Ohkawa	TR-707 Open Hi-Hat	[EXC1] Jublag	Jublag
	57	TR-808 Kick	High Kotsuzumi	TR-606 Open Hi-Hat	[EXC1] Jublag	Jublag
	58	TR-909 Kick 2	Low Kotsuzumi	[88] TR-808 Open Hi-Hat	[EXC1] Jublag	Jublag
	59	TR-909 Kick 1	Yyoo Dude	TR-808 Open Hi-Hat	[EXC1] Jublag	Jublag
	60	Standard 1 Snare 1	Buk	CR-78 Open Hi-Hat	[EXC1] Penyacah	Penyacah
C4	61	Standard 1 Snare 2	Buk Rim	Crash Cymbal 1	[EXC3] Penyacah	Penyacah
	62	[88] Standard 2 Snare 1	Gengari p	[EXC1] Crash Cymbal 2	[EXC4] Penyacah	Penyacah
	63	[88] Standard 2 Snare 2	Gengari Mute Low	[EXC1] Crash Cymbal 3	Penyacah	Penyacah
	64	[55] Tight Snare	Gengari f	[EXC2] Brush Crash Cymbal	Penyacah	Penyacah
	65	[55] Concert Snare	Gengari Mute High	[EXC2] Hard Crash Cymbal	Penyacah	Penyacah
	66	Jazz Snare 1	Gengari Saml	TR-909 Crash Cymbal	Penyacah	Penyacah
	67	Jazz Snare 2	Jang-Gu Che	TR-808 Crash Cymbal	Pemade	Pemade
	68	Room Snare 1	Jang-Gu Kun	Mute Crash Cymbal 1	[EXC3] Pemade	Pemade
	69	Room Snare 2	Jang-Gu Rim	Mute Crash Cymbal 2	[EXC4] Pemade	Pemade
	70	LoFi Snare 1	Jing p	Reverse Crash Cymbal 1	[EXC3] Pemade	Pemade
	71	LoFi Snare 2	Jing f	[EXC3] Reverse Crash Cymbal 2	Pemade	Pemade
	72	[55] Gated Snare	Jing Mute	[EXC3] Reverse Crash Cymbal 3	Pemade	Pemade
C5	73	LoFi Snare Rim	Asian Gong	Reverse TR-909 Crash Cymbal	Pemade	Pemade
	74	[88] Dance Snare 2	Big Gong	[55] Splash Cymbal	Pemade	Pemade
	75	HipHop Snare 1	Small Gong	Splash Cymbal	Pemade	Pemade
	76	HipHop Snare 2	Pai Ban	[88] Ride Bell	Pemade	Pemade
	77	Dance Snare	Ban Gu	[88] Brush Ride Bell	Reyong	Reyong
	78	TR-606 Snare 2	Tang Gu	[EXC4] [88] Ride Cymbal 1	Reyong	Reyong
	79	Techno Snare	Tang Gu Mute	[EXC4] [88] Ride Cymbal 2	Reyong	Reyong
	80	House Snare	Shou Luo	[88] Brush Ride Cymbal	Reyong	Reyong
	81	Rock Snare Dry	Bend Gong	Ride Cymbal Low Inner	Reyong	Reyong
	82	Jungle Snare	Hu Yin Luo Low	Ride Cymbal Mid Inner	Reyong	Reyong
	83	Jungle Snare Roll	Hu Yin Luo Mid	[EXC5] Ride Cymbal High Inner	Reyong	Reyong
	84	[88] Brush Tap 1	Hu Yin Luo Mid 2	[EXC5] Ride Cymbal Low Edge	Reyong	Reyong
C6	85	[88] Brush Tap 2	Hu Yin Luo High	[EXC6] Ride Cymbal Mid Edge	Reyong	Reyong
	86	Brush Tap 2	Hu Yin Luo High 2	[EXC6] Ride Cymbal High Edge	Reyong	Reyong
	87	Brush Slap 2	Nao Bo	TR-606 Ride Cymbal	Reyong	Reyong
	88	[88] Brush Slap 3	Xiao Bo	TR-808 Ride Cymbal	Reyong	Reyong
	89	[88] Brush Swirl 1	Dholak 1	Chinese Cymbal	---	---
	90	[88] Brush Swirl 2	Dholak 2	Chinese Cymbal 2	---	---
	91	[88] Brush Long Swirl	---	[55] Hand Clap	---	---
	92	[Pro] Standard 1 Snare 1	---	[88] Hand Clap 2	---	---
	93	[Pro] Standard 1 Snare 2	---	[88] Hand Clap	---	---
	94	[Pro] Standard 1 Snare 3	---	Hand Clap	---	---
	95	[Pro] Rap Snare	---	Hand Clap 2	---	---
C7	96	[Pro] Hip-Hop Snare 2	---	TR-707 Hand Clap	---	---

Appendices

[Pro] : Same as the percussion sound of SC-8820 PC : Program Number (Drum Set Number)
 [88] : Same as the percussion sound of SC-88 <- : Same as the percussion sound of
 [55] : Same as the percussion sound of SC-55 "STANDARD1"(PC1).
 [EXC] : Percussion sound of the same number --- : No sound
 will not be heard at the same time. * : Tones which are created using two voices

SC-8820 Drum Set (7)

* About Notes 0-21, and 95-127, refer to p.139, p.140.

	PC 57 SFX	[Pro]	PC 58 RHYTHM FX	[Pro]	PC 59 RHYTHM FX 2	[Pro]	PC 60 RHYTHM FX 3
	22		MC-500 Beep 2	---	---	---	Reverse Clean Guitar Mute Up
	23		Guitar Slide	---	---	---	Reverse Clean Guitar Mute Down
	24		Guitar Wah	---	---	---	Reverse Distortion Guitar Cut Noise Up
	25		Guitar Slap	---	---	---	Reverse Distortion Guitar Cut Noise Down
	26		Chord Stroke Down	---	---	---	Reverse Distortion Guitar Stroke Noise
	27		Chord Stroke Up	---	---	---	Reverse Distortion Guitar Mute Noise
	28		Biwa FX	---	---	---	Reverse Steel Guitar Slide Noise 1
	29		Phonograph Noise	---	---	---	Reverse Steel Guitar Slide Noise 2
	30		Tape Rewind	---	---	---	Reverse Steel Guitar Slide Noise 3
	31		Scratch Push 2	[EXC1]	---	---	Reverse Steel Guitar Slide Noise 4
	32		Scratch Pull 2	[EXC1]	---	---	Reverse Steel Guitar Stroke Noise
	33		Cutting Noise 2 Up	---	---	---	Reverse Steel Guitar Stroke Noise Up 1
	34		Cutting Noise 2 Down	---	---	---	Reverse Steel Guitar Stroke Noise Down 1
	35		Distortion Guitar Cutting Noise Up	---	---	---	Reverse Steel Guitar Stroke Noise Up 2
	36		Distortion Guitar Cutting Noise Down	---	---	---	Reverse Steel Guitar Stroke Noise Down 2
	37		Bass Slide	Reverse Kick 1	Reverse TR-707 Kick 1	Reverse TR-909 Kick 1	Reverse Trombone Noise
	38		Pick Scrape	Reverse Concert Bass Drum	Reverse TR-909 Kick 1	Reverse Hip-Hop Kick 1	Reverse Trumpet Noise
	39		High Q	Reverse Power Kick1	Reverse Hip-Hop Kick 1	Reverse Jungle Kick 2	Reverse Standard Kick 2
	40		Slap	Reverse Electric Kick 1	Reverse Techno Kick 2	Reverse Techno Kick 2	Reverse Standard Kick 1
	41		Scratch Push	Reverse Snare 1	Reverse Snare 2	Reverse TR-606 Snare 2	Reverse Room Kick 2
	42		Scratch Pull	[EXC7]	Reverse Standard 1 Snare 1	Reverse CR-78 Snare 1	Reverse Room Kick 1
	43		Sticks	Reverse Tight Snare	Reverse CR-78 Snare 2	Reverse CR-78 Snare 2	Reverse Jazz Kick 2
	44		Square Click	Reverse Dance Snare	Reverse Jungle Snare 2	Reverse Jungle Snare 2	Reverse Jazz Kick 1
	45		Metronome Click	Reverse 808 Snare	Reverse Techno Snare 2	Reverse Techno Snare 2	Reverse Brush Kick 2
	46		Metronome Bell	Reverse Tom 1	Reverse Tom 1	Reverse TR-707 Snare	Reverse Brush Kick 1
	47		Guitar Fret Noise	Reverse Tom 2	Reverse TR-606 Snare 1	Reverse TR-606 Snare 1	Reverse HipHop Kick 2
	48		Guitar Cutting Noise Up	Reverse Sticks	Reverse TR-909 Snare 1	Reverse TR-909 Snare 1	Reverse HipHop Kick 1
	49		Guitar Cutting Noise Down	Reverse Slap	Reverse Hip-Hop Snare 2	Reverse Hip-Hop Snare 2	Reverse Jungle Kick 2
	50		String Slap of Double Bass	Reverse Cymbal 1	Reverse Jungle Snare 1	Reverse Jungle Snare 1	Reverse Jungle Kick 1
	51		Flute Key Click Noise	Reverse Cymbal 2	Reverse House Snare	Reverse TR-808 Kick	Reverse TR-808 Kick
	52		Laughing	Reverse Open Hi-Hat	Reverse Closed Hi-Hat	Reverse Closed Hi-Hat	Reverse TR-909 Kick 2
	53		Screaming	Reverse Ride Cymbal	Reverse TR-606 Closed Hi-Hat	Reverse TR-606 Closed Hi-Hat	Reverse TR-909 Kick 1
	54		Punch	Reverse CR-78 Open Hi-Hat	Reverse TR-707 Closed Hi-Hat	Reverse TR-707 Closed Hi-Hat	Reverse Fat Kick
	55		Heart Beat	Reverse Closed Hi-Hat	Reverse TR-808 Closed Hi-Hat	Reverse TR-808 Closed Hi-Hat	Reverse Dance Kick
	56		Footsteps 1	Reverse Gong	Reverse Jungle Hi-Hat	Reverse Jungle Hi-Hat	Reverse Standard Snare 1
	57		Footsteps 2	Reverse Bell Tree	Reverse Tambourine 2	Reverse Tambourine 2	Reverse Standard Snare 2
	58		Applause	Reverse Guiro	Reverse Shake Tambourine	Reverse Shake Tambourine	Reverse Room Snare 1
	59		Door Creaking	Reverse Bendir	Reverse TR-808 Open Hi-Hat	Reverse TR-808 Open Hi-Hat	Reverse Room Snare 2
	60		Door	Reverse Gun Shot	Reverse TR-707 Open Hi-Hat	Reverse TR-707 Open Hi-Hat	Reverse Jazz Snare 1
	61		Scratch	Reverse Scratch	Reverse Open Hi-Hat	Reverse Open Hi-Hat	Reverse Jazz Snare 2
	62		Wind Chimes	Reverse Laser Gun	Reverse TR-606 Open Hi-Hat	Reverse TR-606 Open Hi-Hat	Reverse Brush Snare 1
	63		Car - Engine	Key Click	Reverse Hu Yin Luo	Reverse Hu Yin Luo	Reverse Brush Snare 2
	64		Car - Stop	Techno Thip	Reverse TR-707 Crash Cymbal	Reverse TR-707 Crash Cymbal	Reverse Lo-Fi Snare 1
	65		Car - Passing	Pop Drop	Voice One	Voice One	Reverse Lo-Fi Snare 2
	66		Car - Crash	Woody Slap	Reverse Voice One	Reverse Voice One	Reverse HipHop Snare 1
	67		Siren	Distortion Kick	Voice Two	Voice Two	Reverse HipHop Snare 2
	68		Train	Syn. Drops	Reverse Voice Two	Reverse Voice Two	Reverse House Snare 1
	69		Jetplane	Reverse Hi Q	Voice Three	Voice Three	Reverse Jungle Snare
	70		Helicopter	Pipe	Reverse Voice Three	Reverse Voice Three	Reverse 606 Snare 2
	71		Starship	Ice Block	Voice Tah	Voice Tah	Reverse Techno Snare
	72		Gun Shot	Digital Tambourine	Reverse Voice Tah	Reverse Voice Tah	Reverse Dance Snare
	73		Machine Gun	Alias	Voice Ou	Voice Ou	Reverse Rock Snare Dry
	74		Laser Gun	Modulated Bell	Voice Au	Voice Au	Reverse Lo-Fi Snare Rim
	75		Explosion	Spark	Voice Whey	Voice Whey	Reverse 909 Snare Rim
	76		Dog	Metallic Percussion	Frog Vpoco	Frog Vpoco	Reverse Jungle Snare Rim
	77		Horse-Gallop	Velocity Noise FX	Reverse Yyoo Dude	Reverse Yyoo Dude	Reverse Dance Snare Rim
	78		Birds	Stereo Noise Clap	Douby	Douby	Reverse House Snare Rim
	79		Rain	Swish	Reverse Douby	Reverse Douby	Reverse Brush Tom 1
	80		Thunder	Slappy	Baert High	Baert High	Reverse Brush Tom 2
	81		Wind	Voice Ou	Baert Low	Baert Low	Reverse Brush Tom 3
	82		Seashore	Voice Au	Bounce	Bounce	Reverse 606 Tom
	83		Stream	Hoo	Reverse bounce	Reverse bounce	Reverse Jungle Crash Cymbal
	84		Bubble	Tape Stop 1	Distortion Knock	Distortion Knock	Reverse Standard Closed Hi-Hat
	85		Kitty	Tape Stop 2	Guitar Slide	Guitar Slide	Reverse Room Closed Hi-Hat
	86		Bird 2	Missile	Sub Marine	Sub Marine	Reverse Jazz Closed Hi-Hat
	87		Growl	Space Birds	Noise Attack	Noise Attack	Reverse Brush Closed Hi-Hat
	88		<-	Flying Monster	Space Worms	Space Worms	Reverse 707 Claps
	89		Telephone 1	---	Emergency !	Emergency !	Reverse 909 Claps
	90		Telephone 2	---	Calculating...	Calculating...	Reverse R&B Claps 1
	91		Small Club 1	---	Saw LFO Saw	Saw LFO Saw	Reverse HipHop Claps
	92		Small Club 2	---	---	---	Reverse Comp Claps 2
	93		Applause Wave	---	---	---	Reverse Shaker 2
	94		Eruption	---	---	---	Reverse Jungle Shaker
	95		Big Shot	---	---	---	Reverse Clap Hit
	96		Percussion Bang	---	---	---	Reverse Boeeeen

SC-8820 Drum Set (8)

	PC 61 SFX 2	PC 62 VOICE	PC 63 CYM&CLAPS 2
	22	---	---
	23	---	---
C1	24	---	---
	25	---	---
	26	---	---
	27	---	---
	28	---	---
	29	---	---
	30	---	---
	31	Acoustic Bass Mute Noise	---
	32	Acoustic Bass Touch Noise	Reverse Standard Closed Hi-Hat
	33	Acoustic Bass Attack Noise	Reverse Room Closed Hi-Hat
	34	Distortion Guitar Mute Noise	Reverse Jazz Closed Hi-Hat
	35	Steel Guitar Slide Noise 1	Reverse Brush Closed Hi-Hat
C2	36	Steel Guitar Slide Noise 2	Standard 1 Closed Hi-Hat
	37	Steel Guitar Slide Noise 3	Room Closed Hi-Hat
	38	Steel Guitar Slide Noise 4	Jazz Closed Hi-Hat
	39	Guitar Stroke Noise 1	Brush Closed Hi-Hat
	40	Guitar Stroke Noise 2	TR-707 Closed Hi-Hat
	41	Guitar Stroke Noise 3	TR-606 Closed Hi-Hat
	42	Guitar Stroke Noise 4	TR-808 Closed Hi-Hat
	43	Guitar Stroke Noise 5	CR-78 Closed Hi-Hat
	44	Open CD Tray	Pedal Hi-Hat
	45	Audio Switch	Pedal Hi-Hat
	46	Keyboard Typing 1	Pedal Hi-Hat
	47	Keyboard Typing 2	Half-Open Hi-Hat 1
C3	48	Keyboard Typing 3	Half-Open Hi-Hat 2
	49	Keyboard Typing 4	Standard 1 Open Hi-Hat
	50	Keyboard Typing 5	Room Open Hi-Hat
	51	Keyboard Typing 6	Jazz Open Hi-Hat
	52	Baby Laughing	Brush Open Hi-Hat
	53	Clap Hit	TR-909 Open Hi-Hat
	54	Stab! 1	TR-707 Open Hi-Hat
	55	Stab! 2	TR-606 Open Hi-Hat
	56	Bounce Hit	TR-808 Open Hi-Hat
	57	Boeeeen	CR-78 Open Hi-Hat
	58	Glass Stir	Standard 1 Crash Cymbal
	59	Ice Ring	Room Crash Cymbal
C4	60	Crack Bottle	Jazz Crash Cymbal
	61	Pour Bottle	Brush Crash Cymbal
	62	Soda	Hard Crash Cymbal
	63	Car Engine 2	TR-909 Crash Cymbal
	64	Car - Horn	Jungle Crash Cymbal
	65	Railroad Crossing	TR-808 Crash Cymbal
	66	SL 1	Standard 1 Mute Crash Cymbal
	67	SL 2	Room Mute Crash Cymbal
	68	Over Blow	Jazz Mute Crash Cymbal
	69	Sword Boom!	Brush Mute Crash Cymbal
	70	Sword Cross	Mute Crash Cymbal 1
	71	Industry Hit	Mute Crash Cymbal 2
C5	72	Drill Hit	Reverse Standard 1 Crash Cymbal
	73	Compressor	Reverse Room Crash Cymbal
	74	Thrill Hit	Reverse Jazz Crash Cymbal
	75	Explosion 2	Reverse Brush Crash Cymbal
	76	Seal	Splash Cymbal
	77	Fancy Animal	Standard Ride Bell
	78	Cricket	Room Ride Bell
	79	Bear	Jazz Ride Bell
	80	Frog Vpoce	Brush Ride Bell
	81	Wind 2	Standard Ride Cymbal
	82	Scratch 3	Room Ride Cymbal
	83	Scratch 4	Jazz Ride Cymbal
C6	84	Scratch 5	Brush Ride Cymbal
	85	Scratch 6	TR-606 Ride Cymbal
	86	Scratch 7	TR-808 Ride Cymbal
	87	Noise Attack	Chinese Cymbal
	88	Bounce	Chinese Cymbal 2
	89	Dist Knock	TR-707 Claps
	90	Bound	Hip-Hop Claps
	91	---	R&B Claps
	92	---	TR-909 Claps
	93	---	Comp Claps 2
	94	---	Hand Clap
	95	---	[Pro] Hand Clap 2
C7	96	---	[Pro] TR-707 Hand Clap

Appendices

[Pro] : Same as the percussion sound of SC-8820
 [88] : Same as the percussion sound of SC-88
 [55] : Same as the percussion sound of SC-55
 [EXC] : Percussion sound of the same number will not be heard at the same time.

PC : Program Number (Drum Set Number)
 <- : Same as the percussion sound of "STANDARD1"(PC1).
 --- : No sound
 * : Tones which are created using two voices

SC-8820 Drum Set (9)

* Notes 0-21 and 95-127 are as follows.

	PC1 STANDARD 1	PC2 STANDARD 2 [Pro]	PC3 STANDARD L/R	PC9 ROOM	PC10 HIP HOP
C-1 0	[88] Standard 1 Kick 1	<-	---	<-	[88] Electric Kick 2
1	[88] Standard 1 Kick 2	<-	---	<-	[88] Electric Kick 1 *
2	[88] Standard 2 Kick 1	<-	---	<-	[Pro] CR-78 Kick 1
3	[88] Standard 2 Kick 2	<-	---	<-	[Pro] CR-78 Kick 2
4	[55] Kick Drum 1	<-	---	<-	[Pro] TR-606 Kick1
5	[55] Kick Drum 2	<-	---	<-	[Pro] TR-707 Kick 1
6	[88] Jazz Kick 1	<-	---	<-	[55] TR-808 Kick
7	[88] Jazz Kick 2	<-	---	<-	[88] TR-808 Kick
8	[88] Room Kick 1	<-	---	<-	[Pro] TR-808 Kick 2
9	[88] Room Kick 2	<-	---	<-	[88] TR-909 Kick
10	[88] Power Kick 1	<-	---	<-	[88] Dance Kick
11	[88] Power Kick 2	<-	---	<-	[Pro] Hip-Hop Kick 2
C0 12	[88] Electric Kick 2	<-	---	<-	[Pro] TR-909 Kick 1 *
13	[88] Electric Kick 1	<-	---	<-	[Pro] Hip-Hop Kick 3
14	[88] TR-808 Kick	<-	---	<-	[Pro] Jungle Kick 1
15	[88] TR-909 Kick	<-	---	<-	[Pro] Techno Kick 1
16	[88] Dance Kick	<-	---	<-	[Pro] Bounce Kick
17	[Pro] Voice One	<-	<-	<-	<-
18	[Pro] Voice Two	<-	<-	<-	<-
19	[Pro] Voice Three	<-	<-	<-	<-
20	Room Kick 2	---	---	Standard 1 Kick 2 *	Jungle Kick 2
21	Room Kick 1	---	---	Standard 1 Kick 1 *	Jungle Kick 1
:	:	:	:	:	:
:	:	:	:	:	:
:	:	:	:	:	:
95	Room Snare 1	---	[L] Standard Kick 2 *	Standard 1 Snare 1 *	Room Snare 2
96	Room Snare 2	---	[L] Standard Kick 1	Standard 1 Snare 2	Dance Snare
97	[88] Standard 1 Snare1	<-	[L] Standard Crash Cymbal *	<-	[Pro] Techno Hit
98	[88] Standard 1 Snare 2	<-	[L] Standard Snare 1 *	<-	[Pro] Philly Hit *
99	[88] Standard 2 Snare 1	<-	[L] Standard Ride Cymbal	<-	[Pro] Impact Hit *
100	[88] Standard 2 Snare 2	<-	[L] Standard Snare 2	<-	[Pro] Lo-Fi Rave *
101	[55] Snare Drum 2	<-	[L] Standard Low Tom	<-	[Pro] Bam Hit
102	[Pro] Standard 1 Snare 1	<-	[L] Standard Closed Hi-Hat [EXC8]	<-	[Pro] Bim Hit
103	[Pro] Standard 1 Snare 2	<-	[L] Standard Mid Tom	<-	[Pro] Tape Rewind
104	[Pro] Standard 1 Snare 3	<-	[L] Standard Ride Bell	<-	[Pro] Phonograph Noise
105	[88] Jazz Snare 1	<-	[L] Standard High Tom	<-	[88] Power Snare 1
106	[88] Jazz Snare 2	<-	[L] Standard Open Hi-Hat [EXC8]	<-	[88] Dance Snare 1
107	[88] Room Snare 1	<-	[R] Standard Kick 2	<-	[88] Dance Snare 2
C8 108	[88] Room Snare 2	<-	[R] Standard Kick 1	<-	[88] Disco Snare
109	[88] Power Snare 1	<-	[R] Standard Crash Cymbal	<-	[88] Electric Snare 2
110	[88] Power Snare 2	<-	[R] Standard Snare 1	<-	[55] Electric Snare
111	[55] Gated Snare	<-	[R] Standard Ride Cymbal	<-	[88] Electric Snare 3 *
112	[88] Dance Snare 1	<-	[R] Standard Snare 2	<-	[Pro] TR-606 Snare 2
113	[88] Dance Snare 2	<-	[R] Standard Low Tom	<-	[Pro] TR-707 Snare 1
114	[88] Disco Snare	<-	[R] Standard Closed Hi-Hat [EXC9]	<-	[88] TR-808 Snare 2
115	[88] Electric Snare 2	<-	[R] Standard Mid Tom	<-	[88] TR-808 Snare 1 *
116	[55] Electric Snare	<-	[R] Standard Ride Bell	<-	[Pro] TR-808 Snare 2
117	[88] Electric Snare 3	<-	[R] Standard High Tom	<-	[88] TR-909 Snare 1
118	[Pro] TR-707 Snare 1	<-	[R] Standard Open Hi-Hat [EXC9]	<-	[88] TR-909 Snare 2 *
119	[88] TR-808 Snare 1	<-	---	<-	[Pro] TR-909 Snare 1
120	[88] TR-808 Snare 2	<-	---	<-	[Pro] TR-909 Snare 2
C9 121	[88] TR-909 Snare 1	<-	---	<-	[Pro] Rap Snare
122	[88] TR-909 Snare 2	<-	---	<-	[Pro] Jungle Snare
123	[Pro] Rap Snare	<-	---	<-	[Pro] House Snare 1
124	[Pro] Jungle Snare 1	<-	---	<-	[88] House Snare *
125	[Pro] House Snare 1	<-	---	<-	[Pro] House Snare 2
126	[88] House Snare	<-	---	<-	[Pro] Voice Tah
127	[Pro] House Snare 2	<-	---	<-	[88] Slappy *

SC-8820 Drum Set (10)

* Notes 0-21 and 95-127 are as follows.

	PC 11 JUNGLE	PC 12 TECHNO	PC 13 ROOM L/R	PC 14 HOUSE	PC 25 ELECTRONIC	[Pro]
					PC 26 TR-808	[Pro]
C-1 0	[88] Electric Kick 2	[88] Electric Kick 2	---	[88] Electric Kick 2	[88] Electric Kick 2	
1	[88] Electric Kick 1	[88] Electric Kick 1	---	[88] Electric Kick 1	[88] Electric Kick 1	*
2	[Pro] CR-78 Kick 1	[Pro] CR-78 Kick 1	---	[Pro] CR-78 Kick 1	CR-78 Kick 1	
3	[Pro] CR-78 Kick 2	[Pro] CR-78 Kick 2	---	[Pro] CR-78 Kick 2	CR-78 Kick 2	
4	[Pro] TR-606 Kick1	[Pro] TR-606 Kick1	---	[Pro] TR-606 Kick1	TR-606 Kick1	
5	[Pro] TR-707 Kick 1	[Pro] TR-707 Kick 1	---	[Pro] TR-707 Kick 1	TR-707 Kick 1	
6	[55] TR-808 Kick	[55] TR-808 Kick	---	[55] TR-808 Kick	[55] TR-808 Kick	
7	[88] TR-808 Kick	[88] TR-808 Kick	---	[88] TR-808 Kick	[88] TR-808 Kick	
8	[Pro] TR-808 Kick 2	[Pro] TR-808 Kick 2	---	[Pro] TR-808 Kick 2	TR-808 Kick 2	
9	[88] TR-909 Kick	[88] TR-909 Kick	---	[88] TR-909 Kick	[88] TR-909 Kick	
10	[88] Dance Kick	[88] Dance Kick	---	[88] Dance Kick	[88] Dance Kick	
11	[Pro] Hip-Hop Kick 2	[Pro] Hip-Hop Kick 2	---	[Pro] Hip-Hop Kick 2	Hip-Hop Kick 2	
C0 12	[Pro] TR-909 Kick 1	[Pro] TR-909 Kick 1	---	[Pro] TR-909 Kick 1	TR-909 Kick 1	*
13	[Pro] Hip-Hop Kick 3	[Pro] Hip-Hop Kick 3	---	[Pro] Hip-Hop Kick 3	Hip-Hop Kick 3	
14	[Pro] Jungle Kick 1	[Pro] Jungle Kick 1	---	[Pro] Jungle Kick 1	Jungle Kick 1	
15	[Pro] Techno Kick 1	[Pro] Techno Kick 1	---	[Pro] Techno Kick 1	Techno Kick 1	
16	[Pro] Bounce Kick	[Pro] Bounce Kick	---	[Pro] Bounce Kick	Bounce Kick	
17	<-	<-	<-	<-	<-	
18	<-	<-	<-	<-	<-	
19	<-	<-	<-	<-	<-	
20	HipHop Kick 2	TR-909 Kick 2	---	Fat Kick	---	
21	HipHop Kick 1	Fat Kick	---	Dance Kick	---	
:	:	:	:	:	:	:
:	:	:	:	:	:	:
95	Rock Snare Dry	HipHop Snare 1	[L] Room Kick 2	LoFi Snare 2	---	
96	LoFi Snare 1	HipHop Snare 2	[L] Room Kick 1	Jungle Snare	---	
97	[Pro] Techno Hit	[Pro] Techno Hit	[L] Room Crash Cymbal	[Pro] Techno Hit	Techno Hit	
98	[Pro] Philly Hit	[Pro] Philly Hit	[L] Room Snare 1	[Pro] Philly Hit	Philly Hit	*
99	[Pro] Impact Hit	[Pro] Impact Hit	[L] Room Ride Cymbal	[Pro] Impact Hit	Impact Hit	*
100	[Pro] Lo-Fi Rave	[Pro] Lo-Fi Rave	[L] Room Snare 2	[Pro] Lo-Fi Rave	Lo-Fi Rave	*
101	[Pro] Bam Hit	[Pro] Bam Hit	[L] Room Low Tom	[Pro] Bam Hit	Bam Hit	
102	[Pro] Bim Hit	[Pro] Bim Hit	[L] Room Closed Hi-Hat [EXC8]	[Pro] Bim Hit	Bim Hit	
103	[Pro] Tape Rewind	[Pro] Tape Rewind	[L] Room Mid Tom	[Pro] Tape Rewind	Tape Rewind	
104	[Pro] Phonograph Noise	[Pro] Phonograph Noise	[L] Room Ride Bell	[Pro] Phonograph Noise	Phonograph Noise	
105	[88] Power Snare 1	[88] Power Snare 1	[L] Room High Tom	[88] Power Snare 1	[88] Power Snare 1	
106	[88] Dance Snare 1	[88] Dance Snare 1	[L] Room Open Hi-Hat [EXC8]	[88] Dance Snare 1	[88] Dance Snare 1	
107	[88] Dance Snare 2	[88] Dance Snare 2	[R] Room Kick 2	[88] Dance Snare 2	[88] Dance Snare 2	
C8 108	[88] Disco Snare	[88] Disco Snare	[R] Room Kick 1	[88] Disco Snare	[88] Disco Snare	
109	[88] Electric Snare 2	[88] Electric Snare 2	[R] Room Crash Cymbal	[88] Electric Snare 2	[88] Electric Snare 2	
110	[55] Electric Snare	[55] Electric Snare	[R] Room Snare 1	[55] Electric Snare	[55] Electric Snare	
111	[88] Electric Snare 3	[88] Electric Snare 3	[R] Room Ride Cymbal	[88] Electric Snare 3	[88] Electric Snare 3	*
112	[Pro] TR-606 Snare 2	[Pro] TR-606 Snare 2	[R] Room Snare 2	[Pro] TR-606 Snare 2	TR-606 Snare 2	
113	[Pro] TR-707 Snare 1	[Pro] TR-707 Snare 1	[R] Room Low Tom	[Pro] TR-707 Snare 1	TR-707 Snare 1	
114	[88] TR-808 Snare 2	[88] TR-808 Snare 2	[R] Room Closed Hi-Hat [EXC9]	[88] TR-808 Snare 2	[88] TR-808 Snare 2	
115	[88] TR-808 Snare 1	[88] TR-808 Snare 1	[R] Room Mid Tom	[88] TR-808 Snare 1	[88] TR-808 Snare 1	*
116	[Pro] TR-808 Snare 2	[Pro] TR-808 Snare 2	[R] Room Ride Bell	[Pro] TR-808 Snare 2	TR-808 Snare 2	
117	[88] TR-909 Snare 1	[88] TR-909 Snare 1	[R] Room High Tom	[88] TR-909 Snare 1	[88] TR-909 Snare 1	
118	[88] TR-909 Snare 2	[88] TR-909 Snare 2	[R] Room Open Hi-Hat [EXC9]	[88] TR-909 Snare 2	[88] TR-909 Snare 2	*
119	[Pro] TR-909 Snare 1	[Pro] TR-909 Snare 1	---	[Pro] TR-909 Snare 1	TR-909 Snare 1	
120	[Pro] TR-909 Snare 2	[Pro] TR-909 Snare 2	---	[Pro] TR-909 Snare 2	TR-909 Snare 2	
C9 121	[Pro] Rap Snare	[Pro] Rap Snare	---	[Pro] Rap Snare	Rap Snare	
122	[Pro] Jungle Snare	[Pro] Jungle Snare	---	[Pro] Jungle Snare	Jungle Snare	
123	[Pro] House Snare 1	[Pro] House Snare 1	---	[Pro] House Snare 1	House Snare 1	
124	[88] House Snare	[88] House Snare	---	[88] House Snare	[88] House Snare	*
125	[Pro] House Snare 2	[Pro] House Snare 2	---	[Pro] House Snare 2	House Snare 2	
126	[Pro] Voice Tah	[Pro] Voice Tah	---	[Pro] Voice Tah	Voice Tah	
127	[88] Slappy	[88] Slappy	---	[88] Slappy	[88] Slappy	*

Appendices

[Pro] : Same as the percussion sound of SC-8820
 [88] : Same as the percussion sound of SC-88
 [55] : Same as the percussion sound of SC-55
 [EXC] : Percussion sound of the same number will not be heard at the same time.
 PC : Program Number (Drum Set Number)
 <- : Same as the percussion sound of "STANDARD1"(PC1).
 --- : No sound
 * : Tones which are created using two voices

SC-8820 Drum Set (11)

* Notes 0-21 and 95-127 are as follows.

	PC 27 DANCE	PC 28 CR-78 PC 29 TR-606 PC 30 TR-707 PC 31 TR-909	[Pro]	PC 33 JAZZ	PC 34 JAZZ L/R	PC 41 BRUSH	[Pro]
C-1 0	[88] Electric Kick 2	[88] Electric Kick 2	<-	<-	<-	<-	
1	[88] Electric Kick 1	[88] Electric Kick 1	<-	<-	<-	<-	
2	[Pro] CR-78 Kick 1	CR-78 Kick 1	<-	<-	<-	<-	
3	[Pro] CR-78 Kick 2	CR-78 Kick 2	<-	<-	<-	<-	
4	[Pro] TR-606 Kick1	TR-606 Kick1	<-	<-	<-	<-	
	TR-707 Kick 1	TR-707 Kick 1	<-	<-	<-	<-	
5	[55] TR-808 Kick	[55] TR-808 Kick	<-	<-	<-	<-	
6	[88] TR-808 Kick	[88] TR-808 Kick	<-	<-	<-	<-	
7	TR-808 Kick 2	TR-808 Kick 2	<-	<-	<-	<-	
8	[88] TR-909 Kick	[88] TR-909 Kick	<-	<-	<-	<-	
9	[88] Dance Kick	[88] Dance Kick	<-	<-	<-	<-	
10	[Pro] Hip-Hop Kick 2	Hip-Hop Kick 2	<-	<-	<-	<-	
11	[Pro] TR-909 Kick 1	TR-909 Kick 1	<-	<-	<-	<-	
C0 12	[Pro] Hip-Hop Kick 3	Hip-Hop Kick 3	<-	<-	<-	<-	
13	[Pro] Jungle Kick 1	Jungle Kick 1	<-	<-	<-	<-	
14	[Pro] Techno Kick 1	Techno Kick 1	<-	<-	<-	<-	
15	[Pro] Bounce Kick	Bounce Kick	<-	<-	<-	<-	
16	<-	<-	<-	<-	<-	<-	
17	<-	<-	<-	<-	<-	<-	
18	<-	<-	<-	<-	<-	<-	
19	TR-909 Kick 2	<-	Brush Kick 2	<-	<-	<-	
20	TR-909 Kick 1	<-	Brush Kick 1	<-	<-	<-	
21	<-	<-	<-	<-	<-	<-	
95	HipHop Snare 1	<-	<-	[L] Jazz Kick 2	<-	<-	
96	Hip-Hop Snare 2	<-	<-	[L] Jazz Kick 1	<-	<-	
97	[Pro] Techno Hit	Techno Hit	<-	[L] Jazz Crash Cymbal	<-	<-	
98	[Pro] Philly Hit	Philly Hit	<-	[L] Jazz Snare 1	<-	<-	
99	[Pro] Impact Hit	Impact Hit	<-	Brush Tap 2	<-	<-	
100	[Pro] Lo-Fi Rave	Lo-Fi Rave	<-	Brush Slap 2	[L] Jazz Ride Cymbal	<-	
101	[Pro] Bam Hit	Bam Hit	[88] Brush Tap 2	[L] Jazz Snare 2	[88] Brush Tap 1	<-	
102	[Pro] Bim Hit	Bim Hit	[88] Brush Tap 1	[L] Jazz Low Tom	[88] Brush Tap 2	<-	
103	[Pro] Tape Rewind	Tape Rewind	[88] Brush Slap 1	[L] Jazz Closed Hi-Hat	[EXC8] [88] Brush Slap 1	<-	
104	[Pro] Phonograph Noise	Phonograph Noise	[88] Brush Slap 2	[L] Jazz Mid Tom	[88] Brush Slap 2	<-	
105	[88] Power Snare 1	[88] Power Snare 1	[88] Brush Slap 3	[L] Jazz Ride Bell	[88] Brush Slap 3	<-	
106	[88] Dance Snare 1	[88] Dance Snare 1	[88] Brush Swirl 1	[L] Jazz High Tom	[88] Brush Swirl 1	<-	
107	[88] Dance Snare 2	[88] Dance Snare 2	[88] Brush Swirl 2	[L] Jazz Open Hi-Hat	[EXC8] [88] Brush Swirl 2	<-	
C8 108	[88] Disco Snare	[88] Disco Snare	[88] Brush Long Swirl	[R] Jazz Kick 2	[88] Brush Long Swirl	<-	
109	[88] Electric Snare 2	[88] Electric Snare 2	[88] Jazz Snare 1	[R] Jazz Kick 1	[88] Jazz Snare 1	<-	
110	[55] Electric Snare	[55] Electric Snare	[88] Jazz Snare 2	[R] Jazz Crash Cymbal	[88] Jazz Snare 2	<-	
111	[88] Electric Snare 3	[88] Electric Snare 3	[88] Standard 1 Snare1	[R] Jazz Ride Cymbal	[88] Standard 1 Snare1	<-	
112	[Pro] TR-606 Snare 2	TR-606 Snare 2	[88] Standard 1 Snare2	[R] Jazz Snare 2	[88] Standard 2 Snare1	<-	
113	[Pro] TR-707 Snare 1	TR-707 Snare 1	[88] Standard 2 Snare1	[R] Jazz Snare 2	[88] Standard 2 Snare1	<-	
114	[88] TR-808 Snare 2	[88] TR-808 Snare 2	[88] Standard 2 Snare2	[R] Jazz Low Tom	[88] Standard 2 Snare2	<-	
115	[88] TR-808 Snare 1	[88] TR-808 Snare 1	[55] Snare Drum 2	[R] Jazz Closed Hi-Hat	[EXC9] [55] Snare Drum 2	<-	
116	[Pro] TR-808 Snare 2	TR-808 Snare 2	[Pro] Standard 1 Snare 1	[R] Jazz Mid Tom	Standard 1 Snare 1	<-	
117	[88] TR-909 Snare 1	[88] TR-909 Snare 1	[Pro] Standard 1 Snare 2	[R] Jazz Ride Bell	Standard 1 Snare 2	<-	
118	[88] TR-909 Snare 2	[88] TR-909 Snare 2	[Pro] Standard 1 Snare 3	[R] Jazz High Tom	Standard 1 Snare 3	<-	
119	[Pro] TR-909 Snare 1	TR-909 Snare 1	[88] Room Snare 1	[R] Jazz Open Hi-Hat	[EXC9] [88] Room Snare 1	<-	
120	[Pro] TR-909 Snare 2	TR-909 Snare 2	[88] Room Snare 2	<-	[88] Room Snare 2	<-	
C9 121	[Pro] Rap Snare	Rap Snare	[88] Power Snare 1	<-	[88] Power Snare 1	<-	
122	[Pro] Jungle Snare	Jungle Snare	[88] Power Snare 2	<-	[88] Power Snare 2	<-	
123	[Pro] House Snare 1	House Snare 1	[88] Power Snare 2	<-	[88] Power Snare 2	<-	
124	[88] House Snare	[88] House Snare	[88] Gated Snare	<-	[88] Gated Snare	<-	
125	[Pro] House Snare 2	House Snare 2	[88] Gated Snare	<-	[88] Gated Snare	<-	
126	[Pro] Voice Tah	Voice Tah	[88] Dance Snare 1	<-	[88] Dance Snare 1	<-	
127	[88] Slappy	[88] Slappy	[88] Dance Snare 2	<-	[88] Dance Snare 2	<-	
			[88] Disco Snare	<-	[88] Disco Snare	<-	
			[88] Electric Snare 2	<-	[88] Electric Snare 2	<-	
			[88] Electric Snare 3	<-	[88] Electric Snare 3	<-	

SC-8820 Drum Set (12)

* Notes 0–21 and 95–127 are as follows.

	PC 42 BRUSH 2	PC 43 BRUSH 2 L/R	PC 49 ORCHESTRA	[Pro]	PC 50 ETHNIC	[Pro]	PC 51 KICK & SNARE	[Pro]	PC 52 KICK & SNARE 2
C-1 0	<	---	<		---		---		---
1	<	---	<		---		---		---
2	<	---	<		---		---		---
3	<	---	<		---		---		---
4	<	---	<		---		---		---
5	<	---	<		---		---		---
6	<	---	<		---		---		---
7	<	---	<		---		---		---
8	<	---	<		---		---		---
9	<	---	<		---		---		---
10	<	---	<		---		---		---
11	<	---	<		---		---		---
C0 12	<	---	<		---		---		---
13	<	---	<		---		---		---
14	<	---	<		---		---		---
15	<	---	<		---		---		---
16	<	---	<		---		---		---
17	<	<	<		---		---		---
18	<	<	<		---		---		---
19	<	<	<		---		---		---
20	Jazz Kick 2	---	---		---		---		---
21	Jazz Kick 1	---	---		---		---		---
:	:	:	:		:		:		:
:	:	:	:		:		:		:
:	:	:	:		:		:		:
95	---	[L] Brush Kick 2	---		Cabasa Up		[Pro] Rap Snare		---
96	---	[L] Brush Kick 1	---		Cabasa Down		[Pro] Hip-Hop Snare 2		---
97	---	[L] Brush Crash Cymbal	Applause 2		Claves		[Pro] Jungle Snare 1		---
98	Jazz Snare 1	[L] Brush Tap 2	Small Club 1		High Wood Block		[Pro] Jungle Snare 2		---
99	Jazz Snare 2	[L] Brush Ride Cymbal	[55] Timpani D#		Low Wood Block		[Pro] Techno Snare 1		---
100	[88] Brush Tap 1	[L] Brush Slap 2	[55] Timpani E		---		[Pro] Techno Snare 2		---
101	[88] Brush Tap 2	[L] Brush Low Tom	[55] Timpani F		---		[Pro] House Snare 2		---
102	[88] Brush Slap 1	[L] Brush Closed Hi-Hat [EXC8]	[55] Timpani F#		---		[Pro] CR-78 Snare 1		---
103	[88] Brush Slap 2	[L] Brush Mid Tom	[55] Timpani G		---		[Pro] CR-78 Snare 2		---
104	[88] Brush Slap 3	[L] Brush Ride Bell	[55] Timpani G#		---		[Pro] TR-606 Snare 1		---
105	[88] Brush Swirl 1	[L] Brush High Tom	[55] Timpani A		---		[Pro] TR-606 Snare 2		---
106	[88] Brush Swirl 2	[L] Brush Open Hi-Hat [EXC8]	[55] Timpani A#		---		[Pro] TR-707 Snare 1		---
107	[88] Brush Long Swirl	[R] Brush Kick 2	[55] Timpani B		---		[Pro] TR-707 Snare 2		---
C8 108	[88] Jazz Snare 1	[R] Brush Kick 1	[55] Timpani c		---		[Pro] Standard 3 Snare 2		---
109	[88] Jazz Snare 2	[R] Brush Crash Cymbal	[55] Timpani c#		---		[Pro] TR-808 Snare 2		---
110	[88] Standard 1 Snare1	[R] Brush Tap 2	[55] Timpani d		---		[Pro] TR-909 Snare 1		---
111	[88] Standard 1 Snare2	[R] Brush Ride Cymbal	[55] Timpani d#		---		[Pro] TR-909 Snare 2		---
112	[88] Standard 2 Snare1	[R] Brush Slap 2	[55] Timpani e		---		---		---
113	[88] Standard 2 Snare2	[R] Brush Low Tom	[55] Timpani f		---		---		---
114	[55] Snare Drum 2	[R] Brush Closed Hi-Hat [EXC9]	---		---		---		---
115	[Pro] Standard 1 Snare 1	[R] Brush Mid Tom	---		---		---		---
116	[Pro] Standard 1 Snare 2	[R] Brush Ride Bell	---		---		---		---
117	[Pro] Standard 1 Snare 3	[R] Brush High Tom	---		---		---		---
118	[88] Room Snare 1	[R] Brush Open Hi-Hat [EXC9]	---		---		---		---
119	[88] Room Snare 2	---	---		---		---		---
C9 120	[88] Power Snare 1	---	---		---		---		---
121	[88] Power Snare 2	---	---		---		---		---
122	[88] Gated Snare	---	---		---		---		---
123	[88] Dance Snare 1	---	---		---		---		---
124	[88] Dance Snare 2	---	---		---		---		---
125	[88] Disco Snare	---	---		---		---		---
126	[88] Electric Snare 2	---	---		---		---		---
127	[88] Electric Snare 3	---	---		---		---		---

Appendices

[Pro] : Same as the percussion sound of SC-8820
 [88] : Same as the percussion sound of SC-88
 [55] : Same as the percussion sound of SC-55
 [EXC] : Percussion sound of the same number will not be heard at the same time.

PC : Program Number (Drum Set Number)
 <- : Same as the percussion sound of "STANDARD!" (PC1).
 --- : No sound
 * : Tones which are created using two voices

SC-8820 Drum Set (13)

* Notes 0-21 and 95-127 are as follows.

	PC 57 SFX	PC 60 [Pro] RHYTHM FX 3
C-1 0	---	---
1	---	---
2	---	---
3	---	---
4	---	---
5	---	---
6	---	---
7	---	---
8	---	---
9	---	---
10	---	---
11	---	---
C0 12	---	---
13	---	---
14	---	---
15	---	---
16	---	---
17	---	Reverse Bass Mute Noise
18	---	Reverse Bass Touch Noise
19	---	Reverse Bass Attack Noise
20	---	Reverse Clean Guitar Cut Noise Up
21	MC-500 Beep 1	Reverse Clean Guitar Cut Noise Down
:	:	:
:	:	:
95	Big Shot *	Reverse Clap Hit
96	Percussion Bang *	Reverse Boeeeen
97	---	Reverse Bounce
98	---	Reverse CD Tray
99	---	Reverse Drill
100	---	Reverse Glass Stir
101	---	Reverse Ice Ring
102	---	Reverse Industry Hit
103	---	Reverse Scratch 4
104	---	Reverse Scratch 5
105	---	Reverse Scratch 6
106	---	Reverse Scratch 7
107	---	Reverse Seal
C8 108	---	Reverse Stab! 1
109	---	Reverse Stab! 2
110	---	Reverse Sword Boom
111	---	Reverse Sword Cross
112	---	Reverse Thrill Hit
113	---	Reverse Audio Switch
114	---	Reverse Keyboard Typing 1
115	---	Reverse Keyboard Typing 2
116	---	Reverse Keyboard Typing 3
117	---	Reverse Keyboard Typing 4
118	---	Reverse Keyboard Typing 5
119	---	Reverse Keyboard Typing 6
C9 120	---	---
121	---	---
122	---	---
123	---	---
124	---	---
125	---	---
126	---	---
127	---	---

SC-88Pro Drum Set (1)

* About Notes 0-19 and 97-127, refer to p.147.

	PC1 STANDARD 1	PC2 STANDARD 2	[88]	PC3 STANDARD 3	PC9 ROOM	[88]	PC10 Hip-Hop
21	MC-500 Beep 1	<-	<-	<-	<-	<-	<-
22	MC-500 Beep 2	<-	<-	<-	<-	<-	<-
23	Concert SD	<-	<-	<-	<-	<-	<-
C24	Snare Roll	<-	<-	<-	<-	<-	<-
25	Finger Snap 2	Finger Snap	<-	<-	Finger Snap	<-	<-
26	High Q	<-	<-	<-	<-	<-	<-
27	Slap	<-	<-	<-	<-	<-	<-
28	Scratch Push	[EXC7] <-	<-	<-	<-	<-	Scratch Push 2 [EXC7]
	Scratch Pull	[EXC7] <-	<-	<-	<-	<-	Scratch Pull 2 [EXC7]
29	Sticks	<-	<-	<-	<-	<-	<-
30	Square Click	<-	<-	<-	<-	<-	<-
31	Metronome Click	<-	<-	<-	<-	<-	<-
32	Metronome Bell	<-	<-	<-	<-	<-	<-
33	Standard 1 Kick 2	Standard 2 Kick 2	<-	Standard 3 Kick 2	Room Kick 2	<-	Hip-Hop Kick 2
34	Standard 1 Kick 1	Standard 2 Kick 1	<-	[RND] Kick	Room Kick 1	<-	Hip-Hop Kick 1
35	Side Stick	<-	<-	<-	<-	<-	TR-808 Rim Shot
C36	Standard 1 Snare 1	Standard 2 Snare 1	<-	[RND] Snare	Room Snare 1	<-	Rap Snare
37	TR-909 Hand Clap	Hand Clap	<-	[RND] Hand Clap	Hand Clap	<-	<-
38	Standard 1 Snare 2	Standard 2 Snare 2	<-	Standard 3 Snare 2	Room Snare 2	<-	Hip-Hop Snare 2
39	Low Tom 2	<-	<-	<-	Room Low Tom 2	*	TR-909 Low Tom 2
40	Closed Hi-Hat	[EXC1] Closed Hi-Hat	[EXC1] <-	[RND] Closed Hi-Hat	[EXC1] Closed Hi-Hat 3	[EXC1] <-	Room Closed Hi-Hat [EXC1]
41	Low Tom 1	<-	<-	<-	Room Low Tom 1	*	TR-909 Low Tom 1
42	Pedal Hi-Hat	[EXC1] Pedal Hi-Hat	[EXC1] <-	[RND] Pedal Hi-Hat	[EXC1] Pedal Hi-Hat	[EXC1] <-	Pedal Hi-Hat [EXC1]
43	Mid Tom 2	<-	<-	<-	Room Mid Tom 2	*	TR-909 Mid Tom 2
44	Open Hi-Hat	[EXC1] Open Hi-Hat	[EXC1] <-	[RND] Open Hi-Hat	[EXC1] Open Hi-Hat 3	[EXC1] <-	Room Open Hi-Hat [EXC1]
45	Mid Tom 1	<-	<-	<-	Room Mid Tom 1	*	TR-909 Mid Tom 1
46	High Tom 2	<-	<-	<-	Room High Tom 2	*	TR-909 High Tom 2
47	Crash Cymbal 1	<-	<-	[RND] Crash Cymbal	<-	<-	TR-909 Crash Cymbal
C38	High Tom 1	<-	<-	<-	Room High Tom 1	*	TR-909 High Tom 1
49	Ride Cymbal 1	<-	<-	[RND] Ride Cymbal 1	*	<-	<-
50	Chinese Cymbal	<-	<-	<-	<-	<-	Reverse Cymbal
51	Ride Bell	<-	<-	[RND] Ride Bell 1	<-	<-	<-
52	Tambourine	<-	<-	<-	<-	<-	Shake Tambourine
53	Splash Cymbal	<-	<-	<-	<-	<-	<-
54	Cowbell	<-	<-	<-	<-	<-	TR-808 Cowbell
55	Crash Cymbal 2	<-	<-	<-	<-	<-	<-
56	Vibra-slap	<-	<-	<-	<-	<-	<-
57	Ride Cymbal 2	<-	<-	[RND] Ride Cymbal 2	*	<-	<-
58	High Bongo	<-	<-	<-	<-	<-	<-
59	Low Bongo	<-	<-	<-	<-	<-	<-
C40	Mute High Conga	<-	<-	<-	<-	<-	<-
61	Open High Conga	<-	<-	<-	<-	<-	<-
62	Low Conga	<-	<-	<-	<-	<-	<-
63	High Timbale	<-	<-	<-	<-	<-	<-
64	Low Timbale	<-	<-	<-	<-	<-	<-
65	High Agogo	<-	<-	<-	<-	<-	<-
66	Low Agogo	<-	<-	<-	<-	<-	<-
67	Cabasa	<-	<-	<-	<-	<-	<-
68	Maracas	<-	<-	<-	<-	<-	TR-808 Maracas
69	Short High Whistle	[EXC2] <-	<-	<-	<-	<-	<-
70	Long Low Whistle	[EXC2] <-	<-	<-	<-	<-	<-
71	Short Guiro	[EXC3] <-	<-	<-	<-	<-	<-
C52	Long Guiro	[EXC3] <-	<-	<-	<-	<-	CR-78 Guiro [EXC3]
72	Claves	<-	<-	<-	<-	<-	TR-808 Claves
73	High Wood Block	<-	<-	<-	<-	<-	<-
74	Low Wood Block	<-	<-	<-	<-	<-	<-
75	Mute Cuica	[EXC4] <-	<-	<-	<-	<-	High Hoo [EXC4]
76	Open Cuica	[EXC4] <-	<-	<-	<-	<-	Low Hoo [EXC4]
77	Mute Triangle	[EXC5] <-	<-	<-	<-	<-	Mute Triangle
78	Open Triangle	[EXC5] <-	<-	<-	<-	<-	Open Triangle
79	Shaker	<-	<-	<-	<-	<-	TR-626 Shaker
80	Jingle Bell	<-	<-	<-	<-	<-	<-
81	Bell Tree	Bar Chimes	<-	<-	<-	<-	<-
82	Castanets	<-	<-	<-	<-	<-	<-
C64	Mute Surdo	[EXC6] <-	<-	<-	<-	<-	<-
84	Open Surdo	[EXC6] <-	<-	<-	<-	<-	<-
85	Applause 2	<-	<-	<-	<-	<-	Small Club 1
86	---	---	---	---	---	---	---
87	---	---	---	---	---	---	---
88	---	---	---	---	---	---	---
89	---	---	---	---	---	---	---
90	---	---	---	---	---	---	---
91	---	---	---	---	---	---	---
92	---	---	---	---	---	---	---
93	---	---	---	---	---	---	---
94	---	---	---	---	---	---	---
95	---	---	---	---	---	---	---
C796	---	---	---	---	---	---	---

Appendices

[Pro] : Same as the percussion sound of SC-8820 PC : Program Number (Drum Set Number)
 [88] : Same as the percussion sound of SC-88 <- : Same as the percussion sound of
 [55] : Same as the percussion sound of SC-55 "STANDARD1"(PC1)
 [EXC] : Percussion sound of the same number --- : No sound
 * : Tones which are created using two voices

SC-88Pro Drum Set (2)

* About Notes 0-19 and 97-127, refer to p.147.

	PC 11 JUNGLE	PC 12 TECHNO	PC 17 POWER	PC 25 ELECTRONIC	[88]	PC 26 TR-808
22	<-	<-	<-	<-	<-	<-
23	<-	<-	<-	<-	<-	<-
C1 24	<-	<-	<-	<-	<-	<-
25	<-	<-	<-	<-	<-	<-
26	<-	<-	<-	Finger Snap 2	<-	<-
27	<-	<-	<-	<-	<-	<-
28	<-	<-	<-	<-	<-	<-
29	Scratch Push 2 [EXC7]	Scratch Push 2 [EXC7]	<-	[EXC7] Scratch Push 2 [EXC7]	Scratch Push 2 [EXC7]	Scratch Push 2 [EXC7]
30	Scratch Pull 2 [EXC7]	Scratch Pull 2 [EXC7]	<-	[EXC7] Scratch Pull 2 [EXC7]	Scratch Pull 2 [EXC7]	Scratch Pull 2 [EXC7]
31	<-	<-	<-	<-	<-	<-
32	<-	<-	<-	<-	<-	<-
33	<-	<-	<-	<-	<-	<-
34	<-	<-	<-	<-	<-	<-
35	<-	<-	<-	<-	<-	<-
C2 36	Jungle Kick 2	Techno Kick 2	Power Kick 2	Electric Kick 2		TR-808 Kick 2
	Jungle Kick 1	Techno Kick 1	Power Kick 1	Electric Kick 1 *		TR-808 Kick 1
37	<-	TR-808 Rim Shot	<-	<-		TR-808 Rim Shot
38	Jungle Snare 1	Techno Snare 1	Power Snare 1	Electric Snare 1		TR-808 Snare 1
39	Hand Clap 2	TR-707 Hand Clap	Hand Clap	Hand Clap		Hand Clap
40	Jungle Snare 2	Techno Snare 2	Power Snare 2	Electric Snare 2		TR-808 Snare 2
41	TR-909 Low Tom 2	TR-808 Low Tom 2 *	Power Low Tom 2 *	Electric Low Tom 2 *		TR-808 Low Tom 2 *
42	TR-606 Closed Hi-Hat [EXC1]	TR-707 Closed Hi-Hat [EXC1]	<-	Closed Hi-Hat 2 [EXC1]		TR-808 Closed Hi-Hat 2 [EXC1]
43	TR-909 Low Tom 1	TR-808 Low Tom 1 *	Power Low Tom 1 *	Electric Low Tom 1 *		TR-808 Low Tom 1 *
44	Jungle Hi-Hat [EXC1]	CR-78 Closed Hi-Hat [EXC1]	<-	Pedal Hi-Hat [EXC1]		TR-808 Closed Hi-Hat [EXC1]
45	TR-909 Mid Tom 2	TR-808 Mid Tom 2 *	Power Mid Tom 2 *	Electric Mid Tom 2 *		TR-808 Mid Tom 2 *
46	TR-606 Open Hi-Hat [EXC1]	TR-909 Open Hi-Hat [EXC1]	<-	Open Hi-Hat 2 [EXC1]		TR-808 Open Hi-Hat [EXC1]
47	TR-909 Mid Tom 1	TR-808 Mid Tom 1 *	Power Mid Tom 1 *	Electric Mid Tom 1 *		TR-808 Mid Tom 1 *
C3 48	TR-909 High Tom 2	TR-808 High Tom 2 *	Power High Tom 2 *	Electric High Tom 2 *		TR-808 High Tom 2 *
49	TR-808 Crash Cymbal	TR-909 Crash Cymbal	<-	<-		TR-808 Crash Cymbal
50	TR-909 High Tom 1	TR-808 High Tom 1 *	Power High Tom 1 *	Electric High Tom 1 *		TR-808 High Tom 1 *
51	<-	<-	<-	<-		TR-606 Ride Cymbal
52	Reverse Cymbal	Reverse Cymbal	<-	Reverse Cymbal		<-
53	<-	<-	<-	<-		<-
54	Shake Tambourine	Shake Tambourine	<-	<-		CR-78 Tambourine
55	<-	<-	<-	<-		<-
56	TR-808 Cowbell	TR-808 Cowbell	<-	<-		TR-808 Cowbell
57	<-	TR-909 Crash Cymbal	<-	<-		TR-909 Crash Cymbal
58	<-	<-	<-	<-		<-
59	<-	<-	<-	<-		Ride Cymbal 2
C4 60	<-	CR-78 High Bongo	<-	<-		CR-78 High Bongo
61	<-	CR-78 Low Bongo	<-	<-		CR-78 Low Bongo
62	<-	TR-808 High Conga	<-	<-		TR-808 High Conga
63	<-	TR-808 Mute Conga	<-	<-		TR-808 Mute Conga
64	<-	TR-808 Low Conga	<-	<-		TR-808 Low Conga
65	<-	<-	<-	<-		<-
66	<-	<-	<-	<-		<-
67	<-	<-	<-	<-		<-
68	<-	<-	<-	<-		<-
69	<-	<-	<-	<-		<-
70	TR-808 Maracas	TR-808 Maracas	<-	<-		TR-808 Maracas
71	<-	<-	<-	<-		<-
C5 72	<-	<-	<-	<-		<-
73	<-	<-	<-	<-		<-
74	CR-78 Guiro [EXC3]	CR-78 Guiro [EXC3]	<-	<-		CR-78 Guiro [EXC3]
75	TR-808 Claves	TR-808 Claves	<-	<-		TR-808 Claves
76	<-	<-	<-	<-		<-
77	<-	<-	<-	<-		<-
78	High Hoo [EXC4]	High Hoo [EXC4]	<-	<-		High Hoo [EXC4]
79	Low Hoo [EXC4]	Low Hoo [EXC4]	<-	<-		Low Hoo [EXC4]
80	Mute Triangle	Mute Triangle	<-	<-		Mute Triangle
81	Open Triangle	Open Triangle	<-	<-		Open Triangle
82	TR-626 Shaker	TR-626 Shaker	<-	<-		TR-626 Shaker
83	<-	<-	<-	<-		<-
C6 84	<-	<-	<-	<-		<-
85	<-	<-	<-	<-		<-
86	<-	<-	<-	<-		<-
87	<-	<-	<-	<-		<-
88	Small Club 1 *	<-	<-	Small Club 1 *		Small Club 1 *
89	---	---	---	---		---
90	---	---	---	---		---
91	---	---	---	---		---
92	---	---	---	---		---
93	---	---	---	---		---
94	---	---	---	---		---
95	---	---	---	---		---
C7 96	---	---	---	---		---

SC-88Pro Drum Set (3)

* About Notes 0-19 and 97-127, refer to p.147.

	PC 27 DANCE	PC 28 CR-78	PC 29 TR-606	PC 30 TR-707
22	<-	<-	<-	<-
23	<-	<-	<-	<-
C1 24	<-	<-	<-	<-
25	<-	<-	<-	<-
26	Finger Snap 2	<-	<-	<-
27	<-	<-	<-	<-
28	<-	<-	<-	<-
29	Scratch Push 2 [EXC7]	Scratch Push 2 [EXC7]	Scratch Push 2 [EXC7]	Scratch Push 2 [EXC7]
30	Scratch Pull 2 [EXC7]	Scratch Pull 2 [EXC7]	Scratch Pull 2 [EXC7]	Scratch Pull 2 [EXC7]
31	<-	<-	<-	<-
32	<-	<-	<-	<-
33	<-	<-	<-	<-
34	<-	<-	<-	<-
35	TR-909 Comp Kick	CR-78 Kick 2	CR-78 Kick 2	TR-707 Kick 2
C2 36	Electric Kick 2	CR-78 Kick 1	TR-606 Kick 1	TR-707 Kick 1
37	<-	CR-78 Rim Shot	CR-78 Rim Shot	TR-707 Rim Shot
38	House Snare	CR-78 Snare 1	TR-606 Snare 1	TR-707 Snare 1
39	<-	TR-707 Hand Clap	TR-707 Hand Clap	TR-707 Hand Clap
40	Dance Snare 2	CR-78 Snare 2	TR-606 Snare 2	TR-707 Snare 2
41	Electric Low Tom 2 *	CR-78 Low Tom 2 *	TR-606 Low Tom 2	TR-707 Low Tom 2 *
42	CR-78 Closed Hi-Hat [EXC1]	CR-78 Closed Hi-Hat [EXC1]	TR-606 Closed Hi-Hat [EXC1]	TR-707 Closed Hi-Hat [EXC1]
43	Electric Low Tom 1 *	CR-78 Low Tom 1 *	TR-606 Low Tom 1	TR-707 Low Tom 1 *
44	TR-808 Closed Hi-Hat 2 [EXC1]	TR-606 Closed Hi-Hat [EXC1]	TR-606 Closed Hi-Hat [EXC1]	TR-707 Closed Hi-Hat [EXC1]
45	Electric Mid Tom 2 *	CR-78 Mid Tom 2 *	TR-606 Mid Tom 2	TR-707 Mid Tom 2 *
46	CR-78 Open Hi-Hat [EXC1]	CR-78 Open Hi-Hat [EXC1]	TR-606 Open Hi-Hat [EXC1]	TR-707 Open Hi-Hat [EXC1]
47	Electric Mid Tom 1 *	CR-78 Mid Tom 1 *	TR-606 Mid Tom 1	TR-707 Mid Tom 1 *
C3 48	Electric High Tom 2 *	CR-78 High Tom 2 *	TR-606 High Tom 2	TR-707 High Tom 2 *
49	TR-808 Crash Cymbal	TR-808 Crash Cymbal	TR-808 Crash Cymbal	TR-909 Crash Cymbal
50	Electric High Tom 1 *	CR-78 High Tom 1 *	TR-606 High Tom 1	TR-707 High Tom 1 *
51	TR-606 Ride Cymbal	TR-606 Ride Cymbal	TR-606 Ride Cymbal	TR-909 Ride Cymbal *
52	Reverse Cymbal	<-	<-	<-
53	<-	<-	<-	<-
54	Shake Tambourine	CR-78 Tambourine	CR-78 Tambourine	Tambourine 2
55	<-	<-	<-	<-
56	TR-808 Cowbell	CR-78 Cowbell	CR-78 Cowbell	TR-808 Cowbell
57	<-	TR-909 Crash Cymbal	TR-909 Crash Cymbal	<-
58	<-	<-	<-	<-
59	<-	Ride Cymbal Edge	Ride Cymbal Edge	Ride Cymbal Edge
C4 60	<-	CR-78 High Bongo	CR-78 High Bongo	<-
61	<-	CR-78 Low Bongo	CR-78 Low Bongo	<-
62	<-	TR-808 High Conga	TR-808 High Conga	<-
63	<-	TR-808 Mute Conga	TR-808 Mute Conga	<-
64	<-	TR-808 Low Conga	TR-808 Low Conga	<-
65	<-	<-	<-	<-
66	<-	<-	<-	<-
67	<-	<-	<-	<-
68	<-	<-	<-	<-
69	<-	<-	<-	<-
70	<-	CR-78 Maracas	CR-78 Maracas	TR-808 Maracas
71	<-	<-	<-	<-
C5 72	<-	<-	<-	<-
73	<-	<-	<-	<-
74	<-	CR-78 Guiro [EXC3]	CR-78 Guiro [EXC3]	<-
75	<-	CR-78 Claves	CR-78 Claves	<-
76	<-	<-	<-	<-
77	<-	<-	<-	<-
78	High Hoo [EXC4]	High Hoo [EXC4]	High Hoo [EXC4]	High Hoo [EXC4]
79	Low Hoo [EXC4]	Low Hoo [EXC4]	Low Hoo [EXC4]	Low Hoo [EXC4]
80	Mute Triangle	CR-78 Metallic Beat 1 [EXC5]	CR-78 Metallic Beat 1 [EXC5]	Mute Triangle
81	Open Triangle	CR-78 Metallic Beat 2 [EXC5]	CR-78 Metallic Beat 2 [EXC5]	Open Triangle
82	TR-626 Shaker	TR-626 Shaker	TR-626 Shaker	TR-626 Shaker
83	<-	<-	<-	<-
C6 84	<-	<-	<-	<-
85	<-	<-	<-	<-
86	<-	<-	<-	<-
87	<-	<-	<-	<-
88	Small Club 1 *	Small Club 1 *	Small Club 1 *	Small Club 1 *
89	---	---	---	---
90	---	---	---	---
91	---	---	---	---
92	---	---	---	---
93	---	---	---	---
94	---	---	---	---
95	---	---	---	---
C7 96	---	---	---	---

Appendices

[Pro] : Same as the percussion sound of SC-8820 PC : Program Number (Drum Set Number)
 [88] : Same as the percussion sound of SC-88 <- : Same as the percussion sound of
 [55] : Same as the percussion sound of SC-55 "STANDARD1"(PC1).
 [EXC] : Percussion sound of the same number --- : No sound
 * : Tones which are created using two voices

SC-88Pro Drum Set (4)

* About Notes 0-19 and 97-127, refer to p.147.

	PC 31 TR-909	PC 33 JAZZ	PC 41 BRUSH	PC 49 ORCHESTRA	[88]
22	<-	<-	<-	<-	
23	<-	<-	<-	<-	
24	<-	<-	<-	<-	
25	<-	<-	<-	<-	
26	<-	Finger Snap 2	Finger Snap 2	Finger Snap	
27	<-	<-	<-	Closed Hi-Hat 2	[EXC1]
28	<-	<-	<-	Pedal Hi-Hat	[EXC1]
29	Scratch Push 2	[EXC7]	<-	Open Hi-Hat 2	[EXC1]
30	Scratch Pull 2	[EXC7]	<-	Ride Cymbal 1	
31	<-	<-	<-	<-	
32	<-	<-	<-	<-	
33	<-	<-	<-	<-	
34	<-	<-	<-	<-	
35	TR-909 Kick 2	Jazz Kick 2	Jazz Kick 2	Jazz Kick 1	
36	TR-909 Kick 1	Jazz Kick 1	Jazz Kick 1	Concert BD 1	
37	TR-909 Rim	<-	<-	<-	
38	TR-909 Snare 1	Jazz Snare 1	Brush Tap 1	Concert SD	
39	<-	Hand Clap 2	Brush Slap 1	Castanets	
40	TR-909 Snare2	Jazz Snare 2	Brush Swirl 1	Concert SD	
41	TR-909 Low Tom 2	<-	Brush Low Tom 2	Timpani F	
42	TR-707 Closed Hi-Hat	[EXC1] Closed Hi-Hat 2	[EXC1] Brush Closed Hi-Hat	[EXC1] Timpani F#	
43	TR-909 Low Tom 1	<-	Brush Low Tom 1	Timpani G	
44	TR-707 Closed Hi-Hat	[EXC1] Pedal Hi-Hat	[EXC1] Pedal Hi-Hat	[EXC1] Timpani G#	
45	TR-909 Mid Tom 2	<-	Brush Mid Tom 2	Timpani A	
46	TR-909 Open Hi-Hat	[EXC1] Open Hi-Hat 2	[EXC1] Brush Open Hi-Hat	[EXC1] Timpani A#	
47	TR-909 Mid Tom 1	<-	Brush Mid Tom 1	Timpani B	
48	TR-909 High Tom 2	<-	Brush High Tom 2	Timpani c	
49	TR-909 Crash Cymbal	<-	Brush Crash Cymbal	Timpani c#	
50	TR-909 High Tom 1	<-	Brush High Tom 1	Timpani d	
51	TR-909 Ride Cymbal	Ride Cymbal Inner	Ride Cymbal Inner	Timpani d#	
52	<-	<-	<-	Timpani e	
53	<-	<-	Brush Ride Bell	Timpani f	
54	Tambourine 2	<-	<-	<-	
55	<-	<-	<-	<-	
56	TR-808 Cowbell	<-	<-	<-	Concert Cymbal 2
57	<-	<-	<-	<-	
58	<-	<-	<-	<-	
59	Ride Cymbal Edge	Ride Cymbal Edge	Ride Cymbal Edge	Concert Cymbal 1	
60	<-	<-	<-	<-	
61	<-	<-	<-	<-	
62	<-	<-	<-	<-	
63	<-	<-	<-	<-	
64	<-	<-	<-	<-	
65	<-	<-	<-	<-	
66	<-	<-	<-	<-	
67	<-	<-	<-	<-	
68	<-	<-	<-	<-	
69	<-	<-	<-	<-	
70	TR-808 Maracas	<-	<-	<-	
71	<-	<-	<-	<-	
72	<-	<-	<-	<-	
73	<-	<-	<-	<-	
74	CR-78 Guiro	[EXC3]	<-	<-	
75	TR-808 Claves	<-	<-	<-	
76	<-	<-	<-	<-	
77	<-	<-	<-	<-	
78	High Hoo	[EXC4]	<-	<-	
79	Low Hoo	[EXC4]	<-	<-	
80	Mute Triangle	<-	<-	<-	
81	Open Triangle	<-	<-	<-	
82	TR-626 Shaker	<-	<-	<-	
83	<-	<-	<-	<-	
84	<-	<-	<-	<-	
85	<-	<-	<-	<-	
86	<-	<-	<-	<-	
87	<-	<-	<-	<-	
88	<-	Applause	Applause	Applause	*
89	---	---	---	---	---
90	---	---	---	---	---
91	---	---	---	---	---
92	---	---	---	---	---
93	---	---	---	---	---
94	---	---	---	---	---
95	---	---	---	---	---
96	---	---	---	---	---

SC-88Pro Drum Set (5)

* About Notes 0-19 and 97-127, refer to p.147.

	PC 50 ETHNIC	[88]	PC 51 KICK & SNARE	[88]	PC 53 ASIA	PC 54 CYMBAL&CLAPS
	25	Finger Snap	CR-78 Kick 1		Gamelan Gong 1	---
	26	Tambourine	CR-78 Kick 2		Gamelan Gong 2	---
	27	Castanets	TR-606 Kick		Gamelan Gong 3	---
	28	Crash Cymbal 1	TR-707 Kick		Gamelan Gong 4	---
	29	Snare Roll	TR-808 Kick 1		Gamelan Gong 5	---
	30	Concert SD	TR-909 Kick 1		Gamelan Gong 6	---
	31	Concert Cymbal	TR-909 Kick 2	*	Gamelan Gong 7	---
	32	Concert BD 1	Hip-Hop Kick 2		Gamelan Gong 8	Reverse Open Hi-Hat
	33	Jingle Bell	Hip-Hop Kick 1		Gamelan Gong 9	Reverse Closed Hi-Hat 1
	34	Bell Tree	Jungle Kick 2		Gamelan Gong 10	Reverse Closed Hi-Hat 2
	35	Bar Chimes	Jungle Kick 1		Gender 1	Jungle Hi-Hat [EXC1]
C2	36	Wadaiko	Techno Kick 2		Gender 2	[55] Closed Hi-Hat [EXC1]
	37	Wadaiko Rim	Techno Kick 1		Gender 3	[88] Closed Hi-Hat 2 [EXC1]
	38	Shime Taiko	Standard 1 Kick 2		Gender 4	[88] Closed Hi-Hat 3 [EXC1]
	39	Atarigane	Standard 1 Kick 1		Gender 5	Closed Hi-Hat 4 [EXC1]
	40	Hyoushigi	[88] Standard 1 Kick 1		Bonang 1	Closed Hi-Hat [EXC1]
	41	Ohkawa	[88] Standard 1 Kick 2		Bonang 2	TR-707 Closed Hi-Hat [EXC1]
	42	High Kotsuzumi	[88] Standard 2 Kick 1		Bonang 3	TR-606 Closed Hi-Hat [EXC1]
	43	Low Kotsuzumi	[88] Standard 2 Kick 2		Bonang 4	[88] TR-808 Closed Hi-Hat [EXC1]
	44	Ban Gu	[55] Kick Drum 1		Bonang 5	TR-808 Closed Hi-Hat [EXC1]
	45	Big Gong	[55] Kick Drum 2		Rama Cymbal Low	CR-78 Closed Hi-Hat [EXC1]
	46	Small Gong	[88] Soft Kick		Rama Cymbal High	[55] Pedal Hi-Hat [EXC1]
	47	Bend Gong	[88] Jazz Kick 1		Sagat Open [EXC7]	[88] Pedal Hi-Hat [EXC1]
C3	48	Thai Gong	[88] Jazz Kick 2		Sagat Closed [EXC7]	Pedal Hi-Hat [EXC1]
	49	Rama Cymbal	[55] Concert BD 1		Jaws Harp	Half-Open Hi-Hat 1 [EXC1]
	50	Gamelan Gong	[88] Room Kick 1		Wadaiko	Half-Open Hi-Hat 2 [EXC1]
	51	Udo Short	[EXC1] [88] Room Kick 2		Wadaiko Rim	[55] Open Hi-Hat [EXC1]
	52	Udo Long	[EXC1] [88] Power Kick 1		Small Taiko	[88] Open Hi-Hat 2 [EXC1]
	53	Udo Slap	[88] Power Kick 2		Shimedaiko	[88] Open Hi-Hat 3 [EXC1]
	54	Bendir	[88] Electric Kick 2		Atarigane	Open Hi-Hat 2 [EXC1]
	55	Req Dum	[88] Electric Kick 1	*	Hyoushigi	TR-909 Open Hi-Hat [EXC1]
	56	Req Tik	[55] Electric Kick		Ohkawa	TR-707 Open Hi-Hat [EXC1]
	57	Tabla Te	[88] TR-808 Kick		High Kotsuzumi	TR-606 Open Hi-Hat [EXC1]
	58	Tabla Na	[88] TR-909 Kick		Low Kotsuzumi	[88] TR-808 Open Hi-Hat [EXC1]
	59	Tabla Tun	[88] Dance Kick		Yyoo Dude	TR-808 Open Hi-Hat [EXC1]
C4	60	Tabla Ge	[88] Standard 1 Snare 1		Buk	CR-78 Open Hi-Hat [EXC1]
	61	Tabla Ge Hi	[88] Standard 1 Snare 2		Buk Rim	Crash Cymbal 1 [EXC3]
	62	Talking Drum	[88] Standard 2 Snare 1		Gengari p [EXC1]	Crash Cymbal 2 [EXC4]
	63	Bend Talking Drum	[88] Standard 2 Snare 2		Gengari Mute Low [EXC1]	Crash Cymbal 3
	64	Caxixi	[55] Tight Snare		Gengari f [EXC2]	Brush Crash Cymbal
	65	Djembe	[55] Concert Snare		Gengari Mute High [EXC2]	Hard Crash Cymbal
	66	Djembe Rim	[88] Jazz Snare 1		Gengari Samll	TR-909 Crash Cymbal
	67	Timbales Low	[88] Jazz Snare 2		Jang-Gu Che	TR-808 Crash Cymbal
	68	Timbales Paila	[88] Room Snare 1		Jang-Gu Kun	Mute Crash Cymbal 1 [EXC3]
	69	Timbales High	[88] Room Snare 2		Jang-Gu Rim	Mute Crash Cymbal 2 [EXC4]
	70	Cowbell	[88] Power Snare 1		Jing p [EXC3]	Reverse Crash Cymbal 1
	71	High Bongo	[88] Power Snare 2		Jing f [EXC3]	Reverse Crash Cymbal 2
	72	Low Bongo	[55] Gated Snare		Jing Mute [EXC3]	Reverse Crash Cymbal 3
C5	73	Mute High Conga	[88] Dance Snare 1		Asian Gong	Reverse TR-909 Crash Cymbal
	74	Open High Conga	[88] Dance Snare 2		Big Gong	[55] Splash Cymbal
	75	Mute Low Conga	[88] Disco Snare		Small Gong	Splash Cymbal
	76	Conga Slap	[88] Electric Snare 2		Pai Ban	[88] Ride Bell
	77	Open Low Conga	[88] House Snare	*	Ban Gu	[88] Brush Ride Bell
	78	Conga Slide	[55] Electric Snare 1		Tang Gu [EXC4]	[88] Ride Cymbal 1
	79	Mute Pandiero	[88] Electric Snare 3	*	Tang Gu Mute [EXC4]	[88] Ride Cymbal 2
	80	Open Pandiero	[88] TR-808 Snare 1		Shou Luo	[88] Brush Ride Cymbal
	81	Open Surdo	[EXC2] [88] TR-808 Snare 2	*	Bend Gong	Ride Cymbal Low Inner
	82	Mute Surdo	[EXC2] [88] TR-909 Snare 1		Hu Yin Luo Low	Ride Cymbal Mid Inner
	83	Tamborim	[88] TR-909 Snare 2	*	Hu Yin Luo Mid [EXC5]	Ride Cymbal High Inner
C6	84	High Agogo	[88] Brush Tap 1		Hu Yin Luo Mid 2 [EXC5]	Ride Cymbal Low Edge
	85	Low Agogo	[88] Brush Tap 2		Hu Yin Luo High [EXC6]	Ride Cymbal Mid Edge
	86	Shaker	[88] Brush Slap 1		Hu Yin Luo High 2 [EXC6]	Ride Cymbal High Edge
	87	High Whistle	[EXC3] [88] Brush Slap 2		Nao Bo	TR-606 Ride Cymbal
	88	Low Whistle	[EXC3] [88] Brush Slap 3		Xiao Bo	TR-808 Ride Cymbal
	89	Mute Cuica	[EXC4] [88] Brush Swirl 1		---	Chinese Cymbal
	90	Open Cuica	[EXC4] [88] Brush Swirl 2		---	Chinese Cymbal 2
	91	Mute Triangle	[EXC5] [88] Brush Long Swirl		---	[55] Hand Clap
	92	Open Triangle	[EXC5] Standard 1 Snare 1		---	[88] Hand Clap 2
	93	Short Guiro	[EXC6] Standard 1 Snare 2		---	[88] Hand Clap
	94	Long Guiro	[EXC6] Standard 1 Snare 3		---	Hand Clap
	95	Cabasa Up	Rap Snare		---	Hand Clap 2
C7	96	Cabasa Down	Hip-Hop Snare 2		---	TR-707 Hand Clap
	97	Claves	Jungle Snare 1		---	---
	98	High Wood Block	Jungle Snare 2		---	---
	99	Low Wood Block	Techno Snare 1		---	---

Appendices

[Pro] : Same as the percussion sound of SC-8820 PC : Program Number (Drum Set Number)
 [88] : Same as the percussion sound of SC-88 <- : Same as the percussion sound of
 [55] : Same as the percussion sound of SC-55 "STANDARD1"(PC1).
 [EXC] : Percussion sound of the same number --- : No sound
 * : Tones which are created using two voices

SC-88Pro Drum Set (6)

	PC 57 SFX	PC 58 RHYTHM FX	[88]	PC 59 RHYTHM FX 2
21	MC-500 Beep 1	---	---	---
22	MC-500 Beep 2	---	---	---
23	Guitar Slide	---	---	---
24	Guitar Wah	---	---	---
25	Guitar Slap	---	---	---
26	Chord Stroke Down	---	---	---
27	Chord Stroke Up	---	---	---
28	Biwa FX	---	---	---
29	Phonograph Noise	---	---	---
30	Tape Rewind	---	---	---
31	Scratch Push 2	[EXC1]	---	---
32	Scratch Pull 2	[EXC1]	---	---
33	Cutting Noise 2 Up	---	---	---
34	Cutting Noise 2 Down	---	---	---
35	Distortion Guitar Cutting Noise Up	---	---	---
36	Distortion Guitar Cutting Noise Down	Reverse Kick 1	---	Reverse TR-707 Kick 1
37	Bass Slide	Reverse Concert Bass Drum	---	Reverse TR-909 Kick 1
38	Pick Scrape	Reverse Power Kick1	---	Reverse Hip-Hop Kick 1
39	High Q	Reverse Electric Kick 1	---	Reverse Jungle Kick 2
40	Slap	Reverse Snare 1	---	Reverse Techno Kick 2
41	Scratch Push	[EXC7] Reverse Snare 2	---	Reverse TR-606 Snare 2
42	Scratch Pull	[EXC7] Reverse Standard 1 Snare 1	---	Reverse CR-78 Snare 1
43	Sticks	Reverse Tight Snare	---	Reverse CR-78 Snare 2
44	Square Click	Reverse Dance Snare	---	Reverse Jungle Snare 2
45	Metronome Click	Reverse 808 Snare	---	Reverse Techno Snare 2
46	Metronome Bell	Reverse Tom 1	---	Reverse TR-707 Snare
47	Guitar Frat Noise	Reverse Tom 2	---	Reverse TR-606 Snare 1
48	Guitar Cutting Noise Up	Reverse Slicks	---	Reverse TR-909 Snare 1
49	Guitar Cutting Noise Down	Reverse Slap	---	Reverse Hip-Hop Snare 2
50	String Slap of Double Bass	Reverse Cymbal 1	---	Reverse Jungle Snare 1
51	Flute Key Click Noise	Reverse Cymbal 2	---	Reverse House Snare
52	Laughing	Reverse Open Hi-Hat	---	Reverse Closed Hi-Hat
53	Screaming	Reverse Ride Cymbal	---	Reverse TR-606 Closed Hi-Hat
54	Punch	Reverse CR-78 Open Hi-Hat	---	Reverse TR-707 Closed Hi-Hat
55	Heart Beat	Reverse Closed Hi-Hat	---	Reverse TR-808 Closed Hi-Hat
56	Footsteps 1	Reverse Gong	---	Reverse Jungle Hi-Hat
57	Footsteps 2	Reverse Bell Tree	---	Reverse Tambourine 2
58	Applause	Reverse Guiro	---	Reverse Shake Tambourine
59	Door Creaking	Reverse Bendir	---	Reverse TR-808 Open Hi-Hat
60	Door	Reverse Gun Shot	---	Reverse TR-707 Open Hi-Hat
61	Scratch	Reverse Scratch	---	Reverse Open Hi-Hat
62	Wind Chimes	Reverse Laser Gun	---	Reverse TR-606 Open Hi-Hat
63	Car - Engine	Key Click	---	Reverse Hu Yin Luo
64	Car - Stop	Techno Thip	---	Reverse TR-707 Crash Cymbal
65	Car - Passing	Pop Drop	---	Voice One
66	Car - Crash	Woody Slap	---	Reverse Voice One
67	Siren	Distortion Kick	*	Voice Two
68	Train	Syn. Drops	---	Reverse Voice Two
69	Jetplane	Reverse Hi Q	---	Voice Three
70	Helicopter	Pipe	---	Reverse Voice Three
71	Starship	Ice Block	---	Voice Tah
72	Gun Shot	Digital Tambourine	*	Reverse Voice Tah
73	Machine Gun	Alias	---	Voice Ou
74	Laser Gun	Modulated Bell	---	Voice Au
75	Explosion	Spark	---	Voice Whey
76	Dog	Metallic Percussion	---	Frog Vpocce
77	Horse-Gallop	Velocity Noise FX	---	Reverse Yyoo Dude
78	Birds	Stereo Noise Clap	*	Douby
79	Rain	Swish	---	Reverse Douby
80	Thunder	Slappy	*	Baert High
81	Wind	Voice Ou	---	Baert Low
82	Seashore	Voice Au	---	Bounce
83	Stream	Hoo	---	Reverse bounce
84	Bubble	Tape Stop 1	*	Distortion Knock
85	Kitty	Tape Stop 2	*	Guitar Slide
86	Bird 2	Missile	*	Sub Marine
87	Growl	Space Birds	---	Noise Attack
88	<-	Flying Monster	---	Space Worms
89	Telephone 1	---	---	Emergency !
90	Telephone 2	---	---	Calculating...
91	Small Club 1	*	---	Saw LFO
92	Small Club 2	*	---	---
93	Applause Wave	*	---	---
94	Eruption	---	---	---
95	Big Shot	*	---	---
96	Percussion Bang	*	---	---

Appendices

[Pro] : Same as the percussion sound of SC-8820
 [88] : Same as the percussion sound of SC-88
 [55] : Same as the percussion sound of SC-55
 [EXC] : Percussion sound of the same number will not be heard at the same time.

PC : Program Number (Drum Set Number)
 < : Same as the percussion sound of "STANDARD1"(PC1).
 --- : No sound
 * : Tones which are created using two voices

SC-88 Drum Set (1)

	PC 1 STANDARD 1	PC 2 STANDARD 2	PC 9 ROOM	PC 17 POWER	PC 25 ELECTRONIC
25	Snare Roll	<	<	<	<
26	Finger Snap	<	<	<	<
27	High Q	<	<	<	<
28	Slap	<	<	<	<
29	Scratch Push	[EXC7] <	<	<	Scratch Push2 [EXC7]
30	Scratch Pull	[EXC7] <	<	<	Scratch Pull2 [EXC7]
31	Sticks	<	<	<	<
32	Square Click	<	<	<	<
33	Metronome Click	<	<	<	<
34	Metronome Bell	<	<	<	<
35	Standard 1 Kick 2	Standard 2 Kick 2	Room Kick 2	Power Kick 2	Electric Kick 2
36	Standard 1 Kick 1	Standard 2 Kick 1	Room Kick 1	Power Kick 1	Electric Kick 1
37	Side Stick	<	<	<	<
38	Standard 1 Snare 1	Standard 2 Snare 1	Room Snare 1	Power Snare 1	Electric Snare 1
39	Hand Clap	<	<	<	<
40	Standard 1 Snare 2	Standard 2 Snare 2	Room Snare 2	Power Snare 2	Electric Snare 2
41	Low Tom2	*	Room Low Tom2	* Power Low Tom2	* Electric Low Tom2
42	Closed Hi-hat1	[EXC1] Closed Hi-hat2	[EXC1] Closed Hi-hat3	[EXC1] Closed Hi-hat3	[EXC1] Closed Hi-hat2 [EXC1]
43	Low Tom1	*	Room Low Tom1	* Power Low Tom1	* Electric Low Tom1
44	Pedal Hi-hat	[EXC1] <	<	<	<
45	Mid Tom2	*	Room Mid Tom2	* Power Mid Tom2	* Electric Mid Tom2
46	Open Hi-hat1	[EXC1] Open Hi-hat2	[EXC1] Open Hi-hat3	[EXC1] Open Hi-hat3	[EXC1] Open Hi-hat2 [EXC1]
47	Mid Tom1	*	Room Mid Tom1	* Power Mid Tom1	* Electric Mid Tom1
48	High Tom2	*	Room Hi Tom2	* Power Hi Tom2	* Electric Hi Tom2
49	Crash Cymbal1	<	<	<	<
50	High Tom1	*	Room Hi Tom1	* Power Hi Tom1	* Electric Hi Tom1
51	Ride Cymbal1	<	<	<	<
52	Chinese Cymbal	<	<	<	Reverse Cymbal
53	Ride Bell	<	<	<	<
54	Tambourine	<	<	<	<
55	Splash Cymbal	<	<	<	<
56	Cowbell	<	<	<	<
57	Crash Cymbal2	<	<	<	<
58	Vibra-slap	<	<	<	<
59	Ride Cymbal2	<	<	<	<
60	High Bongo	<	<	<	<
61	Low Bongo	<	<	<	<
62	Mute High Conga	<	<	<	<
63	Open High Conga	<	<	<	<
64	Low Conga	<	<	<	<
65	High Timbale	<	<	<	<
66	Low Timbale	<	<	<	<
67	High Agogo	<	<	<	<
68	Low Agogo	<	<	<	<
69	Cabasa	<	<	<	<
70	Maracas	<	<	<	<
71	Short Hi Whistle	[EXC2] <	<	<	<
72	Long Low Whistle	[EXC2] <	<	<	<
73	Short Guiro	[EXC3] <	<	<	<
74	Long Guiro	[EXC3] <	<	<	<
75	Claves	<	<	<	<
76	High Wood Block	<	<	<	<
77	Low Wood Block	<	<	<	<
78	Mute Cuica	[EXC4] <	<	<	<
79	Open Cuica	[EXC4] <	<	<	<
80	Mute Triangle	[EXC5] <	<	<	<
81	Open Triangle	[EXC5] <	<	<	<
82	Shaker	<	<	<	<
83	Jingle Bell	<	<	<	<
84	Bell Tree	Bar Chimes	<	<	<
85	Castanets	<	<	<	<
86	Mute Surdo	[EXC6] <	<	<	<
87	Open Surdo	[EXC6] <	<	<	<
88	----	----	----	----	----
89	----	----	----	----	----
90	----	----	----	----	----
91	----	----	----	----	----
92	----	----	----	----	----
93	----	----	----	----	----
94	----	----	----	----	----
95	----	----	----	----	----
96	----	----	----	----	----
97	----	----	----	----	----
98	----	----	----	----	----
99	----	----	----	----	----

SC-88 Drum Set (2)

	PC 26 TR-808/909	PC 27 DANCE	PC 33 JAZZ	PC 41 BRUSH	PC 49 ORCHESTRA
25	<	<	<	<	<
26	<	<	<	<	<
27	<	<	<	<	<
28	<	<	<	<	Closed Hi-hat2 [EXC1]
					Pedal Hi-hat [EXC1]
29	Scratch Push2 [EXC7]	Scratch Push2 [EXC7]	<	<	Open Hi-hat2 [EXC1]
30	Scratch Pull2 [EXC7]	Scratch Pull2 [EXC7]	<	<	Ride Cymbal1
31	<	<	<	<	<
32	<	<	<	<	<
33	<	<	<	<	<
34	<	<	<	<	<
35	909 Bass Drum	Dance Kick	Jazz Kick 2	Jazz Kick 2	Jazz Kick 1
C36	808 Bass Drum	Electric Kick 2	Jazz Kick 1	Jazz Kick 1	Concert BD1
37	808 Rim Shot	<	<	<	<
38	808 Snare 1	Dance Snare 1	Jazz Snare 1	Brush Tap1	Concert SD
39	<	<	Hand Clap2	Brush Slap1	Castanets
40	909 Snare 1	Dance Snare 2	Jazz Snare 2	Brush Swirl1	Concert SD
41	808 Low Tom2 *	Electric Low Tom2 *	<	Brush Low Tom2 *	Timpani F
42	808 CHH [EXC1]	CR-78 CHH [EXC1]	Closed Hi-hat2 [EXC1]	Brush Closed Hi-hat [EXC1]	Timpani F#
43	808 Low Tom1 *	Electric Low Tom1 *	<	Brush Low Tom1 *	Timpani G
44	808 CHH [EXC1]	808 CHH [EXC1]	<	<	Timpani G#
45	808 Mid Tom2 *	Electric Mid Tom2 *	<	Brush Mid Tom2 *	Timpani A
46	808 OHH [EXC1]	CR-78 OHH [EXC1]	Open Hi-hat2 [EXC1]	Brush Open Hi-hat [EXC1]	Timpani A#
47	808 Mid Tom1 *	Electric Mid Tom1 *	<	Brush Mid Tom1 *	Timpani B
C38	808 Hi Tom2 *	Electric High Tom2 *	<	Brush Hi Tom2 *	Timpani c
49	808 Cymbal	<	<	Brush Crash Cymbal	Timpani c#
50	808 Hi Tom1	Electric High Tom1 *	<	Brush Hi Tom1 *	Timpani d
51	<	<	<	Brush Ride Cymbal	Timpani d#
52	<	Reverse Cymbal	<	<	Timpani e
53	<	<	<	Brush Ride Bell	Timpani f
54	<	<	<	<	<
55	<	<	<	<	<
56	808 Cowbell	<	<	<	<
57	<	<	<	<	Concert Cymbal2
58	<	<	<	<	<
59	<	<	<	<	Concert Cymbal1
C60	<	<	<	<	<
61	<	<	<	<	<
62	808 High Conga	<	<	<	<
63	808 Mid Conga	<	<	<	<
64	808 Low Conga	<	<	<	<
65	<	<	<	<	<
66	<	<	<	<	<
67	<	<	<	<	<
68	<	<	<	<	<
69	<	<	<	<	<
70	808 Maracas	<	<	<	<
71	<	<	<	<	<
C52	<	<	<	<	<
72	<	<	<	<	<
73	<	<	<	<	<
74	<	<	<	<	<
75	808 Claves	<	<	<	<
76	<	<	<	<	<
77	<	<	<	<	<
78	<	High Hoo [EXC4]	<	<	<
79	<	Low Hoo [EXC4]	<	<	<
80	<	Electric Mute Triangle [EXC5]	<	<	<
81	<	Electric Open Triangle [EXC5]	<	<	<
82	<	<	<	<	<
83	<	<	<	<	<
C64	<	<	<	<	<
84	<	<	<	<	<
85	<	<	<	<	<
86	<	<	<	<	<
87	<	<	<	<	<
88	----	----	----	----	Applause *
89	----	----	----	----	----
90	----	----	----	----	----
91	----	----	----	----	----
92	----	----	----	----	----
93	----	----	----	----	----
94	----	----	----	----	----
95	----	----	----	----	----
C796	----	----	----	----	----
96	----	----	----	----	----
97	----	----	----	----	----
98	----	----	----	----	----
99	----	----	----	----	----

Appendices

[Pro] : Same as the percussion sound of SC-8820 PC : Program Number (Drum Set Number)
 [88] : Same as the percussion sound of SC-88 ← : Same as the percussion sound of
 [55] : Same as the percussion sound of SC-55 "STANDARD1"(PC1).
 [EXC] : Percussion sound of the same number --- : No sound
 * : Tones which are created using two voices
 will not be heard at the same time.

SC-88 Drum Set (3)

	PC 50 ETHNIC	PC 51 KICK&SNARE	PC 57 SFX	PC 58 RHYTHM FX
25	Finger Snap	----	----	----
26	Tambourine	----	----	----
27	Castanets	----	----	----
28	Crash Cymbal1	----	----	----
29	Snare Roll	----	----	----
30	Concert Snare Drum	----	----	----
31	Concert Cymbal	----	Scratch Push2	[EXC1] ----
32	Concert BD1	----	Scratch Pull2	[EXC1] ----
33	Jingle Bell	----	Cutting Noise 2 Up	----
34	Bell Tree	----	Cutting Noise 2 Down	----
35	Bar Chimes	----	Distortion Guitar Cutting Noise Up	----
C2 36	Wadaiko	----	Distortion Guitar Cutting Noise Down	Reverse Kick 1
37	Wadaiko Rim	----	Bass Slide	Reverse Concert BD 1
38	Shime Taiko	----	Pick Scrape	Reverse Power Kick 1
39	Atarigane	----	High Q	Reverse Electric Kick 1
40	Hyoushigi	Standard 1 Kick 1	Slap	Reverse Snare 1
41	Ohkawa	Standard 1 Kick 2	Scratch Push	Reverse Snare 2
42	High Kotsuzumi	Standard 2 Kick 1	Scratch Pull	[EXC7] Reverse Standard set1 Snare 1
43	Low Kotsuzumi	Standard 2 Kick 2	Sticks	Reverse Tight Snare
44	Ban Gu	Kick 1	Square Click	Reverse Dance Snare
45	Big Gong	Kick 2	Metronome Click	Reverse 808 Snare
46	Small Gong	Soft Kick	Metronome Bell	Reverse Tom1
47	Bend Gong	Jazz Kick 1	Guitar Fret Noise	Reverse Tom2
C3 48	Thai Gong	Jazz Kick 2	Guitar Cutting Noise Up	Reverse Sticks
49	Rama Cymbal	Concert BD	Guitar Cutting Noise Down	Reverse Slap
50	Gamelan Gong	Room Kick 1	String Slap of Double Bass	Reverse Cymbal1
51	Udo Short	[EXC1] Room Kick 2	Fl.Key Click	Reverse Cymbal2
52	Udo Long	[EXC1] Power Kick 1	Laughing	Reverse Open Hi-hat
53	Udo Slap	Power Kick 2	Scream	Reverse Ride Cymbal
54	Bendir	Electric Kick 2	Punch	Reverse CR-78 OHH
55	Req Dum	Electric Kick 1	Heart Beat	Reverse Closed Hi-hat
56	Req Tik	Electric Kick	Footsteps1	Reverse Gong
57	Tabla Te	808 Bass Drum	Footsteps2	Reverse Bell Tree
58	Tabla Na	909 Bass Drum	Applause	Reverse Guiro
59	Tabla Tun	Dance Kick	Door Creaking	Reverse Bendir
C4 60	Tabla Ge	Standard 1 Snare 1	Door	Reverse Gun Shot
61	Tabla Ge Hi	Standard 1 Snare 2	Scratch	Reverse Scratch
62	Talking Drum	Standard 2 Snare 1	Wind Chimes	Reverse Laser
63	Bend Talking Drum	Standard 2 Snare 2	Car-Engine	Key Click
64	Caxixi	Tight Snare	Car-Stop	Tekno Thip
65	Djembe	Concert Snare	Car-Pass	Pop Drop
66	Djembe Rim	Jazz Snare 1	Car-Crash	Woody Slap
67	Timbales Low	Jazz Snare 2	Siren	Distortion Kick
68	Timbales Paila	Room Snare 1	Train	Syn.Drop
69	Timbales High	Room Snare 2	Jetplane	Reverse High Q
70	Cowbell	Power Snare 1	Helicopter	Pipe
71	Hi Bongo	Power Snare 2	Starship	Ice Block
C5 72	Low Bongo	Gated Snare	Gun Shot	Digital Tambourine
73	Mute Hi Conga	Dance Snare 1	Machine Gun	Alias
74	Open Hi Conga	Dance Snare 2	Lasergun	Modulated Bell
75	Mute Low Conga	Disco Snare	Explosion	Spark
76	Conga Slap	Electric Snare2	Dog	Metalic Percussion
77	Open Low Conga	House Snare	Horse-Gallop	Velocity Noise FX
78	Conga Slide	Electric Snare 1	Birds	Stereo Noise Clap
79	Mute Pandiero	Electric Snare 3	Rain	Swish
80	Open Pandiero	808 Snare 1	Thunder	Slappy
81	Open Surdo	[EXC2] 808 Snare 2	Wind	Voice Ou
82	Mute Surdo	[EXC2] 909 Snare 1	Seashore	Voice Au
83	Tamborim	909 Snare 2	Stream	Hoo
C6 84	High Agogo	Brush Tap1	Bubble	Tape Stop1
85	Low Agogo	Brush Tap2	Kitty	Tape Stop2
86	Shaker	Brush Slap1	Bird2	Missile
87	High Whistle	[EXC3] Brush Slap2	Growl	Space Bird
88	Low Whistle	[EXC3] Brush Slap3	Applause2	Flying Monster
89	Mute Cuica	[EXC4] Brush Swirl1	Telephone1	----
90	Open Cuica	[EXC4] Brush Swirl2	Telephone2	----
91	Mute Triangle	[EXC5] Brush Long Swirl	----	----
92	Open Triangle	[EXC5] ----	----	----
93	Short Guiro	[EXC6] ----	----	----
94	Long Guiro	[EXC6] ----	----	----
95	Cabasa Up	----	----	----
C7 96	Cabasa Down	----	----	----
97	Claves	----	----	----
98	High Wood Block	----	----	----
99	Low Wood Block	----	----	----

SC-55 Drum Set (1)

	PC 1 / PC 33 STANDARD / JAZZ	PC 9 ROOM	PC 17 POWER	PC 25 ELECTRONIC	PC 26 TR-808	PC 41 BRUSH	PC 49 ORCHESTRA
25	----	----	----	----	----	----	----
26	----	----	----	----	----	----	----
27	High Q	<--	<--	<--	<--	<--	Closed Hi-hat [EXC1]
28	Slap	<--	<--	<--	<--	<--	Pedal Hi-hat [EXC1]
29	Scratch Push	<--	<--	<--	<--	<--	Open Hi-hat [EXC1]
30	Scratch Pull	<--	<--	<--	<--	<--	Ride Cymbal1
31	Sticks	<--	<--	<--	<--	<--	<--
32	Square Click	<--	<--	<--	<--	<--	<--
33	Metronome Click	<--	<--	<--	<--	<--	<--
34	Metronome Bell	<--	<--	<--	<--	<--	<--
35	Kick Drum2 / Jazz BD2	<--	<--	<--	<--	Jazz BD2	Concert BD2
C2 36	Kick Drum1 / Jazz BD1	<--	MONDO Kick	Elec BD	808 Bass Drum	Jazz BD1	Concert BD1
37	Side Stick	<--	<--	<--	808 Rim Shot	<--	<--
38	Snare Drum1	<--	Gated SD	Elec SD	808 Snare Drum	Brush Tap	Concert SD
39	Hand Clap	<--	<--	<--	<--	Brush Slap	Castanets
40	Snare Drum2	<--	<--	Gated SD	<--	Brush Swirl	Concert SD
41	Low Tom2	Room Low Tom2	Room Low Tom2	Elec Low Tom2	808 Low Tom2	<--	Timpani F
42	Closed Hi-hat [EXC1]	<--	<--	<--	808 CHH [EXC1]	<--	Timpani F#
43	Low Tom1	Room Low Tom1	Room Low Tom1	Elec Low Tom1	808 Low Tom1	<--	Timpani G
44	Pedal Hi-hat [EXC1]	<--	<--	<--	808 CHH [EXC1]	<--	Timpani G#
45	Mid Tom2	Room Mid Tom2	Room Mid Tom2	Elec Mid Tom2	808 Mid Tom2	<--	Timpani A
46	Open Hi-hat [EXC1]	<--	<--	<--	808 OHH [EXC1]	<--	Timpani A#
47	Mid Tom1	Room Mid Tom1	Room Mid Tom1	Elec Mid Tom1	808 Mid Tom1	<--	Timpani B
C3 48	High Tom2	Room Hi Tom2	Room Hi Tom2	Elec Hi Tom2	808 Hi Tom2	<--	Timpani c
49	Crash Cymbal1	<--	<--	<--	808 Cymbal	<--	Timpani c#
50	High Tom1	Room Hi Tom1	Room Hi Tom1	Elec Hi Tom1	808 Hi Tom1	<--	Timpani d
51	Ride Cymbal1	<--	<--	<--	<--	<--	Timpani d#
52	Chinese Cymbal	<--	<--	Reverse Cymbal	<--	<--	Timpani e
53	Ride Bell	<--	<--	<--	<--	<--	Timpani f
54	Tambourine	<--	<--	<--	<--	<--	<--
55	Splash Cymbal	<--	<--	<--	<--	<--	<--
56	Cowbell	<--	<--	<--	808 Cowbell	<--	<--
57	Crash Cymbal2	<--	<--	<--	<--	<--	Concert Cymbal2
58	Vibra-slap	<--	<--	<--	<--	<--	<--
59	Ride Cymbal2	<--	<--	<--	<--	<--	Concert Cymbal1
C4 60	High Bongo	<--	<--	<--	<--	<--	<--
61	Low Bongo	<--	<--	<--	<--	<--	<--
62	Mute High Conga	<--	<--	<--	808 High Conga	<--	<--
63	Open High Conga	<--	<--	<--	808 Mid Conga	<--	<--
64	Low Conga	<--	<--	<--	808 Low Conga	<--	<--
65	High Timbale	<--	<--	<--	<--	<--	<--
66	Low Timbale	<--	<--	<--	<--	<--	<--
67	High Agogo	<--	<--	<--	<--	<--	<--
68	Low Agogo	<--	<--	<--	<--	<--	<--
69	Cabasa	<--	<--	<--	<--	<--	<--
70	Maracas	<--	<--	<--	808 Maracas	<--	<--
71	Short Hi Whistle [EXC2]	<--	<--	<--	<--	<--	<--
C5 72	Long Low Whistle [EXC2]	<--	<--	<--	<--	<--	<--
73	Short Guiro	<--	<--	<--	<--	<--	<--
74	Long Guiro	<--	<--	<--	<--	<--	<--
75	Claves	<--	<--	<--	808 Claves	<--	<--
76	High Wood Block	<--	<--	<--	<--	<--	<--
77	Low Wood Block	<--	<--	<--	<--	<--	<--
78	Mute Cuica [EXC4]	<--	<--	<--	<--	<--	<--
79	Open Cuica [EXC4]	<--	<--	<--	<--	<--	<--
80	Mute Triangle [EXC5]	<--	<--	<--	<--	<--	<--
81	Open Triangle [EXC5]	<--	<--	<--	<--	<--	<--
82	Shaker	<--	<--	<--	<--	<--	<--
83	Jingle Bell	<--	<--	<--	<--	<--	<--
C6 84	Bell Tree	<--	<--	<--	<--	<--	<--
85	Castanets	<--	<--	<--	<--	<--	<--
86	Mute Surdo [EXC6]	<--	<--	<--	<--	<--	<--
87	Open Surdo [EXC6]	<--	<--	<--	<--	<--	<--
88	----	----	----	----	----	----	Applause *
89	----	----	----	----	----	----	----
90	----	----	----	----	----	----	----
91	----	----	----	----	----	----	----
92	----	----	----	----	----	----	----
93	----	----	----	----	----	----	----
94	----	----	----	----	----	----	----
95	----	----	----	----	----	----	----
C7 96	----	----	----	----	----	----	----
97	----	----	----	----	----	----	----
98	----	----	----	----	----	----	----
99	----	----	----	----	----	----	----

Appendices

[Pro] : Same as the percussion sound of SC-8820 PC : Program Number (Drum Set Number)
 [88] : Same as the percussion sound of SC-88 <- : Same as the percussion sound of
 [55] : Same as the percussion sound of SC-55 "STANDARD1"(PC1).
 [EXC] : Percussion sound of the same number --- : No sound
 will not be heard at the same time * : Tones which are created using two voices

SC-55 Drum Set (2)

	PC 57	PC 128
	SFX	CM-64/32L
C2 35	----	CM Kick Drum
36	----	CM Kick Drum
37	----	CM Rim Shot
38	----	CM Snare Drum
39	High Q	CM Hand Clap
40	Slap	CM Electronic Snare Drum
41	Scratch Push [EXC7]	CM Acoustic Low Tom
42	Scratch Pull [EXC7]	CM Closed High Hat [EXC1]
43	Sticks	CM Acoustic Low Tom
44	Square Click	CM Open Hi-Hat2
45	Metronome Click	CM Acoustic Middle Tom
46	Metronome Bell	CM Open Hi-Hat1 [EXC1]
47	Guitar Fret Noise	CM M.TomAcoustic Middle Tom
C3 48	Guitar cutting noise/up	CM Acoustic High Tom
49	Guitar cutting noise/down	CM Crash Cymbal
50	String slap of double bass	CM Acoustic High Tom
51	Fl.Key Click	CM Ride Cymbal
52	Laughing	----
53	Scream	----
54	Punch	CM Tambourine
55	Heart Beat	----
56	Footsteps1	CM Cowbell
57	Footsteps2	----
58	Applause	----
59	Door Creaking	----
C4 60	Door	CM High Bongo
61	Scratch	CM Low Bongo
62	Wind Chimes	CM Mute High Conga
63	Car-Engine	CM High Conga
64	Car-Stop	CM Low Conga
65	Car-Pass	CM High Timbale
66	Car-Crash	CM Low Timbale
67	Siren	CM High Agogo
68	Train	CM Low Agogo
69	Jetplane	CM Cabasa
70	Helicopter	CM Maracas
71	Starship	CM Short Whistle
C5 72	Gun Shot	CM Long Whistle
73	Machine Gun	CM Vibrato Slap
74	Lasergun	----
75	Explosion	CM Claves
76	Dog	Laughing
77	Horse-Gallop	Scream
78	Birds	Punch
79	Rain	Heart Beat
80	Thunder	Footsteps1
81	Wind	Footsteps2
82	Seashore	Applause
83	Stream	Creaking
84	Bubble	Door
C6 85	----	Scratch
86	----	Wind Chimes
87	----	Car-Engine
88	----	Car-Stop
89	----	Car-Pass
90	----	Car-Crash
91	----	Siren
92	----	Train
93	----	Jetplane
94	----	Helicopter
95	----	Starship
C7 96	----	Gun Shot
97	----	Machine Gun
98	----	Lasergun
99	----	Explosion
100	----	Dog
101	----	Horse-Gallop
102	----	Birds
103	----	Rain
104	----	Thunder
105	----	Wind
106	----	SeaShore
107	----	Stream
C8 108	----	Bubble

GM 2 Instrument List

The SC-8820 receives Initialize for General MIDI 2 (GM2 System On) message.

PC#	CC32	Tone Name	V oices
Piano			
1	0	Piano 1	1
	1	Piano 1w	1
	2	European Pf	1
2	0	Piano 2	2
	1	Piano 2w	2
3	0	Piano 3	2
	1	Piano 3w	2
4	0	Honky-tonk	2
	1	Honky-tonk 2	2
5	0	E.Piano 1	1
	1	St.Soft EP	2
	2	FM+SA EP	2
6	3	Wurly	2
	0	E.Piano 2	2
	1	Detuned EP 2	2
	2	St.FM EP	2
7	3	EP Legend	2
	4	EP Phase	2
	0	Harpsichord	1
	1	Coupled Hps.	2
8	2	Harpsi.w	1
	3	Harpsi.o	2
	0	Clav.	1
1	Pulse Clav	1	

Chromatic percussion

9	0	Celesta	1
10	0	Glockenspiel	1
11	0	Music Box	1
12	0	Vibraphone	1
	1	Vibraphone w	1
13	0	Marimba	1
	1	Marimba w	1
14	0	Xylophone	1
15	0	Tubular-bell	1
	1	Church Bell	1
	2	Carillon	1
	0	Santur	1

Organ

17	0	Organ 1	2
	1	Trem. Organ	2
	2	60's Organ 1	1
18	3	70's E.Organ	2
	0	Organ 2	2
	1	Chorus Or.2	2
19	2	Perc. Organ	2
	0	Organ 3	2
20	0	Church Org.1	1
	1	Church Org.2	2
	2	Church Org.3	2
21	0	Reed Organ	1
	1	Puff Organ	2
22	0	Accordion Fr	1
	1	Accordion It	1
23	0	Harmonica	1
24	0	Bandoneon	2

PC#	CC32	Tone Name	V oices
Guitar			
25	0	Nylon-str.Gt	2
	1	Ukulele	1
	2	Nylon Gt.o	2
26	3	Nylon Gt.2	1
	0	Steel-str.Gt	1
	1	12-str.Gt	2
	2	Mandolin	2
27	3	Steel + Body	2
	0	Jazz Gt.	1
	1	Pedal Steel	1
28	0	Clean Gt.	1
	1	Chorus Gt.	2
29	2	Mid Tone GTR	1
	0	Muted Gt.	1
	1	Funk Pop	1
30	2	Funk Gt.2	1
	3	Jazz Man	2
	0	Overdrive Gt	2
31	1	Guitar Pinch	1
	0	DistortionGt	2
32	1	Feedback Gt.	2
	2	Dist Rtm GTR	1
	0	Gt.Harmonics	1
1	Gt. Feedback	1	

Bass

33	0	Acoustic Bs.	1
34	0	Fingered Bs.	1
	1	Finger Slap	2
35	0	Picked Bass	1
36	0	Fretless Bs.	1
37	0	Slap Bass 1	1
38	0	Slap Bass 2	2
39	0	Synth Bass 1	2
	1	SynthBass101	1
40	2	Acid Bass	1
	3	Clavi Bass	2
	4	Hammer	2
	0	Synth Bass 2	2
1	Beef FM Bass	2	
2	RubberBass 2	2	
3	Attack Pulse	1	

Orchestra

41	0	Violin	:2
	1	Slow Violin	1
42	0	Viola	:2
43	0	Cello	:2
44	0	Contrabass	1
45	0	Tremolo Str	1
46	0	PizzicatoStr	1
47	0	Harp	1
48	1	Yang Qin	2
	0	Timpani	1

Appendices

PC#	CC32	Tone Name	V oices
Ensemble			
49	0	Strings	2
	1	Orchestra	2
	2	60s Strings	2
50	0	Slow Strings	1
51	0	Syn.Strings1	2
	1	Syn.Strings3	2
52	0	Syn.Strings2	2
53	0	Choir Aahs	1
	1	Chorus Aahs	2
54	0	Voice Oohs	1
	1	Humming	2
55	0	SynVox	1
	1	Analog Voice	1
56	0	OrchestraHit	2
	1	Bass Hit	2
	2	6th Hit	2
	3	Euro Hit	2
Brass			
57	0	Trumpet	1
	1	Dark Trumpet	1
58	0	Trombone	1
	1	Trombone 2	1
	2	Bright Tb	1
59	0	Tuba	1
60	0	MutedTrumpet	1
	1	MuteTrumpet2	1
61	0	French Horns	1
	1	Fr.Horn 2	2
62	0	Brass 1	2
	1	Brass 2	2
63	0	Synth Brass1	2
	1	Pro Brass	2
	2	Oct SynBrass	2
	3	Jump Brass	1
64	0	Synth Brass2	2
	1	SynBrass sfz	1
	2	Velo Brass 1	2
Reed			
65	0	Soprano Sax	1
66	0	Alto Sax	1
67	0	Tenor Sax	2
68	0	Baritone Sax	2
69	0	Oboe	1
70	0	English Horn	1
71	0	Bassoon	1
72	0	Clarinet	1
73	0	Piccolo	1
74	0	Flute	1
75	0	Recorder	1
76	0	Pan Flute	2
77	0	Bottle Blow	2
78	0	Shakuhachi	2
79	0	Whistle	1
80	0	Ocarina	1
Synth Lead			
81	0	Square Wave	2
	1	MG Square	1
	2	2600 Sine	1
82	0	Saw Wave	2
	1	OB2 Saw	1
	2	Doctor Solo	2
	3	Natural Lead	2
	4	SequencedSaw	2
83	0	Syn.Calliope	2
84	0	Chiffer Lead	2
85	0	Charang	2
	1	Wire Lead	2
86	0	Solo Vox	2
87	0	5th Saw Wave	2
88	0	Bass & Lead	2
	1	Delayed Lead	2

PC#	CC32	Tone Name	V oices
Synth Pad			
89	0	Fantasia	2
90	0	Warm Pad	1
	1	Sine Pad	2
91	0	Polysynth	2
92	0	Space Voice	1
	1	Itopia	2
93	0	Bowed Glass	2
94	0	Metal Pad	2
95	0	Halo Pad	2
96	0	Sweep Pad	1
Synth SFX			
97	0	Ice Rain	2
98	0	Soundtrack	2
99	0	Crystal	2
	1	Syn Mallet	1
100	0	Atmosphere	2
101	0	Brightness	2
102	0	Goblin	2
103	0	Echo Drops	1
	1	Echo Bell	2
	2	Echo Pan	2
104	0	Star Theme	2
Ethnic misc			
105	0	Sitar	1
	1	Sitar 2	2
106	0	Banjo	1
107	0	Shamisen	1
108	0	Koto	2
	1	Taisho Koto	1
109	0	Kalimba	1
110	0	Bagpipe	1
111	0	Fiddle	1
112	0	Shanai	1
Percussive			
113	0	Tinkle Bell	1
114	0	Agogo	1
115	0	Steel Drums	1
116	0	Woodblock	1
	1	Castanets	1
117	0	Taiko	1
	1	Concert BD	1
118	0	Melo. Tom 1	1
	1	Melo. Tom 2	1
119	0	Synth Drum	1
	1	808 Tom	2
	1	Elec Perc	1
120	0	Reverse Cym.	1

PC#	CC32	Tone Name	Voices
SFX			
121	0	Gt.FretNoise	1
	1	Gt.Cut Noise	1
	2	String Slap	1
122	0	Breath Noise	1
	1	Fl.Key Click	1
123	0	Seashore	1
	1	Rain	1
	2	Thunder	1
	3	Wind	1
	4	Stream	2
	5	Bubble	2
124	0	Bird	2
	1	Dog	1
	2	Horse-Gallop	1
	3	Bird 2	1
125	0	Telephone 1	1
	1	Telephone 2	1
	2	DoorCreaking	1
	3	Door	1
	4	Scratch	1
	5	Wind Chimes	2
126	0	Helicopter	1
	1	Car-Engine	1
	2	Car-Stop	1
	3	Car-Pass	1
	4	Car-Crash	2
	5	Siren	1
	6	Train	1
	7	Jetplane	2
	8	Starship	2
	9	Burst Noise	2
127	0	Applause	2
	1	Laughing	1
	2	Screaming	1
	3	Punch	1
	4	Heart Beat	1
	5	Footsteps	1
128	0	Gun Shot	1
	1	Machine Gun	1
	2	Lasergun	1
	3	Explosion	2

GM 2 Drum Set List

The GM 2 Drum Set corresponds to that of the SC-8820's as follows.

PC	GM2 Name	SC-8820 Name
1	STANDARD	STANDARD 1
9	ROOM	ROOM
17	POWER	POWER
25	ELECTRONIC	ELECTRONIC
26	ANALOG	TR-808
33	JAZZ	JAZZ
41	BRUSH	BRUSH
49	ORCHESTRA	ORCHESTRA
57	SFX	SFX

Insertion Effect List

<Example of effect types and effect parameters>

Parameter	Setting Value	Value (Hex.)	MSB/LSB (H)
-----------	---------------	--------------	-------------

01 : Stereo-EQ			01 00
Low Freq	200/400	00/01	03

- The **MSB/LSB** column shows the following ** portion of the Exclusive message. (Hexadecimal notation) (p.176)
For Effect Type (Data section)
F0 41 dev 42 12 40 03 00 ** ** sum F7
For Effect Parameter (LSB part of address)
F0 41 dev 42 12 40 03 ** data sum F7
(dev: device ID, sum: checksum)
- Parameters that have a + in front of their name can be modified by Effect Control 1 (EFX C.Src1). (p.176)
- Parameters that have a # in front of their name can be modified by Effect Control 2 (EFX C.Src2). (p.176)
- Values shown in boldface in the **Setting Value** column are the default value of the parameter.
- The correspondence between setting values and hexadecimal values for items in the Value column indicated with * is shown in **Effect Parameter Value Conversion Table** (p. 164).

Effect Parameter Value Conversion Table (p. 164).

*1: Pre Delay Time	*6: Rate 1	*11: LPF
*2: Delay Time 1	*7: Rate 2	*12: Manual
*3: Delay Time 2	*8: HF Damp	*13: Azimuth
*4: Delay Time 3	*9: Cutoff Freq	*14: Accl
*5: Delay Time 4	*10: EQ Freq	

○ Effects that modify the tone (filter type)

Parameter	Setting Value	Value (Hex.)	MSB/LSB (H)
-----------	---------------	--------------	-------------

00 : Thru			00 00
------------------	--	--	--------------

01 : Stereo-EQ			01 00
Low Freq	200/400	00/01	03
Low Gain	-12-+5-+12	34-4C	04
Hi Freq	4k/8k	00/01	05
Hi Gain	-12-+12	34-4C	06
M1 Freq	200-1.6k-6.3k	*10	07
M1 Q	0.5/1.0/2.0/4.0/9.0	00/01/02/03/04	08
M1 Gain	-12-+8-+12	34-4C	09
M2 Freq	200-1k-6.3k	*10	0A
M2 Q	0.5/1.0/2.0/4.0/9.0	00/01/02/03/04	0B
M2 Gain	-12-+8-+12	34-4C	0C
+ Level	0-127	00-7F	16

02 : Spectrum			01 01
----------------------	--	--	--------------

Band 1	-12-+4-+12	34-4C	03
Band 2	-12-+1-+12	34-4C	04
Band 3	-12-+3-+12	34-4C	05
Band 4	-12-+6-+12	34-4C	06
Band 5	-12-+2-+12	34-4C	07
Band 6	-12-+1-+12	34-4C	08
Band 7	-12-+4-+12	34-4C	09
Band 8	-12-+5-+12	34-4C	0A
Width	0.5/1.0/2.0/4.0/9.0	00/01/02/03/04	0B
+ Pan	L63-0-R63	00-7F	15
# Level	0-127	00-7F	16

Parameter	Setting Value	Value (Hex.)	MSB/LSB (H)
-----------	---------------	--------------	-------------

03 : Enhancer			01 02
+ Sens	0-64-127	00-7F	03
# Mix	0-127	00-7F	04
Low Gain	-12-+3-+12	34-4C	13
Hi Gain	-12-0-+12	34-4C	14
Level	0-127	00-7F	16

04 : Humanizer			01 03
-----------------------	--	--	--------------

Drive	0-48-127	00-7F	03
Drive Sw	Off/On	00/01	04
+ Vowel	a/i/u/e/o	00/01/02/03/04	05
Accel	0-15	*14	06
Low Gain	-12-0-+12	34-4C	13
Hi Gain	-12-0-+12	34-4C	14
Pan	L63-0-R63	00-7F	15
# Level	0-127	00-7F	16

○ Effects that distort the sound (distortion type)

05 : Overdrive			01 10
-----------------------	--	--	--------------

+ Drive	0-48-127	00-7F	03
Amp Type	Small/BItn/2-Stk/3-Stk	00/01/02/03	04
Amp Sw	Off/On	00/01	05
Low Gain	-12-0-+12	34-4C	13
Hi Gain	-12-0-+12	34-4C	14
# Pan	L63-0-R63	00-7F	15
Level	0-96-127	00-7F	16

06 : Distortion			01 11
------------------------	--	--	--------------

+ Drive	0-76-127	00-7F	03
Amp Type	Small/BItn/2-Stk/3-Stk	00/01/02/03	04
Amp Sw	Off/On	00/01	05
Low Gain	-12-0-+12	34-4C	13
Hi Gain	-12-8-+12	34-4C	14
# Pan	L63-0-R63	00-7F	15
Level	0-84-127	00-7F	16

○ Effects that modulate the sound (modulation type)

07 : Phaser			01 20
--------------------	--	--	--------------

+ Manual	100-620-8k	*12	03
# Rate	0.05-0.85-10.0	*6	04
Depth	0-64-127	00-7F	05
Reso	0-16-127	00-7F	06
Mix	0-127	00-7F	07
Low Gain	-12-0-+12	34-4C	13
Hi Gain	-12-0-+12	34-4C	14
Level	0-104-127	00-7F	16

08 : Auto Wah			01 21
----------------------	--	--	--------------

Fil Type	LPF/BPF	00/01	03
Sens	0-127	00-7F	04
+ Manual	0-68-127	00-7F	05
Peak	0-62-127	00-7F	06
# Rate	0.05-2.05-10.0	*6	07
Depth	0-72-127	00-7F	08
Polarity	Down/Up	00/01	09
Low Gain	-12-0-+12	34-4C	13
Hi Gain	-12-0-+12	34-4C	14
Pan	L63-0-R63	00-7F	15
Level	0-96-127	00-7F	16

Parameter	Setting Value	Value (Hex.)	MSB/LSB (H)
09 : Rotary			01 22
Low Slow	0.05-0.35-10.0	*6	03
Low Fast	0.05-6.40-10.0	*6	04
Low Accl	0-3-15	*14	05
Low Level	0-127	00-7F	06
Hi Slow	0.05-0.90-10.0	*6	07
Hi Fast	0.05-7.50-10.0	*6	08
Hi Accl	0-11-15	*14	09
Hi Level	0-64-127	00-7F	0A
Separate	0-96-127	00-7F	0B
+ Speed	Slow/Fast	00/7F	0D
Low Gain	-12-0-+12	34-4C	13
Hi Gain	-12-0-+12	34-4C	14
# Level	0-127	00-7F	16

Parameter	Setting Value	Value (Hex.)	MSB/LSB (H)
10 : Stereo Flanger			01 23
Pre Filter	Off/LPF/HPF	00/01/02	03
Cutoff	250-8k	*9	04
Pre Dly	0-1.6ms-100ms	*1	05
+ Rate	0.05-0.60-10.0	*6	06
Depth	0-24-127	00-7F	07
# Feedback	-98%-+80%-+98%	0F-71	08
Phase	0-180	00-5A	09
Balance	D> 0E-D=E-D 0<E	00-7F	12
Low Gain	-12-0-+12	34-4C	13
Hi Gain	-12-0-+12	34-4C	14
Level	0-104-127	00-7F	16

Parameter	Setting Value	Value (Hex.)	MSB/LSB (H)
11 : Step Flanger			01 24
Pre Dly	0-1.0ms-100ms	*1	03
Rate	0.05-0.30-10.0	*6	04
Depth	0-95-127	00-7F	05
+ Feedback	-98%-+30%-+98%	0F-71	06
Phase	0-180	00-5A	07
# Step Rate	0.05-2.75-10.0	*6	08
Balance	D> 0E-D=E-D 0<E	00-7F	12
Low Gain	-12-0-+12	34-4C	13
Hi Gain	-12-0-+12	34-4C	14
Level	0-96-127	00-7F	16

Parameter	Setting Value	Value (Hex.)	MSB/LSB (H)
12 : Tremolo			01 25
Mod Wave	Tri/Sqr/Sin/Saw1/Saw2	00/01/02/03/04	03
+ Mod Rate	0.05-3.05-10.0	*6	04
# Mod Depth	0-96-127	00-7F	05
Low Gain	-12-0-+12	34-4C	13
Hi Gain	-12-0-+12	34-4C	14
Level	0-127	00-7F	16

Parameter	Setting Value	Value (Hex.)	MSB/LSB (H)
13 : Auto Pan			01 26
Mod Wave	Tri/Sqr/Sin/Saw1/Saw2	00/01/02/03/04	03
+ Mod Rate	0.05-3.05-10.0	*6	04
# Mod Depth	0-96-127	00-7F	05
Low Gain	-12-0-+12	34-4C	13
Hi Gain	-12-0-+12	34-4C	14
Level	0-127	00-7F	16

○ Effects that affect the level (compressor type)

Parameter	Setting Value	Value (Hex.)	MSB/LSB (H)
14 : Compressor			01 30
Attack	0-72-127	00-7F	03
Sustain	0-100-127	00-7F	04
Post Gain	0/+6/+12/+18	00/01/02/03	05
Low Gain	-12-0-+12	34-4C	13
Hi Gain	-12-0-+12	34-4C	14
+ Pan	L63-0-R63	00-7F	15
# Level	0-104-127	00-7F	16

Parameter	Setting Value	Value (Hex.)	MSB/LSB (H)
15 : Limiter			01 31
Threshold	0-85-127	00-7F	03
Ratio	1/1.5,1/2,1/4,1/100	00/01/02/03	04
Release	0-16-127	00-7F	05
Post Gain	0/+6/+12/+18	00/01/02/03	06
Low Gain	-12-0-+12	34-4C	13
Hi Gain	-12-0-+12	34-4C	14
+ Pan	L63-0-R63	00-7F	15
# Level	0-127	00-7F	16

○ Effects that broaden the sound (chorus type)

Parameter	Setting Value	Value (Hex.)	MSB/LSB (H)
16 : Hexa Chorus			01 40
Pre Dly	0-2.4ms-100ms	*1	03
+ Rate	0.05-0.45-10.0	*6	04
Depth	0-127	00-7F	05
Pre Dly Dev	0-5-20	00-14	06
Depth Dev	-20-+2-+20	2C-54	07
Pan Dev	0-16-20	00-14	08
# Balance	D> 0E-D=E-D 0<E	00-7F	12
Low Gain	-12-0-+12	34-4C	13
Hi Gain	-12-0-+12	34-4C	14
Level	0-112-127	00-7F	16

Parameter	Setting Value	Value (Hex.)	MSB/LSB (H)
17 : Tremolo Chorus			01 41
Pre Dly	0-1.6ms-100ms	*1	03
Cho Rate	0.05-0.45-10.0	*6	04
Cho Depth	0-40-127	00-7F	05
Trem Phase	0-80-180	00-5A	06
+ Trem Rate	0.05-3.05-10.0	*6	07
Trem Sep	0-96-127	00-7F	08
# Balance	D> 0E-D=E-D 0<E	00-7F	12
Low Gain	-12-0-+12	34-4C	13
Hi Gain	-12-0-+12	34-4C	14
Level	0-127	00-7F	16

Parameter	Setting Value	Value (Hex.)	MSB/LSB (H)
18 : Stereo Chorus			01 42
Pre Filter	Off/LPF/HPF	00/01/02	03
Cutoff	250-8k	*9	04
Pre Dly	0-1.0ms-100ms	*1	05
+ Rate	0.05-0.45-10.0	*6	06
Depth	0-111-127	00-7F	07
Phase	0-180	00-5A	09
# Balance	D> 0E-D=E-D 0<E	00-7F	12
Low Gain	-12-0-+12	34-4C	13
Hi Gain	-12-0-+12	34-4C	14
Level	0-104-127	00-7F	16

Parameter	Setting Value	Value (Hex.)	MSB/LSB (H)
19 : Space D			01 43
Pre Dly	0-3.2ms-100ms	*1	03
+ Rate	0.05-0.45-10.0	*6	04
Depth	0-127	00-7F	05
Phase	0-180	00-5A	06
# Balance	D> 0E-D=E-D 0<E	00-7F	12
Low Gain	-12-0-+12	34-4C	13
Hi Gain	-12-0-+12	34-4C	14
Level	0-96-127	00-7F	16

Parameter	Setting Value	Value (Hex.)	MSB/LSB (H)
20 : 3D Chorus			01 44
Pre Dly	0-1.0ms-100ms	*1	03
+ Cho Rate	0.05-0.45-10.0	*6	04
Cho Depth	0-72-127	00-7F	05
Out	Speaker/Phones	00/01	11
# Balance	D> 0E-D=E-D 0<E	00-7F	12
Low Gain	-12-0-+12	34-4C	13
Hi Gain	-12-0-+12	34-4C	14
Level	0-80-127	00-7F	16

Appendices

○ Effects that reverberate the sound (delay/reverb type)

Parameter	Setting Value	Value (Hex.)	MSB/LSB (H)
21 : Stereo Delay 01 50			
Dly Tm L	0-150ms-500ms	*4	03
Dly Tm R	0-300ms-500ms	*4	04
+ Feedback	-98%+48%+98%	0F-71	05
Fb Mode	Norm/Cross	00/01	06
Phase L	Norm/Invert	00/01	07
Phase R	Norm/Invert	00/01	08
HF Damp	315-8k/Bypass	*8	0A
# Balance	D> 0E-D>74E-D 0<E	00-7F	12
Low Gain	-12-0+12	34-4C	13
Hi Gain	-12-0+12	34-4C	14
Level	0-127	00-7F	16
22 : Mod Delay 01 51			
Dly Tm L	0-40ms-500ms	*4	03
Dly Tm R	0-220ms-500ms	*4	04
Feedback	-98%+48%+98%	0F-71	05
Fb Mode	Norm/Cross	00/01	06
+ Mod Rate	0.05-0.65-10.0	*6	07
Mod Depth	0-21-127	00-7F	08
Mod Phase	0-180	00-5A	09
HF Damp	315-8k/Bypass	*8	0A
# Balance	D> 0E-D>61E-D 0<E	00-7F	12
Low Gain	-12-0+12	34-4C	13
Hi Gain	-12-0+12	34-4C	14
Level	0-127	00-7F	16
23 : 3 Tap Delay 01 52			
Dly Tm C	200ms-300ms-990ms/1sec	*2	03
Dly Tm L	200ms-200ms-990ms/1sec	*2	04
Dly Tm R	200ms-235ms-990ms/1sec	*2	05
+ Feedback	-98%+32%+98%	0F-71	06
Dly Lev C	0-127	00-7F	07
Dly Lev L	0-127	00-7F	08
Dly Lev R	0-127	00-7F	09
HF Damp	315-8k/Bypass	*8	0A
# Balance	D> 0E-D>74E-D 0<E	00-7F	12
Low Gain	-12-0+12	34-4C	13
Hi Gain	-12-0+12	34-4C	14
Level	0-127	00-7F	16
24 : 4 Tap Delay 01 53			
Dly Tm 1	200ms-500ms-990ms/1sec	*2	03
Dly Tm 2	200ms-300ms-990ms/1sec	*2	04
Dly Tm 3	200ms-400ms-990ms/1sec	*2	05
Dly Tm 4	200ms-200ms-990ms/1sec	*2	06
Dly Lev 1	0-127	00-7F	07
Dly Lev 2	0-127	00-7F	08
Dly Lev 3	0-127	00-7F	09
Dly Lev 4	0-127	00-7F	0A
+ Feedback	-98%+32%+98%	0F-71	0B
HF Damp	315-8k/Bypass	*8	0C
# Balance	D> 0E-D>74E-D 0<E	00-7F	12
Low Gain	-12-0+12	34-4C	13
Hi Gain	-12-0+12	34-4C	14
Level	0-127	00-7F	16
25 : Tm Ctrl Delay 01 54			
+ Dly Time	200ms-500ms-990ms/1sec	*3	03
Accel	0-10-15	*14	04
# Feedback	-98%+32%+98%	0F-71	05
HF Damp	315-8k/Bypass	*8	06
EFX Pan	L63-0-R63	00-7F	07
Balance	D> 0E-D>74E-D 0<E	00-7F	12
Low Gain	-12-0+12	34-4C	13
Hi Gain	-12-0+12	34-4C	14
Level	0-127	00-7F	16

Parameter	Setting Value	Value (Hex.)	MSB/LSB (H)
26 : Reverb 01 55			
Type	Room1/2/Stage1/2/Hall1/200/01/02/03/04/05		03
Pre Dly	0-74ms-100ms	*1	04
+ Time	0-120-127	00-7F	05
HF Damp	315-6.3k-8k/Bypass	*8	06
# Balance	D> 0E-D=E-D 0<E	00-7F	12
Low Gain	-12-0+12	34-4C	13
Hi Gain	-12-0+12	34-4C	14
Level	0-127	00-7F	16
27 : Gate Reverb 01 56			
Type	Norm/Reverse/Sweep1/2	00/01/02/03	03
Pre Dly	0-0.5ms-100ms	*1	04
Gate Time	0-65ms-500ms	00-63	05
+ Balance	D> 0E-D>65E-D 0<E	00-7F	12
Low Gain	-12-0+12	34-4C	13
Hi Gain	-12-3+12	34-4C	14
# Level	0-112-127	00-7F	16
28 : 3D Delay 01 57			
Dly Tm C	0-300ms-500ms	*4	03
Dly Tm L	0-200ms-500ms	*4	04
Dly Tm R	0-240ms-500ms	*4	05
+ Feedback	-98%+32%+98%	0F-71	06
Dly Lev C	0-40-127	00-7F	07
Dly Lev L	0-64-127	00-7F	08
Dly Lev R	0-64-127	00-7F	09
HF Damp	315-8k/Bypass	*8	0A
Out	Speaker/Phones	00/01	11
# Balance	D> 0E-D>74E-D 0<E	00-7F	12
Low Gain	-12-0+12	34-4C	13
Hi Gain	-12-0+12	34-4C	14
Level	0-127	00-7F	16

○ Effects that modify the pitch (pitch/shift type)

Parameter	Setting Value	Value (Hex.)	MSB/LSB (H)
29 : 2 Pitch Shifter 01 60			
+ Coarse 1	-24+7+12	28-4C	03
Fine 1	-100-4+100	0E-72	04
Pre Dly 1	0-100ms	*1	05
EFX Pan 1	L63-0-R63	00-7F	06
# Coarse 2	-24-5+12	28-4C	07
Fine 2	-100+4+100	0E-72	08
Pre Dly 2	0-100ms	*1	09
EFX Pan 2	L63-0-R63	00-7F	0A
Shift Mode	1-3-5	00-04	0B
L.Bal	A> 0B-A=B-A 0<B	00-7F	0C
Balance	D> 0E-D>74E-D 0<E	00-7F	12
Low Gain	-12-0+12	34-4C	13
Hi Gain	-12-0+12	34-4C	14
Level	0-95-127	00-7F	16
30 : Fb P.Shifter 01 61			
+ P.Coarse	-24+7+12	28-4C	03
P.Fine	-100-0+100	0E-72	04
# Feedback	-98%+40%+98%	0F-71	05
Pre Dly	0-45ms-100ms	*1	06
Mode	1-3-5	00-04	07
EFX Pan	L63-0-R63	00-7F	08
Balance	D> 0E-D=E-D 0<E	00-7F	12
Low Gain	-12-0+12	34-4C	13
Hi Gain	-12-6+12	34-4C	14
Level	0-127	00-7F	16

○ Others

Parameter	Setting Value	Value (Hex.)	MSB/LSB (H)
31 : 3D Auto			01 70
Azimuth	180/L168-0-R168	*13	03
+ Speed	0.05-1.30-10.0	*6	04
Clockwise	-/+	00/01	05
# Turn	Off/On	00/01	06
Out	Speaker/Phones	00/01	11
Level	0-127	00-7F	16
32 : 3D Manual			01 71
+ Azimuth	180/L168-0-R168	*13	03
Out	Speaker/Phones	00/01	11
# Level	0-127	00-7F	16
33 : Lo-Fi 1			01 72
Pre Filter	1-2-6	00-05	03
Lo-Fi Type	1-6-9	00-08	04
Post Filter	1-2-6	00-05	05
+ Balance	D> 0E-D 0<E	00-7F	12
Low Gain	-12-0-+12	34-4C	13
Hi Gain	-12-0-+12	34-4C	14
# Pan	L63-0-R63	00-7F	15
Level	0-127	00-7F	16
34 : Lo-Fi 2			01 73
Lo-Fi Type	1-2-6	00-05	03
Fil Type	Off/LPF/HPF	00/01/02	04
Cutoff	250-630-8k	*9	05
+ R.Detune	0-127	00-7F	06
R.Nz Lev	0-64-127	00-7F	07
W/P Sel	White/Pink	00/01	08
W/P LPF	250-6.3k/Bypass	*11	09
W/P Level	0-127	00-7F	0A
Disc Type	LP/EP/SP/RND	00/01/02/03	0B
Disc LPF	250-6.3k/Bypass	*11	0C
Disc Nz Lev	0-127	00-7F	0D
Hum Type	50Hz/60Hz	00/01	0E
Hum LPF	250-6.3k/Bypass	*11	0F
Hum Level	0-127	00-7F	10
M/S	Mono/Stereo	00-01	11
# Balance	D> 0E-D 0<E	00-7F	12
Low Gain	-12-0-+12	34-4C	13
Hi Gain	-12-0-+12	34-4C	14
Pan(Mono)	L63-0-R63	00-7F	15
Level	0-127	00-7F	16

○ Effects that connect two types of effect in series (series 2)

Parameter	Setting Value	Value (Hex.)	MSB/LSB (H)
35 : OD → Chorus			02 00
OD Drive	0-48-127	00-7F	03
+ OD Pan	L63-0-R63	00-7F	04
OD Amp	Small/BitIn/2-Stk/3-Stk	00/01/02/03	05
OD Amp Sw	Off/On	00/01	06
Cho Dly	0-1.0ms-100ms	*1	08
Cho Rate	0.05-0.45-10.0	*6	09
Cho Depth	0-72-127	00-7F	0A
# Cho Bal	D> 0E-D=E-D 0<E	00-7F	0C
Low Gain	-12-0-+12	34-4C	13
Hi Gain	-12-0-+12	34-4C	14
Level	0-80-127	00-7F	16

Parameter	Setting Value	Value (Hex.)	MSB/LSB (H)
36 : OD → Flanger			02 01
OD Drive	0-48-127	00-7F	03
+ OD Pan	L63-0-R63	00-7F	04
OD Amp	Small/BitIn/2-Stk/3-Stk	00/01/02/03	05
OD Amp Sw	Off/On	00/01	06
FL Dly	0-1.6ms-100ms	*1	08
FL Rate	0.05-0.60-10.0	*6	09
FL Depth	0-40-127	00-7F	0A
FL Fb	-98%+80%+98%	0F-71	0B
# FL Bal	D> 0E-D>49E-D 0<E	00-7F	0C
Low Gain	-12-0-+12	34-4C	13
Hi Gain	-12-0-+12	34-4C	14
Level	0-80-127	00-7F	16
37 : OD → Delay			02 02
OD Drive	0-48-127	00-7F	03
+ OD Pan	L63-0-R63	00-7F	04
OD Amp	Small/BitIn/2-Stk/3-Stk	00/01/02/03	05
OD Amp Sw	Off/On	00/01	06
Dly Time	0-250ms-500ms	*4	08
Dly Fb	-98%+32%+98%	0F-71	09
Dly HF	315-8k/Bypass	*8	0A
# Dly Bal	D> 0E-D>74E-D 0<E	00-7F	0C
Low Gain	-12-0-+12	34-4C	13
Hi Gain	-12-0-+12	34-4C	14
Level	0-80-127	00-7F	16
38 : DS → Chorus			02 03
DS Drive	0-48-127	00-7F	03
+ DS Pan	L63-0-R63	00-7F	04
DS Amp	Small/BitIn/2-Stk/3-Stk	00/01/02/03	05
DS Amp Sw	Off/On	00/01	06
Cho Dly	0-1.0ms-100ms	*1	08
Cho Rate	0.05-0.45-10.0	*6	09
Cho Depth	0-72-127	00-7F	0A
# Cho Bal	D> 0E-D=E-D 0<E	00-7F	0C
Low Gain	-12-0-+12	34-4C	13
Hi Gain	-12-0-+12	34-4C	14
Level	0-72-127	00-7F	16
39 : DS → Flanger			02 04
DS Drive	0-48-127	00-7F	03
+ DS Pan	L63-0-R63	00-7F	04
DS Amp	Small/BitIn/2-Stk/3-Stk	00/01/02/03	05
DS Amp Sw	Off/On	00/01	06
FL Dly	0-1.1ms-100ms	*1	08
FL Rate	0.05-0.60-10.0	*6	09
FL Depth	0-24-127	00-7F	0A
FL Fb	-98%+80%+98%	0F-71	0B
# FL Bal	D> 0E-D>49E-D 0<E	00-7F	0C
Low Gain	-12-0-+12	34-4C	13
Hi Gain	-12-0-+12	34-4C	14
Level	0-72-127	00-7F	16
40 : DS → Delay			02 05
DS Drive	0-48-127	00-7F	03
+ DS Pan	L63-0-R63	00-7F	04
DS Amp	Small/BitIn/2-Stk/3-Stk	00/01/02/03	05
DS Amp Sw	Off/On	00/01	06
Dly Time	0-250ms-500ms	*4	08
Dly Fb	-98%+32%+98%	0F-71	09
Dly HF	315-8k/Bypass	*8	0A
# Dly Bal	D> 0E-D>74E-D 0<E	00-7F	0C
Low Gain	-12-0-+12	34-4C	13
Hi Gain	-12-0-+12	34-4C	14
Level	0-72-127	00-7F	16

Appendices

Parameter	Setting Value	Value (Hex.)	MSB/LSB (H)
41 : EH → Chorus			02 06
+ EH Sens	0- 64 -127	00-7F	03
EH Mix	0- 127	00-7F	04
Cho Dly	0- 14ms -100ms	*1	08
Cho Rate	0.05- 0.45 -10.0	*6	09
Cho Depth	0- 101 -127	00-7F	0A
# Cho Bal	D> 0E- D=E -D 0<E	00-7F	0C
Low Gain	-12- 0 +12	34-4C	13
Hi Gain	-12- 0 +12	34-4C	14
Level	0- 80 -127	00-7F	16

Parameter	Setting Value	Value (Hex.)	MSB/LSB (H)
42 : EH → Flanger			02 07
+ EH Sens	0- 64 -127	00-7F	03
EH Mix	0- 127	00-7F	04
FL Dly	0- 1.6ms -100ms	*1	08
FL Rate	0.05- 0.60 -10.0	*6	09
FL Depth	0- 24 -127	00-7F	0A
FL Fb	-98%- +80% +98%	0F-71	0B
# FL Bal	D> 0E- D>74E -D 0<E	00-7F	0C
Low Gain	-12- 0 +12	34-4C	13
Hi Gain	-12- 0 +12	34-4C	14
Level	0- 96 -127	00-7F	16

Parameter	Setting Value	Value (Hex.)	MSB/LSB (H)
43 : EH → Delay			02 08
+ EH Sens	0- 64 -127	00-7F	03
EH Mix	0- 127	00-7F	04
Dly Time	0- 250ms -500ms	*4	08
Dly Fb	-98%- +32% +98%	0F-71	09
Dly HF	315-8k/ Bypass	*8	0A
# Dly Bal	D> 0E- D>74E -D 0<E	00-7F	0C
Low Gain	-12- 0 +12	34-4C	13
Hi Gain	-12- 0 +12	34-4C	14
Level	0- 88 -127	00-7F	16

Parameter	Setting Value	Value (Hex.)	MSB/LSB (H)
44 : Cho → Delay			02 09
Cho Dly	0- 1.0ms -100ms	*1	03
Cho Rate	0.05- 0.50 -10.0	*6	04
Cho Depth	0- 120 -127	00-7F	05
+ Cho Bal	D> 0E- D=E -D 0<E	00-7F	07
Dly Time	0- 250ms -500ms	*4	08
Dly Fb	-98%- +32% +98%	0F-71	09
Dly HF	315-8k/ Bypass	*8	0A
# Dly Bal	D> 0E- D>74E -D 0<E	00-7F	0C
Low Gain	-12- 0 +12	34-4C	13
Hi Gain	-12- 0 +12	34-4C	14
Level	0- 127	00-7F	16

Parameter	Setting Value	Value (Hex.)	MSB/LSB (H)
45 : FL → Delay			02 0A
FL Dly	0- 1.6ms -100ms	*1	03
FL Rate	0.05- 0.60 -10.0	*6	04
FL Depth	0- 24 -127	00-7F	05
+ FL Fb	-98%- +80% +98%	0F-71	06
FL Bal	D> 0E- D=E -D 0<E	00-7F	07
Dly Time	0- 250ms -500ms	*4	08
Dly Fb	-98%- +32% +98%	0F-71	09
Dly HF	315-8k/ Bypass	*8	0A
# Dly Bal	D> 0E- D>74E -D 0<E	00-7F	0C
Low Gain	-12- 0 +12	34-4C	13
Hi Gain	-12- 0 +12	34-4C	14
Level	0- 127	00-7F	16

Parameter	Setting Value	Value (Hex.)	MSB/LSB (H)
46 : Cho → Flanger			02 0B
Cho Dly	0- 1.0ms -100ms	*1	03
Cho Rate	0.05- 0.45 -10.0	*6	04
Cho Depth	0- 120 -127	00-7F	05
+ Cho Bal	D> 0E- D=E -D 0<E	00-7F	07
FL Dly	0- 1.6ms -100ms	*1	08
FL Rate	0.05- 0.60 -10.0	*6	09
FL Depth	0- 24 -127	00-7F	0A
FL Fb	-98%- +80% +98%	0F-71	0B
# FL Bal	D> 0E- D=E -D 0<E	00-7F	0C
Low Gain	-12- 0 +12	34-4C	13
Hi Gain	-12- 0 +12	34-4C	14
Level	0- 112 -127	00-7F	16

○ Effects that connect three or more types of effect in series (series 3/4/5)

Parameter	Setting Value	Value (Hex.)	MSB/LSB (H)
47 : Rotary Multi			03 00
+ OD Drive	0- 13 -127	00-7F	03
OD Sw	Off/ On	00/01	04
EQ L Gain	-12- 0 +12	34-4C	05
EQ M Fq	200- 1.6k -6.3k	*10	06
EQ M Q	0.5 /1.0/2.0/4.0/9.0	00/01/02/03/04	07
EQ M Gain	-12- 0 +12	34-4C	08
EQ H Gain	-12- 0 +12	34-4C	09
RT L Slow	0.05- 0.35 -10.0	*6	0A
RT L Fast	0.05- 6.40 -10.0	*6	0B
RT Lo Accl	0- 3 -15	*14	0C
RT Lo Lev	0- 127	00-7F	0D
RT H Slow	0.05- 0.90 -10.0	*6	0E
RT H Fast	0.05- 7.50 -10.0	*6	0F
RT Hi Accl	0- 11 -15	*14	10
RT Hi Lev	0- 64 -127	00-7F	11
RT Sept	0- 96 -127	00-7F	12
# RT Speed	Slow /Fast	00/7F	13
Level	0- 96 -127	00-7F	16

Parameter	Setting Value	Value (Hex.)	MSB/LSB (H)
48 : GTR Multi 1			04 00
Cmp Atck	0- 100 -127	00-7F	03
Cmp Sus	0- 80 -127	00-7F	04
Cmp Level	0- 100 -127	00-7F	05
Cmp Sw	Off/ On	00/01	06
OD Sel	Odrv /Dist	00/01	07
+ OD Drive	0- 80 -127	00-7F	08
OD Amp	Small /Bltn/2-Stk/3-Stk	00/01/02/03	09
OD Amp Sw	Off/ On	00/01	0A
OD L Gain	-12- +5 +12	34-4C	0B
OD H Gain	-12- +10 +12	34-4C	0C
OD Sw	Off/ On	00/01	0D
CF Sel	Chorus /Flangr	00/01	0E
CF Rate	0.05- 0.45 -6.40	*7	0F
CF Depth	0- 30 -127	00-7F	10
CF Fb	-98%- +76% +98%	0F-71	11
CF Mix	0- 40 -127	00-7F	12
Dly Time	0- 300ms -635ms	*5	13
Dly Fb	0- 34 -127	00-7F	14
# Dly Mix	0- 15 -127	00-7F	15
Level	0- 110 -127	00-7F	16

Parameter	Setting Value	Value (Hex.)	MSB/LSB (H)	Parameter	Setting Value	Value (Hex.)	MSB/LSB (H)
49 : GTR Multi 2				52 : Clean Gt Multi2			
Cmp Atck	0-70-127	00-7F	04 01	AW Filter	LPF/BPF	00/01	04 04
Cmp Sus	0-127	00-7F	03	+ AW Man	0-55-127	00-7F	03
Cmp Level	0-90-127	00-7F	04	AW Peak	0-40-127	00-7F	04
Cmp Sw	Off/On	00/01	05	AW Rate	0.05-1.50-6.40	*7	05
OD Sel	Odrv/Dist	00/01	06	AW Depth	0-80-127	00-7F	06
+ OD Drive	0-80-127	00-7F	07	AW Sw	Off/On	00/01	07
OD Amp	Small/Bltn/2-Stk/3-Stk	00/01/02/03	08	EQ L Gain	-12-+12	34-4C	08
OD Amp Sw	Off/On	00/01	09	EQ M Fq	200-1.6k-6.3k	*10	09
OD Sw	Off/On	00/01	0A	EQ M Q	0.5/1.0/2.0/4.0/9.0	00/01/02/03/04	0A
EQ L Gain	-12-+12	34-4C	0B	EQ M Gain	-12-0-+12	34-4C	0B
EQ M Fq	200-1k-6.3k	*10	0C	EQ H Gain	-12-0-+12	34-4C	0C
EQ M Q	0.5/1.0/2.0/4.0/9.0	00/01/02/03/04	0D	CF Sel	Chorus/Flangr	00/01	0D
EQ M Gain	-12-+5-+12	34-4C	0E	CF Rate	0.05-0.45-6.40	*7	0E
EQ H Gain	-12-10-+12	34-4C	0F	CF Depth	0-20-127	00-7F	0F
CF Sel	Chorus/Flangr	00/01	10	CF Fb	-98%-+76%-+98%	0F-71	10
CF Rate	0.05-0.45-6.40	*7	11	CF Mix	0-100-127	00-7F	11
CF Depth	0-96-127	00-7F	12	Dly Time	0-30ms-635ms	*5	12
CF Fb	-98%-+76%-+98%	0F-71	13	Dly Fb	0-15-127	00-7F	13
# CF Mix	0-127	00-7F	14	# Dly Mix	0-80-127	00-7F	14
Level	0-80-127	00-7F	15	Level	0-76-127	00-7F	15
			16				16
50 : GTR Multi 3				53 : Bass Multi			
Wah Fil	LPF/BPF	00/01	04 02	Cmp Atck	0-72-127	00-7F	04 05
+ Wah Man	0-60-127	00-7F	03	Cmp Sus	0-100-127	00-7F	03
Wah Peak	0-10-127	00-7F	04	Cmp Level	0-75-127	00-7F	04
Wah Sw	Off/On	00/01	05	Cmp Sw	Off/On	00/01	05
OD Sel	Odrv/Dist	00/01	06	OD Sel	Odrv/Dist	00/01	06
# OD Drive	0-80-127	00-7F	07	+ OD Drive	0-48-127	00-7F	07
OD Amp	Small/Bltn/2-Stk/3-Stk	00/01/02/03	08	OD Amp	Small/Bltn/2-Stk	00/01/02	08
OD Amp Sw	Off/On	00/01	09	OD Amp Sw	Off/On	00/01	09
OD L Gain	-12-0-+12	34-4C	0A	OD Sw	Off/On	00/01	0A
OD H Gain	-12-0-+12	34-4C	0B	EQ L Gain	-12-+2-+12	34-4C	0B
OD Sw	Off/On	00/01	0C	EQ M Fq	200-1.6k-6.3k	*10	0C
CF Sel	Chorus/Flangr	00/01	0D	EQ M Q	0.5/1.0/2.0/4.0/9.0	00/01/02/03/04	0D
CF Rate	0.05-0.45-6.40	*7	0E	EQ M Gain	-12-+4-+12	34-4C	0E
CF Depth	0-127	00-7F	0F	EQ H Gain	-12-0-+12	34-4C	0F
CF Fb	-98%-+50%-+98%	0F-71	10	CF Sel	Chorus/Flangr	00/01	10
CF Mix	0-50-127	00-7F	11	CF Rate	0.05-0.30-6.40	*7	11
Dly Time	0-160ms-635ms	*5	12	CF Depth	0-20-127	00-7F	12
Dly Fb	0-64-127	00-7F	13	CF Fb	-98%-+76%-+98%	0F-71	13
Dly Mix	0-30-127	00-7F	14	# CF Mix	0-64-127	00-7F	14
Level	0-88-127	00-7F	15	Level	0-76-127	00-7F	15
			16				16
51 : Clean Gt Multi 1				54 : Rhodes Multi			
Cmp Atck	0-50-127	00-7F	04 03	EH Sens	0-64-127	00-7F	04 06
Cmp Sus	0-127	00-7F	03	EH Mix	0-64-127	00-7F	03
Cmp Level	0-75-127	00-7F	04	PH Man	100-620-8k	*12	04
Cmp Sw	Off/On	00/01	05	PH Rate	0.05-0.85-6.40	*7	05
EQ L Gain	-12-+12	34-4C	06	PH Depth	0-32-127	00-7F	06
EQ M Fq	200-6.3k	*10	07	PH Reso	0-16-127	00-7F	07
EQ M Q	0.5/1.0/2.0/4.0/9.0	00/01/02/03/04	08	PH Mix	0-64-127	00-7F	08
EQ M Gain	-12-+5-+12	34-4C	09	CF Sel	Chorus/Flangr	00/01	09
EQ H Gain	-12-+12	34-4C	0A	CF LPF	250-6.3k/Bypass	*11	0A
CF Sel	Chorus/Flangr	00/01	0B	CF Dly	0-1.0ms-100ms	*1	0B
CF Rate	0.05-0.45-6.40	*7	0C	CF Rate	0.05-0.45-6.40	*7	0C
CF Depth	0-40-127	00-7F	0D	CF Depth	0-64-127	00-7F	0D
CF Fb	-98%-+30%-+98%	0F-71	0E	CF Fb	-98%-+80%-+98%	0F-71	0E
+ CF Mix	0-100-127	00-7F	0F	CF Mix	0-127	00-7F	0F
Dly Time	0-120ms-635ms	*5	10	TP Sel	Trem/Pan	00/01	10
Dly Fb	0-40-127	00-7F	11	TP Mod WV	Iri/Sqr/Sin/Saw1/Saw2	00/01/02/03/04	11
Dly HF	315-8k/Bypass	*8	12	+ TP Mod RT	0.05-3.05-6.40	*7	12
# Dly Mix	0-30-127	00-7F	13	# TP Mod Dep	0-64-127	00-7F	13
Level	0-95-127	00-7F	14	TP Sw	Off/On	00/01	14
			15	Level	0-127	00-7F	15
			16				16

Appendices

Parameter	Setting Value	Value (Hex.)	MSB/LSB (H)
55 : Keyboard Multi			
+ RM Mod Freq	0-50-127	00-7F	03
# RM Bal	D> 0E-D>30E-D 0<E	00-7F	04
EQ L Gain	-12-+3-+12	34-4C	05
EQ M Fq	200-6.3k	*10	06
EQ M Q	0.5/1.0/2.0/4.0/9.0	00/01/02/03/04	07
EQ M Gain	-12-+5-+12	34-4C	08
EQ H Gain	-12-3-+12	34-4C	09
PS Coarse	-24-+7-+12	28-4C	0A
PS Fine	-100-0-+100	0E-72	0B
PS Mode	1-5	00-04	0C
PS Bal	D> 0E-D>60E-D 0<E	00-7F	0D
PH Man	100-620-8k	*12	0E
PH Rate	0.05-0.45-6.40	*7	0F
PH Depth	0-90-127	00-7F	10
PH Reso	0-80-127	00-7F	11
PH Mix	0-75-127	00-7F	12
Dly Time	0-100ms-635ms	*5	13
Dly Fb	0-64-127	00-7F	14
Dly Mix	0-40-127	00-7F	15
Level	0-96-127	00-7F	16

○ Effects that connect two types of effect in parallel (parallel 2)

Parameter	Setting Value	Value (Hex.)	MSB/LSB (H)
56 : Cho / Delay			
Cho Dly	0-1.0ms-100ms	*1	03
Cho Rate	0.05-0.45-10.0	*6	04
Cho Depth	0-120-127	00-7F	05
+ Cho Bal	D> 0E-D=E-D 0<E	00-7F	07
Cho Pan	L63-0-R63	00-7F	12
Cho Level	0-127	00-7F	13
Dly Time	0-250ms-500ms	*4	08
Dly Fb	-98%-+32%-+98%	0F-71	09
Dly HF	315-8k/Bypass	*8	0A
# Dly Bal	D> 0E-D>61E-D 0<E	00-7F	0C
Dly Pan	L63-0-R63	00-7F	14
Dly Level	0-127	00-7F	15
Level	0-96-127	00-7F	16

Parameter	Setting Value	Value (Hex.)	MSB/LSB (H)
57 : FL / Delay			
FL Dly	0-1.6ms-100ms	*1	03
FL Rate	0.05-0.60-10.0	*6	04
FL Depth	0-24-127	00-7F	05
FL Fb	-98%-+80%-+98%	0F-71	06
+ FL Bal	D> 0E-D=E-D 0<E	00-7F	07
FL Pan	L63-0-R63	00-7F	12
FL Level	0-127	00-7F	13
Dly Time	0-250ms-500ms	*4	08
Dly Fb	-98%-+32%-+98%	0F-71	09
Dly HF	315-8k/Bypass	*8	0A
# Dly Bal	D> 0E-D>74E-D 0<E	00-7F	0C
Dly Pan	L63-0-R63	00-7F	14
Dly Level	0-127	00-7F	15
Level	0-96-127	00-7F	16

Parameter	Setting Value	Value (Hex.)	MSB/LSB (H)
58 : Cho / Flanger			
Cho Dly	0-1.6ms-100ms	*1	03
Cho Rate	0.05-0.45-10.0	*6	04
Cho Depth	0-120-127	00-7F	05
+ Cho Bal	D> 0E-D=E-D 0<E	00-7F	07
Cho Pan	L63-0-R63	00-7F	12
Cho Level	0-127	00-7F	13
FL Dly	0-1.6ms-100ms	*1	08
FL Rate	0.05-0.60-10.0	*6	09
FL Depth	0-24-127	00-7F	0A
FL Fb	-98%-+80%-+98%	0F-71	0B
# FL Bal	D> 0E-D=E-D 0<E	00-7F	0C
FL Pan	L63-0-R63	00-7F	14
FL Level	0-127	00-7F	15
Level	0-88-127	00-7F	16

Parameter	Setting Value	Value (Hex.)	MSB/LSB (H)
59 : OD1 / OD2			
OD1 Sel	Odrv/Dist	00/01	03
+ OD1 Drive	0-48-127	00-7F	04
OD1 Amp	Small/Bltn/2-Stk/3-Stk	00/01/02/03	05
OD1 Amp Sw	Off/On	00/01	06
OD1 Pan	L63-0-R63	00-7F	12
OD1 Level	0-96-127	00-7F	13
OD2 Sel	Odrv/Dist	00/01	08
# OD2 Drive	0-76-127	00-7F	09
OD2 Amp	Small/Bltn/2-Stk/3-Stk	00/01/02/03	0A
OD2 Amp Sw	Off/On	00/01	0B
OD2 Pan	L63-0-R63	00-7F	14
OD2 Level	0-84-127	00-7F	15
Level	0-127	00-7F	16

Parameter	Setting Value	Value (Hex.)	MSB/LSB (H)
60 : OD / Rotary			
OD Sel	Odrv/Dist	00/01	03
+ OD Drive	0-48-127	00-7F	04
OD Amp	Small/Bltn/2-Stk/3-Stk	00/01/02/03	05
OD Amp Sw	Off/On	00/01	06
OD Pan	L63-0-R63	00-7F	12
OD Level	0-96-127	00-7F	13
RT L Slow	0.05-0.35-10.0	*6	08
RT L Fast	0.05-6.40-10.0	*6	09
RT Lo Accl	0-3-15	*14	0A
RT Lo Lev	0-127	00-7F	0B
RT H Slow	0.05-0.90-10.0	*6	0C
RT H Fast	0.05-7.50-10.0	*6	0D
RT Hi Accl	0-11-15	*14	0E
RT Hi Lev	0-64-127	00-7F	0F
RT Sept	0-96-127	00-7F	10
# RT Speed	Slow/Fast	00/7F	11
RT Pan	L63-0-R63	00-7F	14
RT Level	0-127	00-7F	15
Level	0-127	00-7F	16

Parameter	Setting Value	Value (Hex.)	MSB/LSB (H)
61 : OD / Phaser			
OD Sel	Odrv/Dist	00/01	03
+ OD Drive	0-48-127	00-7F	04
OD Amp	Small/Bltn/2-Stk/3-Stk	00/01/02/03	05
OD Amp Sw	Off/On	00/01	06
OD Pan	L63-0-R63	00-7F	12
OD Level	0-96-127	00-7F	13
PH Man	100-620-8k	*12	08
# PH Rate	0.05-0.85-10.0	*6	09
PH Depth	0-64-127	00-7F	0A
PH Reso	0-16-127	00-7F	0B
PH Mix	0-127	00-7F	0C
PH Pan	L63-0-R63	00-7F	14
PH Level	0-127	00-7F	15
Level	0-127	00-7F	16

Parameter	Setting Value	Value (Hex.)	MSB/LSB (H)
62 : OD / AutoWah			
OD Sel	Odrv/Dist	00/01	03
+ OD Drive	0-48-127	00-7F	04
OD Amp	Small/Bltn/2-Stk/3-Stk	00/01/02/03	05
OD Amp Sw	Off/On	00/01	06
OD Pan	L63-0-R63	00-7F	12
OD Level	0-96-127	00-7F	13
AW Filter	LPF/BPF	00/01	08
AW Sens	0-127	00-7F	09
# AW Man	0-68-127	00-7F	0A
AW Peak	0-62-127	00-7F	0B
AW Rate	0.05-2.05-10.0	*6	0C
AW Depth	0-72-127	00-7F	0D
AW Pol	Down/Up	00/01	0E
AW Pan	L63-0-R63	00-7F	14
AW Level	0-127	00-7F	15
Level	0-127	00-7F	16

Parameter	Setting Value	Value (Hex.)	MSB/LSB (H)
63 : PH / Rotary			
PH Man	100- 620 -8k	*12	11 07
+ PH Rate	0.05- 0.85 -10.0	*6	03
PH Depth	0- 64 -127	00-7F	04
PH Reso	0- 16 -127	00-7F	05
PH Mix	0- 127	00-7F	06
PH Pan	L63 -0-R63	00-7F	07
PH Level	0- 127	00-7F	12
RT L Slow	0.05- 0.35 -10.0	*6	13
RT L Fast	0.05- 6.40 -10.0	*6	08
RT Lo Accl	0- 3 -15	*14	09
RT Lo Lev	0- 127	00-7F	0A
RT H Slow	0.05- 0.90 -10.0	*6	0B
RT H Fast	0.05- 7.50 -10.0	*6	0C
RT Hi Accl	0- 11 -15	*14	0D
RT Hi Lev	0- 64 -127	00-7F	0E
RT Sept	0- 96 -127	00-7F	0F
# RT Speed	Slow /Fast	00/7F	10
RT Pan	L63-0- R63	00-7F	11
RT Level	0- 127	00-7F	14
Level	0- 127	00-7F	15
			16
64 : PH / AutoWah			
PH Man	100- 620 -8k	*12	11 08
+ PH Rate	0.05- 0.85 -10.0	*6	03
PH Depth	0- 64 -127	00-7F	04
PH Reso	0- 16 -127	00-7F	05
PH Mix	0- 127	00-7F	06
PH Pan	L63 -0-R63	00-7F	07
PH Level	0- 127	00-7F	12
AW Filter	LPF/ BPF	00/01	13
AW Sens	0-127	00-7F	08
# AW Man	0- 68 -127	00-7F	09
AW Peak	0- 62 -127	00-7F	0A
AW Rate	0.05- 2.05 -10.0	*6	0B
AW Depth	0- 72 -127	00-7F	0C
AW Pol	Down/ Up	00/01	0D
AW Pan	L63-0- R63	00-7F	0E
AW Level	0- 127	00-7F	14
Level	0- 127	00-7F	15
			16

Effect Parameter Value Conversion Table

Here is a table for converting between the hexadecimal value and the actual setting for each parameter. These parameters are used in the following effect types.

- | | | | | | |
|---|--|---|---|---|--|
| 1. Pre Delay Time
10: Stereo Flanger
11: Step Flanger
16: Hexa Chorus
17: Tremolo Chorus
18: Stereo Chorus
19: Space-D
20: 3D Chorus
26: Reverb
27: Gate Reverb
29: 2 Pitch Shifter
30: Fb P.Shifter
35: OD → Chorus
36: OD → Flanger
38: DS → Chorus
39: DS → Flanger
41: EH → Chorus
42: EH → Flanger
44: Cho → Delay
45: FL → Delay
46: Cho → Flanger
54: Rhodes Multi
56: Cho/Delay
57: FL/Delay
58: Cho/Flanger | 2. Delay Time1
23: 3 Tap Delay
24: 4 Tap Delay

3. Delay Time2
25: Tm Ctrl Delay

4. Delay Time3
21: Stereo Delay
22: Mod Delay
28: 3D Delay
37: OD → Delay
40: DS → Delay
43: EH → Delay
44: Cho → Delay
45: FL → Delay
56: Cho/Delay
57: FL/Delay

5. Delay Time4
48: GTR Multi 1
50: GTR Multi 3
51: Clean Gt Multi 1
52: Clean Gt Multi 2
55: Keyboard Multi | 6. Rate1
07: Phaser
08: Auto Wah
09: Rotary
10: Stereo Flanger
11: Step Flanger
12: Tremolo
13: Auto Pan
16: Hexa Chorus
17: Tremolo Chorus
18: Stereo Chorus
19: Space-D
20: 3D Chorus
22: Mod Delay
31: 3D Auto
35: OD → Chorus
36: OD → Flanger
38: DS → Chorus
39: DS → Flanger
41: EH → Chorus
42: EH → Flanger
44: Cho → Delay
45: FL → Delay
46: Cho → Flanger
47: Rotary Multi | 56: Cho/Delay
57: FL/Delay
58: Cho/Flanger
60: OD/Rotary
61: OD/Phaser
62: OD/Auto Wah
63: PH/Rotary
64: PH/Auto Wah

7. Rate 2
48: GTR Multi 1
49: GTR Multi 2
50: GTR Multi 3
51: Clean Gt Multi 1
52: Clean Gt Multi 2
53: Bass Multi
54: Rhodes Multi
55: Keyboard Multi

8. HF Damp
21: Stereo Delay
22: Mod Delay
23: 3 Tap Delay
24: 4 Tap Delay
25: Tm Ctrl Delay | 26: Reverb
28: 3D Delay
37: OD → Delay
40: DS → Delay
43: EH → Delay
44: Cho → Delay
45: FL → Delay
51: Clean Gt Multi 1
56: Cho/Delay
57: FL/Delay

9. Cutoff Freq
10: Stereo Flanger
18: Stereo Chorus
34: Lo-Fi 2

10. EQ Freq
01: Stereo-EQ
47: Rotary Multi
49: GTR Multi 2
51: Clean Gt Multi 1
52: Clean Gt Multi 2
53: Bass Multi
55: Keyboard Multi | 11. LPF
34: Lo-Fi 2
54: Rhodes Multi

12. Manual
07: Phaser
54: Rhodes Multi
55: Keyboard Multi
61: OD/Phaser
63: PH/Rotary
64: PH/Auto Wah

13. Azimuth
31: 3D Auto
32: 3D Locate

14. Accel
04: Humanizer
09: Rotary
60: OD/Rotary
63: PH/Rotary |
|---|--|---|---|---|--|

Value (Hex.)	Value (Dec.)	1 Pre Delay Time (ms)	2 Delay Time 1 (ms)	3 Delay Time 2 (ms)	4 Delay Time 3 (ms)	5 Delay Time 4 (ms)	6 Rate1 (Hz)	7 Rate2 (Hz)	8 HF Damp (Hz)	9 Cutoff Freq (Hz)	10 EQ Freq (Hz)	11 LPF (Hz)	12 Manual (Hz)	13 Azimuth (deg)	14 Accel
00	0	0.0	200	200	0.0	0	0.05	0.05	315	250	200	250	100	L180(=R180)	0
01	1	0.1	205	205	0.1	5	0.10	0.10	"	"	"	"	110	"	"
02	2	0.2	210	210	0.2	10	0.15	0.15	"	"	"	"	120	"	"
03	3	0.3	215	215	0.3	15	0.20	0.20	"	"	"	"	130	"	"
04	4	0.4	220	220	0.4	20	0.25	0.25	"	"	"	"	140	"	"
05	5	0.5	225	225	0.5	25	0.30	0.30	"	"	"	"	150	"	"
06	6	0.6	230	230	0.6	30	0.35	0.35	"	"	"	"	160	L168	"
07	7	0.7	235	235	0.7	35	0.40	0.40	"	"	"	"	170	"	"
08	8	0.8	240	240	0.8	40	0.45	0.45	400	315	250	315	180	"	1
09	9	0.9	245	245	0.9	45	0.50	0.50	"	"	"	"	190	"	"
0A	10	1.0	250	250	1.0	50	0.55	0.55	"	"	"	"	200	L156	"
0B	11	1.1	255	255	1.1	55	0.60	0.60	"	"	"	"	210	"	"
0C	12	1.2	260	260	1.2	60	0.65	0.65	"	"	"	"	220	"	"
0D	13	1.3	265	265	1.3	65	0.70	0.70	"	"	"	"	230	"	"
0E	14	1.4	270	270	1.4	70	0.75	0.75	"	"	"	"	240	L144	"
0F	15	1.5	275	275	1.5	75	0.80	0.80	"	"	"	"	250	"	"
10	16	1.6	280	280	1.6	80	0.85	0.85	500	400	315	400	260	"	2
11	17	1.7	285	285	1.7	85	0.90	0.90	"	"	"	"	270	"	"
12	18	1.8	290	290	1.8	90	0.95	0.95	"	"	"	"	280	L132	"
13	19	1.9	295	295	1.9	95	1.00	1.00	"	"	"	"	290	"	"
14	20	2.0	300	300	2.0	100	1.05	1.05	"	"	"	"	300	"	"
15	21	2.1	305	305	2.1	105	1.10	1.10	"	"	"	"	320	"	"
16	22	2.2	310	310	2.2	110	1.15	1.15	"	"	"	"	340	L120	"
17	23	2.3	315	315	2.3	115	1.20	1.20	"	"	"	"	360	"	"
18	24	2.4	320	320	2.4	120	1.25	1.25	630	500	400	500	380	"	3
19	25	2.5	325	325	2.5	125	1.30	1.30	"	"	"	"	400	"	"
1A	26	2.6	330	330	2.6	130	1.35	1.35	"	"	"	"	420	L108	"
1B	27	2.7	335	335	2.7	135	1.40	1.40	"	"	"	"	440	"	"
1C	28	2.8	340	340	2.8	140	1.45	1.45	"	"	"	"	460	"	"
1D	29	2.9	345	345	2.9	145	1.50	1.50	"	"	"	"	480	"	"
1E	30	3.0	350	350	3.0	150	1.55	1.55	"	"	"	"	500	L96	"
1F	31	3.1	355	355	3.1	155	1.60	1.60	"	"	"	"	520	"	"
20	32	3.2	360	360	3.2	160	1.65	1.65	800	630	500	630	540	"	4
21	33	3.3	365	365	3.3	165	1.70	1.70	"	"	"	"	560	"	"
22	34	3.4	370	370	3.4	170	1.75	1.75	"	"	"	"	580	L84	"
23	35	3.5	375	375	3.5	175	1.80	1.80	"	"	"	"	600	"	"
24	36	3.6	380	380	3.6	180	1.85	1.85	"	"	"	"	620	"	"
25	37	3.7	385	385	3.7	185	1.90	1.90	"	"	"	"	640	"	"
26	38	3.8	390	390	3.8	190	1.95	1.95	"	"	"	"	660	L72	"
27	39	3.9	395	395	3.9	195	2.00	2.00	"	"	"	"	680	"	"
28	40	4.0	400	400	4.0	200	2.05	2.05	1000	800	630	800	700	"	5
29	41	4.1	405	405	4.1	205	2.10	2.10	"	"	"	"	720	"	"
2A	42	4.2	410	410	4.2	210	2.15	2.15	"	"	"	"	740	L60	"
2B	43	4.3	415	415	4.3	215	2.20	2.20	"	"	"	"	760	"	"
2C	44	4.4	420	420	4.4	220	2.25	2.25	"	"	"	"	780	"	"
2D	45	4.5	425	425	4.5	225	2.30	2.30	"	"	"	"	800	"	"
2E	46	4.6	430	430	4.6	230	2.35	2.35	"	"	"	"	820	L48	"
2F	47	4.7	435	435	4.7	235	2.40	2.40	"	"	"	"	840	"	"

Appendices

		1	2	3	4	5	6	7	8	9	10	11	12	13	14
Value (Hex.)	Value (Dec.)	Pre Delay Time (ms)	Delay Time 1 (ms)	Delay Time 2 (ms)	Delay Time 3 (ms)	Delay Time 4 (ms)	Rate1 (Hz)	Rate2 (Hz)	HF Damp (Hz)	Cutoff Freq (Hz)	EQ Freq (Hz)	LPF (Hz)	Manual (Hz)	Azimuth (deg)	Accl
30	48	4.8	440	440	4.8	240	2.45	2.45	1250	1000	800	1000	860	"	6
31	49	4.9	445	445	4.9	245	2.50	2.50	"	"	"	"	880	"	"
32	50	5.0	450	450	5.0	250	2.55	2.55	"	"	"	"	900	L36	"
33	51	5.5	455	455	5.5	255	2.60	2.60	"	"	"	"	920	"	"
34	52	6.0	460	460	6.0	260	2.65	2.65	"	"	"	"	940	"	"
35	53	6.5	465	465	6.5	265	2.70	2.70	"	"	"	"	960	"	"
36	54	7.0	470	470	7.0	270	2.75	2.75	"	"	"	"	980	L24	"
37	55	7.5	475	475	7.5	275	2.80	2.80	"	"	"	"	1000	"	"
38	56	8.0	480	480	8.0	280	2.85	2.85	1600	1250	1000	1250	1100	"	7
39	57	8.5	485	485	8.5	285	2.90	2.90	"	"	"	"	1200	"	"
3A	58	9.0	490	490	9.0	290	2.95	2.95	"	"	"	"	1300	L12	"
3B	59	9.5	495	495	9.5	295	3.00	3.00	"	"	"	"	1400	"	"
3C	60	10	500	500	10	300	3.05	3.05	"	"	"	"	1500	"	"
3D	61	11	505	505	11	305	3.10	3.10	"	"	"	"	1600	"	"
3E	62	12	510	510	12	310	3.15	3.15	"	"	"	"	1700	0	"
3F	63	13	515	515	13	315	3.20	3.20	"	"	"	"	1800	"	"
40	64	14	520	520	14	320	3.25	3.25	2000	1600	1250	1600	1900	0	8
41	65	15	525	525	15	325	3.30	3.30	"	"	"	"	2000	"	"
42	66	16	530	530	16	330	3.35	3.35	"	"	"	"	2100	R12	"
43	67	17	535	535	17	335	3.40	3.40	"	"	"	"	2200	"	"
44	68	18	540	540	18	340	3.45	3.45	"	"	"	"	2300	"	"
45	69	19	545	545	19	345	3.50	3.50	"	"	"	"	2400	"	"
46	70	20	550	550	20	350	3.55	3.55	"	"	"	"	2500	R24	"
47	71	21	560	555	21	355	3.60	3.60	"	"	"	"	2600	"	"
48	72	22	570	560	22	360	3.65	3.65	2500	2000	1600	2000	2700	"	9
49	73	23	580	565	23	365	3.70	3.70	"	"	"	"	2800	"	"
4A	74	24	590	570	24	370	3.75	3.75	"	"	"	"	2900	R36	"
4B	75	25	600	575	25	375	3.80	3.80	"	"	"	"	3000	"	"
4C	76	26	610	580	26	380	3.85	3.85	"	"	"	"	3100	"	"
4D	77	27	620	585	27	385	3.90	3.90	"	"	"	"	3200	"	"
4E	78	28	630	590	28	390	3.95	3.95	"	"	"	"	3300	R48	"
4F	79	29	640	595	29	395	4.00	4.00	"	"	"	"	3400	"	"
50	80	30	650	600	30	400	4.05	4.05	3150	2500	2000	2500	3500	"	10
51	81	31	660	610	31	405	4.10	4.10	"	"	"	"	3600	"	"
52	82	32	670	620	32	410	4.15	4.15	"	"	"	"	3700	R60	"
53	83	33	680	630	33	415	4.20	4.20	"	"	"	"	3800	"	"
54	84	34	690	640	34	420	4.25	4.25	"	"	"	"	3900	"	"
55	85	35	700	650	35	425	4.30	4.30	"	"	"	"	4000	"	"
56	86	36	710	660	36	430	4.35	4.35	"	"	"	"	4100	R72	"
57	87	37	720	670	37	435	4.40	4.40	"	"	"	"	4200	"	"
58	88	38	730	680	38	440	4.45	4.45	4000	3150	2500	3150	4300	"	11
59	89	39	740	690	39	445	4.50	4.50	"	"	"	"	4400	"	"
5A	90	40	750	700	40	450	4.55	4.55	"	"	"	"	4500	R84	"
5B	91	41	760	710	50	455	4.60	4.60	"	"	"	"	4600	"	"
5C	92	42	770	720	60	460	4.65	4.65	"	"	"	"	4700	"	"
5D	93	43	780	730	70	465	4.70	4.70	"	"	"	"	4800	"	"
5E	94	44	790	740	80	470	4.75	4.75	"	"	"	"	4900	R96	"
5F	95	45	800	750	90	475	4.80	4.80	"	"	"	"	5000	"	"
60	96	46	810	760	100	480	4.85	4.85	5000	4000	3150	4000	5100	"	12
61	97	47	820	770	110	485	4.90	4.90	"	"	"	"	5200	"	"
62	98	48	830	780	120	490	4.95	4.95	"	"	"	"	5300	R108	"
63	99	49	840	790	130	495	5.00	5.00	"	"	"	"	5400	"	"
64	100	50	850	800	140	500	5.10	5.05	"	"	"	"	5500	"	"
65	101	52	860	810	150	505	5.20	5.10	"	"	"	"	5600	"	"
66	102	54	870	820	160	510	5.30	5.15	"	"	"	"	5700	R120	"
67	103	56	880	830	170	515	5.40	5.20	"	"	"	"	5800	"	"
68	104	58	890	840	180	520	5.50	5.25	6300	5000	4000	5000	5900	"	13
69	105	60	900	850	190	525	5.60	5.30	"	"	"	"	6000	"	"
6A	106	62	910	860	200	530	5.70	5.35	"	"	"	"	6100	R132	"
6B	107	64	920	870	210	535	5.80	5.40	"	"	"	"	6200	"	"
6C	108	66	930	880	220	540	5.90	5.45	"	"	"	"	6300	"	"
6D	109	68	940	890	230	545	6.00	5.50	"	"	"	"	6400	"	"
6E	110	70	950	900	240	550	6.10	5.55	"	"	"	"	6500	R144	"
6F	111	72	960	910	250	555	6.20	5.60	"	"	"	"	6600	"	"
70	112	74	970	920	260	560	6.30	5.65	8000	6300	5000	6300	6700	"	14
71	113	76	980	930	270	565	6.40	5.70	"	"	"	"	6800	"	"
72	114	78	990	940	280	570	6.50	5.75	"	"	"	"	6900	R156	"
73	115	80	1000	950	290	575	6.60	5.80	"	"	"	"	7000	"	"
74	116	82	--	960	300	580	6.70	5.85	"	"	"	"	7100	"	"
75	117	84	--	970	320	585	6.80	5.90	"	"	"	"	7200	"	"
76	118	86	--	980	340	590	6.90	5.95	"	"	"	"	7300	R168	"
77	119	88	--	990	360	595	7.00	6.00	"	"	"	"	7400	"	"
78	120	90	--	1000	380	600	7.50	6.05	Bypass	8000	6300	Bypass	7500	"	15
79	121	92	--	1000	400	605	8.00	6.10	"	"	"	"	7600	"	"
7A	122	94	--	1000	420	610	8.50	6.15	"	"	"	"	7700	R180(=L180)	"
7B	123	96	--	1000	440	615	9.00	6.20	"	"	"	"	7800	"	"
7C	124	98	--	1000	460	620	9.50	6.25	"	"	"	"	7900	"	"
7D	125	100	--	1000	480	625	10.00	6.30	"	"	"	"	8000	"	"
7E	126	100	--	1000	500	630	10.00	6.35	"	"	"	"	8000	"	"
7F	127	100	--	1000	500	635	10.00	6.40	"	"	"	"	8000	"	"

MIDI Implementation

Model SC-8820 Version 1.00 '99.10

The SC-8820 implements additional functionality and parameters over and above the SC-88Pro, which itself was an expansion of the GS sound generator format. These functions and parameters are marked by a [8820] symbol. If MIDI messages marked by a [8820] symbol are transmitted to another GS format sound generator or to the SC-88Pro, those messages may not be recognized.

1. Receive data

■ Channel Voice Messages

● Note off

Status	2nd byte	3rd byte
8nH	kkH	vvH
9nH	kkH	00H

n = MIDI channel number: 0H – FH (Ch.1 – 16)
 kk = note number: 00H – 7FH (0 – 127)
 vv = note off velocity: 00H – 7FH (0 – 127)

- * For Drum Parts, these messages are received when Rx.NOTE OFF = ON for each Instrument.
- * The velocity values of Note Off messages are ignored.

● Note on

Status	2nd byte	3rd byte
9nH	kkH	vvH

n = MIDI channel number: 0H – FH (Ch.1 – 16)
 kk = note number: 00H – 7FH (0 – 127)
 vv = note on velocity: 01H – 7FH (1 – 127)

- * Not received when Rx.NOTE MESSAGE = OFF. (Initial value is ON)
- * For Drum Parts, these messages are not received when Rx.NOTE ON = OFF for each Instrument.

● Polyphonic Key Pressure

Status	2nd byte	3rd byte
AnH	kkH	vvH

n = MIDI channel number: 0H – FH (Ch.1 – 16)
 kk = note number: 00H – 7FH (0 – 127)
 vv = key pressure: 00H – 7FH (0 – 127)

- * Not received when Rx.POLY PRESSURE (PAF) = OFF. (Initial value is ON)
- * The resulting effect is determined by System Exclusive messages. With the initial settings, there will be no effect.

● Control Change

- * When Rx.CONTROL CHANGE = OFF, all control change messages except for Channel Mode messages will be ignored.
- * The value specified by a Control Change message will not be reset even by a Program Change, etc.

○ Bank Select (Controller number 0, 32)

Status	2nd byte	3rd byte
BnH	00H	mmH
BnH	20H	llH

n = MIDI channel number: 0H – FH (Ch.1 – 16)
 mm = Bank number MSB: 00H – 7FH (GS Variation number 0 – 127), Initial value = 00H
 ll = Bank number LSB: 00H – 04H (MAP), Initial value = 00H

- * Not received when Rx.BANK SELECT = OFF.
- * "Rx.BANK SELECT" is set to OFF by "GM1 System On," and Bank Select messages will be ignored.
- * Rx.BANK SELECT is set to ON by "GM2 System On."
- * Rx.BANK SELECT is set to ON by power-on reset or by receiving "GS Reset."
- * When Rx.BANK SELECT LSB = OFF, Bank number LSB (llH) will be handled as 00H regardless of the received value. However, when sending Bank Select messages, you have to send both the MSB (mmH) and LSB (llH, the value should be 00H) together.
- * Bank Select processing will be suspended until a Program Change message is received.
- * The GS format "Variation number" is the value of the Bank Select MSB (Controller number 0) expressed in decimal.

- * The SC-8820 recognizes the Bank Select LSB (Controller number 32) as a flag for switching between the SC-55MAP, the SC-88MAP, the SC-88ProMAP, and the SC-8820MAP. With a Bank Select LSB of 00H, the map selected by the front panel INST MAP button will be selected. With an LSB of 01H, the SC-55MAP and with an LSB of 02H, the SC-88MAP, and with an LSB of 03H, the SC-88Pro MAP, and with an LSB of 04H, the SC-8820MAP will be selected respectively.
- * Some other GS devices do not recognize the Bank Select LSB (Controller number 32).

○ Modulation (Controller number 1)

Status	2nd byte	3rd byte
BnH	01H	vvH

n = MIDI channel number: 0H – FH (Ch.1 – 16)
 vv = Modulation depth: 00H – 7FH (0 – 127)

- * Not received when Rx.MODULATION = OFF (Initial value is ON)
- * The resulting effect is determined by System Exclusive messages. With the initial settings, this is Pitch Modulation Depth.

○ Portamento Time (Controller number 5)

Status	2nd byte	3rd byte
BnH	05H	vvH

n = MIDI channel number: 0H – FH (Ch.1 – 16)
 vv = Portamento Time: 001H – 7FH (0 – 127), Initial value = 00H (0)

- * This adjusts the rate of pitch change when Portamento is ON or when using the Portamento Control. A value of 0 results in the fastest change.

○ Data Entry (Controller number 6, 38)

Status	2nd byte	3rd byte
BnH	06H	mmH
BnH	26H	llH

n = MIDI channel number: 0H – FH (Ch.1 – 16)
 mm, ll = the value of the parameter specified by RPN/NRPN
 mm = MSB, ll = LSB

○ Volume (Controller number 7)

Status	2nd byte	3rd byte
BnH	07H	vvH

n = MIDI channel number: 0H – FH (Ch.1 – 16)
 vv = Volume: 00H – 7FH (0 – 127), Initial value = 64H (100)

- * Volume messages are used to adjust the volume balance of each Part.
- * Not received when Rx.VOLUME = OFF. (Initial value is ON)

○ Pan (Controller number 10)

Status	2nd byte	3rd byte
BnH	0AH	vvH

n = MIDI channel number: 0H – FH (Ch.1 – 16)
 vv = pan: 00H – 40H – 7FH (Left – Center – Right),
 Initial value = 40H (Center)

- * For Rhythm Parts, this is a relative adjustment of each Instrument's pan setting.
- * Not received when Rx.PANPOT = OFF. (Initial value is ON)

○ Expression (Controller number 11)

Status	2nd byte	3rd byte
BnH	0BH	vvH

n = MIDI channel number: 0H – FH (Ch.1 – 16)
 vv = Expression: 00H – 7FH (0 – 127), Initial value = 7FH (127)

- * This adjusts the volume of a Part. It can be used independently from Volume messages. Expression messages are used for musical expression within a performance; e.g., expression pedal movements, crescendo and decrescendo.
- * Not received when Rx.EXPRESSION = OFF. (Initial value is ON)

○ Hold 1 (Controller number 64)

Status	2nd byte	3rd byte
BnH	40H	vvH

n = MIDI channel number: 0H – FH (Ch.1 – 16)
 vv = Control value: 00H – 7FH (0 – 127)

- * Not received when Rx.HOLD1 = OFF. (Initial value is ON)

○Portamento (Controller number 65)

Status	2nd byte	3rd byte
BnH	41H	vvH

n = MIDI channel number: 0H – FH (Ch.1 – 16)
 vv = Control value: 00H – 7FH (0 – 127) 0 – 63 = OFF, 64 – 127 = ON

* Not received when Rx.PORTAMENTO = OFF. (Initial value is ON)

○Sostenuto (Controller number 66)

Status	2nd byte	3rd byte
BnH	42H	vvH

n = MIDI channel number: 0H – FH (Ch.1 – 16)
 vv = Control value: 00H – 7FH (0 – 127) 0 – 63 = OFF, 64 – 127 = ON

* Not received when Rx.SOSTENUTO = OFF. (Initial value is ON)

○Soft (Controller number 67)

Status	2nd byte	3rd byte
BnH	43H	vvH

n = MIDI channel number: 0H – FH (Ch.1 – 16)
 vv = Control value: 00H – 7FH (0 – 127) 0 – 63 = OFF, 64 – 127 = ON

* Not received when Rx.SOFT = OFF. (Initial value is ON)

○Filter Resonance (Timbre/Harmonic Intensity) (Controller number 71) [8820]

Status	2nd byte	3rd byte
BnH	471H	vvH

n = MIDI channel number: 0H – FH(Ch.1 – 16)
 vv = Resonance value (relative change): 00H – 7FH(-64 – 0 – +63).
 Initial value = 40H (no change)

○Release Time (Controller number 72) [8820]

Status	2nd byte	3rd byte
BnH	48H	vvH

n = MIDI channel number: 0H – FH(Ch.1 – 16)
 vv = Release Time value (relative change): 00H – 7FH (-64 – 0 – +63).
 Initial value = 40H (no change)

○Attack time (Controller number 73) [8820]

Status	2nd byte	3rd byte
BnH	49H	vvH

n = MIDI channel number: 0H – FH (Ch.1 – 16)
 vv = Attack time value (relative change): 00H – 7FH (-64 – 0 – +63).
 Initial value=40H (no change)

○Cutoff (Controller number 74) [8820]

Status	2nd byte	3rd byte
BnH	4AH	vvH

n = MIDI channel number: 0H – FH (Ch.1 – 16)
 vv = Cutoff value (relative change): 00H – 7FH(-64 – 0 – +63). Initial value = 40H (no change)

○Decay Time (Controller number 75) [8820]

Status	2nd byte	3rd byte
BnH	4BH	vvH

n = MIDI channel number: 0H – FH (Ch.1 – 16)
 vv = Decay Time value (relative change): 00H – 7FH (-64 – 0 – +63).
 Initial value = 40H (no change)

○Vibrato Rate (Controller number 76) [8820]

Status	2nd byte	3rd byte
BnH	4CH	vvH

n = MIDI channel number: 0H – FH (Ch.1 – 16)
 vv = Vibrato Rate value (relative change): 00H – 7FH (-64 – 0 – +63).
 Initial value = 40H (no change)

○Vibrato Depth (Controller number 77) [8820]

Status	2nd byte	3rd byte
BnH	4DH	vvH

n = MIDI channel number: 0H – FH (Ch.1 – 16)
 vv = Vibrato Depth Value (relative change): 00H – 7FH (-64 – 0 – +63).
 Initial Value = 40H (no change)

○Vibrato Delay (Controller number 78) [8820]

Status	2nd byte	3rd byte
BnH	4EH	vvH

n = MIDI channel number: 0H – FH (Ch.1 – 16)
 vv = Vibrato Delay value (relative change): 00H – 7FH (-64 – 0 – +63).
 Initial value=40H (no change)

○Portamento control (Controller number 84)

Status	2nd byte	3rd byte
BnH	54H	kkH

n = MIDI channel number: 0H – FH (Ch.1 – 16)
 kk = source note number: 00H – 7FH (0 – 127)

- * A Note-on received immediately after a Portamento Control message will change continuously in pitch, starting from the pitch of the Source Note Number.
- * If a voice is already sounding for a note number identical to the Source Note Number, this voice will continue sounding (i.e., legato) and will, when the next Note-on is received, smoothly change to the pitch of that Note-on.
- * The rate of the pitch change caused by Portamento Control is determined by the Portamento Time value.

Example 1.

On MIDI	Description	Result
90 3C 40	Note on C4	C4 on
B0 54 3C	Portamento Control from C4	no change
90 40 40	Note on E4	glide from C4 to E4
80 3C 40	Note off C4	no change
80 40 40	Note off E4	E4 off

Example 2.

On MIDI	Description	Result
B0 54 3C	Portamento Control from C4	no change
90 40 40	Note on E4	E4 is played with glide from C4 to E4
80 40 40	Note off E4	E4 off

○Effect 1 (Reverb Send Level) (Controller number 91)

Status	2nd byte	3rd byte
BnH	5BH	vvH

n = MIDI channel number: 0H – FH (Ch.1 – 16)
 vv = Reverb Send Level: 00H – 7FH (0 – 127), Initial value = 28H (40)

* This message adjusts the Reverb Send Level of each Part.

○Effect 3 (Chorus Send Level) (Controller number 93)

Status	2nd byte	3rd byte
BnH	5DH	vvH

n = MIDI channel number: 0H – FH (Ch.1 – 16)
 vv = Chorus Send Level: 00H – 7FH (0 – 127), Initial value = 00H (0)

* This message adjusts the Chorus Send Level of each Part.

○Effect 4 (Delay Send Level) (Controller number 94)

Status	2nd byte	3rd byte
BnH	5EH	vvH

n=MIDI channel number: 0H – FH (Ch.1 – 16)
 vv=Delay Send Level: 00H – 7FH (0 – 127), Initial value = 00H (0)

- * This message adjusts the Delay Send Level of each Part.
- * Some other GS devices may not recognize this message.

Appendices

○NRPN MSB/LSB (Controller number 98, 99)

Status	2nd byte	3rd byte
BnH	63H	mmH
BnH	621H	llH

n = MIDI channel number: 0H – FH (Ch.1 – 16)

mm = upper byte (MSB) of the parameter number specified by NRPN

ll = lower byte (LSB) of the parameter number specified by NRPN

- * Rx.NRPN is set to OFF by power-on reset or by receiving "GM1 System On" or "GM2 System On," and NRPN message will be ignored. NRPN message will be received when Rx.NRPN = ON, or by receiving "GS RESET."
- * The value set by NRPN will not be reset even if Program Change or Reset All Controllers is received.

NRPN

The NRPN (Non Registered Parameter Number) message allows an extended range of control changes to be used. On the SC-8820, NRPN messages can be used to modify sound parameters, etc.

To use these messages, you must first use NRPN messages (Controller number 98 and 99, their order does not matter) to specify the parameter to be controlled, and then use Data Entry messages (Controller number 6) to specify the value of the specified parameter. Once an NRPN parameter has been specified, all Data Entry messages received on that channel will modify the value of that parameter. To prevent accidents, it is recommended that you set RPN Null (RPN Number = 7FH 7FH) when you have finished setting the value of the desired parameter. Refer to Section 5. Supplementary material **Examples of actual MIDI messages** <Example 4> (page 183). On the SC-8820, Data entry LSB (Controller number 38) of NRPN is ignored, so it is no problem to send Data entry MSB (Controller number 6) only (without Data entry LSB).

On the SC-8820, NRPN can be used to modify the following parameters.

NRPN	Data entry	Function and range
MSB LSB	MSB	
01H 08H	mmH	Vibrato Rate (relative change) mm: 00H – 40H – 7FH (-64 – 0 – +63)
01H 09H	mmH	Vibrato Depth (relative change) mm: 00H – 40H – 7FH (-64 – 0 – +63)
01H 0AH	mmH	Vibrato Delay (relative change) mm: 00H – 40H – 7FH (-64 – 0 – +63)
01H 20H	mmH	TVF Cutoff Frequency (relative change) mm: 00H – 40H – 7FH (-64 – 0 – +63)
01H 21H	mmH	TVF Resonance (relative change) mm: 00H – 40H – 7FH (-64 – 0 – +63)
01H 63H	mmH	TVF&TVA Envelope Attack Time (relative change) mm: 00H – 40H – 7FH (-64 – 0 – +63)
01H 64H	mmH	TVF&TVA Envelope Decay Time (relative change) mm: 00H – 40H – 7FH (-64 – 0 – +63)
01H 66H	mmH	TVF&TVA Envelope Release Time (relative change) mm: 00H – 40H – 7FH (-64 – 0 – +63)
18H rrH	mmH	Drum Instrument Pitch Coarse (relative change) rr: Drum Instrument note number mm: 00H – 40H – 7FH (-64 – 0 – +63 semitone)
1AH rrH	mmH	Drum Instrument TVA Level (absolute change) rr: Drum Instrument note number mm: 00H – 7FH (0 – max)
1CH rrH	mmH	Drum Instrument Panpot (absolute change) rr: Drum Instrument note number mm: 00H, 01H – 40H – 7FH (random, left – center – right)
1DH rrH	mmH	Drum Instrument Reverb Send Level (absolute change) rr: Drum Instrument note number mm: 00H – 7FH (0 – max)
1EH rrH	mmH	Drum Instrument Chorus Send Level (absolute change) rr: Drum Instrument note number mm: 00H – 7FH (0 – max)
1FH rrH	mmH	Drum Instrument Delay Send Level (absolute change) rr: Drum Instrument note number mm: 00H – 7FH (0 – max)

- * Parameters marked "relative change" will change relatively to the preset value(40H). Even among different GS devices, "relative change" parameters may sometimes differ in the way the sound changes or in the range of change.
- * Parameters marked "absolute change" will be set to the absolute value of the parameter, regardless of the preset value.
- * It is not possible to simultaneously use both Chorus Send Level and Delay Send Level on a single Drum Instrument.
- * Data entry LSB (llH) is ignored.

○RPN MSB/LSB (Controller number 100, 101)

Status	2nd byte	3rd byte
BnH	65H	mmH
BnH	64H	llH

n = MIDI channel number: 0H – FH (Ch.1 – 16)

mm = upper byte (MSB) of parameter number specified by RPN

ll = lower byte (LSB) of parameter number specified by RPN

- * Not received when Rx.RPN = OFF.
- * The value specified by RPN will not be reset even by messages such as Program Change or Reset All Controller.

RPN

The RPN (Registered Parameter Number) messages are expanded control changes, and each function of an RPN is described by the MIDI Standard.

To use these messages, you must first use RPN (Controller number 100 and 110, their order does not matter) to specify the parameter to be controlled, and then use Data Entry messages (Controller number 6, 38) to specify the value of the specified parameter. Once an RPN parameter has been specified, all Data Entry messages received on that channel will modify the value of that parameter. To prevent accidents, it is recommended that you set RPN Null (RPN Number = 7FH 7FH) when you have finished setting the value of the desired parameter. Refer to Section 5. **Examples of actual MIDI messages** <Example 4> (page 183).

On the SC-8820, RPN can be used to modify the following parameters.

RPN	Data entry	Explanation
MSB LSB	MSB	LSB
00H 00H	mmH	---
		Pitch Bend Sensitivity mm: 00H – 18H (0 – 24 semitones), Initial value = 02H (2 semitones) ll: ignored (processed as 00H) specify up to 2 octaves in semitone steps
00H 01H	mmH	llH
		Master Fine Tuning mm, ll: 00 00H – 40 00H – 7F 7FH (-100 – 0 – +99.99 cents), Initial value = 40 00H (+/- 0 cent) Refer to 5. Supplementary material, About the Tuning (page 184).
00H 02H	mmH	---
		Master Coarse Tuning mm: 28H – 40H – 58H (-24 – 0 – +24 semitones), Initial value = 40H (+/- 0 semitone) ll: ignored (processed as 00H)
00H 05H	mmH	llH
		Modulation Depth Range mm: 00H – 04H (0 – 4 semitones) ll: 00H – 7FH (0 – 100 cents) 100/128 Cent/Value RPN null
7FH 7FH	---	---
		Set condition where RPN and NRPN are unspecified. The data entry messages after set RPN null will be ignored. (No Data entry messages are required after RPN null). Settings already made will not change. mm, ll: ignored

●Program Change

Status	2nd byte
CnH	ppH

n = MIDI channel number: 0H – FH (Ch.1 – 16)

pp = Program number: 00H – 7FH (prog.1 – prog.128)

- * Not received when Rx.PROGRAM CHANGE = OFF. (Initial value is ON)
- * After a Program Change message is received, the sound will change beginning with the next Note-on. Voices already sounding when the Program Change message was received will not be affected.
- * For Drum Parts, Program Change message will not be received on lower byte of the bank numbers (the value of Control Number 0 is other than 0 (00H)).

●Channel Pressure

Status	2nd byte
DnH	vvH

n = MIDI channel number: 0H – FH (Ch.1 – 16)

vv = Channel Pressure: 00H – 7FH (0 – 127)

- * Not received when Rx.CH PRESSURE (CA) = OFF. (Initial value is ON)
- * The resulting effect is determined by System Exclusive messages. With the initial settings there will be no effect.

●Pitch Bend Change

Status	2nd byte	3rd byte
BnH	11H	mmH

n = MIDI channel number: 0H – FH (Ch.1 – 16)
 mm, ll = Pitch Bend value: 00 00H – 40 00H – 7F 7FH (-8192 – 0 – +8191)

- * Not received when Rx.PITCH BEND = OFF. (Initial value is ON)
- * The resulting effect is determined by System Exclusive messages. With the initial settings the effect is Pitch Bend.

■Channel Mode Messages

●All Sounds Off (Controller number 120)

Status	2nd byte	3rd byte
BnH	78H	00H

n = MIDI channel number: 0H – FH (Ch.1 – 16)

- * When this message is received, all currently sounding notes on the corresponding channel will be turned off immediately.

●Reset All Controllers (Controller number 121)

Status	2nd byte	3rd byte
BnH	79H	00H

n = MIDI channel number: 0H – FH (Ch.1 – 16)

- * When this message is received, the following controllers will be set to their reset values.

Controller	Reset value
Pitch Bend Change	+/-0 (center)
Polyphonic Key Pressure	0 (off)
Channel Pressure	0 (off)
Modulation	0 (off)
Expression	127 (max)
Hold 1	0 (off)
Portamento	0 (off)
Sostenuto	0 (off)
Soft	0 (off)
RPN	unset; previously set data will not change
NRPN	unset; previously set data will not change

●All Notes Off (Controller number 123)

Status	2nd byte	3rd byte
BnH	7BH	00H

n = MIDI channel number: 0H – FH (Ch.1 – 16)

- * When All Notes Off is received, all notes on the corresponding channel will be turned off. However, if Hold 1 or Sostenuto is ON, the sound will be continued until these are turned off.

●OMNI OFF (Controller number 124)

Status	2nd byte	3rd byte
BnH	7CH	00H

n = MIDI channel number: 0H – FH (Ch.1 – 16)

- * The same processing will be carried out as when All Notes Off is received.

●OMNI ON (Controller number 125)

Status	2nd byte	3rd byte
BnH	7DH	00H

n = MIDI channel number: 0H – FH (Ch.1 – 16)

- * The same processing will be carried out as when All Notes Off is received.OMNI ON will not be turned on.

●MONO (Controller number 126)

Status	2nd byte	3rd byte
BnH	7EH	mmH

n = MIDI channel number: 0H – FH (Ch.1 – 16)
 mm = mono number: 00H – 10H (0 – 16)

- * The same processing will be carried out as when All Sounds Off and All Notes Off is received, and the corresponding channel will be set to Mode 4 (M = 1) regardless of the value of "mm (mono number)."

●POLY (Controller number 127)

Status	2nd byte	3rd byte
BnH	7FH	00H

n = MIDI channel number: 0H – FH (Ch.1 – 16)

- * The same processing will be carried out as when All Sounds Off and All Notes Off is received, and the corresponding channel will be set to Mode 3.

■System Realtime Message

●Active Sensing

Status
FEH

- * When Active Sensing is received, the unit will begin monitoring the intervals of all further messages. While monitoring, if the interval between messages exceeds 420 ms, the same processing will be carried out as when All Sounds Off, All Notes Off and Reset All Controllers are received, and message interval monitoring will be halted.

■System Exclusive Message

Status	Data byte	Status
F0H	iiH, ddH,eeH	F7H

F0H: System Exclusive Message status
 ii = ID number: an ID number (manufacturer ID) to indicate the manufacturer whose Exclusive message this is. Roland's manufacturer ID is 41H.
 ID numbers 7EH and 7FH are extensions of the MIDI standard; Universal Non-realtime Messages (7EH) and Universal Realtime Messages (7FH).
 dd,.....ee = data: 00H – 7FH (0 – 127)
 F7H: EOX (End Of Exclusive)

The System Exclusive Messages received by the SC-8820 are; messages related to mode settings, Universal Realtime System Exclusive messages, Data Requests (RQ1), and Data Set (DT1).

Appendices

● System Exclusive messages related to mode settings

These messages are used to initialize a device to GS or General MIDI mode, or change the operating mode. When creating performance data, a "GM1 System On" message should be inserted at the beginning of a General MIDI 1 score, a "GM2 System On" message at the beginning of a General MIDI 2 score, and a "GS Reset" message at the beginning of a GS music data. Each song should contain only one mode message as appropriate for the type of data. (Do not insert two or more mode setting messages in a single song.)

"GM System On" uses Universal Non-realtime Message format. "GS Reset" uses Roland system Exclusive format "Data Set 1 (DT1)."

○ GM1 System On

This is a command message that resets the internal settings of the unit to the General MIDI 1 initial state. After receiving this message, the SC-8820 will automatically be set to the proper condition for correctly playing a General MIDI score.

Status	Data byte	Status
F0H	7EH, 7FH, 09H, 01H	F7H

Byte	Explanation
F0H	Exclusive status
7EH	ID number (Universal Non-realtime Message)
7FH	Device ID (Broadcast)
09H	Sub ID#1 (General MIDI Message)
01H	Sub ID#2 (General MIDI 1 On)
F7H	EOX (End Of Exclusive)

* When this message is received, Rx.BANK SELECT will be OFF and Rx.NRPN will be OFF.

* There must be an interval of at least 50 ms between this message and the next message.

○ GM2 System On

[8820]

Status	Data byte	Status
F0H	7EH 7FH 09H 03H	F7H

Byte	Explanation
F0H	Exclusive status
7EH	ID number (Universal Non-realtime Message)
7FH	Device ID (Broadcast)
09H	Sub ID#1 (General MIDI Message)
03H	Sub ID#2 (General MIDI 2 On)
F7H	EOX (End Of Exclusive)

* When this message is received, the SC-8820 will be able to receive the messages specified by General MIDI 2, and use the General MIDI 2 sound map.

○ GM System Off

[8820]

"GM System Off" is a command message that resets the internal state of the SC-8820 from the GM state to its native condition. The SC-8820 will reset to the GS default state.

Status	Data byte	Status
F0H	7EH, 7F, 09H, 02H	F7H

Byte	Explanation
F0H	Exclusive status
7EH	ID number (Universal Non-realtime Message)
7FH	Device ID (Broadcast)
09H	Sub ID#1 (General MIDI Message)
02H	Sub ID#2 (General MIDI Off)
F7H	EOX (End Of Exclusive)

* When this message is received, the SC-8820 will reset to the GS default state.

○ GS reset

GS Reset is a command message that resets the internal settings of a device to the GS initial state. This message appears at the beginning of GS music data, and a GS device that receives this message will automatically be set to the proper state to correctly play back GS music data.

Status	Data byte	Status
F0H	41H, dev, 42H, 12H, 40H, 00H, 7FH, 00H, 41H	F7H

Byte	Explanation
F0H	Exclusive status
41H	ID number (Roland)
10H	Device ID
42H	Model ID (GS)
12H	Command ID (DT1)
40H	Address MSB
00H	Address
7FH	Address LSB
00H	Data (GS reset)
41H	Checksum
F7H	EOX (End Of Exclusive)

* The "dev" is own device number or 7FH (Broadcast)

* When this message is received, Rx.NRPN will be ON.

* There must be an interval of at least 50 ms between this message and the next.

● Universal Realtime System Exclusive Messages

○ Master Volume

Status	Data byte	Status
F0H	7FH, 7FH, 04H, 01H, lIH, mmH	F7H

Byte	Explanation
F0H	Exclusive status
7FH	ID number (universal realtime message)
7FH	Device ID (Broadcast)
04H	Sub ID#1 (Device Control messages)
01H	Sub ID#2 (Master Volume)
lIH	Master Volume lower byte
mmH	Master Volume upper byte
F7H	EOX (End Of Exclusive)

* The lower byte (lIH) of Master Volume will be handled as 00H.

○ Master Fine Tuning

[8820]

Status	Data byte	Status
F0H	7FH, 7FH, 04H, 03H, lIH, mmH	F7H

Byte	Explanation
F0H	Exclusive status
7FH	ID number (universal realtime message)
7FH	Device ID (Broadcast)
04H	Sub ID#1 (Device Control)
03H	Sub ID#2 (Master Fine Tuning)
lIH	Master Fine Tuning LSB
mmH	Master Fine Tuning MSB
F7H	EOX (End Of Exclusive)

mm, lI : 00 00H - 40 00H - 7F 7FH (-100 - 0 - +99.9 [cents])

○ Master Coarse Tuning

[8820]

Status	Data byte	Status
F0H	7FH, 7FH, 04H, 04H, lIH, mmH	F7

Byte	Explanation
F0H	Exclusive status
7FH	ID number (universal realtime message)
7FH	Device ID (Broadcast)
04H	Sub ID#1 (Device Control)
04H	Sub ID#2 (Master Coarse Tuning)
lIH	Master Coarse Tuning LSB
mmH	Master Coarse Tuning MSB
F7H	EOX (End Of Exclusive)

lIH : ignored (processed as 00H)

mmH : 28H - 40H - 58H (-24 - 0 - +24 [semitones])

●Global Parameter Control

Parameters of the **Global Parameter Control** are newly provided for the General MIDI 2.

○Reverb Parameters [8820]

Status	Data byte	Status
F0H	7FH,7FH,04H,05H,01H,01H,01H,01H,01H,ppH,vvH	F7H
Byte Explanation		
F0H	Exclusive status	
7F1	ID number (universal realtime message)	
7FH	Device ID (Broadcast)	
04H	Sub ID#1 (Device Control)	
05H	Sub ID#2 (Global Parameter Control)	
01H	Slot path length	
01H	Parameter ID width	
01H	Value width	
01H	Slot path MSB	
01H	Slot path LSB (Effect 0101: Reverb)	
ppH	Parameter to be controlled.	
vvH	Value for the parameter.	
F7H	EOX (End Of Exclusive)	
pp=0 Reverb Type		
	vv = 00H Small Room (Room1)	
	vv = 01H Medium Room (Room2)	
	vv = 02H Large Room (Room3)	
	vv = 03H Medium Hall (Hall1)	
	vv = 04H Large Hall (Hall2)	
	vv = 08H Plate (Plate)	
* The SC-8820 displays Reverb Type as described in the parenthesis.		
pp=1 Reverb Time		
	vv = 00H - 7FH 0 - 127	

○Chorus Parameters [8820]

Status	Data byte	Status
F0H	7FH,7FH,04H,05H,01H,01H,01H,01H,02H,ppH,vvH	F7H
Byte Explanation		
F0H	Exclusive status	
7F1	ID number (universal realtime message)	
7FH	Device ID (Broadcast)	
04H	Sub ID#1 (Device Control)	
05H	Sub ID#2 (Global Parameter Control)	
01H	Slot path length	
01H	Parameter width	
01H	Value width	
01H	Slot path MSB	
02H	Slot path LSB (Effect 0102: Chorus)	
ppH	Parameter to be controlled.	
vvH	Value for the parameter.	
F7H	EOX (End Of Exclusive)	
pp=0 Chorus Type		
	vv=0 Chorus1	
	vv=1 Chorus2	
	vv=2 Chorus3	
	vv=3 Chorus4	
	vv=4 FB Chorus	
	vv=5 Flanger	
pp=1 Mod Rate		
	vv= 00H - 7FH 0 - 127	
pp=2 Mod Depth		
	vv = 00H - 7FH 0 - 127	
pp=3 Feedback		
	vv = 00H - 7FH 0 - 127	
pp=4 Send To Reverb		
	vv = 00H - 7FH 0 - 127	

○Channel Pressure [8820]

Status	Data byte	Status
F0H	7FH,7FH,09H,01H,0nH,ppH,rrH	F7H
Byte Explanation		
F0H	Exclusive status	
7FH	ID number (universal realtime message)	
7FH	Device ID (Broadcast)	
09H	Sub ID#1 (Controller Destination Setting)	
01H	Sub ID#2 (Channel Pressure)	
0nH	MIDI Channel (00 - 0F)	
ppH	Controlled parameter	
rrH	Controlled range	
F7H	EOX (End Of Exclusive)	
pp=0 Pitch Control		
	rr = 28H - 58H -24 - +24 [semitones]	
pp=1 Filter Cutoff Control		
	rr = 00H - 7FH -9600 - +9450 [cents]	
pp=2 Amplitude Control		
	rr = 00H - 7FH 0 - 200%	
pp=3 LFO Pitch Depth		
	rr = 00H - 7FH 0 - 600 [cents]	
pp=4 LFO Filter Depth		
	rr = 00H - 7FH 0 - 2400 [cents]	
pp=5 LFO Amplitude Depth		
	rr = 00H - 7FH 0 - 100%	

○Controller [8820]

Status	Data byte	Status
F0H	7FH,7FH,09H,03H,0nH,ccH,ppH,rrH	F7H
Byte Explanation		
F0H	Exclusive status	
7F1	ID number (universal realtime message)	
7FH	Device ID (Broadcast)	
09H	Sub ID#1 (Controller Destination Setting)	
03H	Sub ID#2 (Control Change)	
0nH	MIDI Channel (00 - 0F)	
ccH	Controller number (01 - 1F, 40 - 5F)	
ppH	Controlled parameter	
rrH	Controlled range	
F7H	EOX (End Of Exclusive)	
pp=0 Pitch Control		
	rr = 28H - 58H -24 - +24 [semitones]	
pp=1 Filter Cutoff Control		
	rr = 00H - 7FH -9600 - +9450 [cents]	
pp=2 Amplitude Control		
	rr = 00H - 7FH 0 - 200%	
pp=3 LFO Pitch Depth		
	rr = 00H - 7FH 0 - 600 [cents]	
pp=4 LFO Filter Depth		
	rr = 00H - 7FH 0 - 2400 [cents]	
pp=5 LFO Amplitude Depth		
	rr = 00H - 7FH 0 - 100%	

Appendices

○Scale/Octave Tuning Adjust

Status	Data byte	Status
F0H	7EH,7FH,08H,08H,ffH,ggH,hhH,ssH...	F7
Byte	Explanation	
F0H	Exclusive status	
7EH	ID number (Universal Non-realtime Message)	
7FH	Device ID (Broadcast)	
08H	Sub ID#1 (MIDI Tuning Standard)	
08H	Sub ID#2 (scale/octave tuning 1-byte form)	
ffH	Channel/Option byte1	
	bits 0 to 1 = channel 15 to 16	
	bit 2 to 6 = Undefined	
ggH	Channel byte2	
	bits 0 to 6 = channel 8 to 14	
hhH	Channel byte3	
	bits 0 to 6 = channel 1 to 7	
ssH	12 byte tuning offset of 12 semitones from C to B	
	00H = -64 [cents]	
	40H = 0 [cents] (equal temperament)	
	7FH = +63 [cents]	
F7H	EOX (End Of Exclusive)	

[8820]

●Data transmission

The SC-8820 can use Exclusive messages to transmit internal settings to other devices. There are two types of Exclusive data transmission; Individual Parameter Transmission (page 173) in which single parameters are transmitted one by one, and Bulk Dump Transmission (page 181) in which a large amount of data is transmitted at once.

The Exclusive message used when transmitting GS format data has a model ID of 42H and a device ID of 10H. (The SC-8820 allows you to change the Device ID setting.)

○Request data 1 RQ1 (11H)

This message requests the other device to send data. The Address and Size determine the type and amount of data to be sent. There are two types of request; Individual Parameter Request which requests data for an individual parameter, and Bulk Dump Request which requests a large amount of data at once. In either case, the "Data Request 1 (RQ1)" message format is used, and the Address and Size included in the message determine the type and amount of data that is desired.

For Individual Parameter Request, refer to **3. Individual Parameter Transmission** (page 173).

For Bulk Dump Request, refer to **4. Bulk Dump** (page 181).

When a Data Request message is received, if the device is ready to transmit data and if the address and size are appropriate, the requested data will be transmitted as a "Data Set 1 (DT1)" message. If not, nothing will be transmitted.

○Key-Based Instrument Controllers

Status	Data byte	Status
F0H	7FH,7FH,0AH,01H,0nH,kkH,nnH,vvH...	F7H
Byte	Explanation	
F0H	Exclusive status	
7FH	ID number (universal realtime message)	
7FH	Device ID (Broadcast)	
0AH	Sub ID#1 (Key-Based Instrument Control)	
01H	Sub ID#2 (Controller)	
0nH	MIDI Channel (00 - 0F)	
kkH	Key Number	
nnH	Control Number	
vvH	Value	
F7	EOX (End Of Exclusive)	
nn=07H	Level	
	vv = 00H - 7FH 0 - 200% (Relative)	
nn=0AH	Pan	
	vv = 00H - 7FH Left - Right (Absolute)	
nn=5BH	Reverb Send	
	vv = 00H - 7FH 0 - 127 (Absolute)	
nn=5D	Chorus Send	
	vv = 00H - 7FH 0 - 127 (Absolute)	

[8820]

Status	Data byte	Status
F0H	41H, dev, 42H, 11H, aaH, bbH, ccH, ssH, ttH, uuH, sum	F7H
Byte	Explanation	
F0H	Exclusive status	
41H	ID number (Roland)	
10H	Device ID	
42H	Model ID (GS)	
11H	Command ID (RQ1)	
aaH	Address MSB: upper byte of the starting address of the requested data	
bbH	Address: middle byte of the starting address of the requested data	
ccH	Address LSB: lower byte of the starting address of the requested data	
ssH	Size MSB	
ttH	Size	
uuH	Size LSB	
sum	Checksum	
F7H	EOX (End Of Exclusive)	

* The amount of data that can be transmitted at one time will depend on the type of data, and data must be requested using a specific starting address and size. Refer to the Address and Size listed in **Section 3. Individual Parameter Transmission** (page 173).

* Regarding the checksum, please refer to **Section 5** (p.184)

○Data set 1 DT1 (12H)

This is the message that actually performs data transmission, and is used when you wish to transmit the data.

Status	Data byte	Status
F0H	41H, dev, 42H, 12H, aaH, bbH, ccH, ddH, ... eel I, sum	F7H
Byte	Explanation	
F0H	Exclusive status	
41H	ID number (Roland)	
10H	Device ID	
42H	Model ID (GS), 45H	
12H	Command ID (DT1)	
aaH	Address MSB: upper byte of the starting address of the transmitted data	
bbH	Address: middle byte of the starting address of the transmitted data	
ccH	Address LSB: lower byte of the starting address of the transmitted data	
ddH	Data: the actual data to be transmitted. Multiple bytes of data are transmitted starting from the address.	
:	:	
eeH	Data	
sum	Checksum	
F7H	EOX (End Of Exclusive)	

* The amount of data that can be transmitted at one time depends on the type of data, and data can be received only from the specified starting address and size. Refer to the Address and Size given in **Section 3. Individual Parameter Transmission** (page 173).

* Data larger than 128 bytes must be divided into packets of 128 bytes or less. If "Data Set 1" is transmitted successively, there must be an interval of at least 40 ms between packets.

* Regarding the checksum, please refer to **Section 5** (p.184)

●Universal Non-realtime System Exclusive Messages

○Identity Request Message

Status	Data byte	Status
F0H	7EH, dev, 06H, 01H	F7H
Byte	Explanation	
F0H	Exclusive status	
7EH	ID number (Universal Non-realtime Message)	
dev	Device ID	
06H	Sub ID#1 (General Information)	
01H	Sub ID#2 (Identity Request)	
F7H	EOX (End Of Exclusive)	

* The "dev" is 10H (own device) number or 7FH (Broadcast)

2. Transmit data

■System Realtime Message

●Active sensing

Status
FEH

- * This will be transmitted constantly at intervals of approximately 250 ms.

■System Exclusive messages

"Identity Reply" and "Data Set 1 (DT1)" are the only System Exclusive messages transmitted by the SC-8820.

When an appropriate "Identity Request Message" and "Data Request 1 (RQ1)" message are received, the requested internal data will be transmitted.

○Identity Reply

Status	Data byte	Status
F0H	7EH, dev, 06H, 02H, 41H, 42H, 00H, 00H, 06H, ssH, ssH, ssH, ssH	F7H

Byte	Explanation
F0H	Exclusive status
7EH	ID number (Universal Non-realtime Message)
10H	Device ID
06H	Sub ID#1 (General Information)
02H	Sub ID#2 (Identity Reply)
41H	ID number (Roland)
42H	Device family code (LSB)
00H	Device family code (MSB)
00H	Device family number code (LSB)
06H	Device family number code (MSB)
ssH	Software revision level
ssH	Software revision level
ssH	Software revision level
ssH	Software revision level
F7H	EOX (End of Exclusive)

- * Reply the message by the unique device ID (dev) when the device has received the "Identity Request Message" in the Broadcast.

○Data set 1DT1 (12H)

Status	Data byte	Status
F0H	41H, dev, 42H, 12H, aaH, bbH, ccH, ddH, ..., eeH, sum	F7H

Byte	Explanation
F0H	Exclusive status
41H	ID number (Roland)
10H	Device ID
42H	Model ID (GS)
12H	Command ID (DT1)
aaH	Address MSB: upper byte of the starting address of the data to be sent
bbH	Address: middle byte of the starting address of the data to be sent
ccH	Address LSB: lower byte of the starting address of the data to be sent.
ddH	Data: the actual data to be sent. Multiple bytes of data are transmitted in order starting from the address.
:	:
eeH	Data
sum	Checksum
F7H	EOX (End Of Exclusive)

- * The amount of data that can be transmitted at one time depends on the type of data, and data will be transmitted from the specified starting address and size. Refer to the Address and Size given in **Section 3. Individual Parameter Transmission** (page 173).
- * Data larger than 128 bytes will be divided into packets of 128 bytes or less, and each packet will be sent at an interval of about 40 ms.
- * Regarding the checksum, please refer to **Section 5** (p.184)

There are two ways in which GS data is transmitted: Individual Parameter Transmission (Section 3 page 173) in which individual parameters are transmitted one by one, and Bulk Dump Transmission (Section 4 page 181) in which a large amount of data is transmitted at once.

3. Individual Parameter Transmission

(Model ID=45H or 42H)

Individual Parameter Transmission transmits data (or requests data) for one parameter as one Exclusive message (one packet of "F0.....F7").

In Individual Parameter Transmission, you must use the Address and Size listed in the following "Parameter Address Map". Addresses marked by "#" cannot be used as starting addresses.

■Address Block map

An outlined address map of the Individual Parameter Transmission is as follows;

<Model ID = 42H>

●Port-A

Address (H)	Block
00 00 00	SYSTEM
20 00 00	USER TONE BANK
21 00 00	USER DRUM SET
40 00 00	PATCH COMMON #A
40 10 00	PATCH PART (BLOCK00-0F) A
41 00 00	DRUM SETUP A

Parameter address map

This map indicates address, size, Data (range), Parameter, Description, and Default Value of parameters which can be transferred using "Request data 1 (RQ1)" and "Data set 1 (DT1)". All the numbers of address, size, Data, and Default Value are indicated in 7-bit Hexadecimal-form. Numbers in the explanatory column are given in decimal notation. The MODEL ID = 45H parameters are related to LCD display.

System Parameters

Parameters affecting the entire unit are called System Parameters.

<MODEL ID = 42H>

Address(H)	Size(H)	Data(H)	Parameter	Description	Default(H)	Description
00 00 7F	00 00 01	00 - 01	SYSTEM MODE SET	00 00: MODE-1 (Single module mode) (Rx. only)	MODE-1	
00 01 00	00 00 01	00 - 03	CHANNEL MSG RX PORT BLOCK00	PORT A, B	00	PORT A
:	:	:	:	:	:	:
00 01 0F	00 00 01	00 - 03	BLOCK0F	PORT A, B	00	PORT A
00 01 10	00 00 01	00 - 03	BLOCK10	PORT A, B	01	PORT B
:	:	:	:	:	:	:
00 01 1F	00 00 01	00 - 03	BLOCK1F	PORT A, B	01	PORT B

* When the Data value 00 is received, the same processing will be carried out as when GS Reset is received. Other values are ignored.

* You can modify the receiving MIDI port at which channel messages will be received for each BLOCK. We suggest that normally you use PORT A for BLOCK00 - 0F, PORT B for BLOCK10 - 1F. (In this case there is no need to change the setting.)

* Refer to page 176 for details of each BLOCK.

Patch parameters

Patch common parameters

The parameters common to all Parts in each module are called Patch Common parameters.

Address(H)	Size(H)	Data(H)	Parameter	Description	Default Value (H)	Description
40 00 00	00 00 04	0018 - 07E8	MASTER TUNE	-100.0 - +100.0 [cents] Use nibblized data.	00 04 00 00	0 [cents]
40 00 01#						
40 00 02#						
40 00 03#						
40 00 04	00 00 01	00 - 7F	MASTER VOLUME	0 - 127 (= F0 7F 7F 04 01 00 vv F7)	7F	127
40 00 05	00 00 01	28 - 58	MASTER KEY-SHIFT	-24 - +24 [semitones]	40	0 [semitones]
40 00 06	00 00 01	01 - 7F	MASTER PAN	-63 (LEFT) - +63 (RIGHT)	40	0 (CENTER)
40 00 7F	00 00 01	00	MODE SET	00 = GS Reset (Rx. only)		
40 01 00	00 00 10	20 - 7F	PATCH NAME	16 ASCII Characters		
40 01 : #						
40 01 0F#						
40 01 30	00 00 01	00 - 07	REVERB MACRO	00: Room 1 01: Room 2 02: Room 3 03: Hall 1 04: Hall 2 05: Plate 06: Delay 07: Panning Delay	04	Hall 2
40 01 31	00 00 01	00 - 07	REVERB CHARACTER	0 - 7	04	4
40 01 32	00 00 01	00 - 07	REVERB PRE-LPF	0 - 7	00	0
40 01 33	00 00 01	00 - 7F	REVERB LEVEL	0 - 127	40	64
40 01 34	00 00 01	00 - 7F	REVERB TIME	0 - 127	40	64
40 01 35	00 00 01	00 - 7F	REVERB DELAY FEEDBACK	0 - 127	00	0
40 01 37	00 00 01	00 - 7F	REVERB PREDELAY TIME	0 - 127 [ms]	00	0

* REVERB MACRO is a macro parameter that allows global setting of reverb parameters. When you select the reverb type with REVERB MACRO, each reverb parameter will be set to their most suitable value.

* REVERB CHARACTER is a parameter that changes the reverb algorithm. The value of REVERB CHARACTER corresponds to the REVERB MACRO of the same number.

Address(H)	Size(H)	Data(H)	Parameter	Description	Default Value (H)	Description
40 01 38	00 00 01	00 - 07	CHORUS MACRO	00: Chorus 1 01: Chorus 2 02: Chorus 3 03: Chorus 4 04: Feedback Chorus 05: Flanger 06: Short Delay 07: Short Delay(FB)	02	Chorus 3
40 01 39	00 00 01	00 - 07	CHORUS PRE-LPF	0-7	00	0
40 01 3A	00 00 01	00 - 7F	CHORUS LEVEL	0-127	40	64
40 01 3B	00 00 01	00 - 7F	CHORUS FEEDBACK	0-127	08	8
40 01 3C	00 00 01	00 - 7F	CHORUS DELAY	0-127	50	80
40 01 3D	00 00 01	00 - 7F	CHORUS RATE	0-127	03	3
40 01 3E	00 00 01	00 - 7F	CHORUS DEPTH	0-127	13	19
40 01 3F	00 00 01	00 - 7F	CHORUS SEND LEVEL TO REVERB	0-127	00	0
40 01 40	00 00 01	00 - 7F	CHORUS SEND LEVEL TO DELAY	0-127	00	0

* CHORUS MACRO is a macro parameter that allows global setting of chorus parameters. When you select the chorus type with CHORUS MACRO, each chorus parameter will be set to their most suitable value.

40 01 50	00 00 01	00 - 09	DELAY MACRO	00: Delay 1 01: Delay 2 02: Delay 3 03: Delay 4 04: Pan Delay 1 05: Pan Delay 2 06: Pan Delay 3 07: Pan Delay 4 08: Delay to Reverb 09: Pan Repeat	00	Delay1
40 01 51	00 00 01	00 - 07	DELAY PRE-LPF	0 - 7	00	0
40 01 52	00 00 01	01 - 73	DELAY TIME CENTER	0.1 ms - 1 sec	61	340
40 01 53	00 00 01	01 - 78	DELAY TIME RATIO LEFT	4 - 500%	01	4
40 01 54	00 00 01	01 - 78	DELAY TIME RATIO RIGHT	4 - 500%	01	4
40 01 55	00 00 01	00 - 7F	DELAY LEVEL CENTER	0 - 127	7F	127
40 01 56	00 00 01	00 - 7F	DELAY LEVEL LEFT	0 - 127	00	0
40 01 57	00 00 01	00 - 7F	DELAY LEVEL RIGHT	0 - 127	00	0
40 01 58	00 00 01	00 - 7F	DELAY LEVEL	0 - 127	40	64
40 01 59	00 00 01	00 - 7F	DELAY FEEDBACK	-64 - +63	50	+16
40 01 5A	00 00 01	00 - 7F	DELAY SENDLEVEL TO REVERB	0 - 127	00	0

* DELAY MACRO is a macro parameter that allows global setting of delay parameters. When you select the delay type with DELAY MACRO, each delay parameter will be set to their most suitable value.

* The relation between the DELAY TIME CENTER value and the actual delay time is as follows.

DELAY TIME	Time Range [ms]	Resolution [ms]
01 - 14	0.1 - 2.0	0.1
14 - 23	2.0 - 5.0	0.2
23 - 2D	5.0 - 10.0	0.5
2D - 37	10.0 - 20.0	1.0
37 - 46	20.0 - 50.0	2.0
46 - 50	50.0 - 100.0	5.0
50 - 5A	100.0 - 200.0	10.0
5A - 69	200.0 - 500.0	20.0
69 - 73	500.0 - 1000.0	50.0

* DELAY TIME RATIO LEFT and DELAY TIME RATIO RIGHT specify the ratio in relation to DELAY TIME CENTER. The resolution is 100/24(%).

40 02 00	00 00 01	00 - 01	EQ LOW FREQ	200Hz, 400Hz	00	200Hz
40 02 01	00 00 01	34 - 4C	EQ LOW GAIN	-12 - +12dB	40	0
40 02 02	00 00 01	00 - 01	EQ HIGH FREQ	3kHz, 6kHz	00	3kHz
40 02 03	00 00 01	34 - 4C	EQ HIGH GAIN	-12 - +12dB	40	0

Appendices

Address(H)	Size(H)	Data(H)	Parameter	Default Value (H)	Description
40 03 00	00 00 02	00 - 7F	EFX TYPE	00 00	00: Thru
40 03 01#					
40 03 03	00 00 01	00 - 7F	EFX PARAMETER 1		
40 03 04	00 00 01	00 - 7F	EFX PARAMETER 2		
40 03 05	00 00 01	00 - 7F	EFX PARAMETER 3		
40 03 06	00 00 01	00 - 7F	EFX PARAMETER 4		
40 03 07	00 00 01	00 - 7F	EFX PARAMETER 5		
40 03 08	00 00 01	00 - 7F	EFX PARAMETER 6		
40 03 09	00 00 01	00 - 7F	EFX PARAMETER 7		
40 03 0A	00 00 01	00 - 7F	EFX PARAMETER 8		
40 03 0B	00 00 01	00 - 7F	EFX PARAMETER 9		
40 03 0C	00 00 01	00 - 7F	EFX PARAMETER 10		
40 03 0D	00 00 01	00 - 7F	EFX PARAMETER 11		
40 03 0E	00 00 01	00 - 7F	EFX PARAMETER 12		
40 03 0F	00 00 01	00 - 7F	EFX PARAMETER 13		
40 03 10	00 00 01	00 - 7F	EFX PARAMETER 14		
40 03 11	00 00 01	00 - 7F	EFX PARAMETER 15		
40 03 12	00 00 01	00 - 7F	EFX PARAMETER 16		
40 03 13	00 00 01	00 - 7F	EFX PARAMETER 17		
40 03 14	00 00 01	00 - 7F	EFX PARAMETER 18		
40 03 15	00 00 01	00 - 7F	EFX PARAMETER 19		
40 03 16	00 00 01	00 - 7F	EFX PARAMETER 20		

* Regarding EFX TYPE and EFX PARAMETER, please refer to page 48, 156

Address(H)	Size(H)	Data(H)	Parameter	Description	Default Value (H)	Description
40 03 17	00 00 01	00 - 7F	EFX SEND LEVEL TO REVERB	0-127	28	40
40 03 18	00 00 01	00 - 7F	EFX SEND LEVEL TO CHORUS	0-127	00	0
40 03 19	00 00 01	00 - 7F	EFX SEND LEVEL TO DELAY	0-127	00	0
40 03 1B	00 00 01	00 - 7F	EFX CONTROL SOURCE1	Off, CC1-95, CAf, Bend	00	Off
40 03 1C	00 00 01	00 - 7F	EFX CONTROL DEPTH1	-100 - 0 - +100 [%]	40	0 (%)
40 03 1D	00 00 01	00 - 7F	EFX CONTROL SOURCE2	Off, CC1 - 95, CAf, Bend	00	Off
40 03 1E	00 00 01	00 - 7F	EFX CONTROL DEPTH2	-100 - 0 - +100 [%]	40	0 (%)
40 03 1F	00 00 01	00 - 7F	EFX SEND EQ SWITCH	OFF/ON	01	ON

* EFX TYPE is a macro parameter which sets various Insertion Effect parameters as a group. When you use EFX TYPE to select an Insertion Effect type, each effect parameter will be set to the most suitable value.

○Patch Part parameters

The SC-8820 has 16 Parts in Group A, Group B respectively. Parameters that can be set individually for each Part are called Patch Part parameters. If you specify a part in Group A, specify the address 40 *** using the block number to the corresponding part from PORT A (normally MIDI IN). If you specify a part in Group B, specify the address 40 *** using the block number to the corresponding part from PORT B.

If you use Exclusive messages to set Patch Part parameters, specify the address by Block number rather than Part Number (normally the same number as the MIDI channel). The Block number can be specified as one of 16 blocks, from 0(H) to F(H).

The relation between Part number and Block number is as follows.

x...BLOCK NUMBER (0 - F),	Part 1	(default MIDIch = 1)	x=1
	Part 2	(default MIDIch = 2)	x=2
	:	:	:
	Part 9	(default MIDIch = 9)	x=9
	Part10	(default MIDIch =10)	x=0
	Part11	(default MIDIch =11)	x=A
	Part12	(default MIDIch =12)	x=B
	:	:	:
	Part16	(default MIDIch =16)	x=F

n... MIDI channel number (0 - F) of the BLOCK.

In the following map, the control numbers of the control changes are indicated as CC#.

Address(H)	Size(H)	Data(H)	Parameter	Description	Default Value (H)	Description
40 1x 00	00 00 02	00 - 7F	TONE NUMBER	CC#00 VALUE 0 - 127	00	0
40 1x 01#		00 - 7F		P.C. VALUE 1 - 128	00	1
40 1x 02	00 00 01	00 - 10	Rx. CHANNEL	1 - 16, OFF	Same as the Part Number	
40 1x 03	00 00 01	00 - 01	Rx. PITCH BEND	OFF/ON	01	ON
40 1x 04	00 00 01	00 - 01	Rx. CH PRESSURE(CAf)	OFF/ON	01	ON
40 1x 05	00 00 01	00 - 01	Rx. PROGRAM CHANGE	OFF/ON	01	ON
40 1x 06	00 00 01	00 - 01	Rx. CONTROL CHANGE	OFF/ON	01	ON
40 1x 07	00 00 01	00 - 01	Rx. POLY PRESSURE(PAf)	OFF/ON	01	ON
40 1x 08	00 00 01	00 - 01	Rx. NOTE MESSAGE	OFF/ON	01	ON
40 1x 09	00 00 01	00 - 01	Rx. RPN	OFF/ON	01	ON
40 1x 0A	00 00 01	00 - 01	Rx. NRPN	OFF/ON	00 (01*)	OFF (ON*)

* When "GM1 System On" and "GM2 System On" are received, Rx. NRPN will be set OFF. When "GS Reset" is received, it will be set ON.

Address(H)	Size(H)	Data(H)	Parameter	Description	Default Value (H)	Description
40 1x 0B	00 00 01	00 - 01	Rx. MODULATION	OFF/ON	01	ON
40 1x 0C	00 00 01	00 - 01	Rx. VOLUME	OFF/ON	01	ON
40 1x 0D	00 00 01	00 - 01	Rx. PANPOT	OFF/ON	01	ON
40 1x 0E	00 00 01	00 - 01	Rx. EXPRESSION	OFF/ON	01	ON
40 1x 0F	00 00 01	00 - 01	Rx. HOLD1	OFF/ON	01	ON
40 1x 10	00 00 01	00 - 01	Rx. PORTAMENTO	OFF/ON	01	ON
40 1x 11	00 00 01	00 - 01	Rx. SOSTENUTO	OFF/ON	01	ON
40 1x 12	00 00 01	00 - 01	Rx. SOFT	OFF/ON	01	ON
40 1x 13	00 00 01	00 - 01	MONO/POLY MODE	Mono/Poly (=CC# 126 01/CC# 127 00)	01	Poly
40 1x 14	00 00 01	00 - 02	ASSIGN MODE	0 = SINGLE 1 = LIMITED-MULTI 2 = FULL-MULTI	SC-8820/SC-88Pro/SC-88 MAP 01 SC-55 MAP 00 at x=0 01 at x≠0	LIMITED-MULTI SINGLE (Drum Part) LIMITED-MULTI (Normal Part)

Single : If the same note is played multiple times in succession, the previously-sounding note will be completely silenced, and then the new note will be sounded.

LimitedMulti : If the same note is played multiple times in succession, the previously-sounding note will be continued to a certain extent even after the new note is sounded. (Default setting)

FullMulti : If the same note is played multiple times in succession, the previously-sounding note(s) will continue sounding for their natural length even after the new note is sounded.

* ASSIGN MODE is the parameter that determines how voice assignment will be handled when sounds overlap on identical note numbers in the same channel (i.e., repeatedly struck notes). This is initialized to a mode suitable for each Part, so for general purposes there is no need to change this.

40 1x 15	00 00 01	00 - 02	USE FOR RHYTHM PART	0 = OFF 1 = MAP1 2 = MAP2	00 at≠0 01 at x=0	OFF (Normal Part) MAP1 (Drum Part)
----------	----------	---------	---------------------	---------------------------------	----------------------	---------------------------------------

* This parameter sets the Drum Map of the Part used as the Drum Part. The SC-8820 can simultaneously (in different Parts) use up to two Drum Maps (MAP1, MAP2). With the initial settings, Part10 (MIDI CH=10, x=0) is set to MAP1 (1), and other Parts are set to normal instrumental Parts (OFF(0)).

Address(H)	Size(H)	Data(H)	Parameter	Description	Default Value (H)	Description
40 1x 16	00 00 01	28 - 58	PITCH KEY SHIFT	-24 - +24 [semitones]	40	0 [semitones]
40 1x 17	00 00 02	08 - F8	PITCH OFFSET FINE	-12.0 - +12.0 [Hz]	08 00	0 [Hz]
40 1x 18#				Use nibblized data.		

* PITCH OFFSET FINE allows you to alter, by a specified frequency amount, the pitch at which notes will sound. This parameter differs from the conventional Fine Tuning (RPN #1) parameter in that the amount of frequency alteration (in Hertz) will be identical no matter which note is played. When a multiple number of Parts, each of which has been given a different setting for PITCH OFFSET FINE, are sounded by means of an identical note number, you can obtain a Celeste effect.

40 1x 19	00 00 01	00 - 7F	PART LEVEL	0 - 127 (=CC# 7)	64	100
40 1x 1A	00 00 01	00 - 7F	VELOCITY SENSE DEPTH	0 - 127	40	64
40 1x 1B	00 00 01	00 - 7F	VELOCITY SENSE OFFSET	0 - 127	40	64
40 1x 1C	00 00 01	00 - 7F	PART PANPOT	-64 (RANDOM), -63 (LEFT) - +63 (RIGHT) (=CC# 10, except RANDOM)	40	0 (CENTER)
40 1x 1D	00 00 01	00 - 7F	KEYBOARD RANGE LOW	(C-1) - (G9)	00	C-1
40 1x 1E	00 00 01	00 - 7F	KEYBOARD RANGE HIGH	(C-1) - (G9)	7F	G 9
40 1x 1F	00 00 01	00 - 5F	CC1 CONTROLLER NUMBER	0 - 95	10	16
40 1x 20	00 00 01	00 - 5F	CC2 CONTROLLER NUMBER	0 - 95	11	17
40 1x 21	00 00 01	00 - 7F	CHORUS SEND LEVEL	0 - 127 (=CC# 93)	00	0
40 1x 22	00 00 01	00 - 7F	REVERB SEND LEVEL	0 - 127 (=CC# 91)	28	40
40 1x 23	00 00 01	00 - 01	Rx.BANK SELECT	OFF/ON	01(00*)	ON(OFF*)

* When "GM1 System On" is received, Rx.BANK SELECT will be set OFF.

* When "GS RESET" is received, Rx.BANK SELECT will be set ON.

40 1x 24	00 00 01	00 - 01	RX BANK SELECT LSB	OFF/ON	01	ON
----------	----------	---------	--------------------	--------	----	----

* When RX BANK SELECT LSB = OFF, Bank Select LSB (Bn 20 11) will be treated as 00H regardless of its value.

40 1x 2A	00 00 02	00 00 - 40 00 - 7F 7F	PITCH FINE TUNE	-100 - 0 - +100 [cents] (= RPN#1)	40 00	0
40 1x 2B#						
40 1x 2C	00 00 01	00 - 7F	DELAY SEND LEVEL	0-127 (=CC# 94)	00	0
40 1x 30	00 00 01	00 - 7F	TONE MODIFY1 Vibrato Rate	-64 - +63 (=NRPN# 8/CC#76)	40	0
40 1x 31	00 00 01	00 - 7F	TONE MODIFY2 Vibrato Depth	-64 - +63 (=NRPN# 9/CC#77)	40	0
40 1x 32	00 00 01	00 - 7F	TONE MODIFY3 TVF Cutoff Freq	-64 - +63 (=NRPN# 32/CC#74)	40	0

Appendices

Address(H)	Size(H)	Data(H)	Parameter	Description	Default Value (H)	Description
40 1x 33	00 00 01	00 - 7F	TONE MODIFY4	-64 - +63	40	0
			TVF Resonance	(=NRP# 33/CC#71)		
40 1x 34	00 00 01	00 - 7F	TONE MODIFY5	-64 - +63	40	0
			TVF&TVA Env.attack	(=NRP# 99/CC#73)		
40 1x 35	00 00 01	00 - 7F	TONE MODIFY6	-64 - +63	40	0
			TVF&TVA Env.decay	(=NRP# 100/CC#75)		
40 1x 36	00 00 01	00 - 7F	TONE MODIFY7	-64 - +63	40	0
			TVF&TVA Env.release	(=NRP# 102/CC#72)		
40 1x 37	00 00 01	00 - 7F	TONE MODIFY8	-64 - +63	40	0
			Vibrato Delay	(=NRP# 10/CC#78)		
40 1x 40	00 00 0C	00 - 7F	SCALE TUNING C	-64 - +63 [cents]	40	0 [cents]
40 1x 41#		00 - 7F	SCALE TUNING C#	-64 - +63 [cents]	40	0 [cents]
40 1x 42#		00 - 7F	SCALE TUNING D	-64 - +63 [cents]	40	0 [cents]
40 1x 43#		00 - 7F	SCALE TUNING D#	-64 - +63 [cents]	40	0 [cents]
40 1x 44#		00 - 7F	SCALE TUNING E	-64 - +63 [cents]	40	0 [cents]
40 1x 45#		00 - 7F	SCALE TUNING F	-64 - +63 [cents]	40	0 [cents]
40 1x 46#		00 - 7F	SCALE TUNING F#	-64 - +63 [cents]	40	0 [cents]
40 1x 47#		00 - 7F	SCALE TUNING G	-64 - +63 [cents]	40	0 [cents]
40 1x 48#		00 - 7F	SCALE TUNING G#	-64 - +63 [cents]	40	0 [cents]
40 1x 49#		00 - 7F	SCALE TUNING A	-64 - +63 [cents]	40	0 [cents]
40 1x 4A#		00 - 7F	SCALE TUNING A#	-64 - +63 [cents]	40	0 [cents]
40 1x 4B#		00 - 7F	SCALE TUNING B	-64 - +63 [cents]	40	0 [cents]

* SCALE TUNING is a function that allows fine adjustment to the pitch of each note in the octave. The pitch of each identically-named note in all octaves will change simultaneously. A setting of +/- 0 cents (40H) is equal temperament (page 184).

40 2x 00	00 00 01	28 - 58	MOD PITCH CONTROL	-24 - +24 [semitones]	40	0 [semitones]
40 2x 01	00 00 01	00 - 7F	MOD TVF CUTOFF CONTROL	-9600 - +9600 [cents]	40	0 [cents]
40 2x 02	00 00 01	00 - 7F	MOD AMPLITUDE CONTROL	-100.0 - +100.0 [%]	40	0 [%]
40 2x 03	00 00 01	00 - 7F	MOD LFO1 RATE CONTROL	-10.0 - +10.0 [Hz]	40	0 [Hz]
40 2x 04	00 00 01	00 - 7F	MOD LFO1 PITCH DEPTH	0 - 600 [cents]	0A	10 [cents]
40 2x 05	00 00 01	00 - 7F	MOD LFO1 TVF DEPTH	0 - 2400 [cents]	00	0 [cents]
40 2x 06	00 00 01	00 - 7F	MOD LFO1 TVA DEPTH	0 - 100.0 [%]	00	0 [%]
40 2x 07	00 00 01	00 - 7F	MOD LFO2 RATE CONTROL	-10.0 - +10.0 [Hz]	40	0 [Hz]
40 2x 08	00 00 01	00 - 7F	MOD LFO2 PITCH DEPTH	0 - 600 [cents]	00	0 [cents]
40 2x 09	00 00 01	00 - 7F	MOD LFO2 TVF DEPTH	0 - 2400 [cents]	00	0 [cents]
40 2x 0A	00 00 01	00 - 7F	MOD LFO2 TVA DEPTH	0 - 100.0 [%]	00	0 [%]
40 2x 10	00 00 01	40 - 58	BEND PITCH CONTROL	0 - 24 [semitones]	42	2 [semitones]
40 2x 11	00 00 01	00 - 7F	BEND TVF CUTOFF CONTROL	-9600 - +9600 [cents]	40	0 [cents]
40 2x 12	00 00 01	00 - 7F	BEND AMPLITUDE CONTROL	-100.0 - +100.0 [%]	40	0 [%]
40 2x 13	00 00 01	00 - 7F	BEND LFO1 RATE CONTROL	-10.0 - +10.0 [Hz]	40	0 [Hz]
40 2x 14	00 00 01	00 - 7F	BEND LFO1 PITCH DEPTH	0 - 600 [cents]	00	0 [cents]
40 2x 15	00 00 01	00 - 7F	BEND LFO1 TVF DEPTH	0 - 2400 [cents]	00	0 [cents]
40 2x 16	00 00 01	00 - 7F	BEND LFO1 TVA DEPTH	0 - 100.0 [%]	00	0 [%]
40 2x 17	00 00 01	00 - 7F	BEND LFO2 RATE CONTROL	-10.0 - +10.0 [Hz]	40	0 [Hz]
40 2x 18	00 00 01	00 - 7F	BEND LFO2 PITCH DEPTH	0 - 600 [cents]	00	0 [cents]
40 2x 19	00 00 01	00 - 7F	BEND LFO2 TVF DEPTH	0 - 2400 [cents]	00	0 [cents]
40 2x 1A	00 00 01	00 - 7F	BEND LFO2 TVA DEPTH	0 - 100.0 [%]	00	0 [%]
40 2x 20	00 00 01	28 - 58	CAf PITCH CONTROL	-24 - +24 [semitones]	40	0 [semitones]
40 2x 21	00 00 01	00 - 7F	CAf TVF CUTOFF CONTROL	-9600 - +9600 [cents]	40	0 [cents]
40 2x 22	00 00 01	00 - 7F	CAf AMPLITUDE CONTROL	-100.0 - +100.0 [%]	40	0 [%]
40 2x 23	00 00 01	00 - 7F	CAf LFO1 RATE CONTROL	-10.0 - +10.0 [Hz]	40	0 [Hz]
40 2x 24	00 00 01	00 - 7F	CAf LFO1 PITCH DEPTH	0 - 600 [cents]	00	0 [cents]
40 2x 25	00 00 01	00 - 7F	CAf LFO1 TVF DEPTH	0 - 2400 [cents]	00	0 [cents]
40 2x 26	00 00 01	00 - 7F	CAf LFO1 TVA DEPTH	0 - 100.0 [%]	00	0 [%]
40 2x 27	00 00 01	00 - 7F	CAf LFO2 RATE CONTROL	-10.0 - +10.0 [Hz]	40	0 [Hz]
40 2x 28	00 00 01	00 - 7F	CAf LFO2 PITCH DEPTH	0 - 600 [cents]	00	0 [cents]
40 2x 29	00 00 01	00 - 7F	CAf LFO2 TVF DEPTH	0 - 2400 [cents]	00	0 [cents]
40 2x 2A	00 00 01	00 - 7F	CAf LFO2 TVA DEPTH	0 - 100.0 [%]	00	0 [%]
40 2x 30	00 00 01	28 - 58	PAf PITCH CONTROL	-24 - +24 [semitones]	40	0 [semitones]
40 2x 31	00 00 01	00 - 7F	PAf TVF CUTOFF CONTROL	-9600 - +9600 [cents]	40	0 [cents]
40 2x 32	00 00 01	00 - 7F	PAf AMPLITUDE CONTROL	-100.0 - +100.0 [%]	40	0 [%]
40 2x 33	00 00 01	00 - 7F	PAf LFO1 RATE CONTROL	-10.0 - +10.0 [Hz]	40	0 [Hz]
40 2x 34	00 00 01	00 - 7F	PAf LFO1 PITCH DEPTH	0 - 600 [cents]	00	0 [cents]
40 2x 35	00 00 01	00 - 7F	PAf LFO1 TVF DEPTH	0 - 2400 [cents]	00	0 [cents]
40 2x 36	00 00 01	00 - 7F	PAf LFO1 TVA DEPTH	0 - 100.0 [%]	00	0 [%]
40 2x 37	00 00 01	00 - 7F	PAf LFO2 RATE CONTROL	-10.0 - +10.0 [Hz]	40	0 [Hz]
40 2x 38	00 00 01	00 - 7F	PAf LFO2 PITCH DEPTH	0 - 600 [cents]	00	0 [cents]
40 2x 39	00 00 01	00 - 7F	PAf LFO2 TVF DEPTH	0 - 2400 [cents]	00	0 [cents]
40 2x 3A	00 00 01	00 - 7F	PAf LFO2 TVA DEPTH	0 - 100.0 [%]	00	0 [%]
40 2x 40	00 00 01	28 - 58	CC1 PITCH CONTROL	-24 - +24 [semitones]	40	0 [semitones]
40 2x 41	00 00 01	00 - 7F	CC1 TVF CUTOFF CONTROL	-9600 - +9600 [cents]	40	0 [cents]

Address(H)	Size(H)	Data(H)	Parameter	Description	Default Value (H)	Description
40 2x 42	00 00 01	00 - 7F	CC1 AMPLITUDE CONTROL	-100.0 - +100.0 [%]	40	0 [%]
40 2x 43	00 00 01	00 - 7F	CC1 LFO1 RATE CONTROL	-10.0 - +10.0 [Hz]	40	0 [Hz]
40 2x 44	00 00 01	00 - 7F	CC1 LFO1 PITCH DEPTH	0 - 600 [cents]	00	0 [cents]
40 2x 45	00 00 01	00 - 7F	CC1 LFO1 TVF DEPTH	0 - 2400 [cents]	00	0 [cents]
40 2x 46	00 00 01	00 - 7F	CC1 LFO1 TVA DEPTH	0 - 100.0 [%]	00	0 [%]
40 2x 47	00 00 01	00 - 7F	CC1 LFO2 RATE CONTROL	-10.0 - +10.0 [Hz]	40	0 [Hz]
40 2x 48	00 00 01	00 - 7F	CC1 LFO2 PITCH DEPTH	0 - 600 [cents]	00	0 [cents]
40 2x 49	00 00 01	00 - 7F	CC1 LFO2 TVF DEPTH	0 - 2400 [cents]	00	0 [cents]
40 2x 4A	00 00 01	00 - 7F	CC1 LFO2 TVA DEPTH	0 - 100.0 [%]	00	0 [%]
40 2x 50	00 00 01	28 - 58	CC2 PITCH CONTROL	-24 - +24 [semitones]	40	0 [semitones]
40 2x 51	00 00 01	00 - 7F	CC2 TVF CUTOFF CONTROL	-9600 - +9600 [cents]	40	0 [cents]
40 2x 52	00 00 01	00 - 7F	CC2 AMPLITUDE CONTROL	-100.0 - +100.0 [%]	40	0 [%]
40 2x 53	00 00 01	00 - 7F	CC2 LFO1 RATE CONTROL	-10.0 - +10.0 [Hz]	40	0 [Hz]
40 2x 54	00 00 01	00 - 7F	CC2 LFO1 PITCH DEPTH	0 - 600 [cents]	00	0 [cents]
40 2x 55	00 00 01	00 - 7F	CC2 LFO1 TVF DEPTH	0 - 2400 [cents]	00	0 [cents]
40 2x 56	00 00 01	00 - 7F	CC2 LFO1 TVA DEPTH	0 - 100.0 [%]	00	0 [%]
40 2x 57	00 00 01	00 - 7F	CC2 LFO2 RATE CONTROL	-10.0 - +10.0 [Hz]	40	0 [Hz]
40 2x 58	00 00 01	00 - 7F	CC2 LFO2 PITCH DEPTH	0 - 600 [cents]	00	0 [cents]
40 2x 59	00 00 01	00 - 7F	CC2 LFO2 TVF DEPTH	0 - 2400 [cents]	00	0 [cents]
40 2x 5A	00 00 01	00 - 7F	CC2 LFO2 TVA DEPTH	0 - 100.0 [%]	00	0 [%]

* You may not always be able to obtain the desired effect by modifying the LFO 1 and LFO 2 parameters.

40 4x 00	00 00 01	00 - 04	TONF MAP NUMBER (= CC#32 : Bank number LSB)	MAP 0 - 4 00: SELECTED 01: SC-55 MAP 02: SC-88 MAP 03: SC-88Pro MAP 04: SC-8820 MAP	00	
----------	----------	---------	--	--	----	--

* When "GS Reset" is received, this will be 00: SELECTED.

40 4x 01	00 00 01	01 - 04	TONE MAP-0 NUMBER	01: SC-55 MAP 02: SC-88 MAP 03: SC-88Pro MAP 04: SC-8820 MAP	(04)	
----------	----------	---------	-------------------	---	------	--

* This specifies a MAP when TONE MAP NUMBER is 00.

40 4x 20	00 00 01	00 - 01	EQ ON/OFF	OFF/ON	01	ON
----------	----------	---------	-----------	--------	----	----

* This turns the EQ (equalizer) on/off.

40 4x 22	00 00 01	00 - 01	PART EFX ASSIGN	00: BYPASS 01: EFX	00	BYPASS
----------	----------	---------	-----------------	-----------------------	----	--------

●Drum setup parameters

m: Map number (0 = MAP1, 1 = MAP2)

rr: drum part note number (00H - 7FH: 0 - 127)

Address(H)	Size(H)	Data(H)	Parameter	Description
41 m0 00	00 00 0C	20 - 7F	DRUM MAP NAME	ASCII Character
41 m0 0B#				#
41 m1 rr	00 00 01	00 - 7F	PLAY NOTE NUMBER	Pitch coarse
41 m2 rr	00 00 01	00 - 7F	LEVEL	TVA level (=NRP# 26)
41 m3 rr	00 00 01	00 - 7F	ASSIGN GROUP NUMBER	Non, 1 - 127
41 m4 rr	00 00 01	00 - 7F	PANPOT	-64 (RANDOM), -63 (LEFT) - +63 (RIGHT) (=NRP# 28, except RANDOM)
41 m5 rr	00 00 01	00 - 7F	REVERB SEND LEVEL	0.0 - 1.0 Multiplicand of the part reverb level (=NRP# 29)
41 m6 rr	00 00 01	00 - 7F	CHORUS SEND LEVEL	0.0 - 1.0 Multiplicand of the part chorus level (=NRP# 30)
41 m7 rr	00 00 01	00 - 01	Rx. NOTE OFF	OFF/ON
41 m8 rr	00 00 01	00 - 01	Rx. NOTE ON	OFF/ON
41 m9 rr	00 00 01	00 - 7F	DELAY SEND LEVEL	0.0 - 1.0 Multiplicand of the part delay level (=NRP# 31)

* When the Drum Set is changed, DRUM SETUP PARAMETER values will all be initialized.

* It is not possible to simultaneously use both Chorus Send Level and Delay Send Level for a single Drum Instrument.

Appendices

●User instrument

You can modify the parameters of the SC-8820 sound to your taste, and save your new settings in Variation numbers 64 or 65 of the SC-8820 map/SC-88Pro map/SC-88 map. A sound saved in this way is called a User Instrument. You can save 256 different sounds in this way.

The parameters you can set are Vibrato, Filter and Envelope.

The other sound parameters will use the values specified for the Part (Part parameters, p.33). Each Part has Part parameters which are named identically to the User parameters listed above which can be set for each sound. This means that the parameter value that actually applies to the sound will be a combination of these two settings. For example, if the Vibrato Rate has been set to +20 as a Part parameter, and to -5 as a User instrument parameter, the Vibrato Rate of the resulting sound will be 20 - 5 = +15

b: bank number (0H = GS Variation number 64, 1H = GS Variation number 65)

pp: program number (00 - 7F: 1 - 128)

Address(H)	Size(H)	Data(H)	Parameter	Description	Default Value (H)	Description
20 b0 pp	00 00 01	01 - 04	SOURCE TONE# (MAP)	---		
20 b1 pp	00 00 01	00 - 7F	(CC#00 : Bank number MSB)	---		
20 b2 pp	00 00 01	00 - 7F	(PG# : Program number)	---		
20 b3 pp	00 00 01	00 - 7F	USER INST MODIFY1-2 Vibrato Rate	-64 - +63	40	0
20 b4 pp	00 00 01	00 - 7F	USER INST MODIFY2-2 Vibrato Depth	-64 - +63	40	0
20 b5 pp	00 00 01	00 - 7F	USER INST MODIFY3-2 TVF Cutoff Freq	-64 - +63	40	0
20 b6 pp	00 00 01	00 - 7F	USER INST MODIFY4-2 TVF Resonance	-64 - +63	40	0
20 b7 pp	00 00 01	00 - 7F	USER INST MODIFY5-2 TVF&TVA Env.attack	-64 - +63	40	0
20 b8 pp	00 00 01	00 - 7F	USER INST MODIFY6-2 TVF&TVA Env.decay	-64 - +63	40	0
20 b9 pp	00 00 01	00 - 7F	USER INST MODIFY7-2 TVF&TVA Env.release	-64 - +63	40	0
20 bA pp	00 00 01	00 - 7F	USER INST MODIFY8-2 Vibrato Delay	-64 - +63	40	0

* On the SC-8820, these settings will be lost when the power is turned off.

●User Drum Set

You can modify drum instrument parameters to your liking, and save this data as a Drum Set. A Drum Set saved in this way is called a User Drum Set. You can save up to two Drum Sets, and since each set contains 128 instrumental sounds, this provides a total of 256 instrumental sounds (Drum Instruments). You can also give each User Drum Set a name of your choice. User Drum Sets are stored in Drum Set numbers 65 and 66 of the SC-8820/ SC-88Pro/ SC-88 map.

d: drum set number (0H = User drum set number 65, 1H = User Drum Set number 66)

rr: drum part note number (00 - 7F: 0-127)

Address(H)	Size(H)	Data(H)	Parameter	Description
21 d0 00	00 00 0C	20 - 7F	USER DRUM SET NAME	32 - 127 (ASCII 12 characters)
21 d0 0B#				
21 d1 rr	00 00 01	00 - 7F	PLAY NOTE	0 - 127
21 d2 rr	00 00 01	00 - 7F	LEVEL	0 - 127
21 d3 rr	00 00 01	00 - 7F	ASSIGN GROUP	0 - 127
21 d4 rr	00 00 01	00 - 7F	PAN	0 - 127
21 d5 rr	00 00 01	00 - 7F	REVERB SEND LEVEL	0 - 127
21 d6 rr	00 00 01	00 - 7F	CHORUS SEND LEVEL	0 - 127
21 d7 rr	00 00 01	00 - 01	RX NOTE OFF	OFF/ON
21 d8 rr	00 00 01	00 - 01	RX NOTE ON	OFF/ON
21 d9 rr	00 00 01	00 - 7F	DELAY SEND LEVEL	0 - 127
21 dA rr	00 00 01	01 - 04	SOURCE DRUM SET# (MAP)	1 - 4
21 dB rr	00 00 01	00 - 7F	(PG# : Program number)	0 - 127
21 dC rr	00 00 01	00 - 7F	SOURCE NOTE NUMBER	0 - 127

* On the SC-8820, these settings will be lost when the power is turned off.

4. Bulk Dump

Bulk Dump allows you to transmit a large amount of data at once, and is convenient for storing settings for the entire unit on a computer or sequencer.

To make the SC-8820 perform a Bulk Dump transmission, send it a "Bulk Dump Request" message. Bulk Dump Request uses the Data Request 1 (RQ1) format, but unlike when transmitting individual parameters, the "Size" specified by the request message refers not to size of the data but rather specifies the contents of the data. For the data contents corresponding to each Size, refer to "Parameter dump."

When the SC-8820 receives a Bulk Dump Request, it will transmit a Bulk Dump in the format given below.

The SC-8820 is also able to transmit a list of its internal sounds. This function can be used to display a list of sounds on a computer.

■Parameter dump

○Parameter dump request (receive only)

This is a command that requests a set of parameter data, and uses "Data Request 1 (RQ1)" format. The Size specifies the requested data contents.

Address:	0C 00 00	
Size:	00 00 00: ALL	request a dump of all parameters
	00 00 01: ALL 1	use this when not using USER TONE BANK or USER DRUM SET
	00 00 02: ALL 2	use this when USER TONE BANK, USER DRUM SET and DRUM SETUP settings have not been modified
	00 00 10: 16-part GS 1	use this when using only 16 Parts
	00 00 11: 16-part GS 2	use this when using only 16 Parts, and DRUM SETUP settings have not been modified
	00 01 00: USER TONE BANK (ALL)	request a dump of all USER TONE BANK data
	00 01 40: USER TONE BANK #64	request a dump of USER TONE BANK #64 data (128 sounds)
	00 01 41: USER TONE BANK #65	request a dump of USER TONE BANK #65 data (128 sounds)
	00 02 00: USER DRUM SET (ALL)	request a dump of all USER DRUM SET data
	00 02 40: USER DRUM SET #65	request a dump of USER DRUM SET #65 data
	00 02 41: USER DRUM SET #66	request a dump of USER DRUM SET #66 data

Example) Dump request for all parameters: F0 41 dev 42 11 0C 00 00 00 00 00 74 F7

Normally, using ALL (00 00 00) provides the greatest predictability, but the amount of data is very large, and transmission may take more than half a minute. In order to reduce transmission time and data volume, we suggest that you request a dump only of the necessary data. Panel button operations allow you to transmit dumps of ALL, ALL 1, 16-part GS 1, 16-part GS 2, USER TONE BANK (ALL), USER DRUM SET (ALL).

○Parameter dump

When a Parameter Dump Request is received, or when panel operations initiate a dump transmission, the following data will be transmitted in "Data Set 1 (DT1)" format.

Address	Description	Number of packets	16-part						USER TONE BANK			USERDRUMSET			
			ALL	ALL1	ALL2	GS1	GS2	ALL	#64	#65	ALL	#65	#66		
08 00 00 - 08 00 7F	SETUP	2	○	○	○	○	○								
28 00 00 - 28 0A 7F	USER TONE BANK #64	11	○						○	○					
28 10 00 - 28 1A 7F	USER TONE BANK #65	11	○						○		○				
29 00 00 - 29 0B 0F	USER DRUM SET #65	12	○									○	○		
29 10 00 - 29 1B 0F	USER DRUM SET #66	12	○									○		○	
48 1D 10 - 48 26 0F	PATCH EXTENSION A	9	○	○	○	○	○								
48 00 00 - 48 1D 0F	SYSTEM/PATCH A	30	○	○	○	○	○								
49 00 00 - 49 1F 7F	DRUM SETUP A	32	○	○		○									
58 1D 10 - 58 26 0F	PATCH EXTENSION B	9	○	○	○										
58 00 00 - 58 1D 0F	SYSTEM/PATCH B	30	○	○	○										
59 00 00 - 59 1F 7F	DRUM SETUP B	32	○	○											

- * When data dumped by the SC-8820 is reloaded into the SC-8820, be aware that the data may not be set correctly if the transmission order of the packets is changed, if the time interval between packets is changed, or if other messages are inserted between packets.
- * The Parameter Dump data of the SC-8820 includes data for GS format compatible devices, and this data is compatible in both directions. However, depending on the parameters which are newly extended on the SC-8820, the musical result may differ.
- * If the SC-8820 does not operate correctly with Bulk Dump data from another GS format compatible device, transmit a GS reset before retransmitting the data.

■ Dumping a list of internal sounds

● Instrument list dump

○ Instrument list dump request (receive only)

This command requests a bulk dump of a list of the preset sounds (Instruments) in internal memory, and uses "Data Request 1 (RQ1)" format. The Size specifies the contents of the requested data.

Address: 0C 00 01
 Size: 00 00 00: ALL
 00 00 01: SC-55 MAP
 00 00 02: SC-88 MAP
 00 00 03: SC-88Pro MAP
 00 00 04: SC-8820 MAP
 00 mm bb mm = MAP# 01 - 04 (01 = SC-55 MAP, 02 = SC-88 MAP, 03 = SC-88Pro MAP, 04 = SC-8820 MAP)
 bb = BANK# 00 - 7F

○ Instrument list dump (transmit only)

When Instrument List Dump Request is received, the sound names of the specified map will be transmitted continuously in the format given below, where 16 bytes are used for each sound name. The Address of the transmitted data is 0C 00 01 for all packets. User bank sound names are not transmitted.

DUMP FORMAT:

0	1	2	3	4	5	6	7	8	9	A	B	C	D	E	F
CC0	MAP	PC	00	TONE NAME(ASCII 12 Characters)											

CC0: Variation number

MAP: MAP number 01 = SC-55 MAP, 02 = SC-88 MAP, 03 = SC-88Pro MAP, 04 = SC-8820 MAP

PC: Program number

● Drum set list dump

○ Drum set list dump request (receive only)

This command requests a bulk dump transmission of a list of Preset Drum Sets in internal memory, and uses "Data Request 1 (RQ1)" format. The Size specifies the desired data contents.

Address: 0C 00 02
 Size: 00 00 00: ALL
 00 00 01: SC-55 MAP
 00 00 02: SC-88 MAP
 00 00 03: SC-88Pro MAP
 00 00 04: SC-8820 MAP

○ Drum set list dump (transmit only)

When a Drum Set List Dump Request is received, the Drum Set names of the specified MAP will be transmitted successively in the format given below, where 16 bytes are used for each sound. The Address of the transmitted data will be 0C 00 02 for each packet.

DUMP FORMAT:

0	1	2	3	4	5	6	7	8	9	A	B	C	D	E	F
00	MAP	PC	00	DRUM TONE NAME(ASCII 12 Characters)											

MAP: MAP number 01 = SC-55 MAP, 02 = SC-88 MAP, 03 = SC-88Pro MAP, 04 = SC-8820 MAP

PC: Program number

● Drum instrument list dump

○ Drum instrument list dump request (receive only)

This command requests a bulk dump transmission of the Instrument list of an internal Preset Drum Sets, and uses "Data Request 1 (RQ1)" format. The Size specifies the desired data contents.

Address: 0C 00 03
 Size: 00 00 00: ALL
 00 00 01: SC-55 MAP
 00 00 02: SC-88 MAP
 00 00 03: SC-88Pro MAP
 00 00 04: SC-8820 MAP

○ Drum instrument list dump (transmit only)

When a Drum Instrument List Dump Request is received, the Drum Instrument names of the specified Drum Set will be transmitted in the following format where 16 bytes are used for each Drum Instrument name. The address of the transmitted data will be 0C 00 03 for each packet.

DUMP FORMAT:

0	1	2	3	4	5	6	7	8	9	A	B	C	D	E	F
00	MAP	PC	KEY	DRUM TONE NAME(ASCII 12 Characters)											

MAP: MAP number 01 = SC-55 MAP, 02 = SC-88 MAP, 03 = SC-88Pro MAP, 04 = SC-8820 MAP

PC: Program number

KEY: Note number

● Insertion effect list dump

○ Insertion effect list dump request (receive only)

This command requests a bulk dump transmission of the Insertion effect list of an internal memory, and uses "Data Request 1 (RQ1)" format. The Size specifies the desired data contents.

Address: 0C 00 04
 Size: 00 00 00: ALL

○ Insertion effect list dump (transmit only)

When an Insertion Effect List Dump Request is received, the specified Insertion Effect names will be transmitted in the following format where 20 bytes are used for each Effect name. The address of the transmitted data will be 0C 00 04 for each packet.

DUMP FORMAT:

0	1	2	3	4	5	6	7	8	9	A	B	C	D	E	F	10	11	12	13
MSB	LSB	00	00	EFFECT NAME(ASCII 16 Characters)															

MSB: Category

LSB: Type

5. Supplementary material

●Decimal and Hexadecimal table

(An "H" is appended to the end of numbers in hexadecimal notation.)

In MIDI documentation, data values and addresses/sizes of Exclusive messages, etc. are expressed as hexadecimal values for each 7 bits.

The following table shows how these correspond to decimal numbers.

Dec.	Hex.	Dec.	Hex.	Dec.	Hex.	Dec.	Hex.
0	00H	32	20H	64	40H	96	60H
1	01H	33	21H	65	41H	97	61H
2	02H	34	22H	66	42H	98	62H
3	03H	35	23H	67	43H	99	63H
4	04H	36	24H	68	44H	100	64H
5	05H	37	25H	69	45H	101	65H
6	06H	38	26H	70	46H	102	66H
7	07H	39	27H	71	47H	103	67H
8	08H	40	28H	72	48H	104	68H
9	09H	41	29H	73	49H	105	69H
10	0AH	42	2AH	74	4AH	106	6AH
11	0BH	43	2BH	75	4BH	107	6BH
12	0CH	44	2CH	76	4CH	108	6CH
13	0DH	45	2DH	77	4DH	109	6DH
14	0EH	46	2EH	78	4EH	110	6EH
15	0FH	47	2FH	79	4FH	111	6FH
16	10H	48	30H	80	50H	112	70H
17	11H	49	31H	81	51H	113	71H
18	12H	50	32H	82	52H	114	72H
19	13H	51	33H	83	53H	115	73H
20	14H	52	34H	84	54H	116	74H
21	15H	53	35H	85	55H	117	75H
22	16H	54	36H	86	56H	118	76H
23	17H	55	37H	87	57H	119	77H
24	18H	56	38H	88	58H	120	78H
25	19H	57	39H	89	59H	121	79H
26	1AH	58	3AH	90	5AH	122	7AH
27	1BH	59	3BH	91	5BH	123	7BH
28	1CH	60	3CH	92	5CH	124	7CH
29	1DH	61	3DH	93	5DH	125	7DH
30	1EH	62	3EH	94	5EH	126	7EH
31	1FH	63	3FH	95	5FH	127	7FH

- * Decimal values such as MIDI channel, bank select, and program change are listed as one greater than the values given in the above table.
- * A 7-bit byte can express data in the range of 128 steps. For data where greater precision is required, we must use two or more bytes. For example, two hexadecimal numbers aa bbH expressing two 7-bit bytes would indicate a value of aa x 128+bb.
- * In the case of values which have a +/- sign, 00H = -64, 40H = +/-0, and 7FH = +63, so that the decimal expression would be 64 less than the value given in the above chart. In the case of two types, 00 00H = -8192, 40 00H = +/-0, and 7F 7FH = +8191. For example, if aa bbH were expressed as decimal, this would be aa bbH - 40 00H = aa x 128+bb - 64 x 128.
- * Data marked "Use nibbled data" is expressed in hexadecimal in 4-bit units. A value expressed as a 2-byte nibble 0a 0bH has the value of a x 16+b.

<Example 1> What is the decimal expression of 5AH ?

From the preceding table, 5AH = 90

<Example 2> What is the decimal expression of the value 12 34H given as hexadecimal for each 7 bits?

From the preceding table, since 12H = 18 and 34H = 52
18 x 128+52 = 2356

<Example 3> What is the decimal expression of the nibbled value 0A 03 09 0D ?

From the preceding table, since 0AH = 10, 03H = 3, 09H = 9, 0DH = 13
((10 x 16+3) x 16+9) x 16+13 = 41885

<Example 4> What is the nibbled expression of the decimal value 1258?

16) 1258
16) 78 ... 10
16) 4 ... 14
0 ... 4

Since from the preceding table, 0 = 00H, 4 = 04H, 14 = 0EH, 10 = 0AH, the result is: 00 04 0E 0AH.

●Examples of actual MIDI messages

<Example 1> 92 3E 5F

9n is the Note-on status, and n is the MIDI channel number. Since 2H = 2, 3EH = 62, and 5FH = 95, this is a Note-on message with MIDI CH = 3, note number 62 (note name is D4), and velocity 95.

<Example 2> CE 49

CnH is the Program Change status, and n is the MIDI channel number. Since EH = 14 and 49H = 73, this is a Program Change message with MIDI CH = 15, program number 74 (Flute in GS).

<Example 3> EA 00 28

EnH is the Pitch Bend Change status, and n is the MIDI channel number. The 2nd byte (00H = 0) is the LSB and the 3rd byte (28H = 40) is the MSB, but Pitch Bend Value is a signed number in which 40 00H (= 64 x 12+80 = 8192) is 0, so this Pitch Bend Value is 28 00H - 40 00H = 40 x 12+80 - (64 x 12+80) = 5120 - 8192 = -3072

If the Pitch Bend Sensitivity is set to 2 semitones, -8192 (00 00H) will cause the pitch to change -200 cents, so in this case -200 x (-3072) ÷ (-8192) = -75 cents of Pitch Bend is being applied to MIDI channel 11.

<Example 4> B3 64 00 65 00 06 0C 26 00 64 7F 65 7F

BnH is the Control Change status, and n is the MIDI channel number. For Control Changes, the 2nd byte is the control number, and the 3rd byte is the value. In a case in which two or more messages consecutive messages have the same status, MIDI has a provision called "running status" which allows the status byte of the second and following messages to be omitted. Thus, the above messages have the following meaning.

B3 64 00 MIDI ch.4, lower byte of RPN parameter number:00H
(B3) 65 00 (MIDI ch.4) upper byte of RPN parameter number:00H
(B3) 06 0C (MIDI ch.4) upper byte of parameter value:0CH
(B3) 26 00 (MIDI ch.4) lower byte of parameter value:00H
(B3) 64 7F (MIDI ch.4) lower byte of RPN parameter number:7FH
(B3) 65 7F (MIDI ch.4) upper byte of RPN parameter number:7FH

In other words, the above messages specify a value of 0C 00H for RPN parameter number 00 00H on MIDI channel 4, and then set the RPN parameter number to 7F 7FH.

RPN parameter number 00 00H is Pitch Bend Sensitivity, and the MSB of the value indicates semitone units, so a value of 0CH = 12 sets the maximum pitch bend range to +/-12 semitones (1 octave). (On GS sound generators the LSB of Pitch Bend Sensitivity is ignored, but the LSB should be transmitted anyway (with a value of 0) so that operation will be correct on any device.)

Once the parameter number has been specified for RPN or NRPN, all Data Entry messages transmitted on that same channel will be valid, so after the desired value has been transmitted, it is a good idea to set the parameter number to 7F 7FH to prevent accidents. This is the reason for the (B3) 64 7F (B3) 65 7F at the end.

It is not desirable for performance data (such as Standard MIDI File data) to contain many events with running status as given in <Example 4>. This is because if playback is halted during the song and then rewound or fast-forwarded, the sequencer may not be able to transmit the correct status, and the sound generator will then misinterpret the data. Take care to give each event its own status.

It is also necessary that the RPN or NRPN parameter number setting and the value setting be done in the proper order. On some sequencers, events occurring in the same (or consecutive) clock may be transmitted in an order different than the order in which they were received. For this reason it is a good idea to slightly skew the time of each event (about 1 tick for TPQN = 96, and about 5 ticks for TPQN = 480).

- * TPQN: Ticks Per Quarter Note

Appendices

● Example of an Exclusive message and calculating a checksum

Roland Exclusive messages (RQ1, DT1) are transmitted with a checksum at the end (before F7) to make sure that the message was correctly received. The value of the checksum is determined by the address and data (or size) of the transmitted Exclusive message.

○ How to calculate the checksum (hexadecimal numbers are indicated by "H")

The checksum is a value derived by adding the address, size, and checksum itself and inverting the lower 7 bits.

Here's an example of how the checksum is calculated. We will assume that in the Exclusive message we are transmitting, the address is aa bb ccH and the data or size is dd ee ffH.

aa+bb+cc+dd+ee+ff = sum
sum ÷ 128 = quotient ... remainder
128 - remainder = checksum

<Example 1> Setting REVERB MACRO to ROOM 3

According to the "Parameter Address Map (p.174)," the REVERB MACRO Address is 40 01 30H, and ROOM 3 is a value of 02H. Thus,

F0	41	10	42	12	40 01 30	02	??	F7
(1)	(2)	(3)	(4)	(5)	address	data	checksum	(6)

(1) Exclusive Status, (2) ID (Roland), (3) Device ID (17),
(4) Model ID (GS), (5) Command ID (DT1), (6) End of Exclusive

Next, we calculate the checksum.

40H+01H+30H+02H = 64+1+48+2 = 115 (sum)
115 (sum) ÷ 128 = 0 (quotient) ... 115 (remainder)
checksum = 128 - 115 (remainder) = 13 = 0DH

This means that F0 41 10 42 12 40 01 30 02 0D F7 is the message we transmit.

<Example 2> Requesting transmission of the LEVEL for DRUM MAP 1 NOTE NUMBER 75 (D#5; Claves)

NOTE NUMBER 75 (D#5) is 4BH in hexadecimal.

According to the "Parameter Address Map (p.179)," the LEVEL of NOTE NUMBER 75 (D#5; Claves) in DRUM MAP 1 has an Address of 41 02 4BH and a Size of 00 00 01H. Thus,

F0	41	10	42	11	41 02 4B	00 00 01	??	F7
(1)	(2)	(3)	(4)	(5)	address	size	checksum	(6)

(1) Exclusive Status, (2) ID (Roland), (3) Device ID (17),
(4) Model ID (GS), (5) Command ID (RQ1), (6) End of Exclusive

Next we calculate the checksum.

41H+02H+4BH+00H+00H+01H = 65+2+75+0+0+1 = 143 (sum)
143 (sum) ÷ 128 = 1 (quotient) ... 15 (remainder)
checksum = 128 - 15 (remainder) = 113 = 71H

This means that F0 41 10 42 11 41 02 4B 00 00 01 71 F7 is the message we transmit.

<Example 3> Setting REVERB LEVEL to 12

According to the "Parameter Address Map (p.174)," the REVERB LEVEL Address is 40 01 33H, and the parameter value is 0CH. Thus,

F0	41	10	42	12	40 01 33	0C	??	F7
(1)	(2)	(3)	(4)	(5)	address	data	checksum	(6)

(1) Exclusive Status, (2) ID (Roland), (3) Device ID (17),
(4) Model ID (GS), (5) Command ID (DT1), (6) EOX

Next we calculate the checksum.

40H + 01H + 33H + 0CH = 64 + 1 + 51 + 12 = 128 (sum)
128 (sum) ÷ 128 = 0 (quotient) ... 0 (remainder)
checksum = 128 - 0 (remainder) = 128 = 80H

In this case, however, the checksum value should be 00H, not 80H. You should use 00H if the remainder is 0.

This means that F0 41 10 42 12 40 01 33 0C 00 F7 is the message we transmit.

● About the Tuning

In MIDI, individual Parts are tuned by sending RPN #1 (Master Fine Tuning) to the appropriate MIDI channel.

In MIDI, an entire device is tuned by either sending RPN #1 to all MIDI channels being used, or by sending a System Exclusive MASTER TUNE (address 40 00 00H).

RPN #1 allows tuning to be specified in steps of approximately 0.012 cents (to be precise, 100/8192 cent), and System Exclusive MASTER TUNE allows tuning in steps of 0.1 cent. One cent is 1/100th of a semitone.

The values of RPN #1 (Master Fine Tuning) and System Exclusive MASTER TUNE are added together to determine the actual pitch sounded by each Part.

Frequently used tuning values are given in the following table for your reference. Values are in hexadecimal (decimal in parentheses).

Hz at A4	cents	RPN #1	Sys.Ex. 40 00 00
445.0	+19.56	4C 43 (+1603)	00 04 0C 04 (+196)
444.0	+15.67	4A 03 (+1283)	00 04 09 0D (+157)
443.0	+11.76	47 44 (+ 964)	00 04 07 06 (+118)
442.0	+ 7.85	45 03 (+ 643)	00 04 04 0E (+ 79)
441.0	+ 3.93	42 42 (+ 322)	00 04 02 07 (+ 39)
440.0	0	40 00 (0)	00 04 00 00 (0)
439.0	- 3.94	3D 3D (- 323)	00 03 0D 09 (- 39)
438.0	- 7.89	3A 7A (- 646)	00 03 0B 01 (- 79)

<Example> Setting the tuning of MIDI channel 3 to A4 = 442.0 Hz

Send RPN#1 to MIDI channel 3. From the above table, the value is 45 03H.

B2	64 00	MIDI ch.3, lower byte of RPN parameter number: 00H
(B2)	65 01	(MIDI ch.3) upper byte of RPN parameter number: 01H
(B2)	06 45	(MIDI ch.3) upper byte of parameter value: 45H
(B2)	26 03	(MIDI ch.3) lower byte of parameter value: 03H
(B2)	64 7F	(MIDI ch.3) lower byte of RPN parameter number: 7FH
(B2)	65 7F	(MIDI ch.3) upper byte of RPN parameter number: 7FH

● The Scale Tune Feature (address: 40 1x 40)

The scale Tune feature allows you to finely adjust the individual pitch of the notes from C through B. Though the settings are made while working with one octave, the fine adjustments will affect all octaves. By making the appropriate Scale Tune settings, you can obtain a complete variety of tuning methods other than equal temperament. As examples, three possible types of scale setting are explained below.

○ Equal Temperament

This method of tuning divides the octave into 12 equal parts. It is currently the most widely used form of tuning, especially in occidental music. On the SC-8820, the default settings for the Scale Tune feature produce equal temperament.

○ Just Temperament (Tonic of C)

The principal triads resound much more beautifully than with equal temperament, but this benefit can only be obtained in one key. If transposed, the chords tend to become ambiguous. The example given involves settings for a key in which C is the keynote.

○ Arabian Scale

By altering the setting for Scale Tune, you can obtain a variety of other tunings suited for ethnic music. For example, the settings introduced below will set the unit to use the Arabian Scale.

Example Settings

Note name	Equal Temperament	Just Temperament (Keytone C)	Arabian Scale
C	0	0	-6
C#	0	-8	+45
D	0	+4	-2
D#	0	+16	-12
E	0	-14	-51
F	0	-2	-8
F#	0	-10	+43
G	0	+2	-4
G#	0	+14	+47
A	0	-16	0
A#	0	+14	-10
B	0	-12	-49

The values in the table are given in cents. Refer to the explanation of Scale Tuning on page 178 to convert these values to hexadecimal, and transmit them as Exclusive data.

For example, to set the tune (C-B) of the Part1 Arabian Scale, send the following data:

F0 41 10 42 12 40 11 40 3A 6D 3E 34 0D 38 6B 3C 6F 40 36 0F 76 F7

SOUND Canvas
Model SC-8820

MIDI Implementation Chart

Date : 1999.10
Version : 1.00

Function...	Transmitted	Recognized	Remarks	
Basic Default Channel Changed	X X	1-16 1-16	When the power is off, it can be memorized.	
Mode Default Messages Altered	X X *****	Mode 3 Mode 3, 4 (M = 1)	* 2	
Note Number : True Voice	X *****	0-127 0-127		
Velocity Note On Note Off	X X	O X		
After Key's Touch Channel's	X X	O O O O	*1 *1	
Pitch Bend	X	O	*1	
Control Change	0, 32 X 1 X 5 X 6, 38 X 7 X 10 X 11 X 64 X 65 X 66 X 67 X 84 X 91 X 93 X 94 X 98, 99 X 100, 101 X	O X O O O	*1 *1 *1 *1 *1 *1 *1 *1 *1 *1 *1 *1 *1 *1 *1 *1 *1	Bank select Modulation Portamento time Data entry Volume Panpot Expression Hold 1 Portamento Sostenuto Soft Portamento control Effects 1 (Reverb Send Level) Effects 3 (Chorus Send Level) Effects 4 (Delay Send Level) NRPN LSB, MSB RPN LSB, MSB
Program Change : True Number	X *****	O 0-127	*1 Program No. 1-128	
System Exclusive	O	O	*1	
System : Song Position Common : Song Select : Tune Request	X X X	X X X		
System : Clock Real Time : Commands	X X	X X		
Aux : All Sound Off Messages : Reset All Controllers : Local ON/OFF : All Notes Off : Active Sensing : System Reset	X X X X O X	O (120, 126, 127) O X O (123-125) O O X		
Notes	* 1 O X is selectable. * 2 Recognized as M=1 even if M≠1.			

Mode 1 : OMNI ON, POLY
Mode 3 : OMNI OFF, POLY

Mode 2 : OMNI ON, MONO
Mode 4 : OMNI OFF, MONO

O : Yes
X : No

Specifications

Model: Sound Canvas SC-8820

(General MIDI System / GS Format)

●Number of parts

32

●Maximum Polyphony

64 (voices)

●Internal Sounds

Sound Maps: 4 (SC-8820, SC-88Pro, SC-88, SC-55)

Preset Sounds: 1608

Drum sound sets: 63

●Effects

Reverb (8 types)

Chorus (8 types)

Delay (10 types)

2 Band Equalizer

Insertion Effect (64 types)

●Display

Power indicator

USB indicator

Part level indicator (PART A, PART B)

●Connectors

MIDI connectors (IN 1, OUT 1)

Audio Input jack (L, R)

Audio Output jack (L, R)

Headphones jack

Serial connector

USB connector

●Power Supply

DC 9V (AC Adaptor)

●Current Draw

400 mA

●Dimensions

203 (W) x 159 (D) x 35 (H) mm

8 (W) x 6-1/4 (D) x 1-3/8 (H) inches

●Weight

0.4 kg

14 oz

●Accessories

Owner's manual

CD-ROM

* In the interest of product improvement, the specifications and/or appearance of this unit are subject to change without prior notice.

Index

Numerics

2 Pitch Shifter	61
3 Tap Delay	58
3D Auto	62
3D Chorus	56
3D Delay	61
3D effects	84
3D Manual	63
4 Tap Delay	59

A

AC adaptor jack	9
Active Sensing	102
Aftertouch	32, 101
All Notes Off	101
All Sounds Off	101
Amplitude	32
AMPLITUDE CONTROL	32
Another MIDI Sound Source	19
Arabic-style Scale	31
Attack Time	35
Audio Input Jacks	16
Auto Pan	54
Auto Wah	51

B

Bank Select	99
Bass Multi	75
baud rate	12
Bend	31, 99
BEND PITCH CONTROL	28
Bulk Dump Request	181

C

Caf	32
CC1	32
CC1 Controller Number	30
Channel aftertouch	32
Channel Pressure	101
Cho → Delay	69
Cho → Flanger	70
Cho/Delay	78
Cho/Flanger	79
Chorus	40, 55
CHORUS DELAY	42
Chorus Delay Time	42
Chorus Depth	42
Chorus Feedback	42
Chorus Level	42
Chorus Macro	42–43
Chorus parameters	42
Chorus Pre-LPF	42
Chorus Rate	42
Chorus Send Level	27, 100
Chorus Send Level To Delay	42
Chorus Send Level To Reverb	42
Chorus1	42
Chorus2	42
Chorus3	42
Chorus4	42
Clean Gt Multi1	74
Clean Gt Multi2	74
Compressor	54

Computer	10
Computer Cable	106
COMPUTER switch	9, 11–13, 17, 19
Connect	10, 12–13, 16–17, 19
Control Change	99
Cutoff Freq	34
Cutoff Frequency	32, 34

D

Data Entry	101
Decay Time	35
Decimal	183
Delay	40
Delay Feedback	44
Delay Level	44
Delay Level Center	44
Delay Level Left	44
Delay Level Right	44
Delay Macro	44–45
Delay parameters	44
Delay Pre-LPF	44
Delay Send Level	27, 100
Delay Send Level To Reverb	45
Delay Time Center	44
Delay Time Ratio Left	44
Delay Time Ratio Right	44
delay/reverb	57
Delay1	44
Delay2	44
Delay3	44
Delay4	44
display	9
Distortion	50
Dly To Rev	44
Drum Instrument Chorus Send Level	104
Drum Instrument Delay Send Level	104
Drum Instrument Pan	104
Drum Instrument Pitch Coarse	104
Drum Instrument Reverb Send Level	104
Drum Instrument TVA Level	104
Drum Part	24
Drum Parts	20
Drum Set List	24
DS → Chorus	66
DS → Delay	67
DS → Flanger	66

E

EDIT	27
EFFECT	27
Effect Parameter	48
Effect types	48
effects	39
EFX	39
EFX PARAMETER	47, 85
EFX SEND LEVEL TO CHORUS	47
EFX SEND LEVEL TO DELAY	47
EFX SEND LEVEL TO REVERB	47
EFX TYPE	47, 85
EH → Chorus	67
EH → Delay	68
EH → Flanger	68
Enhancer	50

Index

- Envelope35
EQ HIGH FREQ46
EQ HIGH GAIN46
EQ LOW FREQ46
EQ LOW GAIN46
EQ ON/OFF27
Equal Temperament31
Equalizer High Frequency46
Equalizer High Gain46
Equalizer Low Frequency46
Equalizer Low Gain46
Equalizer Parameters46
Exclusive messages102
Expression99
- F**
Fb P.Shifter62
Feedback Chorus42
Filter34, 49
FL → Delay69
FL/Delay79
Flanger42
- G**
Gate Reverb60
GM (General MIDI)7
GM 2 (General MIDI 2)7
GM 2 Instrument List153
GM1 System On102
GM2 System On102
GS format7
GS Reset103
GTR Multi 171
GTR Multi 272
GTR Multi 373
- H**
Hall140
Hall240
Headphones16
Hexa Chorus55
Hexadecimal183
Hold100
Humanizer50
- I**
INPUT jack9
Insertion Effect List156
Insertion Effect Parameters47
Insertion Effects27, 39
Instrument20
Instrument List21, 107
INSTRUMENT MAP button9
interface10
interface board10
- J**
Just Intonation (Tonic of C)31
- K**
Keyboard Multi77
Keyboard Range High30
Keyboard Range Low30
- L**
Legato-enabled Sounds26
LF1 PITCH DEPTH32
LFO RATE CONTROL32
LFO TVA DEPTH32
LFO TVF DEPTH32
Limiter54
Lo-Fi 163
Lo-Fi 263
LSB22-23
- M**
Master Key Shift36
Master Pan36
Master Tune36
Master Volume36, 103
MIDI95
MIDI Bank numbers22
MIDI Channels95
MIDI Connectors13
MIDI Implementation166
MIDI Implementation chart185
MIDI IN connector9
MIDI Keyboard17
MIDI OUT connector9
MIDI Thru15
Mod31
Mod Delay57
MOD LFO1 PITCH DEPTH28
MODIFY31
Modulation31, 51, 99
Modulation Depth28
Mono28
Mono Mode28
Mono/Poly Mode28
MSB22
multitimbral sound generator20
Multitimbral Sound Modules95
- N**
Non Registered Parameter Number104, 168
Normal Parts20
Note messages99
Note number99
Note off99
Note on99
notes26
NRPN101, 104, 168
NRPN LSB, MSB101
null105

O

octave	28, 31, 36
OD → Chorus	64
OD → Delay	65
OD → Flanger	65
OD/Auto Wah	82
OD/Phaser	81
OD/Rotary	80
OD1/OD2	80
OUTPUT jack	9
Overdrive	50

P

Pan	36, 100
Pan Delay1	44
Pan Delay2	44
Pan Delay3	44
Pan Delay4	44
Panning Delay	40
PanRepeat	44
Part	20
PART EFX ASSIGN	27
Part Equalizer	27
PART LEVEL	27
Part level indicator	9, 18
Part Mode	20
Part Number	37
PART PANPOT	27
PH/Auto Wah	83
PH/Rotary	83
Phaser	51
PHONES jack	9
pitch	28, 31, 36
Pitch Bend	28, 31, 99
PITCH CONTROL	32
PITCH FINE TUNE	28
PITCH KEY SHIFT	28
pitch shift	61
Plate	40
Poly	28
Poly Mode	28
Portamento	100
Portamento Control	100
Portamento Time	100
POWER indicator	9
Power Off	18
Power On	18
POWER switch	9
Preview function	18
Program Change	99

R

Random	37
Registered Parameter Number	168
Release Time	35
Remark	21
Reset All Controllers	102
Resonance	34
Reverb	40, 60
Reverb Character	40
Reverb Delay Feedback	41
Reverb Level	40
Reverb Macro	40–41
Reverb parameters	40

Reverb Pre-Delay Time	41
Reverb Pre-LPF	40
Reverb Send Level	27, 100
Reverb Time	41
Rhodes Multi	76
Roland Super MPU II	10
Room1	40
Room2	40
Room3	40
Rotary	52
Rotary Multi	70
RPN	101, 168
RPN LSB, MSB	101
Rx. CHANNEL	28

S

SC-55 map	25
SC-88 map	25
SC-8820 map	25
SC-88Pro map	25
SCALE TUNING	31
SCALE TUNING C-B	31
Serial Connector	9, 12
Serial MIDI Driver	13
Short Delay	42
Short Delay (FB)	42
Simultaneous Notes	26
Soft	100
Sostenuto	100
Space D	56
Spectrum	49
Step Flanger	53
Stereo Chorus	56
Stereo Delay	57
Stereo Flanger	52
Stereo Position	27, 36
Stereo-EQ	49
Super MPU II	13
System Effects	39
System Exclusive messages	102

T

Thru	49
Thru function	15
Tm Ctrl Delay	59
TPQN	105
Tremolo	53
Tremolo Chorus	55
Troubleshooting	89
Tune	36
TVF CUTOFF CONTROL	32
TVF Cutoff Frequency	104
TVF Resonance	104
TVF&TVA Envelope Attack Time	104
TVF&TVA Envelope Decay Time	104
TVF&TVA Envelope Release Time	104

U

U.INST	32
USB	10
USB connection indicator	9
USB Connector	9–10
USB Driver	11
USE FOR RHYTHM PART	28

V

Velocity	99
VELOCITY SENSE DEPTH	29
VELOCITY SENSE OFFSET	29
Velocity Sensitivity Depth	29
Velocity Sensitivity Offset	29
Vib Delay	33
Vib Depth	33
Vib Rate	33
Vibrato	33
Vibrato Delay	33, 104
Vibrato Depth	33, 104
Vibrato Rate	33, 104
Voices	21, 26
Volume	99
VOLUME Knob	9

Operations via MIDI

Applying Insertion Effect to a certain Part	85
Changing a Normal Part to a Drum Part	38
Changing the chorus type	43
Changing the delay type	45
Changing the drum set of a part	25
Changing the Equalizer Low Gain	46
Changing the level of a part	37
Changing the map and variation sound of a part	23
Changing the pan of a part	37
Changing the pan of a part to Random	37
Changing the pitch of a drum instrument	105
Changing the reverb type	41
Changing the sound of a part	23
Changing the value of the cutoff frequency of a Part	105
Changing the variation sound of a part	23
Turning off the Equalizer of a Part	37

For the U.K.

IMPORTANT: THE WIRES IN THIS MAINS LEAD ARE COLOURED IN ACCORDANCE WITH THE FOLLOWING CODE.

BLUE: NEUTRAL
BROWN: LIVE

As the colours of the wires in the mains lead of this apparatus may not correspond with the coloured markings identifying the terminals in your plug, proceed as follows:

The wire which is coloured BLUE must be connected to the terminal which is marked with the letter N or coloured BLACK.
The wire which is coloured BROWN must be connected to the terminal which is marked with the letter L or coloured RED.
Under no circumstances must either of the above wires be connected to the earth terminal of a three pin plug.

For EU Countries



This product complies with the requirements of European Directive 89/336/EEC.

For the USA

FEDERAL COMMUNICATIONS COMMISSION RADIO FREQUENCY INTERFERENCE STATEMENT

This equipment has been tested and found to comply with the limits for a Class B digital device, pursuant to Part 15 of the FCC Rules. These limits are designed to provide reasonable protection against harmful interference in a residential installation. This equipment generates, uses, and can radiate radio frequency energy and, if not installed and used in accordance with the instructions, may cause harmful interference to radio communications. However, there is no guarantee that interference will not occur in a particular installation. If this equipment does cause harmful interference to radio or television reception, which can be determined by turning the equipment off and on, the user is encouraged to try to correct the interference by one or more of the following measures:

- Reorient or relocate the receiving antenna.
- Increase the separation between the equipment and receiver.
- Connect the equipment into an outlet on a circuit different from that to which the receiver is connected.
- Consult the dealer or an experienced radio/TV technician for help.

Unauthorized changes or modification to this system can void the users authority to operate this equipment.
This equipment requires shielded interface cables in order to meet FCC class B Limit.

For Canada

NOTICE

This Class B digital apparatus meets all requirements of the Canadian Interference-Causing Equipment Regulations.

AVIS

Cet appareil numérique de la classe B respecte toutes les exigences du Règlement sur le matériel brouilleur du Canada.

Information

When you need repair service, call your nearest Roland/EDIROL Service Center or authorized Roland/EDIROL distributor in your country as shown below.

Roland

AFRICA

EGYPT

AI Fanny Trading Office
P.O. Box 2904,
El Horrieh Heliopolis, Cairo,
EGYPT
TEL: (02) 4185531

REUNION

Maison FO - YAM Marcel
25 Rue Jules Merman ZL
Chaudron - BP79 97491
Ste Clotilde REUNION
TEL: 28 29 16

SOUTH AFRICA

That Other Music Shop (PTY) Ltd.
11 Melle Street (Car Melle and Jute Street)
Braamfontein 2001
Republic of SOUTH AFRICA
TEL: (011) 403 4105

Paul Bothner (PTY) Ltd.
17 Werdmuller Centre Claremont
7700
Republic of SOUTH AFRICA

P.O. Box 23032
Claremont, Cape Town
SOUTH AFRICA, 7735
TEL: (021) 64 4030

ASIA

CHINA

Beijing Xinghai Musical Instruments Co., Ltd.
6 Huangmuchiang Chao Yang District, Beijing, CHINA
TEL: (010) 6774 7491

HONG KONG

Tom Lee Music Co., Ltd. Service Division
22-32 Pun Shan Street, Tsuen Wan, New Territories,
HONG KONG
TEL: 2415 0911

INDIA

Rivera Digitec (India) Pvt. Ltd.
409, Nirman Kendra Mahalaxmi Flats Compound Off. Dr. Edwin Moses Road, Mumbai-400011, INDIA
TEL: (022) 498 3079

INDONESIA

PT Citra Inti Rama
Jl. Cideng Timur No. 15J-150 Jakarta Pusat
INDONESIA
TEL: (021) 6324170

KOREA

Cosmos Corporation Service Station
261 2nd Floor Nak-Won Arcade Jong-Ro ku, Seoul, KOREA
TEL: (02) 742 8844

MALAYSIA

Bentley Music SDN BHD
140 & 142, Jalan Bukit Bintang 55100 Kuala Lumpur, MALAYSIA
TEL: (03) 2443333

PHILIPPINES

G.A. Yupangco & Co. Inc.
339 Gil J. Puyat Avenue Makati, Metro Manila 1200, PHILIPPINES
TEL: (02) 899 9801

SINGAPORE

CRISTOFORI MUSIC PTE LTD
Blk 3014, Bedok Industrial Park E, #02-2148, SINGAPORE 489980
TEL: 243 9555

TAIWAN

ROLAND TAIWAN ENTERPRISE CO., LTD.
Room 5, 9fl. No. 112 Chung Shan N.Road Sec.2, Taipei, TAIWAN, R.O.C.
TEL: (02) 2561 3339

THAILAND

Theera Music Co., Ltd.
330 Vergg NakornKasem, Soi 2, Bangkok 10100, THAILAND
TEL: (02) 2248821

VIETNAM

Saigon Music
138 Tran Quang Khai St., District 1
Ho Chi Minh City
VIETNAM
TEL: (08) 844-4068

AUSTRALIA/ NEW ZEALAND

NEW ZEALAND Roland Corporation (NZ) Ltd.
97 Mt. Eden Road, Mt. Eden, Auckland 3, NEW ZEALAND
TEL: (09) 3098 715

CENTRAL/LATIN AMERICA

ARGENTINA Instrumentos Musicales S.A.
Florida 656 2nd Floor Office Number 206A Buenos Aires
ARGENTINA, CP1005
TEL: (54-11) 4- 393-6057

BRAZIL

Roland Brasil Ltda.
R. Coronel Octaviano da Silveira 205 08522-010 Sao Paulo BRAZIL
TEL: (011) 3743 9377

MEXICO

Casa Veerkamp, s.a. de c.v.
Av. Toluca No. 323 Col. Olivar de los Padres 01780 Mexico D.F. MEXICO
TEL: (525) 668 04 80

La Casa Wagner de Guadalajara s.a. de c.v.
Av. Corona No. 202 S.J. Guadalajara, Jalisco Mexico C.P.44100 MEXICO
TEL: (3) 613 1414

PANAMA Productos Superiores, S.A.
Apartado 655 - Panama 1 REP. DE PANAMA
TEL: (507) 270-2200

URUGUAY

Todo Musica
Cuareim 1488, Montevideo, URUGUAY
TEL: 5982-924-2335

VENEZUELA

Musiland Digital C.A.
Av. Francisco de Miranda, Centro Parque de Cristal, Nivel C2 Local 20 Caracas VENEZUELA
TEL: (02) 285 9218

EUROPE

AUSTRIA

Roland Austria GES.M.B.H.
Siemensstrasse 4, P.O. Box 74, A-6063 RUM, AUSTRIA
TEL: (0512) 26 44 260

BELGIUM/HOLLAND/ LUXEMBOURG

Roland Benelux N. V.
Houtstraat 3 B-2260 Oevel (Westerlo) BELGIUM
TEL: (014) 575811

DENMARK

Roland Scandinavia A/S
Nordhavnsvej 7, Postbox 880 DK-2100 Copenhagen DENMARK
TEL: (039)16 6200

FRANCE

Roland France SA
4, Rue Paul Henri SPAAK Parc de l'Esplanade F 77 462 St. Thibault Lagny Cedex FRANCE
TEL: 01 600 73 500

FINLAND

Roland Scandinavia As, Filial Finland
Lauttasaarentie 54 B Fin-00201 Helsinki, FINLAND
TEL: (9) 682 4020

GERMANY

Roland Elektronische Musikinstrumente Handelsgesellschaft mbH.
Oststrasse 96, 22844 Norderstedt, GERMANY
TEL: (040) 52 60090

GREECE

STOLLAS S.A. Music Sound Light
155, New National Road 26422 Patras, GREECE
TEL: 061-435400

HUNGARY

Intermusica Ltd.
Warehouse Area 'DEPO' Pf.83 H-2046 Torokbalint, HUNGARY
TEL: (23) 511011

IRELAND

Roland Ireland Audio House, Belmont Court, Donnybrook, Dublin 4, Republic of IRELAND
TEL: (01) 2603501

ITALY

Roland Italy S. p. a.
Viale delle Industrie, 8 20020 Arese Milano, ITALY
TEL: (02) 937-78300

NORWAY

Roland Scandinavia Avd. Kontor Norge
Lilleakerveien 2 Postboks 95 Lilleaker N-0216 Oslo NORWAY
TEL: 273 0074

POLAND

P. P. H. Brzostowicz
UL. Gibraltaraska 4 PL-03664 Warszawa POLAND
TEL: (022) 679 44 19

PORTUGAL

Tecnologias Musica e Audio, Roland Portugal S.A.
RUA SANTA CATARINA 131 - 4000 Porto -PORTUGAL
TEL: (02) 208 44 56

ROMANIA

FBS LINES
Plata Libertatii 1. RO-4200 Cheorgheni
TEL: (066) 164-609

RUSSIA

Slami Music Company
Sadovaya-Triumfalnaja st., 16 103006 Moscow, RUSSIA
TEL: 095 209 2193

SPAIN

Roland Electronics de España, S. A.
Calle Bolivia 239 08020 Barcelona, SPAIN
TEL: (93) 308 1000

SWEDEN

Roland Scandinavia A/S SWEDISH SALES OFFICE
Danvik Center 28, 2 tr. S-131 30 Nacka SWEDEN
TEL: (08) 702 0020

SWITZERLAND

Roland (Switzerland) AG Musitronic AG
Gerberstrasse 5, CH-4410 Liestal SWITZERLAND
TEL: (061) 921 1615

UKRAINE

TIC-TAC
Mira Str. 19/108 P.O. Box 180 295400 Munkachevo, UKRAINE
TEL: (03131) 414-40

UNITED KINGDOM

Roland (U.K.) Ltd.
Atlantic Close, Swansea Enterprise Park SWANSEA SA7 9FL, UNITED KINGDOM
TEL: (01792) 700139

MIDDLE EAST

BAHRAIN

Moon Stores
Bab Al Bahrain Road, P.O. Box 20077 State of BAHRAIN
TEL: 211 005

CYPRUS

Radex Sound Equipment Ltd.
17 Diagorou St., P.O. Box 2046, Nicosia CYPRUS
TEL: (02) 453 426

ISRAEL

Halihit P. Greenspoon & Sons Ltd.
8 Retzif Fa'aliya Hashnya St. Tel-Aviv-Yahoe ISRAEL
TEL: (03) 6823666

JORDAN

AMMAN Trading Agency
Prince Mohammed St. P.O. Box 825 Amman 11118 JORDAN
TEL: (06) 4641200

KUWAIT

Easa Husain Al-Yousifi
P.O. Box 126 Safat 13002 KUWAIT
TEL: 5719499

LEBANON

A. Chahine & Fils
P.O. Box 16-5857 Gergi Zeidan St. Chahine Building, Achrafieh Beirut, LEBANON
TEL: (01) 335799

OMAN

OHI Electronics & Trading Co. LLC
P.O. Box 889 Muscat Sultanate of OMAN
TEL: 959085

QATAR

Badie Studio & Stores
P.O. Box 62, DOHA QATAR
TEL: 423554

SAUDI ARABIA

aDawlah Universal Electronics AFL
P.O. Box 2154 ALKHOBAR 31952, SAUDI ARABIA
TEL: (03) 898 2081

SYRIA

Technical Light & Sound Center
Khaled Ibn Al Walid St. P.O. Box 13520 Damascus - SYRIA
TEL: (011) 2235 384

TURKEY

Barkat Muzik aletleri ithalat ve ihracat limited ireketi
Siraselvilier Cad. Billureu Sok. Mucadelle Cikmeze No. 11-13 Taksim - Istanbul, TURKEY
TEL: (0212) 2499324

U.A.E.

Zak Electronics & Musical Instruments Co.
Zabeel Road, Al Sherouq Bldg., No. 14, Grand Floor DUBAI U.A.E.
P.O. Box 8050 DUBAI, U.A.E.
TEL: (04) 360715

-EDIROL-

AUSTRALIA

EDIROL Australia Pty. Ltd.
72 Central Avenue Oak Flats NSW 2529 AUSTRALIA
TEL: (02) 4258 9040

U. S. A. / CANADA

EDIROL Corporation North America
808 Harrison Ave., Suite 2010 P.O. Box 4919 Blaine, WA 98231 U. S. A.
TEL: (360) 332-4211

EUROPE

EDIROL (Europe) Ltd.
500 Chiswick High Road, London W4 5RG U. K.
TEL: +44 (0) 181 956 2224

As of June 11, 1999 (EDIROL)

 Roland®

71560812

UPC

71560812



10961

Roland