



PV[®]6 • PV[®]6BT Compact Mixer

Operating Manual





FCC/ICES Compliancy Statement

This device complies with Part 15 of the FCC rules and Industry Canada license-exempt RSS Standard(s). Operation is subject to the following two conditions: (1) this device may not cause harmful interference, and (2) this device must accept any interference received, that may cause undesired operation.

Le présent appareil est conforme aux CNR d'Industrie Canada applicables aux appareils radio exempts de licence. L'exploitation est autorisée aux deux conditions suivantes: (1) l'appareil ne doit pas produire de brouillage, et (2) l'utilisateur de l'appareil doit accepter tout brouillage radioélectrique subi, même si le brouillage est susceptible d'en compromettre le fonctionnement.

Warning: Changes or modifications to the equipment not approved by Peavey Electronics Corp. can void the user's authority to use the equipment.

Note – This equipment has been tested and found to comply with the limits for a Class B digital device, pursuant to Part 15 of the FCC Rules. These limits are designed to provide reasonable protection against harmful interference in a residential installation. This equipment generates, uses, and can radiate radio frequency energy and, if not installed and used in accordance with the instructions, may cause harmful interference to radio communications. However, there is no guarantee that interference will not occur in a particular installation. If this equipment does cause harmful interference to radio or television reception, which can be determined by turning the equipment off and on, the user is encouraged to try and correct the interference by one or more of the following measures.

- Reorient or relocate the receiving antenna.
- Increase the separation between the equipment and receiver.
- Connect the equipment into an outlet on a circuit different from that to which the receiver is connected.
- Consult the dealer or an experienced radio/TV technician for help.

Caution

The equipment complies with FCC radiation exposure limits set forth for an uncontrolled environment.



PV[®]6 and PV[®]6BT

Compact Mixers

Introducing the next level in world class non-powered mixer performance. The all new PV series mixing consoles include Peavey's reference-quality mic preamps that deliver an incredible 0.0007% THD, making the PV series mixers excellent for live or recording applications. The PV 6 BT includes 2 channels of reference-quality mic preamps, 2 direct outputs for recording, 2 stereo channels, media channel with Bluetooth wireless input, high quality digital effects, streaming USB out, 48 volt phantom power, dual selectable control room outputs, compression, one channel of on board selectable guitar preamp, 3-band EQ per channel with bypass, effects level per channel, signal clip indicators, and a stereo master LED meter bridge. This amazingly versatile mixer is at home both in the studio as well as live applications. Its modern features such as Bluetooth allow seamless connection to almost any "smart" device. Direct outs allow easy connection to most DAW interfaces for recording; in addition, the PV 6 BT can stream audio directly to a PC. EQ bypass allows the user to compare the EQ'd signal to the original signal with the push of a button. Compression keeps signals with difficult levels under control, and Peavey's exclusive guitar-shape adjusts the EQ and preamp specifically for guitar. The all new PV series mixers represent the pinnacle of performance and value. Combine Peavey's legendary reliability with our 5 year warranty, and you can be assured of years of quality reliable service!

FEATURES (both models):

- 2 Combination 1/4" balanced / XLR inputs feeding Silencer™ preamps
- Stereo 1/4"/ 3.5mm input channel with input gain, EQ, Effects send and Pan / Balance
- Switchable 1/4" / RCA (/ Bluetooth PV6 BT only) stereo input with input balance and level control
- 3-band EQ on all channels
- 2 Channels of Peavey's Exclusive Mid-Morph
- LED clip and signal present indication
- EQ Bypass on mic channels
- Dual selectable control room outputs
- Global 48V phantom power
- 1/4" balanced Main stereo outputs
- Rugged console design
- Built-in stereo compressor with enable switch
- Stereo pan control per channel
- 2 Channels of direct out
- Stereo USB-B streaming audio in and out
- High quality master LED meter bridge
- Studio quality headphone output
- Peavey's exclusive on-board 1 Meg Ω guitar input
- Control room output with level control
- Electric Guitar Pre-Shape switch
- External universal input power supply

PV6BT ADDITIONAL FEATURES:

- Bluetooth wireless stereo audio input
- Efx Mute switch

PV6 ONLY:

- Efx master level feeding balanced 1/4" output



Installation Note:

This unit must have the following clearances from any combustible surface: top: 8", sides: 12", back: 12"

Front Panel: MONO MIC INPUT CHANNEL

1 Electric Guitar Pre-Shape

Engaging this button optimizes the on board equalization for guitar.

2 Signal Presence/Clip LED

This LED helps in setting the gain control. Gain (3) should be adjusted so that the green LED flashes in time with the source, and turns red only on the loudest peaks. If adding EQ results in clipping (red LED), compensate here by reducing gain (3). The red clipping LED lights when roughly 5dB of headroom remains.

3 Gain

The Input Gain control is used to establish proper gain structure in the channel. The input gain can be adjusted over a wide range to compensate for soft voices or very loud drums. To maximize the signal-to-noise ratio, the gain should be set to the proper level, with the Level Knob (10) set to 0. If the clip LED comes on and remains lit, try reducing the gain.

4 High EQ

This High EQ shelving type of active tone control varies the treble frequencies (+/- 15 dB at 12 kHz) and is designed to remove noise or add brilliance to the signal, depending on the quality of the source.

5 Mid EQ

Where most mid-range controls work at just one frequency, the Mid-Morph works at two. When turned counterclockwise, it cuts at 250 Hz to reduce frequencies that muddy the sound. When turned clockwise, it boosts at 4 kHz to add intelligibility to vocals. Either way, improved vocal or instrument definition can be achieved.

6 Low EQ

A shelving type of EQ that varies the bass frequency levels (+/- 15 dB at 80 Hz). Low EQ adds depth to thin-sounding signals or cleans up the muddy ones. As with any EQ, use sparingly. Too much of this EQ can give you a booming bottom end. Caution: Excessive low frequency boost causes greater power consumption and increases the possibility of speaker damage.

7 EQ Bypass

Engaging this button bypasses the equalization of the channel.

8 EFX Send

This control adjusts the level of the channel signal added to the effects mix. The signal is sent to the internal effects processor (PV6 BT) or the EFX send jack (PV6). Turning the knob to the left (min) will turn off effects on the associated channel, while turning the knob to the right will increase the amount of the selected effect.

9 Pan

This knob controls the placement of the signal in the stereo field. When rotated completely counterclockwise, the signal is present only on the left channel; when rotated completely clockwise, only in the right channel. This control functions as a balance control to adjust the relative level of the left and right signals on stereo channels.

10 Channel Level

This controls the output level of the channel into the main mix. The gain is 0 dB when set to the detent at mid-rotation (12:00). 10 dB of boost is available at the max gain setting. Normal operation is to start with this knob at the detent, and set the input gain and EQ with the source playing such that normal levels are seen at the bicolor LED and the main meter array. As additional sources are added, it is normal to turn this knob down slightly.

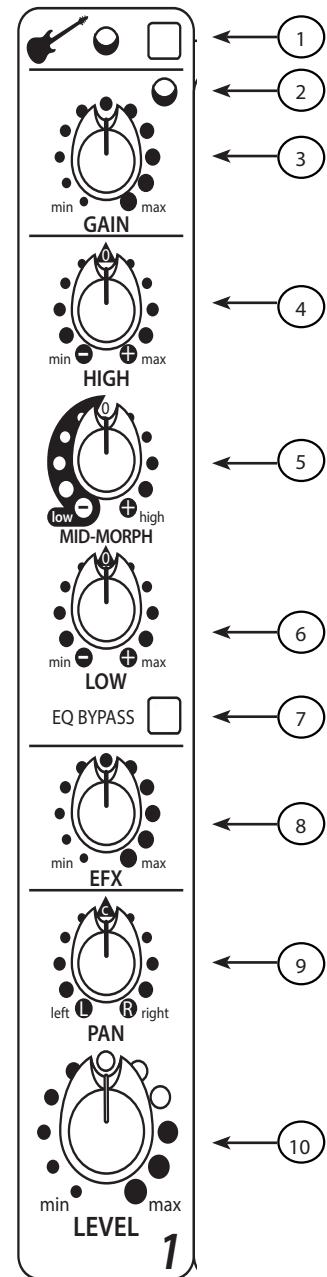

Front Panel: STEREO INPUT CHANNEL

2 Signal Presence/Clip LED

This LED helps in setting the gain control. Gain (3) should be adjusted so that the green LED flashes in time with the source, and turns red only on the loudest peaks. If adding EQ results in clipping (red LED), compensate here by reducing gain (3). The red clipping LED lights when roughly 5dB of headroom remains.

3 Gain

The Input Gain control is used to establish proper gain structure in the channel. The input gain can be adjusted over a wide range to compensate for soft voices or very loud drums. To maximize the signal-to-noise ratio, the gain should be set to the proper level, with the Level Knob (10) set to 0. If the clip LED comes on and remains lit, try reducing the gain.

4 High EQ

This High EQ shelving type of active tone control varies the treble frequencies (+/- 15 dB at 12 kHz) and is designed to remove noise or add brilliance to the signal, depending on the quality of the source.

5 Mid EQ

This midrange control adjusts the stereo channel's eq +/-20 dB @ 440Hz

6 Low EQ

A shelving type of EQ that varies the bass frequency levels (+/- 15 dB at 80 Hz). Low EQ adds depth to thin-sounding signals or cleans up the muddy ones. As with any EQ, use sparingly. Too much of this EQ can give you a booming bottom end. Caution: Excessive low frequency boost causes greater power consumption and increases the possibility of speaker damage.

7 EQ Bypass

Engaging this button bypasses the equalization of the channel.

8 EFX Send

This control adjusts the level of the channel signal added to the effects mix. The signal is sent to the internal effects processor (PV6 BT) or the EFX send jack (PV6). Turning the knob to the left (min) will turn off effects on the associated channel, while turning the knob to the right will increase the amount of the selected effect.

9 Pan

This knob controls the placement of the signal in the stereo field. When rotated completely counterclockwise, the signal is present only on the left channel; when rotated completely clockwise, only in the right channel. This control functions as a balance control to adjust the relative level of the left and right signals on stereo channels.

10 Channel Level

This controls the output level of the channel into the main mix. The gain is 0 dB when set to the detent at mid-rotation (12:00). 10 dB of boost is available at the max gain setting. Normal operation is to start with this knob at the detent, and set the input gain and EQ with the source playing such that normal levels are seen at the bicolor LED and the main meter array. As additional sources are added, it is normal to turn this knob down slightly.

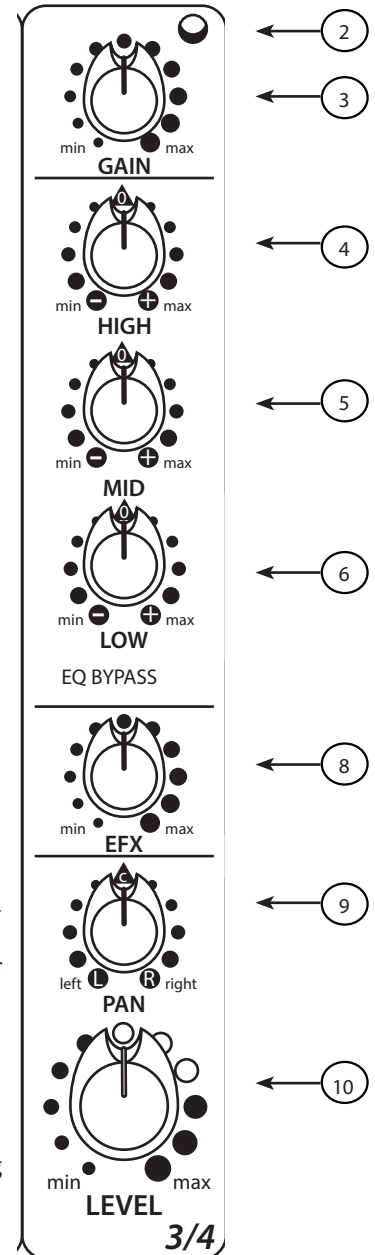

PV⁶ Front Panel

- 11 **Two-way Audio Input Selector**
Allows you to select between a 1/4" and RCA audio input.

- 12 **Balance**
Adjusts relative levels of left and right channels.

- 13 **Level**
Adjusts the level of the source selected by (11).

- 14 **Global Compressor Enable Button**
When depressed, the compressor is enabled.

- 15 **LED Meters**
Two six-segment LED arrays are provided to monitor the levels of the main left/right outputs. These meters range from -18 dBu to +19dBu. The highest green LED corresponds to +4 dBu at the outputs.

- 16 **Digital Return Level**
Controls the signal level coming in to the USB digital audio port, typically from a USB-equipped computer. The nominal setting is near 12:00 for this control.

- 17 **To Control Room**
When depressed, USB digital audio return is routed to the control room and headphone outputs. Use this setting when recording with DAW software to avoid unintended loops.

- 18 **To Main**
When depressed, USB digital audio return is routed to the Main summing amp. This setting is recommended only when there is a requirement to playback through the main outputs, at which time the DAW software must have input monitoring disabled.

 Beware of creating an unintended loop, which results in very LOUD and uncontrolled oscillation that can damage loudspeakers and eardrums!

- 19 **RCA Connectors for Monitor**
Connect powered monitors, or an amplifier feeding monitor speakers here. Set the volume controls on the monitors A and B to be equal when the A/B switch is toggled. The signal sent to this output is normally the Left/Right mix. When the "To Control Room" switch (17) is engaged, the USB return signal is also sent to the Monitor Outputs.

- 20 **A/B Toggle Switch**
When depressed, the A outputs are muted and the B outputs are on. When raised, the A outputs are on and the B outputs are muted. This allows the easy checking of a computer DAW mix on two different sets of monitors.

- 21 **Monitor Level**
Use this control to set the listening level in your control room monitors. The optimum setting for this control is 12:00, so monitor amplifier levels (or powered monitor levels) should be adjusted with this knob at 12:00. There is an additional 17 dB of gain available on this pot at the max position.

- 22 **Phantom Power**
This Switch applies +48 VDC voltage to the input XLR connectors to power microphones requiring phantom power.
 If phantom power is used, do not connect unbalanced dynamic microphones or other devices to the XLR inputs that cannot handle this Voltage.

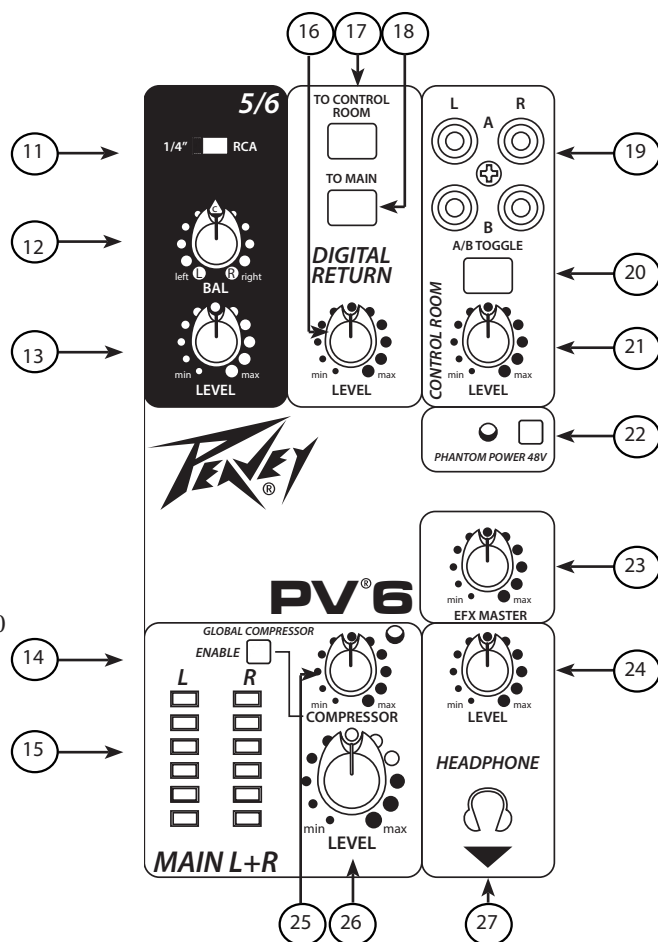

25 26 27

23 **EFX Level**

This is the master output level control for the EFX mix. The output level sent to the EFX Send jack is controlled by the Channel Level Control (10), the channel EFX Send controls (8), and by this master control. The 12:00 position is the recommended setting for this control.

24 **Headphone Level**

This knob sets the headphone and control room output levels. To avoid damage to your hearing, make sure to turn the dial fully counterclockwise before using headphones. Slowly turn the knob clockwise until you reach a comfortable listening level.

25 **Compressor Control**

Adjusting this knob clockwise lowers the threshold of the compressor, thereby increasing the amount of compression. The compressor ratio is in the 4:1 range, varying with signal levels and the amount of compression. This is useful for controlling peak levels from live sources. The compressor is after the master level control(26), and before the main outs (35) and the USB port(39), so it can be used to tame vocals being recorded into a DAW. You can audition the effect of the compressor by switching it in and out with the Enable switch (14). When the compressor is active, the adjacent red LED will illuminate.

26 **Level**

This is the master level control, which controls the overall level sent to the main outputs (35) and the USB port (39).

27 **Headphone Output**

The Headphone Output is a 1/4" TRS (Tip= Left; Ring = Right; Sleeve = Ground) jack. The signal sent to this output is normally the Left/Right mix. When the "To Control Room" switch (17) is engaged, the USB return signal is also sent to the headphones.

- 11 **Three-way Audio Input Selector**
Allows you to select between a 1/4", RCA audio input, or Bluetooth connection.
- 12 **Balance**
Adjusts relative levels of left and right channels.
- 13 **Level**
Adjusts the level of the source selected by (11).
- 14 **EFX Mute**
Depressing this button will cut all digital effects from the main mix.
- 15 **EFX Adjust**
This rotary encoder adjusts the parameter of the effect selected by EFX SELECT (16). For reverbs, double, slapback, and delays, the knob controls the time. For chorus effects, this knob controls the rate. Any adjustment you make with this knob will be stored into memory until the next time you adjust the parameter. In other words, your changes will "stick" even if you select a different effect. When you return, things will be the way you left them.
- 16 **EFX SELECT**
Use this rotary encoder to choose which effect you want to apply. There are 9 reverbs, 4 delays, and 3 chorus effects. You can fine-tune the behavior of the selected effect with the EFX ADJUST knob.
- 17 **Global Compressor Enable Button**
When depressed, the compressor is enabled.
- 18 **LED Meters**
Two six-segment LED arrays are provided to monitor the levels of the main left/right outputs. These meters range from -18 dBu to +19dBu. The highest green LED corresponds to +4 dBu at the outputs.
- 19 **Digital Return Level**
Controls the signal level coming in to the USB digital audio port, typically from a USB-equipped computer. The nominal setting is near 12:00 for this control.
- 20 **To Control Room**
When depressed, USB digital audio return is routed to the control room and headphone outputs. Use this setting when recording with DAW software to avoid unintended loops.
- 21 **To Main**
When depressed, USB digital audio return is routed to the Main summing amp. This setting is recommended only when there is a requirement to playback through the main outputs, at which time the DAW software must have input monitoring disabled.

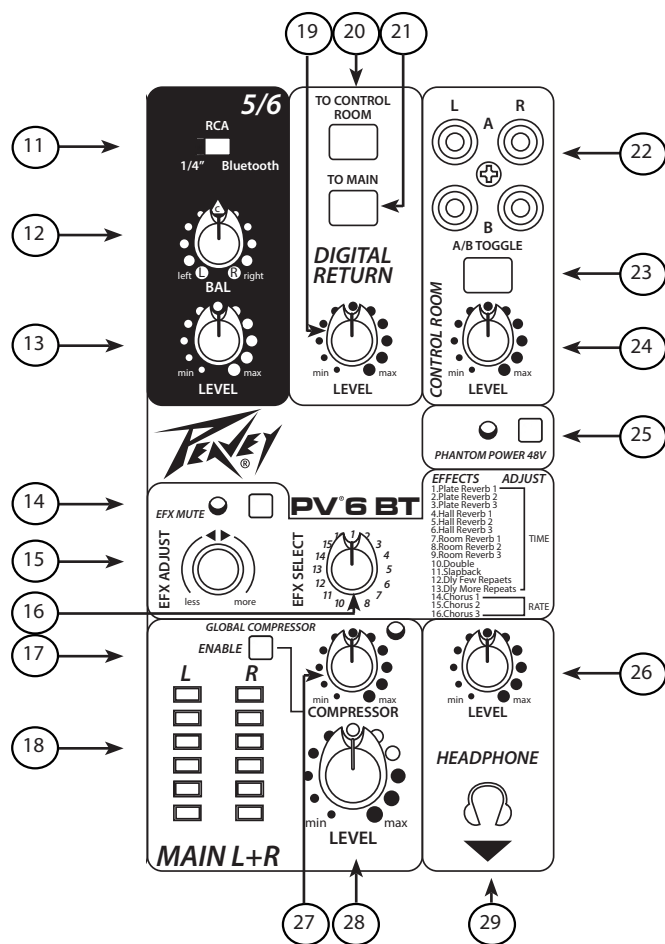

Beware of creating an unintended loop, which results in very LOUD and uncontrolled oscillation that can damage loudspeakers and eardrums!

22 RCA Connectors for Monitor

Connect powered monitors, or an amplifier feeding monitor speakers here. Set the volume controls on the monitors A and B to be equal when the A/B switch is toggled. The signal sent to this output is normally the Left/Right mix. When the "To Control Room" switch (20) is engaged, the USB return signal is also sent to the Monitor Outputs.

23 A/B Toggle Switch

When depressed, the A outputs are muted and the B outputs are on. When raised, the A outputs are on and the B outputs are muted. This allows the easy checking of a computer DAW mix on two different sets of monitors.

24 Monitor Level

Use this control to set the listening level in your control room monitors. The optimum setting for this control is 12:00, so monitor amplifier levels (or powered monitor levels) should be adjusted with this knob at 12:00. There is an additional 17 dB of gain available on this pot at the max position.

25 Phantom Power

This Switch applies +48 VDC voltage to the input XLR connectors to power microphones requiring phantom power.



If phantom power is used, do not connect unbalanced dynamic microphones or other devices to the XLR inputs that cannot handle this Voltage.

26 Headphone Level

This knob sets the headphone and control room output levels. To avoid damage to your hearing, make sure to turn the dial fully counterclockwise before using headphones. Slowly turn the knob clockwise until you reach a comfortable listening level.

27 Compressor Control

Adjusting this knob clockwise lowers the threshold of the compressor, thereby increasing the amount of compression. The compressor ratio is in the 4:1 range, varying with signal levels and the amount of compression. This is useful for controlling peak levels from live sources. The compressor is after the master level control (28), and before the main outs (36) and the USB port(39), so it can be used to tame vocals being recorded into a DAW. You can audition the effect of the compressor by switching it in and out with the Enable switch (14). When the compressor is active, the adjacent red LED will illuminate.

28 Level

This is the master level control, which controls the overall level sent to the main outputs (36) and the USB port (39).

29 Headphone Output

The Headphone Output is a 1/4" TRS (Tip= Left; Ring = Right; Sleeve = Ground) jack. The signal sent to this output is normally the Left/Right mix. When the "To Control Room" switch (20) is engaged, the USB return signal is also sent to the headphones.

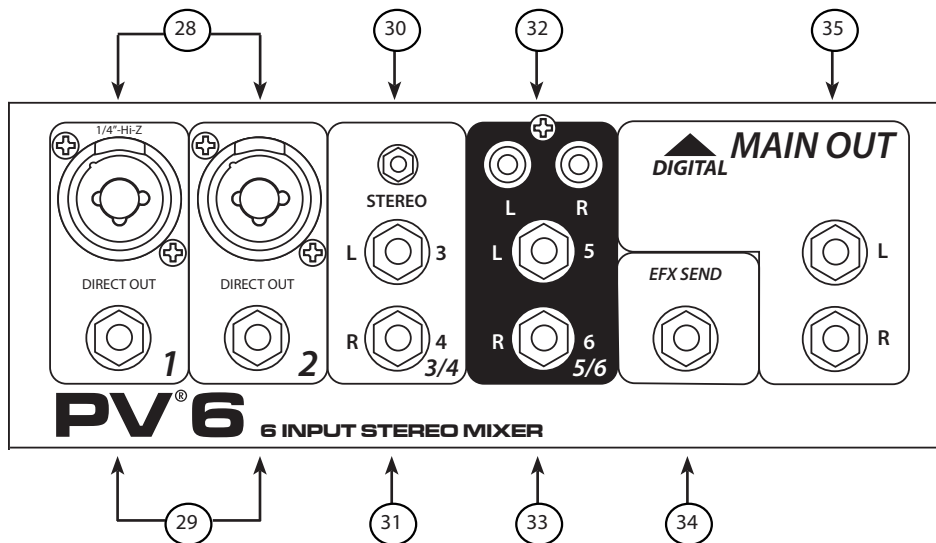

28 MIC/LINE INPUT

This combination input jack can accept either a 1/4" (balanced or unbalanced) input or a XLR balanced, low-impedance connection. The tip is positive on the 1/4" balanced input, and pin 2 is positive on the XLR. When ELECTRIC GUITAR PRE-SHAPE is depressed, the channel 1 1/4" input changes to a high impedance (1 MegΩ), like a 12AX7 vacuum tube guitar amplifier input.

29 1/4" TRS Direct Outs

Impedance-balanced outputs fed by the mic preamp. Channel 1 output is after the ELECTRIC GUITAR PRE-SHAPE switch.

30 Stereo 3.5mm Input

Accept a stereo input from the output of an MP3 player, CD player, tape deck or other similar device. This input is optimized for portable handheld devices and therefore has very high sensitivity.

31 Stereo Inputs

Channels 3 and 4 feature stereo inputs via 1/4" jack. If only one jack is used, it behaves as a mono source with a pan control. Once both jacks are connected, it behaves as a stereo source with a balance control; 3 is Left and 4 is Right.

32 RCA Connection

Accept a stereo input from the output of an MP3 player, CD player, tape deck or other similar device. This input is optimized for portable handheld devices and therefore has very high sensitivity.

33 Stereo

Accept a stereo input from the output of an MP3 player, CD player, tape deck or other similar device. This input is optimized for portable handheld devices and therefore has very high sensitivity.

34 EFX Send

Ground compensated TRS balanced output fed by the EFX SEND master level (23). These outputs can be used with Tip Ring Sleeve (TRS) balanced or Tip Sleeve (TS) unbalanced connectors.

35 Main Out

Ground compensated TRS balanced outputs fed by the master LEVEL control (26). These outputs can be used with Tip Ring Sleeve (TRS) balanced or Tip Sleeve (TS) unbalanced connectors.

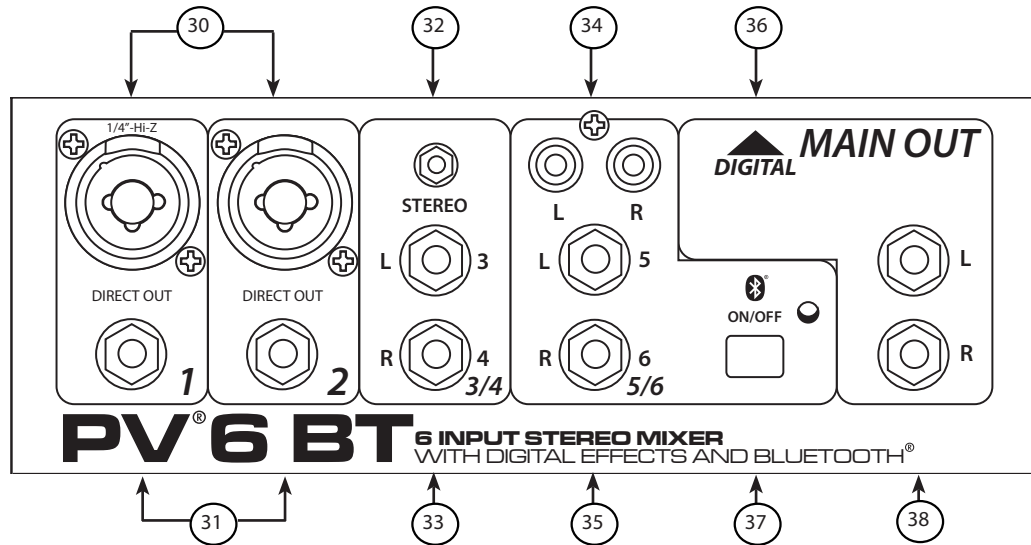

- 30 MIC/LINE INPUT**
This combination input jack can accept either a 1/4" (balanced or unbalanced) input or a XLR balanced, low-impedance connection. The tip is positive on the 1/4" balanced input, and pin 2 is positive on the XLR. When ELECTRIC GUITAR PRE-SHAPE is depressed, the channel 1 1/4" input changes to a high impedance (1 MegΩ), like a 12AX7 vacuum tube guitar amplifier input.
- 31 1/4" TRS Direct Outs**
Impedance-balanced outputs fed by the mic preamp. Channel 1 output is after the ELECTRIC GUITAR PRE-SHAPE switch.
- 32 Stereo 3.5mm Input**
Accept a stereo input from the output of an MP3 player, CD player, tape deck or other similar device. This input is optimized for portable handheld devices and therefore has very high sensitivity.
- 33 Stereo Inputs**
Channels 3 and 4 feature stereo inputs via 1/4" jack. If only one jack is used, it behaves as a mono source with a pan control. Once both jacks are connected, it behaves as a stereo source with a balance control; 3 is Left and 4 is Right.
- 34 RCA Connection**
Accept a stereo input from the output of an MP3 player, CD player, tape deck or other similar device. This input is optimized for portable handheld devices and therefore has very high sensitivity.
- 35 Stereo**
Accept a stereo input from the output of an MP3 player, CD player, tape deck or other similar device. This input is optimized for portable handheld devices and therefore has very high sensitivity.
- 36 Main Out**
Ground compensated TRS balanced outputs fed by the master LEVEL control (28). These outputs can be used with Tip Ring Sleeve (TRS) balanced or Tip Sleeve (TS) unbalanced connectors.
- 37 Bluetooth® Activation Button**
Press and hold this button until the LED blinks 3 times, indicating the Bluetooth has been powered on or off, then release. Once turned on, the Bluetooth will automatically enter pairing mode. You can pair any Bluetooth-enabled device with the mixer using the PIN 7878. The mixer will remember up to 10 devices that it was previously paired with and will automatically connect to the last device with which it was paired when turned on. To clear the paired device memory, make sure the Bluetooth is turned off and press and hold the button for at least 10 seconds. The LED will initially blink 3 times but then should remain off. Once you have released the button after 10 seconds, you can proceed by powering it on as normal, **and the memory will be cleared.**
- 38 Left/Right Outputs**
The Left/Right Outputs feature two 1/4" TRS Z-balanced jacks. These outputs can be used with Tip Ring Sleeve (TRS) balanced or Tip Sleeve (TS) unbalanced connectors.

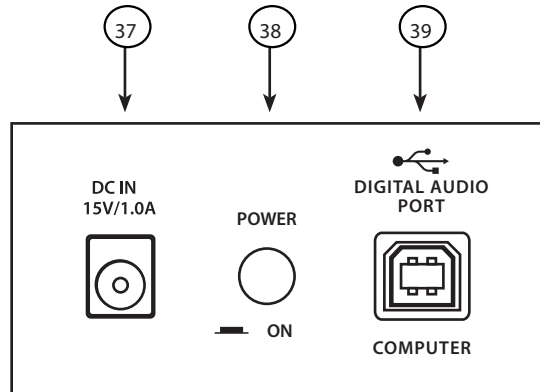

28 DC POWER INLET



Use to connect the included power supply. Be sure the power supply is connected to the PV®10 before connecting to a power source. Use 15VDC, 1A adapter only. Replace only with Peavey part number 30908119.

29 POWER SWITCH

This is the main power switch.

30 USB PORT TYPE B

The USB port is used to connect the PV® Series USB mixer to a computer for recording or playing back digital audio to/from your computer. The USB port sends the mixer's main/tape stereo out to the computer. The USB port receives digital audio from the computer; it can then be assigned through the USB TO Main switch ({18}, PV6; {21}, PV6BT) to the main left/right output, if the computer is being used for playback only. For recording, use the USB TO CONTROL ROOM control ({17}, PV6; {20}, PV6BT), to avoid creating a loop. **Compatible with Windows® Vista, Windows 7, & Windows 8, Mac OS X® 10.0 or later, and iOS devices.**

- 1 - Plate Reverb Bright
- 2 - Plate Reverb Medium Low-Pass
- 3 - Plate Reverb Dark
- 4 - Hall Reverb Vocal
- 5 - Hall Reverb Vocal Huge
- 6 - Hall Reverb Strings
- 7 - Room Reverb Vocal Air
- 8 - Room Reverb Snare Low
- 9 - Room Reverb Acoustic Guitar
- 10 - Delay Double
- 11 - Delay Slapback
- 12 - Delay Bright, Few Repeats
- 13 - Delay Bright, More Repeats
- 14 - Chorus High Depth, Slow Rate
- 15 - Chorus Moderate Depth, Wide Rate
- 16 - Chorus Short Depth, Fast Rate

Block Diagram

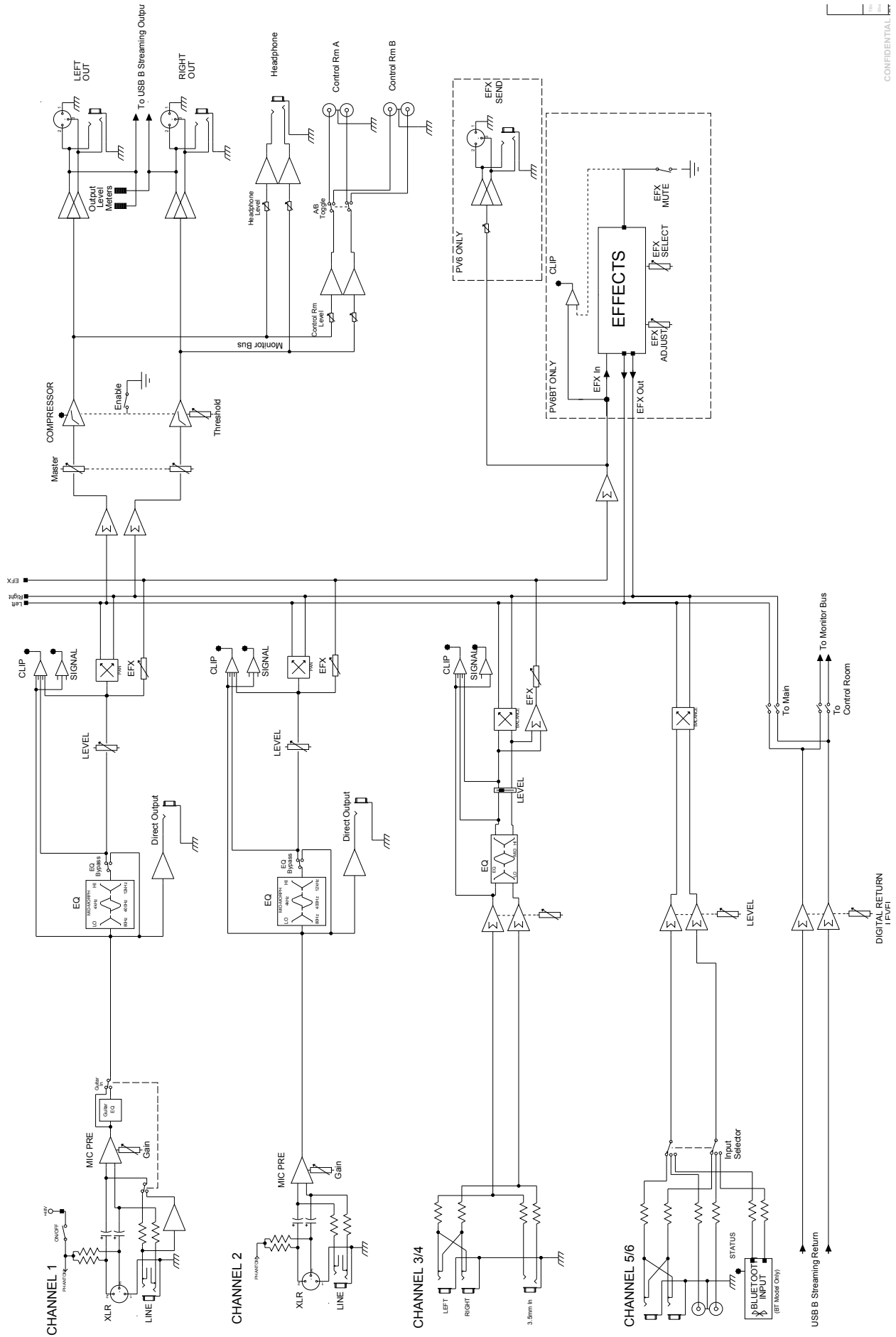

PV[®]6 & PV[®]6BT Series Specifications

Mic pre EIN = -126 dBu @ max gain with 150 ohm source

Inputs

Function	Input Z	Input Gain Setting	Input Levels			Bal/Unbal	Connector
			Min**	Nominal*	Max		
Microphone (150 ohms)	2 k Ω	Max Gain (59 dB)	-71 dBu	-51 dBu	-39 dBu	Bal	XLR Pin 1 Gnd Pin 2 (+) Pin 3 (-)
		Min Gain (4 dB)	-17 dBu	+5 dBu	+16 dBu		
Line (10 k ohms) Line 1, GTR SHAPE ON	10 k Ω	Max Gain (40 dB)	-52 dBu	-32 dBu	-20 dBu	Bal	1/4" TRS; Tip (+) Ring (-) Sleeve Ground
	1 Meg Ω @ \leq 200 Hz, like 12AX7 input.	Min Gain (-15 dB)	+2 dBu	+23 dBu	> +32 dBu		
Line 3/4	10 k Ω	Max Gain (19 dB)	-32 dBu	-12 dBu	+2 dBu	Unbal	1/4" TS; Tip (+) Sleeve Ground
		Nominal	-15 dBu	+6 dBu	+13 dBu		
3.5mm	2.8 k Ω	Max Gain (30 dB)	-44 dBu	-24 dBu	-10 dBu	Unbal	3.5mm; Tip=L, Ring=R, Sleeve Ground
		Nominal	-27 dBu	-6 dBu	+8 dBu		
Line 5/6	6.8 k Ω	Max Gain (18 dB)	-43 dBu	-23 dBu	-10 dBu	Unbal	1/4" TS; Tip (+), Sleeve Ground
		Nominal	-13dBu	-3 dBu	+12dBu		
RCA	2.2 k Ω	Max Gain (29 dB)	-32 dBu	-22 dBu	-8 dBu	Unbal	RCA: Tip (+), Sleeve Ground
		Nominal	-19 dBu	-8 dBu	+6dBu		

0 dBu=0.775 V (RMS)

** Min Input Level (sensitivity) is the smallest signal that will produce nominal output (+4 dBu) with channel and master faders set for maximum gain.

* Nominal settings are defined as all controls set at 0 dB (or 50% rotation for rotary pots) except the gain adjustment pot which is as specified.

Outputs

Function	Min Load Z (ohms)	Output Levels		Bal/Unbal	Connector
		Nominal	Max		
Main Left/Right	600	+4 dBu	+20 dBu	Bal	XLR Pin Ground Tip Pin 2 (+), Pin 3 (-) 1/4" TRS: Tip (+), Ring (-) Sleeve Ground
Effects Send (PV6 only)	600	+4 dBu	+20 dBu	Bal	1/4" TRS: Tip (+), Ring (-) Sleeve Ground
Control Room	600	+4 dBu	+20 dBu	Unbal	RCA: Tip (+), Sleeve Ground
Headphone	8	+4 dBu (no load)	+20 dBu	Unbal	1/4" TRS; Tip Left, Ring Right Sleeve Ground

0 dBu=0.775 V (RMS)

Gain

Mic Input Gain Adjustment Range:	+4 dB to +59 dB
Mic Input to Left/Right Balance Output	79 dB (max gain)
Line Input Gain Adjustment Range:	-15 dB to 40 dB
Line Input to Left/Right Balance Output	60 dB (max gain)
Stereo 3/4 Gain Adjustment Range:	Off to +19 dB
Stereo3/4 to Left/Right Output	39 dB (max gain)
3.5mm Input Gain Adjustment Range:	Off to +30 dB
3.5mm Input to Left/Right Output	51 dB (max gain)
Stereo Line 5/6 Gain Adjustment Range:	Off to +18 dB
Stereo 5/6 to Left/Right Output	28 dB (max gain)
RCA Gain Adjustment Range:	Off to +29 dB
RCA to Left/Right Output	39 dB (max gain)

Frequency Response

Mic Input to Left/Right Output | 10 Hz to 20 kHz +0 dB/-1 dB

Total Harmonic Distortion

<0.006% Typical | (22 Hz to 22 kHz BW)

Hum and Noise

Output	Residual Noise	S/N Ratio (Ref: +4dBu)	Test Conditions
Master Left/Right	-97 dBu	101 dB	Master Fader Down, Channel Levels Down
	-92 dBu	96 dB	Master Fader Nominal, Channel Levels Down, Efx muted
	-82 dBu	86 dB	Master Fade Nominal, Channel Faders Nominal, Panned Odd Channels (left), Even Channels (right)

(Hum and noise measurements: 22 Hz to 22 kHz BW)

Equivalent Input Noise (EIN)

-126 dBu (input terminated with 150 ohms, bandwidth 20 kHz)

Crosstalk/Attenuation

Adjacent Input Channels (1 kHz) >90 dB	
Left to Right Outputs (1 kHz) >70 dB	Channel level control Kill (1 kHz) >85 dB

Common Mode Rejection Ratio (Mic Input)

50 dB minimum (20 Hz to 20 kHz)
70 dB typical @ 1 kHz

Meters

6 segment, peak reading (top green LED = +4 dBu)

Signal/Overload Indicators

Red LED lights 5 dB below clipping

Dimensions

7.25" wide x 11" deep x 3.1875" high
(18.42 cm x 27.94 cm x 8.1 cm)

Weight

PV6: 3.99 lbs (1.81 kg)
PV6BT: 4.06 lbs (1.84 kg)

Power Requirements

100-240 VAC 50/60 Hz 15 Watts



Installation Note:

This unit must have the following clearances from any combustible surface: top: 8", sides: 12", back: 12"

PEAVEY ELECTRONICS CORPORATION LIMITED WARRANTY

Effective Date: 11/01/2011

What This Warranty Covers

Your Peavey Warranty covers defects in material and workmanship in Peavey products purchased and serviced in the U.S.A. and Canada.

What This Warranty Does Not Cover

The Warranty does not cover: (1) damage caused by accident, misuse, abuse, improper installation or operation, rental, product modification or neglect; (2) damage occurring during shipment; (3) damage caused by repair or service performed by persons not authorized by Peavey; (4) products on which the serial number has been altered, defaced or removed; (5) products not purchased from an Authorized Peavey Dealer.

Who This Warranty Protects

This Warranty protects only the original purchaser of the product.

How Long This Warranty Lasts

The Warranty begins on the date of purchase by the original retail purchaser. The duration of the Warranty is as follows:

Product Category	Duration
Guitars/Basses, Amplifiers, Preamplifiers, Mixers, Electronic Crossovers and Equalizers	2 years *(+ 3 years)
Drums	2 years *(+ 1 year)
Enclosures	3 years *(+ 2 years)
Digital Effect Devices and Keyboards and MIDI Controllers	1 years *(+ 1 year)
Microphones	2 years
Speaker Components (incl. Speakers, Baskets, Drivers, Diaphragm Replacement Kits and Passive Crossovers)	1 year
Tubes and Meters	90 Days
Cables	Limited Lifetime
AmpKit Link, Xport, Rockmaster Series, Strum'n Fun, RetroFire, GT & BT Series Amps	1 year
Marvel Jr. Guitar	90 Days

[* Denotes additional Warranty period applicable if optional Warranty Registration Card is completed and returned to Peavey by original retail purchaser within 90 days of purchase.]

What Peavey Will Do

We will repair or replace (at Peavey's discretion) products covered by Warranty at no charge for labor or materials. If the product or component must be shipped to Peavey for Warranty service, the consumer must pay initial shipping charges. If the repairs are covered by Warranty, Peavey will pay the return shipping charges.

How To Get Warranty Service

(1) Take the defective item and your sales receipt or other proof of date of purchase to your Authorized Peavey Dealer or Authorized Peavey Service Center.

OR

(2) Ship the defective item, prepaid, to Peavey Electronics Corporation, International Service Center, 412 Highway 11 & 80 East, Meridian, MS 39301. Include a detailed description of the problem, together with a copy of your sales receipt or other proof of date of purchase as evidence of Warranty coverage. Also provide a complete return address.

Limitation of Implied Warranties

ANY IMPLIED WARRANTIES, INCLUDING WARRANTIES OF MERCHANTABILITY AND FITNESS FOR A PARTICULAR PURPOSE, ARE LIMITED IN DURATION TO THE LENGTH OF THIS WARRANTY.

Some states do not allow limitations on how long an implied Warranty lasts, so the above limitation may not apply to you.

Exclusions of Damages

PEAVEY'S LIABILITY FOR ANY DEFECTIVE PRODUCT IS LIMITED TO THE REPAIR OR REPLACEMENT OF THE PRODUCT, AT PEAVEY'S OPTION. IF WE ELECT TO REPLACE THE PRODUCT, THE REPLACEMENT MAY BE A RECONDITIONED UNIT. PEAVEY SHALL NOT BE LIABLE FOR DAMAGES BASED ON INCONVENIENCE, LOSS OF USE, LOST PROFITS, LOST SAVINGS, DAMAGE TO ANY OTHER EQUIPMENT OR OTHER ITEMS AT THE SITE OF USE, OR ANY OTHER DAMAGES WHETHER INCIDENTAL, CONSEQUENTIAL OR OTHERWISE, EVEN IF PEAVEY HAS BEEN ADVISED OF THE POSSIBILITY OF SUCH DAMAGES.

Some states do not allow the exclusion or limitation of incidental or consequential damages, so the above limitation may not apply to you.

This Warranty gives you specific legal rights, and you may also have other rights which vary from state to state.

If you have any questions about this Warranty or services received or if you need assistance in locating an Authorized Service Center, please contact the Peavey International Service Center at (601) 483-5365.

Features and specifications are subject to change without notice.



Logo referenced in Directive 2002/96/EC Annex IV (OJ(L)37/38,13.02.03 and defined in EN 50419: 2005
The bar is the symbol for marking of new waste and is applied only to equipment manufactured after 13 August 2005

FROM:

Peavey Electronics Corporation
Attn: Warranty Department
PO Box 1150
Meridian, Ms 39305



Place
Postage
Here

