



# Delta Blues™ 115/210

## GUITAR AMPLIFIER

### Operating Manual





Intended to alert the user to the presence of uninsulated “dangerous voltage” within the product’s enclosure that may be of sufficient magnitude to constitute a risk of electric shock to persons.



Intended to alert the user of the presence of important operating and maintenance (servicing) instructions in the literature accompanying the product.

**CAUTION:** Risk of electrical shock — DO NOT OPEN!

**CAUTION:** To reduce the risk of electric shock, do not remove cover. No user serviceable parts inside. Refer servicing to qualified service personnel.

**WARNING:** To prevent electrical shock or fire hazard, this apparatus should not be exposed to rain or moisture, and objects filled with liquids, such as vases, should not be placed on this apparatus. Before using this apparatus, read the operating guide for further warnings.



Este símbolo tiene el propósito, de alertar al usuario de la presencia de “(voltaje) peligroso” sin aislamiento dentro de la caja del producto y que puede tener una magnitud suficiente como para constituir riesgo de descarga eléctrica.



Este símbolo tiene el propósito de alertar al usuario de la presencia de instrucciones importantes sobre la operación y mantenimiento en la información que viene con el producto.

**PRECAUCION:** Riesgo de descarga eléctrica ¡NO ABRIR!

**PRECAUCION:** Para disminuir el riesgo de descarga eléctrica, no abra la cubierta. No hay piezas útiles dentro. Deje todo mantenimiento en manos del personal técnico cualificado.

**ADVERTENCIA:** Para prevenir choque eléctrico o riesgo de incendios, este aparato no se debe exponer a la lluvia o a la humedad. Los objetos llenos de líquidos, como los floreros, no se deben colocar encima de este aparato. Antes de usar este aparato, lea la guía de funcionamiento para otras advertencias.



Ce symbole est utilisé dans ce manuel pour indiquer à l'utilisateur la présence d'une tension dangereuse pouvant être d'amplitude suffisante pour constituer un risque de choc électrique.



Ce symbole est utilisé dans ce manuel pour indiquer à l'utilisateur qu'il ou qu'elle trouvera d'importantes instructions concernant l'utilisation et l'entretien de l'appareil dans le paragraphe signalé.

**ATTENTION:** Risques de choc électrique — NE PAS OUVRIR!

**ATTENTION:** Afin de réduire le risque de choc électrique, ne pas enlever le couvercle. Il ne se trouve à l'intérieur aucune pièce pouvant être réparée par l'utilisateur. Confiez l'entretien et la réparation de l'appareil à un réparateur Peavey agréé.

**AVIS:** Dans le but de réduire les risques d'incendie ou de décharge électrique, cet appareil ne doit pas être exposé à la pluie ou à l'humidité et aucun objet rempli de liquide, tel qu'un vase, ne doit être posé sur celui-ci. Avant d'utiliser de cet appareil, lisez attentivement le guide fonctionnant pour avertissements supplémentaires.



Dieses Symbol soll den Anwender vor unisolierten gefährlichen Spannungen innerhalb des Gehäuses warnen, die von Ausreichender Stärke sind, um einen elektrischen Schlag verursachen zu können.



Dieses Symbol soll den Benutzer auf wichtige Instruktionen in der Bedienungsanleitung aufmerksam machen, die Handhabung und Wartung des Produkts betreffen.

**VORSICHT:** Risiko — Elektrischer Schlag! Nicht öffnen!

**VORSICHT:** Um das Risiko eines elektrischen Schlages zu vermeiden, nicht die Abdeckung entfernen. Es befinden sich keine Teile darin, die vom Anwender repariert werden könnten. Reparaturen nur von qualifiziertem Fachpersonal durchführen lassen.

**WARNUNG:** Um elektrischen Schlag oder Brandgefahr zu verhindern, sollte dieser Apparat nicht Regen oder Feuchtigkeit ausgesetzt werden und Gegenstände mit Flüssigkeiten gefüllt, wie Vasen, nicht auf diesen Apparat gesetzt werden. Bevor dieser Apparat verwendet wird, lesen Sie bitte den Funktionsführer für weitere Warnungen.

## IMPORTANT SAFETY INSTRUCTIONS

**WARNING:** When using electrical products, basic cautions should always be followed, including the following:



1. Read these instructions.
2. Keep these instructions.
3. Heed all warnings.
4. Follow all instructions.
5. Do not use this apparatus near water.
6. Clean only with a dry cloth.
7. Do not block any of the ventilation openings. Install in accordance with manufacturer's instructions.
8. Do not install near any heat sources such as radiators, heat registers, stoves or other apparatus (including amplifiers) that produce heat.
9. Do not defeat the safety purpose of the polarized or grounding-type plug. A polarized plug has two blades with one wider than the other. A grounding type plug has two blades and a third grounding plug. The wide blade or third prong is provided for your safety. If the provided plug does not fit into your outlet, consult an electrician for replacement of the obsolete outlet.
10. Protect the power cord from being walked on or pinched, particularly at plugs, convenience receptacles, and the point they exit from the apparatus.
11. Only use attachments/accessories provided by the manufacturer.
12.  Use only with a cart, stand, tripod, bracket, or table specified by the manufacturer, or sold with the apparatus. When a cart is used, use caution when moving the cart/apparatus combination to avoid injury from tip-over.
13. Unplug this apparatus during lightning storms or when unused for long periods of time.
14. Refer all servicing to qualified service personnel. Servicing is required when the apparatus has been damaged in any way, such as power-supply cord or plug is damaged, liquid has been spilled or objects have fallen into the apparatus, the apparatus has been exposed to rain or moisture, does not operate normally, or has been dropped.
15. Never break off the ground pin. Write for our free booklet "Shock Hazard and Grounding." Connect only to a power supply of the type marked on the unit adjacent to the power supply cord.
16. If this product is to be mounted in an equipment rack, rear support should be provided.
17. Note for UK only: If the colors of the wires in the mains lead of this unit do not correspond with the terminals in your plug, proceed as follows:
  - a) The wire that is colored green and yellow must be connected to the terminal that is marked by the letter E, the earth symbol, colored green or colored green and yellow.
  - b) The wire that is colored blue must be connected to the terminal that is marked with the letter N or the color black.
  - c) The wire that is colored brown must be connected to the terminal that is marked with the letter L or the color red.
18. This electrical apparatus should not be exposed to dripping or splashing and care should be taken not to place objects containing liquids, such as vases, upon the apparatus.
19. The on/off switch in this unit does not break both sides of the primary mains. Hazardous energy can be present inside the chassis when the on/off switch is in the off position. The mains plug or appliance coupler is used as the disconnect device, the disconnect device shall remain readily operable.
20. Exposure to extremely high noise levels may cause a permanent hearing loss. Individuals vary considerably in susceptibility to noise-induced hearing loss, but nearly everyone will lose some hearing if exposed to sufficiently intense noise for a sufficient time. The U.S. Government's Occupational Safety and Health Administration (OSHA) has specified the following permissible noise level exposures:

Duration Per Day In Hours	Sound Level dBA, Slow Response
8	90
6	92
4	95
3	97
2	100
1 1/2	102
1	105
1/2	110
1/4 or less	115

According to OSHA, any exposure in excess of the above permissible limits could result in some hearing loss. Ear plugs or protectors to the ear canals or over the ears must be worn when operating this amplification system in order to prevent a permanent hearing loss, if exposure is in excess of the limits as set forth above. To ensure against potentially dangerous exposure to high sound pressure levels, it is recommended that all persons exposed to equipment capable of producing high sound pressure levels such as this amplification system be protected by hearing protectors while this unit is in operation.

**SAVE THESE INSTRUCTIONS!**

## Delta Blues™ Single Unit Guitar Amplifier

The 15" speaker, borrowed from its big brother, the 50-watt Blues Classic®, is specially voiced for rich, full range tone. It has both more low end and more high end than the 12" speaker in the Classic® 30. The extra high end also makes for an exceptional sounding acoustic guitar amp—with a bluesy edge.

An obvious choice for an external speaker would be the Classic® 115E, which uses the same speaker in a large cabinet. This combination creates a huge sound that is more than capable of keeping up with a rhythm section in a small club.



Before you begin playing through your amplifier, it is very important to ensure that the product has the proper AC line voltage supplied. You can find the proper voltage for your amp printed next to the IEC line (power) cord on the rear panel of the unit. Each product feature is numbered. Refer to the front panel diagram in this manual to locate the particular features next to its number.

Please read this guide carefully to ensure your personal safety as well as the safety of your amplifier.

### FEATURES:

- 30 watts RMS into 16 or 8 ohms
- All-tube (three 12AX7 and four EL84 tubes)
- 2-channel preamp
- Blue Marvel® Speakers
- Tremolo with speed and intensity
- Pre- and post-gain controls on lead channel
- Normal volume control on clean channel
- 3-band passive EQ (bass, middle, treble)
- Boost switch
- Master reverb
- Footswitch selectable channel switching and tremolo
- Effects loop
- Tweed-covered cabinet with chrome-plated chassis
- External speaker jack



**Ventilation:** For proper ventilation, allow 24" clearance from nearest combustible surface.

## Front Panel

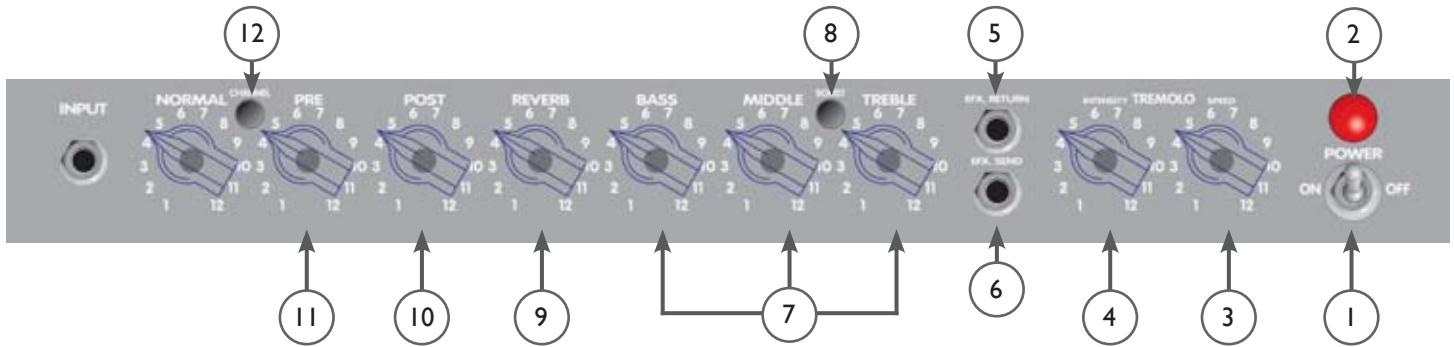

### **Power Switch (1)**

Switch to "ON" position to turn on.

### **Pilot Light LED (2)**

Illuminates when AC power is being supplied to the unit.

### **Tremolo Speed (3)**

The speed control determines the rate at which the signal is modulated. This control varies the speed of the Tremolo master oscillator and should provide any speed desired for modern music. Clockwise rotation of the speed control increases the speed of the modulation of the tremolo. The Tremolo feature is defeatable from a remote footswitch.

### **Tremolo Intensity (4)**

The intensity control is used to vary the amount of amplitude modulation of the clean signal. It can be adjusted from barely perceptible to dramatic modulation. Clockwise rotation of the intensity control increases the depth of the tremolo.

### **Effects Return (5)**

Input for returning signals to external effects or signal processing equipment.

### **Effects Send (6)**

Output for supplying signal to external effects or signal processing equipment.

### **Treble, Middle AND Bass EQ (7)**

Passive tone controls that regulate high, mid, and low frequencies, respectively.

### **Boost Switch (8)**

Boosts the overall system gain. Depress to the "in" position to activate.

### **Reverb (9)**

Reverberation is an echo effect. Rotate clockwise to increase the effect.

### **Post Gain (10)**

Controls the overall volume level of the Lead channel. The final level adjustment should be made after the desired sound has been activated.

### **Pre Gain (11)**

Controls the input volume level of the Lead channel.

### **Channel Select Switch (12)**

Allows selection of the Lead or Normal channel.

**Note:** Channel selection may also be achieved by the remote footswitch. If remote selection is desired, the channel switch must be in the "in" (Lead) position.

## **⚡ WARNING ⚡**

THE ON/OFF SWITCH IN THIS APPARATUS DOES NOT BREAK BOTH SIDES OF THE MAINS. HAZARDOUS ENERGY MAY BE PRESENT INSIDE THE ENCLOSURE WHEN THE POWER SWITCH IS IN THE OFF POSITION.

## Front Panel

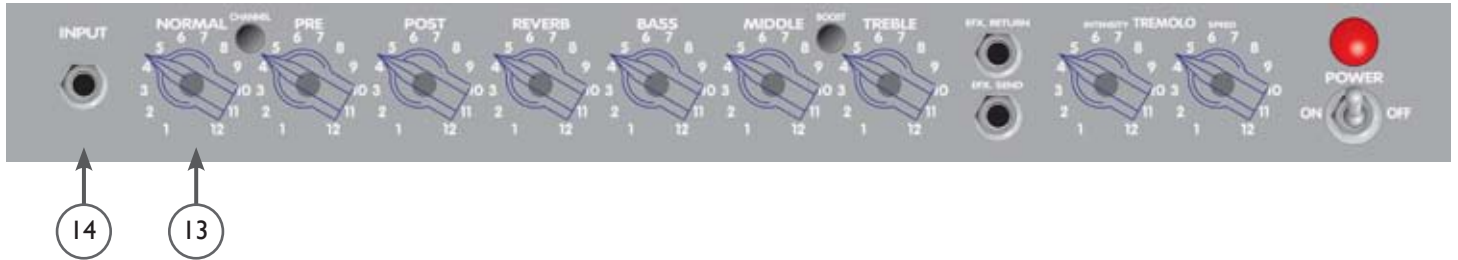

### **Normal Gain (13)**

Controls the volume level of the Normal channel.

### **Input (14)**

The input jack will accept signals from all types of guitar pickups. Be sure to use a high-quality shielded cable to connect the guitar to the amplifier.

## Rear Panel



### **External Speaker Jack (15)**

Provided for the connection of external speaker cabinet. Minimum total impedance is 16 ohms.

### **Remote Switch Jack (16)**

Provided for the connection of the optional remote footswitch. Footswitch is used to select the Lead or Normal channels and defeat tremolo. When using remote footswitch, always insert the plug fully (second click) to ensure proper operation.

# Delta Blues™

## Guitar Amplifier

### SPECIFICATIONS

#### POWER AMPLIFIER SECTION

Four 6BQ5/EL84's with 12AX7 driver

#### Rated Power & Load:

30 watts RMS into 16 or 8 ohms

#### Power @ Clipping (Typically):

(5% THD, 1 kHz, 120 V AC line)  
30 watts RMS into 16 or 8 ohms  
(Bias must be reduced to measure)

#### Frequency Response:

+0, -2 dB, 50 Hz to 15 kHz,  
@ 20 watts RMS into 16 ohms

#### Hum & Noise:

Greater than 80 dB below rated power

#### Power Consumption:

150 watts, 50/60 Hz, 120 VAC  
(Domestic)

#### PREAMP SECTION

Two 12AX7's

The following specs are measured @ 1 kHz with the controls preset as follows:

Pre & Post (lead) @ 0  
Reverb Level @ 0  
Bass & Treble EQ @ 12  
Middle EQ @ 0  
Channel Select Out  
Boost Switch Out

Nominal level is with Input Gain @ 6.

Minimum level is with Input Gain @ 12.

#### Preamp Normal Input:

Impedance: Very high Z,  
470 K ohms

#### Lead Channel

(Post Gain @ 12):

Nominal Input Level: -40 dBV,  
10 mV RMS  
Minimum Input Level: -70 dBV,  
0.3 mV RMS

#### Normal Channel:

Nominal Input Level: -17 dBV,  
140 mV RMS

Minimum Input Level: -28 dBV,  
40 mV RMS  
Maximum Input Level: 0 dBV,  
1.0 V RMS

#### Equalization:

(Lead and Normal Channels)  
Custom bass, middle, and treble passive-type EQ

#### Effects Send:

Load Impedance: 1 K ohm  
or greater  
Nominal Output Level: -6 dBV,  
0.5 V RMS

#### Effects Return:

Impedance: High Z, 2 M ohms  
Designed Input Level: -6 dBV,  
0.5 V RMS (Switching jack  
provides Effects Send to Effects  
Return connection when not used.)

#### External Footswitch Function:

Normal/Lead Channel Select (when  
Lead activated)  
Tremolo Defeat

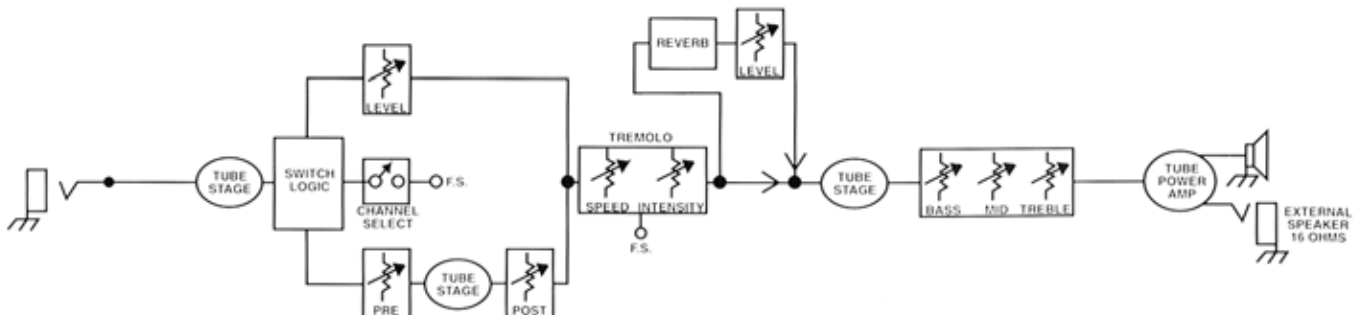

# STONE ISLAND GUITAR AMP TONE SETTINGS

## ROCK

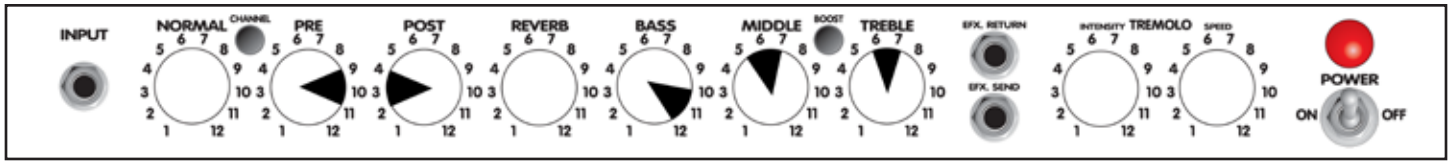

CHANNEL  
"IN"

BOOST  
"OUT"

ADJUST TO  
TASTE

## METAL

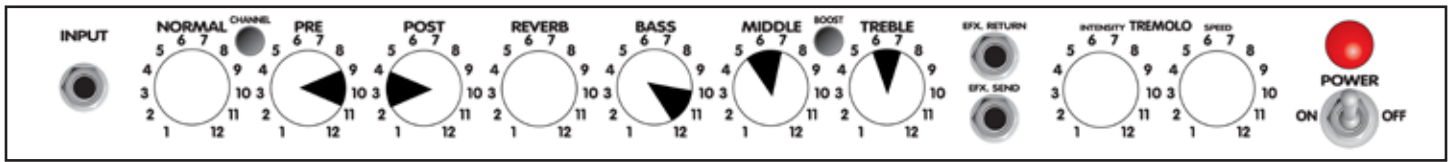

CHANNEL  
"IN"

BOOST  
"OUT"

ADJUST TO  
TASTE

## BLUES

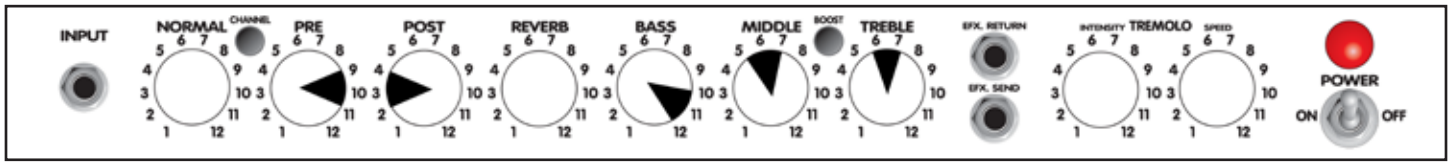

CHANNEL  
"OUT"  
IN FOR LEAD

BOOST  
"OUT"

ADJUST TO  
TASTE

## COUNTRY

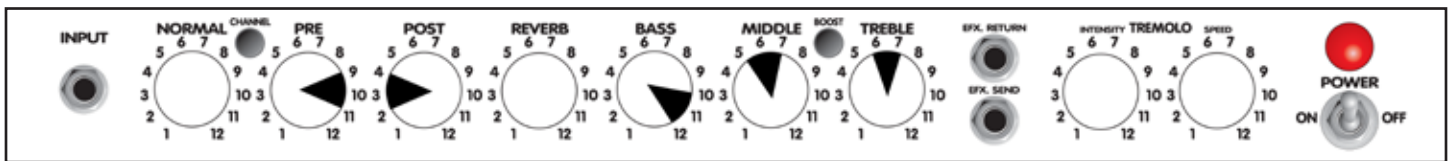

CHANNEL  
"OUT"  
IN FOR LEAD

BOOST  
"OUT"

ADJUST TO  
TASTE



# PEAVEY ELECTRONICS CORPORATION LIMITED WARRANTY

EFFECTIVE DATE: SEPTEMBER 5, 2007

## What This Warranty Covers

Your Peavey Warranty covers defects in material and workmanship in Peavey products purchased and serviced in the U.S.A. and Canada.

## What This Warranty Does Not Cover

The Warranty does not cover: (1) damage caused by accident, misuse, abuse, improper installation or operation, rental, product modification or neglect; (2) damage occurring during shipment; (3) damage caused by repair or service performed by persons not authorized by Peavey; (4) products on which the serial number has been altered, defaced or removed; (5) products not purchased from an Authorized Peavey Dealer.

## Who This Warranty Protects

This Warranty protects only the original retail purchaser of the product.

## How Long This Warranty Lasts

The Warranty begins on the date of purchase by the original retail purchaser. The duration of the Warranty is as follows:

Product Category	Duration
<b>Guitars/Basses, Amplifiers, Pre-Amplifiers, Mixers, Electronic Crossovers and Equalizers</b>	<b>2 years (+ 3 years)*</b>
<b>Drums</b>	<b>2 years (+ 1 year)*</b>
<b>Enclosures</b>	<b>2 years (+ 3 years)*</b>
<b>Digital Effect Devices</b>	<b>1 year (+ 1 year)*</b>
<b>Microphones</b>	<b>2 years</b>
<b>Speaker Components (incl. speakers, baskets, drivers, diaphragm replacement kits and passive crossovers)</b>	<b>1 year</b>
<b>Tubes and Meters</b>	<b>90 days</b>
<b>Cables</b>	<b>Limited Lifetime</b>

[\*Denotes additional warranty period applicable if optional Warranty Registration Card is completed and returned to Peavey by original retail purchaser within 90 days of purchase.]

## What Peavey Will Do

We will repair or replace (at Peavey's discretion) products covered by warranty at no charge for labor or materials. If the product or component must be shipped to Peavey for warranty service, the consumer must pay initial shipping charges. If the repairs are covered by warranty, Peavey will pay the return shipping charges.

## How To Get Warranty Service

(1) Take the defective item and your sales receipt or other proof of date of purchase to your Authorized Peavey Dealer or Authorized Peavey Service Center.

OR

(2) Ship the defective item, prepaid, to Peavey Electronics Corporation, International Service Center, 412 Highway 11 & 80 East, Meridian, MS 39301. Include a detailed description of the problem, together with a copy of your sales receipt or other proof of date of purchase as evidence of warranty coverage. Also provide a complete return address.

## Limitation of Implied Warranties

ANY IMPLIED WARRANTIES, INCLUDING WARRANTIES OF MERCHANTABILITY AND FITNESS FOR A PARTICULAR PURPOSE, ARE LIMITED IN DURATION TO THE LENGTH OF THIS WARRANTY.

*Some states do not allow limitations on how long an implied warranty lasts, so the above limitation may not apply to you.*

## Exclusions of Damages

PEAVEY'S LIABILITY FOR ANY DEFECTIVE PRODUCT IS LIMITED TO THE REPAIR OR REPLACEMENT OF THE PRODUCT, AT PEAVEY'S OPTION. IF WE ELECT TO REPLACE THE PRODUCT, THE REPLACEMENT MAY BE A RECONDITIONED UNIT. PEAVEY SHALL NOT BE LIABLE FOR DAMAGES BASED ON INCONVENIENCE, LOSS OF USE, LOST PROFITS, LOST SAVINGS, DAMAGE TO ANY OTHER EQUIPMENT OR OTHER ITEMS AT THE SITE OF USE, OR ANY OTHER DAMAGES WHETHER INCIDENTAL, CONSEQUENTIAL OR OTHERWISE, EVEN IF PEAVEY HAS BEEN ADVISED OF THE POSSIBILITY OF SUCH DAMAGES.

*Some states do not allow the exclusion or limitation of incidental or consequential damages, so the above limitation or exclusion may not apply to you.*

*This Warranty gives you specific legal rights, and you may also have other rights which vary from state to state.*

If you have any questions about this warranty or service received or if you need assistance in locating an Authorized Service Center, please contact the Peavey International Service Center at (601) 483-5365

FEATURES AND SPECIFICATIONS SUBJECT TO CHANGE WITHOUT NOTICE.



Logo referenced in Directive 2002/96/EC Annex IV (OJ(L)37/38, 13.02.03 and defined in EN 50419: 2005  
The bar is the symbol for marking of new waste and is applied only to equipment manufactured after 13 August 2005



Features and specifications subject to change without notice.

Peavey Electronics Corporation  
5022 Hartley Peavey Drive • Meridian, MS 39305  
(601) 483-5365 • FAX (601) 486-1278 • [www.peavey.com](http://www.peavey.com)