

OPERATING GUIDE

CLASSIC[®] 50
212/410

Single Unit Guitar Amp





Intended to alert the user to the presence of uninsulated “dangerous voltage” within the product’s enclosure that may be of sufficient magnitude to constitute a risk of electric shock to persons.



Intended to alert the user to the presence of important operating and maintenance (servicing) instructions in the literature accompanying the product.

CAUTION Risks of electrical shock — **DO NOT OPEN**

CAUTION To reduce the risk of electric shock, do not remove cover. No user serviceable parts inside. Refer Servicing to qualified service personnel.

WARNING To prevent electrical shock or fire hazard, do not expose this appliance to rain or moisture. Before using this appliance, read the operating guide for further warnings.



Este simbolo tiene el propósito de alertar al usuario de la presencia de instrucciones importantes sobre la operación y mantenimiento en la literatura que viene con el producto.



Este simbolo tiene el propósito de alertar al usuario de la presencia de “(voltaje) peligroso” que no tiene aislamiento dentro de la caja del producto que puede tener una magnitud suficiente como para constituir riesgo de corrientazo.

PRECAUCION Riesgo de corrientazo - No abra.

PRECAUCION Para disminuir el riesgo de corrientazo, no abra la cubierta. No hay piezas adentro que el usuario pueda reparar. Deje todo mantenimiento a los técnicos calificados.

ADVERTENCIA Para evitar corrientazos o peligro de incendio, no deje expuesto a la lluvia o humedad este aparato. Antes de usar este aparato, lea más advertencias en la guía de operación.



Ce symbole est utilisé pour indiquer à l'utilisateur qu'il ou qu'elle trouvera d'importantes instructions sur l'utilisation et l'entretien (service) de l'appareil dans la littérature accompagnant le produit.



Ce symbole est utilisé pour indiquer à l'utilisateur la présence à l'intérieur de ce produit de tension non-isolée dangereuse pouvant être d'intensité suffisante pour constituer un risque de choc électrique.

ATTENTION Risques de choc électrique — **NE PAS OUVRIR!**

ATTENTION Afin de réduire le risque de choc électrique, ne pas enlever le couvercle. Il ne se trouve à l'intérieur aucune pièce pouvant être réparée par l'utilisateur. Confier l'entretien à un personnel qualifié.

AVERTISSEMENT Afin de prévenir les risques de décharge électrique ou de feu, n'exposez pas cet appareil à la pluie ou à l'humidité. Avant d'utiliser cet appareil, lisez les avertissements supplémentaires situés dans le guide d'utilisation.



Dieses Symbol soll den Benutzer auf wichtige Instruktionen in der Bedienungsanleitung aufmerksam machen, die Handhabung und Wartung des Produkts betreffen.



Dieses Symbol soll den Anwender vor unisolierten gefährlichen Spannungen innerhalb des Gehäuses warnen, die von Ausreichender Stärke sind, um einen elektrischen Schlag verursachen zu können.

VORSICHT Risiko - Elektrischer Schlag! Nicht öffnen!

VORSICHT Um das Risiko eines elektrischen Schlages zu vermeiden, nicht die Abdeckung entfernen. Es befinden sich keine Teile darin, die vom Anwender repariert werden könnten. Reparaturen nur von qualifiziertem Fachpersonal durchführen lassen.

ACHTUNG Um einen elektrischen Schlag oder Feuergefahr zu vermeiden, sollte dieses Gerät nicht dem Regen oder Feuchtigkeit ausgesetzt werden. Vor Inbetriebnahme unbedingt die Bedienungsanleitung lesen.

FRONT PANEL

3

12 13

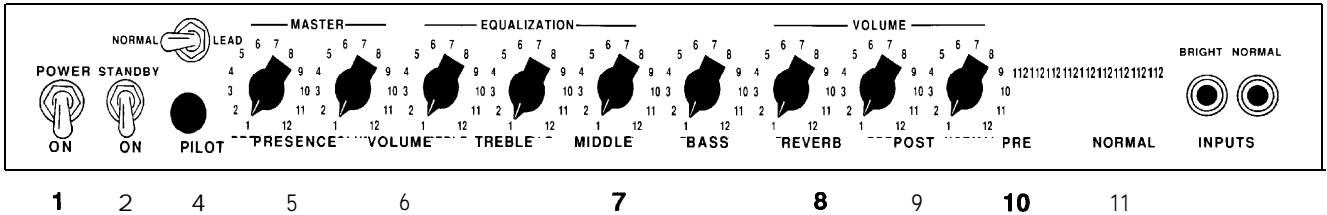

POWER SWITCH (1)

Switch to “on” position to turn on.

STANDBY SWITCH (2)

Allows amp to be placed in standby or active mode. In standby mode the tubes remain hot, but the amplifier is not operational.

CHANNEL SELECT SWITCH (3)

Allows selection of the Lead or Normal Channel.

NOTE: Channel selection may also be accomplished by the remote footswitch. If remote selection is desired the channel switch must be in the “in” (Lead) position.

PILOT LIGHT LED (4)

Illuminates when AC power is being supplied to the amp.

PRESENCE (5)

An active tone control that boosts the extreme high frequencies by 6 dB.

MASTER VOLUME (6)

Controls the overall volume level of the system.

TREBLE, MIDDLE, AND BASS EQ (7)

Passive tone controls that regulate high, mid, and low frequencies respectively.

REVERB (8)

Reverberation is an echo effect. Rotate clockwise to increase the effect. Remote footswitch can control On/Off.

POST GAIN (9)

Controls the overall volume level of the Lead channel. The final level adjustment should be made after the desired sound has been achieved.

PRE GAIN (10)

Controls the input volume level of the Lead channel.

NORMAL GAIN (11)

Controls the volume level of the Normal channel.

BRIGHT INPUT (12)

Input for instrument-level signals. This input produces enhanced high frequency response (treble), similar to a bright switch when compared to the normal input.

NORMAL INPUT (13)

Input for instrument-level signals. For brighter frequency response (highs) see Bright Input No. 12.

REAR PANEL

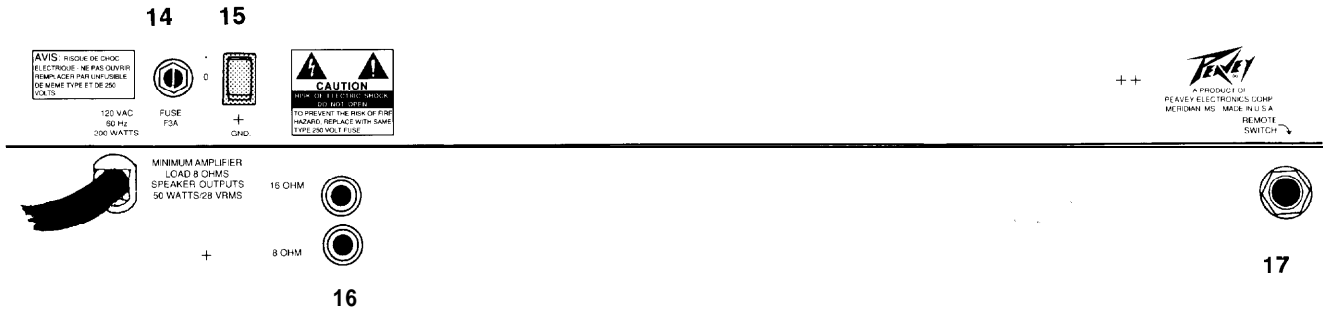

FUSE (14)

The fuse is located within the cap of the fuseholder. If the fuse should fail, IT MUST BE REPLACED WITH THE SAME TYPE AND VALUE IN ORDER TO AVOID DAMAGE TO THE EQUIPMENT AND TO PREVENT VOIDING THE WARRANTY. If the amp repeatedly blows fuses, it should be taken to a qualified service center for repair.

WARNING: THE FUSE SHOULD ONLY BE REPLACED WHEN THE POWER CORD HAS BEEN DISCONNECTED FROM ITS POWER SOURCE.

GROUND SWITCH (15)

Three position rocker-type switch which, in most applications, should be operated in its center or zero position. There may be some situations when audible hum and/or noise will come from the loudspeaker. If this situation arises, position the ground switch to either positive (+ or -) or until the noise is minimized.

NOTE: Should the noise problem continue, consult your Authorized Peavey Dealer, the Peavey Factory, or a qualified service technician. THE GROUND SWITCH IS NOT FUNCTIONAL ON 220/240 VOLT MODELS.

SPEAKER OUTPUTS (16)

Speaker output ($\frac{1}{4}$ ") jacks are provided for 16 and 8 ohms. When both jacks are engaged, amplifier impedance is 8 ohms.

REMOTE SWITCH JACK (17)

Provided for the connection of the optional remote footswitch. Footswitch is used to select the Lead or Normal channels and defeat reverb. When using remote footswitch, always insert the plug fully (second click) to ensure proper operation.

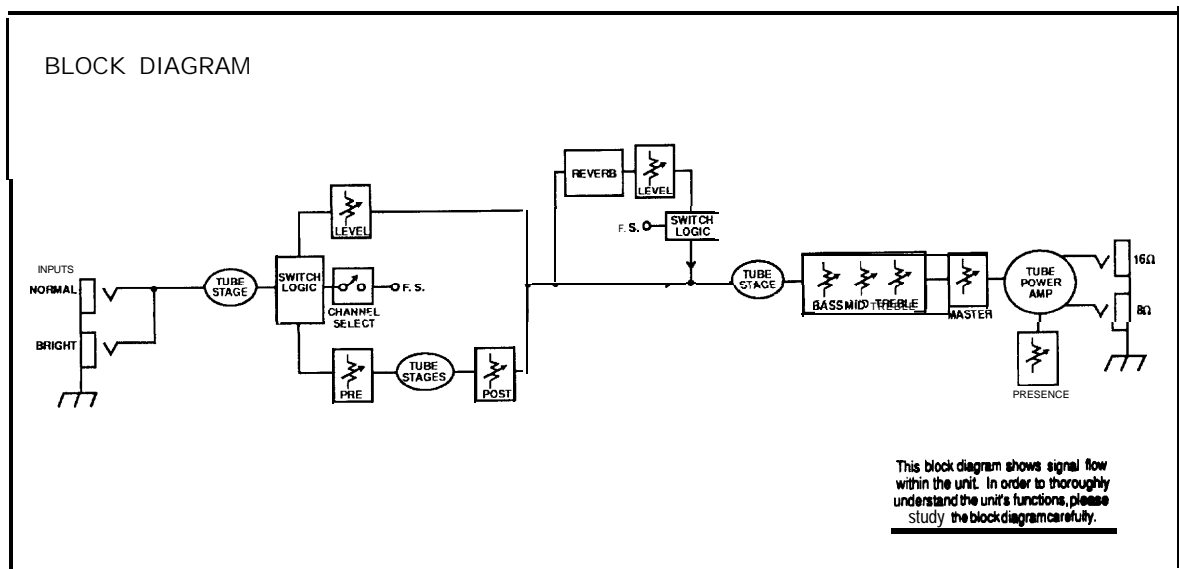

SPECIFICATIONS

POWER AMPLIFIER SECTION

4 - 6BQ5/EL84's with
12AX7 driver

Rated Power & Load:

50 W RMS into 16 or 8 ohms

Power @ Clipping: (Typically)

(5% THD, 1 kHz,
120 V AC line)
50 W RMS into 16 or 8 ohms
(Bias must be reduced
to measure)

Frequency Response:

+0, -2 dB, 50 Hz to 15 kHz,
@ 40 W RMS into 16 ohms

Hum & Noise:

Greater than 80 dB below
rated power

Power Consumption:

200 watts, 50/60 Hz,
120 V AC (Domestic)

PREAMP SECTION

2 - 12AX7's

The following specs are measured @
1 kHz with the controls preset as follows:

Pre & Post (lead) @ 0
Reverb Level @ 0
Bass & Treble EQ @ 12
Middle EQ @ 0
Master Volume @ 12
Presence @ 6

Nominal level is with Input

Gain @ 6

Minimum levels is with Input

Gain @ 12

Preamp Normal Input:

Impedance: Very high Z,
470 K ohms

Lead Channel

(Post gain @ 10)

Nominal Input Level: -40 dBV,
10 mV RMS

Minimum Input Level: -70 dBV,
0.3 mV RMS

Normal Channel:

Nominal Input Level : -17 dBV,
140 mV RMS
Minimum Input Level: -28 dBV,
40 mV RMS
Maximum Input Level : 0 dBV,
1.0 V RMS

Preamp Bright Input:

Impedance: Very high Z, 470 K
ohms +12 dB boost @ 2 kHz

Equalization:

(Lead & Normal Channels)

Custom bass, middle & treble
passive type EQ

External Footswitch Function:

Reverb Defeat
(when reverb control is raised)
Normal/Lead Channel Select
(when Lead activated)

TONE SETTING

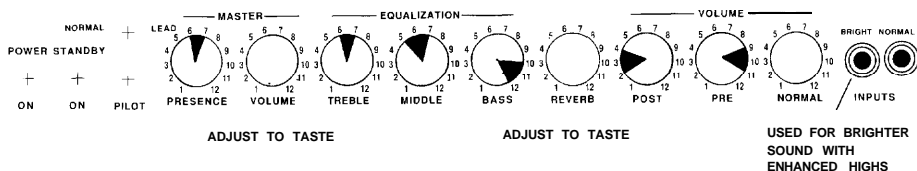

ROCK

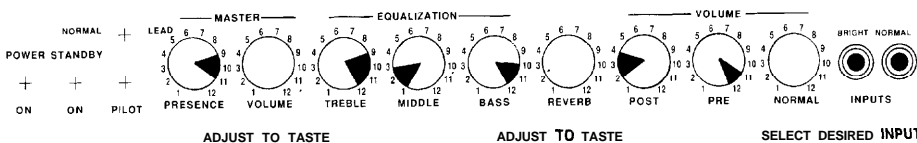

METAL

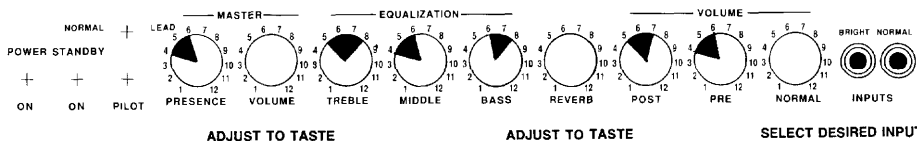

COUNTRY

Tone settings given are general and will vary according to type of guitar, type and gauges of strings, type of pickup and even type of pick. Personal taste, playing style, and type of music greatly contribute to desired tonality.

Consulte los diagramas del panel delantero en la sección de inglés de este manual.

POWER SWITCH (Interruptor de corriente) (1)

Coloque a la posición “on” para encender.

STANDBY SWITCH (Interruptor de condición de espera) (2)

Este interruptor le permite a su aparato estar en condición de “espera” o la condición de activo. En la condición “standby” los tubos permanecen calientes, pero el amplificador no está en operación.

CHANNEL SELECT SWITCH (Interruptor de selección de canal) (3)

Permite la selección del canal “Lead” (solista) o Normal.

NOTA: También se puede lograr la selección del canal por medio del pedal interruptor remoto. Si desea la selección a control remoto, el interruptor de canal debe estar en la posición “in” (hacia adentro) (canal de solista).

PILOT LIGHT LED (LED indicadora de lámpara piloto) (4)

Se ilumina cuando el amplificador recibe corriente alterna.

PRESENCE (Presencia) (5)

Control de tono activo que aumenta en 6 dB las frecuencias de los extremos agudos.

MASTER VOLUME (Volumen de maestra) (6)

Controla el nivel global de volumen del sistema.

TREBLE, MIDDLE, AND BASS EQ (Ecuador de tiples, medias y agudas) (7)

Controles de tono pasivo que regulan las frecuencias altas, medias y agudas, respectivamente.

REVERB (Reverberación) (8)

La reverberación es un efecto de eco. Haga girar a la derecha para aumentar el efecto. El encendido/apagado (“on/off”) se puede controlar con el pedal interruptor de control remoto.

POST GAIN (Control de ganancia posterior del preamplificador) (9)

Controla el volumen general del canal solista. El ajuste final de nivel debe hacerse después de que se haya obtenido el sonido deseado.

PRE GAIN (Control del preamplificador) (10)

Controla la entrada de volumen del canal solista.

NORMAL GAIN (Ganancia normal) (11)

Controla el nivel de volumen del canal Normal.

BRIGHT INPUT (Entrada de brillo) (12)

Esta entrada es para las señales a nivel de instrumentos. Esta entrada produce una respuesta de frecuencias agudas (tiple), semejante al interruptor de brillo cuando se compara con la entrada normal.

NORMAL INPUT (Entrada normal) (13)

Entrada para señales de nivel de instrumento. Para obtener respuestas de frecuencia más brillantes (altas) ver Entrada de Brillo Número 12.

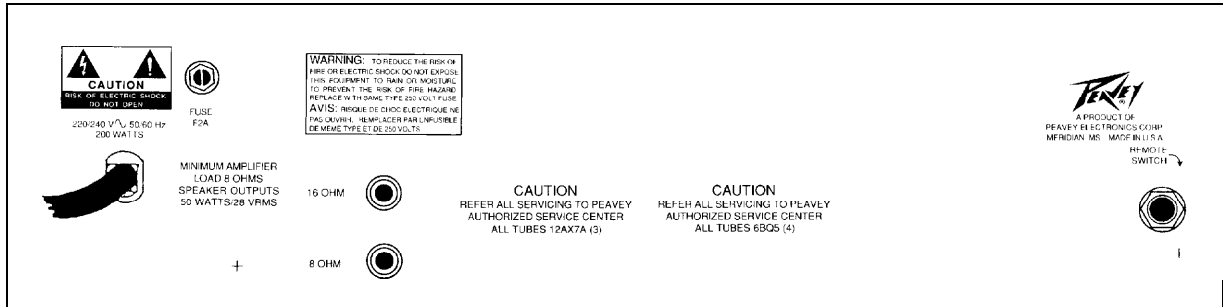

FUSE (Fusible) (14)

El fusible se encuentra localizado dentro de la cápsula del portafusible. Si el fusible se quema o falla, SE DEBERA REEMPLAZAR CON UNO DEL MISMO TIPO Y VALOR, PARA EVITAR DAÑO AL APARATO Y EL ANULAMIENTO DE LA GARANTIA. Si el aparato quema los fusible repetidamente, cerciórese de que está conectado a un tomacorriente con el voltaje adecuado, si esto es correcto, entonces desconéctelo y llévelo a revision por un técnico autorizado.

ATENCION: Antes de reemplazar el fusible quemado, cerciórese de que el aparato está completamente desconectado del tomacorriente.

GROUND SWITCH (Interruptor de tierra) (15)

Un interruptor tipo balancín de tres posiciones que, en la mayoría de las aplicaciones, debe ser operado en su posición del centro o cero (0). Puede haber situaciones cuando un zumbido audible salga del altavoz. Si esta situación ocurre, ajuste la posición del interruptor de tierra a positivo o negativo (+ o -) o hasta que el ruido disminuya.

NOTA: Si el problema de ruido continúa, consulte su representante autorizado de Peavey, la fábrica de Peavey, o un técnico de servicio calificado. EL INTERRUPTOR DE TIERRA NO FUNCIONA EN LOS MODELOS DE 220/240 VOLTIOS.

SPEAKER OUTPUTS (Salidas de parlante) (16)

Se proporcionan enchufes hembras de salida de parlante de ¼ de pulgada para 16 y 8 ohmios. Cuando se utilizan ambos conectores, la impedancia de amplificador es de 8 ohmios.

REMOTE SWITCH JACK (Enchufe hembra de interruptor remoto) (17)

Se suministra para la conexión del pedal interruptor de control remoto opcional . El pedal interruptor se utiliza para seleccionar los canales solista o normal y desactivar la reverberación. Cuando utilice el pedal de control remoto, inserte siempre la clavija completamente (segundo retén) para asegurar el correcto funcionamiento.

**Veillez vous référer au “front panel line art”
situé dans la section en langue anglaise de ce manuel.**

POWER SWITCH (Interrupteur d'alimentation) (1)

Mettre en position “On” pour mettre sous tension.

STANDBY SWITCH (S₁electeur attente) (2)

Permet de sélectionner l'état de l'ampli: mode “Active” (actif) ou mode “Standby” (attente). En position “Standby”, l'amplificateur ne fonctionne pas mais les lampes (“tubes”) restent chaudes pour permettre de le remettre en service sans délai.

CHANNEL SELECT SWITCH (S₁electeur de canal) (3)

Permet de sélectionner les canaux “Lead” ou “Normal”.

NOTE: La sélection de canal peut aussi s'accomplir à distance à l'aide de la pédale-interrupteur. Pour que la sélection à distance soit possible, le canal doit être en position “In” (“Lead”).

PILOT LIGHT LED (DEL témoin) (4)

S'allume lorsque l'ampli reçoit l'alimentation CA.

PRESENCE (Pr₁esence) (5)

Réglage de tonalité actif qui renforce les fréquences extrêmes aiguës (+6 dB).

MASTER VOLUME (Principal volume) (6)

Contrôle le niveau de volume général du système.

TREBLE, MIDDLE, AND BASS EQ (★Egalisation aiguës, moyennes, graves) (7)

Réglages de tonalité passif ajustant respectivement les fréquences aiguës, moyennes et graves.

REVERB (R₁everb₁eration) (8)

La reverberation est un effet d'écho. Tournez dans le sens du mouvement des aiguilles d'une montre pour augmenter l'intensité de l'effet. L'interrupteur au pied peut contrôler la mise en circuit ou hors circuit (“On/Off”).

POST GAIN (9)

Commande le volume général du canal “Lead”. Le réglage final de niveau doit être effectué après avoir obtenu la sonorité désirée à l'aide des autres réglages.

PRE GAIN (10)

Contrôle le niveau de volume à l'entrée sur du canal “Lead”.

NORMAL GAIN (Gain canal normal) (11)

Contrôle le niveau de volume du canal “Normal”.

BRIGHT INPUT (Entr₁ee “Bright”) (12)

Entrée pour signaux de niveau instrument. Cette entrée produit une réponse accentuée des fréquences aiguës, similaire à un sélecteur de brillance comparé à une entrée normale.

NORMAL INPUT (Entr₁ee normale) (13)

Entrée pour les signaux de niveau instrument. Pour une réponse en fréquence plus brillante (hautes) voir Bright Input No. 12.

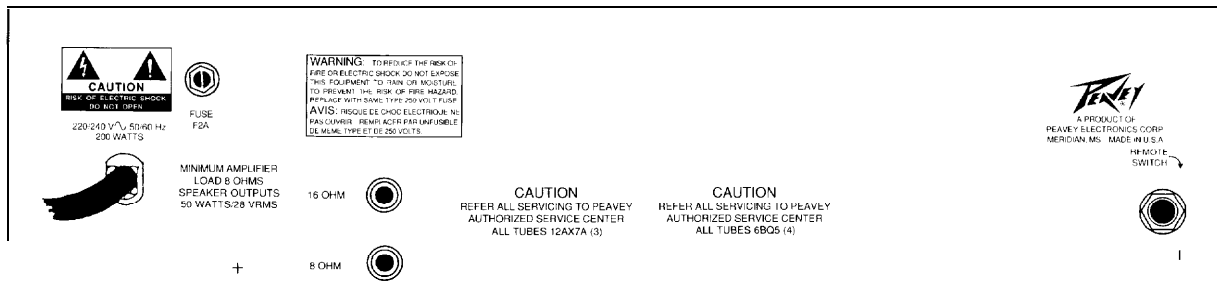

FUSE (Fusible) (14)

Le fusible se trouve à l'intérieur de son support. Si le fusible grille, IL DOIT ÊTRE REMPLACÉ PAR UN FUSIBLE DE MÊME TYPE ET MÊME VALEUR POUR ÉVITER TOUT DOMMAGE À L'APPAREIL ET ÉVITER D'ANNULER LA GARANTIE. Si le fusible grille de façon répétée, apportez l'appareil à un centre de service qualifié pour réparation. AVERTISSEMENT: LE FUSIBLE NE DOIT ÊTRE REMPLACÉ QUE LORSQUE LE CORDON D'ALIMENTATION EST DÉBRANCHÉ DE LA SOURCE D'ALIMENTATION.

GROUND SWITCH (Sélecteur de mise à terre) (15)

Commutateur rotatif à trois positions devant, la plupart du temps, être en position centrale (zero). Dans certaines situations un bruit de ronflement ou un bourdonnement audible peut provenir des haut-parleurs de puissance. Dans ce cas, bougez le sélecteur de mise à terre jusqu'en position positive ou négative (+ ou -) ou jusqu'à ce que le bruit diminue.

NOTE: Si le problème de bruit persiste, consultez votre détaillant autorisé Peavey, la fabrique Peavey, ou un technicien de service qualifié. LE SÉLECTEUR DE MISE À TERRE NE FONCTIONNE PAS SUR LES APPAREILS 220/240 VOLT.

SPEAKER OUTPUTS (Sortie pour haut-parleur) (16)

Les jacks 1/4" (6,35 mm) de sortie pour haut-parleur sont prévus pour 16 et 8 ohms. Lorsque les deux jacks sont utilisés, l'impédance de l'amplificateur est de 8 ohms.

REMOTE SWITCH JACK (Prise pour interrupteur à distance) (17)

Sert à brancher la pédale-interrupteur (en option). L'interrupteur au pied est utilisé pour sélectionner les canaux "Lead" ou "Normal" et mettre la reverberation hors service. Afin d'assurer un bon fonctionnement lors de l'utilisation de l'interrupteur au pied, insérez la fiche à fond jusqu'au second cran (au second clic).

Siehe diagramm der frontplatte im englischen teil des handbuchs.

POWER SWITCH (1)

Zum Einschalten diesen Schalter auf "on" stellen.

STANDBY SWITCH (2)

Ermöglicht es, den Verstärker mit abgeschaltetem Tonsignal betriebsbereit zu halten. In der "Standby"-Betriebsart werden die Röhren weiter beheizt, das Signal ist jedoch abgeschaltet.

CHANNEL SELECT SWITCH (3)

Zur Umschaltung von Lead auf Normal Kanal.

MERKE: Kanalwahl kann auch mittels dem Fernbedienungsfußschalter ausgeführt werden. Dazu muß der "Channel"-Schalter sich in der "in" (lead) Position befinden.

PILOT LIGHT (4)

Leuchtet auf, wenn das Gerät eingeschaltet ist.

PRESENCE (5)

Eine aktive Tonkontrolle, welche die extrem hohen Frequenzen um 6 dB boostet (anhebt).

MASTER VOLUME (6)

Regler für die Gesamtlautstärke des Systems.

TREBLE, MIDDLE, AND BASS EQ (7)

Passive Klangregler die jeweils die Höhen, Mitten und Bässe bearbeiten.

REVERB (8)

Eingebautes Echo-Hall-System. In Uhrzeigerrichtung drehen, um den Effekt zu verstärken. Fernbedienungs Fußschalter zum Ein- und Ausschalten des Effekts.

POST GAIN (9)

Kontrolliert den gesamten Lautstärke-pegel des Hauptkanals (Mastervolumen). Die endgültige Lautstärkereglung sollte vorgenommen werden, nachdem der gewünschte Sound eingestellt ist.

PRE GAIN (10)

Kontrolliert den Vorstufenpegel des Lead-Kanals.

NORMAL GAIN (11)

Regelt den Pegel des Normal Kanals.

BRIGHT INPUT (12)

Dieser Instrumenten-Eingang erhöht die Wiedergabe der hohen Frequenzen, ähnlich wie ein Bright-Schalter im Vergleich zum Normal-Eingang.

NORMAL INPUT (13)

Eingang für Signale mit Instrumentenpegel. Für brillantere Frequenzwiedergabe in den Höhen siehe Bright Input No. 12.

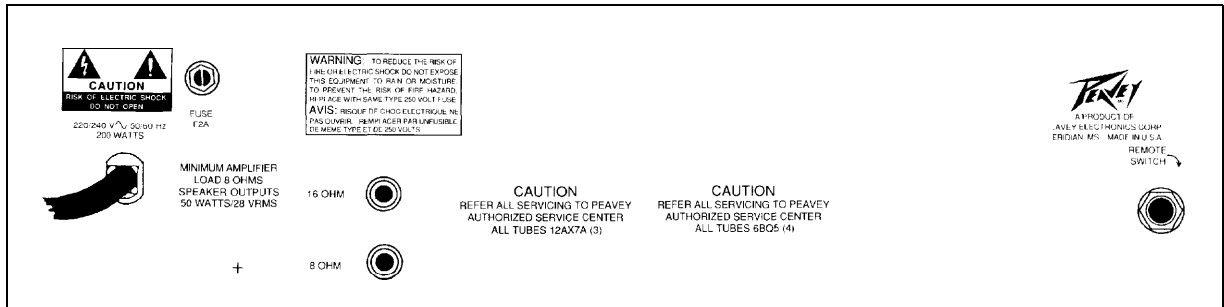

FUSE (14)

Die Sicherung befindet sich innerhalb der Kappe des Sicherungshalters. Wenn die Sicherung durchbrennt, MUSS SIE DURCH EINE DES GLEICHEN TYPUS UND MIT DEM GLEICHEN WERT ERSETZT WERDEN, UM DAS GERÄT ZU SCHÜTZEN UND DIE GARANTIELEISTUNGEN ZU ERHALTEN. Wenn am Verstärker wiederholt die Sicherung durchbrennt, muß das Gerät in eine qualifizierte Fachwerkstatt.

WARNUNG: SICHERUNGSWECHSEL NUR BEI ABGEZOGENEM NETZKABEL VORNEHMEN!

GROUND SWITCH (15)

Der Ground-Schalter funktioniert nicht bei den 220/240 Volt-Modellen.

LAUTSPRECHERAUSGANGE (16)

Für die Lautsprecherausgänge stehen klinkenbuchsen für 16 und 8 ohm zur Verfügung. Wenn beide Buchsen belegt sind, beträgt die Impedanz des Verstärkers 8 ohm.

REMOTE SWITCH JACK (Remote Switch Jack) (17)

Vorgesehen für den Anschluß des als Option erhältlichen Fußschalters. Der Fußschalter kann zum Anwählen des Normal- und Leadkanals sowie zum Schalten des Halls verwendet werden. Um eine einwandfreie Funktion zu gewährleisten, ist beim Anschluß des Fußschalters darauf zu achten, daß der Stecker vollständig (bis zum 2. Klick) eingesteckt ist. ion erhältlichen Fußschalters. Der Fußschalter kann zum Anwählen des Normal- und Leadkanals sowie zum Schalten des Halls verwendet werden. Um eine einwandfreie Funktion zu gewährleisten, ist beim Anschluß des Fußschalters darauf zu achten, daß der Stecker vollständig (bis zum 2. Klick) eingesteckt ist.

THIS LIMITED WARRANTY VALID ONLY WHEN PURCHASED AND REGISTERED IN THE UNITED STATES OR CANADA. ALL EXPORTED PRODUCTS ARE SUBJECT TO WARRANTY AND SERVICES TO BE SPECIFIED AND PROVIDED BY THE AUTHORIZED DISTRIBUTOR FOR EACH COUNTRY.

Ces clauses de garantie ne sont valables qu'aux Etats-Unis et au Canada. Dans tout les autres pays, les clauses de garantie et de maintenance sont fixees par le distributeur national et assuree par lui seion la legislation en vigueur.

Diese Garantie ist nur in den USA und Kanada gultig. Alle Export-Produkte sind der Garantie und dem Service des Importeurs des jeweiligen Landes unterworfen. Esta garantia es valida solamente cuando el producto es comprado en E.U. continentales o en Canada. Todos los productos que sean comprados en el extranjero, estan sujetos a las garantias y servicio que cada distribuidor autorizado determine y ofrezca en los diferentes paises.

PEAVEY ONE-YEAR LIMITED WARRANTY/REMEDY

PEAVEY ELECTRONICS CORPORATION ("PEAVEY") warrants this product, EXCEPT for covers, footswitches, patchcords, tubes and meters, to be free from defects in material and workmanship for a period of one (1) year from date of purchase. PROVIDED, however, that this limited warranty is extended only to the original retail purchaser and is subject to the conditions, exclusions, and limitations hereinafter set forth:

PEAVEY 90-DAY LIMITED WARRANTY ON TUBES AND METERS

If this product contains tubes or meters, Peavey warrants the tubes or meters contained in the product to be free from defects in material and workmanship for a period of ninety (90) days from date of purchase; PROVIDED, however, that this limited warranty is extended only to the original retail purchaser and is also subject to the conditions, exclusions, and limitations hereinafter set forth.

CONDITIONS, EXCLUSIONS, AND LIMITATIONS OF LIMITED WARRANTIES

These limited warranties shall be void and of no effect, if:

- The first purchase of the product is for the purpose of resale; or
- The original retail purchase is not made from an AUTHORIZED PEAVEY DEALER; or
- The product has been damaged by accident or unreasonable use, neglect, improper service or maintenance, or other causes not arising out of defects in material or workmanship; or
- The serial number affixed to the product is altered, defaced, or removed.

In the event of a defect in material and/or workmanship covered by this limited warranty, Peavey will:

- In the case of tubes or meters, replace the defective component without charge.
- In other covered cases (i.e., cases involving anything other than covers, footswitches, patchcords, tubes or meters), repair the defect in material or workmanship or replace the product, at Peavey's option; and provided, however, that, in any case, all costs of shipping, if necessary, are paid by you, the purchaser.

THE WARRANTY REGISTRATION CARD SHOULD BE ACCURATELY COMPLETED AND MAILED TO AND RECEIVED BY PEAVEY WITHIN FOURTEEN (14) DAYS FROM THE DATE OF YOUR PURCHASE.

In order to obtain service under these warranties, you must:

- Bring the defective item to any PEAVEY AUTHORIZED DEALER or AUTHORIZED PEAVEY SERVICE CENTER and present therewith the ORIGINAL PROOF OF PURCHASE supplied to you by the AUTHORIZED PEAVEY DEALER in connection with your purchase from him of this product.
If the DEALER or SERVICE CENTER is unable to provide the necessary warranty service you will be directed to the nearest other PEAVEY AUTHORIZED DEALER or AUTHORIZED PEAVEY SERVICE CENTER which can provide such service.

OR

- Ship the defective item, prepaid, to:

PEAVEY ELECTRONICS CORPORATION
International Service Center
Highway 80 East
MERIDIAN, MS 39301

including therewith a complete, detailed description of the problem, together with a legible copy of the original PROOF OF PURCHASE and a complete return address. Upon Peavey's receipt of these items:

If the defect is remedial under these limited warranties and the other terms and conditions expressed herein have been complied with, Peavey will provide the necessary warranty service to repair or replace the product and will return it, FREIGHT COLLECT, to you, the purchaser.

Peavey's liability to the purchaser for damages from any cause whatsoever and regardless of the form of action, including negligence, is limited to the actual damages up to the greater of \$500.00 or an amount equal to the purchase price of the product that caused the damage or that is the subject of or is directly related to the cause of action. Such purchase price will be that in effect for the specific product when the cause of action arose. This limitation of liability will not apply to claims for personal injury or damage to real property or tangible personal property allegedly caused by Peavey's negligence. Peavey does not assume liability for personal injury or property damage arising out of or caused by a non-Peavey alteration or attachment, nor does Peavey assume any responsibility for damage to interconnected non-Peavey equipment that may result from the normal functioning and maintenance of the Peavey equipment.

UNDER NO CIRCUMSTANCES WILL PEAVEY BE LIABLE FOR ANY LOST PROFITS, LOST SAVINGS, ANY INCIDENTAL DAMAGES, OR ANY CONSEQUENTIAL DAMAGES ARISING OUT OF THE USE OR INABILITY TO USE THE PRODUCT, EVEN IF PEAVEY HAS BEEN ADVISED OF THE POSSIBILITY OF SUCH DAMAGES.

THESE LIMITED WARRANTIES ARE IN LIEU OF ANY AND ALL WARRANTIES, EXPRESSED OR IMPLIED, INCLUDING, BUT NOT LIMITED TO, THE IMPLIED WARRANTIES OF MERCHANTABILITY AND FITNESS FOR A PARTICULAR USE; PROVIDED, HOWEVER, THAT IF THE OTHER TERMS AND CONDITIONS NECESSARY TO THE EXISTENCE OF THE EXPRESSED, LIMITED WARRANTIES, AS HEREINABOVE STATED, HAVE BEEN COMPLIED WITH, IMPLIED WARRANTIES ARE NOT DISCLAIMED DURING THE APPLICABLE ONE-YEAR OR NINETY-DAY PERIOD FROM DATE OF PURCHASE OF THIS PRODUCT.

SOME STATES DO NOT ALLOW LIMITATION ON HOW LONG AN IMPLIED WARRANTY LASTS, OR THE EXCLUSION OR LIMITATION OF INCIDENTAL OR CONSEQUENTIAL DAMAGES, SO THE ABOVE LIMITATIONS OR EXCLUSIONS MAY NOT APPLY TO YOU. THESE LIMITED WARRANTIES GIVE YOU SPECIFIC LEGAL RIGHTS, AND YOU MAY ALSO HAVE OTHER RIGHTS WHICH MAY VARY FROM STATE TO STATE.

THESE LIMITED WARRANTIES ARE THE ONLY EXPRESSED WARRANTIES ON THIS PRODUCT, AND NO OTHER STATEMENT, REPRESENTATION, WARRANTY, OR AGREEMENT BY ANY PERSON SHALL BE VALID OR BINDING UPON PEAVEY.

In the event of any modification or disclaimer of expressed or implied warranties, or any limitation of remedies, contained herein conflicts with applicable law, then such modification, disclaimer or limitation, as the case may be, shall be deemed to be modified to the extent necessary to comply with such law.

Your remedies for breach of these warranties are limited to those remedies provided herein and Peavey Electronics Corporation gives this limited warranty only with respect to equipment purchased in the United States of America.

INSTRUCTIONS — WARRANTY REGISTRATION CARD

1. Mail the completed WARRANTY REGISTRATION CARD to:

PEAVEY ELECTRONICS CORPORATION
POST OFFICE BOX 2898
MERIDIAN, MISSISSIPPI 39302-2898

- a. Keep the PROOF OF PURCHASE. In the event warranty service is required during the warranty period, you will need this document. **There will be no identification card issued by Peavey Electronics Corporation.**

- 2 IMPORTANCE OF WARRANTY REGISTRATION CARDS AND NOTIFICATION OF CHANGES OF ADDRESSES

a Completion and mailing of WARRANTY REGISTRATION CARDS — Should notification become necessary for any condition that may require correction, the REGISTRATION CARD will help ensure that you are contacted and properly notified

b Notice of address changes — If you move from the address shown on the WARRANTY REGISTRATION CARD, you should notify Peavey of the change of address so as to facilitate your receipt of any bulletins or other forms of notification which may become necessary in connection with any condition that may require dissemination of information or correction.

- 3 You may contact Peavey directly by telephoning (601) 483-5365

IMPORTANT SAFETY INSTRUCTIONS

WARNING When using electric products, basic cautions should always be followed, including the following.

1. Read all safety and operating instructions before using this product.
2. All safety and operating instructions should be retained for future reference.
3. Obey all cautions in the operating instructions and on the back of the unit.
4. All operating instructions should be followed.
5. This product should not be used near water, i.e., a bathtub, sink, swimming pool, wet basement, etc.
6. This product should be located so that its position does not interfere with its proper ventilation. It should not be placed flat against a wall or placed in a built-in enclosure that will impede the flow of cooling air.
7. This product should not be placed near a source of heat such as a stove, radiator, or another heat producing amplifier.
8. Connect only to a power supply of the type marked on the unit adjacent to the power supply cord.
9. Never break off the ground pin on the power supply cord. For more information on grounding, write for our free booklet "Shock Hazard and Grounding."
10. Power supply cords should always be handled carefully. Never walk or place equipment on power supply cords. Periodically check cords for cuts or signs of stress, especially at the plug and the point where the cord exits the unit.
11. The power supply cord should be unplugged when the unit is to be unused for long periods of time.
12. If this product is to be mounted in an equipment rack, rear support should be provided.
13. Metal parts can be cleaned with a damp rag. The vinyl covering used on some units can be cleaned with a damp rag, or an ammonia-based household cleaner if necessary. Disconnect unit from power supply before cleaning.
14. Care should be taken so that objects do not fall and liquids are not spilled into the unit through the ventilation holes or any other openings.
15. This unit should be checked by a qualified service technician if
 - a. The power supply cord or plug has been damaged.
 - b. Anything has fallen or been spilled into the unit.
 - c. The unit does not operate correctly.
 - d. The unit has been dropped or the enclosure damaged.
16. The user should not attempt to service this equipment. All service work should be done by a qualified service technician.
17. This product should be used only with a cart or stand that is recommended by Peavey Electronics.
18. Exposure to extremely high noise levels may cause a permanent hearing loss. Individuals vary considerably in susceptibility to noise induced hearing loss, but nearly everyone will lose some hearing if exposed to sufficiently intense noise for a sufficient time.

The U.S. Government's Occupational Safety and Health Administration (OSHA) has specified the following permissible noise level exposures

Duration Per Day In Hours	Sound Level dBA, Slow Response
8	90
6	92
4	95
3	97
2	100
1½	102
1	105
½	110
¼ or less	115

According to OSHA, any exposure in excess of the above permissible limits could result in some hearing loss.

Ear plugs or protectors in the ear canals or over the ears must be worn when operating this amplification system in order to prevent a permanent hearing loss if exposure is in excess of the limits as set forth above. To ensure against potentially dangerous exposure to high sound pressure levels, it is recommended that all persons exposed to equipment capable of producing high sound pressure levels such as this amplification system be protected by hearing protectors while this unit is in operation.

SAVE THESE INSTRUCTIONS



Features and specifications subject to change without notice.



Peavey Electronics Corporation 711 A Street / Meridian, MS 39301 / U.S.A. / (601) 483-5365 / Fax 486-1278

01992

#80301444

Printed in U.S.A. 9/95