



INSTALLATION INSTRUCTION - INSTRUCCIONES DE INSTALACION WOOD HINGED PATIO DOOR - (INCLUDES - STANDARD, PERFORMANCE UPGRADE AND HURRICANESHIELD® IMPACT RESISTANT IN-SWING, OUT-SWING)

Instrucciones español en el reverso.

Important Safety Information:

Pella® HurricaneShield® Products have been tested in accordance with the large missile impact testing requirements have been certified to meet those requirements. Check with the individual (building owner, architect, contractor, installer and/or consumer) responsible for the project in addition to local building code officials to determine if these products comply with local codes. Pella HurricaneShield Products are neither hurricane proof nor are they shatter proof. Severe wind and rain may produce temporary conditions which exceed product performance standards. When these units are subjected to intense storms or extreme conditions, which exceed the intended design pressures, air, water and flying debris infiltration may occur.

These instructions were developed and tested for use with typical wood frame wall construction in a wall system designed to manage water. **These instructions are not to be used with any other construction method.** Installation instructions for use with other construction methods, multiple units or bow and bay windows, may be obtained from Pella Corporation or a local Pella retailer, or by visiting <http://www.pella.com>. Building designs, construction methods, building materials, and site conditions unique to your project may require an installation method different from these instructions and additional care. Determining the appropriate installation method is the responsibility of you, your architect, or construction professional.

IMPORTANT NOTICE: To achieve maximum door performance, the performance upgrade installation may be required. Additional performance information may be obtained from your Pella retailer of www.pella.com. All HurricaneShield doors are required to use the Performance Upgrade Installation steps contained within this instruction.

REMEMBER TO USE APPROPRIATE PERSONAL PROTECTIVE EQUIPMENT.

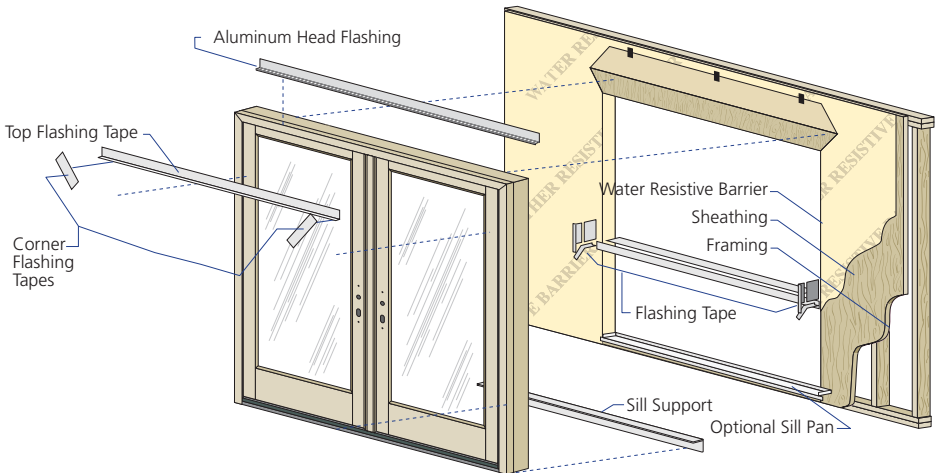







Always read the Pella® Limited Warranty before purchasing or installing Pella products. By installing this product, you are acknowledging that this Limited Warranty is part of the terms of the sale. Failure to comply with all Pella installation and maintenance instructions may void your Pella product warranty. See Limited Warranty for complete details at <http://warranty.pella.com>.

The performance of any building is dependent upon the design, installation, and workmanship of the entire building system. Pella Corporation strongly recommends consulting an experienced architect, contractor, or structural engineer prior to installation of Pella products.

The individual (building owner, architect, contractor, installer and/or consumer) responsible for the project must take into account local conditions, building codes, inherent component limitations, the effects of aging and weathering on building components, and other design issues relevant to each project.

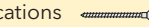
The determination of the suitability of all building components for each project, as well as the design and installation of flashing and sealing systems, are the responsibility of the building owner, architect, contractor, installer and/or consumer.













YOU WILL NEED TO SUPPLY:

- Cedar or Impervious shims/spacers (12 to 20) 
- 16d galvanized finish nails (1/4 lb.) 
- #10 x 3-1/4" corrosion resistant wood screws (Performance Upgrade and HurricaneShield) 
- Masonry screws for concrete applications (Minimum of 3/16" diameter x 3") 
- Closed cell foam backer rod/sealant backer (21 to 30 ft.) 
- Pella® SmartFlash™ foil backed butyl window and door flashing tape or equivalent 
- High quality exterior grade polyurethane or silicone sealant (2 to 3 tubes per door) 
- Great Stuff™ Window and Door Insulating Foam Sealant by the Dow Chemical Company or equivalent low pressure polyurethane window and door foam - DO NOT use high pressure or latex foams 
- Sill Pan (Optional)
6-5/8" x (Rough Opening Width + 2")
- Pella aluminum sill support or wood blocking
- Interior trim and/or jamb extensions (15 to 40 ft.)
- Aluminum Head Flashing

INSTALLATION CLIP OPTION:

- 6" or 8" installation clips 
- #6 x 5/8" corrosion resistant flat head wood screws
- #8 x 1-1/2" corrosion resistant screws or 3/16" x 1-1/2" masonry screw

TOOLS REQUIRED:

- Tape measure 
- Level 
- Square 
- Hammer 
- Stapler 
- Sealant gun 
- Scissors or utility knife 
- Tin snips 
- Screwdrivers (#2 Phillips with 8" shaft and small flat blade) 
- T20 Torx Wrench 
- Drill 
- Drill bits 13/64" and 1/8" and masonry bit for concrete applications 

1 ROUGH OPENING PREPARATION

- A. **Confirm the opening is plumb and level.**

Note: It is critical that the bottom is level.

- B. **Confirm the door will fit the opening.** Measure all four sides of the opening to make sure it is $\frac{3}{4}$ " larger than the door in width and $\frac{1}{2}$ " larger in height. Measure the width at the top, bottom, and center. Measure the height at the far left side, the far right side, and in the center.

Note: 1-1/2" or more of solid wood blocking is required around the perimeter of the opening. Fix any problems with the rough opening before proceeding.

- C. **Cut the water resistive barrier.**

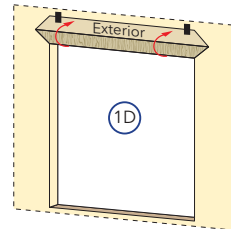
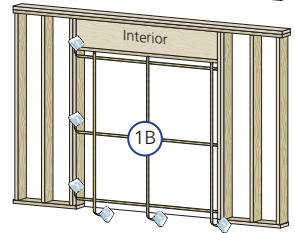
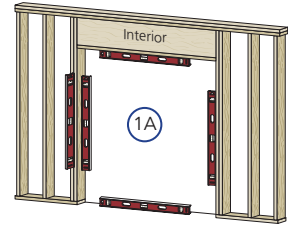
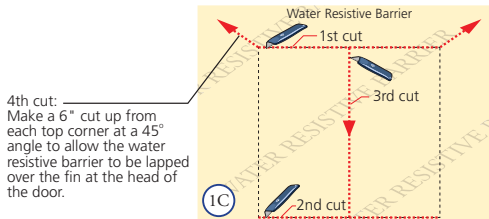

- D. **Fold the water resistive barrier.** Fold side flaps into the opening and staple to inside wall. Fold top flap up and temporarily fasten with flashing tape.

For Doors Using Optional Sill Pan Go To Step 11.

- E. **Apply sill flashing tape #1.** Cut a piece of flashing tape 12" longer than the opening width. Apply at the bottom of the opening as shown in (1E) so it overhangs 1" to the exterior.

Note: The tape is cut 12" longer than the width so that it will extend 6" up each side of the opening.

- F. **Tab the sill flashing tape and fold.** Cut 1" wide tabs at each corner ($\frac{1}{2}$ " from each side of corner) (1F). Fold tape to the exterior and press firmly to adhere it to the water resistive barrier.

- G. **Apply sill flashing tape #2.** Cut a piece of flashing tape 12" longer than the opening width. Apply at the bottom, overlapping tape #1 by at least 1". **DO NOT** allow the tape to extend past the interior face of the framing (1G).

In-swing doors: If the wall depth is greater than 5", add a third piece of flashing tape. The flashing tape should come to within 1" of the interior face of the framing.

Note: The flashing tape may not fully cover the framing members.

- H. **Attach the aluminum sill support or wood blocking** to the exterior of the box plate to support the edge of the door sill. Place the sill support flush with the subfloor.

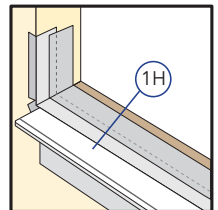
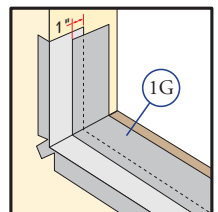
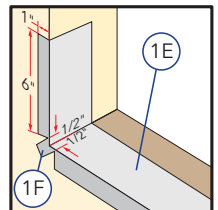

GO TO STEP 2

- T. **Attach the aluminum sill support or wood blocking** to the exterior of the box plate to support the edge of the door sill. Place the sill support flush with the subfloor.

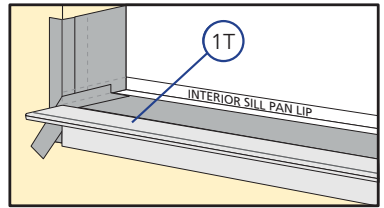

2 PREPARE THE DOOR FOR INSTALLATION

TWO OR MORE PEOPLE WILL BE REQUIRED TO HANDLE THE PANEL AND FRAME SAFELY.

- A. **Remove plastic wrap and cardboard packaging from door.** Do not remove plastic shipping spacers. The shipping spacers will help keep the door square during installation. Do not unlock or open the door until it is fully fastened.

Note: If grilles or hardware are removed from the door at this time, label them and store them in a protected area.

Standard Brickmould Installation go to Step 3

Applications for Performance Upgrade and HurricaneShield product requires additional clip installation or screw installation. Clip installation prep is included in Step 2B. Screw installation steps are included in Step 5.

For HurricaneShield and Performance Upgrade Applications:

DIAGRAM FOR
PLACEMENT OF
FRAME SCREWS OR
INSTALLATION CLIPS

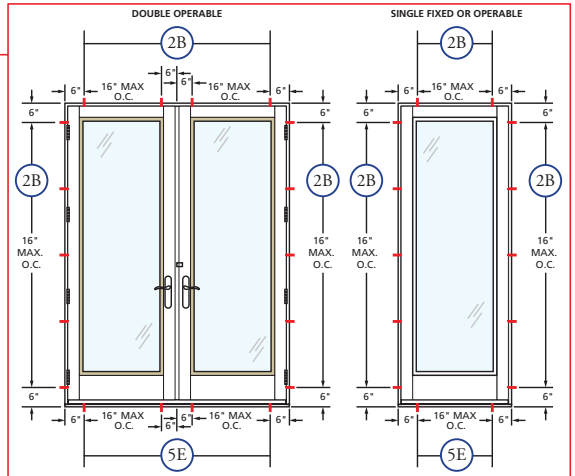

Out-Swing Sill

In-Swing Sill

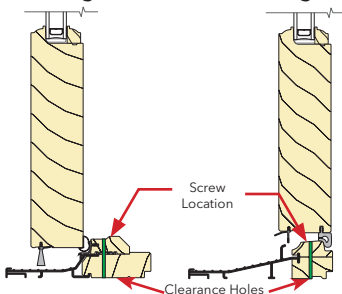

- B. Doors using Installation Clips:**
 Install installation clips. Place each clip so the lip is facing up and against the brickmould at the locations shown in the placement diagram. Secure each clip by driving a #6 x 5/8" corrosion resistant screw through each of the outer two holes of the three holes shown.

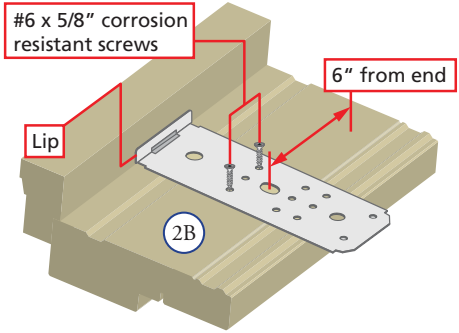

Note: If clips are to be bent; pre-bend before attaching to frame.

3 SETTING AND FASTENING THE DOOR

- A. Place three 3/8" beads of sealant.** Place the first bead of sealant 1/2" from the base of the interior sill pan lip. This bead should also continue up the corner of the sill pan at each end, sealing the vertical joints of the sill pan legs. Continue the first bead up 6" onto each jamb side of the rough opening. The second bead should be approximately 1/2" from the exterior edge of the rough opening, running from jamb to jamb with a 2" break in the middle of the opening. Place a third sealant bead in the groove of the sill support from end to end or 1/4" from the exterior edge of the wood blocking.

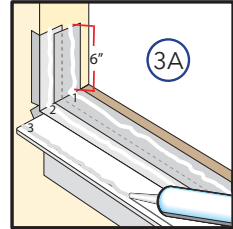
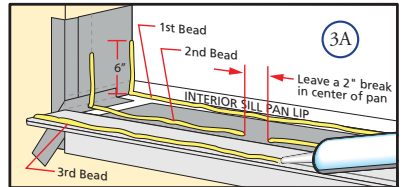

Applications without sill pan

TWO OR MORE PEOPLE WILL BE REQUIRED FOR THE FOLLOWING STEPS.

- B. Cut and remove the strap that runs** from the door lock to the sill of the door.
- C. Insert the door from the exterior of the building**
DO NOT slide the bottom of the door into the opening. Sliding will damage the sealant lines. Place the bottom of the door at the bottom of the opening with the door centered between the sides of the opening to allow for shimming, then tilt the top into position. Insert one 16d galvanized finishing nail at each upper corner of the brickmould. These are used to hold the door in place while shimming it plumb and square.

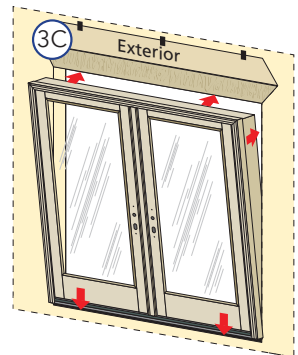

- N. **For Doors with adjustable hinges:** The hinges can be used to move the panel side to side by moving all hinges in the same direction or the hinges can slightly rotate the panel by adjusting the hinges in opposite directions. Use a T20 Torx wrench to turn the center screw clockwise (+) to increase the space between the hinge side of the frame and door panel. Turn the center screws counter-clockwise (-) to decrease the space between the hinge side of the frame and the door panel.

Note: Do not adjust the hinge with the top and bottom screws loose; this could force the hinge to adjust beyond its design capability which can cause the hinge to bind, damage the hinge and/or pull out the screws. A 3/4 turn of the center screw provides approximately 5/32" adjustment.

- O. **On doors with a lock strike in the side,** drill a 1/8" diameter x 2" deep pilot hole into the rough opening through the two pre-drilled holes in the frame. One pre-drilled frame hole is located in the center lock strike hole and the other is the upper frame corner installation hole approximately 8" from the top of the door frame head. Insert a #8 x 3" screw (provided) into the pilot hole making sure it passes through the shim and into the rough opening framing.

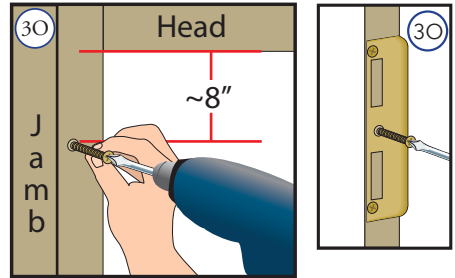

Note: This step does not apply to center latching double doors.

4 INTEGRATING THE DOOR TO THE WATER RESISTIVE BARRIER

- A. **Apply a corner bead of sealant at the point** where the brickmould or flat casing contacts the wall along the head and jambs. Also apply a bead of sealant at each end of the head brickmould.
- B. **Install the head flashing.**
- C. **Apply a piece of flashing tape** over the head flashing as shown.
- D. **Fold down the top flap of the water resistive barrier.** Cut the water resistive barrier so it covers the vertical leg of the head flashing, however does not lap onto the horizontal leg of the head flashing.
- E. **Apply flashing tape to the diagonal cuts.** Cut two pieces of flashing tape at least 1" longer than the diagonal cuts in the water resistive barrier. Apply the tape covering the entire diagonal cut in the water resistive barrier at both upper corners of the brickmould/flat casing.

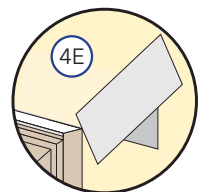
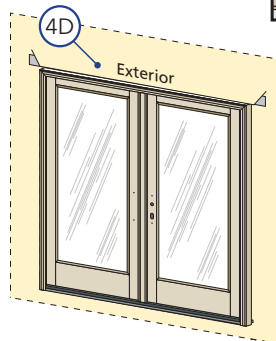
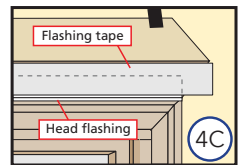
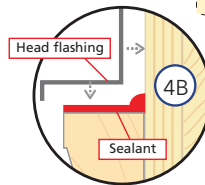
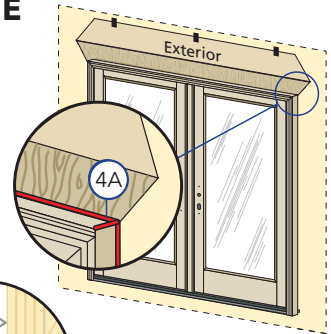

5 INSTALL THE PERFORMANCE UPGRADE OR HURRICANESHIELD FASTENERS

Frame Screw Method:

Note: If installing with installation clips, proceed to Step E.

A. Jamb:

Out-swing: On the room side of the jamb; drill and counter-sink 13/64" deep diameter clearance holes through the door frame only and not into the rough opening in the locations shown. (See Out-Swing diagram in lower right).

In-swing: Open door panels; drill and counter-sink 13/64" deep diameter clearance holes through the door frame only and not into the rough opening in the locations shown. (On hinge jamba; clearance hole locations are centered between hinges).

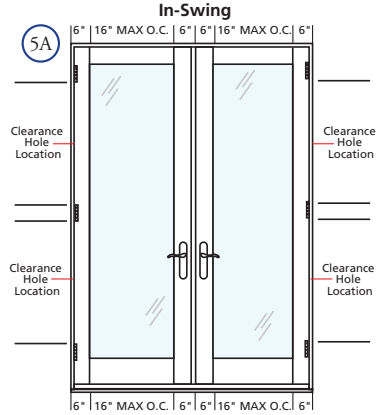

Hinge Jamba: See (5A) In-Swing diagram (upper right). Fixed and Lock jamba diagram for placement of threshold screws and installation clips (see out-swing diagram in lower right).

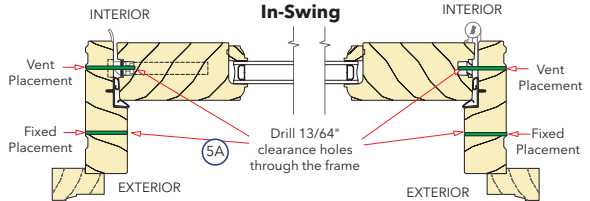
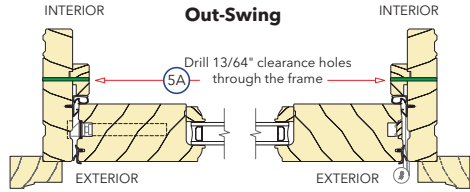

- B. **Drill 13/64" deep clearance holes through the door frame head** only and not into the rough opening in the locations shown.
- C. **Drill 1/8" x 1" deep pilot holes through the clearance holes** and into the rough opening framing in the head, jamba, and threshold of the unit frame.

Note: Be certain to shim between jamba and rough opening at all screw locations.

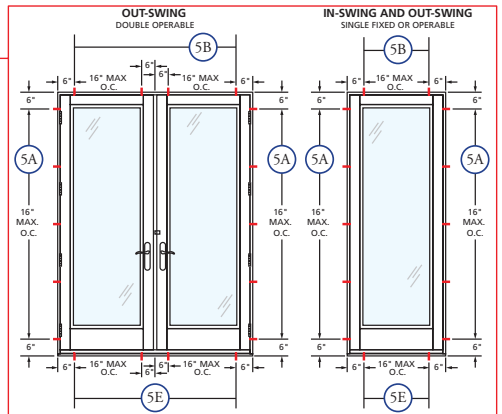
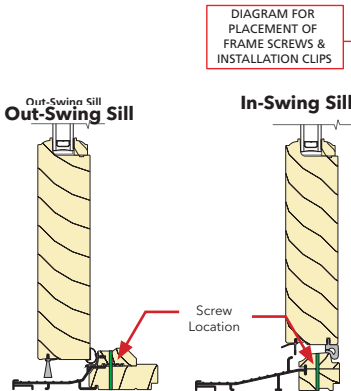

- D. **Secure the jambs and head of the door.** Drive #10 x 3-1/2" corrosion resistant wood screws through the door frame and shim, into the rough framing. Drive the screws until snug but **DO NOT** over-tighten the screws. **DO NOT** bend or bow the unit frame.

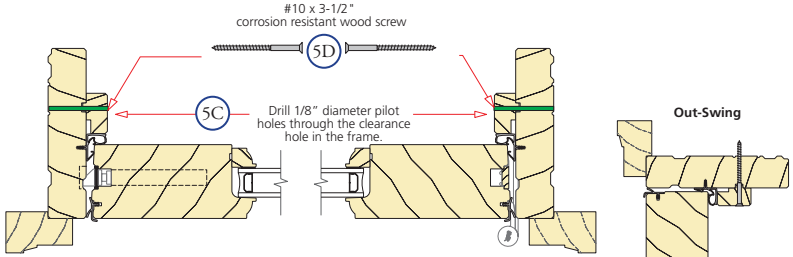

- E. **Drill 13/64" clearance holes through the threshold** but not into the rough opening, at the locations shown in illustration on previous page (5E & 5G). Install # 10 x 3/1-2" corrosion resistant wood screws through the threshold into the floor. For Masonry applications use masonry screws that are a minimum size of 3/16" diameter x 3" and pilot drill per screw manufacturer's recommendations.

NOTE: Not required on In-swing Fixed doors.

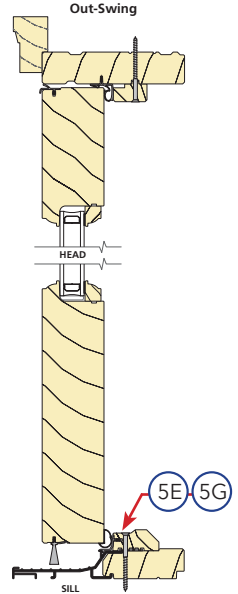

Installation Clip Method:

- F. **Fasten the door to the opening by driving two #8 x 1-1/4" corrosion resistant screws** into the pre-punched holes in the clips. If the clips are bent and fastened to the interior stud/block, install the screws as close to the bend as possible.

Note: DO NOT shim above the door. For masonry openings use two masonry screws that are a minimum size of 3/16" x 1-1/2" per clip. Pre-drill the masonry per screw manufacturer's recommendations before attempting to drive the screws in.

Frame Screw and Installation Clip Methods:

- G. **Drive #10 x 3-1/2" corrosion resistant wood screws** through the holes in the threshold into the floor.

Note: For concrete floors, use masonry screws that are a minimum size of 3/16" diameter x 3".

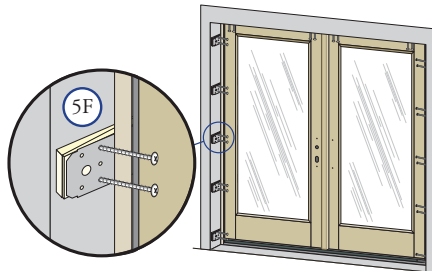

6 INTERIOR SEAL

Caution: Ensure use of low pressure polyurethane window and door insulating foams and strictly follow the foam manufacturer's recommendations for application. Use of high pressure foams or improper application of the foam may cause the door frame to bow and hinder operation.

- A. Add a sealant bead across the inner sill and 6" up each jamb between the frame and rough opening.

Note: If needed, first place backer rod between frame jamb and opening 6" up each jamb.

- B. Apply insulating foam sealant. From the interior, insert the nozzle of the applicator approximately 1" deep into the space between the door and the rough opening and apply a 1" deep bead of foam. This will allow room for expansion of the foam and will minimize squeeze out. Apply sealant across the interior surface of shims to create a continuous seal. For doors with jamb extensions installed, ensure the foam is placed between the window frame and the rough opening, not between the jamb extension and the rough opening. Follow foam manufacturer's instructions.

Note: It may be necessary to squeeze the end of the tube with pliers to insert it into the space between the door frame and the rough opening. DO NOT completely fill the space from the back of the fin to the interior face of the opening.

- C. Check the door operation by opening and closing the door.

Note: If the door does not operate correctly, check to make sure it is still plumb, level, square and that the sides are not bowed. If adjustments are required, remove the foam with a serrated knife. Adjust the shims, and reapply the insulating foam sealant.

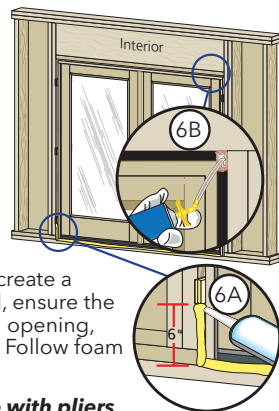

7 SEALING THE DOOR TO THE EXTERIOR WALL CLADDING

When applying siding, brick veneer or other exterior finish material, leave adequate space between the door frame and the material for sealant. Refer to the illustration that corresponds to your finish material.

Note: The sealant details shown are standard recommendations from the sealant industry. Contact your sealant supplier for recommendations and instructions for these and any other applications.

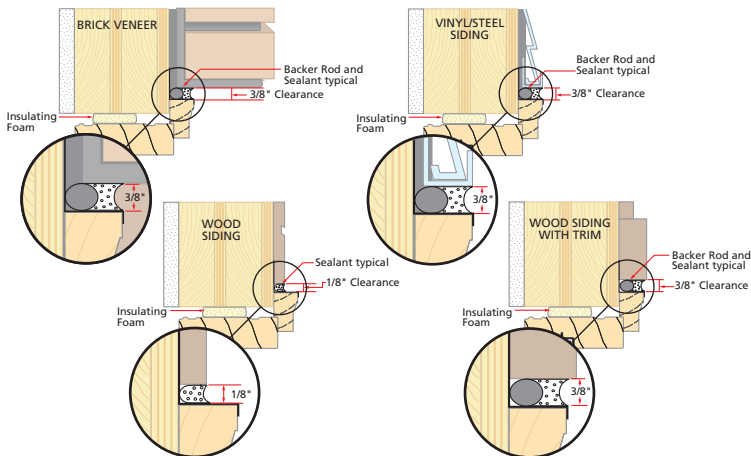

- A. **Insert backer rod** into the space around the door so there is at least a 1/2" clearance between the backer rod and the exterior face of the wall cladding and the brickmould or wood trim.

Note: Backer rod adds shape and depth for the sealant line.

- B. **Apply a bead of sealant** to the entire perimeter of the door. At each end of the bottom of the door, insert sealant into the spaces between the bottom of door and the sill support and connect it to the perimeter sealant.

- C. **Shape, tool and clean excess sealant.** When finished, the sealant should be the shape of an hourglass.

Note: This method creates a more flexible sealant line capable of expanding and contracting.

- D. **Remove plastic guards at the base of the door** once construction is complete.
- E. **Install the hardware.** Refer to the instructions included in the hardware box.

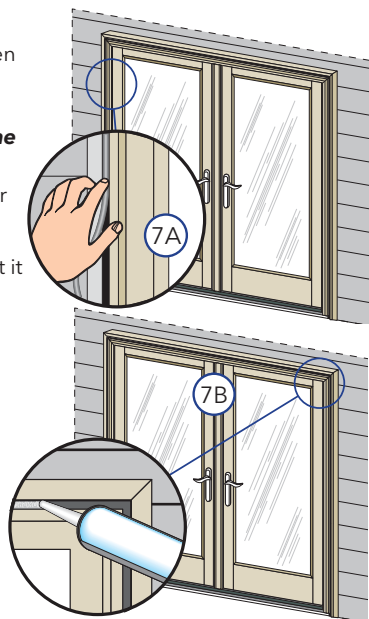

INTERIOR FINISHING

If products cannot be finished immediately, cover with clear plastic to protect from dirt, damage and moisture. Remove any construction residue before finishing. Sand all wood surfaces lightly with 180 grit or finer sandpaper. **DO NOT** use steel wool. **BE CAREFUL NOT TO SCRATCH THE GLASS.** Remove sanding dust.

Pella products must be finished per the below instructions; failure to follow these instructions voids the Limited Warranty.

- On casement and awnings, it is optional to paint, stain or finish the vertical and horizontal sash edges.
- On single-hung and double-hung, do not paint, stain or finish the vertical sash edges, any finish on the vertical sash edges may cause the sash to stick; it is optional to paint, stain or finish the horizontal sash edges.
- On patio doors, it is optional to paint, stain or finish the vertical and horizontal panel edges.

Note: To maintain proper product performance do not paint, finish or remove the weather-stripping, mohair dust pads, gaskets or vinyl parts. Air and water leakage will result if these parts are removed. After finishing, allow venting windows and doors to dry completely before closing them.

Pella Corporation is not responsible for interior paint and stain finish imperfections for any product that is not factory-applied by Pella Corporation. Use of inappropriate finishes, solvents, brickwash, or cleaning chemicals will cause adverse reactions with window and door materials and voids Limited Warranty. For additional information on finishing see the Pella Owner's Manual or go to www.pella.com.

EXTERIOR FINISHING

Wood doors require painting immediately after installation. The factory applied primer is not intended for long term exterior exposure. Painting instructions are located in the Pella® Owners Manual. You can obtain an owner's manual by contacting your local Pella retailer. This information is also available on www.pella.com. Please note that failure to finish your Pella door may void their warranty, and the Pella warranty does not cover problems associated with improper finishing.

CARE AND MAINTENANCE

Care and maintenance information is available in the Pella Owner's Manual. You can obtain an owner's manual by contacting your local Pella retailer. This information is also available at www.pella.com.

IMPORTANT NOTICE

Because all construction must anticipate some water infiltration, it is important that the wall system be designed and constructed to properly manage moisture. Pella Corporation is not responsible for claims or damages caused by anticipated and unanticipated water infiltration; deficiencies in building design, construction and maintenance; failure to install Pella® products in accordance with Pella installation instructions; or the use of Pella products in wall systems which **DO NOT** allow for proper management of moisture within the wall systems. The determination of the suitability of all building components, including the use of Pella products, as well as the design and installation of flashing and sealing systems are the responsibility of the Buyer or User, the architect, contractor, installer, or other construction professional and are not the responsibility of Pella.

Pella products should not be used in barrier wall systems which **DO NOT** allow for proper management of moisture within the wall systems, such as barrier Exterior Insulation and Finish Systems, (EIFS) (also known as synthetic stucco) or other non-water managed systems. Except in the states of California, New Mexico, Arizona, Nevada, Utah, and Colorado, **Pella makes no warranty of any kind and assumes no responsibility for Pella windows and doors installed in barrier wall systems. In the states listed above, the installation of Pella products in barrier wall or similar systems must be in accordance with Pella installation instructions.**

Product modifications that are not approved by Pella Corporation will void the Limited Warranty.

TROUBLESHOOTING - Adjustable Strike Latching Issues

Issue 1:

Door is difficult to latch. Remove the strike and adjustable strike shim then reinstall the strike.

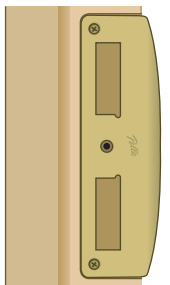

Issue 2:

Door needs to close more tightly against the weather-strip. Remove the strike and adjustable strike shim. Remove the tabs from the adjustable strike shim and install so that the thicker side is visible at the strike edge. Reinstall the strike.

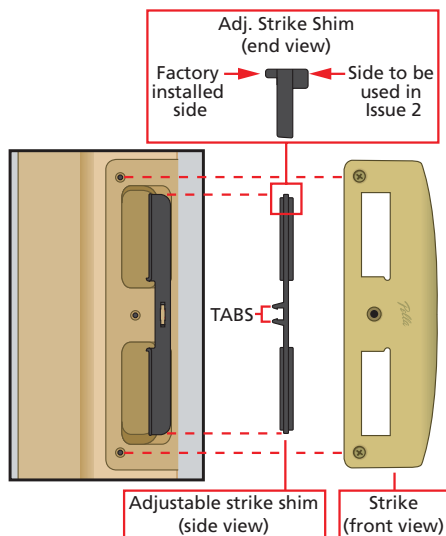
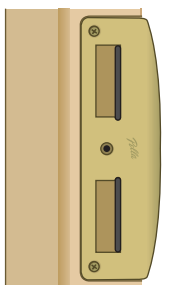

This page left blank intentionally.

This page left blank intentionally.