

MANUAL

IUH-F117-V1-EU

IUH-F117-V1-US

IUH-F117-V1-CN

R/W head for IDENTControl



With regard to the supply of products, the current issue of the following document is applicable: The General Terms of Delivery for Products and Services of the Electrical Industry, published by the Central Association of the Electrical Industry (Zentralverband Elektrotechnik und Elektroindustrie (ZVEI) e.V.) in its most recent version as well as the supplementary clause: "Expanded reservation of proprietorship"

1	Introduction.....	5
2	Declaration of Conformity	6
3	Safety.....	7
3.1	Symbols relevant to safety	7
3.2	Intended Use	7
3.3	General notes on safety.....	8
4	Product Description	9
4.1	UHF general	9
4.1.1	Advantages of UHF	9
4.1.2	Permissible Operating Capacity of UHF	9
4.1.3	Permissible Frequency Range of UHF.....	9
4.1.4	Applications for UHF systems.....	9
4.1.5	Memory Structure of a Tag in Accordance with ISO 18000-6C/ EPC Class 1 Gen 2	10
4.1.6	Electronic product code EPC	11
4.1.7	Unique numbering as per ISO	12
4.1.8	Influence of various materials on the sensing range	13
4.1.9	Countries of Use.....	14
4.1.10	Dense Reader Mode DRM	14
4.1.11	Europe.....	15
4.1.12	China.....	15
4.1.13	USA.....	16
4.1.14	RFID Frequency Bands	16
4.1.15	Relevant UHF standards	16
4.2	General Functions and Features.....	17
4.3	Indicators and Controls	17
4.4	Connection	18
4.5	Scope of Delivery.....	18
4.6	Accessories	18
4.6.1	IDENTControl	18
4.6.2	Read/Write Tags.....	19
4.6.3	Connection cable for R/W heads and trigger sensors	19
4.6.4	Cable connectors for the power supply	20
4.6.5	Installation accessories	20

5	Installation	21
5.1	Storage and transport.....	21
5.2	Unpacking.....	21
5.3	Mounting.....	21
5.3.1	Orientation in the room	22
5.3.2	Minimum and Maximum Distances	22
5.3.3	Polarization	23
5.4	Connection.....	24
5.5	EMC concept	24
6	Commissioning	26
6.1	Connection.....	26
6.2	Device settings.....	26
6.3	Operating via the Command Interface.....	26
7	Operation	31
7.1	General.....	31
7.2	Read/Write Commands	31
7.3	Configuration commands	34
7.3.1	ChangeTag Command.....	34
7.3.2	ReadParam/WriteParam Commands.....	35
7.3.3	ParamTyp.....	36
7.4	Legend	40
7.5	Fault/status messages.....	41
8	Service and Maintenance	42
9	Troubleshooting	43
10	ASCII table	44
11	Appendix.....	45
11.1	Dimensions	45
11.2	Technical Data.....	45
11.3	Detection Range	46

1 Introduction

Congratulations

You have chosen a device manufactured by Pepperl+Fuchs. Pepperl+Fuchs develops, produces and distributes electronic sensors and interface modules for the market of automation technology on a worldwide scale.

Before you install this device and put it into operation, please read the operating instructions thoroughly. The instructions and notes contained in this operating manual will guide you step-by-step through the installation and commissioning procedures to ensure trouble-free use of this product. By doing so, you:

- guarantee safe operation of the device
- can utilize the entire range of device functions
- avoid faulty operation and the associated errors
- reduce costs from downtimes and incidental repairs
- increase the effectiveness and operating efficiency of your plant.

Store this operating manual somewhere safe in order to have it available for future work on the device.

After opening the packaging, please ensure that the device is intact and that the package is complete.

Symbols used

The following symbols are used in this manual:



Note!

This symbol draws your attention to important information.



Handling instructions

You will find handling instructions beside this symbol

Contact

If you have any questions about the device, its functions, or accessories, please contact us at:

Pepperl+Fuchs GmbH
Lilienthalstraße 200
68307 Mannheim
Telephone: +49 621 776-4411
Fax: +49 621 776-274411
E-Mail: fa-info@pepperl-fuchs.com

2 Declaration of Conformity

All products were developed and manufactured under observance of the applicable European standards and guidelines.



Note!

A Declaration of Conformity can be requested from the manufacturer.

The product manufacturer, Pepperl+Fuchs GmbH, 68307 Mannheim, has a certified quality assurance system that conforms to ISO 9001.



FCC ID: IREIUH-F117-V1

This device complies with Part 15 of the FCC Rules. Operation is subject to the following two conditions:

1. this device may not cause harmful interference, and
2. this device must accept any interference received, including interference that may cause undesired operation.

Notice:

Changes or modifications made to this equipment not expressly approved by Pepperl+Fuchs GmbH may void the FCC authorization to operate this equipment.

NOTE:

This equipment has been tested and found to comply with the limits for a Class A digital device, pursuant to part 15 of the FCC Rules. These limits are designed to provide reasonable protection against harmful interference when the equipment is operated in a commercial environment. This equipment generates, uses, and can radiate radio frequency energy and, if not installed and used in accordance with the instruction manual, may cause harmful interference to radio communications. Operation of this equipment in a residential area is likely to cause harmful interference in which case the user will be required to correct the interference at his own expense.

3 Safety

3.1 Symbols relevant to safety



Danger!

This symbol indicates a warning about an immediate possible danger.

In case of ignoring the consequences may range from personal injury to death.



Warning!

This symbol indicates a warning about a possible fault or danger.

In case of ignoring the consequences may cause personal injury or heaviest property damage.



Caution!

This symbol indicates a warning about a possible fault.

In case of ignoring the devices and any connected facilities or systems may be interrupted or fail completely.

3.2 Intended Use

The IUH-F117-V1-* is a read/write head for passive code and read/write tags.

The IUH-F117-V1-* operates at a frequency in the UHF range (Europe: 865–868 MHz, USA: 902–928 MHz, China: 920–925 MHz).

Always operate the device as described in these instructions to ensure that the device and connected systems function correctly. The protection of operating personnel and plant is only guaranteed if the device is operated in accordance with its intended use.

Read through these instructions thoroughly. Familiarize yourself with the device before installing, mounting, or operating.

Pepperl+Fuchs GmbH provides no guarantee that the information contained in this document does not contain third party industrial property rights.

Pepperl+Fuchs GmbH does not issue any licenses to its own or third party patents or other industrial property rights in this document.



Note!

The installation recommendations made in this document are based on favorable basic conditions. Pepperl+Fuchs GmbH provides no guarantee of correct function in environments belonging to other systems.



Warning!

Minimum distance

When installing the device in areas covered under **US Code of Federal Regulations Part 15** a minimum distance of 25 cm between antenna and the human body must be maintained.



Warning!

Malfunctions with pacemakers

This device does **not** exceed the permissible limits for electromagnetic fields. Maintain a minimum distance of 25 cm between the device and your pacemaker.

Inadequate distance from the read/write head can result in inhibitions, reprogramming or incorrect stimulation pulses.

3.3 General notes on safety

Only instructed specialist staff may operate the device in accordance with the operating manual.

User modification and or repair are dangerous and will void the warranty and exclude the manufacturer from any liability. If serious faults occur, stop using the device. Secure the device against inadvertent operation. In the event of repairs, return the device to your local Pepperl+Fuchs representative or sales office.

The connection of the device and maintenance work when live may only be carried out by a qualified electrical specialist.

The operating company bears responsibility for observing locally applicable safety regulations.

Store the not used device in the original packaging. This offers the device optimal protection against impact and moisture.

Ensure that the ambient conditions comply with regulations.



Note!

Disposal

Electronic waste is hazardous waste. When disposing of the equipment, observe the current statutory requirements in the respective country of use, as well as local regulations.

4 Product Description

4.1 UHF general

4.1.1 Advantages of UHF

- Large sensing range
- UHF high-temperature transponder available for the automobile industry
- UHF transponders are available as low-cost, space-saving adhesive labels
- High transfer rates
- Large quantities of data transferred, depending on the transponder

4.1.2 Permissible Operating Capacity of UHF

In Europe, a maximum of 2 W_{ERP} (+33 dBm ERP in accordance with DIN EN 302208-1) are permitted.

In the USA, a maximum of 4 W are_{EIRP} permitted.

In China, a maximum of 2 W are_{ERP} permitted.

4.1.3 Permissible Frequency Range of UHF

The frequency range for UHF, in which the IUH-F117-V1-* read/write head operates, is:

- 865 MHz to 868 MHz in Europe in accordance with DIN EN 302208-1
- 902 MHz to 928 MHz in the USA
- 920 MHz to 925 MHz in China

4.1.4 Applications for UHF systems

- Identification in galvanic coating or painting systems used in automotive production,
- Identification of vehicle bodies in final vehicle assembly,
- Palette identification and tracking of goods in the logistics sector and
- Truck identification for access control at loading stations.

4.1.5

Memory Structure of a Tag in Accordance with ISO 18000-6C/EPC Class 1 Gen 2

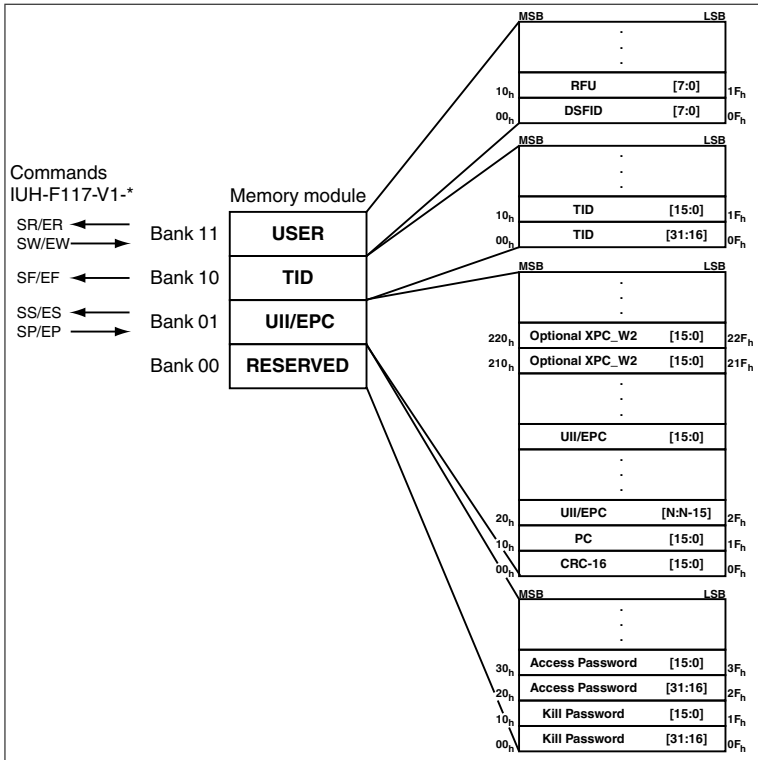

The memory module of an EPC-type Class 1 Gen 2 tag is split into 4 segments. The essential contents of these segments are:

Segment	Function	Length
Bank 00	Password manager	Depending on the tag type, see table "Tag Types UHF 868 MHz" on page 35 "Special read-only code" column
Bank 01	Unique Item Identifier (UII) Electronic Product Code (EPC)	Depending on the tag type, see table "Tag Types UHF 868 MHz" on page 35 "Special read-only code" column
Bank 10	Tag ID (TID)	8 byte
Bank 11	User data	Depending on the tag type, see table "Tag Types UHF 868 MHz" on page 35 "Special read-only code" column

Bank 00

The segment bank 00 contains the password manager, comprising the access password and the kill password. This range is not currently supported by IUH-F117-V1-*

Bank 01

In addition to the UII, the segment bank 01 contains a calculated checksum CRC (cyclic redundancy check) for verifying data on the tag and the protocol control (PC) range. The PC range contains:

- The length of the UII
- The characteristic of the Application Family Identifier (AFI) field
- A bit switch that shows whether the UII contains an EPC or MITL number sequence in accordance with ISO (see chapter 4.1.6, see chapter 4.1.7& see chapter 7.3)
- A bit switch that shows whether data is stored in segment bank 11 (if present)

All data in segment bank 01 are automatically set by IUH-F117-V1-*. The data is addressed via the commands single read special read-only code (SS), single write special read-only code (SP), enhanced read special read-only code (ES) and enhanced write special read-only code (EP). (see "Single Read Special Read-Only Code SS" on page 31, see "Single Write Special Read-Only Code SP" on page 32, see "Enhanced Read Special Read-Only Code ES" on page 32& see "Enhanced Write Special Read-Only Code EP" on page 32)

Bank 10

Segment bank 10 contains the part number and the serial number of the tag. This data is permanently stored without being changed.

The data in segment bank 10 can be read out via the commands single read read-only code (SF) and enhanced read read-only code (EF). (see "Single read fixcode SF" on page 31& see "Enhanced read fixcode (EF)" on page 31)

Bank 11

Segment bank 11 contains an area to which the user has free access. Depending on chip type, this area has different sizes or is not present.

The data in segment bank 11 is addressed via the commands single read words (SR), single write words (SW), enhanced read words (ER) and enhanced write words (EW). (see "Single Read Words SR" on page 32, see "Single Write Words SW" on page 33, see "Enhanced Read Words ER" on page 33& see "Enhanced Write Words EW" on page 33)

4.1.6 Electronic product code EPC

The electronic product code is a unique code composed of a series of digits. This series of digits has a defined structure and a length of 64 bits, 80 bits, 96 bit or longer (depending on the EPC identification number used), is stored on the RFID transponder and uniquely identifies every transponder all over the world.

GS1/EPCglobal developed the system of Electronic Product Codes (EPC) for use in resource planning. Transponders with a memory for EPC codes are programmed by the user. The memories of new transponders do not have to contain valid EPC codes. The EPC numbers are allocated and managed by GS1. If you require EPC numbers, please contact the respective GS1 branch in your country (<http://www.gs1.com/contact>).

The electronic product code has a defined layout that is structured as follows:

1. **Header:** the header specifies the EPC standard used and contains the series of digits.
2. **Filter value:** describes the product unit, e.g., end product, packaging, product range.
3. **Partition:** describes the point at which the EPC manager mentioned below stops and the object data starts.
4. **EPC Manager:** allocated series of digits that identify the manufacturer.
5. **Object class:** series of digits that describe the object, e.g., article number.
6. **Serial number:** series of digits that identify the article, e.g., consecutive serial numbers of the article.

	Header	Filter value	Partition	EPC Manager	Object class	Serial number
Length	8 Bit	3 Bit	3 Bit	28 Bit	24 Bit	36 Bit
Value	0011 1001	010	004 ¹	50123456 ¹	001234567 ¹	1234567891234 ¹

¹ = decimal

To work with unique identifications without having to revert to potentially costly EPC codes, we recommend using the UID and TID of the transponders programmed permanently into the transponder chips by the semiconductor manufacturer.



Note!

The TID on some transponder types is not unique. See table "Tag Types UHF 868 MHz" on page 35.

4.1.7

Unique numbering as per ISO

In addition to the Electronic Product Code (EPC), a series of MITL numbers can also be used as a Ull in accordance with ISO. MITL stands for Multi Industry Transport Label.

Example:

25SLHUNIK15000905130035

The series consists of the following

1. Data identifier
25S describes a unique object.
2. Unique company ID

LH describes the issuing authority, in this example the European Health Industry Business Communications Council "EHIBCC."

UNIK describes the company, in this case "UNIK."

3. Serial number

15000905130035 is the unique serial number.

The relevant standards relating to unique identification include ISO/IEC 15434, ISO/IEC 15459-1 to 8 and ISO/IEC TR 29162 (in preparation).

4.1.8

Influence of various materials on the sensing range

In the UHF range, the nature of the surrounding area and the surface to which the transponder is secured have a serious influence on the range that the system can attain. The UHF transponder cannot be mounted on metal without requiring adaptations. Glass has a negative influence on the sensing range when used as a mounting surface. If a UHF transponder is mounted on damp material, the sensing range is much poorer than the range of a transponder mounted on dry material. The mounting surface often affects the read range much more than the material between the transponder and the read/write head. The graph shows the effect of different materials on the sensing range.

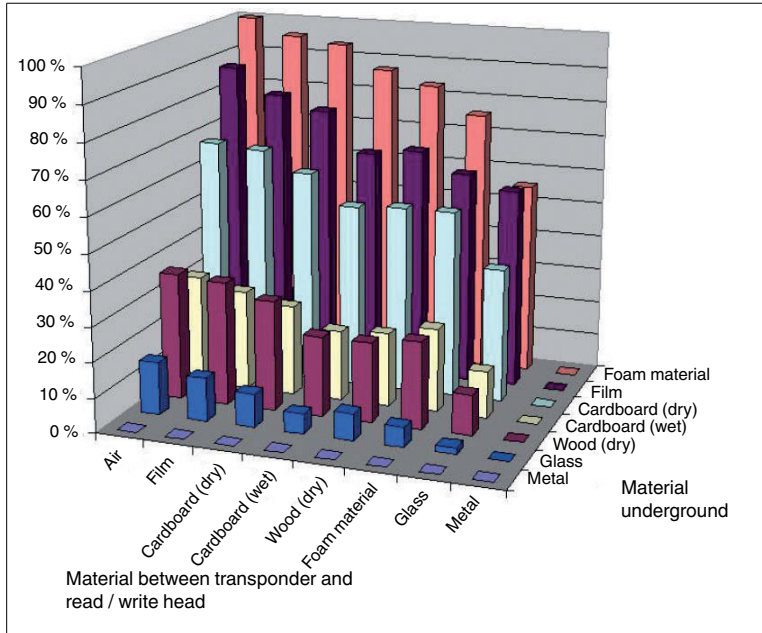

4.1.9 Countries of Use

The IUH-F117-V1-* read/write head has transmission license in accordance with DIN EN 302208-2.



Note!

If you wish to use a device in a country in which this standard is not effective, make sure beforehand that the following values for the device are consistent with the local conditions:

- Frequency band
- Power level
- The described modulation and operating modes must be permitted

A list of countries of use can be found in "ERC Recommendation ERC/REC70-03". These are available on the "European Communications Office ERO" website under www.ero.dk as recommendation. The currently applicable countries of use are listed in this document under Appendix 11.

4.1.10 Dense Reader Mode DRM

A special operating mode for read/write tags in accordance with the UHF Gen 2 specification allows several read/write heads to be operated next to each other without interference.

Europe

In line with EPC Global and ETSI EN 302208, only channels 4, 7, 10 and 13 are used in this mode for transmission for the IUH-F117-V1-EU read/write head (read/write head -> read/write tag communication path). The transmission power is max. $2 W_{erp}$.

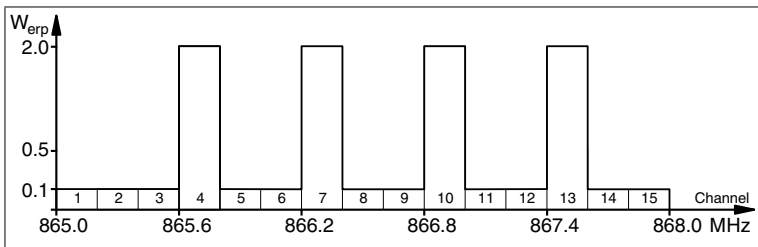

Figure 4.1

The read/write head can therefore only use preset channels. The response from the read/write tag appears via the frequency offset, which is achieved by the modulation used in this mode on the two adjacent channels. The IUH-F117-V1-EU read/write head transmits on the four transmission channels 4, 7, 10 and 13, provided that these channels have been preset. Due to the high level difference between the transmission channels and the response channels, this technology offers major benefits for reusing frequencies. This requires minimum distances and therefore a minimum coupling between the antennas of adjacent read/write heads to be maintained.

4.1.11 Europe

The IUH-F117-V1-EU read/write head has wireless approval to DIN EN 302208-2. The read/write head is operated in dense reader mode (DRM). This operating mode in accordance with the UHF Gen 2 specification allows several read/write heads to be operated next to each other in the permitted channels (4, 7, 10 and 13) without interference.

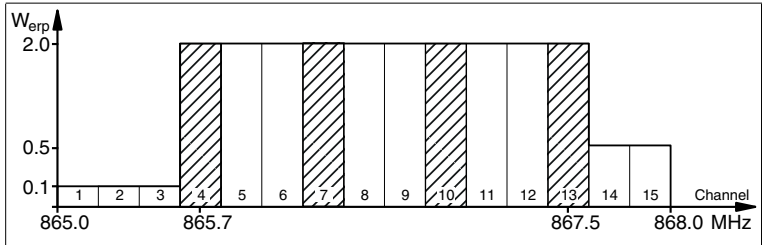

Figure 4.2

4.1.12 China

In China, the frequency ranges 840–845 MHz and 920–925 MHz are available for UHF-RFID readers. This read/write head uses the 920–925 MHz range. The range is split into 20 channels, each with a bandwidth of 250 kHz. On channels 0, 1, 18, and 19, only 100 mW_{erp} of transmission power are permitted at the edge of the spectrum. On channels 2–17, 2 W_{erp} are permitted. The transmission power can be set. It is stated in W_{erp}. FHSS with a maximum 2 seconds retention time is used.

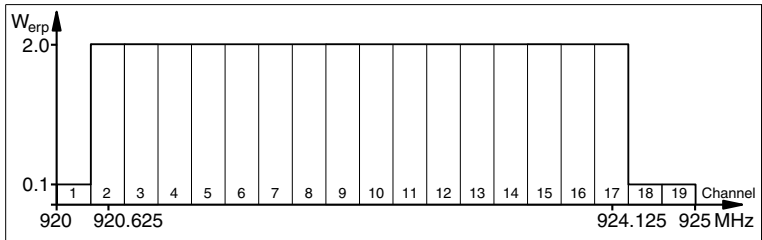

Figure 4.3

4.1.13 USA

The ISM band from 902 to 928 MHz is available in the USA. The band is split into 50 channels, each with a 500 kHz bandwidth. FHSS with a maximum retention time of 4 seconds is employed. All channels must be used. Channel restriction is not permitted.

In contrast to the read/write heads for Europe and China, the transmission power is stated in W_{eirp} .

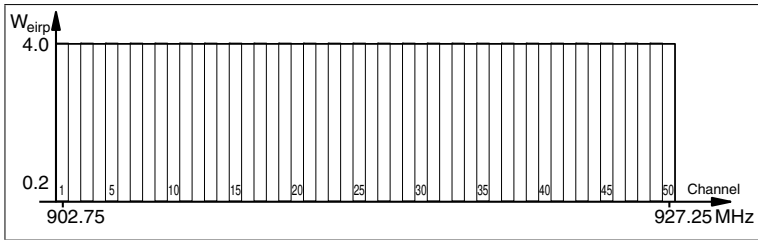
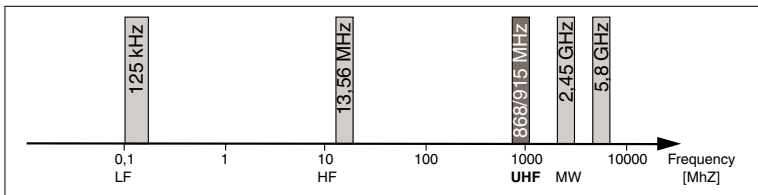

Figure 4.4

4.1.14 RFID Frequency Bands



- 100–135 kHz: Low frequency LF
- 13.56 MHz: High frequency HF
- 865–868 MHz (Europe), 902–928 MHz (USA), 920–925 MHz (China): ultra-high frequency UHF
- 2.45 GHz and 5.8 GHz: Microwave MW

4.1.15 Relevant UHF standards

European radio standards: EN 300220 and EN 302208

Application recommendations for RFID labels, information on recyclability, installation of readers and antennas: ISO/IEC TR 24729 parts 1-4

Installation and commissioning of UHF RFID systems: ETSI TR 102436

Radio interface description "UHF Gen2", "Electronic Product Code" (EPC): ISO/IEC 18000-6, Annex 1 in part C

4.2 General Functions and Features



Functions

The read/write head IUH-F117-V1-* was developed for writing and reading passive read/write tags with a UHF range operating frequency.

Detection range

An integrated, highly-sensitive transmission and receiver unit enables a read/write tag detection range of up to 6 meters and permits tag protocols in accordance with EPC Class1 Gen2 and ISO 18000-6 C. Special blocking options support the operation of closely located read/write heads. (see chapter 4.1.10)

Decoding

The integrated powerful high-performance module decodes Miller-coded tag signals with 80 kbit/s (EU).
(Miller-coding = side band modulation for the dense reader mode)

Features

The IUH-F117-V1-* read/write head has the following features:

- 2 dual LEDs for function display
- Industrial housing
- Interference-free operation, even with other read/write heads in the direct vicinity
- Connects to the IDENTControl via connector V1 (M12 x 1)
- Protects against failures (such as antenna short-circuit) and electrostatic discharge

4.3 Indicators and Controls

The IUH-F117-V1-* read/write head has two dual LEDs (green/yellow). The two LEDs are located on opposite sides and are clearly visible. The various indicators mean:

- Green: power on
- Flashing green: attempting to read/write
- Yellow: command executed

4.4 Connection

The read/write head is connected to the IDENTControl interface via an M12 x 1 connector.

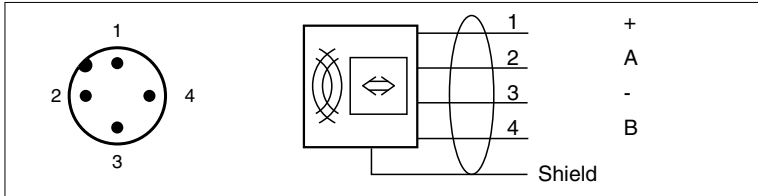

4.5 Scope of Delivery

- Read/write head IUH-F117-V1-*
- Manual

4.6 Accessories

4.6.1 IDENTControl

The IUH-F117-V1-^{*} can be connected to Pepperl+Fuchs IDENTControl control interfaces as a read/write head.

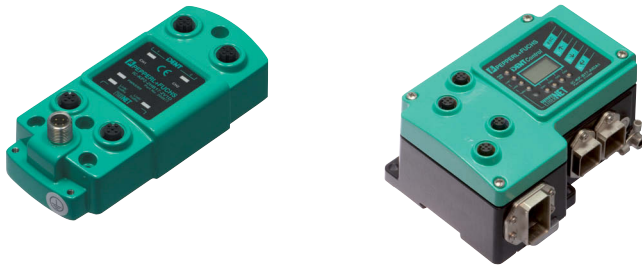

Interface	Designation
4 read/write heads:	
Ethernet	IC-KP-B17-AIDA1
2 read/write heads:	
Ethernet	IC-KP2-2HB17-2V1D
CC-Link	IC-KP2-2HB18-2V1
1 read/write head:	
PROFIBUS	IC-KP2-1HB6-V15B IC-KP2-2HB6-V15B
Ethernet	IC-KP2-1HB17-2V1D
Serial	IC-KP2-1HRX-2V1 IC-KP2-2HRX-2V1

Table 4.1 IDENTControl

4.6.2 Read/Write Tags

Type	Designation
ISO 18000-6 C	IUC72-C8-T14 IUC72-F151 IUC72-F152 IUC73-F153 IUC76-F157-M

4.6.3 Connection cable for R/W heads and trigger sensors

Compatible connection cables with shielding are available for connecting the R/W heads and trigger sensors.

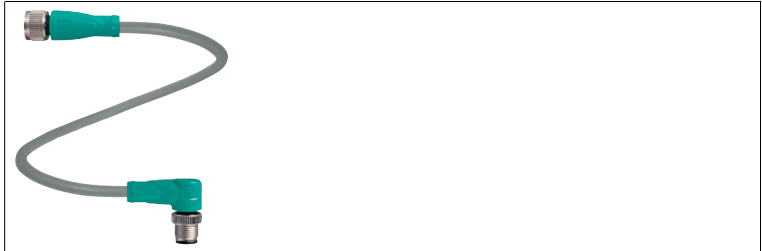

Figure 4.5

Accessories	Description
2 m long (straight female, angled male)	V1-G-2M-PUR-ABG-V1-W
5 m long (straight female, angled male)	V1-G-5M-PUR-ABG-V1-W
10 m long (straight female, angled male)	V1-G-10M-PUR-ABG-V1-W
20 m long (straight female, angled male)	V1-G-20M-PUR-ABG-V1-W
Field attachable female connector, straight, shielded	V1-G-ABG-PG9
Field attachable male connector, straight, shielded	V1S-G-ABG-PG9
Field attachable female connector, angled, shielded	V1-W-ABG-PG9
Field attachable male connector, angled, shielded	V1S-W-ABG-PG9
Dummy plug M12x1	VAZ-V1-B

4.6.4 Cable connectors for the power supply

Compatible M12 sockets with an open cable end for connecting the IDENTControl to a power supply are available in different lengths.

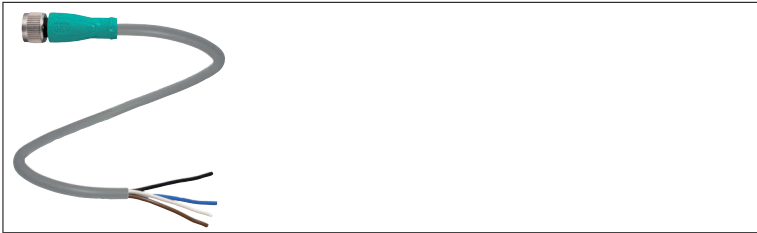

Figure 4.6

Accessories	Designation
Length 2 m (straight socket)	V1-G-2M-PUR
Length 5 m (straight socket)	V1-G-5M-PUR
Length 10 m (straight socket)	V1-G-10M-PUR

4.6.5 Installation accessories

Two different mounting brackets are available to mount the read/write head on a wall or pole.

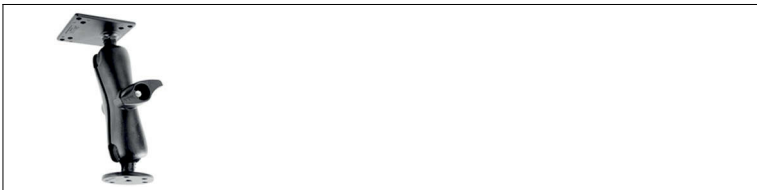

Figure 4.7 IUZ-MH10

Accessories	Designation
Mounting bracket for wall attachment	IUZ-MH10
Mounting bracket for pipe installation (pipe with maximum diameter of 40 mm)	IUZ-MH11

5 Installation

5.1 Storage and transport

For storage and transport purposes, package the unit using shockproof packaging material and protect it against moisture. The best method of protection is to package the unit using the original packaging. Furthermore, ensure that the ambient conditions are within allowable range.

5.2 Unpacking

Check the product for damage while unpacking. In the event of damage to the product, inform the post office or parcel service and notify the supplier.

Check the package contents with your purchase order and the shipping documents for:

- Delivery quantity
- Device type and version in accordance with the type plate
- Accessories
- Quick start guide

Retain the original packaging in case you have to store or ship the device again at a later date.

Should you have any questions, please contact Pepperl+Fuchs.

5.3 Mounting



Note!

Please note that radio waves in the UHF range do not disperse evenly due to reflections on objects in the surrounding environment. Aligning the transponder correctly is therefore extremely important.

The read/write head was designed for mounting on walls or brackets in internal areas. Please always secure the read/write head to the holes provided on the housing. The preferred installation position is with the cable connection vertical facing downwards.

5.3.1 Orientation in the room

The alignment of the antennas on the data carrier in relation to the antenna on the read/write head influences the sensing range of the system. Therefore, make sure that the antennas are aligned parallel to one another.

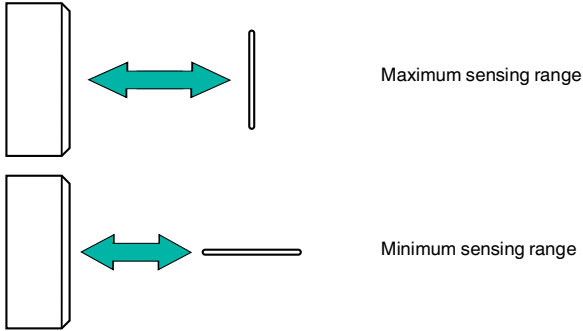

5.3.2 Minimum and Maximum Distances

When positioning the read/write head, please observe the minimum distances. The lateral distance between the read/write head and metals or liquids should be at least 50 cm. The distance between the read/write head and the ground should also be at least 50 cm. The mounting surface material does not affect the read/write head.

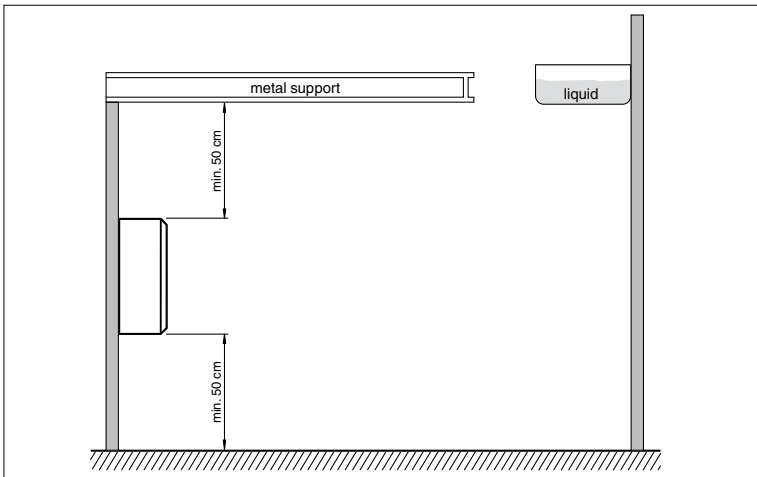

Figure 5.1

If you wish to position multiple read/write heads next to each other or above each other, the distance should be no less than 20 cm between each unit. A minimum distance of 50 cm is reasonable.

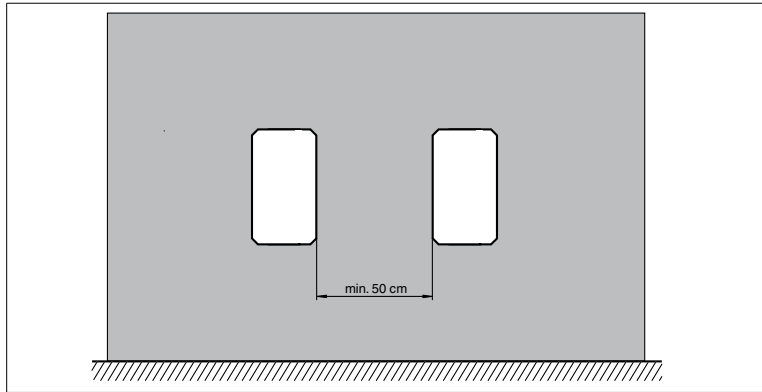

Figure 5.2

5.3.3

Polarization

The polarization of an electromagnetic wave emitted from an antenna depends on the electromagnetic field component and the spatial position of the antenna. A fundamental distinction is drawn between linear and circular polarization. The polarization of the read/write head must be adapted to the polarization of the transponder in order for a UHF system to utilize the full sensing range. Refer to the corresponding data sheet for details on the polarization of the transponder.

- Linear polarization: the direction of the vector of an electromagnetic field component that generates an electromagnetic wave with linear polarization is always constant. Linear polarization is available in a vertical and horizontal configuration, which is dependent on the spatial position of the antenna.
- Circular polarization: the vector of an electromagnetic field component that generates an electromagnetic wave with circular polarization rotates around an axis parallel with the beam direction. The rotation of the antenna around the communication axis has no influence.

The IUH-F117-V1 read/write head is supplied with circular polarization. Polarization can be changed from circular to linear using the software on the IDENTControl interface. With linear polarization, the polarization level is aligned horizontally when the read/write head is mounted in the preferred installation direction with the cable connection vertical facing downwards.

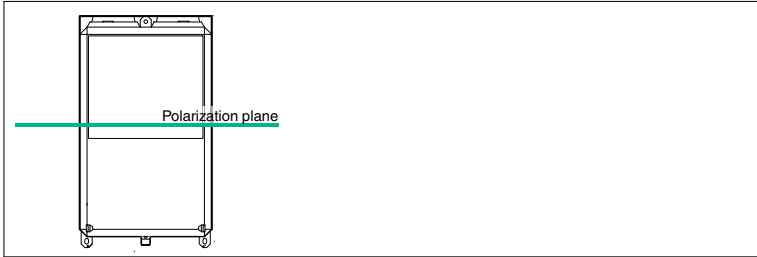

Figure 5.3 Polarization plane IUH-F117-V1-* with linear polarization

5.4 Connection

Connect the read/write head to the IDENTControl interface using a shielded connection cable (see chapter 4.6.2). Make sure that the shielding is continuous to prevent EMC interference. (see chapter 5.5)

5.5 EMC concept

The outstanding noise immunity of the IDENTControl against emission and immission is based on its consistent shielding design, which uses the principle of the Faraday cage. Interference is caught in the shield and safely diverted via the ground connections.

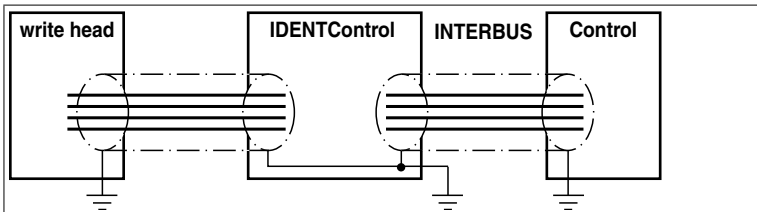

The screening of cables provides for the discharge of electromagnetic interference. When screening a cable, both sides of the screen must be connected to the earth with low resistance and low inductance.



Note!

If cables with double shields are used, e.g. wire mesh and metalized foil, the both shields must be connected together, with low resistance, at the ends when making up the cable.

Power supply cables are the source of much interference, e.g. from the supply lines of 3-phase electric motors. For this reason, the parallel laying of power supply cables with data and signal cables should be avoided, particularly in the same cable duct.

The metal enclosure of the IDENTControl and the metal enclosure of the R/W heads complete the consistent shielding concept.

The most important issue here is that the shields are connected to ground with low resistance and low inductance. The metal enclosure ensures that the shielding is not interrupted, i.e. the complete electronics system and all routed cables are located within a Faraday cage.

6 Commissioning

6.1 Connection



Caution!

Uncontrollable triggered processes

The plant where the device is installed may be damaged.

Before commissioning, make sure that all processes run in a controlled manner.



Warning!

Incorrect electrical connection

Damage to the device or system caused by incorrect electrical connection

Check all connections in the plant before commissioning the device.

When you connect the control interface to the power supply, the PWR/ERR LED on the device lights up green. If the LED on the device does not light up, the power supply is connected incorrectly. The LED on the device lights up red when a device fault occurs. If the PWR/ERR LED flashes red and green alternately after you connect the IUH-F117-V1 read/write head, the power supply does not offer sufficient power. If the LED on the read/write head slowly flashes green, the control interface is configured incorrectly.

6.2 Device settings



Caution!

Device not configured or configured incorrectly

System failure caused by incorrectly configured device

Configure the device prior to commissioning.

You must configure the control interface before commissioning the read/write head. Read the chapter "Commissioning" in the manual accompanying your control interface.

Configure the R/W heads with the described system commands.see chapter 7.3.2). To view an example of parameterization see chapter 6.3.

6.3 Operating via the Command Interface

This section shows you how to operate the IUH-F117-V1-* read/write head using an IDENTControl Compact control interface with serial interface. The commissioning procedure described relates to the RS 232 interface and involves a PC. The examples also include the syntax for coding the commands and parameters via the Ethernet TCP/IP and PROFIBUS interface. Further details about these codes and the factory setting for your IDENTControl control interface can be found in the manual.



Note!

Hexadecimal format

In the examples, hexadecimal values are displayed in **.03** format. A period is followed by two characters of hexadecimal code.

.03_{hex} = <ETX>

.41_{hex} = A



Commissioning the IDENTControl Compact Control Interface

1. On the PC, open a terminal program (e. g. "Hyperterminal" or the command input window of the "RFIDControl" software supplied with the control interface).
2. Use the terminal program to set the interface configuration to
 - 38400 baud,
 - 8 data bits,
 - no parity,
 - 1 stop bit,
 - no handshake
 - protocol: <CHCK><ETX>
3. Switch the device operating voltage off and on.

↳ When the voltage is switched on, the message below appears on the terminal:

```
20b.03
2 = Status
0 = IDENTControl channel
b = checksum
.03 = <ETX> = final symbol
```

The communication from the device to the terminal program functions. The device is ready for operation.

4. Send the version command **VE** to the device as confirmation.

↳ The device name, item number and software version of the control interface and the read/write head are displayed.

```
Example:
Control interface
00(C) P+F IDENT IC-KP2-2HRX-2V1 #204980 1831464 05/03/10
<CHCK><ETX>
Read/write head
01 IUH-F117-V1 #206057 R010500-F010103 1831569 05/19/10
<CHCK><ETX>
```

(The software number and the software date may differ. For a description of the **VE** command, read the "System commands" section in your control interface manual.)

If you receive a different response, communication between your PC and the device has failed. Check the installation and repeat the steps for commissioning the device.



Note!

The device makes no distinction between commands entered in upper and lower case. Make sure that there are **no spaces** in all parameters that come after the command.

Example:

In the examples below, the read/write head is connected to channel 1 of the control interface.

The control interface must be connected to an RS 232 interface.

Reading Tags

Set the tag type to IUC80. Do this by transmitting the command change tag (see "Change Read/Write tag CT" on page 34) to the read/write head. Once you have set this general tag type, all tags can only be addressed via the read/write commands single read fixcode and enhanced read fixcode (see "Single read fixcode SF" on page 31 and see "Enhanced read fixcode (EF)" on page 31) .

Change Read/Write Tag

	Serial	Ethernet	PROFIBUS
Command:	CT180	.00.06.04.02.38.30	.04.02.38.30
Confirmation:	-	.00.06.04.02.FF.09	.04.02.FF.09
Response:	01	.00.06.04.02.00.0A	.04.02.00.0A

Transmit the command enhanced read fixcode to the read/write head. The LEDs on the read/write head flash green.

Enhanced Read Read-Only Code

	Serial	Ethernet	PROFIBUS
Command:	EF1	.00.04.1D.03	.1D.03
Confirmation:	-	.00.06.1D.03.FF.0B	.1D.03.FF.0B
Response:	51	.00.06.1D.03.05.0C	.1D.03.05.0C

Table 6.1 No tag in the detection range

Move a IUC* tag into the read/write head's detection range. When the tag is detected and the read-only code is read out, the LED on the read/write head turns yellow. The read-only code is displayed in the terminal program.

Enhanced Read Read-Only Code

	Serial	Ethernet	PROFIBUS
Command:	EF1	.00.04.1D.03	.1D.03
Confirmation:	-	.00.06.1D.03.FF.36	.1D.03.FF.36
Response:	01.E0.04.26.70.18. 01.00.00	.00.0E.1D.03.00.37. E0.04.26.70.18.01. 00.00	.1D.03.00.37.E0.04. 26.70.18.01.00.00

Table 6.2 Tag in the detection range

Describing Tags

Set the tag type to IUC72. Do this by transmitting the command change tag (see "Change Read/Write tag CT" on page 34) to the read/write head.

Change Read/Write Tag

	Serial	Ethernet	PROFIBUS
Command:	CT172	.00.06.04.02.37.32	.04.02.37.32
Confirmation:	-	.00.06.04.02.FF.15	.04.02.FF.15
Response:	01	.00.06.04.02.00.16	.04.02.00.16

Transmit the command single write special fixcode (see "Single Write Special Read-Only Code SP" on page 32) to the read/write head while an IUC72 tag is located within the detection range.

Single Write Special Read-Only Code

	Serial	Ethernet	PROFIBUS
Command:	SP10D10.08.33.B2. DD.D9.04.80.35.05. 00.00	.00.13.0D.D3.00.00. 31.30.08.33.B2.DD. D9.04.80.35.05.00. 00	.0D.D3.00.00.31.30. 08.33.B2.DD.D9.04. 80.35.05.00.00
Confirmation:	-	.00.06.0D.D3.FF.2D	.0D.D3.FF.2D
Response:	01	.00.06.0D.03.00.2E	.0D.03.00.2E

As confirmation, read out the read-only code of the IUC72 tag within the read/write head's detection range via the command single read special fixcode (see "Single Read Special Read-Only Code SS" on page 31).

Single Read Special Read-Only Code

	Serial	Ethernet	PROFIBUS
Command:	SS10	.00.04.0A.02	.0A.02
Confirmation:	-	.00.04.0A.02.FF.2F	.0A.02.FF.2F
Response:	0110.08.33.B2.DD. D9.04.80.35.05.00. 00	.00.13.0A.02.00.30. 31.30.08.33.B2.DD. D9.04.80.35.05.00. 00	.0A.02.00.30.31.30. 08.33.B2.DD.D9.04. 80.35.05.00.00

Example of parameterization:

Setting and requesting the read/write head's transmission power.

Read out the read/write head's transmission power with the read param PT:

	Serial	Ethernet	PROFIBUS
Command:	RP1UPT	.00.09.BE.03.55.50. 54.00.00	.BE.03.55.50.54.00. 00
Confirmation:	-	.00.06.BE.03.FF.3E	.BE.03.FF.3E
Response:	01.07.D0	.00.08.BE.03.00.3F. 07.D0	.BE.03.00.3F.07.D0

Use the write param PT to change the read/write head's transmission power to 500 mW:

	Serial	Ethernet	PROFIBUS
Command:	WP1UPT.00.02.01. F4	.00.0B.BF.03.55.50. 54.00.02.01.F4	.BF.03.55.50.54.04. 00.02.01.F4
Confirmation:	-	.00.06.BF.03.FF.11	.BF.03.FF.11
Response:	01	.00.06.BF.03.00.12	.BF.03.00.12

7 Operation

7.1 General

The sections below contain the details on the commands that specifically address the read/write head IUH-F117-V1-*. The commands are described using the example of an IDENTControl control interface with serial interface. All other generally applicable commands and error or status messages can be found in the manual for your IDENTControl control interface.

Display

Angle brackets contain the abbreviated meaning of a command structure

Square brackets with the index ₁₀ describe a decimal number

The index _{hex} describes a hexadecimal number

7.2 Read/Write Commands

Single read fixcode SF

One attempt is made to read a read only code.

Command: SF <ChanNo> <CHCK> <ETX>

Response: <Status> <Fixcode> <CHCK> <ETX>

Enhanced read fixcode (EF)

This command makes continuous attempts to read a read only code until successful. If a read only code is read, a signal is sent once to the control interface. If there is no read only code in the detection area or the transponder leaves the detection area before the read only code is read, a status 5 message is sent to the control interface in response.

Command: EF <ChanNo> <CHCK> <ETX>

Response: <Status> <Fixcode> <CHCK> <ETX>

Single Read Special Read-Only Code SS

This command reads the Ull segment from tags from type 72 (EPC Class 1 Gen2)

Command: SS <ChanNo> <Length> <CHCK> <ETX>

Response: <Status> <FData> <CHCK> <ETX>

For the length of an EPC code, set <Length> = 00. The actual length of the EPC code is defined during the write operation and stored on the tag.

<FData>: <PC> & <Ull>

Example:

SS1 0 reads the EPC code.

Enhanced Read Special Read-Only Code ES

This command continuously attempts to read the Ull segment of tags from type 72 (EPC Class 1 Gen2). If a Ull is read, this is reported once to the control interface. If there is no Ull in the detection range or if the tag leaves the detection range before the Ull is read, a status 5 is reported to the evaluation unit as a response.

Command: ES <ChanNo> <Length> <CHCK> <ETX>

Response: <Status> <FData> <CHCK> <ETX>

For the length of an EPC code, set <Length> = 00. The actual length of the EPC code is defined during the write operation and stored on the tag.

<FData>: <PC> & <Ull>

Single Write Special Read-Only Code SP

This command writes an n-byte long EPC code to tags from type 72 (EPC Class 1 Gen2)

Command: SP <ChanNo> <Length> <FData> <CHCK> <ETX>

Response: <Status> <CHCK> <ETX>

Set for <Length> = Length <FData>

<FData> = <PC> & <Ull>

Example:

SP1E.30.00.30.05.FB.63.AC.1F.36.81.EC.88.04.68 writes for <PC> the value .30.00 and the EPC code ".30.05.FB.63.AC.1F.36.81.EC.88.04.68" with a length of 12 bytes on channel 1.

Enhanced Write Special Read-Only Code EP

This command writes an n-byte long EPC code once to tag type 72 (EPC Class 1 Gen2) and then permanently reads out the EPC code.

Command: EP <ChanNo> <Length> <FData> <CHCK> <ETX>

Response: <Status> <CHCK> <ETX>

Set for <Length> = Length <FData>

<FData> = <PC> & <Ull>

Single Read Words SR

One attempt is made to read, <WordNum> 32-bit words from address <WordAddr>.

Command: SR <ChanNo> <WordAddr> <WordNum> <CHCK> <ETX>

Response: <Status> <Data> <CHCK> <ETX>



Note!

The **memory bank MB** parameter defines the bank which this command accesses. See "Memory Bank MB" on page 40.

Enhanced Read Words ER

An attempt is made until <WordNum> 32-bit words are successfully read from the address <WordAddr>. Only changing data is transferred via the interface. When a read/write tag leaves the read range, status 5 is output.

Command: ER <ChanNo> <WordAddr> <WordNum> <CHCK> <ETX>

Response: <Status> <Data> <CHCK> <ETX>



Note!

The **memory bank MB** parameter defines the bank which this command accesses. See "Memory Bank MB" on page 40.

Single Write Words SW

One attempt is made to write <WordNum> 32-bit words from the address <WordAddr>.

Command: SW <ChanNo> <WordAddr> <WordNum> <Data> <CHCK> <ETX>

Response: <Status> <CHCK> <ETX>



Note!

The **memory bank MB** parameter defines the bank which this command accesses. See "Memory Bank MB" on page 40.

Enhanced Write Words EW

This command behaves in the same way as the write words command. When a read/write tag leaves the read range, status 5 is output.

Command: EW <ChanNo> <WordAddr> <WordNum> <Data> <CHCK> <ETX>

Response: <Status> <CHCK> <ETX>



Note!

The **memory bank MB** parameter defines the bank which this command accesses. See "Memory Bank MB" on page 40.



Note!

16-Bit Read/Write Commands

The read/write commands SR, ER, SW and EW are interpreted as 16-bit versions by means of a preceding # symbol.

The 16-bit read/write commands behave in the same way as the 32-bit versions.

- 16-bit commands write or read a word with a length of 2 bytes.
- 32-bit commands write or read a word with a length of 4 bytes.

Example:

#SW000202ABCD corresponds to SW000101ABCD

7.3 Configuration commands

7.3.1 ChangeTag Command

Change Read/Write tag CT

This command tells the R/W system with which read/write tag to communicate.

Command: CT <ChanNo> <TagType> <CHCK> <ETX>

Response: <Status> <CHCK> <ETX>

Default: TagType = IUC80

Example:

CT172 sets TagType to IUC72

CT180 sets TagType to All, permits the read-only code to be read out from all tag types and hence draw conclusions about the tag actually in use.



Note!

Tag Type

The CT command automatically sets the parameters that are suitable for the selected tag.

The following tag types are currently supported:

Tag Types UHF 868 MHz

Tag type	Chip type	Details	P+F designation	TID	Data [bytes]	Bank 00 [bit]	Special read-only code [bit]	Unique read-only code
72	EPC Class 1 Gen 2	NXP UCode-EPC-G2XM	IUC72	E2006003 + serial number	64	32 + 32	240	Yes
73	EPC Class 1 Gen 2	Alien Higgs-2	IUC73	E2003411	-	32 + 32	96	No
74	EPC Class 1 Gen 2	NXP UCode-EPC-G2	IUC74	E2006001 + serial number	28	32 + 32	96	Yes
75	EPC Class 1 Gen 2	Impinj Monza 2.0	IUC75	E2001071	-	32 + 32	96	No
76	EPC Class 1 Gen 2	Alien Higgs-3	IUC76	E2003412 + serial number	64	32 + 32	240	Yes
80	EPC Class 1 Gen 2	-	-	Serial number	-	-	Max. 96	-

Table 7.1 Tag types 868 MHz

7.3.2 ReadParam/WriteParam Commands

The configuration commands enable you to set or read the following parameters via the **WriteParam WP** and **ReadParam RD** commands:

- Linear/circular antenna polarization, type=AP (AntennaPolarisation)
- Transmission power, type=PT (PowerTransmit)
- Permitted channels in the Dense Reader Mode, type=CD (ChannelDRM)
- Complete reset of all parameters to the default condition, type=RD (Reset to Default)
- Anti-collision algorithm on/off, type=AC (AntiCollision)
- Permitted number of read/write attempts in the event of an error, type=TA (TriesAllowed)
- Number of unsuccessful read attempts up to Status 5, type=E5 (EnhancedStatus5)
- Specified bank on which the write and read commands SR, ER and SW are accessed, type=MB (Memory Bank)

The parameters are generally saved in the read/write head IUH-F117-V1-* as non-volatile.

Read Param

This command reads configuration parameters from the IQH2-... and IUH-F117-V1-* read/write head.

Command: RP <ChanNo> <SystemCode> <ParamTyp> <ParamLength> <CHCK> <ETX>

Response: <Status> <Data> <CHCK> <ETX>

Syntax

RP <SystemCode><ParamTyp> <ParamLength>

Write Param

This command writes configuration parameters to the IQH2-... and IUH-F117-V1-* read/write head.

Command: WP <ChanNo> <SystemCode> <ParamTyp> <ParamLength> <Data> <CHCK> <ETX>

Response: <Status> <CHCK> <ETX>

Syntax

WP <SystemCode><ParamTyp><ParamLength><Value>

For additional details on the parameters see chapter 7.3.3.

7.3.3

ParamTyp

Stored Configuration SC

This parameter reads out the entire parameterization of the IUH-F117-V1-* read/write head.

ParamTyp: SC

Example:

RP1USC.00.00 reads out the entire parameterization in the following sequence:

Byte position	Meaning	Value range
[0] [1]	Device detection	IUH-F117-V1-* = .7D.68 IUH-F117-V1 = .7B.51
[2]	Default flag	Default = .64 Modified = .6D
[3] [4]	PT parameter	from 100 mW = .00.64 to 2000 mW = .07.D0
[5]	CD parameter	Number of set channels = 1–4
[6]–[9]		Set channels see "Channel DRM CD (IUH-F117-V1-EU Only)" on page 38

Byte position	Meaning	Value range
[10]	TA parameter	See "Tries Allowed TA" on page 39
[11]	E5 parameter	See "Enhanced Status 5 E5" on page 39
[12]	AP parameter	See "Antenna Polarization AP" on page 37
[13]	AC parameter	See "Anti-Collision AC" on page 38
[14]	QV parameter	See "Q-Value QV" on page 39
[15]	MB parameter	See "Memory Bank MB" on page 40

Antenna Polarization AP

This parameter switches polarization to linear/circular or reads out the currently set polarization.

ParamTyp: AP
 Default: AP = C
 Value range: L, C

Example:

WP1UAP.00.01L switches the polarization to linear
 WP1UAP.00.01C switches the polarization to circular
 RP1UAP.00.00 reads out the set polarization

Set the polarization according to the read/write tag used (see chapter 5.3.3).

- Higher sensitivity if both the read/write head and the read/write tag are polarized linearly.
- There are gaps in the detection range if the read/write head is polarized linearly.

Power Transmit PT

This parameter sets the transmission power in mW or reads out the set transmission power.

The transmission power is stated for IUH-F117-V1-EU and IUH-F117-V1-CN in W_{erp} . The transmission power is stated in W for the read/write head IUH-F117-V1-US_{eirp}.

ParamTyp: PT
 Default: $PT = .07.D0_{bin} = 2000 \text{ mW}_{erp}$
 Value range: $100\text{--}2000 \text{ mW}_{erp}$
 $100\text{--}4000 \text{ mW}_{eirp}$

Example:

WP1UPT.00.02.00.64 sets 100 mW_{erp}
 WP1UPT.00.02.07.D0 sets 2000 mW_{erp}
 RP1UPT.00.00 reads out the set transmission power

- ⊕ Higher range if the transmission power increases.
- ⊖ Possible overreaches if the transmission power increases.
- ⊖ Adjacent read/write heads might be affected if the range increases.

Channel DRM CD (IUH-F117-V1-EU Only)

This parameter sets the sequence of the channels permitted in the DRM (= dense reader mode) or reads out the sequence of the permitted channels. Only channels 4, 7, 10 and 13 are available.

ParamTyp: CD
 Default: CD = .07.0A.04.0D
 Value range: .04, .07, .0A, .0D

Example:

WP1UCD.00.04.07.0A.04.0D defines the sequence 7, 10, 4 and 13 as defined channels

RP1UCD.00.00 reads out the sequence of permitted channels.

Reset to Default RD

This parameter returns all settings of the IUH-F117-V1-* to its default configuration.

ParamTyp: RD

Example:

WP1URD.00.00

Anti-Collision AC

This parameter switches on/off the anti-collision algorithm for handling several tags within the detection range or reads out whether the algorithm is switched on or off.

ParamTyp: AC
 Default: AC = .01
 Value range: .00, .01

Example:

WP1UAC.00.01.01 detects several tags in the detection range and provides a warning with Status A

WP1UAC.00.01.00 does not provide a warning with Status A

RP1UAC when several tags are in the detection range.00.00 reads out whether the algorithm is switched on or off

Recommendation: Do not alter the settings of this parameter.

When the anti-collision algorithm is switched off:

- ⊕ Shorter access time.

- ➔ No distinct reading/writing when several tags are within the detection range, no warning message.

- ➔ Much more complex collision management when several tags are in the detection range.

Q-Value QV

The QV parameter controls the multi-tag operating mode for the read/write head. This operating mode controls the ability to deal with several read/write tags within the detection range.

The default value is fixed at 0 = single tag mode.

Tries Allowed TA

This parameter sets the permitted number of write or read attempts in the event of a read or write error between the read/write head and the tag, or reads out the permitted number of attempts.

ParamTyp: TA
Default: TA = .03
Value range: .01 to .FF

Example:

WP1UTA.00.01.01 permits precisely one attempt (= no repeats)

WP1UTA.00.01.03 permits 3 attempts

RP1UTA.00.00 reads out the permitted number of attempts

If the permitted number of write or read attempts between the read/write head and the tag is increased, this results in:

- ➔ More reliable reading and writing

- ➔ An increased response time when reading or writing is not possible

Enhanced Status 5 E5

This parameter sets the number of possible read repeats until a status 5 message is output for an enhanced command, or reads the number of read repeats.

ParamTyp: E5
Default: E5 = .05
Value range: .00 to .FF

Example:

WP1UE5.00.01.05 sets the number to 5 possible read repeats

RP1UE5.00.00 reads out the number of possible read repeats

If the number of read repeats is reduced:

- ➔ Faster response time in enhanced mode.

- ➔ Status 5 messages in the event of unstable tag reading.

Memory Bank MB

This parameter specifies the bank which the read/write commands SR, ER, SW and EW access.

ParamTyp: MB
 Default: MB = .03 = User Memory
 Value range: .01 = Ull
 .02 = TID
 .03 = User Memory

If Bank 01 (Ull) is defined as the access range, the Control PC protocol can only be changed in 16-bit mode. The PC determines many factors, including the length of the EPC/Ull. In 32-bit mode, PC and checksum CRC-16 are written together as one word. The CRC-16 is write-protected.

Example:
 WP1UMB.00.01.03 sets the bank to User Memory

The response from the reader is a status message. During the read operation, a status message and the corresponding data are received as the response.

7.4

Legend

<ChanNo>: IDENTControl channel
 <CHCK>: 1 ASCII character, 8-bit checksum with the addition of all preceding characters, without overflow
 <Code>: n-byte long EPC code
 <Data>: <WordNum> times 4 bytes.
 <FDaten>: <PC> & <Ull/EPC>
 ERP: Effective Radiated Power
 <ETX>: 1 ASCII character 03
 <Read-only code>: 8-byte UID/TID
 <Length>: 1 ASCII character, n_{hex} , = number of data bytes when describing the Ull-Segment + 1
 Range "03", "05", "07" etc (read)
 "00" (write)
 <ParamTyp>: Parameter type, 2 ASCII characters
 <ParamLength>: Parameter length, 2 binary characters, HighByte, LowByte
 <PC>: Protocol control word in accordance with ISO/IEC 18000-6:2010, 2 binary characters, HighByte, LowByte
 Protocol control describes the length of the Ull.
 Example:
 .00.00 = Ull with the length 00
 .08.00 = Ull with the length 02
 .10.00 = Ull with the length 04
 ...
 .30.00 = Ull with the length 12
 ...
 <Status>: 1 ASCII character (see chapter 7.5)
 <SW-No>: Application software number

- <SystemCode>: = U
- <Tagtype>: 2 ASCII characters
- <Timeout>: Interface timeout; an error message is sent after this time runs out
- <Ull/EPC>: Unique Item Identifier, memory area of a tag in accordance with ISO 18000-6 C, in which the EPC code is stored, for example.
- <WordAddr>: Word start address in the read/write tag, 4 ASCII characters, range from '0000h' to 'FFFFh', depending on tag type.
- <WordNum>: Number of words to be read or written (length of 4 bytes), 2 ASCII characters. Range from "01" to "20", depending on tag type.

7.5 Fault/status messages

Status	Meaning
0	The command has been executed without error.
1	The command is processing.

Error messages triggered by the identification system

Status	Meaning
1	Reserved
2	Switch-on message, reset has been executed.
3	Reserved
4	Incorrect or incomplete command or parameter not in the valid range.
5	No data carrier in the detection range.
6	Hardware error, e.g. error during self-test or read/write head defective.
7	Internal device error.
8	Reserved
9	The parameterized data carrier type is not compatible with the connected read head.
A	There are several transponders in the detection range (UHF).
B	Reserved
C	Reserved
D	Reserved
E	The internal cache is full.
F	Reserved

8 Service and Maintenance

The device is designed and constructed to function stable over long periods of time. For this reason, regular cleaning or maintenance is unnecessary.

9 Troubleshooting

Problem	Solution
Interference from several read/write heads in the direct vicinity	<ul style="list-style-type: none"> ■ Send the parameter CA ■ Change the channel setting ■ Reduce the transmitting power
Status 5 message even though transponder in the detection area	<ul style="list-style-type: none"> ■ Check the preset transponder type (see chapter 7.3.1), change the transponder type to 70, read the TID using the SF command, you can derive the transponder type from the TID
Status A message	<ul style="list-style-type: none"> ■ Check whether several transponders are located in the detection area: place the transponder in an enclosed metal container to remove it from the detection area Repeat the read or write process

10 ASCII table

hex	dec	ASCII	hex	dec	ASCII	hex	dec	ASCII	hex	dec	ASCII
00	0	NUL	20	32	Space	40	64	@	60	96	'
01	1	SOH	21	33	!	41	65	A	61	97	a
02	2	STX	22	34	"	42	66	B	62	98	b
03	3	ETX	23	35	#	43	67	C	63	99	c
04	4	EOT	24	36	\$	44	68	D	64	100	d
05	5	ENQ	25	37	%	45	69	E	65	101	e
06	6	ACK	26	38	&	46	70	F	66	102	f
07	7	BEL	27	39	'	47	71	G	67	103	g
08	8	BS	28	40	(48	72	H	68	104	h
09	9	HT	29	41)	49	73	I	69	105	i
0A	10	LF	2A	42	*	4A	74	J	6A	106	j
0B	11	VT	2B	43	+	4B	75	K	6B	107	k
0C	12	FF	2C	44	,	4C	76	L	6C	108	l
0D	13	CR	2D	45	-	4D	77	M	6D	109	m
0E	14	SO	2E	46	.	4E	78	N	6E	110	n
0F	15	SI	2F	47	/	4F	79	O	6F	111	o
10	16	DLE	30	48	0	50	80	P	70	112	p
11	17	DC1	31	49	1	51	81	Q	71	113	q
12	18	DC2	32	50	2	52	82	R	72	114	r
13	19	DC3	33	51	3	53	83	S	73	115	s
14	20	DC4	34	52	4	54	84	T	74	116	t
15	21	NAK	35	53	5	55	85	U	75	117	u
16	22	SYN	36	54	6	56	86	V	76	118	v
17	23	ETB	37	55	7	57	87	W	77	119	w
18	24	CAN	38	56	8	58	88	X	78	120	x
19	25	EM	39	57	9	59	89	Y	79	121	y
1A	26	SUB	3A	58	:	5A	90	Z	7A	122	z
1B	27	ESC	3B	59	;	5B	91	[7B	123	{
1C	28	FS	3C	60	<	5C	92	\	7C	124	
1D	29	GS	3D	61	=	5D	93]	7D	125	}
1E	30	RS	3E	62	>	5E	94	^	7E	126	~
1F	31	US	3F	63	?	5F	95	_	7F	127	DEL

11 Appendix

11.1 Dimensions

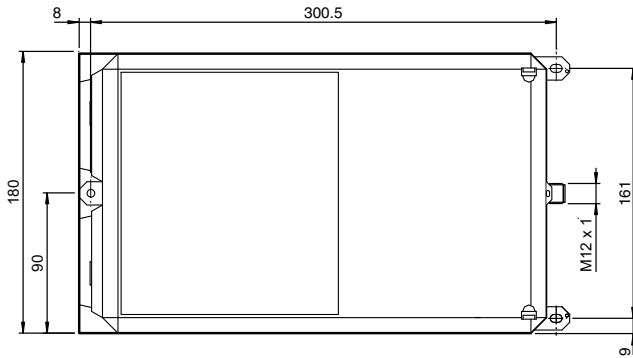

11.2 Technical Data

General specifications

Device	IUH-F117-V1-EU	IUH-F117-V1-US	IUH-F117-V1-CN
Operating frequency	865.1 ... 867.9 MHz	902 ... 928 MHz	920.5 ... 924.5 MHz
Radiated power	2 W ERP	4 W EIRP	2 W ERP
Operating distance	maximum: 6 m	maximum: 6 m	maximum: 6 m

Indicators/operating means

LED green/yellow	green: power on green flashing: read/write attempt performed yellow: command executed
------------------	---

Electrical specifications

Power consumption	≤ 30 W
Supply	from the IDENTControl

Compliance with standards and directives

Directive conformity

R&TTE Directive 1995/5/EC	EN 301489-1, EN 301489-3, EN 302208, EN 60950-1
---------------------------	---

Standard conformity

Electromagnetic compatibility	EN 301489-1:2008, EN 301489-3:2002
Protection degree	EN 60529:2000
Standards	EN 50364:2010

Ambient conditions

Ambient temperature	-25 ... 55 °C (-13 ... 131 °F)
Storage temperature	-25 ... 85 °C (-13 ... 185 °F)

Mechanical specifications

Protection degree	IP54
Connection	M12 x 1 connector
Material	
Housing	aluminum / ABS
Mass	approx. 3.1 kg

11.3

Detection Range

The maximum range of the UHF antenna IUH-F117-V1-* in open areas is 6 m. The specified maximum working range in the industrial environment is 3 m. These ranges depend largely on the respective tag type.

Please note the distance tables. The distance tables and additional information on your product can be found at <http://www.pepperl-fuchs.com>. To do this, simply enter the product name or model number in the **search** box and then click the **Search** key.



Select your product from the list of search results. Click on the information you require in the product information list, e.g., **Technical documents**.



A list of all available documents is displayed.

Measurements produced the following far field for the UHF antenna IUH-F117-V1-*. The diagram shows the detection range for horizontal polarization under ideal conditions. The detection range shown is an example and varies depending on the tag types.

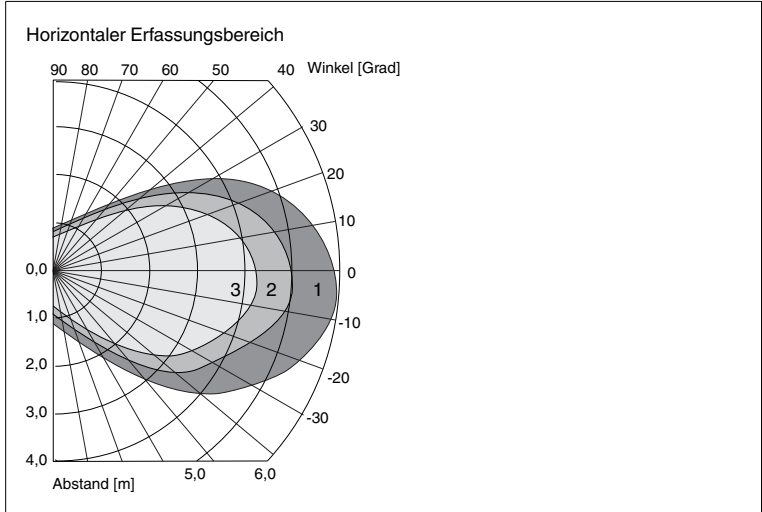

Figure 11.1 Horizontal detection range with horizontal polarization

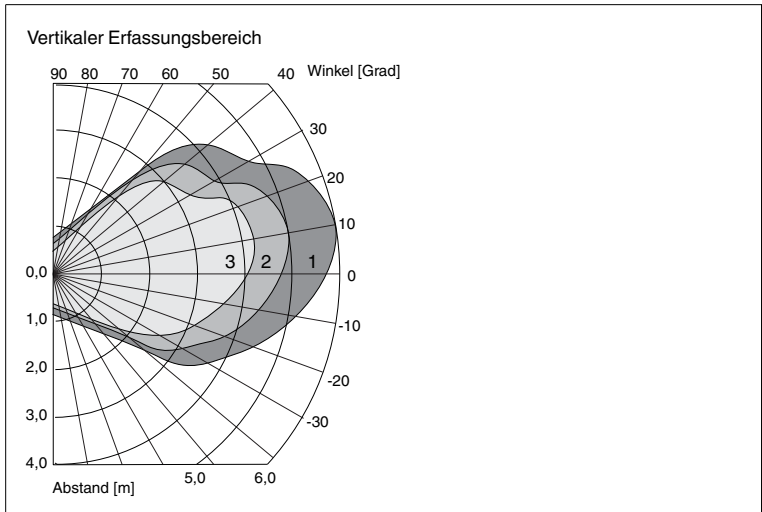

Figure 11.2 Vertical detection range with horizontal polarization

Curve 1 shows the detection range under optimum operating conditions with a transmission power of 2000 mW ERP.

Curve 2 shows the detection range under optimum operating conditions with a transmission power of 1000 mW ERP.

Curve 3 shows the detection range under optimum operating conditions with a transmission power of 500 mW ERP.

Passing Speed

The passing speed is the speed at which the tag moves through the detection range of a read/write head. The passing speed determines the time during which a tag is located within the detection range and therefore the time available for transmitting data. The passing speed depends on a number of different factors.

Example:

Read/write head with the enhanced read read-only code EF command continuously attempts to read a read-only code.

Time taken for the read-only code to be successfully read = 20 ms

Distance from the tag to the read/write head = 1.5 m for a detection range of $\pm 30^\circ$.
The ideal distance is \leq half the max. read distance as per the datasheet.

Therefore:

Distance covered (s) within the detection range: results from two

$$\tan 30^\circ = \frac{x}{1,5 \text{ m}} \text{ attempts } \mathbf{s = 2x = 2 \cdot 1,5 \text{ m} \cdot \tan 30^\circ = 1,73 \text{ m}}$$

$$\text{Maximum tag speed: } v_{\max} = \frac{1,73 \text{ m}}{20 \text{ ms}} = 86,5 \text{ m/s} \approx 300 \text{ km/h}$$

Under industrial operating conditions, a read attempt may need to be repeated. The time required for this repeat is allowed for when calculating a maximum speed under real conditions. The maximum speed in this case is therefore $\approx 150 \text{ km/h}$.

Please consult Pepperl+Fuchs for specific data on read and write times, as well as passing speeds.



FACTORY AUTOMATION – SENSING YOUR NEEDS



Worldwide Headquarters

Pepperl+Fuchs GmbH
68307 Mannheim · Germany
Tel. +49 621 776-0
E-mail: info@de.pepperl-fuchs.com

USA Headquarters

Pepperl+Fuchs Inc.
Twinsburg, Ohio 44087 · USA
Tel. +1 330 4253555
E-mail: sales@us.pepperl-fuchs.com

Asia Pacific Headquarters

Pepperl+Fuchs Pte Ltd.
Company Registration No. 199003130E
Singapore 139942
Tel. +65 67799091
E-mail: sales@sg.pepperl-fuchs.com

www.pepperl-fuchs.com

 **PEPPERL+FUCHS**
SENSING YOUR NEEDS

Subject to modifications
Copyright PEPPERL+FUCHS • Printed in Germany

TDOCT2077D_ENG
09/2012