

THE MANUAL

On rights

©2008 Phase One A/S. All rights reserved. Made in Denmark.
Ver. 1.0

Learn more about Capture One 4 on www.phaseone.com/4

Learn more about Phase One 645 AF on www.phaseone.com/camera

On liability

The information in this user guide is provided “as is”.

Under no circumstances, including negligence, shall Phase One be liable for any incidental, special, direct, indirect or consequential damages arising out of or relating to use of the information provided in this guide with or without the software described in the guide.

Trademarks & acknowledgements

Capture One and Phase One are either registered trademarks or trademarks of Phase One A/S in the European Union and/or other countries.

All other trademarks are the property of their respective owners.



Contents

1.0	Introduction	4	5.0	Tethered shooting	54
1.1	Open Platform – Freedom of Choice	4	5.1	Connecting	54
1.2	warranty	5	5.2	Driver set-up	54
1.3	Recommended hardware	5	5.3	Tethered operations	55
1.4	Installing and Activation of software	6	6.0	The Back	56
1.5	Deactivation of Capture One 4	8	6.1	CF card usage	57
1.6	Screen calibration	9	6.2	Mounting and dismounting card on computers	60
2.0	The Body - the system	10	6.3	Navigating the Back menu	62
2.1	Unpacking the system	10	6.4	Playmode	65
2.2	Batteries for camera	12	6.5	Playmode – zoom functions	66
2.3	Batteries for the back	13	6.6	Menu Mode	68
2.4	The parts of the camera system	14	7.0	Custom function	80
2.5	Attach and remove lens	15	7.1	Setting custom functions	80
2.6	Attaching the back	16	7.2	Types of custom functions	81
2.7	The display	17		Custom Functions overview	85
2.8	The buttons	18	8.0	Lenses and Multi Mount	86
2.9	LED lights	18	8.1	Functions of the Phase One lens	86
2.10	Setting diopter	19	8.2	Function of the Phase One lens adaptor	87
2.11	Adjusting the Strap	19	8.3	List of alternative lenses	88
2.12	Eyeiece shutter	20	8.4	Lens Cast	89
2.13	Setting date and time	20	8.5	4 simple steps to calibrate on fixed lenses (MAC)	90
3.0	Basic functions	22	8.6	Large format and stitched images (MAC)	90
3.1	Setting ISO	22	8.7	4 simple steps to calibrate on fixed lenses (PC)	91
3.2	Easy Photography	23	8.8	Large format and stitched images (PC)	92
3.3	Measuring light – Exposure Metering	25	9.0	Software	94
3.4	Focus modes	27	9.1	Getting started	94
3.5	Using focus lock and infrared focusing	32	9.2	Importing from CF card	95
3.6	Shutter release modes	34	10.0	Large format and technical cameras	96
3.8	Flash photography	39	10.1	Large format photography	96
3.9	flash compensation settings	42	10.2	Technical cameras	97
4.0	Advanced functions	43	11.0	Maintenance	98
4.1	Exposure Compensation	43	11.1	changing the focusing screen	98
4.2	AE Lock	44	11.2	Battery socket	99
4.3	Auto Bracketing	46	11.3	Tripod/Electronic shutter release contact	99
4.4	Taking photos with the mirror up	48	11.4	Camera display error-notification	100
4.5	Long exposure - Bulb Mode	49	11.5	Lens maintenance	101
4.6	Camera display light	49	11.6	Back Maintenance	101
4.7	Front/rear dial lock mechanisms	50	11.7	housing specification	102
4.8	Depth of field	51	11.8	P+ series Technical specifications	103
4.9	Infrared photography	52	11.9	End User support Policy	104

1.0 Introduction

1.1 Open Platform – Freedom of Choice

Thank you for choosing the Phase One 645 Camera.

The Phase One 645 Camera provides you the most powerful digital camera solution whether you are working portable in the field, or tethered in a studio.

When shooting portrait, landscape, fashion, wedding, product or architectural photography you will always find a solution from Phase One that fits your needs.

The camera system gives you the absolute best solution when it comes to image quality and workflow thanks to the ongoing research and development made by the Phase One through more than 20 years. Phase One is committed to not only provide the best digital solution for the professional photographer, but also to ensure the photographer freedom of choice regarding lenses, bodies, back, software, and accessories.

The Capture One raw workflow software for Mac OS X and Windows™ is the new generation 4 software, with tethered shooting as your option.

The P+ Series of backs are legendary in the photographic business, used by world class photographers for years. The system comes in a suitcase and is ready to be used right out of the box.

We sincerely hope you will enjoy working with this new and innovative camera platform.

1.2 warranty

Please read the enclosed warranty certificate. Should any problem occur, please contact the place of purchase, your local dealer for consultancy. – Do not try to repair the camera yourself, unauthorized attempt for repairing will terminate the warranty.

1.3 Recommended hardware

Capture One 4 may run on older computers, but Phase One recommends following the minimum requirement to ensure the best result from Capture One 4.

Apple® Macintosh®:

G4, G5 or Intelbased Macs

768MB RAM

1GB of free hard disk space

Calibrated color monitor with 1280x800, 24-bit resolution

Mac OS X 10.4.11 or Mac OS X 10.5

Microsoft® Windows®:

Intel® Pentium® 4 or equivalent

768MB RAM

1GB free hard disk space

Calibrated color monitor in 1280x800, 24-bit resolution

Windows XP®, Service Pack 2 or higher

Windows Vista®

Microsoft® .NET Framework 3.0 Redistributable package – In case you do not already have this installed, Capture One will initiate installation of this.

We would recommend upgrading your computer in the areas below if you work with high pixel-count cameras or simply want to optimize performance:

Use processors with multiple cores, e.g. Intel Core™ DUO or better.

Having 2GB RAM or more.

Plenty of hard disk space for your images.

1.4 Installing and Activation of software

You can only install Capture One 4 when your computer is connected to the internet. unless you choose to install DB only.

Install on Mac OS X:

Capture One software includes an easy-to-use installer that will install all the software necessary to run the application on Mac OS X.

To install the software follow the procedure below:

1. Either load the Capture One DVD, or download the application from the Phase One website: www.phaseone.com.
2. Open the Capture One disk image
3. Read and accept the license agreement presented
4. Drag the Capture One icon to the Applications folder
5. Open Capture One from your Applications folder

Install on Windows:

Capture One 4.1 includes an easy-to-use installer that will install all the software you need to run the application on a Windows based computer.

To install the software follow the procedure below:

1. Either load the Capture One DVD, or download the application from the Phase One website: www.phaseone.com.
2. Run the executable software install file.
3. Read and accept the license agreement presented
4. Follow the on-screen instructions to complete the installation.

- In case you do not already have Microsoft® .NET Framework 3.0 installed, Capture One will initiate installation of this.

To activate Capture One 4 you normally need to be connected to the internet. **But installing as Digital Back Only does not need internet connection.**

Open the license activation dialogue via the menu Capture One>License.

Your first step towards activating Capture One is by opening the license activation dialogue in the application as illustrated.

Enter your License code and personal details In the license activation dialogue, type in the license code provided with your purchase of Capture One. You received the License code either by email or with the original software package.

Type in the personal details that you want to register along with your software activation. Once you have entered the information press the “Activate License” button and your activation will be validated by Phase One’s activation server. Your software is now activated and ready for use!

Troubleshooting

If you are experiencing problems activating the software, follow the instructions provided in the application, read the software manual enclosed or visit our website for inspiration and troubleshooting: <http://www.phaseone.com/support>



1.5 Deactivation of Capture One 4

To deactivate Capture One 4 from a computer you need to be connected to the internet.

Open the license dialogue via the menu Capture One>License.

Press the Deactivate button.

Once you deactivate Capture One, the application will return to trial mode. If the trial period for the computer has expired, all current and pending processing will be cancelled, and you will not be able to continue working with the application until you reactivate it.

Confirm that you want to perform the deactivation. After doing so, you can activate Capture One on another computer.

1.6 Screen calibration

Your monitor is key-element in your daily workflow. One thing that assists your ability of viewing the captures you have made is by using color neutral light.

Consider your monitor the new digital lightbox. To ensure accuracy, monitors need to be hardware calibrated for accuracy. A quality monitor and calibration tool provides you with a guarantee that what you are seeing on screen is correct. Once a monitor has been calibrated, the color and brightness controls should be locked to prevent inadvertent changes.

Hardware-based monitor calibrators are now available at reasonable prices. The process is simple, quick and enables images to be judged with certainty. Higher level monitors have internal calibrating software that works with professional calibration devices for ultimate accuracy.

2.0 The Body - the system

The Phase One Camera system is created to provide as much flexibility and openness as possible. Phase One have for years been producing the 2 lines, Classic and Value Added, below here you can see the content of the 2 different kits.

2.1 Unpacking the system

The Phase One 645AF system is delivered in a case created for the travelling photographer, the waterproof and impact resistant case has the standard measurements of carry-on baggage in airplanes.

Open the case by pressing and pull-back the latches on the front/ opening.

Classic:

The case is flexible inside, created for you to decide the actual content and interior of the case. But as delivered the case will hold:

- Phase One 645 AF body with
- P+ Digital Back
- Phase One 80mm f 2.8 Lens
- Waterproof flexible case in carry-on size

Pouch 1

- 4.5 meter FireWire cable
 - Digital back duo-battery charger
 - Digital back battery
 - Capture One raw workflow software
 - Battery charger power supply
-
- International outlet adaptors
 - Protection caps body, lens and back

Startbox

- USB key with User Guide, technical documents and more
- Quick Guide
- Warranty Brochure

Value Added:

Case

- Phase One 645 AF body with
- P+ Digital Back
- Phase One 80mm f 2.8 Lens with lens hood and cap
- Waterproof flexible case in carry-on size with room for laptop computer
- CF card installed
- 4.5 meter FireWire cable
- QP reference grey card
- Lens cast calibration card
- Capture One raw workflow software
- Sensor Cleaning Kit

Startbox

- USB key with User Guide, technical documents and more
- Quick Guide
- Warranty Brochure

Pouch 1

- Digital back battery charger
- Two digital back batteries

Pouch 2

- Battery charger power supply
- International outlet adaptors
- CF card reader
- CF card reader cable
- Camera power module

Accessories Box

- Phase One 645 AF-HB multi-mount
- Protection caps body, lens and back
- Lens cleaning cloth

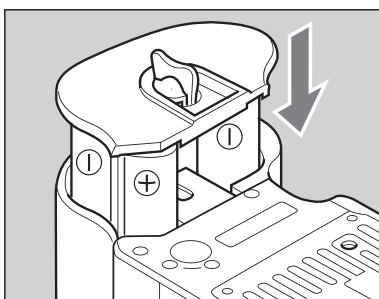
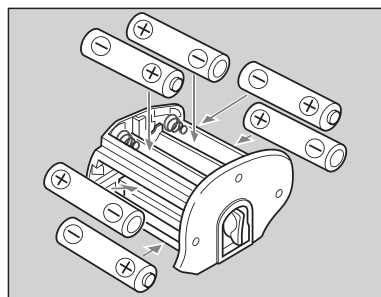
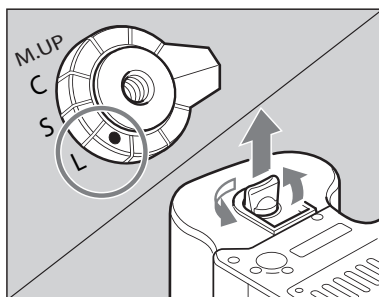

The batteries are sufficiently charged.



There is little power remaining. Have new batteries on hand. Camera will still operate.



There is very little power remaining. Camera will not operate. Set the shutter release mode selector lever to "L" (to turn the power off) and replace the batteries with new ones.



When the batteries are emptied for power, "batt" flashes on the main LCD and the viewfinder's LCD when the shutter release button is pressed.

2.2 Batteries for camera

Set the shutter release mode selector lever to "L" (to turn the power off).

Use six "AA" alkaline.

NiCD batteries should only be used in the camerabody if CF07 is set on rechargeable.

1. Lift the battery case lock lever, turn it counter clockwise and pull out the battery holder.

2. Insert fresh batteries with the + and - ends as shown in the drawing.

3. Return the battery holder to its case and lock it by turning the lever clockwise. Make sure it is firmly attached.

- Be sure the batteries are placed with proper polarity

Checking the Battery Power

Set the shutter release mode selector lever to "S" (to turn the power on).

Check the battery condition in the lower right corner of the top LCD display.

When replacing the batteries, be sure to use six new batteries of the same type. Do not mix different types of batteries or old batteries with new ones. NEVER throw out batteries.



2.3 Batteries for the back

When the system is unpacked the first thing to do, is to give the batteries a full charge.

In the Value Added Suitcase comes with two 7.2 volt Lithium-Ion batteries.

Only one battery is used in the P+ back at a time, but it is recommended to charge both batteries fully before you start.

While charging the batteries, you can still use the camera back if you connect it to the IEEE1394/FireWire port on your computer, by using the 6pin FireWire.

The charger can adapt to voltages within a range of 110 to 250 volts.

It comes with an international set of source outlet adaptors (placed in the suitcase utility compartment), please select one that fits your outlet, and mount it by sliding it in from the top.

Connect the unit to the outlet and charge the batteries (approximately 2,5 to 3 hours).

NEVER throw out batteries, when a battery does not work, deliver the battery for appropriate disposal.

Purchasing extra batteries

The Phase One P+ back comes with two 2500mAh batteries. If you need to purchase extra batteries Phase One recommend Canon BP 915 2500 mAh.

Due to difference in the tolerances of some third party batteries, these may not fit into the digital back's battery compartment. Do not try to force a battery into the compartment. When pressing the battery release button it should slide in without problems.

Warning!

- Only use the Charger to charge the specified batteries
- Do not allow charger to get wet or get exposed to moisture
- Keep the Charger out of reach of children
- Once charging is completed, unplug the transformer from power source
- Only use the original mains adaptor 12V DC or car lead
- Never apply excessive force when connecting or disconnecting a battery or contact plate.
- Keep all contacts clean.
- Do not force down any of the contacts.
- Do not short-circuit the contacts.
- Never store the battery connected to the charger for an extensive period of time.
- Do not expose to excessive heat or naked flame.
- Do not dismantle or carry out any alteration to the product

2.4 The parts of the camera system

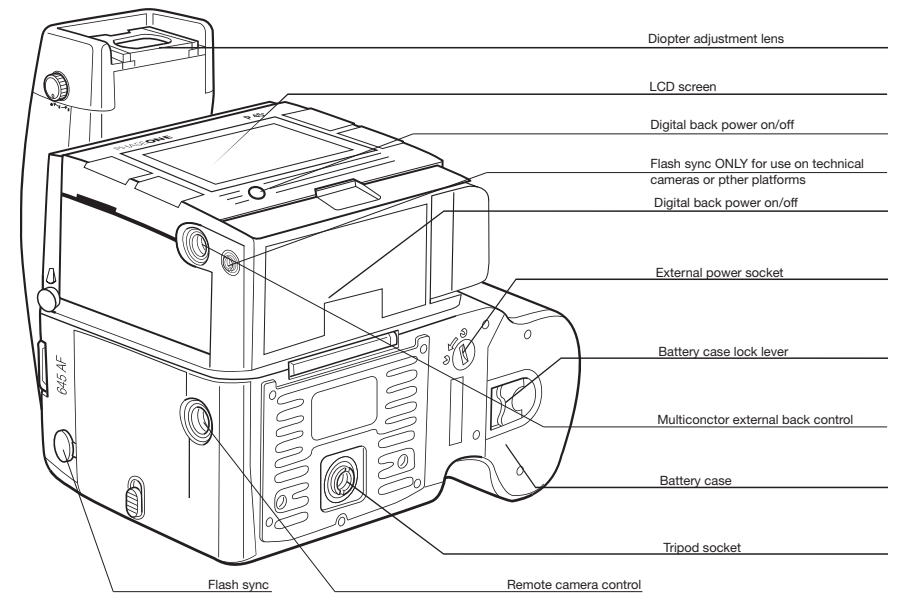
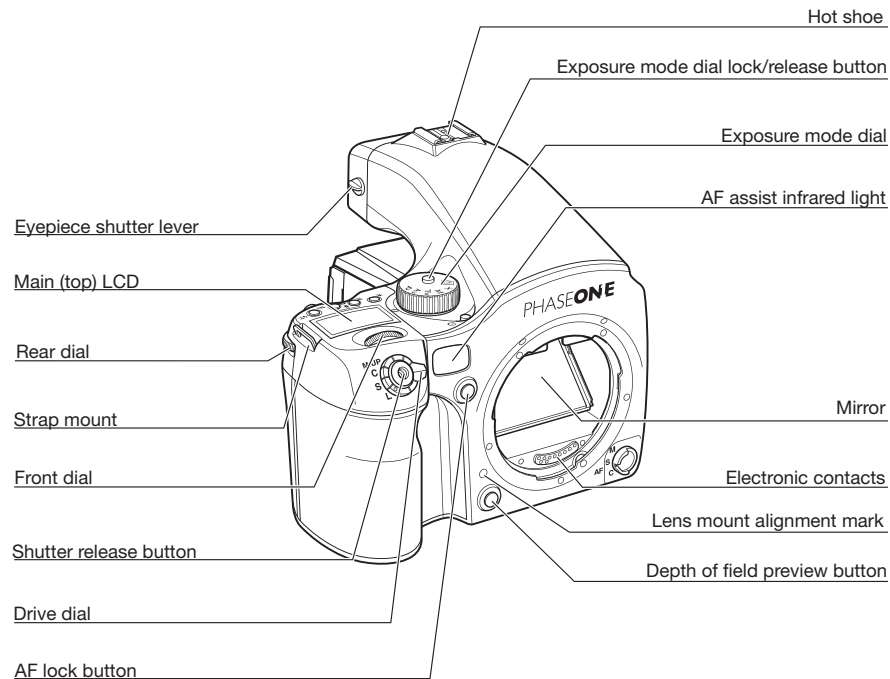
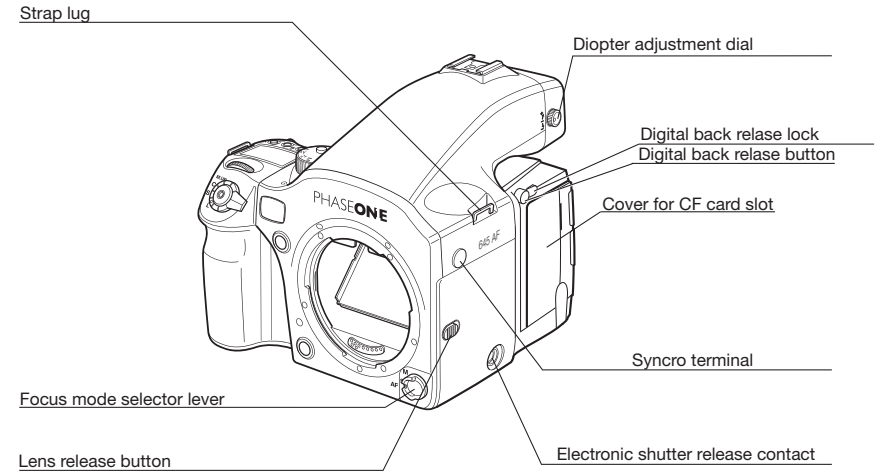
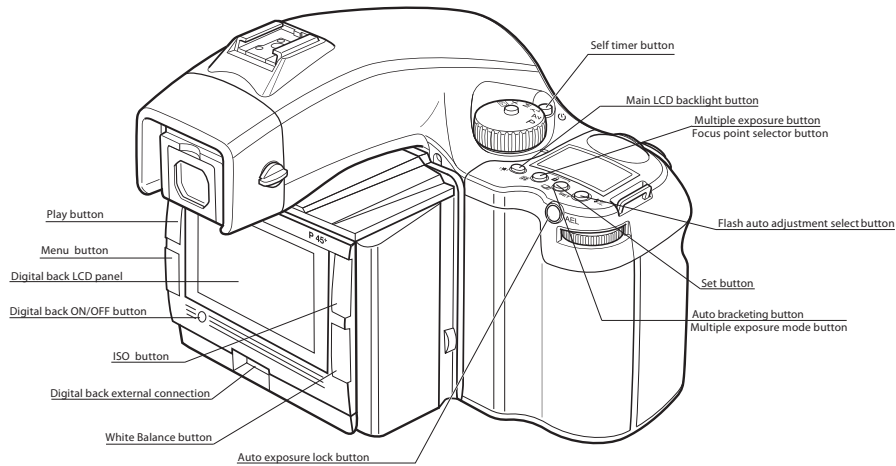

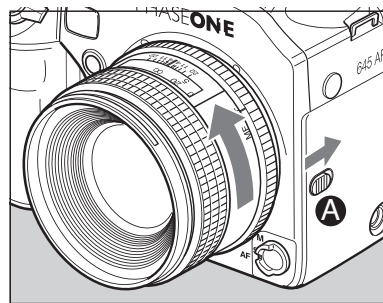
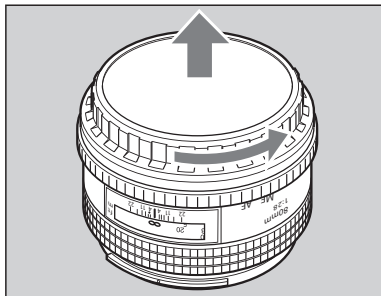
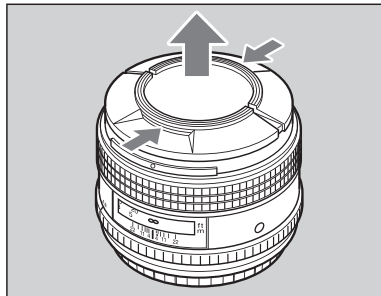
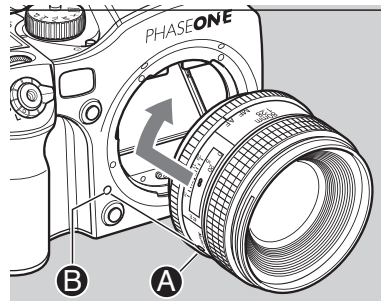
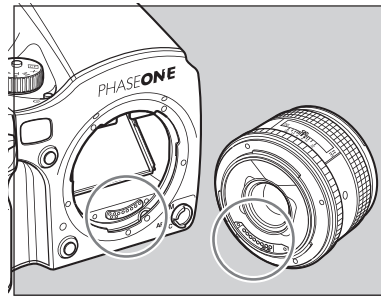
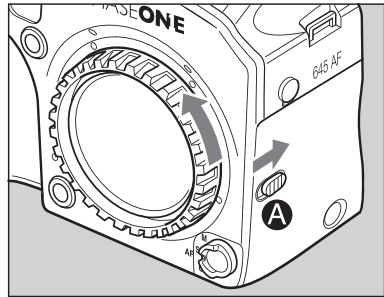

2.5 Attach and remove lens

1. Remove the front body cap, just like you would remove a lens, by pushing the lens release button backward and then turn the front body cap or the lens itself counter clockwise and lift out.

2. Align the white alignment dot of the lens [A](on the shiny flange) with the camera's white dot[B], fit the lens into the camera and rotate it clockwise until it clicks into place.

To remove the front lens cap, squeeze the shiny sections together and lift out.

To remove rear lens cap turn it counterclockwise.

Removing

While sliding the lens release button back, rotate the lens counter clockwise until it stops and lift it off.

After removing the lens from the camera body, protect both ends by attaching the caps.

Oil, dust, fingerprints or water on the electronic contacts could result in malfunction or corrosion. Wipe such impurities off with a clean piece of cloth.

Do not touch the distance ring or other rotating parts when attaching the lens. - When installing a lens, do not press the lens release button.

2.6 Attaching the back

The P+ back is fully integrated with the camera body and is a part of the whole camera system.

When no cassette is attached to the Phase One 645AF camera house the mirror is up and the shutter is open. This is the correct position when no back is attached.

When attaching the P+ back to the camera body the shutter will close and the mirror comes down. It is important to ensure that the bottom part of the P+ back is pressed well into the locking mechanism on the camera back before the upper locking mechanism is pressed together.

Failure to do this can cause an error with the camera body. The error is a state of continuously opening and closing the shutter. If this occurs, remove the P+ back.

Please be aware that the shutter should be in the correct starting position (shutter open), if this is not the case, attach and remove the P+ back again to make sure that the camera body gets in the correct starting position.

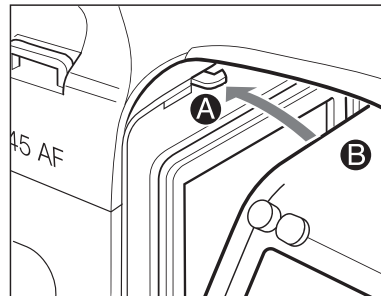
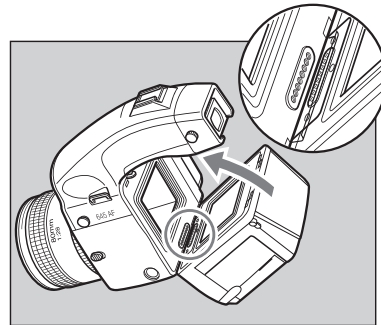

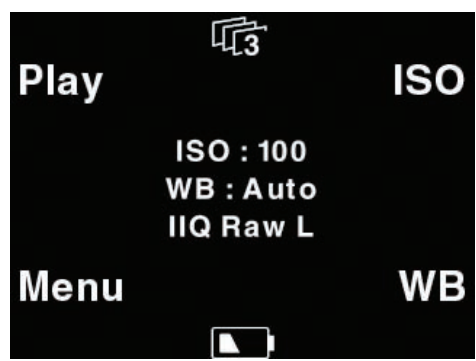
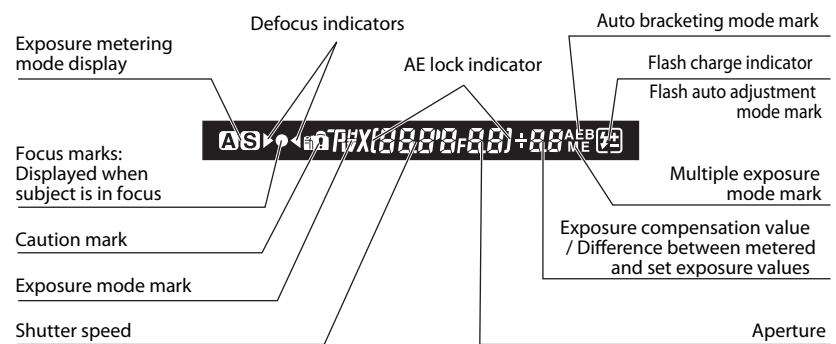
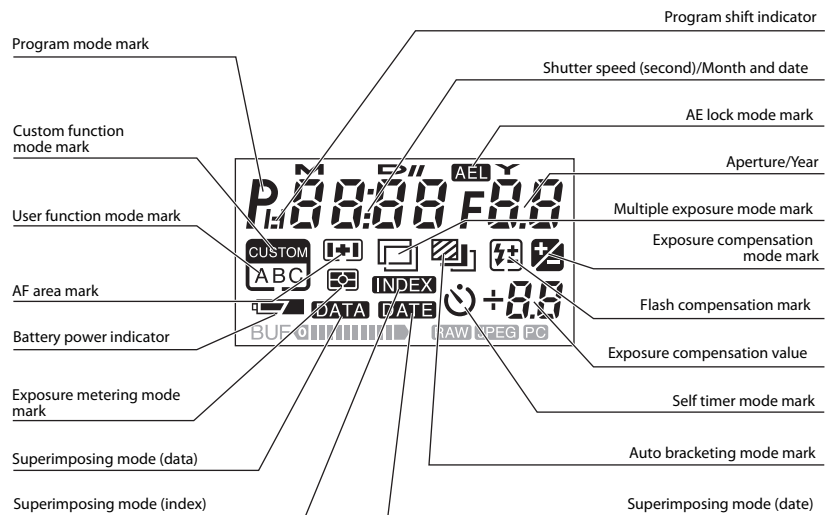

2.7 The display

The display on the camera housing will provide valuable information on shutterspeed/aperture value also you find information on exposure program, compensations see the drawing for explanation; the most relevant information regarding the capture can be read on the bottom display in the viewer along with the auto-focus mark indicating that the focus is in place.

The display on the back is a multifunctional display, the menus changes depending on the status and choices you make.

Besides providing navigation, the display on the back can work as preview screen.

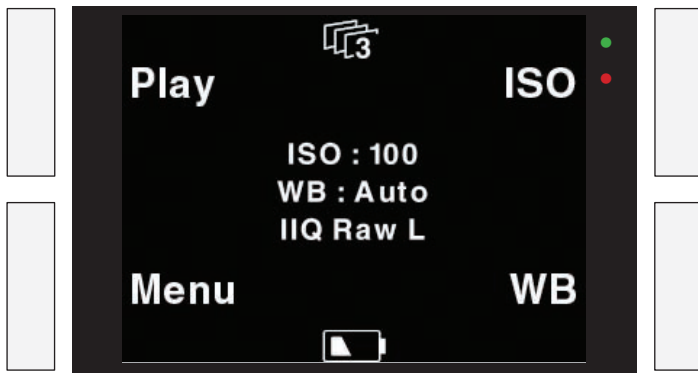

2.8 The buttons

The back is equipped with four buttons, these buttons will take you through all functions of the back, and the buttons will change function to match the menu shown on the display. Read more on the menus in the chapter regarding this.

2.9 LED lights

When the camera is powered up you will see a short blink in the green and red LED's in the right hand side of the display and you will hear a ready beep. The lights will turn off immediately. This is an indication that the camera is ready to capture.

Green: When capturing an image the green LED is blinking rapidly to indicates that the P+ back is busy.

Steady green light indicates that the backlight of the display is dimmed but the camera is still ready to shoot.

(The time before this happens can be set in the P+ back and is described later under "Menu mode")

RED: If the red LED is on this indicates that the P+ back is writing to the storage media thereof the buffer is not emptied.

The red LED indicator located just beside the CF-cardslot under the cover in the left side is assigned to only indicate CF card activity.

When the red CF-slot LED is on do not remove the card from the card slot! This can damage the formatting of the card, resulting images or data might be lost or corrupted.

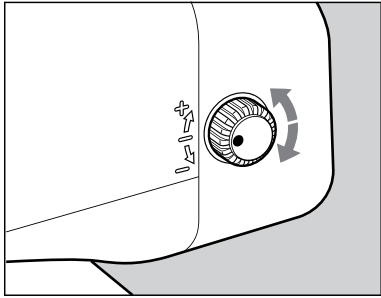

2.10 Setting diopter

Look through the viewfinder and make sure that the focus frame (Rectangle with Circle) is in sharp focus. If it is not, turn the diopter adjustment dial in the “-” direction if you are nearsighted, in the “+” direction if you are farsighted. If this is not sufficient you may require an optional diopter correction lens. See below.

Point the camera at a bright, plain object such as a white wall when making this adjustment.

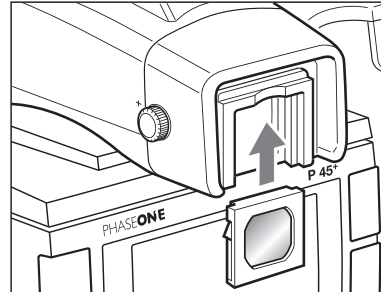
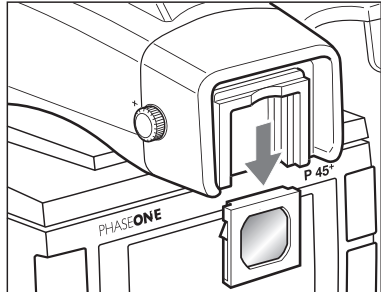

Replacing the Diopter Correction Lens

If there is dirt or dust on the lens surface, remove it with a blower or sweep it off gently with a lens brush.

If there are fingerprints or dirt on the lens surface, wipe them off with a piece of clean, soft gauze.

Using solvents could discolor the diopter correction lens frame.

1. Remove the lens supplied with the finder by pulling it downward.
2. Push the replacement diopter correction lens upward into the viewfinder's eyepiece frame until it clicks into place.

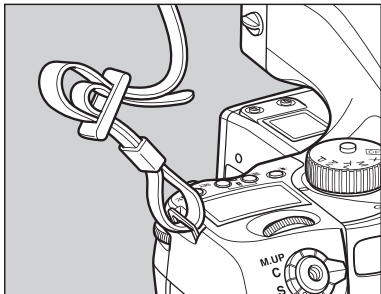
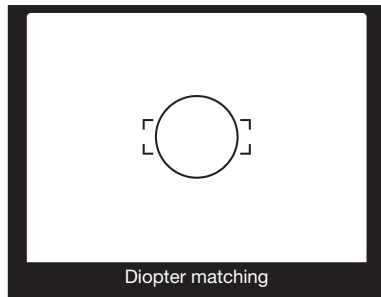
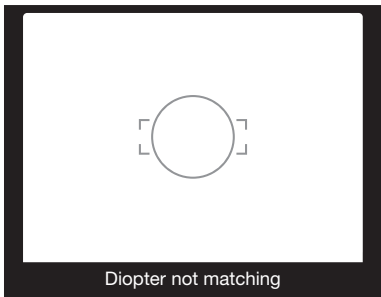

2.11 Adjusting the Strap

Put the neck strap through the mounts and secure it to the buckle as illustrated.

After attaching the strap, pull it and make sure it does not loosen at the buckle.

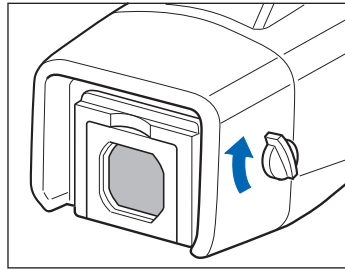

2.12 Eyepiece shutter

Close the eyepiece shutter when there is a strong light source behind the camera or when pressing the shutter release button without looking through the viewfinder.

(This prevents exposure error due to light entering from the viewfinder.)

Turn the eyepiece shutter lever in the direction of the arrow.

2.13 Setting date and time

Date and time is set and controlled through the digital back.

Default date and time is GMT+1.

If the digital back has been without power for a longer period of time, it will automatically ask you to setup time and date when it is powered up.

In the “Time & Date” menu you can set the time and date using the four buttons on the P+ back. Left side buttons will step through the hours, minutes and seconds field, while the right up and down buttons can be used to set the value of the fields.

The time and date is applied to all files captured with the P+ back.

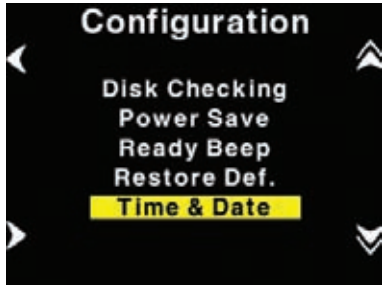

3.0 Basic functions

3.1 Setting ISO

ISO functionality is controlled by the back.

The default ISO setting is ISO 50 or 100 depending on the back of the Camera system. A rule of thumb is that the higher ISO you are using, the higher is the degree of noise in the image, though Capture One has a powerful noise reduction.

Depending on the back the Phase One ISO scale is currently 50, 100, 200, 400, 800 OR 100, 200, 400, 800, 1600 using the button on the top left, when in the main menu on the back scroll up and down and press “enter” and the desired ISO is chosen, OR if using tethered mode use the Capture panel in the Capture One application.

ISO and White Balance

When the display is in its home position the two buttons to the left, ISO and WB brings you directly to the ISO and White balance settings, where you can scroll up and down, and select the setting you want with the “Enter” button. Also White Balance can be controlled by Capture One if you are working tethered.

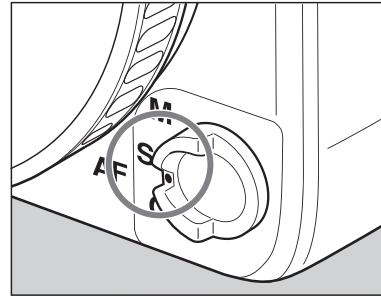
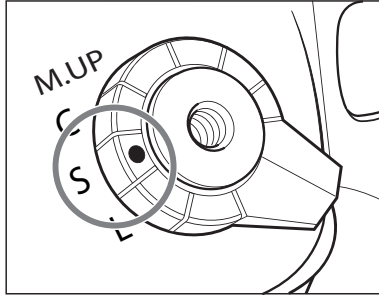

3.2 Easy Photography

1. Set the shutter release mode selector lever to “S” (single-frame advance mode).

There are two shutter release modes: “S” (singleframe advance mode) and “C” (continuous advance mode).
When set to “L,” the power is turned off.

2. Set the focus mode selector lever to “S” (single focus mode).

There are three focus modes: “S” (single focus mode), “C” (continuous focus mode) and “M” (manual focus mode).

3. Set the exposure mode selector dial to “P” (program auto exposure).

There are four exposure modes:

- “P” (program AE),
- “Av” (aperture priority AE)
- “Tv” (shutter priority AE)
- “M” (manual mode).

Focus Mode		Focusing
S	Single focus mode	Half-press the shutter release button to focus. When the focus mark lights, the focus is fixed and the shutter can be released.
C	Continuous focus mode	The camera keeps focusing continuously while the shutter release button is half-pressed. The shutter can be released regardless of whether or not the focus mark is lit.
M	Manual focus mode	Focus manually.

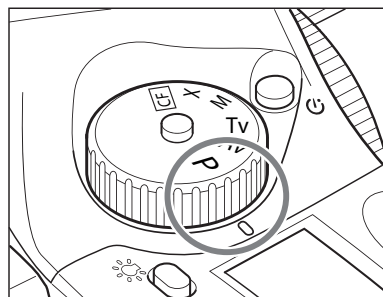

P: Program AE - The aperture and shutter speed are determined automatically according to the shooting conditions. This mode is best suited for general photography, since it allows you to concentrate on the shooting. You can change the shutter speed and aperture by turning the front and rear dials while the “P” (Program AE) mode is selected.

Av: Aperture priority AE - Set the desired aperture and the camera selects the correct shutter speed. Use this mode to control depth of field.

Tv: Shutter priority AE - Set the desired shutter speed and the camera selects the correct aperture. Use this mode to stop motion.

M: Manual mode - Set this mode when you want to use special combinations of the aperture and shutter speed.

4. Exposure metering mode is automatically set to average/spot exposure metering before exposure metering is performed.

There are three exposure metering modes: In the “A” mode the average brightness in the entire frame is measured with emphasis on the center of the frame. The brightness at a specific spot in the center of the frame is metered in the “S” mode. The “A-S” mode automatically switches between these two modes depending on the contrasts in the picture.

)

NOTE:

When a polarizing filter is used, ensure that a circular polarizing filter(C-PL) is used. The correct exposure cannot be obtained with a normal(linear) polarizing filter (PL).

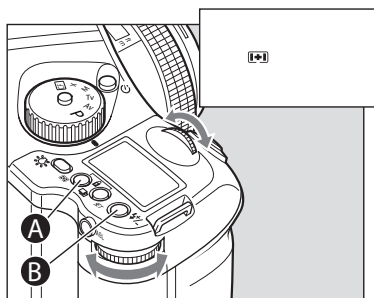

3.3 Measuring light – Exposure Metering

1. Exposure mode mark is displayed when the exposure mode button A is pressed. Since three different exposure modes are displayed sequentially when either the front or rear dial is turned, select an appropriate exposure mode.

2. Press the SET button or exposure metering mode button A to enter the setting.

Average/spot auto exposure metering	<p>Exposure metering is performed after automatically selecting average/spot exposure metering. • Depending on the subject conditions, center-weighted average/spot exposure metering is selected automatically, and the correct exposure is measured.</p> <ul style="list-style-type: none"> • Spot exposure metering is automatically selected when the brightness of the spot exposure metering range becomes darker than the brightness of the entire screen. • If there is very little difference between the spot exposure metering value and center-weighted average exposure metering value, the correct exposure level is obtained as the intermediate value.
Center-weighted average/spot exposure metering	<p>The average brightness of the entire screen is measured, emphasizing the center of the screen.</p>
Center spot exposure metering	<p>The brightness of an area equivalent to 7.6% at screen center is measured, and the exposure is determined. The circle at screen center serves as a general guideline. This mode is suited to measuring subjects with strong contrasts or measuring only screen portions.</p>

Exposure Warnings

With an inappropriate exposure setting, when shooting subjects that are too light or dark, the user is warned by the flashing external LCD or the LCD inside the viewfinder.

At such times, the correct exposure cannot be obtained.

Warnings that the exposure is outside the metering range

- Program AE (P)
The shutter speed and f-number blink.

- Aperture priority AE (Av)
The shutter speed blinks.

- Shutter priority AE (Tv)
The f-number blinks.

- Manual mode (M)
The exposure metering value difference is displayed.



NOTE:

you can change the amount of time the metered value is shown by entering Custom Settings C-04.

Exposure compensation

In some situations, such as a great difference between the subject and background brightness or overall subject tones that will not meter correctly because they are all black or white, the resulting photograph may be under- or overexposed. When this occurs, use the exposure compensation function. Exposure compensation can also be used when you want to intentionally create overexposed or underexposed pictures.

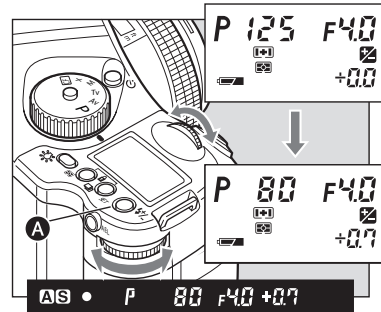

1. When exposure compensation button A is pressed, [+/-] appears on the external LCD. When the front or rear dial is turned counterclockwise, the exposure is increased; conversely, when it is turned clockwise, it is decreased. The exposure compensation value can be checked on the external LCD or LCD inside the viewfinder.

2. After taking the pictures, press exposure compensation button A again to return the exposure compensation value to 0. The exposure compensation value mark on the external LCD is cleared, and the exposure compensation function is released.

After taking pictures using the exposure compensation feature, be sure to return the exposure compensation dial to the “0” position.

Exposure compensation is also possible during AE lock.

The shutter speed changes with exposure compensation in manual mode (“M”).

Display of the exposure compensation of the viewfinder LCD
- Without usage of Metz Flash.

Exposure Mode	Exposure Compensation display	
P	Program AE	The set value is displayed
Av	Aperture priority AE	
Tv	Shutter Priority AE	
M	Manual mode	The difference between the metered value and the set exposure value is displayed
X	Synchro mode	Not displayed

NOTE:

1. The width of the exposure compensation step can be changed.
Custom settings 01
2. The maximum exposure compensation step can be changed to $\pm 5EV$.
Custom settings C-05 .

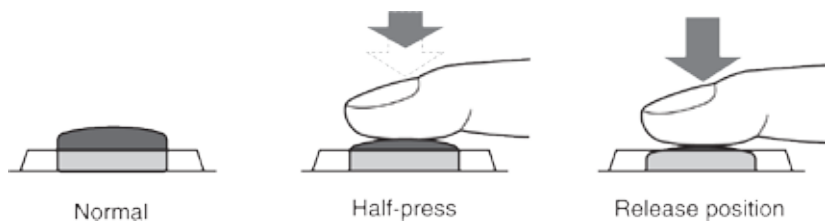

3.4 Focus modes

If autofocus AF is desired, chose AF on the focusing selector ring on the lens, then chose between S(single) and C(continuously) focusing. The Focus selection ring on the lens will help you to rapidly switch between AF and M, without having to change your grip of the camera.

The shutter release button has a two-step action. When pressed lightly it stops at a certain point. In this manual this position is called the “half-press” position. When you “half-press” this button, the camera functions are activated. When the shutter button is pressed further down, the shutter is tripped. This position is called the “full-press” position.

When you “half-press” this button, camera functions are activated.

1. Aim the camera so that the subject is within the focus frame.
2. Half-press the shutter release button, and focus will be adjusted automatically.

When the focus mark lights, the picture is in focus.

3. When lights, press the shutter release button further down to release the shutter.

Out of focus Marks

Flashing: The picture is not focused and the shutter cannot be released.

Either press the shutter release button again to adjust the focus or move the camera to change the position of the focus frame.

While the camera is operated in the auto focus mode, lenses not equipped with the focus mode selector ring turn their focusing rings automatically to focus. Do not touch the focus ring.

Lenses with the focus mode selector

When a lens with the focus mode selector is attached and the focus

mode selector lever of the camera body is set at “S” or “C”, you can change focus modes between automatic and manual with the selector of the lens.

To use the auto focus function, both the camera body and the lens have to be set in the auto focus mode.

When either the camera body or the lens is set in the manual focus mode, auto focus does not function.

See the instruction manual for each lens for the way to switch focus modes on the lens.

Single focus mode (S)

This mode uses the focus-priority mechanism. The shutter can be released when the focus mark in the viewfinder is lit. This mode is suited for still subjects. Focus is locked when the focus mark lights in the viewfinder's LCD.

The shutter cannot be released if the subject is not in focus (if the focus mark does not light).

To take another photo with a different composition, take your finger off the shutter release button then re-press the shutter release button again.

Continuous focus mode (C)

In this mode shutter release has priority to focusing. The shutter can be released regardless of whether the focus mark in the viewfinder's LCD is lit. Focus is adjusted continuously while the shutter release button is half-pressed. This mode is suited for moving subjects.

Focus is not locked even if the focus mark is lit.

The shutter can be released even if the focus mark is not lit.

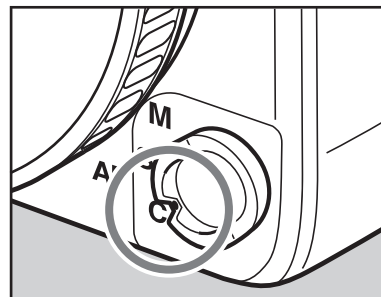
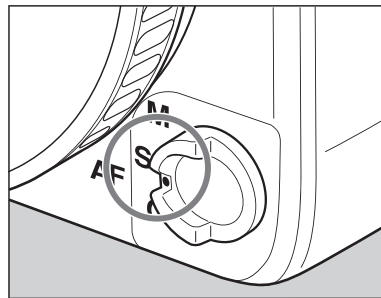

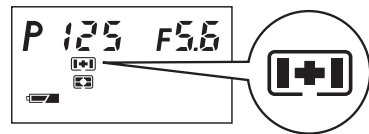

Focus point selection mark

Notice:

You can select whether or not to display the focus mark and the out of focus direction mark. Custom settings C-18.

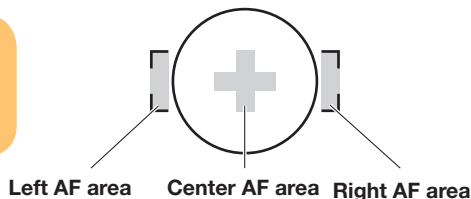

Left AF area Center AF area Right AF area

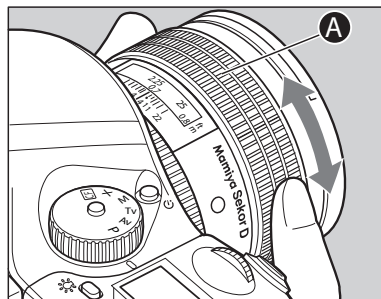
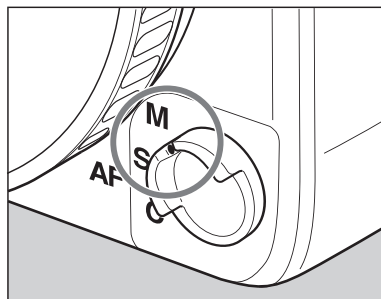

Focus Areas

You can select the focus area that best suits the kind of pictures you intend to take. The selected focus area can be checked on the external LCD panel.

Normal focus area

Position the subject within frame in the focus fame in the viewfinder. If there are multiple objects in the focus frame located at various distances, the camera will focus the nearest object.

Spot focus area

The camera focuses at the center of the mark in the focus frame [O] in the viewfinder.

Manual Focus Mode (M)

The auto focus function can be cancelled, and you can focus manually.

1. Switch to “M” (manual focus mode).
Turn the focus mode selector lever and set it to “M” (manual focus mode). [MF]Appears on the top LCD panel.

2. Manual Focus Operation for Telephoto and Zoom lenses.
All Mamiya 645 AF Telephoto and Zoom lenses can be switched from Auto Focus to Manual Focus by sliding the focusing ring on the lens FORWARD until it clicks. When this is done, the “Auto Focus” inscription on the lens barrel is covered and the lens can then be focused manually. When the FOCUSING RING is set in this position the external LCD display on the top of the camera will show. It is not necessary to set the FOCUS MODE SELECTOR on the body to “M”. To switch back to auto focus, simply slide the focusing ring BACK towards the camera and the “Auto Focus” inscription on top of the lens will again be visible. This method applies to Mamiya 645 AF Telephoto and Zoom lens only.

3. Adjust the focus.

Turn the lens focusing ring until the subject is in focus. When it is in focus, the focusmark lights on the viewfinder LCD.

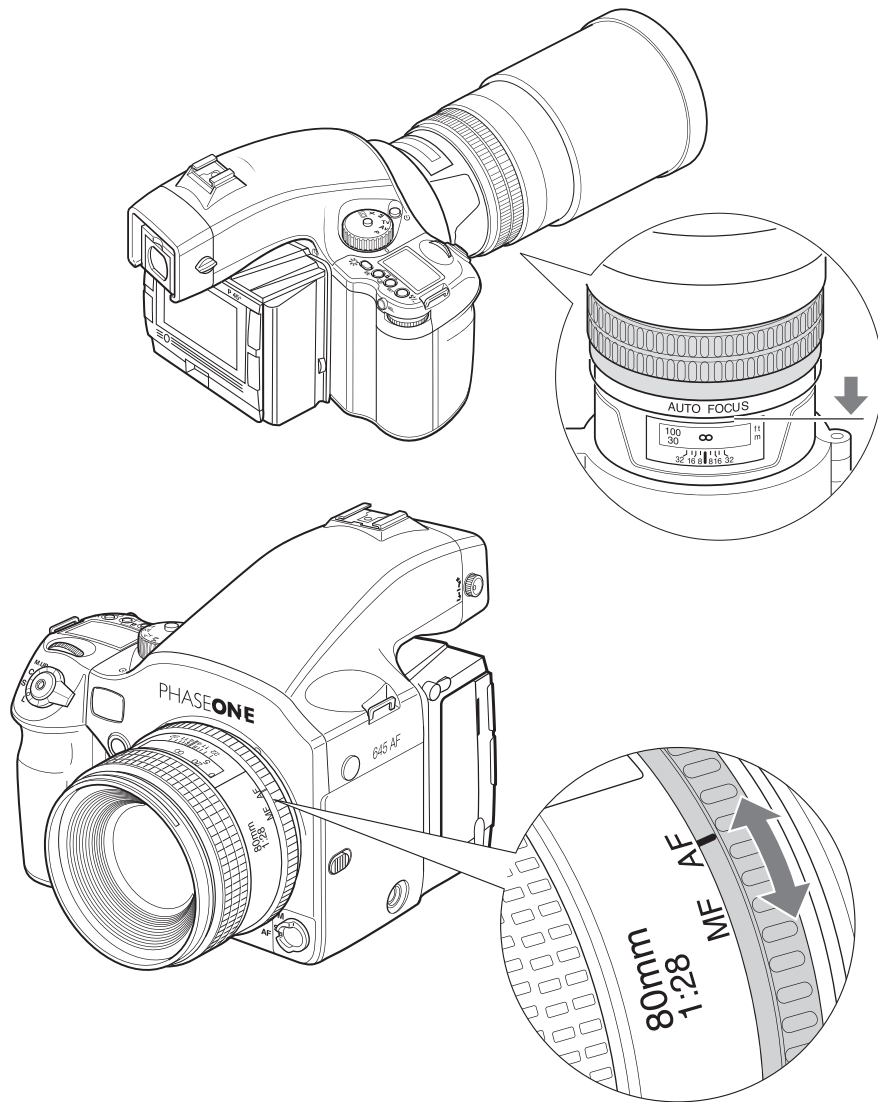

Manual focusing

1. Switch to “M” (manual focus mode).

Turn the focus mode selector lever and set it to “M” (manual focus mode). Appears on the external LCD panel.

2. Manual Focus Operation for Telephoto and Zoom lenses.

All Mamiya 645 AF Telephoto and Zoom lenses can be switched from Auto Focus to Manual Focus by sliding the focusing ring on the lens FORWARD until it clicks. When this is done, the “Auto Focus” inscription on the lens barrel is covered and the lens can then be focused manually. When the FOCUSING RING is set in this position the external LCD display on the top of the camera will show. It is not necessary to set the FOCUS MODE SELECTOR on the body to “M”. To switch back to auto focus, simply slide the focusing ring BACK towards the camera and the “Auto Focus” inscription on top of the lens will again be visible.

This method applies to Mamiya 645 AF Telephoto and Zoom lens only.

3. Adjust the focus.

Turn the lens focusing ring A until the subject is in focus. When your motive is in focus the focus mark lights in the viewfinder LCD.

- When a lens with the focus mode selector is attached and the focus mode selector lever of the camera body is set at “S” or “C”, you can change focus modes between automatic and manual with the selector of the lens.
- To use the auto focus function, both the camera body and the lens have to be set in the auto focus mode.
- When either the camera body or the lens is set in the manual focus mode, auto focus does not function.
- See the instruction manual for each lens for the way to switch focus modes on the lens.

Manual focusing using the focus mark (Focus confirmation method)

With this camera, the focus mark lights in the viewfinder's LCD when the picture is in focus. With the shutter release button half-pressed, turn the lens focusing ring to focus on the subject. When the subject is in focus, the focus mark lights in the viewfinder's LCD.

If it is lit in the viewfinder's LCD, the camera is focused on a point behind the object. If it is lit, the camera is focused on a point in front of the object.

- Use the focus mark when taking photos in manual focus mode or using the M645 manual lens.

- If you adjust focus using the focus mark with an M645 lens, make sure to open the aperture. You can use this function with a lens of f/5.6 aperture or higher.

- You can set the camera so that only the focus mark is displayed. Custom settings C-18

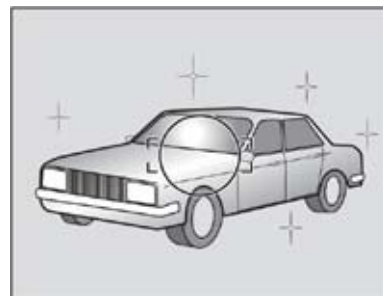
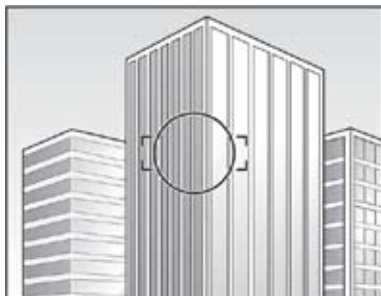
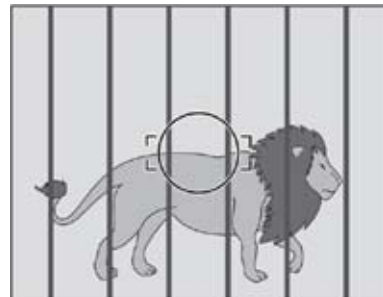
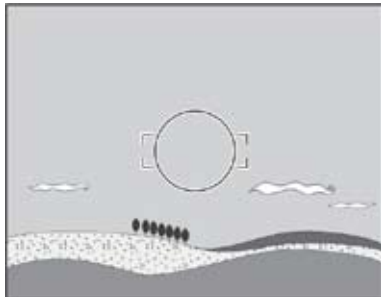
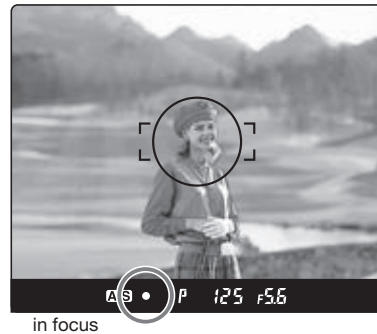

When Auto Focus is Failed

The auto focus function requires contrast on subject. Auto focusing may fail to achieve focus with certain subjects described below. In such cases, either switch to the manual focus mode and focus manually or focus an object at the same distance as the object you want to photograph, lock the focus using the focus lock mechanism, then take a picture.

- Low-contrast subject (blue skies, white walls and other objects)
- Two or more objects overlapping at different distances within the focus frame (animals in cages, etc.)
- Subjects with continuous repeated patterns (building exteriors, blinds, etc.)
- Extremely backlit reflective subjects (car bodies, water surfaces, etc.)
- Or when the subject is far smaller than the focus frame

3.5 Using focus lock and infrared focusing

Using the Focus Lock Function

If the object that you want to focus on is not in the focus frame, the camera focuses on the background at the center. In such cases use the focus lock function to lock the focus before releasing the shutter.

1. Set the focus mode selector lever to “S” or “C.”

Put the subject in the focus frame and halfpress the shutter release button.

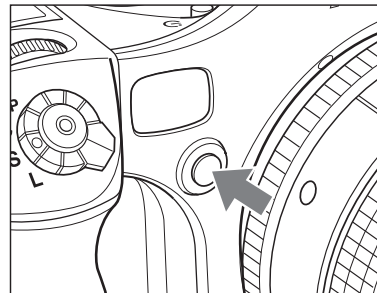
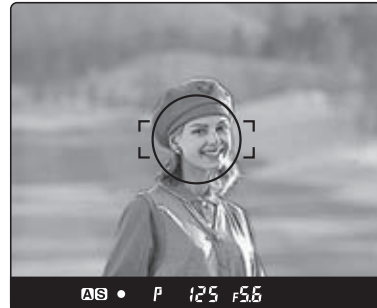

2. Lock the focus.

When the focus mark in the viewfinder LCD is lit, press the AF lock button on the front of the camera to lock the focus.

3. Adjust the composition.

With the shutter release button half-pressed, slide the camera to achieve the desired composition, and release the shutter.

When the focus mode is set at “S” (single focus mode) and the focus mark is lit, hold the shutter release button halfway down to lock the focus.

NOTE

Assignment of the AEL and AFL buttons can be swapped.
Custom settings C-15.

- You can set the camera so that when the AFL button is pressed, AF is activated and AF lock is performed Custom settings C-19.

AF Assist Infrared Light

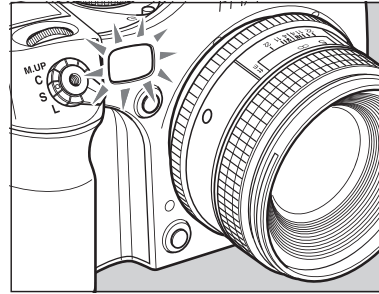

When the subject is dark or very low-key and the camera can fail to auto-focus, a red lamp may light on the front of the camera when the shutter release button is half-pressed. This light assists the camera's auto focus function.

Notice:

The AF assist infrared light is emitted only when the focus mode is set to "S" (single focus mode).

Effective range of the AF assist infrared light is limited. It does not reach distant subjects. - Range: 9m/29.5 ft. (using 80 mm f/2.8 lens)

When using a lens hood or a bellows lens hood (sold as an optional accessory) that may interfere the assist light, set focus before mounting the hood.

The AF assist infrared light can be disabled. Custom settings C-26.

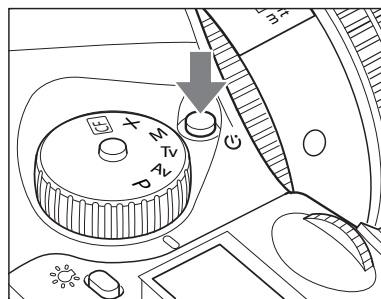
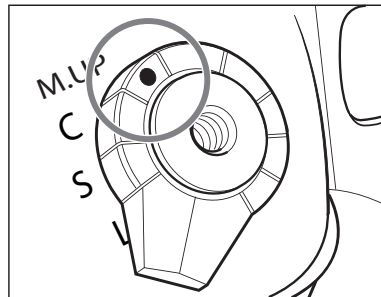
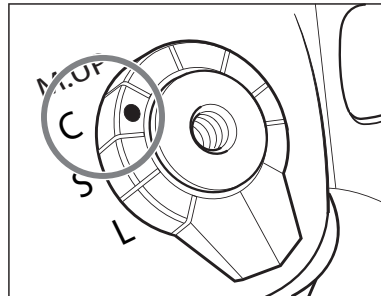
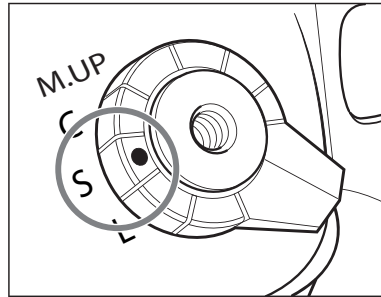

3.6 Shutter release modes

Single-Frame Mode

The film is advanced one frame each time the shutter is released.

Set the shutter release mode selector to “S”

Continuous Mode

Photos are taken as long as the shutter release button is pressed.

Set the shutter release mode selector lever to “C”. Photos are taken continuously at a rate depending on the buffer speed of the back mounted on the camera.

Mirror up mode

When the shutter button is half-pressed, the mirror moves up, and when the shutter button is pressed again, the shutter is tripped, and a picture is taken. For the mirror up shooting procedure.

Self-Timer Mode

In this mode, the shutter will be released 10 seconds after the shutter release button is pressed.

Turn the shutter release mode selector lever to the ☺ position.

When the shutter release is pressed, the self timer lamp will blink for 7 seconds. Then, it will blink more rapidly for 3 seconds and the camera releases the shutter. For instructions about the self timer function.

NOTICE:

If a correct exposure cannot be obtained, the shutter speed and aperture value blink. In such cases, the pictures can be taken but they may out too bright or too dark

If the shutter speed and aperture values blink on the main LCD and in the viewfinder display when the program line is shifted, the proper exposure cannot be achieved. Please select a different Program mode.

When the Program line is shifted, the aperture value changes along with the shutter speed to maintain the proper exposure.

You can choose either aperture or shutter-speed to give priority in program line shift. Custom settings C-14.

Increment of the aperture and shutter speed can be set at either 1/3 or 1/2-stop. Custom settings C-01.

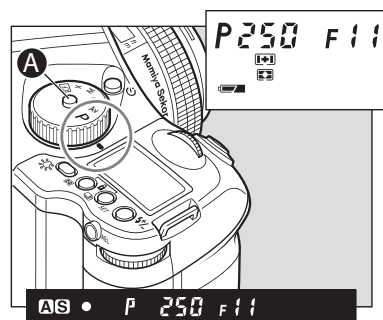

3.7 Exposure Modes

(P) Program AE

The aperture and shutter speed are determined automatically for the optimum exposure, according to the existing ambient light. This mode is best suited for general photography, allowing the user freedom to concentrate on the subject.

Hold down the [program] button and turn the exposure mode setting dial to “P” (program AE) position.

Program Shift (PH/PL)

You can change the shutter speed and aperture value by turning the front and rear dials in the “P” (Program AE) mode. In order to avoid blurred images (due to shaking while releasing the shutter), or to open the aperture, change to “PH” (high speed). For slower shutter speeds and wider depth of field, change to “PL” (low speed). This function allows you to make these changes quickly.

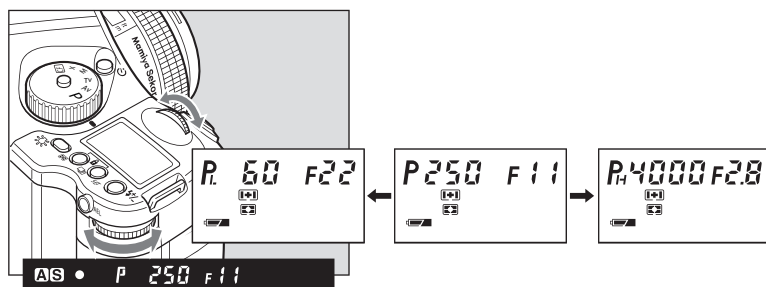

Phase One 645 program shift chart

(ISO100/AF80mm F2.8 D)

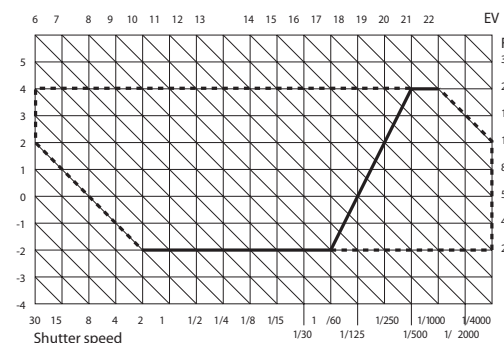

— Normal
- - - Program shift area

NOTICE:

The shutter speed value will blink when the subject is too dark or too bright for a correct exposure. To obtain the correct aperture, adjust the aperture value until the shutter speed value stops blinking and remains lit.

When the exposure is compensated with the rear dial, the aperture can be set with the front dial only.

Increment of the aperture can be set at either 1/3 or 1/2-stop. Custom settings C-01.

Rotation direction of the dials to change the values can be altered. Custom settings C-13.

The selected aperture level can be locked.

NOTICE:

The aperture value will blink when the subject is too dark or too bright for a correct exposure. To obtain the correct aperture, adjust the shutter speed value until the aperture value stops blinking and remains lit.

When the exposure is compensated with the rear dial, the shutter speed can be set with the front dial only.

Increment of the shutter speed can be set at either 1/3 or 1/2-stop. Custom settings C-01

Rotation direction of the dials to change the values can be altered. Custom settings C-13.

The selected shutter speed can be locked.

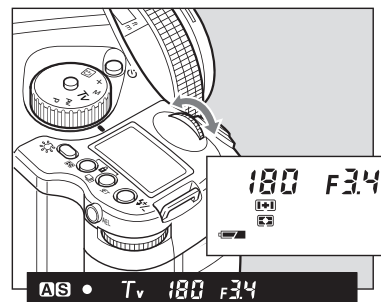
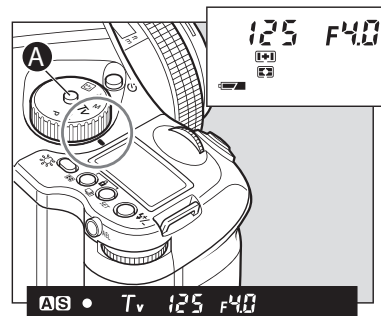
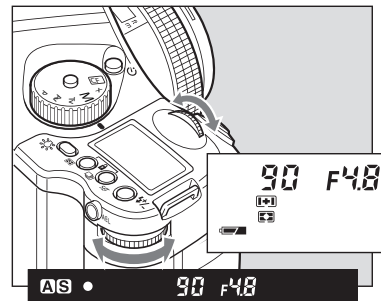
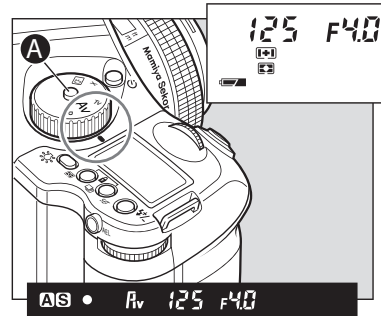

Aperture Priority AE (Av)

Set the desired aperture, and the camera selects the optimum shutter speed accordingly. Use the Av mode to maintain specific control over depth of field, i.e. taking portraits or landscapes.

1. Hold down the button and turn the exposure mode setting dial to “Av” (aperture-priority AE) position.
2. Turn the front or rear dial to set the desired aperture.

Shutter Priority AE (Tv)

Set the desired shutter speed and the camera selects the optimum aperture accordingly. Fast shutter speed can be used to freeze motion, and slow shutter speed can be used to blur motion on purpose.

1. Hold down the button and turn the exposure mode setting dial to “Tv” (shutter-priority AE) position.
2. Turn the front or rear dial to set the desired shutter speed.

NOTICE:

When the exposure is compensated in the Manual mode, the difference between the metered value and the compensated value will be displayed on the viewfinder LCD. In the B (Bulb) mode, the difference with the metered value is not displayed.

Increment of the aperture and shutter speed value can be set at either 1/3 or 1/2-stop. Custom settings C-01.

The assignments of the front and rear dials can be swapped. Custom settings C-11.

Rotation direction of the dials to change the values can be altered. Custom settings C-13.

The selected aperture and shutter speed can be locked.

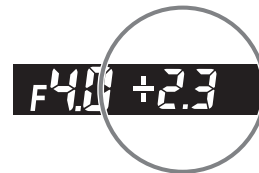
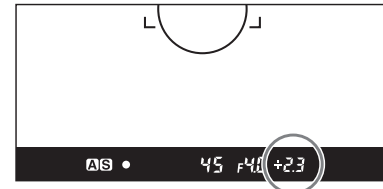
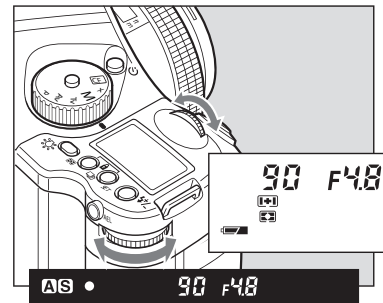
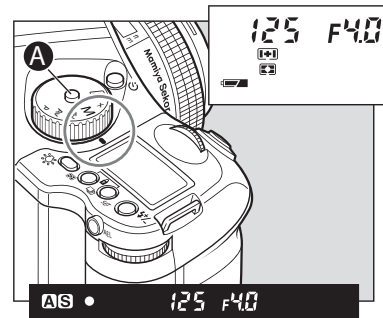

Notice:

When the set value matches with the metered value, the difference indicator will show "0.0". When the difference between the set value and the metered value is greater than $\pm 6\text{EV}$ and the set value is lower the metered value, the indicator in the viewfinder LCD shows "- u -". Contrarily when the set value is higher than the metered value, the indicator shows "- o -".

Manual Mode (M)

This mode is used to set both the aperture and shutter speed for total exposure control. Shutter speeds can be selected from B (bulb), 30 seconds to 1/4000 of a second. Aperture values can be set from the open to the minimum aperture. B (bulb) can also be specified in this mode.

1. Hold down the button and turn the exposure mode setting dial to "M" (Manual) position.
2. Turn the rear dial to set the desired aperture.
3. Turn the front dial to set the desired shutter speed.
4. When the shutter release button is halfpressed, the difference between the present settings and the metered value is displayed in the viewfinder's LCD panel. The value is displayed in 1/3 stop increments within a range of $\pm 6\text{EV}$.

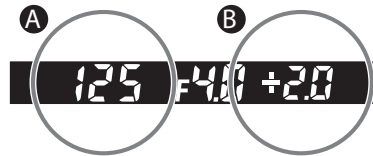
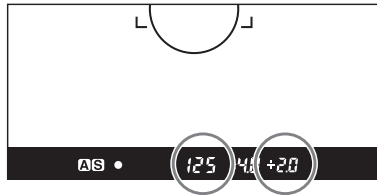

One-push shift function

When difference between the set value and metered value is displayed on the viewfinder LCD in the Manual “M” mode, press the AEL button for approx. 1 second and the camera will automatically adjust the shutter speed to achieve the correct exposure based on the set aperture value.

While the difference [B] between the set value [A] and the metered value is displayed on the viewfinder LCD, press the AEL button [C] for approximately one second. The camera changes the shutter speed to an appropriate level.

Notice:
The aperture level can be selected for the parameter to shift. Custom settings C-20.

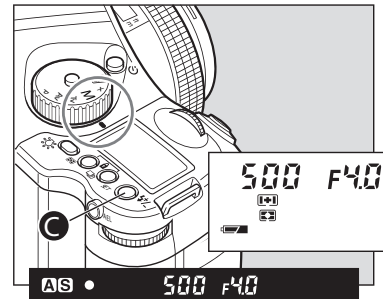

Notice:
The selected aperture value can be locked.

The synchronizing speed can be changed. Custom settings C-23.

When you take a photograph with TTL light metering with a Metz flash.

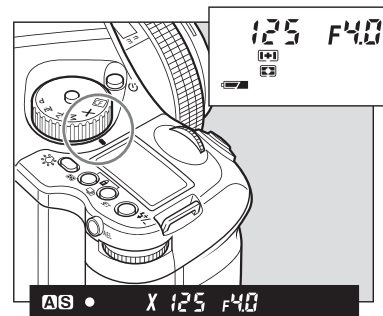

X Mode (X)

Select this mode when you use a flash. The shutter speed will be fixed at 1/125 second for synchronization.

3.8 Flash photography

Phase One 645 AF is equipped with a horizontal local-plane metal shutter; this makes it unnecessary for the user to acquire lenses equipped with central shutters, though it still is possible to use these lenses optically.

The focal-plane shutter provides higher shutter speeds, compared to central shutter lenses, which allow you to freeze a fast moving target by using very high shutter speeds.

When using a focal-plane shutter it is not possible to achieve flash synchronization faster than 1/125sec, as the 2 shutter blades at e.g. 1/500 are moving parallel creating a small slit allowing a small fraction of the light to enter the sensor area of the digital back. This shutter method allows for shutter speeds of up to 1/4000 sec.

A central shutter will make it possible to achieve slightly higher shutter and flash sync speeds, but central shutters but will not be able to achieve high shutter speed.

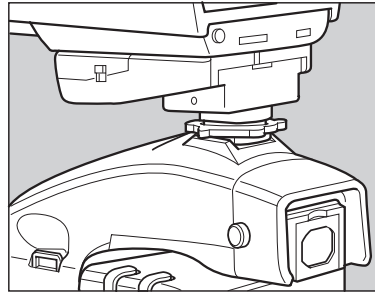

NOTICE:

This camera's synchro contact is an X contact.

Using flashes designed exclusively for other makers of cameras may damage the camera's internal mechanisms if connected to the camera's hot-shoe. In this situation, use an off-camera flash bracket and connect a sync. cord to the camera's synchro terminal.

When using flashes with a flash duration of 1/500 sec. or longer, set the shutter speed to 1/30 sec. or less.

1. To use a grip type flashgun or a strobe with other electric contacts than X contact, connect the sync. cord to the camera's sync. terminal. (See note below about flashes designed exclusively for other camera makes.)
2. While pressing the unlock button, turn the exposure mode setting dial and set it to "X" (1/125 sec.) or "M" (manual). When "M" (manual) is selected, turn the front dial and set the shutter speed to 1/125 sec. or slower.
3. Turn the rear dial to set the aperture, and then take the picture.

In addition to its standard flash sync system, the Phase One 645 AF features TTL (through the lens), off the film (OTF), electronic flash exposure metering.

A flash sensor located inside the camera body reads the flash reflected off the film surface at the moment of exposure. The sensor is connected via the Phase One 645 AF s dedicated hot-shoe to a shoe- or handlemount style Metz flash unit via the Metz SCA 3952 TTL Adapter. Maximum flash sync speed is 1/125 sec., making daytime synchronization possible.

The ISO of the flash is automatically set through the TTL connection from the camera's Film Magazine; any adjustment to this is instantly recognized after the setting is locked and the shutter release is half-pressed. Also, when Film Magazines with different ISO settings are switched on the camera body, the TTL flash connection instantly recognizes the change.

To utilize the TTL flash feature with all TTL-operable Metz flash units, a Metz SCA 3952 Module is required. Please see the chart below for compatibility and/or additional adapters that may be necessary.

Adapter	Type of flash	SCA3952 Module	SCA3000C Converter
Metz 44 MZ-2 Metz Flash Unit	shoe-mount	x	
Metz 54 Mz-3	shoe-mount	x	
Metz 45 CL-3 & 4	Handle-mount	x	x
Metz 60 CT-4	Handle-mount	x	x
Metz 70 Mz-5 & 4	Handle-mount	x	

The resulting flash exposure automation determines correct flash exposure and automatically adjusts the output of the flash. It also automatically corrects for exposure compensation normally required when using filters, close-up bellows or extension tubes. However, as with all TTL systems, it requires manual compensation for differences in film surface reflection characteristics. The amount of compensation is determined by experimentation and is performed on the Mamiya Film Magazine ISO setting.

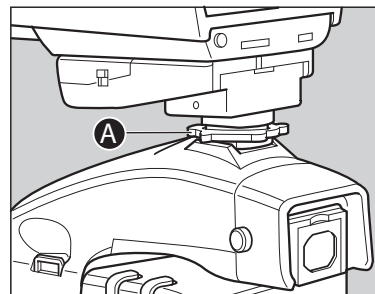

1. Mount the SCA3952 adapter onto the Metz flash, insert fully into the camera's hot shoe, and then tighten with the locking knob.

2. Set the exposure mode, and then check the shutter speed and aperture.

Exposure mode		Shutter speed	Aperture
P	Program AE	Automatically set by camera to 1/60 sec.	Automatically set by camera
Av	Aperture priority AE	when the metered shutter speed is 1/60 or slower, and 1/125 when it is 1/125 sec. or faster.	Any aperture
Tv	Shutter priority AE	Automatically set by camera to 1/125 when the set shutter speed is 1/125 sec. or faster.	Automatically set by camera
M	Manual mode		Any aperture
X	Synchro mode	1/125 sec.	Any aperture

NOTICE:

With TTL flash photography, the reflection of the flash is metered and the intensity of the flash is adjusted automatically, so TTL flash photography may not be able to suit to all conditions. In the cases described below, we recommend that you use a flashmeter to check the intensity of the flash or to use a manual flash setting.



Example:

(1) When the size of the subject you want to light with the flash is relatively small within the picture

(2) When the background behind the subject is extremely bright or when there is a strongly reflective object in the background

(3) When the background behind the subject is extremely dark (outdoors at night, etc.)

(4) For flash photography with a narrow film latitude

1. While in the P or Av modes, the camera can be set to release the shutter at the metered value, even the background behind the subject is dark. Custom settings C-24.

2. The sync. speed in the X mode can be set between 1/40 and 1/125 seconds. Custom settings C-23.

* When the shutter speed is set to 1/2 increments, the sync. speed can be set between 1/45 and 1/125 seconds.

Rear Curtain Syncro

When a moving subject has been shot under this function, the flash of light appears after the moving subject.

Rear curtain sync mode

Front curtain sync mode

This function is set by Custom function setting. Custom setting C-27.

3.9 flash compensation settings

By combined use of a Metz flash and the SCA3952 adapter, the camera adjusts for flash. It can be adjusted within $\pm 3\text{EV}$ in increments of $1/3$ steps.

1. Turn on the power

Install the SCA3952 adapter on the Metz flash, and put it on the camera then lock the flash in place using the locking knob on the flash shoe. Turn the shutter release mode selector lever to the “S” or “C” position, and turn ON the flash power switch.

2. When the flash charge confirmation lamp lights, press the set button A in. The is displayed on the main LCD panel.

3. Turn the front or rear dial to select the flash compensation value. External LCD Panel (normal display)

4. When the shutter button is half-pressed, the display appears on the external LCD, and appears on the LCD inside the viewfinder with a + compensation, or appears with a - compensation.

Viewfinder LCD readouts

- If the flash-charge mark is not displayed, the flash compensation button [A] can not be used.

- Keep pressing the set button to activate the flash compensation mode. You can check the exposure compensation value.

- If you turn the shutter release mode selector lever to the “L” (power OFF) position, the compensation value will be canceled.

Exposure compensation and flash compensation can be linked. Custom settings C-25.

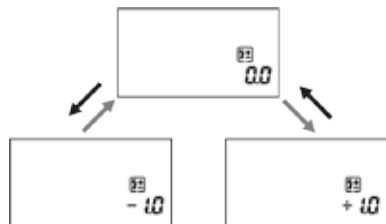
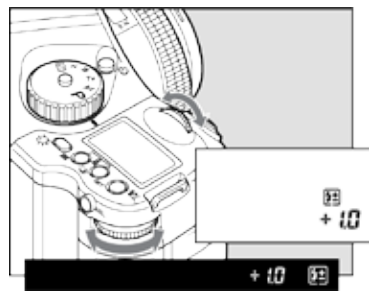
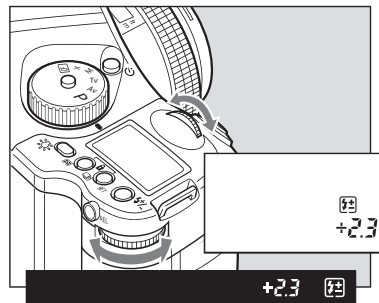
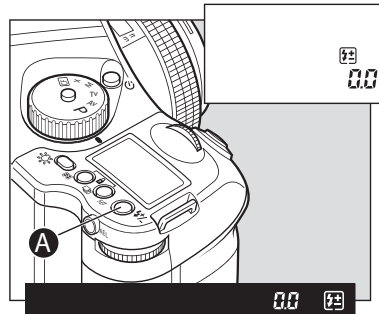
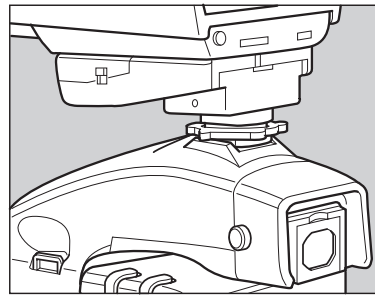

NOTICE:

After taking pictures using the exposure compensation feature, be sure to return the exposure compensation dial to the "0" position.

The exposure compensation dial is locked at the "0" and positions.

The exposure compensation feature is available during AE locked operation.

The width of the exposure compensation step can be changed. Custom settings C-01.

The maximum amount of the compensation can be set either at ± 3 or ± 5 . Custom settings C-05.

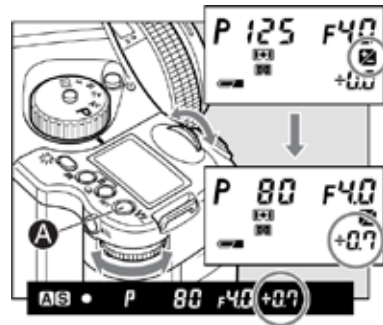

4.0 Advanced functions

4.1 Exposure Compensation

In some situations, such as a great difference between the subject and background brightness or overall subject tones that will not meter correctly because they are all black or white, the resulting photograph may be under- or overexposed. When this occurs, use the exposure compensation function. Exposure compensation can also be used when you want to intentionally create overexposed or underexposed pictures. Please keep in mind; you can do quite a lot of work using the High Dynamic Range Tool in Capture One 4.

With the exposure compensation dial

1. When exposure compensation button A is pressed,  appears on the external LCD. When the front or rear dial is turned counter-clockwise, the exposure is increased; conversely, when it is turned clockwise, it is decreased. The exposure compensation value can be checked on the external LCD or LCD inside the viewfinder.

2. After taking the pictures, press exposure compensation button A again to return the exposure compensation value to 0. The exposure compensation value mark on the external LCD is cleared, and the exposure compensation function is released.

Exposure mode	Exposure compensation display	
P	Program AE	The set value is displayed
Av	Aperture Value Priority	
Tv	Time Value Priority	
M	Manual Mode	The difference between the metered value and the set Exposure value is displayed
X	Sync Mode	Not displayed

NOTICE:

[] in the viewfinder LCD blinks to indicate the exposure is locked, when you continue to take the next picture in the AE lock mode.

NOTICE: If you turn the shutter release mode selector lever to the “L” (power OFF) position, or after elapse of one hour, the AE lock mode will automatically be cancelled.

NOTICE: In the Manual “M” exposure mode, you cannot use the AE lock function. When the difference between the metered value and the set value is displayed, press the AEL button for approximately one second, and one-push shift function will be activated and the camera will automatically adjust the shutter speed.

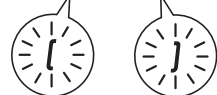
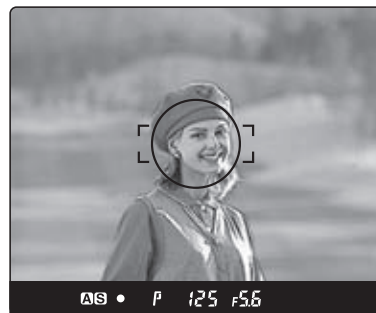
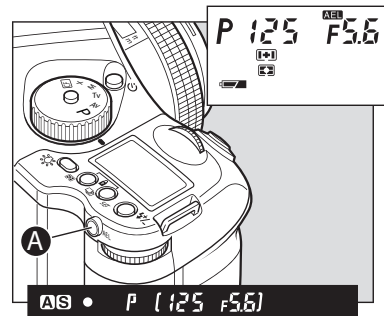

4.2 AE Lock

Shooting with the AE lock function is useful in cases where the subject to be brought into focus differs from the subject whose exposure is to be measured or when measuring the exposure of a particular part to be brought into focus using spot exposure metering mode while that part is on the shooting screen.

The AEL button will lock the Auto-exposure value as the photo is being recomposed.

1. Turn the shutter release mode selector lever to “S” or “C.”
2. Turn the exposure mode setting dial and select any of “P,” “Av,” or “T”.
3. Focus on the subject for metering exposure, and press the AEL button on the rear of the grip. [] Will appear on the viewfinder LCD, indicating that the exposure value is locked.
4. Slide the camera to recompose the shot, and take the picture.



Metered-value difference indicator

Keep pressing the AEL button and the difference between the metered exposure value and the exposure of the new composition will be displayed on the viewfinder LCD. This function can be used to see if an object of very different brightness levels can be properly photographed.

If the difference between the set value and the metered value exceeds 6EV, the viewfinder LCD blinks “- u -” for underexposure and “- o -” for overexposure.

By turning the front or rear dial in the AE lock mode, you can change the aperture and shutter speed value without changing the exposure value that is set when entered into AE lock mode.

In the “P” mode (Program AE) mode, turning either the front or rear dial shifts the program to “PH” and “PL.” When in “Av” (Aperture-priority AE) or “Tv” Shutterpriority AE), turning one of the dials changes both the aperture and shutter speed values.

NOTICE:

The way to cancel the AE lock can be changed. Custom settings C-17.

Half-pressing of the shutter release button can activate the AE lock mode. Custom settings C-16.

The assignment of the AEL button and AFL button can be swapped by using Custom settings C-15.

Exposure compensation and auto-bracketing function can be used when the camera is in the AE lock mode in normal operation or with the mirror locked up.

NOTICE:

When you want to cancel the auto-bracketing mode, turn the rear dial to change “On” to “OF”

NOTICE:

The letters (n, u, o) indicate the type of exposure (“n” for normal, “u” for underexposure and “o” for overexposure) and numbers indicate increment (0.3 for 1/3, 0.5 for 1/2, 0.7 for 2/3, and 1.0 for 1/1)

By pressing any other button or leaving the camera for 5 seconds, setting for the auto bracketing will be stored.

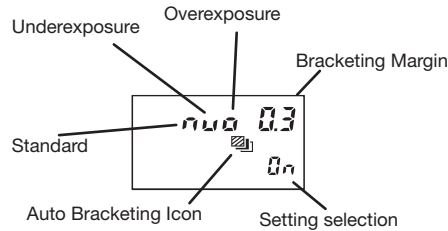
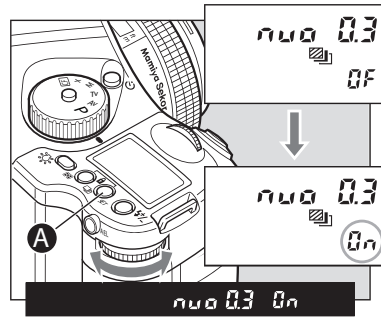

4.3 Auto Bracketing

With auto exposure bracketing, you can capture different exposure variations automatically for three or two successive frames, when it is difficult to determine an exposure compensation value. The number of frames to be taken, the bracketed shooting sequence, bracketing margin and other settings can be selected as desired for shooting in auto bracketing mode.

1. Turn the shutter release mode selector lever to the “S” or “C” position.

When set at the “S” position, you can shoot one frame with each press of the shutter release button. In the “C” mode, the camera takes three (or two) frames successively with one press of the shutter release button.

2. Keep pressing the auto-bracketing button for approximately one second, the auto bracketing mark will blink on the top LCD panel. Turn the rear dial before this indicator goes out, and change “OF” on the display to “On”.

3. While the auto bracketing mark is blinking, turn the front dial to change number of frames (3 or 2), sequence of the shots in 2-shot mode (shown above), and increment (1/3, 1/2, 2/3 or 1-stop).

4. Press the shutter release button.

When the shutter button is pressed in auto bracketing mode the shooting sequence and auto bracketing mark blink on the LCD inside the viewfinder. Furthermore, the auto bracketing mark blinks, the bracket step width is displayed, and the shooting sequence can be checked on the external LCD.

5. After taking pictures, press auto bracketing set button A, turn the rear dial, set auto bracketing mode to “OF,” and release.

Then press the auto bracketing set button or half-press the shutter button to return to the normal display mode.

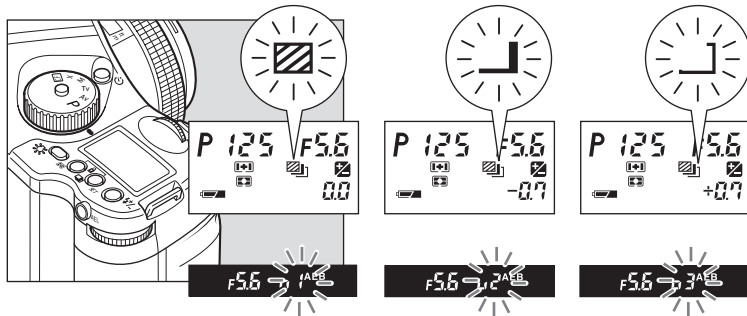
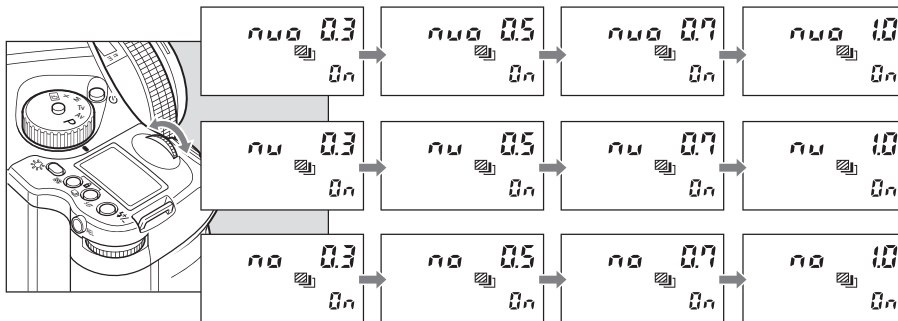

Normal exposure Overexposure Underexposure

AE settings under auto-bracketing mode

	Exposure Mode	Setting
P	Program AE	Shutter speed varies
Av	Aperture Priority AE	Shutter speed varies
Tv	Shutter Priority AE	Aperture varies
M	Manual Mode	Shutter speed varies
X	X-sync mode	No setting

Single-Frame Mode (S)

Press the shutter release button for each shot.

The camera meters adequate exposure value for each shot and performs auto-bracketing. The camera stays in the auto-bracketing mode until the last frame of the roll film is exposed or you cancel the auto-bracketing mode manually.

Continuous Mode (C)

By pressing the shutter release button once, the camera takes 3 (or 2) shots in series. With each press of the shutter release button, the camera repeats auto-bracketing. The standard (normal) exposure value will be fixed when you take the first frame.

When the number of available frames of the current film is less than 3 (or 2) in the auto-bracketing mode, the “– no –” mark blinks and the camera automatically cancels the auto-bracketing mode. When you want to cancel the auto-bracketing mode, turn the rear dial to change “On” to “OF”.

NOTICE:

If you turn the shutter release mode selector to the “C” position before taking three (or two) frames, the camera will restart the auto-bracketing from the initial frame (normal exposure in the default setting).

NOTICE:

Order of the exposures in 3-shot auto-bracketing can be changed. Custom settings C-10.

The way to cancel auto-bracketing mode can be changed. Custom settings C-11.

NOTICE:

Auto bracketing exposures can be made when the auto bracketing mode is set before taking photos with mirror up.

The mirror goes back to the normal position in 30 seconds. This can be changed to 60 seconds or no limitation by the custom function . (See page 89) Keeping the mirror up consumes more power.

The mirror will return to the original position if the lens is removed from the camera body.

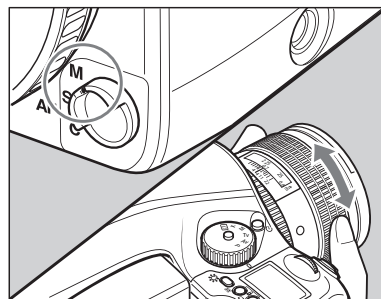
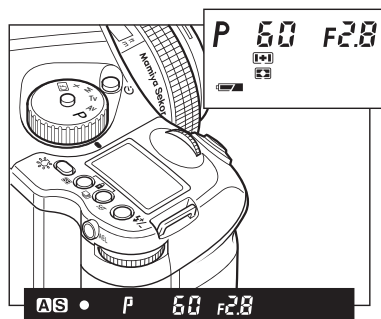
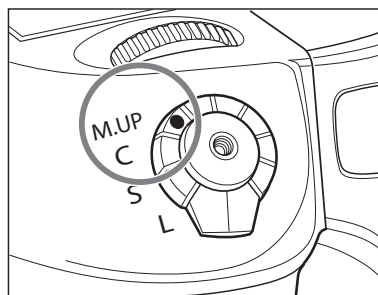

WARNING:

DO NOT point the lens at the sun during the mirror up mode. The sun's intense light can scorch and damage the shutter curtain.

4.4 Taking photos with the mirror up

This function prevents mirror-caused vibrations which may blur the image in close-up photography, when shutter speed is slow, when a telephoto lens is used, or when photographing a poster or another picture.

When using the mirror-up, Electromagnetic Cable Release RE401 (optional) is recommended.

1. Set the drive dial to “M.UP”
2. Select “S” (single focus mode) by turning the focus mode selector lever.
3. Turn the exposure mode-setting dial to choose any of “P”, “Av” or “Tv” exposure mode.
4. Focus the subject, and determine composition and exposure
5. The mirror moves up when the shutter button is fully pressed.
6. Press the shutter button again to take pictures.

In the manual mode

1. Set the focus mode selector lever at “M” (manual focus mode) position. Turn the lens-focusing ring to focus.
2. Determine the exposure, focusing and frame structure by pressing the shutter release button halfway while looking into the view finder.
3. Lock the mirror up by pressing the mirror-up button.

NOTICE:

As the camera is electronically controlled even during exposures, it is recommended to replace batteries before bulb exposure.

Normally the camera can take a picture with a bulb shot up to 60 minutes. However, the bulb shot time can be changed from one minute to infinite. Custom settings C-21.

It is possible to set the camera as the shutter remains open until the button is pressed once again. Custom settings C-22.

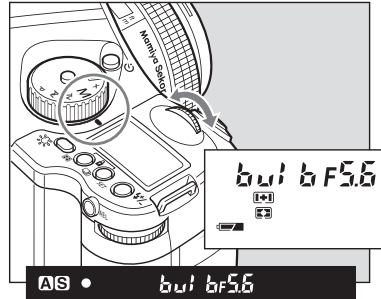

4.5 Long exposure - Bulb Mode

To expose film longer than 30 seconds, adjust the shutter speed to “B” (bulb). In order to prevent camera shake, use an electromagnetic shutter release and tripod.

1. While pressing the unlock button, turn the exposure mode dial and set it to “M” (manual mode).
2. Turn the front dial to select “bulb”, then turn the rear dial to set the aperture.
3. Determine the composition, focus, and then take the picture. The shutter remains open as long as the shutter release button is pressed.

NOTICE:

When releasing the shutter, or pressing the backlight button A/ while the backlight is on, the backlight will go OFF.

The backlight can be set to turn on during the camera is holding metered value. Custom settings C-06.

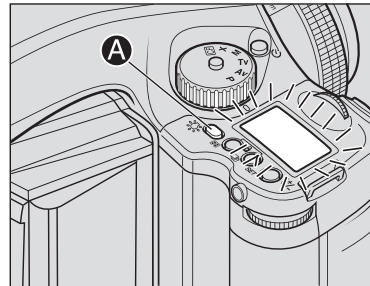

4.6 Camera display light

To see the top display at night or in dark places, press the backlight button A/.

The backlight will go on approximately 10 seconds and go off unless there is another operation.

When operating the camera while the backlight is on, the backlight will be lit for approximately another 10 seconds.

NOTICE:

The setting will be stored after one second.

Dial lock can not be set when the exposure mode is "P" (program AE).

Even while dial lock is set, the front dial or rear dial can still be used to perform the various settings. (Dial lock is temporarily released.)

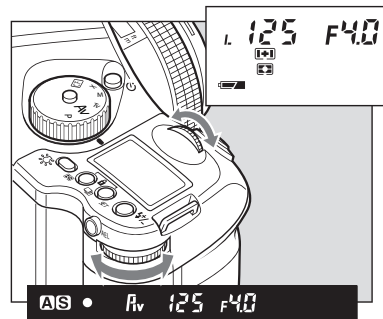
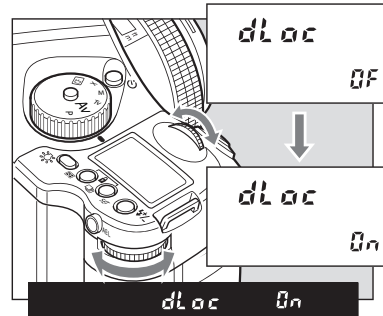

4.7 Front/rear dial lock mechanisms

When the Electronic Dial Lock is "On," all currently set values in "Av" (Aperture Priority AE), "Tv" (Shutter Priority AE) and "M" (Manual mode) cannot be adjusted with the front or rear dials. This prevents accidental change of shutter speed or aperture values.

Press down both the multiple exposure mode button and the auto bracketing mode button for approximately one second, until the "On" indicator blinks.

To release the mode, hold down the same buttons until "OF" blinks.

3. "L" is displayed on the main LCD to indicate that operation of the front and rear dials is blocked.

When the dial lock is ON, the shutter speed and aperture will not change even if you turn the front or rear dial.

When you activate the electronic dial lock, and if you then operate the electronic dial, the dial lock indicator "L" on the main panel blinks for three seconds to show that the electronic dial lock is functioning.

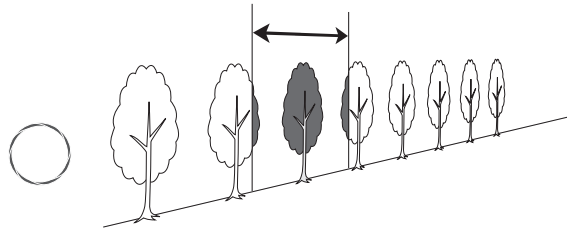
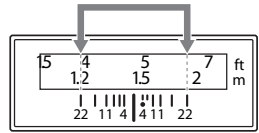

When the aperture is open (the subject depth is small)

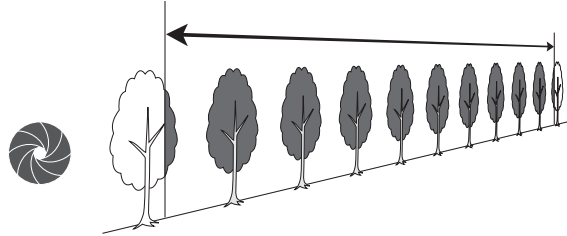

When the aperture is stopped down (the subject depth is large)

4.8 Depth of field

Depth of field (D.O.F.) is defined as the zone of sharpness before and behind the plane of focus. It depends on distance to subject, focal length of lens, aperture setting and distance the lens is focused at.

In addition to visual observation via the depth of field preview button, the D.O.F. can be determined by using the depth of field scale on each lens. The f/stop numbers appear on both the right and left side of the white index mark in the center of the scale. Simply read the figures which appear above the f/stop numbers on the distance scale of the lens. (see illustration below)

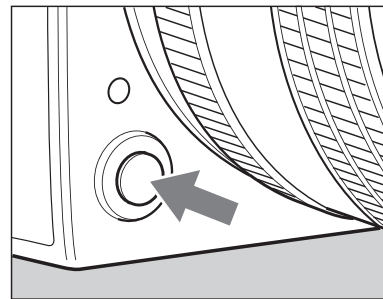

Depth of Field Preview Button

When the preview button is pressed in, the depth of field for the aperture set on the camera can be checked by looking through the viewfinder.

After focusing, press the preview button. The diaphragm will be stopped down to the set aperture.

NOTICE:

While operating the preview button, you cannot release the shutter

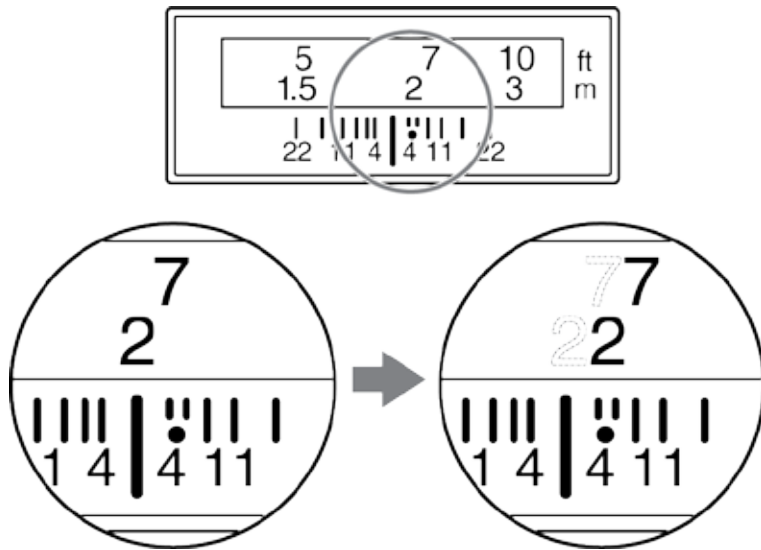

4.9 Infrared photography

Infrared Photography is complicated when using digital backs, as the digital back is adjusted to match the viewable light perfectly. To make good infrared photography, you need the back adjusted for this or a back dedicated to infrared photography. **DO NOT TRY THIS AT HOME**

– all corrections in this area must be done by Phase One to ensure the precision. If you remove the protection glass or make other physical adjustments on the back the warranty will immediately be annulled.

If you consider Infrared Photography, please contact your local Phase One dealer for technical advice and pricing on this.

When taking photos using infrared film, the position at which the subject is in focus is slightly different than that of regular films. This is because the infrared rays have a longer wavelength and the image converges behind the film plane of regular film. Use the procedure described below when taking photos using infrared film.

1. Set the focus as usual. Read the point on the distance scale matching the center index of the depth scale.
2. Set the focus mode selector lever to “M” (manual focus mode). Turn the focusing ring clockwise and align the read point to the infrared index.

NOTICE:

Use a red filter when taking photos using infrared film.

Be sure to read the infrared film's usage instructions.

You cannot take photos in AE modes when using an infrared film.

5.0 Tethered shooting

Tethered photography with Phase One is as easy as plug and play can be, even though the quality and technology is advanced, it is created to match all studio environments.

5.1 Connecting

Connect the Fire-wire cable to the back of the camera and on the back of your Mac or WinPC – though there can be found computers with Fire-Wire plug-ins on the front, our experience is that the back connection is more stable, and functions better. Capture One will automatically recognize the camera, and settings shared, read more on capturing in the software manual.

5.2 Driver set-up

Install Capture One on your computer, follow the instructions provided with the software, and activate the software.

There is no specific program set-up except the set-up or recommended hardware provided in the beginning of this user guide as well as in the user guide for Capture One.

Eventual firm ware announcements will be available on our website, and in our newsletters.

5.3 Tethered operations

When operating in a studio, connected to a computer via FireWire you are not dependent on battery power or storage media. You can capture directly to the Phase One Capture One Raw workflow software on either Mac or PC, providing power to the P+ back via FireWire without the battery or CF-card inserted.

When operating tethered you have the option of capturing the images to the CF-card or transferring captures directly to the currently assigned capture folder in the Capture One application on the computer hard disk.

The display on the P+ back can either be turned off while shooting tethered or set to display the images while they are shot, just as if shooting untethered.

When unplugging the P+ back from the FireWire, the P+ back will default to untethered mode, capturing to CF-card or microdrive, and using the battery for power.

Also when capturing tethered to a laptop with 4 pin mini 1394/FireWire without power it will require a battery in the P+ back.

With the (non P+) P 20 and P 25 it is necessary to use the Phase One “No Firewire Power Solution” Part.# 70508 to force battery power.

Using the four menu buttons you can setup the preferences for all these operational features.

Consult the Capture One 4 manual for detailed intro to the software

6.0 The Back

The back is a highly developed piece of electronic. The Phase One backs are created to provide a natural and easy workflow, without creating unnecessary complicated functions or menubrowsing. You can see the menuflowchart here and read more on the menuoptions in this chapter.

MENU FLOW CHART

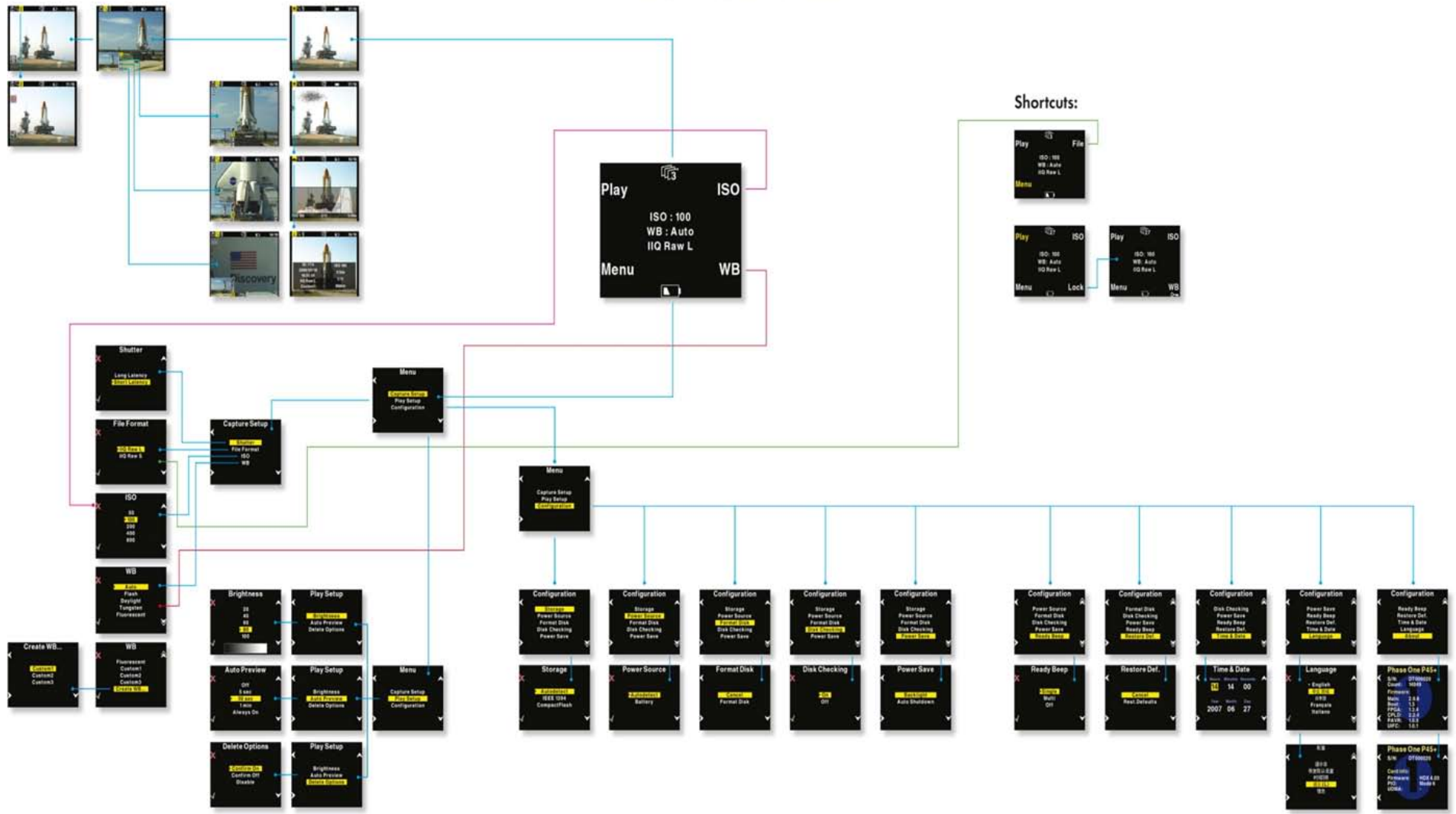

6.1 CF card usage

When working with CF-cards, card readers and digital cameras it is very important to follow a few rules, to avoid loss of data.

Phase One recommends that you test-drive all new Compact Flash™ cards (including the one enclosed). By doing an initial test to verify that the capture files are stored properly on the card and can be accessed on a computer you will avoid unpleasant surprises on location or when you return from a job. Compact Flash™ cards are manufactured by other suppliers, and Phase One cannot guarantee that the cards are not defective.

Inserting and ejecting cards on the P+ back

The compact flash card or microdrive is inserted in the hidden slot located under the cover on the left hand side of the P+ back.

Insert the card with the brand label facing the display end of the digital back as shown in the image.

When the card is inserted no parts are sticking out, the cover can be closed.

To eject the card push the small button just above the card once, and an ejecting pin will come out.

Pushing this pin all the way back in will eject the card.

Always format your Memory card in the P+ back in general all CF-cards or microdrives comes preformatted and ready to use in the P+ backs.

However to ensure the best performance from these cards it is to be considered best practice to always format them in the P+ back.

Formatting of the memory card is done in either FAT 16 or FAT 32 depending on card size, and if the formatting is done in the P+ back cluster sizes on the disk is set for best performance.

It is however also possible to format the cards on either Mac or Windows, this is explained in the following sections of this chapter.

CF card usage – 3S the Secure Storage System

When a card is inserted into the P-back, a complete disk check for a valid file structure is performed.

For normal CF-cards you will not even notice the extra time it takes larger cards will of course take slightly longer to load

Large Microdrives are experienced as slow, but a progress bar showing the status if the time exceeds 2 seconds

The progress of a disk check is indicated with series of small dots in the disk icon.



It is not recommended to turn off disk checking, but it is possible by selecting the “Disk Checking” available in the “Menu” under “Storage”.

Whenever Disk Checking is turned off the capture counter turns red to indicate that the disk has not been checked.

Disk Check summary

With the 3S technology we have created a new and safe storage system in the P – back that is much more rugged than anything else seen in the industry.

- We now offer full formatting support in the P – back (no more need for formatting on the computer)
- Damaged or wrong formatted cards will be detected immediately, and we now also have the ability to reformat the cards to correct them.
- Ejecting a card while in a writing session will not damage the file structure of the entire CF-card, only the image being written and the images in the buffer can be damaged.
- No other digital back or DSLR camera has this level of storage security!

6.1 CF card usage in general

Ejecting the card while the P+ back is still writing to the card (red LED is on) will cause images that are still not written to the card, to be lost or damaged.

Also, ejecting the battery while the P+ back is still writing might result in loss of the data that is not yet written to the memory card.

For rescue tips in situations where the P+ back reports that you have a damaged card, please see “Sandisk card and Card reader” section.

General handling guidelines

Especially when using microdrives you have to be careful not to drop them on the ground or even on a table.

Compact flash cards are not as vulnerable as microdrives. Please keep the card away from moisture and sand and don't bend it. Use the supplied jewel box as a storage container for the card.

Using cards in the card reader

When inserting the card into the card reader on a Mac or PC, the card will be mounted as a removable drive on the computer.

For information on how to import the files to Phase One Capture One, please consult the Capture One online user guide available under “Capture One Help” in the Help Menu.

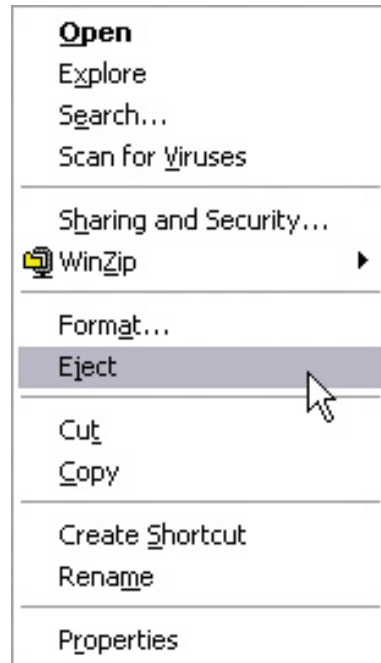

6.2 Mounting and dismounting card on computers

On Windows XP and Windows 2000 you can avoid confusing the system or, worst case, end up with a CF-card that was unintentionally erased, it is required to safely eject the card by right clicking the icon in “My Computer” and select the “Eject” option.

On a Mac the card have to be unmounted, by dragging it into the trash, or selecting eject in the “File” menu, or ejecting from the Capture panel inside the Capture One software.

Just removing it, and reinserting it can confuse the system, possibly resulting in uncontrolled read or write errors. If this happens, restarting the computer usually solves the problems.

Preparing the CF-cards

Most CF cards are pre-formatted and ready to be used in the P+ back.

The P+ back supports cards formatted in either FAT 16 or FAT 32.

If your card is not recognized in the P+ back it is possibly due to a wrong file system formatting on the card.

Mac HFS, UNIX or NTFS file systems are not supported by the P+ back, and cards with these file systems will not be recognized.

The card will have to be formatted in either FAT 16 or FAT 32 using a computer, Mac OS X or Windows.

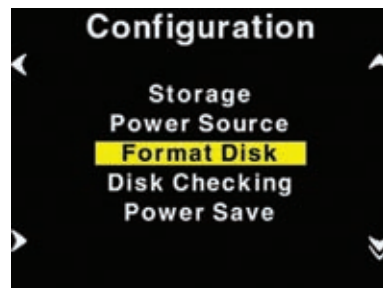

Recommended formatting is by using the back

Selecting “Format disk” will erase the CF-card in the P+ back. The CF-card will be formatted as FAT-32.

Formatting on a Mac OS X computer

On Mac OS X the formatting cannot be done directly in the finder but is easily done inside the Disk Utility located in the Applications > Utilities folder.

Open the Disk utility and select the Disk (not just the partition, but the entire disk).

Select the Erase panel as shown on next page, and select MS-DOS File System. Give the disk a name and click on Erase to erase and format the entire disk for use with the P+ back.

Choose “Options” in the formatting dialog to specify a complete and thorough formatting of the media.

Formatting on a Windows computer

Insert the CF-card in the card reader, and select the drive when it mounts in “My computer” or in the Explorer.

Right click on the drive and select “Format” from the pop-up menu.

Select FAT32 or FAT16 from the “File System” pop-up.

Give the card a name and click Start to format the card to be used with the P+ back.

To specify a complete and thorough formatting of the media resetting all to zeros, do not enable the quick erase option.

Disabling iPhoto Autostart (Mac OS X)

iPhoto Autostart can be disabled in the Mac system preference. Select “CD’s & DVD’s” and change the setting for “Picture CD” to either “Ignore” or point it to the Capture One Application you are using.

6.3 Navigating the Back menu

When the P+ back is turned on, the screen will always be in its home display position or “Main screen”.

Pressing and holding down the upper left button on the back will also bring you to the Main screen, regardless of where you are in the menu system.

The Main screen has an indicator in the top showing remaining captures, and a battery indicator at the bottom showing the remaining battery capacity.

When either indicator reaches zero, it will start blinking, to indicate that either storage or battery needs replacement before capturing any more images.

The main screen also shows the current ISO setting, white balance setting and IIQ Raw file format selected.

Menu buttons

The Phase One P+ back has four menu buttons to control the menu system on the display.

When the P+ back is in its initial state (just after power up) or at the menu systems “home” position (Main screen), the four buttons each has a shortcut assigned. Play, Menu, ISO and WB.

Inside the menu system arrows will indicate the function of the four buttons, the two buttons to the left are used to enter and exit the selected menus. The two buttons to the right are used to go up and down in the menu system.



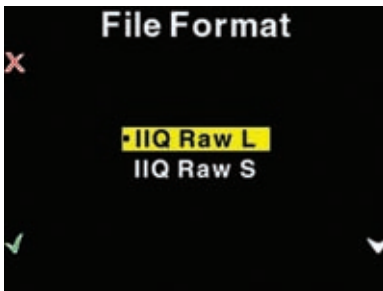
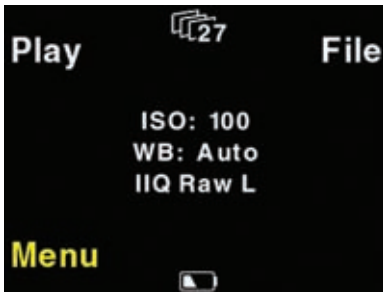
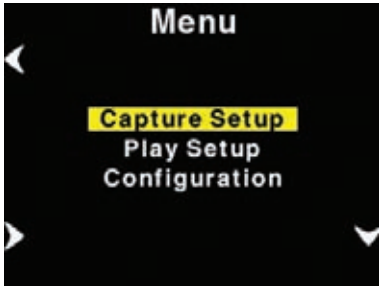

From the home position, pressing the “Play” button will bring up the image browser, where you can go up and down with the right hand buttons, to browse through images.

Pressing the “Menu” button will bring you to the menu system where you can scroll up and down in the menu system with the right hand buttons to select the menu options to set.

When the desired option is highlighted it can be selected by pressing the “Enter” button.

Exiting the menus is done with the “Exit” button.

Home shortcut

Holding down the “Exit” button for a few seconds will always bring you to the home position or main screen immediately.

File format shortcut

Holding down the “Menu” button while in Home position colors the word “Menu” in yellow, and at the same time reveals a shortcut with the word “File” in the place where ISO was.

Pressing this button at the same time will bring up the File format Menu, where you can select between IIQ Raw L and IIQ Raw S. For more explanation on selecting in the menus please consult the “Menu mode” section later in this manual.

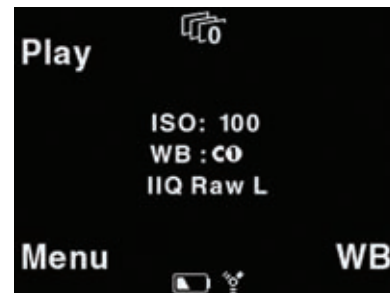
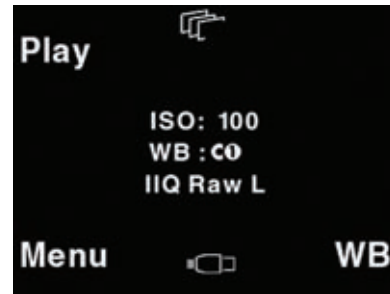
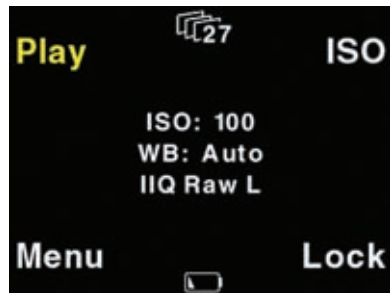
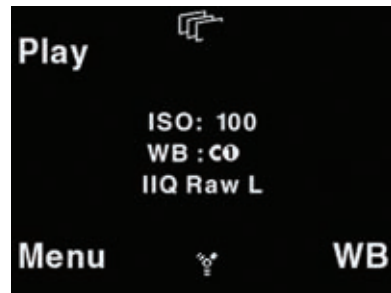
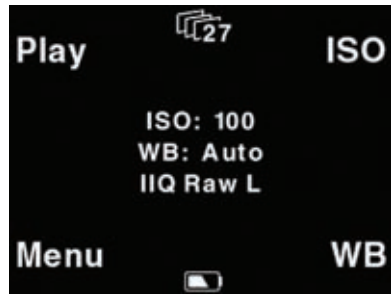

Battery and Power Indicator

The below screen dumps illustrates the battery and power mode indicators.

This is the initial view that meets the user when switching on the P+ back (not connected to a computer)

When a FireWire cable is inserted and the P+ Back draws the power from FireWire this is shown with an icon in the bottom of the main menu.

When Capture One is started on the computer this is indicated with a FireWire Icon in place of the cable icon.

When the P+ back is forced to get power from the battery, this is indicated with an additional battery icon.

Force battery power is invoked from the “Configuration > Power Source” menu.

Button Lock shortcut

Holding down the “Play” button while in Home position colors the word “Play” in yellow, and at the same time reveals a shortcut with the word “Lock” in the place where WB was.

Pressing this button twice when holding down the “Play” will lock operation of the four menu buttons. This is useful to avoid unintended button operation while carrying around the camera.

To Unlock the buttons hold down the “Play” button again and tab the “Lock” button twice again. When the buttons are locked, the key icon is displayed just below “WB”.

6.4 Playmode

“Play mode” can be used to review, zoom and delete images.

From the “Main screen”, pressing the top left button the P+ back is set to Play mode.



In Play mode the top of the screen will show a menu bar. In the right side of the menu bar the current image number and the number of images captured on the media is displayed. In this example it shows number 5 out of 19 images.

Pressing the Up and Down buttons on the P+ back (right hand side) it is possible to browse through the images.

Holding down the “Enter” button while pressing the up and down icon will bring you to the first and last image accordingly.

Battery life and number of captures left are also shown in the menu bar.

Pressing the Play button on the P+ back (top left hand button) will step through the options available in the menu bar.

From left to right these are: Review, Zoom and Delete.

Pressing the “Enter” button on the P+ back (bottom left hand button) selects the option.

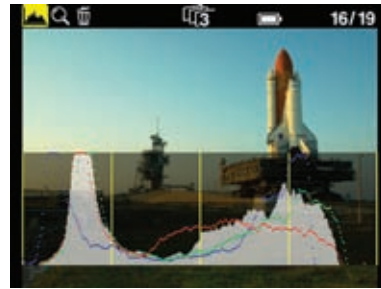

View modes

Play mode has four view modes, or review modes; Normal image display, Exposure warning overlay, Histogram overlay or File Info overlay.

After entering the Play mode, press the “Enter” button to shift to the view mode you want.

Exposure warning overlay will knock out the highlight areas as a flashing color, to warn about burned out areas in the image.

Histogram overlay will show a transparent Histogram over the image.

File Info overlay will show detailed capture information like capture number, capture time, date, ISO, WB, file format and shutter speed, etc.

The setting that Play mode is left in will also be the setting used for review of images while shooting.

This means, that if the Play mode is set to show images with a histogram, and you then exit to the Main screen. All subsequent captures will be shown on the display with a histogram over the image.

6.5 Playmode – zoom functions

After entering Play mode, advance to the eyeglass icon by pressing the Play button again and press the “Enter” button to select it.

It is now possible to zoom in the image with the “Enter” button.

The zoom has four amounts, Normal, enlargement 1, enlargement 2 and enlargement 3.

When zoomed into enlargement 1, 2 or 3 the insert view in the lower left corner can be used to navigate around in the image.

A small rectangle will show the current position and the up and down buttons can be used to scroll up and down.

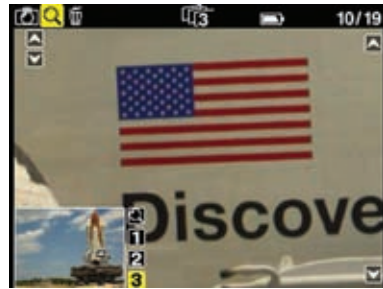

An icon just beside the Play button (top left hand button) will show the direction of scroll as either vertical or horizontal.

Pressing the “Play” button once will change this from horizontal to vertical scroll when using the up and down buttons. (Left side)

To exit the zoom function use the enter key to navigate to the eyeglass icon in the pan view and press the Play button to step to the next icon in the menu bar. Or hold down the “Exit” button for more than 1 second.

Browsing inside Zoom

While in the Zoom tool (enlargement 1, 2 or 3) holding down the “Enter” key, will hide the two up and down indicators. It is now possible to browse through the images by pressing the Up and Down buttons without leaving the Zoom functions.

This means that the exact same focus point can be evaluated on several pictures in a row by pressing “Enter” - “Up” or “Enter” - “Down”.

Delete

Navigate to the delete function by pressing the play button.

When in the delete view press the Up and Down buttons to browse through images.

Pressing the Enter button brings up an X or a √ (checkmark). Pressing “Enter” again will select √ and delete the image.

Pressing the exit button will select X and cancel the deletion.

If “Confirm Delete “ is set to “Off” in the “Play Setup”, the X and √ confirmation will be skipped, and the image deleted immediately when pressing “Enter” while on the delete menu.

Exit the Play mode

Exit the Play Setup at any time by holding down the Play button for two seconds.

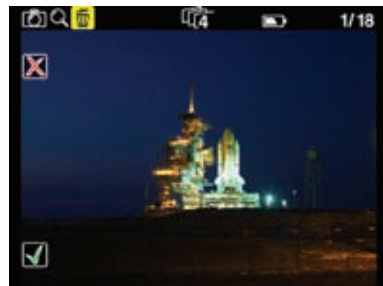
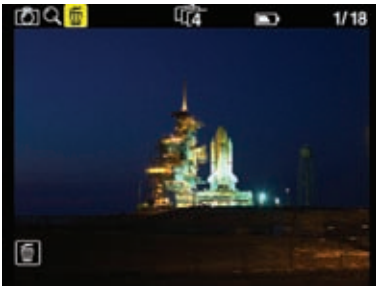

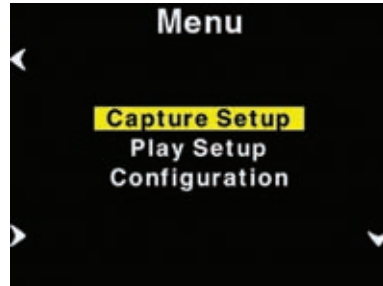

6.6 Menu Mode

Pressing the lower left button sets the P+ back in “Menu mode”

Entering Menu mode by pressing the lower left button allows you to set up all the preferences of the P+ back.

Menus are navigated by following the Enter, Exit, Up and Down arrows and pressing the corresponding buttons on the P+ back.

Whenever you want to exit to the main screen hold down the exit button (upper left button) for more than two seconds, and you will be back at the main screen.

When entering the menu mode you have three options: Capture Setup, Play Setup and Configuration.

Capture Setup

Capture Setup is where you setup preferences for the capture.

Enter the Capture Setup by pressing the enter button (lower left button)

In the Capture Setup you can select ISO, WB, FileFormat or Shutter.

By scrolling down with the down button you can select the options.

Shutter

Shutter refers to the shutter of the camera the P+ back resides on.

Due to the sleeping architecture of the P+ back, where the CCD is put to sleep to reduce power consumption, the P+ back needs to wake up before shooting. The timing of this wake up signal is referred to as the latency.



In general, if the camera is used with medium format cameras with digital interface the setting can be either “Short latency” or “Long latency”.

Short latency has a shorter response time, but is power consuming, so when battery time is an issue you should select “Long latency” on the cost of response time from the camera.

If the P+ back is used in “two shoot mode” on a large format camera with i.e. a copal shutter or another mechanical shutter where the shutter is released one time for waking up the back, and another time for shooting the image, then the shutter setting in the P+ back should be set to “long latency”.

While short latency will respond immediately to triggering the camera, Long latency will not be that fast, but in return you gain much longer battery power.



FileFormat

In “FileFormat” you can select two options “IIQ Raw L” and “IIQ Raw S”.

“IIQ Raw” is a short term for Intelligent Image Quality Raw.

“IIQ Raw L” is set as the default and is the loss less capture format of the P+ back.

“IIQ Raw S” is a smaller file, and not totally loss less in the format. The “IIQ Raw L” is approximately 1/3 file size of the processed TIFF file. “IIQ Raw S” is approximately 1/5 of the processed TIFF. Most users will use the “IIQ Raw S” as there is virtually no quality difference between the two settings.

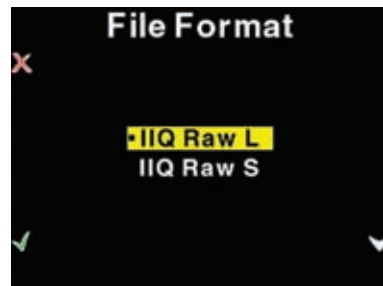

Please consult the camera specific sections in this manual to learn more about how to use shutter latency with your particular P+ back setup.

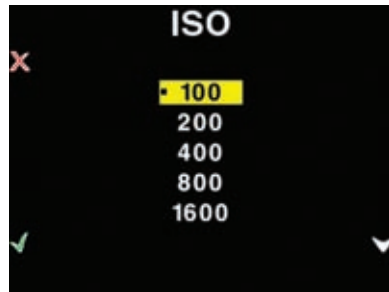

ISO

In the ISO Menu choose from ISO 50 to ISO 1600 depending on the conditions you want (number of ISO options may vary depending on which model P+ back is used).

In general the higher ISO, the more noise in the image. This means that for optimal image quality, it is a better strategy to have more light in the scene, or adjusting the f-stop on the camera, than just turning to a higher ISO.

When the preferred ISO setting is set press the “Enter” button to confirm the choice (green ✓ check mark).

Or if you regret the choice and just want to go back to the previous setting (the one with the little dot), select the “Exit” button (the red X).

White Balance

Setting Auto WB will calculate a white balance based on the information in the image. Auto WB is good for most applications.

If you are using a specific lightsource you can choose that option here.

If the camera back is tethered to a computer, and white balance is set from within Capture One it is indicated with the C1 icon in place of the WB indicator on the main screen.

Custom White Balance

Your P+ back allows you to create up to 3 custom white balances.

Custom WB is available when pressing the WB button at the main menu.

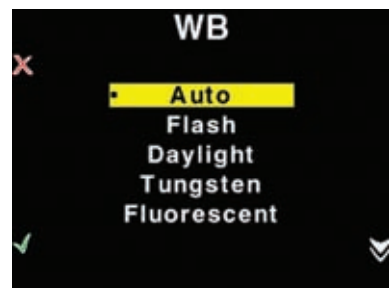



When scrolling to the bottom of the WB options four options are available:

“Custom1”, “Custom2”, “Custom3” and “CreateWB...”

To make a new custom white balance select CreateWB... and choose which one from the following: “Custom1”, “Custom2” or “Custom3”

When one of the options is selected the “Make Custom WB” will be blinking.

Now you are ready to capture the image that should be used for white balancing. Place the viewfinder center circle on an area (gray card or neutral white surface) and capture the image. You have now made the custom white balance and it has been set as the current capture white balance.

All subsequent captures will now have the new custom white balance applied.

3 different custom white balances can be defined and used as shooting white balances.

Custom white balance from Capture One

You can also choose to easily transfer a white balance from Capture One to the P+ back:

1. Create a custom white balance inside Capture One.
2. While tethered to the computer select WB from the lower right button on the P+ back.
3. Select “Custom1”, “Custom2” or “Custom3” on the P+ back depending on where you want to store the new white balance.
4. Finally Click the “Set as capture white balance” button inside capture One.

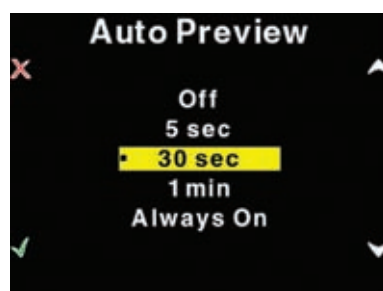
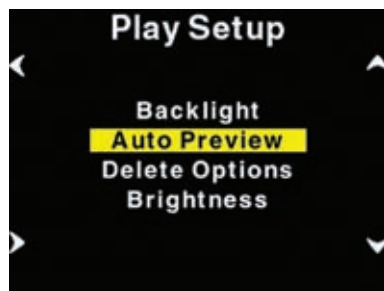
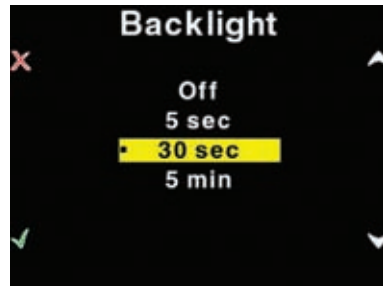
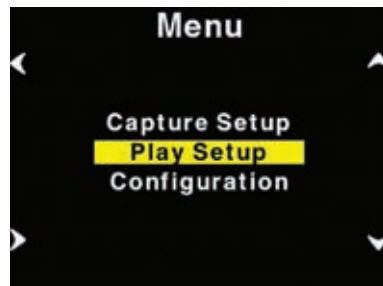
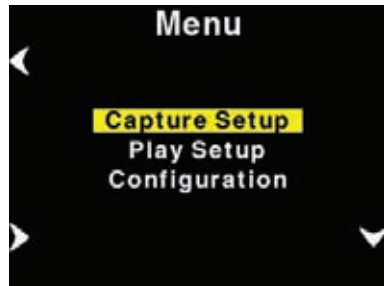

Notice
- If a button is touched during the auto preview period, the preview will remain on and the time-out will be disabled until next capture.

The P+ back will beep, confirming that the custom white balance is now uploaded, will be applied when the P+ back has been disconnected.

This technique is useful because you can bring up to three predefined custom white balances taken in the studio to your location shoot.

Please be aware that when shooting tethered to the computer, the white balance must still be set in the Capture One application. White balance cannot be set on the P+ back while tethered.

Play Setup

The second option in the menu mode is Play Setup.

Inside "Play Setup" you can select between "Backlight", "Auto Preview", "Delete options" and "Brightness".

Backlight

"Backlight" allow you to setup how many seconds or minutes of inactivity there may be before the light of the display fades.

This setting affects the battery life of the P+ back. The more time before light is dimmed, the faster the battery is drained.

Auto Preview

The second option in "Play Setup" is "Auto Preview". "Auto Preview" refers to the time the image is remains on the screen after capture.

If Auto Preview is set to "Off" the preview will not be shown automatically when a capture is taken.

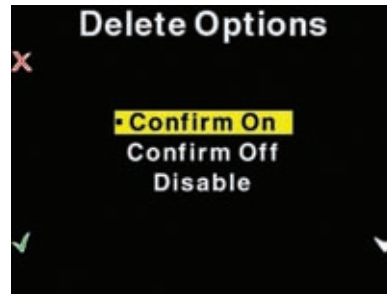
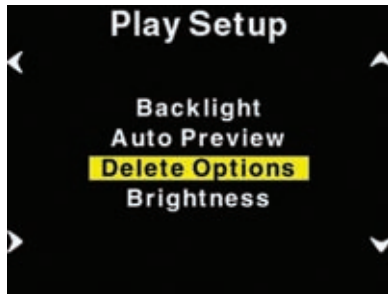

Delete options

There are three delete options: “Confirm On”, “Confirm Off” and “Disable”.

In Delete options you can setup whether you want an extra confirmation when you delete images (Confirm On - Default), delete images immediately (Confirm Off), or you can disable deleting of images on the P+ back to avoid unintended loss of images.

Brightness

In the Brightness setup, you can set the brightness of the preview LCD screen

Default setting is Bright.

Only the Brightness of the display is affected. Exposure warning, histogram and final capture is not affected by this setting.

When you are outdoor with much ambient light this is helpful but especially with images taken with low-light, a brighter display is helpful.

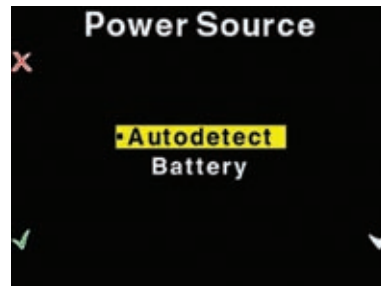
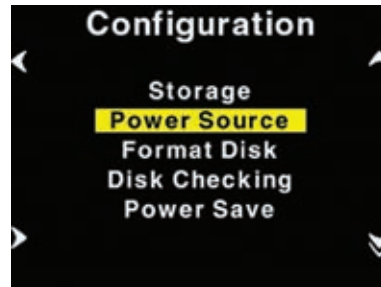
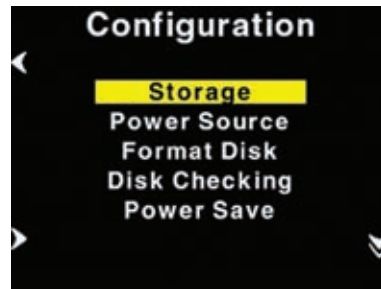

Configuration

“Configuration” is used to setup general settings and perform general tasks on the P+ back.

“Configuration” contains more menu entries than can be displayed on one screen. This is indicated by a double arrow pointing down on the right side.

Scrolling past the last menu entry will reveal the next entry. Now the arrow in the top right side will turn into a double arrow, to indicate that there are hidden entries at the top.

Storage

“Storage” is as default set to “Autodetect”. If a card is inserted in the P+ back it will automatically capture to this card. If not, it will try to capture via the IEEE 1394/FireWire port directly to the computer. – if a card is in the back at the same time as the back is connected by FireWire to a computer, this connection will have priority.

If the P+ back is not tethered to a computer you will get an error message that the card slot in the P+ back is empty.

The P+ back can also be forced to shoot to either Compact Flash or IEEE 1394/FireWire by selecting the options inside “Storage”.

Power Source

Power source only has two options, “Autodetect” or “Battery”.

In Autodetect, the P+ back will detect if an IEEE 1394/FireWire connection is supplying power, and automatically shut of the battery power.

If Power Source is set to “Battery” the power source is forced to come from the battery, and the digital back will not consume power from the FireWire connection.

This is especially useful to avoid draining the battery in a MacBook or PowerBook.



Format disk

Selecting "Format disk" will erase the CF-card in the P+ back. The CF-card will be formatted as FAT-32.

Please see CF-card section for troubleshooting if your card is not recognized.



Disk Checking

Disk Checking is done per default on every card inserted to the P+ back.

If for some reason this check is not wanted the feature can be turned off in this menu.

Phase One recommends leaving diskchecking turned on, to maximize data security on memory cards.

Read more about the Phase One Secure Storage system in Chapter 5 of this manual.



Power Save

Power Save only has two options "Auto Shutdown" and "Backlight".

Auto Shutdown is used to set the time frame before the P+ back Shuts down, when there is no activity.

If the P+ back is automatically shut down it can only be woken up by pressing the "Power" button.

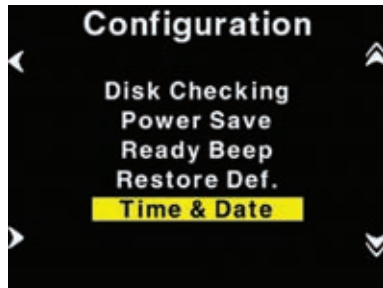

Ready beep

“Ready beep” is the small beep that sounds from the back when ready for a new capture.

The “Ready beep” signals that the P+ back is ready for next capture. “Ready beep” can be either “Single”, “Multi” or “Off”. Default is “Single”

“Multi” is for use in noisy surroundings, i.e. where it can be difficult to hear if it was the back or the flash that made the ready beep.

Restore def. (Defaults)

Selecting restore defaults will restore the settings of the P+ back to its default settings. Be careful before using this option as all settings made in the P+ back will be reset to factory settings.

Time & Date

In “Time & Date” you can set the time and date using the four buttons on the P+ back. Left side buttons will step through the hours, minutes and seconds field, while the right up and down buttons can be used to set the value of the fields. The time and date is applied to all files captured with the P+ back.



Language

The “Language” option in the “Configuration” Menu can be used to select preferred language of the user interface.

Expressions in the main menu like: ISO, WB, Play and Menu are not translated.

These are regarded as icons, and also understood widely as expressions used to navigate even on the Japanese or Chinese interface.

However switching to an unknown language unintentionally can be frustrating and the user can have difficulty getting it back to the native language back on the menu.

Phase One have made this easy by incorporating a large “L” in a parenthesis after the Language menu.

Finding this “L” will help the user get the native language back.

Currently (When this manual was written) the following languages are supported on the P+: English (default), Japanese, Chinese (Simplified), French, Italian, German and Spanish.

If there is sufficient request for more languages, these might be made available through a Firmware upgrade.

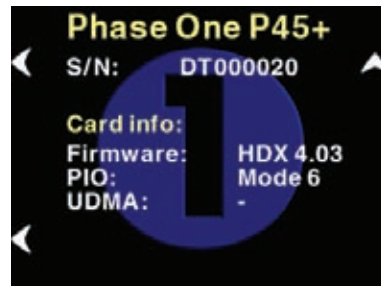
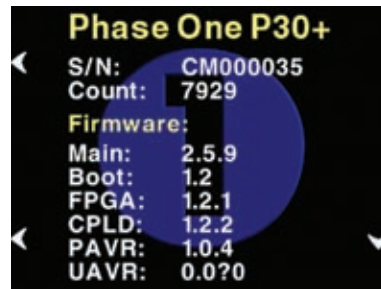

About the P+ Back

The "About" option in the "Setup Menu" displays technical information about the hardware and embedded software ("Firmware") in the camera. This is especially

useful if support is needed or if you want to check if Phase One is offering a newer firmware for your camera.

Firmware might be made available in the download section at www.phaseone.com

Before contacting your dealer or Phase One Support please make sure to have access to the "About" box or write down the entire contents of the "About" box.

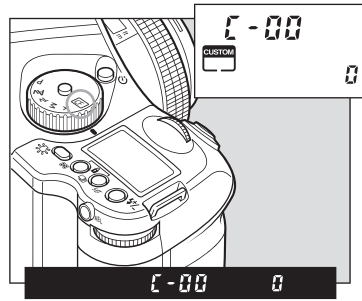

7.0 Custom function

The functions of Phase One 645 AF is predetermined to work in one way, but you can personalize your camera platform to work the way you prefer. No matter what you do in changes of the platforms workspace, you can always return to default, read more on this in chapter 7.2 types of custom functions.

7.1 Setting custom functions

The custom functions allow you to change the method for using or accessing the camera functions as you like. Take photographs the way you are most comfortable with.

The custom functions can store separate settings for 3 users. You can preset the functions for indoor, outdoor or portrait photographs and for other conditions. When at C-00, chose 1 (A), 2 (B), or 3 (C) to store a specific set of user function selections for the group of custom settings from C-01 to C-32.

However, if you set C-00 to 0, the settings used will be the default set. With this choice you can change only C-31 to 35.

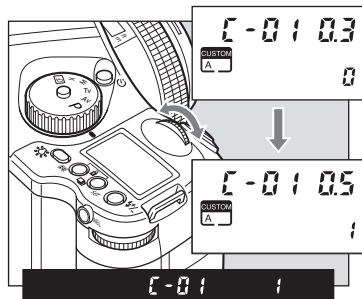
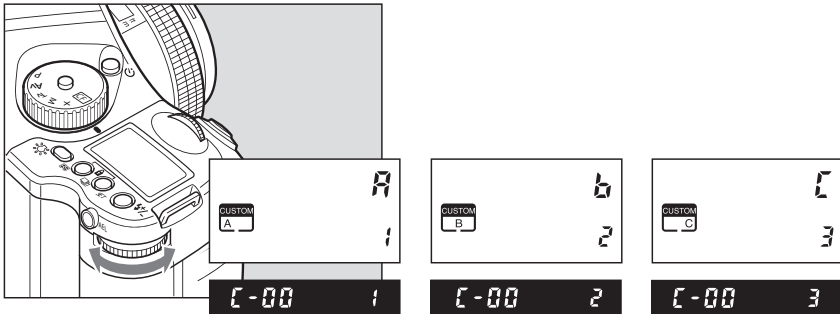

7.2 Types of custom functions

C-00 Custom functions No.

0: [Initial setting]

1: A

2: B

3: C

When “0” has been selected and set, none of the custom items can be set. “1,” “2” or “3” must be selected and set without fail.

C-01 Steps of aperture, shutter speed, exposure compensation.

This function is used to set the shutter speed, f-number and exposure compensation value step width.

0: 0.3 (1/3EV step: initial setting)

1: 0.5 (1/2EV step)

2: 1.0 (1EV step)

C-02 Data imprinting

This function is used to set whether to imprint the shooting data on the film.

0: No imprinting (initial setting)

1: Yes (data, index)

2: Yes (date, index)

C-03 Aperture setting after lens change

This function is used to set the f-number display method for the previously used lens when the lenses have been changed over. The initial setting is “Yes,” in which case the f-number of the lens prior to the changeover is displayed.

0: Yes (previous f-number: initial setting)

1: Aperture open

2: Minimum aperture setting

3: Number of stops from open

C-04 Metered value display time

This function is used to set the time it should take for sleep mode to be established after the camera’s power is turned on. The initial setting is 15 seconds. 5, 10, 15, 20, 25, 30, 40, 50, 60 or “on” can be selected and set. Note that the batteries will discharge when “on” (no sleep mode) has been set.

C-05 Range of exposure compensation

This function is used to set the maximum extent of exposure compensation. Its setting takes effect in AE shooting modes (P, Tv and Av).

0: ± 3 EV (initial setting)

1: ± 5 EV

C-06 External LCD backlight

This function is used to set the method for lighting the backlight of the external LCD panel.

0: Set using Backlight button (initial setting)

1: Always on (metering retention period)

C-07 Select battery

This function is used to set the batteries used in the camera so that the remaining battery charge will be displayed correctly on the external LCD panel.

0: Primary batteries (alkaline/manganese batteries, lithium batteries: initial setting)

1: Secondary batteries (nickel-metal hydride batteries, nickel-cadmium batteries)

C-08 Bracketing order

This function is used to set the shooting sequence for auto bracketing. The initial setting is “n-u-o” (normal/under/over). The shooting sequence for 2-frame bracketing is set in auto bracketing setting mode.

0: n-u-o (normal/under/over: initial setting)

1: n-o-u (normal/over/under)

2: u-n-o (under/normal/over)

3: o-n-u (over/normal/under)

C-09 Cancel auto bracket

This function is used to set the release method of the auto bracketing shooting setting upon completion of auto bracketing shooting.

0: Released by turning the power OFF (initial setting)

1: Until released

2: Released after one shot

C-10 Manual mode bracketing

This function is used to set whether bracketing is to be performed using the shutter speed or f-number during M (manual) mode auto bracketing shooting.

0: Shutter speed (initial setting)

1: F-number

C-11 Front/Rear dial function exchange in manual mode

This function is used to change over the operations of the front and rear dials in the M (manual mode).

0: Front dial: shutter speed, rear dial: f-number (initial setting)

1: Front dial: f-number, rear dial: shutter speed

C-12 Rear function dial enabled/disabled

In the initial setting, exposure compensation can be provided by the sub (rear) dial in P, Tv and Av modes. This function is used to set whether to allocate the operations of the front dial to the rear dial.

0: No (exposure compensation: initial setting)

1: Yes

C-13 Dial function direction

This function is used to determine the direction in which the electronic dial is to be rotated to increase and decrease shutter speed, the f-number, and exposure compensation.

0: No switching (CCW: decrease,

CW: increase: initial setting)

1: Switched (CCW: increase, CW: decrease)

C-14 Program shift

This function is used to set the type of program shift. Under the initial setting, the shifting is performed along the program line. Av enables aperture priority shift within the possible metering range; Tv enables shutter speed-priority shift.

0: Program shift (initial setting)

1: F-number shift

2: Shutter speed shift

C-15 AEL & AFL function button exchange

This function is used to set whether to change over the functions of the front and rear AEL and AFL buttons.

0: No (front: AFL, rear: AEL: initial setting)

1: Yes (front AEL, rear: AFL)

C-16 Half-press shutter release function mode

This function is used to set the AE lock and AF operations when the shutter button is half-pressed.

0: AF operation (initial setting)

1: AF operation/AE lock

C-17 AEL function lock/unlock mode

This function is used to set the method of operating the AEL button to lock AE. At the initial setting, when the AEL button is pressed, AE is locked; pressing the button again releases the AE lock. At the “1” setting (released after one shot), after AE lock is set, it is released when the shutter is tripped. At the “2” setting, AE lock is set while the shutter button is being pressed.

0: Continuous: initial setting

1: Released after one shot

2: While the shutter button is pressed

C-18 Focus indicator selection

This function is used to set whether the defocusing mark is to be displayed.

0: Yes (initial setting)

1: No (focusing mark only)

C-19 AFL function lock mode

This function is used to set the AF lock method when the AFL button is operated.

There is a choice between AF locking by pressing the AFL button and performing the AF operation for AF locking and AE locking.

0: Yes (AF lock only: initial setting)

1: Yes (AF operation/AE lock)

C-20 M mode one-push setting

This function is used to set whether one-push shift operation in manual mode is to be based on the shutter speed or f-number.

0: Shutter speed shift (initial setting)

1: F-number shift

C-21 Bulb exposure time setting

This function enables bulb shooting by setting the bulb shooting time from 1 to

60 minutes provided that the battery charge lasts. It can be used to decide on the bulb shooting time from 1 to 60 minutes.

C-22 Bulb shutter release setting

This function is used to set how to operate the shutter button for bulb shooting. At the “0” setting, the shutter is opened and closed while the shutter button is held down; at the “1” setting, it is opened and closed each time the shutter button is pressed.

0: While shutter button is pressed (initial setting)

1: Each time shutter button is pressed

C-23 Shutter speed in X mode

This function is used to set the shutter speed in X (synchronizing) mode. The initial setting is 1/125 sec. The kind of large flash unit for use in studios has a long firing time and so it may not synchronize at a high shutter speed setting. Take one or more test shots, and set the synchronization speed.

0: 1/125 sec. (initial setting)

1: 1/90 sec. (1/80 sec.*)

2: 1/60 sec.

3: 1/45 (1/40 sec.*)

* When the exposure value step width has been set to 1/2 step

C-24 Automatic sync speed setting

This function is used to set the shutter speed when using the flash unit made by Metz (with the SCA3952 adapter) in P (program) or Av mode.

0: 1/60 to 1/125 sec. (initial setting)

1: Less than 1/125 sec. (metered value)

C-25 TTL flash compensation mode

This function is used to set whether to link exposure compensation and flash compensation when using the flash unit made by Metz (with the SCA3952 adapter).

0: Not linked (initial setting)

1: Linked

C-26 AF beam setting

The AF auxiliary light fires automatically when the subject is too dark to perform AF, but this function can be used to prevent the AF auxiliary light from firing.

0: Fires (initial setting)

1: Does not fire

C-27 Flash sync. timing

When a moving subject has been shot using the flash, a flash of light will appear ahead of the subject's movement under the initial setting. This function makes it possible to change this so that the flash of light comes after the moving subject as illustrated.

0: No (front curtain synchronization: initial setting)

1: Yes (rear curtain synchronization)

C-28 Copy custom function

This function is used to group all the user symbol settings selected (custom functions that have been set) together with the other user symbols, and copy them.

0: No (initial setting)

1: Yes (copied to user A)

2: Yes (copied to user B)

3: Yes (copied to user C)

C-29 Custom function reset

This function is used to group all the user function settings selected from C- 01 to C-27 together, and initialize them (to the default settings).

0: No (initial setting)

1: Yes

C-30 Shutter release without film

This function is used to set whether the shutter is to be tripped even when the film has not been loaded.

0: No (initial setting)

1: Yes

C-31 Auto film loading setting

This function is used to set whether to feed the film (to the first frame) by halfpressing the shutter button or by closing the rear cover when the film has been loaded. The film can be fed to the first frame by halfpressing the shutter button even when the rear cover close has been established as the setting.

0: By half-pressing the shutter button (initial setting)

1: By closing the rear cover

When the camera is in sleep mode, the film will not start moving even when the rear cover is closed. Half-press the shutter button.

C-32 Multiple exposure mode

This function is used to select whether, during multiple exposure shooting, the multiple exposures are to be taken by pressing the shutter button until the multiple exposure button is pressed after the number of multiple exposures has been set (initial setting). When the number of multiple exposures is set, the film is wound up by one frame after the completion of the number of multiple exposures.

0: Until the multiple exposure button is pressed (initial setting)

1: Multiple exposure number is set

C-33 Digital back CF configuration

This function is used to select the user function (A, B or C) when an MSCElisted digital pack has been loaded.

0: No (initial setting)

1: A

2: B

3: C

C-34 Clock/calendar setting

This function is used for setting the calendar and clock.

C-35 Index setting

This function is used for setting the index numbers. – ONLY relevant when using filmback.

C-36 firmware version -

Press+/- to view firmware version: number on top of display is body firmware. Number on bottom of display is firmware number for the mounted lens.

Custom Functions overview

No.	Item	(Initial setting)	1	2	3
C-00	Custom functions No		A	B	C
C-01	Steps of aperture, shutter speed, exposure compensation	1/3EV step	1/2EV step	1EV step	
C-02	Data imprinting	No	Yes (data, index)	Yes (date, index)	
C-03	Aperture setting after lens change	Yes	Open	Minimum	Number of stops
C-04	Metered value display time	15 sec.	5 to 60, on		
C-05	Range of exposure compensation	± 3EV	± 5EV		
C-06	External LCD backlight	Backlight button used	on		
C-07	Select battery	Alkaline-manganese	"Ni-CD, Ni-HM"		
C-08	Bracketing order	N-U-O	N-O-U	U-N-O	O-N-U
C-09	Cancel auto bracket	Power OFF	Until released	Released after one shot	
C-10	Manual mode bracketing	Shutter speed	F-number		
C-11	Front/Rear dial function exchange in manual mode	F front: Tv, rear : Av	Front: Av, rear: Tv		
C-12	Rear function dial enabled/disabled	No (Exposure compensation)	Yes		
C-13	Dial function direction	No switching (CCW:decrease/CW:increase)	Switched (CCW:increase/CW:decrease)		
C-14	Program shift	Program shift	F-number shift	Shutter speed shift	
C-15	AEL & AFL function button exchange	No (front: AFL /rear: AEL)	Yes (front: AEL /rear: AFL)		
C-16	Half-press shutter release function mode	AF operation	AF operation/AE lock,		
C-17	AEL function lock/unlock mode	Continuous	Released after one shot	While the shutter button is pressed	
C-18	Focus indicator selection	Yes	No		
C-19	AFL function lock mode	Yes (no AF operation)	Yes (AF operation)		
C-20	M mode one-push setting	Shutter speed shift	F-number shift		
C-21	Bulb exposure time setting	60 minutes	1 to 60 minutes , on		
C-22	Bulb shutter release setting	While shutter button is pressed	Each time shutter button is pressed		
C-23	Shutter speed in X mode	1/125	1/90 (1/80)	1/60	1/45(1/40)
C-24	Automatic sync speed setting	1/60 to 1/125	Metered value (less than 1/125)		
C-25	TTL flash compensation mode	No	Yes		
C-26	AF beam setting	Fires	Does not fire		
C-27	Flash sync. timing	No	Yes		
C-28	Copy custom function	No	Yes (User A)	Yes (User B)	Yes (User C)
C-29	Custom function reset	No	Yes		
C-30	Shutter release without film	No	Yes		
C-31	Auto film loading setting	Shutter button pressed halfway	Closing rear cover		
C-32	Multiple exposure mode	Until multiple exposure button is pressed	Multiple exposure number setting		
C-33	Digital back CF configuration	No	A	B	C
C-34	Clock/calendar setting				
C-35	Index setting				

8.0 Lenses and Multi Mount

Phase One provides the widest range of possibilities, when it comes to lenses, this increases the possible creative solutions for the photographer, This chapter is looking closer at some possible lenses, but it is worth noticing that there are more lenses usable than what we show here. The enthusiastic user can find loads of information on the internet as well as mount-adaptors, like the Phase One Multi-Mount.

Phase One will of course always recommend our products, but we are well aware that creativity will only grow co-operation and by using the free market and free choices that follows the market.

Please note, errors or damage caused by thirds party products is not covered by the warranty, test new product with curious caution.

8.1 Functions of the Phase One lens

The Phase One 80mm f.2,8 - a sharp, new and well tested digital photography prepared lens. The lens is mounted by aligning the white dot on the lens right in front of the white dot on the camerabody, carefully mount the lens by turning it clockwise, until a clicksound is heard, if you feel resistance or if you hear a grate-like sound stop and retry – NEVER use force when mounting the lens, it should always slide in without resistance.

The lens has 2 rings, the inner ring provides the possibility of changing the focus mode without changing grip of the body, keep the focus selector on the camera body on either “S” or “C” to decide whether focusing single or continuously, and decide whether to do autofocus or manual focus on the inner ring of the lens.

The focus ring is the outer ring on the lens, use this ring to manually set the focus, read more on focusing in the chapter 3.4 regarding autofocus.

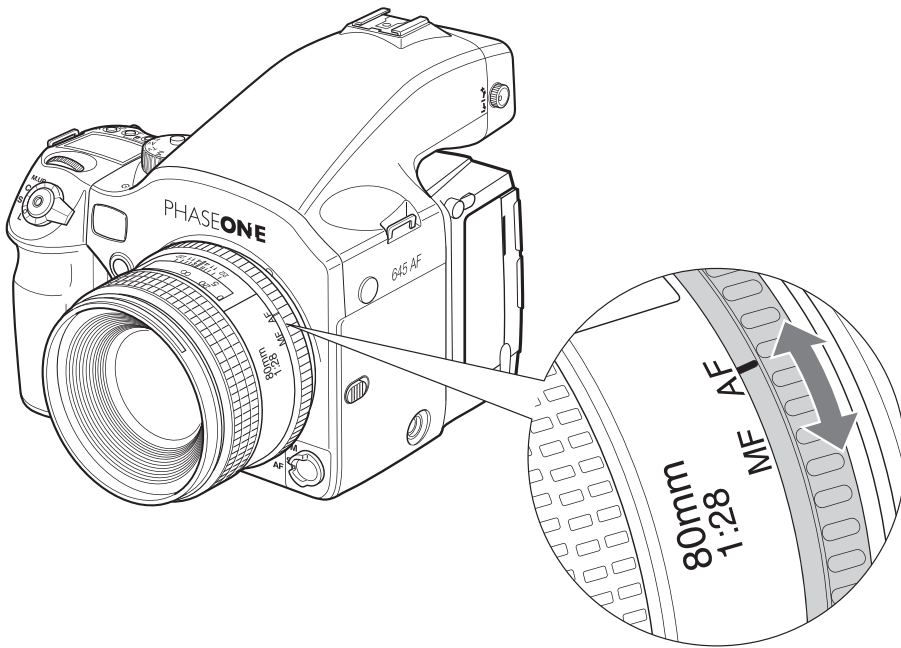

Notice:

If you select MF on the camera body, you might have to turn the camera off before the autofocus will start.

8.2 Function of the Phase One lens adaptor

To mount the Phase One Multi-Mount, match the white dot on the camera up with the white dot on the Multi-Mount and turn slowly clockwise, **NEVER** use force to mount the ring. When the Phase One Multi-Mount is mounted you can fit Carl Zeiss/Hasselblad V and Hasselblad 200series lenses on the camera.

8.3 List of alternative lenses

Recommended digital lenses

Producer	specs	limitations	adaptor/mount	notice
Mamiya	28 f.4,5 AFD		Mamiya 645AFD	Sekor
Mamiya	75-150 f.4,5		Mamiya 645AFD	Sekor

Recommended lenses

Producer	specs	limitations	adaptor/mount	notice
Mamiya	35 f.3,5		Mamiya 645AFD	
Mamiya	45 f.2,8		Mamiya 645AFD	
Mamiya	55 f.2,8		Mamiya 645AFD	
Mamiya	150 f.3,5		Mamiya 645AFD	
Mamiya	210 f.4,0		Mamiya 645AFD	ULD
Mamiya	300 f.4,5		Mamiya 645AFD	APO
Mamiya	55-110 f.4,5		Mamiya 645AFD	
Mamiya	105-210 f.4,5		Mamiya 645AFD	ULD

Producer	specs	limitations	adaptor/mount	notice
----------	-------	-------------	---------------	--------

Recommended MF lenses

Mamiya	A 500 f.4,5	1+2	Mamiya 645	MF
Mamiya	A 300 f.2,8	1+2	Mamiya 645	MF+APO
Mamiya	A 200 f.2,8	1+2	Mamiya 645	MF+APO
Mamiya	55	1+2	Mamiya 645	leafshutter
Mamiya	80 f.2,8 N/L	1+2	Mamiya 645	leafshutter
Mamiya	150 f.3,8 N/L	1+2	Mamiya 645	leafshutter
Mamiya	105-210 f.4,5	1+2	Mamiya 645	
Mamiya	500 f.5,6	1+2	Mamiya 645	
Mamiya	55-110 f.4,5 N	1+2	Mamiya 645	
Mamiya	150 f.2,8	1+2	Mamiya 645	
Mamiya	300	1+2	Mamiya 645	
Mamiya	24 f.4,0	1+2	Mamiya 645	
Mamiya	35	1+2	Mamiya 645	
Mamiya	150 f.3,5 N	1+2	Mamiya 645	
Mamiya	45	1+2	Mamiya 645	
Mamiya	210 N	1+2	Mamiya 645	
Mamiya	80 f.1,9	1+2	Mamiya 645	
Mamiya	55	1+2	Mamiya 645	
Mamiya	80 f. 2,8 N	1+2	Mamiya 645	

Hartblei	MC TS-PC 45 f. 3,5		mamiya/Pentacon six	super-rotator tilt/shift
Hartblei	MC Hartblei 2x converter		pentacon six	

Producer	specs	limitations	adaptor/mount	notice
Arsat	MC Arsat 30 f.3,5 fisheye		Pentacon six	
Arsat	MC Arsat 45 f.3,5 Wide Angle		Pentacon six	
Arsat	MC PCS Arsat 45 f.3,5		Pentacon six	shift
Arsat	MC PCS Arsat 55 f.4,5		Pentacon six	shift
Arsat	MC PCS Arsat 65 f.3,5		Pentacon six	shift
Arsat	MC Arsat 80 f.2,8		Pentacon six	
Arsat	MC Arsat 600 f.8,0		Pentacon six	Mirror

Lenses usable in combination with Phase One Multi-Mount

Carl Zeiss	CFi 30 f.3,5	3	hasselblad V	
Carl Zeiss	CFE 40 f.4,0	3	hasselblad V	
Carl Zeiss	CFi 50 f.4,0	3	hasselblad V	
Carl Zeiss	CFi 60 f.3,5	3	hasselblad V	
Carl Zeiss	CFE 80 f.2,8	3	hasselblad V	
Carl Zeiss	CFi 100 f.3,5	3	hasselblad V	
Carl Zeiss	CFE 120 f. 4,0	3	hasselblad V	
Carl Zeiss	CFi 150 f.4,0	3	hasselblad V	
Carl Zeiss	CFE 180 f.4,0	3	hasselblad V	
Carl Zeiss	CFi 250 f.5,6	3	hasselblad V	
Carl Zeiss	CFE 350 f.5,6	3	hasselblad V	SA

Special purpose lenses

Mamiya	120 f.4,0 MACRO		Mamiya 645	MF
Mamiya	50 SHIFT	1	Mamiya 645	MF
Mamiya	645 Auto bellows unit	1	Mamiya 645	
Mamiya	80 MACRO	1	Mamiya 645	

Other lenses usable in combination with adapter

Hasselblad	30			fisheye
Hasselblad	40			
Hasselblad	50			

Pentacon	flektogon 50			
----------	--------------	--	--	--

Arsat	55mm Shift			
Biometar	80mm			
Biometer	120mm			
Sonnar	180mm			

Limitationcodes:

- 1: Stopped down metering not possible
- 2: Discontinued
- 3: Leaf shutter disables, only aperture priority

8.4 Lens Cast

What is Lens Cast?

Lens cast may occur if using the camera back with wide- angle lenses e.g. Horseman Digiflex II, Hasselblad Flexbody or Hasselblad 905SWC or on other large format cameras with different tilt or swing settings. On a medium format camera lens cast is very rare if using fixed lenses from 60 mm to 120 mm.

Why does lens cast occur?

Lens cast occurs as a result of the angle at which the CCD is exposed to light. If the CCD is exposed to light coming from a very sharp angle e.g. wide-angle or extreme degrees of tilting you may experience lens cast.

What does it look like?

Depending on the light conditions and photographic setup, lens cast can appear differently, on some lens/back combinations there will appear to be a transition from green-ish to magenta-ish, but blue, red - all colors can appear, if you want to test your lens for color cast, take a photo of a grey wall or cardboard. And check this image for colors.

How to get rid of Lens Cast?

If working with large format cameras with tilt and swing, you would have to make a new calibration file if you change the tilt and swing position. Phase One provides a solution in the Capture one software that helps you get rid of the lens cast.

We call it: Lens Cast Calibration (LCC). By holding an opal white plate in front of the lens and capturing a calibration image that you then apply to all of your capture files you are able to remove the lens cast.

On medium format cameras the calibration is very simple: You do one calibration for each lens and then save the calibration files and apply them when needed by clicking “Set as default for new Captures”.

8.5 4 simple steps to calibrate on fixed lenses (MAC)

1. Hold the calibration plate in front of the fixed lens (as close as possible), and capture. In order to ensure correct exposure you may have to up a few f-stops or in a very dark setup, put on more light directly onto the plate.
2. In the Capture One software you select the 'calibration' image and click on the "Save LCC" button (the LCC tool is located under the grey balance tab).
3. Give the calibration file a name that corresponds to the lens in use or the set-up (e.g. 45mmDaylight)
4. Select the calibration file: "45mm Daylight" from the "Lens CC" drop-down list and click "Set as default for new Captures".

8.6 Large format and stitched images (MAC)

Large format and stitched images (Mac)

When using LCC in combination with large format capture and image stitching you must capture one calibration file per image and make sure that you match the calibration file to the right image prior to stitching.

1. Start by capturing the two calibration files and the two image files.
2. Save the right-side calibration file by clicking the "Save LCC"
3. Name the calibration file i.e.CarsRight.
4. Save the left-side calibration file the same way.
5. Select the right-side image and apply the right-side calibration file. Select the left-side image and apply the left-side calibration file.
6. A simple way to gray calibrate is to select all images in the thumbnail window. Click on the left-side center of the right side calibration file and apply that gray balance to all images by clicking the "Apply to all selected" (remember to only select apply gray balance in the dialog).

PLEASE NOTE: As soon as grey calibration is done and the calibration files are saved and appear in the Lens CC drop-down box the calibration files can be deleted from the thumbnail window.

8.7 4 simple steps to calibrate on fixed lenses (PC)

1. Hold the calibration plate in front of the fixed lens (as close as possible), and capture. In order to ensure correct exposure you may have to open up a few f-stops or in a very dark setup, put on more light directly onto the plate.
2. In the Capture One software you select the 'calibration' image and click on the "Generate..." button (the LCC tool is located under the white balance tab).
3. Give the calibration file a name that corresponds to the lens in use or the set-up (e.g. 45mmDaylight)
4. Select the calibration file: "45mm Daylight" from the "Lens CC" drop-down list and set a checkmark in the "Apply LCC for next Captures".

If working with large format cameras with tilt and swing, you would have to make a new calibration file if you change the tilt and swing position.

When using LCC in combination with large format capture and image stitching you must capture one calibration file per image and make sure that you match the calibration file to the right image prior to stitching.

8.8 Large format and stitched images (PC)

1. Start by capturing the two calibration files and the two image files.
2. Save the left-side calibration file by clicking the “Generate...” button
3. Name the calibration file i.e.CarsLeft.
4. Save the right-side calibration file the same way.
5. Select the right-side image and apply the right- side calibration file. Select the left-side image and apply the left-side calibration file.
6. A simple way to white balance is to select all images in the thumbnail window and click on the left-side center of the right side calibration file and apply that white balance to all images by clicking the “Apply this White Balance to the current selection of captures”.

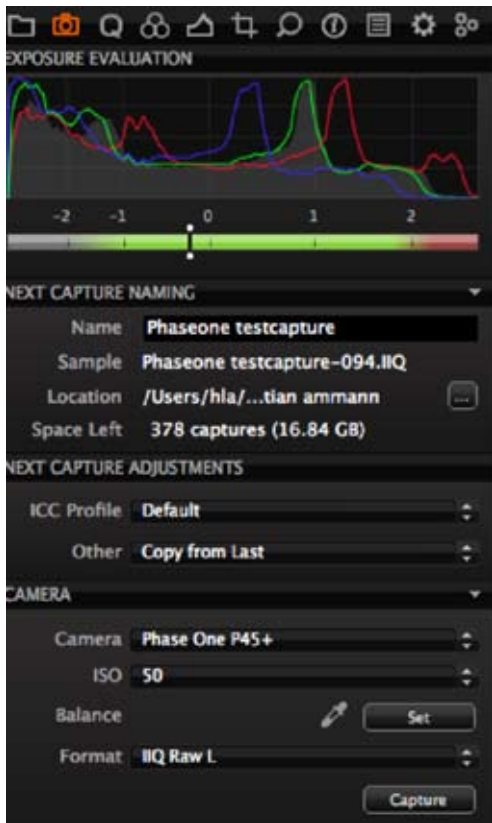

9.0 Software

Capture One 4.1 Digital Back Only, is a part of the new Phase One camera platform.

For further information regarding functions of Capture One 4.1 please read the users guide for this, the user guide is found under the menu help on win and on MAC.

9.1 Getting started

The user interface of Capture One 4.1 is very close to the original Capture One 4, you will find the well known tabs Library, Quick, Color, Exposure, Composition, Details, Adjustments, Meta, Process and Batch, besides these we have added a new tab, Capture; this tab provides of course the possibility of making the Capture via the connected FireWire cable. You can control certain parts of the camera settings such as ISO format and White Balance.

Read the software manual before using the software, and do test shots before using the software for professional use.



9.2 Importing from CF card

Like using e.g. win-explorer it is easy to browse to a disk containing RAW images on a local or network computer. You can also choose to import directly from a memory card in a card reader.

Choose File > Import images or select the import images button to begin the import process. Immediately, a large dialogue box appears showing a preview of files to be imported. This dialogue box also provides a range of options from which to choose.

Inserting a memory card into a card reader will automatically bring up the import dialogue window. The Import window offers a range of options to make importing a quick and straightforward task.

It is important to remember that you are importing images from one location to another. You need to create or define a folder to which the files will be imported to. This can be done manually or through the Locations tab in the file importer window.

Capture One 4 can automatically create subfolders, named by date or user defined. When importing you can also choose to rename the files, as they are imported from the camera or cd/memorycard, the file names can be changed by double-clicking on the filename in the browser or when exporting the files.

10.0 Large format and technical cameras

Phase One's status as open platform does not only mean the possibility of fitting the back on different medium format cameras, but also large format and Technical cameras.

10.1 Large format photography

You can do large format photography, digital captures with the Phase One back.

As the light sensitive chip in the P-back is not (yet!) 4x5" or 8x10 you have to use an adapter to move the back to capture the entire view, the FlexAdapter is a sliding back used to connect a Phase One back to a large format camera. A ground glass is provided for initial set-up that slides over to position the digital back in the perfect orientation to the focused area.

Markings are provided for the stitching function which allows two captures to be taken, beside each other with a slight overlap. Capture One software automatically stitches these together with the built in stitch tool.

The design is simple and clever, using a standard lens board mounted on the back of the adapter for specific large format systems. Currently there are versions for Sinar, Cambo, Arca Swiss, Linhof and Toyo systems. Large format cameras that use a lens board for mounting the ground glass assembly can be custom adapted (custom adaptation service not provided by Phase One). All Phase One camera solutions from the P 21+ to the P 45+ can be used with the FlexAdapter and all backs can provide stitched images.

Capture One PRO provides stitch function to put the captures together in one large format file; this is still used in architectural photography.

- Please read the specific largeformat leaflets, and consult your local dealer, you will be amazed of the possibilities.

10.2 Technical cameras

The use of technical cameras is growing. Images taken with a technical camera can have different look and feel compared to DSLR or medium format capture. The look is achieved through unique focal lengths, use of rise/drop and shift movements available since photography began and a different optical point of view.

For many photographers, quality cannot be compromised. A technical camera provides significantly more optical quality especially when combined with a Phase One back and Capture One software. The optical path is straight and simple with no mirror systems to worry about. This removes the need of retro-focus design wide-angle lenses that compromise image quality with DSLRs and mediumformat.

Both Rodenstock and Schneider have produced technical camera lenses that are tuned to the capture area and quality requirements for digital photography. A technical camera solution offers the sharpest possible results.

For more information on technical photography consult your local dealer.

NOTICE

Since the Focusing Screens' surfaces are soft and easily damaged, handle them carefully.

Never touch the surface with bare fingers. Should dust settle on it, merely blow away by using a blower.

If the Focusing Screen needs cleaning, send it to the nearest authorized Phase One service center.

Do not attempt to clean the surface of the Focusing Screen, as it is very delicate.

Do not touch and damage the mirror in any way.

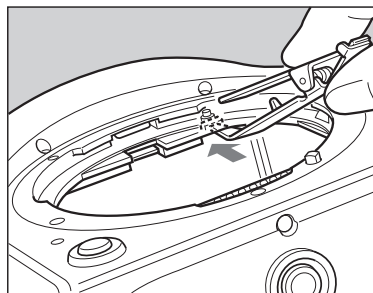
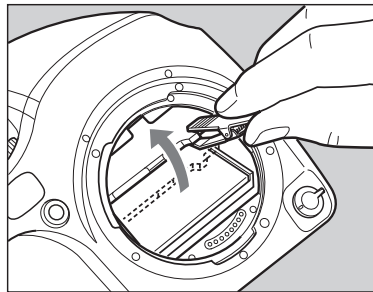
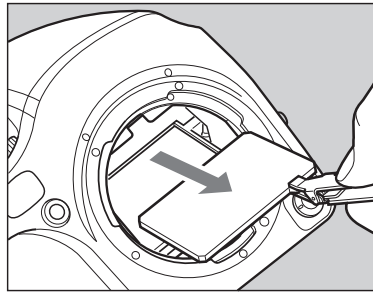
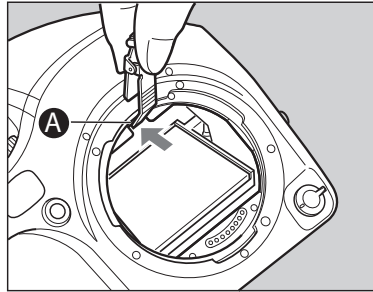

11.0 Maintenance

In general very little maintenance is needed, but this is a professional tool, and should be treated with care and caution. If the gear for some reason have not been used for a period, you should always do test shots before the photographic session.

A frequently used product should be inspected periodically at the nearest official Phase One repair center. Should there be errors or malfunctions of camera, lens or back – do NOT try to repair – consult your local dealer.

11.1 changing the focusing screen

1. Remove the lens.
2. Pull the Focusing Screen Release lever **A** forward, as illustrated, with the tweezers to let the Focusing Screen down.
3. Remove the Focusing Screen from the Focusing Screen Frame by grasping the tab on the edge of the screen with tweezers as illustrated.
4. When installing the screen, pinch the tab of the screen with tweezers, and put the screen on the screen frame.
5. Push up the screen frame using the tweezers until hearing a clicking sound. The screen is now properly installed. - Never press down on other parts as this will affect the focus function.

11.2 Battery socket

Never leave batteries in the socket, if the camera or back is not supposed to be used for longer periods.

Keep contacts clean and dry at all times.

11.3 Tripod/Electronic shutter release contact

Keep all contact clean and dry at all time.

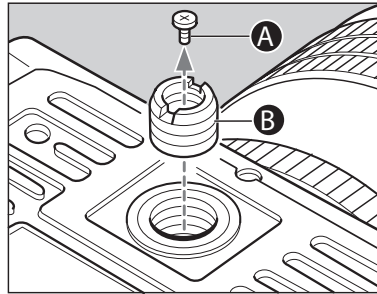

When using a tripod with 3/8" screw (instead of 1/4" screw) remove the small screw A from the tripod screw hole on the bottom of the body using a plus screwdriver, then use a coin to remove the tripod screw adapter bushing B.

You will find Electronic shutter release both on the camera body and on the back. When used, it is recommendable to use the shutter release on the back. Keep both contacts dry and clean.

11.4 Camera display error-notification

LCD Display		Causes and Remedies	
Main LCD panel	Viewfinder LCD readouts	Problems	Remedies
	▶ ◀	If the camera cannot focus in the AF "S" (single) mode, you cannot release the shutter.	Try to adjust focus again, or change to the focus lock mode or manual focus mode
batt	batt	The indicator appears when the battery capacity is low.	Replace with new batteries
-no-Fb	-no-Fb	The shutter will not operate when the digital back is not mounted on the body. If you press the shutter release, this symbol will appear.	Mount a digital back.
		This symbol appears when setting the custom functions but no choice of user is made.	Select a user before changing custom settings. CF-00
	- u - - o -	While in manual exposure mode, and when the difference between the set value and metered value exceeds + or - 6EV, this indicator will appear.	Change aperture or shutter speed.
F - -	- -	This will appear when a lens is not mounted	Try mounting a lens...!
Err-01 Err-02 Err-03 Err-04 Err-05 Err-06 Err-07		When "Err" appears, some abnormality has been detected in the course of taking photos.	Replace with new batteries and press the shutter release button, if the "Err" does not disappear then contact your local dealer.

11.5 Lens maintenance

Never touch the inner optics of the lens with your fingers, keep the inneroptics perfectly clean with air, lens brush or the dry cloth delivered with the lens.

Do not touch the contacts; keep the contacts clean, either by dry cloth or by using fiberglass brush, do not use tools of any kind on the lens.

The lens is not waterproof, if wet it should be dried with a cloth, if exposed to salt, moisten a cloth, wring it and clean.

11.6 Back Maintenance

Cleaning the CCD

When the Phase One P+ back is not attached to a camera, the camera back must be protected with the protection plate. However, over time dust may accumulate on the IR filter. This will degrade the image quality if not removed.

Please follow the directions included in the CCD cleaning kit in the P+ back suitcase.

11.7 housing specification

Camera Type : 6x4.5cm format, electronically controlled focal-plane shutter, TTL multiple mode AE, AF Single Lens Reflex

Actual Image Size : 56x41.5 mm

Lens Mount : Mamiya 645 AF Mount, compatible with M645 Mount (manual focus confirmation, focus aid, stopped-down exposure metering)

Viewfinder : Fixed prism viewfinder magnification x0.71; built-in diopter adjustment (-2.5 to +0.5, optional diopter correction lenses provide adjustment ranges of -5 to -2 diopter and 0 to +3 diopter); built-in eye-piece shutter

Focusing Screen : Interchangeable, Matte (standard), Checker, and Microprism Type C for Non-AF M645 lenses.

Field of View : 94%* of actual image

Viewfinder Info : Focus mark, defocus mark, warning mark, aperture value, shutter speed, metering mode (A, S, A/S), exposure compensation value (difference between set value and metered value) and flash ready / OK lamp with TTL Metz connection.

AF method : TTL phase difference detection method; sensor: CCD line sensor (I+I type); operating range: EV0 to EV18 (ISO 100)

Focus area : Display the focus area in the viewfinder screen

AF assist beam : Activates automatically under low light, low contrast.

Range: 9m, Automatic switching to flash unit's built-in assist beam if Metz flash unit is attached.

AF Lock : By pressing the shutter release button halfway down in the AF-S mode, or by pressing the AFL button.

Exposure Modes : Aperture-priority AE, shutter-priority AE, programmed AE (PH, PL setting possible), and manual

AE metering mode : TTL metering, center-weighted average (AV), spot (S), and variable ratio (A-S auto)

Shutter increments : Both the shutter speed and the aperture level can be set to 1/3 or speed and aperture 1/2 using the electronic dial lock function

Metering Range : EV 2 to EV 19 (with ISO100 film, f/2.8 lens)

Exp. comp. : ±3 EV (1/3 step) Expandable to ±5 EV

Film speed : ISO 25 to 6400

AE lock : With AEL button; canceled by pressing the button again or shutter release

Shutter : Electronically controlled vertical metal focal-plane shutter. (vertical travel)

Shutter speed : AE 30 to 1/4000 sec. (1/8 step), manual 30 to 1/4000 sec. (1/2 or 1/3 steps), X, B (Bulb, electronically controlled), shutter curtain protection mechanism (open when magazine is removed, automatically closed when magazine is attached)

Auto bracket shot : Enable with auto bracket button (2 frame shots, or 3 frame shot with auto bracketing). Specify 1/3, 1/2, 2/3 or 1EV steps.

Flash Synchro : X contact point, 1/125 seconds (when 1/3 step is selected it can be set between 1/40 and 1/125 seconds).

Flash control : TTL direct flash control, supports Metz SCA3002 system (SCA3952 Adapter)

Multiple Exposure : Enable with multiple exposure button (the number of exposures can be set from 2 to 6). It can be canceled in the middle and the number of exposures can be changed, or you can switch to an arbitrary multiple exposure style.

Mirror up shot : Select by pressing the mirror up button.

LCD displays : Main LCD display: Program mode mark, custom function mode mark, AF area mark, battery level indicator, manual focus mode, superimpose mode, dial lock mark, shutter speed, AE lock mark, aperture value, multiple exposure mode mark, exposure compensation mode mark, flash compensation mark, exposure compensation value, self-timer mark, auto bracket mark, time mark (while setting the clock).

Data Imprinting : 7 segment dot matrix; DATA mode: exposure mode, aperture value, shutter speed value, exposure compensation, metering mode, ID number; DAY mode: year, month, date, time, ID number, ID mode; ID number

Sync terminal : X contact (sync speed 1/125 sec.)

Cable release : On shutter button

Remote terminal : On side of body; electromagnetic cable release

Self-Timer : 2 to 60 sec. (standard: 10 sec., can be set in 1 sec. steps between 2 and 10 sec., and in 10 sec. steps between 10 and 60 sec.)

Depth-of-field confirmation : Preview Button on body

Custom settings : 35 items + Firmware Information

Tripod Socket : U 1/4 inch and U 3/8 included

Power Requirements : 6 AA-size batteries (alkaline-magnesium, lithium)

External power socket : An external battery case can be connected.

Size & Weight : 6 "(W)X5 "(H)X7.3 "(D) / 153(W)X128(H)X184(D)mm : 3.8 pounds / 1,730 g (W/O battery)
* This information is based on a linear (horizontal/vertical) measurement.





11.8 P+ series Technical specifications

Please read the schedule for detailed overview of the different backs.

THE PHASE ONE P+ SERIES

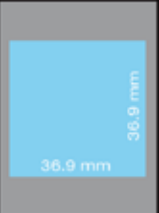

CCD size compared to capture area of a 645 camera (medium format)

	P 45+	P 25+	P 30+	P 21+	P 20+
	Top of the line shooter with unlimited burst sequences and optimized for large format photography with live preview functionality for easy composition and focus checking	All-round shooter with unlimited burst sequences and optimized for large format photography with live preview functionality for easy composition and focus checking	The top quality fast fashion shooter with ISO 1600, with superior moiré control and well suited for harsh environments	The fast and flexible high-end DSLR alternative with high dynamic range, brilliant ISO 800 and unlimited burst capture. Very useful in large and wide angle photography, and well suited for harsh environments	The square format all-round studio portrait shooter with an attractive price tag. Optimized for 6x6 camera systems as well as large format photography
					
Lens factor	1.1	1.1	1.3	1.3	1.4
Pixel size (micron)	6.8 x 6.8	9 x 9	6.8 x 6.8	9 x 9	9 x 9
Resolution (mega pixels)	39	22	31.6	18	16
Active pixels	7216 x 5412	5436 x 4080	6496 x 4872	4904 x 3678	4080 x 4080
Light sensitivity (ISO)	50-800	50-800	100-1600	100-800	50-800
Exposure time	1/10,000 sec. up to one hour with XPose+ technology				
Live preview	Composition and focus mode, 1.5 - 3 frames/sec., good color reproduction, large scalable focus window for long distance viewing				
Image quality	OptiColor+ and Dynamic+ technologies (pat. pend.) for improved image quality				
Capture time (sec/frame)	1.5	1.5	1.25	0.8	1.15
Battery lifetime (captures/4 hours)	2500	4000	3000	5000	4500
Burst size	Unlimited, untethered with Sandisk Extreme IV CF card and tethered to fast PC or Mac				
Image buffer	640 MB high speed RAM for much longer untethered bursts with slow CF cards				
Display	2.2" QVGA TFT with 230,000 pixels, high brightness and contrast both indoor and outdoor, very fine details				

PHASEONE

www.phaseone.com

All specifications are subject to change without notice

11.9 End User support Policy

Please check www.phaseone.com for updated support policy

By purchase of a Phase One product we guarantee you World Class Support and Service!

World Wide Dealer Network

At Phase One we think globally but act locally. Phase One's products are sold through a world wide network of dedicated and competent local partners to make after-sales support convenient for you.

Phase One's local partners offer first line support to their customers. Many provide additional services such as training, extended warranty agreements, upgrade programs, and many other services that will add value to your Phase One investment. Contact your local Phase One partner to discuss your options. Digital camera back pricing and repairs are also handled locally.

If there is no local partner in your area, then please contact Phase One directly, and we will assist you directly or through one of our partners. Find your local Phase One partner or take advantage of Phase One's wide range of on-line support tools at <http://support.phaseone.com>.

FAQ, Tutorials & Documentation

The FAQ is a collection of the most frequently asked questions and related answers in the Phase One Knowledge Base. Use the FAQ as the first and best place to find answers on many technical questions. If you are seeking more detailed information about Capture One, Portrait One, or our Digital Backs, you can download user guides and manuals or watch some of the tutorials available.

Knowledge Base

Phase One's searchable Knowledge Base at <http://support.phaseone.com> provides you with detailed answers to most of your questions. This 'self-service' site is free of charge and available to all Phase One owners.

Capture One On-line Support Forums

On Phase One's official support forum you may share your experiences and get assistance from other Phase One owners as well as from Phase One's Technical Support team. Some Phase One partners offer on-line support forums, hosted from their own web pages. Please note that these forums are governed by separate rules. Phase One offers no guarantees and assumes no responsibility or liability with respect to the support provided by our local partners.

On-Line Support

You can contact Phase One Technical Support directly by creating an on-line support case on <http://support.phaseone.com>. Phase One Technical Support will do its best to answer your question as quickly as possible.

