

# Wireless Music Center + Station

## WACS700



THANK YOU FOR CHOOSING PHILIPS!

### NEED HELP FAST?

Read your Quick-Use guide and/or owner's manual first for quick tips that make using your Philips product more enjoyable. If you have read your instructions and still need assistance,

you may access our online help at [www.usasupport.philips.com](http://www.usasupport.philips.com)

or call **1-888-PHILIPS(744-5477)** while with your product, (and model/serial number).

User manual

Manuel d'utilisation

Manual del usuario



# PHILIPS

# Return your Product Registration Card today to get the very most from your purchase.

Registering your model with PHILIPS makes you eligible for all of the valuable benefits listed below, so don't miss out. Complete and return your Product Registration Card at once to ensure:

## \*Proof of Purchase

Returning the enclosed card guarantees that your date of purchase will be on file, so no additional paperwork will be required from you to obtain warranty service.

## \*Product Safety Notification

By registering your product, you'll receive notification - directly from the manufacturer - in the rare case of a product recall or safety defect.

## \*Additional Benefits of Product Ownership

Registering your product guarantees that you'll receive all of the privileges to which you're entitled, including special money-saving offers.

## Know these safety symbols



 This “bolt of lightning” indicates uninsulated material within your unit may cause an electrical shock. For the safety of everyone in your household, please do not remove product covering.

 The “exclamation point” calls attention to features for which you should read the enclosed literature closely to prevent operating and maintenance problems.

## For Customer Use

Enter below the Serial No. which is located on the rear of the cabinet. Retain this information for future reference.

Model No. \_\_\_\_\_

Serial No. \_\_\_\_\_

**WARNING:** TO PREVENT FIRE OR SHOCK HAZARD, DO NOT EXPOSE THIS EQUIPMENT TO RAIN OR MOISTURE.

**CAUTION:** To prevent electric shock, match wide blade of plug to wide slot, fully insert.

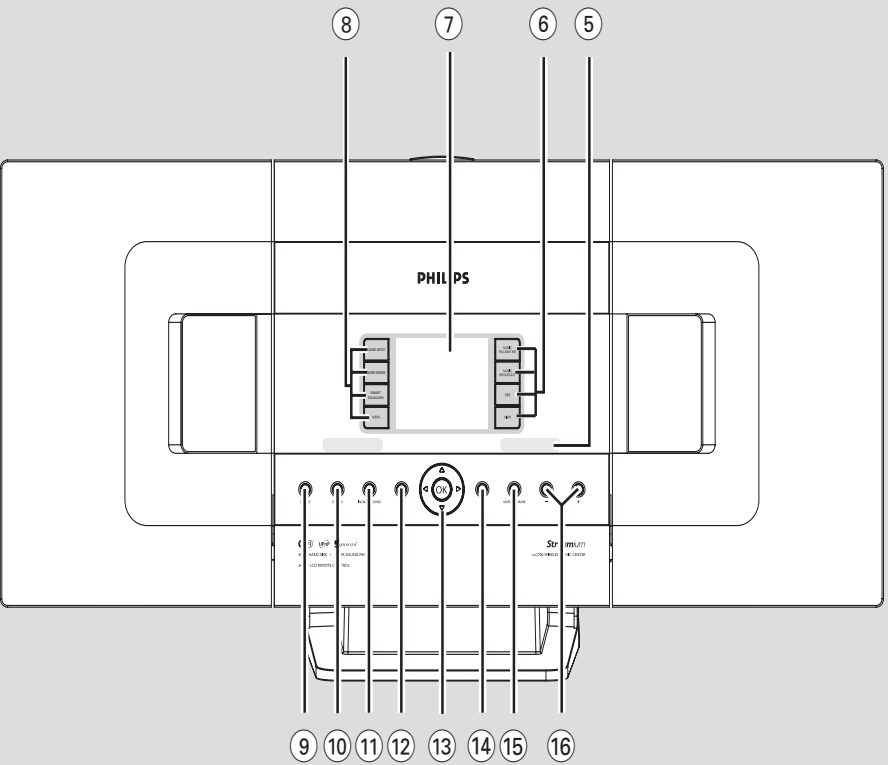
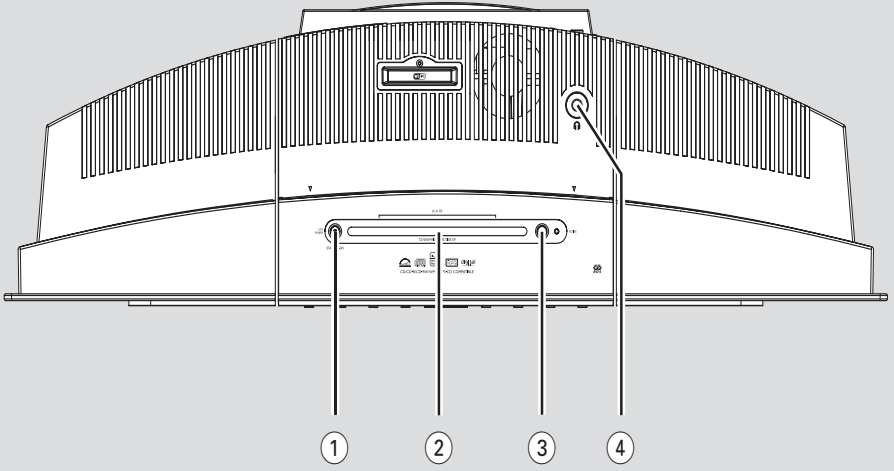

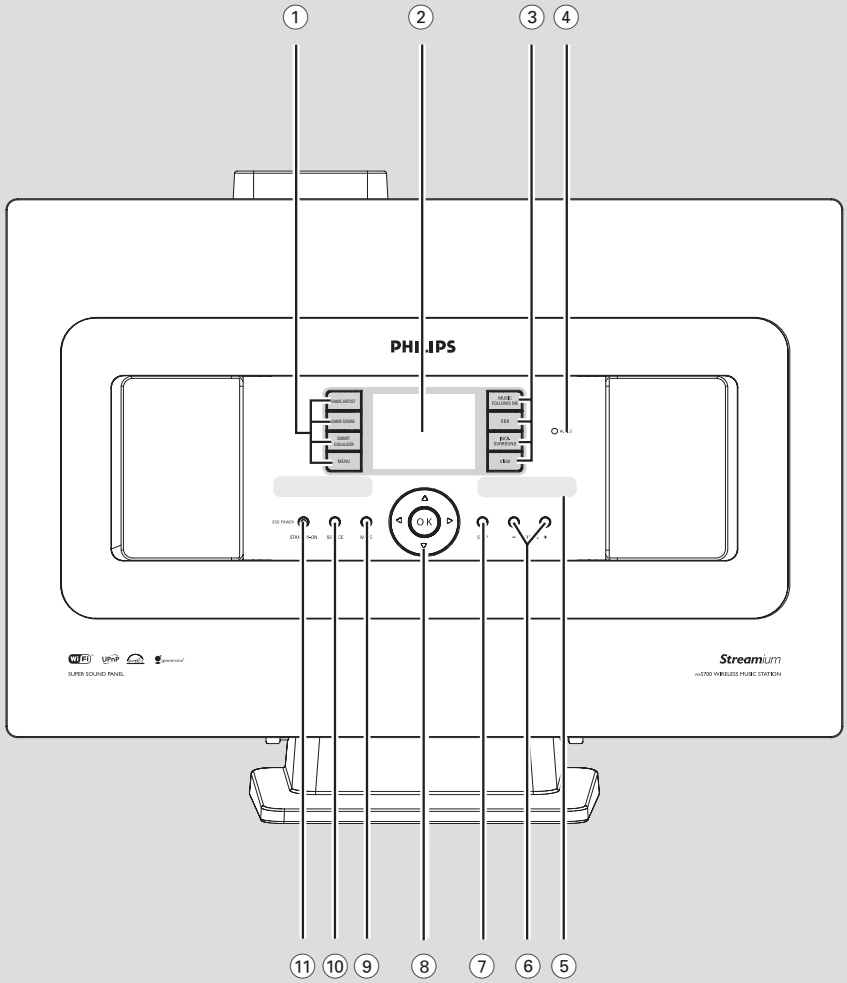

# PHILIPS

***Congratulations on your purchase,  
and welcome to the “family!”***

**Dear PHILIPS product owner:**

Thank you for your confidence in PHILIPS. You've selected one of the best-built, best-backed products available today. We'll do everything in our power to keep you happy with your purchase for many years to come.

As a member of the PHILIPS “family,” you're entitled to protection by one of the most comprehensive warranties and outstanding service networks in the industry. What's more, your purchase guarantees you'll receive all the information and special offers for which you qualify, plus easy access to accessories from our convenient home shopping network.

Most importantly, you can count on our uncompromising commitment to your total satisfaction.

All of this is our way of saying welcome - and thanks for investing in a PHILIPS product.

**P.S. To get the most from your PHILIPS purchase, be sure to complete and return your Product Registration Card at once.**

# IMPORTANT SAFETY INSTRUCTIONS

1. **Read these instructions.**
2. **Keep these instructions.**
3. **Heed all warnings.**
4. **Follow all instructions.**
5. **Do not use this apparatus near water.**
6. **Clean only with a piece of dry cloth.**
7. **Do not block any ventilation openings. Install in accordance with the manufacturer's instructions.**
8. **Do not install near any heat sources**

such as radiators, heat registers, stoves, or other apparatus (including amplifiers) that produce heat.

9. **Do not defeat the safety**

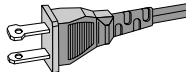

**AC Polarized Plug**

**purpose** of the polarized or grounding-type plug. A polarized plug has two blades with one wider than the other. A grounding type plug has two blades and a third grounding prong. The wide blade or the third prong are provided for your safety. If the provided plug does not fit into your outlet, consult an electrician for replacement of the obsolete outlet.

10. **Protect the power cord** from being walked on or pinched, particularly at plugs, convenience receptacles, and the point where they exit from the apparatus.
11. **Only use attachments/accessories** specified by the manufacturer:

12.  **Use only with the cart,** stand, tripod, bracket, or table specified by the manufacturer or sold with the apparatus. When a cart is used, use caution when moving the cart /apparatus combination to avoid injury from tip-over.

13. **Unplug this apparatus** during lightning storms or when unused for long periods of time.
14. **Refer all servicing** to qualified service personnel. Servicing is required when the apparatus has been damaged in any way, such as power-supply cord or plug is damaged, liquid has been spilled or objects have fallen into the apparatus, the apparatus has been exposed to rain or moisture, does not operate normally, or has been dropped.

15. **Battery usage CAUTION** – To prevent battery leakage which may result in bodily injury, property damage, or damage to the unit:

Install **all** batteries correctly, **+** and **-** as marked on the unit.

Do not mix batteries (**old** and **new** or **carbon** and **alkaline**, etc.).

Remove batteries when the unit is not used for a long time.

16. **Apparatus shall not be exposed to dripping or splashing.**
17. **Do not place any sources of danger on the apparatus** (e.g. liquid filled objects, lighted candles).

18. This product may contain lead and mercury. Disposal of these materials may be regulated due to environment considerations.

**For disposal or recycling information, please contact your local authorities or the Electronic Industries Alliance: [www.eiae.org](http://www.eiae.org).**

**EL 6475-S004: 03/12**

**Class II equipment symbol**   
This symbol indicates that the unit has a double insulation system

**The set complies with the FCC-Rules, Part 15 and with RSS-210 of Industry Canada.**

**Operation is subject to the following two conditions:**

- 1. this device may not cause harmful interference, and**
- 2. this device must accept any interference received, including interference that may cause undesired operation.**

This equipment has been tested and found to comply with the limits for a Class B digital device, pursuant to Part 15 of the FCC Rules.



These limits are designed to provide reasonable protection against harmful interference in a residential installation. This equipment generates, uses, and can radiate radio frequency energy and, if not installed and used in accordance with the instructions, may cause harmful interference to radio communications. However, there is no guarantee that interference will not occur in a particular installation. If this equipment does cause harmful interference to radio or television reception, which can be determined by turning the equipment off and on, the user is encouraged to try to correct the interference by one or more of the following measures:

- Reorient or relocate the receiving antenna.
- Increase the separation between the equipment and the receiver.
- Connect the equipment into an outlet on a circuit different from that to which the receiver is connected.
- Consult the dealer or an experienced radio/TV technician for help.

## **IMPORTANT NOTE:**

### **FCC Radiation Exposure Statement:**

This equipment complies with FCC radiation exposure limits set forth for an uncontrolled environment. This equipment should be installed and operated with minimum distance 20cm between the radiator and your body. This transmitter must not be co-located or operating in conjunction with any other antenna or transmitter.

## **Canada**

### **English:**

This digital apparatus does not exceed the Class B limits for radio noise emissions from digital apparatus as set out in the Radio Interference Regulations of the Canadian Department of Communications.

### **Français:**

Cet appareil numérique n'émet pas de bruits radioélectriques dépassant les limites applicables aux appareils numériques de Class B prescrites dans le Règlement sur le Brouillage Radioélectrique édicté par le Ministère des Communications du Canada.



**End-User License Agreement USE OF THIS PRODUCT IMPLIES ACCEPTANCE OF THE TERMS BELOW.**

This product contains technology and data from Gracenote of Emeryville, California ("Gracenote"). The technology from Gracenote (the "Gracenote Embedded Software") enables this product to do disc identification and obtain music-related information, including name, artist, track, and title information ("Gracenote Data"), which is included on the Gracenote Database (the "Gracenote Database").

You agree that you will use Gracenote Data, the Gracenote Database, and Embedded Software for your own personal non-commercial use only. You agree that you will access Gracenote Data only by means of the standard end user functions and features of this product. You agree not to assign, copy, transfer or transmit the Embedded Software or any Gracenote Data to any third party. YOU AGREE NOT TO USE OR EXPLOIT GRACENOTE DATA, THE GRACENOTE DATABASE, OR GRACENOTE COMPONENT, EXCEPT AS EXPRESSLY PERMITTED HEREIN.

You agree that your non-exclusive license to use the Gracenote Data, the Gracenote Database, and Embedded Software will terminate if you violate these restrictions. If your license terminates, you agree to cease any and all use of the Gracenote Data, the Gracenote Database, and Gracenote Embedded Software. Gracenote reserves all rights in the Gracenote Data, Gracenote Database, and Gracenote Embedded Software, including all ownership rights. You agree that Gracenote may enforce its rights under this Agreement against you directly in its own name.

The Embedded Software and each item of Gracenote Data are licensed to you "AS IS." Gracenote makes no representations or warranties, express or implied, regarding the accuracy of any Gracenote Data. Gracenote reserves the right to delete data or to change data categories in any Data updates and for any cause that Gracenote deems sufficient. No warranty is made that the Embedded Software is error-free or that functioning of the Embedded Software will be uninterrupted. Gracenote is not obligated to provide you with any new enhanced or additional data types or categories that Gracenote may choose to provide in the future.

GRACENOTE DISCLAIMS ALL WARRANTIES EXPRESS OR IMPLIED, INCLUDING, BUT NOT LIMITED TO, IMPLIED WARRANTIES OF MERCHANTABILITY, FITNESS FOR A PARTICULAR PURPOSE, TITLE, AND NON-INFRINGEMENT. GRACENOTE DOES NOT WARRANT THE RESULTS THAT WILL BE OBTAINED BY YOUR USE OF THE GRACENOTE COMPONENT OR ANY GRACENOTE SERVER. IN NO CASE WILL GRACENOTE BE LIABLE FOR ANY CONSEQUENTIAL OR INCIDENTAL DAMAGES OR FOR ANY LOST PROFITS OR LOST REVENUES.



## LGPL Library written offer

This product contains Linux 2.4.27-vrsl, that is made available under the GNU LGPL license version 2.1 (hereafter called "the Library").

Philips Electronics Hong Kong Ltd. hereby offers to deliver or make available, upon request, for a charge no more than the cost of physically performing source distribution, a complete machine-readable copy of the corresponding source code of the Library on a medium customarily used for software interchange.

Please contact:

Mr. Bin Li  
 BLC Audio PDCC Development  
 5/F., Philips Electronics Building  
 5 Science Park East Avenue  
 Hong Kong Science Park  
 Shatin Hong Kong

This offer is valid for a period of three years after the date of purchase of this product.

## GPL Package written offer

This product contains Linux 2.4.27-vrsl, that is made available under the GNU GPL license version 2 (hereafter called "the Program").

Philips Electronics Hong Kong Ltd. hereby offers to deliver or make available, upon request, for a charge no more than the cost of physically performing source distribution, a complete machine-readable copy of the corresponding source code of the Program on a medium customarily used for software interchange.

Please contact:

Mr. Bin Li  
 BLC Audio PDCC Development  
 5/F., Philips Electronics Building  
 5 Science Park East Avenue  
 Hong Kong Science Park  
 Shatin Hong Kong

This offer is valid for a period of three years after the date of purchase of this product.

**English ----- 10**

**Français ----- 56**

**Español ----- 103**

---

## General Information

About WACS700 .....	12
Supplied accessories .....	12
Philips on-line support .....	13
Environmental information .....	14
Maintenance .....	14
Safety information .....	14

---

## Controls

Controls on the Center .....	15
Controls on the Station .....	16
Center's 2-way remote control .....	17-18
Station's remote control .....	18-19

---

## Installation

Placing Center and Station .....	21
Rear connections .....	21-23
Antennas connection	
Connecting to your PC	
Connecting an additional appliance	
Connecting to an additional appliance with powerful speakers	
Using AC power .....	23
Setting up Wi-Fi connection between Center and Station .....	23-24

---

## Preparation

Using the remote control .....	24-25
Using Center's remote control	
To replace the remote controls' batteries	
Using the navigation controls .....	26

---

## Basic Functions

Switching to standby/on and selecting functions .....	27
Switching to power-saving mode .....	27
Auto-standby .....	27
Volume control .....	27
MUTE .....	28
Sound control .....	28
Equalizer	
Bass adjustment	
Incredible surround	
Display adjustment .....	29
Selecting languages .....	29

---

## HD

Playing Harddisk(HD) .....	30
Selecting and searching .....	30-31
Selecting a different album or track	
Finding a passage within a track during playback	
Selecting tracks of a particular artist	
Selecting tracks of a particular genre	
Different play modes: REPEAT, SHUFFLE .....	31
SMART EQUALIZER .....	31
Creating Playlist: custom collection of your favorite music .....	32
Deleting a playlist, album or track .....	32
Building music library on Center .....	33-34
Ripping CDs	
Importing from PC	
Recording from Radio or External source	
Display track information .....	35
Moving between Center and Station .....	35-36
MUSIC FOLLOWS ME	
MUSIC BROADCAST	
Station management .....	36-37
Adding a station	
Deleting a station	
Viewing station status	
Information about your WACS700 .....	37
Firmware .....	37
Upgrading firmware	
Restoring previous firmware	
Re-establishing Wi-Fi connection	

---

## CD (on center only)

Discs for playback .....	38
Playing discs .....	38-39
Selecting and searching .....	39
Selecting a different album/track	
Finding a passage within a track during playback	
Different play modes: REPEAT, SHUFFLE .....	40
Display track information .....	40

---

## FM radio

Tuning to radio stations .....	41
Storing preset radio stations .....	41
Autostore: automatic programming	
Manual programming	
To listen to a preset station	
RDS .....	42
NEWS .....	42
Activating NEWS	
Deactivating NEWS	

---

## AUX/SLEEP

AUX (Listening to an external source) .....	43
SLEEP .....	43

---

## Reset

Reset .....	44
-------------	----

---

<b>Specifications</b> .....	45
-----------------------------	----

---

<b>Troubleshooting</b> .....	46-48
------------------------------	-------

---

## Appendix

How to mount your Center and Station onto walls .....	49-50
---	-------

# General Information

## About WACS700

**WACS700** comprise a **WAC700** Center and a **WAS700** Station. Up to 5 **WAS700** Stations can be connected to a **WAC700** Center:

On **WAC700**'s 40GB\* hard disk, you can centrally store up to 750 audio CDs. All the stored music can be wirelessly streamed, via Wi-Fi\*\*, from Center to connected Stations. No need to be bound to your CD player or PC etc., or be troubled by the wiring. With **WACS700**, you can easily listen to your favourite music around your home.

\* Available storage capacity is based on 4 minutes per song, 10 songs per CD on average, 128 kbps MP3 encoding and given the fact that operational software is part of the product's memory.

Actual free space is 33GB or less, due to the buffer partition for MP3 compression, firmware, music CD database and demo tracks stored.

\*\* Wi-Fi, or IEEE802.11 b/g, is the international leading industry standard for wireless broadband networking. It transfers digital data with wider range and bandwidth.

## Supplied accessories

- Center's remote control with 4 x AAA batteries
- Station's remote control with 1 x CR2025 battery
- 1 x Ethernet cable
- PC installer CD
- 2 x FM wire antenna
- 2 x Mounting kit (for Center and Station)

### **CAUTION**

***Use of controls or adjustments or performance of procedures other than herein may result in hazardous radiation exposure or other unsafe operation.***

### **CAUTION**

***Changes or modifications not expressly approved by Philips could void FCC authorization to operate this equipment.***

## Philips on-line support

Philips products have been designed and manufactured to the highest quality standards. If your Philips Connected Planet product is not working correctly, we recommend you check your User Manual to verify that your product is properly connected and configured.

The web site for Connected Planet support: **www.philips.com/support** offers you all information you need to optimally enjoy your product, and about new additions to this exciting range, to make your home entertainment experience even more enjoyable.

Please visit: **www.philips.com/support** and enter your product name (**WACS700**) to view:

- **FAQ** (Frequently Asked Questions)
- Latest user manuals and PC software manuals
- Firmware upgrade files for **WACS700**
- Latest PC software downloads
- Interactive troubleshooting

Since it is possible for you to upgrade your product, we recommend that you register your product on **www.philips.com/register** so we can inform you as soon as new free upgrades become available.

Enjoy your **WACS700**!

**The model number is on the rear of the set.**

## Environmental information

All unnecessary packaging has been omitted. We have tried to make the packaging easy to separate into three materials: cardboard (box), polystyrene foam (buffer) and polyethylene (bags, protective foam sheet).

Your system consists of materials which can be recycled and reused if disassembled by a specialized company. Please observe the local regulations regarding the disposal of packaging materials, exhausted batteries and old equipment.

## Disposal of your old product

**Your product is designed and manufactured with high quality materials and components, which can be recycled and reused.**

**When this crossed-out wheeled bin symbol is attached to a product it means the product is covered by the European Directive 2002/96/EC**



**Please inform yourself about the local separate collection system for electrical and electronic products.**

**Please act according to your local rules and do not dispose of your old products with your normal household waste. The correct disposal of your old product will help prevent potential negative consequences for the environment and human health.**

## Maintenance

### Cleaning the Sets

- Use a soft cloth slightly moistened with a mild detergent solution. Do not use a solution containing alcohol, spirits, ammonia or abrasives. Do not press the speakers hard.

### Cleaning Discs

- When a disc becomes dirty, clean it with a cleaning cloth. Wipe the disc from the center out.
- Do not use solvents such as benzene, thinner, commercially available cleaners, or antistatic spray intended for analog records.

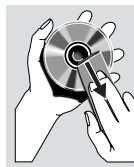

## Safety information

- Place the sets on a flat, hard and stable surface.
- Do not expose the system, batteries or discs to excessive moisture, rain, sand or heat sources caused by heating equipment or direct sunlight.
- Place the sets in a location with adequate ventilation to prevent internal heat build-up in your system. Allow at least 10 cm (4 inches) clearance from the rear and the top of the unit and 5 cm (2 inches) from each side.
- The ventilation should not be impeded by covering the ventilation openings with items, such as newspapers, table-cloths, curtains, etc.
- The apparatus shall not be exposed to dripping or splashing.
- No objects filled with liquids, such as vases, shall be placed on the apparatus.
- No naked flame sources, such as lighted candles, should be placed on the apparatus.
- The mechanical parts of the set contain self-lubricating bearings and must not be oiled or lubricated.

## Controls on the Center (Top and front panels)

### ① STANDBY-ON/ ECO POWER

- press briefly to switch Center on or to standby mode ;
- press and hold to switch Center to Eco Power mode or on

### ② CD slot loader

### ③ EJECT

- ejects a disc from the slot loader

### ④

- 3.5 mm headphone socket

#### **Helpful hints:**

- *Adjust the volume to a moderate level before you plug in the headphones.*
- *Connecting headphones will switch off the speakers.*

### ⑤ IR

- sensor for the infrared remote control

**Helpful hints:** *Always point the remote control towards this sensor.*

### ⑥ MUSIC FOLLOWS ME

- **HD:** moves music playback from Center to Station, or from Station to Center

#### **MUSIC BROADCAST**

- **HD:** broadcast music from Center to Station

#### **DBB (Dynamic Bass Boost)**

- turns the bass enhancement on (**DBB1, DBB2, DBB3**) or off.

#### **VIEW**

- toggles playback display and previous option list

### ⑦ Display

- shows status of Center

### ⑧ SAME ARTIST

- **HD:** plays all the tracks of current Artist

#### **SAME GENRE**

- **HD:** plays all the tracks of current Genre

#### **SMART EQUALIZER**

- **HD:** selects match sound setting for current Genre

## MENU

- enters or exits setup menu.

### ⑨ SOURCE

- selects sound source **HD, CD, Radio** or **AUX**
- **In standby mode:** switches Center on and selects sound source **HD, CD, Radio** or **AUX**

### ⑩ RECORD

- **CD/Radio/AUX:** starts the recording to hard disk

### ⑪ INCR. SURROUND

- selects surround sound effect

### ⑫ MUTE

- switches the sound off temporarily

### ⑬ ◀ / ▶ / ▲ / ▼

- navigation controls (left, right, up, down) to scroll through the option list



- **HD/CD:** returns to previous option lists
- **Radio:** enters the list of preset stations



- **HD/CD:** skips/searches tracks/passage backward/forward (in playback screen); fast scrolls the option list
- **Radio:** tunes to radio stations



- confirms selection



- **HD/CD:** starts or pauses playback

### ⑭ STOP

- stops playback or recording

### ⑮ MARK · UNMARK

- **CD:** selects or deselects tracks to be recorded on hard disk

### ⑯ VOLUME -, +

- adjusts the volume level

# Controls (illustrations on page 4)

## Controls on the Station ( front panel)

### ① SAME ARTIST

- **HD:** plays all the tracks of current artist

### SAME GENRE

- **HD:** plays all the tracks of current genre

### SMART EQUALIZER

- **HD:** selects match sound setting for current genre

### MENU

- enters or exits setup menu

### ② Display

- shows status of Station

### ③ MUSIC FOLLOWS ME

- **HD:** moves music playback from Station to Center; or from Center to Station

### DBB (Dynamic Bass Boost)

- turns the bass enhancement on (**DBB1, DBB2, DBB3**) or off

### INCR. SURROUND

- selects surround sound effect

### VIEW

- toggles playback display and previous option list

### ④ ACTIVE

- **HD/CD/AUX:** lights up green when Center and Station are connected (after you have switched on Station)

### ⑤ IR

- sensor for the infrared remote control

**Helpful hints:** Always point the remote control towards this sensor.

### ⑥ VOLUME -, +

- adjusts the volume level

### ⑦ STOP

- stops playback

### ⑧ ◀ / ▶ / ▲ / ▼

- navigation controls (left, right, up, down) to scroll through the option list



- **HD:** returns to previous option lists
- **Radio:** enters the list of preset stations



- **HD:** skips/searches tracks/passage backward/forward (in playback screen); fast scrolls the option list
- **Radio:** tunes to radio stations



- confirms selection



- **HD:** starts or pauses playback

### ⑨ MUTE

- switches the sound off temporarily

### ⑩ SOURCE

- selects sound source **HD, Radio** or **AUX**

### ⑪ STANDBY-ON/ ECO POWER

- press briefly to switch Station on or to standby mode;
- press and hold to switch Station to Eco Power mode or on



## Center's 2-way remote control

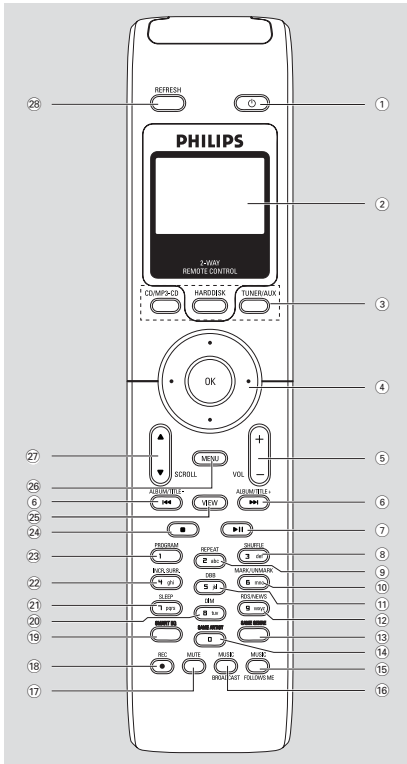

- ① **⏻**
  - press briefly to switch the set to standby mode
  - press and hold to switch the set to Eco Power mode or on
- ② **Synchro display**
  - synchronous display of the set's status
- ③ **Source buttons**
  - CD/MP3-CD**
    - selects **CD** source
    - **In standby mode:** switches the set on and selects **CD** source.
  - HARDDISK**
    - selects **HD** source
    - **In standby mode:** switches the set on and selects **HD** source
  - TUNER/AUX**
    - selects **Radio** source or the audio input from an additional connected appliance

- **In standby mode:** switches the set on and selects **Radio** source or the audio input from an additional connected appliance
- ④ **◀ / ▶ / ▲ / ▼**
  - navigation controls (left, right, up, down) to scroll through the option list
  - ◀
    - **HD/CD:** returns to previous option lists
    - **Radio:** enters the list of preset stations
  - ▲ / ▼
    - **HD/CD:** skips/searches tracks/passage backward/forward (in playback screen); fast scrolls the option list
    - **Radio:** tunes to radio stations
  - ▶ / **OK**
    - confirms selection
- ⑤ **VOL +, -**
  - adjusts the volume level
- ⑥ **◀◀ / ▶▶**
  - **HD/CD:** skips/searches tracks/passage backward/forward (in playback screen)
- ⑦ **⏸**
  - **HD/CD:** starts or pauses playback
- ⑧ **SHUFFLE**
  - selects random playback
- ⑨ **REPEAT**
  - selects continuous playback
- ⑩ **MARK/UNMARK**
  - **CD:** selects or deselects tracks to be recorded on hard disk
- ⑪ **DBB (Dynamic Bass Boost)**
  - turns the bass enhancement on (**DBB1, DBB2, DBB3**) or off
- ⑫ **RDS/NEWS**
  - **Radio:** selects RDS information
  - **HD/CD/AUX:** turns NEWS function on or off
- ⑬ **SAME GENRE**
  - **HD:** plays all the tracks of current Genre
- ⑭ **SAME ARTIST**
  - **HD:** plays all the tracks of current Artist
- ⑮ **MUSIC FOLLOWS ME**
  - **HD:** moves music playback from Center to Station, or from Station to Center

# Controls

- ①⑥ **MUSIC BROADCAST**
  - **HD**: broadcasts music from Center to Station
- ①⑦ **MUTE**
  - switches the sound off temporarily
- ①⑧ **REC**
  - **CD/Radio/AUX**: starts the recording to hard disk
- ①⑨ **SMART EQ**
  - **HD**: selects match sound setting for current genre
- ②⑦ **DIM**
  - changes the brightness of display illumination
- ②⑧ **SLEEP**
  - adjusts/displays/switches off sleep timer
- ②② **INCR. SURROUND**
  - selects surround sound effect
- ②③ **PROGRAM**
  - manually programs preset radio stations
- ②④ **■**
  - stops playback or recording
- ②⑤ **VIEW**
  - toggles playback screen and previous option list
- ②⑥ **MENU**
  - enters or exits setup menu
- ②⑦ **▲ / ▼ SCROLL**
  - scroll the display screen upward or downward
- ②⑧ **REFRESH**
  - synchronize remote control's display with the set's display

## Station's remote control

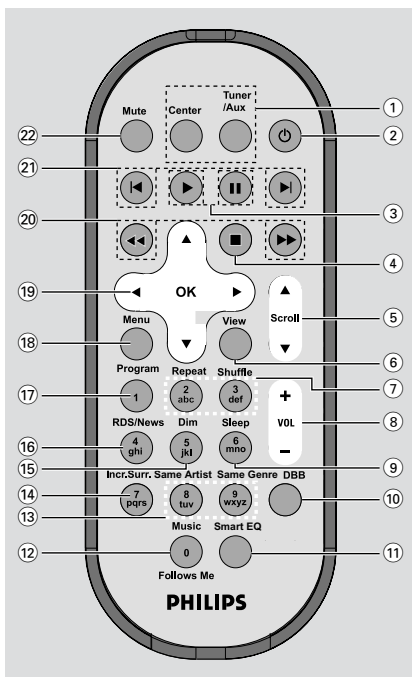

- ① **Source buttons**
  - Center**
    - selects **HD** source (located on Center)
    - **In standby mode**: switches the set on and selects **HD** source (located on Center)
  - Tuner/Aux**
    - selects **Radio** source or the audio input from an additional connected appliance
    - **In standby mode**: switches the set on and selects **Radio** source or the audio input from an additional connected appliance
- ② **⏻**
  - press briefly to switch the set to standby mode
  - press and hold to switch the set to Eco Power mode or on
- ③ **▶**
  - **HD/CD**: starts playback
- ⏸**
  - **HD/CD**: pauses playback

- ④ ■
  - stops playback or recording
- ⑤ ▲ / ▼ **Scroll**
  - scroll the display screen upward or downward
- ⑥ **View**
  - toggles playback display and previous option list
- ⑦ **Repeat**
  - selects continuous playback
- Shuffle**
  - selects random playback
- ⑧ **VOL +, -**
  - adjusts the volume level
- ⑨ **Sleep**
  - adjusts/displays/switches off sleep timer
- ⑩ **DBB (Dynamic Bass Boost)**
  - turns the bass enhancement on (**DBB1**, **DBB2**, **DBB3**) or off
- ⑪ **Smart EQ**
  - **HD**: selects match sound setting for current genre
- ⑫ **Music Follows Me**
  - **HD**: moves music playback between Center and Station
- ⑬ **Same Artist**
  - **HD**: plays all the tracks of current Artist
- Same Genre**
  - **HD**: plays all the tracks of current Genre
- ⑭ **Incr. Surr.**
  - selects surround sound effect
- ⑮ **Dim**
  - changes the brightness of display illumination
- ⑯ **RDS/News**
  - **Radio**: selects RDS information
  - **HD/CD/AUX**: turns NEWS function on or off
- ⑰ **Program**
  - manually programs preset radio stations
- ⑱ **Menu**
  - enters or exits setup menu
- ⑲ ◀ / ▶ / ▲ / ▼
  - navigation controls (left, right, up, down) to scroll through the option list
- ◀
  - **HD/CD**: returns to previous option lists
  - **Radio**: enters the list of preset stations
- ▲ / ▼
  - **HD/CD**: skips/searches tracks/passage backward/forward (in playback screen); fast scrolls the option list
  - **Radio**: tunes to radio stations
- ▶ / OK
  - confirms selection
- ⑳ ◀◀ / ▶▶
  - **HD/CD**: searches track passage backward/forward (in playback screen)
- ㉑ |◀, ▶|
  - **HD/CD**: skips tracks backward/forward (in playback screen)
- ㉒ **MUTE**
  - switches the sound off temporarily

# Installation

English

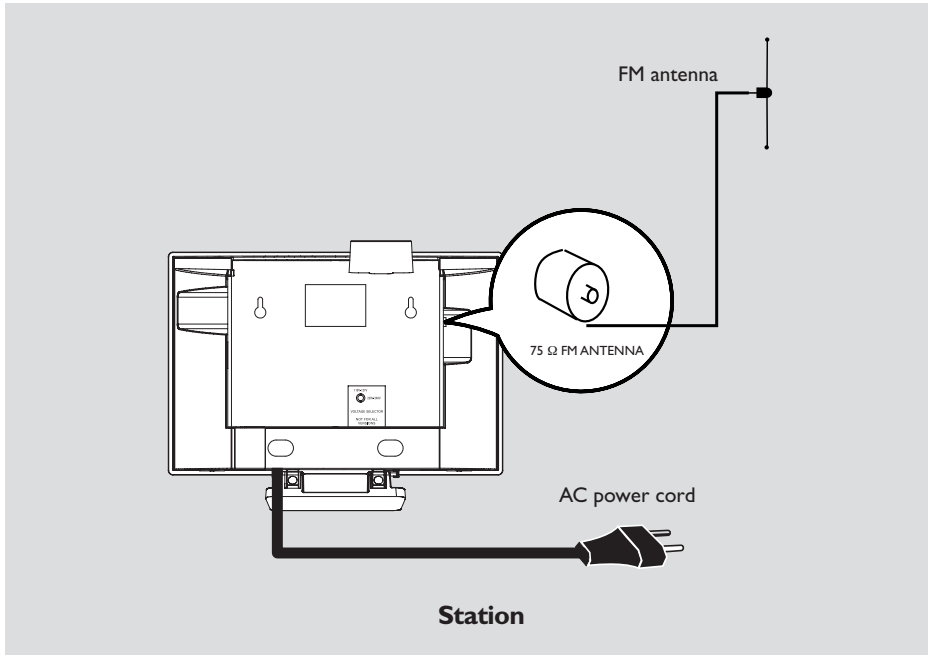
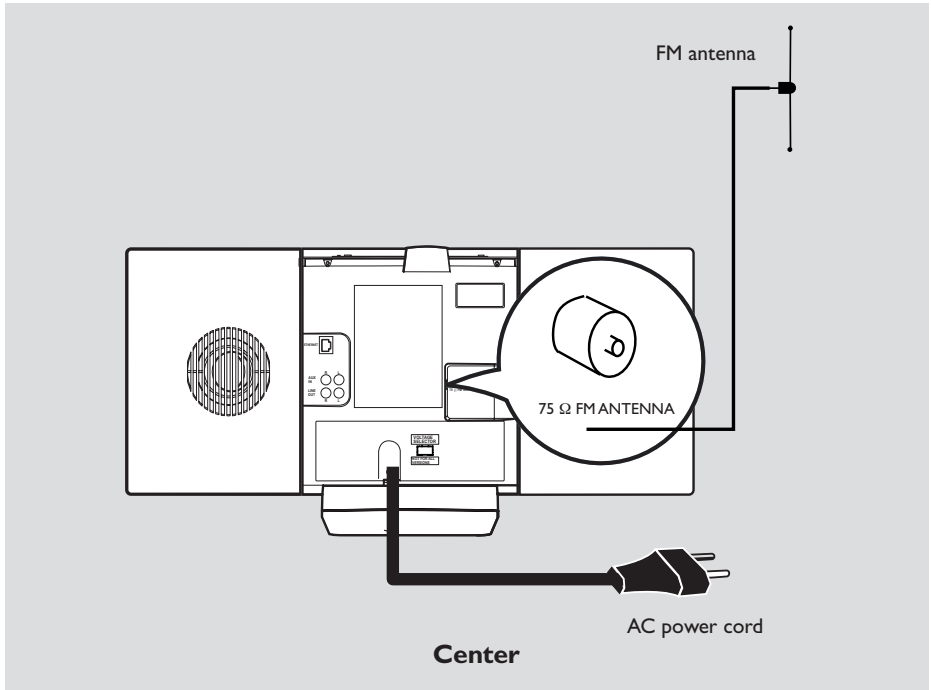

## Placing Center and Station

With the detachable stands and by-packed wall mounting kits, WACS700 Center and Station allow you to place them in two ways: **on desktops with stands** or **on walls without stands**.

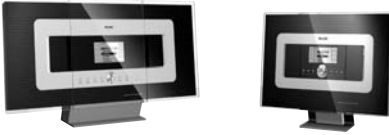

(on desktops with stands)  
or

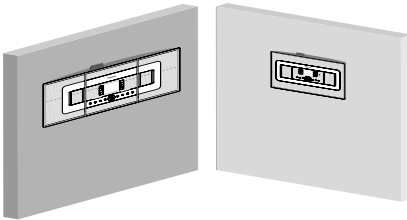

(on walls without stands)

See **Appendix: How to mount your Center and Station onto walls** to learn more about wall mounting

### IMPORTANT!

- Before you decide where and how to place your Center and Station, try the following rear connections and Wi-Fi connection to find a suitable location.
- Keep your Center and Station away from the source of interference (microwave ovens, DECT phones, bluetooth devices, cordless phones, other Wi-Fi products, etc.)
- Avoid placing your Center or Station close to the plasma TV. It may result in improper display on your Center's 2-way remote control.
- Keep Stations adequately apart or in different angles (e.g. in different rooms blocked by one wall). Within a distance and angle (e.g. in the same room), your Center's remote control is powerful enough to simultaneously operate several Stations, which may also result in improper display on the 2-way remote control.

## Rear connections

### Warning:

**Never make or change connections with the mains supply switched on.**

### Ⓐ Antenna Connection

- 1 Extend the wire antenna and fit it to the **FM ANTENNA** as shown below.

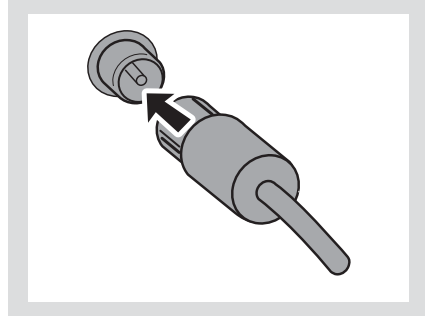

- 2 To improve FM reception, fit the plug of the wire antenna, as shown, **into** the plug of the extension line

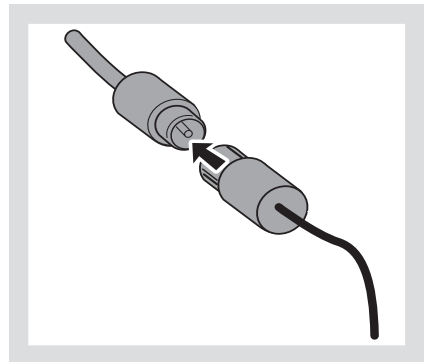

# Installation

- 3 Extend the extension line and move it in different positions for optimal reception (as far away as possible from the TV,VCR or other radiation sources)

- 4 Fix the extension line's end to the ceiling

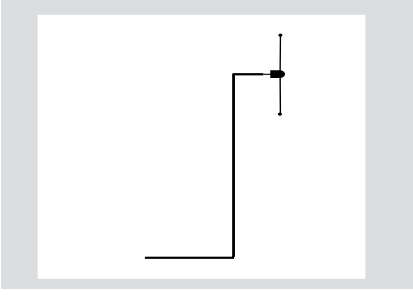

## B Connecting to your PC

- Connect the supplied Ethernet cable to Center's **ETHERNET** and your computer's Ethernet port. For details, see the manual **Connect to your PC**

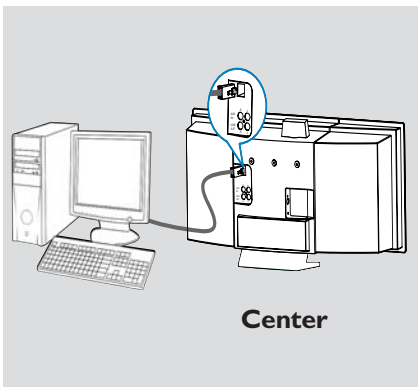

## C Connecting an additional appliance

It is possible to use an additional appliance, e.g. TV,VCR, Laser Disc player,DVD player with the Center or Station.

- 1 Insert the red plug of the red/white audio cables (not supplied) to the red socket **AUX IN R** and the white plug to the white socket **AUX IN L**.
- 2 Connect the other end of the audio cables to the **AUDIO OUT** terminals of the additional appliance

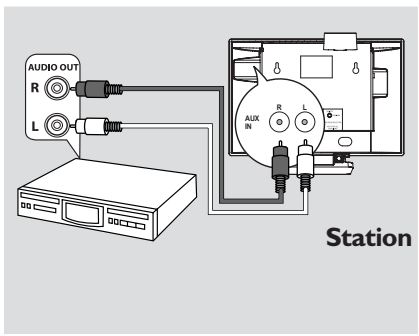
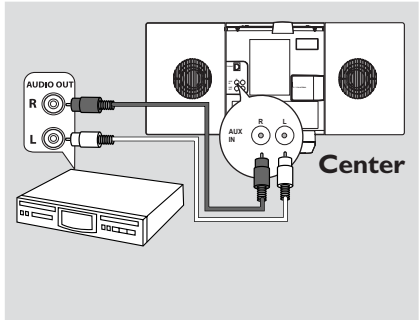

### Helpful hints:

- If the connected device has only a single audio out terminal, connect it to the AUX IN left terminal. Alternatively, you can use a "single to double" cinch cable, but the output sound still remain mono.
- Always refer to the owner's manual of other equipment for complete connection.

## D Connecting to an additional appliance with powerful speakers

To enjoy the sound effect brought by powerful speakers on an external appliance, e.g. a hi-fi mini system, use red/white audio cables (not supplied) to connect Center with the appliance.

- 1 Insert the red plug of the red/white audio cables to the red socket **LINE OUT R** and the white plug to the white socket **LINE OUT L**
- 2 Connect the other end of the audio cables to the **AUX IN** terminals of the additional appliance

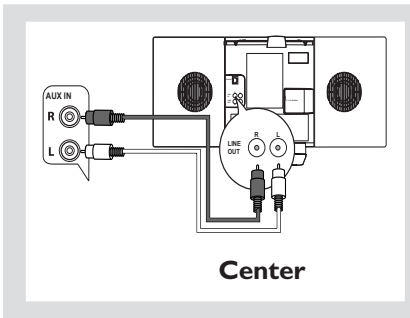

## Using AC power

- 1 Make sure all the connections have been made before switching on the power supply
- 2 Connect the AC power cord to the wall socket. This switches on the power supply

When Center or Station is switched to standby, it is still consuming some power. **To disconnect the system from the power supply completely, remove the power plug from the wall socket.**

**The type plate is located on the rear of the set.**

## Setting up Wi-Fi connection between Center and Station

Wi-Fi connection starts automatically when you power up WACS700 Center and WAS700 Station

- 1 The first time you set up Wi-Fi connection, place Center and Station side by side on a flat and firm surface
- 2 First, connect the Center to power supply, and then, connect the Station to power supply

### Center/Station:

→ The screen lights up. Auto installation/connection starts

→ You will enter HD (Harddisk) mode when the installation/connection is finished

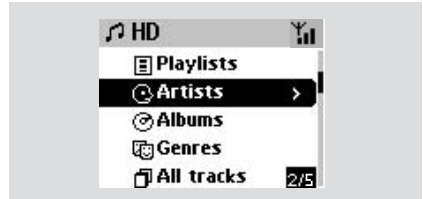

- 3 Relocate Center and Station as desired: plug and stream
- Simply unplug your Center or Station and power them up in other rooms.
  - You will be able to stream the harddisk music between Center and Station

### Helpful hints:

– Make sure you have powered up Center before powering up Station.

### IMPORTANT!

- Avoid thick walls. Your Center and Station should never be blocked by 2 or more walls.
- Avoid placing the sets close to large metal objects.
- Adjust the location of your Center and Station according to the reception status of Wi-Fi signals.
  - indicates maximum reception
  - indicates minimum reception
- WACS700 do not support range expander devices.

**If there is interference in the neighborhood, the set may pause during playback or respond slowly to your operation. In such cases**

- Keep the Center or Station at least 3 meters away from microwave ovens, DECT phones, bluetooth devices (e.g. headphones, a computer mouse), wireless access points (e.g. routers), cordless phones, Wi-Fi compatible printers and PDAs, etc..

- Use the WEP\* key when connecting your Center and Station to an existing wireless PC network. see the Owner's manual of your router and the manual

**Connect to your PC: Option 2.**

- Change the operating channel of your Center and Station when connecting them to an existing wireless PC network. To learn about how to change channels, see the manual **Connect to your PC: Option 2.**

**Option 2.**

- If possible, change the operating channels of the other Wi-Fi devices at your home.
- Turn the above devices in different directions to minimize interference.

\* stands for **Wired Equivalent Privacy**. It is a security protocol for wireless local area network

## Using the remote control

WACS700 are equipped with two remote controls, one for Center and the other for Station. By using either of the remote controls, you can operate both Center and Station.

**IMPORTANT!**

- Remove the protective plastic tab before using the Station's remote control.
- Always point the remote control directly towards IR area on the Center or Station you wish to operate.
- Some functional keys on Center's remote control are exclusively used for Center (for example, CD/MP3-CD, MARK/UNMARK, MUSIC BROADCAST etc.)

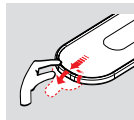

## Using Center's remote control

**Battery usage:** As a remote control with synchronous display, Center's remote control consumes more power than normal remote controls. When its batteries are low or empty, the icon  appears on the remote control's display. Replace the batteries with new alkaline batteries.

By default, Center's remote control works with Center only. **To operate Station using Center's remote control,**

- 1 Press and hold **REFRESH** until the select screen appears on the display of Center's remote control

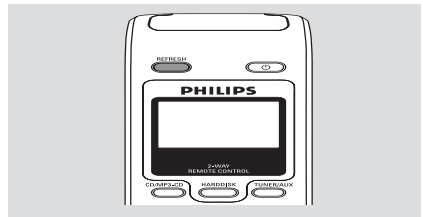

- 2 Press the navigation controls **▲** or **▼** and **▶** to select **Station**

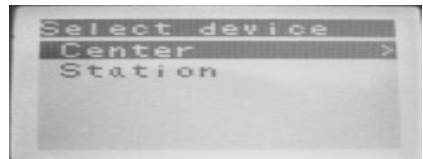

**On Center's remote control:**

- Display shows current status of Station after Station is connected
- You can use Center's remote control to operate Station now

**Helpful hints:**

- To operate Center using the remote control again, repeat the above steps 1-2 to select Center.
- **Center's remote control will return to its default setting (works with Center only) when you insert new batteries into it.**

**Using the display on the Center's remote control**

You can synchronize the status of your Center or Station onto the display of Center's 2-way remote control. With the synchronized display, your operation of remote control becomes quicker and easier.



**Note:**

- Avoid placing your Center or Station close to the plasma TV. It may result in improper display on your Center's remote control.
- If you switch on your Center or Station using the **STANDBY-ON/ ECO POWER** button on the set, press **REFRESH** on Center's remote control to synchronize the remote control's display.
- The display supports 6 European languages: English, French, Spanish, Dutch, Italian and German

**To replace the remote controls' batteries**  
**Center's remote control:**

- 1 Open the battery compartment and remove the old batteries

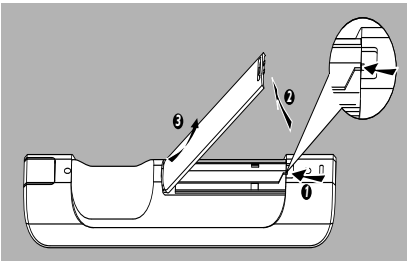

- 2 Insert 4 batteries type R03 or AAA into the remote control with the correct polarity as indicated by the "+" and "-" symbols inside the battery compartment

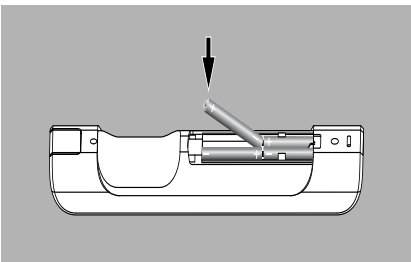
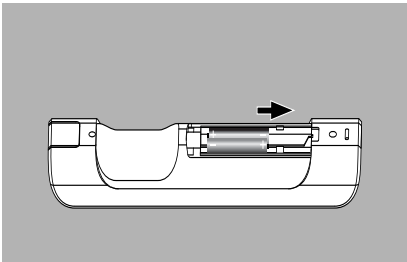

- 3 Put back the compartment door

**Station's remote control:**

- 1 Press and hold ◀ as indicated
- 2 Simultaneously, pull the battery tray at ▼
- 3 Remove the old battery and put a new CR2025 battery in place
- 4 Put back the battery tray

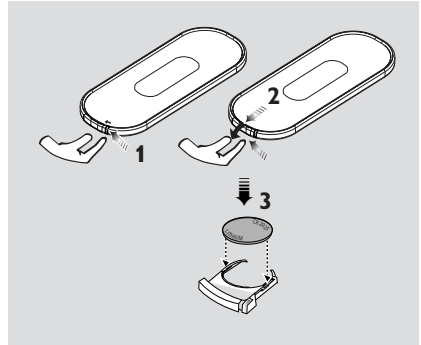

**CAUTION!**

- Remove batteries if they are exhausted or will not be used for a long time.
- Do not use old and new or different types of batteries in combination.
- Batteries contain chemical substances, so they should be disposed of properly.

# Preparation

## Using the navigation controls

When selecting options on the set's screen, you often need to use the navigation controls ◀ / ▶ / ▲ / ▼.

- 1 Press ▲ / ▼ to highlight an option
- 2 Enter its submenu by pressing ▶
- 3 Press ◀ to return to the previous option list screen
- 4 Press **OK** or ▶ to confirm

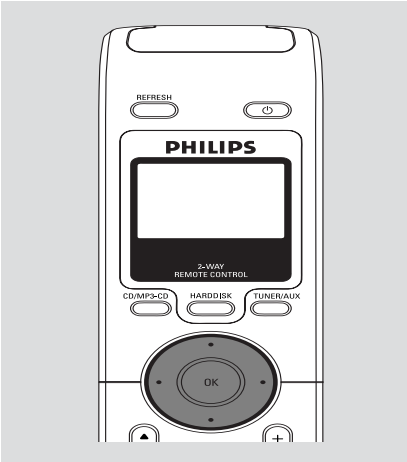

## Switching to standby/on and selecting functions

- 1 When the set is on, press **STANDBY-ON/ ECO POWER** to switch it to standby (or  on the remote control)
  - Display shows **GoodBye**. Then,
  - The screen dims out.
- 2 To switch on, press **STANDBY-ON/ ECO POWER** on the set
  - The set switches to the last source selected

### OR

On the remote control, press the source button (e.g. **HARDDISK, CD/MP3-CD, TUNER/AUX, Center**).

- 3 To select your function, press **SOURCE** once or more on the set (or **HARDDISK, CD/MP3-CD, TUNER/AUX** on the remote control)
- On Station's remote control, press **Center** to select **HD** source (music stored on Center)

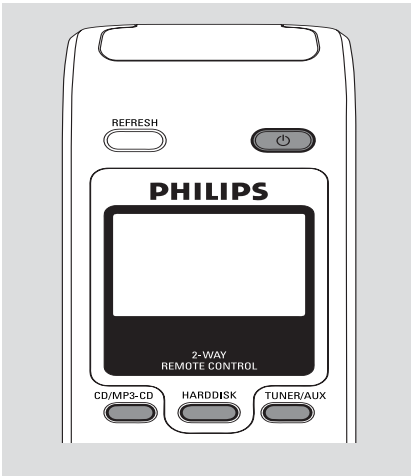

### Helpful hints:

- *CD/MP3-CD source is only available on Center.*



## Switching to power-saving mode

In the power-saving Eco power mode, the set's Wi-Fi connection are turned off. The Center's harddisk also stops working. When you switch Center to Eco power; it is impossible to move music between Center and Station or import music from PC to Center.

- 1 When the set is on, press and hold **STANDBY-ON/ ECO POWER** to switch it to Eco power (or  on the remote control)
  - The display is switched off
- 2 To switch on, press and hold **STANDBY-ON/ ECO POWER** (or  on the remote control) or press and hold **SOURCE** on the set
  - The set switches to the last source selected

### Helpful hints:

- *In the standby/Eco power mode, the settings of networking, sound, display, language and CD recording, the tuner presets, and the volume level (maximum: the moderate level) will be retained in the set's memory.*

## Auto-standby

- When the set has reached the end of playback/recording and remains in the stop position for more than 5 minutes, the set will switch to standby automatically to save power.

## Volume control

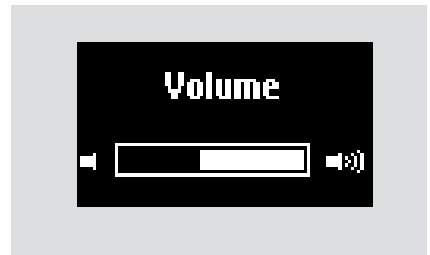

- 1 Check the playback starts
- 2 Adjust the volume with **VOL +/-** buttons
  - Display shows the volume bar, indicating the volume level



# Basic functions

## MUTE

During playback, you can temporarily switch off the sound without switching off the set.

- 1 Press **MUTE** to switch off the sound  
→ The icon  appears. Playback continues without sound
- 2 To switch on the sound, press **MUTE** again or adjust the volume with **VOL +/-**  
– You can also switch on the sound by activating **MUSIC BROADCAST** on the Center.  
→ The icon  disappears

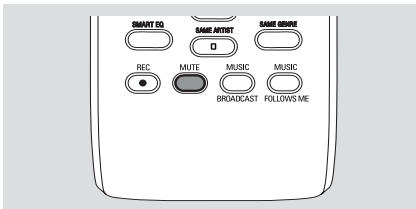

## Sound control

### Equalizer

**Equalizer** enables you to select predefined sound settings.

- 1 Press **MENU** to enter the **MENU** screen
- 2 Use the navigation controls **▲** or **▼** and **▶** to select **Equalizer**
- 3 Press **▲** or **▼** and **▶** to select **Rock**, **Pop** (default), **Jazz**, **Neutral**, **Techno**, **Classical** or **Bass/Treble**
- 4 Press **OK** or **▶** to confirm



### Bass adjustment

- Press **DBB (Dynamic Bass Boost)** once or more to select your option: **DBB OFF** (by default), **DBB 1**, **DBB 2** or **DBB 3**
- To select **Treble/Bass** options:
  - 1 Press **MENU** to enter the **MENU** screen
  - 2 Use the navigation controls **▲** or **▼** and **▶** to select **Settings**
  - 3 Press **▲** or **▼** and **▶** to select **Treble/Bass**
  - 4 Press **◀ / ▶ / ▲ / ▼** to select your options: Treble (+3 to -3), Bass (+3 to -3)

### Helpful hints:

– Some discs might be recorded in high modulation, which causes a distortion at high volume. If this occurs, switch off **DBB** or reduce the volume.

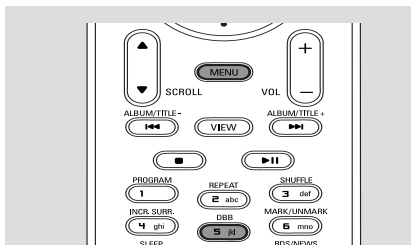

### Incredible surround

- Press **Incr. Surr.** once or more to turn the surround sound effect on or off  
→ Display shows **IS ON** or **IS OFF**

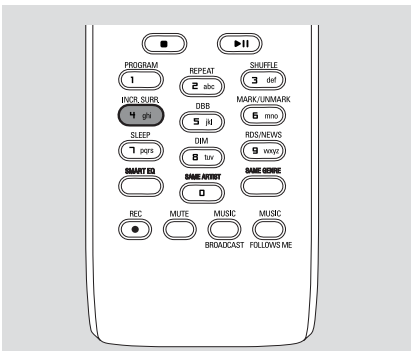

## Display adjustment

You can adjust the display's backlight and contrast settings

- 1 Press **MENU** to enter the **MENU** screen
- 2 Use the navigation controls ▲ or ▼ and ► to select **Settings**
- 3 Press ▲ or ▼ and ► to select **Display**
- 4 Press ◀ / ► / ▲ / ▼ to select your options:

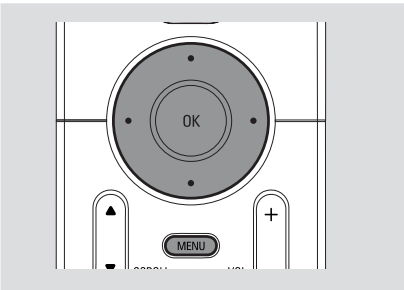

### Backlight:

Press ▲ or ▼ and ► to select on or off

- You can also turn the backlight on or off by pressing **DIM** on the remote control

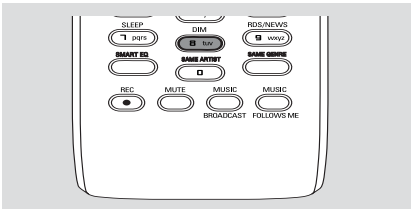

### Contrast:

Press ◀ / ► to reduce or enlarge the contrast



## Selecting languages

- 1 Press **MENU** to enter the **MENU** screen
- 2 Use the navigation controls ▲ or ▼ and ► to select **Settings**
- 3 Use the navigation controls ▲ or ▼ and ► to select **Language**
- 4 Press ▲ or ▼ and ► to select:

**English, French, Spanish, Dutch, Italian**  
and **German**

## Playing Harddisk (HD)

On WAC700 Center is located a 40GB hard disk, where music is centrally stored. Via Wi-Fi, all the stored music can be streamed and played on Station.

- 1 Check the Center or Station is switched on or to standby
- **For Station:** also check the Center is switched on or to standby (See **Basic functions, Switching to standby/on and selecting functions, Switching to Eco power/ on**)
- 2 Press **SOURCE** once or more to select **HD** (on Center's remote control, press **HARDDISK** on Station's remote control, press **Center**)
  - Display shows **HD** and the categories of your music library **Playlists, Artists, Albums, Genres, All tracks**
  - Demo tracks are stored in **Playlists**

**Playlists** (📁): custom collection of your favorite tracks sorted by the playlists' name in alphanumeric order

**Artists** (👤): collection of albums sorted by the artists' name in alphanumeric order

**Albums** (📀): albums sorted by the albums' name in alphanumeric order

**Genres** (🎵): artists' album collection sorted by music style

**All tracks** (📁): tracks sorted by the tracks' name in alphanumeric order

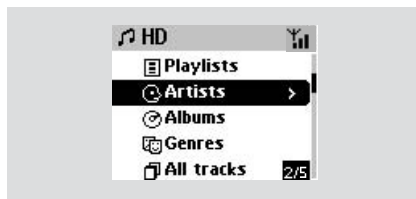

- 3 Press the navigation controls ▲ or ▼ and ► to select your option
- 4 Press ► (or **OK**) to start playback, if necessary
- Press **OK** on a highlighted artist, genre or album to start playback from the beginning of the item (or ►|| on Center's remote control; the Play key ► on Station's remote control)
  - The playback screen shows:
    - on the top:** your HD option (e.g. Playlist, Artist);
    - in the middle:** current track name, elapsed playing time and some track information;
    - at the bottom:** equalizer setting and, if DBB is activated, DBB setting.



- 5 To pause playback, press **OK** (or ►|| on Center's remote control; || on the Station's remote control). To resume playback, press the button again (on Station's remote control, press the Play key ►)
- 6 To stop playback, press **STOP** ■

## Selecting and searching

### Selecting a different album or track

- 1 If necessary, repeatedly press ◀ to enter previous option lists
- 2 Repeatedly press the navigation controls ▲ or ▼ and ► to select the desired album or track.
- 3 Press **VIEW** to return to the playback screen, if necessary

### To select a different track in current album during playback

- In the playback screen, briefly and repeatedly press the navigation controls ▲ or ▼ to select previous or next tracks (or ◀◀ or ▶▶ on Center's remote control; ◀, ▶ on Station's remote control)

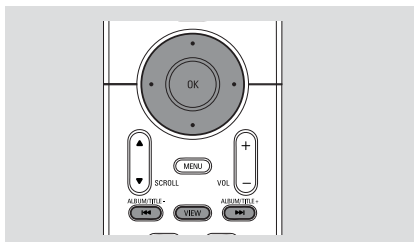

### Using the fast skip ▲ or ▼

Use this function to find an option (e.g. an album or a track) in a long option list

- Press and hold the navigation controls ▲ or ▼ in the long option list
  - You will skip the options faster and faster
  - At the high speed skip, the initial letter of current options appears for easy identification



### Finding a passage within a track during playback

- 1 In the playback screen, press and hold the navigation controls ▲ or ▼ (or ◀◀ or ▶▶ on Center's remote control; ◀◀/ ▶▶ on Station's remote control)
  - The HD plays at a high speed
- 2 When you recognize the passage you want, release ▲ or ▼ (or ◀◀ or ▶▶ on Center's remote control; ◀◀/ ▶▶ on Station's remote control)
  - Normal playback resumes

### Selecting tracks of a particular artist

- During playback, press **SAME ARTIST**
  - Playback of current artist's tracks continues after current track

### Selecting tracks of a particular genre

- During playback, press **SAME GENRE**
  - Playback of current genre's tracks continues after current track

## Different play modes: REPEAT, SHUFFLE

- 🔁 – plays the current track continuously
- 🔁 – repeats all the tracks (under current artist, genre or album)
- 🔁 – repeats all the tracks (under current artist, genre or album) in random order
- 🔁 – tracks (under current artist, genre or album) are played in random order

- 1 During playback, press once or more **REPEAT** or/ and **SHUFFLE** to select play modes
- 2 To return to normal playback, press **REPEAT** or **SHUFFLE** repeatedly until the various modes are no longer displayed

## SMART EQUALIZER

This function enables you to playback music of current genre with the match sound settings.

- During playback, press **SMART EQUALIZER**
  - The icon 🎚️ appears if **SMART EQUALIZER** is activated
- To deactivate **SMART EQUALIZER**, adjust the sound settings (**DBB**, **Treble/Bass setting**, **Incr. Surr.** or **Equalizer**)
  - The icon 🎚️ disappears

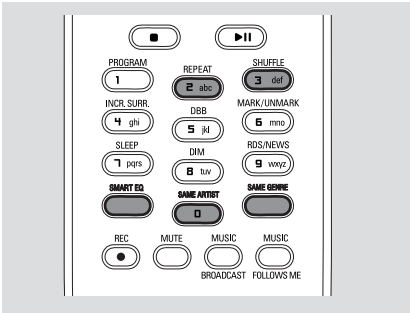

## Creating Playlist: custom collection of your favorite music

On Center's hard disk, you can create up to 99 playlists consisting of your favorite tracks in the desired sequence.

### Helpful hints:

– You can also create your playlists on your computer via Philips Digital Media Manager (DMM). For details, see DMM's help file. Refer to the manual Connect to your PC to learn how to install DMM software.

- 1 Press **MENU** to enter the **MENU** screen
- 2 Use the navigation controls ▲ or ▼ and ► to select **Create Playlist**



→ A new playlist is created. Display shows: **Playlist created. To add tracks, select "Add to Playlist"**

- 3 Use the navigation controls ◀ / ▶ / ▲ / ▼ to highlight the desired track/album (see **Selecting and searching**)
- 4 To select **Add to Playlist**,
  - a. Press **MENU** to enter the **MENU** screen
  - b. In the **MENU** screen, use the navigation controls ▲ or ▼ and ► to select
 → A list of playlists appears

- 5 Use the navigation controls ▲ or ▼ and ► to select the desired playlist  
→ Display shows: **Track(s) added to playlist**
- 6 Repeat steps 3, 4, 5 to select and store all desired tracks in this way

## Deleting a playlist, album or track

- 1 Use the navigation controls ▲ or ▼ and ► to enter a category (Playlist, Artists, Albums, Genres, All tracks)
  - If necessary, press ▲ or ▼ and ► once or more to enter the album/track list
- 2 Press ▲ or ▼ to highlight a selected playlist, album or track
- 3 To select **Delete Playlist, Delete Album** or **Delete Track**
  - a. Press **MENU** to enter the **MENU** screen
  - b. In the **MENU** screen, use the navigation controls ▲ or ▼ and ► to select.
- 4 Press ▲ or ▼ and ► to select **Yes**

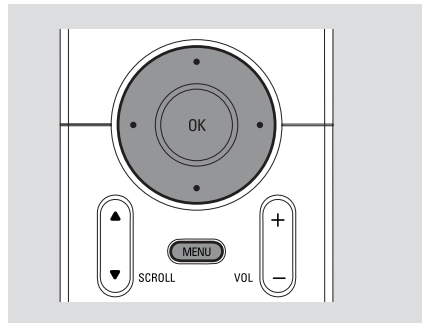



## Building music library on Center

By **ripping CDs**, **Importing from PC** and **Recording from radio or external source** you can build your music library on Center's hard disk.

### IMPORTANT!

- **Recording is permissible if copyright or other rights of third parties are not infringed upon.**
- **For CDs encoded with copyright protection technologies by some record companies, recording is restricted.**

### Ripping CDs

With WAC700 Center, you can rip audio CD tracks from your pre-recorded CDs and store them as MP3 files in the Center's hard disk. The Gracenote® music recognition service enables your set to look up from its built-in database the CD track information (including album, artist, genre, track information). It allows the ripped CD tracks to be properly categorized (for example, under **Artists, Albums, Genres** or **All tracks**) and also merged with the existing tracks in the harddisk. To update your Gracenote® music recognition service database, see the manual **Connect to your PC**.

POWERED BY

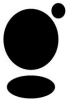

gracenote.

Music recognition technology and related data are provided by Gracenote®. Gracenote is the industry standard in music recognition technology and related content delivery. For more information, visit [www.gracenote.com](http://www.gracenote.com).

CD and music-related data from Gracenote, Inc., copyright© 2000-2005 Gracenote. Gracenote CDDB® Client Software, copyright 2000-2005 Gracenote. This product and service may practice one or more of the following U.S. Patents: #5,987,525; #6,061,680; #6,154,773, #6,161,132, #6,230,192, #6,230,207, #6,240,459, #6,330,593, and other patents issued or pending. Services supplied and/or device manufactured under license for following Open Globe, Inc. United States Patent 6,304,523.

Gracenote and CDDB are registered trademarks of Gracenote. The Gracenote logo and logotype, and the "Powered by Gracenote" logo are trademarks of Gracenote.

## To rip a disc at fast speed (default) (For audio CDs, MP3/WMA CDs)

- 1 Insert a CD into Center's CD loader; CD graphic printed side facing you

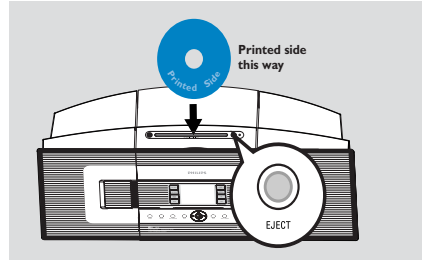

→ Display shows: **Reading CD**

→ List of tracks appears

- 2 **MP3/WMA:** To enter the track list, press ► on a highlighted file folder
- 3 In the screen of track list, press **RECORD**  
→ List of track checkboxes appears
- 4 Press **MARK·UNMARK** once or more to select or deselect the tracks to be recorded
- 5 To select/deselect all tracks, press and hold **MARK·UNMARK**

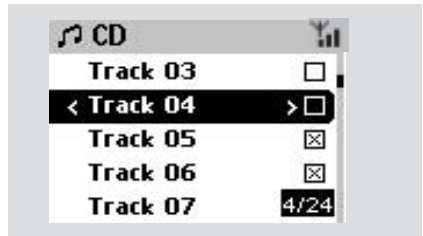

- 4 To select **Rec quality**,
  - a. Press **MENU**
  - b. Use the navigation controls ▲ or ▼ and ► to enter **Settings** menu
  - c. In **Settings** menu, use the navigation controls ▲ or ▼ and ► to select
- 5 To start recording, press **RECORD** or **OK**  
→ Display shows **CD-Rec** and the album name of the track being recorded.  
(a default album name, e.g. Album\_001, is assigned if the CD track information cannot be found in Center's built-in Gracenote® music recognition service database)



→ Center will return to **CD** mode when ripping is finished

→ All the functions are available at this time

- 6 To rip another CD, repeat the **step 1-5** above (Up to 8 CDs can be ripped consecutively)
- 7 To stop recording, press **STOP/■**

### To rip a disc during playback (for audio CDs only)

- During playback, press **RECORD**.
    - Recording and playback start from current track
- Or**
- 1 Follow the Step 1-3 under **To rip a disc at fast speed**
  - 2 Select **Normal speed** by
    - a. Press **MENU**
    - b. Use the navigation controls ▲ or ▼ and ► to enter **Settings** menu
    - c. In **Settings** menu, use the navigation controls ▲ or ▼ and ► to select **Rec speed**
    - d. Press ▲ or ▼ and ► to select
  - 3 To start recording, press **RECORD**
    - Recording and playback start
    - Display shows the album name of the track being recorded

#### Helpful hints:

- To switch off the sound output temporarily, press **MUTE**.

#### Important!

- It takes some time to convert the ripped tracks into MP3 files.
- If power failure occurs during the conversion, you will lose all the ripped tracks.

### To find your ripped tracks

After MP3 conversion is completed, you can find and playback the ripped tracks in **Albums**.

- 1 Select **HD** source
- 2 In **Albums**, use the navigation controls ▲ or ▼ and ► to enter the album of recorded tracks
  - Only the completely ripped track can be found on Center's harddisk

### Importing from PC

The supplied PC Installer CD contains Digital Media Manager (DMM) software. It will help you organize the music files on your PC and import them to WAC700 Center. For details, see DMM's help file. Refer to the manual

**Connect to your PC** to learn how to install DMM software.

### Recording from Radio or External source

A maximum of 3-hour recording can be made from the radio or external source.

- 1 In **Radio** mode, tune to the desired radio station (See **Tuner, Tuning to radio stations**) or In **AUX** mode, start playback from the external source (see **AUX**)
- 2 Press **RECORD**
  - Recording starts
- 3 To stop recording, press **STOP/■**
  - The recording is saved as a file under **RADIO** or **AUX** in **Albums**. A file name is given, e.g. Radio\_xx, or Aux\_xx (where xx denotes a number)

### To find your recording

- 1 Select **HD** source
- 2 In **Albums**, use the navigation controls ▲ or ▼ and ► to enter **RADIO** or **AUX**

## Display track information

- 1 During playback, press **VIEW** once or more to enter the playback screen  
→ The display shows:

**on the top:** HD

**in the middle:** current track name, elapsed playing time and some track information

**at the bottom:** equalizer setting and, if DBB is activated, DBB setting.

- 2 Press ►  
→ The display shows track information (e.g. track name, file type, file size, bit rate of mp3/wma files).
- 3 Press **VIEW** once or more to return to the playback screen

## Moving between Center and Station

Up to 5 WAS700 Stations can be connected to WAC700 Center. Via Wi-Fi, music can move between Center and Stations. Even in different places of your house, you and your family will enjoy and share music with ease.

### MUSIC FOLLOWS ME

As you move around at home, let music move around you, from **Center** to **Station** or from **Station** to **Center**.

**On the first unit (Center or Station), where music will leave:**

- 1 During HD playback, select the album or playlist you wish to play on the second unit (see **Selecting and searching, Selecting a different album or track**)
- 2 Press **MUSIC FOLLOWS ME** to activate  
→ The icon  appears. Playback continues
- 3 To start playback from the beginning on the second unit, first press ►|| on the Center's remote control (or || on the Station's remote control, and then, press **MUSIC FOLLOWS ME**
- 3 To deactivate **MUSIC FOLLOWS ME**, press **MUSIC FOLLOWS ME** again or other functional keys (e.g. **SLEEP**, **RDS/NEWS** or ◀ / ▶ / ▲ / ▼)

- **MUSIC FOLLOWS ME** will be automatically deactivated if you do not activate **MUSIC FOLLOWS ME** on the second unit within 5 minute

**On the second unit (Center or Station), where music will continue**

- 4 Check you have selected HD, CD or AUX source on the second unit or have switched the unit to standby mode (see **Basic functions, Switch on/to standby and selecting functions**)
- 5 Press **MUSIC FOLLOWS ME**
- **MUSIC FOLLOWS ME** will be automatically deactivated if you do not activate **MUSIC FOLLOWS ME** on the second unit within 5 minutes  
→ Selected music stops on the first unit and continues on the second unit. The icon  disappears  
→ Selected play modes (e.g. , ) are retained on the second unit (see **Different play modes: REPEAT, SHUFFLE**)
- 6 To stop **MUSIC FOLLOWS ME**, press **STOP/■** on the second unit

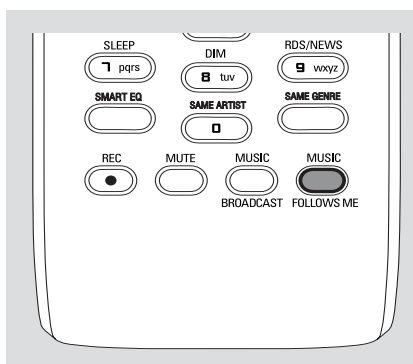

### Helpful hints:

After **MUSIC FOLLOWS ME** is activated on the second unit, on the first unit:

- make sure the first unit is switched on or to standby mode.
- you can select other tracks or source for playback.

## MUSIC BROADCAST

**MUSIC BROADCAST** allows you to broadcast music from **Center** to **Station (s)**.

### On Station(s)

- 1 Check you have selected HD/AUX source on the Station(s) or have switched the Station(s) to standby mode (see **Basic functions, Switch on/to standby and selecting functions**)

### On Center

- 2 During HD playback, select the album or playlist you wish to broadcast to Station(s)
- 3 Press **MUSIC BROADCAST** to activate  
→ The icon  appears on Center and Station(s). 5-second countdown starts

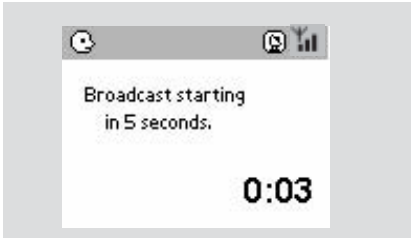

→ **On Center and Station (s)**: Selected music plays simultaneously several seconds after the 5-second countdown

→ If connection fails on a Station, the Center will try to re-establish the connection on the next track

- 4 For a station to exit **MUSIC BROADCAST**, press **STOP/■** on the Station
- To broadcast music to the station again, you have to stop **MUSIC BROADCAST** on Center and then, activate **MUSIC BROADCAST** again on Center
- 5 To stop **MUSIC BROADCAST**, press **STOP/■** on the Center

**Helpful hints:** **MUSIC BROADCAST** will also stop when:

- you switch Center to Standby or Eco power;
- the selected album or playlist has reached the end.

## Station management

### Adding a station

You can add a station to an existing Wi-Fi network of Center and Station. Up to 5 WAC700 stations can be connected to a WAC700 Center:

#### On Center

- 1 Switch on WAC700 Center and select **HD** source
- 2 To select **Add New Station** on Center
  - a. Press **MENU**
  - b. Use the navigation controls ▲ or ▼ and ► to enter **Station Mgmt** menu
  - c. In **Station Mgmt** menu, use the navigation controls ▲ or ▼ and ► to select  
→ You will enter the **Installation Mode**. Searching for the new station start  
→ Playback stops on the previously associated Station if you are playing the HD source

#### On Station

- 3 Connect the new station to power supply
- 4 Select **AUX** mode and enter **Installation Mode** by:
  - a. Press **MENU**
  - b. Use the navigation controls ▲ or ▼ and ► to select **Installation Mode**

#### On Center

- 5 Press **STOP/■** on the Center when all the stations are found

#### Helpful hints:

- To change your setting of Wi-Fi connection, see the manual *Connect to your PC*.

### Deleting a station

- 1 Switch on WAC700 Center and select **HD** source
- 2 To select **Delete Station** on Center
  - a. Press **MENU**
  - b. Use the navigation controls ▲ or ▼ and ► to enter **Station Mgmt** menu
  - c. In **Station Mgmt** menu, use the navigation controls ▲ or ▼ and ► to select  
→ On the Center's display shows the list of connected stations
- 3 Press ▲ or ▼ and ► to select the station you wish to delete
- 4 Press ▲ or ▼ and ► to select **Yes**

### Viewing station status

- 1 Switch on WAC700 Center and select **HD** source
- 2 To select **Station Status** on Center
  - a. Press **MENU**
  - b. Use the navigation controls ▲ or ▼ and ► to enter **Station Mgmt** menu
  - c. In **Station Mgmt** menu, use the navigation controls ▲ or ▼ and ► to select  
→ On the Center's display shows the list of stations connected or ever connected
- 3 Press ► to view the connection information

## Information about your WACS700

- 1 Switch on WAC700 Center (or WAS700 Station) and select **HD** source
- 2 To select **Information** on Center or Station
  - a. Press **MENU**
  - b. Use the navigation controls ▲ or ▼ and ► to enter Information menu  
→ The display shows: the name of Center or Station, firmware version and free harddisk space (for Center only)

## Firmware

### Upgrading firmware

The supplied PC Installer CD contains Digital Media Manager (DMM) software. It will help you get the upgrades for WAC700 Center. For details, see DMM's help file. Refer to the manual **Connect to your PC** to learn how to install DMM software.

### Restoring previous firmware

After the Center's firmware is upgraded, you can restore it to its previous version as desired.

- 1 In Center's HD mode, press **MENU**
- 2 Use the navigation controls ▲ or ▼ and ► to enter **Settings** menu
- 3 Press ▲ or ▼ and ► to select **Firmware**
- 4 Press ▲ or ▼ and ► to select **Restore firmware**
- 5 Press ▲ or ▼ and ► to select **Yes**.

### Re-establishing Wi-Fi connection

After upgrading or restoring the Center's firmware, you need to re-establish the Wi-Fi connection between Center and Stations.

#### On Center,

- Select **HD** mode and then, enter **Installation Mode** by:
  - a. Press **MENU**
  - b. Use the navigation controls ▲ or ▼ and ► to enter **Station Mgmt** menu
  - c. In **Station Mgmt** menu, use the navigation controls ▲ or ▼ and ► to select **Add New Station**  
→ Searching for Stations starts

#### On the Stations,

- Select **AUX** mode and enter **Installation Mode** by:
  - a. Press **MENU**
  - b. Use the navigation controls ▲ or ▼ and ► to select **Installation Mode**

#### On Center,

- Press **STOP** ■ to exit **Installation Mode** when Center has found all the stations

# CD (on Center only)

## Discs for playback

With this system, you can play

- all pre-recorded audio CDs (CDDA)
- all finalized audio CD-Rs and CD-RWs (12cm CD and 8cm 185 or 200 MB CD)
- MP3/WMA-CDs (CD-Rs/CD-RWs with MP3/WMA files)



### IMPORTANT!

– This system is designed for regular discs. Therefore, do not use any accessories such as disc stabilizer rings or disc treatment sheets, etc.

## About MP3/WMA

The music compression technology MP3 (MPEG1 Audio Layer 3) and WMA (Windows Media Audio) significantly reduces the digital data of an audio CD while maintaining CD quality sound.

**Windows Media Audio® is a registered trademark of Microsoft Corporation.**

### Supported formats:

- Disc format ISO9660, Joliet, UDF (created on Adaptec Direct CD v5.0 and Nero Burning ROM UDF v5.5) and multi-session CDs
- MP3 bit rate (data rate): 32-320 Kbps and variable bit rate
- 12-cm 650Mb and 700Mb CD-R/ CD-RWs
- Directory nesting up to a maximum of 8 levels
- WMA v7 or earlier (max. 192Kbps cbr)

### The system will not play or support the following:

- Empty albums: an empty album is an album that does not contain MP3/WMA files, and will not be shown in the display.
- Non-supported file formats are skipped. This means that e.g.: Word documents .doc or MP3 files with extension .dlf are ignored and will not be played.
- DRM protected WMA files
- WMA files in Lossless or VBR format

### IMPORTANT!

- Make sure that the file names of MP3 files end with .mp3.
- For DRM protected WMA files, use **Windows Media Player 10 (or later) for CD burning/conversion.** Visit [www.microsoft.com](http://www.microsoft.com) for details about **Windows Media Player and WM DRM (Windows Media Digital Rights Management).**

## Playing discs

- 1 Check the Center is switched on or to standby (See **Basic functions, Switching on/to standby and selecting functions, Switching to Eco power/ on**)
- 2 Insert a CD/CD-R(W) into Center's CD slot load, with the graphics facing you
- Make sure you have removed any other disc from the loader

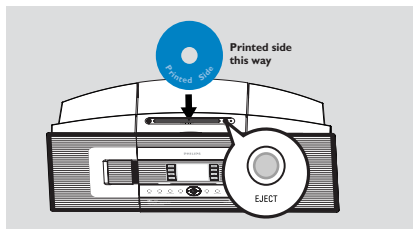

→ **Reading CD** is displayed as the player scans the contents of a disc.

→ **Audio CD:** the list of tracks appears (track information appears if it is available after the lookup of Gracenote Music Recognition Service database)

→ **MP3/WMA:** the list of albums appears

### Helpful hints:

- If you have not organized MP3/WMA files into any albums on your disc, an album “**Others**” will be automatically assigned for all those files..
- If the disc contains both audio CD tracks (CDDA) and MP3/WMA files, “**CDDA**” will be automatically assigned for all the audio CD tracks.
- “**All tracks**” is shown as an album for MP3/WMA CD.

- 3 Press once or more the navigation controls ▲ or ▼ and ► to select a track
- 4 Press ► (or **OK**) to start playback, if necessary
- **MP3/WMA:** Press **OK** on a highlighted album to start playback of the album (or ► **II** on Center's remote control; the Play key ► on Station's remote control)
- **MP3/WMA:** Press **OK** on the highlighted album **All tracks** to start playback of all the tracks on the disc (or ► **II** on Center's remote control; the Play key ► on Station's remote control)
- 5 To pause playback, press **OK** (or ► **II** on Center's remote control; **II** on the Station's remote control). To resume playback, press the button again (on Station's remote control, press the Play key ►)
- 6 To stop playback, press **STOP ■**
- 7 To remove the disc, press **EJECT** on Center

## Selecting and searching

### Selecting a different album/track

- 1 If necessary, repeatedly press ◀ to enter previous option lists
- 2 Repeatedly press the navigation controls ▲ or ▼ and ► to select the desired album or track.
- 3 Press **VIEW** to return to the playback screen, if necessary

### To select a different track (in current album) during playback

- In the playback screen, briefly and repeatedly press the navigation controls ▲ or ▼ to select previous or next tracks (or ◀◀ or ▶▶ on Center's remote control; ◀, ▶ on Station's remote control)

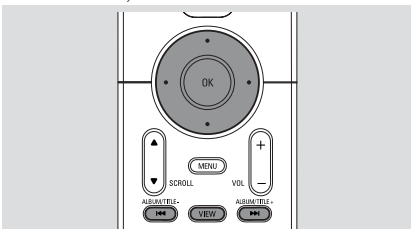

### Using the fast skip ▲ or ▼

Use this function to find an option (e.g. an album or a track) in a long option list.

- Press and hold the navigation controls ▲ or ▼ in the long option list
  - You will skip the options faster and faster
  - At the high speed skip, the initial letter of current options appears for easy identification

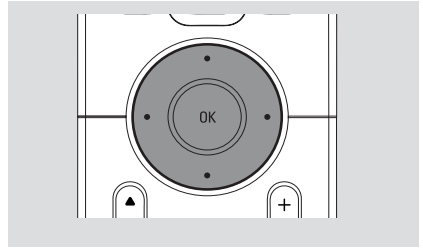

### Finding a passage within a track during playback

- 1 In the playback screen, press and hold the navigation controls ▲ or ▼ (or ◀◀ or ▶▶ on Center's remote control; ◀◀ / ▶▶ on Station's remote control)
  - The CD plays at a high speed
- 2 When you recognize the passage you want, release ◀◀ or ▶▶ (or ◀◀ / ▶▶ on Station's remote control)
  - Normal playback resumes

# CD (on Center only)

## Different play modes: REPEAT, SHUFFLE

- plays the current track continuously
- repeats all the tracks (under current album)
- repeats all the tracks (under current album) in random order
- tracks (under current album) are played in random order

- 1 During playback, press once or more **REPEAT** or/ and **SHUFFLE** to select play modes
- 2 To return to normal playback, press **REPEAT** or **SHUFFLE** repeatedly until the various modes are no longer displayed

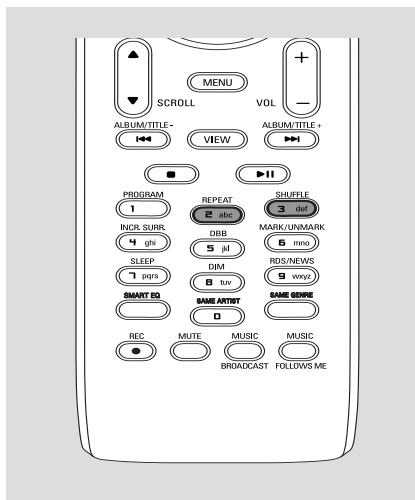

## Display track information

- 1 During playback, press **VIEW** once or more to enter the playback screen  
→ The display shows:  
**on the top:** CD  
**in the middle:** current track name, elapsed playing time and some track information  
**at the bottom:** equalizer setting and, if DBB is activated, DBB setting.
- 2 Press → The display shows track information (e.g. track name, file type, file size, bit rate of mp3/wma files)
- 3 Press **VIEW** once or more to return to the playback screen

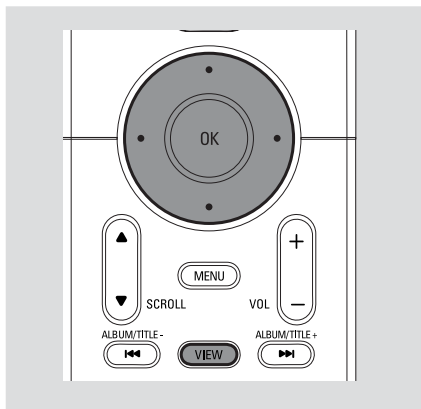



## Tuning to radio stations

- 1 Check the set is switched on or to standby (See **Basic functions, Switching on/to standby and selecting functions, Switching to Eco power/ on**)
- 2 Press **SOURCE** once or more to select **Radio** (on the remote control, press **TUNER/AUX** once or more)
  - Playback screen appears. Display shows: **Radio**, radio station frequency and If programmed, a preset number

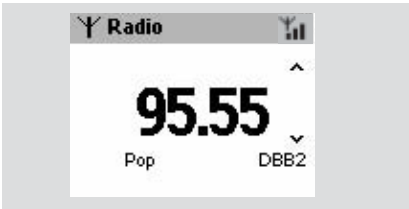

- 3 Press and hold **▲** or **▼** until the frequency in the display starts running
    - The radio automatically tunes to a station of sufficient reception. Display shows **searching** during automatic tuning
    - If a station is received in stereo, is shown
    - When you are receiving an RDS station, is shown
  - 4 Repeat step 3 if necessary until you find the desired radio station
- To tune to a weak station, press **▲** or **▼** briefly and repeatedly until optimal reception is found

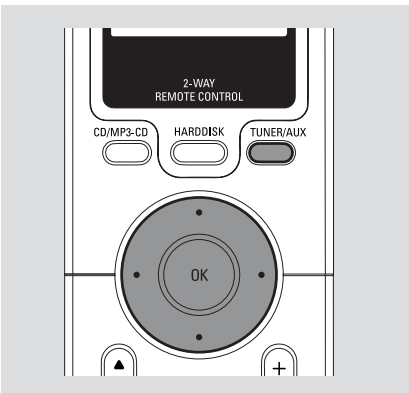

## Storing preset radio stations

You can store up to 40 preset radio stations in the memory.

### Autostore: automatic programming

Autostore automatically starts programming radio stations from preset 1. Available stations are programmed in the order of radio frequencies: RDS stations followed by FM stations. Maximum 10 RDS stations will be stored (from Preset 01 to Preset 10).

- To select **Autostore radio**,
  - a. Press **MENU**
  - b. Use the navigation controls **▲** or **▼** and **▶** to select
    - Display shows: **Autostore Please wait...**
    - After all stations are stored, the first autostore preset station will then automatically play

### Manual programming

- 1 Tune to your desired radio station (see **Tuning to radio stations**)
- 2 On the remote control, press **Program** to store the station
  - The station is stored in the 1st vacant preset position. Display shows its preset number
- 3 Repeat steps 1-2 to store other stations

### Helpful hints:

– If you store more than 40 stations, the new station will replace the 1st preset station.

### To listen to a preset station

- 1 Press **◀** to enter the list of presets



- 2 Use the navigation controls **▲** or **▼** and **▶** to select the desired station

# FM radio

## RDS

**RDS (Radio Data System)** is a service that allows FM stations to send additional information along with FM radio signal



- 1 Tune to the desired RDS radio station (see **Autostore: automatic programming**)
- 2 Press **RDS/NEWS** repeatedly to view the following information (if available):
  - Station name
  - program type (for example: News, Pop Music)
  - RDS radio text



## NEWS

While listening to HD, CD or AUX source, you can activate NEWS. The set will tune to the news station if the related signals are received from a RDS station.

### Activating NEWS

- During playback in **HD, CD** or **AUX** source, press **RDS/NEWS** on the remote control
  - The icon  appears and NEWS ON is displayed briefly
  - Playback continues when the set scans the first 10 preset stations
  - When news transmission is detected, the set will switch to the news station. The icon  starts flashing

#### Helpful hints:

- Make sure you have stored RDS stations in the first 10 preset locations (see **Autostore: automatic programming**).
- If no news transmission is detected during the set's scanning, the icon  disappears and **NO RDS NEWS** is displayed.

### Deactivating NEWS

- Press **RDS/NEWS** again on the remote control
- or
- Switch the set to **Radio** source
  - The icon  disappears and **NEWS OFF** is displayed briefly

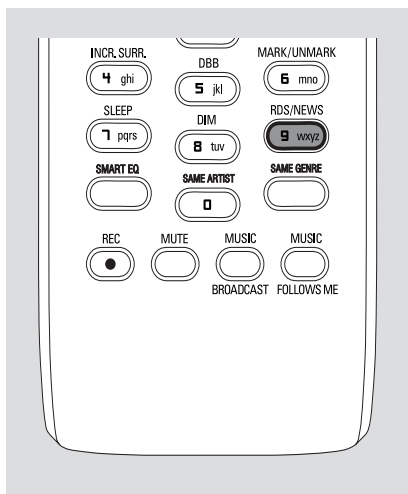

## AUX (Listening to an external source)

You can listen to the sound of the connected external device through your Center or Station.

- 1 Check the external device has been properly connected. (See **Installation, Connecting an additional appliance**)
- 2 Check the set is switched on or to standby (See **Basic functions, Switching on/to standby and selecting functions, Switching to Eco power/ on**)
- 3 Press **SOURCE** once or more to select **AUX** (on the remote control, press **TUNER/AUX** once or more)
- 4 To avoid noise distortion, turn down the volume on your external device
- 5 Press the **PLAY** key on the connected device to start playback
- 6 To adjust the sound and volume, use the sound controls on your external device and the WACS700

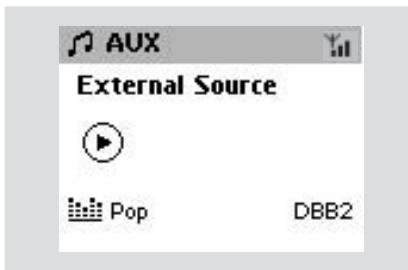

## SLEEP

You can set a certain period of time after which the Center or Station will switch to standby.



- 1 On the remote control, press **SLEEP** repeatedly to select the desired time period options (in minutes):  
 → Display shows in sequence: **Sleep 15, 30, 45, 60, 90, 120, Off**  
 → Display shows the selected option briefly and returns to its previous status. The icon **Z<sup>2</sup>** appears
- 2 To view the time countdown to the standby mode, press **SLEEP** again

To deactivate the sleep timer, press **SLEEP** until **Sleep Off** is displayed

or

Press **STANDBY-ON/ ECO POWER** to switch the set to standby (or **⏻** on the remote control)

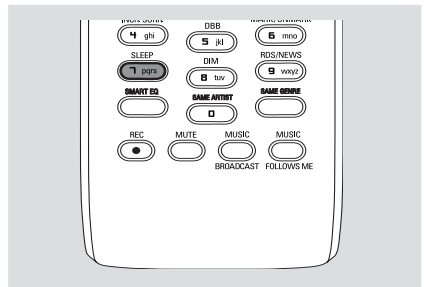

## Reset

If desired, you can restore your Center or Stations to their default setting (including the network setting).

### When to reset Center or Station:

- Resetting Center or Station helps to re-establish the connection between Center and Station.
  - To change the way your Center connects to PC, you need to reset the Center (see the Option 1, Option 2 or Option 3 in manual Connect to your PC)
- 1 Check the set is switched on (See **Basic functions**)
  - 2 Press **MENU** to enter the **MENU** screen
  - 3 Use the navigation controls ▲ or ▼ and ► to enter **Settings**
  - 4 Use the navigation controls ▲ or ▼ and ► to enter **Restore settings**
  - 5 Press ▲ or ▼ and ► to select **Yes**  
→ The set is rebooted. Language selection screen appears
  - 6 Select your desired language: **English, French, Spanish, Dutch, Italian and German**  
→ The set enters Installation Mode  
→ The search for Center or Stations starts. The Wi-Fi connection is being re-established

### If the Center is reset and Stations are not reset:

- On the Stations, select **AUX** mode and enter **Installation Mode** by:
  - a. Press **MENU**.
  - b. Use the navigation controls ▲ or ▼ and ► to select **Installation Mode**  
→ The Stations start to connect Center

### If a Station is reset and the Center is not:

- On the Center; select **HD** mode and then, enter **Installation Mode** by:
  - a. Press **MENU**
  - b. Use the navigation controls ▲ or ▼ and ► to enter **Station Mgmt** menu
  - c. In **Station Mgmt** menu, use the navigation controls ▲ or ▼ and ► to select **Add New Station**  
→ Searching for Stations starts

### If both Center and Stations are reset:

- Do as you did in the first-time Wi-Fi connection (see **Installation, Set up Wi-Fi connection between Center and Station**)
- 7 On Center; press **STOP** ■ to exit **Installation Mode** when all the Stations are found

## General

AC Power	
WAC700 .....	120V ±10% (max. 110W)
WAS700 .....	120V ±10% (max. 55W)

## Power consumption

Active	
WAC700 .....	< 35W
WAS700 .....	< 25W
Standby	
WAC700 .....	< 18W
WAS700 .....	< 14W

## Eco Power Standby

WAC700 .....	< 1W
WAS700 .....	< 1W

## Dimensions (w x h x d)

WAC700 .....	608 x 303 x 175 mm
.....	23.9 x 11.9 x 6.9 Inch
WAS700 .....	360 x 283 x 128 mm
.....	14.2 x 11.1 x 5.0 Inch

## Weight

WAC700 .....	7.7 kg
.....	16.9 Pounds
WAS700 .....	4.2 kg
.....	9.2 Pounds

## Amplifier

### Output power

WAC700 .....	RMS 2 x 13W + 2 x 22W
WAS700 .....	RMS 2 x 4W + 1 x 8W

Frequency response ..... 50-16,000Hz, - 3dB

S/N ratio ..... ≥ 72 dBA (IEC)

### Input sensitivity

AUX/CDR IN ..... 500mV/1V

### Output

#### Impedance speakers

(WAC700) ..... ≥16 Ω (Panel) ≥8 Ω (Subwoofer)

(WAS700) ..... ≥6 Ω (Panel) ≥12 Ω (Subwoofer)

Impedance headphones ..... 32Ω -150Ω

## Wireless

Wireless standard .....	802.11g /b
Wireless security .....	..... WEP (64 or 128bit), WPA-PSK
Frequency range	2412-2462 MHz (CH1-CH11)

## Tuner

### Wave range

FM .....	87.5-108 MHz
Number of presets .....	40x
FM Antenna/cable .....	..... COAX /T-antenna (75Ω IEC-connector)

## HDD/CD player (wac700 only)

Frequency range ..... 30-18000 Hz, -3 dB

S/N ratio ..... ≥ 72 dBA (IEC)

MPEG 1 Layer 3 (MP3-CD) ..... MPEG AUDIO

MP3-CD bit rate .....

..... 32-256 kbps, VBR, 128 kbps advised

WMA bit rate ..... up to 160kbps

Sampling frequencies ..... 32, 44.1, 48 kHz

HDD Storage capacity (WAC700 only) .. 40GB\*

Recording quality ..... 128kbps or 160kbps

Recording speed ..... 1x, 4x

\* Actual formatted capacity will be less

**Specifications and external appearance are subject to change without notice.**

## WARNING

Under no circumstances should you try to repair the system yourself, as this will invalidate the warranty. Do not open the system as there is a risk of electric shock.

If a fault occurs, first check the points listed below before taking the system for repair. If you are unable to remedy a problem by following these hints, consult your dealer or Philips for help.

Problem	Solution
<p><b>Wi-Fi connection:</b></p> <p><b>During the first-time setup, Station's display shows "Searching for Center".</b></p> <p><b>I get interference on my wireless (WiFi) link between center and station.</b></p> <p>The WACS 700 operate in the 2.4GHz radio frequency spectrum. Many other household/IT devices also operate in the frequency spectrum, for example: microwave ovens, Dect phones, bluetooth devices like bluetooth headphones, computer mouse, wireless routers, cordless phones, WiFi compatible printers, PDAs. These devices can interfere with the WiFi link between Center and Station, resulting in such interference as the pause during playback, the set's slow response to your operation. The severity of interference varies depending on the extent of radiation from the device and the strength of Wi-Fi signals in the position.</p>	<ul style="list-style-type: none"><li>✓ Check you have placed the Center and Station side by side on a flat and firm surface</li><li>✓ Check you have connected the Center to power supply</li><li>✓ When adding a new station, check your center is in <b>Installation mode</b> (See <b>HD, Station management</b>)</li></ul> <p>If you are playing the set, stop playback and take the appropriate measures as follows:</p> <ul style="list-style-type: none"><li>✓ Keep the Center or Station at least 3 meters away from such devices.</li><li>✓ Use the WEP key when connecting your Center and Station to an existing wireless PC network. Refer to the owner's manual of your router and <b>Option 2 in Connect to your PC.</b></li><li>✓ Change the operating channel of your Center and Station when connecting them to an existing wireless PC network. To learn about how to change channels, see the manual <b>Connect to your PC: Option 2.</b></li><li>✓ If possible, change the operating channels of the other Wi-Fi devices at your home.</li><li>✓ Turn the devices in different directions to minimize interference.</li></ul>
<p><b>Remote control:</b></p> <p><b>When I am using the Center's 2-way remote control, it starts to show "connecting ....connecting" on the display endlessly.</b></p> <p>When you read this message on the 2-way remote control, there could be the following interference on your remote control:</p> <ol style="list-style-type: none"><li>1) interference signals from the Plasma TV screen (if this device is turned on);</li><li>2) conflicting IR signals from a nearby WAS700 Station</li></ol>	<ul style="list-style-type: none"><li>✓ Check your plasma TV is turned off</li><li>✓ Check you have placed two IR operated devices ( Station) in separate rooms wherever possible.</li></ul>

**Stations react when you operate Center's remote control**

- ✓ Center's remote control is powerful enough to operate several Stations within certain distance or angle. Check you have placed the Stations in different rooms or place Stations in different angles
- ✓ Use Station's remote control or the controls on the set.

**"x" flashes on the sychro display of Center's remote control**

- ✓ Signal error: Check you have pointed the remote control toward the IR area of the set you wish to operate

**After the set is switched on, nothing appears on the synchronous display of Center's remote control**

- ✓ You switched on the set by using the control on the set instead of center's remote control. Press **REFRESH** on center's remote control to synchronize its display.

**The remote control does not function properly.**

- ✓ Remove the protective plastic tab before using the Station's remote control.
- ✓ Reduce the distance between the remote control and the set.
- ✓ Insert the batteries with their polarities (+/- signs) aligned as indicated.
- ✓ Replace the batteries.
- ✓ Point the remote control directly towards the IR sensor.

## CD

**"No Disc"/"Cannot read CD" is displayed**

- ✓ Insert a suitable disc.
- ✓ Check if the disc is inserted with graphics facing front
- ✓ Wait until the moisture condensation at the lens has cleared.
- ✓ Replace or clean the disc, see "Maintenance".
- ✓ Use a finalized CD-RW or CD-R.

**Sound cannot be heard or is of poor quality.**

- ✓ Adjust the volume.
- ✓ Disconnect the headphones.
- ✓ Switch off MUTE.

**The disc skips tracks**

- ✓ Replace or clean disc
- ✓ Switch off SHUFFLE

**Sound skips during MP3/WMA playback**

- ✓ MP3 file made at compression level exceeding 320kbps. Use a lower compression level to rip audio CD tracks.
- ✓ Replace or clean disc.

## Tuner

---

### Radio reception is poor

#### **There will be interference on the radio reception whenever my Center or Station is near the PC.**

Such interference happens to most of the built-in tuner product.

## Wall mounting

---

### **How do I mount the Center or Station onto walls?**

- ✓ If the signal is too weak, adjust the antenna or connect an external antenna for better reception.
- ✓ Increase the distance between the set and your TV or VCR.
- ✓ Install the supplied FM wire antenna for better reception.
- ✓ Keep your Center or Station at least 1 meter away from PC.
  
- ✓ Use the by-packed wall mounting kits. It is recommended you get a qualified person to fix the mounting brackets safely onto your walls before you mount the Center or Station. For details, refer to the **Appendix : How to mount your Center or Station onto Walls**



## How to mount your Center and Station onto walls

### IMPORTANT!

- The wall mounting instructions are for the use of the qualified wall mounting person only!
- Ask a qualified person to help you with the wall mounting, which includes drilling holes on the wall, fixing the mounting brackets to the wall, and mounting the sets onto the brackets.

### What's in the supplied mounting kits

#### For Center:

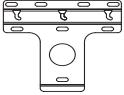

1 x mounting bracket



3 x screws (for Center mounting)



1 x protective card sheet

#### For Station:

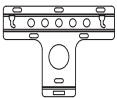

1 x mounting bracket



2 x screws (for Station mounting)

### What else you'll need

- 8 x screws for fixing the Center's bracket
- 6 x screws for fixing the Station's bracket
- Drilling tools (e.g. electric drill)

### Preparation

- To find a suitable location for mounting, try your necessary rear connections and the Wi-Fi connection between Center and Station (see the chapter **Installation**).
- Ask a qualified person to help you with the wall mounting, who should:
  - to avoid unexpected damage, learn about the piping, wiring and other relevant information inside your walls;
  - according to your walls' materials, decide what type of screws you need to fix the mounting brackets and hold the weight of a Center or Station;
  - according to the drilling requirements, choose suitable drilling tools;
  - take other precautions necessary for the wall mounting work.

### Mounting your Center or Station

- 1 Align the bracket (for Center or Station) in the chosen location on a wall. Use a pencil to mark the drilling positions.

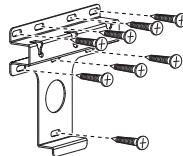

Center

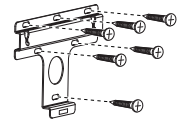

Station

- 2 Drill holes as marked.
- 3 Fix the brackets to the wall using suitable screws (not supplied).
- 4 As shown, fasten the supplied screws to your Center or Station using a screwdriver

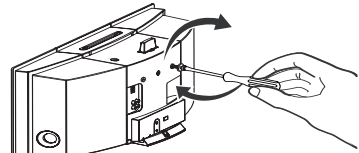

Center

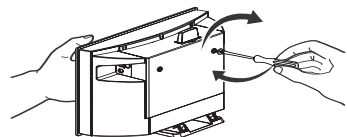

Station

# Appendix

- 5 To detach the stand from Center or Station,
- As shown, hold down the **Lock•unlock** button(s).
  - Move out the stand to detach.

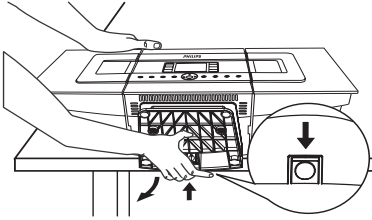

Center

- 7 As shown, hook and mount Center or Station in place.

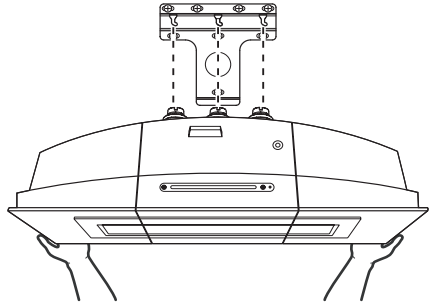

Center

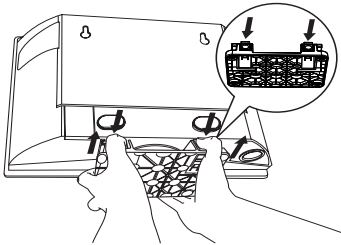

Station

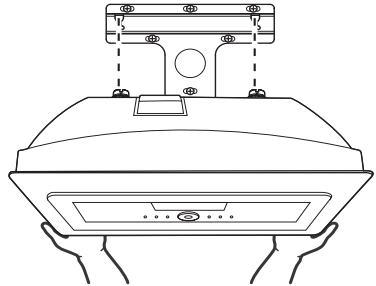

Station

- 6 On Center; insert the supplied protective card sheet where the stand was installed.

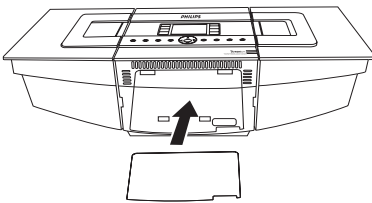

# PHILIPS LIMITED WARRANTY

## One (1) Year Labor and Parts Repair (Facility)

**PHILIPS CONSUMER ELECTRONICS** warrants this product against defect in material or workmanship, subject to any conditions set forth as follows:

### PROOF OF PURCHASE:

You must have proof of the date of purchase to receive warranted repair on the product. A sales receipt or other document showing the product and the date that you purchased the product as well as the authorized retailer included, is considered such proof.

### COVERAGE:

(If this product is determined to be defective)

**LABOR:** For a period of one (1) year from the date of purchase, Philips will repair or replace the product, at its option, at no charge, or pay the labor charges to the Philips authorized repair facility (see warranty service phone numbers in next column). After the period of one (1) year, Philips will no longer be responsible for charges incurred.

**PARTS:** For a period of one (1) year from the date of purchase, Philips will supply, at no charge, new or rebuilt replacement parts in exchange for defective parts. Philips authorized repair facility will provide removal and installation of the part under the specified labor warranty.

### EXCLUDED FROM WARRANTY COVERAGE

Your warranty does not cover:

- Labor charges for installation or setup of the product, adjustment of customer controls on the product, and installation or repair of antenna systems outside of the product.
- Product repair and/or part replacement because of improper installation, connections to improper voltage supply, abuse, neglect, misuse, accident, unauthorized repair or other cause not within the control of Philips.
- A product that requires modification or adaptation to enable it to operate in any country other than the country for which it was designed, manufactured, approved and/or authorized, or repair of products damaged by these modifications.
- Damage occurring to product during shipping when improperly packaged or cost associated with packaging.
- Product lost in shipment and no signature verification of receipt can be provided.
- A product used for commercial or institutional purposes (including but not limited to rental purposes).
- Products sold AS IS or RENEWED.

### SHIP-IN WARRANTY

For Ship-In warranty repair, ship the product to a Philips authorized service facility for repair in its original carton and packing material. If you do not have the original carton or packing material, have your product professionally packed for shipping. Ship product via a traceable carrier. When it is necessary for you to ship the product to Philips for repair, you will pay the shipping cost for shipment to Philips. Philips will pay the shipping costs when returning the product to you.

### TO OBTAIN WARRANTY SERVICE IN THE U.S.A., PUERTO RICO, OR U.S. VIRGIN ISLANDS...

Contact Philips Customer Care Center at:  
1-888-PHILIPS (1-888-744-5477)

### TO OBTAIN WARRANTY SERVICE IN CANADA...

1-800-661-6162 (French Speaking)  
1-888-PHILIPS (1-888-744-5477) (English or Spanish Speaking)

REPAIR OR REPLACEMENT AS PROVIDED UNDER THIS WARRANTY IS THE EXCLUSIVE REMEDY FOR THE CONSUMER. PHILIPS SHALL NOT BE LIABLE FOR ANY INCIDENTAL OR CONSEQUENTIAL DAMAGES FOR BREACH OF ANY EXPRESS OR IMPLIED WARRANTY ON THIS PRODUCT, EXCEPT TO THE EXTENT PROHIBITED BY APPLICABLE LAW, ANY IMPLIED WARRANTY OF MERCHANTABILITY OR FITNESS FOR A PARTICULAR PURPOSE ON THIS PRODUCT IS LIMITED IN DURATION TO THE DURATION OF THIS WARRANTY.

Some states do not allow the exclusions or limitation of incidental or consequential damages, or allow limitations on how long an implied warranty lasts, so the above limitations or exclusions may not apply to you. In addition, if you enter into a service contract agreement with the PHILIPS partnership within ninety (90) days of the date of sale, the limitation on how long an implied warranty lasts does not apply.

*This warranty gives you specific legal rights. You may have other rights which vary from state/province to state/province.*

Philips, P.O. Box 671539, Marietta, GA. 30006-0026

(Warranty: 4835 710 27100)