

Streamium

WACS7500

WAS7500



Congratulations on your purchase and welcome to Philips!
To fully benefit from the support that Philips offers, register your product at www.philips.com/welcome

For support call 1-888-744-5477

Wireless Music Center + Station

Thank you for choosing Philips.

STOP!

Need help fast?

Read your Quick Start Guide and/or User Manual first for quick tips that make using your Philips product more enjoyable.

If you have read your instructions and still need assistance, you may access our online help at

www.philips.com/welcome or call
1-888-PHILIPS (744-5477) while with your product (and Model / Serial number)

PHILIPS

EN	Wireless Music Center + Station	1
FR	Centre + Station Audio Sans Fil	95
ES	Wireless Music Estación central + Satélite	191

Important notes for users in the U.K.

Mains plug

This apparatus is fitted with an approved 13-Amp plug. To change a fuse in this type of plug, proceed as follows:

- 1 Remove fuse cover and fuse.
- 2 Fix the new fuse which should be a BS1362 5-Amp, A.S.T.A. or BSI approved type.
- 3 Refit the fuse cover.

If the fitted plug is not suitable for your socket outlets, it should be cut off and an appropriate plug should be fitted in its place.

If the mains plug contains a fuse, it should have a value of 5 Amp. If a plug without a fuse is used, the fuse at the distribution board should not be greater than 5 Amp.

Note: The severed plug must be disposed, so as to avoid a possible shock hazard due to it being inserted into another 13-Amp socket.

How to connect a plug

The wires in the mains lead are colored using the following codes: blue = neutral (N), brown = live (L).

- As these colors may not correspond with the color markings identifying the terminals in your plug, proceed as follows:
 - Connect the blue wire to the terminal marked N or colored black.
 - Connect the brown wire to the terminal marked L or colored red.
 - Do not connect either wire to the earth terminal in the plug, marked E (or e) or colored green (or green and yellow).

Before replacing the plug cover, make sure that the cord grip is clamped over the sheath of the lead and not simply over the two wires.

Copyright in the U.K.

Recording and playback of any materials may require consent. See Copyright Act 1956 and The Performer's Protection Acts 1958 to 1972.

Norge

Typeskilt finnes på apparatens bakside.

Observer: Nettbryteren er sekundert innkopleet. Den innebygde nettdelen er derfor ikke frakopleet nettet så lenge apparatet er tilsluttet nettkontakten.

For å redusere faren for brann eller elektrisk støt, skal apparatet ikke utsettes for regn eller fuktighet.

CE 0682						R&TTE Directive 1999/5/EC					
BE	✓	DK	✓	GR	✓	ES	✓	FR	✓		
IE	✓	IT	✓	LU	✓	NL	✓	AT	✓		
PT	✓	FI	✓	SE	✓	UK	✓	NO	✓		
DE	✓	CH	✓	PL	✓	HU	✓	SK	✓		
CZ	✓										

**CLASS 1
LASER PRODUCT**

Table of contents

1	Important	3	4.2.1	Remote control battery installation	29
1.1	Safety	3	4.2.2	Remote control, 2-way	31
1.2	GPL Package written offer	4	4.3	Navigation controls	32
1.3	LGPL Library written offer	4	4.4	Alphanumeric keys	32
1.4	Environmental information	4	5	Basic functions	33
1.4.1	Disposal of product & packing material	5	5.1	Power modes and functions	33
1.4.2	Battery disposal information	5	5.2	Eco Standby (power-saving mode)	35
1.5	Maintenance	6	5.3	Auto-Standby	35
1.6	Hearing Safety	7	5.4	Volume control	35
1.7	Legal-USA and Canada-Notice of compliance with radio interference requirements	8	5.5	MUTE	36
1.8	EU-Notice of compliance with radio interference requirements	8	5.6	Sound control	36
1.9	Legal-Class 2 Label	8	5.6.1	Smart equalizer	36
1.10	Know these safety symbols	9	5.6.2	Equalizer	36
1.11	Important safety instructions	9	5.6.3	DBB (Dynamic Bass Boost)	37
1.12	Register your product	11	5.6.4	Incredible surround	37
2	Your Wireless Music Center & Station	12	5.7	Display adjustment	37
2.1	What's in the box	12	5.8	Selecting languages	38
2.2	Overview Wireless Music Center & Station	14	5.9	Sleep	38
2.2.1	Controls on Center and Station	14	5.10	Alarm	39
2.3	Overview remote controls	16	5.10.1	Set alarm / alarm time / repeat mode	39
2.3.1	2-way remote control	16	6	HD (Hard Disk)	40
2.3.2	1-way remote control	18	6.1	Play HD Music	40
2.4	Overview display	20	6.2	Search	40
3	Installation	21	6.2.1	Search by keywords	40
3.1	Install Center and Station	21	6.2.2	Select track of same artist	41
3.2	Connect AC power	22	6.2.3	Select track of same genre	41
3.3	Set up Wi-Fi connection between Center and Station	22	6.2.4	Find track in current album (during playback)	42
3.4	Rear connections	22	6.2.5	Find passage in current track (during playback)	42
3.4.1	Connect antennas	23	6.3	Play modes REPEAT, SHUFFLE	42
3.4.2	Connect a portable (USB) device	23	6.4	Build music library on Center	43
3.4.3	Connect your iPod (optional)	24	6.4.1	Rip music from CDs	43
3.4.4	Connect additional appliances	25	6.4.2	Import from your PC	45
3.4.5	Connect an additional device with external speakers	25	6.4.3	Record from radio or external source	46
4	Prepare	26	6.5	Create a playlist	46
4.1	Set the clock	26	6.6	Delete a playlist, album or track	47
4.1.1	View the clock	28	6.7	View track information	47
4.2	Remote control	29	6.8	Backup to PC	48
			6.9	Move music playback between Center and Station	48
			6.9.1	MUSIC FOLLOWS ME	48
			6.9.2	MUSIC BROADCAST	49
			6.10	View system information	50

6.11	Edit track information	51	11.2.2	Set network on Station	73
7	CD (Center only)	52	11.3	Connect to wired home network	74
7.1	Supported discs	52	11.3.1	Set network on Center	74
7.2	Play discs	53	11.3.2	Set network on Station	75
7.2.1	Search by keywords	54	11.4	Connect to two different home networks	76
7.2.2	Find track in current album (during playback)	55	11.5	View connection status	76
7.2.3	Find passage in current track (during playback)	55	11.5.1	View Station status in Wi-Fi network of Center	76
7.3	Play modes REPEAT, SHUFFLE	55	11.5.2	Viewing the connection with home network	77
8	FM radio	56	11.6	Connect to Internet	77
8.1	Tune radio stations	56	12	Connect to your PC	79
8.2	Store preset radio stations	56	13	Gracenote® CD Information	82
8.2.1	Autostore: Automatic preset program	57	13.1	Gracenote® music recognition database	82
8.2.2	Manual store: Manual preset program	57	13.1.1	Update Gracenote® music recognition database	82
8.2.3	Listen to preset station	57	13.2	Gracenote® Internet Queries	82
8.3	RDS	58	13.2.1	Look up CD track information	83
8.4	NEWS	58	14	Firmware Upgrade	84
8.5	Internet radio*	59	14.1	Upgrade firmware	84
8.5.1	First time use	59	14.2	Restore previous firmware	85
8.5.2	Regular use	60	14.3	Re-establish Wi-Fi network of Center and Stations	85
8.5.3	Add internet radio stations and bookmark your favorites	61	15	Reset	86
9	UPnP	62	16	Technical data	87
9.1	UPnP (Universal Plug and Play)	62	16.1	Center	87
9.1.1	About UPnP*	62	16.2	Station	88
9.1.2	About UPnP* enabled devices	62	17	Frequently asked questions	89
9.2	Connect to the UPnP device	63	18	Appendix	95
9.3	UPnP playback	63	18.1	How to mount Station to a wall	95
9.3.1	Play music from UPnP device	63	18.1.1	What's in the supplied mounting kit	95
9.3.2	Play music from Center	64	18.1.2	What else you'll need	95
10	External sources	65	18.1.3	Preparation	96
10.1	Play or record to USB mass storage device	65	18.1.4	Mounting Station	96
10.1.1	About USB device	65			
10.1.2	Play music from USB device	66			
10.1.3	Transfer music to USB device	67			
10.2	Play your iPod music	69			
10.3	Play external sources	69			
11	Network settings	70			
11.1	Add Stations to Wi-Fi network of Center	70			
11.1.1	Delete a Station	71			
11.2	Connect to Wi-Fi (wireless) enabled home network	72			
11.2.1	Network settings on Center	72			

* Internet radio requires broadband Internet access.

1 Important

1.1 Safety

Warning! To avoid the risk fire, electric shock, injuries or damages, follow these safety instructions:

- Do not open the product or remove the cover. The interior does not contain any user-serviceable parts.
- Do not place objects filled with liquid, such as vases, on the product.
- Do not stick objects into the openings of the product.
- Do not drop objects such as paperclips into the openings.
- Do not expose the product to splashing or dripping water.
- Do not expose the product to rain or high humidity. The product is for indoor use only.
- Do not place sources of naked flames, such as burning candles, on the product.
- Position the product in a location with adequate ventilation. Allow at least 10 cm (4 inches) clearance at the rear and the top of the product and 5 cm (2 inches) on each side.
- Do not cover the ventilation openings with items such as newspapers, tablecloths, curtains, etc.
- Do not oil or lubricate the mechanical parts of the product.

Caution! To avoid the risk of injuries or damages, follow these safety instructions:

- Visible and invisible laser radiation! Do not look at the laser beam.
- The set does not contain any user-serviceable parts.
- Place the set on a level, firm and sturdy surface.
- Keep the system, batteries and discs in a cool dry place.
- Do not expose the product to humidity, rain, or heat sources like radiators, amplifiers, or direct sunlight.
- Modification of the product can result in hazardous EMC radiation or other unsafe operations.

This product complies with the radio interference requirements of the European Community.

Philips Electronics, BG Entertainment Solutions, hereby declare that this product WACS7500 is in compliance with the essential requirements and other relevant provisions of the Directive 1999/5/EC.

The making of unauthorized duplicates of copy-protected materials, including computer programs, files, broadcasts and sound recordings, may be an infringement of copyrights and constitutes as criminal offence. This equipment should not be used for such purposes.

Note

The use of controls or adjustments or performance of procedures other than described in the user manual may result in hazardous radiation exposure or unsafe operation.

1.2 GPL Package written offer

This product contains Linux 2.4.27-vrsl that is made available under the GNU GPL license version 2 (hereafter called 'the Program').

Philips Electronics Hong Kong Ltd. hereby offers to deliver or make available, upon request, for a charge no more than the cost of physically performing source distribution, a complete machine-readable copy of the corresponding source code of the Program on a medium customarily used for software interchange. Please contact: Head of Development BLC Audio PDCC Development 5/F, Philips Electronics Building 5 Science Park East Avenue Hong Kong Science Park Shatin Hong Kong

This offer is valid for a period of three years after the date of purchase of this product.

1.3 LGPL Library written offer

This product contains Linux 2.4.27-vrsl that is made available under the GNU LGPL license version 2.1 (hereafter called 'the Library').

Philips Electronics Hong Kong Ltd. hereby offers to deliver or make available, upon request, for a charge no more than the cost of physically performing source distribution, a complete machine-readable copy of the corresponding source code of the Library on a medium customarily used for software interchange. Please contact: Head of Development BLC Audio PDCC Development 5/F, Philips Electronics Building 5 Science Park East Avenue Hong Kong Science Park Shatin Hong Kong

This offer is valid for a period of three years after the date of purchase of this product.

1.4 Environmental information

All redundant packaging material has been omitted. We made the packaging easily separable into three mono materials: cardboard (box), polystyrene foam (buffer) and polyethylene (bags, protective foam sheet).

Your system consists of materials which can be recycled and reused if disassembled by a specialized company. Please observe the local regulations regarding the disposal of packaging materials, exhausted batteries and old equipment.

1.4.1 Disposal of product & packing material



Your product is designed and manufactured with high quality materials and components, which can be recycled and reused.

When this crossed-out wheeled bin symbol is attached to a product, it means the product is covered by the European Directive 2002/96/EC.

Please be informed about the local separate collection system for electrical and electronic products.

Please act according to your local rules and do not dispose of your old products with your normal household waste. The correct disposal of your old product will help prevent potential negative consequences for the environment and human health.

In order to preserve, protect and improve the quality of the environment, protect human health, and utilize natural resources prudently and rationally, you should return the unserviceable product either to the place where you purchased it, or to a relevant facility in accordance with the local statutory regulations.

The crossed-out wheeled bin indicates that the product must not be disposed of in the household refuse. The symbol is used in conjunction either with a solid bar or the date of manufacture / launch.

All redundant packing material has been omitted. We have done our utmost to make the packaging easily separable into mono materials.

Please observe the local regulations regarding the disposal of packing materials.

1.4.2 Battery disposal information

Batteries (including built-in rechargeable batteries) contain substances that may pollute the environment. Always hand the appliance in at an official collection point to remove any built-in batteries before you discard the appliance. All batteries should be disposed of at an official collection point.

1.5 Maintenance

Clean the set

- Use a soft cloth slightly moistened with a mild detergent solution.
- Do not use any solutions that contain alcohol, spirits, ammonia or abrasives, as these can harm the product.

Clean your discs

- When a disc becomes dirty, clean it with a cleaning cloth. Wipe the disc from the center out.
- Do not use solvents such as benzene, thinner, or antistatic spray intended for analog records.

Care for the HD (Hard Disk)

The HD is a delicate piece of equipment that is prone to damage due to its long recording capacity and high speed operation.

- Do not move the unit while it is switched on.
- Do not remove the AC power plug from the power outlet during operation.
- Do not use the unit in excessively hot or humid places as this may cause condensation to form inside the unit.

If the HD fails, playback and recording will not be possible. In this case, it will be necessary to replace the HD unit.

Note

The HD is not recommended for permanent storage of recorded contents. Before creating your music library, create a back up of the music on your PC. If necessary, you can later restore your system with these backup files.

1.6 Hearing Safety

Listen at a moderate volume.

- Using headphones at a high volume can impair your hearing. This product can produce sounds in decibel ranges that may cause hearing loss for a normal person, even for exposure less than a minute. The higher decibel ranges are offered for those that may have already experienced some hearing loss.
- Sound can be deceiving. Over time your hearing 'comfort level' adapts to higher volumes of sound. So after prolonged listening, what sounds 'normal' can actually be loud and harmful to your hearing. To guard against this, set your volume to a safe level before your hearing adapts and leave it there.



To establish a safe volume level:

- Set your volume control at a low setting.
- Slowly increase the sound until you can hear it comfortably and clearly, without distortion.

Listen for reasonable periods of time:

- Prolonged exposure to sound, even at normally 'safe' levels, can also cause hearing loss.
- Be sure to use your equipment reasonably and take appropriate breaks.

Be sure to observe the following guidelines when using your headphones.

- Listen at reasonable volumes for reasonable periods of time.
- Be careful not to adjust the volume as your hearing adapts.
- Do not turn up the volume so high that you can't hear what's around you.
- You should use caution or temporarily discontinue use in potentially hazardous situations.
- Do not use headphones while operating a motorized vehicle, cycling, skateboarding, etc.; it may create a traffic hazard and is illegal in many areas.

Important (for models supplied with headphones):

Philips guarantees compliance with the maximum sound power of its audio players as determined by relevant regulatory bodies only with the original model of provided headphones. In case this one needs replacement, we recommend that you contact your retailer to order a model identical to that of the original, provided by Philips.

1.7 Notice of compliance with radio interference requirements

Notice of compliance

Warning: Changes or modifications made to this equipment not expressly approved by Philips may void the FCC authorization to operate this equipment.

For USA:



This equipment has been tested and found to comply with the limits for a Class B digital device, pursuant to Part 15 of the FCC Rules. These limits are designed to provide reasonable protection against harmful interference in a residential installation. This equipment generates, uses and can radiate radio frequency energy and, if not installed and used in accordance with the instructions, may cause harmful interference to radio communications. However, there is no guarantee that interference will not occur in a particular installation. If this equipment does cause harmful interference to radio or television reception, which can be determined by turning the equipment off and on, the user is encouraged to try to correct the interference by one or more of the following measures:

- Reorient or relocate the receiving antenna.
- Increase the separation between the equipment and receiver.
- Connect the equipment into an outlet on a circuit different from that to which the receiver is connected.
- Consult the dealer or an experienced radio/TV technician for help.

For Canada:

This Class B digital apparatus complies with Canadian ICES-003.

The set complies with the FCC-Rules, Part 15, with 21 CFR 1040.10 and with RSS-210 of Industry Canada. Operation is subject to the following two conditions:

- This device may not cause harmful interference, and
- This device must accept any interference received, including interference that may cause undesired operation.

Declaration of Conformity

Model number: WACS7500/37, WAS7500/37

Trade name: Philips

Responsible party: Philips Consumer Lifestyle
A Division of Philips Electronics
North America Corp.
P.O. Box 671539
Marietta, GA 30006-0026
1-800-PHILIPS (744-5477)

Radiofrequency radiation exposure Information:

This equipment complies with FCC radiation exposure limits set forth for an uncontrolled environment. This equipment should be installed and operated with minimum distance of 20 cm between the radiator and your body.

This transmitter must not be co-located or operating in conjunction with any other antenna or transmitter.

1.8 EU-Notice of compliance with radio interference requirements



This product complies with the radio interference requirements of the European Community.

This product complies with the requirements of the following directives and guidelines: 73/23/EEC + 89/336/EEC + 93/68/EEC

1.9 Legal-Class 2 Label

Class II equipment symbol



This symbol indicates that the unit has a double insulation system.

1.10 Know these safety symbols



 This 'bolt of lightning' indicates uninsulated material within your unit may cause an electrical shock. For the safety of everyone in your household, please do not remove product covering.



 The "exclamation point" calls attention to features for which you should read the enclosed literature closely to prevent operating and maintenance problems.

WARNING: To reduce the risk of fire or electric shock, this apparatus should not be exposed to rain or moisture and objects filled with liquids, such as vases, should not be placed on this apparatus.

CAUTION: To prevent electric shock, match wide blade of plug to wide slot, fully insert.

1.11 Important safety instructions

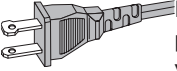
- 1 Read these instructions.
- 2 Keep these instructions.
- 3 Heed all warnings.
- 4 Follow all instructions.

- 5 Do not use this apparatus near water.
- 6 Clean only with dry cloth.
- 7 Do not block any ventilation openings. Install in accordance with the manufacturer's instructions.
- 8 Do not install near any heat sources such as radiators, heat registers, stoves, or other apparatus (including amplifiers) that produce heat.
- 9  For countries with a polarized mains, do not defeat the safety purpose of the polarized or grounding-type plug. A polarized plug has two blades with one wider than the other. A grounding type plug has two blades and a third grounding prong. The wide blade or the third prong are provided for your safety. If the provided plug does not fit into your outlet, consult an electrician for replacement of the obsolete outlet.
- 10 Protect the power cord from being walked on or pinched, particularly at plugs, convenience receptacles, and the point where they exit from the apparatus.
- 11 Only use attachments/accessories specified by the manufacturer.
- 12  Use only with the cart, stand, tripod, bracket, or table specified by the manufacturer or sold with the apparatus. When a cart is used, use caution when moving the cart/apparatus combination to avoid injury from tip-over.
- 13 Unplug this apparatus during lightning storms or when unused for long periods of time.
- 14 Refer all servicing to qualified service personnel. Servicing is required when the apparatus has been damaged in any way, such as power-supply cord or plug is damaged, liquid has been spilled or objects have fallen into the apparatus, the apparatus has been exposed to rain or moisture, does not operate normally, or has been dropped.
- 15 Battery usage **CAUTION** - To prevent battery leakage which may result in bodily injury, property damage, or damage to the unit:
 - Install all batteries correctly, + and - as marked on the unit.
 - Do not mix batteries (old and new or carbon and alkaline, etc.).
 - Remove batteries when the unit is not used for a long time.
- 16 Apparatus shall not be exposed to dripping or splashing.
- 17 Do not place any sources of danger on the apparatus (e.g. liquid filled objects, lighted candles).
- 18 This product may contain lead and mercury. Disposal of these materials may be regulated due to environmental considerations. For disposal or recycling information, please contact your local authorities or the Electronic Industries Alliance: www.eiae.org.

EL 6475-S004: 03/12

Never remove the casing of this Wireless Music Center and Station.

Never lubricate any part of this Wireless Music Center and Station.

Place this Wireless Music Center and Station on a flat, hard and stable surface.

Never place this Wireless Music Center and Station on other electrical equipment.

Only use this Wireless Music Center and Station indoors. Keep this Wireless Music Center and Station away from water, moisture and liquid-filled objects.

Keep this Wireless Music Center and Station away from direct sunlight, naked flames or heat.

1.12 Register your product

To fully benefit from the support that Philips offers, register your product at www.philips.com/welcome.

As it is possible for you to upgrade your product, we recommend that you also register your product on www.club.philips.com so that we can inform you as soon as new and free upgrades are available.

Products from Philips have been designed and manufactured to the highest quality standards. If your product does not work correctly, perhaps the connection and configuration must be revised.

To enhance your home entertainment experience, our support website (www.philips.com/support) offers you the information you need to enjoy your product as well as new additions to our range of products.

Please visit www.philips.com/support and enter the product name (WACS7500) to view:

- FAQ (Frequently Asked Questions)
- Latest user manuals and PC software manuals
- Firmware upgrade files for WACS7500 online
- Interactive troubleshooting

If you register your product at www.club.philips.com, we will be able to inform you as soon as new and free upgrades are available.

Enjoy your Wireless Music Center & Station!

2 Your Wireless Music Center & Station

Congratulations on your purchase and welcome to Philips!

With the Wireless Music Center & Station you can:

- Stream music from your PC
- Dock your iPod
- Plug & play from USB devices
- Enjoy HD playback

You can store up to 15000 songs in the 80GB Hard Disk of the Center **■C■** and you can connect up to 5 Stations **■S■** to Center **■C■**.

All stored music can be wirelessly streamed from **■C■** to the connected Stations using Wi-Fi*. Your CD player and PC are no longer bound by wires.

* *Wi-Fi is used to describe wireless LAN enabled products that are based on the IEEE 802.11 standards. The presence of the Wi-Fi logo indicates that a product has been certified for interoperability.*

2.1 What's in the box



WAC7500 Wireless Music Center, 1x



WAS7500 Wireless Music Station, 1x

Supplied accessories

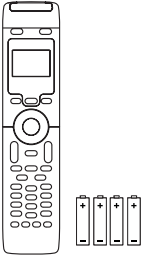

Remote control, 2-way, incl. 4x AAA batteries

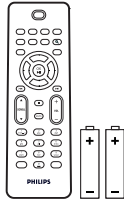

Remote control, 1-way, incl. 2x AAA batteries

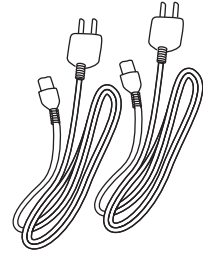

Power cable, 2x

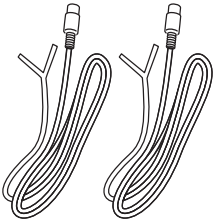

FM wire antenna, 2x



Ethernet cable, 1x



PC Suite CD, 1x

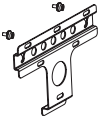



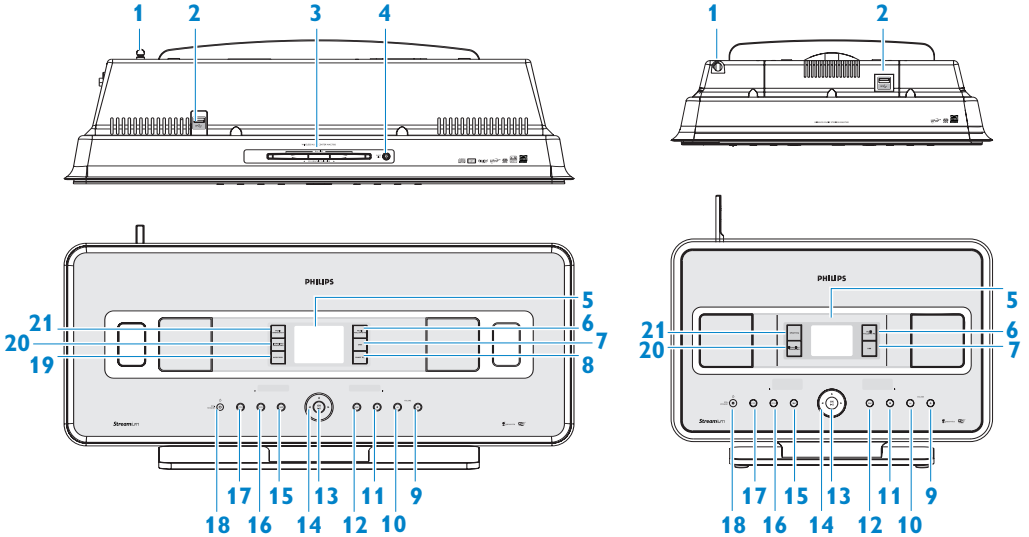

Mounting kit, 1x (for Station)

2.2 Overview Wireless Music Center & Station



2.2.1 Controls on Center **C** and Station **S**

- 1 Antenna**
- 2**  USB jack
- 3 Disc slot (loader) (only **C**)**
Insert discs with graphics facing you
- 4**  (only **C**)
Ejects a disk from the CD slot
- 5 LCD**
Display shows the status of the set
- 6 MUSIC FOLLOWS ME**
HD: moves music playback between Center and Station
- 7 DBB (Dynamic Bass Boost)**
Toggles the bass enhancement between on (DBB1, DBB2, DBB3) and off
- 8 SMART EQ (only **C**)**
HD: toggles between sound settings for the current Genre on or off
- 9 VOLUME +**
Adjusts the volume level up
- 10 VOLUME -**
Adjusts the volume level down
- 11**  Stops playback or recording
- 12**  Press to skip to next track / press & hold to fast forward
- 13 OK / **
Confirms selection
Starts or pauses playback

14 

Navigation controls (left, right up, down) allow you to scroll through the option lists



HD/CD/USB/UPnP: returns to previous option lists



HD/CD/USB/UPnP: skips/searches tracks/passage back/forward (in playback screen)

Fast scroll through options/alphanumeric lists

Radio: tunes to stations



Confirms selection

Radio: enters the list of present stations

15 

Press to skip to previous track / press & hold to rewind

16 MENU

Enters or exits setup menu

17 HOME

Selects

HD Music 

CD 

Radio 

UPnP (Universal Plug & Play) 

Portable (USB Universal Serial Bus)  or,

AUX (separately connected device) 

18  **ON / STANDBY / ECO STANDBY**

Press briefly to toggle between modes Standby and ON.

Press & hold to toggle power modes between ON and Eco Standby (power-saving mode).

Green indicator light = the set is switched ON.

Red indicator light = the set is switched to Standby or Eco Standby.

19  **RECORD** (only )

CD/Radio/AUX: starts to record to the HARD DISK (HD)

20 INCR.SURR.

Selects Incredible Surround sound effect

21 MUSIC BROADCAST (only )

HD: broadcasts music from Center to Station

SMART EQ (only )

HD: toggles between sound settings for the current Genre on or off

**Note**

The illumination of one corner of the casing is a design element.

2.3 Overview remote controls

Important!

The following features require the use of the 1-way remote control:

- Internet radio registration
- Network configuration
- Editing track information

2.3.1 2-way remote control

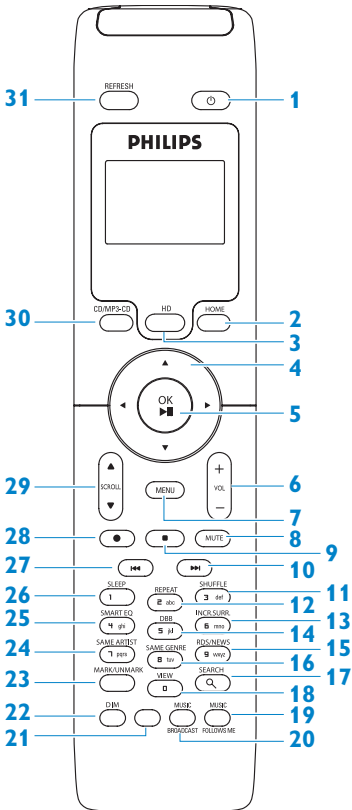





- 1** Press briefly to switch the set to ON or Standby
Press & hold to switch the set to Eco Standby (power-saving mode)

- 2** **HOME**
Selects
HD Music

CD ,
Radio ,
UPnP (Universal Plug & Play) ,
Portable (USB Universal Serial Bus) , or
AUX (separately connected device)

In Standby mode: switches the set **ON** and selects
HD Music ,
CD ,
Radio ,
UPnP ,
Portable , or
AUX

- 3** **HD**
Selects HD (Hard Disk) source
In Standby mode: switches the set ON and selects HD (Hard Disk) source
- 4** Navigation controls (left, right, up, down) allow you to scroll through the option lists
 HD/CD/USB/UPnP: returns to previous option lists
Text input: moves the cursor backwards
 HD/CD/USB/UPnP: skips/searches tracks/passage back/forward (in playback screen)
Scrolls fast through options list
Radio: tunes to stations
 Confirms selection
Radio: enters the list of preset stations
Text entry: confirms input and moves the cursor forward

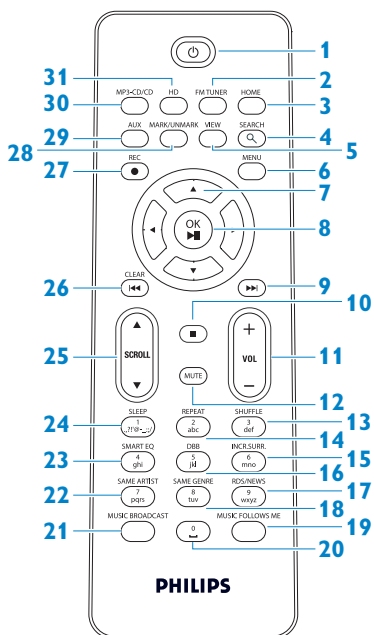

- 5 OK, ►/II**
Confirms selection starts playing
- 6 VOL +, -**
Adjusts the volume level up or down
- 7 MENU**
Enters or exits the setup menu
- 8 MUTE**
Deactivates the sound temporarily
- 9 ■**
Stops playback or recording
- 10 ►►**
Press to skip to previous track / press & hold to fast forward
- 11 SHUFFLE (3 def)**
Selects random playback
- 12 REPEAT (2 abc)**
Selects continuous playback
- 13 INCR.SURR. (6 mno)**
Selects Incredible Surround sound effect
- 14 DBB (Dynamic Bass Boost) (5 jkl)**
Toggles the bass enhancement between on (DBB1, DBB2, DBB3) and off
- 15 RDS/NEWS (9 wxyz)**
Radio: selects RDS information
HD/CD/UPnP/AUX/USB: toggles between NEWS function on and off
- 16 SAME GENRE (8 tuv)**
HD: plays all the tracks of the current Genre
- 17 SEARCH (Q)**
Searches by leading keywords
- 18 MARK/UNMARK (0 _) (only )**
Selects or deselects tracks you want to record (press & hold to select/deselect ALL tracks)
- 19 MUSIC FOLLOWS ME**
HD: moves music playback between Center and Station
- 20 MUSIC BROADCAST (only )**
HD: broadcasts music from Center to Station
- 21 Spare**
- 22 DIM**
Toggles display brightness between dim and normal
- 23 VIEW**
Toggles between playback screen and previous options list
- 24 SAME ARTIST (7 pqrs)**
HD: plays all the tracks of the current artist
HD: enables wireless range extender (refer to extender's manual for details)
- 25 SMART EQ (4 ghi)**
HD: toggles between sound settings for the current Genre on or off
- 26 SLEEP (1 .,!'@-_:;/)**
Adjusts, displays or switches off the sleep timer
- 27 ◀◀**
Press to skip to previous track / press & hold to rewind
- CLEAR**
Text entry: deletes the input before the cursor
- 28 REC ● (only )**
CD/Radio/AUX: starts to record to the HD
- 29 SCROLL ▲, ▼**
Scrolls the display screen up or down
- 30 CD/MP3-CD (only )**
Selects CD source
In Standby mode: switches the set ON and selects CD source
- 31 REFRESH**
Synchronizes the displays of the set and the remote control

2.3.2 1-way remote control



























- 1 Press briefly to switch the set to ON or Standby
Press & hold to switch the set to Eco Standby (power-saving mode)
- 2 **FM TUNER**
Selects FM radio
- 3 **HOME**
Selects
HD Music ,
CD ,
Radio ,
UPnP (Universal Plug & Play) ,
Portable (USB Universal Serial Bus) , or
AUX (separately connected device)
In Standby mode: switches the set **ON** and selects **HD Music** ,
CD ,
Radio ,
UPnP ,
Portable , or
AUX

- 4 **SEARCH** (Q)
Searches by keywords
- 5 **VIEW**
Toggles between playback screen and previous options list
- 6 **MENU**
Enters or exits the setup menu
- 7 / / /
Navigation controls (left, right, up, down) allow you to scroll through the option lists
- HD/CD/USB/UPnP:** returns to previous option lists
Text input: moves the cursor backwards
- /
HD/CD/USB/UPnP: skips/searches tracks/passage back/forward (in playback screen)
Scrolls fast through options list
Radio: tunes to stations
- Confirms selection
Radio: enters the list of preset stations
Text entry: confirms input and moves the cursor forward
- 8 **OK, ►/||**
Confirms selection
Starts playing
- 9
Fast forwards or skips to next track
- 10
Stops playback or recording
- 11 **VOL +, -**
Adjusts the volume level up or down

- 12 MUTE**
Deactivates the sound temporarily
- 13 SHUFFLE (3 def)**
Selects random playback
- 14 REPEAT (2 abc)**
Selects continuous playback
- 15 INCR.SURR. (6 mno)**
Selects Incredible Surround sound effect
- 16 DBB (Dynamic Bass Boost) (5 jkl)**
Toggles the bass enhancement between on (DBB1, DBB2, DBB3) and off
- 17 RDS/NEWS (9 wxyz)**
Radio: selects RDS information
HD/CD/UPnP/AUX/USB: toggles between NEWS function on and off
- 18 SAME GENRE (8 tuv)**
HD: plays all the tracks of the current Genre
- 19 MUSIC FOLLOWS ME**
HD: moves music playback between Center and Station
- 20 (0 _)**
- 21 MUSIC BROADCAST (only )**
HD: broadcasts music from Center to Station
- 22 SAME ARTIST (7 pqrs)**
HD: plays all the tracks of the current artist
HD: enables wireless range extender (refer to extender's manual for details)
- 23 SMART EQ (4 ghi)**
HD: toggles between sound settings for the current Genre on or off
- 24 SLEEP (1 .,?!@-_:;/)**
Adjusts, displays or switches off the sleep timer
- 25 SCROLL ▲, ▼**
Scrolls the display screen up or down
- 26 ⏮**
Rewinds or skips to previous track
- CLEAR**
Text entry: deletes the input before the cursor
- 27 REC ● (only )**
CD/Radio/AUX: starts to record to the HD
- 28 MARK/UNMARK (0 V) (only )**
Selects or deselects tracks you want to record (press & hold to select/deselect ALL tracks).
- 29 AUX**
Selects AUX (separately connected device)
- 30 CD/MP3-CD (only )**
Selects CD source
In Standby mode: switches the set ON and selects CD source
- 31 HD**
Selects HD (Hard Disk) source
In Standby mode: switches the set ON and selects HD (Hard Disk) source

2.4 Overview display

Icons of the LCD:

Icon	Description	Icon	Description
	Client connected		Repeat all
	Client not connected		Repeat 1
	Music		Shuffle
	Radio		Alarm
	UPnP		Music broadcast
	Aux mode		Music follows me
	CD mode		Mute
	HD mode		RDS
	Radio mode		Sleep
	Record (rip) mode		Smart EQ
	Transfer mode		Wi-Fi connected
	USB mode		Wi-Fi and Ethernet connected

3 Installation

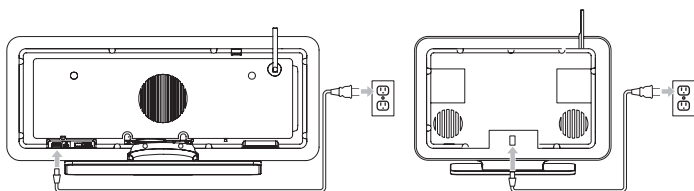

3.1 Install Center (C) and Station (S)

Note

Before you decide where and how to install the set, test the Wi-Fi connection and rear cable connections to find a suitable location.

You can install **S** in two ways, free standing (using the supplied stands) or wall mounted (without the stands). Use the **C** free standing. For the **S** we have enclosed a wall mounting kit.



(free standing)



(wall mounted)

To learn more about wall mounting, see **18 Appendix** on How to mount Station to a wall.

3.2 Connect AC power

Important! Always press & hold  to switch the set to power-saving mode before removing its power plug.

Ensure that all rear connections are established before you power up the set.

Connect the AC power cord to the mains outlet. The set is now powered up (switched on).





When in Standby or Eco Standby mode,  and  still consume some power.

To disconnect the system from the power supply completely, remove the power plug from the mains outlet.

For users in the U.K., please follow the instructions on page iii.





3.3 Set up Wi-Fi connection between Center () and Station ()

Note



- Always press & hold  to switch the set to Eco standby (power-saving mode) before removing its power plug.
- Always power up the  first, and then power up the .
- Never block  from  by thick walls or more than one wall.
- Avoid installation near large metal objects.

The Wi-Fi connection starts automatically when you power up both  and .

The first time you set up a Wi-Fi connection place  and  side by side on a level and sturdy surface.



- 1 Using the supplied power cables, connect first  and then  to the power supply.
>  and  are ready for use.

Tip

For better Wi-Fi reception, rotate the Wi-Fi antenna or adjust the location of  and .

3.4 Rear connections

Note

- Never connect or disconnect power cables when the mains supply is switched on.
- Install  and  within easy reach of suitable AC power outlets.

3.4.1 Connect antennas

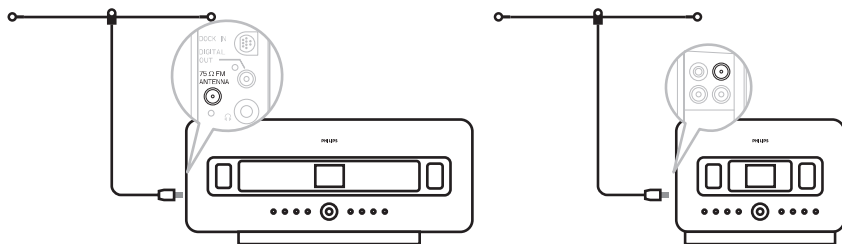

- 1 Extend wire antenna.
- 2 Connect wire antenna to **FM antenna** jack:
- 3 Optional: To improve FM reception you can install an extension line (sold separately) between the wire antenna and the antenna jack.
- 4 Unwind the antenna extension line completely.
- 5 Move it in different directions to find the optimal reception (if possible, keep it away from the TV, VCR or other radiation sources).
- 6 For best results elevate or ceiling-mount the antenna.

3.4.2 Connect a portable (USB) device

On **C** or **S**, you can play back music from a portable device.

You can also transfer music from the library on **C** to the portable device.

- 1 Insert the USB plug of the portable device into the socket  on **C** or **S**.

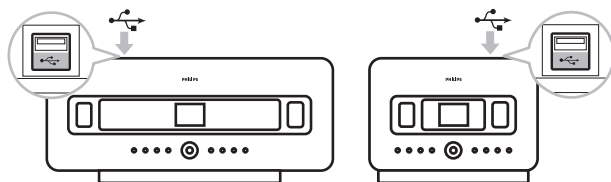

For portable devices with USB cable:

- 1 Insert one end of the USB cable (not supplied) into the socket  on **C** or **S**.
- 2 Insert the other end of the USB cable into the USB output terminal of the portable device.

To play back music from the portable device:

- 1 Press **HOME**.
- 2 Select **PORTABLE** .
- 3 Select **USB**.
> *Your portable device is displayed.*
- 4 Use **▲** or **▼** and **▶** to select your music.

For more details and instructions on how to record music to the portable device: See **10 External sources**.

Tip

- **C** and **S** only support portable (USB) devices that adhere to the following standards:
 - USB MSC (Type '0')
 - USB MTP
 - File system in FAT12 / FAT16 / FAT32
 - Operations based on simple folder type navigation (also known as a normal FAT file system), and not based on proprietary track database.
- The following USB devices will not be supported by **C** or **S**:
Products with database UI (Artists, Albums and Genre based navigation) as these products normally store music files in a specific hidden folder and use embedded proprietary track database that **C** and **S** are unable to read properly.

3.4.3 Connect your iPod (optional)

You can connect your iPod (not supplied) to **C** or **S** using Philips docking cradle and data/audio cable (Philips docking cradle for iPod, model DC1050 sold separately). Now you can enjoy the music library in your iPod via the sophisticated speaker system of the set. You can even charge your iPod at the same time.

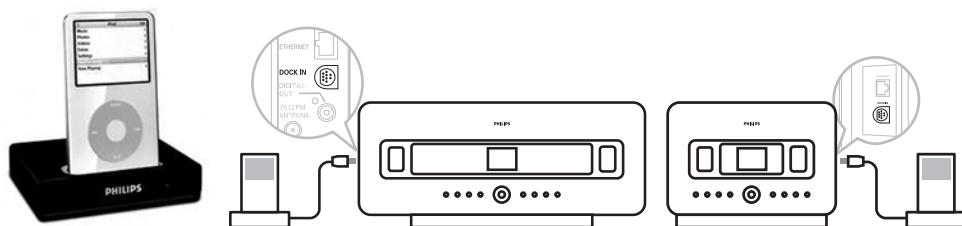

To play back music from your iPod:

- 1 Press **HOME** and select **Portable (iPod)** .
Your iPod is displayed.

- Use ▲ or ▼ and ► on the remote control (or use the navigation control of your iPod) to select the music in your iPod menu system.
(See also **10 External sources**).

3.4.4 Connect additional appliances

It is possible to play audio output from an external source, e.g. TV, VCR, Laser Disc player, DVD player on **C** or **S**. You can also record the audio output to the music library in the HD of **C**.

On the additional appliance

Connect one end of the audio cable (not supplied) to the AUDIO OUT terminals on the additional appliance.

On **C** or **S**

Connect the other end of the audio cables to the **AUX IN** terminals on **C** or **S**.

To play back audio output from the additional appliance:

- On **C** or **S**, press **HOME** and select **AUX** **E**.
Your additional appliance (external source) is displayed.
- On your additional appliance, use the controls as you normally would.
(See also **10 External sources**).

To record audio output to the library (HD) of **C**, see section **HD: Building music library on Center**.

✳ Tip

- If the connected device has only one single audio out terminal, connect it to the AUX IN left terminal. (Alternatively, you can use a 'single to double' cinch cable, but the sound output is still mono).
- Always refer to the user manual of your other equipment for complete connection.

3.4.5 Connect an additional device with external speakers

To enjoy the good sound quality of the product's speakers with an additional device, e.g. a mini Hi-Fi system, use red/white audio cables (not supplied) to connect **C** to the external device.

On **C**

- Connect the red plug of the red/white audio cable (not supplied) to the red socket **LINE OUT R** and the white plug to the white socket **LINE OUT L**.

On the additional device

- Connect the other end of the audio cable to the AUX IN terminals.
- Select **AUX** mode on the connected additional device.

4 Prepare

4.1 Set the clock

The time can be displayed in 24-hour or 12-hour format. You can set up your clock on **C** or **S**. There are two methods to set the clock, RDS automatic time synchronization and manual time set-up.

RDS auto time sync:

If you have preset RDS radio stations, you can synchronize the clock with one of the RDS stations.

- 1 Press **MENU** to enter the menu screen.

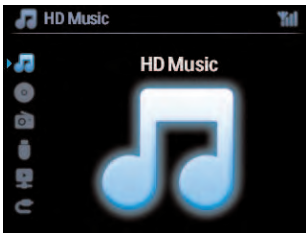

- 2 Use **▲** or **▼** and **▶** to select **Settings** followed by **Time**.

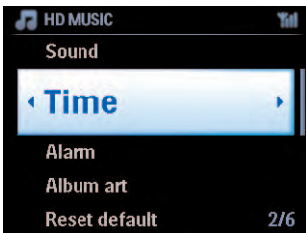

- 3 Use **▲** or **▼** and **▶** to select **Auto Time Sync**.

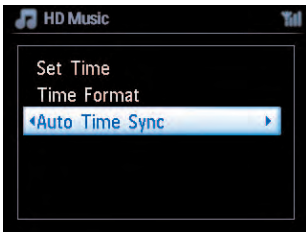

- 4 Use ▲ or ▼ and ► to select the RDS radio station you wish to synchronize the clock with.
 > The screen shows a confirmation screen:

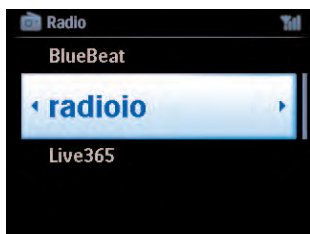

Manual time set:

- 1 Press **MENU** to enter the menu screen.

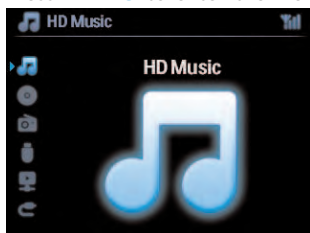

- 2 Use ▲ or ▼ and ► to select **Settings** followed by **Time**.

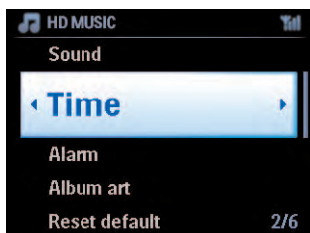

- 3 Use ▲, ▼, or the numeric keypad (0-9), and ► to select **Set Time**.
 > The display shows current clock setting (00:00 by default)

- 4 Use ▲, ▼, or the numeric keypad (0-9) repeatedly to set the hours followed by the minutes.

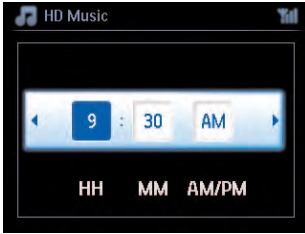

- 5 Confirm with **OK**.

*** Tip**

- Change to 12-hour or 24-hour format:
 - 1 In the Time menu, select **Time Format**.
 - 2 Use ▲ or ▼ and ► to select your option.
- If you disconnect the power supply (pull the mains plug), the clock will be reset (settings will not be saved).

4.1.1 View the clock

- 1 Press & hold **VIEW** button for about 5 seconds.
The clock will appear briefly in the display.

*** Tip**

- In Standby mode, you can briefly press **VIEW** to turn on the LCD backlights and view clock more clearly.
- If you disconnect the power supply (pull the mains plug), the clock will be reset (settings will not be saved).

4.2 Remote control

The set is supplied with a 2-way remote control and a 1-way remote control. You can use these to control functions on **C** or **S**.

Note

Use the 1-way remote control for Station management, Network configuration, and to Edit track information. The 2-way remote control cannot be used for these tasks.

Important!

- Always point the remote control directly towards the IR sensor on **C** or **S** you wish to operate.
- First, select the source you wish to control by pressing one of the source select keys on the remote control (for example CD/MP3-CD, HD, FM TUNER, AUX).
- Then select the desired function (for example ▶/|| / ◀◀ / ▶▶).

4.2.1 Remote control battery installation

Caution!

To avoid the risk of explosion:

- Do not puncture, cut, or manipulate batteries in any way and do not throw them into the fire.
- Do not short-circuit the battery terminals.

To avoid burn injuries:

- Wear protective gloves when you handle leaking batteries.

To avoid leakage of corrosive battery fluid and damage to the product:

- Always replace all batteries at the same time
- Do not mix old and new batteries or batteries of different types.
- Replace batteries immediately if they are exhausted.
- Always remove the batteries, if the remote control will not be used for a longer period of time.

To avoid batteries being accidentally swallowed:

- Always keep them out of reach of children and pets. (Consult a physician immediately, if a battery has been swallowed!)

Installing batteries:

Open battery compartment.

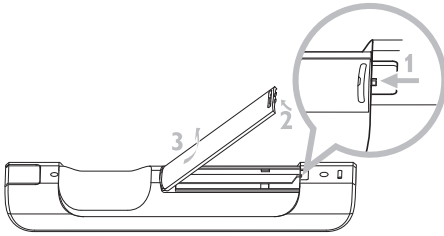

Install into

- 2-way remote control: 4 batteries type LR03 or AAA.
- 1-way remote control: 2 batteries type LR03 or AAA.

Observe correct polarity (refer to '+' / '-' symbols inside the battery compartment).

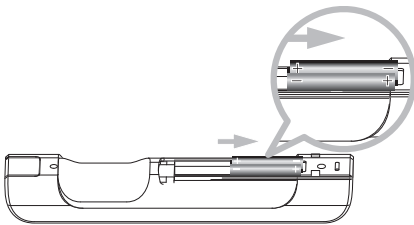

Close battery compartment.

IMPORTANT BATTERY INFORMATION!

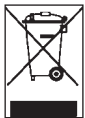

Batteries containing hazardous substances are marked with the crossed-out wheeled bin. The symbol indicates that it is prohibited to dispose of the product with the domestic refuse. The chemical symbols for the respective hazardous substances are Cd = Cadmium, Hg = Mercury, Pb = Lead.

You - as the user - are legally obliged to dispose of all batteries in accordance with your local regulations or to return them to the shop where you purchased the batteries.

Thus, you fulfill your legal obligations and contribute to environmental protection!

4.2.2 Remote control, 2-way

You can choose to use the 2-way remote control to operate either **C** or **S**. Depending on the level of interference, you can also select your preferred operational mode: Enhanced Mode or Normal Mode.

Important! To save battery power, if no buttons are pressed for approx. 15 seconds, the 2-way remote control enters idle mode. Press any button to reengage the control.

Center (default): to operate **C**

Station: to operate **S**

Enhanced Mode (default): This mode offers a better range (distance and angle). Use this mode if there is no interference from a plasma TV nearby.

Normal Mode: Choose this mode if there is interference from a plasma TV nearby that is distorting the display of the 2-way remote control.

- 1 Press & hold **REFRESH** until the Select Device screen appears in the display of the 2-way remote control.

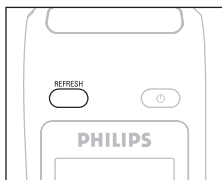

- 2 Use **▲** or **▼** to highlight and **▶** to select **Center** or **Station**.
- 3 Use **▲** or **▼** to highlight and **▶** to select **Normal Mode** or **Enhanced Mode**.
- 4 Confirm with **OK**.

Tip

- Avoid placing **C** or **S** near a plasma TV. The interference may distort the display on your 2-way remote control.
- The status of **C** or **S** is synchronized into the display of the 2-way remote control, so it is easier to operate the remote control.
- To synchronize the remote control display after activating the **⏻** button on the set, press **REFRESH** on the remote control of Center.

4.3 Navigation controls

- 1 Use the navigation controls ◀ / ▶ / ▲ / ▼ when navigating through options.
- 2 Highlight options with ▲ / ▼.
- 3 Enter submenus with ▶.
- 4 Confirm selections with **OK** or ▶.



4.4 Alphanumeric keys

- 1 Use the alphanumeric keys to enter letters or numbers.
- 2 When the text box appears, press the alphanumeric keys repeatedly until the desired letter/number appears.

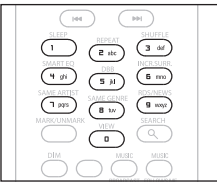

- 3 Use ◀ / ▶ to move the cursor back / forward.
- 4 Press ⏪ to delete the entry before the cursor.
- 5 Press **OK** to close the text box and move to the next option list.



Note

You will enter the previous / next option list if the cursor reaches the beginning or the end of the text box.

5 Basic functions

5.1 Power modes and functions

When you plug the product into your mains supply, it powers up and is in power mode **ON**. The  button allows you to change the power mode. A colored light in the button indicates the current power mode:

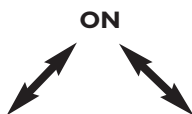

Center () / Station ():

Status	Button indicator light
ON	green
Standby	red
Eco Standby (power-saving mode)	red



Status	STANDBY	ECO STANDBY
Characteristics	fast boot	slow boot
Display	dimmed	off
Remote control	on standby	off
Streaming	on standby	off

- 1 When the set is ON (green button light), press :



 /  switches to Standby mode.

The button light changes from green to red.

: The screen dims.

The display shows connected (or last connected) 

: The screen dims.

The display shows the connected  (or screen will remain blank if no is found )

During Standby the display shows the time (or display shows —:— if you have not set the clock).

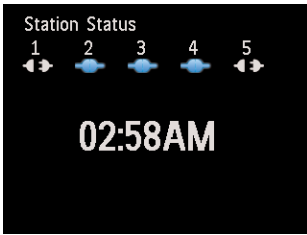

To switch the **C** / **S** back ON again,

- a press .
C / **S** switches ON and remembers the last source selected:
The button light changes from red to green.

OR

- b press one of the source buttons on the remote control, **CD/MP3-CD** (only **C**), **HD**, **FM TUNER**, **AUX**, or **HOME**.
- 2 To select functions, press **HOME** once or more times (**CD/MP3-CD** (only **C**), **HD**, or **HOME** on remote control).

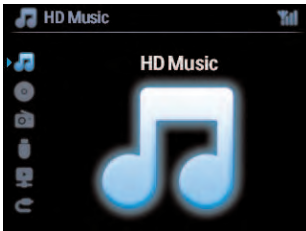

*** Tip**

- CD/MP3-CD source is only available on **C**.
- FM TUNER and AUX source buttons are only available on the 1-way remote control.

5.2 Eco Standby (power-saving mode)

In the power-saving mode Eco Standby, the display and Wi-Fi connections of the product are turned off. The HD (Hard Disk) of **[C]** also becomes inactive. When **[C]** is switched to Eco Standby, you cannot stream music between **[C]** and **[S]** or import music from the PC to **[C]**. During Eco Standby the remote controls are inactive.

- 1 With the set switched ON, press & hold **[P]**:
[C] / **[S]** changes to Eco Standby.
 The button lights up red.
 The display is switched off.
- 2 To switch the **[C]** / **[S]** ON, press **[P]** on the set. (The remote controls are still inactive.)
[C] / **[S]** switches to the last source selected.

✳ Tip

- In the power-saving mode Eco Standby, the settings for networking, sound, display, language and CD recording, as well as the tuner presets, and the volume level (maximum: moderate level) will be retained in the memory of the set.
- To protect the HD, always switch **[C]** to Eco Standby before removing its power plug from the mains outlet.
- Remember that the remote controls are inactive during Eco Standby.

5.3 Auto-Standby

If at the end of playback / recording (ripping) the set remains in the stop mode for longer than 20 minutes, the set will automatically switch to Standby mode in order to save power.

5.4 Volume control

- 1 Check that playback has started.
- 2 Adjust the volume with **VOL +/-** buttons.
 > Display shows a horizontal bar indicating the volume level.

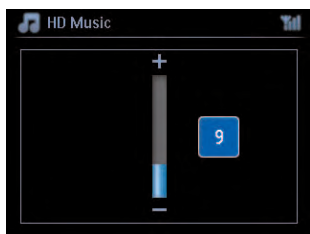

5.5 MUTE

During playback, you can deactivate the sound without switching off the set.

1 To deactivate the sound, press **MUTE**.

>  appears.

Playback continues without sound.

2 To reactivate the sound, press **MUTE** again or adjust the volume with **VOL +**.

> The icon  disappears.

5.6 Sound control

5.6.1 Smart equalizer

This function enables you to play music of the current genre with the matching sound settings.

1 During playback, press **SMART EQUALIZER**

>  appears if Smart Equalizer is activated.

2 To deactivate the Smart Equalizer, press **SMART EQUALIZER**

>  disappears.

5.6.2 Equalizer

Equalizer enables you to select predefined sound settings.

Set Equalizer:

1 Press **MENU** to enter the menu screen.

2 Use **▲** or **▼** and **▶** to select **Equalizer**.

3 Use **▲** or **▼** and **▶** to select **Rock, Pop** (default), **Jazz, Neutral, Techno, Classical, Treble/Bass**.

4 Confirm with **OK**.

Set Treble or Bass:

1 Press **MENU** to enter the menu screen.

2 Use **▲** or **▼** and **▶** to select **Settings**, followed by **Treble** or **Bass**.

3 Navigate **◀ / ▶ / ▲ / ▼** to highlight your option:
Treble (+3 to -3), Bass (+3 to -3)

5.6.3 DBB (Dynamic Bass Boost)

Press **DBB** (Dynamic Bass Boost) once or more times to change the bass settings. Select your option: **DBB OFF** (default), **DBB 1**, **DBB 2**, or **DBB 3**.

Tip

Some discs might be recorded in high modulation, which causes a distortion at high volume. If this occurs, switch off DBB or reduce the volume.

5.6.4 Incredible surround

Press **INCR. SURROUND** (**INCR. SURR.** on the 1-way remote control) once or more times to toggle the surround sound effect **On** and **Off**.

Display shows: **IS ON** or **IS OFF**.

5.7 Display adjustment

With the controls on **C** or **S** (or on the 1-way remote control) you can adjust the backlight and contrast settings of the display.

- 1 Press **MENU** to enter the menu screen
- 2 Use **▲** or **▼** and **▶** to select **Settings**, followed by **Display**.
- 3 Press **▲** / **▼** and **▶** to select **Backlight** or **Contrast**:

Backlight

- 1 Press **▲** or **▼** and **▶** to select **On** or **Off**.

Contrast:

- 1 Press **▲** or **▼** to increase or reduce the contrast.

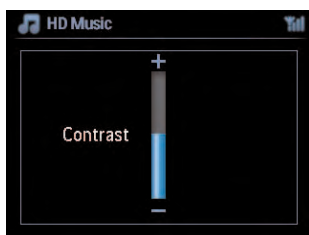

Note

You can also toggle the Backlight On and Off by pressing DIM on the 1-way remote control.

5.8 Selecting languages

- 1 Press **MENU** to enter the menu screen.
- 2 Use ▲ or ▼ and ► to select **Settings**, followed by **Language**.
- 3 Use ▲ or ▼ and ► to choose **English, Français, Español, Nederlands, Italiano** or **Deutsch**.

5.9 Sleep

You can preset a certain period of time after which  or  will switch to Standby mode.

- 1 On the remote control, press **SLEEP** repeatedly to select the desired time period (in minutes):
 - > *Display shows in sequence: Sleep **15, 30, 45, 60, 90, 120, OFF**.*
- 2 Select the desired time period.
 - > *Display shows the selected option briefly and returns to its previous status.  appears when a time is selected.*
- 3 To view the countdown time to Standby mode, briefly press **SLEEP** again.

When the selected sleep time expires,  or  automatically switches to Standby mode.

- 4 To deactivate the sleep timer before the sleep time expires, press **SLEEP** repeatedly until **SLEEP OFF** is selected.
 - > *The icon  disappears.*

5.10 Alarm

Important! The clock must be set correctly before the alarm is set.

5.10.1 Set alarm / alarm time / repeat mode

- 1 Press **MENU** to enter the menu screen.
- 2 Use ▲ or ▼ and ▶ to select **Settings**.
- 3 Use ▲ or ▼ and ▶ to select **Alarm**, followed by **Alarm On** or **Off**.
> *The Alarm Time screen appears.*
- 4 In the Alarm Time screen, use ▲ or ▼ and ▶ to enter the hours and minutes.
- 5 Confirm the alarm time with **OK** or ▶.
- 6 Use ▲ or ▼ and ▶ to select repeat mode **Once** or **Daily**.
> *The screen briefly shows **Alarm On** and  appears in the display.*

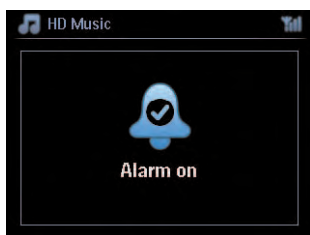

6 HD (Hard Disk)

6.1 Play HD Music

Music is centrally stored in the 80GB HD (Hard Disk) on the **C**. All the stored music can be streamed and played on **S** via Wi-Fi.

- 1 Check that **C** or **S** is switched ON or in Standby mode (see **5 Basic functions**).
- 2 Press **HOME** and select **HD Music** (or press **HD** on remote control).
> *Display shows **HD Music** and the categories of your music library: **Playlists, Artists, Albums, Genres, All tracks**.*

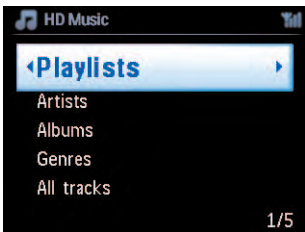

Playlists: customizable collection of your favorite tracks sorted by playlist name in alphanumeric order.

Artists: collection of albums sorted by artist name in alphanumeric order.

Albums: collection of albums sorted by album name in alphanumeric order.

Genres: collection of albums sorted by music style (only if album information available).

All tracks: All tracks sorted by track name in alphabetical order.

- 3 Use **▲** or **▼** and **▶** to select your option.

6.2 Search

6.2.1 Search by keywords

The keyword should be the first letter or word in the title of the track you wish to search for: By entering a keyword, you can quickly find all the items beginning with the keyword you entered (note that this feature is case sensitive).

- 1 Navigate **◀** / **▶** / **▲** / **▼** to enter desired option list of tracks, albums or playlists.
- 2 On remote control, press **SEARCH**
> *Display: text box appears*



- 3 Use alphanumeric keys to enter keyword (maximum 8 characters) (see **4.4 Prepare: Alphanumeric keys**)
- 4 Press **OK** to start searching
 - > Display: **Searching...**
*Searching starts from the beginning of current option list.
 The matched items appear at the top of the list.
 The option list automatically shows the closest match in the alphabet if no match is found.
 Display: **Searching...** disappears.*
- 5 Press **STOP**  to stop searching.

Tip

Searching will also stop when:

- you select another source
- you switch off the set

6.2.2 Select track of same artist

- 1 During playback, press **SAME ARTIST**
 - > Playback of found tracks by the current artist continues after current track.

6.2.3 Select track of same genre

- 1 During playback, press **SAME GENRE**
 - > Playback of found tracks of same genre as current track continues after current track.

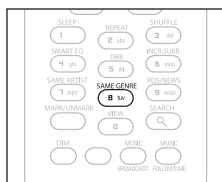

Tip

Not all tracks have an automatic genre tag, so you may have to manually assign a genre for your tracks when loading them to the HD of .

6.2.4 Find track in current album (during playback)

In playback screen, navigate with ▲ / ▼ to select track in current album during playback.

6.2.5 Find passage in current track (during playback)

- 1 In playback screen, press & hold ▲ / ▼ or ⏮ / ⏭
> *Track gets scanned at high speed.*
- 2 When you found the passage you want, release ▲ / ▼ or ⏮ / ⏭
> *Normal play resumes.*

6.3 Play modes REPEAT, SHUFFLE



plays the current track continuously



repeats all the tracks (under current selection of playlist, artist, genre, album, or All tracks)





repeats all the tracks (under current selection of playlist, artist, genre, album, or All tracks) in random order



plays tracks (under current selection of playlist, artist, genre, album, or All tracks) in random order

- 1 During playback press **REPEAT** or / and **SHUFFLE** once or more times to select desired play mode. The play mode icons appear in the display.
- 2 To return to normal playback, press **REPEAT** or / and **SHUFFLE** repeatedly until the various mode icons disappear from the display.

Note

If  is active, it will be deactivated when pressing **SHUFFLE**. To activate  /  press first **SHUFFLE**, then **REPEAT 1**.

6.4 Build music library on Center (LC)

Important!

- Recording is permitted only if there is no infringement of copyrights or any other rights of third parties.
- For CDs encoded with copyright protection technologies used by some record companies, recording will be restricted.
- The making of unauthorized duplicates of copy-protected material, including computer programs, files, broadcasts and sound recordings, may be an infringement of copyrights and constitute a criminal offence. This equipment should not be used for such purposes.



Be responsible
Respect copyrights

You can build a music library in the HD of **LC** by ripping from CDs, importing from PC and recording from external sources.

6.4.1 Rip music from CDs

Important!

Ripped files are first stored in a temporary memory:

Do not switch the Center to standby - wait until Center has fully processed the files and automatically switches to standby. While the Center is processing the files, you can continue to listen to your music.

With the **LC**, you can rip audio CD tracks from your CDs and store them as MP3 files in the HD of **LC**. The Gracenote MusicID® enables your set to look up CD information (including album, artist, genre, track information) from its database. It allows the recorded CD tracks to be properly categorized (for example, under artist, albums, genres or all tracks) and also to be merged with the existing tracks in the HD. To update your Gracenote® Media Database, see the section **12 Connect to your PC** in this manual.

Music recognition technology and related data are provided by Gracenote®. Gracenote is the industry standard in music recognition technology and related content delivery. For more information, please visit www.gracenote.com.

CD and music-related data from Gracenote, Inc., copyright © 2000-2007 Gracenote. Gracenote Software, copyright © 2000-2007 Gracenote. This product and service may practice one or more of the following U.S. Patents: #5,987,525; #6,061,680; #6,154,773; #6,161,132; #6,230,192; #6,230,207; #6,240,459; #6,304,523; #6,330,593; #7,167,857, and other patents issued or pending. Gracenote and CDDB are registered trademarks of Gracenote. The Gracenote logo and logotype, and the 'Powered by Gracenote' logo are trademarks of Gracenote.

Gracenote® is a registered trademark of Gracenote, Inc. The Gracenote logo and logotype, and the 'Powered by Gracenote' logo are trademarks of Gracenote.

Note

When ripping CDs without active internet connection, the album art will not be shown. The local copy of the Gracenote® database does not contain album art.

Rip from a CD at high speed:

(Audio CD, MP3/WMA CD)

- 1 Insert CD with printed side facing you:

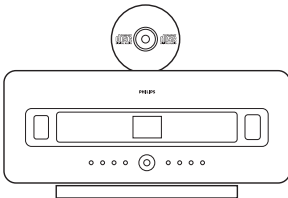

For MP3/WMA CD, press  on a highlighted file folder to enter the track list.



- 2 In the track list screen, press **RECORD ●** (remote control **REC**).
- > *List of tracks with check boxes appears:*

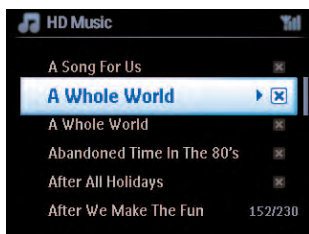

- 3 Press **MARK/UNMARK** to select/deselect tracks (hold **MARK/UNMARK** to select/deselect all tracks).
- 4 Press **RECORD ●** (**REC**) to start ripping.
- > *Display shows **CD-Rip** and the current track name.*

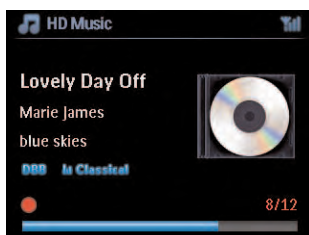

(A default album name, e.g. Album_001 is assigned if the CD track information cannot be found in the Gracenote® database.)

> *Center returns to CD mode when ripping is complete.*

- 5 To rip another CD repeat steps 1 to 4 again.
- 6 To stop ripping, press **STOP ■**.

6.4.2 Import from your PC

The Wireless Audio Device Manager (WADM) in the supplied PC installer helps you organize music files on your PC and import them into **CD**. For details, see the section **12 Connect to your PC** in this manual.

6.4.3 Record from radio or external source

A maximum recording time of 3-hours can be made from the radio or an external source.

1

- a In Radio mode, tune the desired radio station (see **8.1 FM radio: Tuning radio stations**),
or
- b In AUX mode, start playback from the external source.

2 Press **RECORD**

> *The recording starts.*

3 Press **STOP** ■ to stop recording.

The recording will be saved as a file under RADIO or AUX in Albums. A file name is assigned, e.g. Radio_01, or Aux_01.

6.5 Create a playlist

A playlist is a custom collection of your favorite music. You can create up to 99 playlists in the HD of .

1 In **HD Music** mode, press **MENU** to enter the menu screen.

2 Use ▲ or ▼ and ▶ to select **Create Playlist**

> *A new playlist is created (a default album name, e.g. Playlist_001, is assigned).
Display shows: Playlist created. To add tracks, select Add to Playlist.*

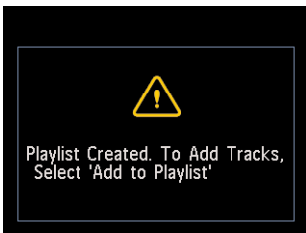

1 Navigate with ◀ / ▶ / ▲ / ▼ to highlight the desired Track or All tracks.

2 Select **Add to Playlist**.

3 Press **MENU** to enter the menu screen.

4 Use ▲ or ▼ and ▶ to display the selection of playlists.











5 Use ▲ or ▼ and ▶ to select the desired playlist.

> *Display shows all added tracks in playlist.*

6 Repeat steps to select and store all desired tracks.

6.6 Delete a playlist, album or track

This feature works only on .

- 1 Navigate with  /  /  /  to enter a category (Playlist, Artists, Albums, Genres, All tracks).
- 2 If necessary, press  or  and  once or more times to highlight the playlist album or track you wish to delete.
- 3 Press **MENU** to enter the menu screen.
- 4 Use  or  and  to select **Delete Playlist**, **Delete Album** or **Delete Track**
- 5 Press  to select **Yes**.

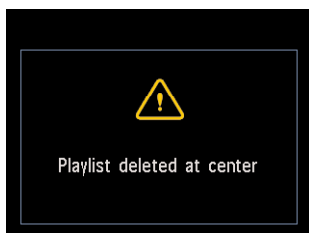

6.7 View track information

Note

The feature View track information is only available in mode HD Music.

- 1 Use the **VIEW** button on the remote control to toggle the display between the HD playback screen and the track list screen.

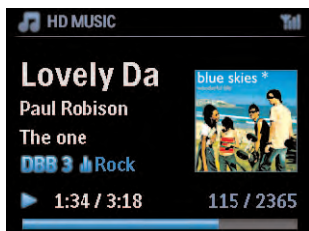

To view more track information:

- 1 In HD playback screen, press ▶ to display the full view album art screen.



- 2 In full view album art screen, press ◀ to return to the HD playback screen

6.8 Backup to PC

The **Wireless Audio Device Manager** (WADM) in the supplied PC Suite CD allows you to backup contents on the HD to your PC. The backup files on your PC can be subsequently restored to **C** if the files on the HD are lost or corrupted. For details, see the section **12 Connect to your PC** in this manual.

6.9 Move music playback between Center (**C**) and Station (**S**)

You can connect up to 5 Stations **S** to Center **C** via Wi-Fi, so your music playback can be moved between Center **C** and Stations **S**. You and your family will be able to enjoy and share music with ease wherever you are in your home.

6.9.1 MUSIC FOLLOWS ME



As you move around at home, let the music move with you between **C** and **S** or between **S** and **C**.

On the source unit (S**) where music is playing:**

- 1 Press **MUSIC FOLLOWS ME** to stop playback from that unit and activate the function.
- > The icon  appears on the displays of Center and Station.

On the destination unit (C** or **S**) where you want to listen:**

- 2 Press **MUSIC FOLLOWS ME** to activate the playback.
- > The icon  disappears from the displays of **C** and **S**, and the music will start to play. Simultaneously, the music (audio output) of the source unit is stopped.

Any selected play modes (e.g.  ) will be retained on the destination unit (see **6.3 Play modes REPEAT, SHUFFLE**).

3 To stop **MUSIC FOLLOWS ME**, press **STOP ■** on the destination unit.

⚙️ Tip

- **MUSIC FOLLOWS ME** will be automatically deactivated if you do not activate **MUSIC FOLLOWS ME** on the destination unit within 5 minutes
- To deactivate **MUSIC FOLLOWS ME**, press **MUSIC FOLLOWS ME** again.
- After activating **MUSIC FOLLOWS ME** on the destination unit you can select other tracks or source for playback.

6.9.2 MUSIC BROADCAST

MUSIC BROADCAST allows you to broadcast music from Center (**C**) to Stations (**S**).

On Stations (**S**)

1 Check that **S** is switched on or in standby mode (see **5 Basic functions**).

On Center (**C**)

2 In HD source, play back the music that you wish to broadcast to Stations (**S**).

3 Press **MUSIC BROADCAST** to activate the function.

> The icon **B** appears on Center (**C**) and Stations (**S**).

A countdown of 5 seconds starts.

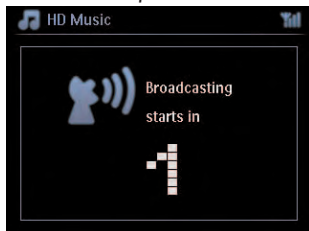

On **C** and **S**:

The selected music starts to play simultaneously after about 5 seconds.

4 To stop **MUSIC BROADCAST**, press **STOP ■** on **C**.

⚙️ Tip

- To exit **MUSIC BROADCAST** on **S**, press **STOP ■** on **S**. To broadcast music to **S** again, press **STOP ■** on **C**, and then start playback again and activate **MUSIC BROADCAST** on **C** again.
- **MUSIC BROADCAST** will also stop when:
 - **C** is switched to Standby mode or Eco Standby mode
 - the selected album or list (Playlist, Artist, Genre,...) has reached the end

6.10 View system information

- 1 Press **MENU** to enter the menu screen.
- 2 Use **▲** or **▼** and **▶** to enter **Information** menu.
The display shows: **System, Wireless** and **Wired**.
 - a Use **▲** or **▼** and **▶** to select **System**.
 - > Name of **C** or **S** and firmware version (on **C** also: free hard disk space) is shown on the display:

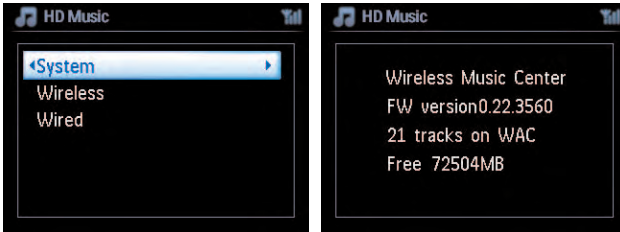

- b Use **▲** or **▼** and **▶** to select **Wireless**.
 - > List of available information items (e.g. SSID, Wireless Mode, WEP Key, MAC Address, Subnet mask, IP Address, and IP Mode) is shown on the display:

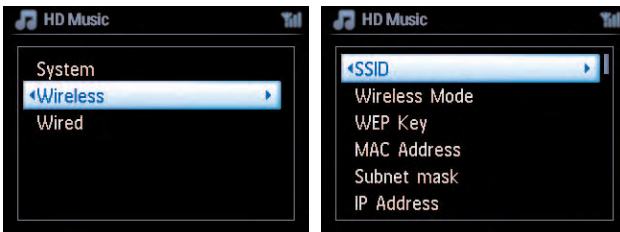

- c Use **▲** or **▼** and **▶** to select **Wired**.
 - > List of available information (e.g. Subnet mask, IP Address, and IP mode) are shown on the display:

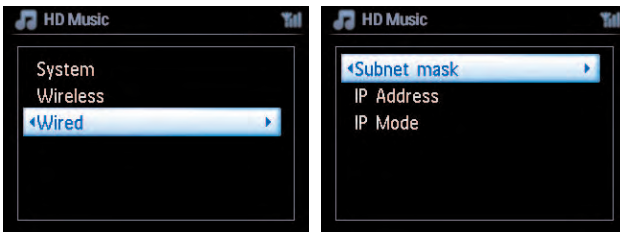

6.11 Edit track information

Note

Use the 1-way remote control to **Edit track information**. The 2-way remote control cannot be used for this task.

You can edit track title, album name, etc. on **CD**:

- 1 Press **HOME** to select **HD**.
- 2 Use **▲** or **▼** and **▶** to select the track to be edited.
- 3 Press **MENU**.
> 'Edit' is shown on the LCD display
- 4 Use **▲** or **▼** and **▶** to select **Edit**.
> Now you can start editing track information by following the sequence:

Edit track title > Edit Artist name > Edit Album name > Edit Genre name

- 5 Press the following keys on remote control to edit track information:

Alphanumeric keys	Insert text into the current position.
◀	Move highlight to previous editing position. In leftmost position: press to move to previous screen.
▶	Move highlight to next editing position.
◀◀	Press briefly to delete highlighted text, Press & hold to delete all text.
OK	Confirms text and enters next screen.

When you completed your editing, the LCD shows 'Updating...' followed by 'Update success' (or 'System busy, please edit later' if the update was not successful).

Tip

- If no key is pressed for 60 seconds, the edit screen will disappear without saving anything.
- You can enter an editing string of max. 21 characters.
- You can also edit album/playlist names. (All tracks in that album/playlist will bear the new album/playlist name.)
- You can also use **▲** or **▼** on **CD** or remote control to enter text:

▲	Press briefly to skip to previous character, Press & hold to fast scroll through the character list
▼	Press briefly to skip to next character, Press & hold to fast scroll through the character list.

7 CD (Center only)

7.1 Supported discs

You can play the following discs on the system:

- Pre-recorded audio CDs (CDDA)
- Finalized audio CD-Rs and CD-RWs (12cm CD / 8cm CD, 185 MB / 200 MB)
- MP3/WMA-CDs (CD-R/CD-RWs with MP3/WMA files)
- AAC-CDs (MPEG4 AAC LC raw format, .m4a/.m4b files)

Important! This system is designed for regular discs. Therefore, do not use any accessories such as disc stabilizer rings or disc treatment sheets, etc.

About MP3/WMA

The music compression technology MP3 (MPEG1 Audio Layer 3) and WMA (Windows Media Audio) significantly reduces the digital data of an audio CD, while maintaining the sound quality.

Windows Media Audio® is a registered trademark of Microsoft Corporation.

Supported formats:

- Disc format ISO9660, Joliet, UDF (created on Adaptec Direct CD v5.0 and Nero Burning ROM UDF v5.5) and multi-session CDs
- MP3 bit rate (data rate): 32-320 Kbps and variable bit rate.
- 8-cm and 12-cm CD-R/CD-RW up to 730MB
- Directory nesting up to a maximum of 8 levels
- Directory nesting up to a maximum of 8 levels
- MP3 VBR, WMA VBR
- AAC (MPEG4 AAC LC raw format, .m4a/.m4b files)

The system does not play or support the following:

- Empty albums that do not contain any MP3/WMA files and hence will not be displayed.
- Unsupported formats are skipped (e.g. files with .doc extension are ignored).
- DRM protected WMA files
- WAV, PCM audio files
- WMA files in lossless format

Tip

- Make sure that MP3 files end on extension .mp3, WMA files end on extension .wma, and AAC files end on extension .m4a or .m4b.
- To burn/convert DRM protected WMA files use Windows Media Player 10 (or later. Visit www.microsoft.com for details about Windows Media Player and WM DRM (Windows Media Digital Rights Management).

7.2 Play discs

- 1 Insert CD into CD loader slot on **C** with printed (label) side facing you.
> *Display shows: Reading CD.*

Audio CD: list of tracks appears (Track information may not appear, if it is not found in the HD database and if there is no Internet connection to update the missing information from the Gracenote® service site.)

MP3/WMA CD: list of albums appears.

Display shows:

Others	MP3/WMA/AAC files that are not sorted into albums (folders) located in the root directory of the disc.
CDDA	CDDA files on an enhanced CD or a mixed mode CD.
All tracks	All supported files in any albums (folders) on the disc.

- 2 Press the navigation controls ▲ or ▼ and ► to select your option.
- 3 Press ►II to start playback
 - On a highlighted album, to start playback of album.
 - On All tracks, to start playback of all tracks on disc.
- 4
 - a To temporarily pause playback, press ►II.
 - b To resume playback, press button again.
- 5 To stop playback, press **STOP ■**.
- 6 To remove disc, press **EJECT** on Center.

7.2.1 Search by keywords

The keyword should be the first letter or word of the album title, artist name, track title, genre name, or playlist name you wish to search for: By entering a keyword, you can quickly find the item that most closely matches to your search criteria. The search cursor will stop at the closest alphabetical match in the list.

⊖ Note

The keyword search is supported in modes HD Music and USB only.

- 1 Navigate ◀ / ▶ / ▲ / ▼ to enter desired option list of albums, artists, tracks, genres or playlists.
- 2 On remote control, press **SEARCH**
Display: text box appears



- 3 Use alphanumeric keys to enter keyword (maximum 8 characters) (see 4.4 Prepare: **Alphanumeric keys**)
- 4 Press **OK** to start searching
> Display: **Searching...**
Searching starts from the beginning of current option list.
The matched items appear at the top of the list.
The option list automatically shows the closest match in the alphabet if no match is found.
Display: **Searching...** disappears.

⊗ Tip

The search will also stop when:

- you select another source
- you switch off the set

7.2.2 Find track in current album (during playback)

In playback screen, press ▲ / ▼ (or ⏮ / ⏭) to select previous or next track in current album during playback.

7.2.3 Find passage in current track (during playback)

- 1 In playback screen, press & hold ▲ / ▼ (or ⏮ / ⏭) to scan currently playing track at high speed.
- 2 When you found the passage you want, release ▲ / ▼ (or ⏮ / ⏭) to resume normal playback.

7.3 Play modes REPEAT, SHUFFLE



plays the current track continuously



repeats all the tracks (under current artist, genre, or album)



repeats all the tracks (under current artist, genre, or album) in random order



plays tracks (under current artist, genre, or album) in random order

- 1 During playback press **REPEAT** or / and **SHUFFLE** once or more times to select play mode.
- 2 To return to normal playback, press **REPEAT** or / and **SHUFFLE** repeatedly until the various modes are no longer displayed.

8 FM radio

8.1 Tune radio stations

- 1 Connect the supplied FM wire antenna to **C** and **S** (see **3 Installation**).
- 2 Ensure that the set is switched on or in Standby mode (see **5 Basic functions**).
- 3 Press **HOME** once or more times to select Radio.
> Playback screen appears.
Display: Radio, radio station frequency and preset number (if programmed).
- 4 Press & hold **▲** or **▼** until frequency in display starts running.

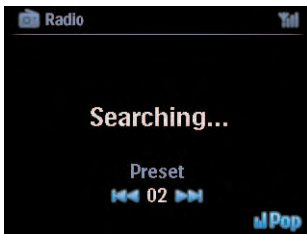

- > The radio automatically tunes to a station of sufficient reception.
*Display during automatic tuning: **Searching...***
*When you are receiving an RDS station, **FM** is shown.*
- 5 Repeat tuning process until you find the desired radio station.
 - 6 To tune to a weak station, press **▲** or **▼** briefly and repeatedly until you have established optimum reception.



8.2 Store preset radio stations

You can store up to 60 radio stations in the preset memory.

8.2.1 Autostore: Automatic preset program

Autostore automatically starts programming radio stations into the preset memory, beginning with Preset 1. Available stations are programmed in the order of their radio frequency, RDS stations are followed by FM stations. A maximum of 10 RDS stations will be stored (Preset 01 to Preset 10).

- 1 Press **MENU** to enter the menu screen.
- 2 Use **▲** or **▼** and **▶** to select autostore radio.
 - > Display: **Autostore, please wait... Press 'Stop' to exit.**

When all stations are stored, the first preset station automatically starts playing.

8.2.2 Manual store: Manual preset program

- 1 In FM radio mode, use **▲** or **▼** to select / tune your desired radio station.
- 2 Press **MENU** to enter the menu screen.
- 3 Use **▲** or **▼** and **▶** to select **Save to Preset**.
- 4 Use **▲** or **▼** and **▶** to select the desired preset number (PR01, PR02,...PR60).
 - > *Current radio station is stored under selected preset number.*

8.2.3 Listen to preset station

- 1 In FM radio mode, press **▶** to access the list of preset stations.
- 2 Use **▲** or **▼** and **▶** to select the preset station.



8.3 RDS

RDS (Radio Data System) is a service that allows FM stations to send additional information along with the FM radio signal.

Tune to RDS radio station (see **8.2.1 Autostore: Automatic preset program**)

Display shows (if available):

- Name of radio station
- Radio frequency
- Program type (e.g. News, Pop, Music)
- RDS radio text



8.4 NEWS

You can activate radio **NEWS** while listening to another source on WACS7500. The set will tune to a RDS radio station stored in the preset memory under one of the 10 first numbers.

- 1 During playback (any source except radio) press **RDS/NEWS** on remote control.

Icon  appears and **NEWS ON** is briefly displayed.

(If no RDS station is found or no news transmission is detected during the scan, the icon  disappears and **NEWS OFF** is briefly displayed.)

Playback continues while the set scans the first 10 preset stations.

When a news transmission is detected, the set will switch to the RDS station broadcasting the news transmission and the icon  starts flashing.

After the news transmission is over, the set will stay tuned to the news station.

- 2 To deactivate **NEWS**, press **RDS/NEWS** again.
> Icon  disappears and **NEWS OFF** is briefly displayed.

Tip

Ensure that you have stored RDS stations in the first 10 preset locations (see **8.2.1 Autostore: Automatic preset program**).

8.5 Internet radio*

You can also listen to all the most popular Internet Radio stations by connecting through the **Philips** web service, where automated links to active stations are maintained and updated at regular intervals.

The Internet Radio feature requires registration with **Philips**. The registration process only has to be completed once, when you are using the **Internet Radio** for the first time. You can register more than one user. Each user will have to register separately, following these instructions:

8.5.1 First time use

Important!

Ensure you are connected to the Internet when you use the Internet Radio feature. See 11. Network Settings for information on how to get your system connected to the home network and the Internet.

Use the 1-way remote control for the registration process.

For first time use of the Internet radio you must register with Philips.
To register you need a valid email address.

Note

If you enter an email address that is already registered with Philips, the display asks for your password. Enter your password and enjoy Internet radio!

Internet radio registration process:

On **C** or **S**

- 1 Press **HOME** one or more times to select **Radio**.
 - 2 From the radio menu, select **Internet Radio**.
- > *Internet connection starts:*

The Internet Radio registration help screen appears:

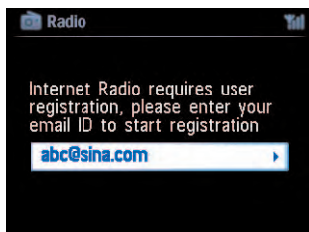

- 3 Enter any valid email address.
- > *Display shows confirmation that the automated email dispatch has been initiated:*

* *Internet radio requires broadband Internet access.*

On your PC:

- 1 Check the inbox of the email address you entered and look for a message from 'ConsumerCare@Philips.com' with the subject: **Your Streamium Registration....**
- 2 Read and follow the instructions given in the email to complete your registration process on the **Philips** website.

On **C** or **S**

Display returns to Radio menu.

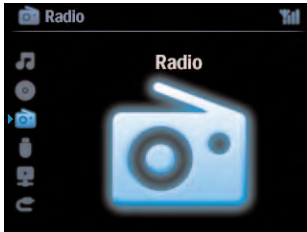

Note

- Press **HOME** to exit any time. Your email address will be remembered.
- Other persons can register individually to enjoy Internet radio with their own settings.

8.5.2 Regular use

Regular users can access the **Internet radio** directly through the **Radio** menu screen.

8.5.2.1 Radio services

On **C** or **S**

- 1 Press **HOME** one or more times to select **Radio**.
- 2 From the Radio menu, select **Internet Radio**.
- 3 Use **▲** or **▼** and **▶** to select **User**.
- 4 Use **▲** or **▼** and **▶** to select **Services**.
- 5 Use **▲** or **▼** and **▶** to make your selection from the **Service List (RadioIO, or Live360)**.
- 6 Use **▲** or **▼** and **▶** to select the desired station.

8.5.3 Add internet radio stations and bookmark your favorites

On **C** or **S**

In Internet radio mode press ► to bookmark the current radio station as a favorite.

OR

On your PC

1 Log in with your registered email address at www.philips.com/welcome.

2 Select **Streamium Management** on the left hand side of the window.

3 Choose radio stations from the list.

4 Mark them as favorites.

The marked stations will appear as **My Media** and **Favorite Stations** the next time you connect.

8.5.3.1 My Media

On **C** or **S**

1 Press **HOME** one or more times to select **Radio**.

2 From the radio menu, select **Internet Radio**.

If multiple users are registered:

a Use ▲ or ▼ and ► to select

3 Use ▲ or ▼ and ► to select **My Media**.

4 Use ▲ or ▼ and ► to make your selection from the **My Media List of Stations**.

8.5.3.2 Favorite stations

On **C** or **S**

1 Press **HOME** one or more times to select **Radio**.

2 From the radio menu, select **Internet Radio**.

If multiple users are registered:

a Use ▲ or ▼ and ► to select

3 Use ▲ or ▼ and ► to select **Favorite Stations**.

4 Use ▲ or ▼ and ► to make your selection from the **List of Favorite Stations**.

Note



Ensure you are connected to your home network when you use the UPnP feature. See **11 Network Settings** for information on how to get your system connected to the home network and the Internet.

9.1 UPnP (Universal Plug and Play)

UPnP is a standard which connects multiple devices (wirelessly or wired) with each other and enables them to work seamlessly. If you are familiar with UPnP enabled devices, WACS7500 brings you additional benefits to enrich your wireless music streaming experience. If you are not familiar with UPnP-enabled devices, please visit www.upnp.org for details.

9.1.1 About UPnP*

In addition to the music library of , an UPnP-enabled device can also serve as a music library.







The music collection on the UPnP enabled device can be played on  or , wirelessly or through the supplied Ethernet cable.

You can also play the music library of  on the UPnP enabled device, thus expanding your home music network.

* *Universal Plug and Play (UPnP™) builds on standard networking technologies and provides standardized protocols for a wide variety of home and small business devices. It allows easy interoperability of all the devices supporting the networking technologies.*

9.1.2 About UPnP* enabled devices

The UPnP device can be a PC or other device running UPnP software.

- 1 To use the UPnP device with  or , connect  or  to the UPnP network of the device (see **9.2 Connect to UPnP device**).
- 2 To play the music library of your UPnP device on  or , check that UPnP server software is properly installed and enabled on the device (e.g. Windows Media Player supplied PC Suite CD, Windows Media Player 11 or Philips Multimedia Manager). For more help refer to Windows Media Player.
- 3 To play the music library of  on the UPnP device, check with the user manual of your UPnP device to make sure it is able to receive music from other UPnP enabled devices.

9.2 Connect to the UPnP device

When connecting to the network of the UPnP device, you have the following options:

- Connect wirelessly or through an Ethernet cable.
- Connect **C** or **S**, **C** only, or **S** only.

For more information on the connection, see **11.2 Network settings: Connect to Wi-Fi enabled or wired home network**.

Tip

Connecting other UPnP clients to Philips Wireless Music Center may take longer than connecting a Philips Wireless Music Station to Center.

9.3 UPnP playback

Note

- You can only stream unprotected music files in MP3, WMA, or AAC (.m4a) format when WACS7500 is in UPnP mode.
- You cannot stream video or picture contents.

During UPnP playback, some playback features in the Wi-Fi network on Center will be unavailable, including Music Broadcast, Music Follows Me, Same Artist, Same Genre, Creating / Deleting Playlist, and Recording.

9.3.1 Play music from UPnP device

Tip

If you cannot find the UPnP server on the network, refresh the UPnP mode of Center by changing the mode (press **HOME** key).

- 1 Check that the UPnP device is switched on.
- 2 Switch off the firewall running on the UPnP enabled PC during UPnP playback.
- 3 Check that **C** or **S** is connected to the network of the UPnP device (see **11.5 Network settings:View connection status**).

C or **S**:

- 4 Press **HOME** on remote control to select UPnP mode.
 - > The display on the set shows a list of connected UPnP devices (up to 4 UPnP devices).
(Server not found appears if there is no UPnP device found in the network.)

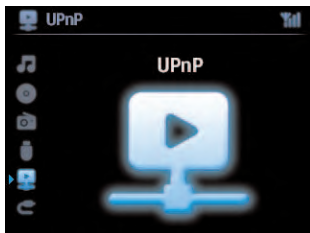

- 5 Use **▲** or **▼** and **▶** to select your desired UPnP device.
 - > The music library of the UPnP device appears on **C** or **S** as well as on the UPnP device.

On **C** or **S**:

- 6 Play the music library of the UPnP device in the same way as you play Hard Disk (HD) (see **6 HD**).

9.3.2 Play music from Center (**C**)

- 1 Check that **C** is switched on or already in standby mode.
- 2 Check that the UPnP device is connected to **C** (see **11.5 Network settings :View connection status**)
 - > The music library of **C** appears on the UPnP enabled device as it does on **C**
- 3 Use the function keys on the UPnP device to play the music library of **C**.

10 External sources

10.1 Play or record to USB mass storage device

You can playback music from a USB device on **C** or **S**. You can also transfer the music library of **C** to a USB mass storage device, so that you can carry your favorite music with you wherever you go.

10.1.1 About USB device

Note

- In some USB flash (or memory) devices, the stored contents is recorded using copyright protection technology. Such protected contents cannot be played on any other devices (such as **C** / **S**).
- MTP (Media Transfer Protocol) USB devices are not supported.
- Protected (DRM) WMA files cannot be played due to copyright issues.

Compatible USB mass storage devices:

The following devices can be used on **C** or **S**:

- USB flash devices (USB 2.0 or USB1.1)
- USB flash memory devices (USB 2.0 or USB1.1)

Supported formats:

- USB or memory file format FAT12, FAT16, FAT32 (sector size: 512 - 65,536 bytes)
- MP3 bit rate (data rate): 32-320 Kbps and variable bit rate
- WMA v9 or earlier versions
- Directory nesting up to a maximum of 8 levels
- Number of albums/folders: maximum 99
- Number of tracks/titles: maximum 999
- File name in Unicode UTF8 (maximum length: 256 bytes)
- MP3 VBR, WMA VBR, AAC VBR format

C or **S** will not play or support the following:

- Empty albums that do not contain any MP3/WMA files and hence will not be displayed.
- Unsupported formats are skipped (e.g. files with .doc extension are ignored).
- WAV, PCM audio files
- DRM protected WMA files
- WMA files in Lossless

How to transfer music files from your PC to a USB mass storage device

You can easily transfer your favorite music from your PC to a USB mass storage device by drag & drop.

You can use the music management software of your flash device for the music transfer.

How to organize your MP3/WMA files on a USB mass storage device

C or **S** browses MP3/WMA files in the same way as **C** reads the HD.

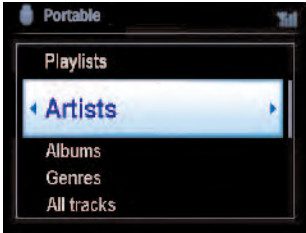

Organize your MP3/WMA files in different folders or sub-folders as needed.

Tip

- Make sure that MP3 files end on extension .mp3 and WMA files end on extension .wma.
- For DRM protected WMA files, use Windows Media Player 10 (or later) for CD burning / conversion. Visit www.microsoft.com for details about Windows Media Player and WM DRM (Windows Media Digital Rights Management)

10.1.2 Play music from USB device

- 1 Check that USB device is properly connected to **C** or **S** (see 3.4.2 Installation: Connect a portable (USB mass storage) device)
- 2 Press **HOME** once or more times to select **USB**.
> The screen shows 'USB direct'.

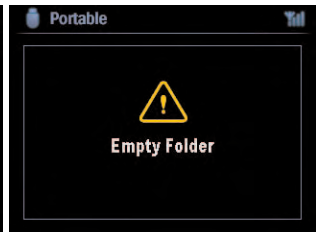
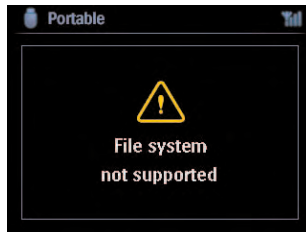

No USB Device Present appears if the USB device is not supported by **C** or **S**.
File system not supported appears if unsupported file formats are used on the USB device.
Empty Folder appears if no supported audio format file is found on the USB device.

- 3 Play audio files on the USB as you do with the albums/tracks on a HD (see 6 HD).

Tip

Due to compatibility reasons, the album/track information may differ from what is displayed through the music management software of the flash device.

10.1.3 Transfer music to USB device

Important!

- There is no support for transfer of music to MTP devices.
- Recording is permitted only if there is no infringement of copyrights or any other rights of third parties.
- For CDs encoded with copyright protection technologies used by some record companies, recording will be restricted.
- Making unauthorized duplicates of copy-protected material, including computer programs, files, broadcasts and sound recordings, may be an infringement of copyrights and constitute a criminal offence. This equipment should not be used for such purposes.
- Transfer to USB device is only supported by **CD**.
- DRM protected files might not play if they are transferred to the USB device.

- 1 Check that the USB device is properly connected to **CD**.
- 2 On **CD**, press **HOME** and use **▲** or **▼** and **▶** as necessary to select **HD**.
> If it is in **HD playing mode**, press **STOP** to stop playing.
- 3 Use **▲** or **▼** and **▶** to select an option (Playlists, Artists, etc...) and enter the corresponding list of tracks.
- 4 In the track list screen, press **RECORD (REC)** on remote control)
> The list of tracks appears.
- 5 Press **MARK/UNMARK** to select or deselect the tracks to be recorded.
> To select/deselect all tracks, Press & hold **MARK/UNMARK**.

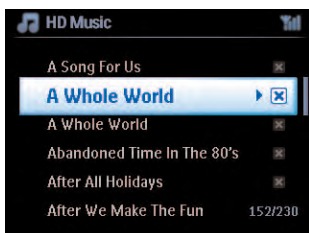

- 6 Press **RECORD** to start recording.
- > Display shows: **Transferring...**
The number of tracks transferred / to be transferred appears.
Selected tracks are transferred to the USB device.

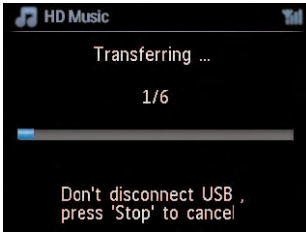

✳ Tip

- Press ◀ to stop selecting tracks and return to the list of tracks. To continue, repeat steps 3 to 5.
- Recording will also stop when:
 - the USB device is unplugged and the display shows: Connection interrupt, Cancel transfer...
 - the USB device has more than 99 folders and 999 titles and the display shows: Device is full, Cancel transferring...

Find the transferred tracks on your USB device

All the transferred tracks are saved in the USB device under the folder structure Music\Genre\Artist\Album, and are named as XX-trackname.mp3.

Play the transferred tracks on another music player

You can play the transferred tracks on music players supporting USB playback. On different players, the files/folders may be browsed in different ways.

10.2 Play your iPod music

You can enjoy the music library on your iPod player through the speaker system of the WACS7500. This feature requires a Dock. The designated Philips Docking Cradle, Model DC1050 is sold separately.

- 1 Check that **C** or **S** is switched on or in standby mode.
- 2 Connect your Dock to **C** or **S**:
 - a Connect the 9-pin docking cable to the **DOCK IN** of **C** or **S**.
 - b Connect the audio cable to the **AUX IN*** on **C** or **S** (red & white plugs must match color coding of **AUX IN**).
- 3 Insert your iPod into the Dock.
- 4 Press **HOME** to enter the main menu and use the navigation controls **▲** or **▼** and **▶** to select **Portable ▶ iPod**.
- 5 The iPod can now be controlled via the remote control of the **C** or **S**.

✳ Tip

All features except for the volume can still be controlled on the iPod itself too.

10.3 Play external sources

You can play files from external sources on **C** or **S** by connecting the audio output (e.g. TV, VCR, Laser Disc player, DVD player). You can also record up to 3 hours of audio output to the music library in the HD of **C**.

- 1 Check that the external device is properly connected (see **3.4.4 Installation: Connect additional appliances**).
- 2 Ensure that **C** or **S** is switched on or in standby mode (see **5 Basic functions**).

On **C** or **S**:

- 3 Press **HOME** once or more times to select **AUX** **e**.

On external source:

- 4 Turn down the volume to avoid noise distortion.
Press **▶II** to start playback.
- 5 To adjust sound and volume, use the sound controls on WACS7500 or on your external source.

11 Network settings

Note

Use the 1-way remote control for Station management and Network configuration. The 2-way remote control cannot be used for these tasks.

You can add **C** and/or **S** to your existing home network. Set your network according to your needs as follows:

Type	What you want	Go to
Simple network settings	Add another S to C	Section 11.1
	Connect to your PC for configuration management	Section 12
	Connect to internet for Gracenote® internet service	Section 13
Advanced network settings	Connect to Wi-Fi home network	Section 11.2
	Connect to wired home network	Section 11.3
Expert network setting	Connect to two different networks	Section 11.4

11.1 Add Stations to Wi-Fi network of Center (**C**)

You can connect up to five **S** to **C**. When adding a **S** to the Wi-Fi network of **C**, you can play the music library of **C** on **S**, or move music playback between **C** and **S** (see **6 HD**).

On **C**:

- 1 Check that **C** is in HD source.
- 2 Press **MENU** to enter the menu screen.
- 3 Use **▲** or **▼** and **▶** to enter **Station Management (Mgnt)** menu.
- 4 Use **▲** or **▼** and **▶** to select **Add New Station**.
 - > You will enter *Installation Mode*. Search for the new station starts.
Playback stops on the previously associated **S** if you are playing the HD source.

Tip

If five **S** are already connected, the option Add New Station is not available. In this case, please delete another **S** first and then add the new **S**.

On **S**:

- 1 To enter Installation Mode
 - On a new Station that is still unassociated with the Center:
 - a Power up new Station.
 - b Select language.
 - > Station enters automatic installation mode.

- On a Station that was already paired with another Center:
 - a Press **MENU**
 - b Select Installation mode
 - > Station enters automatic installation mode.

- 2 Disconnect the power plug of **S** and then connect it to the power supply again.
 - > Display: **Connecting to Center**

- 3 On remote control, press **MENU** to enter Installation Mode.
 - > The following messages are shown in succession:
Center found
Connecting to Center...

- On **C**:
 - 4 Press **STOP** when all the **S** are found.
 - > HD screen appears once **S** is connected to **C**.



11.1.1 Delete a Station (**S**)

- 1 Check that **C** is in **HD** source.
- 2 Press **MENU** to enter the menu screen.
- 3 Use **▲** or **▼** and **▶** to enter **Station Management (Mgmt)** menu.
- 4 Press **▲** or **▼** and **▶** to select **Delete Station**.
 - > The list of connected **S** will be displayed on **C**.
- 5 Use **▲** or **▼** and **▶** to select **S** you wish to delete.
- 6 Press **▲** or **▼** and **▶** to select **YES**.

11.2 Connect to Wi-Fi (wireless) enabled home network

The Wi-Fi enable network is a Wi-Fi infrastructure network or a Wi-Fi enable home network with a router.

Important! Connections that include a Wi-Fi router require that the router is switched on at all times.

- 1 To connect **C** or **S** to a Wi-Fi enabled home network, start the **Add Network** procedure on **C** or **S** respectively.
- 2 For music playback within the home network, see **9.3 UPnP Playback**.

11.2.1 Network settings on Center (**C**)

Note

For WEP (Wired Equivalent Privacy) / WPA (Wi-Fi Protected Access) key setting to secure your network, always refer to the user manual of the Router. WPA is the newest and strongest encryption method. If this is not available (generally for older devices) choose WEP.

On **C**, search for networks:

- 1 Press **MENU** to enter the menu screen.
- 2 Use **▲** or **▼** and **▶** to enter **Settings** followed by **Network**, then **Wireless**.
> Display: **Searching for Networks...**
*List of networks appears. (**Network Not Found** appears if no network is found.)*
- 3 Select the Wi-Fi network where your desired UPnP device is located.
- 4 Press **▶** to continue.

- | | | | |
|---|---|---|-----------------------------|
| 5 | If you already know the WEP/WPA key for the Wi-Fi network: | Use the 1-way remote control to enter the WEP or WPA key. | Press OK to confirm. |
| | If there is no WEP/WPA key for the Wi-Fi network: | Press OK to skip. | |

- 6 In screen **Set IP Mode**, select **Automatic**

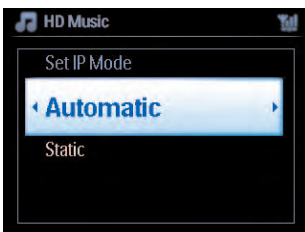

7 As prompted, select **Yes** to apply the settings.

C is connected to the Wi-Fi home network.

S might be disconnected from the Wi-Fi network of **C**.

✳ Tip

- To add **S** to the network of **C**, follow the steps under user manual section **3.1 Installation: Install Center **C** and Station **S****.
- If you change the WEP/WPA key after you have added the WACS7500 into your home network, the connection between the WACS7500 and your home network will be lost. In this case, please restart WACS7500 **C** and **S** in order to refresh the IP update.

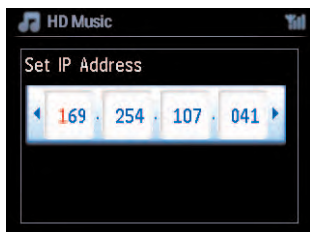

Applicable if you already have a wireless network (hub/switch/router).

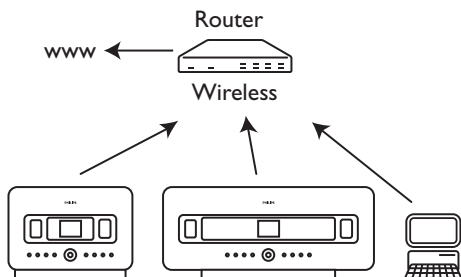

11.2.2 Set network on Station (**S**)

- Press **MENU** to enter the menu screen.
- Use **▲** or **▼** and **▶** to enter Settings followed by Network, then Wireless.
- Press **▶** to continue.
> Display: **Searching for Networks...**
List of networks appears. (Network Not Found appears if no network is found.)
- Select the Wi-Fi network where your desired UPnP device is located.
- Press **▶** to continue.

6 If you already know the WEP/WPA key for the Wi-Fi network:	Use the 1-way remote control to enter the WEP or WPA key.	Press OK to confirm.
6 If there is no WEP/WPA key for the Wi-Fi network:	Press OK to skip.	

7 Select **Automatic**.

8 As prompted, select **YES** to apply the settings.

C is connected to the Wi-Fi home network.

S will be disconnected from the Wi-Fi network of **C**.

11.3 Connect to wired home network

The wired home network can be a single PC, a PC network, another **C** or **S**.

C and **S** can both access the wired and wireless home network at the same time. Using the supplied Ethernet cable, you can connect **C** or a **S** separately to a wired network while maintaining its Wi-Fi connection (e.g. the Wi-Fi connection between **C** and on or more **S**, or the Wi-Fi connection with a home network). In this way, you can opt to play the music library of the wired network only on **C** or a single **S** (UPnP playback).

At the same time, you can still enjoy all the music playback features on the Wi-Fi network.

11.3.1 Set network on Center (**C**)

- 1 Check that network device is switched on and firewall (if applicable) is switched off.
- 2 Connect supplied Ethernet cable to Ethernet ports on network device and **C**.
- 3 Press **MENU** to enter the menu screen.
- 4 Use **▲** or **▼** and **▶** to enter **Settings** followed by **Network**, then **Wired**.
- 5 Press **▶** to continue.

- 6 In **Set IP Mode** screen: If you are using a DHCP* enabled network device, select **Automatic**.

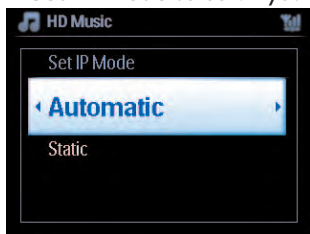



- * **DHCP** stands for **D**ynamic **H**ost **C**onfiguration **P**rotocol. It is a protocol for assigning dynamic IP addresses to devices on a network.

11.3.2 Set network on Station (S)

If there is no DHCP:

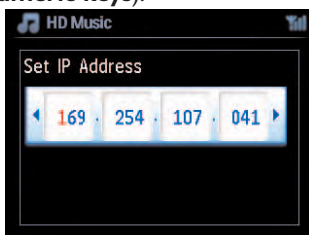
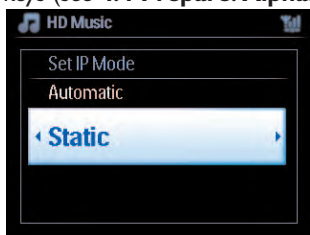
- 1 Select **Static** and assign an IP address and subnet mask as prompted, using the alphanumeric keys (see 4.4 Prepare: Alphanumeric keys).



- 2 As prompted, select **YES** to apply the settings.
 > **C** is connected to the external wired network.
 On the display, the icon  changes to .

Applicable if you already have a wired home network (hub/switch/router).

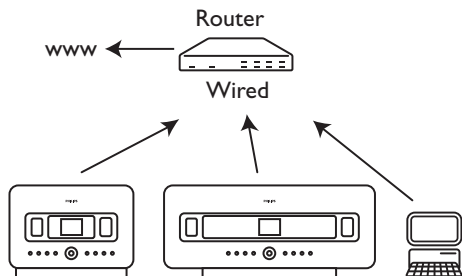

Tip

You can connect **C** or **S** directly to your PC using the supplied Ethernet cable and the **Wireless Audio Device Manager (WADM)** in the supplied PC Suite CD. For details, see section **12 Connect to your PC**.

11.4 Connect to two different home networks

WACS7500 can be added into two different home networks via wired and wireless network ports. Note that the IP addresses of the two different network ports cannot be in one subnet: WACS7500 has no router function and cannot determine which port to use.

Note

Once **C** is added to the Wi-Fi network, all Wi-Fi ad-hoc connections with the WAC7500 will be shut down.

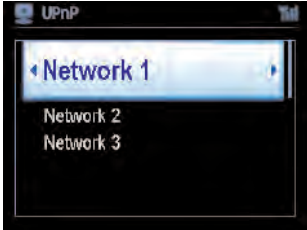

Applicable if you have two home networks.

Once a **S** is added to the Wi-Fi (wireless) home network, the Wi-Fi wireless connection of this particular **S** to the **C** will be shut down. However **C** may still maintain its Wi-Fi ad-hoc connection with one or more other **S**.

WACS7500 cannot shadow the IP of a network device that is not activated. Please be careful of the IP address settings to avoid IP address conflict between the wired and Wi-Fi ports.

11.5 View connection status

11.5.1 View Station (**S**) status in Wi-Fi network of Center (**C**)

- 1 Check that **C** is in **HD** source.
- 2 Press **MENU** to enter the menu screen.
- 3 Use **▲** or **▼** and **▶** to enter **Station Management** (Mgnt) menu.
- 4 Use **▲** or **▼** and **▶** to select **Station Status**.
> A list of connected **S** or previously connected **S** is displayed on the **C**.
- 5 Press **▶** to view the connection information.

11.5.2 Viewing the connection with home network

- 1 Check that **C** or **S** is in HD source.
- 2 Press **MENU** to enter the menu screen.
- 3 Use **▲** or **▼** and **▶** to enter **Information** menu.
> The display shows: **System, Wireless and Wired**.
- 4 Use **▲** or **▼** and **▶** to select **Wireless** or **Wired**.
 - Wi-Fi: information about the Wi-Fi settings.
 - Ethernet: information about the Ethernet settings.

11.6 Connect to Internet

Important! Make sure that no dial-up, user name or password is required for the Internet access.

Check that you have connected **C** to an Access Point or Router with Internet access or connect **C** to an ADSL modem with internet access directly.

Set DNS and Gateway

If you are using a **DHCP*** enabled Access Point, Router or ADSL modem, the DNS and Gateway can be obtained automatically, so you need only to set **C** to **Automatic (DHCP)**:

- 1 Press **MENU**.
- 2 Use **▲** or **▼** and **▶** to select **Settings** followed by **Network**.
- 3 Select **Wired** or **Wireless**.
- 4 Use **▲** or **▼** and **▶** to select **Automatic (DHCP)**.

* **DHCP** stands for **Dynamic Host Configuration Protocol**. It is a protocol for assigning dynamic IP addresses to devices on a network.

The following steps show how to get DNS and Gateway settings of the current network from the PC connected to the same network:

- 1 On your PC, click **Start** > **Run**
- 2 Type **cmd** and click **OK**
- 3 Type **ipconfig/all**
- 4 Write down the DNS and Gateway of the current connection.

On **C**

- 1 Press **MENU** to enter the menu screen.
- 2 Use **▲** or **▼** and **▶** to enter **Settings** followed by **Network**, then **Wired**.
- 3 Press **▶** to continue.

Set DNS

- 1 Enter the DNS server you wrote down.
- 2 Press **OK** to confirm.
- 3 Press **OK** to skip **Set DNS2**.

Tip

If necessary, follow Steps 1 and 2 above to set a secondary DNS server in Set DNS2.

Set Gateway

- 1 Enter the Gateway you wrote down.
- 2 Press **OK** to confirm.

Set proxy

- 1 If you are using a proxy server to visit websites, enable Proxy and proceed with the proxy setting as prompted, then press **OK** to confirm. Otherwise, press **OK** to skip.
- 2 Choose to apply the settings as prompted.
> *Settings will change.*
Connection to station could be lost appears.

12 Connect to your PC

Minimum PC requirements:

- Windows 2000 SP4 (or above) / XP SP2 / Vista
- Pentium III 500MHz processor or higher
- 256MB RAM
- CD-ROM drive
- Ethernet adapter, enabled (for wired connection) - or
- Wireless network adapter 802.11 b/g (for wireless connection)
- 500MB free hard disk space

Install WADM (Philips Wireless Audio Device Manager, see 17 FAQ)

- 1 Log onto your PC with administrator rights enabled.
- 2 Disable the firewall of your computer to make the connection.
 - a **For Windows 2000 / XP:** On your PC, press **Start > Settings > Control Panel > (Security Center >) Firewall > Off.**
 - b **For Windows Vista:** On your PC, press **Start > Control Panel > Firewall > Turn Firewall On or Off > Off.**
- 3 Insert PC Suite CD into your PC.
- 4 Select language and accept license terms.
- 5 On the Welcome screen, click **Next**.
 - > *The installation process starts automatically.*
- 6 When installation is completed, click **Quit**.

Connect Center to PC (Wired connection)

Use the supplied orange Ethernet cable to connect the WAC7500 to your PC. (Make sure that the Ethernet port on your PC is enabled to establish WADM connection).

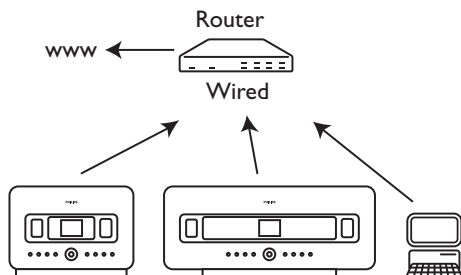

Launch WADM

- 1 Double click **WADM**.
- 2 If your Center appears, continue with step 6.
- 3 If your Center is not found, select **Connection Wizard**.
- 4 In **Connection Wizard** screen, select **Express Mode**.
- 5 Click **Next** and follow the instructions.
- 6 Select your Center from the list and click **Connect now**.

Connect Center to PC (Wireless connection)

Enable your wireless Access Point or Wireless Router.

Configure Network from Center: Select **Menu > Settings > Network > Wireless** (select desired Network) > (enter encryption key) > **Automatic > Apply Settings > Yes**

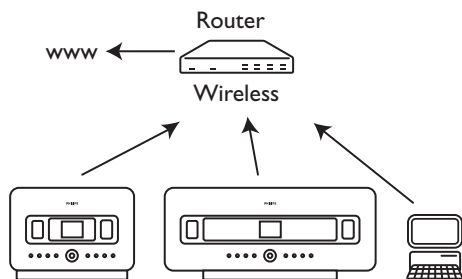

Launch for Windows XP or Vista:

- 1 Double click **WADM**.
- 2 A list of discovered Centers appears.
- 3 If your Center appears, continue with step 6.
- 4 If your Center is not found, select **Connection Wizard**.
- 5 In **Connection Wizard** screen, select **Express Mode**.
- 6 Click **Next** and follow the instructions.
- 7 Select your Center from the list and click **Connect now**.

✳ Tip

- If the IP configuration of Center is not in the default range (Subnet mask: 255.255.0.0; IP address: 172.31.x.x), select **Connection Wizard > Express Mode**. Enter the current IP configuration of Center as prompted. Press **MENU** and select **Information > Wired** to check IP configuration.
- When WADM is running, Internet access of your PC may be disabled. Close WADM to restore access.

13 Gracernote® CD Information



The Gracernote® music recognition service provides the set with CD track information (including album, artist, genre, track information) from its built-in database. It allows the recorded CD tracks to be properly categorized (for example, under Artists, Albums, Genres or All tracks) and be merged with the existing tracks in the hard disk.

13.1 Gracernote® music recognition database

A 800 MB CD database (contains 800,000 most popular CDs) is embedded in every  for quick look-up on track information. An update file that contains newly released CDs is available quarterly on www.club.philips.com for download.

13.1.1 Update Gracernote® music recognition database

Use your PC to register your product on www.club.philips.com and go to 'Show Upgrades & Support' page to download Gracernote® Music recognition database update. Note that the updates are posted quarterly and new updates are independent from old updates, i.e. a new update can be installed, even without the previous update.

After storing the file on your PC, you can either burn a CD with the update file using your favorite CD burning software and drop the CD into  for automatic update, or you can use the Gracernote® update option of WADM if you have connected your PC to .

13.2 Gracernote® Internet Queries

If the CD track information of your new CD disc cannot be displayed on the WACS7500, the quickest and surest solution is to ensure you have followed the steps in **11.6 Connect to Internet** and follow **13.2.1 Look up track information**.

13.2.1 Look up CD track information

When an internet connection present (see **11.6 Connect to Internet**), insert the CD of which you require the information (insert disc into loader slot of  with graphics facing you).

Searching start immediately. The system will search the local Gracernote® CD database first. If the CD track information cannot be found, the online search will start. The search results are shown on the display of .

Tip

If the internet query failed due to a disruption in the internet connection, the error message 'Check the internet setup for CD Database on-line' will appear.

Check if your internet connection is correct (see **11.6 Connect to Internet**).

14 Firmware Upgrade

14.1 Upgrade firmware

The supplied PC Installer CD Wireless Audio Device Manager (WADM) helps you get the upgrades for WACS7500 Center and Station.

Important!

On Philips Wireless Music **C** / **S**:

- Never interrupt the firmware upgrading before its completion.
- Never operate other functions before finishing the installation.

- 1 Register your Philips Wireless Music Center with www.club.philips.com.
- 2 Download the firmware upgrade files and store them on your PC.
- 3 Place **C** and **S** side by side on a level and sturdy surface.
- 4 Connect **C** and **S** to power supply.
> *HD screen appears on **C**.*
*HD screen appears on **S** when the **S** is connected to **C**.*
- 5 Connect **C** to your PC via the supplied Ethernet cable.
- 6 Install and launch WADM (see section **12 Connect to your PC**).
- 7 Click to enter the Firmware upgrade submenu.
- 8 As prompted, click **Browse** and indicate the location where you kept the firmware upgrade files on PC.
- 9 Click **Apply** to start upgrading firmware.

On Philips Wireless Music Center (C**):**

The display shows '**Updating firmware, please wait...**'.

C will reboot itself during the installation process.

When **C** returns to HD screen, the installation is completed...

On Philips Wireless Music Station (S**):**

Installation starts automatically

When **S** returns to HD screen, the installation is completed.

14.2 Restore previous firmware

After the firmware of **C** is upgraded, you can restore it to its previous version as desired.

On **C**:

- 1 Press **MENU** to enter the menu screen.
- 2 Use **▲** or **▼** and **▶** to enter **Settings** followed by **Firmware**, then **Restore firmware**.
- 3 Press **▶** to select **Yes**.

After upgrading or restoring the firmware of **C**, you need to reestablish the Wi-Fi connection between **C** and **S**.

14.3 Re-establish Wi-Fi network of Center (**C**) and Stations (**S**)

On **C**:

- 1 Press **MENU** to enter the menu screen.
- 2 Use **▲** or **▼** and **▶** to enter **Station Mgmt** menu.
- 3 Use **▲** or **▼** and **▶** to select **Add New Station**.
> *Searching for Stations starts.*

On **S**:

- 1 Disconnect the power plug of **S** and then connect them to the power supply again.
> *Connecting to Center appears.*
- 2 Press **MENU** on the remote control to enter the selection screen of **Installation Mode** and **Select Server**.
- 3 Use **▲** or **▼** and **▶** to enter **Installation Mode**.
> *Stations start to connect to C.*
- 4 Press **STOP** on **C** when all **S** are found.

15 Reset

You can restore **C** or **S** to the default settings (including network settings).

When to reset **C** or **S**:

- Reset **C** or **S** to reestablish Wi-Fi connection between **C** and **S**.
- Reset **C** or **S** to change the way **C** or **S** connects to a Wi-Fi enabled / wired home network.

- 1 Check that the set is switched on (see **5 Basic functions**).
- 2 Press **MENU** to enter the menu screen.
- 3 Use **▲** or **▼** and **▶** to enter **Settings** followed by **Restore settings**.
- 4 Press **▶** to select **Yes**.
 - > *The set is rebooted.*
 - Language selection screen appears.*
- 5 Select your desired language: English, Français, Español, Nederlands, Italiano or Deutsch.
 - > *The set enters Installation Mode.*
 - The search for **C** or **S** starts.*
 - The Wi-Fi connection is being reestablished.*

If the **C** is reset and **S** are not reset:

- 1 On the **S**, disconnect the power plug and connect them to the power supply again.
- 2 **Connecting to Center** appears.
- 3 On the remote control, press **MENU** to enter menu screen.
- 4 Use **▲** or **▼** and **▶** to enter **Installation Mode**.
- 5 **S** start to connect to **C**.

If a **S** is reset and **C** is not reset:

- 1 On **C**, select **HD** mode.
- 2 Press **MENU** to enter the menu screen.
- 3 Use **▲** or **▼** and **▶** to enter **Station Management (Mgnt)** menu.
- 4 Use **▲** or **▼** and **▶** to select **Add New Station**.
 - > *Searching for Stations starts.*

If **C** and **S** are reset:

- 1 Select language and then enter **Installation Mode**.
- 2 Press **STOP ■** on **C** when all **S** are found.

✳ Tip

- Restoring to default settings does not delete any stored music tracks.
- After restoration to default settings, the network mode will return to ad-hoc mode.

16 Technical data

16.1 Center

General

AC Power	230V \pm 10%
Dimensions (w x h x d)	616x272x172mm
Weight (Net)	approx. 8.8kg

Power consumption

Active	<45W
Standby	< 22W
Eco Power Standby	< 1W

Amplifier

Output power	2x20+40W(RMS)
Frequency response	60-20,000Hz, - 3dB
Signal-to-noise ratio	72 dBA (IEC)

Speakers

Tweeter

Power	20W RMS / 30 W music
Frequency response	5 KHz - 20 KHz
Sensitivity	76 dB / m / W
Impedance	6 Ω (Ohms)
Dimensions (w x h)	72 x 42 mm

Midrange

Power	20W RMS / 30 W music
Frequency response	130 Hz - 5 KHz
Sensitivity	76 dB / m / W
Impedance	6 Ω (Ohms)
Dimensions (w x h)	75 x 75 mm

Subwoofer

Power	50W RMS / 75 W music
Frequency response	75Hz - 500 Hz
Sensitivity	83dB / m / W
Impedance	12 Ω (Ohms)
Dimensions (\emptyset)	125mm

Headphones

Impedance	16-150 Ω (Ohms)
-----------	------------------------

Input sensitivity

AUX IN	500mV
--------	-------

Wireless

Wireless standard	802.11g, backwards compatible to 802.11b
Wireless security	WEP (64 or 128 bit), WPA/WPA2 (8-63 characters)
Frequency range	2412-2462MHz (CH1-CH11)

Wired (LAN / Ethernet)

Wired standard	802.3 / 802.3u
Speed	10 / 100MBit/s
Mode	half / full duplex
Crossover detection (Auto MDIX)	Yes

Tuner

FM wave range	87.5-108MHz
Number of presets	60
FM antenna/cable	COAX / Dipole-antenna (75W IEC-connector)

HD player

Frequency range	60-20,000Hz, -3dB
Signal-to-noise ratio	72dBA (IEC)
MPEG 1 Layer 3 (MP3-CD)	MPEG AUDIO
MP3-CD bit rate	32-320kbps, VBR
WMA bit rate	up to 160kbps
Sampling frequencies	32, 44.1, 48kHz
HD storage capacity	80GB*
Recording quality	128, or 160, or 192, or 256, or 320kbps
Recording speed	1x, 4x
CDDB (CD recognition database)	internal Gracenote® / online access enabled

* Actual formatted capacity will be less

USB player

USB	12Mb/s, V1.1 (support MP3, WMA and M4A files)
USB class	MSC, MTP
Number of tracks/titles maximum	9999

Specifications and external appearance are subject to change without notice.

16.2 Station

General

AC Power	230V \pm 10%
Dimensions (w x h x d)	387x272x128mm
Weight (Net)	approx. 3.6kg

Power consumption

Active	<25W
Standby	< 20W
Eco Power Standby	< 1W

Amplifier

Output power	2x7.5+15W(RMS)
Frequency response	60-20,000Hz, - 3dB
Signal-to-noise ratio	72 dBA (IEC)

Speakers

Full range

Power	10W RMS / 15W music
Frequency response	150Hz - 20 KHz
Sensitivity	75 dB / m / W
Impedance	4 Ω (Ohms)
Dimensions (w x h)	75 x 75 mm

Woofer

Power	10W RMS / 15W music
Frequency response	120Hz - 400Hz
Sensitivity	77dB / m / W
Impedance	14 Ω (Ohms)
Dimensions (\varnothing)	64mm
Impedance	12 Ω (Ohms)

Headphones

Impedance	16-150 Ω (Ohms)
-----------	------------------------

Input sensitivity

AUX IN	500mV
--------	-------

Wireless

Wireless standard	802.11g, backwards compatible to 802.11b
Wireless security	WEP (64 or 128 bit), WPA/WPA2 (8-63 characters)
Frequency range	2412-2462MHz (CH1-CH11)

Wired (LAN / Ethernet)

Wired standard	802.3 / 802.3u
Speed	10 / 100MBit/s
Mode	half / full duplex
Crossover detection (Auto MDIX)	Yes

Tuner

FM wave range	87.5-108MHz
Number of presets	60
FM antenna/cable	COAX / Dipole-antenna (75W IEC-connector)

HD player

Frequency range	60-20,000Hz, -3dB
Signal-to-noise ratio	72dBA (IEC)
MPEG 1 Layer 3 (MP3-CD)	MPEG AUDIO

MP3-CD bit rate	32-320kbps, VBR
WMA bit rate	up to 160kbps
Sampling frequencies	32, 44.1, 48kHz

USB player

USB	12Mb/s, V1.1 (support MP3, WMA and M4A files)
USB class	MSC, MTP
Number of tracks/titles maximum	9999

Specifications and external appearance are subject to change without notice.







17 Frequently asked questions

Attention!

- Never try to repair the system yourself as this will invalidate the warranty. Do not open the system as there is a risk of electric shock.
- If a fault occurs, first check the points listed below before taking the system for repair. If you are unable to resolve a problem by following these hints, consult your dealer or Philips for help.

Problem	Solution
<p>During the first-time setup, the display on S shows 'Searching for Center'.</p>	<ul style="list-style-type: none"> • Check that you have placed C and S side by side on a level and sturdy surface. • Check that you have connected C to the power supply. • When adding a new S, check that C is in Installation mode (see 11.1 Network settings: Add Stations to Wi-Fi network of Center C). • Turn off any nearby wireless access points if you encounter difficulty connecting C and S.

Problem	Solution
<p>I get interference on my wireless (Wi-Fi) link between C and S.</p> <p>The WACS7500 operates in the 2.4GHz radio frequency spectrum. Many other household/IT devices also operate in this frequency spectrum, for example: microwave ovens, Dect phones, bluetooth devices like bluetooth headphones, computer mouses, wireless routers, cordless phones, Wi-Fi compatible printers, PDAs. These devices can interfere with the Wi-Fi link between C and S, resulting in interference such as pause during playback, slow response to my operation, etc. The severity of interference varies depending on the extent of radiation from the device and the strength of Wi-Fi signals in that position.</p>	<ul style="list-style-type: none"> • If you are playing the set, stop playback and take the appropriate measures as follows: • Keep C or S at least 3 meters away from such devices. • Use the WEP/WPA key when connecting C and S to an existing wireless PC network. To set WEP/WPA key, connect C / S to your PC using Philips Wireless Audio Device Manager (WADM) in the supplied PC Suite CD. In the WADM device configuration, enter the Wireless Network submenu, and in Device Wireless Authentication Type, select WEP or WPA. • Change operating channel of C and S when connecting them to an existing wireless PC network. To change channels, connect C / S to your PC using Philips Wireless Audio Device Manager (WADM) in the supplied PC Suite CD. In the WADM Device configuration, enter the SSID of your Wireless Network, and select ad-hoc mode. See the section 12 Connect to your PC and the WADM help file. • If possible, change the operating channels of the other Wi-Fi devices in your home. • Turn the devices in different directions to minimize interference.
<p>Stations react when you operate the remote control of C.</p>	<ul style="list-style-type: none"> • The remote control for C is powerful enough to operate several S within a certain distance or angle. Check that you have placed S in different rooms or place them at different angles. • Use the remote control for S or the controls on the set.
<p>'x' flashes on the synchronous display of the remote control of C.</p>	<p>Signal error. Check that you have pointed the remote control towards the IR sensor of the set you wish to operate.</p>

Problem	Solution
Nothing appears on the synchronous display of the 2-way remote control of  even after the set is switched on.	You have switched on the set with the  button on the set and not the  button on the 2-way remote control. Press REFRESH on center's 2-way remote control to synchronize its display.
The remote control does not function properly.	<ul style="list-style-type: none"> • Reduce the distance between the remote control and the set. • Insert the batteries with correct polarity (+/- as indicated inside the compartment). • Replace the batteries. • Point the remote control directly towards the IR sensor.
The screen of  is stuck in a menu or shows no response for a long period of time (2-5 minutes).	Please first try to press  to go to power-saving mode. If the problem persists, restart the power (disconnect and reconnect the mains plug) to reset  .
'No Disc' / 'Cannot read CD' is displayed.	<ul style="list-style-type: none"> • Insert a suitable disc. • Check if the disc is inserted with the graphics side (label) facing you. • Wait for the moisture condensation on the lens to clear. • Replace or clean the disc, see 1.5 Maintenance. • Use a finalized CD-RW or CD-R.
Sound cannot be heard or is of poor quality.	<ul style="list-style-type: none"> • Adjust the volume. • Disconnect the headphones. • Switch off MUTE.
The disc skips tracks.	<ul style="list-style-type: none"> • Replace or clean disc. • Switch off SHUFFLE.
Sound skips during MP3/WMA playback.	<ul style="list-style-type: none"> • The MP3/WMA file may be made at a compression level exceeding 320kbps. Use a lower compression level to rip audio CD tracks. • Replace or clean disc.

Problem	Solution
Some files on the USB device are not displayed.	<ul style="list-style-type: none"> • Check if the number of folders exceeds 99 or the number of titles exceeds 999. • Only completely recorded MP3/WMA files can be found and played by WACS7500. Check if the file has been recorded completely. • DRM-protected WMA files cannot be played on WACS7500.
Radio reception is poor.	<ul style="list-style-type: none"> • If the signal is too weak, adjust the antenna or connect an external antenna for better reception. • Increase the distance between the set and your TV or VCR.
There is interference on the radio reception whenever the C or S is near my PC. (Such interference happens to most built-in tuner products.)	<ul style="list-style-type: none"> • Install the supplied FM wire antenna for better reception. • Keep C or S at least 1 meter away from your PC.
How do I mount S to the wall?	Use the supplied wall mounting kit for Station. It is recommended that you consult qualified personnel to mount the bracket safely to your wall before you install Station. For details, refer to Appendix: How to mount Station (S) to a wall.
Some WADM functions cannot be used.	Your anti-virus software might affect the running of the WADM. Turn off your anti-virus software temporarily.
I edited ID3 tags in WADM, but the screen does not show the updated ID3 tags. What shall I do?	<ul style="list-style-type: none"> • Go to File > Refresh Content to refresh the WADM. • Restart WADM.
Backup function no longer works.	The previously backed up file was deleted in Windows Explorer. Do not delete the file this way. If you want to delete the backup file, please use WADM to manage. If the backup file is accidentally deleted, please find the file named YOURMAC.inx by using your Explorer search tool and then delete it. Only after that you can do backups again.

Problem	Solution
I have problems installing WADM or launching WADM after installation.	<ul style="list-style-type: none"> • Please make sure your Operating System is either Windows 2000 with Service Pack 4 and above, or Windows XP. • Please check if your PC has a virus. • Please make sure your PC has the Microsoft Windows Media Player installed.
Wireless upgrade of S failed.	<p>Upgrade S via Ethernet cable following steps below:</p> <ol style="list-style-type: none"> 1 Connect S to your PC via the supplied Ethernet cable and power on the Station. 2 Download the firmware upgrade file specified for S. 3 Launch WADM and click Firmware upgrade. 4 Follow the on-screen information to complete the remaining steps.

Problem	Solution
<p>I have done all the steps described in Connect to PC guide to connect my WACS7500 to my home wireless network, but C and S are still not connected to each other.</p>	<ul style="list-style-type: none"> • On C, go to Menu > Information > Wireless > Status. Check that C has been changed from ad-hoc to infrastructure mode. Also check that the SSID, WEP key, or WPA key matches the setup of your wireless home network. Do the same on S. • Try to change the SSID on your router to a more unique name if it is too generic, as your neighbors might be using a router with the same SSID. • WACS7500 supports wireless and wired connection at the same time. There is a chance that your wireless IP address and wired IP address are on the same subnet and this will confuse WACS7500. Suggest to change the DHCP range of your wireless router so that the wireless IP received by WACS7500 is on a different subnet from its wired IP. • You may have forgotten to set up the wireless network settings on S. If you have not done so, follow the section 12 Connect to PC on how to set up S to join the network. • Try to change the channel of your home network settings on the router. • On your router, we suggest that you use WPA key instead of WEP key. When you use WEP as your encryption key, set all 4 keys to be the same. • Make sure that the Turbo mode of your wireless router is switched off (if your router is has this function).
<p>I see the message ‘Check the internet setup for CD Database online’ even though I am sure that the WACS7500 is connected to my home wireless network with internet connection.</p>	<ul style="list-style-type: none"> • Go to Menu > Network > Internet to check if your DNS server is correctly set up. Also make sure that you have set up the proxy server if your home wireless network needs a proxy server for internet connection. • There is a chance that you are already successfully connected to Gracernote® online, but your CD is not in their database.

18 Appendix

18.1 How to mount Station (**S**) to a wall

Important!

- The wall mounting instructions are intended for qualified installation personnel only!
- Request for qualified installation personnel to carry out the wall mounting which includes drilling the holes, fixing the bracket, and mounting **S** to the bracket.

Mount **S** and use **C** free standing.

18.1.1 What's in the supplied mounting kit

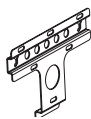

1 x mounting bracket for **S**



2 x screws

18.1.2 What else you'll need

- Suitable screws and wall anchors for each of the holes in the provided mounting bracket.
- Electric drill
- Screwdriver

18.1.3 Preparation

Try the necessary rear connections and the Wi-Fi connections between **C** AND **S** in order to find a suitable location for installation/mounting (see **3 Installation**).

Important!

To avoid the risk of injury and damage to property as well as to the product:

- Check for supply lines (gas, water, electricity, etc.) before drilling holes.
- Assess the type of screws necessary to bear Station.
- Choose the right drill and bit for the type of wall to drill the holes.
- Take all other precautions to be observed when carrying out this type of mounting/installation job.

18.1.4 Mounting Station

You can mount Station to the wall using the provided bracket.

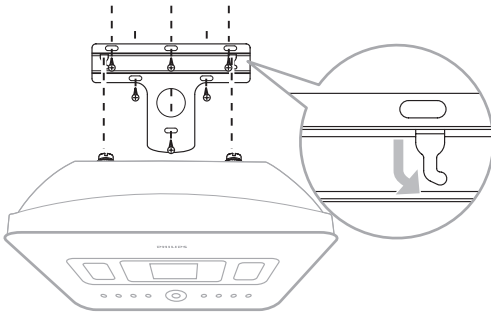

- 1 Align the bracket in the chosen location on a wall. Use a pencil to mark the drilling positions.
- 2 Drill the holes as marked.
- 3 Fix the bracket to the wall using suitable screws (not provided) and wall anchors (not provided) for all the holes provided in the wall mounting bracket.
- 4 Use a screwdriver and fasten the supplied screws to **S** as shown.
- 5 Hook / mount **S** in place as shown.



End-User License Agreement

USE OF THIS PRODUCT IMPLIES ACCEPTANCE OF THE TERMS BELOW

Gracenote® MusicID® Terms of Use

This device contains software from Gracenote, Inc. of Emeryville, California ('Gracenote'). The software from Gracenote (the 'Gracenote Software') enables this application to carry out online disc identification and obtain music related information, including name, artist, track, and title information ('Gracenote Data') from online servers ('Gracenote Servers') and to perform other functions. You may use Gracenote Data only by means of the intended end user functions of this device.

You agree that you will use Gracenote Data, the Gracenote Software, and Gracenote Servers for your own personal non commercial use only. You agree not to assign, copy, transfer, or transmit the Gracenote Software or any Gracenote Data to any third party. **YOU AGREE NOT TO USE OR EXPLOIT GRACENOTE DATA, THE GRACENOTE SOFTWARE, OR GRACENOTE SERVERS, EXCEPT AS EXPRESSLY PERMITTED HEREIN.**

You agree that your non exclusive license to use the Gracenote Data, the Gracenote Software, and Gracenote Servers will terminate if you violate these restrictions. If your license terminates, you agree to cease any and all use of the Gracenote Data, the Gracenote Software, and Gracenote Servers. Gracenote reserves all rights in Gracenote Data, the Gracenote Software, and the Gracenote Servers, including all ownership rights. Under no circumstances will Gracenote become liable for any payment to you for any information that you provide. You agree that Gracenote, Inc. may enforce its rights under this Agreement against you directly in its own name.

The Gracenote MusicID Service uses a unique identifier to track queries for statistical purposes. The purpose of a randomly assigned numeric identifier is to allow the Gracenote MusicID service to count queries without knowing anything about who you are. For more information, see the web page for the Gracenote Privacy Policy for the Gracenote MusicID Service.

The Gracenote Software and each item of Gracenote Data are licensed to you 'AS IS'. Gracenote makes no representations or warranties, express or implied, regarding the accuracy of any Gracenote Data from in the Gracenote Servers. Gracenote reserves the right to delete data from the Gracenote Servers or to change data categories for any cause that Gracenote deems sufficient. No warranty is made that the Gracenote Software or Gracenote Servers are error-free or that functioning of Gracenote Software or Gracenote Servers will be uninterrupted. Gracenote is not obligated to provide you with new enhanced or additional data types or categories that Gracenote may provide in the future and is free to discontinue its online services at any time.

GRACENOTE DISCLAIMS ALL WARRANTIES EXPRESS OR IMPLIED, INCLUDING, BUT NOT LIMITED TO, IMPLIED WARRANTIES OF MERCHANTABILITY, FITNESS FOR A PARTICULAR PURPOSE, TITLE, AND NON-INFRINGEMENT. GRACENOTE DOES NOT WARRANT THE RESULTS THAT WILL BE OBTAINED BY YOUR USE OF THE GRACENOTE SOFTWARE OR ANY GRACENOTE SERVER. IN NO CASE WILL GRACENOTE BE LIABLE FOR ANY CONSEQUENTIAL OR INCIDENTAL DAMAGES OR FOR ANY LOST PROFITS OR LOST REVENUES.

**Return your Product Registration Card or register online at
www.philips.com/welcome today to get the very most from your purchase.**

Registering your model with PHILIPS makes you eligible for all of the valuable benefits listed below, so don't miss out. Complete and return your Product Registration Card at once, or register online at www.philips.com/welcome to ensure:

***Proof of Purchase**

Returning the enclosed card guarantees that your date of purchase will be on file, so no additional paperwork will be required from you to obtain warranty service.

***Product Safety Notification**

By registering your product, you'll receive notification - directly from the manufacturer - in the rare case of a product recall or safety defect.

***Additional Benefits**

Registering your product guarantees that you'll receive all of the privileges to which you're entitled, including special money-saving offers.

PHILIPS

**Congratulations on your purchase,
and welcome to the "family!"**

Dear PHILIPS product owner:

Thank you for your confidence in PHILIPS. You've selected one of the best-built, best-backed products available today. We'll do everything in our power to keep you happy with your purchase for many years to come.

As a member of the PHILIPS "family," you're entitled to protection by one of the most comprehensive warranties and outstanding service networks in the industry. What's more, your purchase guarantees you'll receive all the information and special offers for which you qualify, plus easy access to accessories from our convenient home shopping network.

Most importantly, you can count on our uncompromising commitment to your total satisfaction.

All of this is our way of saying welcome - and thanks for investing in a PHILIPS product.

P.S. To get the most from your PHILIPS purchase, be sure to complete and return your Product Registration Card at once, or register online at:

www.philips.com/welcome

Know these **safety** symbols



 This "bolt of lightning" indicates uninsulated material within your unit may cause an electrical shock. For the safety of everyone in your household, please do not remove product covering.

 The "exclamation point" calls attention to features for which you should read the enclosed literature closely to prevent operating and maintenance problems.

WARNING: To reduce the risk of fire or electric shock, this apparatus should not be exposed to rain or moisture and objects filled with liquids, such as vases, should not be placed on this apparatus.

CAUTION: To prevent electric shock, match wide blade of plug to wide slot, fully insert.

ATTENTION: Pour éviter les chocs électriques, introduire la lame la plus large de la fiche dans la borne correspondante de la prise et pousser jusqu'au fond.

For Customer Use

Enter below the Serial No. which is located on the rear of the cabinet. Retain this information for future reference.

Model No. _____

Serial No. _____

PHILIPS

Visit our World Wide Web Site at <http://www.philips.com/welcome>

PHILIPS LIMITED WARRANTY ONE (1) YEAR

WARRANTY COVERAGE:

PHILIPS warranty obligation is limited to the terms set forth below.

WHO IS COVERED:

Philips warrants the product to the original purchaser or the person receiving the product as a gift against defects in materials and workmanship as based on the date of original purchase ("Warranty Period") from an Authorized Dealer. The original sales receipt showing the product name and the purchase date from an authorized retailer is considered such proof.

WHAT IS COVERED:

The Philips warranty covers new products if a defect in material or workmanship occurs and a valid claim is received by Philips within the Warranty Period. At its option, Philips will either (1) repair the product at no charge, using new or refurbished replacement parts, or (2) exchange the product with a product that is new or which has been manufactured from new, or serviceable used parts and is at least functionally equivalent or most comparable to the original product in Philips current inventory, or (3) refund the original purchase price of the product. Philips warrants replacement products or parts provided under this warranty against defects in materials and workmanship from the date of the replacement or repair for ninety (90) days or for the remaining portion of the original product's warranty, whichever provides longer coverage for you. When a product or part is exchanged, any replacement item becomes your property and the replaced item becomes Philips' property. When a refund is given, your product becomes Philips' property.

Note: Any product sold and identified as refurbished or renewed carries a ninety (90) day limited warranty.

Replacement product can only be sent if all warranty requirements are met. Failure to follow all requirements can result in delay.

WHAT IS NOT COVERED - EXCLUSIONS AND LIMITATIONS:

This Limited Warranty applies only to the new products manufactured by or for Philips that can be identified by the trademark, trade name, or logo affixed to it. This Limited Warranty does not apply to any non-Philips hardware product or any software, even if packaged or sold with the product. Non-Philips manufacturers, suppliers, or publishers may provide a separate warranty for their own products packaged with the bundled product.

Philips is not liable for any damage to or loss of any programs, data, or other information stored on any media contained within the product, or any non-Philips product or part not covered by this warranty. Recovery or reinstallation of programs, data or other information is not covered under this Limited Warranty.

This warranty does not apply (a) to damage caused by accident, abuse, misuse, neglect, misapplication, or non-Philips product, (b) to damage caused by service performed by anyone other than Philips or Philips Authorized Service Location, (c) to a product or a part that has been modified without the written permission of

Philips, or (d) if any Philips serial number has been removed or defaced, or (e) product, accessories or consumables sold "AS IS" without warranty of any kind by including refurbished Philips product sold "AS IS" by some retailers.

This Limited Warranty does not cover:

- Shipping charges to return defective product to Philips.
- Labor charges for installation or setup of the product, adjustment of customer controls on the product, and installation or repair of antenna/signal source systems outside of the product.
- Product repair and/or part replacement because of improper installation or maintenance, connections to improper voltage supply, power line surge, lightning damage, retained images or screen markings resulting from viewing fixed stationary content for extended periods, product cosmetic appearance items due to normal wear and tear, unauthorized repair or other cause not within the control of Philips.
- Damage or claims for products not being available for use, or for lost data or lost software.
- Damage from mishandled shipments or transit accidents when returning product to Philips.
- A product that requires modification or adaptation to enable it to operate in any country other than the country for which it was designed, manufactured, approved and/or authorized, or repair of products damaged by these modifications.
- A product used for commercial or institutional purposes (including but not limited to rental purposes).
- Product lost in shipment and no signature verification receipt can be provided.
- Failure to operate per Owner's Manual.

TO OBTAIN ASSISTANCE IN THE U.S.A., PUERTO RICO, OR U.S. VIRGIN ISLANDS...

Contact Philips Customer Care Center at:
1-888-PHILIPS (1-888-744-5477)

TO OBTAIN ASSISTANCE IN CANADA...

1-800-661-6162 (French Speaking)
1-888-PHILIPS (1-888-744-5477) - (English or Spanish Speaking)

REPAIR OR REPLACEMENT AS PROVIDED UNDER THIS WARRANTY IS THE EXCLUSIVE REMEDY FOR THE CONSUMER. PHILIPS SHALL NOT BE LIABLE FOR ANY INCIDENTAL OR CONSEQUENTIAL DAMAGES FOR BREACH OF ANY EXPRESS OR IMPLIED WARRANTY ON THIS PRODUCT. EXCEPT TO THE EXTENT PROHIBITED BY APPLICABLE LAW, ANY IMPLIED WARRANTY OF MERCHANTABILITY OR FITNESS FOR A PARTICULAR PURPOSE ON THIS PRODUCT IS LIMITED IN DURATION TO THE DURATION OF THIS WARRANTY.

Some states do not allow the exclusions or limitation of incidental or consequential damages, or allow limitations on how long an implied warranty lasts, so the above limitations or exclusions may not apply to you.

This warranty gives you specific legal rights. You may have other rights which vary from state/province to state/province.

Philips, P.O. Box 671539, Marietta, GA. 30006-0026

3121 233 48802

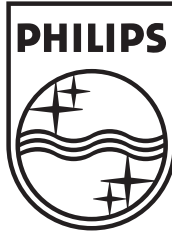

Specifications are subject to change without notice.
Trademarks are the property of Koninklijke Philips
Electronics N.V. or their respective owners
© 2008 Koninklijke Philips Electronics N.V.
All rights reserved.
www.philips.com



Printed in China
wk8033