Philips Telemetry System

with the M2601B Transmitter and
Telemetry Functions

at the IntelliVue Information Center

Notice

Operation of this equipment requires the prior coordination with a frequency coordinator designated by the FCC for the Wireless Medical Telemetry Service.

Instructions for Use

Part Number: M2600-92201

Printed in the U.S.A. November 2004

First Edition

PHILIPS

Notice

Equipment specifications are subject to alteration without notice. All changes will be in compliance with regulations governing manufacture of medical equipment.

Printed in the USA.
Document number: M2600-92201

© Copyright 2004 Koninklijke Philips Electronics N.V. All Rights Reserved.
OxiCliq and OxiMax are registered trademarks of Nellcor Incorporated.

Printing History

New editions of this document incorporate all material updated since the previous edition. Update packages may be issued between editions and contain replacement and additional pages to be merged by a revision date at the bottom of the page. Pages that are rearranged due to changes on a previous page are not considered revised.

The documentation printing date and part number indicate its current edition. The printing date changes when a new edition is printed. (Minor corrections and updates which are incorporated at reprint do not cause the date to change.) The document part number changes when extensive technical changes are incorporated.

First Edition..... November 2004

Philips Telemetry System, model M2600B is compatible with:

- M2604A Philips Mainframe, #01D or #0EU, revision E.00.19
- Philips Information Center, revisions F.00, E.01, E.00, D.01, D.00
- M2636B TeleMon Companion Monitor, Options A02/A03
- Philips Transmitter, model M2601A
- Philips Transmitter, model M1400A/B/J

Note—Some features are not available on all products.

About this Book

This book contains operating instructions for use of the M2601B Transmitter, a part of the Philips Telemetry System. It also includes operational information for the telemetry functions of the IntelliVue Information Center. The intended audience is the clinician who uses and/or teaches others to use the equipment in a healthcare environment. For operating information on other functionality of the Information Center, see the *IntelliVue Information Center Instructions for Use* (order number M3150-9001F). For preventive maintenance, repair, and test methods for verification of device performance, refer to the *M2600B Philips Telemetry System Service Guide* in the *M2600B Documentation Kit*, shipped with the product (order number M2600-90323).

This book does not address Philips IntelliVue TRx transceivers or the Philips IntelliVue Telemetry System. For information on those products, refer to the manual *Philips IntelliVue Telemetry System Instructions for Use* (order number M4841-91001).

Note—Standard and EASI M2601A Transmitters can be used with the Philips Telemetry System and can operate simultaneously with M2601B Transmitters. “What’s New” on page 1-2 summarizes the differences between the M2601B and M2601A transmitters.

About this Book

Document Conventions

Procedures

Procedures are indicated in text by the heading **Task Summary** followed by the following table:

Step	Action
1	
2	
3	

Bold Typeface

Objects of actions in procedures appear in **bold** typeface. Note the following example:

Click the **Standby** button.

Warnings

Warning

Warnings are information you should know to avoid injuring patients and personnel.

Cautions

Caution

Cautions are information you should know to avoid damaging your equipment and software.

Notes

Note—Notes contain additional information on Philips Telemetry System usage.

Product Safety Information

The warnings below refer to the following devices:

- Philips M2601B Transmitter
- Philips Telemetry System
- IntelliVue Information Center

Warning

For continued safe use of this equipment, it is necessary that the listed instructions are followed. Instructions in this manual in no way supersede established medical procedures.

Warning

Do not touch the patient, or table, or instruments during defibrillation. The battery door must be closed during defibrillation. These steps protect the clinician from high defibrillator voltage.

Warning

This device is not to be used in the vicinity of electrosurgery units because use may interrupt or interfere with the transmission of signals from the transmitter.

Warning

This equipment is not suitable for use in the presence of a flammable anesthetic mixture with air or with oxygen or nitrous oxide.

Product Safety Information

Warning

Do not use patient cables with detachable lead wires that have exposed male pins. Electrocutation could result if these pins are plugged into AC power.

Warning

Use of product accessories (e.g., ECG lead sets, SpO₂ sensors) other than those prescribed by Philips could lead to patient injury.

Warning

Strangulation Hazard! Under no circumstances should any pouch be tied solely around a patient's neck.

Warning

ECG SAFETY FOR ALL PATIENTS

Always confirm Information Center observations with clinical observation of the patient before administering interventions.

**Every lead must be secured to an electrode on the patient.
Conductive parts of electrodes must not contact earth or other conductive parts.**

Philips recommends that you change the lead label only to reflect the physical placement of electrodes. This will ensure a match between the monitored lead and the label, and prevent any possible confusion.

When switching between EASI and Standard monitoring, there is a loss of data for 30 seconds.

Warning

ECG SAFETY FOR PACED PATIENTS

The output power of the M2601B Transmitter and other sources of radio frequency energy, when used in the proximity of a pacemaker, can be sufficient to interfere with pacemaker performance. Due to the shielding effects of the body, internal pacemakers are somewhat less vulnerable than external pacemakers. However, caution should be exercised when monitoring any paced patient.

In order to minimize the possibility of interference, position electrodes, electrode wires, and the transmitter as far away from the pacemaker as possible.

Consult the pacemaker manufacturer for information on the RF susceptibility of their products and the use of their products with the Philips Telemetry System. See the *IntelliVue Information Center Instructions for Use* for additional information on monitoring paced patients.

Warning

ST/AR ARRHYTHMIA SAFETY FOR ALL PATIENTS

During complete heart block or pacemaker failure (to pace or capture), tall P-waves (greater than 1/5 of the average R-wave height) can be erroneously counted by the arrhythmia algorithm, resulting in missed detection of cardiac arrest.

Learning/Relearning

--If you initiate learning during ventricular rhythm, the ectopics can be incorrectly learned as the normal QRS complex. This can result in missed detection of subsequent events of V-Tach and V-Fib.

--When using EASI ECG monitoring, Relearn happens automatically when there is a LEADS OFF technical alarm. If learning takes place during ventricular rhythm, the ectopics can be incorrectly learned as the normal QRS complex. This can result in missed detection of subsequent events of V-Tach and V-Fib. Be sure to check the beat labels and initiate a relearn to correct. Therefore, when a technical alarm is generated:

- 1. Respond to the technical alarm [for example, reconnect the electrode(s)].**
 - 2. Ensure that the arrhythmia algorithm is labeling beats correctly.**
-
-

Warning

ST/AR ARRHYTHMIA SAFETY FOR PACED PATIENTS

It is possible that pacemaker pulses will not be detected when the ECG analog output of a defibrillator or telemetry unit is plugged into a bedside monitor. This can result in the arrhythmia algorithm's failure to detect pacemaker non-capture or asystole.

Some pace pulses can be difficult to reject. When this happens, the pulses are counted as a QRS complex, and could result in an incorrect HR and failure to detect cardiac arrest or some arrhythmias. Keep pacemaker patients under close observation.

-- During complete heart block or pacemaker failure (to pace or capture), tall P-waves (greater than 1/5 of the average R-wave height) can be erroneously counted by the arrhythmia algorithm, resulting in missed detection of cardiac arrest.

-- When arrhythmia monitoring paced patients who exhibit only intrinsic rhythm, the monitor can erroneously count pace pulses as QRS complexes when the algorithm first encounters them, resulting in missed detection of cardiac arrest.

For patients who exhibit intrinsic rhythm only, the risk of missing cardiac arrest can be reduced by monitoring these patients with the low heart rate limit at or slightly above the basic/demand pacemaker rate. A low heart rate alarm alerts you when the patient begins pacing. Proper detection and classification of the paced rhythm can then be determined.

-- When an external pacemaker is being used on a patient, arrhythmia monitoring is severely compromised due to the high energy level in the pacer pulse. This can result in the arrhythmia algorithm's failure to detect pacemaker non-capture or asystole.

Product Safety Information

Contents

1. Introduction to the Philips Telemetry System.....	1-1
What's New.....	1-2
New Transmitter.....	1-2
Connection to TeleMon.....	1-4
Own Bed Overview.....	1-4
Indications for Use.....	1-5
Regulatory Information.....	1-6
System Overview.....	1-7
Transmitters.....	1-9
M2601B Transmitter Features.....	1-10
Transmitter Controls - Front.....	1-11
Transmitter Controls - Back.....	1-15
Sounds.....	1-18
Transmitter Safety Information.....	1-18
Briefing the Patient.....	1-19
Pouch Use.....	1-19
Securing the Pouch.....	1-20
Showering.....	1-21
Making Monitoring Adjustments.....	1-22
Turning the Transmitter On/Off.....	1-22
Turning Telemetry Monitoring On/Off.....	1-23
Transmitter Auto Shutoff.....	1-23
Turning Nurse Call On/Off.....	1-23
Standby Mode.....	1-24
Use with TeleMon B, Options A02/A03.....	1-25
Operation with TeleMon.....	1-25
Testing the Transmitter Functionality.....	1-27
Self Test.....	1-27
Status Check.....	1-28
Battery Information.....	1-29
Battery Safety Information.....	1-29
Inserting/Removing Batteries.....	1-31
Checking the Battery Power Level.....	1-32
Receiver Module.....	1-34
Receiver Mainframe.....	1-35
Antenna System.....	1-36

2. Alarms	2-1
Alarm Indicators	2-2
Pause/Suspend Alarms	2-2
Alarm Behavior with Own Bed Overview	2-3
Physiologic (Patient) Alarms	2-6
Technical Alarms (INOPs)	2-11
3. ECG & ST/AR Measurement	3-1
Measuring ECG	3-2
EASI ECG	3-2
ECG Lead Sets	3-2
ECG Leads Monitored	3-4
Setting Up for ECG Monitoring	3-7
Positioning ECG Electrodes	3-8
Connecting the ECG Cable	3-14
Verifying Electrode Connections	3-17
Making ECG Adjustments	3-18
Changing Lead/Label	3-18
Adjusting Wave Size	3-19
Monitoring During Leads Off	3-19
Lead Fallback	3-19
Extended Monitoring	3-20
Relearning	3-20
Using EASI Leads to Troubleshoot	3-21
Optimizing System Performance	3-22
The Telemetry Signal	3-22
Troubleshooting Signal Disturbance	3-23
Dropouts	3-23
Muscle and Movement Artifact	3-24
ECG Safety Information	3-27
ST/AR Arrhythmia Analysis	3-28
ECG and ST/AR Alarms	3-30
ST/AR Arrhythmia Safety Information	3-31
4. ST/AR ST Segment Monitoring	4-1
ST/AR ST Algorithm	4-2
Intended Use	4-2
Patient Population	4-2
The Measurement	4-3
How the Algorithm Works	4-4

Displayed ST Data	4-4
EASI ST Analysis	4-4
Adjusting Measurement Points	4-5
Establishing ST Reference Beats (Baseline)	4-7
Turning ST On/Off	4-7
ST Alarms	4-8
ST Alarm Adjustments	4-9
5. SpO₂ Monitoring	5-1
About the Pulse Oximetry Measurement	5-2
Pulse Indication	5-3
SpO ₂ Information for the User	5-4
Preparing for Telemetry SpO ₂ Monitoring	5-7
SpO ₂ Sensors	5-8
Disposable Sensors	5-8
Reusable Sensors	5-8
Selecting an SpO ₂ Sensor	5-9
Applying the Sensor	5-12
Sensor Application Safety Information	5-12
Adult Finger Sensor (M1191A)	5-14
Small Adult/Pediatric Finger Sensor (M1192A)	5-15
Ear Clip Sensor (M1194A)	5-16
Connecting the SpO ₂ Cable	5-17
Making SpO ₂ Measurements	5-18
SpO ₂ Measurement when Connected to TeleMon	5-18
Making a Spot Check Measurement	5-19
Monitoring SpO ₂ Continuously	5-20
Turning SpO ₂ Monitoring Off	5-20
Turning the SpO ₂ Parameter On/Off	5-21
SpO ₂ Parameter Auto ON	5-22
Turning SpO ₂ Alarms On/Off	5-22
Turning the Pulse Parameter On/Off	5-23
Measurement Limitations	5-24
Optimizing Sensor Performance	5-25
SpO ₂ Alarms and Technical Alarms	5-25

6. Maintenance and Configuration	6-1
Troubleshooting	6-2
Basic Troubleshooting	6-2
Testing Alarms	6-2
Maintenance	6-3
Transmitter Cleaning, Disinfection, & Cross-Infection Prevention	6-4
Cleaning the Transmitter	6-4
Disinfecting the Transmitter	6-5
Cross-Infection Prevention for the Transmitter	6-7
Receiver Mainframe Cleaning	6-15
Configuration	6-16
Configuration Settings	6-17
M2604A Mainframe	6-17
Philips M2601B Transmitter	6-19
Changing the Configuration	6-19
7. System Safety and Specifications	7-1
Product Safety	7-2
.....	7-2
System Classification	7-3
Essential Performance	7-4
Philips Telemetry System Warnings	7-4
Electromagnetic Compatibility	7-5
M2600B Philips Telemetry System Testing	7-5
FCC Compliance (USA only)	7-7
Canadian Radio Equipment Compliance (Canada Only)	7-7
System Symbols	7-9
Type CF Defibrillation Proof	7-14
Installation and Maintenance Safety	7-14
Installation	7-14
Preventive Maintenance	7-18
End of Life	7-18
Additional Safety Information	7-19
System Specifications	7-20
Battery Life Specifications	7-20
Environmental Specifications	7-21
Electrical Power Specifications	7-22
Antenna System Specifications	7-26
Measurement Specifications	7-30

A. Optional Patient Monitor/Holter Interface (Analog Output)	A-1
Overview	A-2
Correct Labeling	A-2
Analog Output Bedside Monitor Cables	A-3
Lead Placement and Selection	A-5
Using Non-Standard Lead Placement	A-5
Controls for Telemetry Setup	A-6
Functionality with Paced Waves	A-6
Technical Alarms (Inoperative Conditions)	A-7
Holter Interface	A-8
B. Accessory List	B-1
Accessory Safety	B-1
ECG Accessories	B-2
SpO2 Accessories	B-4
C. Sales and Support Offices	C-1

Introduction to the Philips Telemetry System

This chapter introduces the Philips Telemetry System. It includes the following sections:

- What's New 1-2
- Indications for Use 1-5
- System Overview 1-7
- Transmitters. 1-9
- Briefing the Patient 1-19
- Making Monitoring Adjustments 1-22
- Use with TeleMon B, Options A02/A03. 1-25
- Testing the Transmitter Functionality. 1-27
- Battery Information. 1-29
- Receiver Module 1-34
- Receiver Mainframe 1-35
- Antenna System 1-36

What's New

This section highlights the differences between the M2600B Philips Telemetry System, utilizing the M2601B Transmitter and the Philips M2600A Telemetry System, Release C, utilizing the M2601A Transmitter.

New Transmitter

The main difference between the two systems is the introduction of the new M2601B transmitter.

Differences Between Transmitters

The following table summarizes the differences between the two transmitters.

	M2601B	M2601A
Function	One transmitter for both Standard and EASI monitoring -- clinician simply changes the ECG lead set position	Separate Standard or EASI versions of transmitter
	FAST (Fourier Artifact Suppression Technology) SpO ₂ algorithm	Traditional (not motion tolerant) SpO ₂ algorithm
	Continuous and Spot Check (Manual) SpO ₂ measurements	Continuous, Spot Check (Manual), and Intermittent (1- and 5-minute) SpO ₂ measurements

	M2601B	M2601A
Controls & Indicators	Spot Check SpO ₂ initiated by inserting sensor cable	Manual measurement initiated by button push on transmitter
	Auditory feedback for Spot Check and self test	N/A
	Two electrode placement diagrams show <i>both</i> Standard <i>and</i> EASI placement	One electrode placement diagram appropriate for the transmitter: <i>either</i> Standard <i>or</i> EASI placement
	Check button for verifying transmitter status: lead set type, battery level, EASI indicator (if in use)	N/A
	Battery gauge to indicate power level	N/A
	Audible volume/mute configurations	N/A
	Audible pulse detection during Spot Check measurement	N/A
	Unit designator label on battery compartment	N/A
Physical	Smaller and lighter ECG-only transmitter ECG/SpO ₂ transmitter approximately same size as the M2601A	One-size transmitter (ECG-only or ECG/SpO ₂)
Power Source	Battery Type: 2 AA Alkaline	Battery Types: 1 9-volt Alkaline, Lithium, Zinc Air
	No Support for Battery Extender	Compatible with Battery Extender
Accessories	New 5-wire lead sets, with color-coded lead wires available	

Connection to TeleMon

The M2601B Transmitter also has a different method of connecting to the TeleMon Companion Monitor:

- M2601B: Transmitter is connected to the outside of TeleMon via a 3-meter tether cable.
- M2601A: Transmitter is docked in TeleMon.

Own Bed Overview

The system supports the concept of Own Bed Overview, the pairing of a telemetry bed and an IntelliVue Patient Monitor (Release B.1 or higher) for a single patient. Own Bed Overview provides the telemetry-monitor data (waveforms, parameters, and alarms) in an integrated form both on the bedside monitor and at the IntelliVue Information Center.

Own Bed Overview is available with both the M2601B and M2601A transmitters.

Information on Own Bed Overview can be found in the *IntelliVue Patient Monitor Instructions for Use* and the *IntelliVue Information Center Instructions for Use*. In this book, “Alarm Behavior with Own Bed Overview” on page 2-3 summarizes alarm functionality with Own Bed Overview.

Indications for Use

The paragraphs below are the elements of the indications for use statement for the Philips Telemetry System.

Condition The licensed clinician decides that the Philips Telemetry System should be used to monitor the patient.

Prescription Versus Over-the-Counter The Philips Telemetry System is a prescription device.

Part of the Body or Type of Tissue with which the Device Interacts The ECG signal is obtained from accessory electrodes in contact with the patient's skin. The SpO₂ signal is obtained from an accessory sensor in contact with the patient's skin.

Frequency of Use As prescribed by a licensed physician.

Physiological Purpose To monitor the ECG and SpO₂ of patients on the order of a licensed physician.

Patient Population Adult and pediatric patients.

Indications for Use

Intended Use

The Philips Telemetry System is a comprehensive ambulatory system solution for the intermediate care unit for adult and pediatric patients. The foundation of the system is a transmitter that can capture and transmit ECG signals and SpO₂ values (if available) that are then processed and displayed on the IntelliVue Information Center. The Information Center generates alarms and recordings, thus notifying clinicians of changes in patients' conditions. The Telemetry System communicates with other devices via the Philips patient care system.

Warning

United States law restricts this device to sale by or on the order of a physician. This product is intended for use in health care facilities by trained health care professionals. It is not intended for home use.

Regulatory Information

This device is not for use with infant or neonatal patients.

The transmitter and related accessories are in compliance with the relevant requirements of EN ISO 10993-1 for Biocompatibility. The transmitter is not designed for direct contact with the patient's skin. The accompanying pouch is the appropriate means for holding the transmitter.

Use of the transmitter is restricted to one patient at a time.

The system is not intended to be connected to public mains as defined in CISPR 11.

System Overview

The Philips Telemetry System is used with the IntelliVue Information Center to provide multi-parameter measurements for transitional care and other ambulatory monitoring environments for adult and pediatric patients. The system:

- Enunciates patient monitoring alarms.
- Monitors adult and pediatric patients' ECG.
- Provides ST/AR arrhythmia detection.
- Measures pulsatile arterial oxygen saturation (SpO₂) and pulse rate, if available.
- Enables viewing of ECG and SpO₂ measurements and waveforms at the patient's side when connected to the TeleMon Companion Monitor.
- Makes ST segment measurements.

The Philips Telemetry System consists of:

- A transmitter for each patient.
- An antenna system.
- A receiver for each transmitter.
- A mainframe housing up to eight receivers.

Other possible items include:

- The TeleMon Companion Monitor: TeleMon can be used to view waveforms and heart rate and SpO₂ numerics as well as measure NBP. For more information see the *Philips TeleMon B A02/A03 Companion Monitor Instructions for Use*.

See the *Philips Telemetry System Service Guide* or your local trained service professional for assistance.

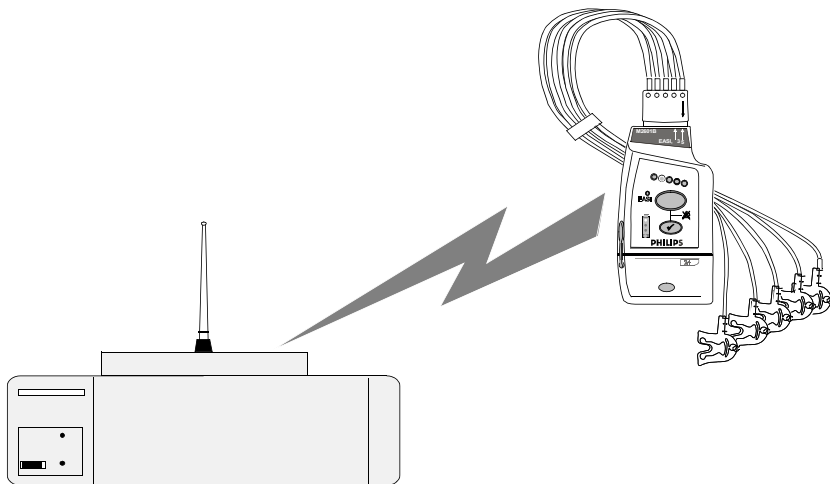

Philips Telemetry System

Dual-Band Operation

The Philips Telemetry System (M2600B) can operate in both the 406-480 MHz and 590-614 MHz ranges. The exact operating frequency for each transmitter/receiver pair is set so as to meet specific customer needs, while maintaining compliance with local and international radio regulations.

For United States operation, the M2600B will operate only in the protected, dedicated Wireless Medical Telemetry Service (WMTS) band (608-614 MHz).

Transmitters

The following Philips transmitters can be used with the Philips Telemetry System:

- ECG-only transmitter
- ECG/SpO₂ transmitter

Standard and EASI M2601A transmitters can also be used. These transmitters can operate simultaneously with M2601B transmitters. For operating information, refer to the *Instructions for Use* for the Philips Telemetry System (part number M2600-9001C).

Note—“What’s New” on page 1-2 summarizes the differences between the M2601B and M2601A transmitters.

The M2601B Transmitter models are illustrated on the following pages in this chapter. Subsequent tables describe the controls, indicators, markings, and audible sounds respectively.

If your hospital uses both the M2601B Transmitter and IntelliVue TRx devices

The M2601B Transmitter and M4841A TRx Transceiver are similar in appearance. You can distinguish between them by:

- | |
|--|
| <ul style="list-style-type: none">• Name on the front of the device• Label color (dark gray for M2601B and pale gray for TRx) |
|--|

M2601B Transmitter Features

- Clinician-selectable Standard or EASI leads in same transmitter, at the bedside.
- Powered by two AA Alkaline batteries.
- Spot Check SpO₂ without using any control buttons.
- FAST-SpO₂ (Fourier Artifact Suppression Technology) for improved motion artifact rejection and low-perfusion performance.
- Simultaneous operation in system with M2601A Transmitter.
- Two sizes - smaller ECG-only version and larger ECG-SpO₂ version.
- Battery gauge on transmitter.
- Designed to be ergonomic and comfortable for patients to wear.
- Colored labels provide clinical unit identifiers.
- Lead sets are optimized for ambulating patients, with a cable length of 79 cm (30 in).
- Gunk guards prevent dirt from accessing unused ECG and SpO₂ cable ports and the unused TeleMon/Service port, thus simplifying cleaning.
- New pouches with clear front and flaps.

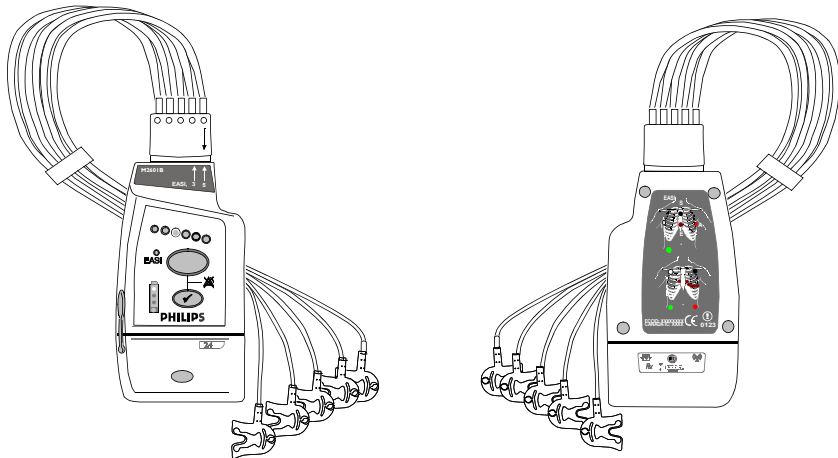

Front View

Back View

M2601B Transmitter - ECG only

Transmitter Controls - Front

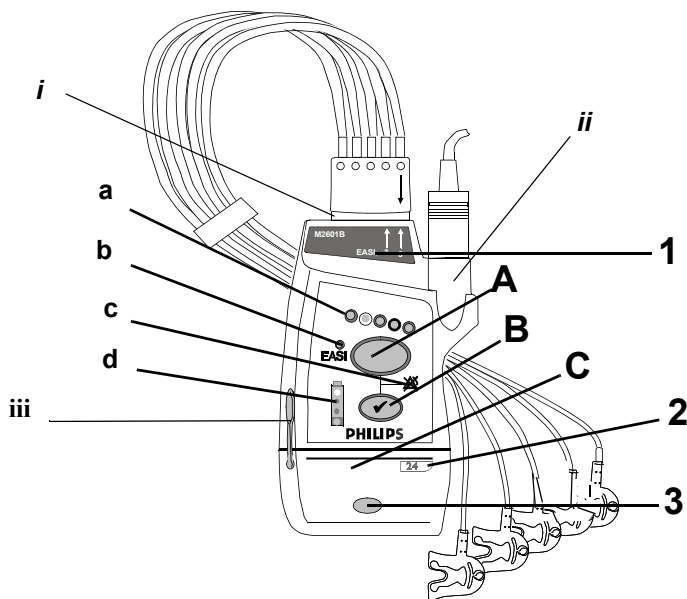



ECG/SpO₂ Transmitter - Front View

The labeled items in the diagram above include:





- Transmitter controls (A-C)
- Indicators (a-d)
- Labels (1-3)
- Ports (i-iii)

These items are defined on subsequent tables.

Controls



Callout	Control	Definition
A		<p>Telemetry Button: Depending on the configuration, this multi-function button directs the Information Center to generate a Nurse Call, central recording, both, or none.</p> <p>If desired, you can turn Nurse Call off for individual patients at the Information Center by using the Telemetry Setup Window. See “Turning Nurse Call On/Off” on page 1-23 for additional information.</p> <p><i>Note</i>—Recordings generated by the telemetry button are stored in Alarm Review at the Information Center.</p> <p><i>Note</i>—If the installation includes a paging system and if the Information Center is configured for paging upon receipt of Nurse Call, a Nurse Page signal will be initiated.</p>
B		<p>Check Button. Checks the status of the transmitter. When pressed, the battery gauge, lead set type, and EASI (if in use) indicators illuminate.</p>
C	Power On/Off	<p>Battery Compartment. Battery insertion turns power on; battery removal turns power off.</p>

Indicators

Callout	Indicator	Definition
a		<p>Lead Indicator.</p> <ul style="list-style-type: none"> Lights momentarily to display leads attached when lead set is inserted or when the Check button is pressed. When a Leads Off condition occurs, the light(s) indicate the lead(s) that need to be reapplied. The light(s) remain on until the Leads Off condition ends. <p><i>Note</i>—The 6th indicator (left-most LED) is not used for the M2601B Transmitter.</p>
b		<p>EASI Indicator. Illuminates momentarily upon insertion of lead set in EASI position. Lit by Check button when EASI is in use.</p>
c		<p>Alarms Pause/Suspend Indicator. Inactive.</p> <p><i>Note</i>—If the transmitter is connected to the TeleMon Companion Monitor this indicator is lit during 3 minute alarm pause period initiated at TeleMon.</p>
d		<p>Battery Gauge. When the Check button is pressed, indicates the amount of power remaining in the batteries. Valid only for recommended battery type.</p> <p><i>Note</i>—See “Checking the Battery Power Level” on page 1-32.</p>

Transmitters

Front Labels

Callout	Label	Definition
1	 A rectangular label with a dark background. It contains the text 'M2601B' at the top left, 'EASL' in the center, and two upward-pointing arrows on the right side, with the numbers '3' and '5' positioned below each arrow respectively.	Lead Set Insertion Guide. See “Connecting the ECG Cable” on page 3-14.
2	 A small, light-colored rectangular label with rounded corners, containing the number '24' in a bold, black font.	Device Identification Label
3	 A simple, light-colored oval-shaped label outline.	Unit Identification Label. (one of seven colors). Color-coded sticker.

Ports

Callout	Definition
<i>i</i>	ECG Lead Set Port. Connection for 3-wire or 5-wire lead set.
<i>ii</i>	SpO₂ Sensor Port. Connection for SpO ₂ sensor.
<i>iii</i>	TeleMon/Service Port. Connection for cable to TeleMon Companion Monitor or to Service Tool.

Transmitter Controls - Back

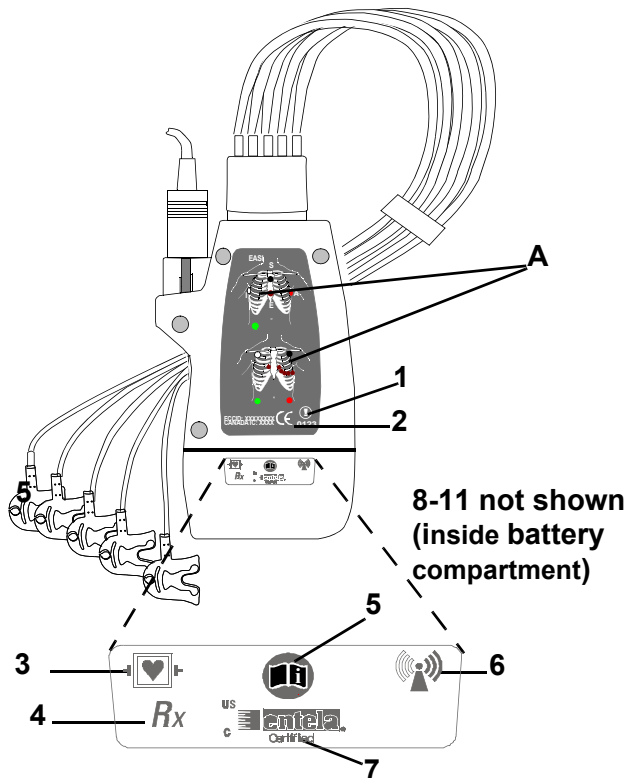

ECG/SpO₂ Transmitter - Back View

TO TRANSLATORS: use appropriate graphic showing electrode colors (IEC graphics are in "13 August graphics IEC").

The labeled items in the diagram above include:





- Labels (A)
- Safety symbols and other markings (1-11)







These items are defined on subsequent tables.

Back Labels

Callout	Definition
A	Electrode Placement Diagrams (See “Positioning ECG Electrodes” on page 3-8.)

Safety Symbols and Other Markings

Callout	Label	Definition
1		Considered Class 2 radio equipment per Directive 1999/5/EC for which Member States may apply restrictions on putting the device into service or placing it on the market. This device is intended to be connected to the publicly available interfaces (PAI) for use throughout the EEA.
2		Compliance to Council Directive 93/42/EEC (MDD).
3		The transmitter patient connections are protected against defibrillation (DEFIBRILLATION-PROOF) and are a TYPE CF APPLIED PART.
4	R_x	Prescription device.
5		Follow operating instructions.

Callout	Label	Definition
6		Non-Ionizing Radiation. Interference to electronic equipment may occur in the vicinity of devices marked with this symbol.
7		Complies with all applicable Canadian and American standards.
8		Serial Number. Needed to identify the equipment during a call to the Response Center.
9		Philips Catalog Number.
10		MAC Address of device.
11		Date of manufacture.

Sounds

The transmitter produces auditory information signals to inform you of measurement and battery conditions. The main tone, which can be set to one of 5 different volume settings or turned off, is configurable. In addition, a lower pitched tone is used to identify a pulse beat occurring during an SpO₂ Spot Check measurement.

Auditory Information Signal	Definition
Beep	Power On Self Test Passed SpO ₂ Spot Check Measurement Complete
Beep Beep	Power On Self Test Failed SpO ₂ Spot Check Measurement Failed
Boop	Boop signal corresponding to detected Pulse (during SpO ₂ Spot Check measurement only)

Transmitter Safety Information

Warning

If another radio medical device is operating at the same frequency as the transmitter, it is possible that either device will not function properly.

Warning

Although the transmitter is shielded against Electromagnetic Interference (EMI), avoid the use of other electrically radiating devices in close proximity to the transmitter, which might interfere with transmitter operation.

Warning

Place the transmitter in a pouch or over clothing, or both, during patient use. The transmitter should not touch the patient's skin during use.

Briefing the Patient

Warning

Patients should be instructed not to open the battery cover while the transmitter is in use.

If the Telemetry button has been configured to generate a Nurse Call, recording at the Information Center, or both, instruct the patient to use the button when needed.

Note—If desired, the clinician can turn off patient use of the button at the Information Center. See “Turning Nurse Call On/Off” on page 1-23.

Pouch Use

The transmitter is not designed for direct contact with the patient’s skin. During normal use, the transmitter should be worn over clothing, in a pocket or, preferably, in a pouch. The carrying pouch is an appropriate means for holding the transmitter.

Securing the Pouch

Task Summary

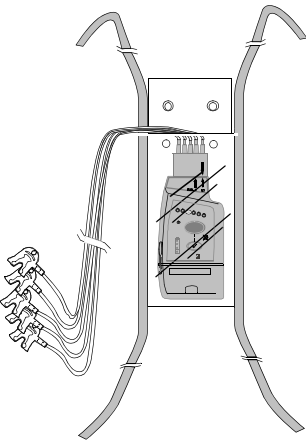
Step	Action
1	<p data-bbox="447 412 1170 472">Secure the pouch on the patient with upper ties around the patient's head and arm, and lower ties around the patient's lower torso.</p> <hr/> <p data-bbox="458 496 565 524">Warning</p> <hr/> <p data-bbox="447 537 1130 597">To avoid strangulation, do not tie a pouch solely around the patient's neck.</p> <hr/>
2	<p data-bbox="447 667 1114 727">Insert the transmitter into the pouch with lead wires and SpO2 sensor cable, if used, exiting from the same side.</p>  <p data-bbox="447 1235 1177 1295"><i>Important</i>—Do not coil the cables inside the pouch. They are part of the antenna system and need to be freely exposed.</p>

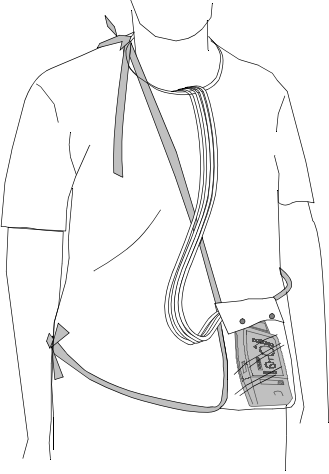
Step	Action
3	Fold the flap down and snap closed.
4	<p>Check that the patient is comfortable wearing the pouch with transmitter.</p>  <p>The diagram shows a line drawing of a person's torso and arms. A shoulder strap is worn over the right shoulder, crossing the chest, and then looping under the left arm. A rectangular pouch containing a transmitter is attached to the end of the strap on the left side. The pouch has a flap and a strap that is secured with a snap.</p>

Showering

Warning

Signal quality and leads off detection may be compromised when showering due to significant patient movement. Appropriate clinical precautions must be taken.

The transmitter can be used to monitor a patient in the shower, but only when placed inside a Philips carrying pouch with the flap closed and the snaps secured. The combination of the transmitter and pouch will withstand showering for up to 10 minutes.

**Drying the
Transmitter
after
Showering**

After showering, perform the following steps to continue monitoring:

1. Pat dry the lead set connections at the electrodes.
2. Wipe the lead wires with care.
3. If wet, dry the outside of the transmitter with a non-lint-producing cloth.
4. If wet, wipe the inside of the battery compartment dry. Dry the batteries.
5. If wet, disconnect the ECG lead block and shake out any water. Dry the connector pin area with a cotton swab.

Note—The transmitter should not be used for monitoring if the battery compartment is wet. Remove the batteries and wipe the compartment dry before continued monitoring use.

**Accidental
Wetting**

If the transmitter is accidentally immersed in liquid for up to 5 minutes, no damage to the device and no electrical safety issues for the patient will result. Remove the device, dry it off, and follow the procedure for cleaning/disinfection or cleaning/cross-infection prevention under “Transmitter Cleaning, Disinfection, & Cross-Infection Prevention” on page 6-4 as appropriate.

Making Monitoring Adjustments

**Turning the
Transmitter
On/Off**

The transmitter is powered by two AA alkaline batteries. To turn the transmitter on, insert both batteries. Remove the batteries to turn the power off.

Note—Transmitter settings (SpO2 mode, audible tone volume, etc.) set using the Service Tool/TeleMon are retained indefinitely after battery removal.

Turning Telemetry Monitoring On/Off

Telemetry monitoring can be turned on or off in one of two ways:

- Manually, by activating Monitoring Standby at the IntelliVue Information Center (see “Standby Mode” on page 1-24).
- Automatically, if Auto Shutoff is enabled at the transmitter and if all leads are off for 10 minutes (see “Transmitter Auto Shutoff” on page 1-23).

Note—Turning telemetry monitoring off *does not turn the transmitter off*. Turn the transmitter off by removing the batteries.

Transmitter Auto Shutoff

A service feature of the transmitter is RF Automatic Shutoff, which causes the transmitter to stop broadcasting a radio signal if all leads are off for 10 minutes. This prevents interference with other transmitters in use. The technical alarm message at the Information Center is TRANSMITTER OFF. To restart monitoring, attach leads to the patient. Automatic Shutoff can be configured off. Batteries must be removed when the transmitters are not in use to prevent RF interference and unnecessary battery drain.

Note—Automatic Shutoff does not save battery life. In order to allow an automatic turn-on when the leads are reattached, transmitter functions are not completely disabled in this mode. To extend battery life, remove the batteries when the transmitter is not in use.

Turning Nurse Call On/Off

If the Telemetry button on the transmitter is configured for a Nurse Call alarm, you can inhibit the alarm for individual patients by using the Telemetry Setup Window on the Information Center. If your system is configured for both a Nurse Call alarm and a recording, only the Nurse Call alarm is inhibited by turning it off: recordings are still made.

Task Summary

Turn the Telemetry button on the transmitter on or off by performing the following steps:

Step	Action
1	On the Patient Window click the All Controls button.

Step	Action
2	On the All Controls Window click Telemetry Setup .
3	On the Telemetry Setup Window turn the Telemetry button on or off by clicking in the Telemetry Button Allow Calls checkbox. A check mark in the checkbox indicates that the Telemetry button is on.

Standby Mode

When a patient is temporarily off the unit or out of antenna range you can suspend monitoring by placing telemetry in Standby mode. Standby suspends monitoring, and you won't get any waveforms or alarms.

Note—If you remove the leads before putting a patient into Standby, you'll get a LEADS OFF technical alarm, and reminders if configured.

Warning

If you put telemetry in Standby mode, you *must* remember to turn monitoring back on when the patient returns to the unit.

Note—When you take an EASI transmitter out of Standby, the lead settings revert back to the central's default lead settings (i.e., II and V2).

Task Summary

Place a patient in Standby by performing the following steps:

Step	Action
1	On the Patient Window click the Standby button.
2	Select the patient's location from the pre-defined list.

Step	Action
3	<p>Click the Suspend Monitoring button. This suspends all monitoring and displays the following message in the Patient Sector TELEMETRY STANDBY and the location (for example, X-Ray).</p> <p><i>Note</i>—Be sure to take the bed out of Standby before discharging. Since Standby is associated with the equipment assigned to a bed, if a patient is discharged and the bed is in Standby mode, that equipment will be in Standby for the next patient, and monitoring will continue to be interrupted.</p>
4	<p>When the patient comes back, restart monitoring by clicking on Resume Monitoring in the Patient Sector.</p>

Use with TeleMon B, Options A02/A03

The M2601B Transmitter can employ the full functionality of the TeleMon B (Options A02 or A03) Companion Monitor, including NBP measurement and local display of alarms. Connection is made through an interface cable at the TeleMon/Service port. Please refer to the *Philips TeleMon B A02/A03 Companion Monitor Instructions for Use* for operating instructions.

Note—Option A02 can be used with either the M2601B transmitter tethered to the monitor or the M2601A transmitter docked to it. Option A03 can be used only with the M2601B transmitter tethered to the monitor. (TeleMon B Options A02/A03 units are distinguished by a gray front bezel; while Option A01 units have a dark green front bezel.)

Operation with TeleMon

When the transmitter is tethered to TeleMon:

- Standby mode is not available.
- 3-minute alarm pause/suspend is available from TeleMon. The alarm pause indicator on the transmitter will accurately reflect the current state of alarm pause at TeleMon.

- After a change in lead set or SpO₂ sensor, TeleMon returns to the default ECG settings. Be sure to check the monitoring leads after you switch leads or sensor.
- Arrhythmia relearn will occur at TeleMon automatically if the lead set is changed.
- When the Check button is pressed, the transmitter battery gauge indicates full regardless of battery state.
- The transmitter receives operating power from TeleMon when tethered/docked.
Note—Batteries are not being charged when the transmitter is tethered/docked.

SpO₂ Operation

- When the transmitter is connected to TeleMon, SpO₂ operation is always switched to Continuous mode unless SpO₂ is turned off.
- TeleMon can also be used to change the SpO₂ operating mode when the transmitter is tethered. See “SpO₂ Measurement when Connected to TeleMon” on page 5-18.

Defibrillation

In the event of patient defibrillation, it may take several seconds for the ECG trace to appear on the screen.

Testing the Transmitter Functionality

There are two tests of the transmitter functionality:

- **Self Test** - performed automatically each time the transmitter is turned on.
- **Status Check** - initiated manually by the clinician.

Self Test

Warning

Do not use the transmitter for patient monitoring if it fails the Power On Self Test.

A self test of the transmitter functions is automatically performed each time that the transmitter is turned on (that is, batteries are inserted).

Self Test Status	Auditory Signal (if configured on)	Visual Indicators
Passed	Single beep	All LEDs illuminate for 3 seconds
Failed	Double beep tone	One or more indicators do not light up.

In Case of Failure

If any portion of the self test fails, the transmitter will attempt to report the failure to the monitoring system. In case of failure, use another transmitter, and contact your Service Provider.

Status Check

You can check the status of the transmitter indicators at any time.

Task Summary To initiate a Status Check, use the following instructions.

Step	Action
1	Press the Check button.
2	The following indicators should illuminate for as long as the Check button is depressed. <ul style="list-style-type: none">• Battery gauge• Type of lead set• EASI (if in use)
3	If one or more of the expected indicators do not light up, check the following: <ul style="list-style-type: none">• Make sure the lead set block is correctly inserted in the transmitter and the orange line at the base of the cable is not visible (see “Connecting the ECG Cable” on page 3-14)• Power and position of batteries (see “Checking the Battery Power Level” on page 1-32)• Lead positions and connections (see “Verifying Electrode Connections” on page 3-17)
4	If there is still a problem, contact your Service Provider for assistance.

Battery Information

Battery Safety Information

Warning

Use Duracell MN 1500 AA 1.5V Alkaline batteries to ensure specified performance. Outdated, mismatched, or poor-quality batteries can give unacceptable performance (e.g., insufficient Battery-Weak warning time). The use of fresh high-quality alkaline batteries is strongly recommended.

Batteries should be removed from the transmitter at the end of the battery's useful life to prevent leakage.

If battery leakage should occur, use caution in removing the batteries. The leaked substance may cause eye or skin irritation. Avoid contact with skin. Clean the battery compartment according to instructions in "Chapter 6. Maintenance and Configuration". Wash hands.

Certain failure conditions, such as short circuits, can cause a battery to overheat during normal use. High temperatures can cause burns to the patient and/or user. If the transmitter becomes hot to the touch, place it aside until it cools. Then remove the batteries and discard them. Have the transmitter operation checked by your Service Provider to identify the cause of overheating.

The battery door must be closed during defibrillation.

If you receive a BATTERY WEAK alarm, the batteries must be promptly replaced. A "Battery Weak" condition that is not corrected will result in transmitter shutdown and cessation of monitoring.

Be careful not to short circuit the battery. Short circuiting is caused when a piece of metal connects both positive and negative terminals together. More than a momentary short circuit will generally reduce the battery life.

Disposal of Batteries

Caution

The battery must be removed if a transmitter will be stored for an extended period of time.

Important—When disposing of batteries, follow local laws for proper disposal. Dispose of batteries in approved containers. If local regulations require you to recycle batteries, recycle batteries in accordance with regulations.

Battery Life

Battery life is dependent upon:

- Condition of the batteries.
- Parameters being monitored - ECG only, ECG and Spot Check SpO₂, or ECG and Continuous SpO₂.

By observing the following guidelines, you can optimize battery life in the Philips transmitter:

- REMOVE THE BATTERIES when the transmitter is not in use.
- If using TeleMon, see the *Philips TeleMon B A02/A03 Companion Monitor Instructions for Use*, page 3-7.

Note—Automatic Shutoff of the transmitter does not eliminate battery usage. In order to allow an automatic turn-on, the transmitter ECG and SpO₂ functions are not completely disabled in this mode.

Note—The Battery Extender for the M2601A Transmitter **cannot** be used with the M2601B Transmitter to extend battery life.

Inserting/ Removing Batteries

The battery compartment is located at the bottom of the transmitter and accommodates a pair of AA 1.5V Alkaline batteries. Only this type of disposable battery shall be used.

Important—Do not use rechargeable batteries. Use of this type of battery will adversely affect:

- Battery gauge performance.
- Battery low warnings.
- Battery life performance.

Task Summary Insert batteries into the transmitter using the following procedure.

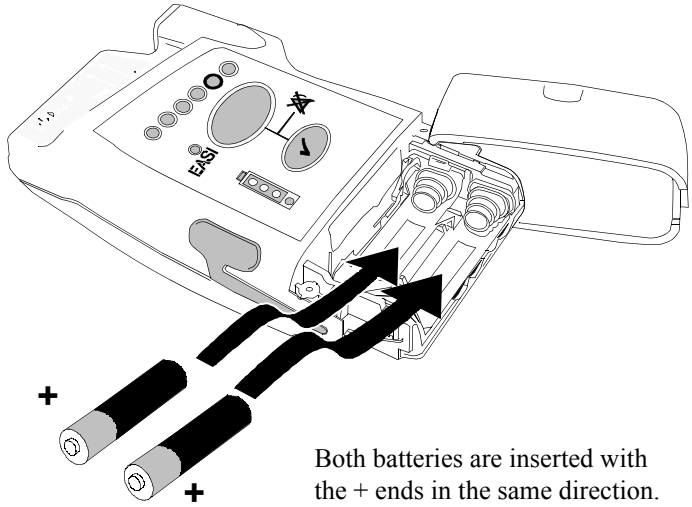
Step	Action
1	Open battery compartment by swinging the compartment door 90° into an open hinged position.
2	Insert two disposable AA 1.5V Alkaline batteries, matching the polarity with the +/- indications inside the compartment.  <p data-bbox="826 1250 1176 1307">Both batteries are inserted with the + ends in the same direction.</p>
3	Close the battery compartment door.

Battery Information

Batteries should be changed in sets, that is, if you change one battery, change them both.

If you remove good batteries to turn off the transmitter, keep them together as a set for later re-use so that both batteries will have the same level of power remaining.

Batteries should be removed when the transmitter is not in use or is being stored. **DO NOT STORE BATTERIES BY LEAVING THEM IN THE INCORRECT POLARITY POSITION INSIDE THE TRANSMITTER.**

Be careful not to short circuit the batteries. Short circuits are caused when a piece of metal touches both the positive and negative terminals simultaneously (for example, by carrying batteries in a pocket with loose change). More than a momentary short circuit will generally reduce the battery life. In case of a short circuit, discard both batteries in a pair, or just the shorted one if the batteries are new.

Checking the Battery Power Level

When the Check button is pressed, the battery gauge on the transmitter indicates the battery power level.

The approximate battery life remaining indicated by the gauge is given in the table below. The percentages and times are for ECG operation only.

Note—The battery life times are based on Duracell MN 1500 batteries. Battery life for other brands may be different.

Battery Gauge	Approximate Battery Life Remaining (ECG Only)	Approximate Operating Time Remaining	Functionality
4 green indicators	>75%	>30.4 hours Japanese version: >33 hours	Normal operation
3 green indicators	>50%	>20.3 hours Japanese version: >22 hours	Normal operation

Battery Gauge	Approximate Battery Life Remaining (ECG Only)	Approximate Operating Time Remaining	Functionality
2 green indicators	>25%	>10.1 hours Japanese version: >11 hours	Normal operation
1 green indicator	25% to BATTERY WEAK level	>15 minutes	Normal operation
1 red indicator	BATTERY WEAK level to REPLACE BATTERY level	<15 minutes	SpO ₂ disabled
no indicator	REPLACE BATTERY level (Check batteries for correct polarity)		Transmitter shutdown

Task Summary

To check the power level, use the following instructions.

Step	Action
1	Insert batteries if the transmitter is not already on.
2	Press the Check button to determine the level. (See “Checking the Battery Power Level” on page 1-32.):
3	<p>If no indicators flash:</p> <ol style="list-style-type: none"> 1. Check that the batteries are inserted properly. 2. Replace both batteries. 3. If there are still no indicators on the battery gauge, contact your Service Provider. <p>If the indicators illuminate but do not behave as described in Step 2 above, the transmitter has malfunctioned. Contact your Service Provider.</p>

Receiver Module

The Philips receiver modules are housed in the receiver mainframe. Each receiver module is dedicated to a specific transmitter by an internal identity code. This prevents another patient's waveform from being erroneously transmitted and displayed. The receiver acquires the ECG and SpO₂ signals from the transmitter and sends them to the receiver mainframe.

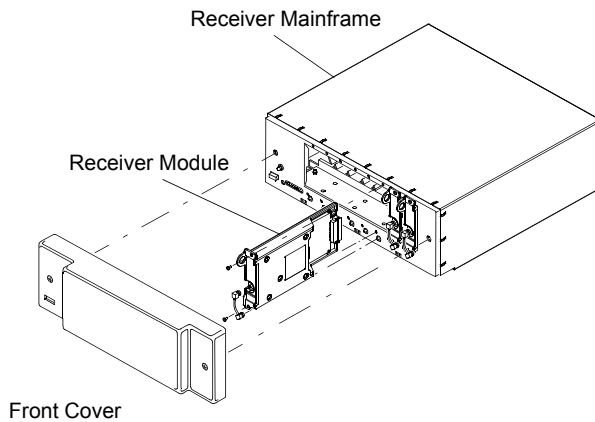

Receiver Mainframe

The Philips receiver mainframe houses up to eight receiver modules. For each receiver, the receiver mainframe calculates the heart rate, and sends the waveform, patient alarms, technical alarms, and status messages over the Philips patient care system to the IntelliVue Information Center for display and recording. If SpO₂ is available, the transmitter processes the data and sends it to the IntelliVue Information Center via the network as well.

Turning the Receiver Mainframe On or Off

The receiver mainframe must be turned on for individual transmitters and receivers to work. To turn the receiver mainframe on, the power cord must be attached and connected to an AC outlet. A green LED on the rear of the Mainframe will light then.

If the receiver mainframe is turned off, the light and all receiver modules are off.

Receiver Mainframe Malfunction Light

A red light on the front panel of the mainframe illuminates when either the mainframe or one of the receivers has malfunctioned. Depending on the problem, you may see the message, NO DATA FROM BED or RECEIVER MALF, in single or multiple patient sectors. Contact your Service Provider.

When the mainframe is first turned on, the red light flashes. If no problems are detected, the flashing stops and the light turns off.

Channel Frequencies

The frequency of Philips transmitters and receivers are programmable, thus enabling changes in frequency if interference is detected. In case of interference, contact service.

Retaining Telemetry Settings

If power to the receiver mainframe is interrupted or turned off, settings controlled by the mainframe such as leads may be affected.

- If the receiver mainframe is turned off for less than three hours, your settings should still be in effect.
- If the mainframe is turned off for more than three hours, your settings revert to default, that is, to the configured settings at installation.

Antenna System

The telemetry antenna system is custom-designed for your unit to ensure adequate coverage, therefore the telemetry signal can only be received where there are receiving antennas. After it is received by the antenna system, it is sent to the receiver which recovers the patient's ECG and optional SpO₂. This information is then sent to a monitoring display.

2

Alarms

This chapter describes alarm behavior and lists Physiologic Alarms (Patient Alarms) and Technical Alarms (Inoperative Conditions). Both types of alarms are listed alphabetically.

- Alarm Indicators 2-2
- Pause/Suspend Alarms 2-2
- Alarm Behavior with Own Bed Overview 2-3
- Physiologic (Patient) Alarms 2-6
- Technical Alarms (INOPs) 2-11

Alarm Indicators

A description of visual and auditory information signals for patient and technical alarms on the Information Center is located in the *IntelliVue Information Center Instructions for Use* and the Online Help. The Information Center documentation also includes the default alarm settings and physiological alarm limit ranges.

Pause/Suspend Alarms

All alarms for a patient can be paused/suspended from the Information Center, or from the TeleMon Companion Monitor, if connected. See the *Instructions for Use* for the Information Center or TeleMon for directions.

If connected to TeleMon, alarms can be suspended only from TeleMon, and not from the Information Center. If alarms are suspended from TeleMon, the Alarms Suspend icon on the transmitter is lit (see “Transmitter Controls - Front” on page 1-11) and an ALARMS SUSPENDED message appears at TeleMon and the Information Center.

Alarm Behavior with Own Bed Overview

Both the IntelliVue Patient Monitor and the telemetry system source alarms. The following tables summarize alarm behavior when Own Bed Overview is used. For detailed information, see the *IntelliVue Patient Monitor Instructions for Use* and the *IntelliVue Information Center Instructions for Use*.

Alarm Pause/Suspend

When alarms are paused/suspended, the messages and types of alarms affected depend on where the pause/suspend was initiated.

If alarms are paused/suspended from....	these alarms are paused/suspended	and this message appears
Information Center	both bedside and telemetry measurements	<p>Information Center: ALARMS PAUSED or ALARMS SUSPENDED</p> <p>Bedside: ALARMS OFF in Overview window and ALARMS PAUSED or ALARMS OFF on the monitor (depending on configuration)</p>
IntelliVue Patient Monitor	bedside measurements only	<p>Information Center: BED ALARMS OFF or BED ALARMS SUSPEND (depending on configuration)</p> <p>Bedside: ALARMS PAUSED or ALARMS OFF</p>

Alarm Silence

When an active alarm is silenced, the types of alarms that are silenced depend on the alarm source and where the silence was initiated.

Alarm Source	Where Silenced	Effect at Paired Bedside	Effect at Information Center
Bedside alarm	Bedside	Alarm is silenced	Bedside alarm is silenced. There is no effect on telemetry alarms
Telemetry alarm	Bedside	No effect on telemetry alarms	No effect on telemetry alarms
Bedside and/or telemetry alarm	Overview Silence Control	Bedside or telemetry alarm is silenced	Bedside alarm is silenced (if Silence Overview Alarms is configured)
Bedside and/or telemetry alarm	Information Center	Bedside or telemetry alarm is silenced	Bedside or telemetry alarm is silenced

Note—If tethered to TeleMon, silencing an active alarm at TeleMon silences the alarm at TeleMon only. It has no effect on the paired bedside monitor or the Information Center.

Alarm/INOPs at the Information Center

The alarms and INOPs that are displayed, recorded and stored at the Information Center depend on the type of alarm.

Type of Alarm/INOP	Effect at Information Center
All ECG telemetry alarms and INOPs <i>Note</i> —ECG is generated from telemetry when paired.	Displayed, recorded (if configured), and stored
Bedside ECG INOPs and RESP INOPs	Ignored. Not displayed, recorded, or stored
Bedside non-ECG alarms and non-ECG INOPs	Displayed, recorded (if configured), and stored

Physiologic (Patient) Alarms

There are no physiologic (patient) alarm signals generated by the transmitter. **All physiologic alarms are generated at the IntelliVue Information Center, and all alarm signals must be acknowledged at the Information Center.**

Arrhythmia alarm chaining and other aspects of alarm behavior, such as alarm levels, setting alarm limits, customizing arrhythmia alarm settings on a per patient basis, switching individual measurement alarms on/off, and reviewing alarm messages, are described in *IntelliVue Information Center Instructions for Use*.

If arrhythmia is turned off at the Information Center, the cardioteach is available on the telemetry mainframe for the following alarms: Asystole, V-fib, High HR, Low HR.

There are two levels of arrhythmia analysis available at the Information Center: Basic and Enhanced. Enhanced analysis includes Basic alarms.

In the table Red (***) alarms are listed alphabetically, followed by the Yellow (**) alarms, then Yellow (*) arrhythmia alarms.

Note—In Release D.00/D.01/E.00/E.01 of the IntelliVue Information Center, yellow ST/AR arrhythmia alarms are indicated by (**) rather than (*).

Physiologic (Patient) Alarms

Alarm Text	Priority	Condition	Source
***ASYSTOLE	Red	Asystole. No QRS for 4 consecutive seconds	ST/AR Basic and Enhanced Arrhythmia Mainframe cardiotech
*** BRADY yyy <xxx	Red	Extreme Bradycardia. HR < extreme Brady HR Limit	ST/AR Enhanced Arrhythmia
*** EXTREME BRADY	Red	Extreme Bradycardia. HR < extreme Brady HR Limit	ST/AR Basic and Enhanced Arrhythmia
*** EXTREME TACHY	Red	Extreme Tachycardia. HR > extreme Tachy HR Limit	ST/AR Basic and Enhanced Arrhythmia
*** TACHY yyy < xxx	Red	Extreme Tachycardia. HR > extreme Tachy HR Limit	ST/AR Enhanced Arrhythmia
*** VFIB	Red	Ventricular Fibrillation. Fibrillatory waveform for 4 consecutive seconds	Mainframe cardiotech
*** V-FIB/TACH	Red	Ventricular Fibrillation. Fibrillatory waveform for 4 consecutive seconds	ST/AR Basic and Enhanced Arrhythmia
*** V-TACH	Red	Ventricular Tachycardia. Sustained run of PVCs accompanied by a high heart rate	ST/AR Basic and Enhanced Arrhythmia
** HIGH HR	Yellow	High Heart Rate. HR > high HR Limit	Mainframe cardiotech

Physiologic (Patient) Alarms

Alarm Text	Priority	Condition	Source
** LOW HR	Yellow	Low Heart Rate. HR < low HR Limit	Mainframe cardiotech
** NURSE CALL	Yellow	Telemetry button press on the transmitter (when configured for Nurse Call operation)	Clinician/patient-initiated at the transmitter
** SpO2 yyy > xxx	Yellow	High SpO ₂ . SpO ₂ value greater than high SpO ₂ Limit	SpO ₂
** SpO2 yyy < xxx	Yellow	Low SpO ₂ . SpO ₂ value less than low SpO ₂ Limit	SpO ₂
* HR yyy > xxx	Yellow	High Heart Rate. HR > high HR Limit	ST/AR Enhanced Arrhythmia
* HR yyy < xxx	Yellow	Low Heart Rate. HR < low HR Limit	ST/AR Enhanced Arrhythmia
* IRREGULAR HR	Yellow	Irregular Heart Rate. Constantly irregular HR.	ST/AR Enhanced Arrhythmia
* LOW HR	Yellow	Low Heart Rate. HR < low HR Limit	ST/AR Basic and Enhanced Arrhythmia
* MISSED BEAT	Yellow	Missed Beat. Beat omitted	ST/AR Enhanced Arrhythmia
* MULTI ST Ld X, Ld Y	Yellow	Multi ST Leads exceeding Limit (EASI mode or when selected). Two ST leads (Ld X, Ld Y) exceed elevation or depression for > 60 seconds	ST/AR Arrhythmia
* MULTIFORM PVCs	Yellow	Multiform PVCs	ST/AR Enhanced Arrhythmia

Physiologic (Patient) Alarms

Alarm Text	Priority	Condition	Source
* NON-SUSTAIN VT	Yellow	Non-Sustained VT. Non-Sustained Ventricular Tachycardia	ST/AR Enhanced Arrhythmia
* PACER NOT CAPT	Yellow	Pacer Not Capture. Missed beat with pace pulse (paced patient).	ST/AR Basic and Enhanced Arrhythmia
* PACER NOT PACE	Yellow	Pacer Not Pacing. Missed beat without pace pulse (paced patient).	ST/AR Basic and Enhanced Arrhythmia
* PAIR PVCs	Yellow	Pair of PVCs.	ST/AR Enhanced Arrhythmia
* PAUSE	Yellow	Pause. No QRS for > x seconds	ST/AR Enhanced Arrhythmia
* PVC > xx/min	Yellow	PVCs > xx/min. PVCs > Rate Limit	ST/AR Basic and Enhanced Arrhythmia
* R-ON-T PVCs	Yellow	R-on-T PVCs	ST/AR Enhanced Arrhythmia
* RUN PVCs	Yellow	Run PVCs. Run of PVCs length ≥ 2	ST/AR Enhanced Arrhythmia
* ST lead > xxx	Yellow	STx > Elevation limit. ST segment is elevated	ST/AR Arrhythmia
* ST lead < xxx	Yellow	STx < Depression limit. ST segment is depressed.	ST/AR Arrhythmia
* SVT	Yellow	Supra Ventricular Tachycardia. SVT for > 15 seconds	ST/AR Enhanced Arrhythmia

Physiologic (Patient) Alarms

Physiologic (Patient) Alarms

Alarm Text	Priority	Condition	Source
* VENT BIGEMINY	Yellow	Ventricular Bigeminy. Predominant Bigeminy rhythm present.	ST/AR Enhanced Arrhythmia
* VENT RHYTHM	Yellow	Ventricular Rhythm. Ventricular rhythm present.	ST/AR Enhanced Arrhythmia
* VENT TRIGEMINY	Yellow	Ventricular Trigeminy. Predominant Trigeminy rhythm present.	ST/AR Enhanced Arrhythmia

Technical Alarms (INOPs)

Technical Alarms, or INOPs, are sourced at the transmitter or TeleMon Companion Monitor, and identify inoperative conditions. There are three types of Technical Alarms. *Severe* technical alarms must be acknowledged by a clinician. A *Hard* technical alarm indicates that monitoring and alarms are disabled and generates an audible tone at the Information Center. With a *Soft* technical alarm, monitoring and alarms remain active, and no audible tone is generated.

Technical Alarms (INOPs)

Alarm Text	Priority	Condition	What to do
##nnn/nnn(nnn)nnn (RF technical alarm)	Soft	Used by service in troubleshooting the radio signal	Contact Service Provider.
ARRHY REQUIRED	Hard	Arrhythmia monitoring was turned off for an EASI transmitter.	Turn arrhythmia monitoring on or move lead set to the Standard ECG position if arrhythmia monitoring is not desired.
BATTERY WEAK	Soft	Weak batteries	Replace batteries promptly to avoid transmitter shutdown and cessation of monitoring.
CANNOT ANALYZE ECG	Hard	Arrhythmia algorithm cannot reliably analyze the ECG data on any monitored leads.	Assess the lead selections, initiate relearn, and validate analyzed rhythm. <i>Note</i> —See “Optimizing System Performance” on page 3-22.

Technical Alarms (INOPs)

Alarm Text	Priority	Condition	What to do
CANNOT ANALYZE ST	Soft	ST algorithm cannot reliably generate any valid ST values on any monitored lead.	Assess the lead selections. <i>Note</i> —See “Optimizing System Performance” on page 3-22.
ECG EQUIP MALF	Hard	Failure of the ECG equipment or failure to calibrate ECG	Replace transmitter or calibrate ECG with Service Tool.
INTERFERENCE	Hard	Interference due to outside source	Check that there are no transmitters stored with batteries inserted. Change the Philips transmitter and receiver frequency. Contact Service Provider.
INVALID LEADSET	Hard	Bad lead selection switches in transmitter	Replace transmitter case. Use supported lead set.
INVALID SIGNAL E01	Hard	Receiver is picking up a duplicate frequency.	When the transmitter is not being used, turn telemetry monitoring off for the bed. If the situation continues, contact Service. If this is a new transmitter, the system must learn the new transmitter ID code - contact Service Provider.
LEADS OFF	Hard	Single or multiple leads off	Reattach ECG leads to patient.

Technical Alarms (INOPs)

Alarm Text	Priority	Condition	What to do
NO RECEIVER	Hard	Receiver absent or malfunctioning	This message appears after the mainframe is turned on and indicates the absence of a receiver or a receiver is faulty. Contact Service Provider.
NO SIGNAL	Hard	Patient is out of range, radio board has failed, no batteries in transmitter, or batteries inserted incorrectly.	Make sure that the transmitter is in range. Check batteries for correct insertion. Replace transmitter if Power On Self Test fails, and notify Service Provider.
RECEIVER MALF	Hard	Receiver is malfunctioning.	Contact Service Provider.
REPLACE BATTERY	Hard, Latched Message remains until acknowledged by clinician.	Batteries are unable to power the transmitter, or batteries are inserted backwards. No monitoring is occurring.	Replace batteries/check batteries for correct insertion.
SpO2 EQUIP MALF	Hard	Malfunction in the SpO ₂ hardware	SpO ₂ board needs to be replaced. Call Service Provider.
SpO2 ERRATIC	Hard	Erratic SpO ₂ measurements, often due to a faulty sensor or invalid SpO ₂ measurements, or incorrect sensor position	Repeat measurement, reposition sensor on patient, or finally, replace sensor.

Technical Alarms (INOPs)

Alarm Text	Priority	Condition	What to do
SpO ₂ INTERFERENCE	Hard	Level of ambient light or level of electrical interference are so high that the SpO ₂ sensor cannot measure SpO ₂ and pulse rate.	Reduce ambient light to sensor or electrical noise sources. Conceal/cover sensor with opaque non-white cover.
SpO ₂ NO TRANSDUCER	Hard	No sensor attached to SpO ₂ device	Attach SpO ₂ sensor.
SpO ₂ NOISY SIGNAL	Hard	Excessive patient movements or electrical interference are causing irregular pulse patterns	Reduce movement or electrical noise sources.
SpO ₂ NON-PULSATILE	Hard	Pulse is too weak or not detectable	Check connection to patient. Change sensor site. Avoid site distal to BP cuff or intra-arterial line.
SpO ₂ TRANS MALF	Hard	Malfunction of the SpO ₂ sensor/adapter-cable	Replace sensor.

Technical Alarms (INOPs)

Alarm Text	Priority	Condition	What to do
TEL CANNOT ANALYZE	Hard INOP	Shorts bursts of data corruption inhibiting an accurate HR count. (Often accompanied by WEAK SIGNAL, NO SIGNAL, or INTERFERENCE INOPs.)	<p>Check that there are no transmitters stored with batteries.</p> <p>Check to see if the patient is in the coverage area, and return patient if needed.</p> <p>If the patient is in the coverage area and is stationary, move the transmitter or patient about 6 inches (15 cm.).</p> <p>If the situation persists, contact Service Provider.</p>
TRANSMITTER MALF	Hard	Transmitter malfunction	Replace transmitter and notify Service Provider.

Technical Alarms (INOPs)

Alarm Text	Priority	Condition	What to do
TRANSMITTER OFF	Soft	RF shut off after 10 minutes of leads off	Reattach ECG leads to patient.
WEAK SIGNAL	Soft	Weak RF signal received at Telemetry Mainframe from transmitter	<p>Move transmitter into RF coverage area and re-check transmitter. If condition exists in close proximity to the antenna, replace transmitter.</p> <p>Check to see if the patient is in the coverage area, and return patient if needed.</p> <p>If the patient is in the coverage area and is stationary, move the transmitter or patient about 6 inches (15 cm.).</p> <p>If the situation persists, contact Service Provider.</p>

ECG & ST/AR Measurement

This chapter covers the specifics of ECG measurement, as well as arrhythmia monitoring using the ST/AR algorithm. It includes the following sections:

- Measuring ECG. 3-2
- Setting Up for ECG Monitoring 3-7
- Connecting the ECG Cable 3-14
- Verifying Electrode Connections 3-17
- Making ECG Adjustments 3-18
- Monitoring During Leads Off 3-19
- Optimizing System Performance 3-22
- ECG Safety Information 3-27
- ST/AR Arrhythmia Analysis. 3-28

TO TRANSLATORS for geographies where IEC ECG lead sets are used:

Please use the graphics showing IEC electrode colors (see "13 August graphics IEC.fm").

Also, if needed, change the electrode colors in the text to conform to the IEC colors.

Note that the graphics and text in this chapter say "V1, V2, V3....." for the chest lead designations. For IEC please substitute "C2, C2, C3, etc.".

Measuring ECG

The electrocardiogram (ECG) measures the electrical activity of the heart and displays it on the Information Center as a waveform and a numeric.

There is no cardiotech within the transmitter: cardiotech analysis resides in the telemetry mainframe. The type of ECG analysis depends on whether or not arrhythmia analysis is on or off at the Information Center.

- When arrhythmia is turned *on* at the Information Center, the cardiotech is included as part of arrhythmia analysis in the Information Center for standard lead placement.
- When arrhythmia is turned *off* at the Information Center, the cardiotech is available on the telemetry mainframe.

Note—Arrhythmia analysis must be turned on at the Information Center when using EASI mode.

ECG Lead Sets

The M2601B Transmitter supports two different lead sets (see “Connecting the ECG Cable” on page 3-14). It detects the inserted lead set type and automatically determines the ECG measurement and transmitted leads. The Lead Set Insertion Guide on the device will assist you in ensuring the correct measurement during transmitter usage (see “Connecting the ECG Cable” on page 3-14). The 5-wire lead set can be used for either Standard or EASI electrode configurations. The lead sets are compatible with the 5- and 3-wire lead sets used with the IntelliVue family of monitors.

Important—M2601B Transmitter lead sets are not compatible with M2601A Transmitters.

The electrode placements for the illustrations in this chapter use the AAMI labels and colors. 5-wire lead sets are available with the lead-wire color option. The following table lists the AAMI and IEC electrode locations and colors.

Electrode Locations and Colors

Lead Set Type	Electrode Location	AAMI Electrode Color	IEC Electrode Color
3-wire	LA	Black	Yellow
	RA	White	Red
	LL	Red	Green
5-wire (in Standard Mode) (in EASI Mode)	LA	Black	Yellow
	RA	White	Red
	LL	Red	Green
	RL	Green	Black
	V	Brown	White
	S	Black	Yellow
	I	White	Red
	A	Red	Green
	N	Green	Black
	E	Brown	White

ECG Leads Monitored

Depending on the lead set connected to the transmitter, a different set of viewable leads are available at the Information Center. The transmitter can source up to four raw ECG waves. The transmitter automatically recognizes the lead set connected.

If you are using ... **these leads are available**

3-wire

If Lead Select is configured off:

- Default is II.
- To monitor a different lead, change the electrode placement to the lead you want. Then, at the Information Center, select the lead label that reflects the electrode placement.
- Choices are I, II, or III.
Note—The raw ECG is received on Channel 1 as II.

If Lead Select is configured on:

- Default is II.
- If tethered to TeleMon, you can select a different lead at TeleMon without moving the electrodes. Choices are I, II, or III.
Note—The raw ECG is received on Channel 1 as I, II, or III, depending on which lead is selected.

If you are using ... **these leads are available**

5-wire (Standard Mode) I, II, III, aVR, aVL, aVF, MCL, and V

Defaults are II, V, III

In Standard mode, the raw ECG waves are received as:

- Channel 1 = Lead II
- Channel 2 = Lead III
- Channel 3 = Lead MCL

Lead selection is available at the Information Center.

Important—Do not set the primary and secondary channels to the same lead.

5-wire (EASI Mode)

I, II, III, aVR, aVL, aVF, V1, V2, V3, V4, V5, V6

EASI 12-lead selection is available at the Information Center.

In EASI mode, the sourced waves are received as:

- Channel 1 = Vector 1 (A-I)
- Channel 2 = Vector 2 (A-S)
- Channel 3 = Vector 3 (E-S)

Although you can view and perform ST analysis on all 12 EASI derived leads, arrhythmia monitoring is performed only on the primary and secondary leads selected at the Information Center.

Reconstructed Leads

Reconstruction of 3 and 5 leads from the sourced wave is defined by the calculations in the following table. EASI reconstructed leads are a linear combination of all three raw EASI leads. Default labels/leads are shown in bold.

ECG Lead Reconstruction

ECG Lead		Clinical Calculations in terms of electrodes
3-wire	5-wire Standard	
I	I	LA-RA
II	II	LL-RA
III	III	LL-LA
-	MCL	Va-LA, C=Va
-	aVR	RA-(LA+LL)/2
-	aVL	LA-(RA+LL)/2
-	aVF	LL-(LA+RA)/2
-	V	C-(RA+LA+LL)/3, C=Va

Setting Up for ECG Monitoring

Task Summary

Step	Action
1	<p>Prepare the patient's skin. Good electrode-to-skin contact is important for a good ECG signal, as the skin is a poor conductor of electricity.</p> <ul style="list-style-type: none"> • Select sites with intact skin, without impairment of any kind. • Clip or shave hair from site, as necessary • Wash site with soap and water, leaving no soap residue. <i>Note—Philips does not recommend using ether or pure alcohol, because they dry the skin and increase the resistance.</i> • Dry thoroughly. • Use ECG skin preparation paper (abrasive) to remove dead skin cells and to improve the conductivity of the electrode site.
2	<p>Check electrodes for moist gel, and attach to the clips/grabbers. If you are not using pre-gelled electrodes, apply electrode gel to the electrodes before placement.</p> <p><i>Note—Gel must be moist to provide a good signal.</i></p>
3	<p>Place the electrodes on the patient according to the lead placement you have chosen (see "Electrode Placement" on page 3-8). Place the edge down, then "roll down" the rest of the pad. Press firmly around the adhesive edge toward the center.</p> <p><i>Note—When placing electrodes, choose a flat, non-muscular site where the signal will not be interfered with by either movement or bones. Correct lead placement is always important for accurate measurement, especially in the precordial leads, which are close to the heart. QRS morphology can be greatly altered if an electrode is moved away from its correct location.</i></p>

Positioning ECG Electrodes

Warning

Do not mix and match electrodes of different types. In particular, do not use electrodes of dissimilar metals. This helps ensure optimal signal quality.

Warning

When you are connecting the electrodes or the patient cable, make sure that the connectors never come into contact with other conductive parts, or with earth. In particular, make sure that all of the ECG electrodes are attached to the patient, to prevent them from contacting conductive parts or earth. This helps maintain maximum electrical patient safety.

Warning

Non-manufacturer supplied accessories and supplies can corrupt the performance of the equipment. Use only AAMI EC-12 compliant electrodes with this device. Use of electrodes that are non-compliant may provide erroneous results.

Caution

To protect the transmitter from damage during defibrillation, to ensure accurate ECG information, and to provide protection against signal noise and other interference, use only ECG electrodes and cables specified by Philips.

Electrode Placement

Diagrams for Standard 5-wire and EASI electrode placement are located on the back of the transmitter. Additional lead placement information is available in the Online Help in the IntelliVue Information Center.

Philips recommends that electrodes be changed every 24 hours.

**Locating the
Fourth
Intercostal
Space**

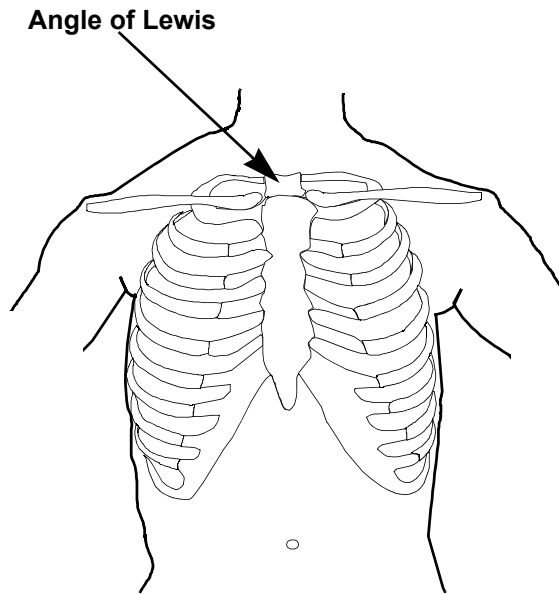

For accurate chest electrode placement and measurement, it is important to first locate the fourth intercostal space. This can be done using the Angle of Lewis.

1. Locate the second intercostal space by first palpating the Angle of Lewis (the bony protuberance where the body of the sternum joins the manubrium). This rise in the sternum is where the second rib is attached, and the space just below this is the second intercostal space.
2. Palpate and count down the chest until you locate the fourth intercostal space.

**5-wire
Placement
(Standard
Mode)**

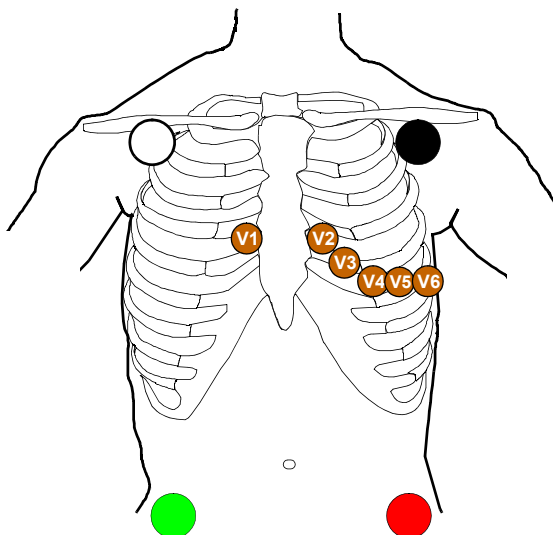

Lead	Placement
RA	directly below the clavicle and near the right shoulder
LA	directly below the clavicle and near the left shoulder
RL	on the right lower abdomen
LL	on the left lower abdomen
V	on the chest, the position depends on your required lead selection. The default position is V2.
V1	on the fourth intercostal space at the right sternal border

Lead	Placement
V2	on the fourth intercostal space at the left sternal border
V3	midway between the V2 and V4 electrode positions
V4	on the fifth intercostal space at the left midclavicular line
V5	on the left anterior axillary line, horizontal with the V4 electrode position
V6	on the left anterior axillary line, horizontal with the V4 electrode position

**5-wire
Placement
(EASI Mode)**

Warning

EASI derived 12-lead ECGs and their measurements are approximations to conventional 12-lead ECGs. As the 12-lead ECG derived with EASI is not exactly identical to the 12-lead conventional ECG obtained from an electrocardiograph, it should not be used for diagnostic interpretations.

EASI lead placement is supported for adult patients only

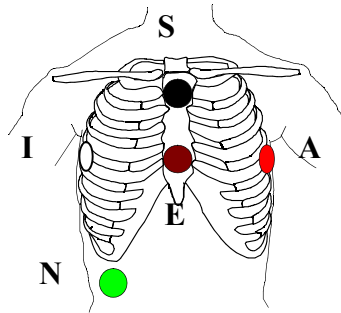

Lead	Corresponds to Standard Lead	Placement
E	V	on the lower sternum at the level of the fifth intercostal space
A	LL	on the left midaxillary line at the same level as the E electrode
S	LA	on the upper sternum
I	RA	on the right midaxillary line at the same level as the E electrode
N	Reference	can be anywhere, usually below the sixth rib on the right hip

**3-wire
Placement**

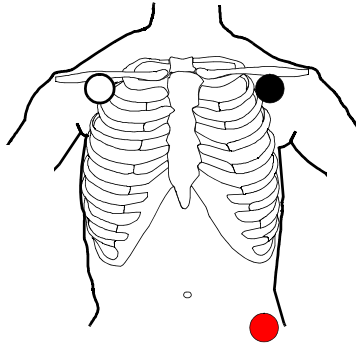

Lead	Placement
RA	directly below the clavicle and near the right shoulder
LA	directly below the clavicle and near the left shoulder
LL	on the left lower abdomen

Connecting the ECG Cable

Task Summary

Note—Your transmitters may have alignment guides that assist lead set insertion.

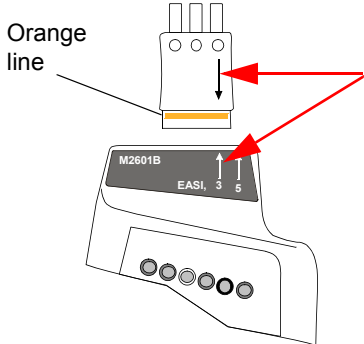
Step	Action
1	<p>Match the arrow on the ECG cable with the arrow on the Lead Set Insertion Guide according to the lead type you have chosen, and insert the ECG cable into transmitter.</p> <p><i>Important</i>—Make sure that the cable is pushed <i>completely</i> into the transmitter. When correctly inserted, the orange line at the base of the cable is not visible.</p>
	<p>3-wire:</p>  <p>Orange line</p> <p>Match the arrow on the cable with the <i>left</i> arrow (labeled EASI, 3) on the Lead Set Insertion Guide.</p>

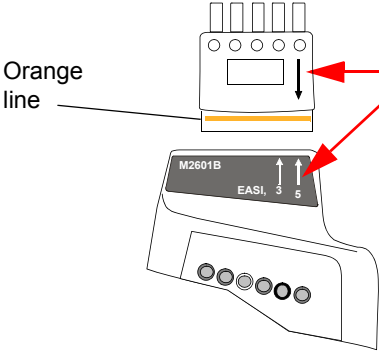
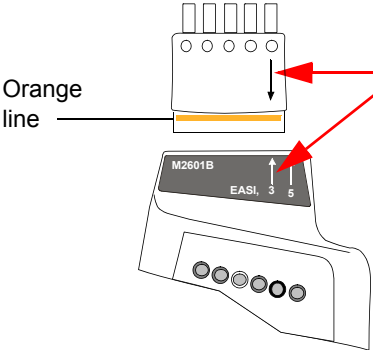
Step	Action
	<p data-bbox="494 245 571 272">5-wire</p> <p data-bbox="494 305 1220 427"><i>Note</i>—If you are using the 5-wire lead set in both Standard and EASI modes, insert the protective plug into the open lead port with the wide lip facing the leads. Then, press down firmly so that the plug is securely under the lead set and the orange line is not visible.</p> <p data-bbox="494 456 685 483">Standard Mode:</p>  <p data-bbox="934 511 1206 625">Match the arrow on the cable with the <i>right</i> arrow (labeled 5) on the Lead Set Insertion Guide.</p> <p data-bbox="494 873 638 901">EASI Mode:</p>  <p data-bbox="934 928 1220 1042">Match the arrow on the cable with the <i>left</i> arrow (labeled EASI, 3) on the Lead Set Insertion Guide.</p>

Connecting the ECG Cable

Step	Action
2	<p data-bbox="447 248 1171 337">Check that the correct lead indicators are lit for the lead set you are using, and that the EASI indicator light is illuminated appropriately. See “Verifying Electrode Connections” on page 3-17.</p> <p data-bbox="447 370 1094 423"><i>Important</i>—When using 5-wire Standard, note that the EASI indicator does not illuminate.</p> <p data-bbox="447 435 1130 521">When using EASI, the EASI indicator should illuminate for 5 seconds after the lead set is inserted (as well as when the Check button is pressed).</p>

Cable Disconnection

When disconnecting the lead set from the transmitter, grasp the lead block firmly and pull free. Do not pull on the lead wires.

Verifying Electrode Connections

The electrode indicator LEDs (Light Emitting Diodes) enable you to verify that the leads are available for the desired monitoring. Each electrode is color-coded. Pressing and holding the Check button enables you to view the lead set status. During routine use of the transmitter for monitoring, all LEDs are off.

Task Summary To verify electrode connections, use the following procedure:

Step	Action
1	Press and hold the Check button for 2 seconds
2	<p>Expected Response:</p> <ul style="list-style-type: none"> • If 3-wire cable is attached: Red, White and Black LEDs illuminate, then all turn off. • If 5-wire cable in Standard mode is attached: Red, White, Black, Green & Brown LEDs illuminate, then all turn off. • If using EASI: Red, White, Black, Green & Brown LEDs illuminate, then all turn off. The EASI indicator also illuminates briefly. • If no lead set is attached: all LEDs are off.
3	<p>Unexpected Response:</p> <p>Any other response indicates a problem. Check the lead block connection and/or use a new lead set. If the problem is not corrected, contact your Service Provider.</p>

During routine monitoring, the electrode indicators also notify you if one or more leads are not functioning. When a LEADS OFF condition occurs, the transmitter automatically illuminates the indicator corresponding to the missing lead.

Making ECG Adjustments

You can make the following adjustments from the IntelliVue Information Center:

- Change the lead or the lead label.
- Change the wave size.

With 5-wire lead sets, you can monitor two leads. With a 3-wire lead set you can monitor one lead. When monitoring two leads, the first lead is the primary lead. Singlelead arrhythmia analysis uses this lead. It is also the lead used for alarm and delayed recordings. Multilead analysis uses both leads.

If you are not receiving a good ECG wave and the electrodes are securely attached, you should try changing the lead in which you are monitoring.

Bandwidth

Bandwidth is not user adjustable, but is assigned automatically by the Information Center. The settings are:

Setting	Bandwidth
ST off	Monitor (0.5 to 40 Hz)
ST on	ST (0.05 to 40 Hz)

Changing Lead/Label

To change the lead/label place your cursor over the wave in the Patient Window.

- For a 3-wire lead set, apply the electrodes to monitor the lead you want and select the label from the pop-up box to match the placement.

Note—If the TeleMon Companion Monitor is available, you can change the lead on a 3-wire lead set (if configured for Lead Select). See “ECG Leads Monitored” on page 3-4.

- For a 5-wire lead set, you can change the lead without moving the electrodes.

Adjusting Wave Size

To change the amplitude of the ECG wave on the display or for recordings, place your cursor over the wave in the Patient Window and select the size you want from the pop-up box. There are five sizes available: 1/4 (smallest), 1/2, 1, 2, and 4 (largest).

You can use the 1 mV cal bar on the Patient Window to check the height of the R-wave. If the wave is not at least 0.5 mV high (one-half the size of the cal bar), change the lead.

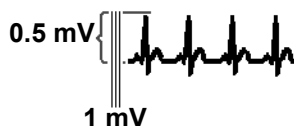

Monitoring During Leads Off

ECG Fallback and Extended Monitoring occur when the primary and/or secondary leads are in a Leads Off condition for >10 seconds. The system performs this action in an attempt to maintaining monitoring and arrhythmia analysis.

Lead Fallback is used if the primary or secondary lead is available. Extended Monitoring is used if neither is available.

Lead Fallback

Lead Fallback is configured on or off by your Service Provider.

Monitoring During Leads Off

Multilead Analysis

If the system is using multilead analysis, the active secondary lead becomes the primary lead, and the arrhythmia algorithm switches the leads on the display. When the Leads Off condition is corrected, the leads are switched back to their original state. Arrhythmia Relearn does not occur.

Singlelead Analysis

For singlelead analysis, if there are two leads available, the other lead is made the primary lead until the Leads Off condition is corrected. The arrhythmia algorithm performs a Relearn.

Fallback for EASI

If one of the derived EASI leads is in a technical alarm condition, a flat line is displayed. After 10 seconds, the directly acquired EASI AI, AS, or ES lead, depending on which is available, is displayed with the label "ECG" and is analyzed by the arrhythmia algorithm. Arrhythmia Relearn occurs with transition to/from EASI Lead Fallback.

Extended Monitoring

When both the primary and secondary leads have a Leads Off condition, if another lead is available it becomes the primary lead and the system does a Relearn. This is called Extended Monitoring.

Extended Monitoring applies if:

- Telemetry is configured for Extended Monitoring ON.
- The lead set provides more than two leads (i.e., when using a 5-wire lead set).

Relearning

Whenever there is a Leads Off condition, the arrhythmia algorithm performs a Relearn, using the available leads.

Warning

Since Relearn happens automatically, if learning takes place during ventricular rhythm, the ectopics can be incorrectly learned as the normal QRS complex. This can result in missed detection of subsequent events of V-Tach and V-Fib. For this reason, you should:

- 1. Respond promptly to any technical alarm.**
 - 2. Ensure that the arrhythmia algorithm is labeling beats correctly.**
-
-

Using EASI Leads to Troubleshoot

If there is artifact in the ECG waves or a CANNOT ANALYZE ECG technical alarm condition, you can use the three EASI leads to troubleshoot:

1. Click **12-Lead ECG** on the Patient Window, then on **3 EASI Leads**.
2. The three directly acquired EASI leads will be displayed so that you can determine which electrodes are causing the problem and need to be replaced.

Optimizing System Performance

While telemetry monitoring offers many advantages, it can be a challenge. The reliability and quality of the signal transmission through the air and hospital walls is governed by a number of variables which can be difficult to control. A telemetry system cannot be as dependable as a hardwired bedside monitor that transmits its signal through a wire.

The effect of interference on the telemetry system ranges from a momentary loss of ECG to complete inoperability, depending on the situation. The strength, frequency, and proximity of the source of interference to transmitters or the antenna system are factors that determine the degree of severity. In cases where the source of interference is known - for example, cellular phones, magnetic equipment such as MRI, other radio or motorized equipment - removing or moving away from the source of interference will increase the system's dependability.

Warning

The Philips Telemetry System should not be used for primary monitoring in applications where the momentary loss of the ECG is unacceptable.

In this section, we'll investigate some of the problems affecting ECG signal clarity and when possible, show you how you can greatly enhance performance.

Note—The Philips Telemetry System also emits radio frequencies (defined in Chapter 7, “System Safety and Specifications”) that may affect the operation of other devices. Contact the manufacturer of other equipment for possible susceptibility to these frequencies.

The Telemetry Signal

The transmitter worn by the patient acquires the patient's physiological data, amplifies and digitizes it, detects pace pulses and broadcasts this information via radio waves to the antenna system. Since the signal passes through the air, it is susceptible to interference from many sources.

Troubleshooting Signal Disturbance

Dropouts

Because the telemetry system is a wireless system, under certain conditions RF “dropouts” can occur. Dropouts result from a weak signal or RF interference. There will be signal drops to the bottom of channel for a minimum of 200 ms to indicate to the clinical user that it is a non-physiological event. If dropouts are frequent enough to affect the heart rate count, the TEL CANNOT ANALYZE, as well as CANNOT ANALYZE ECG or CANNOT ANALYZE ST technical alarms occur.

The following recording strip is an example of dropouts.

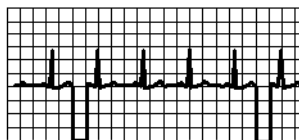

If frequent dropouts are occurring, the following section describes some steps you can take to improve performance.

Signal Strength

The antenna system is custom designed for your unit, so reliable signal reception is only possible where there are receiving antennas. When the signal is too low, the following technical alarms occur:

- TEL CANNOT ANALYZE
- CANNOT ANALYZE ECG
- CANNOT ANALYZE ST
- WEAK SIGNAL
- NO SIGNAL

To correct, first check the location of the patient. If not in the coverage area, do one of the following.

- Return the patient to the specified antenna coverage area.
- Put telemetry in Standby mode. See “Standby Mode” on page 1-24.

Warning

If you put telemetry in Standby mode, you *must* remember to turn monitoring back on when the patient returns to the unit.

- If the patient is in the coverage area and is stationary, try moving the location of the transmitter or patient about 6 inches (15 cm.).



**Radio
Frequency
Interference**



Radio frequency (RF) interference is caused by anything that intrudes into the transmitted electrical signal, such as paging transmitters. We are all familiar with electrical interference in our homes and cars when it causes signal loss or static on a cell phone. These same types of interference can occur with the transmitted telemetry signal. Even though the Philips Telemetry System is designed to resist these effects, interference can occasionally be seen in the form of "dropouts". To improve performance, the source of the interference must be identified and eliminated.

**Muscle and
Movement
Artifact**

Muscle and movement artifact differ from radio frequency interference since you can prevent much of the occurrence. Noise on the ECG signal can be caused by many sources, such as interference from other electrical equipment, muscle artifact and respiration variation. It is up to the clinician to use certain techniques to minimize these types of noise.

Use the following table to help you troubleshoot the most common sources of ECG noise.

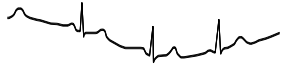
Problem	Cause	Remedy
<p>60-Cycle (AC) Interference</p> 	<p>Poor electrode placement. Possible non-grounded instrument near patient.</p>	<p>Re-apply electrodes Disconnect electrical appliances near patient (one at a time) by pulling wall plugs, to determine faulty grounding. Have engineering check grounding.</p>
<p>Muscle Artifact</p> 	<p>Tense, uncomfortable patient. Poor electrode placement. Tremors. Diaphoresis.</p>	<p>Make sure patient is comfortable. Check that electrodes are applied on flat non-muscular areas of the torso; re-apply the electrodes if necessary, using good skin preparation (see “Setting Up for ECG Monitoring” on page 3-7).</p>
<p>Irregular Baseline</p> 	<p>Poor electrical contact. Respiratory interference. Faulty electrodes. Dry electrodes.</p>	<p>Re-apply electrodes, using good skin preparation (see “Setting Up for ECG Monitoring” on page 3-7). Move electrodes away from areas with greatest movement during respiration.</p>

Problem	Cause	Remedy
<p>Baseline Wander</p> 	<p>Movement of patient.</p> <p>Improperly applied electrodes.</p> <p>Respiratory interference.</p>	<p>Make sure patient is comfortable.</p> <p>Re-apply electrodes, using good skin preparation (see “Setting Up for ECG Monitoring” on page 3-7). Check that patient cable is not pulling electrodes.</p> <p>Move electrodes away from areas with greatest movement during respiration.</p>
<p>Poor Electrode Contact</p> 	<p>Loose electrodes.</p> <p>Defective cables.</p> <p>Lead set not firmly connected.</p>	<p>Change electrodes, using good skin preparation (see “Setting Up for ECG Monitoring” on page 3-7).</p> <p>Replace cables.</p>

ECG Safety Information

Warning

FOR ALL PATIENTS

Always confirm Information Center observations with clinical observation of the patient before administering interventions.

Every lead should be secured to an electrode on the patient. Conductive parts of electrodes should not contact earth or other conductive parts.

Philips recommends that you change the lead label only to reflect the physical placement of electrodes. This will ensure a match between the monitored lead and the label, and prevent any possible confusion.

When switching from EASI to Standard monitoring, there is a loss of data for 30 seconds.

Warning

FOR PACED PATIENTS

The output power of the transmitter and other sources of radio frequency energy, when used in the proximity of a pacemaker, can be sufficient to interfere with pacemaker performance. Due to the shielding effects of the body, internal pacemakers are somewhat less vulnerable than external pacemakers. However, caution should be exercised when monitoring any paced patient.

In order to minimize the possibility of interference, position electrodes, electrode wires, and the transmitter as far away from the pacemaker as possible.

Consult the pacemaker manufacturer for information on the RF susceptibility of their products and the use of their products with the Philips Telemetry System. See the *IntelliVue Information Center Instructions for Use* for additional information on monitoring paced patients.

ST/AR Arrhythmia Analysis

For information on arrhythmia detection and ST monitoring, refer to the following:

- *IntelliVue Information Center Instructions for Use* and Online Help
- *ST/AR Algorithm - Arrhythmia Monitoring* Application Note (4522 981 93051).
- *ST/AR Algorithm - ST Segment Monitoring* Application Note (4522 981 92851).

The intended use of the ST/AR basic arrhythmia analysis algorithm is to monitor the patient's ECG for heart rate and ventricular arrhythmias and to produce events/alarms simultaneously for one or more ECG leads. The arrhythmia

algorithm is effective when monitoring both paced and non-paced patients in a clinical environment.

ST/AR provides Heart Rate and PVC Rate numerics and alarm detection for the conditions listed in the table below. There are two levels: Basic and Enhanced. Enhanced includes the Basic alarms. See “Physiologic (Patient) Alarms” on page 2-6 for arrhythmia alarm text and descriptions.

Basic & Enhanced Arrhythmia Detection

Basic Arrhythmia Detection	Enhanced Arrhythmia Detection	
Asystole	Tachy yyy > xxx	Vent Bigeminy
V Fib/Tach	Brady yyy < xxx	Vent Trigeminy
V Tach	Non-Sustain VT	Multiform PVCs
Extreme Brady	Vent Rhythm	HR yyy > xxx
Extreme Tachy	Run PVCs	HR yyy < xxx
High HR	Pair PVCs	Irregular HR
Low HR	Pause	
PVCs > xx/min	Missed Beat	
Pacer Not Capturing	SVT	
Pacer Not Pacing	R-on-T PVCs	

ST/AR Arrhythmia Analysis

Beat classification determined by the ST/AR algorithm is shown on the primary delayed wave in Arrhythmia Analysis at the Information Center. To access the waves with beat annotations, select **Arrhythmia Analysis** from the Patient Window.

The annotation requires clinical validation of the analyzed heart rhythm. If the analysis is inaccurate, perform a Relearn of the rhythm.

<u>Annotation</u>	<u>Beat Classification</u>	<u>Color</u>
A	Artifact	Blue
I	Inoperative	Red
L	Learning	Red
M	Missed Beat	Red
N	Normal	Blue
P	Paced Beat	Blue
S	Supraventricular Premature	Blue
V	Ventricular Premature	Red
?	Questionable	Red
'	Pacer Mark	Blue

When monitoring is initiated, when the Channel 1 lead is changed, or if Relearn is selected, a question mark (?) is displayed next to HR and the annotation “L” appears on the annotated wave until the HR is calculated and the rhythm is learned.

ECG and ST/ AR Alarms

See Chapter 2, “Alarms” for a list of all ECG and arrhythmia alarms.

**ST/AR
Arrhythmia
Safety
Information**

Warning

FOR ALL PATIENTS

During complete heart block or pacemaker failure (to pace or capture), tall P-waves (greater than 1/5 of the average R-wave height) can be erroneously counted by the arrhythmia algorithm, resulting in missed detection of cardiac arrest.

Learning/Relearning

--If you initiate learning during ventricular rhythm, the ectopics can be incorrectly learned as the normal QRS complex. This can result in missed detection of subsequent events of V-Tach and V-Fib.

--When using EASI ECG monitoring, Relearn happens automatically when there is a LEADS OFF technical alarm. If learning takes place during ventricular rhythm, the ectopics can be incorrectly learned as the normal QRS complex. This can result in missed detection of subsequent events of V-Tach and V-Fib. Be sure to check the beat labels and initiate a Relearn to correct.

1. Respond to the technical alarm [for example, reconnect the electrode(s)].
 2. Ensure that the arrhythmia algorithm is labeling beats correctly.
-
-

Warning

FOR PACED PATIENTS

It is possible that pacemaker pulses will not be detected when the ECG analog output of a defibrillator or telemetry unit is plugged into a bedside monitor. This can result in the arrhythmia algorithm's failure to detect pacemaker non-capture or asystole.

Some pace pulses can be difficult to reject. When this happens, the pulses are counted as a QRS complex, and could result in an incorrect HR and failure to detect cardiac arrest or some arrhythmias. Keep pacemaker patients under close observation.

--During complete heart block or pacemaker failure (to pace or capture), tall P-waves (greater than 1/5 of the average R-wave height) can be erroneously counted by the arrhythmia algorithm, resulting in missed detection of cardiac arrest.

--When arrhythmia monitoring paced patients who exhibit only intrinsic rhythm, the monitor can erroneously count pace pulses as QRS complexes when the algorithm first encounters them, resulting in missed detection of cardiac arrest.

For patients who exhibit intrinsic rhythm only, the risk of missing cardiac arrest can be reduced by monitoring these patients with the low heart rate limit at or slightly above the basic/demand pacemaker rate. A low heart rate alarm alarms you when the patient begins pacing. Proper detection and classification of the paced rhythm can then be determined.

--When an external pacemaker is being used on a patient, arrhythmia monitoring is severely compromised due to the high energy level in the pacer pulse. This can result in the arrhythmia algorithm's failure to detect pacemaker non-capture or asystole.

ST/AR ST Segment Monitoring

This chapter describes the ST/AR ST algorithm for telemetry of the IntelliVue Information Center. It includes the following sections:

- ST/AR ST Algorithm 4-2
- Adjusting Measurement Points 4-5
- Establishing ST Reference Beats (Baseline) 4-7
- Turning ST On/Off 4-7
- ST Alarms 4-8

ST/AR ST Algorithm

Intended Use

The intended use of the ST/AR ST algorithm for the IntelliVue Information Center is to monitor ST segment elevation or depression for each available telemetry ECG lead and produce events/alerts simultaneously. ST values update with every measurement period and enunciate, depending upon the severity of the change, events and alerts as they are detected.

Patient Population

You can perform ST analysis on both non-paced and atrially paced patients. The ST/AR ST algorithm is approved only for adult telemetry-monitored patients. With EASI monitoring, ST analysis is performed on up to 12 leads.

Note—Studies have validated the maximal EASI derived ST measurements on male and female patients with ages from 33 to 82, heights 147 to 185 cm (58 to 73 in), weights 53 to 118 kg (117 to 261 lb) and height-to-weight ratios of 1.41 to 2.99 cm/kg (0.25 to 0.54 in/lb).

The Measurement

The ST measurement for each beat complex is the vertical *difference* between two measurement points. The **isoelectric point** provides the baseline for the measurement and the **ST point** provides the other measurement point. It is positioned with reference to the J point.

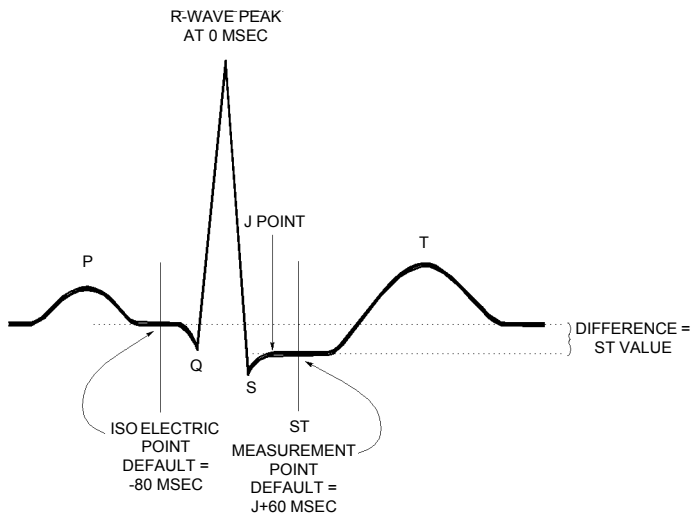

Warning

This device provides ST level change information; the clinical significance of the ST level change information should be determined by a physician.

How the Algorithm Works

When ST analysis is being performed on two leads, the averaged derived and reconstructed ST waves and associated ST segment values are given for up to six leads, depending on the type of patient cable:

- 3-wire: one lead
- 5-wire: up to two leads if monitoring a chest and a limb lead
- 5-wire: up to six leads if monitoring two limb leads with the Philips transmitter (without EASI monitoring)
- 5-wire: up to 12 leads if monitoring using EASI

Note—No ST analysis is done on a patient if an electrode falls off.

ST analysis uses the ST/AR arrhythmia beat classification to select only normal and atrially paced beats for its analysis.

The ST/AR ST algorithm processing includes special ST filtering, beat selection and statistical analysis, calculation of ST segment elevations and depressions, and lead reconstruction and wave generation.

Displayed ST Data

ST data displays as values in the Patient Sector and Patient Window. A positive value indicates ST segment elevation; a negative value indicates depression. You can view ST data in ST Review, Trend Review, and Event Review windows.

EASI ST Analysis

ST/AR ST analysis for EASI derived transmitters is done on all 12 leads. The value presented in the patient sector and Patient Window is “STindx”. STindx is a summation of three ST segment measurements, using the leads that can indicate ST segment changes in the different locations of the heart:

- anterior lead V2
- lateral lead V5
- inferior lead aVF

Caution

Be sure not to duplicate the lead labels. This can result in incorrect ST values being displayed for those leads.

Adjusting Measurement Points

The ST Setup Window allows you to adjust the ST measurement points to ensure accurate data.

There are three measurement cursors:

- The ISO measurement cursor positions the isoelectric point in relation to the R-wave peak.
- The J-point cursor positions the J point in relation to the R-wave peak. The purpose of the J point is to correctly position the ST measurement point.
- The ST measurement cursor positions the ST point a fixed distance from the J point.

Note—The ST measurement points may need to be adjusted if the patient's heart rate or ECG morphology changes significantly.

Task Summary

Perform the following steps to adjust the ST measurement points:

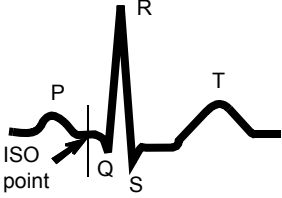
Step	Action
1	Access the ST Setup window by clicking on the All Controls button in the Patient Window then clicking on the ST Setup button.
2	If you need to adjust the ISO (isoelectric) point, place the cursor over the ISO button to access the adjustment arrows. Then use the arrows to position the bar in the middle of the flattest part of the baseline (between the P and Q waves or in front of the P wave). <div style="text-align: center; margin-top: 10px;">  <p>The diagram shows a standard ECG waveform with P, Q, R, S, and T waves labeled. A vertical line labeled 'ISO point' is drawn between the P and Q waves, with an arrow pointing to it from the text 'ISO point' on the left.</p> </div>

Adjusting Measurement Points

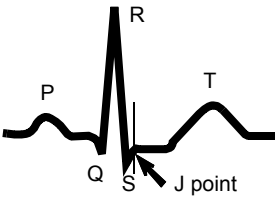
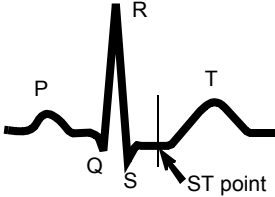
Step	Action
3	<p>Adjust the J point, if necessary, by placing the cursor over the J-point button to access the adjustment arrows. Then use the arrows to position the bar at the end of the QRS complex and the beginning of the ST segment.</p> 
4	<p>Adjust the ST point, if necessary, by using the J point as an “anchor” and place the bar at the midpoint of the ST segment. Choices are J + 0, J + 20, J + 40, J + 60, or J + 80).</p> 

Establishing ST Reference Beats (Baseline)

After adjusting the measurement points, you can establish baseline reference beats for all available leads in the ST Review window at the IntelliVue Information Center. Reference beats enable you to compare waveform changes, for example from admission, or prior to or after treatment. The reference continues to be saved beyond the 24 hour review window, but you can update it to any beat within the last 24 hours. Please refer to the *IntelliVue Information Center Instructions for Use* or Online Help for directions.

Turning ST On/Off

The ST Setup Window allows you to turn ST monitoring on/off for all available ECG leads. You would turn ST monitoring off if:

- You are unable to get any lead that is not noisy.
- Arrhythmias such as atrial fib/flutter cause irregular baseline.
- The patient is continuously ventricularly paced.
- The patient has left bundle branch block.

Task Summary

To turn ST monitoring on/off perform the following steps:

Step	Action
1	Access the ST Setup Window by clicking the All Controls button on the Patient Window then clicking the ST Setup button.
2	If you want to turn all ST monitoring on/off click ST On .

ST Alarms

All IntelliVue Information Center alarm settings (limits and on/off status) have unit default settings. The Information Center however, lets you set the high and low ST alarm limits for individual patients based on:

- Your assessment of the patient's clinical condition.
- Unit protocols.
- Physician orders or medication specified limits.

You can make the following adjustments to ST alarm limits to accommodate the clinical condition of individual patients:

- Turn all alarms off/on.
- Adjust the alarm limits:
 - to specific high and low limits.
 - to Smart Limits (see the *IntelliVue Information Center Instructions for Use* for information on Smart Limits).
 - back to unit default settings.

You adjust the ST alarm limits in the ST Alarms Window. Each ST parameter has its own alarm limit. The alarm is triggered when the ST value exceeds its alarm limit for more than 1 minute. The alarm will be a yellow alarm.

When more than one ST parameter is in alarm, only one alarm message displays. For multilead alarms when using an EASI transmitter, an alarm is generated if two or more ST leads exceed the alarm limits. The default setting is +/-1.0. The alarm message indicates the two leads that are in greatest violation of the limits, for example, “**MULTI ST AVR, V6”. If another lead becomes deviant, the message changes but it is considered the same alarm (no new alarm sounds and it is not listed as a new event).

See Chapter 2, “Alarms” for a list of all ST alarms.

Note—See the *IntelliVue Information Center Instructions for Use* for specifics on alarm management and behavior.

ST Alarm Adjustments

Task Summary Make adjustments to ST alarms on the ST Alarms window.

Step	Action
1	Access the ST Alarms window by clicking on the All Controls button in the Patient Window then clicking the ST Alarms button under Alarm Management and Setup.
2	<p>Make the adjustments on the ST Alarms window. Choices for setting the ST alarm limits are:</p> <p>Unit Settings—Click on this button if want to have the specific limits that are pre-set for your unit.</p> <p>Smart Limits—Click on this button to set high and low limits around your patient's current ST value. The difference above and below the patient's ST value are pre-set for your unit.</p> <p><i>Note</i>—Smart Limits can be configured to automatically be activated when the patient is connected. See the <i>IntelliVue Information Center Instructions for Use</i> for additional information on using smart limits.</p> <p>Specified limits—Use these to set the high and low alarm limits based on your assessment of the patient's clinical condition, unit protocols, or physician orders or medication specified limits. A good guideline is + 1.0 mm or - 1.0 mm from the patient's ST, or follow your unit protocol.</p>

ST Alarms

5

SpO₂ Monitoring

This chapter provides an introduction to the SpO₂ measurement and its application. It includes the following sections:

- About the Pulse Oximetry Measurement 5-2
- Preparing for Telemetry SpO₂ Monitoring 5-7
- SpO₂ Sensors 5-8
- Selecting an SpO₂ Sensor 5-9
- Applying the Sensor 5-12
- Connecting the SpO₂ Cable 5-17
- Making SpO₂ Measurements 5-18
- Measurement Limitations 5-24
- Optimizing Sensor Performance 5-25
- SpO₂ Alarms and Technical Alarms 5-25

About the Pulse Oximetry Measurement

The M2601B transmitter supports an SpO₂ sensor connection using Fourier Artifact Suppression Technology (FAST). The FAST algorithm provides superior motion artifact rejection and low-perfusion performance. SpO₂ can be measured continuously, where a value is sent to the Information Center every second, or as a single, individual measurement (Spot Check). The Spot Check measurement will be removed from the Information Center display after 24 hours. If 1-minute or 5-minute sampling is selected at TeleMon, the M2601B Transmitter will provide Continuous SpO₂ measurement (see “SpO₂ Measurement when Connected to TeleMon” on page 5-18).

The SpO₂ parameter measures the arterial oxygen saturation. That is, the percentage of oxygenated hemoglobin in relation to the total hemoglobin.

If, for example, a total of 97% of the hemoglobin molecules in the red blood cells of the arterial blood combine with oxygen, then the blood has an oxygen saturation of 97%. The SpO₂ numeric that appears on the monitor will read 97%. The SpO₂ numeric indicates the percentage of hemoglobin molecules which have combined with oxygen molecules to form oxyhemoglobin.

- The oxygen saturation is measured using the pulse oximetry method. This is a noninvasive method of measuring the arterial hemoglobin oxygen saturation. It measures how much light, sent from light sources on one side of the sensor, travels through patient tissue (such as a finger or an ear), to a receiver on the other side.
- The amount of light getting through depends on many factors, most of which are constant, such as tissue or venous blood. However one of the factors, the blood flow in the arterioles, varies with time - because it is pulsatile.

This measurement principle is used to derive the SpO₂ measurement. The numeric that is displayed at the Information Center is the oxygen saturation of the arterial blood - the measurement of light absorption during a pulsation.

Pulse Indication

During Spot Check measurement, the pulse signal is detected and communicated to you via an auditory signal. The indicator is a single low-pitched tone for each pulse detected. The tone (volume, mute) is configured. The pulse indication stops when a measurement is complete. However, since it is possible to have a strong pulse but fail an SpO₂ measurement, you should listen for the successful completion of a measurement (single beep), or a double beep if the measurement fails.

The pulse indicator is for information only; it should not be used as an indication for treatment. The indicator is not functional in Continuous measurement mode.

Clinical Note: If you are in Spot Check mode and the sensor light is illuminated but you do not hear a pulse indication sound synchronized with the pulse, readjust the sensor, or move the sensor to another site to find better detection.

SpO₂ Information for the User¹

The pulse oximeter is calibrated to indicate fractional oxyhemoglobin, and displayed results can range from 0 to 100%.

A 10 second averaging filter is used in the calculation of the result. Displayed results are typically updated every second, but the update period can be automatically delayed by up to 30 seconds in the presence of noise.

Physiological SpO₂ alarm signals will be generated at the Information Center. The SpO₂ low limit can be set between 50 and 99% inclusive, in 1% increments. The SpO₂ high alarm limit can be set between 51 and 100% inclusive, in 1% increments. The maximum delay between the physiological alarm condition and alarm signal generation at the Information Center is 10 seconds.

Pulse rate is also derived from the pulsatile SpO₂ measurement, and displayed results can range from 30 to 300 b/min. There is no alarm function for pulse rate.

The pleth wave (on the TeleMon Companion Monitor, if available) is auto-scaled to maximum display size. It decreases only when the signal quality becomes marginal. Pleth wave size is NOT directly proportional to the pulse volume.

1. A functional tester cannot be used to assess the accuracy of a pulse oximeter sensor or a pulse oximeter monitor. If there is independent demonstration that a particular calibration curve is accurate for the combination of a pulse oximeter monitor and a pulse oximeter sensor, then a functional tester can measure the contribution of a monitor to the total error of a monitor/sensor system. The functional tester can then measure how accurately a particular pulse oximeter monitor is reproducing that calibration curve.

SpO₂ Safety Information

Warning

Prolonged, continuous monitoring can increase the risk of changes in skin characteristics, such as irritation, reddening, blistering or pressure necrosis, particularly on patients with impaired perfusion and varying or immature skin morphology. Specific attention must be given to sensor site inspection for changes in skin quality, proper optical path alignment and attachment. Check the application site at regular intervals and change the site if any compromise in skin quality should occur. More frequent checking can be required due to an individual patient's condition.

Using a sensor during MR imaging can cause severe burns. To minimize this risk, ensure that the cable is positioned so that no inductive loops are formed. If the sensor does not appear to be operating properly, remove it immediately from the patient.

Do not use disposable sensors on patients who exhibit allergic reactions to the adhesive.

Avoid placing the SpO₂ sensor on any extremity with an arterial catheter, or intravascular venous infusion line.

Injected dyes such as methylene blue or intravascular dyshemoglobins such as methemoglobin and carboxyhemoglobin can lead to inaccurate (over-estimated) measurements.

Interference leading to inaccurate measurements can be caused by:

- High levels of ambient light (Hint: cover application site with opaque material)**
 - Electromagnetic interference**
 - Excessive patient movement and vibration.**
-
-

Warning

Removal of the SpO₂ sensor during Continuous SpO₂ monitoring results in a SpO₂ NO TRANSDUCER technical alarm. There is no technical alarm for a "No sensor" condition in Spot Check mode.

Preparing for Telemetry SpO₂ Monitoring

The Philips Telemetry System provides remote monitoring of SpO₂ measurement for adult and pediatric patients. You need to prepare your telemetry patient and perform setup tasks for the measurement to display at the IntelliVue Information Center or the TeleMon Companion Monitor.

Task Summary Perform the following steps to set up for telemetry SpO₂ monitoring:

Step	Action
1	Select the site and appropriate sensor (see “Selecting an SpO ₂ Sensor” on page 5-9).
2	Attach the sensor cable to the transmitter (see “Connecting the SpO ₂ Cable” on page 5-17).
3	Attach the transducer cable to the transmitter. Plug <i>reusable</i> transducers directly into the transmitter. Plug <i>disposable</i> transducers into the adapter cable, then plug the adapter cable into the transmitter. Remove the protective backing. Attach the sensor to the appropriate part of the patient's body.
4	If connected to TeleMon, use the pleth wave to check the signal quality.
5	Adjust SpO ₂ alarms in the Patient Window.
6	Make other adjustments in the Telemetry Setup Window.

SpO₂ Sensors

Disposable Sensors

Only use disposable sensors once and then discard. However, you can relocate them to a different patient-site if the first location does not give the desired results. Do not reuse disposable sensors on different patients. Disposable sensors are not available as Philips Medical Systems parts in the USA or Canada. Contact Nellcor® Incorporated at 1-800-635-5267 or 1-888-744-1414.

Reusable Sensors

You can use reusable sensors on different patients after cleaning and disinfecting them. For care and cleaning instructions, see the instructions accompanying the sensors. Reusable sensors should be changed to another site regularly. See the Directions for Use supplied by Nellcor® Incorporated for instructions on preparation and application of disposable sensors.

Warning

When the specified Nellcor® sensors are used, the application must be consistent with the sensor manufacturer's own guidelines.

Selecting an SpO₂ Sensor

Philips reusable sensors in adult, pediatric and infant models can be used, as well as Philips and Nellcor disposable sensors.

Use only specified sensors (probes) and cables.

“Selecting an SpO₂ Sensor” on page 5-10 is a guide in selecting the correct sensor type. To use the figure, find the patient’s weight on the vertical axis. On the horizontal axis at this weight, the shaded areas indicate that the sensor is a "best choice" for the patient. Unshaded areas indicate a "good choice." For example, the best reusable sensor for a 50 kg patient is the M1191A, applied to the finger or toe. Alternatively, you could use M1194A applied to the ear

Selecting an SpO2 Sensor

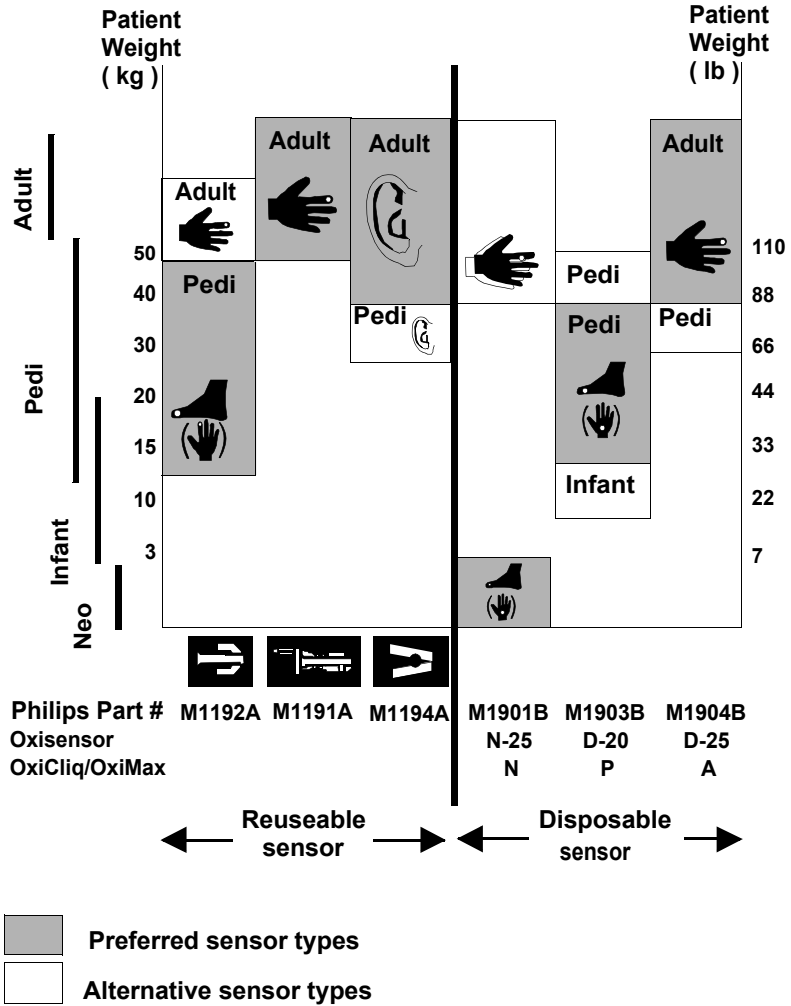

Selecting an SpO2 Sensor

Caution

Do not use OxiCliq disposable sensors in a high humidity environment, or in the presence of fluids. These can contaminate sensor and electrical connections, and thereby cause unreliable or intermittent measurements.

Do not use disposable sensors on patients who have allergic reactions to the adhesive.

Applying the Sensor

Sensor Application Safety Information

Warning

Failure to apply a sensor properly can reduce the accuracy of the SpO₂ measurement.

Loose/Tight sensor: If a sensor is too loose, it can compromise the optical alignment or fall off. If it is too tight, for example because the application site is too large or becomes too large due to edema, excessive pressure can be applied. This can result in venous congestion distal from the application site, leading to interstitial edema, hypoxia and tissue malnutrition. Skin irritations or ulcerations can occur as a result of the sensor being attached to one location for too long.

To avoid skin irritations and ulcerations, inspect the sensor application site every 2-3 hours, and change the application site at least every 4 hours or according to clinical practice guidelines.

Venous Pulsation: Do not apply sensor too tightly as this results in venous pulsation and can severely obstruct circulation and lead to inaccurate measurements.

Ambient Temperature: Never apply an SpO₂ sensor at ambient temperatures from above 37 °C (99 °F) because this can cause severe burns after prolonged application.

Extremities to Avoid: Avoid sites distal to BP cuff or intra-arterial line.

A minimum pulsatile flow must be present at the application site of your patient to obtain measurements.

Select an appropriate sensor and apply the sensor properly to avoid incorrect measurements. Applying a small amount of pressure at the application site can improve the measurement. Use one of the preferred application sites for your sensor. Selecting the most suitable sensor and application site will help you to ensure that:

- The light emitter and the photodetector are directly opposite each other and that all the light from the emitter passes through the patient's tissues,
- The application site is of the correct thickness for light to pass through. If the application site is too thick or too thin, an SpO₂ NON-PULSATILE technical alarm will occur. You should then select another site as appropriate.

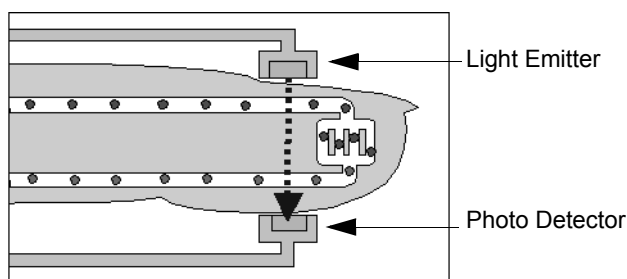

Positioning of the Light Emitter and Photo Detector

Inspect the application site every 2 to 3 hours or according to clinical practice guidelines to ensure skin integrity and correct optical alignment. If skin integrity changes, move the sensor to another site.

**Adult Finger
Sensor
(M1191A)**

Place the sensor over the fingertip in such a way that the fingertip touches but does not protrude from the end of the sensor. The fingertip must be uppermost and the cable must lie on the back of the hand. This ensures that the light sources cover the base of the fingertip giving the best measurement results. The cable can be held in place by the accompanying wristband.

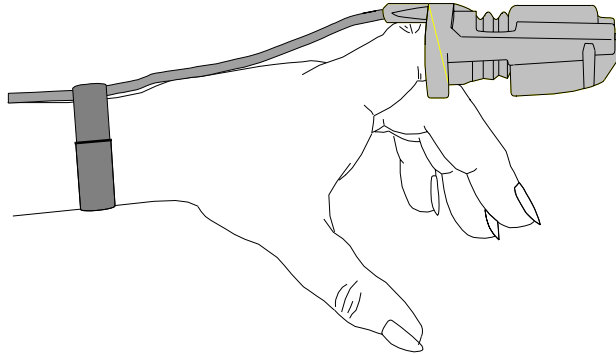

Warning

Failure to apply the sensor properly may cause incorrect measurement of SpO₂. For example, not placing the sensor far enough over the finger can result in inaccurate SpO₂ readings. Placing the sensor too far, so that the finger protrudes from the sensor, can pinch the finger, resulting in inaccurately low SpO₂ readings.

**Small Adult/
Pediatric
Finger
Sensor
(M1192A)**

Place the sensor over the fingertip in such a way that the fingertip touches but does not protrude from the end of the sensor.

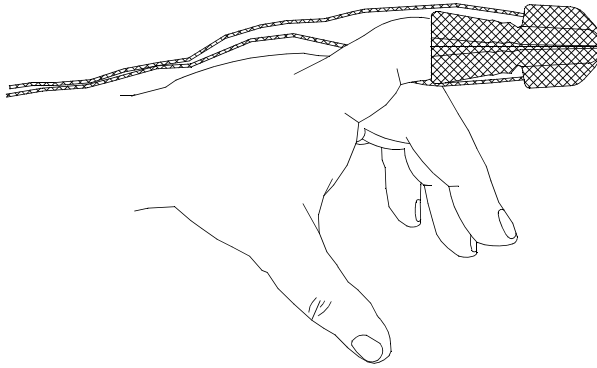

Applying the Sensor

Ear Clip Sensor (M1194A)

Clip the probe onto the fleshy part of the ear lobe as shown in the diagram below. The plastic fixing mechanism helps to minimize artifact generated by patient motion. Do not position the probe on cartilage or where it presses against the head.

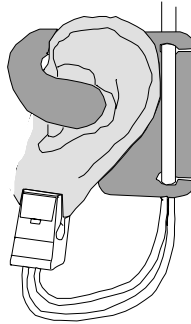

The clip sensor can be used as an alternative if the adult finger sensor does not provide satisfactory results. The preferred application site is the ear lobe, although other application sites with higher perfusion (such as the nostril) can be used. Due to the physiologically lower perfusion in the ear lobe, you should be aware of the reduced accuracy of the measurement and more frequent technical alarms.

Connecting the SpO₂ Cable

Task Summary

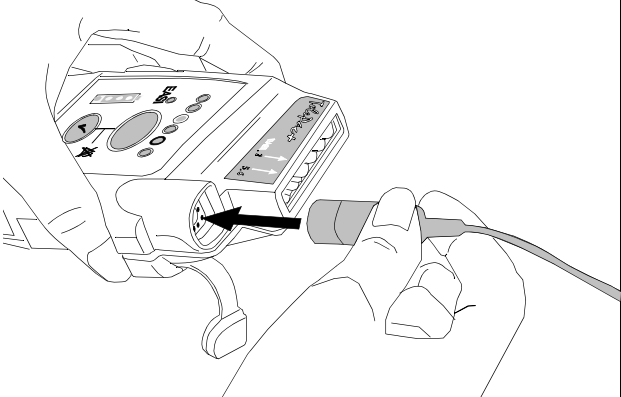
Step	Action
1	<p>Connect the sensor cable to the transmitter. If you are using a disposable sensor, plug the sensor into the adapter cable and plug this cable into the transmitter. Plug reusable sensors directly into the transmitter</p> 
2	<p>Ensure that the sensor and connector are positioned away from power cables, to avoid electrical interference.</p>

Caution

Extension cables: Do not use extension cables with the transmitter.

Electrical Interference: Position the sensor cable and connector away from power cables, to avoid electrical interference.

Making SpO₂ Measurements

SpO₂ measurements can be made continuously, or manually on an as-needed basis (Spot Check). The SpO₂ parameter is turned on/off by inserting/removing the sensor cable into the transmitter. SpO₂ monitoring consumes considerable electrical energy. If the battery power is not at least 25% full, no measurements of SpO₂ can be made.

Setting the mode at Continuous or Spot Check is done at TeleMon or is configured using the Service Tool.

SpO₂ Measurement when Connected to TeleMon

When the M2601B transmitter is connected to TeleMon:

- The measurement mode is *always* Continuous.
- You can change the mode. Changes to the mode take effect when the transmitter is disconnected from TeleMon. The following settings will be used:

Mode Setting at TeleMon	Mode at Disconnected Transmitter
Continuous	Continuous
5-minute	Continuous
1-minute	Continuous
Manual	Spot Check

Note—When using the M2601A Transmitter, 5-minute and 1-minute settings are available when disconnected from TeleMon.

If the transmitter had been set to Continuous or Spot Check before connection to TeleMon, it returns to the setting it had when the transmitter is disconnected (provided that it wasn't changed when connected).

Making a Spot Check Measurement

When the transmitter is configured for Spot Check measurement, use the following instructions to take an individual, manual SpO₂ reading from the transmitter.

Task Summary

Step	Action
1	Attach the sensor to the patient.
2	Connect the SpO ₂ cable to the transmitter, and check that: <ul style="list-style-type: none"> • The SpO₂ sensor light turns on. • A low-pitched tone detecting each pulse is audible (unless sounds are muted).
3	After approximately 30 seconds, a tone from the transmitter indicates that a measurement has been completed successfully (single beep), or failed (double beep). If failed, you must retake the measurement. The value, with the measurement time, is displayed at the Information Center, and the sensor light extinguishes. <i>Note</i> —The SpO ₂ value and time stamp will remain on the Information Center for 24 hours or until another measurement is taken, with one exception. If the batteries are removed from the transmitter, the Spot Check measurement will be erased from the display, but the SpO ₂ measurements will be available in Trend Review.
4	To repeat a Spot Check measurement at the bedside, disconnect then reconnect the SpO ₂ cable to the transmitter.

Monitoring SpO₂ Continuously

When the transmitter is configured for Continuous SpO₂ measurement, use the following directions to initiate Continuous SpO₂ monitoring.

Task Summary

Step	Action
1	Insert the SpO ₂ cable to the transmitter, and check that the sensor light turns on.
2	Attach the sensor to the patient.
3	After approximately 15 seconds, the value, with the measurement time, is displayed at the Information Center. <i>Note</i> —There are no sounds associated with Continuous SpO ₂ measurement.
4	To discontinue monitoring, set SpO ₂ mode to off at the Information Center. If TeleMon is available, connect and change the setting to Spot Check.

Turning SpO₂ Monitoring Off

To turn SpO₂ monitoring off, disconnect the sensor cable from the transmitter. SpO₂ enters a power-down mode after the cable is disconnected from the transmitter, thereby conserving battery life.

SpO₂ should also be turned off at the Information Center. If the transmitter is configured for Continuous SpO₂ measurement and the sensor is removed without turning SpO₂ off, a SpO₂ NO TRANSDUCER technical alarm will result.

Important—It is important to disconnect the sensor from the transmitter. Unplugging the sensor from an adapter cable that is connected to the transmitter does NOT provide SpO₂ power-down mode.

Turning the SpO₂ Parameter On/Off

You can turn the SpO₂ parameter on/off at the Information Center by using the Telemetry Setup Window.

Note—If SpO₂ is turned on, the Patient Sector and Patient Window of the Information Center display the numeric with "T" (for example, SpO₂ T 90%) to indicate that the measurement was made via telemetry.

Turning the SpO₂ parameter off at the Information Center also turns off:

- SpO₂ alarms
- SpO₂ display of numerics
- SpO₂ trending

If the transmitter is connected to the TeleMon Companion Monitor, after you turn SpO₂ *on*, you should adjust the sample rate to match your patient's acuity.

Note—After you turn SpO₂ *off*, setting the sample rate to Spot Check at TeleMon will help you conserve the transmitter's battery life.

Task Summary

Turn the SpO₂ parameter on or off manually by performing the following steps:

Step	Action
1	On the Patient Window click the All Controls button.
2	On the All Controls Window click the Telemetry Setup button.
3	On the Telemetry Setup Window, under SpO ₂ , turn the parameter on or off by clicking in the Parameter ON checkbox. A check mark in the checkbox indicates that SpO ₂ monitoring is on.

SpO₂ Parameter Auto ON

The SpO₂ parameter is automatically turned on at the IntelliVue Information Center if a manual SpO₂ measurement is initiated at the transmitter while in Spot Check mode or the SpO₂ sensor is inserted into the transmitter while the transmitter is in Continuous SpO₂ mode.

When a patient is discharged and the transmitter is in Continuous mode, the SpO₂ parameter is turned off. To reactivate the SpO₂ parameter Auto ON feature from the transmitter, remember to do one of the following when a patient is discharged:

- remove the SpO₂ cable from the transmitter, wait 15 seconds, then reinsert the cable

or

- if using TeleMon, reset the transmitter to Spot Check mode.

Note—The SpO₂ parameter Auto ON feature only needs to be reactivated when the transmitter is in Continuous mode at discharge.

Note— SpO₂ can always be turned on and off at the IntelliVue Information Center.

Turning SpO₂ Alarms On/Off

You can turn SpO₂ alarms on or off by using the Telemetry Setup Window.

Task Summary

Turn SpO₂ alarm on or off by performing the following steps:

Step	Action
1	On the Patient Window click the All Controls button.
2	On the All Controls Window click the Telemetry Setup button.
3	On the Telemetry Setup Window, under SpO ₂ , turn alarms on or off by clicking in the Alarm ON checkbox. A check mark in the checkbox indicates that SpO ₂ alarms are on.

Turning the Pulse Parameter On/Off

If monitoring SpO₂ continuously, the Pulse parameter is available at the IntelliVue Information Center. You can turn the SpO₂ pulse parameter on or off by using the Telemetry Setup Window.

Task Summary Turn the pulse parameter on or off by performing the following steps:

Step	Action
1	On the Patient Window click the All Controls button.
2	On the All Controls Window click the Telemetry Setup button.
3	On the Telemetry Setup Window, under Pulse, turn parameter on or off by clicking in the Parameter ON checkbox. A check mark in the checkbox indicates that pulse monitoring is on.

Note—If pulse is turned on, the Patient Sector and Patient Window of the Information Center display the label with "T" (for example, Pulse T) to indicate that the measurement was made via telemetry.

Measurement Limitations

Refer to this section on problem situations if you have difficulty getting a signal or obtaining accurate measurements.

Distortion

Ambient light, motion, perfusion or incorrect sensor placement may affect the accuracy of the derived measurements.

Arterial Blood Flow

The measurement depends on the pulsatile nature of blood flow in the arteries and arterioles; with the following conditions arterial blood flow may be reduced to a level at which accurate measurements cannot be made:

- shock
- hypothermia
- use of vasoconstrictive drugs
- anemia

Wavelength Absorption

The measurement also depends on the absorption of particular light wavelengths by the oxyhemoglobin and reduced hemoglobin. If other substances are present which absorb the same wavelengths, they will cause a falsely high, or falsely low SpO₂ value to be measured. For example:

- carboxyhemoglobin
- methemoglobin
- methylene blue
- indocyanine green*
- indiocarmine*

*These chemicals are used in dye dilution cardiac output calculations.

Ambient Light

Very high levels of ambient light can also affect the measurement; an SpO₂ INTERFERENCE message will appear on the display. The measurement quality can be improved by covering the sensor with suitable opaque material.

Care and Cleaning

For care and cleaning instructions, see the instructions accompanying the sensors.

See Appendix B, “Accessory List” for ordering information.

Optimizing Sensor Performance

To get the best results from your SpO₂ reusable sensor:

- Always handle the sensor and cable with care. The soft finger sleeve houses a sensitive electronic device that can be damaged by harsh treatment. Always protect the cable from sharp-edged objects.
- Use the wristband that is supplied with your M1191A sensor. By keeping the cable between the finger sensor and the wristband fairly loose, you will maintain good monitoring conditions.

Normal wear and tear associated with patient movement and regular sensor cleaning naturally mean that your sensor will have a limited lifetime. However, provided you handle the sensor and its cable with care, you can expect useful service from it for up to two years. Harsh treatment will drastically reduce the lifetime of the sensor. Moreover, Philips Medical Systems' warranty agreement shall not apply to defects arising from improper use.

SpO₂ Alarms and Technical Alarms

SpO₂ alarms are non-latching. That is, when an SpO₂ limit is exceeded, if the alarm is not silenced, it will reset automatically if the patient's alarm condition returns within the limits. This reduces the number of times you will need to reset alarms at the Information Center when an alarm condition has been corrected at the patient's side (for example, movement-induced artifact alarms).

See Chapter 2, "Alarms" for a list of all SpO₂ alarms.

SpO₂ Alarms and Technical Alarms

Maintenance and Configuration

This chapter describes how to maintain the telemetry equipment and configure the system. It includes the following sections:

- Troubleshooting 6-2
- Maintenance 6-3
- Transmitter Cleaning, Disinfection, & Cross-Infection Prevention 6-4
- Receiver Mainframe Cleaning 6-15
- Configuration 6-16
- Configuration Settings 6-17

Troubleshooting

Basic Troubleshooting

For problems with...	refer to
<ul style="list-style-type: none">• ECG measurement	“Optimizing System Performance” on page 3-22 “Technical Alarms (INOPs)” on page 11
<ul style="list-style-type: none">• SpO₂ measurement	“Measurement Limitations” on page 5-24 “Technical Alarms (INOPs)” on page 11
<ul style="list-style-type: none">• Batteries	“Battery Information” on page 1-29 “Status Check” on page 1-28
<ul style="list-style-type: none">• Nurse Call Alarm	Nurse Call may have been turned off for the patient. See “Turning Nurse Call On/Off” on page 1-23.

Testing Alarms

Visual and auditory alarms appear at the Information Center. One method of verifying visual and auditory alarms at the Information Center is to connect the transmitter to an ECG or ECG/SpO₂ simulator. By varying the ECG rate and SpO₂ value, alarms can be generated and confirmed for proper operation.

Maintenance

Before beginning monitoring on a patient:

- Check for any mechanical damage.
- Check all the external leads, plug-ins and accessories.
- Check all the functions of the instrument which are needed to monitor the patient.
- Ensure that the instrument is in good, working order.
- Ensure that any needed gunk guards are in place.

Important—Do not use the Philips Telemetry Monitoring System for any monitoring procedure on a patient if you identify features which demonstrate impaired functioning of the instrument. Contact the hospital biomedical engineer, or your Service Provider.

Warning

Failure on the part of the responsible individual hospital or institution employing the use of this equipment to implement a satisfactory maintenance schedule may cause undue equipment failure and possible health hazards.

Transmitter Cleaning, Disinfection, & Cross-Infection Prevention

The procedures in this section keep the transmitter clean and provide protection against infectious agents and bloodborne pathogens. Both the outside of the transmitter and the inside of the battery compartment must be kept free of dirt, dust, and debris. The procedures in this section cover the following activities:

- **Cleaning:** removing visible surface decontamination from the device
- **Disinfection:** protecting cleaned devices against infectious agents and bloodborne pathogens by a chemical agent.
- **Cross-Infection Prevention:** using ETO gas treatment to decontaminate cleaned equipment.

Important—After exposure, the transmitter must be cleaned, followed by either **Disinfection** or **Cross-Infection Prevention** procedures according to hospital protocols, before continued use in monitoring.

Cleaning the Transmitter

Caution

Do not use any abrasive cleaning materials or overly vigorous cleaning actions on any part or component of the transmitter. Use of abrasive cleansers and abrasive cleaning actions will damage the components.

Task Summary

Perform the following steps to clean the transmitter of visible surface contamination.

Step	Action
1	Remove the batteries and any cables or accessories.
2	Soak the transmitter in water for up to 5 minutes to soften any dried debris, if necessary.

Step	Action
3	Rinse the transmitter in water.
4	Flush device orifices with a forceful water stream to remove any residue in the openings.
5	Allow to air-dry, or dry with a non-lint producing cloth.
6	Continue with either Disinfection or Cross-Infection Prevention procedure, according to your hospital's protocol.

Disinfecting the Transmitter

Warning

To prevent fire, provide adequate ventilation and do not permit smoking when disinfecting the device with a flammable liquid, such as alcohol.

Caution

Remove the batteries and any cables or accessories before you disinfect the transmitter.

The transmitter can be disinfected by two methods: wiping or soaking. If the device has areas that are difficult to disinfect, soaking for up to five minutes is recommended. The approved disinfection agents are:

- Isopropyl Alcohol, $\geq 70\%$
- Sodium Hypochlorite, 10% solution prepared within 24 hours (for wiping only)

Equipment must be cleaned (see “Cleaning the Transmitter” on page 6-4) before this procedure is performed.

Wiping the Transmitter

Step	Action
1	Remove the batteries and any cables or accessories.
2	Wipe the transmitter clean by using a cloth dampened modestly with one of the following approved cleaning agents: <ul style="list-style-type: none"> • Isopropyl Alcohol ($\geq 70\%$) • Sodium Hypochlorite (chlorine bleach), 10% solution prepared within 24 hours.
3	Wipe all disinfected surfaces with distilled water to remove any residue.
4	Allow to air-dry, or dry with a non-lint producing cloth.

Soaking the Transmitter

Caution

Do not soak the equipment in cleansers other than Isopropyl Alcohol, or soak longer than five minutes. Soaking the transmitter for longer than five minutes or in cleansers other than Isopropyl Alcohol can severely damage the device.

Step	Action
1	Remove the batteries and any cables or accessories.
2	Soak the device in Isopropyl Alcohol ($\geq 70\%$) for up to five minutes. <i>Note</i> —The battery compartment can be closed or open during soaking.

Step	Action
3	Dip all cleaned surfaces in bowl of distilled water to remove any residue.
4	Dry the equipment with a non-lint producing cloth.

Cross-Infection Prevention for the Transmitter

The transmitter can be subjected to one ETOH cross-infection prevention process four times per year for 2 years. Completion of this procedure achieves a cross-infection prevention assurance level of 10E-6.

Equipment must be cleaned (see “Cleaning the Transmitter” on page 6-4) before this procedure is performed.

Note—If there is concern over cross-contamination due to leadsets or sensors, new lead sets or sensors should be used.

Equipment and Materials

Warning

EO is highly explosive, toxic, and a potential occupational carcinogenic and reproductive hazard. Handle it with extreme care, following U.S. Occupational Safety and Health Administration (OSHA) standards for EO (29 CFR 1910.1047)*. Personnel exposure and/or room air must be monitored per OSHA standards.

Vent sterilizer gas outdoors or to a suitable, evacuated container for reprocessing, depending upon state, provincial, or country environmental regulations. Do not vent sterilant indoors.

Vent aerator exhaust only to the outdoors.

* See “References” on page 6-12.

Transmitter Cleaning, Disinfection, & Cross-Infection Prevention

Use the following equipment and material to process the transmitter:

1. Ethylene Oxide (Allied Signal Oxyfume-2002™), heretofore referred to as EO.
2. Gas sterilizer, made by American Sterilizer Company or other manufacturers.
3. Mechanical aerator. The intake air for the aeration chamber must be routed through bacterial filters, and the exhaust air must be vented outside the building.

Note—Available combination sterilizer/aerators bypass the problem of personnel exposure to EO during transfer of treated material to a separate aeration cabinet.

Cross-Infection Process

The following generic procedure can be used to supplement the sterilizer and aerator manufacturers' instructions, although the processing times, temperatures, and pressure must be the same as those given in this procedure.

Important—In order to complete this stage of the process safely, harmful residue gas must be dissipated through aeration.

Task Summary

Step	Action
1	Remove any obvious contamination from the equipment to be processed using approved cleaners.
2	Individually package each transmitter in standard central supply room (CSR) wrapping material secured with EO color-change indicator tape.
3	Apply -26 inHg +/- 1 (-12.77 psig +/- .49) vacuum to the empty sterilizer chamber two times, to remove any residual EO or moisture. Vent the vacuum pump to the outdoors to avoid toxic hazards to personnel.
4	Insert the equipment to be processed into the gas sterilizer.
5	Heat the chamber and its contents to 54.4 +/- 2.8°C (130 +/- 5°F).

Step	Action
6	Apply -26 inHg +/- 1 (-12.77 psig +/- .49) vacuum to the sterilizer chamber.
7	Humidify the chamber at 50% +/- 10% relative humidity for 20 to 30 minutes.
8	<p>Taking a minimum of five minutes, slowly introduce EO sterilant until the sterilizer unit pressure gauge reaches 11 +/- 1 psig.</p> <p><i>Note</i>—At this pressure, the concentration of sterilant in the chamber will be 600 +/- 50 mg/liter, regardless of the chamber size.</p>
9	<p>Process the equipment to be processed as follows:</p> <p style="padding-left: 40px;">Pressure: 11 +/- 1 psig (established in the preceding step).</p> <p style="padding-left: 40px;">Time: 2-3 hours</p> <p style="padding-left: 40px;">Temperature: 54.4 +/- 2.8°C (130 +/- 5°F)</p>
10	<p>Extract the gas mixture from the sterilizer as follows:</p> <hr/> <p>Warning</p> <hr/> <p>Comply with OSHA standards[*]. Do not vent sterilizer gas to the room, but vent only outdoors or to a suitable, evacuated container, depending upon state, provincial, or country environmental regulations. (If the mixture is captured, it can be separated commercially and the component gases re-used.)</p> <p>[*] See “References” on page 6-12.</p> <hr/> <p>a. Pump the gas mixture out of the chamber until you obtain a vacuum of -26 inHg +/- 1 (-12.77 psig +/- .49), returning the mixture to a suitable evacuated container.</p> <p>b. Return the sterilizer chamber to ambient pressure by introducing air that has been bacterially filtered.</p>

Step	Action
11	Air-wash the chamber and material as follows: <ol style="list-style-type: none"> <li data-bbox="532 305 1188 423">a. Apply -26 inHg +/- 1 (-12.77 psig +/- .49) vacuum to the chamber and processed material again, to remove residual EO. The vacuum pump must be vented to the outdoors. <li data-bbox="532 456 1188 513">b. Return the sterilized chamber to ambient pressure by introducing air that has been bacterially filtered.
12	Continue with the "Aeration Procedure" (following).

Aeration Procedure

Warning

To avoid chemical burns and toxic effects, the equipment must be aerated after sterilization, as described. The aerator must have bacterial filters and outdoor venting.

See "References" on page 6-12.

Task Summary

Aerate the processed equipment by performing the following steps:

Step	Action
1	<p>To dissipate residual EO, aerate the processed equipment with air that has been bacterially filtered, using a mechanical aerator or combination sterilizer/aerator as follows:¹</p> <p style="padding-left: 40px;">Time: 8-9 hours</p> <p style="padding-left: 40px;">Temperature: 54.4 +/- 2.8°C (130 +/- 5°F)</p> <p style="padding-left: 40px;">Ventilation Frequency: At least 30 air exchanges per hour.</p>
2	Continue with the Test Procedure (following).

¹ These values will produce EO and Ethylene Chlorohydrin residual levels in the transmitter and patient cable plastic that meet ISO 10993-7 in conjunction with AAMI Technical Information Report 19, that the FDA currently endorses.

References

OSHA: Standard for acceptable levels of personnel exposure to Ethylene Oxide Gas: 1 ppm on an eight-hour time-weighted average basis.

Reference: U.S.A. Federal Regulations 49 FR 25734/29 CFR Part 1910.1047, June 22, 1984; final approval 50 FR 9800/2- CFR Part 1910.1047, March 12, 1985.

Test Procedure

Caution

You must perform this test each time you put a transmitter through the cross-infection prevention procedure.

This test allows you to verify that patient information for both ECG and SpO₂ (if you are monitoring pulse oximetry) appear at the Information Center and at the bedside. You can use this procedure with a patient simulator.

Transmitter Cleaning, Disinfection, & Cross-Infection Prevention

Note—This test assumes that the telemetry system and Information Center are fully installed, and that you have performed the procedure to learn the transmitter identity code.

Task Summary

Test the transmitter by performing the following steps. If the test indications do not appear, refer to your Service Provider.

Step	Action
1	Perform a mechanical inspection of the transmitter (connectors, battery door opening and closing, Telemetry and Check buttons).
2	At the Information Center, select the telemetry bedside you are testing.

Step	Action
3	<p>Test the transmitter:</p> <ul style="list-style-type: none"> a. Put fresh batteries in the transmitter and close the battery door. Result: All indicator lights on the front of the transmitter light momentarily, and you will hear a single beep. b. Attach a lead set to the ECG port, and attach an SpO₂ sensor to the SpO₂ port. If an ECG simulator is available, attach the ECG leads to the simulator and the SpO₂ sensor to yourself. At TeleMon, set the SpO₂ sample rate to Continuous. Result: An ECG trace and SpO₂ information should be visible on the Information Center display. All transmitter lights should be off. c. Disconnect the Right Arm lead for standard ECG or the “I” electrode for EASI. Result: The RA LED or the “I” lead LED should turn on, and a Leads Off INOP should appear on the display at the Information Center. d. Reconnect the electrode.
4	<ul style="list-style-type: none"> a. Connect the transmitter to TeleMon and observe the ECG waveform and SpO₂ numerics on the TeleMon display. Result: The ECG waveform and SpO₂ numerics should be displayed on the TeleMon screen.

Receiver Mainframe Cleaning

The receiver mainframe should be kept free of dust and dirt. You can only clean the outside of the receiver mainframe. Wipe the outside of the receiver mainframe clean by wetting a damp cloth or rag with one of the following approved cleaning agents:

- Soap and Water
- Isopropyl Alcohol ($\geq 70\%$)
- Ethyl Alcohol ($\geq 70\%$)
- Hydrogen Peroxide
- Sodium Hypochlorite (chlorine bleach), 5% solution
- Sodium Hypochlorite (chlorine bleach), 10% solution prepared within 24 hours
- Cidex®
- Windex®
- Lysol®

Wipe all cleaned surfaces with distilled water to remove any residue. Allow to air-dry, or dry with a non-lint producing cloth before use.

Configuration

How your telemetry system performs depends in large part on the configuration choices made during system installation. This chapter provides a summary of the factory-set defaults and the alternative configuration choices that relate to clinical practice. Configuration for the telemetry system is performed at the receiver mainframe, except for Philips transmitters, which are configured at the TeleMon Companion Monitor or using the Service Configuration Tool. All receiver settings, except frequency, pertain to all receivers in the mainframe.

Two of the most frequently performed configuration procedures are also included in this chapter.

For complete configuration information, including the impact of individual choices, refer to the *Philips Telemetry System Installation and Configuration Guide* in the *M2600B Documentation Kit* (M2600-90323).

Configuration Settings

M2604A Mainframe

The following table lists the mainframe configuration settings used by the IntelliVue Information Center.

Note—The IntelliVue Information Center does not use the following settings:

- HR Alarm Limits
- Lead Fallback
- Bandwidth
- ST Settings

Item	Factory Default	User Choices
GENERAL ALARM PARAMETERS		
Alarm Suspend	3 Minutes	3 Minutes, Infinite
Alarm Reminder <i>only applies to:</i> – SpO ₂ – ECG if not arrhythmia monitored	ON	ON, OFF
GENERAL ECG PARAMETERS		
Extended Monitoring	ON	ON, OFF

Item	Factory Default	User Choices
M2601X SERIES TRANSMITTERS ECG PARAMETERS		
Lead Selection - 5 Electrode	Primary = II Secondary = V	Primary = I, II, III, aVR, aVL, aVF, MCL, V Secondary = I, II, III, aVR, aVL, aVF, MCL, V, OFF <i>Note</i> —The ECG primary and secondary must be different lead types, and the primary cannot be OFF.
Lead Labelling - 3 Electrode	Primary = II	Primary = I, II, III, MCL
SpO₂ PARAMETERS		
SpO ₂ Alarm Limits	High: 100 percent Low: 90 percent	High Range = 51-100 percent Low Range = 50-99 percent (increment of 1)
GENERAL PARAMETERS		
Telemetry Button Function	Nurse Call and Record	Nurse Call, Record, Both, Disabled
Language	English	English, German, French, Dutch, Spanish, Swedish, Italian, Japanese, Norwegian, Danish, Finnish, Portuguese

For configuration of the following items, see the *Philips Telemetry System Installation and Configuration Guide* in the *M2600B Documentation Kit*.

- Auto Self Test
- Self-test Strip
- SDN Unit Number
- SDN Branch Number
- Country Code
- Locale Code
- Frequencies

Philips M2601B Transmitter

The following table lists the configuration settings for the Philips M2601B Transmitter.

Item	Factory Default	User Choices
Lead Selection 3-wire lead set	No	Yes, No
Automatic Shutoff (after 10 minutes)	Yes	No, Yes

For configuration of the following items, see *Philips Telemetry System Installation and Configuration Guide*

- Country Code
- Locale Code
- Frequencies

Changing the Configuration

Configuration changes require the TeleMon Companion Monitor or the Service Configuration Tool. If configuration is required (for example to match a replacement Philips transmitter to others in the unit or to change the frequency in case of excessive interference) contact the Service Provider or consult the *TeleMon Service Manual*.

System Safety and Specifications

This chapter provides information on regulatory requirements compliance for patient safety, safety-oriented installation and maintenance procedures, and specifications for the Philips Telemetry System. It includes the following sections:

- Product Safety. 7-2
- Philips Telemetry System Warnings. 7-4
- Electromagnetic Compatibility. 7-5
- System Symbols 7-9
- Installation and Maintenance Safety. 7-14
- Additional Safety Information 7-19
- System Specifications. 7-20

Product Safety



The M2600B Philips Telemetry System, complies with the requirements of the Council Directive 93/42/EEC of 14 June 1993 concerning medical devices and carries CE-marking accordingly. ()

The following symbol  means that this device is considered Class 2 radio equipment per Directive 1999/5/EC for which Member States may apply restrictions on putting the device into service or placing it on the market. This system is intended to be connected to the publicly available interfaces (PAI) for use throughout EEA.

The Philips Telemetry System also complies with the following international safety requirements for medical electrical equipment:

- IEC 601-1:1998 + A1:1991 +A2:1995 General Requirements for Safety (with worldwide deviations, including U.S. deviations)
- IEC 60601-1-1:2000 System Safety
- IEC 60601-1-2:2001 Electromagnetic Interference
- IEC 60601-1-4:1996 Safety for Programmable Electrical Medical Systems
- IEC 60601-2-49:2001 Multi-parameter Monitor Safety
- EN 865:1997 Particular Requirements for Pulse Oximeters
- AAMI Voluntary Performance Standards for Cardiac Monitors: EC 13: 2002, Clauses 4.2.8 and 5.2.8

The system is protected against the effects of defibrillation.

This system provides continuous operation when in use.

The following accessories and system components are independently CE marked to the Medical Device Directive. They are not covered by the CE marking of the Philips Telemetry System:

- All SpO₂ accessories and equipment
- ECG electrodes
- ECG lead sets

Authorized EU Representative:

Philips Medizinsysteme Boeblingen GmbH
 Hewlett-Packard Str. 2
 D-71034 Boeblingen
 Germany

System Classification**Class I Equipment**

M2604A Receiver Mainframe

Class II Equipment

453563647161 Universal Power Converter (UPC)

Characteristic	Definition
Internally Powered Equipment	The M2601B Transmitter is an internally powered device.
Continuous Operation	All equipment is Ordinary Equipment, IPX0, and provides continuous operation.
Type CF Defibrillation Proof	The M2601B Transmitter is Type CF Defibrillation Proof relative to ECG and SpO ₂ patient applied parts.
Water Resistance	<p>When placed inside a Philips carrying pouch with the flap closed and snaps secured, the transmitter is rated IPX3, as per IEC 60529:1989 (+A1:1999): Protected against splashing water.</p> <p>The combination of the transmitter and pouch will withstand showering for up to 10 minutes.</p> <p>The transmitter will not be damaged if it is accidentally immersed in liquid for up to 5 minutes.</p>

Essential Performance

The Philips Telemetry System provides Essential Performance (EP) under normal operating conditions (includes EMC exposure) only as a complete Medical Electrical System, consisting of the M2601B Patient-Connected Device, M2636B TeleMon (opt. A02, A03) Companion Monitor (Optional), M2603A/M2604A Receiver/Mainframe, and M3150A IntelliVue Information Center.

The system achieves its Essential Performance exclusively through alarm generation at the Information Center.

The system protects the patient from unacceptable immediate clinical risk by generating specific Physiological Alarms when appropriate. If the system cannot generate Physiological Alarms, then relevant Technical Alarms (INOPs) will be created.

Philips Telemetry System Warnings

The warnings and cautions described below refer to the following devices:

- Philips M2601B Transmitter
- Philips Telemetry System
- IntelliVue Information Center

Warning

Do not touch the patient, or table, or instruments during defibrillation. The battery door must be closed during defibrillation. These steps protect the clinician from high defibrillator voltage.

Warning

Do not install or use power modules for analog output and antennas within a 2.44 m (8 ft.) radius of the patient. This helps ensure patient electrical safety.

Caution

Installation and setup must be performed by a Philips Medical Systems service representative or designee according to the instructions in *Philips Telemetry Installation & Configuration Guide*, which can be found in the *M2600B Documentation Kit* (order number M2600-90323).

Electromagnetic Compatibility

M2600B Philips Telemetry System Testing

The electromagnetic compatibility (EMC) validation of the Philips M2600B Telemetry System included testing performed according to the international standard for EMC with medical devices. See the Manufacturer's Declaration for details.

Medical electrical equipment can either generate or receive electromagnetic interference. This product has been evaluated for electromagnetic compatibility (EMC) with the appropriate accessories according to IEC 60601-1-2:2001, the international standard for EMC for medical electrical equipment. This IEC standard has been adopted in the European Union as the European Norm, EN 60601-1-2:2001.

Radio frequency (RF) interference from nearby transmitting devices can degrade performance of the product. Electromagnetic compatibility with surrounding devices should be assessed prior to using the product.

Fixed, portable, and mobile radio frequency communications equipment can also affect the performance of medical equipment. See your Service Provider for

assistance with the minimum recommended separation distance between RF communications equipment and the product.

The cables, sensors/transducers, and other accessories for which compliance is claimed are listed in “Appendix B. Accessory List” in this *Instructions for Use* and in the *Philips Telemetry System Service Guide*.

Warning

The use of accessories, transducers and cables other than those specified in the Philips Telemetry System service and user documentation can result in increased emissions or decreased immunity of the product.

Warning

The product should not be used next to or stacked with other equipment. If you must stack the product, you must check that normal operation is possible in the necessary configuration before the product is used.

Reducing Electromagnetic Interference

The system and associated accessories can be susceptible to interference from other RF energy sources and continuous, repetitive, power line bursts. Examples of other sources of RF interference are other medical electrical devices, cellular products, information technology equipment, and radio/television transmission. If interference is encountered, as demonstrated by artifact on the ECG or dramatic variations in physiological parameter measurement values, attempt to locate the source. Assess the following:

- Is the interference due to misplaced or poorly applied electrodes or sensors? If so, re-apply electrodes and sensors correctly according to directions in “Chapter 3. ECG & ST/AR Measurement”.
- Is the interference intermittent or constant?
- Does the interference occur only in certain locations?
- Does the interference occur only when in close proximity to certain medical electrical equipment?
- Do parameter measurement values change dramatically when the AC line cord is unplugged?

Once the source is located, attempt to attenuate the interference by distancing the product from the source as much as possible. If assistance is needed, contact your local Service Provider.

Restrictions for Use

Artifact on ECG and other physiological waveforms caused by electromagnetic interference should be evaluated by a physician or physician authorized personnel to determine if it will negatively impact patient diagnosis or treatment.

FCC Compliance (USA only)

Operation of this equipment requires the prior coordination with a frequency coordinator designated by the FCC for the Wireless Medical Telemetry Service.

The FCC requires the following statement for this device:

The Philips M2600B Telemetry System complies with Part 15 of the Federal Communications Commission (FCC) Rules. Operation is subject to the following two conditions:

- This device may not cause harmful radio frequency interference to a primary licensed user (radio and television stations), and
- This device must accept any interference received from a primary licensed user, including interference that may cause undesired operation.

Pursuant to Part 15.21 of the FCC Rules, any changes or modifications to this equipment not expressly approved by Philips Medical Systems may cause harmful radio frequency interference, and void your authority to operate this equipment.

Canadian Radio Equipment Compliance (Canada Only)

For operation in 608-614 MHz

This telemetry device is only permitted for installation in hospitals and health care facilities. This device shall not be operated in mobile vehicles (even ambulances and other vehicles associated with health care facilities). The installer/user of this device shall ensure that it is at least 80 km from the Penticton radio astronomy station (British Columbia latitude: 49° 19' 12" N, longitude 118° 59' 56" W). For medical telemetry systems not meeting this 80 km separation (e.g., the Okinagan Valley, British Columbia) the installer/user must coordinate with and obtain the written concurrence of the Director of the Penticton radio astronomy station before the equipment can be installed or operated. The Penticton contact is Tel: 250-493-2277; FAX: 250-493-7767.







For operation outside 608-614 MHz

Contact your local Industry Canada offices as licensure is required.









To provide maximum RF shielding and minimum RF interference to the licensed service, this device should be operated indoors and away from windows.

System Symbols

The following is an explanation of the symbols found on the hardware components of the Philips Telemetry System:

<u>Symbol</u>	<u>Explanation</u>
	AC Line Current.
	Active Antenna Combiner.
	Antenna Input.
	Attention. See <i>Instructions for Use</i> .
	Bandpass Filter
	Battery Polarity
	Catalog Number

System Symbols

<u>Symbol</u>	<u>Explanation</u>
	Class 2 Equipment
	Data In
	Data In, Data Out
	Data Out
	Date of Manufacture
	DC Voltage
	Do Not Reuse. Use Only Once. Dispose of properly after use in accordance with local regulations.
	Electrical Input

Symbol

Explanation



Electrical Output.



Equipotential Grounding System.



Follow Operating Instructions.



Frequency Converter



Fuse Input.



Grounding system.



Indoor Use Only











Line Amplifier



MAC Address of Device

System Symbols

<u>Symbol</u>	<u>Explanation</u>
	Non-ionizing Radiation
	Power On/Off
OPT	Product Option
	Protective Earth (Ground)
	Power Tee
	Receiver Mainframe Malfunction
	Receiver Mainframe. For future use.
	Serial Number
	Type CF Defibrillation Proof

Symbol**Explanation****IPX0**

The M2600B is rated IPX0 in degrees of protection by enclosures; not protected against ingress of water.



Complies with applicable Canadian and American medical safety standards.

CE 0123

Compliance to Council Directive 93/42/EEC (Medical Device Directive)



Class 2 Radio equipment identifier (1999/5/EC): Member states may apply restrictions on putting this device into service or placing on the market. This device is intended to be connected to the publicly available interfaces (PAI) for use throughout the EEA

Rx

Federal Law restricts this device in the United States to sale by or on the order of a physician.

Type CF Defibrillation Proof

The following symbol identifies a device that is Type CF Defibrillation Proof.



TYPE CF DEFIBRILLATION PROOF

Type CF Defibrillation Proof equipment is protected against defibrillation (DEFIBRILLATION-PROOF) and is a TYPE CF APPLIED PART.

Installation and Maintenance Safety

Caution

Installation and setup must be performed by a Philips Medical Systems service representative or designee, except for transmitters purchased individually. These can be installed by hospital personnel according to instructions in the *Installation and Configuration Guide* included in the *M2600B Documentation Kit*.

Installation

Environment

Follow the instructions below to ensure a completely safe electrical installation. The environment where the Philips Telemetry System will be used should be relatively free from vibration, dust, corrosive or explosive gases, extremes of temperature, humidity, and so on. For a cabinet mounted installation, allow sufficient room at the front for operation and sufficient room at the rear for servicing with the cabinet access door open.

The Philips Telemetry System operates within specifications at ambient temperatures between 0°C (32°F) and 55°C (131°F). The transmitter ambient temperature specification is between 0°C (32°F) and 37°C (99°F). Ambient temperatures which exceed these limits could effect the accuracy of the

instrument and cause damage to the components and circuits. Allow at least 5 cm (2 inches) clearance around the instrument for proper air circulation.

Grounding

To protect hospital personnel, the cabinet of the Philips Telemetry System must be grounded. Accordingly, the system is equipped with a detachable 3-wire cable which grounds the instrument to the power line ground (protective earth) when plugged into an appropriate 3-wire receptacle. If a 3-wire receptacle is not available, consult the hospital electrician.

Warning

Do not use a 3-wire to 2-wire adapter with this instrument. This ensures optimal electrical safety.

Condensation

Make sure that during operation, the instrument is free of condensation. Condensation can form when equipment is moved from one building to another, thus being exposed to moisture and difference in temperature.

Warning

Possible explosive hazard if used in the presence of flammable anesthetics.

Receiver Mainframe

Rear Panel

The rear panel of the receiver mainframe is shown below.

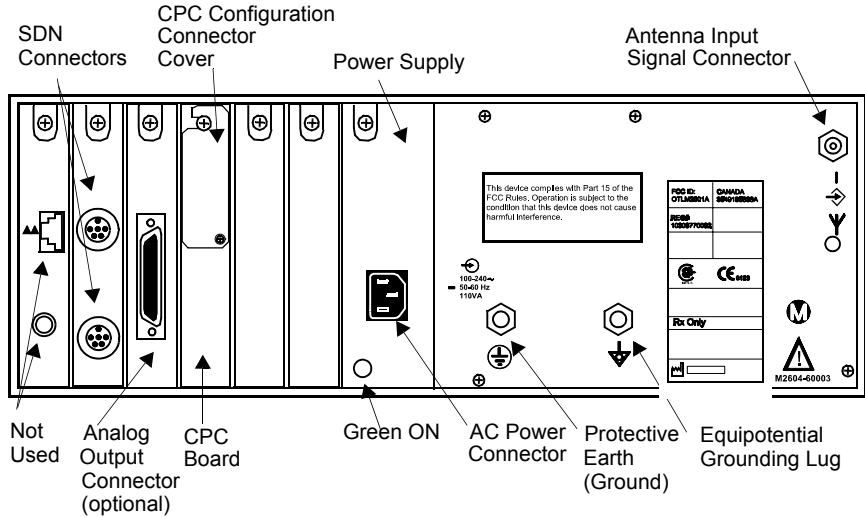

The back of the mainframe should be removed only by qualified service personnel. To remove the protective cover, unfasten screws, remove tab(s) from slot(s), and lift the cover section off.

Connectors

The connectors on the rear panel of the receiver mainframe are:

Connector	Description
AC Power	3-pin connector, used to input the local line voltage. Mainframe plug is a standard IEC mains inlet receptacle.
Analog Output (Patient Monitor/Holter Interface) - optional	High-density 50-pin SCSI connector to send analog signal to output connector box
Antenna Input Signal	BNC coaxial connector. Max voltage +25V DC

Connector	Description
Equipotential Grounding Lug	Grounding stud connector, used to equalize the grounding potential between products (see “Secondary Ground Wire”, below)
SDN	Upstream and downstream connectors that connect to the Philips monitoring network

Secondary Ground Wire

A secondary ground wire is provided with this instrument to comply with IEC-60601-1-1. This wire ensures against excessive chassis leakage current in the event of a single fault in the health care facility's primary grounding means.

It is recommended that the secondary ground wire be used to connect the Equipotential Grounding Lug to a ground source separate from the primary grounding source found in the instrument's power source.

Note—After servicing, be certain to reconnect the secondary ground wire.

Warning

Removal of the secondary grounding wire from the rear of the product voids the IEC approval.

Lifting the Receiver Mainframe

The weight of the receiver mainframe is 13.8 kg (30.5 lb.). When carrying the mainframe, please use proper lifting techniques

Antenna Amplifiers

The antenna amplifiers must be operated only with the Power Supply (AC/DC Adapter), and must be operated at a minimal distance of 2.43 meters (8 feet) from the patient.

M26XXA/M14XX Series Antenna Components

For all voltages, use part number 453563647161.

Patient Monitor/Holter Interface Option

If using the optional Patient Monitor/Holter Interface (Analog Output), the connector box must only be operated with the appropriate power supply) and must be operated at a minimum distance of 2.43 meters (8 feet) from the patient.

For all voltages, use Universal Power Converter (UPC), part number 453563647161.

Preventive Maintenance

Preventive maintenance should be performed by a qualified service person. The Safety and Performance Tests, and what to do if the equipment does not meet these specifications, are described in the *Philips Telemetry System Service Guide* in the *M2600B Documentation Kit*. Contact your biomedical department if your equipment needs testing for safety or performance.

End of Life

There is no specific, predetermined end of life to the Philips Telemetry System or any of its component products. Philips Medical Systems provides service, support and replacement parts and assemblies throughout the support life of the products that allow them to be repaired should any component of the system fail. Please refer to the *Philips Telemetry System Service Guide* for instructions on how to obtain service or replacement parts and for instructions on preventative maintenance. Your local Philips Medical Systems sales or service representative can provide you information regarding the support life of your products.

Additional Safety Information

Warning

The equipment is not suitable for use in the presence of a flammable anesthetic mixture with air or with oxygen or nitrous oxide.

Warning

This device is not to be used in the vicinity of electrosurgery units because use may interrupt or interfere with the transmission of signals from the transmitter.

Warning

Do not touch the patient, or table, or instruments during defibrillation. The battery door must be closed during defibrillation. These steps protect the clinician from high defibrillator voltage.

Warning

Strangulation Hazard! Under no circumstances should any pouch be tied solely around a patient's neck.

Warning

Do not use patient cables with detachable lead wires that have exposed male pins. Electrocutation could result if these pins are plugged into AC power.

Software Hazard Prevention

The minimization of hazards arising from errors in the software program is documented in the following reports:

TO TRANSLATORS: text will follow.

System Specifications

This section lists the specifications for battery life, environmental and electrical power specifications for the hardware components of the system, and measurement specifications.

For complete specifications, see the *M2600B Documentation Kit*.

Battery Life Specifications

Equipment	Specification
Battery Type	2 fresh disposable AA alkaline batteries

Note—The battery life times listed below are based on Duracell MN 1500 batteries. Battery life for other brands may be different.

Operating Mode	Battery Life	Battery Life Japanese Version
ECG Only	39.6 hours, typically	44.71 hours, typically
ECG/SpO ₂ Continuous	16.7 hours, typically	17.01 hours, typically
ECG/SpO ₂ Spot Check	between 14 hours and 41 hours, depending on usage rate	between 15 hours and 45 hours, depending on usage rate

Environmental Specifications

For all hardware components of the Philips Telemetry System except Philips transmitters and reusable pulse oximetry sensors

Operating

Temperature Range: 0 to 55°C (32 to 131°F)

Altitude Range: Up to 4570 m (15,000 ft.)

Humidity Range: 15 to 95% relative humidity

Storage

Temperature Range: -40 to +70°C (-40 to +158°F)

Altitude Range: Up to 4570 m (15,000 ft.)

Humidity Range: 90% relative humidity maximum

For Philips Transmitters

Operating Temperature: 0 to 37 °C (32 to 99 °F)

Operating Humidity: ≤ 95% RH at 40 °C (104 °F) non-condensing

Storage Temperature: -40 °C to 60 °C (-40 to 120 °F) without batteries

Storage Humidity: ≤ 90% RH at 60 °C (120 °F) without batteries

Altitude, Operating and Non-operating: 0 to 3048 m (10,000 ft.)

For Philips Reusable Pulse Oximetry Sensors

Operating

Temperature Range: 15-37°C (50-98.6° F)

Altitude Range: Up to 4570 m (15,000 ft.)

Humidity Range: 95% relative humidity at 37° C (98.6° F) maximum

Storage

Temperature Range: -40 to 70° C (-40 to 158° F)

Altitude Range: Up to 4570 m (15,000 ft.)

Storage Humidity: 95% relative humidity at 65° C (150° F) maximum

Water Resistance

The transmitter can be used to monitor a patient in the shower for up to 10 minutes only when placed inside a Philips carrying pouch with the flap closed and snaps secured. The transmitter will not be damaged if it is accidentally immersed in liquid for up to 5 minutes.

After showering, perform the following steps to continue monitoring:

4. Pat dry the lead set connections at the electrodes.
5. Wipe the lead wires with care.
6. If wet, dry the outside of the transmitter with a non-lint producing cloth.
7. If wet, wipe the inside of the battery compartment dry. Dry the batteries.
8. If wet, disconnect the ECG lead block and shake out any water. Dry the connector pin area with a cotton swab.

Note—The transmitter should not be used for monitoring if the battery compartment is wet. Remove the batteries and wipe the compartment dry before continued monitoring use.

Warning

If the transmitter is used while showering a patient or is accidentally immersed in liquid, detection of "leads off" conditions may be compromised. Appropriate clinical precautions should be taken.

Electrical Power Specifications

Note—Specifications for earlier releases of the product may vary slightly.

M2601B Transmitters

Frequency Range

406-480 MHz and 590-614 MHz, depending on option

Synthesizer Step Size

12.5 KHz

RF Output Power @ 25°C

Non-Japan transmitter: option #001 to option # 008: 6.5 dBm, +1.6/-2.0 dB (2.8 mW to 6.5 mW) not to exceed 10 dBm into Antenna load

Japan only: +0.8/-3.0 dBm (0.5 mW to 1.2 mW) into Antenna load

RF Output Power @ 0 - 45°C

RF Output Power @ 25°C +/- 1.25 dB into Antenna load

Adjacent Channel Power

< - 65 dBm at 25 KHz offset

Harmonic Levels (into Antenna)

For ETSI & CISPR-11 standards

47 - 118 MHz: ≤ -54 dBm
118 - 174 MHz: ≤ -46 dBm
174 - 230 MHz: ≤ -54 dBm
230 - 470 MHz: ≤ -38 dBm (excluding channel output)
470 - 862 MHz: ≤ -54 dBm (excluding channel output)
862 - 1000 MHz: ≤ -38 dBm
> 1000 MHz: ≤ -30 dBm

Frequency Accuracy

Frequency @25°C +/- 2.5 ppm @ (0 - 45°C)

Occupied Bandwidth

≤ 10 KHz

Data Rate

9600 bits per second

Modulation Type

GMSK

RF Specifications in 608-614 WMTS Band

Frequency Ranges

Option Band #037: 608 - 614 MHz (WMTS)

RF Output Power @ 25°C

6.5 dBm, +1.6/-2.0 dB (2.8 mW to 6.5 mW) not to exceed 10 dBm into Antenna load

RF Output Power @ 0 - 45°C

RF Output Power @ 25°C +/- 1.25 dB into Antenna load

Adjacent Channel Power

< - 65 dBm at 25 KHz offset

Harmonic Levels (into Antenna)

For FCC & Canadian standards

30 - 88 MHz: ≤ -56 dBm (≤ 50 dBm in US)
88 - 174 MHz: ≤ -52 dBm (≤ 50 dBm in US)
174 - 230 MHz: ≤ -54 dBm (≤ 50 dBm in US)
230 - 960 MHz: ≤ -50 dBm (excluding channel output)
> 960 MHz: ≤ -42 dBm

Defibrillator Protection

Transmitter ECG input protected against 400 joules discharge into 50 Ohm load

Batteries

Two disposable 1.5V Alkaline batteries

**M2604A
Receiver Main
Frame with
453563489161
Power Supply**

Input Voltage

100-240 VAC

Frequency Range

50 to 60 Hz

Power Consumption

For M2604A: 110 VA maximum, average with 8 M2603A receiver modules

Controls

Front Panel: none

Rear Panel: none

Indicators

Front Panel: Green Instrument Power On LED
Red Instrument Malfunction LED

Rear Panel: Green Power Supply On LED

Connections (rear)

AC Power connector

Analog Output connector

Antenna Input Signal connector

Grounding lug

Downstream SDN connector

Upstream SDN connector

CPC Configuration connector

Radiated Immunity

3 Volts/Meter outside of operating receiver bands

**M2603A
Receiver
Module**

Frequency Tuning

Programmable, synthesizer, PLL controlled.

Channel Spacing

25 kHz.

Carrier Frequency Range

Frequency range depends on transmitter option

**Patient
Monitor Holter
Recorder
Interface
(Analog
Output)
Option J01**

Power Module

453563647161

Input Voltage

100-240 VAC +/- 10%

Frequency Range

47 - 63 Hz.

Power Consumption

33 VA maximum

Analog Output Gain (from output of receiver module)

High-level outputs: $500 \pm 5\%$

Low-level outputs: $1 +7\%/-6\%$

Inoperative Mode (Technical Alarm Condition) Output Level

High-level output: 10.8 volts ± 1.2 volts

Low-level output: >100 megohms with respect to reference electrode

Delay from Transmitter Input to Analog Output

400 milliseconds max -- Philips transmitter

Not intended for use with synchronized cardioversion due to processing delay.

Indicators

Output Connector Box; Status and Power LEDs

Connections

Output Connector Box: Input (50-pin jack); Input (Power Module); Output (8 pairs of 9-pin D connectors)

Analog Output Card: Output (50-pin jack)

System Specifications

Bedside Attenuator: Output (3-conductor phone jack)

Holter Attenuator: Output (set of 5-button connectors)

ECG Bandwidth

M2601B: 0.5 - 40 Hz



To ensure proper operation, installation and setup must be performed by a Philips Medical Systems service representative or designee according to the instructions in *Patient Monitor/Holter Recorder Interface (Analog Output) Installation Note* (part number M2600-90194).

Antenna System Specifications

M2606A Line Amplifier

Input Voltage

19-32 VDC

Current Requirements

38 mA, maximum

Power Consumption

0.75 Watts, average

RF Frequency Range

406-650 MHz

RF Gain

12.0 dB typical at 406 MHz

12.7 dB typical at 465 MHz

13.3 dB typical at 611 MHz

13.2 dB typical at 650 MHz

Indicators

Green LED indicates DC power is applied to the RF Output connector.

Yellow LED indicates DC power is applied to the RF Input connector.

**M2607A
Multiple Unit
Power Supply**

Note—M2607A specifications cover both power module and power tee.

Input Voltage

CE Mark Power Module 453563647161: 100-240 VAC +/- 10%

Frequency Range

47-63 Hz

RF Frequency Range

406-650 MHz

Power Consumption

33 VA maximum

Output Voltage

23 VDC nominal

Output Current

1 Amp maximum (Limited by the circuit breaker in the power tee)

Indicators

Green LED is on when power is present.

**M2608A Active
Antenna/
Combiner**

Input Voltage

19 - 32 VDC

Input Current

62 mA maximum

Power Consumption

1.1 Watts average (2.0 Watts maximum)

RF Frequency Range

406-650 MHz

RF Gain

Antenna Port	9.7 dB +/- 1.0 dB at 406 MHz
	10.2 dB +/- 1.0 dB at 465 MHz
	9.7 dB +/- 1.0 dB at 611 MHz
	9.7 dB +/- 1.5 dB at 650 MHz
Line Port	3.2 dB +/- 0.7 dB at 406 MHz
	3.5 dB +/- 0.3 dB at 465 MHz
	3.9 dB +/- 0.7 dB at 611 MHz
	4.0 dB +/- 0.7 dB at 650 MHz

Indicators

Green LED indicates DC power/signal cable connected correctly.

Red LED indicates DC power/signal cable connected incorrectly.

**M2609A
Attenuator**

Current Carrying Capacity

Maximum DC Voltage: +30 VDC maximum
Maximum DC Current: 1 A maximum

RF Frequency Range:

406-650 MHz

RF Attenuation

1-9 dB in increments of 1 dB, based on option

**M2612A
Bandpass
Filter**

Current Carrying Capacity

Maximum DC Voltage: 32 Volts
Maximum DC Current: 1 A

Power Requirements

Negligible

RF Frequency Range

#004 430-440 MHz
#005 440-450 MHz
#006 450-460 MHz
#007 460-470 MHz

#034 590-596 MHz
#035 596-602 MHz
#036 602-608 MHz
#037 608-614 MHz

Indicators

Green LED is ON when power is present.

**M2616A
External
Frequency
Converter**

Input Voltage

CE Mark Power Module 453563647161: 100-240 VAC +/- 10%

Frequency Range

47-63 Hz

Power Consumption

14.0 VA maximum

RF Input Frequency Range

590-632 MHz

RF Output Frequency Ranges

#130 460-502 MHz

#136 454-496 MHz

#142 448-490 MHz

#148 442-484 MHz

#154 436-478 MHz

#160 430-472 MHz

#166 424-466 MHz

Indicators

Green LED is ON when power is present.

Measurement Specifications

ECG ECG channel transmitted leads

3 electrodes

Channel #1: I, II, or III

5 electrodes

Channel #1: II

Channel #2: III

Channel #3: MCL

5 electrodes, EASI

Channel #1: Vai

Channel #2: Vas

Channel #3: Ves

Resolution

5 μ V

ECG Input

Differential, defibrillator protected against 400 joules discharge into a 50 ohm load

Input Impedance

> 5 megohms (@ 10 Hz)

Input Dynamic Range

+/- 9 mmV (EASI mode, +/-4.7mV)

DC Offset Range

+/- 320 mV

CMRR

+/- 90 dB @ 50, 60 Hz

Bandwidth +/- 3 dB

0.05 to 40 Hz

Gain Accuracy

+/- 5% at 25°C (77°F)

Noise Referred to ECG Input

AAMI: 30 μ V

Lead Wires

3 or 5-wire set. 5-lead compatible with IntelliVue Patient Monitor, AAMI or IEC color code

Time to baseline from Defibrillator

AAMI: 5 s max (until ECG wave is on display but not yet centered, monitoring bandwidth)

Pacer Rejection Performance (pace pulses with no tails)

Positive pacers

<u>Amplitude</u>	<u>Width</u>
+2 to +700 mV	0.1, 0.2, 0.5, and 1.0 ms
+2 to +500 mV	1.5 ms
+2 to +400 mV	2 ms

Negative pacers

<u>Amplitude</u>	<u>Width</u>
-2 to -700 mV	0.1, 0.2, 0.5, and 1.0 ms
-2 to -500 mV	1.5 ms
-2 to -400 mV	2 ms

EMC Performance limits, radiated immunity

Meets Essential Performance, No HR, PVC or Alarm error. But may observe some waveform disturbance in the range 45.00 to 65.00 MHz at levels greater than 2.0 Vrms.

Cardiotach Alarm (Standard ECG only)

Information Center selectable, in 5 b/min. increments.

High: 20 - 250 b/min.

Low: 15 - 245 b/min.

Cardiotach Display (Standard ECG only): 15 - 300 b/min.

Accuracy

Gain: +/- 5% at 25° C (77° F)

Cardiotach (Standard ECG only): +/- 3 beats plus +/- 2% of heart rate for constant rate input.

At fewer than 15 b/min., the heart rate indication is 0.

Cardiotach Alarm (Standard ECG only): +/- 1 b/min., of displayed value

Display

Displayed values are presented in whole numbers.

SpO₂ Measurement Range (Calibration and Display)

0-100%

Display of SpO₂ Numerics

SpO₂ values are displayed as xxx % SpO₂ to meet ISO/EN standard EN 865

Accuracy

See tables, following

Resolution

1%

SpO₂ Numerics Averaging

10 seconds

SpO₂ & Pulse Numerics - Update Rate

Transmitted once per second

Pleth Wave - Sampling Rate

125 sps

Technical Alarms

Triggered if the sensor is disconnected, if a pulse is not detected, if the signal is noisy, if light interference is detected, if the sensor is defective, if the measurement is erratic, or if the module is malfunctioning

Pulse Rate Measurement (available only with Continuous SpO₂)

Range: 30 - 300 b/min.

Accuracy: +/- 2%

Resolution: 1 b/min.

Calibration

Automatic self-calibration when device is turned on. The pulse oximeter is calibrated to display functional saturation.

**Sensor
Accuracy**

Type	Description	Model Number	Accuracy% A_{rms} (70-100% Range)
Philips Reusable Sensors	Adult Finger	M1191A	2.0
	Adult Finger	M1191AL	2.0
	Adult Finger	M1191NL	2.0
	Pediatric Finger	M1192A	2.0
	Pediatric Finger	M1192N	2.0
	Adult/Pediatric Ear	M1194A	3.0
	Adult/Pediatric Ear	M1194N	3.0

Type	Description	Model Number	Accuracy% A_{rms} (70-100% Range)
Philips Disposable Sensors	Adult Finger	M1901B	3.0
	Pediatric Finger	M1903B	3.0
	Adult Finger	M1904B	3.0

System Specifications

Type	Description	Model Number	Accuracy% A_{rms} (70-100% Range)
Nellcor Disposable Sensors (not available from Philips)	OxiCliq A, Adult	N/A	3.0
	OxiCliq N, Adult >40 kg (88 lb)	N/A	3.0
	OxiCliq P, Pediatric	N/A	3.0
	OxiMax MAX-A, Adult >30 kg (66 lb)	N/A	3.0
	OxiMax MAX-AL, Adult >30 kg (>66 lb)	N/A	3.0
	OxiMax MAX-N, Adult >40 kg (>88 lb)	N/A	3.0
	OxiMax MAX-P, Pediatric	N/A	3.0
	Oxisensor II D-20, Pediatric 10-50 kg (22-110 lb)	N/A	3.0
	Oxisensor II D-25, Adult >30 kg (>66 lb)	N/A	3.0
	Oxisensor II N-25, Adult >40 kg (>88 lb)	N/A	3.0

Optional Patient Monitor/ Holter Interface (Analog Output)

This chapter describes the optional Patient Monitor/Holter Interface (Analog Output). It includes the following sections:

- OverviewA-2
- Analog Output Bedside Monitor Cables.A-3
- Lead Placement and SelectionA-5
- Controls for Telemetry SetupA-6
- Functionality with Paced Waves.A-6
- Technical Alarms (Inoperative Conditions)A-7
- Holter Interface.A-8

Overview

The optional Patient Monitor/Holter Interface (Analog Output) gives the Philips Telemetry System the capability of providing ECG outputs to bedside monitors, holter monitors, and other recording devices. This option is not available for telemetry systems with EASI monitoring.

Warning

The Patient Monitor/Holter Interface (Analog Output) Option is intended for display and recording purposes only. The following should not be used with this option:

- Synchronized cardioversion
- Intra-aortic balloon pump

Inherent delays in the telemetry transmitter, receiver, and the analog output processing cause significant time lags between actual ECG occurrence and the signal required to trigger the defibrillator or intra-aortic balloon pump. Failure to adhere to this warning could cause serious injury to the patient.

Correct Labeling

To ensure correct lead labeling at the bedside monitor, the following should be used:

- Correct bedside monitor cable. See the table on page A-4.
- Standard lead placement
- Valid lead selection at the bedside monitor. See “Lead Placement and Selection” on page A-5.

Not adhering to these recommendations may result in mislabeled leads or an invalid display.

Analog Output Bedside Monitor Cables

To connect the telemetry transmitter to the bedside monitor via the optional Patient Monitor/Holter Interface (Analog Output), you will need an analog output bedside monitor cable.

The end of the cable that connects to the bedside monitor will have either a small 12-pin connector or a larger 8-pin connector (See the illustration below).

The other end of the cable has a phone plug connector, and it plugs into the wallplate.

Note—When using the analog output option for the Philips Telemetry System, this cable will replace the bedside monitor patient cable.

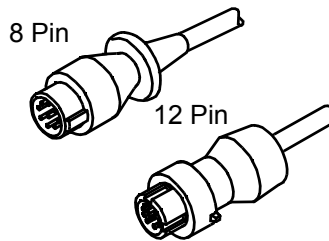

There are four different analog output bedside monitor cables. The cable you use depends upon whether the input connector on your bedside monitor is 8-pin or 12-pin and whether your transmitter lead set is 3- or 5-wire.

The table on page A-5 summarizes the proper cable selection. The 3-wire cables can be distinguished from the 5-wire cable by the attached label (see page A-5).

The lead set type also determines which are the valid leads to be selected at the bedside. Appropriate use of each cable type is illustrated on a label attached to the cable (see page A-5).

Analog Output Bedside Monitor Cables

The following table shows all available analog output bedside monitoring cables.

Lead Set	Bedside Monitor Cable Connector	Analog Output Bedside Monitor Cable
3-wire lead set	8-pin (large)	HP78599AI-#K71
	12-pin (small)	HP78599AI-#K72
5-wire lead set	8-pin (large)	HP78599AI-#K73
	12-pin (small)	HP78599AI-#K74

Caution

To ensure correct lead labeling at the bedside monitor, it is important that you use the correct bedside monitor cable.

Lead Placement and Selection

To ensure valid waves with the correct lead label, you must remember to use the following:

- Standard lead placement (shown on the telemetry transmitter case and in further detail in IntelliVue Information Center or TeleMon On-line Help).
- Valid lead selection (performed at the bedside monitor)

The following table summarizes recommended lead placement and selection.

Lead Set	Lead Placement	Valid Lead Selection on Bedside Monitor
3-wire	Standard	II
5-wire	Standard	II, MCL

Caution

To ensure correct lead labeling at the bedside monitor, standard lead placement and valid lead selection must be used. Not adhering to these recommendations may result in mislabeled leads or an invalid display.

Using Non-Standard Lead Placement

With the 3- and 5-wire lead set, you can use non-standard lead placement, but you must still use a valid lead label selection at the bedside monitor.

This will give you the desired waveform, but it will result in a mislabeled lead at the bedside monitor.

Controls for Telemetry Setup

The interaction with ECG depends on how the system is installed. If it is installed so that you can make changes from the IntelliVue Information Center, the interface for lead and size selection is the same as described in “Changing Lead/Label” on page 3-18. If not, make adjustments at the bedside monitor.

Functionality with Paced Waves

In order for paced waves to be processed correctly by bedside monitors using the analog outputs, the pace pulses must be artificially reconstructed and inserted into the analog output signals. The synthesized pace pulse is very narrow and may not be visible at the bedside display, depending on the type of monitor used.

Warning

To ensure proper cardiotach performance, diagnostic bandwidth (filter off) should be selected at the bedside monitor when monitoring paced patients with a transmitter.

Technical Alarms (Inoperative Conditions)

With the Patient Monitor/Holter Interface (Analog Output) Option, the following telemetry technical alarms (inoperative conditions) will appear as a LEADS OFF message at the bedside monitor.

1. LEADS OFF
2. NO SIGNAL
3. TEL CANNOT ANALYZE
4. REPLACE BATTERY
5. INTERFERENCE
6. RECEIVER MALF
7. NO RECEIVER
8. TRANSMITTER MALF
9. ECG EQUIP MALF
10. TRANSMITTER OFF
11. INVALID LEAD SET

If telemetry controls are located at the bedside monitor, (see “Controls for Telemetry Setup” on page A-6, these technical alarms appear as a LEADS OFF message at the IntelliVue Information Center.

Note—See Chapter 2, “Alarms” for information about the specific alarm messages.

Holter Interface

If you are using a holter monitor, it should be connected to a holter wallplate.

Warning

Using a holter wallplate to interface to a bedside monitor could result in mislabeled leads.

Accessory List

This appendix lists all ECG and SpO₂ accessories that can be used with the transmitter.

For additional information on connecting and using these accessories, see the individual parameter chapters.

Note—Accessories are subject to change. To get the latest accessories, visit the Philips Medical Supplies website located at the following address: <http://shop.medical.philips.com>.

Accessory Safety

Warning

Reuse: Never reuse disposable sensors, accessories and so forth that are intended for single use, or single patient use only.

Philips's approval: Use only Philips-approved accessories.

Packaging: Do not use a sterilized accessory if the packaging is damaged.

ECG Accessories

Electrodes

Order Number	Description
M2202A	60 packages of 5 radio translucent foam electrodes (300 per box)
40489E	10 packages of 30 paper tape electrodes (300 per box)
40493D	60 packages of 5 foam electrodes (300 per box)
40493E	10 packages of 30 foam electrodes (300 per box)

Lead Sets

Order Number	Description
989803133831	3-wire, patient cable set, 79 cm (30"), AAMI, Snap
989803133841	3-wire, patient cable set, 79 cm (30"), AAMI, Grabber
989803133851	3-wire, patient cable set, 79 cm (30"), IEC, Snap
989803133861	3-wire, patient cable set, 79 cm (30"), IEC, Grabber
989803133871	5-wire, patient cable set, 79 cm (30"), AAMI, Snap
989803133881	5-wire, patient cable set, 79 cm (30"), AAMI, Grabber
989803133891	5-wire, patient cable set, 79 cm (30"), IEC, Snap
989803133901	5-wire, patient cable set, 79 cm (30"), IEC, Grabber
989803137241	Colored 5-wire, patient cable set, 79 cm (30"), AAMI, Snap
989803137251	Colored 5-wire, patient cable set, 79 cm (30"), AAMI, Grabber

Order Number	Description
989803137261	Colored 5-wire, patient cable set, 79 cm (30"), IEC, Snap
989803137271	Colored 5-wire, patient cable set, 79 cm (30"), IEC, Grabber

Skin Prep Paper

Order Number	Description
989803134771	Skin preparation sheets, 10 preps/sheet, 10 sheets/package

Alignment Guides

Order Number	Description
989803140401	Single, package of 10
989803140411	Single tethered, package of 10
989803140421	Double, package of 10

Gunk Guards

Order Number	Description
989803140431	ECG, package of 10
989803140441	SpO ₂ , package of 10

Pouches

Order Number	Description
989803137831	Telemetry pouch, box of 50
989803140371	Telemetry pouch, case of 200

Trunk Cable

Order Number	Description
989803137841	5-wire ECG trunk cable

SpO₂ Accessories

**Reusable
Sensors**

Order Number	Description
M1191A	Philips Adult finger, 2 m (6.6 feet)
M1191AL	Philips Adult finger, 3 m (9.8 feet)
M1191NL	Philips Adult finger, 3 m (9.8 feet)
M1192A	Philips Pediatric finger 1.5 m (4.9 feet)
M1192N	Philips Pediatric finger, 1.5 m (4.9 feet)
M1194A	Philips Adult & Pediatric ear, 1.5 m (4.9 feet)
M1194N	Philips Adult & Pediatric ear, 1.5 m (4.9 feet)

**Disposable
Sensors -
Single Use**

Note—OxiCliq, OxiMax and Oxisensor II sensors are not available from Philips in the USA or Canada. Adapter cables are not available from Philips in Canada or Japan. In those countries, contact Nellcor Incorporated directly.

Order Number	Description
M1901B	Philips Adult >40 kg (>88 lb)
M1903B	Philips Pediatric 10-50 kg (22-110 lb)
M1904B	Philips Adult >30 kg (>66 lb)
N/A from Philips	*Nellcor Adhesive OxiCliq A, Adult
N/A from Philips	*Nellcor Adhesive OxiCliq N, Adult >40kg (>88 lb)
N/A from Philips	*Nellcor Adhesive OxiCliq P, Pediatric
N/A from Philips	*Nellcor OxiMax MAX-A, Adult >30 kg (>66 lb)
N/A from Philips	*Nellcor OxiMax MAX-AL, Adult >30 kg (>66 lb)
N/A from Philips	*Nellcor OxiMax MAX-N, Adult >40 kg (>88 kg)
N/A from Philips	*Nellcor OxiMax MAX-P, Pediatric 10-50 kg (22-110 lb)
N/A from Philips	*Nellcor Oxisensor II D-20, Pediatric 10-50 kg (22-110 lb)
N/A from Philips	*Nellcor Oxisensor II D-25, Adult >30 kg (>66 lb)
N/A from Philips	*Nellcor Oxisensor II N-25, Adult >40 kg (>88 lb)
M1943A	Adapter cable for Nellcor SpO ₂ sensor, 2 m (6.6 ft)
M1943AL	Adapter cable for Nellcor SpO ₂ sensor, 3 m (9.8 ft)
* Uses reusable OC-3 Sensor Cable.	

SpO2 Accessories

Wristband

Order Number	Description
M1627A	10 bands per pack

Sales and Support Offices

For more information, please call your local Philips Medical Systems sales office listed in your telephone directory or a Philips Medical Systems regional office listed below for the location of your nearest sales office.

Corporate Headquarters:

Philips Medical Systems
Netherlands B.V.
Postbus 10.000
5680 DA Best
Netherlands

United States

Philips Medical Systems
3000 Minuteman Road
Andover, MA 01810
(800) 934-7372

Canada

Philips Medical Systems Canada
281 Hillmount Road
Markham, ON
L6C 2S3
(800) 291-6743

Europe, Middle East and Africa

Philips Medizinsysteme Böblingen GmbH
Cardiac and Monitoring Systems
Hewlett-Packard Str. 2
71034 Boeblingen
Germany
Fax: (+49) 7031 463 1552

Latin America Headquarters

Philips Medical Systems
5200 Blue Lagoon Drive
9th Floor
Miami, FL 33126
(305) 267-4220

Asia Pacific Headquarters

Philips Medical Systems
24F Cityplaza One
1111 King's Road
Taikoo Shing, Hong Kong
(+852) 3197 7777

A

- accessories
 - ECG, B-2
 - ordering information, B-1
 - SpO₂, B-4
- alarms
 - behavior with Own Bed Overview, 2-3
 - list of physiologic, 2-6
 - list of technical (INOPs), 2-11
 - pause/suspend, 2-2
 - SpO₂, turn on/off, 5-22
 - testing, 6-2
- ambient light
 - effect on SpO₂, 5-24
- analog output, 7-17
 - bedside monitor cables, A-3
 - INOPs, A-7
 - lead labeling, A-2
 - lead placement and selection, A-5
 - making adjustments, A-6
 - use with paced waves, A-6
- antenna amplifiers, 7-17
- arrhythmia
 - ST/AR algorithm, 3-28
- artifact, muscle and movement, 3-24
- auditory signals
 - definition, 1-18
- automatic shutoff
 - transmitter, 1-23

B

- batteries
 - disposal, 1-30
 - gauge indicators, 1-32
 - life, 1-30
 - power level, 1-32
 - safety information, 1-29

C

- Check Button, 1-12
- classification information, 7-3
- cleaning
 - receiver mainframe, 6-15
 - system, 6-3
- compliance
 - Canadian radio equipment, 7-7
 - FCC, 7-7
 - system, 7-2
- configuration
 - changing, 6-19
 - settings, 6-17
- connectors
 - receiver mainframe, 7-16
- continuous SpO₂ measurement, 5-20

D

- defibrillation
 - type of proof against, 7-14
- dropouts, 3-23

E

- EASI
 - sourced waves, 3-5
 - ST, 4-2
- ECG
 - changing lead/labels, 3-18
 - lead sets, 3-2
 - leads available, 3-4
 - measurement, 3-2
 - minimizing artifact (noise), 3-24
 - reconstructed leads, 3-6
 - RF interference, 3-24
 - safety information, 3-27
 - signal too low, 3-23
- ECG monitoring
 - electrode site preparation, 3-7
 - optimizing performance, 3-22
 - preparation for, 3-7

ECG noise
troubleshooting, 3-24

ECG waves
changing size, 3-19
electromagnetic compatibility, 7-5
essential performance, 7-4
EU representative, address, 7-3
Extended Monitoring, 3-20

F

fallback
EASI, 3-20
multilead/singlelead analysis, 3-20
FAST SpO2 algorithm, 5-2

G

grounding, telemetry, 7-15

H

Holter Interface option
see analog output

I

indications for use, 1-5
instructions to patient, 1-19
IntelliVue TRx transceiver, 1-9

L

labels
changing ECG, 3-18
lead sets, 3-2
capabilities, 3-18
leads
changing, 3-18
leads off
monitoring during, 3-19

M

M2600B Philips Telemetry System
new functionality, 1-2

maintenance
preventive, 7-18
system, 6-3
measurement points, ST, 4-3

N

noise
eliminating, 3-24
Nurse Call
turn on/off, 1-23

O

Own Bed Overview
alarm behavior, 2-3
description, 1-4

P

paced patients
safety, 3-32
using analog outputs, A-6
patient
instructions to, 1-19
skin preparation, 3-7
Patient Monitor/Holter Interface option
see analog output
pause/suspend alarms, 2-2
pouch
how to use, 1-20
securing, 1-20
power
specifications, 7-22
pulse
audio signal, 5-23
turn on/off, 5-23

R

receiver mainframe, 1-35
cleaning, 6-15
connectors, 7-16
rear panel, 7-16

- retaining settings, 1-35
- turning on/off, 1-35
- RF interference, 3-23, 3-24
 - reducing, 7-6
 - restrictions for use, 7-7

S

safety

- accessories, B-1
- installation, 7-14
- maintenance, 7-14
- pacing, 3-32
- pouch, 1-20
- ST/AR arrhythmia, 3-31

safety information, 7-19

sensors

- adult finger, 5-14
- application safety information, 5-12
- applying, 5-12
- ear clip, 5-16
- positioning, 5-13
- selecting, 5-25
- small adult/pediatric, 5-15

showering

- drying transmitter, 1-22
- use of transmitter, 1-21

signal too low (ECG)

- action to take, 3-23

Smart Limits

- ST, 4-9

sounds

- description of, 1-18

specifications

- analog output, 7-25
- antenna system, 7-26
- battery life, 7-20
- ECG measurements, 7-30
- environmental, 7-21
- environmental, SpO2 sensors, 7-21
- environmental, transmitter, 7-21

- mainframe, 7-24

- Patient Monitor or Holter Interface, 7-25

- power, 7-22

- receiver module, 7-25

- SpO2 measurements, 7-32

- SpO2 sensors, 7-33

- transmitter, power, 7-22

SpO2

- alarm behavior, 5-25

- alarms, turn on/off, 5-22

- ambient light, effect of, 5-24

- applying sensors, 5-12

- auto on/off, 5-22

- continuous measurement, 5-20

- FAST algorithm, 5-2

- measurement limitations, 5-24

- measurement method, 5-2

- obtaining accurate measurements, 5-24

- preparation for monitoring, 5-7

- reusable sensors, 5-8

- selecting sensors, 5-12

- spot check measurements, 5-19

- troubleshooting, 5-24

- turn on/off, 5-20

- turn parameter on/off, 5-21

- types of measurements, 5-18

- types of sensors

- SpO2

- disposable sensors, 5-8

- spot check measurements, 5-19

ST

- alarm adjustments, 4-9

- analysis, 4-2

- EASI analysis, 4-4

- intended use, 4-2

- measurement, 4-3

- patient population, 4-2

- smart limits, 4-9

- turn on/off, 4-7

- viewing data, 4-4

ST/AR arrhythmia analysis, 3-28
standby mode, 1-24
symbols
 explanation of, 7-9
system
 classification, 7-3
 compliance, Canadian radio equipment, 7-7
 components, 1-7
 diagram of, 1-8
 electromagnetic compatibility, 7-5
 environmental specifications, 7-21
 essential performance, 7-4
 FCC compliance, 7-7
 indications for use, 1-5
 intended use, 1-6
 regulatory information, 1-6
 RF interference, 7-6
 safety compliance, 7-2
 symbols, 7-9
 transmitters used with, 1-9
 warnings, 7-4

T

technical alarms
 analog output, A-7
telemetry
 changing lead/label, 3-18
 dropouts, 3-23
 grounding, 7-15
 muscle and movement artifact, 3-24
 noise, 3-24
 on/off, 1-34
 Patient Monitor/Holter Interface option, 7-17
 receiver mainframe, 7-16
 retaining settings, 1-35
 RF INOPs, 3-23
 standby mode, 1-24
 suspending monitoring, 1-24

Telemetry button, 1-12, 1-23
TeleMon
 operation when connected, 1-25
 SpO2 measurement modes, 5-18
 use with M2601A/B transmitter, 1-25
transmitter
 automatic shutoff, 1-23
 battery disposal, 1-30
 battery life, 1-30
 controls on back, 1-15
 controls on front, 1-11
 M2601A, 1-9
 M2601B and M2601A comparison, 1-2
 M2601B features, 1-10
 pouch use, 1-19
 safety warnings, 1-18
 sounds, 1-18
 turning on/off, 1-22
 use in shower, 1-21
 wetting, 1-22
 where worn, 1-19
troubleshooting, 6-2
 ECG noise, 3-24
 SpO2, 5-24
turn on/off
 pulse parameter, 5-23
 SpO2, 5-20
 SpO2 alarms, 5-22
 SpO2 parameter, 5-21
 ST, 4-7
 transmitter, 1-22

W

warnings
 system, 7-4
waves
 changing size on display/recordings, 3-19
wetting
 use of transmitter, 1-22