



Instructions for Use

Avalon Fetal Monitor

FM20/30, FM40/50, Avalon CL

Release L.3 with Software Revision L.3x.xx

Patient Monitoring

PHILIPS

Table of Contents

1 Introduction	9
Who this Book is For	9
Confirm Fetal Life Before Using the Monitor	10
Introducing the Avalon Family of Fetal Monitors	11
2 What's New	21
What's New in Release L.3	21
What's New in Release J.3	23
3 Basic Operation	27
Supported Measurements	28
Avalon FM20 and FM30	29
Avalon FM40 and FM50	30
Getting to Know Your Avalon FM20/FM30	31
Getting to Know Your Avalon FM40/FM50	34
Connecting the Monitor to AC Mains	36
Wired Transducers	36
Operating and Navigating	38
Operating Modes	44
Automatic Screen Layouts	45
Settings	45
Preparing to Monitor	48
After Monitoring	70
Switching the Monitor to the Standby Screen	71
Disconnecting from Power	71
Power On/Power Off Behavior	71
Monitoring After a Power Failure	72
Troubleshooting	72
4 Cableless Monitoring	73
Avalon CL Transducer System	73
Basics of Cableless Systems	74
Twins and Triplets Support	75
Configuration of Cableless Systems	75
Getting to Know Your Avalon CL	76
Cableless Transducers	84
CL Pods	89
Calling Patients	93
Telemetry	94
Preparing to Monitor Cablelessly	100

Battery Lifetime Management	106
Patient Transport Within the Hospital	107
Underwater Monitoring	108
5 FM20/30 Battery Option	109
<hr/>	
External Power Supply M8023A	109
Using Batteries	110
Optimizing Battery Performance	113
Storing the Battery	115
Cableless Monitoring with FM20/30 Battery Option	116
Patient Transport Within the Hospital	116
6 Alarms	117
<hr/>	
Alarm Mode	118
Nurse Call Systems	118
Visual Alarm Indicators	119
Audible Alarm Indicators	119
Acknowledging Alarms	121
Acknowledging Disconnect INOPs	121
Alarm Reminder	122
Pausing or Switching Off Alarms	122
Alarm Limits	124
Reviewing Alarms	126
Latching Alarms	126
Testing Alarms	128
Alarm Behavior at Power On	128
7 Patient Alarms and INOPs	129
<hr/>	
Alarm Messages	129
Technical Alarm Messages (INOPs)	132
8 Admitting and Discharging	147
<hr/>	
Admit/Discharge on the Monitor	147
New Patient Check	149
OB TraceVue/IntelliSpace Perinatal	149
9 Non-Stress Test Timer	151
<hr/>	
Setting NST Autostart/Autostop	151
Viewing the NST Timer	151
Timer Expiry Notification	151
Accessing the NST Setup Pop-up Keys	152
10 Non-Stress Test Report	153
<hr/>	
Setting Up an NST Report	153
NST Report Status Window	154
NST Criteria	157

11 Cross-Channel Verification (CCV)	159
Misidentification of Heart Rates	159
Cross-Channel Verification Functionality	160
Overview of Cross-Channel Comparisons	161
Coincidence Examples	162
Recommended Actions for Coincidence INOP	164
12 Monitoring FHR and FMP Using Ultrasound	165
Technical Description	165
Limitations of the Technology	166
Misidentification of Maternal HR as FHR	166
What You Need	166
Cableless Monitoring - Important Considerations	167
Preparing to Monitor	168
Selecting Fetal Heart Sound	169
Changing the Fetal Heart Sound Volume	170
Fetal Movement Profile	170
Troubleshooting	172
Additional Information	173
13 Monitoring Twin FHRs	183
Important Considerations	183
Monitoring Twins Externally	184
Monitoring Twins Internally	185
Separating FHR Traces	185
Troubleshooting	189
14 Monitoring Triple FHRs	191
Important Considerations	191
Monitoring Triplets	192
Separating FHR Traces	192
"Standard" Separation Order	193
"Classic" Separation Order	194
Switching Trace Separation On and Off	195
When Trace Separation is On	195
When Trace Separation is Off	195
Troubleshooting	196
15 Fetal Heart Rate Alarms	197
Changing Alarm Settings	197
Changing Signal Loss Delay	198
16 Monitoring FHR Using DECG	199
Misidentification of Maternal HR as FHR	199
What You Need	200
Making Connections	202

Monitoring DECG	202
Suppressing Artifacts	204
Troubleshooting	205
Testing DECG Mode	205
17 Monitoring Uterine Activity Externally	207
<hr/>	
What You Need	207
External Toco Monitoring	208
Toco Sensitivity	208
Troubleshooting	208
18 Monitoring Uterine Activity Internally	211
<hr/>	
What You Need	211
Internal (IUP) Monitoring	213
Troubleshooting	214
19 Monitoring aFHR, aHR, and aToco	215
<hr/>	
Fetal Heart Rate aFHR	215
Uterine Activity aToco	216
What You Need	217
At the Monitor	217
Troubleshooting	218
20 Monitoring Maternal Heart / Pulse Rate	221
<hr/>	
Priority for Maternal Heart / Pulse Rate	221
Misidentification of Maternal HR for FHR	222
Maternal HR from MEEG Electrodes	222
Monitoring MEEG Wave	225
Pulse Rate from Toco MP	227
Pulse Rate from SpO2	228
Adjusting the Heart Rate / Pulse Alarm Limits	228
Average Pulse Rate from Noninvasive Blood Pressure	228
Testing MEEG Mode	229
21 Printing the ECG Waveform	231
<hr/>	
22 Monitoring Noninvasive Blood Pressure	235
<hr/>	
Introducing the Oscillometric Noninvasive Blood Pressure Measurement	235
Preparing to Measure Noninvasive Blood Pressure	237
Starting and Stopping Measurements	239
Enabling Automatic Mode and Setting Repetition Time	239
Enabling Sequence Mode and Setting Up the Sequence	240
Choosing the Alarm Source	240
Assisting Venous Puncture	241
Calibrating NBP	241
Troubleshooting	242

23 Monitoring SpO2	243
Selecting an SpO2 Sensor	243
Applying the Sensor	243
Connecting SpO2 Cables	244
Measuring SpO2	244
SpO2 Signal Quality Indicator (FAST SpO2 only)	245
Assessing a Suspicious SpO2 Reading	246
Understanding SpO2 Alarms	246
Setting Up Tone Modulation	247
Setting the QRS Volume	247
24 Monitoring Maternal Temperature	249
Measuring Tympanic Temperature	249
Entering Temperature Manually	254
25 Paper Save Mode for Maternal Measurements	255
26 Recovering Data	257
Recovering Traces on Paper	257
Recovering Traces on an OB TraceVue/IntelliSpace Perinatal System	258
Manually Recording Stored Data	258
27 Care and Cleaning	261
General Points	261
Cleaning and Disinfecting	262
Cleaning and Disinfecting Monitoring Accessories	263
Cleaning and Disinfecting the Tympanic Temperature Accessories	264
Cleaning and Disinfecting CL Transducers and CL Pods	264
Sterilizing	265
28 Maintenance	267
Inspecting the Equipment and Accessories	267
Inspecting the Cables and Cords	268
Maintenance Task and Test Schedule	268
Recorder Maintenance	269
Cleaning the Print Head	273
Returning Equipment for Repair	273
Disposing of the Monitor	274
29 Accessories and Supplies	275
Information on Latex	275
Avalon CL Base Station	275
Transducers	276
Fetal Accessories	276
Noninvasive Blood Pressure Accessories	278
SpO2 Accessories	280

Tympanic Temperature Accessories	285
Recorder Paper	285
Batteries	285
30 Specifications and Standards Compliance	287
<hr/>	
Environmental Specifications	287
Physical Specifications	289
Interface Specifications	293
Performance Specifications	295
Recorder Specifications	308
External Displays: FM40/FM50 Only	310
Manufacturer's Information	310
Trademark Acknowledgment	310
Regulatory and Standards Compliance	311
Environment	321
Monitoring After a Loss of Power	321
ESU, MRI, and Defibrillation	321
Cardiac Pacemakers and Electrical Stimulators	322
Fast Transients/Bursts	322
Symbols on the System	322
31 Default Settings Appendix	327
<hr/>	
Alarm and Measurement Default Settings	327
Recorder Default Settings	330
Index	333
<hr/>	

Introduction

Who this Book is For

This book is for trained healthcare professionals using the Avalon FM20, FM30, FM40, and FM50 fetal/maternal monitors, and the Avalon CL Transducer System. It describes how to set up and use the monitor and transducers. Familiarize yourself with all instructions including warnings and cautions before starting to monitor patients. Read and keep the Instructions for Use that come with any accessories, as these contain important information about application, care, and cleaning that is not repeated in this book.

If you have received this Instruction for Use because your fetal monitor has been upgraded to a newer software version L.3, be aware that the standards compliance information contained in the Instructions for Use for L.3 does not apply to your fetal monitor. Refer to your original Instructions for Use for standards compliance information.

You should be:

- Trained in the use of fetal heart rate (FHR) monitors.
- Trained in the interpretation of FHR traces.
- Familiar with using medical devices and with standard fetal monitoring procedures.

For information on how to configure and service the monitor, see the Configuration Guide and the Service Guides, or contact your authorized service provider.

Your monitor may not have all of the features and options described in this guide. The exact appearance of the monitor may differ slightly from that shown in the illustrations.

This guide may contain descriptions of functionality and features that are not implemented in the equipment currently shipped to Japan and/or of products that are not currently sold in Japan due to limitations and restrictions under the applicable local laws and regulations in Japan. Please contact your local sales representative and/or Philips Customer Support for details.

In this guide:

- A **warning** alerts you to a potential serious outcome, adverse event, or safety hazard. Failure to observe a warning may result in death or serious injury to the user or patient.
- A **caution** alerts you to where special care is necessary for the safe and effective use of the product. Failure to observe a caution may result in:
 - minor or moderate personal injury,
 - damage to the product or other property,
 - possibly in a remote risk of more serious injury.

- **Monitor** refers to the entire fetal/maternal monitor. **Display** refers to the physical display unit. **Screen** refers to everything you see on the monitor's display, such as measurements, alarms, patient data, and so forth.

- FM30**
- Whenever a monitor's identifier appears to the left of a heading or paragraph, it means that the information applies to that monitor only. Where the information applies to all models, no distinction is made.

Avalon CL
Avalon CTS

Whenever one of these identifiers appear to the left of a heading or paragraph, it means that the information applies to that cableless transducer system. Where the information applies to both systems, no distinction is made.

For installation instructions and technical description, see the corresponding Service Guide of the fetal monitors.

Confirm Fetal Life Before Using the Monitor

Fetal monitoring technology available today is *not always* able to differentiate a fetal heart rate (FHR) signal source from a maternal heart rate (MHR) source in *all* situations. Therefore, you should confirm fetal life *by independent means* before starting to use the fetal monitor, for example, by palpation of fetal movement or auscultation of fetal heart sounds using a fetoscope, stethoscope, or Pinard stethoscope. If you cannot hear the fetal heart sounds, and you cannot confirm fetal movement by palpation, confirm fetal life using obstetric ultrasonography. Continue to confirm that the fetus is the signal source for the FHR during monitoring.

Be aware that:

- a maternal HR trace can exhibit features that are very similar to those of an FHR trace, even including accelerations and decelerations. Do not rely solely on trace pattern features to identify a fetal source.
- Fetal Movement Profile (FMP) annotations on a fetal trace *alone* may not always indicate that the fetus is alive. The body of a deceased fetus can move and cause the monitor to annotate fetal body movements.

Here are some examples where the maternal HR can be misidentified as the FHR.

When using an ultrasound transducer:

- It is possible to pick up maternal signal sources, such as the aorta or other large vessels.
- Misidentification may occur when the maternal HR is higher than normal (especially when it is over 100 bpm).

When using a fetal scalp electrode:

- Electrical impulses from the maternal heart can sometimes be transmitted to the fetal monitor through a recently deceased fetus via the spiral scalp electrode cable, appearing to be a fetal signal source.
- The recorded maternal HR (and any artifact) can be misinterpreted as an FHR (especially when it is over 100 bpm).

When Fetal Movement Profile (FMP) is enabled:

FMP annotations in the absence of fetal life may be a result of:

- Movement of the deceased fetus during or following maternal movement.
- Movement of the deceased fetus during or following manual palpation of fetal movement (especially if the pressure applied is too forceful).

- Movement of the ultrasound transducer.
- The ultrasound transducer detecting a maternal movement source, such as the mother coughing.

See also “[Monitoring FHR and FMP Using Ultrasound](#)” on page 165 and “[Monitoring FHR Using DECG](#)” on page 199.

To reduce the possibility of mistaking the maternal HR for an FHR, it is recommended that you monitor both maternal and fetal heart rates. The monitor's cross-channel verification (CCV) feature can help by automatically detecting when a maternal HR coincides with an FHR. For further details, see “[Cross-Channel Verification \(CCV\)](#)” on page 159.

Introducing the Avalon Family of Fetal Monitors

The Avalon family of fetal monitors consists of the Avalon FM20, FM30, FM40, and FM50. While the FM20/FM30 and the FM40/FM50 have different form factors, the method of operation is very similar for all monitors. The Avalon fetal monitors also share transducers, accessories, software, and are compatible with the Avalon CL, and Avalon CTS Fetal Transducer Systems.

Intended Use

The Philips Avalon FM20 (M2702A), FM30 (M2703A), FM40 (M2704A), and FM50 (M2705A) fetal/maternal monitors are intended for:

- noninvasive monitoring of fetal heart rates and movements.
- noninvasive monitoring of maternal heart rates, maternal pulse rates, uterine activity, maternal noninvasive blood pressure, maternal oxygen saturation, and maternal temperature.
- invasive monitoring of direct fetal heart rate, intrauterine pressure, and for displaying and recording of fetal and maternal electrocardiogram (ECG) (FM30 and FM50 only).
- displaying, storing, and recording patient data and parameter values, and for generating alarms from fetal and maternal parameters.
- transmitting patient data and parameter values to a patient information and surveillance system.
- use by trained health care professionals.
- use in antepartum testing areas, in labor and delivery rooms, and during postpartum recovery in the hospital environment. They are not intended for use in intensive care units or operating rooms.
- monitoring in a bath or shower (Avalon CL cableless transducers Toco⁺ MP, Ultrasound, and ECG/IUP only).
- transport situations in healthcare facilities, for healthcare facilities outside hospitals, such as doctors' offices, and for use in private households (FM20 and FM30 only).

WARNING

The fetal/maternal monitors are not intended for:

- use during defibrillation, electro-surgery, or magnetic resonance imaging (MRI).
 - Electrocardiography (ECG) measurements on patients connected to electrical stimulator or with cardiac pacemakers.
 - use of the invasive measurements IUP and fetal DECG, use of the patient module (M2738A) and use of the Avalon CL system in domestic establishments, and those connected directly to the public low-voltage supply network that supplies buildings used for domestic purposes.
 - measuring the maternal temperature using the tympanic thermometer (866149) in private households.
-

WARNING

No modification of the fetal monitors, transducers, and the Avalon CL base station is allowed.

CAUTION

U.S. federal law restricts this device to sale by, or on the order of, a physician.

All users must read the Instructions for Use before working with the fetal monitor. Disregarding the contents of the Instructions for Use is considered abnormal use.

Indications for Use

Avalon Fetal/Maternal Monitor FM20

Indicated for use by trained health care professionals whenever there is a need for monitoring the physiological parameters uterine activity, heart rate, oxygen saturation, noninvasive blood pressure, pulse rate, and temperature of pregnant women, and the fetal heart rates of single fetuses, twins, and triplets in labor and delivery rooms, in antepartum testing areas, in private households and during transports in healthcare facilities.

Avalon Fetal/Maternal Monitor FM30

Indicated for use by trained health care professionals whenever there is a need for monitoring the physiological parameters uterine activity, heart rate, electrocardiography (ECG), oxygen saturation, noninvasive blood pressure, and pulse rate, and temperature of pregnant women, and the fetal heart rates of single fetuses, twins, and triplets in labor and delivery rooms, in antepartum testing areas, in private households and during transports in healthcare facilities.

Avalon Fetal/Maternal Monitor FM40

Indicated for use by trained health care professionals whenever there is a need for monitoring the physiological parameters uterine activity, heart rate, oxygen saturation, noninvasive blood pressure, and pulse rate, and temperature of pregnant women, and the fetal heart rates of single fetuses, twins, and triplets in labor and delivery rooms and in antepartum testing areas.

Avalon Fetal/Maternal Monitor FM50

Indicated for use by trained health care professionals whenever there is a need for monitoring the physiological parameters uterine activity, heart rate, electrocardiography (ECG), oxygen saturation, noninvasive blood pressure, and pulse rate, and temperature of pregnant women, and the fetal heart rates of single fetuses, twins, and triplets in labor and delivery rooms and in antepartum testing areas.

Safety Information

In this guide:

- A warning alerts you to a potential serious outcome, adverse event or safety hazard. Failure to observe a warning may result in death or serious injury to the user or patient.
- A caution alerts you to where special care is necessary for the safe and effective use of the product. Failure to observe a caution may result in minor or moderate personal injury or damage to the product or other property, and possibly in a remote risk of more serious injury.

Electrical Hazards

WARNING

Electrical shock hazard: Do not open the monitor housing. Refer all servicing to qualified service personnel.

- Always use the supplied power cord with the earthed mains plug to connect to an earthed AC mains socket. Never adapt the mains plug from the fetal monitor to fit an unearthed AC mains socket.
- Do not use AC mains extension cords or multiple portable socket-outlets.
- **FM20/FM30 only:** The protective earth conductor is required for EMC purposes. It has no protective function against electric shock. Double and/or reinforced insulation protects this device against electric shock.
- Do not connect any devices that are not supported as part of a system.
- Any non-medical device placed and operated in the patient's vicinity must be powered with an approved isolation transformer that ensures mechanical fixing of the power cords, and covering of any unused power outlets.
- The fetal/maternal monitor is NOT intended for use during defibrillation, electro-surgery, or MRI. Remove all transducers, sensors, and accessories before performing electro-surgery, defibrillation, or MRI, otherwise harm to the patient or the user can result.
- Do not touch the charging contacts for the cableless transducers at the Avalon CL base station while you are touching the patient.

Leakage currents: If several items of equipment used to monitor a patient are interconnected, the resulting leakage current may exceed allowable limits.

Radio Frequency Interference

WARNING

- Short range radio connections are subject to interruption due to interference from other radio sources in the vicinity, including microwaves, bluetooth devices, WLAN devices (802.11b,g,n), and cordless phones. Depending on the strength and duration of the interference, the interruption may occur for an extended period. A loss of connection, due to moving out-of-range, interference, or for other reasons, is indicated with a **No Host Monitoring INOP** (here the host is the fetal monitor) on the IntelliVue CL NBP or CL SpO₂ Pods, or a **No Host Monitoring**, or **cl NBP Disconnect**, or **cl SpO₂ Disconnect INOP** at the fetal monitor. Correct channel configuration is important, refer to the Service Guides and the Configuration Guide for details.
- To avoid magnetic interference affecting the mode of the pacemaker, ensure that the Avalon CL base station does not come into close contact with implanted pacemakers.
- This equipment generates, uses, and radiates radio-frequency energy, and if it is not installed and used in accordance with its accompanying documentation, may cause interference to radio communications. Operation of this equipment in a residential area may cause interference, in which case the users must take whatever measures may be required to correct the interference.
- Do not use cordless/mobile phones or any other portable RF communication system within the patient vicinity, or within a 1.0 m radius of any part of the fetal monitoring system.

- For paced patients: The radiated SRR power of the CL SpO₂, CL NBP Pods, CL F&M Pod, and the CL Wide Range Pod, and other sources of radio-frequency energy, when used in very close proximity of a pacemaker, might be sufficient to interfere with pacemaker performance. Due to shielding effects of the body, internal pacemakers are somewhat less vulnerable than external pacemakers. However, caution should be exercised when monitoring paced patients.
 - In order to minimize the possibility of interference, avoid positioning and wearing the Cableless Measurement Devices in very close proximity to a pacemaker. Consult the pacemaker manufacturer for information on the RF susceptibility of their products.
-

Use Environment

WARNING

Explosion Hazard:

- Do not use in the presence of flammable anesthetics, such as a flammable anesthetic mixture with air, oxygen, nitrous oxide, or in oxygen rich environment. Use of the devices in such an environment may present an explosion hazard.
- Use only Philips batteries part number M4605A with the FM20 or FM30 with battery option. Use of a different battery may present a risk of fire or explosion.

Environmental Specifications:

- The performance specifications for the monitors, measurements, and accessories apply only for use within the temperature, humidity, and altitude ranges specified in [“Environmental Specifications” on page 287](#).

Liquid Ingress:

- Do not operate the monitor if it is wet. If you spill liquid on the monitor, contact your service personnel, or Philips service engineer.
- Never immerse the fetal monitor or the CL base station in liquid. You must protect them against water sprays or splashes. Place the fetal monitor and the CL base station where there is no chance of contact with, or falling into water or other liquids.
- Do not perform underwater monitoring (for example, in a bath or shower) using wired transducers.
- The CL Fetal & Maternal Pod is not intended for underwater monitoring. The contacts between the CL Fetal & Maternal Pod and the electrode patch have to be kept dry at all times. The CL Fetal & Maternal Pod mounted on the electrode patch, can be worn underneath a shower, as long as the CL Fetal & Maternal Pod stays mounted. Radio transmissions in the shower may be compromised.

Heat Exposure:

- Do not dry equipment using heating devices such as heaters, ovens (including microwave ovens), hair dryers, and heating lamps.
- Do not put equipment or accessories in autoclave (for sterilization).

Positioning Equipment:

- The device should not be used adjacent to, or stacked with, other equipment unless otherwise specified.

Prohibited Environments:

- The monitors and their transducers, Pods, and accessories are not intended for use in an MRI environment or in an oxygen-enriched environment (for example, hyperbaric chambers).
-

Alarms

WARNING

- Do not rely exclusively on the audible alarm system for fetal monitoring. Adjustment of alarm volume to a low level or off during monitoring may result in a dangerous situation. Remember that the most reliable method of fetal monitoring combines close personal surveillance with correct operation of monitoring equipment.
 - Alarm systems of the monitor and those of the connected obstetrical information and surveillance system are independent and not synchronized.
 - In **INOP only** mode, no fetal/maternal patient alarms are enabled or indicated.
-

Accessories

WARNING

Philips' approval: Use only Philips-approved accessories. Using non-Philips-approved accessories may compromise device functionality and system performance, and cause a potential hazard.

Reuse: Never reuse disposable transducers, sensors, accessories, and so forth, that are intended for single use, or single patient use only. Reuse may compromise device functionality and system performance, and cause a potential hazard.

Electromagnetic compatibility: The use of accessories, transducers, and cables other than those specified may result in increased electromagnetic emissions or decreased electromagnetic immunity of the device.

Damage: Do not use a damaged sensor or one with exposed electrical contacts.

Cables and tubing: When connecting devices for acquiring measurements, always position cables and NBP tubing carefully to avoid entanglement or potential strangulation.

Security Information

Protecting Personal Information

Protecting personal health information is a primary component of a security strategy. Each facility using the monitors must provide the protective means necessary to safeguard personal information consistent with country laws and regulations, and consistent with the facility's policies for managing this information. Protection can only be realized if you implement a comprehensive, multi-layered strategy (including policies, processes, and technologies) to protect information and systems from external and internal threats.

As per its intended use, the patient monitor operates in the patient vicinity and contains personal and sensitive patient data. This also includes the trace print-outs at the monitor.

The monitor also includes controls to allow you to adapt the monitor to the patient's care model.

To ensure the patient's safety and protect their personal health information, you need a security concept that includes:

- **Physical security access measures** - access to the monitor **must** be limited to authorized users. It is essential that you consider physical security measures to ensure that unauthorized users cannot gain access.
- **Operational security measures** - for example, ensuring that patients are discharged after monitoring in order to remove their data from the monitor.
- **Procedural security measures** - for example, assigning only staff with a specific role the right to use the monitors.

In addition, any security concept must consider the requirements of local country laws and regulations.

Always consider data security aspects of the network topology and configuration when connecting patient monitors to shared networks. Your medical facility is responsible for the security of the network, where sensitive patient data from the monitor may be transferred.

When a monitor is returned for repair, disposed of, or removed from your medical facility for other reasons, always ensure that all patient data is removed from the monitor by ending monitoring for the last patient (see “Discharging a Patient” on page 148). Also select **Erase All** in the **Stored Data Recording** menu, to erase all stored data.

NOTE

Log files generated by the monitors and measurement modules are used for system troubleshooting and do not contain protected health data.

About HIPAA Rules

If applicable, your facility's security strategy should include the standards set forth in the Health Insurance Portability and Accountability Act of 1996 (HIPAA), introduced by the United States Department of Health and Human Services. You should consider both the security and the privacy rules and the HITECH Act when designing policies and procedures. For more information, please visit:

<http://www.hhs.gov/ocr/privacy/>

About the EU Directives

If applicable, your facility’s security strategy should include the practices set forth in the Directive on the protection of individuals with regard to the processing of personal data and on the free movement of such data (Directive 95/46/EC of the European Parliament and of the Council of 24 October 1995). In addition, your facility should also take into account any additional, more stringent standards put forward by any individual EU countries; that is, Germany, France, and so on.

Philips Product Security Policy Statement

Additional security and privacy information can be found on the Philips product security web site at: <http://www.healthcare.philips.com/main/support/equipment-performance/product-security/index.wpd>

Manufacturer Disclosure Statement for Medical Device Security – MDS2



You can view the Manufacturer Disclosure Statements for Medical Device Security (MDS²) for specific devices at:







<http://www.healthcare.philips.com/main/support/equipment-performance/product-security/index.wpd>

Overview of System Components





The **Avalon CL** system consists of the **Avalon CL base station**, the **Avalon CL transducers**, the **Avalon CL Fetal & Maternal Pod**, the **CL Wide Range Pod**, and the **IntelliVue CL Pods**.

The **IntelliVue CL Pods** are only used for maternal measurements within the **Avalon CL solution**. The following table provides an overview of all the devices.

Avalon FM20/FM30 and FM40/FM50 Wired Transducers	Avalon CL Base Station Avalon CL Transducers	CL Pods
<p data-bbox="191 1199 349 1230">FM20/FM30</p>  <p data-bbox="293 1472 503 1497">M2702A and M2703A</p>		
<p data-bbox="191 1514 349 1545">FM40/FM50</p>  <p data-bbox="293 1745 503 1770">M2704A and M2705A</p>	<p data-bbox="613 1514 894 1545">Avalon CL Base Station</p>  <p data-bbox="784 1745 855 1770">866074</p>	

Avalon FM20/FM30 and FM40/ FM50 Wired Transducers	Avalon CL Base Station Avalon CL Transducers	CL Pods
<p>US transducer (wired)</p>  <p>M2736A</p>	<p>Avalon CL US Transducer (cableless)</p>  <p>866076</p>	<p>Avalon CL Fetal & Maternal Pod</p>  <p>866488</p>
<p>Toco/ Toco MP transducer (wired)</p>  <p>M2734A and M2734B</p>	<p>Avalon CL Toco+ MP Transducer (cableless)</p>  <p>866075</p>	<p>Avalon CL Wide Range Pod</p>  <p>866487</p>

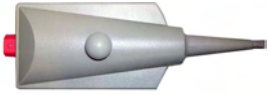
1 Introduction

Avalon FM20/FM30 and FM40/ FM50 Wired Transducers	Avalon CL Base Station Avalon CL Transducers	CL Pods
<p>Toco+ transducer with ECG/IUP capability (wired)</p>  <p>M2735A</p>	<p>Avalon CL ECG/IUP Transducer (cableless)</p>  <p>866077</p>	<p>IntelliVue CL NBP Pod (cableless)</p>  <p>865216</p>
<p>Patient Module for ECG/IUP</p>  <p>M2738A</p>		<p>IntelliVue CL SpO₂ Pod (cableless)</p>  <p>865215</p>

What's New

This section lists the most important new features and improvements to the fetal monitors and their user interface introduced with Release L.3.

You may not have all of these features, depending on the fetal monitor configuration purchased.

What's New in Release L.3

Avalon CL Fetal & Maternal Pod

The Avalon CL Fetal & Maternal Pod is an extension of the Avalon CL solution. The Avalon CL Fetal & Maternal Pod is used together with a single use patch with five abdominal electrodes. Prior to use, the Avalon CL Fetal & Maternal Pod is charged and assigned at the Avalon CL base station. The Avalon CL Fetal & Maternal Pod is used with singleton pregnancies. This solution provides especially benefits to patients with high body mass index (BMI), although it can be used for all patients.

The Avalon CL Fetal & Maternal Pod includes the following features:

- The Avalon CL Fetal & Maternal Pod measures fetal heart rate (**aFHR**), maternal heart rate (**aHR**), and uterine activity (**aToco**) from electrical signals.
- The **cl F&M Electrode Status** window at the monitor gives an overview of the current electrode contact status, when the CL Fetal & Maternal Pod is placed on the electrode patch, and the patch, and the electrodes are applied to the patient's abdominal skin. The window can be opened by selecting the new SmartKey **cl F&M Status**, or selecting the corresponding function in the main setup menu.
- The Avalon CL Fetal & Maternal Pod and the CL Wide Range Pod are assigned at the CL base station in the same easy way as the IntelliVue CL Pods.
- The functions **Finder LED** and **Call Patient** work also with the Avalon CL Fetal & Maternal Pod.

See [“Avalon CL Fetal & Maternal Pod” on page 21](#), [“CL Fetal & Maternal Electrode Patch” on page 91](#), [“Applying the CL Fetal & Maternal Patch and Pod” on page 100](#), and [“CL Pod Assignment” on page 99](#).

Avalon CL Wide Range Pod

The Avalon CL Wide Range Pod is an extension of the Avalon CL solution. The Avalon CL Wide Range Pod extends the signal range of the cableless measurements. It transmits the cableless measurement signals via the hospital WLAN/WiFi to the fetal monitors. Wearing the CL Wide Range Pod, the patient can walk freely within the hospital's WLAN/WiFi range during monitoring. Prior to use, the Avalon CL Wide Range Pod is charged and assigned at the Avalon CL base station.

- A new WLAN symbol is printed on the trace to indicate the use of an assigned and active Avalon CL Wide Range Pod.
- During monitoring with an active Avalon CL Wide Range Pod, the sound from the fetal heart rate is replaced by an artificial QRS sound (when the patient is monitored with a CL US transducer or CL F&M Pod).

See [“CL Wide Range Pod” on page 91](#).

Dawes/Redman

Dawes/Redman is a method of fetal monitoring trace interpretation for helping to assess fetal well-being. The algorithm based on the Dawes/Redman criteria uses the parameters fetal heart rate, gestational age, fetal movement, accelerations and decelerations, and long, and short term variability to generate a report.

Not available in the USA and territories relying on FDA market clearance.

Support of XDS Remote Display

The fetal monitor software supports the IntelliVue XDS “Remote Display” functionality only in combination with IntelliSpace Perinatal revision K or higher. From the user interface of the IntelliSpace Perinatal system, you can access all screen-operable functions of the currently connected fetal monitor. These functions include for example, starting and stopping physiological measurements, changing measurement modes, changing alarm limits, and silencing alarms.

New Alarm Behavior of CL Battery Empty INOP

The CL <xxx> Battery Empty INOP issued by the CL devices and the fetal monitor has a new alarm behavior:

- At the fetal monitor, it is issued now with a cyan INOP alarm and tone.
- At CL devices (CL transducers and CL Pods), it is issued now with a tone.

See [“Patient Alarms and INOPs” on page 129](#).

Using CL Pods with FM20/30 #E25

The CL Pods can now also be used with a battery operated FM20 or FM30 (option #E25). The CL Pods can be assigned and activated. The CL F&M Pod can also be charged.

See [“Using Batteries” on page 110](#).

Entering Notes - Type a Note

In the menu **Enter Note**, it is now possible to enter a note manually, instead of selecting one of the pre-configured notes. To enter a note, select the new menu item **Type a note**. A window with a touch keypad opens. The typed note can be up to 30 characters long.

See [“Typing Notes” on page 70](#).

What's New in Release J.3

Avalon CL Transducer System

The Avalon CL Transducer System provides cableless monitoring with the Avalon FM20/FM30 and FM40/FM50 with the same functionality and performance as the wired measurement devices (e.g. twin and triplets monitoring). The Avalon CL Transducer System has a straight-forward handling and operating concept. The CL transducers are assigned by simply docking them at the CL base station, no further configuration is necessary.

The Avalon CL Transducer System includes the following features:

- Cableless monitoring of twins and triplets (see [“Monitoring Twin FHRs” on page 183](#) and [“Monitoring Triple FHRs” on page 191](#))
- Cableless maternal measurement Pods CL SpO₂ and CL NBP (see [“IntelliVue CL Pods” on page 92](#))
- Maternal pulse from a CL Toco⁺ MP (Smart Pulse) transducer (see [“Monitoring Maternal Heart / Pulse Rate” on page 221](#))
- A cableless ECG/IUP transducer measuring IUP or fetal/maternal ECG (see [“Monitoring MEEG Wave” on page 225](#) and [“Monitoring FHR Using DECG” on page 199](#))
- Watertight cableless transducers that can be used to monitor in water (see [“Underwater Monitoring” on page 108](#))
- Patient call that pages an ambulating mother with an audible signal emitted by the worn CL transducers (see [“Calling Patients” on page 93](#))
- Out-of-range audible signal emitted by the worn CL transducers to inform an ambulating mother that she has reached the limit of the active signal area-of-reach (see [“Standard Radio Range of CL Transducers” on page 87](#))
- A transducer finder LED on all CL transducers to help identify the assigned transducer (see [“Cableless Transducer LED Indication” on page 86](#))

Support For Use of Maternal Cableless Measurement Devices

The IntelliVue CL measurement Pods are patient-worn, battery-powered measurement devices for SpO₂ and NBP. The devices provide measurement values on the built-in display and communicate them to the fetal monitor using the wireless short range radio (SRR) interface of the Avalon CL base station (see [“IntelliVue CL Pods” on page 92](#)).

Maternal Temperature Measurement

To measure maternal temperature, the new optional tympanic thermometer (866149) is available for the Avalon fetal monitors ([“Monitoring Maternal Temperature” on page 249](#)). The measurement data is:

- documented and printed out at the local recorder, and transmitted to the obstetrical information and surveillance system.
- displayed as a numeric on the screen.

Manually Entered Maternal Temperature Measurements

Manually measured temperatures can be entered at the fetal monitor. They are displayed as a numeric on screen, and are printed out on the recorder trace ([“Monitoring Maternal Temperature” on page 249](#)).

SpO₂ Recordings and Transmissions

SpO₂ annotation on local recorder

You can now configure the interval for printing the SpO₂ numeric values on the recorder trace. With the new configuration setting **Record on Trace**, you can set the interval to 1 or 5 minutes.

SpO₂ transmission to an obstetrical information and surveillance system

You can now configure the interval for transmitting the SpO₂ numeric values to an obstetrical information and surveillance system. With the new configuration setting **Send to OB Sys**, you can set the interval to 1 or 5 minutes.

New Design for the User Interface

The user interface for the fetal monitors has been redesigned to bring the presented information into the foreground, letting the structural elements such as keys and frames retreat into the background. Additionally special regard was given to making the "look and feel" similar to that of standard software products (see [“Operating and Navigating” on page 38](#)).

New SmartKeys

- The **Start ECG** SmartKey and menu item is renamed to **Record ECG**.
- With the **Call Patient** SmartKey, you can now page patients who are ambulating wearing Avalon CL transducers.
- With the **Tele Info** SmartKey, you can call up the **Tele Info** window on the fetal monitor display. In the **Tele Info** window, you can control and view the status of the cableless transducers from the connected Avalon CL base station.
- With the **Enter Temp** SmartKey, a pop-up window opens showing a numeric pad for entering manually measured maternal temperature values.
- With the **NBP Modes** SmartKey, you can access the NBP Mode selection and setup, and can directly start and stop a measurement.
- With the **QuickAdmit** SmartKey, you can quick admit a patient to the monitor.

All new SmartKeys are optional, and have to be configured in Configuration Mode for use (see [“SmartKeys” on page 42](#)).

Coincidence INOP Tone

When the cross-channel verification detects that the signal of the maternal heart rate coincides with the fetal heart rate, the **Coincidence** INOP is now issued with a tone at the fetal monitor. The **Coincidence** INOP tone has a configurable delay see [“Cross-Channel Verification \(CCV\)” on page 159](#).

Increased Internal Back-up Memory

The internal back-up memory is now able to store traces and data from at least the last 3.5 hours with the software revision J.3, and minimum 7 hours with the new mainboard hardware revision A 00.18 (see [“Manually Recording Stored Data”](#) on page 258 and [“Recovering Data”](#) on page 257).

Dual System Interface Support

If the fetal monitor is connected via a LAN connection to OB TraceVue/IntelliSpace Perinatal, the RS232 interface can be used independently to connect e.g. an EMR system on read-only basis. The system connected to the RS232 interface in this case cannot alter any data (such as ADT data, or the date and time setting), or interfere with functions of the monitor, but is able to read output data. The obstetrical information and surveillance system connected via LAN has priority.

USB Interface

An optional USB interface allows the use of bar code readers and input devices such as a keyboard, or mouse (see [“Getting to Know Your Avalon FM20/FM30”/“Bottom”](#) on page 32 and [“Getting to Know Your Avalon FM40/FM50”/“Rear”](#) on page 33).

Flexible Nurse Call Interface

An optional Flexible Nurse Call interface allows the connection of a nurse call device to the fetal monitors (see [“Getting to Know Your Avalon FM20/FM30”/“Bottom”](#) on page 32 and [“Getting to Know Your Avalon FM40/FM50”/“Rear”](#) on page 33).

DHCP Support

The DHCP support offers an alternative to BOOTP. DHCP (Dynamic Host Configuration Protocol) enables the fetal monitors to request an IP address (internet protocol address) from the connected network (OB TraceVue/IntelliSpace Perinatal) automatically.

Data Export Support

You can now export measurement values from the monitor to other devices via the LAN interface, or with the optional MIB RS232 interface (see [“Getting to Know Your Avalon FM20/FM30”/“Bottom”](#) on page 32 and [“Getting to Know Your Avalon FM40/FM50”/“Rear”](#) on page 33).

NBP Configurable Measurement Sequence

Up to four measurement cycles can be set up which will run consecutively. For each cycle, you can set the number of measurements and the interval between them. By setting the last cycle to run continuously, you can have regular measurements continue after the sequence has run (see [“Enabling Sequence Mode and Setting Up the Sequence”](#) on page 240).

Alarms Enhancements

In addition to the standard cyan INOPs, some INOPs can now be configured as red or yellow INOPs to provide a severity indication (**ECG Leads Off**, **Cuff Overpress**, **Cuff NotDeflated**, **Battery Empty**, **No Pulse**) (see [“Alarms”](#) on page 117).

Alarm Reminder

In Configuration Mode, you can set now an **Alarm Reminder**. The **Alarm Reminder** emits an audible reminder of alarm conditions that remain active after the alarm is acknowledged. This reminder may take the form of a repetition of the alarm tone for a limited time, or an unlimited repetition of the alarm tone (this is the same as a new alarm). The interval between silencing the alarm and sounding the reminder tone can be set to one, two, or three minutes (see [“Alarm Reminder” on page 122](#)).

Auto Free

In Configuration Mode, you can now set an **Auto Free** setting which discharges a patient automatically when the fetal monitor has been powered off, or is in standby mode for a set time. Only the demographic patient data is deleted, the trace data is not affected.

Basic Operation

This chapter gives you an overview of the monitor and its functions. It tells you how to perform tasks that are common to all measurements (such as entering data, switching on a measurement, changing some monitor settings, and setting up the recorder). The alarms section gives an overview of alarms. The remaining sections tell you how to perform individual measurements, and how to care for and maintain the equipment.



Supported Measurements

Different measurements for the same physiological parameter may have a different appearance on the trace, due to: variability (HR), averaging, delay, amplitude, or artifacts. Before interpreting the trace, regard the fetal monitor setup and transducers used.

The following **Fetal** measurements are supported:

Measurements	FM20	FM30	FM40	FM50
Fetal Heart Rate (FHR) via US (including Twins)	Standard	Standard	Standard	Standard
Triple FHR via US	Optional	Optional	Optional	Optional
dFHR via Direct ECG (DECG)	-	Standard	-	Standard
aFHR via CL F&M Pod	Optional	Optional	Optional	Optional
Toco	Standard	Standard	Standard	Standard
aToco via CL F&M Pod	Optional	Optional	Optional	Optional
Intrauterine Pressure (IUP)	-	Standard	-	Standard

The following **Maternal** measurements are supported:

Measurements	FM20	FM30	FM40	FM50
Maternal Heart Rate (MHR) via Maternal ECG Electrodes	Standard	Standard	Standard	Standard
Maternal ECG (MECG wave)	-	Standard	-	Standard
aHR via CL F&M Pod	Optional	Optional	Optional	Optional
Maternal Pulse from Toco	Standard	Standard	Standard	Standard
Noninvasive Blood Pressure with Pulse Rate	Optional	Optional	Optional	Optional
Pulse Oximetry (Maternal SpO₂) with Pulse Rate	Optional	Optional	Optional	Optional
Maternal Temperature	Optional	Optional	Optional	Optional

Avalon FM20 and FM30

This section outlines the capabilities of your monitor.



Avalon FM20

The Avalon FM20 fetal/maternal monitor provides a solution for external fetal monitoring applications, and optional noninvasive maternal vital signs.

You can monitor fetal heart rates (FHRs) externally using ultrasound, uterine activity and maternal pulse using an external Toco transducer, and the maternal heart rate (MHR) with maternal ECG electrodes, and optionally, noninvasive blood pressure and maternal oxygen saturation (SpO₂).

Measurements are displayed on a 6.5 inch color display as numerics. The display is a touchscreen, and you operate the monitor using this touchscreen interface. The integrated recorder documents fetal and maternal measurements as well as the user-defined annotations.

You can connect the monitor to an OB TraceVue/IntelliSpace Perinatal system via the RS232 connection, or over a LAN connection (with OB TraceVue Revision E.00.00 and later, or IntelliSpace Perinatal Revision H.0 and later).

Avalon FM30

The Avalon FM30 fetal/maternal monitor offers a solution for both external and internal fetal monitoring applications, and optional noninvasive maternal vital signs.

The Avalon FM30 shares all the features and capabilities of the Avalon FM20. In addition, you can monitor one FHR internally with a direct fetal electrocardiogram (DECG), uterine activity internally using an intrauterine pressure (IUP) catheter together with a Toco⁺ transducer or patient module.

The Avalon FM30 carries the **IP** label, indicating that it is capable of intrapartum monitoring.



3 Basic Operation

FM20/30 with Battery Option #E25 Only The battery option for the FM20/30 provides support for the in-transport monitoring of all measurements when disconnected from a power supply. Existing data storage is automatically uploaded to OB TraceVue or IntelliSpace Perinatal after reconnecting it to the system. Trace printing during transport is also possible.

Avalon FM40 and FM50

This section outlines the capabilities of your monitor.



Avalon FM40

The Avalon FM40 fetal/maternal monitor provides a solution for external fetal monitoring applications, and noninvasive maternal vital signs.

You can monitor fetal heart rates (FHRs) externally using ultrasound, uterine activity using an external Toco transducer, and the maternal heart rate (MHR) via maternal ECG electrodes, and noninvasive blood pressure and maternal oxygen saturation (SpO₂).

Measurements are displayed on a 6.5 inch color display as numerics. The display is a touchscreen, and you operate the monitor using this touchscreen interface. The integrated recorder documents fetal and maternal measurements as well as the user-defined annotations.

You can connect the monitor to an OB TraceVue/IntelliSpace Perinatal system with the RS232 connection, or over a LAN connection (with OB TraceVue Revision E.00.00 and later, or IntelliSpace Perinatal Revision H.0 and later).

Avalon FM50

The Avalon FM50 fetal/maternal monitor offers a solution for both external and internal fetal monitoring applications, and noninvasive maternal vital signs.

The Avalon FM50 shares all the features and capabilities of the Avalon FM40. In addition, you can monitor one FHR internally with a direct fetal electrocardiogram (DECG), and uterine activity internally using an intrauterine pressure (IUP) catheter together with a Toco⁺ transducer or patient module.

The Avalon FM50 carries the **IP** label, indicating that it is capable of intrapartum monitoring.



Getting to Know Your Avalon FM20/FM30

Overview

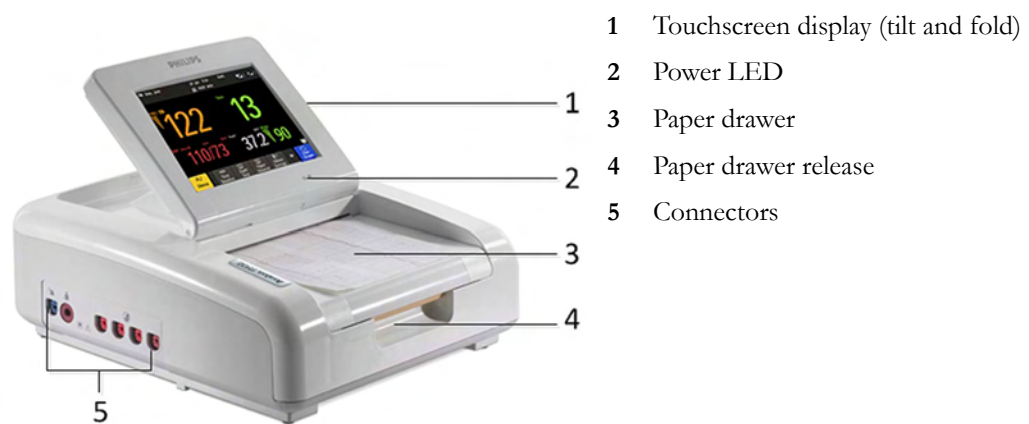

Right Side



3 Basic Operation

with Battery
Option



- 1 On/Standby button with power LED
- 2 MSL connector for external power supply

Left Side

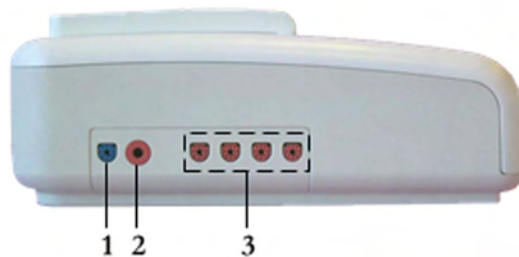

- 1 SpO₂ socket (optional)
- 2 Noninvasive Blood Pressure socket (optional)
- 3 Fetal sensor sockets

Each of the fetal sensor sockets accepts any fetal transducer, one Avalon CL or one Avalon CTS Cableless Fetal Transducer System base station, or an event marker.

Bottom



There are five optional interfaces available for the Avalon FM20/30 monitor:

- LAN/RS232 system interface
- Dual PS/2 interface
- Dual MIB/RS232 interface
- Flexible Nurse Call interface
- USB ports interface

You can use two of the five optional interfaces at the same time.



- 1 LAN/RS232 system interface
- 2 Dual PS/2 system interface

Optional Interfaces	Description
	Flexible nurse call interface card
	Quad. USB ports
	Dual MIB/RS232

Rear



- 1 Display release
- 2 Carrying handle
- 3 Built-in stand

Getting to Know Your Avalon FM40/FM50

Front

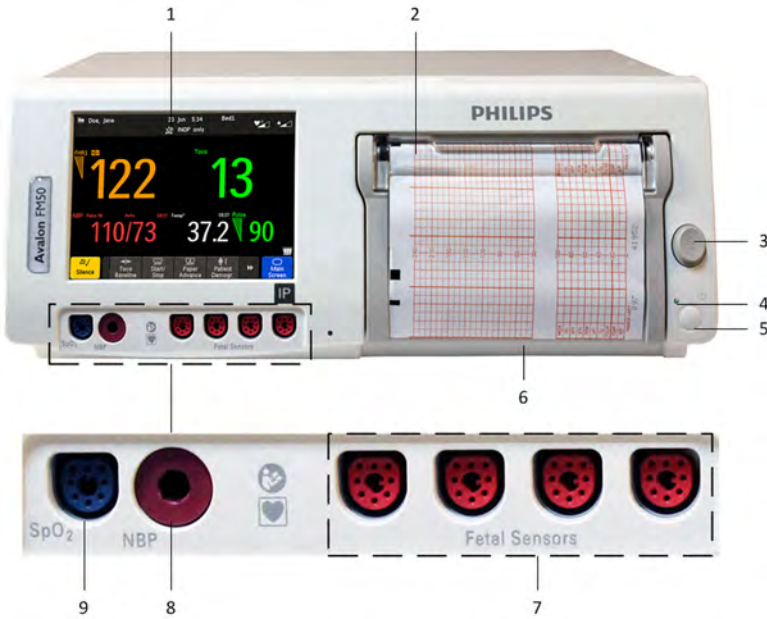

- 1 Touchscreen color display
- 2 Transparent paper guide with tear-off edge
- 3 Paper eject button
- 4 Power LED
- 5 On/Standby button
- 6 Recorder paper table
- 7 Fetal sensor sockets
- 8 Noninvasive blood pressure socket (optional)
- 9 SpO₂ socket (optional)

Connect any fetal sensor or patient module at the fetal sensor sockets, including an Avalon CL or an Avalon CTS via interface cable (with red connector).

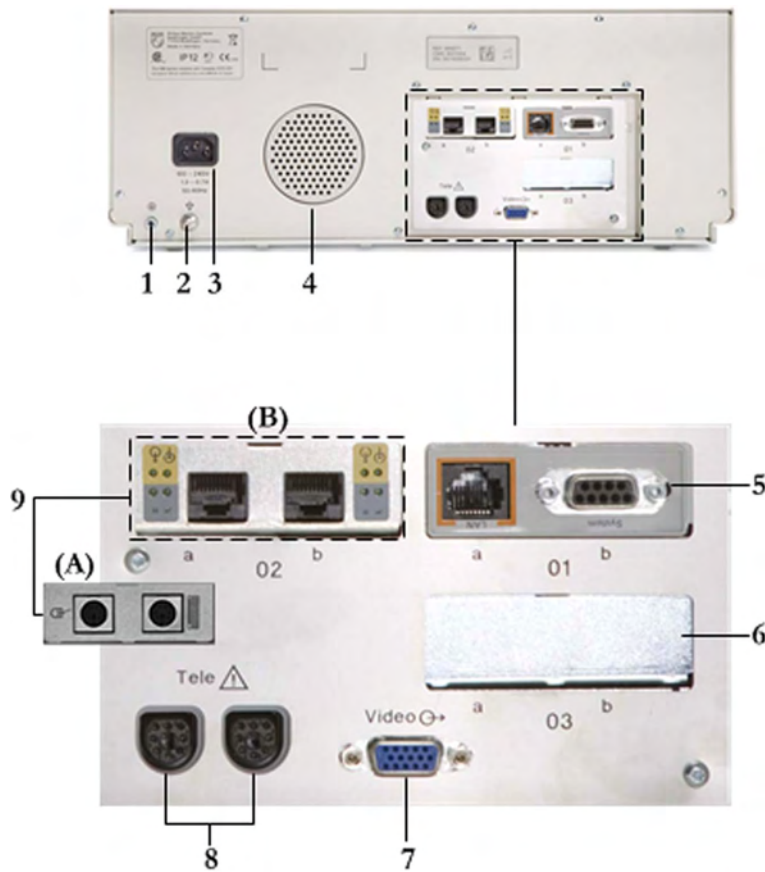

Rear



- 1 Reserved for future use: protective earth intended for use in system installations
- 2 Equipotential grounding point
- 3 Power cord connector
- 4 Loudspeaker
- 5 Slot 01 for optional LAN/RS232 system interface (for connection to an obstetrical information and surveillance system)
- 6 Slot 03 reserved for future use
- 7 Video output (VGA)
- 8 Telemetry interface
- 9 Slot 02 for optional interfaces: *Either* dual PS/2 system interface **(A)** for mouse and keyboard connection) *Or* MIB interface **(B)** for external touchscreen connection, or the optional interfaces for the flexible nurse call or USB ports

Two Avalon CL base stations, or one Avalon CTS can be also connected to the Telemetry interface sockets using the interface cable (with black connector).

Additional Optional Interfaces

Optional Interfaces	Description
	Flexible nurse call interface card
	Quad. USB ports
	Dual MIB/RS232 interface

Connecting the Monitor to AC Mains

WARNING

- Always use the supplied power cord with the earthed mains plug to connect to an earthed AC mains socket. Never adapt the mains plug from the fetal monitor to fit an unearthed AC mains socket.
- Check that the line frequency is correctly configured in the **Global Settings** menu.
- **FM20/FM30 only:** The protective earth conductor is required for EMC purposes. It has no protective function against electric shock. Double and/or reinforced insulation protects this device against electric shock.
- Do not use AC mains extension cords or multiple portable socket-outlets.

Always ensure that the monitor is positioned so that the AC mains plug is easily accessible, to allow disconnection of the monitor from the AC mains.

Wired Transducers

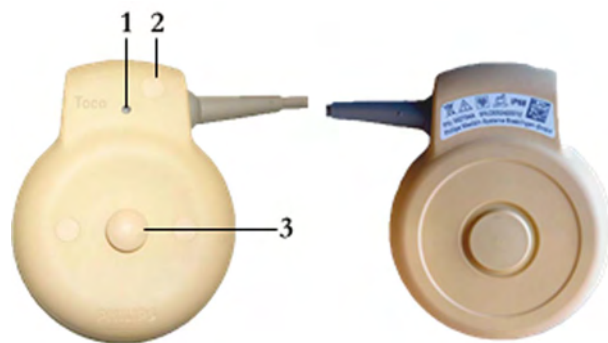

- 1 Transducer finder LED - lights up on the transducer supporting to identify the measurement source
- 2 "MP" for M2734B "Toco MP" transducers (additionally capable of providing the maternal pulse measurement)
- 3 Belt button

Toco (M2734A) and Toco MP Transducer (M2734B)

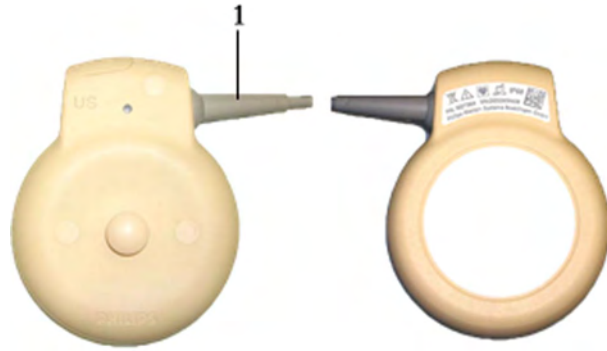

Ultrasound Transducer (M2736A)

- 1 Cable - connects to any of the four fetal sensor sockets on the monitor

The M2736AA US transducer is identical to the M2736A US transducer, including all specifications

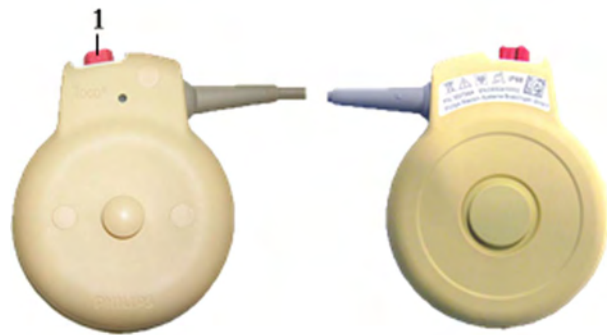

Toco⁺ Transducer with ECG/IUP capability (M2735A)

- 1 Connector - for connecting ECG/IUP adapter cables (M2735A Toco⁺ transducer only)

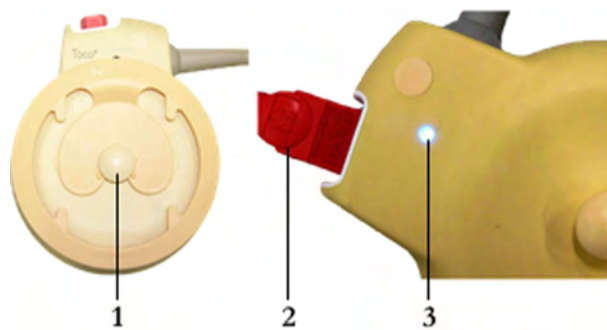

- 1 Butterfly belt clip (shown fitted; for use with belts without button holes)
- 2 Close-up of MECEG adapter cable connected to Toco⁺ transducer
- 3 Close-up of active finder LED



Patient Module for ECG/IUP (M2738A)

- 1 Connector - for connecting ECG/IUP adapter cables (same as for Toco⁺ transducer)
- 2 Cable - connects to any of the four fetal sensor sockets on the monitor

Operating and Navigating

Your monitor has a touchscreen. Everything you need to operate the monitor, except the on and off switch, is contained on its screen. Most screen elements are interactive. Screen elements include measurement numerics, screen keys, information fields, status indicators, alarms fields, and menus.

Operator Position

The typical operator's position is in front of the monitor.

FM40/50 If an optional external touch display is connected to the monitor, you can operate the monitor using the external touch display.

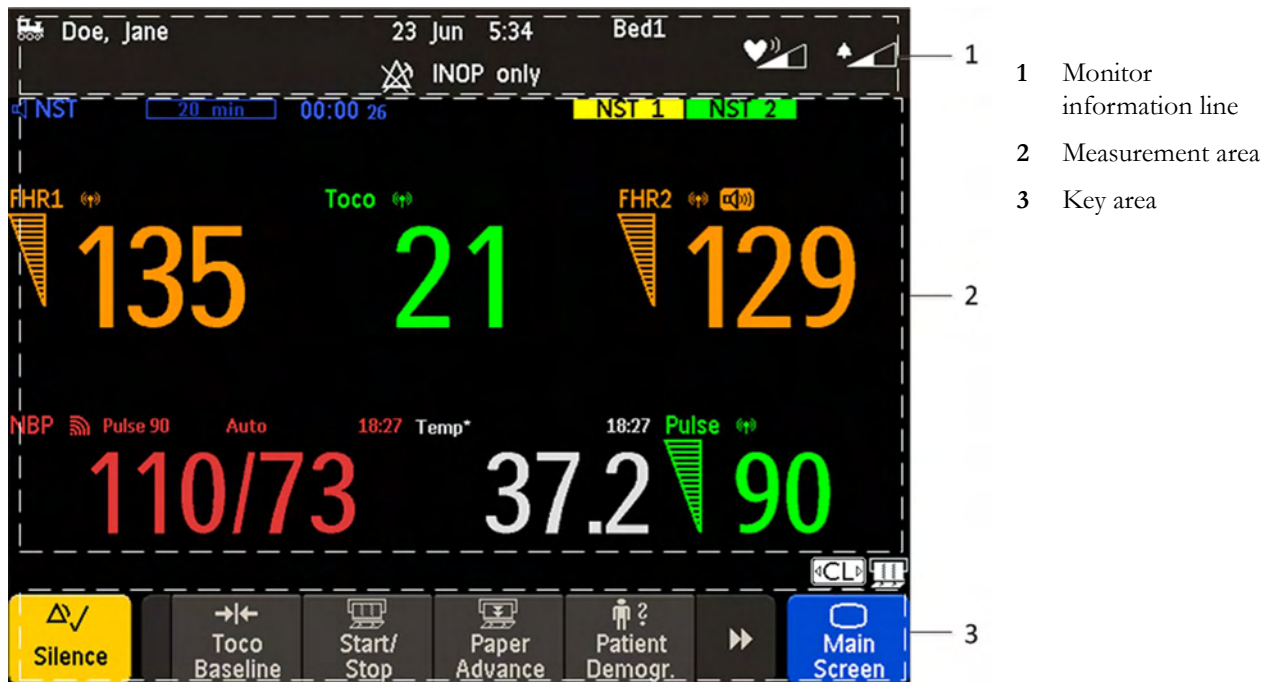

CAUTION

The screen contains sensitive personal data. For information how to protect personal information, see [“Protecting Personal Information”](#) on page 17.

Screen Elements

Monitor Information Line







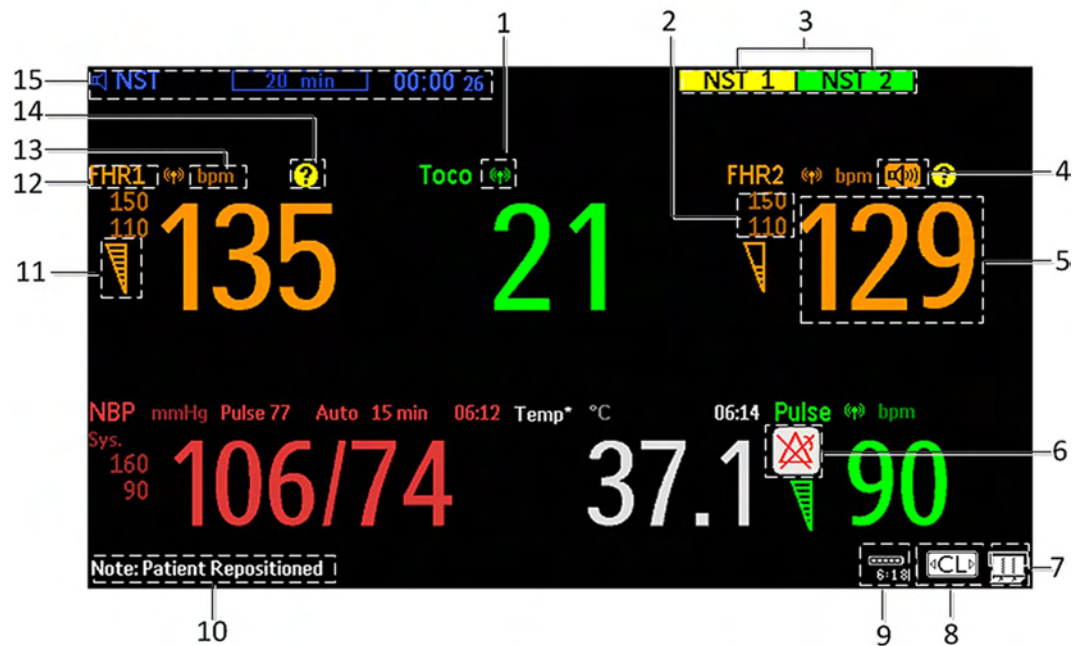



- 1 LAN connection status indicator only. RS232 system connection is not indicated. The locomotive icon indicates if the fetal monitor is connected to OB TraceVue/IntelliSpace Perinatal, via a LAN cable or not.
- 2 Patient identification
- 3 Date and time
- 4 Bed label (when connected to a Philips OB TraceVue/IntelliSpace Perinatal system)
- 5 Fetal heart sound volume adjust/indicator
- 6 Alarm volume adjust/indicator
- 7 INOP and alarm status area - shows active alarm messages

Measurement Area



- 1 Antenna symbol (indicates a cableless measurement from a connected Avalon CL or Avalon CTS system)
- 2 Configurable alarm limits
- 3 NST test
- 4 Audio source symbol
- 5 Measurement numeric
- 6 Alarms off symbol
- 7 Fetal trace recorder - status indicator
- 8 Avalon CL or Avalon CTS system - status indicator
- 9 Battery status indicator
- 10 Status line - shows status and prompt messages
- 11 Signal quality indicator: good, acceptable, poor
- 12 Fetal heart rate measurement label
- 13 Measurement unit (configurable)
- 14 Coincidence symbol (see “Cross-Channel Verification (CCV)” on page 159)
- 15 NST timer, if configured (default is Off)

Screen Details

Icon	Description
	The antenna symbol indicates a cableless measurement (Avalon CL or Avalon CTS).
	Indicates a short range radio measurement (CL Pods).
	Signal quality indicator: 1 Good 2 Acceptable 3 Poor
	Fetal trace recorder - status indicator Fetal recorder is on
	Fetal recorder is off (when Paper Save Mode is off)
	Fetal recorder is off (when Paper Save Mode is on)
	There is a user-solvable recorder error (paper out, paper jam, wrong paper scale set)
	Fetal recorder is defective: call service
	When an Avalon CL or Avalon CTS system is connected to the monitor, a CL symbol is shown. It changes with the states of the connected cableless device see “Cableless Status Indication” on page 95.

Key Area

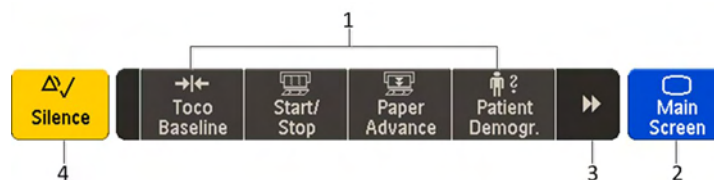



- 1 SmartKeys - these can vary according to your monitor's configuration
- 2 **Main Screen** - closes all open menus and windows and returns to main screen
- 3 Scroll to display more SmartKeys
- 4 **Silence** - acknowledges all active alarms by switching off audible alarm indicators

Keys

The monitor has three different types of keys.









Permanent Keys



















A permanent key is a graphical key that remains permanently on the screen, giving you fast access to functions.

Key	Name	Function
	Silence	Acknowledges all active alarms by switching off audible alarm indicators.
	Main Screen	Closes all open menus and windows and returns to the main screen.

SmartKeys

SmartKeys are configurable graphical keys, located at the bottom of the main screen. They give you fast access to functions. The selection of SmartKeys available on your monitor depends on your monitor configuration, and on the options purchased.

SmartKey	Name	Function
	FRStart/Stop	Turns the trace recorder on or off
	Start Rec	Turns the trace recorder on
	Stop Rec	Turns the trace recorder off
	Paper Advance	Advances the paper automatically to the next fold
	Set Marker	Marks an event
	Enter Notes	Enters notes
	Record ECG	Starts printing the MEKG, DEKG, or both waves, when both are available
	Stored Rec	Prints trace data from the monitor's memory
	NST Report	Initiates an NST trace interpretation and obtains a Non-stress test (NST) report
	Sound Vol. Up	Increases the fetal heart rate volume
	Sound Vol. Down	Decreases the fetal heart rate volume
	Toco/IUP Bsl	Resets Toco baseline
	Tele Info	Calls up the Tele Info window

SmartKey	Name	Function
	Call Patient	Pages the patient. Only enabled if at least one CL transducer is currently active
	cl F&M Status	Calls up the cl F&M Electrode Status window
	Pause Alarms	Pauses alarm indicators. Pause duration depends on monitor configuration. If the pause duration is infinite, this key is labeled Alarms Off Select again to immediately re-enable alarm indicators
	Defaults	Loads User Default
	Main Setup	Enters main setup menu
	Strt/Stop NBP	Starts/stops manual noninvasive blood pressure measurement Starts auto series Stops current automatic measurement within series
	Start NBP	Starts manual noninvasive blood pressure measurement Starts auto series
	Stop NBP	Stops manual noninvasive blood pressure measurement Stops current automatic measurement within series
	Stop All NBP	Stops all noninvasive blood pressure measurements
	Repeat NBP	Sets the time interval between two noninvasive blood pressure measurements
	NBP Modes	Access NBP mode selection and setup, with direct start/stop function
	Enter Temp	Allows the manual input of the patient's temperature
	Zero IUP	Resets the display and trace to 0. If you do not zero the IUP measurement properly, the pressure trace may exceed the paper scaling.
	Timer	Enters NST timer window
	Standby	Switches to standby screen, suspends monitoring. All numerics and waves disappear from the display. All settings and patient data information are retained
	Patient Demogr.	Enters the patient identification menu to admit/discharge
	QuickAdmit	Quick admits the patient for monitoring
	Blank Key	Blank key, can be used as divider between a group of keys

Pop-Up Keys

Pop-up keys are context-sensitive graphical keys that appear automatically on the monitor screen when required. For example, the **Confirm** pop-up key appears when you need to confirm a change.

Using the Touchscreen

Select screen elements by pressing them directly on the monitor's screen.

Disabling Touchscreen Operation

- 1 To temporarily disable the touchscreen operation of the monitor, press and hold the **Main Screen** permanent key for about three seconds. A red padlock will blink on the **Main Screen** permanent key.
- 2 Press and hold the **Main Screen** permanent key again for about three seconds to re-enable the touchscreen operation.



Operating Modes

When you switch on the monitor, it starts up in Monitoring Mode. To change to a different mode:

- 1 Select the **Main Setup** menu.
- 2 Select **Operating Modes** and select a mode.

Your monitor has four operating modes. Some are passcode protected.

Mode	Description	Password Protected
Monitoring Mode	The Monitoring Mode is the normal operating mode to monitor patients. You can change elements such as alarm limits. When you discharge the patient, these elements return to their default values. You cannot select or change grayed out items. These items are for your information only. To change these items, switch to the Configuration Mode.	no
Demo Mode	The Demo Mode is used for demonstration and training purposes. Do not change into Demo Mode during monitoring. When transducers are connected to the monitor and the recorder is on, a demo trace is recorded. But the demo trace is not transmitted when the fetal monitor is connected via RS232 to an information and surveillance system such as OB TraceVue/IntelliSpace Perinatal.	yes

Mode	Description	Password Protected
Configuration Mode	The Configuration Mode is for personnel trained in configuration tasks. You can change and store the default values and patient profiles permanently in the Configuration Mode. These tasks are described in the Configuration Guide. During installation, the fetal monitor is configured for use in your environment. This configuration defines the default settings you work with when you switch on the fetal monitor.	yes
Service Mode	The Service Mode is for trained and authorized service personnel only.	yes

A field displayed at the fetal monitor screen indicates if the monitor is in Demonstration Mode, Configuration Mode, or Service Mode. To change to a different mode, select this field.

Automatic Screen Layouts

Your monitor's preconfigured screen layouts define how measurement information is arranged on the screen. The monitor automatically applies the correct screen layout for the measurements you are monitoring. No user action is required.

Connecting or disconnecting transducers, or activating or deactivating a cableless measurement, results in an automatic adjustment of the screen layout. When a measurement is off, its numerics are removed from the monitor's screen. The monitor stops acquiring data and generating alarms for this measurement. If you disconnect a transducer while it is performing a measurement, the monitor issues a disconnect INOP (and in the case of SpO₂, replaces the measurement numeric with a question mark).

Settings

This section describes the various settings available on the monitor.

Active Settings

What the monitor displays, and the way it operates, is controlled by its settings. They determine sound volume settings, recorder settings, high and low alarm limits and so forth.

The "active settings" are the current settings the monitor uses, including any adjustments made by the last user. Active settings are not permanent, but are retained after a loss of mains power.

There are also two preconfigured default settings:

- User Default
- Factory Default

User Default

The **User Defaults** are a complete configuration stored in the monitor's long-term memory. You can store the active settings, modified to your preference, in the **User Defaults** (in Configuration Mode).

In Monitoring Mode, you can load the **User Defaults** settings to return to your preferred settings:

- 1 Select the **Defaults** SmartKey.



- 2 Select **Confirm** in the dialog box to load the **User Defaults**.

Factory Default

The **Factory Defaults** is a complete configuration predefined at the factory. You cannot modify it. In Configuration Mode, you can load the **Factory Defaults** as the active settings.

CAUTION

This resets all settings to factory defined values, but be aware that some values will differ from those with which the fetal monitor was originally shipped from the factory (recorder speed and paper scale type will need to be corrected, for instance). After loading the **Factory Defaults**, check the settings, and if necessary, change them to the settings you normally use.

You can use the **Factory Defaults** as the basis for producing your **User Defaults**. See the Configuration Guide for details.

Global Settings

General monitor configuration settings are stored in the **Global Settings**. These include settings for line frequency, QRS type, and whether the monitor is automatically reset to the **User Defaults** after a power interruption of more than one minute. You can change the **Global Settings** in Configuration Mode.

Changing Measurement Settings

Each measurement has a setup menu in which you can adjust all of its settings. You can enter a setup menu:

- 1 with the measurement numeric - select the measurement numeric on the screen to enter its setup menu. For example, to enter the **Setup FHR1** menu, select the **FHR1** (fetal heart rate 1) numeric.
- 2 with the **Main Setup** SmartKey - if you want to set up a measurement when the measurement is switched off, use the **Main Setup** SmartKey and select **Measurements**. Then select the measurement name from the pop-up list. With this SmartKey you can access any setup menu in the monitor.

This guide always describes the entry method using the measurement's setup menu. You can use the method you prefer.

Changing Monitor Settings

To change monitor settings such as brightness, or touch tone volume:

- 1 Enter the **Main Setup** menu.



- 2 Select the setting you want to change, or select **User Interface** to enter a sub menu where you can change user interface settings.

Adjusting the Screen Brightness

- 1 Enter the **Main Setup** menu.



- 2 Select **User Interface**.
- 3 Select **Brightness**.
- 4 Select the appropriate setting for the screen brightness. 10 is the brightest, 1 is the least bright. **Optimum** is suitable for most situations.

Adjusting Audio Volume

Here you can adjust the audio volume for **Alarm Volume**, **QRS Volume**, and **Timer Volume**. To adjust an audio volume:

- 1 Enter the **Main Setup** menu.



- 2 Select **User Interface**.
- 3 Select **Audio Volumes**, then select one of the volume types, and select an audio level. 10 is the loudest and 1 is the quietest. Selecting zero switches the volume off.

Setting the Date and Time

The current date and time is displayed in its own element in the information line of the monitor screen.

- 1 Select the date and time screen element from the monitor's information line to enter the **Date, Time** menu.
- 2 Select, in turn, the **Year, Month, Day, Hour** (in 24 hour format), and **Minute**, as necessary.
- 3 Select **Store Date, Time** to change the date and time.

WARNING

Do not change the date and time setting, if the fetal monitor is connected to a Philips OB TraceVue/ IntelliSpace Perinatal system. The monitor uses the OB TraceVue/IntelliSpace Perinatal system date and time, including daylight saving time changes. As long as the fetal monitor is connected to the OB TraceVue/IntelliSpace Perinatal system via the LAN-setup (locomotive symbol displayed on the monitor's screen), the option to change the date and time settings at the fetal monitor are disabled, this is not valid for RS232 connections, or the connection to other systems.

When disconnected from AC power, the monitor retains the date and time setting for at least two months. If the monitor is off longer than two months, and the operating system detects that the date and time settings are invalid, the monitor initiates a "cold" start and sets the date to 1 Jan 1997 and the time to 00:00.

Checking Your Monitor Revision

- 1 Select **Main Setup, Revisions** to open the **Monitor Revision** menu.
- 2 From the **Monitor Revision** menu, select the monitor component for which you need revision information.

Preparing to Monitor

Confirm fetal life before you begin fetal monitoring. Familiarize yourself with the basic operation principles before you start to monitor.

CAUTION

Check the fetal monitors housing for damage before you start to monitor as part of your safety precautions.

After you switch on the monitor:

- 1 Check that you have the correct patient cables and transducers plugged in for the measurement you want to monitor.
- 2 If you use an Avalon CL or Avalon CTS system, check if the cableless transducers are ready and charged (apparent by either a lit up green or yellow LED indicator).
- 3 Admit your patient to the monitor (see [“Admitting a Patient” on page 147](#)).
- 4 Check that the alarm limits, alarm and fetal heart rate volumes, patient category, and so forth, are appropriate for your patient. Change the settings if necessary.
- 5 Refer to the appropriate measurement section for details of how to perform the measurements you require.
- 6 Start recording.

There is no special emergency access for the Avalon Fetal monitors. For all clinical use cases according to the Intended Use, the monitors are taken into operation by connecting them to AC mains and by switching them on.

Switching On: FM20/FM30

- 1 Connect the monitor to AC mains and switch the monitor on.
 - The green power-on LED lights up.
 - The monitor performs a self-test as it starts up. **Selftest: OK**, the serial number, and revisions for the software and firmware are printed on the fetal trace paper (if recorder **Auto Start** is configured to **On**).
 - The monitor display comes on.
 - There is a start-up tone from the loudspeaker.

- Battery Option** • If this option has been chosen, the green power-on LED on both the external power supply and the battery LED indicator will light up.

Switching On: FM40/FM50

- 1 Connect the monitor to AC mains.
 - The green LED lights up.
- 2 Press the On/Standby switch.
 - The monitor performs a self-test as it starts up. **Selftest: OK**, the serial number, and revisions for the software and firmware are printed on the fetal trace paper (if recorder **Auto Start** is configured to **On**).
 - The monitor display comes on.
 - There is a start-up tone from the loudspeaker.

Adjusting the Display Angle (FM20/FM30)

You can tilt the display on the FM20 and FM30 to one of five different positions, or you can fold it completely down. The tilt/fold mechanism works on a one-way ratchet system. You hear a click as each of the five positions is reached. The screen can be folded back down only after tilting the display forwards as far as it will go.

To tilt the display from the folded position:

- 1 Unlock the display by releasing the catch.



- 2 Lift the display forward. You will hear a click as the first position engages. If you want to tilt the display further, lift the display further forward until you reach the desired angle.



3 Basic Operation

- 3 To fold the display, pull the display forwards as far as it will go.

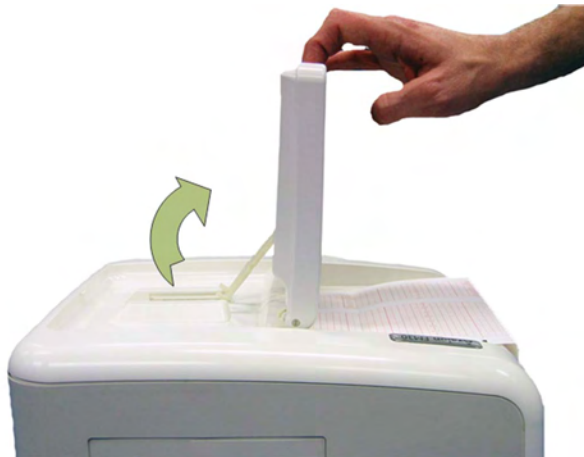

- 4 Then push the display all the way back until it **clicks** shut.



If your monitor is wall-mounted, the display should be folded flat.

Fastening Belts and Transducers

You can use more than one belt if, for example, you are monitoring uterine activity and FHR simultaneously. There are two basic ways to fasten belts and transducers:

- Belts with button fixings.
- Velcro belts together with the butterfly belt clip.

What You Need

- Ultrasound transducer
- Toco MP or CL Toco⁺ MP transducer
- Ultrasound gel
- Transducer belt (and optional butterfly belt clip, if applicable)

Using Belts with Button Fixings

- 1 Place the transducer belt across the bed, so that the fixing button will face away from the mother when it is fastened.
- 2 Lie the patient on the bed and arrange the belt around her until it is tight but still comfortable.
- 3 Fasten the belt by pushing the fixing button through the overlapping section of the belt. Ensure that the fixing button and the loose ends of the belt are at the patient's side.



- 4 When you have positioned a transducer satisfactorily, you can attach it to the belt by pushing the belt button on the transducer through one of the holes in the belt.



3 Basic Operation

- Alternatively, attach the butterfly belt clip to the transducer belt button and use this to attach the transducer to the belt. The clip allows you to slide the transducer for easy repositioning.



Using Belt with Velcro Fixings

Insert one end of the belt between the belt guides on one side of the butterfly belt clip, and secure with the velcro fixing. Insert the other end of the belt between the belt guides on the other side of the butterfly belt clip, adjust for the correct tension, then secure with the velcro fixing.

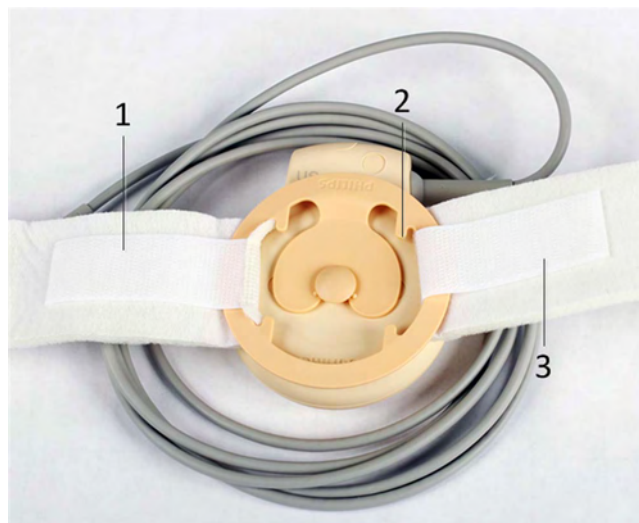

- 1 Velcro fixing
- 2 Belt guides
- 3 Velcro fixing

WARNING

When connecting devices for acquiring measurements, always position cables and NBP tubing carefully to avoid entanglement or potential strangulation.

Repositioning Transducers

A patient possibly wears transducers for long periods without interruption. In rare cases, skin irritations may occur if a transducer is attached to one location for a longer period. To ensure there are no adverse effects on the patient's skin, inspect the transducer application site at least every three hours. If the skin quality changes, move the transducer to another site.

The ultrasound transducer is often repositioned to follow the fetal heart as part of the normal monitoring process, but this is not so for the Toco transducer. Therefore, remember to check its application site (between contractions) at least every three hours.

To reduce the risk of skin irritations, do not allow a cleaning or disinfecting agent to remain on the transducer. Follow all instructions that accompany the specific cleaning and disinfecting agents you are using. Remove agent residues with a cloth dampened in water before applying a transducer to a patient.

See [“Care and Cleaning” on page 261](#) for further information, and a list of approved agents.

Connecting a Transducer to the Monitor

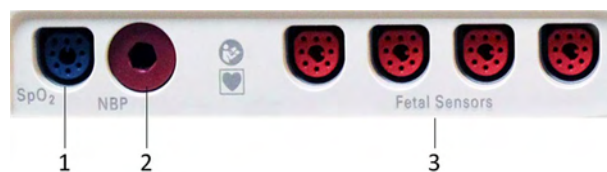

- 1 SpO₂ socket
- 2 Noninvasive blood pressure socket
- 3 Fetal sensor sockets



You can plug a fetal transducer, an ECG/IUP patient module, an Avalon CL or Avalon CTS Cableless Fetal Transducer System interface cable (red connector), or an external event marker into any of the four fetal sensor sockets marked by the fetal symbol, or "Fetal Sensors" (depending on geography).



For measuring maternal SpO₂, connect the sensor to the socket marked with the SpO₂ symbol or "SpO₂" (depending on geography).



For maternal noninvasive blood pressure, connect the cuff to the socket marked with the NBP symbol or "NBP" (depending on geography).

3 Basic Operation

For the FM20 and FM30, you can connect an Avalon CL or Avalon CTS Cableless Fetal Transducer system interface cable (red connector) to one of the fetal sensor sockets at the left side of the monitor. For the FM40 and FM50, you can connect an Avalon CL or Avalon CTS Cableless Fetal Transducer System interface cable (black connector) to one of the two dedicated black sockets marked "Tele" at the rear of the monitor, as an alternative to using one of the fetal sensor sockets (red connector) at the front.



- 1 Interface cable to Avalon CL and Avalon CTS Cableless Fetal Transducer System.
- 2 Connect the black connector to one of the two black sockets (marked "Tele") on the rear of the monitor.

What You See on the Monitor

When you connect a transducer or sensor, the measurement numeric appears on the screen.

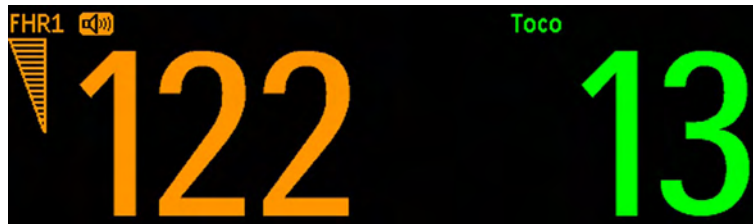

FM20/FM30



FM40/FM50



Fetal heart rate measurements are labeled in the order in which you plug in the transducers for those measurements. It does not matter which fetal sensor socket you use, as the monitor allocates a channel automatically. For instance, when monitoring triplets, the first transducer you connect is automatically allocated a channel, and the measurement is labeled **FHR1**, the second **FHR2**, and the third **FHR3**. See also chapters [“Monitoring Twin FHRs” on page 183](#) and [“Monitoring Triple FHRs” on page 191](#).

When you touch a measurement numeric on the screen, the setup menu for that measurement opens. The fetal sensor socket to which the transducer for this measurement is connected is identified by the transducer position indicator in the setup menu header.

The blue finder LED on a wired fetal transducer lights up when you touch the measurement on the screen, allowing you to identify the corresponding transducer.

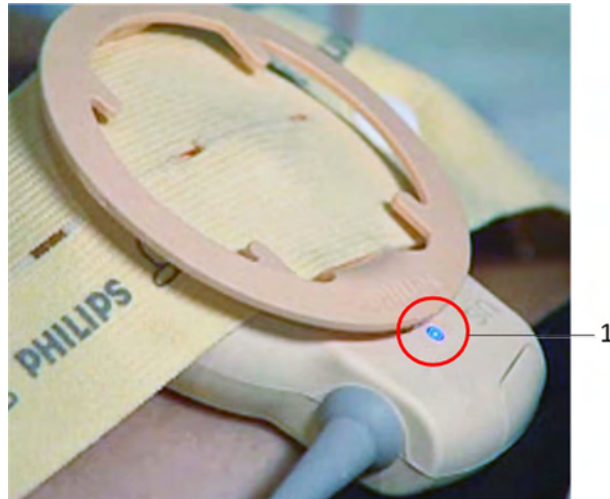

1 finder LED

The white finder LED on a cableless fetal transducer lights up when you touch the measurement on the screen, allowing you to identify the corresponding transducer.



1 finder LED cableless transducer

The recorder prints an annotation showing the date, time, recorder speed, and Monitoring Mode. It repeats this every 10 minutes.

Start Recording

Checking/Setting Paper Scale

You can check the paper **Scale Type** (**US** for USA, or **Internat'l** for other geographies) in the **Fetal Recorder** menu. In Monitoring Mode, you can see these settings (grayed out), but you cannot change them. They can be changed in Configuration Mode, see the Configuration Guide.

NOTE

Check if the scale type of the paper and the settings in the fetal monitor match.

Paper Guide FM40/FM50

The recorder in the FM40 and FM50 features a transparent paper guide which:

- facilitates correct alignment of the paper, both during loading and while the recorder is running. See [“Loading Paper FM40/FM50” on page 65](#).
- incorporates a tear-off edge, which not only allows you to tear off the trace paper where you like (not necessarily at a fold), but also helps to avoid paper misalignment while doing so (see [“Tearing Off the Paper” on page 61](#)).
- is removable (see [“Removing the Paper Guide: FM40/FM50” on page 269](#)).

Switching the Recorder On and Off

In addition to the normal recording of real-time traces, you will sometimes see a trace recovery printout from the monitor's internal backup memory at high speed when the recorder is started. For details, see [“Recovering Traces on Paper” on page 257](#).

For an explanation of the various symbols that can appear on the trace recording, see [“Recorder Specifications” on page 308](#).

To switch the recorder on, select in **Main Setup** the menu item **Fetal Recorder**, or press one of the SmartKeys: **Start/ Stop** or **Start Recordng**.



The "recorder on" status indicator is displayed in the bottom right-hand corner of the screen when you switch on the recorder.



The paper advances quickly for 2 cm and then returns to the set speed. Whenever the recorder is switched on, a trace header is printed vertically on the trace paper, containing the following:

- **Selftest: OK:** confirmation that the monitor's self-test completed successfully, and that it is ready to use
- the software revision and firmware revision
- the serial number
- the time
- the date
- patient name and medical record number (if entered)
- the recorder speed

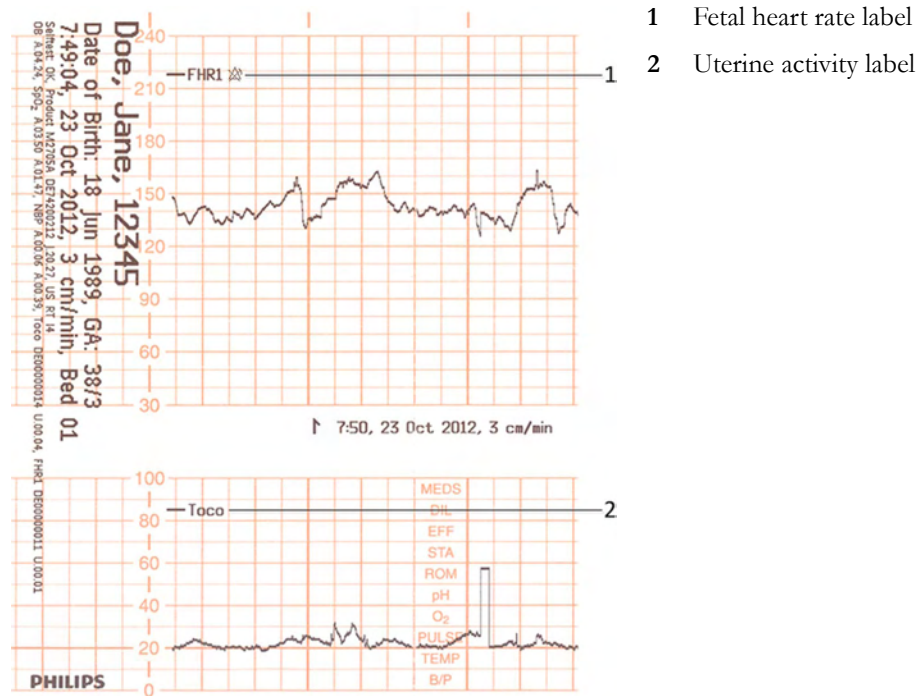

The current monitoring modes (if any transducers are connected to the monitor) are printed. Whenever a transducer's mode is changed, the following are printed:

- the time
- the date
- trace identification symbols
- the recorder speed

The monitor prints the time, date, recorder speed, and monitoring modes in the trace header when first switched on, in a periodic time stamp every ten minutes after, and if the monitoring modes change. The time stamp begins with the symbol shown below. The data is reprinted in the header if the time and date are locally adjusted, or if an obstetrical information and surveillance system is connected that readjusts the time and date automatically.

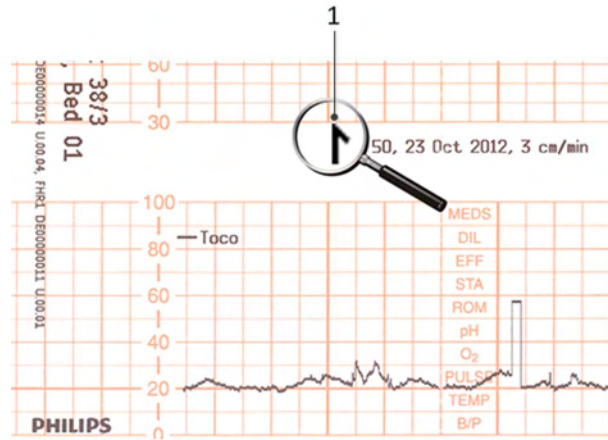

- 1 Time stamp printed every ten minutes

The trace records maternal parameters also. When measuring noninvasive blood pressure, the annotation is made at the end of the measurement. If the noninvasive blood pressure measurement repetition time is short, the noninvasive blood pressure numeric may not always be printed.

The recording of notes (see “[Entering Notes](#)” on page 69) or time/date information may be interrupted by connecting, or unplugging a transducer, or by a change in measurement-related setting (for example, artifact suppression, Toco sensitivity, or alarm settings).

A new patient admission or a change to the paper scale setting stops all annotations, and prompts a new vertical trace header to be printed.

To switch off the recorder:

- 1 *Either* select **Start/Stop** from the **Fetal Recorder** menu.



- 2 Or press one of the SmartKeys (depending on configuration): fetal recorder **Start/ Stop** or **Stop Recordng.**

If your recorder is configured with **Confirmed Stop** on (a Configuration Mode setting), you will need to confirm that you want to stop the recorder, before it will stop.



When the recorder is off, the "recorder off" status indicator is displayed in the bottom right-hand corner of the screen: When the **Paper Save Mode** is set to **Off** the paper symbol shows an **x** mark, and when **Paper Save Mode** is **On** the icon shows a paper trace icon.



Recording Elements

A variety of information can appear on the recorder trace. Here is a sample trace with some of the most common elements and their meaning. Each trace header contains the last name and first name, the patient ID, patient date of birth, the current date and time, patient's bed label, and the gestational age of the pregnancy.

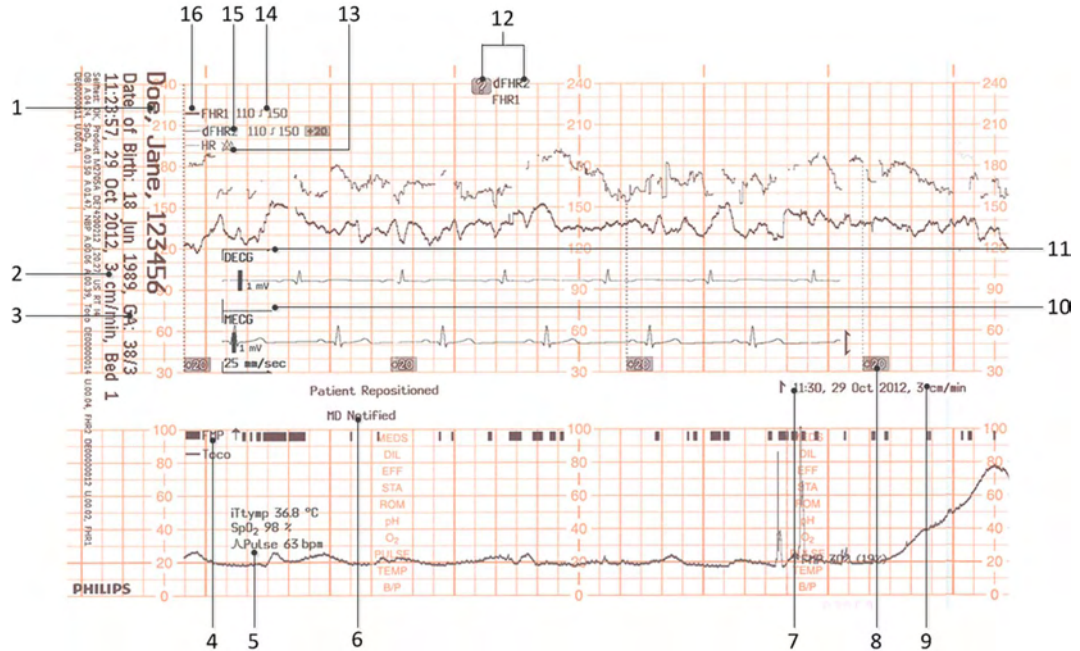

- 1 Name, patient ID, date of birth, current date and time
- 2 Recorder speed
- 3 Gestational age and patient bed label
- 4 FMP - Fetal Movement Profile
- 5 Other measurements for the patient such as temperature, arterial oxygen saturation, and pulse
- 6 Entered notes such as patient repositioned, or MD notified, or others
- 7 Time stamp
- 8 Trace separation
- 9 Recorder speed
- 10 Maternal ECG
- 11 Direct ECG
- 12 Coincidence of heart rate detected
- 13 HR with Alarms Off symbol
- 14 Alarm Limits
- 15 dFHR2 (second fetal heart rate from DECG)
- 16 FHR1 (first fetal heart rate)

Caution

The trace contains sensitive personal data. For information how to protect personal information, see “Protecting Personal Information” on page 17.

Choosing Recorder Speed

You can choose a recorder speed of 1, 2, or 3 centimeters per minute (cm/min). The default setting is 3 cm/min.

The ACOG technical bulletin on FHR monitoring states that "*accurate pattern recognition is difficult if not impossible at 1 cm/min and that 1 cm/min is only recommended for more economic screening. When FHR abnormalities arise, the faster recorder speeds will enhance FHR pattern recognition*".

Additionally, because a change in recorder speed results in a change in the appearance of an FHR trace, you are advised to ensure ALL monitors in your institution are set to the same speed.

To set the recorder speed (in Configuration Mode), see the Configuration Guide.

Advancing the Paper

You can advance the paper automatically to the next fold by pressing the **Paper Advance** SmartKey at any time except during a stored data recording. This is also possible using the **Fetal Recorder** menu.



Marking an Event

You can record significant events on the trace paper (for example, when pain medication is administered or when the mother changes position). The mother can use the remote event marker to mark events herself. You connect the remote event marker to any free fetal sensor socket.

To mark an event on the trace paper, you can:

- 1 Either select the **Set Marker** SmartKey.



- 2 Or press the button on the optional remote event marker (989803143411). The remote event marker is connected to the monitor via any fetal transducer socket.

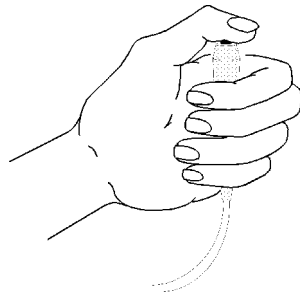

A small arrow is printed on the heart rate scale on the trace paper.



This reflects exactly when the marker button was first pressed; keeping the button pressed has no influence on the annotation.

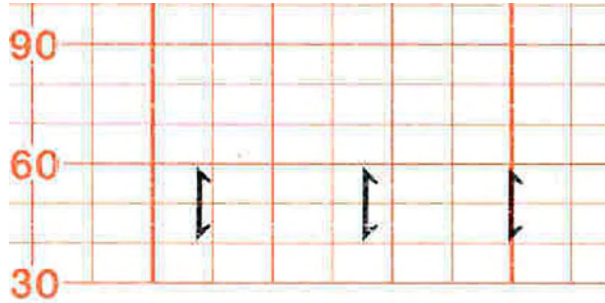

Tearing Off the Paper

CAUTION

Never pull on the paper to advance it, as this can cause misalignment of the paper. Always tear off the paper along the perforation.

FM40/FM50 The recorder's paper guide incorporates a tear-off edge, allowing you to tear off the trace paper cleanly where you like (not necessarily at a fold). When you are **not** using the paper guide, always tear off the paper along the perforation.

To tear off the trace paper after monitoring **using the paper guide**:

- 1 If the recorder is running (the "recorder on" status indicator is displayed), turn off the recorder by selecting the fetal recorder **Start/ Stop** SmartKey or the **Stop Recording** SmartKey.



- 2 Tear off the paper as shown in the picture. To ensure a clean tear, always tear in an upwards motion, as indicated by the arrows. You can start tearing from the left or right (right-handed user

3 Basic Operation

shown). You may want to use both hands to guarantee that the paper is not misaligned during the tear off.

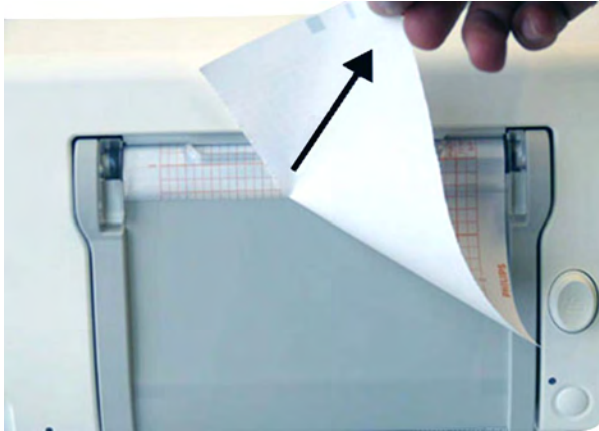

- 3 If you wish to tear off the paper at a fold, select the **Paper Advance** SmartKey, wait for the paper to stop, then tear it off.



FM20/FM30 The FM20/FM30 does not have a paper guide. The procedure is the same as described for the FM40/FM50 with the exception that you should advance the paper to a perforation.

If you wish to tear off the paper at a perforation, select the **Paper Advance** SmartKey, wait for the paper to stop, then tear it off.



Paper-Out Indication

Each pack of paper has 150 pages. The monitor issues a paper-out warning in the status line at the bottom of the screen, when there are five pages to go. If you switch on the recorder or press the **Paper Advance** key when there are fewer than five pages remaining, it may take two pages before the alarm is activated. Load a new pack in time.

If the recorder runs out of paper, an audible paper-out alarm is sounded, if so configured. See [“Loading Paper FM40/FM50” on page 65](#), and [“Loading Paper FM20/FM30” on page 62](#) to learn how to reload paper.

Fetal traces continue to be recorded into the monitor's backup memory, and can be retrieved and printed completely if new paper is loaded within one hour, when the **Bridge Paperout** setting is enabled in Configuration Mode. See [“Recovering Traces on Paper” on page 257](#) for further information.

Loading Paper FM20/FM30

CAUTION

Using recorder paper that is not approved by Philips can result in accelerated paper fading and can damage the thermal line printhead. This type of damage is not covered by warranty.

FM20/FM30 To load a pack of paper:

- 1 If the recorder is on, press the recorder **Start/ Stop** SmartKey or the **Stop Recording** SmartKey to turn it off before loading a new pack of paper.



- 2 Press the paper table release to unlock the paper drawer and then pull the table forward to open it fully.
- 3 Lift out any remaining paper from the tray.



- 4 Prepare to place the new pack of paper in the tray with the bottom side down. The bottom side is indicated by the word **STOP** printed on the final page of the new pack.

3 Basic Operation

- 5 Unfold the top page of the pack and position the uterine activity scale on the right.

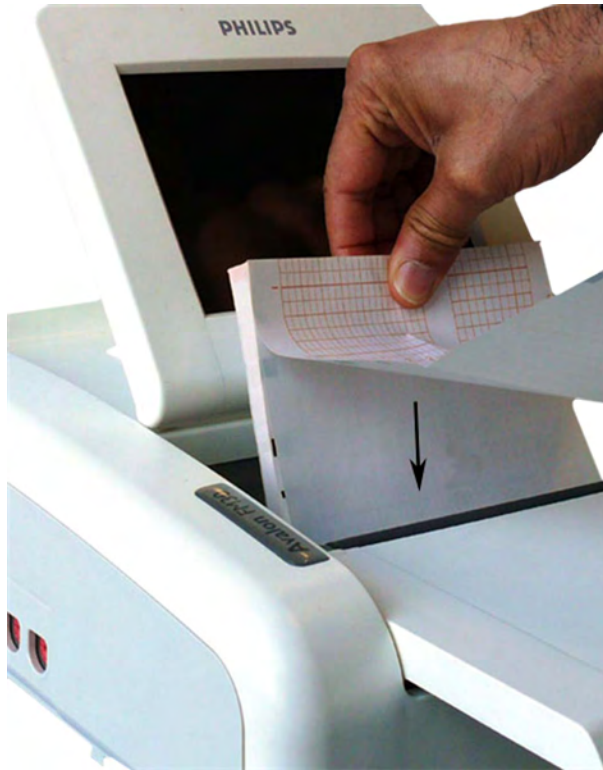

- 6 Slide the pack into the tray.

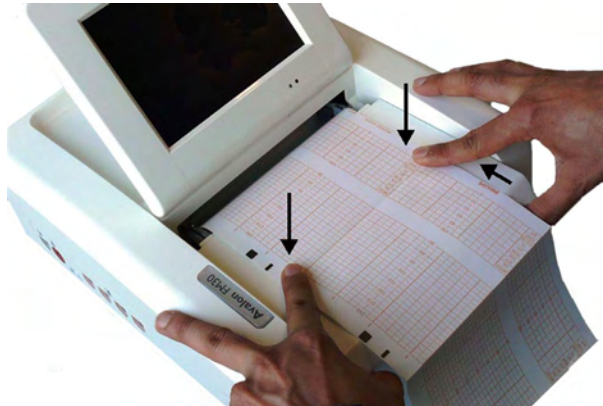

- 7 Push the paper drawer back until it "clicks" closed.



- 8 Press the recorder **Start/ Stop** SmartKey or the **Start Recording** SmartKey to switch on the recorder.



Annotations of trace information are printed on the trace paper (see [“Switching the Recorder On and Off” on page 56](#) for details).

Loading Paper FM40/FM50

CAUTION

Using recorder paper that is not approved by Philips can result in accelerated paper fading and can damage the thermal line printhead. This type of damage is not covered by warranty.

FM40/FM50 To load a pack of paper:

- 1 If the recorder is on, press the **Start/ Stop Rec** SmartKey or the **Stop Recording** SmartKey to turn it off before loading a new pack of paper.



- 2 Press the paper eject button to open the paper drawer.



3 Basic Operation

- 3 Lift out any remaining paper from the tray.
- 4 Press and hold the paper eject button to partially eject the paper, thus making it easier to remove.



- 5 Hinge the transparent paper guide forward. It is held in the closed position by a small protrusion on each side of the holder.



A - Protrusion holds paper guide in closed position.

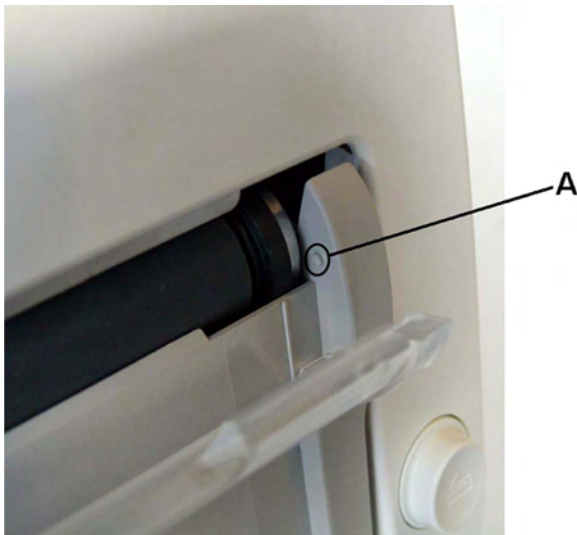

- 6 Prepare to place the new pack of paper in the tray with the bottom side down. The bottom side is indicated by the word STOP printed on the final page of the new pack.
- 7 Unfold the top page of the pack and position the uterine activity scale on the right.
- 8 Slide the pack into the tray.



- 9 Feed the paper evenly through the paper guide. Do not close the paper guide yet.

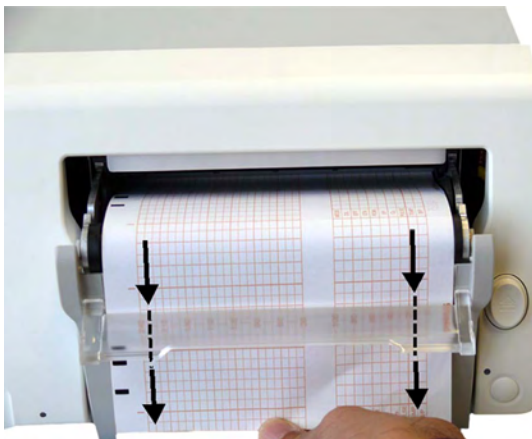
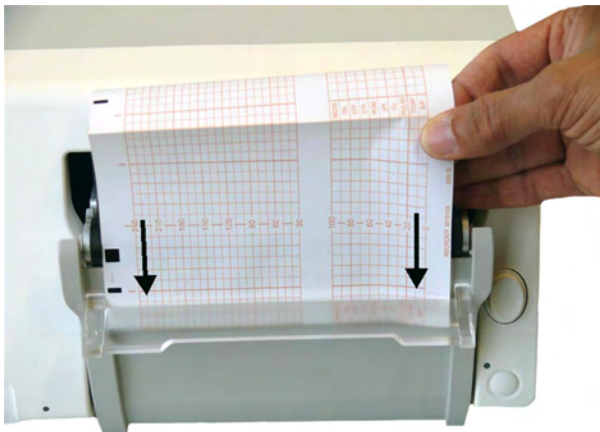

3 Basic Operation

- 10 Close the paper drawer.

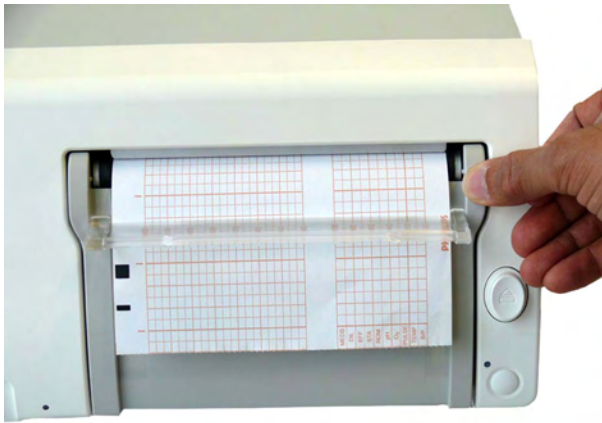

- 11 Now close the paper guide.

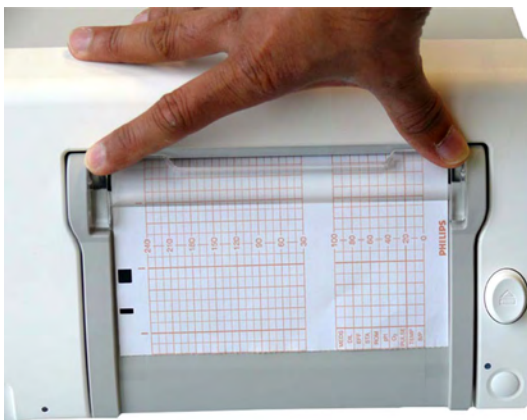
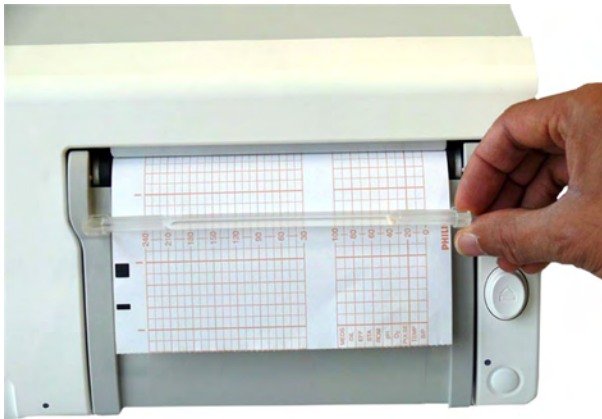

- 12 Press the recorder **Start/ Stop** SmartKey or the **Start Recording** SmartKey to switch on the recorder.



Annotations of trace information are printed on the trace paper (see [“Switching the Recorder On and Off”](#) on page 56 for details).

Entering Notes

Your monitor has a set of 15 factory pre-configured notes (see below). It is possible to edit these notes in Configuration Mode (see the Configuration Guide). The maximum length of one single note is 30 characters.

To enter a note:

- 1 Select the **Enter Notes** SmartKey to open the **Enter Note** menu.



- 2 Scroll if necessary, then select the note you wish to enter. A confirmation dialog box opens:
- 3 Select **Confirm** to enter the note. The note is then shown in the status line of the display, and is annotated on the fetal trace if the fetal recorder is on.
- 4 By default, notes are printed lengthwise in the direction of the trace, in the space between the FHR grid and the uterine activity grid. If you prefer, you can configure the recorder to print across the trace. You can change this in Configuration Mode.

The following are the pre-configured notes from which to choose:

- 1 **Patient Repositioned**
- 2 **Vaginal Examination**
- 3 **MD Notified**
- 4 **Sitting**
- 5 **On Back**
- 6 **Left Lateral**
- 7 **Ambulating**
- 8 **Tocolytic Given**
- 9 **Membranes Ruptured**
- 10 **Amniotomy**
- 11 **Amniotic Fluid Clear**
- 12 **Amniotic Fluid Not Clear**
- 13 **Oxytocin**
- 14 **Urinary Catheter**
- 15 **Micro Blood Analysis**

Up to two notes can be printed directly, and the monitor can temporarily store up to a further two notes, and these are printed after the first two have been printed. Any further notes are discarded. For example, if you enter six notes in quick succession, the first two notes you entered are printed right away, the next two are stored in memory and then printed when the first two have been printed, and the last two are discarded.

If the printing of two notes happens to coincide with the regular printing of the time stamp that takes place once every ten minutes, the time stamp is delayed until the notes have finished printing.

Typing Notes

Other than the pre-configured notes selectable in the **Enter Note** menu, a note can be typed in manually.

To type a note:

- 1 Select the **Enter Notes** SmartKey to open the **Enter Note** menu.



- 2 Select **Type a note** and a window with a touch keypad opens.
- 3 Type the note and select **Enter**. The typed note can be up to 30 characters long. The note is shown in the status line of the display, and is annotated on the fetal trace if the fetal recorder is on.

NOTE

The typed note remains in the window until it is deleted by using the backspace button of the keyboard.

Signal Quality

During monitoring, if the fetal heart rate signal quality fluctuates, and becomes poor, it does not necessarily mean that the transducer needs repositioning. The fluctuation may be caused by fetal movement. Allow time for the signal to stabilize before deciding whether to reposition the transducer (ultrasound), or apply a new electrode (ECG). For the best trace quality, the signal quality indicator should be full, indicating good signal quality, even though it may be possible to make traces at a lower signal quality level.

After Monitoring

Wired and cableless transducers

- 1 Discharge the patient.
- 2 Remove the transducer from the patient and, using a soft tissue, remove any gel from it. Then clean the transducers.
- 3 Dock CL transducers to the base station so they can recharge.
- 4 Tear off the paper at the fold. To avoid misalignment of the recorder mechanism, NEVER pull on the paper to advance it, or try to tear it other than at a fold (unless using the paper guide with the FM40/FM50).
- 5 Switch off the monitor.

NOTE

If an Avalon CL base station is connected to your FM20/30 monitor, do not turn off the monitor if you need to recharge the batteries of the CL transducers. They can only be recharged if the FM20/30 monitor is on. If an Avalon CL base station is connected to an FM40/50 at the Telemetry ports in the rear, the batteries of the CL transducers can be recharged while the monitor is not switched on. If you disconnect a base station from a fetal monitor when the CL transducers are not fully charged, the base station starts beeping. If you want to still disconnect it, confirm your choice by pressing the Standby key of the base station, and the beeping stops.

Switching the Monitor to the Standby Screen

To switch the monitor to the Standby screen:

Either

- 1 Select the **Monitor Standby** SmartKey.



Or

- 1 Enter the **Main Setup** menu using the SmartKey.



- 2 Select **Monitor Standby**.
- 3 Pressing any key or selecting any field on the screen will resume monitoring.

Disconnecting from Power

FM20/30

To disconnect the monitor from AC power, switch the monitor off using the On/Off switch located on the right side of the device, or unplug the power cord from the AC mains socket.

FM20/FM30 with Battery Option and FM40/FM50

The On/Standby button does not disconnect the monitor from the AC power source. To disconnect, unplug the power cord from the AC mains socket. Note that if the power cord is unplugged from the AC mains socket before the monitor is put into Standby, a beeper is activated. The beeper warns you if the monitor is accidentally disconnected from AC mains.

External Power Supply for the Avalon CL Base Station

To disconnect, unplug the power supply from the AC mains socket. Note that if the power supply is unplugged from the AC mains socket before all CL devices are fully charged, a beep is issued. To confirm the disconnection from power, and to silence the beep, press the On/Standby button of the CL base station.

Power On/Power Off Behavior

The general rules determining the behavior of the fetal monitors when connected to, or disconnected from power are as follows:

- A fetal monitor that was switched on prior to a temporary power loss, switches on again when power is restored.
- A fetal monitor that was switched off prior to a temporary power loss, remains off when power is restored.
- When AC mains power is lost, a battery powered monitor (FM20/30) continues to run without interruption on battery power.

Monitoring After a Power Failure

- A fetal monitor that was switched on prior to a temporary power loss, switches on again when power is restored.
- A fetal monitor that was switched off prior to a temporary power loss, remains off when power is restored.
- If the fetal monitor is without power for less than one minute, monitoring will resume with all active settings unchanged.
- If the fetal monitor is without power for more than one minute, the behavior depends on your configuration.
 - If **Automat. Default** is set to **Yes**, the default profile will be loaded when power is restored.
 - If **Automat. Default** is set to **No**, all active settings are retained, if power is restored within 48 hours. The **Automat. Default** setting is made in Configuration Mode.

Troubleshooting

Problem	Possible Causes	Solutions
Light or no trace	Wrong paper	Use recommended paper
	Dirty printhead	Clean printhead, see “Cleaning the Print Head” on page 273
	FM20/30 only: Paper misaligned due to drawer not being correctly shut	Shut the drawer fully, pushing evenly with both hands
End of paper noted when pack not finished	Bad paper feed or wrong paper	Check paper feed and use recommended paper
Check Paper INOP is displayed	INOP messages always indicate equipment problems	See “Patient Alarms and INOPs” on page 129
FetRec Equip Malf INOP is displayed		
Paper End INOP is displayed		
Wrong Paper Scale INOP is displayed		

Cableless Monitoring

Avalon CL Transducer System

The Avalon CL Fetal Transducer System lets you monitor the patient continuously with cableless transducers during the antepartum period, labor, and delivery.

You can monitor the fetal heart rate (FHR):

- Using noninvasive CL Ultrasound transducers
- Invasively, using the CL ECG/IUP transducer or CL Toco⁺MP transducer with a fetal scalp electrode
- Noninvasively, with the CL F&M Pod

The uterine activity can be monitored using:

- Externally, using the CL Toco⁺MP transducer
- Externally, using the CL F&M Pod
- Invasively, using the CL ECG/IUP transducer or CL Toco⁺MP with an IUP catheter

The fetal and maternal parameters are measured and transmitted via radio frequency from the CL transducers and CL Pods to the CL base station, eliminating the need for patient cables. With the Avalon CL Transducer System, you can monitor a single fetus, twins, and triplets.

The Avalon fetal monitor (FM20-FM50) connected to the CL base station displays and records the parameters. All the CL transducers and the CL F&M Pod are watertight. The IntelliVue CL Pods should not be immersed in water. You can continuously monitor patients in a bath or shower using the CL Toco⁺MP and the CL Ultrasound transducers, the CL F&M Pod should not be used during a bath.

Basics of Cableless Systems

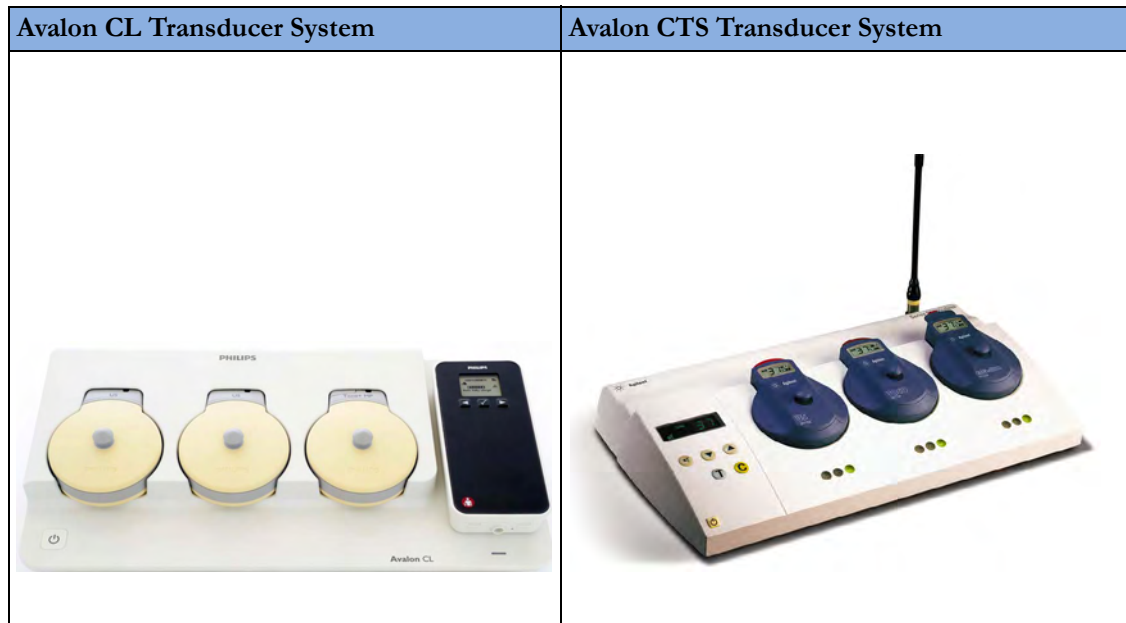

Assigning Cableless Devices

The cableless devices of the Avalon CL are assigned by simply docking them at the base station connected to the patient's fetal monitor. See the Avalon CTS Instructions for Use for the assignment of the CTS transducers.

Activating Cableless Devices

The CL devices of the Avalon CL are activated by picking them up from the base station. If the CL devices are activated, a corresponding symbol is displayed on the fetal monitor screen next to the numeric of the measurement. See the Avalon CTS Instructions for Use for the activation of the CTS transducers.

Deactivating Cableless Devices

The CL devices of the Avalon CL are deactivated by redocking them at a base station. To deactivate all cableless devices at once, press the Standby key of the Avalon CL base station. See the Avalon CTS Instructions for Use for the deactivation of the CTS transducers.

Unassigning Cableless Devices

The CL devices of the Avalon CL are unassigned by manually removing them in the corresponding setup menu from the group of assigned cableless devices, or by unassigning them directly in the **Tele Info** window. See the Avalon CTS Instructions for Use for the unassignment of the CTS transducers.

Twins and Triplets Support

Twins and Triplets	Singletons only
Avalon CL Transducer System and CL transducers	Avalon CTS System
	Avalon CL Transducer System with CL Fetal & Maternal Pod

Configuration of Cableless Systems

You have to configure the radio channels of the Avalon CL and Avalon CTS transducer system for communication to work, and not to interfere with any other telemetry devices.

The configuration of a connected Avalon CL system is done in Configuration Mode or Service Mode of the fetal monitor. Service Mode functions can be used to identify channel assignment conflicts in the hospital environment. The configuration should be carried out by authorized and qualified service personnel, either by the hospital's biomedical department, or by Philips Support.

For a detailed description of the configuration see the Avalon CL Service Guide and the Fetal Monitor Configuration Guide. For details regarding the configuration of a connected Avalon CTS system see the Avalon CTS Service Guide.

Fetal Movement Profile

When using an Avalon CL or Avalon CTS you should be aware that monitoring FMP is not recommended when the mother is likely to move, and you should disable Fetal Movement Profile (FMP) on the fetal monitor (**Fetal Movement Off**) if the mother is walking. Maternal movements are likely to create artifact in the FMP output. See also [“Switching FMP On and Off” on page 171](#), the sections [“Cableless Monitoring - Important Considerations” on page 167](#), and [“Fetal Movement Profile” on page 170](#).

Getting to Know Your Avalon CL

Front

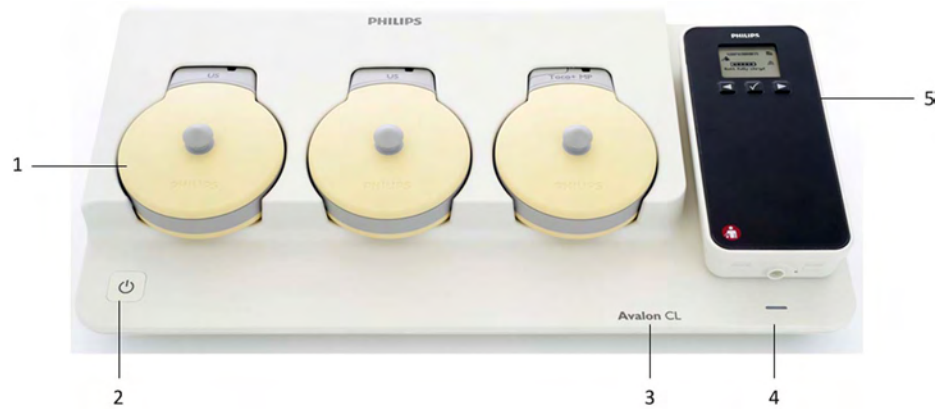

- 1 Transducer docking slots
- 2 On/Standby button with LED
- 3 Device label
- 4 LED for optional cableless Pods
- 5 Docking slot for cableless Pods

WARNING

- To avoid magnetic interference affecting the mode of the pacemaker, ensure that the Avalon CL base station does not come into close contact with implanted pacemakers.
 - This equipment generates, uses, and radiates radio-frequency energy, and if it is not installed and used in accordance with its accompanying documentation, may cause interference to radio communications. Operation of this equipment in a residential area may cause interference, in which case you must take whatever measures may be required to correct the interference.
-

Docking Slots for Cableless Transducers

The Avalon CL base station has three docking slots to hold the CL transducers. The transducers are charged while docked. The base station has a built-in radio interface with an integrated antenna to communicate with the transducers.



On/Standby Button

Pressing the On/Standby button switches the Avalon CL base station between the two modes On and Standby.

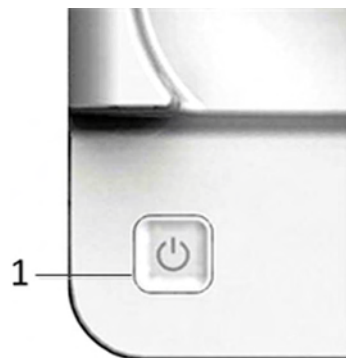

1 On/Standby button

If you switch the base station to **On**, the LED button lights up green. The base station is ready for use. When the transducers are picked up from their docking slot, the base station sets up the radio communication to the CL transducer automatically. Wired transducers connected to the fetal monitor are disabled, and the antenna symbol for the CL transducer is displayed on the screen of the fetal monitor.

If you switch the base station to **Standby**, the LED button turns off. The base station is now in Standby mode. No radio communication occurs, any existing radio communication is stopped.

If the LED of the On/Standby button turns red, it indicates a technical problem has occurred that needs your attention. Check your monitor for a possible related INOP message.

Docking Slot for Cableless Measurement Pods

The Avalon CL base station has one docking slot to hold a CL F&M Pod or an IntelliVue CL Pod. The CL Pod is charged while docked. The LED under the docking slot indicates the battery status of the CL Pod. The base station has a built-in short range radio interface with an integrated antenna to communicate with the CL Pod.



1 Docking slot for CL Pods

WARNING

Short range radio connections are subject to interruption due to interference from other radio sources in the vicinity, including microwaves, bluetooth devices, WLAN devices (802.11b,g,n), and cordless phones. Depending on the strength and duration of the interference, the interruption may occur for an extended period. A loss of connection, due to moving out-of-range, interference, or for other reasons, is indicated with a **No Host Monitoring INOP** (here the host is the fetal monitor) on the NBP or SpO₂ Pods, or a **cl NBP Disconnect** or **cl SpO₂ Disconnect** INOP at the fetal monitor. Correct channel configuration is important, see the Configuration Guide for details.

Audio Signal CL Base Station

The Avalon CL base station has two audio signals:

- If the base station issues a descending tone sequence, the attempt to set up radio communication to a CL transducer or CL Pod has failed.
- The base station issues a permanent beeping tone if it is disconnected from a fetal monitor, or if the FM20 or FM30 monitor is switched off, and the base station has transducers or a Pod currently docked that need to be recharged.

Alarming is only available at the Avalon Fetal Monitor, not at the Cableless Measurement Devices, see the Instructions of Use for the IntelliVue Cableless Measurements.

Rear and Bottom



- 1 Name plate



- 1 Manufacturer label
- 2 Cable reel

Connection Options

The fetal monitors FM20/FM30 and FM40/FM50 are compatible with the Avalon CL and Avalon CTS Transducer Systems. Regard the following points for cableless monitoring:

- You can connect one Avalon CL base station with a red connector to an FM20/FM30 or an FM40/FM50 (fetal socket), or one Avalon CL base station with a black connector to an FM40/FM50 (telemetry socket).



- You can connect two Avalon CL base stations with black connectors to an FM40/FM50 (telemetry sockets)



- You **cannot** connect two Avalon CL base stations to an FM40/FM50, if one Avalon CL base station has a red connector, and the other Avalon CL base station has a black connector.

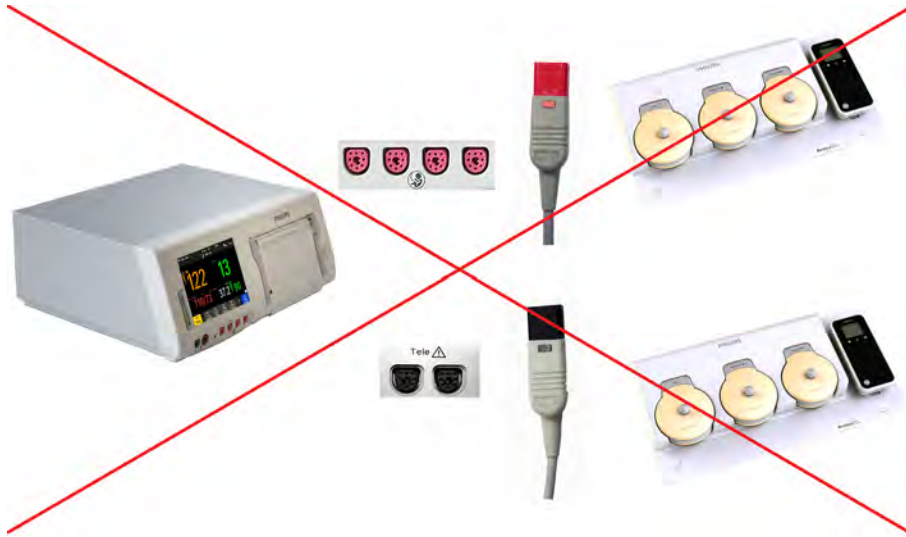

- You can connect one Avalon CTS system to an FM20/FM30 or FM40/FM50 at a time (either fetal or telemetry socket).



4 Cableless Monitoring

- You **cannot** connect an Avalon CTS and an Avalon CL at the same time to the same fetal monitor.

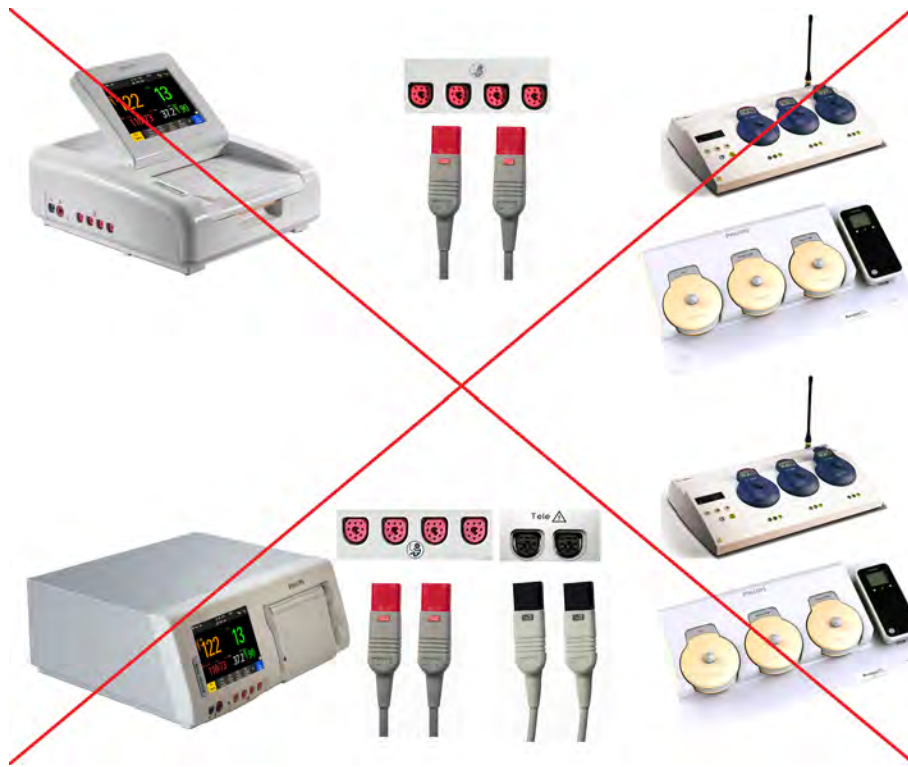

- Monitoring a multiple pregnancy using cableless transducers is supported by the Avalon CL system only.
- Using a mixture of wired and cableless fetal transducers is not supported. You can use *either* wired *or* cableless fetal transducers.
- If you cannot get sufficient signal quality using Avalon CTS transducers, switch to wired transducers.

Connecting Two CL Base Stations to an FM40/50 Monitor

Two base stations can be connected to an FM 40/50 fetal monitor at the rear black telemetry ports. At both base stations CL transducers and CL Pods can be assigned, activated, and redocked for charging. The base stations work as one extended system together. Pressing the Standby key of either base station, puts both base stations in Standby mode. The **Tele Info** window shows both base stations in operation.



External Power Supply (Option K60)

In combination with the optional external AC power supply an Avalon CL base station serves only as a charging station for Avalon CL transducers and IntelliVue CL Pods, and all radio communications are disabled. The On/Standby button of the base station lights up white in this operation mode. The charging indication of the LEDs of the docked CL transducers and the IntelliVue CL Pods remain the same as described in the sections [“Cableless Transducer LED Indication” on page 86](#) and [“Battery Status LED for CL Pods” on page 93](#).

When a transducer is picked up from the base station after charging, it needs to be activated for monitoring by docking it on a CL base station connected to the patient's fetal monitor.

Cableless Transducers

The cableless Avalon CL transducers have a built-in radio interface with an on-board, integrated antenna. The fetal monitor connected to the Avalon CL base station can control the transducer using radio communication. The CL transducer transmits measured values, alarms, and status information to the fetal monitor.

The CL transducers are assigned by simply docking them at the Avalon CL base station. If they are picked up from their docking slot at the base station, they are automatically activated.

CAUTION

To ensure the correct assignment of CL transducers to the fetal monitor in use, always dock them at the base station connected to that fetal monitor before use. This is particularly important when you add an additional CL transducer that was previously docked at another base station.

NOTE

Avoid dropping the transducers.

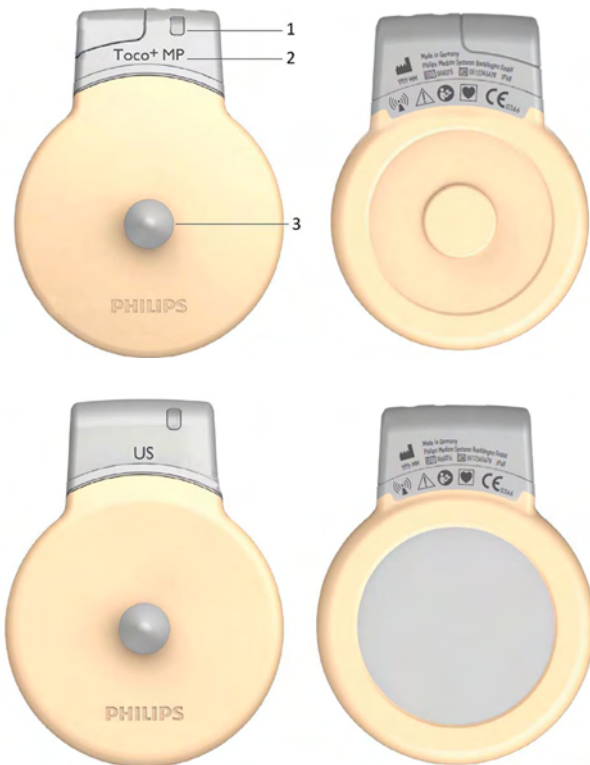

- 1 Transducer finder LED - lights up on the transducer providing the measurement source.
- 2 CL Toco⁺ MP transducers (capable of providing the maternal pulse measurement)
- 3 Belt button

CL Ultrasound transducer



CL ECG/IUP transducer

Connector Cap for the CL Toco+ MP Transducer

The CL Toco⁺ MP transducer is delivered with a connector cap covering the ME/ECG/DE/ECG/IUP connector. The connector cap is designed to cover the connector, not to protect it from water. (The connector itself is water-proof and may be immersed in water).

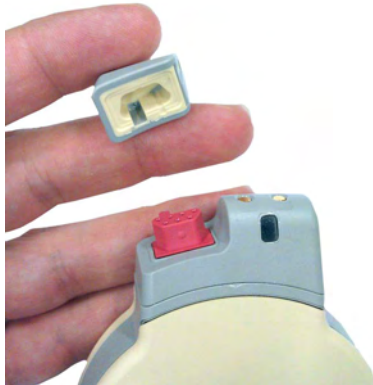

Cableless Transducer LED Indication

The cableless transducers have a multi-color LED that indicates the status of the transducer with specific colors. This LED remains visible when the transducer is correctly attached to the transducer belt (Philips standard belt).

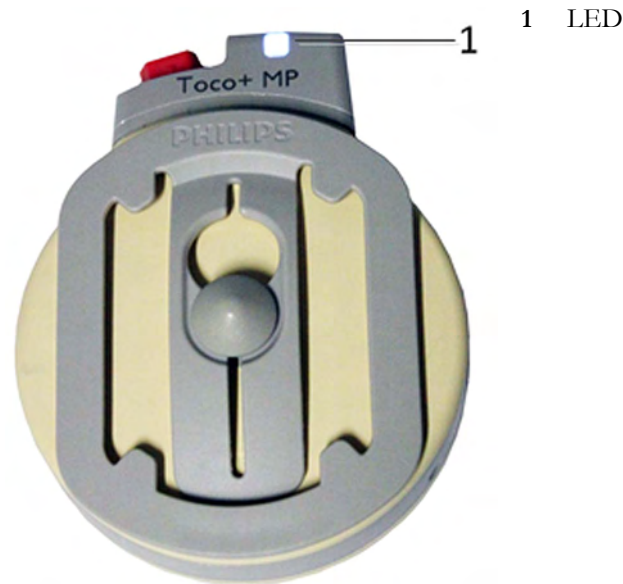

LED Status	Meaning
White	The LED lights up to identify the transducer among other transducers, and to easily verify the correct transducer assignment (transducer finder). The transducer finder LED is controlled by the fetal monitor. Press the numerics to identify the corresponding transducer. The LED also lights up when the mother is paged with the Call Patient SmartKey.
White one short blink	The LED shortly lights up to indicate that the transducer successfully opened a radio communication with the base station and that it is ready to use.
Green	The LED lights up green when the transducer is fully charged and docked at the base station.
Yellow	The LED lights up yellow when the transducer is charging and docked at the base station.
Red	The LED flashes red when the transducer is out of battery and has to be recharged. When a docked transducer performs an update, the LED will blink fast red for about 1 minute. In this case, do not remove the transducer until the LED lights up green or yellow again.
Cyan	The LED lights up cyan to indicate a technical problem that needs your attention. Check your fetal monitor for a related INOP.

Audio Signal CL Transducers

The Avalon CL transducers have three audio signals:

- If an ascending tone sequence is played three times, the transducer was triggered by the fetal monitor to page the patient wearing it, or to locate a not docked transducer.
- If the CL transducer's battery is empty, the transducer issues three beeps in intervals.
- An INOP tone indicates that the transducer has detected a technical problem (INOP). Check your fetal monitor for a related INOP message.

Standard Radio Range of CL Transducers

The CL transducers have an operating range around the base station of at least 100 m/300 ft in the line of sight. Obstructions such as walls, metal doors, elevators, and other environment structures can lead to signal loss. The CL symbol indicator and the **Tele Info** window on the monitor's display (see [“Screen Elements” on page 39](#) and [“Tele Info Window” on page 94](#)) provide information on the status of the signal strength.

When a patient is approaching the end of range, the US sound is replaced by an artificial QRS sound (like DECG), and the DECG and MECG waves are no longer displayed on the monitor.

Out of Range

If the patient walks out-of-range, the CL transducer LED lights up cyan and every 16 seconds a two-tone audio signal is emitted. At the monitor the INOP e.g. **cl US Disconnect** is issued. Inform the patient to return to the CL base station, when a CL transducer starts beeping.

Radiated Transmission Power

The Avalon CL transducers provide all the benefits and flexibility of cableless operation, but do so with an effective radiated transmission power significantly less than that of a typical remote controlled child's toy or mobile phone.

Extended Range Radio

Using the optional CL Wide Range Pod extends the radio range of the CL transducers and the CL Pods to the local WLAN infrastructure. If the CL Wide Range Pod is active, the US sound is replaced by an artificial QRS sound (like DECG), and the DECG and MECG waves are no longer displayed on the fetal monitor. Numerics, alarms, and traces are shown at the fetal monitor as usual. See also [“CL Wide Range Pod” on page 91](#).

Using CL Transducers with a Belt Clip

The Avalon CL transducers can also be used with an optional belt clip to be ordered separately (989803184851).

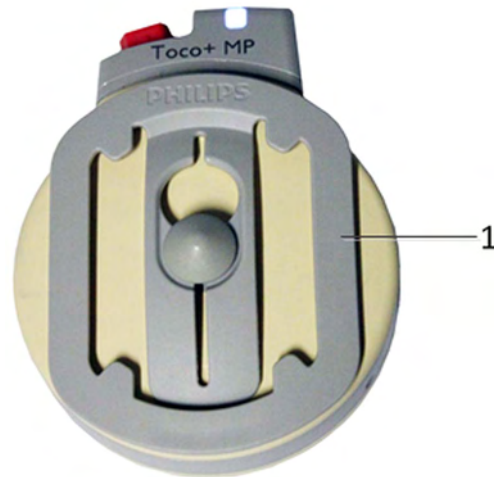

1 Avalon CL belt clip

CL Pods

CL Fetal & Maternal Pod

The CL F&M Pod provides measurement values for FHR, Toco, and HR. It communicates them to the fetal monitor using short range radio (SRR). It is controlled via SRR from the Avalon CL base station and the connected fetal monitor.

The CL F&M Pod is assigned by docking it at the Avalon CL base station. Before monitoring, the CL F&M Pod is mounted on a single-use electrode patch, and held in place by integrated magnets. When the CL F&M Pod is active, the wired transducers connected to the fetal monitor are disabled.

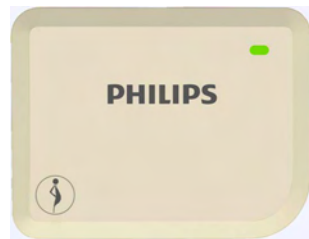

CL F&M Pod



CL F&M Patch

WARNING

The CL Fetal & Maternal Pod has been validated with a gestational age of >36 weeks with patients in labor. It is only intended for singleton pregnancies. If the measurement signals are not good or in any way suspicious, use other means of monitoring (CL transducers or wired transducers).

CL Fetal & Maternal Pod LED Indication

The CL F&M Pod has a multi-color LED that indicates the status of the CL F&M Pod with specific colors.

1 LED

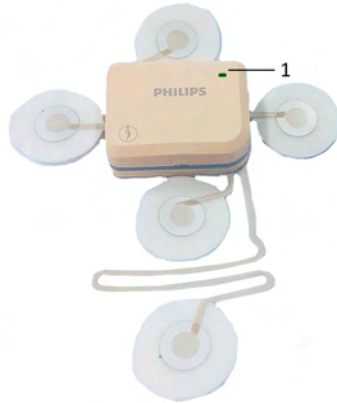

LED Status	Meaning
White	The LED lights up to identify the CL Pod, and to easily verify the correct assignment (finder). The finder LED is controlled by the fetal monitor. Select the numerics to identify the corresponding CL Pod. The LED also lights up when the mother is paged with the Call Patient SmartKey.
White, one short blink	The LED briefly lights up to indicate that the CL Pod successfully opened a radio communication with the base station and that it is ready to use.
Green	The LED lights up green when the CL Pod is fully charged and docked at the base station.
Yellow	The LED lights up yellow when the CL Pod is charging and docked at the base station.
Red	The LED flashes red when the CL Pod's battery is empty, and has to be recharged.
Cyan	The LED lights up cyan to indicate a technical problem that needs your attention. Check your fetal monitor for a related INOP.

Audio Signal CL Fetal & Maternal Pod

The Avalon CL F&M Pod has three audio signals:

- If an ascending tone sequence is played three times, the CL F&M Pod was triggered by the fetal monitor to page the patient wearing it, or to locate a not docked CL F&M Pod.
- If three beeps are issued at intervals, the CL F&M Pod's battery is empty.
- An INOP tone indicates that the CL F&M Pod has detected a technical problem (INOP). Check your fetal monitor for a related INOP message.

CL Fetal & Maternal Electrode Patch

The single-use disposable adhesive electrode patch holds the CL F&M Pod at the intended application site on the abdomen of the patient. The electrode patch has five adhesive electrodes. The CL F&M Pod is held in place during monitoring with magnetic contacts, and a connector. The electrode patch and the CL F&M Pod can only be used together and within the Avalon Cableless Transducer System solution for monitoring.



CAUTION

The electrode patch is single-patient use only, do not reuse the electrode patch on another patient to avoid possible cross-infection.

CL Wide Range Pod

The Avalon CL Wide Range Pod is a battery-powered auxiliary network device that converts the SRR and OB radio technology of Avalon CL transducers and the CL Pods into WLAN technology. This allows data from the measurement devices to be transmitted to a fetal monitor while the patient is ambulating.

The Avalon CL Wide Range Pod is a mobile device which can be worn by the patient or by an attending caregiver. The display on the CL Wide Range Pod shows only technical data that may be useful for troubleshooting system problems.



CL Wide Range Pod

IntelliVue CL Pods

The two IntelliVue CL Pods provide measurement values for SpO₂ and NBP on the built-in display, and communicate them to the fetal monitor using short range radio (SRR). They are controlled with SRR from the Avalon CL base station and the connected fetal monitor.

The maternal measurement pods are assigned by docking them at the Avalon CL base station.



CL NBP Pod



CL SpO₂ Pod

The CL SpO₂ Pod and the CL NBP Pod have an LCD display and three keys for basic operation e.g. to assign the device to a patient:



- 1 Integrated LCD display
- 2 Hardkeys
- 3 Measurement identifier

For further details, see the IntelliVue Cableless Measurements Instructions for Use.

Battery Status LED for CL Pods

The CL Pods do not have their own battery status LED, but a small battery gauge on their display. On the Avalon CL base station, the battery status LED for the CL Pods is located directly under the docking slot.

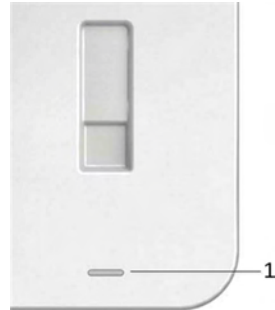

1 Battery status LED for CL Pods

The battery status LED shows five different states:

Status	Meaning
Green	The docked CL Pod is fully charged.
Yellow	The docked CL Pod is charging.
Yellow blinking	The communication is established with the docked CL Pod.
Cyan	Indicates that the docked CL Pod or the charging slot has a technical problem that needs your attention. Check your fetal monitor for a related INOP message.
Off	The battery status LED is off, when no CL Pod is docked.

Audio Signal CL Pods

The CL Pods have audio signals to let you know when a battery has to be recharged. If a CL Pod's battery is empty, the CL Pod issues three beeps at intervals.

Calling Patients

To call a patient currently not near the fetal monitor and base station, select the SmartKey **Call Patient** at the fetal monitor. The base station will then select one transducer, or the CL F&M Pod if it is assigned and active, to emit the tone sequence to notify the patient. Inform the ambulating patient, if the cableless device is issuing any beeping sounds, to return to the room with the fetal monitor.

Telemetry

Tele Info Window

The **Tele Info** window of the fetal monitors allows you to manage the Avalon CL or CTS system. Below is an exemplary view of the **Tele Info** window. Your window may differ depending on the status of the connected system.

To open the **Tele Info** window, you can:

- 1 Configure a **Tele Info** SmartKey to open the window,
- 2 select the **CL** symbol on the main screen, or
- 3 select the **Main Setup** and then **Tele Info**.

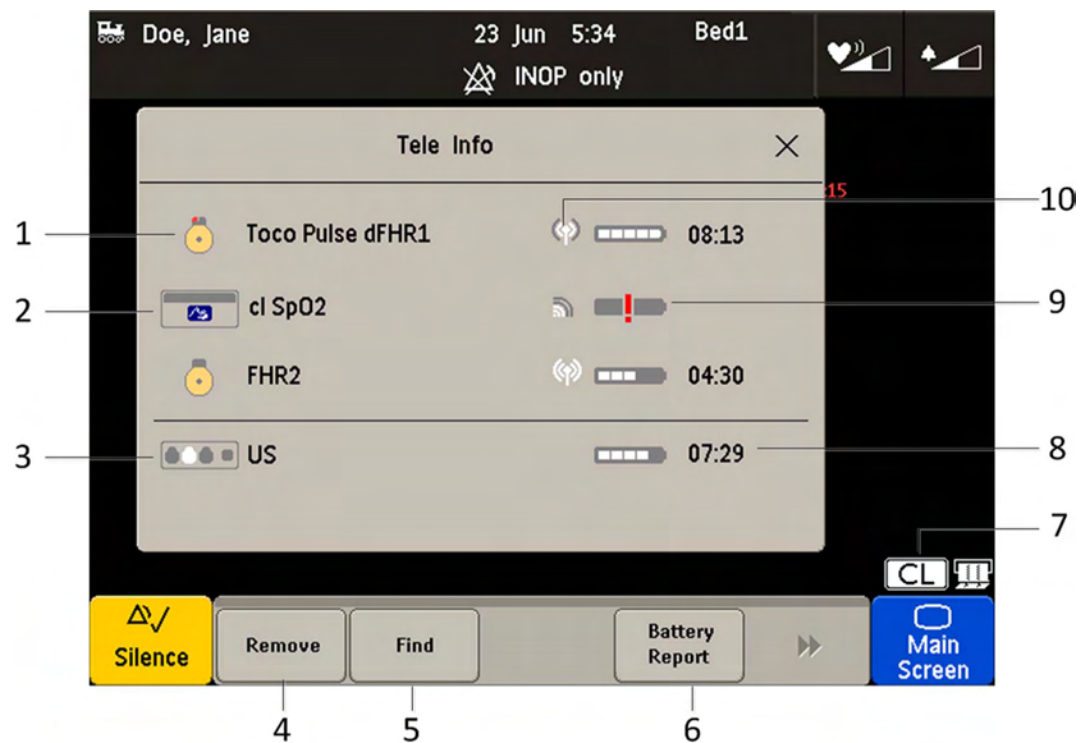



- 1 CL transducer symbol assigned with the parameter labels
- 2 Cableless measurement symbol and equipment ID
- 3 Base station symbol with docking indication (the white slot indicates a charging transducer)
- 4 Key **Remove**
- 5 Key **Find**
- 6 Key **Battery Report** (in Service Mode)
- 7 **CL** symbol
- 8 Remaining battery time
- 9 Out of battery symbol
- 10 Indication of radio signal quality







Cableless Status Indication

When the monitor recognizes a connected Avalon CL or Avalon CTS interface cable (red or black connector), it confirms the recognition with the following status indicators displayed in the lower right-hand corner of the screen:





Avalon CTS

Indicator	Description
	Avalon CTS interface cable is connected to the monitor, but the Avalon CTS base station is not connected to the interface cable, or it is disconnected from AC mains, or is in Standby mode.
	Avalon CTS interface cable is connected to the monitor, Avalon CTS base station is connected, powered on, and cableless transducers are ready to use, but no cableless transducers are currently active (all are still docked at the base station).
	Avalon CTS interface cable is connected to the monitor, Avalon CTS base station is connected, powered on, and at least one cableless transducer is active and assigned.

Avalon CL

Indicator	Avalon CL
	A base station is connected to the monitor, but the base station is in Standby mode.
	A base station is connected to the monitor, but the base station is in Standby mode. The CL Wide Range Pod is activated and trying to connect to the monitor.
	A base station is connected to the monitor, but the base station is in Standby mode. The CL Wide Range Pod is activated and connected to the monitor.
	A base station is connected to the monitor but no cableless transducers and no cableless Pods are currently active. All are still docked at the base station, or the base station holds no transducers.
	A base station is connected to the monitor but no cableless transducers and no cableless Pods (except the CL Wide Range Pod) are currently active. All are still docked at the base station, or the base station holds no transducers. The CL Wide Range Pod is activated and trying to connect to the monitor.
	A base station is connected to the monitor but no cableless transducers and no cableless Pods (except the CL Wide Range Pod) are currently active. All are still docked at the base station, or the base station holds no transducers. The CL Wide Range Pod is activated and connected to the monitor.
	A base station is connected to the monitor, it is on, and minimum one assigned cableless transducer or cableless Pod is active.

4 Cableless Monitoring

Indicator	Avalon CL
	A base station is connected to the monitor, it is on, and minimum one assigned cableless transducer or cableless Pod is active. The CL Wide Range Pod is activated and trying to connect to the monitor.
	A base station is connected to the monitor, it is on, and minimum one assigned cableless transducer or cableless Pod is active. The CL Wide Range Pod is activated and connected to the monitor.
	A CL transducer has moved away from the base station and is approaching the limit of the area of reach (min. 100 m/300 ft in line of sight). The US sound is replaced by an artificial QRS sound (like DECG). The DECG and MECG waves are no longer displayed.
	A CL transducer has moved away from the base station and is approaching the limit of the area of reach (ca. min. 100 m/300 ft in line of sight). The US sound is replaced by an artificial QRS sound (like DECG). The DECG and MECG waves are no longer displayed. The CL Wide Range Pod is activated and trying to connect to the monitor.

NOTE

A CL transducer is considered still active, even if it has an INOP condition (e.g. **cl US Disconnect**), until it is either deactivated by docking it at the base station, or until it is manually removed from the **Tele Info** window.

Pop-up Keys

Pop-Up key	Function
Remove	Selecting the Remove key deactivates and unassigns the selected active transducer or CL Pod and removes it from the list. This key is disabled if no active device is selected.
Find	Selecting the Find key pages the selected active CL transducer. This key is disabled if no active device is selected.

Messages

The fetal monitor issues messages to certain user interactions. For example, if the CL SpO₂ Pod is picked up from the base station to activate it, the monitor displays the message **cl SpO₂ Added** and the equipment label of the CL Pod.

Use Priority When Combining Cableless and Wired Measurements

CL Transducers versus wired transducers

CL transducers have priority over wired transducers. If an Avalon CL or Avalon CTS base station is connected to the fetal monitor, and both wired and CL transducers are connected to the monitor, all the wired transducers are disabled whenever one CL transducer is active. To switch back to using wired transducers, switch the base station to Standby mode, or redock all CL transducers at the base station, and continue monitoring with the wired transducers.

CL NBP and CL SpO₂ versus fetal monitor built-in NBP and SpO₂ measurements

CL NBP and CL SpO₂ have priority over the built-in NBP and SpO₂ measurements. If a CL NBP or CL SpO₂ Pod is activated, the corresponding built-in measurement of the fetal monitor is deactivated. To switch back to the built-in measurements, switch the base station to Standby mode, or redock the CL Pods at the base station.

CL F&M Pod versus wired transducers

The CL F&M Pod has priority over wired transducers. If a CL F&M Pod is active, all the wired transducers are disabled. To switch back to using wired transducers, switch the base station to Standby mode, or redock the CL F&M Pod at the base station.

About RF Signal Quality

If you cannot get sufficient ultrasound signal quality using the Avalon CTS base station, try repositioning the transducers, or switch to wired transducers.

Using an Avalon CL base station you should get a better signal by reducing the distance between the CL transducer and the base station.

Signal transmission can be disturbed if:

- the patient is out of range of the receiving area.
- there is interference from another, possibly stronger, RF signal (a broadcasting station, for instance).
- the patient is near material that absorbs electromagnetic waves (for example, metal-reinforced concrete, elevator doors) or the base station is in an enclosed metal rack.

CL Transducer Assignment

The CL transducers are assigned by simply docking them at the Avalon CL base station connected to the patient's fetal monitor.

Since twins and triplets can be monitored with the Avalon CL base station, it can be delivered with up to six CL transducers: one CL Toco⁺ MP, three CL US, and two CL ECG/IUP transducers. Up to four CL transducer can be assigned at one time to the Avalon CL base station. Four assigned CL transducers enable monitoring combinations such as 1 CL Toco⁺ MP transducer + 3 CL US transducers for monitoring triplets externally, or 1 CL Toco⁺ MP transducer + 2 CL US transducer + 1 CL ECG/IUP transducer for monitoring twins.

Three CL transducers can be docked and charged at the Avalon CL base station at a time. If a fourth transducer should be assigned to the Avalon CL base station:

- 1 Remove first the three docked CL transducers from the base station and place them on the patient.
- 2 Then dock the remaining fourth transducer at the base station and wait until the LED of the fourth transducer signals that it has communication with the base station.
- 3 Place the fourth CL transducer on the patient and check on the fetal monitor in the **Tele Info** window if the base station and the monitor have communication with all four transducers, and if their numerics are displayed on the screen of the fetal monitor.

CL Transducer Unassignment

The cableless transducer needs to be unassigned:

- before being used with another base station on another patient
- to allow cleaning before docking it back onto the base station (e.g. to replace it with a fully charged transducer of the same type)

There are three methods to do this:

- 1 Open the setup menu of the measurement e.g. **FHR1** by selecting the numeric on the screen.
- 2 Select **Remove** from the open setup menu.
- 3 A confirmation window opens with the prompt **Please Confirm** and **Device will be removed**.
- 4 Select the **Confirm** pop-up key. A message confirms **cl US has been removed**.

or

- 1 Open the **Tele Info** window.
- 2 Select the symbol of the cableless transducer you want to unassign, and select **Remove** from the pop-up menu.
- 3 A confirmation window opens with the prompt **Please Confirm** and **Device will be removed**.
- 4 Select **Confirm** the pop-up key. A message confirms **cl US has been removed**.

or

- 1 Redock the CL transducer at the base station.
- 2 Switch the base station to stand-by.
- 3 Remove the CL transducer; it is now unassigned.

NOTE

When a CL transducer is unassigned, all the measurements from this transducer are no longer monitored; e.g. if you unassign a CL Toco⁺MP transducer, the Toco measurement, maternal Pulse, or possibly also MECG or DECG are no longer monitored.

CL Pod Assignment

The CL Pods are assigned by simply docking them at the Avalon CL base station connected to the patient's fetal monitor.

CL Pod Unassignment

The CL Pods have to be unassigned:

- before assigning them to another base station or to another patient
- to allow cleaning, before docking them back onto the base station

There are three methods to do this:

- 1 Open the setup menu of the measurement e.g. by selecting the numeric on the screen.
- 2 Select **Remove** from the open setup menu.
- 3 A confirmation window opens with the prompt **Confirm** and **Device will be removed**.
- 4 Select the **Confirm** pop-up key. A message confirms **<cl Measurement> has been removed**.

or

- 1 Open the **Tele Info** window.
- 2 Select the symbol of the CL Pod, and select **Remove** from the pop-up menu.
- 3 A confirmation window opens with the prompt **Confirm** and **Device will be removed**.
- 4 Select the **Confirm** pop-up key. A message confirms **<cl Measurement> has been removed**.

or

- 1 Redock the CL Pod at the base station.
- 2 Switch the base station to stand-by.
- 3 Remove the CL Pod; it is now unassigned.

To unassign a IntelliVue CL Pod using its user interface, see the Cableless Measurement Instructions for Use.

NOTE

If you unassign a CL Pod, all the measurements from it are no longer monitored, or are monitored by a connected lesser prioritized sensor.

Preparing to Monitor Cablelessly

When monitoring cablelessly with the FM20/30/40/40 monitors, most of the same procedures apply as described in “[Preparing to Monitor](#)” on page 48. Additions and deviations applying to cableless devices and existing procedures are described here.

CL Transducers

- 1 To monitor cablelessly with the CL transducers, assign them at the base station as described in “[CL Transducer Assignment](#)” on page 98.
- 2 Place the CL transducers and the belt on the patient described in “[Fastening Belts and Transducers](#)” on page 50.
- 3 Check the measurements on the monitor, and if necessary, move the CL transducers until you have a good signal for all measurements.

IntelliVue CL Pods

- 1 To monitor cablelessly with the IntelliVue CL Pods, assign them at the base station as described in “[CL Pod Assignment](#)” on page 99.
- 2 Put the CL Pods in their cradles and place them on the patient as described in the IntelliVue Cableless Measurements Instructions for Use.

Applying the CL Fetal & Maternal Patch and Pod

WARNING

Do not use the CL Fetal & Maternal Pod and electrode patch for monitoring if:

- The skin on the abdomen of the patient has established erythema, lesions, infection, inflammation, or any kind of injuries at the applications site
 - The patient has a history of skin irritation, allergies, or hypersensitivity to adhesives
 - The patient carries multiple fetuses
 - The gestational age is less than 36 completed weeks. The measurement method is also only validated with patients in labor.
-

CAUTION

During handling, avoid close contact of the CL Fetal & Maternal Pod or the electrode patch to an implanted pacemaker or defibrillator.

At the Mother's Side

- 1 Have a new single-use electrode patch ready, and make sure that the pouch is still intact. Check the expiration date that is printed on the pouch.
- 2 Clean the application area on the abdomen of the patient. Use mild soap to wash any cream, oil, or gel from the abdomen. Make sure to thoroughly wipe the area dry afterwards, ideally using paper towels.
- 3 Take the electrode patch from its pouch.
- 4 Study the electrode patch Instructions for Use showing the correct placement of the electrode patch on the abdomen of the patient.
- 5 Remove the cover from the adhesive area under the central area of the patch. (Do not remove the cover from any of the five surrounding electrodes yet).
- 6 Verify the correct orientation of the patch. The “Philips/Monica” printed top electrode must point to the patient’s chest.
- 7 Place the central adhesive area of the patch over the patient’s umbilicus as shown in the patch Instructions for Use. Then press it down.

For patients with a displaced umbilicus:

Where the umbilicus has been displaced downwards, position the center of the patch along the midline, where it intersects the horizontal line passing over the iliac crests. Alternatively, estimate the mid-point between the fundus and symphysis pubis.

For very obese patients or patients with a large panniculus:

An alternative strategy is to position the patch along the midline such that the edge of the top electrode is placed 10-12 cm (4-5 in) below the fundus.

- 8 Lift up one of the four electrodes. Identify the small area of the skin where you will place the center of the electrode.
- 9 Use one piece of abrasive ECG skin preparation paper to prepare the patient's skin. Make three horizontal and three vertical strokes with the skin preparation paper. Focus the strokes on the small area of the skin where the conductive center of the electrode will be placed. Make deliberate but gentle strokes, lifting the finger after each stroke.

CAUTION

Do not use too much pressure with the abrasive skin preparation paper to avoid skin injury.



incorrect

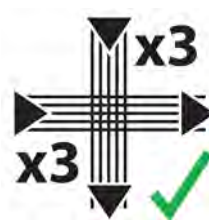

correct

- 10 Remove the protective cover from the electrode. Place the electrode on the prepared skin. Press it down firmly, but avoid pressing the central gel area of electrode.
- 11 Repeat the steps for the skin preparation and electrode placement for the other three electrodes.

- 12 For the last remaining electrode attached to the long flexible cable, identify the small area of skin to prepare, so that the center of this reference electrode will be positioned on the midline, approximately 6 cm (2.4 in) above the rim of the symphysis pubis.

For patients with a displaced umbilicus, very obese patients, or patients with a large panniculus:

Place the electrode on top of the panniculus approximating to the point 6 cm (2.4 in) vertically from the symphysis pubis. If during monitoring the aFHR signal quality is poor, reposition the electrode lower down on the abdomen to maximize the FHR signal, and consider placing the electrode under the panniculus just below the turn.

- 13 Prepare the skin like for the first four electrodes.
- 14 Remove the protective cover from the electrode. Then place the electrode on the prepared skin and press it down firmly, but avoid pressing the central gel area of electrode.
- 15 Assign a CL F&M Pod at the base station as described in [“CL Pod Assignment” on page 99](#).
- 16 Place the CL F&M Pod on the electrode patch.

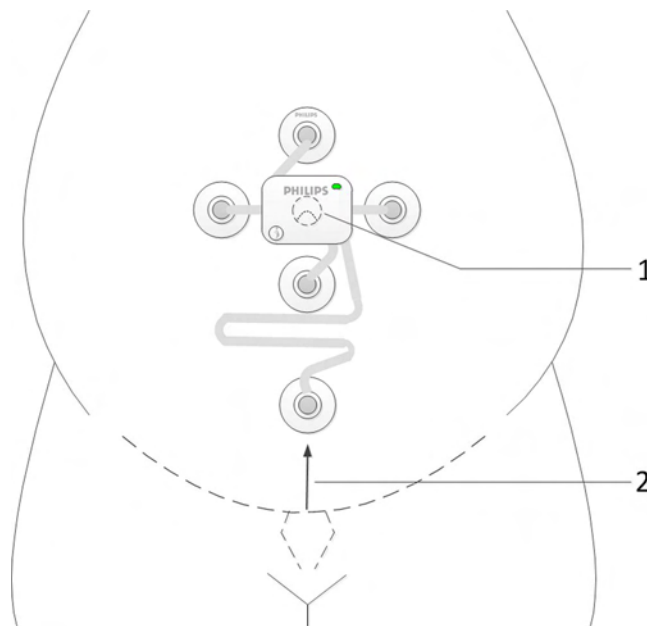

- 1 CL F&M Pod and electrode patch centered on the umbilicus
- 2 Placement of electrode 6 cm (2.4 in) above the rim of the symphysis pubis



At the Monitor

After you have placed the CL F&M Pod on the electrode patch, the **cl F&M Electrode Status** window opens at the monitor.

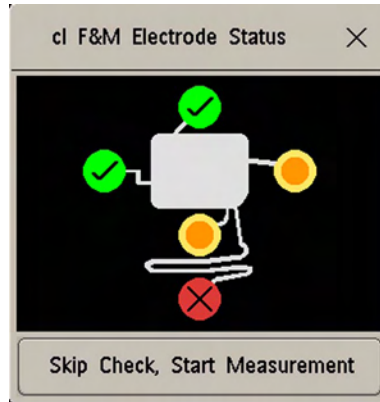

In the **cl F&M Electrode Status** window, the electrodes and their skin contact status are shown. The skin contact status indicates, whether the skin preparation at each electrode site was successful.



- 1 There are three methods to reopen a closed **cl F&M Electrode Status** window. Select:
 - The **clF&M Status** SmartKey (configurable)
 - **cl F&M Status** in the setup menu of one of the CL F&M parameters (for example, **Setup aFHR1**)
 - **cl F&M Status** from the **Main Setup** menu

Electrode Status	Description	What to Do
	The skin contact status is good.	When a good skin contact status is indicated for all five electrodes, the cl F&M Electrode Status window closes, and the measurement starts automatically.
	Further skin preparation may be required.	<ol style="list-style-type: none"> 1 Carefully remove the electrode from the skin. 2 Dry the skin. 3 Repeat the skin preparation procedure. 4 If the contact status cannot be improved, you can choose to skip the electrode status check by selecting the Skip Check, Start Measurement button in the cl F&M Electrode Status window. Measurement accuracy should not be affected, but fetal heart rate detection may be less sensitive.

4 Cableless Monitoring

Electrode Status	Description	What to Do
	Further skin preparation is required.	<ol style="list-style-type: none">1 Carefully remove the electrode from the skin.2 Dry the skin.3 Repeat the skin preparation procedure.4 It is not recommended to skip the electrode status check, if bad skin contact quality is persistently indicated for one or more electrodes.
	Electrode status is unknown.	This status may be shown temporarily, or in case of a patch malfunction, combined with an INOP message.

NOTE

If you have to repeat the skin preparation, or fix a loose electrode, ensure that enough wet gel remains in the conductive middle of the electrode during the reapplication of the electrode. Add additional fixation (any type of medical grade tape) to the pad in case the adhesive is compromised.

- If you cannot get a good measurement signal quality, use an alternative monitoring method.
- The electrode patch can remain applied for up to 48 hours. Remove the electrode patch, if there are signs of skin irritation.
- If you have to replace an electrode patch:
 - Gently remove the electrode patch from the abdomen of the patient.
 - Wipe the abdomen dry thoroughly.
 - Apply a new patch over exactly the same location. In this case, no further skin preparation is required.
- Monitoring with the CL F&M Pod and electrode patch can continue when the patient takes a shower. However, ensure that the CL F&M Pod remains on the electrode patch all the time, to keep the contacts of the electrode patch dry. The achievable maximum wireless operating range may be compromised when monitoring under a shower.
- The CL Fetal & Maternal Pod is not intended for underwater monitoring, for example in a bathtub.

CAUTION

Do not reuse a patch on another patient due to the risk of cross contamination.

After Monitoring

- 1 After monitoring is done, remove the CL F&M Pod from the electrode patch.
- 2 Clean and disinfect the CL F&M Pod, see [“Care and Cleaning” on page 261](#).
- 3 Dock the CL F&M Pod back at the base station.
- 4 Gently remove the electrode patch and the electrodes from the abdomen of the patient.
- 5 Dispose of the electrode patch.
- 6 Remove the residuals of the adhesive from the patient's skin.

CL Wide Range Pod

The CL Wide Range Pod extends the signal range for the cableless measurement devices worn by the ambulating patient.

- 1 Assign the CL Wide Range Pod at the base station as described in [“CL Pod Assignment” on page 99](#).
- 2 Activate the CL Wide Range Pod by taking it off the base station.
The CL Wide Range Pod connects itself over WLAN and LAN with the fetal monitor. As soon as the connection to the monitor is established, the CL Wide Range Pod takes over from the base station, and sends the signals from the cableless devices to the monitor. The connection status of the CL Wide Range Pod is shown on the monitor, see [“Cableless Status Indication” on page 95](#).
- 3 Hand the CL Wide Range Pod to the patient to carry with her, or optionally wearing it using the Mobile CL Transmitter Cradle (989803168881). The CL Wide Range Pod should be worn with its rear side facing the body.

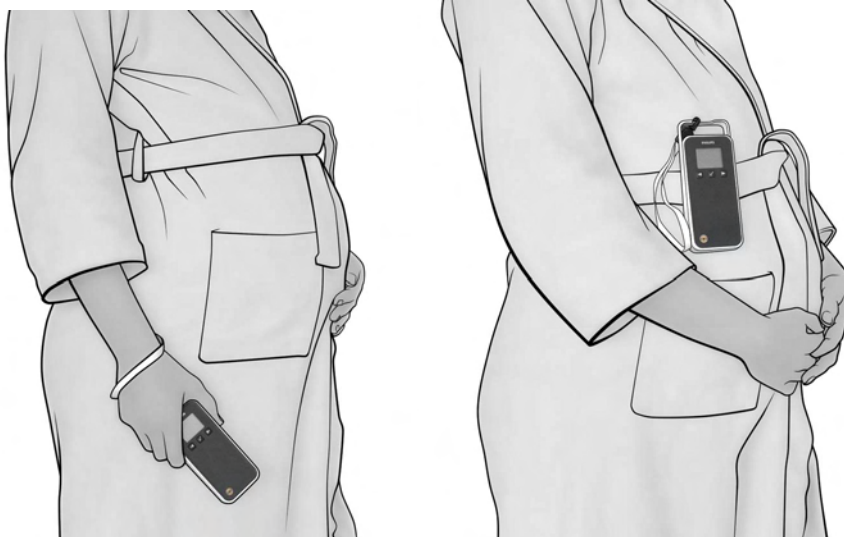

CL Wide Range Pod carried in hand, or CL Wide Range Pod worn with the belt clip (supporting loop and belt clip part of the optional Mobile CL Transmitter Cradle).

- 4 While the CL Wide Range Pod is active, cableless devices can still be assigned or unassigned at the base station dynamically to the patient. To hand the signal transfer back from the CL Wide Range Pod to the base station, redock the CL Wide Range Pod at the base station.

Battery Lifetime Management

The lifetime of a Lithium Ion battery depends on the frequency and duration of use.

CL Transducers

Battery replacement is recommended after 500 charge-discharge cycles, or if the battery is older than 4 years whatever is reached first. If the battery of a cableless transducer has aged and an exchange of the battery is highly recommended, a prompt message is displayed at the fetal monitor for ca. 60 seconds. The prompt is repeated whenever the **Tele Info** window is opened until the battery is replaced. The CL transducer battery allows for 10 hours of continuous operation.

Depending on the transducer type the following messages are displayed:

cl US battery has aged. Replacement strongly recommended

cl Toco battery has aged. Replacement strongly recommended

cl ECG/IUP batt has aged. Replacement strongly recommended

If you are getting this message, contact your service personnel so they can replace the CL transducer's battery.

CL F&M Pod

Pod replacement is recommended after 500 charge-discharge cycles, or if the battery is older than 4 years whatever is reached first. If the battery of a CL F&M Pod has aged and an exchange of the Pod is highly recommended, a prompt message is displayed at the fetal monitor for ca. 60 seconds. The prompt is repeated whenever the **Tele Info** window is opened. The CL F&M battery allows for 16 hours of continuous operation.

The following message is displayed:

cl F&M battery has aged. Replacement strongly recommended

If you are getting this message, contact your service personnel so they can replace the CL F&M Pod.

CL Wide Range Pod

Battery replacement is recommended after 500 charge-discharge cycles, or if the battery is older than 4 years whatever is reached first. If the battery of a CL Wide Range Pod has aged and an exchange of the battery is highly recommended, a prompt message is displayed at the fetal monitor for ca. 60 seconds. The prompt is repeated whenever the **Tele Info** window is opened until the battery is replaced. The CL Wide Range Pod battery allows for 4 hours of continuous operation.

The following message is displayed:

cl WRP battery has aged. Replacement strongly recommended

CL NBP and CL SpO₂ Pods

For battery charge-discharge cycles specification of the IntelliVue CL Pods (NBP and SpO₂), refer to the Service Guide of the Cableless Measurements.

Charge Cycle

The age of a lithium ion battery begins at the date of manufacture. The lithium batteries are designed for frequent recharging. A complete charging cycle is only reached and counted, when all recharging periods equal a 100% charge.

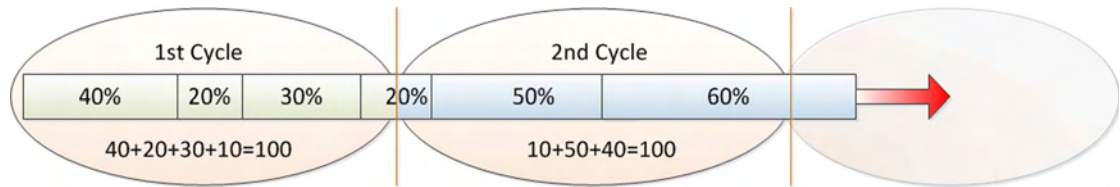

The date of manufacture and number of charge-discharge cycles can be printed out in a battery report.

Patient Transport Within the Hospital

During transport, the patient wearing the CL transducers can be transferred from one fetal monitor to another fetal monitor.

- 1 To stop monitoring, discharge the patient at the fetal monitor. Do not switch the CL base station to Standby.
Note: If you switch the CL base station to Standby after the discharge, the CL transducers only hold the assignment to the CL base station for **1 minute**.
- 2 Disconnect the CL base station from the fetal monitor.
- 3 The CL transducers hold the assignment to the CL base station for **30 minutes**. Transport the patient wearing the CL transducers with the disconnected CL base station to another fetal monitor.
- 4 Connect the CL base station to the other fetal monitor. The fetal monitors need to have the same software revisions, and the correct time and date settings.
- 5 Manually admit the patient to the fetal monitor, unless the patient is transferred to the new fetal monitor with the OB TraceVue/IntelliSpace Perinatal system.
- 6 Resume monitoring. Once the base station and the transducer are connected and assigned to the new monitor, the previous monitor can be switched off or to Standby.

Underwater Monitoring

Only the battery-operated CL transducers of the Avalon CL and Avalon CTS systems can be used to monitor under water. You can use them to monitor patients in a bathtub or shower. This does not apply to the IntelliVue CL SpO₂, CL NBP, and the CL Wide Range Pod, do not immerse the CL Pods into water.

The CL F&M Pod can be worn within the shower, if the Pod is securely placed on the electrode patch, so that the contacts cannot get wet. Radio transmission range of the CL F&M Pod may be reduced under a shower.

Cableless transmission distances are shorter when monitoring under water. A metal bathtub is likely to further reduce the operating range.

WARNING

Never immerse the base station in liquid. You must protect it against water sprays or splashes. Place the base station where there is no chance of contact with water, or falling into water or other liquids.

CAUTION

Avoid the use of pulsating water jets in the bath or shower while monitoring, as these can be misinterpreted as an incorrect (or totally artificial) heart rate.

Toco Baseline drift: When using transducers under warm water, the temperature increase causes a significant baseline change due to internal pressure increase. The depth under water at which the Toco transducer is used also has an effect on the Toco baseline, as the water pressure increases with depth. After immersion, allow one to two minutes for the pressure to stabilize, then adjust the Toco baseline (between contractions), and check it frequently.

When using the transducers underwater, the radio transmission range is reduced, and signal loss may occur.

Water-proof belts like M1562B are recommended for the cableless transducers when monitoring in water.

FM20/30 Battery Option

You can switch between battery-powered and mains-powered (AC) operation without interrupting monitoring.

The monitor is connected to the AC mains power via the external power supply.



NOTE

The battery option is not available for the FM40/FM50.

External Power Supply M8023A

The external power supply M8023A (option #E25) allows you to operate the fetal monitor from an AC (alternating current) power source of 100 V to 240 V ($\pm 10\%$) and 50/60 Hz ($\pm 5\%$). If this option is used, then the M8023A (option #E25) power supply is included for FM20/30.

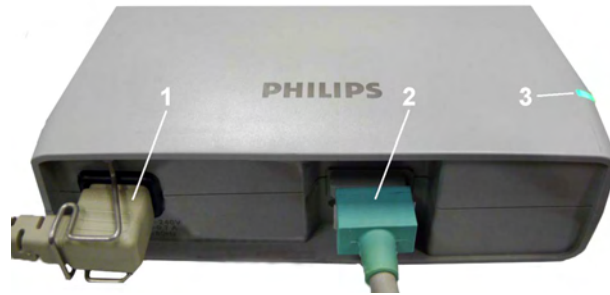

- 1 AC power cord, connected to AC mains socket
- 2 Measurement Link (MSL) cable, supplies the power to the monitor for operation and for battery charging
- 3 Power-on LED, the green light is on when the external power supply is connected to the AC mains

WARNING

- Always use the supplied power cord with the earthed mains plug to connect the external power supply M8023A (option #E25) to an earthed AC mains socket. Never adapt the mains plug from the power supply to fit an unearthed AC mains socket.
 - Do not use AC mains extension cords or multiple portable socket-outlets. If a multiple portable socket-outlet without an approved isolation transformer is used, the interruption of its protective earthing may result in enclosure leakage currents equal to the sum of the individual earth leakage currents, so exceeding allowable limits.
 - Do not connect any devices that are not supported as part of a system.
 - Any non-medical device placed and operated in the patient's vicinity must be powered with an approved isolation transformer that ensures mechanical fixing of the power cords and covering of any unused power outlets.
-

Using Batteries

The Lithium Ion batteries used in your monitor store a large amount of energy in a small package. This allows reliable battery-operated monitoring, but also requires care in use and handling of the batteries. Follow the instructions in this chapter and see the Service Guide for further details.

Battery Power Indicators

The battery LED and battery status information on the main screen, in combination with INOP messages and prompts, help you keep track of the battery power status. The indicators always show the remaining capacity in relation to the battery's actual maximum capacity, which may lessen as the battery ages. You can see the actual capacity in the **Battery Status** window.

Battery LED

The possible battery LED status on the right side of the monitor is described in the table below.

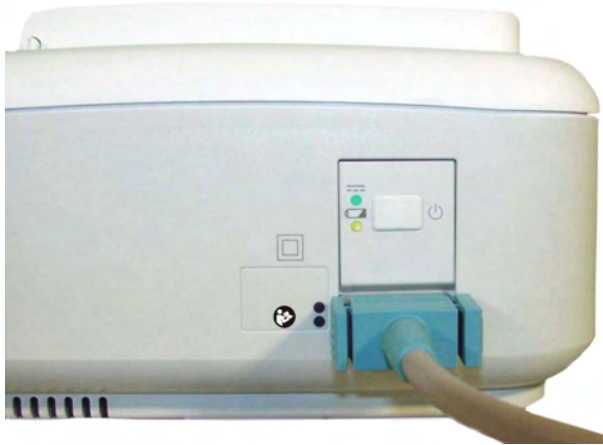

Battery LED Colors	If the monitor is connected to mains power, this means	If the monitor is running on battery power, this means
Green	Battery power is >90%	
Yellow	Battery charging (battery power < 90%)	
Red, flashing		Less than 10 minutes power remaining
Red, flashes intermittently	Battery or charger malfunction	Battery malfunction

Battery Status on the Main Screen





Battery status information is permanently displayed on all screens. It shows the status of the battery, with the battery power remaining, with an estimate of the monitoring time this represents.

Battery power gauge: This shows the remaining battery power. It is divided into sections, each representing 20% of the total power. If three sections are filled, as in this example, this indicates that 60% battery power remains. If no data is available from the battery, a question mark is shown in the gauge.

Monitoring Time Available: Below the battery power gauge a time is displayed. This is the estimated monitoring time available with the current battery power. Note that this time fluctuates depending on the system load (the display brightness, the recorder configuration, and how many measurements you carry out).

Battery malfunction symbols: Normal battery function is indicated by the battery power gauge, together with the remaining operating time, on the main screen. You are informed of problems or changes in the status of the battery by the battery status/malfunction indicator. This consists of a blank battery gauge containing a "!" symbol. If the symbol is red, this indicates a critical situation. You can check the specific cause of the problem by looking at the symbol(s) displayed in the **Battery Status** window.









Battery Status Indicator		Battery Malfunction Indicator	
	<p>Alternates with the battery gauge on the main screen.</p> <p>Check in the Battery Status window to see which status symbol is displayed to identify the cause.</p>		<p>The red exclamation mark flashes. Critical battery situation or malfunction. Check in the Battery Status window to see which malfunction indicator is displayed, or refer to the INOP, to identify the cause.</p>

Battery Status Window

- 1 To access the **Battery Status** window and its associated pop-up keys, select the battery status information on the screen, or select **Main Setup, Battery**.
 - **Capacity, remaining** tells you how much power is left in the battery.
 - **Capacity, fullCharge** tells you how much power the battery can hold when fully charged.
 - **TimeToEmpty** tells you approximately how long you can continue to use the monitor without an AC connection. The time span fluctuates depending on the system load (the display brightness and how many measurements you carry out), and the remaining capacity of the battery.
 - **TimeToFull** is shown in place of **TimeToEmpty** if the monitor is connected to a power supply, and tells you how much time is left until the battery is charged to 90%. If >10 hr is shown here, the battery may not charge completely when the monitor is in use.

Battery status/malfunction symbols: If a problem is detected with the battery, an INOP may be issued, and the following symbols are displayed in the **Battery Status** window, where they may be accompanied by a status message providing more details.

Symbols indicating critical situations are colored red.

Battery Status Symbols		Battery Malfunction Symbols	
	Battery is empty		(Red) incompatible battery
	Battery not charging as the temperature is above or below the specified range		(Red) battery malfunction
	Battery requires maintenance		(Red) battery has no power left
	Charging stopped to protect the battery		(Red) battery temperature too high
			(Red) battery is missing, insert battery

Checking Battery Charge

To check the charge status of a battery, refer to the battery power gauge on the screen, or open the **Battery Status** window.

When Battery Lifetime is Expired

When the battery is aged, either after 3 years from manufacturing date or after 500 charge-discharge cycles, it is recommended to replace the battery. To remind you of this, a message will appear in the **Battery Status** window. This message will only be displayed at the appropriate time when the date and time on the monitor is correct.

Optimizing Battery Performance

The performance of rechargeable batteries may deteriorate over time. Battery maintenance as recommended here can help to slow down this process.

Display Brightness Setting

- 1 In the **Main Setup** menu, select **User Interface, Brightness**, then **Optimum**. This selects a level of brightness suitable for most monitoring locations that uses less battery power than brighter settings.
- 2 Ensure that the current level of brightness is suitable for your monitoring location.

Charging the Battery

To charge the battery:

- 1 Connect the monitor to the external power supply (M8023A).
- 2 Charge the battery until it is full, the battery LED is green, and the battery power gauge is filled.

During high load of the monitor (usage of multiple measurements) the battery may not charge. To remedy this:

- reduce the load by removing measurements
- reduce the screen brightness or stop the recorder

Internal temperature conditions can also cause the battery to not charge. This is necessary to protect the battery from damage and does not indicate a malfunction. Keep the monitor at room temperature and move it away from heat sources or out of direct sunlight. The battery will resume charging when the temperature is within range again. The battery will charge more quickly if the monitor is switched off.

Conditioning the Battery

You must condition the battery when the "battery requires maintenance" symbol shows on the screen. Do not interrupt the charge or discharge cycle during conditioning.

CAUTION

Condition the battery with a monitor not currently in use. The monitor switches off automatically when there is no battery power left.

To condition the battery:

- 1 Charge the battery until it is completely full. Open the **Battery Status** window and check that the **Batt fully charged** message is displayed.
- 2 Disconnect the monitor from mains power, and let the monitor run until there is no battery power left and the monitor switches itself off.
- 3 Reconnect the monitor to mains power and charge the battery until it is full for use or charge to 50% for storage.

Battery Safety Information

WARNING

Use only **Philips batteries** part number M4605A. Use of a different battery may present a risk of fire or explosion.

Do not open batteries, or dispose of them in fire, or cause them to short circuit. They may ignite, explode, leak, or heat up, causing personal injury.

If battery leakage should occur, avoid contact with skin. Refer to qualified and authorized service personnel.

Dispose of used batteries promptly and in an environmentally responsible manner. Do not dispose of the battery in normal waste containers. Consult your hospital administrator to find out about local arrangements. Do not expose batteries to liquids.

Do not crush, drop, or puncture batteries - mechanical abuse can lead to internal damage and internal short circuits which may not be visible externally.

If a battery has been dropped or banged against a hard surface, whether damage is visible externally or not:

- discontinue use
- dispose of the battery in accordance with the disposal instructions above.

Keep batteries out of the reach of children.

CAUTION

Do not disassemble, heat above 100°C (212°F) or incinerate the batteries, to avoid the risk of fire and burns. Keep batteries out of the reach of children and in their original package until you are ready to use them.

If battery leakage should occur, use caution in removing the battery. Avoid contact with skin. Refer to qualified and authorized service personnel.

Do not install or use pre-damaged batteries.

Storing the Battery

WARNING

Remove the battery from the monitor when it is not used for a longer period of time, to avoid potential damage caused by battery leakage.

Batteries should be charged to a maximum of 50% for storage.

The battery will discharge over time if it is stored inside the monitor without AC power connection. The reported values for "remaining capacity" and "runtime" will become less accurate when the battery is stored in this way for a longer period of time (that is, several weeks).

Cableless Monitoring with FM20/30 Battery Option

The CL Pods can be used with the FM20/30 with battery option #E25. The CL Pods can be assigned and activated, but will not be charged. The only exception to this is the CL F&M Pod, which can also be charged.

The charging time of the CL transducers can take up to 6 hours if they are charged from an FM20/30 with battery option.

If you charge the CL transducers at an FM20/30 with battery option, be sure to remove all wired transducers from the fetal monitor. Leaving them connected to the fetal monitor can cause the CL transducers not to charge at all.

Patient Transport Within the Hospital

The FM20 and FM30 fetal monitor with battery option offer the possibility of continuous monitoring of a patient, while she is transported within the hospital.

- 1 Unplug the MSL connector at the fetal monitor. Or, in case an external power supply is mounted on a rollstand, unplug it from the AC Mains.
The fetal monitor is now operating on battery power.
- 2 Move the patient with the fetal monitor (on a cart) to the new location.
- 3 Reconnect the MSL connector at the fetal monitor or the external power supply to the AC Mains.

Alarms

The alarm information here applies to all measurements. Measurement-specific alarm information is contained in the sections on individual measurements.

The fetal monitor has two different types of alarm: patient alarms and INOPs.

Patient Alarms

Patient alarms are red and yellow alarms. A red alarm indicates high priority, such as a potentially life threatening situation (for example, SpO₂ below the desaturation alarm limit). A yellow alarm indicates a lower priority alarm (for example, a fetal heart rate alarm limit violation).

INOPs

INOPs are technical alarms. They indicate that the monitor cannot measure and therefore not detect critical conditions reliably. If an INOP interrupts monitoring and alarm detection (for example, **MECG Leads Off**), the monitor places a question mark in place of the measurement numeric and sounds an audible tone. INOPs without this tone indicate that there may be a problem with the reliability of the data, but that monitoring is not interrupted.

INOPs are cyan by default. The following INOPs can also be configured as red or yellow INOPs to provide a severity indication:

- **ECG Leads Off**
- **Battery Empty** (FM20/30, CL devices)
- **Cuff Overpress**
- **Cuff NotDeflated**
- **No Pulse**

Alarm Delays

There is a delay between a physiological event at the measurement site and the corresponding alarm indication at the monitor. This delay has two components:

- **The general measurement delay time is the time between the occurrence of the physiological event and when this event is represented by the displayed numerical values.** This delay depends on the algorithmic processing and on the measurement dependent averaging time.

- **The time between the displayed numerical values exceeding an alarm limit and the alarm indication on the monitor.** This delay is the sum of the alarm delay configured for the specific measurement plus the system alarm delay. The system alarm delay is the processing time the system needs for any alarm on the monitor to be indicated after the measurement has triggered the alarm. See the performance specifications in [“Specifications and Standards Compliance” on page 287](#) for the system alarm delay specification.

Multiple Alarms

If more than one alarm is active, the alarm messages are shown in the alarm status area in succession. An arrow symbol next to the alarm message informs you that more than one message is active.

The monitor sounds an audible indicator for the highest priority alarm. If more than one alarm condition is active in the same measurement, the monitor announces the most severe alarm condition first.

WARNING

Alarm systems of the monitor and those of the connected obstetrical information and surveillance system are independent and not synchronized.

Alarming is only available at the Avalon fetal monitor, not at the Cableless Measurement Devices, see the Instructions for Use for the IntelliVue Cableless Measurements.

If configured so, **SpO₂ No Pulse** will only be displayed in yellow or red (instead of cyan), when no other Pulse source is valid and is displayed instead of the Pulse from SpO₂.

Alarm Mode

You can configure the alarm mode for your fetal monitor. There are two possible modes:

- **All:** alarms and INOPs are enabled, with all audible and visual indicators active.
- **INOP only:** only INOPs are enabled, with audible and visual indication active.

WARNING

In **INOP only** mode, no fetal/maternal patient alarms are enabled or indicated.

The alarm status area for yellow and red alarms shows the **INOP only** indication in conjunction with the "Alarms Off" symbol. No individual measurement alarm limits or alarm off symbols are displayed. No fetal/maternal patient alarm settings are available in the setup menus.

Nurse Call Systems

If configured to do so, red, yellow, and cyan alarms are indicated on a nurse call system which is connected to the optional nurse call relay.

Visual Alarm Indicators

Alarm message: An alarm message appears in the alarm status area on the second line at the top of the screen indicating the source of the alarm. If more than one measurement is in an alarm condition, the message changes every two seconds, and has an arrow at the side. The background color of the alarm message matches the alarm priority: red for red alarms and red INOPs, yellow for yellow alarms and yellow INOPs, and cyan for INOPs. The asterisk symbols (*) beside the alarm message match the alarm priority: *** for red alarms, and ** for yellow alarms. INOPs are displayed without asterisks, but a red INOP has !!! three exclamation marks, and a yellow INOP has !! two exclamation marks before it.

Depending on how your monitor is configured, it may display alarm limit violation messages:

- in text form, for example **** FHR1 Low** or
- in numeric form, for example ****FHR1 94<110**, where the second number shows the currently set alarm limit, and the first number shows the value at which that alarm limit was violated by the widest margin.

Flashing numeric: The numeric of the measurement in alarm flashes.

Bright alarm limits: If the alarm was triggered by an alarm limit violation, the corresponding alarm limit on the monitor screen is shown more brightly.

Audible Alarm Indicators

The audible alarm indicators configured for your fetal monitor depend on which alarm standard applies in your hospital. Audible alarm indicator patterns are repeated until you acknowledge the alarm by switching it off or pausing it, or until the alarm condition ceases (if audible alarm indication is set to non-latching).

WARNING

Do not rely exclusively on the audible alarm system for fetal monitoring. Adjustment of alarm volume to a low level or off during monitoring may result in a dangerous situation. Remember that the most reliable method of fetal monitoring combines close personal surveillance with correct operation of monitoring equipment.

Alarm Tone Configuration

The audible alarm indicators of your monitor are configurable. In the monitor's Configuration Mode, you can:

- increase the alarm volume of unacknowledged alarms at regular intervals
- change the interval between alarm sounds (ISO/IEC Standard alarms only)
- change the base volume of the red and yellow alarm tones and the INOP tones
- change the alarm sound to suit the different alarm standards valid in different countries

Standard Philips Alarms

- Red alarms and red INOPs: a high pitched sound is repeated once a second.
- Two-star yellow alarms and yellow INOPs: a lower pitched sound is repeated every two seconds.
- One-star yellow alarms (short yellow alarms): the audible indicator is the same as for yellow alarms, but of shorter duration.
- Standard INOPs: an INOP tone is repeated every two seconds.

ISO/IEC Standard Audible Alarms

- Red alarms and red INOPs: a high pitched tone is repeated five times, followed by a configurable pause.
- Two-star yellow alarms and yellow INOPs: a lower pitched tone is repeated three times, followed by a configurable pause.
- One-star yellow alarms (short yellow alarms): the audible indicator is the same as for yellow alarms, but of shorter duration.
- Standard INOPs: a lower pitched tone is repeated twice, followed by a pause.

Changing the Alarm Tone Volume

The alarm volume symbol at the top right of the monitor screen gives you an indication of the current volume. To change the volume:

- 1 Select the volume symbol.



- 2 The volume scale pops up.

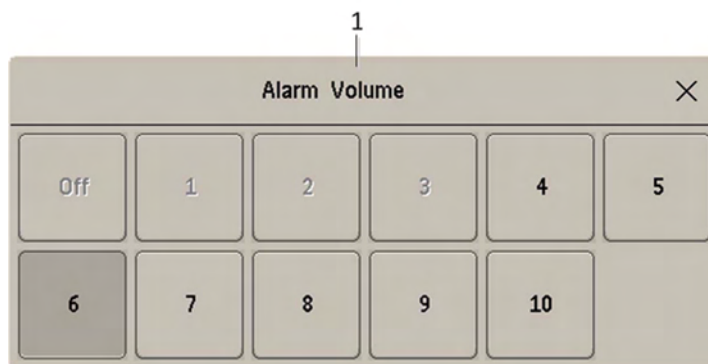

1 Alarm Volume

- 3 Select the required volume from the volume scale.

When the alarm volume is set to zero (**Off**), the alarm volume symbol shows this symbol:



If you switch the alarm volume off, you will not get any audible indication of alarm conditions.

Minimum Volume for Severe Yellow or Red INOPs

Severe yellow or red INOPs require action to ensure the well-being of the patient. Therefore the minimum volume for the INOP tone is set to at least alarm volume 8, irrespective of the current alarm volume setting. The INOP tone will sound even if the monitor alarm volume is set to zero.

The severe INOPs for which this applies are:

INOP	Factory Default	INOP tone
Battery Empty	cyan	severe (fetal monitor with battery option)
Battery Empty	cyan	severe (CL transducers and Pods)
Cuff Overpress	cyan	severe
Cuff NotDeflated	cyan	severe

Power Loss Tone

FM20/30 with
Battery
Option,
FM40/50

When power is lost - no power is available from the AC power source or from the battery - a beeper will sound. The tone can be silenced by pressing the On/Standby button.

Acknowledging Alarms

To acknowledge all active alarms and INOPs, select the **Silence** key. This switches off the audible alarm indicators.



- A checkmark beside the alarm message indicates that the alarm has been acknowledged.
- If the condition that triggered the alarm is still present after the alarm has been acknowledged, the alarm message stays on the screen with a checkmark symbol beside it.
- If the alarm condition is no longer present, all alarm indicators stop and the alarm is reset.
- Switching off the alarms for the measurement in alarm, or switching off the measurement itself, also stops alarm indication.

Acknowledging Disconnect INOPs

Acknowledging an INOP that results from a disconnected transducer, switches off the associated measurement.

Alarm Reminder

If **Alarm Reminder** is configured on for your monitor, you will get an audible reminder of alarm conditions that remain active after you have acknowledged the alarm. This reminder may take the form of a repetition of the alarm tone for a limited time, or an unlimited repetition of the alarm tone (this is the same as a new alarm). **Alarm Reminder** is available only for yellow and red alarms and INOPs and not for standard cyan INOPs.

In Configuration Mode, you can set the interval between silencing the alarm and sounding the reminder tone to one, two, or three minutes.

Pausing or Switching Off Alarms

If you want to temporarily prevent alarms from sounding, for example while you are moving a patient, you can pause alarms. Depending on your fetal monitor configuration, alarms are paused for one, two, or three minutes, or infinitely.

To view the alarm pause setting chosen for your unit:

- 1 Select **Main Setup, Alarms, Alarm Settings**.
- 2 Check the **Alarms Off** setting.

This setting can be changed in Configuration Mode.

There are some settings made in Configuration Mode that can affect the availability of the pause alarms functionality.

- The **Pause Alarms/Alarms Off** SmartKey can be removed from the screen to avoid unintentional switching off of alarms. In this case you can only pause alarms or switch alarms off permanently in the **Alarms** menu, under **Main Setup**.
- The **Pause Alarms/Alarms Off** SmartKey can be configured to pause or switch off red and yellow alarms, yellow alarms only, or not to function at all. If it is configured not to function, you cannot pause alarms or switch alarms off permanently at all.

When the alarms off priority is set to **Yellow Only**, the **Pause Alarms/Alarms Off** key becomes the **Pause Yellow/Yellow Al. Off**.

To Pause All Alarms

If you have configured alarms to be paused for one, two, or three minutes, the SmartKey is labeled **Pause Alarms**.

Select the **Pause Alarms** SmartKey to pause all alarms.



Or

- 1 Select **Main Setup**.
- 2 Select **Alarms**.
- 3 Select **Pause Alarms**.

To Switch All Alarms Off

You can switch alarms off permanently if your monitor is configured to allow infinite alarms pause, and the SmartKey is labeled **Alarms Off**.

Select the **Alarms Off** SmartKey.



Or

- 1 Select **Main Setup**.
- 2 Select **Alarms**.
- 3 Select **Alarms Off**.

While Alarms are Paused or Off

When red alarms are paused or off:

In the alarm field, the monitor displays the message **Al. Paused x:yy** or **Alarms Off**, together with the alarms paused symbol or the alarms off symbol.

When yellow alarms are paused or off:

In the alarm field, the monitor displays the message **YellowPaused x:yy** or **Yellow Alarms Off**, together with the alarms paused symbol or the alarms off symbol.

For red and yellow alarms:



Alarms Paused



Alarms Off

- No alarms are sounded and no alarm messages are shown.
- INOP messages are shown but no INOP tones are sounded.

The only exceptions are the INOPs **Cuff NotDeflated**, **Cuff Overpress**, and **Battery Empty** from the FM20/30 monitor with battery option.

These INOPs switch all alarms back on again, so that an INOP tone can be sounded. You must remove the INOP condition first, before you can switch off or pause the alarms again.

Restarting Paused Alarms

To manually switch on alarm indication again after a pause, select the SmartKey **Pause Alarms** (or **Alarms Off**) again.

Alarm indication starts again automatically after the pause period expires. If the monitor is configured to stay paused infinitely, you must select **Alarms Off** again to restart alarm indication.

Extending the Alarm Pause Time

If your monitor has the function extended alarm pause enabled, you can extend the alarm pause time. Use this to prevent alarms being indicated, for example, while you are washing a patient or carrying out a procedure. Only extend the alarm pause time when you are sure that clinical personnel are available to monitor the patient's condition closely.

To extend the alarm pause time to five or 10 minutes:

- 1 Select one of the alarm fields. This calls up the **Alarm Messages** window.
- 2 Select either the pop-up key **PauseAl. 5 min** or the pop-up key **PauseAl. 10 min**. Each time you select one of these pop-up keys, the Alarm Pause Time is reset to five or 10 minutes.

To Switch Individual Measurement Alarms On or Off

This applies to alarm mode **All**.



- 1 Select the measurement numeric to enter its setup menu.
- 2 Select **Alarms** to switch between **On** and **Off**.

The alarms off symbol is shown beside the measurement numeric.

Alarm Limits

The alarm limits you set determine the conditions that trigger yellow and red limit alarms.

WARNING

Be aware that the monitors in your care area may each have different alarm settings, to suit different scenarios. Always check that the alarm settings are appropriate before you start monitoring.

Viewing Individual Alarm Limits (Alarm Mode "All" Only)



You can usually see the alarm limits set for each measurement next to the measurement numeric on the main screen.

If your monitor is not configured to show the alarm limits next to the numeric, you can see them in the related measurement setup menu. Select the measurement numeric to enter the menu and check the limits.

Changing Alarm Limits

To change individual measurement alarm limits using the measurement's setup menu:

- 1 In the measurement's setup menu, select the alarm limit you want to change. This calls up a list of available values for the alarm limit.
- 2 Select a value from the list to adjust the alarm limit.

CAUTION

Set the alarm limits to a meaningful value for the individual patient. Setting the alarm limits to a too high or too low value may render the alarm function useless.

Extreme Alarm Limits for Heart Rate and Maternal Pulse

The extreme rate alarms, Extreme Tachy and Extreme Brady, generated by the active alarm source, either HR or Pulse, are set in Configuration Mode by adding a set value (the Δ value) to the high and low alarm limits.

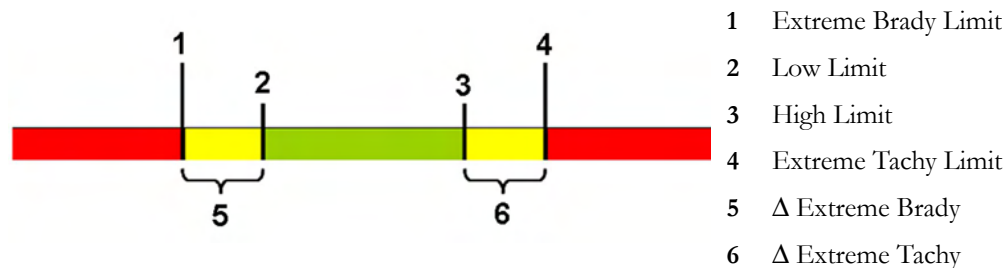

You need to know which value has been configured for your monitor. Changing the high and low alarm limits automatically changes the extreme alarm limits within the allowed range.

To see the extreme rate alarms set for your monitor, in the **Setup ECG** menu, see the menu items **Δ ExtrTachy** and **Δ ExtrBrady**.

Reviewing Alarms

To review the currently active alarms and INOPs, select any of the alarm status areas on the fetal monitor screen. The **Alarm Messages** window pops up. All alarms and INOPs are erased from the monitor's alarm history when you discharge a patient, or if you leave the Demonstration Mode.

Alarm Messages Window

The **Alarm Messages** window shows all the currently active alarms and INOPs in chronological order, beginning at the top with the most recent. INOPs are shown on the left hand side, and alarms are shown on the right hand side. Any active red alarms are shown first, followed by yellow alarms. Acknowledged alarms or INOPs are shown with the checkmark symbol.

The **Alarm Messages** window pop-up keys appear when the window is opened. Selecting the **Review Alarms** pop-up key opens the **Review Alarms** window.

Review Alarms Window

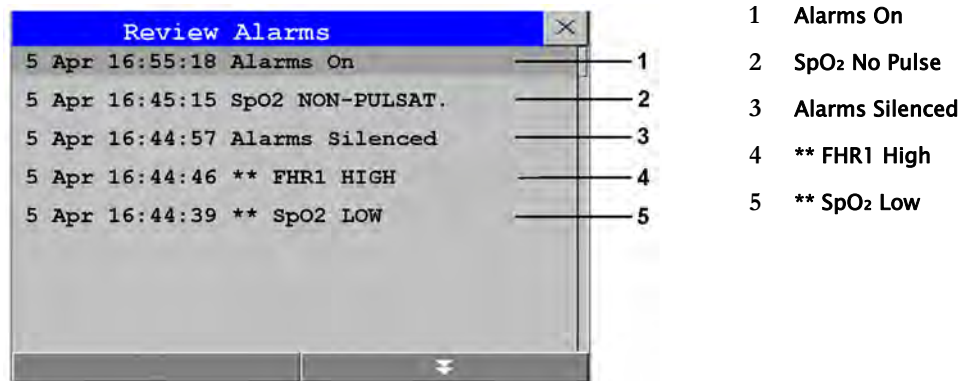

The **Review Alarms** window contains a list of up to 300 of the most recent alarms and INOPs with date and time information. If configured to do so, each alarm is shown with the alarm limit active when the alarm was triggered and the maximum value measured beyond this limit. The **Review Alarms** window also shows any changes made to the **Alarms On/Off** or **Alarms Silenced** status. Only the main alarms On/Off transitions are logged in the alarm history, and On/Off alarm transitions for individual measurements are not logged.

The information in the **Review Alarms** window is deleted when a patient is discharged.

The **Review Alarms** window pop-up keys appear when the window is opened. Selecting the **Active Alarms** pop-up key opens the **Alarm Messages** window.

Latching Alarms

The alarm latching setting for your monitor defines how the alarm indicators behave when you do not acknowledge them. When alarms are set to non-latching, their indicators end when the alarm condition ends. Switching alarm latching on means that visual and/or audible alarm indications are still displayed or announced by the monitor after the alarm condition ends. The indication lasts until you acknowledge the alarm.

Viewing the Alarm Latching Settings

To see the alarm latching setting for your monitor:

- 1 In the monitor's **Main Setup** menu, select **Alarms**.
- 2 Select **Alarm Settings**, and see the **Visual Latching** and **Audible Latching** settings.

This setting can be changed in Configuration Mode. You should be aware of the settings chosen for your unit. There are three possible choices each for visual and audible latching: **Red & Yellow**, **Red Only**, and **Off**. The audible latching configuration can never be configured to a higher level than that configured for the visual latching. In other words, the audible latching setting is always the same level, or lower, than the visual latching setting. For example, if visual latching is configured to **Red Only**, then audible latching can only be set to **Red Only** or **Off**. The following table shows the possible combinations for latching settings:

Possible Combinations for Alarm Latching Settings	
Visual Latching Setting	Audible Latching Setting
Red & Yellow	Red & Yellow
Red & Yellow	Red Only
Red & Yellow	Off
Red Only	Red Only
Red Only	Off
Off	Off

Alarm Latching Behavior

Alarm Condition		Red and Yellow Measurement Alarms		
Acknowledgment	Presence	Non-latching alarms	Visual and audible latching	Visual latching, audible non-latching
Alarm has not been acknowledged	Alarm condition still present	Alarm tone on Alarm message Flashing numerics	Alarm tone on Alarm message Flashing numerics	Alarm tone on Alarm message Flashing numerics
	Alarm condition no longer present	All audible and visual alarm indicators automatically stop	Alarm tone on Alarm message Flashing numerics	Audible alarm indicators automatically stop Alarm message Flashing numerics
Alarm has been acknowledged	Alarm condition still present	Alarm tone off Audible alarm reminder (if configured) Alarm message Flashing numerics	Alarm tone off Audible alarm reminder (if configured) Alarm message Flashing numerics	Alarm tone off Audible alarm reminder (if configured) Alarm message Flashing numerics
	Alarm condition no longer present	Audible and visual alarm indicators automatically stop	Audible and visual alarm indicators automatically stop	Audible and visual alarm indicators automatically stop

All INOPs except the "unplugged" INOPs are non-latching.

Testing Alarms

When you switch the fetal monitor on, a self test is started. You should hear a single tone. This indicates that the audible alarm indicators are functioning correctly. For further testing of individual measurement alarms, perform the measurement on yourself (for example SpO₂ or NBP) or use a simulator. Adjust alarm limits and check that appropriate alarm behavior is observed.

To test the functioning of visible and audible alarms, do the following:

- 1 Enable the alarm (Alarm Mode needs to be set to **All**, see the Configuration Guide).
- 2 Set the alarm limits.
- 3 Measure or simulate the parameter that is out of range, or signal loss.
- 4 Verify that the visible and audible alarms are working.

As an example, to test the FHR alarms:

- 1 Connect the US transducer to a fetal sensor socket.
- 2 Enable the FHR alarming (see [“Turning Alarms On or Off” on page 197](#)).

Set the high alarm limit and delay to 150 bpm and 60 seconds respectively, and the low alarm limit and delay to 110 bpm and 60 seconds respectively (see [“Changing Alarm Limits” on page 197](#)).

- 1 Generate a fetal heart rate of approximately 180 bpm (3 beats per second) for more than one minute.
- 2 Verify the functioning of the visible and audible alarms.

Alarm Behavior at Power On

If the monitor is switched off for longer than one minute and then switched on again, or after a loss of power lasting longer than one minute, the monitor can be configured to restore either the alarm settings from the monitor's **User Defaults**, or the most recently used alarm settings. When a patient is discharged, the **User Defaults** of the monitor are always restored independent of the setting. After any of these situations, ensure that the alarm settings are appropriate for your patient. If power is lost for less than one minute, the alarm settings prior to the power loss are restored.

- If **AlarmsOffAtStart** is enabled in Configuration Mode alarms will be initially paused or off the next time the monitor is switched on, depending on a set of related configuration settings, see the Configuration Guide.

Patient Alarms and INOPs

This chapter lists alarms and technical alarms (INOPs) for the fetal monitors irrespective of their priority.

Alarm Messages

Fetal alarms are identified by either "FHR", "dFHR", or aFHR. All other alarms without these identifiers refer to maternal parameters. Alarm messages can be configured with the **Enhanced** setting to give more information. These messages are shown additionally in the table below, with **xxx** for the measured value and **yyy** for the alarm limit concerned.

Alarm Message	From	Condition	Indication
** aFHR1 High ** aFHR2 High ** aFHR3 High ** aFHR1 xxx>yyy ** aFHR2 xxx>yyy ** aFHR3 xxx>yyy	FHR (CL F&M Pod)	The fetal heart rate obtained from the CL F&M Pod has risen above the high alarm limit. xxx denotes the highest measured value, and yyy is the high alarm limit.	Numeric flashes and high limit is highlighted, yellow alarm message, alarm tone.
** aFHR1 Low ** aFHR2 Low ** aFHR3 Low ** aFHR1 xxx<yyy ** aFHR2 xxx<yyy ** aFHR3 xxx<yyy	FHR (CL F&M Pod)	The fetal heart rate obtained from the CL F&M Pod has fallen below the low alarm limit. xxx denotes the lowest measured value, and yyy is the low alarm limit.	Numeric flashes and low limit is highlighted, yellow alarm message, alarm tone.
**aHR High **HR xxx<yyy	HR (CL F&M Pod)	The maternal heart rate obtained from the CL F&M Pod has risen above the high alarm limit. xxx denotes the highest measured value, and yyy is the high alarm limit.	Numeric flashes and high limit is highlighted, yellow alarm message, alarm tone.
**aHR Low **HR xxx>yyy	HR (CL F&M Pod)	The maternal heart rate obtained from the CL F&M Pod fallen below the low alarm limit. xxx denotes the lowest measured value, and yyy is the low alarm limit.	Numeric flashes and low limit is highlighted, yellow alarm message, alarm tone.

7 Patient Alarms and INOPs

Alarm Message	From	Condition	Indication
*** Brady (Pulse) ***Brady/P xxx<yyy	SpO ₂	The heart rate from the Pulse signal has fallen below the bradycardia limit. xxx denotes the lowest measured value; yyy is the bradycardia limit.	Numeric flashes, red alarm message, alarm tone.
*** Desat *** Desat xx < yy	SpO ₂	The SpO ₂ value has fallen below the desaturation alarm limit. xx denotes the lowest measured value, and yy is the desaturation limit.	Numeric flashes, red alarm message, alarm tone.
** dFHR1 High ** dFHR2 High ** dFHR3 High **dFHR1 xxx>yyy **dFHR2 xxx>yyy **dFHR3 xxx>yyy	FHR (DECG)	The fetal heart rate obtained from DECG has risen above the high alarm limit. xxx denotes the highest measured value, and yyy is the high alarm limit.	Numeric flashes and high limit is highlighted, yellow alarm message, alarm tone.
** dFHR1 Low ** dFHR2 Low ** dFHR3 Low **dFHR1 xxx<yyy **dFHR2 xxx<yyy **dFHR3 xxx<yyy	FHR (DECG)	The fetal heart rate obtained from DECG has fallen below the low alarm limit. xxx denotes the lowest measured value, and yyy is the low alarm limit.	Numeric flashes and low limit is highlighted, yellow alarm message, alarm tone.
*** Extreme Brady ***xBrady xxx<yyy	MECG	The maternal heart rate obtained from the maternal ECG has fallen below the extreme bradycardia limit. xxx denotes the lowest measured value, and yyy is the extreme bradycardia limit.	Numeric flashes, red alarm message, alarm tone.
*** Extreme Tachy ***xTachy xxx>yyy	MECG	The maternal heart rate obtained from the maternal ECG has risen above the extreme tachycardia limit. xxx denotes the highest measured value, and yy is the extreme tachycardia limit.	Numeric flashes, red alarm message, alarm tone.
** FHR1 High ** FHR2 High ** FHR3 High **FHR1 xxx>yyy **FHR2 xxx>yyy **FHR3 xxx>yyy	FHR (ultrasound)	The fetal heart rate obtained from ultrasound has risen above the high alarm limit. xxx denotes the highest measured value, and yyy is the high alarm limit.	Numeric flashes and high limit is highlighted, yellow alarm message, alarm tone.
** FHR1 Low ** FHR2 Low ** FHR3 Low **FHR1 xxx<yyy **FHR2 xxx<yyy **FHR3 xxx<yyy	FHR (ultrasound)	The fetal heart rate obtained from ultrasound has fallen below the low alarm limit. xxx denotes the lowest measured value, and yyy is the low alarm limit.	Numeric flashes and low limit is highlighted, yellow alarm message, alarm tone.

Alarm Message	From	Condition	Indication
** HR High **HR xxx>yyy	MECG	The maternal heart rate obtained from the maternal ECG has risen above the high alarm limit. xxx denotes the highest measured value, and yyy is the high alarm limit.	Numeric flashes and high limit is highlighted, yellow alarm message, alarm tone.
** HR Low **HR xxx<yyy	MECG	The maternal heart rate obtained from the maternal ECG has fallen below the low alarm limit. xxx denotes the lowest measured value, and yyy is the low alarm limit.	Numeric flashes and low limit is highlighted, yellow alarm message, alarm tone.
** <iTemp Label> High	iTemp	The temperature value has exceeded the high alarm limit.	Numeric flashes and high limit is highlighted, alarm tone.
** <iTemp Label> Low	iTemp	The temperature value has dropped below the alarm limit.	Numeric flashes and low limit is highlighted, alarm tone.
** NBP High ** NBPd High ** NBPm High	Noninvasive blood pressure	The measured noninvasive blood pressure value is above the high alarm limits s , d , or m after the label indicates whether the systolic, diastolic, or mean pressure has crossed the limit.	Numeric flashes and high limit is highlighted, yellow alarm message, alarm tone.
** NBP Low ** NBPd Low ** NBPm Low	Noninvasive blood pressure	The measured noninvasive blood pressure value is below the low alarm limits s , d , or m after the label indicates whether the systolic, diastolic, or mean pressure has crossed the limit.	Numeric flashes and low limit is highlighted, yellow alarm message, alarm tone.
** Pulse High	SpO ₂	The pulse rate has exceeded the high alarm limit.	Numeric flashes and high limit is highlighted, yellow alarm message, alarm tone.
** Pulse Low	SpO ₂	The pulse rate has dropped below the low alarm limit.	Numeric flashes and low limit is highlighted, yellow alarm message, alarm tone.
** SpO₂ High	SpO ₂	The arterial oxygen saturation has exceeded the high alarm limit.	Numeric flashes and high limit is highlighted, yellow alarm message, alarm tone.
** SpO₂ Low	SpO ₂	The arterial oxygen saturation has fallen below the low alarm limit.	Numeric flashes and low limit is highlighted, yellow alarm message, alarm tone.
*** Tachy (Pulse) ***Tachy/P xxx>yyy	SpO ₂	The heart rate from the Pulse signal has exceeded the tachycardia limit. xxx denotes the highest measured value, and yyy is the tachycardia limit.	Numeric flashes, red alarm message, alarm tone.

Technical Alarm Messages (INOPs)

Monitor INOPs

INOP Message	Indication	What to do
2nd Tele Incompatible	Monitor: INOP tone	One of the connected base stations is not supported by the monitor. Check software revisions.
Bus Master Incomp	Monitor: INOP tone	The Bus Master board or firmware is incompatible and cannot be used with this monitor software revision. Contact your service personnel.
Bus Master Malfunc	Monitor: INOP tone	There is a problem with the monitor's hardware. Contact your service personnel.
Check Flex Texts	Monitor: INOP tone	If this INOP appears, check the monitor and patient settings before you resume monitoring. If the settings are unexpected, there may be a problem with the monitor software. Contact your service personnel.
Check Keyboard	Monitor: INOP tone	Perform a visual and functional check of the keyboard. Contact your service personnel.
Check Monitor Func	Monitor: INOP tone	A potential internal problem with the monitor has been detected. Contact your service personnel.
Check Mouse	Monitor: INOP tone	Perform a visual and functional check of the mouse input device. Contact your service personnel.
Check OBR Config	Monitor: INOP tone	OBR (OB Radio) channel configuration is invalid or settings are not present. Check channel configuration and hardware option.
Check Settings	Monitor: INOP tone	If this INOP appears, check the monitor and patient settings before you resume monitoring. If the settings are unexpected, there may be a problem with the monitor software. Contact your service personnel.
Check TI Config	Monitor: INOP tone	If this INOP appears, the monitor can be used normally, except for the Trace Interpretation feature. Contact your service personnel.
Check Touch Input	Monitor: Display only	Perform a visual and functional check of the touch input device. Contact your service personnel.
Coincidence !! Coincidence	Monitor: INOP tone	The fetal heart rate(s) and maternal heart rate/pulse persistently coincide with another. (see " Cross-Channel Verification (CCV) " on page 159). The INOP tone has a configurable delay. The default setting is an instant INOP tone.
Internal.Comm.Malf	Monitor: INOP tone	There is a problem with I2C Bus communication in the monitor. Contact your service personnel.
NST Elapsed	Monitor: INOP tone (Message and tone only if Setup NST Timer, Notification is set to Alarm in Configuration Mode).	The time has expired for the NST timer. Clearing the timer clears the INOP.

INOP Message	Indication	What to do
OBR Interference	Monitor: INOP tone	OBR (OB Radio) communication is disturbed by other devices (not necessarily other wireless measurements). Contact service personnel.
Paper End	Monitor: INOP tone	The end of the paper pack is detected. Insert a new pack of paper.
Settings Malfunct	Monitor: INOP tone	The monitor cannot use the predefined settings for monitoring. Contact your service personnel.
Speaker Malfunct	Monitor: INOP tone	Contact your service personnel to check the speaker and the connection to the speaker.
SRR Incompatible	Monitor: INOP tone	The connected SRR (Short Range Radio) board or firmware cannot be used with this base station's software revision. Contact your service personnel.
SRR Interference	Monitor: INOP tone	The short range radio connection has interference from another device. Try using another channel.
SRR Invalid Chan	Monitor: INOP tone	The channel configuration of the Short Range Radio is invalid. Check channel and channel mask configuration.
SRR Malfunction	Monitor: INOP tone	Malfunction in the SRR (Short Range Radio) module(s). If the INOP persists, contact your service personnel.
Tele Incompatible	Monitor: INOP tone	The base station is not supported by the monitor. Check software revisions.
Tele Malfunction	Monitor: INOP tone	Malfunction of the connected base station. If the INOP persists contact your service personnel.
Tele Unplugged	Monitor: INOP tone	The base station has been disconnected from the monitor, while one or more CL devices were active. This INOP is only issued, if the setting Sensor Disconnect is No Auto Off , or the Alarm Mode is set to All .
Unsupported LAN	Monitor: INOP tone	There is a problem with the communication to the network and central monitoring is currently not possible. Check the connection. If the INOP persists, switch off the monitor and contact your service personnel.
User I/F Malfunct	Monitor: INOP tone	Perform a visual and functional check of all the monitor input devices. Contact your service personnel.

FM20/FM30 Battery INOPs

INOP Message	Indication	What to do
Batt Empty	Monitor: INOP tone Battery LED at the monitor flashes. During this INOP, alarms cannot be paused or switched off.	The estimated remaining battery-powered operating time is less than 10 minutes. Connect the monitor to AC immediately. If the condition persists and the monitor is not connected to mains power, this INOP is re-issued two minutes after you acknowledge it.
Batt Incompat	Monitor: INOP tone	The battery cannot be used with this monitor. Replace it with the correct battery.

7 Patient Alarms and INOPs

INOP Message	Indication	What to do
Batt Low	Monitor: INOP tone	The estimated battery-powered operating time remaining is less than 20 minutes.
Batt Malfunction	Monitor: INOP tone Battery at the monitor flashes. During this INOP, alarms cannot be paused or switched off unless the monitor is connected to mains power.	The monitor cannot determine the battery status. If the INOP persists, replace the faulty battery. If the condition persists and the monitor is not connected to mains power, this INOP is reissued two minutes after you acknowledge it.
Batt Missing	Monitor: INOP tone	No battery found in FM20/30. Contact your service personnel.
Charger Malfunc	Monitor: INOP tone Battery at the monitor may flash.	There is a problem with the battery charger in the monitor. Connect the monitor to mains power and contact your service personnel.
Check Batt Temp	Monitor: INOP tone	The temperature of the battery is too high. Check that the monitor is not exposed to heat.

Recorder INOPs

INOP Message	Indication	What to do
Check Paper	Monitor: display only Recorder: printout	Check that there is no paper jam, that the print drawer is properly shut, that the paper is loaded with the grid facing upwards, and that the correct Philips paper is being used.
FetRec Chk Config	Monitor: INOP tone	Recorder Speed and/or Scale Type settings are set to Unknown and need to be set to the correct values in Configuration Mode before the recorder can be operated.
FetRec Equip Malf	Monitor: INOP tone	There is a problem with the fetal recorder hardware. Contact your service personnel.
Printhead Overheat	Monitor: INOP tone	The printhead is too hot. The recorder stops, the recorder Start/ Stop key is disabled, and remains so until the printhead cools down sufficiently. Wait for the printhead to cool down, then press the recorder Start/ Stop key or the Silence key to clear the INOP.
Wrong Paper Scale	Monitor: INOP tone Recorder: printout	The grid scale of the paper in the monitor does not match the grid scale configured in the monitor. Make sure that you use the correct paper and scale for your institution: pre-printed: 30-240 in US and Canada, 50-210 in other geographies.

Wired Transducer INOPs

FHR (Ultrasound)

INOP Message	Indication	What to do
FHR1 Equip Malf FHR2 Equip Malf FHR3 Equip Malf	Monitor: INOP tone	There is a problem with the FHR hardware. Contact your service personnel.
FHR1 Signal Loss FHR2 Signal Loss FHR3 Signal Loss	Monitor: INOP tone INOP tone if Alarm Mode is set to All . No tone if Alarm Mode is set to INOP only .	The input signal quality is not sufficient to process the measurement. Adjust the position of the transducer to obtain a better signal.
FHR1 Unplugged FHR2 Unplugged FHR3 Unplugged	Monitor: INOP tone	Reconnect the FHR transducer to the monitor. Check if all connections are sound.

IUP

INOP Message	Indication	What to do
IUP Equip Malf	Monitor: INOP tone	There is a problem with the IUP hardware. Contact your service personnel.
IUP Unplugged	Monitor: INOP tone	Reconnect the IUP transducer to the monitor. Check if all connections are sound.

Toco

INOP Message	Indication	What to do
Pulse(Toco) Malf	Monitor: INOP tone Toco MP Maternal Pulse Measurement	There is a problem with the Toco MP transducer hardware. Contact your service personnel.
Toco Equip Malf	Monitor: INOP tone	There is a problem with the Toco hardware. Contact your service personnel.
Toco Unplugged	Monitor: INOP tone	Reconnect the Toco transducer to the monitor. Check if all connections are sound.

Cableless Transducer INOPs

INOP Message	Indication	What to do
cl US Batt Empty !!cl US Batt Empty !!!cl US BattEmpty cl Toco Batt Empty !!clToco BattEmpty !!!clTocoBattEmpty cl ECG/IUP Empty !!cl ECG/IUP Empty !!!clECG/IUP Empty	Monitor: INOP tone (configurable cyan, yellow, red) CL transducer: yellow tone and LED flashes red	The remaining monitoring time with this transducer is below 15 minutes. Charge battery.
cl US Batt Low cl Toco Batt Low cl ECG/IUP BattLow	Monitor: Display only CL transducer: LED flashes red	The remaining monitoring time with this transducer is below 30 minutes. Charge battery.
cl US Batt Malf cl Toco Batt Malf clECG/IUP BattMalf	Monitor: INOP tone CL transducer: tone and cyan LED	Malfunction of the battery system (charger circuit or battery) detected (e.g. persistent communication error, overvoltage, overcurrent, battery incompatible). Contact your service personnel.
cl US Check Temp cl Toco Chk Temp clECG/IUP Chk Temp	Monitor: INOP tone CL transducer: tone and cyan LED	The temperature of the transducer or its battery is critically high. If the transducer is docked on the base station, charging is interrupted. Check that the transducer is not covered and do not expose it to a heat source. Do not place the base station in a sunny window in a room without active air conditioning. The environment temperature to charge a transducer battery should not exceed 40°C/104°F. If the INOP persists, remove the transducer from patient and contact your service personnel.
cl US Disconnect cl Toco Disconnect cl ECG/IUP Disconn	Monitor: INOP tone CL transducer: tone and cyan LED	The cableless transducer has lost the connection to the monitor.
cl US Malfunction cl Toco Malf cl ECG/IUP Malf	Monitor: INOP tone Numeric is replaced by a -?- CL transducer: tone and cyan LED	Malfunction of the transducer. Contact your service personnel.

CL Fetal & Maternal Pod INOPs

INOP Message	Indication	What to do
aFHR1 Signal Loss aFHR2 Signal Loss aFHR3 Signal Loss	Monitor: INOP tone Numeric is replaced by a -?- INOP tone if Alarm Mode is set to All . No tone if Alarm Mode is set to INOP only .	The input signal quality is not sufficient to process the measurement. Reapply the electrodes of the electrode patch.
cl F&M Batt Empty !!cl F&M BattEmpty !!!cl F&M BatEmpty	Monitor: INOP tone (configurable cyan, yellow, red) CL F&M Pod: LED flashes red and yellow tone	The remaining monitoring time with the CL F&M Pod is below 15 minutes. Charge the battery.
cl F&M Batt Incmp	Monitor: INOP tone CL F&M Pod: cyan LED and INOP tone	The battery cannot be used with the CL F&M Pod. Contact your service personnel.
cl F&M Batt Low	Monitor: Display only CL F&M Pod: LED flashes red	The remaining monitoring time with the CL F&M Pod is below 30 minutes. Charge the battery.
cl F&M Batt Malf	Monitor: INOP tone CL F&M Pod: cyan LED	Malfunction of the battery system (charger circuit or battery) detected (for example: persistent communication error, overvoltage, overcurrent, battery incompatible). Contact your service personnel.
cl F&M Batt Temp	Monitor: INOP tone CL F&M Pod: cyan LED	The temperature of the CL F&M Pod or its battery is critically high. If the Pod is docked on the base station, charging is interrupted. Check that device is not covered. Do not expose device to heat sources. If INOP persists, remove the CL F&M Pod from patient. Contact your service personnel.
cl F&M Check Batt	Monitor: INOP tone CL F&M Pod: cyan LED	During charging, the battery's temperature is below 0°C (32°F), or above 45°C (113°F). During discharge, the battery's temperature is below -5°C (23°F), or above 55°C (131°F).
cl F&M Chk Chrg IF	Monitor: INOP tone CL F&M Pod: cyan LED	There is an over-, or undervoltage at the charger interface. Contact your service personnel.

7 Patient Alarms and INOPs

INOP Message	Indication	What to do
cl F&M Chk Electr.	Monitor: INOP tone without tone, if no CL F&M Pod parameter shows -?- CL F&M Pod: cyan LED	<ul style="list-style-type: none"> Not all electrodes have sufficient skin contact: Prepare the skin at the application site further with the abrasive pad. One or more leads between the measurement Pod and the electrode(s) is broken: Replace the electrode patch. Contact problem between the CL F&M Pod and the electrode patch: Reconnect the CL F&M Pod. <p>This INOP can only occur in monitoring mode after the initial electrode impedance check has occurred.</p>
cl F&M ChkSettings	Monitor: INOP tone CL F&M Pod: cyan LED	The CL F&M Pod settings are incompatible or corrupted. Check the settings. Contact your service personnel.
cl F&M Disconnect	Monitor: INOP tone CL F&M Pod: cyan LED	The CL F&M Pod has lost the connection to the monitor. Call the patient back to the monitor. If the CL F&M Pod has still no connection, remove it from the monitor, and reassign it. If it still does not have a connection, contact your service personnel.
cl F&M License Req	Monitor: INOP tone CL F&M Pod: cyan LED	There is no valid license registered. Contact your service personnel.
cl F&M Malfunction	Monitor: INOP tone CL F&M Pod: cyan LED	The CL F&M Pod malfunctions. Contact your service personnel.
cl F&M Patch Disc	Monitor: INOP tone CL F&M Pod: cyan LED	The CL F&M Pod has been disconnected from the electrode patch during monitoring mode. Reconnect the CL F&M Pod.
cl F&M Patch Malf	Monitor: INOP tone CL F&M Pod: cyan LED and INOP tone	The connected electrode patch cannot be identified. Either the electrode patch is malfunctioning, or the connection between the CL F&M Pod and the patch is defective.
cl F&M Remove	Monitor: INOP tone CL F&M Pod: cyan LED and INOP tone	The battery temperature is too high 60°C (140°F). Remove the CL F&M Pod immediately from the patient. Contact your service personnel.

CL Wide Range Pod INOPs

INOP Message	Indication	What to do
cl WRP Batt Empty !!cl WRP BattEmpty !!!cl WRP BatEmpty	Monitor: INOP tone (configurable cyan, yellow, red) CL Wide Range Pod: Display only, yellow tone	The remaining time with the CL Wide Range Pod is below 15 minutes. Charge the battery.
cl WRP Batt Incmp	Monitor: INOP tone CL Wide Range Pod: Display and INOP tone	The battery cannot be used with the CL Wide Range Pod. Contact your service personnel.
cl WRP Batt Low	Monitor: Display only CL Wide Range Pod: Display only	The remaining monitoring time with the CL Wide Range Pod is below 30 minutes. Charge the battery.
cl WRP Batt Malf	Monitor: INOP tone CL Wide Range Pod: Display only	Malfunction of the battery system (charger circuit or battery) detected (for example: persistent communication error, overvoltage, overcurrent, battery incompatible). Contact your service personnel.
cl WRP Batt Temp	Monitor: INOP tone CL Wide Range Pod: Display only	The temperature of the CL Wide Range Pod or its battery is critically high. If the Pod is docked on the base station, charging is interrupted. Check that device is not covered. Do not expose device to heat sources. If INOP persists, remove the CL Wide Range Pod from patient. Contact your service personnel.
cl WRP Chk Chrg IF	Monitor: INOP tone CL Wide Range Pod: Display and INOP tone	There is an over-, or undervoltage at the charger interface. Contact your service personnel.
cl WRP ChkSettings	Monitor: INOP tone CL Wide Range Pod: Display and INOP tone	The CL Wide Range Pod settings are incompatible or corrupted. Check the settings. Contact your service personnel.
cl WRP Disconnect	Monitor: INOP tone CL Wide Range Pod: Display and INOP tone	The CL Wide Range Pod has lost the WLAN/LAN connection for more than 10 seconds to the monitor.
cl WRP License Req	Monitor: INOP tone CL Wide Range Pod: Display and INOP tone	There is no valid license registered. Contact your service personnel.
cl WRP Malfunction	Monitor: INOP tone CL Wide Range Pod: Display and INOP tone	The CL Wide Range Pod is malfunctioning. Contact your service personnel.
cl WRP Remove	Monitor: INOP tone CL Wide Range Pod: Display and INOP tone	The battery temperature is too high 60°C (140°F). Remove the CL Wide Range Pod immediately from the patient. Contact your service personnel.

DECG and MECG INOPs

INOP Message	Indication	What to do
dFHR1 Equip Malf dFHR2 Equip Malf dFHR3 Equip Malf	Monitor: INOP tone	There is a problem with the DECG hardware. Contact your service personnel.
dFHR1 Leads Off !! dFHR1 Leads Off !!!dFHR1 Leads Off dFHR2 Leads Off !! dFHR2 Leads Off !!!dFHR2 Leads Off dFHR3 Leads Off !! dFHR3 Leads Off !!!dFHR3 Leads Off	Monitor: INOP tone Numeric is replaced by a -?-	One or more DECG lead is not attached. Make sure that all required leads are attached, and no electrodes have been displaced. Check all connections are sound, and that the leg plate attachment electrode is properly attached. If the INOP persists, try using another adapter cable, or leg plate attachment electrode. If the INOP persists, contact your service personnel.
dFHR1 Signal Loss dFHR2 Signal Loss dFHR3 Signal Loss	Monitor: INOP tone Numeric is replaced by a -?- INOP tone if Alarm Mode is set to All . No tone if Alarm Mode is set to INOP only .	The input signal quality is not sufficient to process the measurement. Reapply the fetal scalp electrode.
dFHR1 Unplugged dFHR2 Unplugged dFHR3 Unplugged	Monitor: INOP tone Numeric is replaced by a -?-	Reconnect the DECG transducer to the monitor. Check if all connections are sound.
MECG Equip Malf	Monitor: INOP tone	There is a problem with the MECG hardware. Contact your service personnel.
MECG Leads Off !! MECG Leads Off !!! MECG Leads Off	Monitor: INOP tone Numeric is replaced by a -?-	One or more MECG lead is not attached. Ensure that all required leads are attached, and no electrodes have been displaced. Check if all connections are sound. If the INOP persists, try using another adapter cable. If the INOP still persists, contact your service personnel.
MECG Unplugged	Monitor: INOP tone Numeric is replaced by a -?-	Reconnect the MECG transducer to the monitor. Check if all connections are sound.

NBP INOPs

INOP Message	Indication	What to do
Cuff Not Deflated !! Cuff Not Deflat !!!Cuff Not Deflat	Monitor: INOP tone (severe yellow/red INOP tone) Numeric is replaced by a -?- During this INOP, alarms cannot be paused or switched off.	Remove the cuff from the patient. Make sure that the tubing is not kinked or twisted. Try restarting the measurement. You can silence the INOP, but the INOP message remains visible until the next measurement is started, or the Stop All SmartKey is selected.
NBP Check Cuff	Monitor: INOP tone Numeric is replaced by a -?-	Check if cuff is connected to the NBP Pod and cuff is applied to the patient; check tubing and cuff for leakage. Try restarting the measurement. If the INOP occurs repeatedly, contact your service personnel. You can silence this INOP, but the INOP message remains visible until the next measurement is started or the Stop All SmartKey is selected. This INOP is issued, when the maximum time for inflation is exceeded, or when there is a significant change in inflation time between two successive measurements in auto and sequence mode.
NBP Cuff Overpress !! Cuff Overpress !!!Cuff Overpress	Monitor: INOP tone (severe yellow/red INOP tone) Numeric is replaced by a -?- During this INOP, alarms cannot be paused or switched off.	The cuff pressure exceeds the overpressure safety limits. Remove the cuff from the patient. Ensure that the tubing is not kinked or twisted, and that the correct patient category is selected. Try restarting the measurement. You can silence this INOP, but the INOP message remains visible until the next measurement is started, or the Stop All SmartKey is selected.
NBP Equip Malf	Monitor: INOP tone Numeric is replaced by a -?-	Remove the cuff from the patient. The noninvasive blood pressure hardware is faulty. Contact your service personnel. You can silence this INOP, but the INOP message remains visible until the next measurement is started, or the Stop All SmartKey is selected.

7 Patient Alarms and INOPs

INOP Message	Indication	What to do
NBP Interrupted	Monitor: INOP tone Numeric is replaced by a -?-	Check the tubing and cuff for leakages or kinks. Check that you are using the correct cuff size and placement, and that the correct patient category is selected. Try restarting the measurement. If the INOP occurs repeatedly, contact your service personnel. You can silence this INOP, but the INOP message remains visible until the next measurement is started, or the Stop All SmartKey is selected. This INOP arises when the measurement needed longer than the maximum time allowed for inflation, deflation, or the total measurement.
NBP Measure Failed	Monitor: INOP tone Numeric is replaced by a -?-	Check that you are using the correct cuff size and placement, and that the correct patient category is selected. Try restarting the measurement. You can silence this INOP, but the INOP message remains visible until the next measurement is started, or the Stop All SmartKey is selected. Check the condition and suitability of the patient for noninvasive blood pressure monitoring. Use another cuff to continue measuring.

CL NBP Pod INOPs

INOP Message	Indication	What to do
Check Charger I/F	Monitor: INOP tone CL NBP Pod: display message	Overvoltage or undervoltage detected at the charger interface. Clean contacts of charger interface at Cableless Measurement Device and charging station. If the INOP persists, contact your service personnel.
cl NBP Batt Empty !!cl NBP BattEmpty !!!cl NBP BatEmpty	Monitor: INOP tone (configurable cyan, yellow, red) CL NBP Pod: display message, yellow tone	The remaining battery time of the CL NBP Pod is below 30 minutes. Charge the battery.
cl NBP Batt Incomp	Monitor: INOP tone CL NBP Pod: display message	The battery in use with the CL NBP Pod is incompatible. Replace it with one approved for use with the CL NBP Pod.
cl NBP Batt Low	Monitor: INOP tone CL NBP Pod: display message	The remaining battery time of the CL NBP Pod is below 2 hours.
cl NBP Batt Malf	Monitor: INOP tone CL NBP Pod: display message	There is a malfunction in the CL NBP Pod's battery system. Contact your service personnel.

INOP Message	Indication	What to do
cl NBP Batt Temp	Monitor: INOP tone CL NBP Pod: display message	The temperature of the battery in the CL NBP Pod is critically high. Check that the Pod is not covered or exposed to a heat source. If the INOP persists, remove the Pod from the patient, and contact your service personnel.
cl NBP Check Batt	Monitor: INOP tone CL NBP Pod: display message	The battery in the CL NBP Pod is nearing the end of its useful life. Only 50 charge-discharge cycles remain. Contact your service personnel to replace the battery.
cl NBP ChkSettings	Monitor: INOP tone CL NBP Pod: display message	If this INOP appears and an INOP tone sounds, check the Cableless Measurement Device and patient settings before you resume making measurements. If the settings are unexpected, there may be a problem with the Cableless Measurement Device software. Contact your service personnel. If this INOP is acknowledged at the Cableless Measurement Device, it is cleared. If it is silenced remotely, only the tone is cleared.
cl NBP Disconnect	Monitor: INOP tone and display CL NBP Pod: display message	The CL NBP Pod has lost the SRR connection to the monitor.
cl NBP No Cradle	Monitor: INOP tone CL NBP Pod: display message	The CL NBP Pod is not in the cradle. You can silence this INOP, but the INOP message remains visible until the CL NBP Pod is inserted into the cradle, and the next measurement is started, or the Stop All SmartKey is selected.
cl NBP Remove	Monitor: INOP tone CL NBP Pod: display message	The temperature of the battery in the CL NBP Pod is too high. Remove the Cableless Measurement Device from the patient and contact service personnel.
cl NBP Serv Batt	Monitor: INOP tone CL NBP Pod: display message	The battery in the CL NBP Pod has reached the end of its useful life. It can no longer be charged. Contact your service personnel to replace the battery.
NBP Check Cuff	Monitor: INOP tone CL NBP Pod: display message	Check if cuff is connected to the NBP Pod and cuff is applied to the patient; check tubing and cuff for leakage. Try restarting the measurement. If the INOP occurs repeatedly, contact your service personnel. You can silence this INOP, but the INOP message remains visible until the next measurement is started or the Stop All SmartKey is selected. This INOP arises when the maximum time for inflation is exceeded or when there is a significant change in inflation time between two successive measurements in auto and sequence mode.

SpO₂ INOPs

INOP Message	Indication	What to do
SpO₂ Equip Malf	Monitor: INOP tone	There is a problem with the SpO ₂ hardware. Contact your service personnel.
SpO₂ Erratic	Monitor: INOP tone Numeric is replaced by a -?-	Check the sensor placement. Try another adapter cable and sensor. If the INOP persists, contact your service personnel.
SpO₂ Extd.Update	Monitor: display only Numeric is replaced by a -?-	The update period of displayed values is extended due to a noninvasive blood pressure measurement on the same limb, or an excessively noisy signal.
SpO₂ Low Perf	Monitor: display only Numeric is replaced by a -?-	Accuracy may be compromised due to very low perfusion. Stimulate circulation at sensor site. If INOP persists, change the measurement site.
SpO₂ No Pulse !! <SpO₂ Label> No Pulse !!!<SpO₂ Label> No Pulse	Monitor: INOP tone Numeric is replaced by a -?-	Check the perfusion at measurement site. If necessary, stimulate circulation or change measurement site. If the INOP is due to noninvasive blood pressure measurement on the same limb, wait until the measurement is finished.
SpO₂ No Sensor	Monitor: INOP tone Numeric is replaced by a -?-	Ensure the SpO ₂ sensor is connected. If the INOP persists, try another adapter cable and sensor. If you silence this INOP, the measurement will be switched off.
SpO₂ NoisySignal	Monitor: INOP tone Numeric is replaced by a -?-	Excessive patient movement or electrical interference is causing irregular pulse patterns. Try to reduce patient movement, or to relieve the cable strain on the sensor.
SpO₂ Poor Signal	Monitor: display only Numeric is replaced by a -?-	The signal condition of the SpO ₂ measurement is poor and measurement accuracy may be compromised.
SpO₂ Pulse?	Monitor: INOP tone Numeric is replaced by a -?-	The detectable pulsations of the SpO ₂ signal are outside the specified pulse rate range.
SpO₂ Searching	Monitor: display only Numeric unavailable	SpO ₂ is analyzing the patient signal to derive Pulse, and SpO ₂ values. Please wait until the search analysis is complete.
SpO₂ Sensor Malf	Monitor: INOP tone Numeric unavailable	The SpO ₂ sensor or adapter cable is faulty. Try another adapter cable and sensor. If the INOP persists, contact your service personnel.
SpO₂ Sensor Off	Monitor: INOP tone Numeric unavailable	The SpO ₂ sensor is not properly applied to the patient. Apply the sensor following the instructions supplied by the manufacturer.
SpO₂ Unkn.Sensor	Monitor: display only Numeric is replaced by a -?-	The connected sensor or adapter cable is not supported by the SpO ₂ measurement. Use only specified sensors and cables.

INOP Message	Indication	What to do
SpO₂ Upgrade	Monitor: display only Numeric unavailable	The SpO ₂ measurement is currently in upgrade mode. Monitoring is not possible in this mode.
SpO₂ Interference	Monitor: INOP tone Numeric is replaced by a -?-	There is too much interference caused by a high level of ambient light, and/or electrical interference. Cover the sensor to minimize ambient light. If the INOP persists, ensure that the sensor cable is not damaged, or positioned too close to power cables.

CL SpO₂ Pod INOPs

INOP Message	Indication	What to do
Check Charger I/F	Monitor: INOP tone CL SpO ₂ Pod: display message	Overvoltage or undervoltage detected at the charger interface. Clean contacts of charger interface at Cableless Measurement Device and charging station. If the INOP persists, contact your service personnel.
cl SpO₂ Batt Empty !!cl SpO₂ BatEmpty !!!cl SpO₂ BtEmpty	Monitor: INOP tone (configurable cyan, yellow, red) CL SpO ₂ Pod: display message, yellow tone	The remaining battery time of the CL SpO ₂ Pod is below 30 minutes. Charge the battery.
cl SpO₂ Batt Incmp	Monitor: INOP tone CL SpO ₂ Pod: display message	The battery in use with the CL SpO ₂ Pod is incompatible. Replace it with one approved for use with the CL SpO ₂ Pod.
cl SpO₂ Batt Low	Monitor: INOP tone CL SpO ₂ Pod: display message	The remaining battery time of the CL SpO ₂ Pod is below 2 hours.
cl SpO₂ Batt Malf	Monitor: INOP tone CL SpO ₂ Pod: display message	There is a malfunction in the CL SpO ₂ Pod's battery system. Contact your service personnel.
cl SpO₂ Batt Temp	Monitor: INOP tone CL SpO ₂ Pod: display message	The temperature of the battery in the CL SpO ₂ Pod is critically high. Check that the Pod is not covered or exposed to a heat source. If the INOP persists, remove the CL Pod from the patient, and contact your service personnel.
cl SpO₂ Check Batt	Monitor: INOP tone CL SpO ₂ Pod: display message	The battery in the CL SpO ₂ Pod is nearing the end of its useful life. Only 50 charge-discharge cycles remain. Contact your service personnel to replace the battery.

7 Patient Alarms and INOPs

INOP Message	Indication	What to do
cl SpO₂ Chk Sett	Monitor: INOP tone CL SpO ₂ Pod: display message	If this INOP appears and an INOP tone sounds, check the Cableless Measurement Device and patient settings before you resume making measurements. If the settings are unexpected, there may be a problem with the Cableless Measurement Device software. Contact your service personnel. If this INOP is acknowledged at the Cableless Measurement Device, it is cleared. If it is silenced remotely, only the tone is cleared.
cl SpO₂ Disconnect	Monitor: INOP tone CL SpO ₂ Pod: INOP tone and display message	The CL SpO ₂ Pod has lost the SRR connection to the monitor.
cl SpO₂ No Cradle	Monitor: INOP tone CL SpO ₂ Pod: display message	The CL SpO ₂ Pod is not in its cradle.
cl SpO₂ Remove	Monitor: INOP tone CL SpO ₂ Pod: display message	The temperature of the battery in the CL SpO ₂ Pod is too high. Remove the CL SpO ₂ Pod from the patient and contact service personnel.
cl SpO₂ Serv Batt	Monitor: INOP tone CL SpO ₂ Pod: display message	The battery in the CL SpO ₂ Pod has reached the end of its useful life. It can no longer be charged. Contact your service personnel to replace the battery.

Tympanic Temperature INOPs

INOP Message	Indication	What to do
<iTemp Label> CalRequired	Monitor: INOP tone	The thermometer requires calibration. Contact your service personnel.
<iTemp Label> Incompat.	Monitor: INOP tone Numeric is replaced by a -?-	The thermometer firmware is not supported by the monitor software.
<iTemp Label> Malfunction	Monitor: INOP tone Numeric is replaced by a -?-	The thermometer or the interface board is defective. Check the thermometer on another monitor - if the same INOP occurs, replace the thermometer. If not, connect another thermometer to this monitor. If the problem persists, the interface board has a problem. Contact your service personnel.
<iTemp Label> Meas Failed	Monitor: INOP tone Numeric is replaced by a -?-	The ambient temperature is out of range. If the ambient temperature is within the valid range, check the thermometer. Try picking up a new probe cover. If the problem persists replace the thermometer and contact your service personnel.
<iTemp Label> Overrange	Monitor: INOP tone Numeric is replaced by a -?-	The measured temperature is out of range. If the temperature is within the valid range, check with another thermometer.

Admitting and Discharging

The fetal monitor can store basic patient demographic information used to identify patients.

Admit/Discharge on the Monitor

This section describes how you admit and discharge patients when using the monitor as a stand-alone device (that is, when not used with an obstetrical information and surveillance system such as OB TraceVue/IntelliSpace Perinatal).

Admitting a Patient

The fetal monitor displays physiological data as soon as a patient is connected. This lets you monitor a patient who is not yet admitted. It is however important to admit patients properly so that you can identify your patient on recordings.

Use the **Patient Demographics** window and its associated pop-up keys to admit and discharge patients.

To admit a patient:

- 1 Select the patient name field or select the **Patient Demogr.** SmartKey to open the **Patient Demographics** window.
- 2 Clear any previous patient data by selecting **Dischrg Patient** and then **Confirm**.
If you do not discharge the previous patient, you will not be able to distinguish data from the previous and current patients on the recording.
- 3 Select **Admit Patient**.
- 4 Enter the patient information: select each field and use the on-screen keyboard.
If a conventional keyboard is connected to the monitor, you can use this to enter patient information:
 - **Last Name:** Enter the patient's last name (family name), for example **Doe**.
 - **First Name:** Enter the patient's first name, for example **Jane**.
 - **MRN:** Enter the patient's medical record number (MRN), for example **12345678**. Depending on your configuration this field may be labeled differently e.g. **Record ID**, **Lifetime ID**, **Account Number**, **Serial Number**, or **SSN**.
 - **Gestational Age:** Enter the gestational age of the pregnancy. Enter one numeric for the week (0-50) and one numeric for the day (0-6).
 - **Date of Birth:** Enter the patient's date of birth.
- 5 Select **Confirm**. The patient status changes to admitted. If the recorder is running, the recorder stops and immediately restarts to annotate the new patient data.

Quick Admitting a Patient

Use **Quick Admit** to quickly admit a patient using only a limited set of demographic data.

- 1 Select the **Quick Admit** SmartKey.
- 2 Enter the required data (ID fields or last name depending on configuration) with the keyboard or a barcode scanner.
- 3 Select **Enter**.
- 4 In the confirmation window, select **Confirm** to stop monitoring for the previous patient.

Complete the rest of the demographic details as soon as possible to fully identify the patient on the network, on the monitor, and on printed reports. To complete the details, open the **Patient Demographics** window and complete all required fields.

Editing Patient Information

To edit the patient information after a patient has been admitted, select the patient name field on the main screen of the fetal monitor to open the **Patient Demographics** window, and enter the required changes.

Discharging a Patient

You should always perform a discharge even if your previous patient was not admitted. A discharge:

- clears the information in the **Patient Demographics** window.
- resets all monitor settings to the settings defined in the **User Defaults**.
- advances the paper automatically if the recorder is running.
- stops the fetal recorder.

When a patient is discharged from the monitor, all patient demographic data is deleted (trace data is not affected).

Depending on your configuration, monitoring for a patient may end automatically when the fetal monitor has been powered off, or is in Standby mode for a set time.

To discharge a patient:

- 1 Select the patient name field to display the **Patient Demographics** window and associated pop-up keys.
- 2 Select the pop-up key for **Discharge Patient**.
- 3 Select **Confirm** to discharge the patient.

CAUTION

In order to ensure that the settings are reset to **User Defaults** for a new patient, always discharge the previous patient from the fetal monitor.

NOTE

In order to ensure a continuous record, it is recommended to discharge the patient at the monitor before performing a new patient admission in OB TraceVue/IntelliSpace Perinatal.

New Patient Check

The fetal monitor can be configured to ask you in certain situations:

- after a specified power-off period
- after a specified standby period

whether a new patient is now being monitored. The pop-up window is entitled **Is this a New Patient?**. The monitor offers a **Yes** key, to discharge the previous patient and begin monitoring a new patient, and a **No** key, to continue monitoring with the current patient data and settings.

The time periods for the two conditions can be configured independently.

OB TraceVue/IntelliSpace Perinatal

When the monitor is connected to an OB TraceVue/IntelliSpace Perinatal system over a LAN connection, it has the control over patient demographic data. All patient and location-related data visible on the monitor is set, overwritten, or updated by the OB TraceVue/IntelliSpace Perinatal system. In the **Patient Demographics** window, a padlock symbol before the patient identification fields indicates the locked state. The locked state prevents the reuse of the monitor for another patient, until the current patient is discharged, and the monitor is freed through the OB TraceVue/IntelliSpace Perinatal system. Locked fields remain locked when system connectivity is lost, until the monitor is freed by discharging the patient. See the OB TraceVue/IntelliSpace Perinatal Instructions for Use for details.

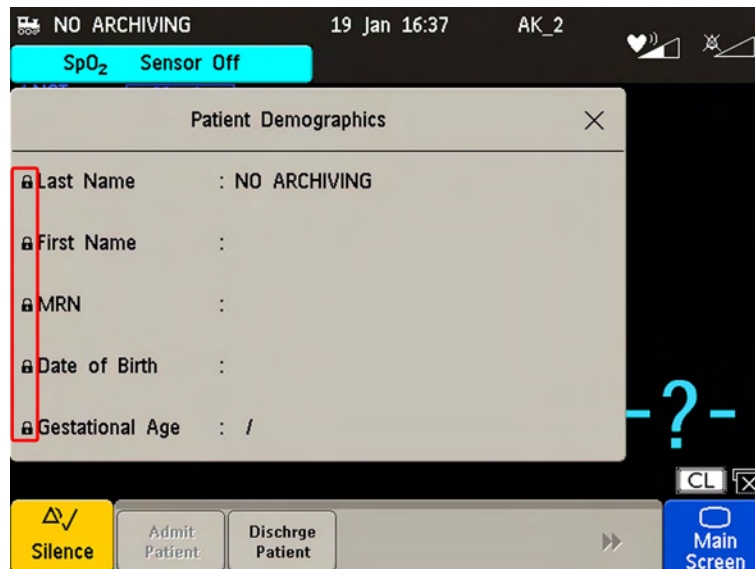

Transferring a Patient

When you are transferring a patient from one bed to another, both the monitor from which you are transferring her and the monitor to which you are transferring her must be switched on and connected to the OB TraceVue/IntelliSpace Perinatal network during the patient transfer.

OB TraceVue/IntelliSpace Perinatal via RS232

In contrast to a LAN connection, when the monitor is connected to an OB TraceVue/IntelliSpace Perinatal system over an RS232 connection, the OB TraceVue/IntelliSpace Perinatal system does not have full control over the monitor's patient admission and discharge functions.

Depending on how OB TraceVue/IntelliSpace Perinatal is configured, *either* the **Last Name, First Name**, and the bed label, *or* just the bed label alone, are taken from the OB TraceVue/IntelliSpace Perinatal system. See the OB TraceVue/IntelliSpace Perinatal Instructions for Use for details.