



Instructions for Use

# IntelliVue Patient Monitor

**MP2**

Release J with Software Revision J.xx.xx

Patient Monitoring

**PHILIPS**



# Table of Contents

<b>1 Installation</b>	11
Installation Checklist	11
Unpacking and Checking the Shipment	12
Mounting the Monitor	13
Mounting the External Power Supply (M8023A)	13
Connecting the Monitor to AC Mains	13
Checking Out the Monitor	15
Operating the Monitor	16
Setting the Date and Time	17
Checking Country-Specific Default Settings	17
Handing Over the Monitor	18
<b>2 Basic Operation</b>	19
Introducing the IntelliVue MP2	19
Controls, Indicators and Connectors	20
Extending Measurements	22
Operating and Navigating	28
Operating Modes	33
Understanding Screens	34
Using the XDS Remote Display	34
Using the Visitor Screen	35
Understanding Profiles	35
Understanding Settings	36
Changing Measurement Settings	37
Switching a Measurement On and Off	37
Adjusting a Measurement Wave	37
Using Labels	38
Using IntelliVue Cableless Measurements	40
Changing Monitor Settings	41
Checking Your Monitor Revision	42
Getting Started	42
Disconnecting from AC Mains Power	43
Monitoring After a Power Failure	44
Networked Monitoring	44
Capturing Alarm Reports and Printing	44
<b>3 What's New?</b>	45
What's New in Release J.0	45
What's New in Release H.0	46
What's New in Release G.0?	47

What's New in Release F.0?	48
<b>4 Alarms</b>	51
Visual Alarm Indicators	52
Audible Alarm Indicators	53
Acknowledging Alarms	55
Pausing or Switching Off Alarms	56
Alarm Limits	58
Reviewing Alarms	61
Latching Alarms	62
Testing Alarms	63
Alarm Behavior at Power On	63
Alarm Recordings	64
<b>5 Patient Alarms and INOPs</b>	65
Patient Alarm Messages	65
Technical Alarm Messages (INOPs)	71
<b>6 Managing Patients and Equipment</b>	89
Patient Concepts	89
Equipment Concepts	89
Managing Patients	90
Transferring Patients	94
Managing Equipment	98
Information Center Compatibility	106
<b>7 ECG, Arrhythmia, ST and QT Monitoring</b>	107
Skin Preparation for Electrode Placement	107
Connecting ECG Cables	107
Selecting the Primary and Secondary ECG Leads	108
Checking Paced Mode	108
Understanding the ECG Display	109
Monitoring Paced Patients	110
Changing the Size of the ECG Wave	111
Changing the Volume of the QRS Tone	112
Changing the ECG Filter Settings	112
Selecting Positions of Va and Vb Chest Leads (for 6-lead placement)	112
Choosing EASI or Standard Lead Placement	113
About ECG Leads	113
ECG Lead Fallback	114
ECG Lead Placements	114
Capture 12-Lead	119
EASI ECG Lead Placement	122
ECG and Arrhythmia Alarm Overview	123
Using ECG Alarms	124
ECG Safety Information	125

About Arrhythmia Monitoring	127
Switching Arrhythmia Analysis On and Off	127
Choosing an ECG Lead for Arrhythmia Monitoring	127
Understanding the Arrhythmia Display	129
Arrhythmia Relearning	132
Arrhythmia Alarms	133
About ST Monitoring	137
Switching ST or STE On and Off	138
Understanding the ST Display and Windows	139
Updating ST Baseline Snippets	141
About the ST Measurement Points	142
ST Alarms	144
STE Alarms	144
Viewing ST Maps	145
About QT/QTc Interval Monitoring	148
QT Alarms	152
Switching QT Monitoring On and Off	153
<b>8 Monitoring Pulse Rate</b>	155
<hr/>	
Entering the Setup Pulse Menu	155
System Pulse Source	155
Switching Pulse On and Off	156
Using Pulse Alarms	156
<b>9 Monitoring Respiration Rate (Resp)</b>	159
<hr/>	
Lead Placement for Monitoring Resp	159
Understanding the Resp Display	160
Changing Resp Detection Modes	160
Changing the Size of the Respiration Wave	161
Changing the Speed of the Respiration Wave	162
Using Resp Alarms	162
Changing the Apnea Alarm Delay	162
Resp Safety Information	162
<b>10 Monitoring SpO2</b>	165
<hr/>	
SpO2 Sensors	165
Applying the Sensor	165
Connecting SpO2 Cables	166
Measuring SpO2	166
Understanding the SpO2 Numerics	168
Assessing a Suspicious SpO2 Reading	169
Changing the Averaging Time	169
Setting the Measurement Mode	169
Understanding SpO2 Alarms	170
Pleth Wave	175
Perfusion Numeric	175

Perfusion Change Indicator	175
Setting SpO2/Pleth as Pulse Source	175
Setting Up Tone Modulation	176
Setting the QRS Volume	176
<b>11 Monitoring NBP</b>	177
<hr/>	
Introducing the Oscillometric NBP Measurement	177
Preparing to Measure NBP	179
Starting and Stopping Measurements	180
Enabling Automatic Mode and Setting Repetition Time	182
Enabling Sequence Mode and Setting Up The Sequence	182
Choosing the NBP Alarm Source	182
Switching Pulse from NBP On/Off	183
Assisting Venous Puncture	183
Calibrating NBP	183
<b>12 Monitoring Temperature</b>	185
<hr/>	
Making a Temp Measurement	185
Calculating Temp Difference	186
<b>13 Monitoring Invasive Pressure</b>	187
<hr/>	
Setting up the Pressure Measurement	187
Zeroing the Pressure Transducer	189
Adjusting the Calibration Factor	190
Displaying a Mean Pressure Value Only	191
Changing the Pressure Wave Scale	191
Optimizing the Waveform	191
Non-Physiological Artifact Suppression	191
Choosing the Pressure Alarm Source	191
Calibrating Reusable Transducer CPJ840J6	192
Calculating Cerebral Perfusion Pressure	194
<b>14 Monitoring Carbon Dioxide</b>	195
<hr/>	
Measurement Principles	196
Measuring CO2 using the CO2 Option or M3014A	196
Measuring Mainstream CO2 using M3016A	200
Measuring Microstream CO2 using M3015A/B	203
Setting up all CO2 Measurements	204
Understanding the IPI Numeric	206
<b>15 Using a Telemetry Device and a Monitor (PIIC only)</b>	209
<hr/>	
How Can You Combine Devices?	209
Unpairing the Monitor and Telemetry Device	211
Temporarily Stopping the Short Range Radio Connection	212

<b>16 Enhancing Telemetry Monitoring with the Monitor</b>	213
Monitor and Telemetry Transceiver Requirements	213
<b>17 Trends</b>	215
Viewing Trends	215
Setting Up Trends	218
Documenting Trends	221
Trends Databases	221
Screen Trends	222
<b>18 Recording</b>	227
Starting and Stopping Recordings	227
Overview of Recording Types	228
Creating and Changing Recordings Templates	228
Recorder Status Messages	229
<b>19 Printing Patient Reports</b>	231
Starting Report Printouts	231
Stopping Reports Printouts	232
Setting Up Reports	232
Setting Up Individual Print Jobs	234
Checking Printer Settings	234
Printing a Test Report	234
Switching Printers On or Off for Reports	235
Dashed Lines on Reports	235
Unavailable Printer: Re-routing Reports	235
Checking Report Status and Printing Manually	236
Printer Status Messages	237
Sample Report Printouts	238
<b>20 Care and Cleaning</b>	241
General Points	241
Cleaning the Monitor	242
Disinfecting the Monitor	242
Sterilizing the Monitor	243
Cleaning, Sterilizing and Disinfecting Monitoring Accessories	243
Cleaning Batteries and the Battery Compartment	243
<b>21 Using Batteries</b>	245
Battery Power Indicators	246
Checking Battery Charge	248
When Battery Lifetime is Expired	248
Replacing a Battery	249
Optimizing Battery Performance	250
Battery Safety Information	252



<b>22 Maintenance and Troubleshooting</b>	253
Inspecting the Equipment and Accessories	253
Inspecting the Cables and Cords	254
Maintenance Task and Test Schedule	254
Troubleshooting	254
Disposing of the Monitor	255
Disposing of Empty Calibration Gas Cylinders	255
<b>23 Accessories</b>	257
ECG/Resp Accessories	257
Invasive Pressure Accessories	261
5-Electrode One Piece Cables	261
Set Combiners and Organizers	261
NBP Accessories	262
SpO2 Accessories	264
Temperature Accessories	268
Mainstream CO2 Accessories	269
Sidestream CO2 Accessories	269
Mainstream CO2 Accessories (for M3016A)	270
Microstream CO2 Accessories	270
Battery Accessories	271
<b>24 Specifications</b>	273
Indications for Use	273
Use Environment	273
Restricted Availability	274
Manufacturer's Information	274
Symbols	275
Installation Safety Information	276
Monitor Mounting Precautions	277
Altitude Setting	277
Monitor Safety Specifications	277
EMC And Radio Regulatory Compliance	278
Out-Of-Hospital Transport - Standards Compliance	279
Physical Specifications	280
Environmental Specifications	281
Monitor Performance Specifications	282
Monitor Interface Specifications	284
865297 Battery Extension Specifications	285
M4607A Battery Specifications	286
M4605A Battery Specifications	286
Measurement Specifications	287
Safety and Performance Tests	299
<b>25 Default Settings Appendix</b>	305
Country-Specific Default Settings	305





Alarm and Measurement Default Settings	313
Alarm Default Settings	313
ECG, Arrhythmia, ST and QT Default Settings	314
Pulse Default Settings	316
Respiration Default Settings	317
SpO2 Default Settings	317
NBP Default Settings	318
Temperature Default Settings	319
Invasive Pressure Default Settings	319
CO2 Default Settings	321
<b>Index</b>	<b>323</b>

---



# Installation

Installation should be carried out by qualified service personnel, either by the hospital's biomedical department, or by Philips Support.

If you have purchased a "customer-installable bundle", it is assumed that your own hospital personnel will install and, if necessary, configure the monitor. You can contact Philips Support for assistance if required; any assistance will be associated with additional costs.

For mechanical and electrical installation, you need technically qualified personnel with a knowledge of english. Additionally, for monitor configuration, you need clinically qualified personnel with a knowledge of the use environment. For further information on Installation, refer to the Service Guide.

---

## WARNING

- Monitor configuration settings must be specified by authorized hospital personnel.
  - For installation of the device as part of a system, always refer to the Service Guide.
  - As the first step in preparing the monitor for use, follow the installation instructions given in this chapter.
- 

## Installation Checklist

Use this checklist to document your installation.

Step	Task	Check Box when Task Done
1	Perform initial inspection of delivery, unpack and check the shipment (see "Unpacking and Checking the Shipment" on page 12).	<input type="checkbox"/>
2	Mount the monitor as appropriate for your installation (see "Mounting the Monitor" on page 13).	<input type="checkbox"/>
3	Insert the battery into the battery compartment (the battery must always be in the battery compartment during use). Connect the monitor to AC mains via the external power supply using the supplied power cord (see "Connecting the Monitor to AC Mains" on page 13).	<input type="checkbox"/>
4	Perform Visual, Power On and Functional test blocks (see "Checking Out the Monitor" on page 15).	<input type="checkbox"/>

Step	Task	Check Box when Task Done
5	Perform Safety Tests, if required by local laws and regulations (see “Checking Out the Monitor” on page 15).	<input type="checkbox"/>
6	Check/set the time and date (see “Setting the Date and Time” on page 17).	<input type="checkbox"/>
7	Check that the country-specific default settings are appropriate (see “Checking Country-Specific Default Settings” on page 17)	<input type="checkbox"/>
8	Perform System Test as necessary (see the Service Guide)	<input type="checkbox"/>

## Unpacking and Checking the Shipment

The monitor and any supporting options ordered are supplied packed in protective shipping cartons.

### Initial Inspection

Before unpacking, check the packaging and ensure that there are no signs of mishandling or damage.

Open the package carefully and remove the monitor and accessories.

Check that the contents are complete and that the correct options and accessories have been delivered.

System Components, Accessories and Supplies	Comments
Monitor with options as ordered	1
ECG accessories	optional
NBP accessories	optional
SpO <sub>2</sub> accessories	optional
Pressure accessories	optional
Temperature accessories	optional
CO <sub>2</sub> Accessories	optional
External Power Supply including AC power cord and MSL cable	1
Rechargeable battery	1
Instructions for Use	1
Quick Guide	1
Documentation DVD (includes Service Guide and Instructions for Use)	1

### Claims for Damage

If the shipping cartons are damaged, contact the carrier.

If any of the equipment is damaged, contact both the carrier and your local Philips service organization for repair or replacement arrangements.

## Repacking

Retain the original packing carton and material, in case you need to return equipment to Philips for service. If you no longer have the original packing materials, Philips can advise you on alternatives.

## Mounting the Monitor

The monitor can be rested on a flat, level surface, hung on the bed rail, or mounted on a wall or on a rollstand. See the *Service Guide* for details.

## Mounting the External Power Supply (M8023A)

The external power supply (M8023A) can be rested on its rubber feet on a flat, level surface, or mounted as described in the *Service Guide*.

The following pictures show examples of correct 😊 and incorrect ☹️ ways to mount the power supply.

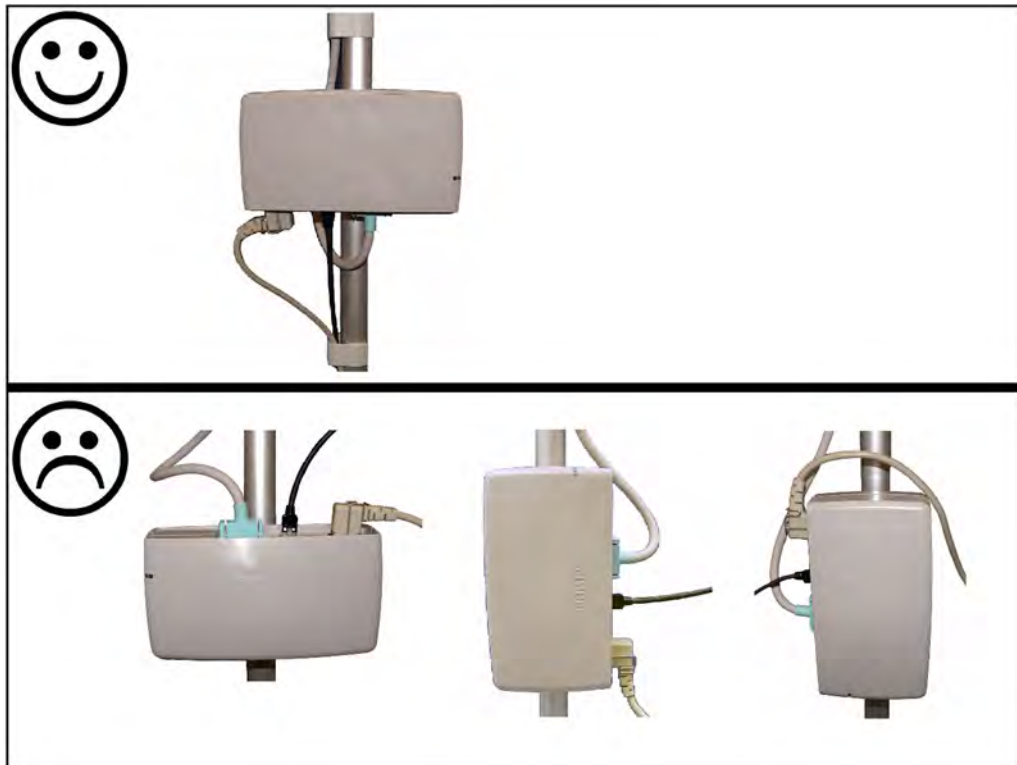

## Connecting the Monitor to AC Mains

The monitor is an electrical Class II device in which the protection against electric shock does not rely on basic insulation and a protective earth conductor but on double and/or reinforced insulation.

The monitor has a wide-range external power supply (M8023A) that allows you to operate the monitor from an AC (alternating current) power source of 100 V to 240 V ( $\pm 10\%$ ) and 50/60 Hz ( $\pm 5\%$ ). The external power supply also charges the monitor's battery.



- 1 MSL Cable connects to power supply (M8023A)

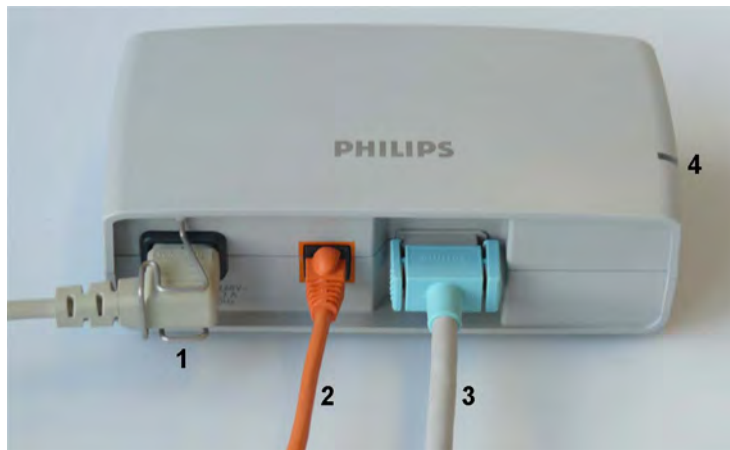

- 1 AC power cord. Connect to AC mains socket.
- 2 Connect LAN cable here. For connection to a PC or Information Center.
- 3 Measurement Link (MSL) cable. Supplies AC input power to the monitor for AC operation and for battery charging. When there is a LAN connection to a PC or Information Center, the MSL cable also carries this data to and from the monitor.
- 4 Power-on LED. The green light is on when the external power supply is connected to AC mains.

---

### WARNING

- Always use the supplied power cord with the earthed mains plug to connect the external power supply (M8023A) to an earthed AC mains socket. Never adapt the mains plug from the power supply to fit an unearthed AC mains socket.
- Do not use AC mains extension cords or multiple portable socket-outlets. If a multiple portable socket-outlet without an approved isolation transformer is used, the interruption of its protective

earthing may result in enclosure leakage currents equal to the sum of the individual earth leakage currents, so exceeding allowable limits.

- Do not connect any devices that are not supported as part of a system.
- Any non-medical device placed and operated in the patient's vicinity must be powered via an approved isolation transformer that ensures mechanical fixing of the power cords and covering of any unused power outlets.

## Checking Out the Monitor

The following table defines which tests and inspections need to be performed, and when they are required.

Test	Test or Inspection to be Performed
Visual	Inspect the monitor, measurement accessories and cables for any damage. Are they free of damage?
Power On	Power on the monitor. Does it start up successfully without errors? Do all alarm lamps light up during power up? After start up, the monitor sounds a tone, and you can see the monitoring main screen (normally with measurement wave channels and numeric positions).
Functionality Test	After power up, touch the battery status indicator in the bottom right of the screen. The <b>Battery Status</b> window should open. Press the blue <b>Main Screen</b> key to close the window and return to the main screen.
Safety Tests (1) to (4)	Perform safety tests (1) to (4), as described in the Service Guide, for standalone devices if required by local laws and regulations, and each time you combine equipment to form a system, or exchange system components. Details of the safety tests and procedures are described in the Service Guide. These safety tests are derived from international standards but may not always be sufficient to meet local requirements.
System	Perform the system test according to IEC 60601-1-1, if applicable, after combining equipment to form a system (see the Service Guide).

For test and inspection information regarding repairs, upgrades and all other service events, refer to the *Service Guide*.

# Operating the Monitor

To complete installation you will need to operate the monitor to check basic functionality. Here is a quick introduction to the monitor.



- Switch on the monitor. After start-up the monitor display will become active. You operate the monitor using the touch screen.

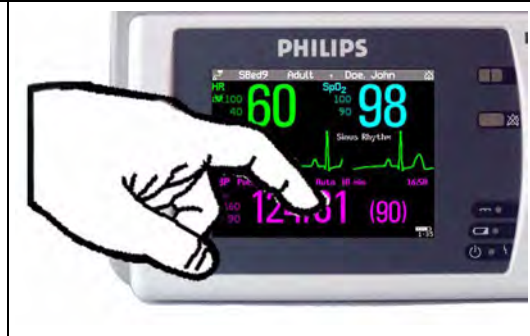

- Touch something on the screen (numerics, waves, other screen items) to enter the corresponding menu. Touching the NBP numeric, for example, brings you to the **Setup NBP** menu.



- Touch again to select an item on the menu and work through the menu activities.

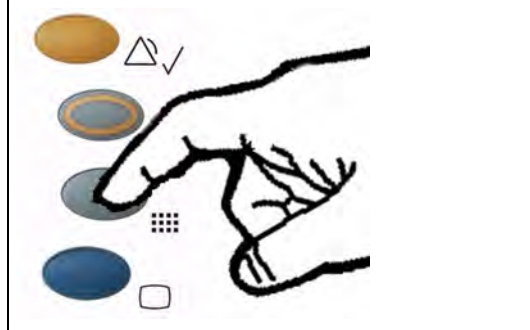

- To access SmartKeys, press the SmartKeys key. **Main Setup** is one of the SmartKeys.

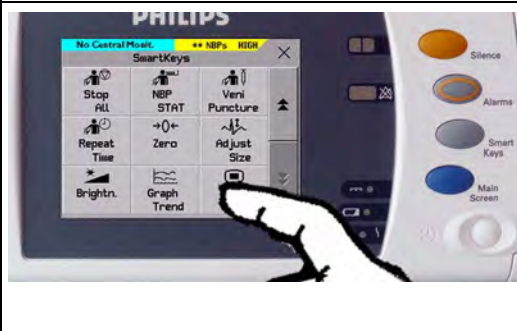

- If you cannot find a menu by touching the screen you can always use the **Main Setup** SmartKey which will get you to all menus on the monitor.

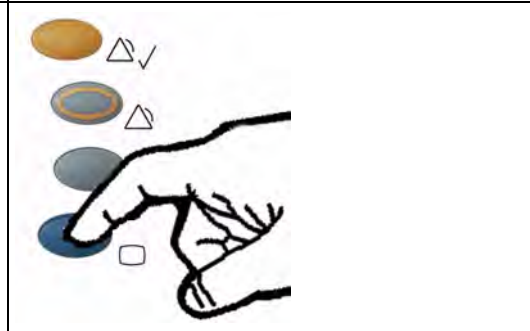

- Press the Main Screen key to close all open menus/windows and return to the main screen. Press again to enter the **Change Screen** menu, where you can choose from a number of pre-configured screens.



## Setting the Date and Time

To set the date and time:

- 1 Press the SmartKeys key  to enter the **SmartKeys** window.
- 2 Select the **Main Setup** SmartKey to enter the **Main Setup** menu.
- 3 Select **Date, Time** to enter the **Date, Time** menu.
- 4 Select, in turn, the **Year, Month, Day, Hour** (in 24 hour format, only) and **Minute** as necessary. Select the correct values from the pop-up list.
- 5 Select **Store Date, Time** to change the date and time.

If your monitor is connected to an Information Center, the date and time are automatically taken from this. Once it is set, the internal clock retains the setting even when you switch off the monitor.

## Checking Country-Specific Default Settings

Some settings are made in the factory to match the typical requirements in a specific country. Line frequency, units for weight and height, and ECG cable colors (AAMI or IEC) have been set to appropriate values. If you suspect that these settings may not match your institution's requirements, check the settings and change them if necessary as described in the Configuration Guide.

---

### WARNING

Before starting monitoring, check that the current configuration meets your requirements, especially patient category, alarm limits and paced setting.

---

If you need to enter configuration mode:

- 1 In the **Main Setup** menu, select **Operating Modes**.
- 2 Select **Config** and enter the passcode.  
The passcode for configuration mode is given in the Service Guide.

The monitor displays **Config** at the right hand side of the status line and in the center of the Screen while you are in configuration mode.

Before you leave configuration mode, always be sure to store any changes you made. You must store changes made to each Settings Block and to each Profile, individually. As it may be difficult to remember whether the settings you changed belong to a Monitor Settings block or a Measurement Settings block, we recommend that you store each block before you leave configuration mode.

To leave configuration mode:

- In the **Main Setup** menu, select **Operating Modes** and then select **Monitoring**.

## Handing Over the Monitor

If you are handing over the monitor to the end-users directly after configuration, make sure that it is in Monitoring mode.

---

### **WARNING**

Users must be adequately trained to use the monitor before monitoring a patient. To achieve this, they should have access to, and read, the following documentation delivered with the monitor:

- Instructions for Use (this book) - for full operating instructions
- Quick Guide - for quick reminders during use

---

Additionally, we recommend working through the Training Guide for self-training on the monitor before use (not available in all languages). Both documents and the training guide are included on the documentation DVD delivered with the monitor.

---

# Basic Operation

These Instructions for Use are for clinical professionals using the IntelliVue MP2 (M8102A) patient monitor.

This basic operation section gives you an overview of the monitor and its functions. It tells you how to perform tasks that are common to all measurements (such as entering data, switching a measurement on and off, setting up and adjusting wave speeds, working with profiles). The alarms section gives an overview of alarms. The remaining sections tell you how to perform individual measurements, and how to care for and maintain the equipment.

Familiarize yourself with all instructions including warnings and cautions before starting to monitor patients. Read and keep the Instructions for Use that come with any accessories, as these contain important information about care and cleaning that is not repeated here.

This guide describes all features and options. Your monitor may not have all of them; they are not all available in all geographies. Your monitor is highly configurable. What you see on the screen, how the menus appear and so forth, depends on the way it has been tailored for your hospital and may not be exactly as shown here.

In this guide:

- A **warning** alerts you to a potential serious outcome, adverse event or safety hazard. Failure to observe a warning may result in death or serious injury to the user or patient.
- A **caution** alerts you to where special care is necessary for the safe and effective use of the product. Failure to observe a caution may result in minor or moderate personal injury or damage to the product or other property, and possibly in a remote risk of more serious injury.
- **Monitor** refers to the entire patient monitor. **Display** refers to the physical display unit. **Screen** refers to everything you see on the monitor's display, such as measurements, alarms, patient data and so forth.

Rx only: U.S. Federal Law restricts this device to sale by or on the order of a physician.

## Introducing the IntelliVue MP2

The Philips IntelliVue MP2 monitor provides a comprehensive set of basic physiological measurements: ECG (including ST analysis and optional 10-lead ECG), NBP, SpO<sub>2</sub>, and optionally invasive blood pressure, temperature and CO<sub>2</sub>. Through networking it provides information integration, documentation and information access. The MP2 can be used with adult, pediatric and neonatal patients in a hospital environment and during patient transport both inside and outside hospitals.

The monitor stores data in trend databases. You can see tabular trends (vital signs) and document them on a central printer. You can view measurement trend graphs, including horizon trends, to help you identify changes in the patient's physiological condition.

The monitor can be powered by a rechargeable battery, or from AC mains using the external power supply (M8023A). For battery charging, care and status information, refer to the chapter “Using Batteries” on page 245.

# Controls, Indicators and Connectors

## MP2 Overview

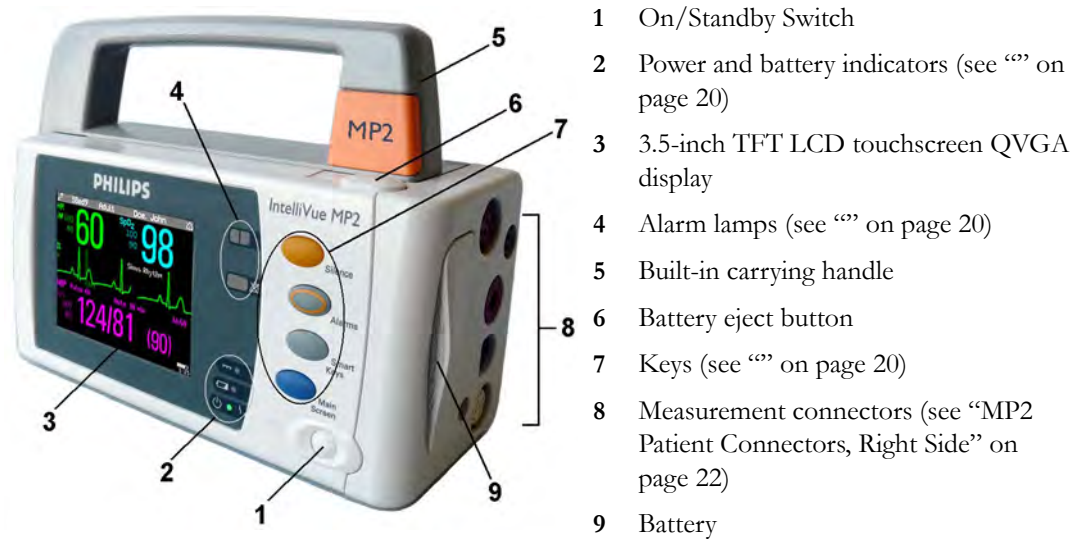

## MP2 Controls and Indicators

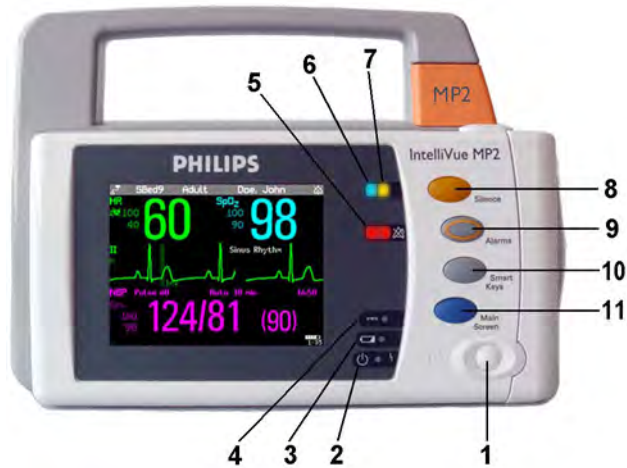

- 1 On/Standby switch
- 2 On/Standby LED. Green when monitor is on. Red indicates an error.
- 3 Battery status LED. Yellow when charging. Flashing red when battery is empty, or a battery malfunction is detected.
- 4 External power LED. Green when monitor is powered from an external power source.
- 5 Alarms off indicator. When alarms are suspended, the lamp is red, and the **ALARMS OFF** message appears on the screen.
- 6 Active INOP alarm lamp in light blue. Stays lit until active INOP is acknowledged.
- 7 Active alarm lamp. Red or yellow, depending on alarm level. Stays lit until active alarm is acknowledged.
- 8 **Silence** key
- 9 **Alarms** key: turns alarms On/Off, or pauses them
- 10 **SmartKeys** key: brings up SmartKeys on the screen
- 11 **Main Screen** key: closes all open menus/windows and returns to the main screen, or selects current screen.

## MP2 Patient Connectors, Right Side

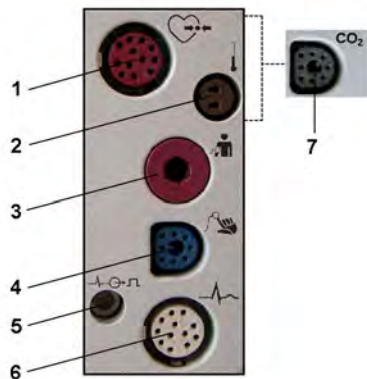

- 1 Pressure (option)
- 2 Temperature (option)
- 3 Noninvasive blood pressure
- 4 SpO<sub>2</sub>
- 5 ECG sync pulse output (See “Monitor Performance Specifications” on page 282 for specifications)
- 6 ECG/Respiration
- 7 CO<sub>2</sub> (option)

## MP2 Left Side

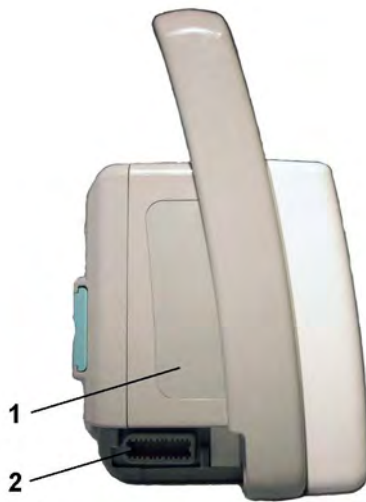

- 1 Loudspeaker
- 2 MSL Connector. Connects to the external power supply via the MSL cable for AC mains operation, battery charging, and communication with a network.

## Extending Measurements

Your monitor is compatible with Philips measurement extensions for use with other IntelliVue patient monitoring devices. These allow you to add specific measurements to those already integrated into your monitor. These measurement extensions are referred to as MMS extensions. During patient transport, the monitor with the connected MMS extension can be powered by the Battery Extension (see “Using the Battery Extension” on page 26).



### MMS Extension M3014A attached to the MP2

The MMS extensions connect to the monitor and use the monitor's settings. Trend data and measurement settings from the measurements in the extensions are stored in the monitor.

---

#### WARNING

- Measurements from an MMS extension are only available when the extension is connected to the monitor, **and** the monitor is running on external power. This is the case when the monitor is running on AC mains via the external power supply (M8023A) or is attached to the Battery Extension (865297). Measurements from an MMS extension connected to the monitor are not available when the monitor is running on its own battery power.
  - Any measurements on an MMS extension that conflict with those in the monitor cannot be used. For example, only one CO<sub>2</sub> measurement is supported.
- 

To separate an extension from the monitor, press the release lever and push the extension forward.



## M3014A, M3015A, M3015B and M3016A Capnography MMS Extensions

The optional **M3014A** Capnography extension adds mainstream capnography or sidestream capnography, and optionally one pressure plus either a pressure or a temperature, Cardiac Output and Continuous Cardiac Output to the MMS.

**M3014A**



- 1 Pressure connectors (red)
- 2 Temperature connector (brown)
- 3 Mainstream/sidestream connector CO<sub>2</sub>
- 4 Cardiac Output connector

The optional **M3015A** Microstream CO<sub>2</sub> extension adds microstream capnography and optionally either pressure or temperature to the MMS. The optional **M3015B** Microstream CO<sub>2</sub> extension adds microstream capnography, two pressures and a temperature to the MMS.

**M3015A**

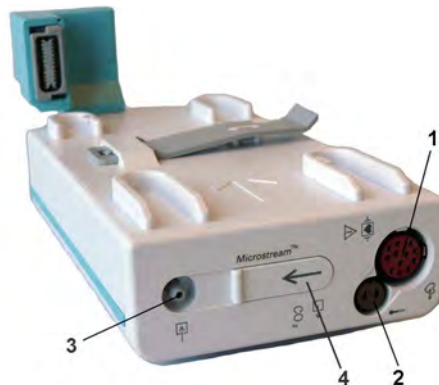

**M3015B**

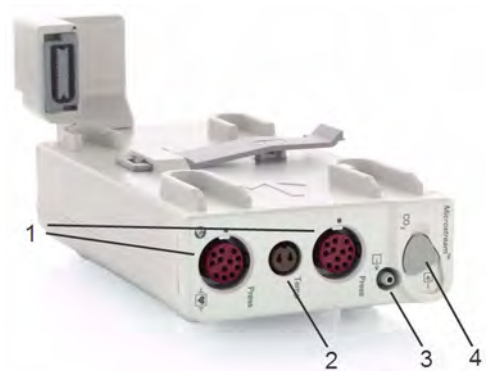

- 1 Pressure connectors (red) - M3015A optional
- 2 Temperature connector (brown) - M3015A optional
- 3 Gas sample outlet
- 4 Microstream connector CO<sub>2</sub> and Inlet



The optional **M3016A** Mainstream CO<sub>2</sub> extension adds mainstream capnography and optionally either pressure or temperature to the MMS.

### M3016A



- 1 Pressure connectors (red)
- 2 Temperature connector (brown)
- 3 Mainstream/sidestream connector CO<sub>2</sub> (optional)

### M3012A Hemodynamic MMS Extension



- 1 Cardiac Output (orange; optional)
- 2 Connection to MMS
- 3 Pressure connectors (red)
- 4 Temperature connectors (brown)

When attached to the MP2 connected to the external power supply, the optional M3012A Hemodynamic extension adds temperature, pressure, and an additional pressure or a temperature to the monitor.

Cardiac Output and Continuous Cardiac Output are not available when used with the MP2.

### Using the Battery Extension

To provide enough power for the use of an MMS Extension during transport, you can use the Battery Extension (865297). The Battery Extension provides additional battery power for situations when no mains power is available and can typically power the monitor with MMS Extension for at least 6 hours.

#### Connecting the Battery Extension



To connect to the Battery Extension, place the monitor with MMS Extension onto the Battery Extension, and then slide it across so that the connection is made and it is firmly seated.

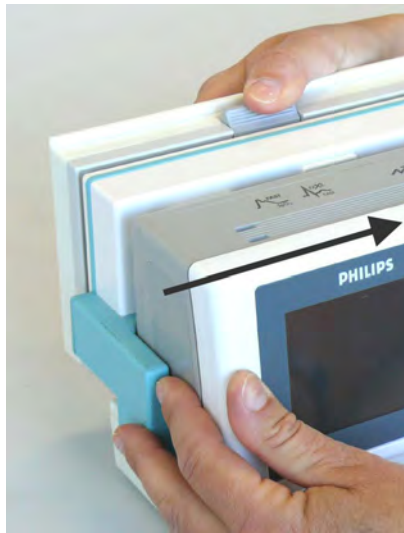

To remove the monitor with MMS Extension, press the release lever and push the monitor across to release the connection.

#### LED Indicators

The Battery Extension has two LED indicators. The power LED lights green when the Battery Extension is connected to external power.

The battery charge led gives battery status information:

LED indication	Status
<b>External power available</b>	
green	Battery fully charged.
yellow	Battery charging.

red flashing (short on phase)	Battery maintenance required.
red flashing (long on phase)	Battery Extension malfunction.
off	No battery inserted in the Battery Extension.
<b>External power not available</b>	
yellow flashing (short on phase)	Battery Extension is charging the monitor battery (monitor is switched off).
red flashing (short on-phase)	If the monitor is running, this indicates very low battery charge (<10 minutes running time left). If the monitor is not running, this indicates that battery maintenance is required.
red flashing (long on-phase)	Battery Extension cannot provide power to the monitor. Either the Battery Extension needs charging, or it has a malfunction.

## IntelliVue Cableless Measurements

The IntelliVue Cableless Measurements (IntelliVue CL SpO<sub>2</sub> Pod and IntelliVue CL NBP Pod) are patient-worn measurement devices which provide measurement values on their built-in screen and communicate them to the monitor using a wireless short range radio (SRR) interface.

### Measurement Device Main Parts and Keys

All IntelliVue Cableless Measurement devices have a display and 3 keys:



- 1 Integrated monochrome LCD display
- 2 Hardkeys
- 3 Measurement identifier

# Operating and Navigating



The principle method of operating your monitor is via the touchscreen. Almost every element on the screen is interactive. Screen elements include measurement numerics, information fields, alarms fields, waveforms and menus. The typical operator's position is in front of the monitor.

There are also four keys to the right of the screen (see also “” on page 20).

These let you:	Key with symbol (international)	Text replaces symbol (English versions only)
<ul style="list-style-type: none"> <li>Silence alarms: the Silence key acknowledges all active alarms by switching off audible alarm indicators and lamps.</li> </ul>		Silence
<ul style="list-style-type: none"> <li>Switch alarms on or off, or pause alarms.</li> </ul>		Alarms
<ul style="list-style-type: none"> <li>Call up SmartKeys on the screen (see below).</li> </ul>		Smart Keys
<ul style="list-style-type: none"> <li>Close all open menus/windows and return to the main screen.</li> <li>If you are already in the main screen (no additional menus/windows are open), then pressing this key opens the <b>Change Screen</b> menu, where you can choose from a number of pre-configured screens.</li> <li>To temporarily disable the touchscreen operation, press and hold this key for 2 seconds. Press the key again to re-enable the touchscreen operation.</li> </ul>		Main Screen

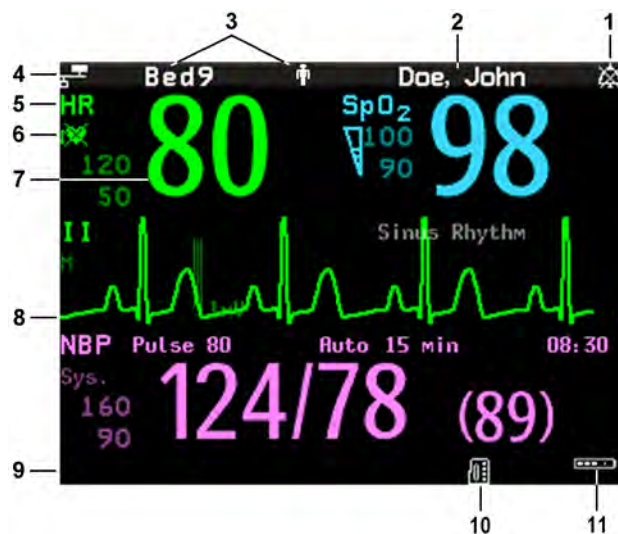
A typical main screen looks like this:

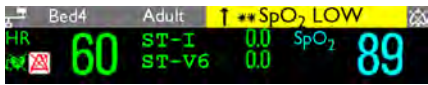
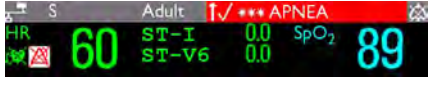

MP2 Screen Elements		
Item	Description	Comments
1	Alarm volume off indicator	 is displayed when the alarm volume is set to zero (0).
2	Patient name / alarm message field	<p>Patient name can be covered by alarm messages or alarms On/Off/Paused message.</p>  <p>If red and yellow alarms are active at the same time, they rotate in the alarm field.</p> 
3	Patient category and bed label / INOP message field	<p>Patient category and bed label can be covered by INOP messages. If there are multiple red/yellow/cyan INOPs active at the same time, they rotate in the INOP field.</p> 
4	Network connection indicator	Documented in Information Center Instructions for Use.
5	Measurement label	Touch the measurement to enter the measurement setup menu.
6	Paced status	Displayed below the HR label.
7	Measurement numeric/values	Touch the numeric to enter the measurement setup menu.
8	Measurement wave	Touch the wave to enter the measurement setup menu.
9	Status line	Shows information and messages prompting you for action.
10	Measurement Selection key	Opens the <b>Measurement Selection</b> window which shows all measurements and where they are physically located. From here you can also enter the measurement setups.
11	Battery status indicator	Gives information about remaining battery charge, estimated operating time, maintenance requirements and malfunctions. See the chapter "Using Batteries" on page 245.

## Using the Touchscreen

Touch a screen element to get to the actions linked to that element. For example, touch a measurement numeric and the setup menu for that measurement opens. Touch a wave to enter the setup menu for that wave.

## Measurement Setup Menus

Each measurement has a setup menu where you can change settings. Typically, the setup menu window covers the whole screen, except the INOP and alarm message fields, which are always displayed at the top. The following picture is an example, and may not show exactly what you see on the screen. All measurement setup windows are similar and share the same basic layout.

Touch the measurement numeric on the screen to enter the setup menu.

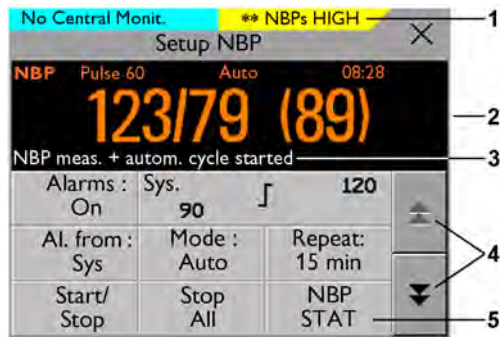

Key to measurement setup menu:		
Item	Description	Comment
1	INOP and alarm message field.	These are always displayed at the top of the screen.
2	Wave/numerics window.	The main measurement numeric and wave (if applicable) are shown in this window so that you do not lose sight of the current measurement while making changes in the menu.
3	Status/prompt message.	Status/prompt messages related to the measurement menu are displayed below the wave/numerics. General status/prompt messages on the main screen are covered by the measurement setup menu.
4	Next page arrows.	The menu may have more than one page, as shown here. Move to another page by touching these arrows.
5	Measurement menu keys.	Each button has two lines of text. To perform an operation on a measurement, press one of the keys. Some keys lead directly to a task. For example, pressing the <b>Start/ Stop</b> key for noninvasive blood pressure starts a measurement. Other keys open a pop-up window, which can have more than one page, from which you make a selection. Again, using noninvasive blood pressure as an example, pressing the <b>Repeat Time</b> key for setting the repetition time opens a pop-up window from which you pick a time, scrolling if necessary.

## Main Setup Menu

There is usually more than one way to enter a setup menu for a measurement, to change a setting or to execute a task. Some routes are more direct than others. You can use whichever method you find most convenient. Which routes are available to you, however, can vary depending on your monitor's configuration.

For this reason, this book generally describes entry to a measurement's setup menu via the **Main Setup** menu, as this route is always available and is not subject to configuration dependencies. You can get to all setup windows from the **Main Setup** menu. You enter the **Main Setup** menu by pressing the SmartKeys key, then selecting the **Main Setup** SmartKey.

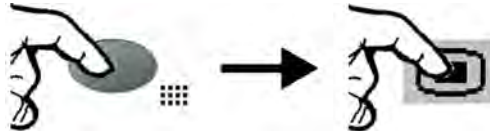





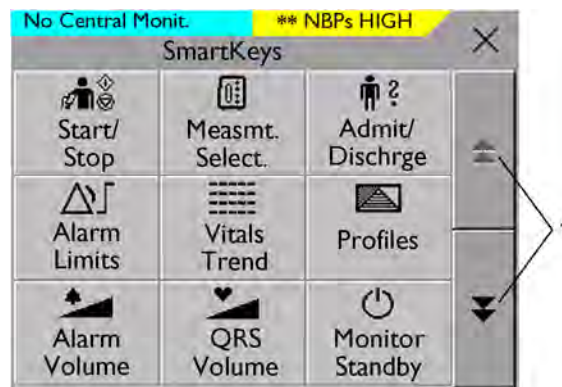

























## SmartKeys

A SmartKey is a configurable graphical key on the screen allowing fast access to frequently used functions. Press the SmartKeys hard key to call up a set of SmartKeys on the screen. Although the selection of SmartKeys available on your monitor depends on the monitor configuration and on the options purchased, the **SmartKeys** window generally looks like this:



- 1 Scroll to see more SmartKeys

	enter Main Setup menu - you can get to all setup windows using this key		enter standby mode - suspends patient monitoring. All waves and numerics disappear from the display. All settings and patient data information are retained.
	enter profile menu, or revert to default profile		change Screen, or revert to default screen
	previous Screen		quick admit a patient
	enter patient identification menu to admit/discharge/transfer		end case to discharge a patient

	lock touchscreen operation		set alarm limits
	change alarm volume		change screen brightness (not for independent displays)
	change QRS volume		change amplitude (size) of ECG wave
	review beat labels (annotate arrhythmia wave)		re-learn arrhythmia
	- start/stop manual NBP measurement - start auto series - stop current automatic measurement within series		start NBP STAT measurement
	stop automatic or STAT NBP measurement and measurement series		start NBP measurement and measurement series
	start venipuncture (inflate cuff to subdiastolic pressure)		stop current NBP measurement
	set the NBP repeat time		access patient reports
	switch CO <sub>2</sub> pump off		zero invasive pressure transducer
	new lead setup		set standard or EASI lead placement
	review vital signs trend		review graph trend
	unpair equipment and continue central monitoring with the monitor		unpair equipment and continue central monitoring with the telemetry device
	start 12-Lead Capture (only available if Information Center is connected)		access ST Map application
	select measurement device		start an SpO <sub>2</sub> measurement
	access NBP mode selection and setup, with direct start/stop function		open the <b>Equipment</b> window

## Pop-Up Keys

Pop-up keys are task-related graphical keys that appear automatically on the monitor screen when required. For example, the **Confirm** pop-up key appears only when you need to confirm a change.



## Using the On-Screen Keyboard

Use this as you would a conventional keyboard. Enter the information by selecting one character after another. Use the **Shift** and capital **Lock** keys to access uppercase letters. Use the **Back** key to delete single characters, or use the **Clr** key to delete entire entries. Select **Enter** to confirm what you have entered and close the on-screen keyboard.

## Operating Modes

When you switch the monitor on, it starts up in monitoring mode. To change to a different mode:

- 1 Select the **Main Setup** menu.
- 2 Select **Operating Modes** and choose the mode you require.

Your monitor has four operating modes. Some are passcode protected.

- **Monitoring Mode:** This is the normal, every day working mode that you use for monitoring patients. You can change elements such as alarm limits, patient category and so forth. When you discharge the patient, these elements return to their default values. Changes can be stored permanently only in Configuration Mode. You may see items, such as some menu options or the altitude setting, that are visible but 'grayed out' so that you can neither select nor change them. These are for your information and can be changed only in Configuration Mode.
- **Demonstration Mode:** Passcode protected, this is for demonstration purposes only. You must not change into Demonstration Mode during monitoring. In Demonstration Mode, all stored trend information is deleted from the monitor's memory.
- **Configuration Mode:** Passcode protected, this mode is for personnel trained in configuration tasks. These tasks are described in the Configuration Guide. During installation the monitor is configured for use in your environment. This configuration defines the default settings you work with when you switch on, the number of waves you see and so forth.
- **Service Mode:** Passcode protected, this is for trained service personnel.

When the monitor is in Demonstration Mode, Configuration Mode, or Service Mode, this is indicated by a box with the mode name in the center of the Screen and a symbol in the bottom right-hand corner. Select the mode box in the center of the screen to change to a different mode.

## Standby Mode

Standby mode can be used when you want to temporarily interrupt monitoring.

To enter Standby mode,

- 1 Press the SmartKeys key .
- 2 *Either* select the **Monitor Standby** SmartKey  
*Or* select the **Main Setup** SmartKey, then select **Monitor Standby**.

The Standby screen is a neutral screen with information about the monitor and instructions on how to leave Standby mode.

The monitor enters Standby mode automatically after the End Case function is used to discharge a patient. Standby suspends patient monitoring. All waves and numerics disappear from the display but all settings and patient data information are retained. The Standby screen is displayed.

If a temporary patient location has been entered at the monitor or at the Information Center, this location will also be displayed on the Standby screen.

To resume monitoring,

- Select anything on the screen or press any key.

When monitoring is resumed, alarms are paused for 1 minute to allow time to finish plugging in the measurement cables.

# Understanding Screens

Your monitor comes with a set of pre-configured Screens, optimized for common monitoring scenarios such as OR adult, or ICU neonatal. A Screen defines the overall selection, size and position of waves, numerics and other elements on the monitor screen when you switch on. You can easily switch between different Screens during monitoring. Screens do NOT affect alarm settings, patient category and so forth.

## Switching to a Different Screen

To switch to a different Screen:

- 1 After closing any open menus or windows, press the Main Screen key to access the **Change Screen** menu.
- 2 Choose the new Screen from the **Change Screen** menu.

## Changing a Screen's Content

If you do not want to change the entire Screen content, but only some parts of it, you can substitute individual waves, numerics, or trends. Be aware that these changes cannot be stored permanently in Monitoring Mode.

To change the selection of elements on a Screen,

- 1 Select the element you want to change. For example, touch the wave to enter the wave setup menu, or touch the numeric to enter the numeric setup menu.
- 2 From the menu that appears, select **Change Wave** or **Change Numeric**, and then select the wave or numeric you want.

In the **Change Screen** menu, the changed Screen is shown linked to the original Screen and marked with an asterisk.

Up to three modified Screens can be accessed via the **Change Screen** menu.

To recall Screens, select the name of the Screen in the **Change Screen** menu.

After a patient discharge, the monitor's default Screen is shown. Modified Screens are still available in the **Change Screen** menu.

If the monitor is switched off and then on again, modified Screens are erased from the monitor's memory and cannot be recalled. If a modified Screen was the last active Screen when the monitor was switched off, it is retained unless the monitor is configured to revert to the default.

# Using the XDS Remote Display

Using the IntelliVue XDS solution it is possible to view an independent monitor screen on an external display. The XDS solution consists of a medical grade PC-based hardware platform, XDS application software and the XDS connectivity option on the monitor. Depending on the configuration you can

also operate the monitor from the external display. The XDS must be connected to the same Local Area Network (LAN) as the monitor.

It is also possible to use an existing PC, connected to the same LAN, to host the XDS Application software.

For more details, including limitations and restrictions, refer to the *IntelliVue XDS Application Instructions for Use*.

## Using the Visitor Screen

If a visitor Screen is configured for your monitor, you can use it to clear the screen of all waves and numerics but continue to monitor the patient with active alarms and trend storage at the bedside and Information Center. You can change the name of the visitor Screen in Configuration Mode.

To activate this Screen,

- 1 Press the Main Screen key to open the **Change Screen** menu.
- 2 Select the name of the visitor Screen configured for your monitor from the list of available Screens.

To select a Screen with waves and numerics again,

- Touch the gray box in the center of the screen showing the visitor Screen's name, or press the Main Screen key, to open the **Change Screen** menu and then select a Screen from the list.

## Understanding Profiles

Profiles are predefined monitor configurations. They let you change the configuration of the whole monitor so you can adapt it to different monitoring situations. The changes that occur when you change a complete profile are more far reaching than those made when you change a Screen. Screens affect only what is shown on the display. Profiles affect all monitor and measurement settings.

The settings that are defined by Profiles are grouped into three categories. Each category offers a choice of 'settings blocks' customized for specific monitoring situations. These categories are:

- **Display** (screens)  
Each profile can have a choice of many different predefined screens.  
When you change the profile, the screen selection configured for the new profile becomes active.
- **Measurement Settings**  
Each profile can have a choice of different predefined measurement settings. These relate directly to individual measurements, for example, measurement on/off, measurement color, alarms limits, NBP alarm source, NBP repeat time, temperature unit (°F or °C), pressure unit (mmHg or kPa).
- **Monitor Settings**  
Each profile can have a choice of different predefined monitor settings. These relate to the monitor as a whole; for example, display brightness, alarms off/paused, alarm volume, QRS tone volume, tone modulation, prompt tone volume, wave speed, resp wave speed, pulse source.

You can change from one complete profile to another or swap individual settings blocks (display/monitor settings/measurement settings) to change a subset of a profile. Changes you make to any element within the settings blocks are not saved when you discharge the patient, unless you save them in Configuration Mode.

Depending on your monitor configuration, when you switch on or discharge a patient the monitor either continues with the previous profile, or resets to the default profile configured for that monitor.

### WARNING

If you switch to a different profile, the patient category and paced status normally change to the setting specified in the new profile. However some profiles may be set up to leave the patient category and paced status unchanged. Always check the patient category, paced status, and all alarms and settings, when you change profiles.

When you leave Demonstration Mode, the monitor uses the default profile.

## Swapping a Complete Profile

- 1 Press the SmartKeys hard key and
  - *Either* select **Main Setup** and then **Profiles** in the **Main Setup** menu.
  - *Or* select the **Profiles** SmartKey



- 2 In the **Profiles** menu, select **Profile**.
- 3 Chose a profile from the pop-up list.
- 4 Confirm your selection.

## Swapping a Settings Block

- 1 Select the **Main Setup** SmartKey and then **Profiles** in the **Main Setup** menu.



- 2 Select the **Profile Details** key.
- 3 In the **Profile Details** menu, select **Display** or **Measmnt.Settings** or **Monitor Settings** to call up a list of the settings blocks in each category.
- 4 Choose a settings block from the pop-up list.
- 5 Confirm your selection.

## Default Profile

Your monitor has a default profile that it uses when you leave Demonstration mode, or when you discharge a patient. This profile is indicated by a diamond shaped symbol.

## Understanding Settings

Each aspect of how the monitor works and looks is defined by a setting. There are a number of different categories of settings, including,

**Screen Settings**, to define the selection and appearance of elements on each individual Screen

**Measurement settings**, to define settings unique to each measurement, for example, high and low alarm limits

**Monitor settings**, including settings that affect more than one measurement or Screen and define general aspects of how the monitor works, for example, alarm volume, reports and recordings, and display brightness.

You must be aware that, although many settings can be changed in Monitoring Mode, permanent changes to settings can only be done in the monitor's Configuration Mode. All settings are reset to the stored defaults:

- when you discharge a patient
- when you load a Profile
- when the monitor is switched off for more than one minute (if **Automat. Default** is set to **Yes**).

## Changing Measurement Settings

Each measurement has a setup menu in which you can adjust all of its settings. You can enter a setup menu:

- via the measurement numeric - select the measurement numeric to enter its setup menu. For example, to enter the **Setup ECG** menu, select the HR (heart rate) numeric.
- via the **Main Setup** SmartKey - if you want to setup a measurement when the measurement is switched off, use the **Main Setup** SmartKey and select **Measurements**. Then select the measurement name from the pop-up list. With this permanent key you can access any setup menu in the monitor.
- via the Measurement Selection key.

## Switching a Measurement On and Off

When a measurement is off, its waves and numerics are removed from the monitor's screen. The monitor stops data acquisition and alarming for this measurement.

- 1 Enter the measurement's setup menu and select the measurement.
- 2 Select the measurement name to toggle between on and off. The screen display indicates the active setting.

If you disconnect a transducer, the monitor replaces the measurement numeric with question marks. If you silence the resulting INOP, the measurement is switched off. Also if you pause or switch off alarms, the measurement may be switched off completely, depending on monitor configuration.

## Adjusting a Measurement Wave

To quickly adjust wave-related measurement settings (such as speed or size), select the measurement wave itself. This displays the measurement wave menu, which has only wave-related measurement settings.

## Changing Wave Speeds

Lowering the wave speed compresses the wave and lets you view a longer time period. Increasing the speed expands the waveform, giving you a more detailed view.

The monitor distinguishes two groups of wave speed settings,

- **RespiratorySpeed**, for CO<sub>2</sub> waves.

- **Global Speed**, for all waves not included in the other group.

### Changing the Wave Group Speed

The wave speed group setting defines the speed of all the waves in the group.

To change the wave speed of a wave speed group,

- 1 Select **Main Setup** and then select **User Interface**
- 2 Select **Global Speed** or **RespiratorySpeed**, as required
- 3 Select a value from the list of available speeds.

### Changing Wave Speed for a Channel

To change the wave speed of an individual wave channel,

- 1 Enter the wave menu for a measurement by selecting its wave.
- 2 Select **Change Speed**.
- 3 To set the speed to the wave group speed, select **RespiratorySpeed** or **Global Speed**.

To set an individual channel speed, select a numeric value from the list of available speeds. This overrides the wave group speed setting and sets the speed for the individual wave channel on the monitor Screen. The wave channel speed is independent of the wave (label) depicted in the channel, if you change the wave, the new wave will retain the set channel speed.

## Using Labels

You can measure up to three invasive pressures and temperatures simultaneously. The monitor uses the labels to distinguish between them. The default settings defined in the profile (such as measurement color, wave scale, and alarm settings) are stored within each label. When you assign a label to a measurement, the monitor automatically applies these default settings to the measurement. The labels assigned are used throughout the monitor, in reports, recordings, and in trends.

### Changing Measurement Labels (e.g. Pressure)

To change a measurement label of a measurement with multiple labels (e.g. invasive pressure or temperature),

- 1 Enter the wave menu of the measurement.
- 2 Select **Label**.
- 3 Choose a label from the list.

The monitor automatically applies the scale, color, etc. settings stored in the Profile for the label you select. You can change scale settings in Monitoring Mode, but color can only be changed in the monitor's Configuration Mode.

Any labels already being used in the monitor are shown "grayed-out" in the list and cannot be selected.

### Resolving Label Conflicts

Each label must be unique, that is, it can only be assigned once. If you have an MMS Extension equipped with a pressure measurement connected to the monitor, there is a potential conflict with, for example, the ABP label. If you manually enter measurement values these may also conflict with existing labels on the monitor.

Depending on your configuration, the monitor will either

- display the **Measurement Selection** window automatically for you to resolve the conflict
- take no action, you must enter the **Measurement Selection** window (using the measurement selection key) and resolve the conflict

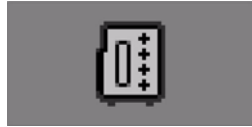

Measurement selection key

All the currently available measurements are depicted in the **Measurement Selection** window. Any measurement labels causing a label conflict are shown in red. If a measurement is connected but currently unavailable, for example, because it was deactivated due to a label conflict, that measurement is shown "grayed-out". If an MMS Extension is not available, for example if monitor is running on battery power and not an external power source, the MMS Extension is not displayed.



- 1 Unavailable measurement shown grayed-out

An MMS Extension is only shown in the **Measurement Selection** window when the monitor is connected to the external power supply (M8023A) and running on AC mains power, and not when running on battery power.

To resolve a label conflict:

- 1 Press the SmartKeys key and
  - Either select **Main Setup** and then **Meas. Selection**
  - Or select the **Measmt. Select.** SmartKey to display the **Measurement Selection** window.
- 2 Select the label to be corrected.
- 3 Use the measurement selection keys to resolve the conflict. Select either:
  - **Change Label:** to assign a different label to the conflicting label.

- **De- Activate:** to disable the conflicting measurement. It retains its label for future use but becomes invisible to the monitor, as though it had been unplugged.
- **Setup <Measurement Label>:** to enter the Setup menu for the measurement and change the conflicting device's label to a different label.

### Label Compatibility

When a new measurement is introduced, or new labels for an existing measurement, these labels will not be shown on older Information Centers, and consequently not on the Overview screen sourced from the Information Center.

When a patient is transferred from a monitor with these new labels to one with an older software revision, the labels will be replaced with a generic label for that measurement. The settings for that generic label will then be used.

If it is critical that the measurement labels are available at the Information Center and after transfers, the older monitors and the Information Center must be upgraded to the appropriate software revision.

### Using IntelliVue Cableless Measurements

The IntelliVue CL SpO<sub>2</sub> Pod or IntelliVue CL NBP Pod can be used together with a monitor with an SRR interface for continuous monitoring. They communicate their measurement values via short range radio to the monitor. The Cableless Measurements allow the patients more mobility without giving up continuous vital signs monitoring.

### Adding a Cableless Measurement Device

When using an IntelliVue CL SpO<sub>2</sub> Pod or an IntelliVue CL NBP Pod for continuous monitoring, you need to assign the cableless measurement device to the monitor.

- 1 Select the Measurement Selection key
- 2 Select the **Add Cbleless** pop-up key

This opens the **Add Cableless** window, which shows any available IntelliVue Cableless Measurements and telemetry devices:



If the device you want to add is not visible, press one of the keys on the device to make the connection and display the device in the window.

- 3 Select the cableless measurement device to be added. The device confirms the successful addition with a tone.

If the corresponding internal measurement in the patient monitor is active, you will be asked to confirm that it should be deactivated in favor of the cableless measurement device.

Adding a device can also be done directly on the cableless measurement devices. See the IntelliVue Cableless Measurements Instructions for Use for details.



**WARNING**

Short Range Radio connections are subject to interruption due to interference from other radio sources in the vicinity, including microwaves, bluetooth devices, WLAN devices (802.11b,g,n) and cordless phones. Depending on the strength and duration of the interference, the interruption may occur for an extended period. A loss of connection, due to moving out-of-range, interference, or for other reasons, is indicated with a **No Host Monitoring** INOP on the NBP or SpO<sub>2</sub> Pods, or a **cl NBP Disconnect** or **cl SpO<sub>2</sub> Disconnect** INOP at the host monitor. Correct channel configuration is important, refer to the *Configuration Guide* for details.

## Removing a Cableless Measurement Device

To remove a cableless measurement device from a monitor and end the assignment:

- 1 Select the Measurement Selection key.
- 2 Select the cableless measurement device to be removed.
- 3 Select the **Remove** pop-up key.

## Changing Monitor Settings

To change monitor settings such as brightness, or QRS tone volume:

- 1 Press the SmartKeys key .
- 2 *Either* Select the appropriate SmartKey for the setting you want to change  
*Or* Enter the **Main Setup** menu by selecting the **Main Setup** SmartKey; then select **User Interface** to enter a submenu where you can change the settings.

## Adjusting the Screen Brightness

- 1 Select the **Brightness** SmartKey.



- 2 Select the appropriate setting for the screen brightness. 10 is the brightest, 1 is the least bright. **Optimum** is suitable for most monitoring locations and optimizes power usage for battery powered monitors.

Your monitor may be configured with a lower brightness for Standby mode and also for transport to conserve battery power. These settings can only be changed in the monitor's Configuration Mode.

## Setting the Date and Time

Enter the **Main Setup** menu by selecting the **Main Setup** SmartKey, then select **Date, Time** to enter the **Date, Time** menu.

- 1 Select, in turn, the **Year, Month, Day, Hour** (in 24 hour format, only) and **Minute** as necessary. Select the correct values from the pop-up list.
- 2 Select **Store Date, Time** to change the date and time.

If your monitor is connected to an Information Center, the date and time are automatically taken from this. Once it is set, the internal clock retains the setting even when you switch off the monitor.

# Checking Your Monitor Revision

- 1 Select **Main Setup** then select **Revisions** to open the **Monitor Revision** menu.
- 2 Select the correct device from the device pop-up keys.
- 3 From the **Monitor Revision** menu, select the monitor component for which you need revision information.

# Getting Started

Once you understand the basic operation principles and have completed the Training Program, you can get ready for monitoring.

## Inspecting the Monitor

---

### WARNING

If the monitor is mechanically damaged, or if it is not working properly, do not use it for any monitoring procedure on a patient. Contact your service personnel.

---

- 1 Before you start to make measurements, carry out the following checks on the monitor.
  - Check for any mechanical damage.
  - Check all the external cables, plug-ins and accessories.
- 2 Always ensure that the battery is loaded in the battery compartment when monitoring a patient, even when the monitor is running on external power.
- 3 If you are using battery power, ensure that the battery has sufficient power for monitoring. When you use a battery for the first time, you must charge it, following the instructions given in the section on charging batteries in the Using Batteries chapter.
- 4 Check all the functions of that you need to monitor the patient, and ensure that the monitor is in good working order.

### NOTE

Measurements from an MMS extension are only available when the extension is connected to the monitor, **and** the monitor is running on external power. This is the case when the monitor is running on AC mains via the external power supply (M8023A) or is attached to the Battery Extension (865297).

## Switching On

Press the power on/standby switch on the monitor for one second. The monitor performs a self test during which all lamps will light up and a tone will be sounded, and is then ready to use. If you see a message such as **CO<sub>2</sub> Sens Warmup** wait until it disappears before starting to monitor that measurement.

## Power On/Power Off Behavior

The general rules determining the behavior of the monitor when connected to, or disconnected from power are as follows:

- A monitor that was switched on prior to a temporary power loss switches on again when power is restored.
- A monitor that was switched off prior to a temporary power loss remains off when power is restored.
- When AC mains power is lost, a battery powered monitor continues to run without interruption on battery power.

## Setting up the Measurements

- 1 Decide which measurements you want to make.
- 2 Connect the required patient cables and sensors. The connectors are color-coded to the patient cables and sensors for easy identification.

---

### WARNING

When connecting devices for acquiring measurements, always position cables and tubing carefully to avoid entanglement or potential strangulation.

---

- 3 If using IntelliVue Cableless Measurements,
  - apply the SpO<sub>2</sub> sensors and/or NBP cuffs to the patient as described in the cableless measurements Instructions for Use.
  - assign the cableless measurements to the monitor:
    - select the Measurement Selection key
    - select the **Add Cbleless** pop-up key
    - select the cableless measurement device to be assigned

If the internal measurement in the patient monitor is active, you will need to confirm that it should be deactivated in favor of the assigned cableless measurement device.

## Starting Monitoring

After you switch on the monitor,

- 1 Admit your patient to the monitor.
- 2 Check that the profile, alarm limits, alarm and QRS volumes, patient category and paced status and so forth are appropriate for your patient. Change them if necessary.
- 3 Refer to the appropriate measurement chapter for further details of how to perform the measurements you require.

## Disconnecting from AC Mains Power

To disconnect the monitor from AC mains power, unplug the power cord for the external power supply (M8023A) from the mains socket.

# Monitoring After a Power Failure

If external power is disconnected or there is a power failure, the monitor continues to run on its rechargeable battery.

If the monitor is without any power (no external power or the battery is empty) for **less** than one minute, monitoring will resume with all active settings unchanged. If the monitor is without power for **more** than one minute, the behavior depends on your configuration. If **Automat. Default** is set to **Yes**, the default profile will be loaded when power is restored. If **Automat. Default** is set to **No**, all active settings are retained, if power is restored within 48 hours. The **Automat. Default** setting is made in Configuration Mode.

# Networked Monitoring

You can connect your monitor to an Information Center on a network, using one of the optional interfaces:

- Standard wired LAN
- Wireless LAN
- IntelliVue Instrument Telemetry System (IIT).

---

### WARNING

Do not connect patient monitors to the standard hospital network.

---

If your monitor is connected to a network, a network symbol is displayed in the upper left corner next to the bed label. To see details about the monitoring equipment and technical information about the network, select the **Main Setup** SmartKey to enter the **Main Setup** menu, then select **Bed Information**.

Be aware that some network-based functions may be limited for monitors on wireless networks in comparison to those on wired networks.

# Capturing Alarm Reports and Printing

You can print out standard reports, alarm reports and trends with the IntelliVue XDS Solution. This is a software package which allows you to print to a standard, off-the-shelf printer or to an electronic file such as PDF. You can download the IntelliVue XDS Solution free-of-charge from the Internet and install it on an existing PC.

## Capturing Alarm Reports

The monitor can be set up to automatically capture alarm reports, triggered by selected alarms. The necessary settings must be made in Configuration mode.

When one of the selected alarms occurs, the monitor automatically captures the alarm and creates a report which is stored in the database. As soon as the monitor is connected to a PC or network with the IntelliVue XDS Solution software, it will automatically print the reports, or send them to a patient-specific folder as an electronic file.

---

# What's New?

This section lists the most important new features and improvements to the monitor and its user interface introduced with each release. Further information is provided in other sections of this book.

You may not have all of these features, depending on the monitor configuration purchased by your hospital.

## What's New in Release J.0

### Flexible, Patient-oriented Workflow (with PIIC iX only)

With the IntelliVue Information Center iX, more flexible, patient-oriented workflows are supported for admitting, tracking and transferring patients. This allows you to adapt monitor use to the patient data flow models in your specific facility and department.

#### Managing Patients

When the patient monitor is connected to an IntelliVue Information Center iX, an extended comparison of patient data allows more intelligent admission and transfer procedures. A **Find Patient** key can be used to search through the patient lists at the Information Center and other connected systems and take over the corresponding data found.

#### Flexible Transfer

A transfer can be initiated in the unit at the monitor, on patient arrival or patient departure, or centrally at the Information Center.

#### Managing Equipment

When used together with an Information Center iX, extended equipment management functionality is now available. Depending on how equipment is used in your facility, there are various ways to associate devices with patients, beds or monitors.

Additionally there are mechanisms to automatically free up equipment that is no longer used. Using the new **Equipment** window you have an overview of all equipment being used for a patient, together with patient and caregiver data.

### Alarm Functionality Enhancements

- Pause Yellow Alarms (with PIIC iX only) - up until now, the **Pause Alarms / Alarms Off** key switched off or paused all red and yellow alarms. Now an alarm priority configuration setting is available to have only yellow alarms affected.
- **Pause Alarms / Alarms Off** not allowed - when the alarm priority is set to **Not Allowed**, alarms can no longer be switched off or paused. The **Pause Alarms / Alarms Off** key is disabled.

- **Pause Alarms / Alarms Off** key can be removed from the screen - a configuration setting removes the permanent key from the screen to avoid unintentional switching off of alarms. Alarms can still be switched off or paused, in the **Alarms** menu, under **Main Setup**.
- Alarms paused after Standby mode - alarms are automatically paused for 1 minute after Standby mode to allow time for patient connection.

## Capture 12-Lead ECG Enhancements (with PIIC iX only)

The existing 12-Lead ECG capture functionality has been extended to offer:

- Download of analysis results from the IntelliVue Information Center.
- Download of 12-Lead captures from the IntelliVue Information Center for review at the patient monitor.
- Analysis results included in reports and additional report selections with ST Map.
- Remote operation of the 12-Lead Export function at the IntelliVue Information Center.
- Remote operation of the 12-Lead Lock/Unlock function at the IntelliVue Information Center.
- New filter settings that are used as a default for future 12-Lead captures.

## New "End Afib" and "End Irregular HR" Alarms

The end of an atrial fibrillation or irregular HR phase is announced with an **\*\* End AFIB** or **\*\*End Irregular HR** alarm. The delay time before the alarm is announced can be configured.

## Integrated Pulmonary Index for Microstream CO2

An Integrated Pulmonary Index (IPI) numeric is provided, that is an indication of the patient's overall ventilatory status based on four measurement parameters: etCO<sub>2</sub>, awRR, pulse rate and SpO<sub>2</sub>.

## Improved Visibility of Gridlines in Overlapping Waves

Visibility of the gridlines for overlapping waves has been improved, and you can now configure gridlines to be shown in white, if you prefer, in a thin or thick style.

## Timeout for "Aged" Numerics

NBP and SpO<sub>2</sub> numerics from intermittent measurements can be configured to be grayed out or to disappear from the screen after a set time. This avoids older numerics being misinterpreted as current data. The time can be set individually for SpO<sub>2</sub> and NBP in Configuration mode.

# What's New in Release H.0

### Battery Extension

The new Battery Extension provides additional battery power for situations when no mains power is available, for example during transport, and can typically power the monitor with MMS Extension for at least 6 hours.

### New Design for the User Interface

The user interface for the patient monitors has been redesigned to bring the presented information into the foreground, letting the structural elements such as keys and frames retreat into the

background. Additionally special regard was given to improved usability and compatibility with standard software products.

### 12 Lead ECG Enhancements

You can now preview the 12-Lead ECG at the bedside before you send it to the Information Center. A new dedicated 12-Lead ECG Report can be printed in diagnostic quality from the bedside.

### Support For Use of IntelliVue Cableless Measurement Devices

The new Cableless Measurement Devices are patient-worn, battery powered measurement devices for SpO<sub>2</sub> and NBP. The devices provide measurement values on the built-in display and communicate them to the monitor using a wireless short range radio (SRR) interface. They can also be controlled via SRR from an assigned patient monitor.

### Vital Signs Trend Based on NBP Measurement Times

You can now have the NBP measurement determine the interval between the columns on the Vital Signs trend. Each NBP measurement will generate a column in the trend table. The values for the other measurements are added to the column to provide a complete vital signs set for the NBP measurement time.

## What's New in Release G.0?

### Short Range Radio Interface for MP2

A short range radio interface is now available for the MP2 monitor. This allows a telemetry transceiver with a short range radio adapter to be assigned to the monitor, resulting in a direct connection. The measurement data from the telemetry transceiver appear directly on the monitor screen with a minimal delay and are combined with the monitor data in one sector at the Information Center.

### IntelliVue XDS Solution

Using the IntelliVue XDS solution it is possible to view an independent monitor screen on an external display. The XDS solution consists of a medical grade PC-based hardware platform, XDS application software and the XDS connectivity option on the monitor. Depending on the configuration you can also operate the monitor from the external display. The XDS must be connected to the same Local Area Network (LAN) as the monitor.

It is also possible to use an existing PC, connected to the same LAN, to host the XDS Application software.

### New Fields in the Admission Form

A Middle Name field is now available in the admission form - whether it appears is configurable. Two additional ID fields, Lifetime Id and Encounter Id, can also be configured to appear and their names can be customized to fit hospital requirements.

### SpO<sub>2</sub> Enhancements

- Additional SpO<sub>2</sub> Labels - **SpO<sub>2</sub>pr** and **SpO<sub>2</sub>po** labels have been added.
- New manual measurement mode when telemetry devices are connected via a short range radio link.
- Signal Quality Indicator displayed with the SpO<sub>2</sub> numerics.

### ECG Enhancements

- New **\* AFIB** / **\*\* AFIB** yellow alarm when an atrial fibrillation waveform is detected.

- **QT View** window - shows current wave and baseline wave with Q and T points marked so that you can verify that the QT algorithm detects correct Q and T points.

## What's New in Release F.0?

### QT/QTc Interval Monitoring

QT interval monitoring is used to assist in the detection of prolonged QT interval syndrome. The QT interval is measured and the heart-rate corrected QT value, QTc, is calculated. The monitor also provides a  $\Delta$ QTc value which tracks variation in the QT interval in relation to a baseline value. High alarm limits can be set for QTc and  $\Delta$ QTc enabling alarm notification.

### Manual Data Entry

Measurement values (for example lab data or manually measured temperatures) can be entered manually into the monitor and stored in the database. They can then be used for trends, reports and also be displayed as a numeric on screen, if required.

### Horizon Trend Enhancements

The trend indicator arrow indicates how the patient trend has developed in a set time period. This period is now configurable and can be set to 10 minutes, 5 minutes or 2 minutes. The horizon (or baseline) can now be set to a range or to a specific value.

### NBP - Programmable Measurement Sequence

Up to four measurement cycles can be set up which will run consecutively. For each cycle you can set the number of measurements and the interval between them. By setting the last cycle to run continuously you can have regular measurements continue after the sequence has run.

### New Printing Options For Reports

Reports can now also be printed via an external PC-based print server or to an internal print database, when no printer is available (for example, during transport). As soon as a printer becomes available, the reports stored in the database will print automatically.

### Manual Pairing At Monitor

Previously, devices could only be manually paired at the Information Center. You can now pair devices at the monitor as long as the monitor is already connected to the Information Center.

### Moving Windows And Menus

Windows and menus can now be moved on the monitor screen. Using touch or a mouse you can select the title of a window and then "drag" it across the screen. Some positions on the screen are not allowed, such as ones overlapping the alarm field or the monitor info line.

### Invasive Pressure Changes

**Wave cursor** - A cursor is now available on the realtime pressure wave to allow you to define a position and store the corresponding value.

**Reduced alarm limit steps in lower ranges** - The alarm limits setting in 2 mmHg steps is now possible in ranges up to 50 mmHg (previously up to 30 mmHg).

### New Patient Check

The monitor can be configured to ask you in certain situations: after a specified power-off period, after a specified standby period and when no basic vitals (HR, RR, Pulse, SpO<sub>2</sub>, NBP) have been measured for a specified period, whether a new patient is now being monitored. By selecting the **Yes** pop-up key you can discharge the previous patient and reset settings.



**New Smart Keys**

A SmartKey is available for **New Lead Setup** when a new ECG lead set with fewer leads than previously is being used.

**Better Visibility Of Gridlines**

The brightness of the gridlines on the realtime waves has been increased for better visibility.



---

# Alarms

The alarm information here applies to all measurements. Measurement-specific alarm information is discussed in the sections on individual measurements.

The monitor has two different types of alarm: patient alarms and INOPs.

## Patient Alarms

Patient Alarms are red and yellow alarms. A red alarm indicates a high priority patient alarm such as a potentially life threatening situation (for example, asystole). A yellow alarm indicates a lower priority patient alarm (for example, a respiration alarm limit violation). Additionally there are short yellow alarms, most of which are specific to arrhythmia-related patient conditions (for example, ventricular bigeminy).

## INOPs

INOPs are technical alarms, they indicate that the monitor cannot measure or detect alarm conditions reliably. If an INOP interrupts monitoring and alarm detection (for example, **Leads Off**), the monitor places a question mark in place of the measurement numeric and an audible indicator tone will be sounded. INOPs without this audible indicator indicate that there may be a problem with the reliability of the data, but that monitoring is not interrupted.

Most INOPs are light blue, however there are a small number of INOPs which are always yellow or red to indicate a severity corresponding to red and yellow alarms. The following INOPs can also be configured as red or yellow INOPs to provide a severity indication:

- **ECG Leads Off**
- **NBP Cuff Overpress**
- **Cuff Not Deflated**
- **Occlusion**
- **<SpO<sub>2</sub> Label> No Pulse**
- **<Press Label> No Pulse**
- **Tele Disconnected**
- **Battery Empty / Replace Battery**

All monitors in a unit should have the same severity configured for these INOPs.

### Alarm Delays

There is a delay between a physiological event at the measurement site and the corresponding alarm indication at the monitor. This delay has two components:

- **The general measurement delay time is the time between the occurrence of the physiological event and when this event is represented by the displayed numerical values.** This delay depends on the algorithmic processing and, for certain measurements (SpO<sub>2</sub>, EEG and BIS), on the configured averaging time. The longer the averaging time configured, the longer the time needed until the numerical values reflect the physiological event.
- **The time between the displayed numerical values crossing an alarm limit and the alarm indication on the monitor.** This delay is the sum of the alarm delay configured for the specific measurement plus the system alarm delay. The system alarm delay is the processing time the system needs for any alarm on the monitor to be indicated after the measurement has triggered the alarm. See the performance specifications in the Specifications chapter for the system alarm delay specification.

The alarm delay configured for a specific measurement is normally a fixed time. For SpO<sub>2</sub> it is also possible to configure a Smart Alarm Delay that is calculated using an intelligent algorithm. See “Smart Alarm Delays” on page 171 in the SpO<sub>2</sub> chapter for more details.

### Multiple Alarms

If more than one alarm is active, the alarm messages are shown in the alarm status area in succession. An arrow symbol next to the alarm message informs you that more than one message is active.

The monitor sounds an audible indicator for the highest priority alarm. If more than one alarm condition is active in the same measurement, the monitor announces the most severe. Your monitor may be configured to increase alarm indicator volume automatically during the time when the alarm is not acknowledged.

## Visual Alarm Indicators

### Alarm Message

An alarm message text appears in the alarm status area at the top of the screen indicating the source of the alarm. There is a field for INOPs (light blue, red or yellow) and a field for patient alarms, which is shared for red and yellow alarms. If more than one measurement is in an alarm condition, the message changes every two seconds, and has an arrow at the side. If both red and yellow alarm conditions are active simultaneously, they alternate every two seconds in the patient alarms field. The background color of the alarm message matches the alarm priority: red for red alarms, yellow for yellow alarms, light blue for standard INOPs, red for red INOPs and yellow for yellow INOPs. The asterisk symbols (\*) beside the alarm message match the alarm priority: \*\*\* for red alarms, \*\* for yellow alarms, \* for short yellow alarms. Standard INOPs do not have a symbol, red and yellow INOPs have exclamation marks beside the alarm message: !!! for red INOPs and !! for yellow INOPs.

Depending on how your monitor is configured, it may display alarm limit violation messages

- in text form, for example **\*\* SpO<sub>2</sub> Low** or
- in numeric form, for example **\*\*Pulse xxx>yyy** where the first number shows the maximum deviation from the alarm limit, and the second number shows the currently set limit.

### Flashing Numeric

The numeric of the measurement in alarm flashes.

## Bright Alarm Limits

If the alarm was triggered by an alarm limit violation, the corresponding alarm limit on the monitor screen is shown more brightly if **Show AlarmLimits** is enabled and there is sufficient room on the screen.

## Alarm Lamp

A lamp on the monitor's front panel flashes. The alarm lamp is divided into two sections. The right one flashes for a patient alarm, except for short yellow alarms where the lamp will light for approximately six seconds. The color is yellow or red corresponding to the highest priority patient alarm currently present. The left one lights continuously for a light blue INOP and flashes for yellow or red INOPs as follows:

INOP Lamp Color	On	Off
Yellow	1.0 seconds	1.0 seconds
Red	0.25 seconds	0.25 seconds

If only patient alarms are present, and no INOPs, the patient alarms will use both left and right sections to flash (for red and yellow alarms) or light for approximately six seconds (for short yellow alarms). If only INOPs are present, and no patient alarms, red and yellow INOPs will use both left and right sections to flash but light blue INOPs will always light continuously in the left section only.

## Audible Alarm Indicators

The audible alarm indicators configured for your monitor depend on which alarm standard applies in your hospital. Audible alarm indicator patterns are repeated until you acknowledge the alarm by switching it off or pausing it, or until the alarm condition ceases (if audible alarm indication is set to non-latching).

---

### WARNING

- Do not rely exclusively on the audible alarm system for patient monitoring. Adjustment of alarm volume to a low level or off during patient monitoring may result in patient danger. Remember that the most reliable method of patient monitoring combines close personal surveillance with correct operation of monitoring equipment.
- 

## Alarm Tone Configuration

The audible alarm indicators of your monitor are configurable. In the monitor's Configuration Mode, you can:

- increase the alarm volume of unacknowledged alarms at regular intervals
- change the interval between alarm sounds (ISO/IEC Standard alarms only)
- change the base volume of the red and yellow alarm tones and the INOP tones
- change the alarm sound to suit the different alarm standards valid in different countries.

## Traditional Audible Alarms (HP/Agilent/Philips/Carenet)

- Red alarms and red INOPs: A high pitched sound is repeated once a second.
- Two-star yellow alarms and yellow INOPs: A lower pitched sound is repeated every two seconds.
- One-star yellow alarms (short yellow alarms): The audible indicator is the same as for yellow alarms, but of shorter duration.
- Standard INOPs: an INOP tone is repeated every two seconds.

## ISO/IEC Standard Audible Alarms

- Red alarms and red INOPs: A high pitched tone is repeated five times, followed by a configurable pause.
- Two-star yellow alarms and yellow INOPs: A lower pitched tone is repeated three times, followed by a configurable pause.
- One-star yellow alarms (short yellow alarms): The audible indicator is the same as for yellow alarms, but of shorter duration.
- Standard INOPs: a lower pitched tone is repeated twice, followed by a pause.

## Changing the Alarm Tone Volume

If you want to change the alarm volume setting, or see where the current setting is on a scale from zero to 10, select the **Alarm Volume** SmartKey. The volume scale pops up. The current setting is indented. To change the setting, select the required number on the scale. Any settings that are inactive ("grayed out") have been disabled in the monitor's Configuration Mode.



When the alarm volume is set to zero (off), the alarm volume symbol reflects this. If you switch the alarm volume off, you will not get any audible indication of alarm conditions.

## Minimum Volume for No Central Monitoring INOP

If your monitor is connected to an Information Center, and the connection is interrupted, the INOP message **No Central Monit.** will appear within 30 seconds, accompanied by an INOP tone. To help ensure that this INOP, and any other active alarm, is not overlooked, the INOP and alarm tones may be configured to have a minimum volume. In this case, INOP and alarm tones will sound even if the monitor alarm volume is set to zero.

## Minimum Volume for Severe Yellow or Red INOPs

Severe yellow or red INOPs require action to ensure the well-being of the patient. Therefore the minimum volume for the INOP tone is set to at least alarm volume 8, irrespective of the current alarm volume setting. The INOP tone will sound even if the monitor alarm volume is set to zero.

The severe INOPs for which this applies are:

**Cuff Not Deflated** (configurable to yellow or red)

**NBP Cuff Overpress** (configurable to yellow or red)



**!! Insert Battery** (yellow)

**Battery Empty / Replace Battery** (configurable to light blue, yellow or red)

## Acknowledging Alarms



To acknowledge all active alarms and INOPs, press the Silence key. This switches off the audible alarm indicators and alarm lamps.

A check mark beside the alarm message indicates that the alarm has been acknowledged . If the monitor is configured to re-alarm, a dashed check mark will be shown .



If the condition that triggered the alarm is still present after the alarm has been acknowledged, the alarm message stays on the screen with a check mark symbol beside it, except for NBP alarms and alarms from other intermittent measurements. When such an alarm is acknowledged the alarm message disappears.

If the alarm condition is no longer present, all alarm indicators stop and the alarm is reset.

Switching off the alarms for the measurement in alarm, or switching off the measurement itself, also stops alarm indication.

## Acknowledging Disconnect INOPs

Acknowledging an INOP that results from a disconnected transducer switches off the associated measurement. The only exception is ECG/Resp: acknowledging a disconnect INOP for ECG leads does not switch off the ECG and Resp measurements. Acknowledging a disconnect INOP at the Information Center switches off the audible INOP indicator but does not switch off the measurement.

## Alarm Reminder

If **Alarm Reminder** is configured on for your monitor, you will get an audible reminder of alarm conditions that remain active after you have acknowledged the alarm. This reminder may take the form of a repetition of the alarm tone for a limited time, or an unlimited repetition of the alarm tone (this is the same as a new alarm). **Alarm Reminder** is not available for standard, light blue INOPs but for yellow and red INOPs.

In Configuration Mode, you can set the interval between silencing the alarm and sounding the reminder tone to one, two, or three minutes.

The alarm reminder behavior at the Information Center is different to that at the monitor. Refer to the Information Center Instructions for Use for further information.

## Pausing or Switching Off Alarms

If you want to temporarily prevent alarms from sounding, for example while you are moving a patient, you can pause alarms. Depending on your monitor configuration, alarms are paused for one, two, or three minutes, or infinitely. Infinite alarm pause is equivalent to switching the alarms off.

To view the alarm pause setting chosen for your unit,

- 1 Select **Main Setup, Alarms**, then **Alarm Settings**
- 2 Check the **Alarms Off** setting.

This setting can only be changed in Configuration Mode.

There are some settings made in Configuration Mode that can affect the availability of the pause alarms functionality.

- The Alarms key can be disabled to avoid unintentional switching off of alarms. In this case you can only pause alarms or switch alarms off permanently in the **Alarms** menu, under **Main Setup**.
- The Alarms key can be configured to pause or switch off red and yellow alarms, yellow alarms only, or not to function at all. If it is configured not to function, you cannot pause alarms or switch alarms off permanently.

### To Pause All Alarms

- Press the Alarms key.

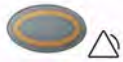

- If your monitor is configured to infinite pause time, the lamp next to the alarms off symbol is red or yellow, depending on the configuration, and pressing this key switches alarms off.



Depending on the configuration, you may need to select **Confirm** to complete the change.

### To Switch All Alarms Off

You can only switch alarms off permanently if your monitor is configured to allow infinite alarms pause.

- Press the Alarms key.

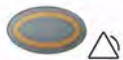

Pausing alarms infinitely is the same as switching them off.

### To Switch Individual Measurement Alarms On or Off

- 1 Select the measurement numeric to enter its setup menu.
- 2 Select **Alarms** to switch between on and off.

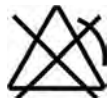



The alarms off symbol is shown beside the measurement numeric.

## While Alarms are Paused or Off

### When red alarms are paused or off:

- The red Alarms Paused lamp on the monitor front panel is lit.  
In the alarm field, the monitor displays the message **Al. Paused x:yy** or **Alarms Off**, together with the alarms paused symbol or the alarms off symbol.

### When yellow alarms are paused or off:

- The yellow Alarms Paused lamp on the monitor front panel is lit.  
In the alarm field, the monitor displays the message **YellowPaused x:yy** or **Yellow Alarms Off**, together with the alarms paused symbol or the alarms off symbol.

### For red and yellow alarms:

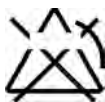

Alarms Paused

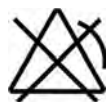

Alarms Off

- No alarms are sounded and no alarm messages are shown.
- INOP messages are shown but no INOP tones are sounded.  
The only exceptions are the INOPs **Cuff Not Deflated**, **NBP Cuff Overpress** and INOPs relating to empty, missing and malfunctioning batteries.

These INOPs switch the alarms on, and the INOP tones are sounded, even if alarms are paused or off. You need to remove the INOP condition first before you can switch the alarm tones off again.

If a disconnect INOP is present and alarms are paused or switched off, the measurement in question may be switched off, depending on monitor configuration.

## Restarting Paused Alarms

To manually switch on alarm indication again after a pause, press the Alarms key again.

Alarm indication starts again automatically after the pause period expires. If the monitor is configured to stay paused infinitely, you must select **Alarms Off** again to restart alarm indication.

## Resetting Arrhythmia Alarm Timeouts

To reset the arrhythmia alarm timeout period, press the Alarms key and then press it again.

## Extending the Alarm Pause Time

If your monitor has extended alarm pause enabled, you can extend the alarm pause time. Use this to prevent alarms being indicated, for example, while you are washing a patient or carrying out a procedure. Only extend the alarm pause time when you are sure that clinical personnel are available to monitor the patient's condition closely.

To extend the alarm pause time to five or 10 minutes,

- Select one of the alarm fields. This calls up the **Alarm Messages** window.
- Select either the pop-up key **PauseAl. 5 Min** or the pop-up key **PauseAl. 10 Min**. Each time you select one of these pop-up keys, the Alarm Pause Time is reset to five (or 10) minutes.

## Alarm Limits

The alarm limits you set determine the conditions that trigger yellow and red limit alarms. For some measurements (for example, SpO<sub>2</sub>), where the value ranges from 100 to 0, setting the high alarm limit to 100 switches the high alarm off. In these cases, the alarms off symbol is not displayed.

---

### WARNING

Be aware that the monitors in your care area may each have different alarm settings, to suit different patients. Always check that the alarm settings are appropriate for your patient before you start monitoring.

---

## Viewing Individual Alarm Limits

You can usually see the alarm limits set for each measurement next to the measurement numeric on the main screen.



If your monitor is not configured to show the alarm limits next to the numeric, or if the numeric is so small that the limits cannot be displayed, you can see them in the appropriate measurement setup menu. Select the measurement numeric to enter the menu and check the limits.

## Viewing All Alarm Limits

The **Alarm Limits** overview window lists the currently set alarm limits for all measurements. If an Apnea alarm delay time is set, this is also shown. The alarms off symbol is shown beside the measurement label of any measurement whose alarm switched off.



To open the **Alarm Limits** window, either select one of the alarm fields then select the **Alarm Limits** pop-up key, or select the **Alarm Limits** SmartKey, if configured.

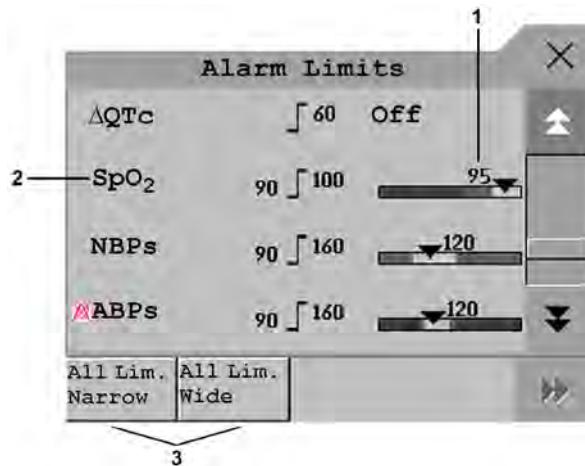

- 1 Graphic view of current yellow and red alarm limits and currently monitored measurement value. **Off** indicates the measurement is switched off
- 2 Measurement labels, with alarms off symbol where appropriate
- 3 Set narrow or wide alarm AutoLimits for all measurements

Select **Show ST Limits** to expand the list of ST leads and view the currently set alarm limits. Selecting **Hide ST Limits** hides the list again.

You can use the pop-up keys that open with the **Alarm Limits** window to perform common tasks:

- **All Lim. Narrow/All Lim. Wide** to set narrow or wide alarm AutoLimits for all measurements.

These pop-up keys are not available in the window for changing individual alarm limits which you access by selecting the measurement label in the **Alarm Limits** window.

## Changing Alarm Limits

To change individual measurement alarm limits using the measurement's Setup Menu,

- 1 In the measurement's setup menu, select the alarm limit you want to change. This calls up a list of available values for the alarm limit.
- 2 Select a value from the list to adjust the alarm limit.

For example, to change the alarm limits for SpO<sub>2</sub>:

- Touch the high limit on the alarm limits menu button.

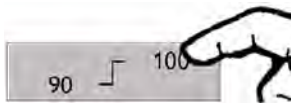

- Choose the high alarm limit from the pop-up list that opens.
- Touch the low limit on the alarm limits menu button.



- Choose the low alarm limit from the pop-up list that opens.

Alternatively, you can use the keys in the measurement alarm limits window, which you access by selecting the measurement label in the **Alarm Limits** window.

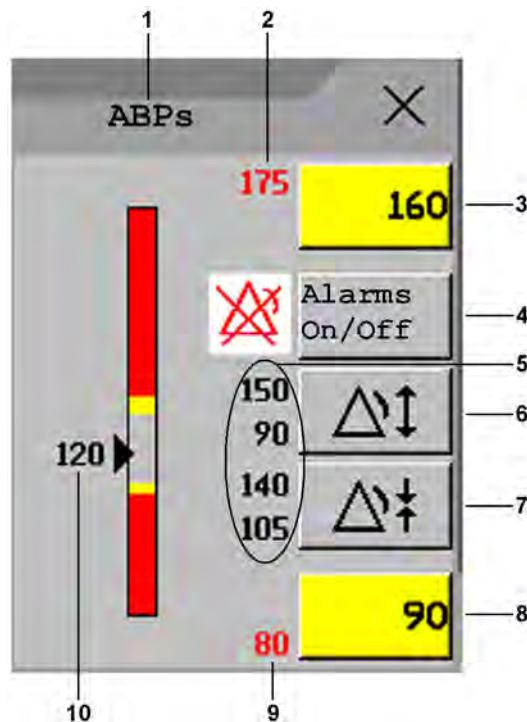

- 1 Parameter label
- 2 High red alarm (view only)
- 3 High yellow alarm field. Select to open a pop-up list of high alarm limits
- 4 **Alarms On/Off** key - select to toggle between alarms on or off
- 5 Preview Alarm AutoLimits for a measurement before applying
- 6 Select to apply wide AutoLimits
- 7 Select to apply narrow AutoLimits
- 8 Low yellow alarm field. Select to open a pop-up list of low alarm limits
- 9 Low red alarm (view only)
- 10 Graphic view of alarm limits with currently measured value

To change alarm limits,

- 1 Enter the **Alarm Limits** window.
- 2 To set the high alarm limit, select the high yellow alarm field to open a pop-up list of high alarm limits. Select a limit from the list. Repeat to set the low yellow alarm field.

If you set the yellow alarm limit outside the red alarm limit, the monitor will automatically set the red alarm to the yellow alarm limit.

When an ST measurement is in the alarm limits window there are also two pop-up keys available labeled **All ST Narrow/All ST Wide**. With these keys you can set Auto Limits for all ST Leads.

## About Automatic Alarm Limits

The monitor can automatically set alarm limits suited to your individual patient, using the Automatic Alarm Limits function (AutoLimits). This tells the monitor to adapt the alarm limits of selected measurements to the measured vital signs within a defined safe limit. The monitor calculates safe AutoLimits for each patient based on the measured values from the last 12 seconds.

The wide and narrow limits have a fixed relationship to the measured value within the non-pathological range. Outside of this range, no auto limits are calculated. To set values outside of the

non-pathological range, limits must be changed manually, based on the clinician's judgment about the specific patient.

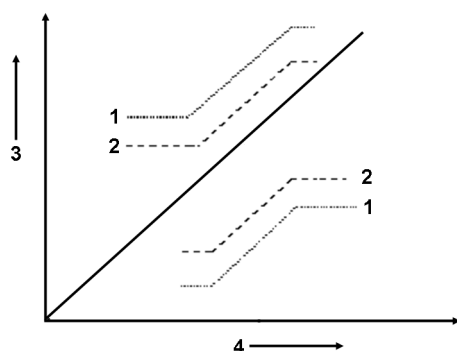

- 1 Wide alarm limits
- 2 Narrow alarm limits
- 3 Alarm Limits
- 4 Measurement value

**Limits Narrow** sets limits close to the currently measured values for situations where it is critical for you to be informed about small changes in your patient's vital signs.

**Limits Wide** sets limits further away from the currently measured values for situations where small changes are not so critical.

Use the keys in the measurement alarm limits window to apply AutoLimits for individual measurements. These keys are not available if AutoLimits have been disabled for the measurement in the monitor's Configuration Mode.

AutoLimits are not available for all measurements. The list of measurements for which AutoLimits can be used is defined in the monitor's Configuration mode.

Use the measurement alarm limits window to check AutoLimits before you apply them to ensure that they are appropriate for your individual patient and their clinical condition. Once applied, AutoLimits are shown on the monitor screen just like manually-set alarm limits. If the AutoLimits are not appropriate for your patient, you must set alarm limits manually. The limits remain unchanged until you set them again or change them manually.

## Documenting Alarm Limits

To print a list of all current alarm limit settings on an available printer:

- 1 Select the **Main Setup** SmartKey.
- 2 Select **Reports** from the **Main Setup** menu.
- 3 Select **Alarm Limits**.

## Reviewing Alarms

You can see which alarms and INOPs are currently active in the respective alarms and INOPs fields at the top of the screen.

To review the history of alarms and INOPs, select the alarms or INOPs field to open the **Review Alarms** window.

All alarms and INOPs are erased from the **Review Alarms** window when you discharge a patient, or if you change to Demonstration Mode.

## Review Alarms Window

The **Review Alarms** window contains a list of the most recent alarms and INOPs with date and time information.

If configured to do so, each alarm is shown with the alarm limit active when the alarm was triggered and the maximum value measured beyond this limit. The **Review Alarms** window also shows when the monitor was switched on (after being switched off for longer than 1 minute) and any actions related to switching alarms on and off, entering or leaving Standby mode, silencing alarms or changing the ECG source.

When you select an item from the list, you can get additional information about that item. If you select a high or low limit alarm in the list, the **Graphical Trends** window will open to provide further data. If you select an alert other than a high or low alarm, a help text window opens with more information. Some items in the list are simply log items not related to a patient alert as such (for example, Alarms On or Alarms Off). You cannot see any further information if you select one of these items. When you close these windows you will return to the **Review Alarms** window.

The information in the Review Alarms window is deleted when a patient is discharged, and when you leave Demonstration Mode.

The **Review Alarms** window pop-up keys appear when the window is opened. If alarm pause extension is disabled, the pause pop-up keys are inactive.

## Latching Alarms

The alarm latching setting for your monitor defines how the alarm indicators behave when you do not acknowledge them. When alarms are set to non-latching, their indicators end when the alarm condition ends. Switching alarm latching on means that visual and/or audible alarm indications are still displayed or announced by the monitor after the alarm condition ends. The indication lasts until you acknowledge the alarm.

## Viewing the Alarm Latching Settings

To see the alarm latching setting for your monitor

- 1 In the monitor's **Main Setup** menu, select **Alarms**.
- 2 Select **Alarm Settings**, and see the **Visual Latching** and **Audible Latching** settings.

This setting can only be changed in Configuration Mode. You should be aware of the settings chosen for your unit. There are three possible choices each for visual and audible latching, red only, red and yellow, and off. These choices can be combined to give the following settings:

Visual Latching	Audible Latching
Red&Yellow	Red&Yellow
Red&Yellow	Red Only
Red&Yellow	Off
Red Only	Red Only
Red Only	Off
Off	Off

## Alarm Latching Behavior

Red & Yellow Measurement Alarms		Non-latching alarms	Visual and audible latching	Visual latching, audible non-latching
Alarm has not been acknowledged.	Alarm condition still present.	Alarm tone on. Alarm lamp on. Alarm message. Flashing numerics.	Alarm tone on. Alarm lamp on. Alarm message. Flashing numerics.	Alarm tone on. Alarm lamp on. Alarm message. Flashing numerics.
	Alarm condition no longer present.	All audible and visual alarm indicators automatically stop.	Alarm tone on. Alarm lamp on. Alarm message. Flashing numerics.	Alarm message. Flashing numerics. Audible alarm indicators automatically stop.
Alarm has been acknowledged.	Alarm condition still present.	Alarm tone off. Alarm lamp off. Alarm message. Flashing numerics. Audible alarm reminder (if configured).	Alarm tone off. Alarm lamp off. Alarm message. Flashing numerics. Audible alarm reminder (if configured).	Alarm tone off. Alarm lamp off. Alarm message. Flashing numerics. Audible alarm reminder (if configured).
	Alarm condition no longer present.	Audible and visual alarm indicators automatically stop.	Audible and visual alarm indicators automatically stop.	Audible and visual alarm indicators automatically stop.

All INOPs are non-latching. See “Yellow Arrhythmia Alarms” on page 133 for information on one-star yellow alarms latching behavior.

## Testing Alarms

When you switch the monitor on, a selftest is started. You must check that the alarms lamps light, one after the other, and that you hear a single tone. This indicates that the visible and audible alarm indicators are functioning correctly. For further testing of individual measurement alarms, perform the measurement on yourself (for example SpO<sub>2</sub> or CO<sub>2</sub>) or use a simulator. Adjust alarm limits and check that appropriate alarm behavior is observed.

## Alarm Behavior at Power On

If the monitor is switched off for longer than one minute and then switched on again (or after a loss of power lasting longer than one minute, or when a patient is discharged), the monitor can be configured to:

- restore the alarm settings from the monitor's configured default Profile,
- restore the most recently used alarm settings, or
- switch the alarms off.

After any of these situations, you should check that the alarm settings are appropriate for your patient and monitoring situation, and if necessary, select the correct Profile and patient category.

If power is lost for less than one minute, the alarm on/off condition prior to the power loss is restored.

# Alarm Recordings

You can set up your monitor so that it automatically triggers alarm recordings locally or at the Information Center, or if configured, to a printer as a realtime report.

- 1 Press the **Main Setup** SmartKey.
- 2 Select **Alarms** from the **Main Setup** menu.
- 3 Select **Alarm Recording** from the **Alarms** menu to open the **Alarm Recordings** menu.
- 4 Select a measurement from those listed for which you want to change the alarm condition that triggers an alarm recording. This opens a pop-up list.
- 5 For the desired measurement(s), choose the alarm condition to trigger an alarm recording:
  - Red Only:** an alarm recording will automatically be triggered when the measurement enters a red alarm condition.
  - Red&Yellow:** both yellow and red alarms will trigger an alarm recording.
  - Off:** disables automatic alarm recording.

Refer to the "Recording" chapter for details of how to set up a recording.



# Patient Alarms and INOPs

This chapter lists patient alarms alphabetically, and technical alarms (INOPs) arranged by the source of the INOP and then alphabetically, irrespective of their priority. All alarms and INOPs are listed here; the ones which can appear on your monitor will depend on the model and the individual options.

## Patient Alarm Messages

The measurement labels and abbreviations for pressure, temperature, SpO<sub>2</sub>, and anesthetic agent alarms are explained in the individual chapters.

Some alarms may be shown at the Information Center in shortened form, when transferred through IntelliVue Instrument Telemetry. These shortened alarm texts are included in the list and identified with the note "at Information Center".

Alarm Message	From	Condition	Indication
* <b>AFIB</b>	ECG/Arrhythmia	Atrial fibrillation waveform detected	yellow alarm lamp, short yellow alarm tone
*** <b>Apnea</b> *** <b>Apnea x:yy</b> *** <b>Apnea &gt;10 min</b>	CO <sub>2</sub> , Resp, Spirometry	Respiration has stopped for longer than the preset apnea time. "x:yy" denotes the Apnea duration in minutes and seconds	numeric flashes, red alarm lamp, alarm tone
*** <b>Asystole</b>	ECG	No QRS detected for a period greater than the asystole threshold (in the absence of Vfib or chaotic ECG)	numeric flashes, red alarm lamp, alarm tone
** <b>awRR High</b>	CO <sub>2</sub> , Resp, AGM	The airway respiration rate has exceeded the high alarm limit.	numeric flashes and high limit is highlighted, yellow alarm lamp, alarm tone
** <b>awRR Low</b>	CO <sub>2</sub> , Resp, AGM	The airway respiration rate has dropped below the low alarm limit.	numeric flashes and low limit is highlighted, yellow alarm lamp, alarm tone
** <b>BIS High</b>	BIS	The Bispectral Index value has exceeded the high alarm limit.	numeric flashes and high limit is highlighted, yellow alarm lamp, alarm tone
** <b>BIS Low</b>	BIS	The Bispectral Index value has dropped below the low alarm limit.	numeric flashes and low limit is highlighted, yellow alarm lamp, alarm tone
*** <b>Brady/P xxx&lt;yyy</b> *** <b>Brady xxx &lt; yyy</b>	Press, SpO <sub>2</sub>	The heart rate from the Pulse signal has fallen below the bradycardia limit. xxx denotes the lowest measured value; yyy is the bradycardia limit.	numeric flashes and alarm limit is highlighted, red alarm lamp, alarm tone

## 5 Patient Alarms and INOPs

Alarm Message	From	Condition	Indication
<b>** CCO High</b> <b>** CCI High</b>	CCO	Continuous Cardiac Output or CC Index is above the high alarm limit.	numeric flashes and high alarm limit is highlighted, yellow alarm lamp, alarm tone
<b>** CCO Low</b> <b>** CCI Low</b>	CCO	Continuous Cardiac Output or CC Index is below the low alarm limit.	numeric flashes and low alarm limit is highlighted, yellow alarm lamp, alarm tone
<b>** CPP High</b>	CPP	The CPP value has exceeded the high alarm limit.	numeric flashes and high limit is highlighted, yellow alarm lamp, alarm tone
<b>** CPP Low</b>	CPP	The CPP value has fallen below the low alarm limit.	numeric flashes and low limit is highlighted, yellow alarm lamp, alarm tone
<b>*** Desat</b> <b>*** Desat xx &lt; yy</b>	SpO <sub>2</sub>	The SpO <sub>2</sub> value has fallen below the desaturation alarm limit. xx denotes the lowest measured value, and yy is the desaturation limit.	numeric flashes, red alarm lamp, alarm tone
<b>** EC10 Alarm</b> <b>*** EC10 Alarm</b> at Information Center	EC10 IntelliBridge	A yellow (**) or red (***) patient alarm is present on the IntelliBridge module. Check the monitor display for more detailed alarm information.	(on monitor) yellow or red alarm lamp; the alarm text is defined by the IntelliBridge device driver
<b>* End AFIB</b>	ECG/Arrhythmia	No Atrial fibrillation waveform was detected for the configured Afib End delay time	yellow alarm lamp, short yellow alarm tone
<b>* End Irregular HR</b>	ECG/Arrhythmia	No irregular HR was detected for the configured irregular HR End delay time	yellow alarm lamp, short yellow alarm tone
<b>** etCO<sub>2</sub> High</b>	CO <sub>2</sub> , AGM	The end tidal CO <sub>2</sub> high alarm limit has been exceeded.	numeric flashes and high limit is highlighted, yellow alarm lamp, alarm tone
<b>** etCO<sub>2</sub> Low</b>	CO <sub>2</sub> , AGM	The end tidal CO <sub>2</sub> value has fallen below the low alarm limit.	numeric flashes and low limit is highlighted, yellow alarm lamp, alarm tone
<b>** etO<sub>2</sub> High</b>	O <sub>2</sub> , AGM	The end tidal O <sub>2</sub> high alarm limit has been exceeded.	numeric flashes and high limit is highlighted, yellow alarm lamp, alarm tone
<b>** etO<sub>2</sub> Low</b>	O <sub>2</sub> , AGM	The end tidal O <sub>2</sub> value has fallen below the low alarm limit.	numeric flashes, and low limit is highlighted, yellow alarm lamp, alarm tone
<b>* Event</b> <b>** Event</b> <b>*** Event</b> at Information center	Event surveillance	An event has occurred and the event notification is configured to alarm. Check on the monitor for more details on event group.	(on monitor) event group name flashes, yellow or red alarm lamp and alarm tone
<b>* Event:&lt;Event Group&gt;</b> <b>** Event:&lt;Event Group&gt;</b> <b>*** Event:&lt;Event Group&gt;</b>	Event surveillance	An event has occurred and the event notification is configured to alarm.	event group name flashes, yellow or red alarm lamp and alarm tone
<b>*** Extreme Brady</b>	ECG	The bradycardia limit has been exceeded.	numeric flashes and alarm limit is highlighted, red alarm lamp, alarm tone

Alarm Message	From	Condition	Indication
* HR High ** HR High	ECG	The heart rate has risen above the high alarm limit.	numeric flashes and high limit is highlighted, yellow alarm lamp, alarm tone. If configured to short yellow, the sound switches off after 5 seconds if Arrhythmia is switched on.
* HR Low ** HR Low	ECG	The heart rate has fallen below the low alarm limit.	numeric flashes and low limit is highlighted, yellow alarm lamp, alarm tone. If configured to short yellow, the sound switches off after 5 seconds if Arrhythmia is switched on.
** IPI Low	CO <sub>2</sub>	The IPI value has fallen below the low alarm limit.	numeric flashes, and low limit is highlighted, yellow alarm lamp, alarm tone
* Irregular HR	ECG/Arrhythmia	Consistently irregular heart rhythm.	numeric flashes, yellow alarm lamp, short yellow audible alarm
* Missed Beat	ECG/Arrhythmia	No beat detected for 1.75*R-R interval, or if HR>120 bpm no beat detected for one second (non-paced patients only).	numeric flashes, yellow alarm lamp, short yellow audible alarm
* More Alarms ** More Alarms *** More Alarms	other assigned devices	There is more than one physiological alarm of the corresponding severity active on the devices that monitor this patient. For details, check the information displayed at the Information Center.	yellow or red alarm lamp and alarm tone
* Multiform PVCs	ECG/Arrhythmia	Two differently shaped Vs detected, each occurring at least twice within the last 300 beats and at least once within the last 60 beats.	numeric flashes, yellow alarm lamp, short yellow audible alarm
** NBP High	NBP	The measured NBP value is above the high alarm limit. <b>s, d, or m</b> after the label indicates whether the systolic, diastolic or mean pressure has crossed the limit.	numeric flashes and high limit is highlighted, yellow alarm lamp, alarm tone
** NBP Low	NBP	The measured NBP value is below the low alarm limit. <b>s, d, or m</b> after the label indicates whether the systolic, diastolic or mean pressure has crossed the limit.	numeric flashes and low limit is highlighted, yellow alarm lamp, alarm tone
* Non-Sustain VT	ECG/Arrhythmia	A run of Vs having a ventricular HR>V-Tach HR limit, but lasting for less than the V-Tach Run limit has been detected.	numeric flashes, yellow alarm lamp, short yellow audible alarm
* OtherMon Alarm ** OtherMon Alarm *** OtherMon Alarm	another assigned monitor	Another monitor used for the patient is in an alarm condition. Check the detailed alarm information at the Information Center.	yellow or red alarm lamp and alarm tone
* Pacer Not Capt	ECG/Arrhythmia (paced patients only)	A missed beat with a pace pulse was detected.	numeric flashes, yellow alarm lamp, short yellow audible alarm
* Pacer Not Pacing	ECG/Arrhythmia (paced patients only)	A missed beat without a pace pulse was detected.	numeric flashes, yellow alarm lamp, short yellow audible alarm

## 5 Patient Alarms and INOPs

Alarm Message	From	Condition	Indication
* Pair PVCs	ECG/Arrhythmia	A non-ventricular contraction, followed by two ventricular contractions, followed by a non-ventricular contraction has been detected.	numeric flashes, yellow alarm lamp, short yellow audible alarm
* Pause	ECG/Arrhythmia	No beat detected for a period greater than the pause threshold.	numeric flashes, yellow alarm lamp, short yellow audible alarm
*** <Press Label> Disconnect	PRESS	The pressure is non-pulsatile and the mean pressure is continuously less than 10 mmHg (1.3 kPa). This alarm occurs only with arterial pressures (P, ABP, ART, Ao, BAP, FAP, PAP, UAP, P1, P2, P3, P4).	numeric flashes, red alarm lamp, alarm tone
*** <Press Label> High	PRESS	The measured pressure value is above the <b>extreme</b> high alarm limit. <b>s, d, or m</b> after the label indicates whether the systolic, diastolic or mean pressure has crossed the limit.	numeric flashes, high limit is highlighted, red alarm lamp, alarm tone
** <Press Label> High	PRESS	The measured pressure value is above the high alarm limit. <b>s, d, or m</b> after the label indicates whether the systolic, diastolic or mean pressure has crossed the limit.	numeric flashes, high limit is highlighted, yellow alarm lamp, alarm tone
*** <Press Label> Low	PRESS	The measured pressure value is below the <b>extreme</b> low alarm limit. <b>s, d, or m</b> after the label indicates whether the systolic, diastolic or mean pressure has crossed the limit.	numeric flashes and low limit is highlighted, red alarm lamp, alarm tone
** <Press Label> Low	PRESS	The measured pressure value is below the low alarm limit. <b>s, d, or m</b> after the label indicates whether the systolic, diastolic or mean pressure has crossed the limit.	numeric flashes and low limit is highlighted, yellow alarm lamp, alarm tone
** Pulse High	PRESS, SpO <sub>2</sub>	The pulse rate has exceeded the high alarm limit.	numeric flashes and high limit is highlighted, yellow alarm lamp, alarm tone
** Pulse Low	PRESS, SpO <sub>2</sub>	The pulse rate has dropped below the low alarm limit.	numeric flashes and low limit is highlighted, yellow alarm lamp, alarm tone
* PVCs/min High	ECG/Arrhythmia	More premature ventricular contractions have been detected in a minute than the limit.	numeric flashes, yellow alarm lamp, short yellow audible alarm
** QTc High	ECG/QT	QTc value has exceeded the QTc high limit for more than 5 minutes	numeric flashes, yellow alarm lamp, alarm tone
** ΔQTc High	ECG/QT	ΔQTc value has exceeded the ΔQTc high limit for more than 5 minutes	numeric flashes, yellow alarm lamp, alarm tone
* R-ON-T PVCs	ECG/Arrhythmia	For HR <100, a PVC with R-R interval < 1/3 the average interval followed by a compensatory pause of 1.25 x average R-R interval or two such Vs without compensatory pause occurring within 5 minutes of each other. (When HR >100, 1/3 R-R interval is too short for detection.).	numeric flashes, yellow alarm lamp, short yellow audible alarm
** RR High	RESP	The respiration rate has exceeded the high alarm limit.	numeric flashes and high limit is highlighted, yellow alarm lamp, alarm tone

Alarm Message	From	Condition	Indication
<b>** RR Low</b>	RESP	The respiration rate has dropped below the low alarm limit.	numeric flashes and low limit is highlighted, yellow alarm lamp, alarm tone
<b>* Run PVCs High</b>	ECG/Arrhythmia	A run of PVCs greater than 2 was detected.	numeric flashes, yellow alarm lamp, short yellow audible alarm
<b>** &lt;SO<sub>2</sub> Label&gt; High</b>	SvO <sub>2</sub> /SO <sub>2</sub>	The the measured intravascular oxygen saturation has exceeded the high limit.	numeric flashes and high alarm limit is highlighted, yellow alarm lamp, alarm tone
<b>** &lt;SO<sub>2</sub> Label&gt; Low</b>	SvO <sub>2</sub> /SO <sub>2</sub>	The measured intravascular oxygen saturation has fallen below the low limit.	numeric flashes and low alarm limit is highlighted, yellow alarm lamp, alarm tone
<b>** &lt;SpO<sub>2</sub> Label&gt; High</b>	SpO <sub>2</sub>	The arterial oxygen saturation has exceeded the high alarm limit.	numeric flashes and high limit is highlighted, yellow alarm lamp, alarm tone
<b>** &lt;SpO<sub>2</sub> Label&gt; Low</b>	SpO <sub>2</sub>	The arterial oxygen saturation has fallen below the low alarm limit.	numeric flashes and low limit is highlighted, yellow alarm lamp, alarm tone
<b>** ST Multi &lt;n&gt;,&lt;n&gt;</b>	ECG/ST	Two contiguous ST leads <n> and <n> have exceeded elevation or depression limits for more than 60 seconds. The limit violations for both leads must be with respect to same limit; either both above the high limit or both below the low limit.	numeric flashes, yellow alarm lamp, alarm tone
<b>** ST Multi</b> at Information Center	ECG/ST	The ST depression or elevation is outside of the limit in two or more leads. Check on the monitor	(on monitor) numeric flashes, yellow alarm lamp, alarm tone
<b>** STE &lt;n&gt;,&lt;n&gt;</b>	ECG/ST	Two contiguous leads <n> and <n> are above their respective STE limits	numeric flashes, yellow alarm lamp, alarm tone
<b>** ST-&lt;n&gt; High</b>	ECG/ST	The ST elevation in lead <n> is higher than the limit. Lead is not contiguous with any other lead.	numeric flashes and high alarm limit is highlighted, yellow alarm lamp, alarm tone
<b>** ST-&lt;n&gt; Low</b>	ECG/ST	The ST depression in lead <n> is lower than the limit. Lead is not contiguous with any other lead.	numeric flashes and low alarm limit is highlighted, yellow alarm lamp, alarm tone
<b>* SVT</b>	ECG/Arrhythmia	A run of supraventricular beats greater than the SVT run limit has been detected and the HR has exceeded the SVT HR limit.	numeric flashes, yellow alarm lamp, alarm tone
<b>*** Tachy xxx &gt; yy</b>	ECG	The tachycardia limit has been exceeded	numeric flashes and alarm limit is highlighted, red alarm lamp, alarm tone
<b>*** Tachy/P xxx&gt;yy</b> or <b>*** Tachy xxx &gt; yy</b>	Press, SpO <sub>2</sub> , ECG	The tachycardia limit has been exceeded. xxx denotes the highest measured value; yy is the tachycardia limit.	numeric flashes, alarm limit is highlighted, red alarm lamp, alarm tone
<b>** Tblood High</b>	C.O.	The blood temperature value has exceeded the high alarm limit.	numeric flashes, high alarm limit is highlighted, yellow alarm lamp, alarm tone
<b>** Tblood Low</b>	C.O.	The blood temperature value has fallen below the low alarm limit.	numeric flashes, low alarm limit is highlighted, yellow alarm lamp, alarm tone

## 5 Patient Alarms and INOPs

Alarm Message	From	Condition	Indication
<b>** tcpO<sub>2</sub> High</b> <b>** tcpCO<sub>2</sub> High</b>	tcGas	The tcpO <sub>2</sub> or tcpCO <sub>2</sub> value has exceeded the high alarm limit.	numeric flashes, high alarm limit is highlighted, yellow alarm lamp, alarm tone
<b>** tcpO<sub>2</sub> Low</b> <b>** tcpCO<sub>2</sub> Low</b>	tcGas	The tcpO <sub>2</sub> or tcpCO <sub>2</sub> value has fallen below the low alarm limit.	numeric flashes, low alarm limit is highlighted, yellow alarm lamp, alarm tone
<b>* Tele Alarm</b> <b>** Tele Alarm</b> <b>*** Tele Alarm</b>	an assigned telemetry device	A telemetry device used for the patient is in an alarm condition. Check the detailed alarm information at the Information Center.	yellow or red alarm lamp and alarm tone
<b>** &lt;Temp Label&gt; High</b>	TEMP	The temperature has exceeded the high alarm limit.	numeric flashes and high limit is highlighted, yellow alarm lamp, alarm tone
<b>** &lt;Temp Label&gt; Low</b>	TEMP	The temperature has fallen below the low alarm limit.	numeric flashes and low limit is highlighted, yellow alarm lamp, alarm tone
<b>* T-Mon Alarm</b> <b>** T-Mon Alarm</b> <b>*** T-Mon Alarm</b>	an assigned transport monitor	A transport monitor used for the patient is in an alarm condition. Check the detailed alarm information at the Information Center.	yellow or red alarm lamp and alarm tone
<b>** TOFcnt High</b>	NMT	TOFcnt value has exceeded the high alarm limit	numeric flashes and high limit is highlighted, yellow alarm lamp, alarm tone
<b>* Vent Bigeminy</b>	ECG/Arrhythmia	A dominant rhythm of N, V, N, V (N = supraventricular beat, V = ventricular beat) was detected.	numeric flashes, yellow alarm lamp, short yellow audible alarm
<b>*** Vent Fib/Tach</b>	ECG	A fibrillatory waveform for 4 consecutive seconds was detected.	numeric flashes, red alarm lamp, alarm tone
<b>* Vent Rhythm</b> <b>** Vent Rhythm</b>	ECG/Arrhythmia	A dominant rhythm of adjacent Vs > vent rhythm limit and ventricular HR < VTach HR limit was detected.	numeric flashes, yellow alarm lamp, short yellow audible alarm
<b>* Vent Trigeminy</b>	ECG/Arrhythmia	A dominant rhythm of N, N, V, N, N, V (N = supraventricular beat, V = ventricular beat) was detected.	numeric flashes, yellow alarm lamp, short yellow audible alarm
<b>*** VTach</b>	ECG, Arrhythmia	Ventricular tachycardia has been detected (Consecutive PVCs exceed V-Tach Run limit and HR exceeds V-Tach HR limit).	numeric flashes, red alarm lamp, alarm tone
<b>** VueLink Alarm</b> <b>*** VueLink Alarm</b> at Information Center	VueLink	A yellow (**) or red (***) patient alarm is present on the VueLink module. Check the monitor display for more detailed alarm information.	(on monitor) yellow or red alarm lamp; the alarm text is defined by the VueLink device driver

## Technical Alarm Messages (INOPs)

If an INOP interrupts monitoring and alarm detection, the measurement numeric will be replaced by **-?-**. If an INOP may lead to unreliable measurement values, a **?** appears next to the numeric.

The measurement labels and abbreviations for pressure, temperature and SpO<sub>2</sub> INOP messages are explained in the individual measurement chapters.

### Monitor INOPs

INOP Message, Indication	What to do
<b>Bad MSL</b> INOP tone	1) An MMS with an incompatible software revision is connected to the monitor. This combination does not allow monitoring, OR 2) You cannot use this combination of monitor, MMS and cable. Switch off the monitor and contact your service personnel.
<b>Central: Tele Only</b> INOP tone	System connectivity via telemetry device is limited (No alarms, only local numerics) when in companion mode and host monitor does not have system connectivity. Only telemetry device parameters can be displayed at central station.
<b>Check Alarm Lamps</b> INOP tone	Perform a visual check of the alarm lamp to establish whether there is a problem. Contact your service personnel to check the internal connections to the alarm lamps.
<b>Check DrugSettings</b> INOP tone	There was a problem loading the drug settings. Check that the settings are complete and correct.
<b>!!Check ECG Source</b> Yellow tone	The telemetry device and the monitor both have valid ECG signals. Unpair the telemetry device and the monitor if they are no longer used for the same patient.
<b>!! Check Equipment</b> INOP tone/Yellow tone	There is an equipment status dispute relating to one or more of the devices assigned to this patient. See the <b>Equipment</b> window for details.
<b>Check Flex Texts</b> INOP tone	Check the names of the monitor menus, for example the labels for screens, profiles, event or trend group names, before you resume monitoring. If they are unexpected, there may be a problem with the monitor software. Contact your service personnel.
<b>Check Keyboard</b> INOP tone	Perform a visual and functional check of the keyboard. Contact your service personnel.
<b>Check Main Board 2</b> INOP tone	There is a problem with the second main board in the monitor. Contact your service personnel.
<b>Check Monitor Func</b> INOP tone	Potential problem with alarm lamps, display or interfaces detected. Contact your service personnel.
<b>Check Monitor Temp</b> INOP tone	The temperature inside the monitor is too high. Check that the monitor ventilation is not obstructed. If the situation continues, contact your service personnel.
<b>Check Mouse</b> INOP tone	Perform a visual and functional check of the mouse input device. Contact your service personnel.
<b>Check MSL Voltage</b> INOP tone	There is a problem with the voltage of the Measurement Link (MSL). Contact your service personnel.
<b>Check Network Conf</b> INOP tone	The monitor is receiving network topology information from more than one source, e.g. the Database Server and an Application Server. Contact your service personnel.
<b>!! Check Pairing</b> Yellow tone	There is a problem with device pairing. Check that the monitor and telemetry device are correctly paired.
<b>!!Check Patient ID</b> Yellow tone	There is a mismatch between patient data in two connected devices. Resolve the mismatch to allow settings and data synchronization.

## 5 Patient Alarms and INOPs

INOP Message, Indication	What to do
<b>Check Screen Res.</b> INOP tone	The Screen you have selected uses a resolution which is not supported by the display. The monitor will show a generic Screen instead until you select a different Screen.  Contact your service personnel if you want the Screen deleted from the Profile(s) to avoid this in future.
<b>Check Settings</b> INOP tone	If this INOP appears, check the monitor and patient settings before you resume monitoring. If the settings are unexpected, there may be a problem with the monitor software. Contact your service personnel.
<b>Check SpeedPoint</b> INOP tone	Perform a visual and functional check of the SpeedPoint input device. Contact your service personnel.
<b>Check Touch Input</b> INOP tone	Perform a visual and functional check of the touch input device. Contact your service personnel.
<b>Check Waves</b> INOP tone	The options purchased with this monitor may not support the number of waves required to show the selected Screen, so some waves or high resolution trends are missing from the Screen. Select a different Screen with fewer waves.  Contact your service personnel if you want the Screen deleted from the Profile(s) to avoid this in future.
<b>Chk ECG Sync Cable</b> INOP tone	The ECG Sync is detecting an invalid signal, or the ECG Sync cable is disconnected.
<b>Chk IndepDsp Cable</b>	The monitor cannot communicate with the D80 Intelligent Display. Check the MSL coupling cable. The end with the gray connector must be connected to the Intelligent Display.
<b>Chk &lt;Measurement Label&gt;Settings</b>	Synchronization of the settings for the measurement cited, has failed. Check that settings are appropriate for your patient.
<b>Chk MSL Connection</b> INOP tone	Check that the MSL cable is properly connected. If this is the case, try using another MSL cable, to check if your cable is defective. If this does not help, the device connected via the MSL cable may be defective, contact your service personnel.
<b>Internal.Comm.Malf</b> INOP tone	There is a problem with I2C Bus communication in the monitor. Contact your service personnel.
<b>MCC Reversed</b> INOP tone	The MSL coupling cable is reversed. Connect the end with the gray connector to the Intelligent Display.
<b>MCC Unsupported</b> INOP tone	An MSL coupling cable has been connected to a device which does not support MSL coupling.
<b>Meas. Deactivated</b>	An X2 or MP5 has been connected to a host monitor (companion mode) and all derived measurements have been deactivated and/or measurements with a label conflict. The measurements can only be reactivated by disconnecting the measurement device from the host monitor.
<b>!!More Bed Alarms</b> <b>!!!More Bed Alarms</b> at Information Center	The monitor is associated with a telemetry device and is sending data to the Information Center via the telemetry device. There are currently more alarms at the bedside than can be transmitted to the Information Center.
<b>More INOPs</b> <b>!! More INOPs</b> <b>!!! More INOPs</b>	There is more than one technical alarm of the corresponding severity active on the devices that monitor this patient. For details check the information displayed at the Information Center.
<b>MSL Power High</b>	The power consumption of the devices connected to the Measurement Link (MSL) cable is too high. If this situation continues, the MSL will be switched off. Contact your service personnel.
<b>MSL Power Off</b> INOP tone	The power consumption of the devices connected to the Measurement Link (MSL) cable was too high for too long and the MSL has been switched off. Contact your service personnel.
<b>MSL Power Overload</b> INOP tone	The power consumption of the devices connected to the Measurement Link (MSL) cable is much too high or there has been a short circuit. The MSL has been switched off. Contact your service personnel.



INOP Message, Indication	What to do
<b>No Central Monit.</b> INOP tone	There is a problem with the communication to the network. Central monitoring is currently not possible (no patient alarms or information). Check the connection. In case the connection is via a telemetry device, the current telemetry use model does not support central monitoring. Contact your service personnel.
<b>No ECG at Central</b>	The ECG measured with the monitor ECG is not being sent to the Information Center via the telemetry device.
<b>OtherMon INOP</b> <b>!! OtherMon INOP</b> <b>!!! OtherMon INOP</b>	Another monitor assigned to the patient (e.g. a transport monitor) is in an INOP condition. Check the detailed INOP information at the Information Center and resolve the INOP condition(s) at the other monitor.
<b>Rem.AlarmDev.Malf.</b> INOP tone	There is a problem with the connection to the remote alert device. Contact your service personnel to check the remote alert device and its connections.
<b>Settings Malfunc.</b> INOP tone	The monitor cannot use the predefined settings for monitoring. Contact your service personnel.
<b>Speaker Malfunc.</b> INOP tone	Contact your service personnel to check the speaker and the connection to the speaker.
<b>SRR Incompatible</b> INOP tone	The short range radio component has compatibility problems. Contact your service personnel.
<b>SRR Interference</b> INOP tone	The short range radio connection has interference from another device. Try using another channel.
<b>SRR Invalid Chan</b> INOP tone	The channel configuration of the Short Range Radio is invalid. Check channel and channel mask configuration.
<b>SRR Malfunction</b> INOP tone	Malfunction in the short range radio device. If the INOP persists contact your service personnel.
<b>TAAP Disabled</b> INOP tone	The currently selected telemetry configuration on the monitor does not allow connection of telemetry devices to the monitor.
<b>Tele Config Unsupp</b> INOP tone	Telemetry Workflow configuration not supported. Check revision and configuration of monitor and central.
<b>Tele ECG Malfunc.</b> Numeric is displayed with a -?- INOP tone	Contact your service personnel. The ECG in the Telemetry device is faulty.
<b>Tele Equip Malf</b> INOP tone	The telemetry device has a malfunction. Disconnect and reconnect the telemetry device. If the INOP reappears, replace the telemetry device.
<b>Tele Incompatible</b>	SRR-enabled telemetry device is not supported by this central software revision. Please check configuration.
<b>Tele INOP</b> <b>!! Tele INOP</b> <b>!!! Tele INOP</b>	A telemetry device assigned to the patient is in an INOP condition. Check the detailed INOP information at the Information Center and resolve the INOP condition(s) at the telemetry device.
<b>Tele Unsupported</b> INOP tone	This telemetry device is not supported for direct connection to the monitor.
<b>TimeExpired:&lt;Timer Label&gt;</b> INOP tone	The time has expired for the timer indicated in the INOP text. Clearing the timer clears the INOP.
<b>T-Mon INOP</b> <b>!! T-Mon INOP</b> <b>!!! T-Mon INOP</b> INOP tone	A transport monitor assigned to the patient is in an INOP condition. Check the detailed INOP information at the Information Center and resolve the INOP condition(s) at the transport monitor.
<b>TransportEquipment</b>	The equipment is ready for transport. See the <b>Equipment</b> window for details.

## 5 Patient Alarms and INOPs

INOP Message, Indication	What to do
<b>Unsupported LAN</b> INOP tone	There is a problem with the communication to the network and central monitoring is currently not possible. Check the connection. If the INOP persists, switch off the monitor and contact your service personnel.
<b>Unsupported WLAN</b>	There is a problem with the communication to the network and central monitoring is currently not possible. Check the wireless connection. If the INOP persists, switch off the monitor and contact your service personnel.
<b>User I/F Malfunct.</b> INOP tone	Perform a visual and functional check of all the monitor input devices. Contact your service personnel.
<b>WLAN OutOf Range</b>	The monitor has been moved out of WLAN range. The connection to the Information Center has been lost. Move the monitor back into the WLAN coverage area.

## Battery INOPs

INOP Message, Indication	What to do
<b>Batt 1 Missing</b> <b>Batt 2 Missing</b> INOP tone During this INOP, alarms cannot be paused or switched off.	The monitor requires two batteries but can detect only one battery. Insert the missing battery immediately.
<b>Batt Empty</b> <b>!!Batt Empty</b> <b>!!!Batt Empty</b> INOP tone, battery LED flashes During this INOP, alarms cannot be paused or switched off.	The estimated remaining battery-powered operating time is less than 10 minutes. Replace the battery immediately.  If the condition persists and the monitor is not connected to mains power, this INOP is re-issued two minutes after you acknowledge it.
<b>Batt Extensn Malf</b> INOP tone	There is a hardware error in the Battery Extension. Contact your service personnel.
<b>Batt Incompat.</b> INOP tone	The battery cannot be used with this monitor. Replace with the correct battery (M4607A).
<b>Batt Low</b> INOP tone	The estimated battery-powered operating time remaining is less than 20 minutes.
<b>Batt Malfunction</b> INOP tone, battery LED flashes During this INOP, alarms cannot be paused or switched off unless the monitor is connected to mains power.	The monitor cannot determine the battery status. If this INOP persists, replace the faulty battery. If the condition persists and the monitor is not connected to mains power, this INOP is re-issued two minutes after you acknowledge it.  Place the battery in a different monitor or in a battery charger. If the same INOP is shown, contact your service personnel.
<b>Batteries Empty</b> <b>!!Batteries Empty</b> <b>!!!Batteries Empty</b> <b>Batt 1 Empty</b> <b>!!Batt 1 Empty</b> <b>!!!Batt 1 Empty</b> <b>Batt 2 Empty</b> <b>!!Batt 2 Empty</b> <b>!!!Batt 2 Empty</b> INOP tone, battery LED flashes During this INOP, alarms cannot be paused or switched off.	The estimated remaining battery-powered operating time of the indicated battery or batteries is less than 10 minutes. Replace the batteries immediately.  If the condition persists and the monitor is not connected to mains power, this INOP is re-issued two minutes after you acknowledge it.

INOP Message, Indication	What to do
<b>Batteries Incompat</b> <b>Batt 1 Incompat.</b> <b>Batt 2 Incompat.</b> INOP tone	The indicated battery or batteries cannot be used with this monitor. Replace with the correct battery or batteries as specified in this book.
<b>Batteries Low</b> <b>Batt 1 Low</b> <b>Batt 2 Low</b> INOP tone	The estimated battery-powered operating time remaining is less than 20 minutes.
<b>Batteries Malfunc</b> <b>Batt 1 Malfunction</b> <b>Batt 2 Malfunction</b> INOP tone, battery LED flashes During this INOP, alarms cannot be paused or switched off unless the monitor is connected to mains power.	The monitor cannot determine the battery status. If this INOP persists, replace the faulty battery or batteries. If the condition persists and the monitor is not connected to mains power, this INOP is re-issued two minutes after you acknowledge it. Place the batteries in a different monitor or in a battery charger. If the same INOP is shown, contact your service personnel.
<b>Charge Batt 1 now</b> <b>Charge Batt 2 now</b> INOP tone	Battery must be charged. Connect the monitor to mains power or exchange the battery.
<b>Charger Malfunc</b> INOP tone, battery LED may flash	There is a problem with the battery charger in the monitor. Connect the monitor to mains power and contact your service personnel.
<b>Check Batt Temp</b> INOP tone	The temperature of one or both batteries is too high. Check that ventilation openings (if applicable) are not blocked and monitor is not exposed to heat.
<b>Chk MSL Connection</b>	Check the MSL connection between X2/MP2 and the battery extension for damage or loose connections. Check also if a second X1 or X2 has been connected accidentally (e.g. in companion mode).
<b>ExtBat Empty</b> <b>!!ExtBat Empty</b> <b>!!!ExtBat Empty</b>	The estimated battery-powered operating remaining time is less than 10 minutes. Replace the battery in the battery extension immediately.
<b>ExtBat Incompat.</b>	The battery in the battery extension cannot be used.
<b>ExtBat Low</b>	The estimated battery-powered operating time remaining is less than 20 minutes.
<b>ExtBat Malfunction</b>	The monitor cannot determine the status of the battery in the battery extension. If this INOP persists, replace the faulty battery in the battery extension. If the condition persists and the monitor is not connected to mains power or a host monitor, this INOP is re-issued two minutes after you acknowledge it.
<b>ExtBat Missing</b>	There is no battery in the Battery Extension
<b>!! Insert Battery</b> Severe yellow INOP tone During this INOP, alarms cannot be paused or switched off.	X2/MP2 only: There is no battery in the battery compartment. You cannot operate the monitor on AC mains while the battery compartment is open (not sealed with a battery). Load a battery immediately.
<b>MSL Power High</b>	The power consumption of the devices connected to the Battery Extension is too high. If this situation continues, the Battery Extension will be switched off. Contact your service personnel.
<b>MSL Power Off</b>	The power consumption of the devices connected to the Battery Extension was too high for too long. The Battery Extension has been switched off. Contact your service personnel.

## MMS, MMS Extensions and FMS INOPs

INOP Message, Indication	What to do
<b>MMS Ext. Unplugged</b> INOP tone	The MMS extension has been disconnected from the Multi-Measurement Module.
<b>MMS Ext. Unpowered</b> INOP tone	The MMS extension cannot operate while the Multi-Measurement Module is running on battery power.
<b>MMS Ext. Unsupp</b> INOP tone	The MMS extension is not supported by your monitor. Contact your service personnel.
<b>MMS Ext. Equip Malf</b> INOP tone	Loss of communication between the Multi-Measurement Module and the MMS extension. Contact your service personnel.

## Display INOPs

INOP Message, Indication	What to do
<b>Indep.Dsp Malfunc.</b>	There is a problem with the Independent Display. Check the MSL coupling cable then contact your service personnel.
<b>Indep.Dsp NotSupp.</b>	The monitor does not support a second main display. The monitor software is incompatible. Contact your service personnel.
<b>Intell.Dsp Malf.</b>	There is a problem with the Intelligent Display. Check the MSL coupling cable then contact your service personnel.
<b>Intell.Dsp Missing</b>	The monitor has lost contact with the connected Intelligent Display. Contact your service personnel.
<b>Intell.Dsp Unsupp.</b>	The monitor does not support the connected Intelligent Display. The monitor software is incompatible.

## ECG, Arrhythmia, QT and ST INOPs

INOP Message, Indication	What to do
<b>C Lead Off</b> HR Numeric is replaced by -?- for 10 seconds. INOP tone	The C electrode (AAMI: V electrode) has become detached from the patient or the lead set has been changed. Reattach the electrode or select <b>New Lead Setup</b> in the <b>Setup ECG</b> menu to confirm the new lead set.
<b>Cannot Analyze ECG</b>	The arrhythmia algorithm cannot reliably analyze the ECG data. Check the ECG signal quality of the selected primary and secondary leads. If necessary, improve lead position or reduce patient motion. If you have arrhythmia analysis on, and you are not getting a reliable HR because the signal is below a minimum amplitude, unstable, or contains artifact, and you have tried to improve the system performance by choosing another lead and changing electrodes, you should consider turning arrhythmia analysis off.
<b>Cannot Analyze QT</b>	The QT algorithm cannot generate a valid QT value for more than 10 minutes, or 1 minute in the initial phase.
<b>Cannot Analyze ST</b>	The ST algorithm cannot generate a valid ST value. Possible causes are large variations in the measured ST values for consecutive beats, or ventricular paced beats. Review the ECG signal quality and the ST measurement points. If the patient has a ventricular pacemaker, ST analysis is not possible.
<b>Cannot Analyze STE</b>	The STE algorithm cannot generate valid ST elevation values. Possible causes are large variations in the measured ST values for consecutive beats, or ventricular paced beats. Review the ECG signal quality and the ST measurement points.
<b>ECG Equip Malf</b> Numeric is replaced by -?- INOP tone	Contact your service personnel. The ECG hardware is faulty.

INOP Message, Indication	What to do
<p>&lt;ECG Lead&gt; Lead Off            !! &lt;ECG Lead&gt; Lead Off            !!! &lt;ECG Lead&gt; Lead Off            Numeric is replaced by -?-            INOP tone</p>	<p>Not all the required leads for ECG monitoring are connected. Check the ECG connections and make sure that the electrode indicated by &lt;ECG lead&gt; [RA, LA, LL, RL, V or C] electrodes is attached. In EASI mode, all 5 electrodes must be connected.</p>
<p>ECG Leads Off            !! ECG Leads Off            !!!ECG Leads Off            Numeric is replaced by -?-            INOP tone</p>	<p>Check that all of the required ECG leads are attached, and that none of the electrodes have been displaced. The INOP may also be caused by a saturated or overloaded ECG amplifier.</p>
<p>ECG Noisy Elec &lt;ECG Lead&gt;</p>	<p>The ECG signal from the named ECG electrodes [RA, LA, LL, RL, V (or C)] is noisy. Check the ECG connections and make sure that the electrode indicated is attached.</p>
<p>ECG Noisy Signal            INOP tone</p>	<p>The ECG signal is too noisy. Check that the electrodes are properly placed and have not dried out. Remove any possible sources of signal noise (such as power cords) from the area around the cable and the patient.            The ECG signal may be saturated or overloaded.</p>
<p>!!ECG/AR AlarmsOff</p>	<p>All ECG alarms have been switched off, or the HR alarm source is not ECG. To resume ECG alarm generation, switch ECG alarms on or select ECG as the alarm source.</p>
<p>ECG/Arrh AlarmsOff            !!ECG/AR AlarmsOff</p>	<p>All ECG alarms have been switched off, or the HR alarm source is not ECG. To resume ECG alarm generation, switch ECG alarms on or select ECG as the alarm source.</p>
<p>EcgOut Equip Malf            INOP tone</p>	<p>There is a problem with the device connected to the ECG Out connector. Contact your service personnel.</p>
<p>LA Lead Off            Numeric is replaced by -?- for 10 seconds.            INOP tone</p>	<p>The LA electrode has become detached from the patient or the lead set has been changed. Reattach the electrode or select <b>New Lead Setup</b> in the <b>Setup ECG</b> menu to confirm the new lead set.</p>
<p>LL Lead Off            Numeric is replaced by -?- for 10 seconds.            INOP tone</p>	<p>The LL electrode has become detached from the patient or the lead set has been changed. Reattach the electrode or select <b>New Lead Setup</b> in the <b>Setup ECG</b> menu to confirm the new lead set.</p>
<p>RA Lead Off            Numeric is replaced by -?-            INOP tone</p>	<p>The RA electrode has become detached from the patient or the lead set has been changed. Reattach the electrode or select <b>New Lead Setup</b> in the <b>Setup ECG</b> menu to confirm the new lead set.</p>
<p>RL Lead Off            Numeric is replaced by -?- for 10 seconds.            INOP tone</p>	<p>The RL electrode has become detached from the patient or the lead set has been changed. Reattach the electrode or select <b>New Lead Setup</b> in the <b>Setup ECG</b> menu to confirm the new lead set.</p>
<p>Some ECG AlarmsOff</p>	<p>This message appears (if configured to do so) when the on/off settings of the yellow arrhythmia alarms differ from the current Profile.</p>
<p>V Lead Off            Numeric is replaced by -?- for 10 seconds.            INOP tone</p>	<p>The V electrode (IEC: C electrode) has become detached from the patient or the lead set has been changed. Reattach the electrode or select <b>New Lead Setup</b> in the <b>Setup ECG</b> menu to confirm the new lead set.</p>

## Resp INOPs

INOP Message, Indication	What to do
<b>Resp Equip Malf</b> Numeric is replaced by -?- INOP tone	Contact your service personnel. The RESP hardware is faulty.
<b>Resp Erratic</b> Numeric is replaced by -?-	The monitor has detected too many artifacts in the measured Resp signal. Check that the RA and LL electrodes are correctly attached and have not dried out.
<b>Resp Leads Off</b> Numeric is replaced by -?- INOP tone	Not all the required leads for Resp monitoring are attached. Make sure that the RA and LL leads are attached.

## NBP INOPs

INOP Message, Indication	What to do
<b>!! Cuff Not Deflat</b> <b>!!!Cuff Not Deflat</b> Numeric is displayed with a -?- Severe yellow/red INOP tone  During this INOP, alarms cannot be paused or switched off.	Remove the cuff from the patient. Make sure that the tubing is not kinked or twisted and that the correct patient category is selected. Try repeating the measurement. You can silence the INOP, but the INOP message remains visible until the next NBP measurement is started or the <b>Stop All</b> SmartKey is selected. [Adult or pediatric patients: The NBP cuff pressure has exceeded 15 mmHg (2 kPa) for more than 3 minutes. Neonatal patients: The NBP cuff pressure has exceeded 5 mmHg (0.7 kPa) for more than 90 seconds.]
<b>!! Cuff Overpress</b> <b>!!!Cuff Overpress</b> Numeric displayed with a -?- Severe yellow/red INOP tone  During this INOP, alarms cannot be paused or switched off.	The NBP cuff pressure exceeds the overpressure safety limits. Remove the cuff from the patient. Make sure that the tubing is not kinked or twisted and that the correct patient category is selected. Try restarting the measurement. You can silence this INOP, but the INOP message remains visible until the next measurement is started or the <b>Stop All</b> SmartKey is selected.
<b>NBP Deactivated</b> INOP tone	The NBP measurement label in the measurement device has been deactivated by deactivating the label in the <b>Measurement Selection</b> window. The measurement automatically disappears from the display. To switch the measurement on again, reactivate the measurement label in the <b>Measurement Selection</b> window.
<b>NBP Equip Malf</b> Numeric is replaced by -?- INOP tone	Remove the cuff from the patient. The NBP hardware is faulty. Contact your service personnel. You can silence this INOP, but the INOP message remains visible until the next measurement is started or the <b>Stop All</b> SmartKey is selected.
<b>NBP Interrupted</b> Numeric is replaced by -?- INOP tone	Check the tubing and cuff for leakages or kinks. Check that you are using the correct cuff size and placement, and that the correct patient category is selected. Try restarting the measurement. If the INOP occurs repeatedly, contact your service personnel. You can silence this INOP, but the INOP message remains visible until the next measurement is started or the <b>Stop All</b> SmartKey is selected. This INOP arises when the measurement needed longer than the maximum time for inflation, deflation or the total measurement.
<b>NBP Measure Failed</b> Numeric may be displayed with a -?- INOP tone	Check that you are using the correct cuff size and placement, and that the correct patient category is selected. Try restarting the measurement. You can silence this INOP, but the INOP message remains visible until the next measurement is started or the <b>Stop All</b> SmartKey is selected. Check the condition and suitability of the patient for NBP monitoring. Use another cuff to continue measuring.

## Temperature INOPs

INOP Message, Indication	What to do
<b>T1, T2, T3, T4</b> INOPs	See <Temp Label> INOPs
<b>Tamb</b> INOPs	See <Temp Label> INOPs
<b>Tart</b> INOPs	See <Temp Label> INOPs
<b>Tcereb</b> INOPs	See <Temp Label> INOPs
<b>Tcore</b> INOPs	See <Temp Label> INOPs
<Temp Label> <b>Deactivated</b> INOP tone	A Temp measurement label in the measurement device has been deactivated, either by connecting a Pressure transducer in the shared Press/Temp socket, or by deactivating the label in the <b>Measurement Selection</b> window.  The measurement automatically disappears from the display.  To switch the measurement on again, either reconnect a Temp transducer or reactivate the measurement label in the <b>Measurement Selection</b> window.
<Temp Label> <b>Equip Malf</b> Numeric is replaced by -?- INOP tone	Contact your service personnel. The temperature hardware is faulty.
<Temp Label> <b>Overrange</b> Numeric is replaced by -?- INOP tone	Try changing the application site of the transducer. [The temperature is less than -1°C, or greater than 45°C.]
<Temp Label> <b>Unplugged</b> INOP tone	A Temp measurement label has been deactivated, either by unplugging a module, or by deactivating the label in the <b>Measurement Selection</b> window.  The measurement automatically disappears from the display.  To switch the measurement on again, either replug the module or reactivate the measurement label in the <b>Measurement Selection</b> window.
<Temp Label> <b>NoTransducer</b> Numeric is replaced by -?- INOP tone	Make sure the TEMP probe is connected to the MMS or module. If you silence this INOP, the measurement will be switched off.
<b>Tesoph</b> INOPs	See <Temp Label> INOPs
<b>Tnaso</b> INOPs	See <Temp Label> INOPs
<b>Trect</b> INOPs	See <Temp Label> INOPs
<b>Tskin</b> INOPs	See <Temp Label> INOPs
<b>Ttymp</b> INOPs	See <Temp Label> INOPs
<b>Tven</b> INOPs	See <Temp Label> INOPs
<b>Tvesic</b> INOPs	See <Temp Label> INOPs

SpO<sub>2</sub> INOPs

INOP Message, Indication	What to do
<SpO <sub>2</sub> Label> <b>Chk Sensor</b>	The condition of the signal at the SpO <sub>2</sub> sensor is not as expected. Accuracy may be compromised. Check proper application of the sensor in accordance with the Instructions for Use. If the INOP persists, consider exchanging the sensor.
<SpO <sub>2</sub> Label> <b>Deactivated</b> INOP tone	The SpO <sub>2</sub> measurement label in the measurement device has been deactivated by deactivating the label in the <b>Measurement Selection</b> window. The measurement automatically disappears from the display. To switch the measurement on again, reactivate the measurement label in the <b>Measurement Selection</b> window.
<SpO <sub>2</sub> Label> <b>Equip Malf</b> Numeric is replaced by -?- INOP tone	The MMS or module is faulty. Unplug and replug the MMS or module. If the INOP persists, contact your service personnel.
<SpO <sub>2</sub> Label> <b>Erratic</b> Numeric is replaced by -?- INOP tone	Check the sensor placement. Try another adapter cable and sensor. If the INOP persists, contact your service personnel.
<SpO <sub>2</sub> Label> <b>Extd.Update</b> Numeric is replaced by -?- (questionable numeric)	The update period of displayed values is extended due to an NBP measurement on the same limb or an excessively noisy signal.
<SpO <sub>2</sub> Label> <b>Low Perf</b> Numeric is replaced by -?- (questionable numeric)	Accuracy may be compromised due to very low perfusion. Stimulate circulation at sensor site. If INOP persists, change the measurement site.
<SpO <sub>2</sub> Label> <b>No Pulse</b> Numeric is replaced by -?- INOP tone	Check the perfusion at measurement site. If necessary, stimulate circulation or change measurement site. If the INOP is due to NBP measurement on the same limb, wait until the NBP measurement is finished.
<SpO <sub>2</sub> Label> <b>No Sensor</b> Numeric is replaced by -?- INOP tone	Make sure the SpO <sub>2</sub> sensor is connected. If the INOP persists, try another adapter cable and sensor. If you silence this INOP, the measurement will be switched off.
<SpO <sub>2</sub> Label> <b>NoisySignal</b> Numeric is replaced by -?- INOP tone	Excessive patient movement or electrical interference is causing irregular pulse patterns. Try to reduce patient movement or to relieve the cable strain on the sensor.
<SpO <sub>2</sub> Label> <b>Poor Signal</b> Numeric is replaced by -?- (questionable numeric)	The signal condition of the SpO <sub>2</sub> measurement is poor and measurement accuracy may be compromised. If the INOP persists, consider changing the application site or using another sensor.
<SpO <sub>2</sub> Label> <b>Pulse?</b> Numeric is replaced by -?- INOP tone	The detectable pulsations of the SpO <sub>2</sub> signal are outside the specified pulse rate range.
<SpO <sub>2</sub> Label> <b>Searching</b> Numeric unavailable	SpO <sub>2</sub> is analyzing the patient signal to derive Pulse, SpO <sub>2</sub> and Perf values. Please wait until the search analysis is complete.
<SpO <sub>2</sub> Label> <b>Sensor Malf</b> Numeric is replaced by -?- INOP tone	The SpO <sub>2</sub> sensor or adapter cable is faulty. Try another adapter cable and sensor. If the INOP persists, contact your service personnel.
<SpO <sub>2</sub> Label> <b>Sensor Off</b> Numeric is replaced by -?- INOP tone	The SpO <sub>2</sub> sensor is not properly applied to the patient. Apply the sensor following the instructions supplied by the manufacturer.



INOP Message, Indication	What to do
<b>&lt;SpO<sub>2</sub> Label&gt; Unkn.Sensor</b> Numeric is replaced by -?- INOP tone	The connected sensor or adapter cable is not supported by the SpO <sub>2</sub> measurement. Use only specified sensors and cables.
<b>&lt;SpO<sub>2</sub> Label&gt; Unplugged</b> Numeric is replaced by -?- INOP tone	An SpO <sub>2</sub> measurement label has been deactivated, either by unplugging a module, or by deactivating the label in the <b>Measurement Selection</b> window.  The measurement automatically disappears from the display.  To switch the measurement on again, either replug the module or reactivate the measurement label in the <b>Measurement Selection</b> window.
<b>&lt;SpO<sub>2</sub> Label&gt; Upgrade</b> Numeric is replaced by -?- Numeric is unavailable	The SpO <sub>2</sub> measurement is currently in upgrade mode. Monitoring is not possible in this mode.
<b>&lt;SpO<sub>2</sub> Label&gt; Interference</b> Numeric is replaced by -?- INOP tone	There is too much interference, caused by a high level of ambient light and/or electrical interference. Cover the sensor to minimize ambient light. If the INOP persists, make sure that the sensor cable is not damaged or positioned too close to power cables.

## Pressure INOPs

INOP Message, Indication	What to do
<b>ABP INOPs</b>	See <b>&lt;Press Label&gt;</b> INOPs
<b>Ao INOPs</b>	See <b>&lt;Press Label&gt;</b> INOPs
<b>ART INOPs</b>	See <b>&lt;Press Label&gt;</b> INOPs
<b>BAP INOPs</b>	See <b>&lt;Press Label&gt;</b> INOPs
<b>CPP Chk Sources</b> Numeric is replaced by -?- INOP tone	Not all measurements or values required to perform the calculation are available. Check the measurement sources.
<b>CPP Chk Units</b> Numeric is replaced by -?- INOP tone	The monitor has detected a conflict in the units used for this calculation. Check the unit settings.
<b>CPP Disabled</b>	CPP has been disabled, either in the setup in Configuration mode, or by loading settings with CPP disabled. This can happen when changing from a pediatric or neonatal profile to an adult profile, as the default profile settings have the CPP measurement disabled in the adult profile and enabled in the pediatric and neonatal profiles. Enable CPP in the current profile to clear the INOP.
<b>CVP INOPs</b>	See <b>&lt;Press Label&gt;</b> INOPs
<b>FAP INOPs</b>	See <b>&lt;Press Label&gt;</b> INOPs
<b>IC1 / IC2 INOPs</b>	See <b>&lt;Press Label&gt;</b> INOPs
<b>ICP INOPs</b>	See <b>&lt;Press Label&gt;</b> INOPs
<b>LAP INOPs</b>	See <b>&lt;Press Label&gt;</b> INOPs
<b>P / P1 / P2 / P3 / P4 INOPs</b>	See <b>&lt;Press Label&gt;</b> INOPs
<b>PAP INOPs</b>	See <b>&lt;Press Label&gt;</b> INOPs
<b>PPV Bad &lt;Press Label&gt; Signal</b>	The arterial pressure source selected for PPV is not providing a pulsatile signal.
<b>PPV Bad Signal</b> at Information Center	The arterial pressure source selected for PPV is not providing a pulsatile signal.
<b>PPV Chk Sources</b>	The arterial pressure source selected for PPV is unplugged or switched off. When this INOP has displayed for 1 minute PPV will be switched off.
<b>&lt;Press Label&gt; Artifact</b> Numeric questionable	A non-physiological event (flush or blood sample) is detected. A resulting limit alarm or non-pulsatile INOP will be suppressed.

## 5 Patient Alarms and INOPs

INOP Message, Indication	What to do
<b>&lt;Press Label&gt; Deactivated</b> INOP tone	A Pressure measurement label in the measurement device or extension has been deactivated, either by connecting a Temp transducer in the shared Press/Temp socket, or by deactivating the label in the <b>Measurement Selection</b> window.  The measurement automatically disappears from the display.  To switch the measurement on again, either reconnect a Pressure transducer or reactivate the measurement label in the <b>Measurement Selection</b> window.
<b>&lt;Press Label&gt; Equip Malf</b> Numeric is replaced by -?- INOP tone	Contact your service personnel. The pressure hardware is faulty.
<b>&lt;Press Label&gt; No Pulse</b> Pulse numeric is replaced by -?- INOP tone	This INOP can only arise when a pressure is selected as the pulse source. It occurs when the pulse rate being measured is less than 25 beats per minute or the amplitude is less than three mmHg. Check the catheter and connections to the patient.
<b>&lt;Press Label&gt; No Transducer</b> Numeric is replaced by -?- INOP tone	Make sure that the pressure transducer is connected to the measurement device or module. If you silence this INOP, the measurement will be switched off.
<b>&lt;Press Label&gt; Noisy Signal</b> Pulse numeric is replaced by -?- INOP tone	This INOP can only arise when a pressure is selected as the pulse source. It occurs when the pulse detector finds a pulse rate above 350 bpm. This is usually caused by movement artifact or electrical interference.
<b>&lt;Press Label&gt; Overrange</b> Numeric is replaced by -?- INOP tone	Make sure that the measurement has been properly prepared and zeroed, and that the transducer is level with the heart. If this INOP persists, try another transducer. Possible causes are a measured pressure outside the allowed pressure range, or a broken wire to the transducer.
<b>&lt;Press Label&gt; Reduce Size</b>	Increase the scale for the pressure wave.
<b>&lt;Press Label&gt; Unplugged</b> INOP tone	A Pressure measurement label has been deactivated, either by unplugging a module, or by deactivating the label in the <b>Measurement Selection</b> window.  The measurement automatically disappears from the display.  To switch the measurement on again, either replug the module or reactivate the measurement label in the <b>Measurement Selection</b> window.
<b>&lt;Press Label&gt; Zero+Check Cal</b> Numeric is replaced by -?-	Perform a zero and check the calibration of the transducer.
<b>RAP</b> INOPs	See <b>&lt;Press Label&gt;</b> INOPs
<b>UAP</b> INOPs	See <b>&lt;Press Label&gt;</b> INOPs
<b>UVP</b> INOPs	See <b>&lt;Press Label&gt;</b> INOPs

CO<sub>2</sub> INOPs

INOP Message, Indication	What to do
<b>CO<sub>2</sub> Auto Zero</b> Numeric is replaced by -?- if the Autozero lasts >15 sec, INOP tone sounds.	The automatic zero calibration is in progress. This typically takes 10 seconds. During this time the CO <sub>2</sub> values may not be updated, or they may be replaced by -?-. Wait until the zero calibration is complete to resume monitoring.
<b>CO<sub>2</sub> Cal Failed</b> Numeric is replaced by -?- INOP tone	Make sure that the Cal cell was changed between CAL1 and CAL2. Repeat the calibration. If the INOP reappears, try another transducer. If the INOP persists, contact your service personnel.
<b>CO<sub>2</sub> Cal Mode</b> CO <sub>2</sub> numeric displays current CO <sub>2</sub> value for accuracy check	Currently no calibration is running. Accuracy can be checked by placing the transducer on the two cells of the calstick and starting calibration. To start monitoring, leave Cal. Mode.
<b>CO<sub>2</sub> Cal Running</b> Numeric is replaced by -?-	Wait until calibration is finished.
<b>CO<sub>2</sub> Check Cal</b> Numeric is replaced by -?- INOP tone	The CO <sub>2</sub> value is outside the measurement range. Perform an accuracy check for both calstick cells and, if necessary, recalibrate the transducer.
<b>CO<sub>2</sub> Chk Adapter</b> Numeric is replaced by -?- INOP tone	Check that the sensor is connected to the airway adapter, clean the airway adapter, if necessary. Perform a zero calibration. If the INOP persists, contact your service personnel.
<b>CO<sub>2</sub> Deactivated</b> INOP tone	The CO <sub>2</sub> measurement label in the measurement device has been deactivated by deactivating the label in the <b>Measurement Selection</b> window. The measurement automatically disappears from the display. To switch the measurement on again, reactivate the measurement label in the <b>Measurement Selection</b> window.
<b>CO<sub>2</sub> Equip Malfunction</b> Numeric is replaced by -?- INOP tone	The Measurement Extension is faulty. Unplug and replug the Multi-Measurement Module with Extension. If you are using the mainstream method, unplug and replug the transducer or try another transducer. If the INOP persists, contact your service personnel.
<b>CO<sub>2</sub> No Sensor</b> from M3014A Numeric is replaced by -?- INOP tone	There is no CO <sub>2</sub> sensor connected. If you silence this INOP the CO <sub>2</sub> measurement will be switched off.
<b>CO<sub>2</sub> No Tubing</b> Numeric is replaced by -?- INOP tone	Either the sample line is disconnected, or an incorrect line is attached. Check the connection. If necessary, connect another sample line (Use only the approved accessories). If you silence this INOP, the measurement will be switched off.
<b>!! CO<sub>2</sub> Occlusion</b> <b>!!! CO<sub>2</sub> Occlusion</b> Numeric is replaced by -?- INOP tone	The sample line or exhaust tube is blocked. Check the tubing, then disconnect and reconnect the sample line. If the INOP persists, connect a new sample line.
<b>CO<sub>2</sub> Overrange</b> Numeric is replaced by -?- INOP tone	The CO <sub>2</sub> value is higher than the measurement range. If you suspect a false high value, contact your service personnel.
<b>CO<sub>2</sub> Pump Off</b> Numeric is replaced by -?-.	The pump has been switched off for fifteen minutes. To switch it on again, select <b>Pump On</b> in the <b>Setup CO<sub>2</sub></b> menu.
<b>CO<sub>2</sub> Purging</b> Numeric is replaced by -?- INOP tone	The Filterline is being purged to remove an occlusion in the line or airway adapter. If the occlusion is removed, the INOP will disappear. If not, the INOP <b>CO<sub>2</sub> Occlusion</b> is displayed.
<b>CO<sub>2</sub> Sens Warmup</b> Numeric is replaced by -?- Microstream CO <sub>2</sub> : INOP tone Mainstream CO <sub>2</sub> : no INOP tone	Wait until the sensor reaches operating temperature and the INOP disappears.

## 5 Patient Alarms and INOPs

INOP Message, Indication	What to do
<b>CO<sub>2</sub> Upgrade FW</b> Numeric is replaced by -?- INOP tone	The software in the Measurement Extension does not match the software in the MMS. Contact your service personnel.
<b>CO<sub>2</sub> Wait Cal2</b> Numeric is replaced by -?-	Calibration on the first calstick cell is complete. Place the transducer on the other calstick cell and start the CAL2 calibration cycle.
<b>CO<sub>2</sub> Zero Failed</b> Numeric is replaced by -?- INOP tone	An error occurred during the last zero calibration. Check the airway adapter and clean, if necessary. Perform another zero calibration. If the INOP persists, contact your service personnel.
<b>CO<sub>2</sub>Change Scale</b>	The CO <sub>2</sub> wave is clipped. Select a more appropriate wave scale to display the whole wave.
<b>CO<sub>2</sub>NoTransducer</b> from mainstream CO <sub>2</sub> (except M3014A) Numeric is replaced by -?- INOP tone	There is no CO <sub>2</sub> transducer connected. If you replace the transducer, the new transducer must be calibrated. If you silence this INOP the CO <sub>2</sub> measurement will be switched off.
<b>CO<sub>2</sub>Zero Running</b>	Wait until zero calibration is finished.
<b>CO<sub>2</sub>ZeroRequired</b> Numeric is replaced by -?- INOP tone	Perform zero calibration for the CO <sub>2</sub> sensor. If the INOP persists, contact your service personnel.
<b>IPI Check Pat. Age</b>	For Adult patients: a date of birth has been entered that results in a calculated patient age of less than 12 years. Enter correct date of birth or, if patient is pediatric, correct patient category.  For pediatric patients: either no date of birth has been entered (it is required for calculation of IPI for pediatric patients) or the calculated age is below 1 year or above 12 years. Check that correct date of birth is entered.
<b>IPI Check Sources</b>	The IPI numeric cannot be provided as one or more of the measurement sources required for IPI is not available. Check availability of etCO <sub>2</sub> , awRR, SpO <sub>2</sub> , and pulse rate.
<b>IPI Neo Patient ?</b>	Check patient category. The IPI numeric is not available for neonatal patients.

## C.O. INOPs

INOP Message, Indication	What to do
<b>C.O. Deactivated</b> INOP tone	The Cardiac Output measurement label in the measurement device has been deactivated by deactivating the label in the <b>Measurement Selection</b> window. The measurement automatically disappears from the display. To switch the measurement on again, reactivate the measurement label in the <b>Measurement Selection</b> window.
<b>C.O. Equip Malf</b> Numeric is replaced by -?- INOP tone	There is a problem with the C.O. hardware. Contact your service personnel.
<b>C.O. Unplugged</b> Numeric is replaced by -?- INOP tone	Plug in the C.O. module. Silencing this INOP switches off the measurement.
<b>CCI No BSA</b> CCI numeric unavailable INOP tone	CCI cannot be calculated because the patient's body surface area is unknown. Enter the patient weight and height to provide the BSA for CCI calculation.
<b>CCO BadPressSignal</b> Numeric is replaced by -?- INOP tone	The arterial pressure wave can currently not be used for pulse contour calculation for CCO or CCI measurement. Possible causes are air bubbles in the tubing or a physiological condition, for example severe arrhythmia.
<b>CCO No Calibration</b> Numeric is replaced by -?-	The CCO measurement is currently not calibrated.

INOP Message, Indication	What to do
<b>CCO No &lt;Press Label&gt;</b> Numeric is replaced by -?- INOP tone may sound	CCO/CCI cannot be calculated. Make sure that the pressure chosen in the <b>Setup CCO</b> menu under <b>CCO From</b> matches the pressure measured with the arterial catheter for CCO measurement. A pressure from an external device cannot be used. Select another pressure label, either ABP, Ao, ART, BAP, FAP, or UAP.
<b>CCO No Press</b> at Information Center	CCO/CCI cannot be calculated. Make sure that the pressure chosen in the <b>Setup CCO</b> menu under <b>CCO From</b> matches the pressure measured with the arterial catheter for CCO measurement. A pressure from an external device cannot be used. Select another pressure label, either ABP, Ao, ART, BAP, FAP, or UAP.
<b>CCO Not Supported</b> Numeric is replaced by -?- INOP tone	A catheter for transpulmonary C.O. measurements has been unplugged and replaced with a Right Heart C.O. catheter, or the measurement mode has been changed manually. Silencing this INOP switches the measurement off.
<b>CCO Overage</b> <b>CCI Overage</b> Numeric is replaced by -?- INOP tone	The measured CCO or CCI value is not within the specified range for CCO/CCI measurement.
<b>CCO Press Invalid</b> at Information Center	The arterial pressure selected for pulse contour calculation for CCO is available but currently invalid. Make sure the pressure transducer is connected and the zero calibration is valid.
<b>CCO &lt;Press Label&gt; Invalid</b> Numeric is replaced by -?- INOP tone may sound	The arterial pressure selected for pulse contour calculation for CCO is available but currently invalid. Make sure the pressure transducer is connected and the zero calibration is valid.
<b>CCO PressOverrange</b> Numeric is replaced by -?- INOP tone	The mean value of the arterial pressure values used for pulse contour calculation for CCO is below 0 mmHg or above 300 mmHg.
<b>CCO PulseOverrange</b> Numeric is replaced by -?- INOP tone	The pulse rate of the pressure used for pulse contour calculation for CCO is below 30 bpm or above 240 bpm.
<b>CCO Recalibrate</b> Numeric is replaced by -?-	The most recent CCO or CCI calibration was made over 8 hours ago or the arterial pressure measurement used for CCO calculation has been zeroed after the CCO calibration was performed. You should recalibrate CCO or CCI with transpulmonary C.O. measurements at least every 8 hours or when the hemodynamic condition of the patient has changed. The pressure measurement must be zeroed before a CCO calibration.
<b>CCO/TbI NoTransduc</b> Numeric is replaced by -?- INOP tone	No transducer attached to the module or catheter disconnected.
<b>Tblood Overage</b> Numeric is replaced by -?-	Tblood out of range 17°C - 43°C.
<b>TbloodNoTransducer</b> Numeric is replaced by -?- INOP tone	No transducer attached to the module or catheter disconnected.

## Telemetry INOPs

INOP Message, Indication	What to do
<b>Check ECG Settings</b> INOP tone	Synchronization of ECG settings between the monitor and Information Center has failed. Check that the ECG settings in use are appropriate.
<b>!!Check ECG Source</b>	Both the telemetry device and the monitor have valid ECG signals
<b>Chk SpO<sub>2</sub>T Settings</b> INOP tone	Synchronization of SpO <sub>2</sub> T settings between the monitor and Information Center has failed. Check that the SpO <sub>2</sub> T settings in use are appropriate.
<b>Invalid Leadset</b>	The leadset plugged in cannot be used with the telemetry device.
<b>Leadset Unplugged</b>	The leadset has been unplugged from the telemetry device.

## 5 Patient Alarms and INOPs

INOP Message, Indication	What to do
<b>No ECG Source</b>	A telemetry device is paired with the monitor but the Information Center is not detecting a valid ECG signal from either of them.
<b>!! Repl. Tele Batt</b> <b>!!!Repl. Tele Batt</b> Severe yellow/red INOP tone  During this INOP, alarms cannot be paused or switched off.	The battery in the telemetry device is almost empty and must be replaced.
<b>Tele Battery Low</b>	The battery in the Telemetry device is low and must be replaced soon.
<b>!!Tele Disconnect</b> <b>!!!Tele Disconnect</b> Severe yellow/red INOP tone	Telemetry transceiver was disconnected or short range radio link was lost. For cable connections; check Telemetry interface, cable connection and setup. For short range radio connections: if the telemetry transceiver has not moved out-of-range, check for interference sources close to the monitor (bluetooth devices, DECT phones, cellular phones, microwaves, etc.). If this INOP persists, ask your service personnel to survey the interference sources.
<b>!! Tele INOP</b> <b>!!! Tele INOP</b> Severe yellow/red INOP tone	Check for further details at the Information Center or in the Telemetry Data window on the monitor.
<b>Tele Sync Unsupp.</b> INOP tone	The MMS in use does not support synchronization of ECG and SpO <sub>2</sub> settings between the monitor and central station after a telemetry device has been paired. Use an MMS with revision E.0 or above.

## Cableless Measurement Device INOPs

INOP Message, Indication	What to do
<b>cl NBP Batt Empty</b> <b>!!cl NBP BattEmpty</b> <b>!!!cl NBP BatEmpty</b> Corresponding INOP tone	The remaining battery time of the NBP Pod is below 30 minutes. Change the battery.
<b>cl NBP Batt Incomp</b> INOP tone	The battery in use with the NBP Pod is incompatible. Replace it with one approved for use with the NBP Pod.
<b>cl NBP Batt Low</b> INOP tone	The remaining battery time of the NBP Pod is below 2 hours.
<b>cl NBP Batt Malf</b> INOP tone	There is a malfunction in the NBP Pod's battery system. Contact your service personnel.
<b>cl NBP Batt Temp</b> INOP tone	The temperature of the battery in the NBP Pod is critically high. Check that the Pod is not covered or exposed to a heat source. If the INOP persists, remove the Pod from the patient and contact your service personnel.
<b>cl NBP Check Batt</b> INOP tone	The battery in the NBP Pod is nearing the end of its useful life. Only 50 charge/discharge cycles remain. Contact your service personnel to replace the battery.
<b>cl NBP Disconnect</b> INOP tone	The NBP Pod has lost the connection to the monitor.
<b>cl NBP No Cradle</b> INOP tone	The NBP Pod is not in its cradle.
<b>cl NBP Remove</b> INOP tone	The temperature of the battery in the NBP Pod is too high. Remove the Cableless Measurement Device from the patient and contact service personnel.
<b>cl NBP Serv Batt</b> INOP tone	The battery in the NBP Pod has reached the end of its useful life. It can no longer be charged. Contact your service personnel to replace the battery.
<b>cl SpO<sub>2</sub> Batt Empty</b> <b>!!cl SpO<sub>2</sub> BatEmpty</b> <b>!!!cl SpO<sub>2</sub> BtEmpty</b> Corresponding INOP tone	The remaining battery time of the SpO <sub>2</sub> Pod is below 30 minutes. Change the battery.

INOP Message, Indication	What to do
<b>cl SpO<sub>2</sub> Batt Incmp</b> INOP tone	The battery in use with the SpO <sub>2</sub> Pod is incompatible. Replace it with one approved for use with the SpO <sub>2</sub> Pod.
<b>cl SpO<sub>2</sub> Batt Low</b> INOP tone	The remaining battery time of the SpO <sub>2</sub> Pod is below 2 hours.
<b>cl SpO<sub>2</sub> Batt Malf</b> INOP tone	There is a malfunction in the SpO <sub>2</sub> Pod's battery system. Contact your service personnel.
<b>cl SpO<sub>2</sub> Batt Temp</b> INOP tone	The temperature of the battery in the SpO <sub>2</sub> Pod is critically high. Check that the Pod is not covered or exposed to a heat source. If the INOP persists, remove the Pod from the patient and contact your service personnel.
<b>cl SpO<sub>2</sub> Check Batt</b> INOP tone	The battery in the SpO <sub>2</sub> Pod is nearing the end of its useful life. Only 50 charge/discharge cycles remain. Contact your service personnel to replace the battery.
<b>cl SpO<sub>2</sub> Disconnect</b> INOP tone	The SpO <sub>2</sub> Pod has lost the connection to the monitor.
<b>cl SpO<sub>2</sub> No Cradle</b> INOP tone	The SpO <sub>2</sub> Pod is not in its cradle.
<b>cl SpO<sub>2</sub> Remove</b> INOP tone	The temperature of the battery in the SpO <sub>2</sub> Pod is too high. Remove the SpO <sub>2</sub> Pod from the patient and contact service personnel.
<b>cl SpO<sub>2</sub> Serv Batt</b> INOP tone	The battery in the SpO <sub>2</sub> Pod has reached the end of its useful life. It can no longer be charged. Contact your service personnel to replace the battery.





---

# Managing Patients and Equipment

When the monitor is used together with an IntelliVue Information Center, a variety of services are provided to manage the interconnections between patients, equipment, hospital beds, caregivers, and so on.

Many services can be used both at the monitor and at the Information Center, resulting in a more efficient workflow.

Which services are available will depend on which Information Center you have. The **Philips IntelliVue Information Center iX (PIIC iX)** provides more services and functionality than the **Philips IntelliVue Information Center (PIIC)**. In these Instructions for Use, information that is only valid for one of the Information Centers will be marked with a corresponding side heading, for example

**PIIC iX** For a list of the differences between the two Information Centers, see “Information Center Compatibility” on page 106.

## Patient Concepts

For a patient to be part of the system their identification data must be entered into the system. A patient can then be assigned to a bed, have equipment assigned directly to him, and have a location set when he is not currently in the bed.

## Equipment Concepts

Depending on how equipment is used in your facility, there are various ways to associate devices with patients, beds or monitors. Equipment usage must be configured appropriately at the Information Center and the monitoring equipment.

**PIIC iX** By configuration, equipment can be assigned:

- permanently to a bed,
- on demand to a bed or host monitor, or
- directly to a patient.

The foundation for a particular equipment use model is laid in the configuration settings in the monitor and the Information Center. Refer to the corresponding configuration guides for further details.

Additionally there are mechanisms to automatically free up equipment that is no longer used. This prevents unnecessary patient mismatches when the equipment is used for the next patient and avoids data of different patients getting mixed.

**PIIC iX** When connected to PIIC iX, equipment states are tracked by the system. When the equipment is not assigned to a patient or no patient is admitted at a monitor, the equipment is considered as free equipment in the system. Equipment that is assigned or has a patient admitted is tracked as used (i.e. not free) equipment.

The Information Center uses the equipment state (free/not free) to maintain and support workflow and equipment lists.

# Managing Patients

In order to attribute collected measurement data to a specific patient, or assign equipment or a bed to a specific patient, each patient in the system must be identified. By admitting a patient, you identify them for the system.

When equipment is freed up (for example by discharging the patient, removing a monitor from a patient or using End Case) the collection of data is officially ended for this patient and important settings on the monitor are reset to the defaults.

## Admitting a Patient

The monitor displays physiological data and stores it in the trends as soon as a patient is connected. This lets you monitor a patient who is not yet admitted. It is however important to admit patients properly so that you can identify your patient on recordings, reports, and networked devices.

During admission you enter data that the monitor needs for safe and accurate operation. For example, the patient category setting determines the algorithm the monitor uses to process and calculate some measurements, the safety limits that apply for some measurements, and the alarm limit ranges.

### NOTE

It is strongly recommended that the same patient data fields be configured to be mandatory at the monitor and the Information Center.

## When No Patient is Admitted

To admit a patient:

- 1 Select the patient name field or select the **Patient Demogr.** SmartKey to open the **Patient Demographics** window.

- 2 Select **Admit Patient**.

The **Enter Demographics** window appears. You can enter data as normal, using the keyboard or a barcode scanner, or, with **PIIC iX**, use the **Find Patient** key to search for patient data in connected systems as described in “Using “Find Patient” to Search for Patient Data” on page 91.

- 3 Enter the patient information: select each field and use the keyboard or barcode scanner or choose from the pop-up list of alternatives to input information.

**PIIC iX** When you enter data, the Information Center will automatically check for corresponding data and will suggest an appropriate action based on what it finds. You can select **Confirm** to accept the suggestion or **Cancel** to reject it.

- **Last Name:** Enter the patient's last name (family name).

- **First Name:** Enter the patient's first name.
- **Middle Name** (if configured to appear): Enter the patient's middle name.
- **Lifetime ID, Encounter ID:** Whether these fields appear and how they are labeled can be configured for your hospital. One or both fields may be displayed and the labels may read: **MRN, Case ID, Visit Number**, or other alternatives. Enter the appropriate data for the fields displayed.
- **Patient Cat.:** Choose the patient category, either **Adult, Pedi**, or **Neo**.
- **Paced Mode:** Choose **On** or **Off** (You must use **On** if your patient has a pacemaker). With **PIIC iX** there is a third choice: **Unconfirmed**. When the paced mode is **Unconfirmed**, the algorithm for paced patients will be used.
- **Height:** Enter the patient's height.
- **Weight:** Enter the patient's weight.
- **BSA:** The monitor calculates the body surface area automatically.
- **Date Of Birth:** Enter the patient's date of birth. Enter this in the form dd/mm/yyyy.
- **Age:** The monitor calculates the patient age automatically.
- **Gender:** Choose **Male** or **Female**.
- **Notes (1) / Notes (2):** Enter any extra information about the patient or treatment.

When admission is complete, the patient's name appears on the monitor info line at the top of the screen.

## When a Patient is Already Admitted

If the patient monitor already has a patient admitted, the **Admit Patient** key is replaced by the **New Patient** key.

When you select **New Patient**, the monitor is freed. All settings are reset to the defaults, all patient data and trend data are deleted, and monitoring at the Information Center may stop for monitors designated as transport monitors. Depending on your equipment configuration, selecting **New Patient** may transfer the currently admitted patient out of the bed. A message will appear requiring your confirmation of these actions.

After selecting **New Patient**, you can admit your patient as described in “When No Patient is Admitted” above.

## Using "Find Patient" to Search for Patient Data

**PIIC iX** You can use the **Find Patient** key to search for patient data in the Information Center and any connected hospital information systems. The search will look for currently admitted or previously admitted patients matching the search data you enter.

To search for patient data:

- 1 Select the **Find Patient** key.  
A window opens with an on-screen keyboard.
- 2 Type in the last name or an ID, or a part of it, and select **Enter** on the keyboard.  
The search results will be displayed in a **Select Patient** window. The system provides a list of all matching patients.
- 3 Highlight the patient you want to admit to this bed.
- 4 Depending on their current status, you will be asked whether you want to readmit them, or transfer them to this bed.

- 5 Select **Confirm** to complete the admission or transfer.

### Patient Category and Paced Mode

The patient category setting determines the algorithm the monitor uses to process and calculate some measurements, the safety limits that apply for some measurements, and the alarm limit ranges.

The paced mode setting determines whether the monitor shows pacemaker pulses or not. When **Paced Mode** is set to **Off**, pace pulses are filtered and therefore do not show in the ECG wave.

---

#### WARNING

**Patient Cat.** and **Paced Mode** will always contain a value, regardless of whether the patient is fully admitted or not. If you do not specify settings for these fields, the monitor uses the default settings from the current profile, which might not be correct for your patient.

#### Patient category

Changing the patient category may change the arrhythmia and NBP alarm limits. If possible, always load a suitable profile after changing patient category, and always check alarm limits to make sure that they are appropriate for your patient.

#### Paced mode

For paced patients, you must set **Paced Mode** to **On**. If it is incorrectly set to **Off**, the monitor could mistake a pace pulse for a QRS and fail to alarm during asystole. With PIIC iX, the paced mode may be **Unconfirmed** which will assume a pacemaker is present. You should still set the **Paced Mode** to **On** for paced patients to make the status clear.

---

### Admitting a Centrally-Monitored Patient

You can admit a patient at either the bedside or the Information Center. When you admit a patient, the patient's name appears on the bedside monitor and the Information Center.

If you do not fill in all patient information required by the Information Center, the Information Center may reject the admission. Complete all the required fields and try again to admit the patient.

### Quick Admitting a Patient

Use Quick Admit to quickly admit a patient using only a limited set of demographic data.

- 1 Select the **Quick Admit** SmartKey.
- 2 Enter the required data (ID fields or last name depending on configuration) with the keyboard or a barcode scanner.
- 3 Select **Enter**.
- 4 In the confirmation window, select **Confirm** to stop monitoring for the previous patient or free up the monitor (if confirmation is configured).
- 5 Check that patient category and paced status are correct for the new patient.
- 6 Check the current profile and, if necessary, load an appropriate profile.

If the monitor is connected to an Information Center and only the ID field is entered, the patient name may be set to - - - at the Information Center, depending on the configuration. With a PIIC iX, the Information Center can look-up patient information in a hospital information system (if available) and complete the patient demographics automatically. Otherwise, complete the rest of the demographic

details as soon as possible to fully identify the patient on the network, on the monitor and on printed reports. To complete the details, open the **Patient Demographics** window and complete all required fields.

## Editing Patient Information

To edit the patient information after a patient has been admitted, select the patient name field on the Main Screen to open the **Patient Demographics** window, and make the required changes.

**PIIC iX** If data has been provided by a hospital information system, you will not be able to edit it on the monitor.

## Ending Monitoring for a Patient

There are several ways to end monitoring for a patient, depending on whether there is an Information Center connection, and on the configuration of the Information Center and the monitor. Discharging a patient and removing the monitor from a patient are described here. You can also end monitoring by admitting a new patient, as described in “When a Patient is Already Admitted” on page 91.

## Discharging a Patient

The discharge function is only available when the patient is monitored centrally at an Information Center. A discharge transfers the patient out of the bed and frees all devices used for the patient. The discharge function may be disabled at a monitor designated as a transport monitor, to ensure that a patient cannot be accidentally discharged from the system when the transport monitor is used for another patient.

A discharge:

- clears the patient demographics
- erases all patient measurement data (such as trend, event, and calculation data) from the monitor, measurement modules and Information Center. This ensures that data from a previous patient are not mixed with data from a new patient.
- resets patient category and paced settings to the settings defined in the default Profile
- resets all monitor and measurement settings as well as the active Screen to the settings defined in the default Profile
- discharges the patient from the Information Center.

Make sure that you have printed out any required reports before discharging. Check that a functioning local or central printer is available before you use **End Case**.

### To Discharge a Patient

- 1 Select the patient name field or select the **Patient Demogr.** SmartKey to open the **Patient Demographics** window and associated pop-up keys.
- 2 Select the pop-up key for either:
  - **End Case** - to print any configured end case reports or vital signs recording, discharge the patient and clear the patient database, then enter standby mode. If an **End Case** SmartKey is configured for your monitor, you can also select this instead and then confirm.

To see which end case reports are set up for your monitor, select **Main Setup, Reports**, then **Auto Reports**. For each auto report, if **End Case Report** is set to **On**, this report will be printed when you select **End Case**. See “Setting Up Auto Reports” on page 233 for information on setting up end case reports.

- **Discharge Patient** - to discharge the patient without printing any reports.

### Removing the Monitor

Removing a monitor stops using the monitor for the current patient and frees up the monitor and all devices assigned to that monitor.

Removing the monitor:

- clears the patient demographics in the monitor.
- erases all patient measurement data (such as trend, event, and calculation data) from the monitor and devices assigned to the monitor. This ensures that data from a previous patient are not mixed with data from a new patient.
- resets patient category and paced settings to the settings defined in the default Profile.
- resets all monitor and measurement settings as well as the active Screen to the settings defined in the default Profile.

If the monitor is locked to the bed and is connected to an Information Center, the remove function is not available and you will have to discharge the patient.

### To Remove a Monitor

- 1 Open the **Equipment** window - either directly in **Main Setup** or by selecting the bed label in the information line.
- 2 Select the monitor.
- 3 Select the **Remove Monitor** pop-up key.

### New Patient Check

The monitor can be configured to ask you whether a new patient is now being monitored in certain situations:

- after a specified power-off period
- after a specified standby period
- when no basic vitals (HR, RR, Pulse, SpO<sub>2</sub>, NBP) have been measured for a specified period

The pop-up window is entitled **Is This A New Patient?**. The monitor offers a **Yes** key to stop monitoring for the previous patient and begin monitoring a new patient and a **No** key to continue monitoring with the current patient data and settings.

The time periods for the three conditions can be configured independently.

## Transferring Patients

To save you from having to enter the same patient data multiple times and enable patient transfer without loss of data, patient demographic information is shared between patient monitors and Information Centers.

### Data Exchange Between Information Centers

You can transfer demographic data and trend data from one IIC to another by selecting **Transfer** on the patient monitor. Trend data is not shared between Information Centers and monitors.

## Transferring Patients with IntelliVue Information Center iX

**PIIC iX** There are several ways to transfer a patient from or to another bed. When a patient is transferred to the destination bed, Information Center monitoring continues in the destination bed and equipment that is not transferred with the patient is freed up.

### Using the Transfer Function

**PIIC iX** To transfer a patient using the transfer function provided on the patient monitor by the Information Center:

- 1 Select the patient name or the **Not Admitted** text at the top of the monitor screen to open the **Patient Demographics** window.
- 2 Select the **Transfer** pop-up key.  
The **Transfer** window opens. If a patient is currently admitted, the window offers the possibility to transfer that patient to another bed (**To Other Bed**). If no patient is currently admitted, the window offers the possibility to transfer a patient **from** another bed using the patient search as described in “Using “Find Patient” to Search for Patient Data” on page 91.
- 3 With **To Other Bed**, if more than one unit is configured, a list of units will appear. When you have selected a unit, or if only one unit is configured, a list of free beds will appear.
- 4 Select a bed from the list.  
You will be asked to confirm the transfer of the patient to this bed.
- 5 Select **Confirm** to complete the transfer.

---

#### WARNING

Before doing a transfer ensure that no other patient is using the destination bed and/or equipment from the destination bed.

When a patient is transferred you need to check that the patient has all the required monitoring equipment at the destination bed.

---

### Using the New Patient Key

**PIIC iX** If the monitor at the destination bed is not free:

- 1 Select the patient name field at the top of the monitor to open the **Patient Demographics** window.
- 2 Select **New Patient** to free up the monitor.
- 3 Select **Find Patient** and enter your patient's name to get the patient data from the system.  
When you select your patient from the list, you will be asked to confirm that the patient should be transferred into this bed. After confirmation the transfer is complete.

## Transferring Patients with IntelliVue Information Center

### Transferring a Centrally-Monitored Patient with the Monitor

Scenario: A centrally-monitored patient is moved with the monitor to another monitoring location on the same Information Center database server without interrupting the collection of patient trend information.

- 1 Select the patient name field or select the **Patient Demogr.** SmartKey to open the **Patient Demographics** window, then select the **Transfer** pop-up key. If the patient is not admitted or not monitored by an Information Center, the **Transfer** key is inactive ("grayed-out").  
This step preserves the patient's demographic data during the transfer.
- 2 At the new location, connect the monitor to the network (only needed for wired networks). If the monitor detects a patient mismatch, a window will open showing your patient's data and asking **Complete Transfer Of This Patient?**
- 3 Select **Yes** to complete the transfer.
- 4 Verify that the settings for patient category and paced mode are correct.

If you accidentally transfer a patient, use **Re-Admit** to restore this patient's data to the Information Center. If you are not connected to the network, select **Clear Transfer** to leave transfer mode. The patient data remains in the monitor.

### Resolving Patient Information Mismatch

When you connect together devices which store patient demographic data, for example, a monitor and an Information Center, the system compares patient category, paced status, and unique patient identification in order to synchronize this information. If configured to do so, the monitor indicates a mismatch if the information is not identical.

---

#### WARNING

- It is important to resolve the mismatches as soon as they are identified. Failure to do so could result in using incorrect/confusing data to make clinical decisions. Certain settings, for example **Paced Mode** and **Patient Cat.**, may not match between the Information Center and the monitor. If the **Paced Mode** is set incorrectly, the system could mistake a pace pulse for a QRS and fail to alarm in the case of asystole. It is important that the patient category is set correctly so the ECG can be analyzed correctly and initial arrhythmia alarm limits set. A **Check Patient ID INOP** will appear when a mismatch has not been resolved.
  - As long as patient mismatch has not been resolved, data integration in the Information Center and the own patient overview functionality might not work as equipment is not assigned correctly to the patient.
- PIIC** • When a monitor is connected to an Information Center by the wireless IntelliVue Instrument Telemetry interface, the patient data will automatically be merged in the case of a transfer. This means there is no patient discharge at the monitor and settings and trend data will be retained. You will see a message on the monitor and the **Patient Demographics** window will automatically appear so that you can check the data and change it if necessary.
-



## Manually Resolving Patient Mismatch

The source of the patient mismatch is indicated by question marks (???) and displayed in the status line at the bottom of the screen (**Patient ???**, **Patient Category ???** or **Paced Mode ???**).

The **Select Patient** window automatically opens so you can decide which patient data to use. You do not have to resolve the mismatch immediately, but the indicators remain until you do. After 5 minutes a **Check Patient ID INOP** will appear to remind you to resolve the mismatch.

For some common mismatch situations, the monitor will simplify the resolution by suggesting a solution for the mismatch. For example, when a patient arrives after transport and the **Transfer** key has been selected, the monitor will show this patient's data and ask **Complete Transfer Of This Patient?**. You can then select **Yes** to complete the transfer. If you select **No** you will go to the **Select Patient** window.

After you resolve the mismatch, the monitor displays a confirmation window that shows the patient that has been selected and where data will be erased, if applicable. Confirm your choice. The monitor automatically displays the **Patient Demographics** window after confirmation. Verify that the settings shown are correct for the patient.

Gender, date of birth, height, weight, and nursing notes do not generate a mismatch. If these fields are different on different devices, the monitor resolves them itself. For example, it may take date of birth from the Information Center, whilst taking gender from the monitor. Always check the patient demographics after combining patients, to ensure that you are satisfied with the results. Change them if necessary.

---

### WARNING

After resolving a patient mismatch, check that the monitor settings (especially patient category, paced status and alarm limits) are correct for the patient.

---

### Patient Mismatch - If One Set of Patient Data is Correct

If there is a mismatch between an Information Center and a monitor, choose the data set you want to continue using for this patient by selecting one of the sectors in the **Select Patient** window.

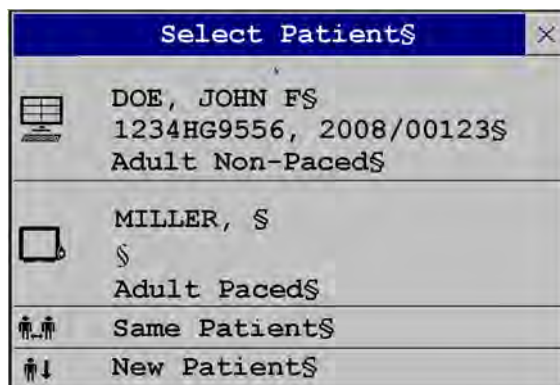

After you resolve the mismatch, the monitor displays a confirmation window that shows the patient that has been selected and where data will be erased, if applicable. Confirm your choice. The monitor automatically displays the **Patient Demographics** window after confirmation. Verify that the settings shown are correct for the patient.

### Patient Mismatch - If Neither Patient Data Set is Correct

A patient mismatch where neither set of patient data is correct might occur if you connect a new MMS to a monitor in order to prepare for a new patient, before you actually start measuring.

Select **New Patient** if you are sure that none of the information is correct. This uses the bed, monitor and MMS for a new patient, erases all data in both the monitor and MMS, resets all settings to the default Profile, and lets you admit a new patient.

## Managing Equipment

Multiple pieces of monitoring equipment can be used for a patient. The association between a patient and a device can be made by:

- identifying the patient at the device (by entering patient data or using **Find Patient** to get patient data)
- "adding" equipment for an existing patient

The association between a patient and a device can be ended by:

- discharging the patient, or selecting **End Case**.
- "removing" the device from the patient.
- transferring the patient without the device.
- admitting a new patient to the device.
- automatic freeing of the device.

---

### WARNING

In all cases listed above, when equipment is freed, all patient identification and measurement data are deleted, all settings are reset to the defaults, and monitoring at the Information Center (if active) is stopped. Any associated devices, e.g. multi measurement modules connected to a monitor, or cableless measurement devices assigned to a monitor, may also be freed, depending on the configuration.

---

### Adding Equipment (PIIC iX)

By selecting the **Add Equipm.** key you can display a list of all free equipment (not currently assigned to a patient) and select a device for use with this patient. If you add another monitor, you need to confirm this at the selected monitor.

### Removing Equipment

The association between a monitor and the patient can be ended by selecting **Remove Monitor**. With PIIC iX, the **Remove Monitor** key is not available when the monitor is locked to a bed.

Other equipment such as telemetry devices or IntelliVue Cableless Measurements can be removed by selecting the device then selecting **Remove** in the menu displayed.

### Equipment Status Disputes



Equipment can come into situations where its status does not match its location. There are three typical situations where this may occur:

- PIIC iX only - equipment is locked to a bed, but has been removed and used at another bed.

- PIIC iX only - equipment has been configured for use in a specific unit, but is now being used in a different unit.
- Equipment has an equipment label but has not been configured at the Information Center and therefore cannot be managed.

If a monitor or a companion device is in one of these situations, a **Check Equipment** INOP will appear and the equipment status will be shown in the **Equipment** window.

The following symbols (in red) are used to show the status in the **Equipment** window:

	equipment is locked to another bed
	equipment is not configured for use in this unit
	equipment label is not in system configuration, or duplicate equipment labels

## Using the Equipment Window

In the **Equipment** window you have access to patient management, workflow functions (set location, transfer), equipment management functions (add/remove equipment) and caregiver-related functions.

You can open the **Equipment** window directly in **Main Setup** or by selecting the bed label in the information line.

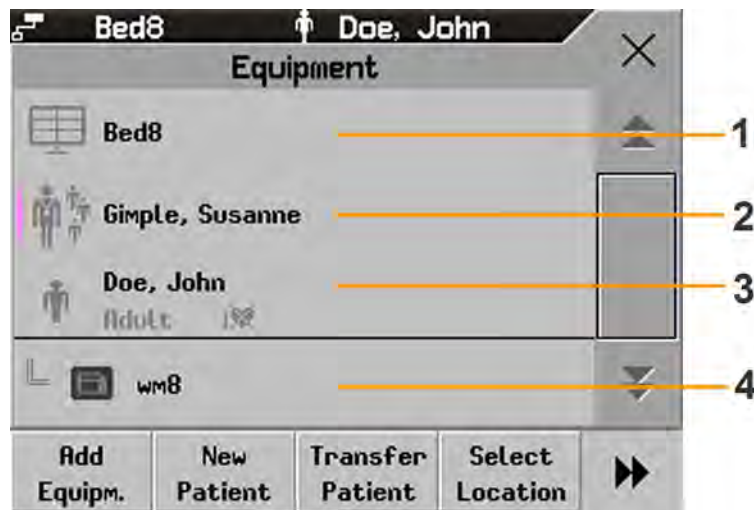

- 1 This bed is Bed 8, the connection to the Information Center is active.
- 2 Caregiver area - depending on your network connection, the name of assigned caregiver may be shown.
- 3 Patient name, category and paced mode.
- 4 This monitor is assigned to the patient and is the one on which you are viewing the window.

The top part of the window contains the patient data, with the assigned caregiver and the status of the connection to the Information Center, and the bed label. In the lower part of the window, all equipment for this patient is shown, with the corresponding assignments and connections.

The device you are currently viewing the window on is shown with a dark background (in the above example, the monitor with the label wm8).

### Changing Caregiver Assignment

When a caregiver is assigned, the caregiver name may appear next to the caregiver symbol in the **Equipment** window (depending on your network connection). Whether the name is shown or not, when you select this area of the window, a menu opens offering the following functions:

- **PIIC iX** • **Select Caregiver** - you can select a different caregiver from a list. When a new caregiver is assigned, the patient will be automatically added to that caregiver's Care Group. The availability of the function and the caregiver list depends on the Information Center configuration.
- **My Patients** - opens the **My Patients** window showing all patients in your Care Group.

### Using the Patient Area

The patient name, patient category and paced status are normally shown in the **Equipment** window. When a patient has been prepared for transfer, the transfer symbol will be shown:



When you select this area in the **Equipment** window, a menu opens giving access to the **Enter Demographics** window, the **Transfer** function (see “Transferring Patients” on page 94) and the **End Case** function.

### Changing the Location

If the monitor is currently assigned to a bed, but the patient is in another department for treatment or a diagnostic procedure, you can show a temporary location for the patient.

- 1 Select the Information Center area on the **Equipment** window.
- 2 Select the current location from the list.

Or alternatively use the **Select Location** pop-up key.

The temporary location is then shown in the **Equipment** window, on the Standby screen on the monitor, and in the sector at the Information Center. When the patient returns, you can set the location back to the bed number in the same way as described above.

### When Multiple Equipment is Used for One Patient

It is possible to assign additional monitoring equipment and a telemetry device to the same patient, resulting in the information from multiple devices being combined in one sector at the Information Center. The measurement data from the other devices will be displayed on the monitor screen in the own patient overview window.

---

#### WARNING

When new equipment has been added for a patient, you will be asked to confirm that the device be used for the patient. Always do this as soon as possible to avoid patient data mismatch.

If multiple equipment is assigned to the patient, resolving a patient mismatch at the monitor may resolve other pending patient mismatches or remove other associated equipment.

---

## Own Patient Overview Window

The measurements from other monitoring devices and telemetry devices are shown combined in the own patient overview window on the monitor, together with related information derived by the Information Center, such as alarms.

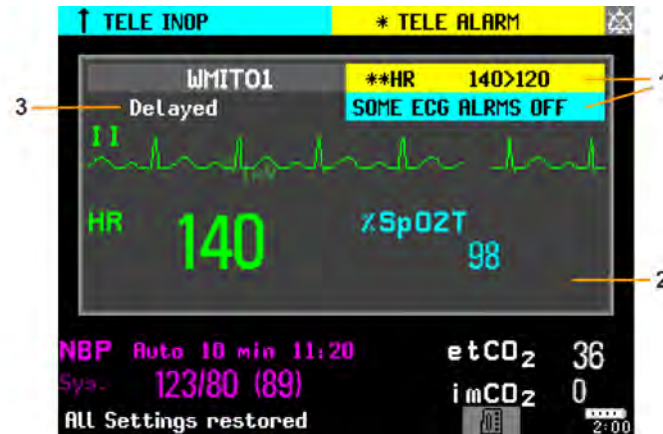



- 1 Current alarm and INOP generated by another device.
- 2 Own patient overview window
- 3 **Delayed** - indication that data in the window is delayed.

### WARNING

All data presented in the own patient overview window are delayed for several seconds.

If you need realtime data, for example for defibrillation, always use the host monitor ECG instead of telemetry or ECG from another monitoring device. As long as the ECG is being measured with another device there will be no ECG signal available at the ECG analog output.

## Visual Alarm Status Information in the Own Patient Overview Window

- If individual measurement alarms are switched off at any of the devices in use for the patient, a crossed alarm symbol on a white background is shown beside the measurement numeric 
- If all alarms are switched off or paused for one of the devices in use for the patient, a crossed alarm symbol on a dark gray background is shown beside all affected measurement numerics (if so configured). If all red and yellow alarms are switched off/paused, the crossed alarm symbol is red. If only yellow alarms are switched off/paused, the crossed alarm symbol is yellow. 

## Assigning a Telemetry Transceiver with an SRR Adapter to a Monitor

Monitors which have this capability have a short range radio symbol  on the model label.

A telemetry device with a short range radio adapter can be assigned to a monitor directly. To assign a telemetry device to a monitor:

- 1 Press the Check button on the telemetry device.  
The measurement selection key on the monitor will change to show the "add cableless" symbol



- 2 Select the symbol.
- 3 In the **Add Cableless** window, select the correct equipment label for the telemetry device.
- 4 Check that the assignment is successful and that transmission has begun:
  - A **Tele Device assigned** message appears on the monitor
  - A tone sounds at the telemetry device and the Leads Off indicators light
  - The ECG wave appears on the monitor

To confirm that the correct telemetry device has been assigned, open the ECG Setup menu. The title of the menu contains the equipment label of the telemetry device; check that this is the correct label.

If a telemetry device is already assigned to a monitor, you cannot assign a further telemetry device to that monitor.

If the telemetry device goes out-of-range or loses the short range radio connection, it will switch over to standard telemetry transmission to the Information Center. In this case, the telemetry data is displayed in the Own Patient Overview Window as described above.

When a telemetry device with a short range radio adapter is assigned to the patient, the short range radio connection to the monitor is made automatically.

If a telemetry device disappears from the list in the **Add Cableless** menu, press the Check button on the telemetry device again. If the monitor is not configured to be used with a telemetry device, the add cableless symbol will appear crossed out .

If the telemetry device is removed (unassigned), the short range radio connection will be ended.

---

### WARNING

Short range radio connections are subject to interruption due to interference from other radio sources in the vicinity, including microwaves, bluetooth devices and DECT phones. Outside the operating frequency band and 5% above and below, i.e. the exclusion band according IEC 60601-1-2, section 36.202.3a)4), the short range radio connection is immune up to 3V/m in the frequency range from 80 MHz to 2.0 GHz and up to 1V/m in the frequency range from 2.0 to 2.3 GHz. Depending on the strength and duration of the interference, the interruption may occur for an extended period. A loss of connection, due to moving out-of-range, interference, or for other reasons, is indicated with a **Tele Disconnected** INOP.

Correct channel configuration is important, refer to the *Configuration Guide* for details.

---

If a **Tele Disconnected** INOP occurs when the telemetry device goes out-of-range, the INOP will disappear (without being silenced) as soon as the ECG signal from the telemetry device is available at the Information Center via standard telemetry transmission.

## Controlling Other Devices from the Bedside

You can change ECG settings for the current ECG source from the patient monitor.

- 1 Select the own patient overview window.
- 2 Select the **Setup Equip** pop-up key.

A setup menu will appear with the settings available for the current ECG source. If it is a telemetry transmitter or patient monitor connected to the Information Center via LAN or WLAN, the following settings are available: adjust HR alarms, relearn arrhythmia, select primary/secondary ECG lead, select arrhythmia analysis mode, change primary/secondary ECG lead size. PIIC iX only: if the current ECG source is a patient monitor connected to the Information Center via IntelliVue Instrument Telemetry (IIT), only the adjust HR alarms setting is available.

## Viewing and Silencing Other Device Alarms at the Bedside

When other devices are assigned to the patient, alarms from those devices will also be indicated on the monitor, in addition to the main indication at the Information Center.

If configured, a generic alarm message will appear in the alarm status area with standard alarm tones. The alarm message will have the color and \* or ! coding corresponding to the severity of the alarm. The specific alarm message (for example **\*\* HR Low**) will appear in the own patient overview window.

If configured, alarms generated from another device can be silenced at the bedside. Either the monitor **Silence** key is configured to silence both monitor and other device alarms (must be configured at the Information Center) or the **Silence Bed** pop-up key will be available:

- 1 Select the own patient overview window.
- 2 Select the **Silence Bed** pop-up key.

Depending on your Information Center configuration, the **Silence Bed** key may silence both other device alarms **and** bedside alarms.

---

### WARNING

Even when the other device data is not visible on the screen, you may be silencing monitor alarms **and** other device alarms, if the Information Center and monitor are so configured.

---

## Switching Off or Pausing Alarms From Other Devices

When you select **Pause Alarms** or **Alarms Off** at the monitor, the alarms are off or paused for the bedside measurements. When you switch alarms off or pause alarms at the Information Center, both monitor alarms and alarms from other assigned devices are affected.

Refer to the Information Center Instructions for Use for more details on the Suspend/Pause alarms behavior of the Information Center.

## Using Standby

When you select Standby mode at the monitor, the bedside goes into Standby mode but other assigned devices may continue monitoring.

Refer to the Information Center Instructions for Use for details on how selecting Standby at the Information Center affects the monitor and other devices.

## ECG Source Tracking at the Information Center

The Information Center continuously checks whether a valid ECG signal is coming from the monitor or from another assigned device. If you unplug the ECG patient cable from the monitor and plug it into another device, the Information Center will automatically switch to monitoring the ECG from the other device. At the monitor, its own ECG measurement will be deactivated and the **Setup ECG** menu will no longer be accessible.

When you unplug the patient cable from the other device and plug it back into the monitor again, the Information Center will switch back to monitoring the ECG from the monitor. The ECG measurement will be activated again at the monitor. [Note that in this case, as the screen switches back to the monitor's own measurements, the SpO<sub>2</sub>T measurement (if present) will no longer be displayed].

In the same way the source is tracked when a telemetry device is directly connected to a monitor, then disconnected and vice versa.

In case of ambiguity, a yellow INOP message **!!Check ECG Source** indicates that more than one valid ECG source is active.

## Synchronized Settings

For some measurements, settings can be synchronized between the monitor and another measurement device. For example, if ECG is measured at the monitor, and then the patient is connected to a telemetry device for monitoring, the Information Center will use the monitor settings for the telemetry device. In general, the following settings will be synchronized:

Heart Rate	HR/Pulse Alarm On/Off, Heart Rate High/Low Limit,
ECG	ECG On/Off, Primary Lead, Secondary Lead, Va Lead <sup>1</sup> , Vb Lead <sup>1</sup> , Lead Placement
Arrhythmia	Analysis Mode, Arrhythmia On/Off, Asystole Threshold, Pause Threshold, VTach HR, VTach Run, PVCs/min, Vent. Rhythm, SVT HR, SVT Run, PVCs/min On/Off, Pacer not capture On/Off, Pacer not pace On/Off, Non-Sustain On/Off, Vent. Rhythm On/Off, Run PVCs On/Off, Pair PVCs On/Off, Missed Beat On/Off, Pause On/Off, R-on-T PVCs On/Off, Vent. Bigeminy On/Off, Vent. Trigeminy On/Off, Multiform PVCs On/Off, Irregular HR On/Off, SVT On/Off, Afib On/Off, Afib/IrrHR Timeout, Afib/IrrHR End Threshold
ST	ST Analysis On/Off, ST Alarm On/Off, ISO Point, J point, ST point, ST Priority List, Single ST Alarm Limit, Multi ST Alarm Limit, ST-Index On/Off, ST Alarm Mode, ISO/J-Point Detection, ST Lead On/Off, ST Baseline
QT	QT analysis On/Off, QT Lead, QTc High Alarm On/Off, ΔQTc Alarm On/Off, QTc High Limit, ΔQTc High Limit, QTc Formula <sup>2</sup> , QT Baseline <sup>3</sup>
SpO <sub>2</sub> T	SpO <sub>2</sub> Alarms on/off, SpO <sub>2</sub> Alarm limits, SpO <sub>2</sub> Low Alarm Delay, SpO <sub>2</sub> High Alarm Limit, Desat Alarm Limit NBP Alarm Suppression On/Off, Pulse(SpO <sub>2</sub> ) On/Off
<sup>1</sup> Va and Vb leads are reset to default (V2, V5) if the configured Va or Vb lead for the telemetry device is not one of V1 through V6. <sup>2</sup> This setting will only be synchronized when the Information Center supports QT Analysis for Telemetry <sup>3</sup> With PIIC, QT baseline is synchronized, but not QT snippets.	



**PIIC iX** With the IntelliVue Information Center iX, the following additional measurement settings can be synchronized:

ECG/Arrhythmia	Hexad Reconstruction Mode, Some ECG Alarms INOP On/Off
ST	STE On/Off, STE Alarm On/Off
NBP	Sys/Dia/Mean Alarm Limits, Alarms On/ Off, Alarm Source
Resp	Apnea Time, Alarm Limits, Detection Mode, Alarm On/Off, Resp On/Off
SpO <sub>2</sub>	SpO <sub>2</sub> Alarms on/off, SpO <sub>2</sub> Alarm limits, SpO <sub>2</sub> Low Alarm delay, SpO <sub>2</sub> High Alarm delay, Desat Alarm Limit, NBP Alarm Suppression On/Off, Pulse(SpO <sub>2</sub> ) On/Off, Measurement Mode <sup>1</sup> , Repetition Time <sup>1</sup>
<sup>1</sup> Measurement Mode and Repetition Time can only be synchronized if SpO <sub>2</sub> comes from a Cableless SpO <sub>2</sub> Pod or a telemetry device.	

### WARNING

- Not all settings are synchronized; after changing the measurement source, always check that the settings are appropriate.
- **ECG:** Va and Vb leads are reset to default (V2, V5) if the configured Va or Vb lead for the telemetry device is not one of V1 through V6.

If later the patient is disconnected from the other device, and reconnected to the monitor again, any changes in the settings made in the meantime will be passed on to the monitor. In this way, settings continuity is preserved when the measurement source changes.

### NOTE

Settings synchronization can be switched off at the monitor in Configuration mode.

In certain situations, you will be asked to confirm that synchronization of settings is appropriate.

Settings synchronization can only take place when there is no patient information mismatch between the monitor and the Information Center.

**PIIC** If a **Check ECG Settings** or **!! Check Pairing** INOP appears always check that the ECG settings, especially the paced setting, are appropriate for your patient.

**PIIC iX** If a **Check ECG Settings**, **Chk SpO<sub>2</sub>T Settings**, or another check settings INOP appears, always check that the settings, especially the paced setting for ECG, are appropriate for your patient.

## Information Center Compatibility

The functionality available for managing patients and equipment depends on the IntelliVue Information Center being used. In the following table the main differences between the PIIC and PIIC iX are shown.

PIIC	PIIC iX
Not available	<b>Find Patient</b> - searching for a patient in the Information Center or other connected hospital systems. (With LAN and WLAN connection only)
<b>Transfer Patient</b> - patient is moved to transfer list.	<b>Transfer Patient</b> - can transfer patient directly to another bed/unit and from another bed/unit. (With LAN and WLAN connection only)
Not available	A unique patient list provides information about the current status of a patient allowing intelligent prompts and preventing the same patient being admitted twice.
<b>Add Equipment</b> - allows only assignment of telemetry devices via manual pairing.	<b>Add Equipment</b> - allows assignment of other monitors, telemetry devices and X2 MMS. (With LAN and WLAN connection only)
<b>Remove</b> equipment - allows only removal of telemetry devices via <b>Unpair To Mon.</b> and <b>Unpair To Tele.</b>	<b>Remove</b> equipment - allows removal of other monitors, telemetry devices and X2 MMS.
Not available	<b>Select Location</b> - allows a temporary location to be shown when a patient is not in the unit. (With LAN and WLAN connection only)
Not available	<b>Select Caregiver</b> - allows a Caregiver to be assigned to a patient
Not available	Paced status <b>Unconfirmed</b> is the initial setting before a paced status has been entered. <b>Unconfirmed</b> will switch pace pulse rejection on but makes the user aware that no paced status has been selected.

---

# ECG, Arrhythmia, ST and QT Monitoring

The electrocardiogram (ECG) measures the electrical activity of the heart and displays it on the monitor as a waveform and a numeric. This section also tells you about arrhythmia monitoring (see “About Arrhythmia Monitoring” on page 127), ST monitoring (see “About ST Monitoring” on page 137) and QT monitoring (see “About QT/QTc Interval Monitoring” on page 148).

## Skin Preparation for Electrode Placement

Good electrode-to-skin contact is important for a good, noise-free ECG signal, as the skin is a poor conductor of electricity.

- 1 Select sites with intact skin, without impairment of any kind.
- 2 Clip or shave hair from sites as necessary.
- 3 Wash sites thoroughly with soap and water, leaving no soap residue.  
We do not recommend using ether or pure alcohol, because this dries the skin and increases the resistance.
- 4 Dry skin thoroughly.

## Connecting ECG Cables

- 1 Attach the clips or snaps to the electrodes before placing them. If you are not using pre-gelled electrodes, apply electrode gel to the electrodes before placement.
- 2 Place the electrodes on the patient according to the lead placement you have chosen.
- 3 Attach the electrode cable to the patient cable.
- 4 Plug the patient cable into the white ECG connector. An ECG waveform and numeric appears on the monitor display.

---

### CAUTION

To protect the monitor from damage during defibrillation, for accurate ECG information and to protect against noise and other interference, use only ECG electrodes and cables specified by Philips. Some non-authorized electrodes may be subject to large offset potentials due to polarization.

---

## Selecting the Primary and Secondary ECG Leads

The monitor uses the primary and secondary lead to compute HR and to analyze and detect cardiac arrhythmias. They are also available for recordings and for display on the Information Center.

The secondary lead is only used if your monitor is configured for multi-lead (instead of single-lead) arrhythmia analysis.

You should choose a lead as primary or secondary lead that has the following characteristics:

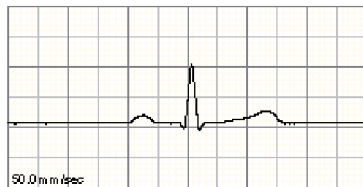

- the QRS complex should be either completely above or below the baseline and it should not be biphasic
- the QRS complex should be tall and narrow
- the P-waves and T-waves should be less than 0.2 mV

To select a lead as primary or secondary lead:

- In the **Setup ECG** menu, select **Primary** or **Secondary**, then select the appropriate lead. You can assign any available lead whether it is currently displayed or not.

## Checking Paced Mode

It is important to set the paced mode correctly when you start monitoring ECG.

- To change the paced mode in the **Setup ECG** menu, select **Paced Mode** to switch between **On**, **Off** or **Unconfirm**.

---

### WARNING

Pace pulse rejection must be switched on for paced patients by setting **Paced Mode** to **On**. Switching pace pulse rejection off for paced patients may result in pace pulses being counted as regular QRS complexes, which could prevent an asystole event from being detected. When changing profiles, and at admission/discharge, always check that paced mode is correct for the patient.

Some pace pulses can be difficult to reject. When this happens, the pulses are counted as a QRS complex, and could result in an incorrect HR and failure to detect cardiac arrest or some arrhythmias. Make sure that pace pulses are detected correctly by checking the pace pulse markers on the display. Keep pacemaker patients under close observation.

---

## Understanding the ECG Display

Your display may be configured to look slightly different.



- 1 Lead label of the displayed wave
- 2 1 mV calibration bar
- 3 Pacer spikes
- 4 Pace pulse markers
- 5 Current heart rate
- 6 Current heart rate alarm limits and paced mode symbol
- 7 EASI lead placement label (located here when present)
- 8 ECG Filter label

**ECG HR numeric:** This is the heart rate derived from the monitored ECG.

**Pace pulse markers:** These are shown if the **Paced Mode** status has been set to **On**, the pacer spikes are not configured to have a fixed size, and the patient has a paced signal.

**Pacer Spikes:** The pacer spikes are shown in white, unless the ECG wave is white, then they will be green. If the pacer spikes have been configured to have a fixed size, they will be displayed in the background as a dotted line.



- 1 Pacer spikes configured to have a fixed size

**Defibrillator synchronization marks:** If an HP/Agilent/Philips defibrillator is connected, the synchronization marks (vertical lines on the ECG wave) are shown on the ECG wave. The synchronization marks will be shown in yellow, unless the ECG wave is yellow, then they will be green.

If so configured, the monitor can supply its own synchronization marks; in this case the synchronization marks from a defibrillator will not be shown.

**ST numerics in ECG wave:** ST numerics can be configured to show underneath the ECG wave on the left side.

## Monitoring Paced Patients

An ECG optimized for monitoring a paced patient should look like this:

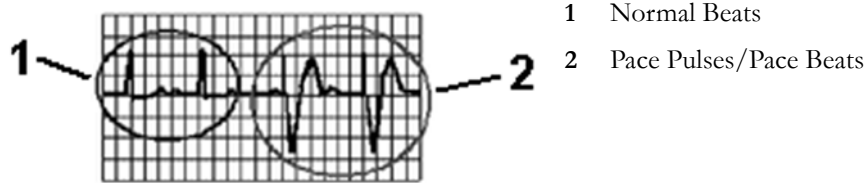

- 1 Normal Beats
- 2 Pace Pulses/Pace Beats

You should choose a lead as primary or secondary lead that has these characteristics:

- the normal QRS complex should be either completely above or below the baseline and it should not be biphasic. For paced patients, the QRS complexes should be at least twice the height of pace pulses.
- the QRS complex should be tall and narrow
- the P-waves and the T-waves should be less than 0.2 mV.

For ease of identification on the screen, the pacer spikes can be configured to have a fixed size. They are then shown in the background as a dotted lines. The length of the dotted line is fixed to the wave channel height and is independent of the actual pacer amplitude.

## Setting the Paced Status

In the **Setup ECG** menu, select **Paced Mode** to switch between **On**, **Off** or **Unconfirm**.

You can also change the paced mode in the **Patient Demographics** window.

When **Paced Mode** is set to **On**:

- Pace Pulse Rejection is switched on. This means that pacemaker pulses are not counted as extra QRS complexes.
- pace pulse marks are shown on the ECG wave as a small dash (only when the pacer spikes are not configured to have a fixed size).
- the paced symbol is displayed under the HR label.

When **Paced Mode** is set to **Off**, pacer spikes are not shown in the ECG wave. Be aware that switching pace pulse rejection off for paced patients may result in pace pulses being counted as regular QRS complexes, which could prevent an asystole event from being detected.

When the paced mode has not yet been set for a patient, the paced symbol will have a question mark indicating the **Unconfirm** mode. When the paced mode is **Unconfirm**, pace pulse rejection is switched on.

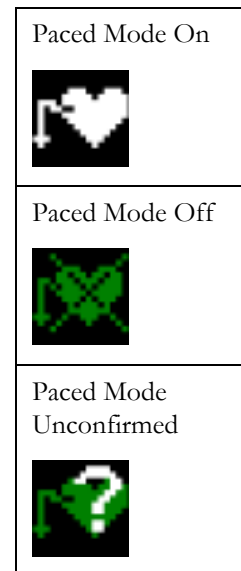

## Avoiding Pace Pulse Repolarization Tails

Some unipolar pacemakers display pace pulses with repolarization tails. These tails may be counted as QRSs in the event of cardiac arrest or other arrhythmias.

If you note a visible repolarization tail, choose a lead that decreases the size of the repolarization tail.

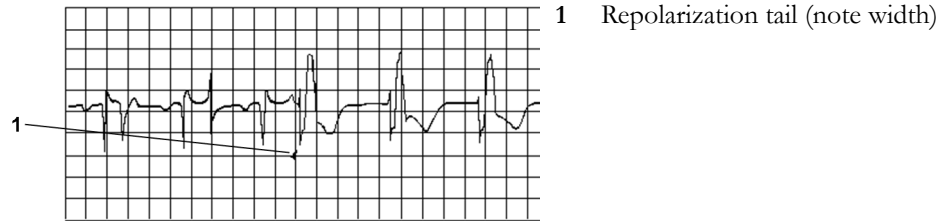

## Changing the Size of the ECG Wave

If any of the displayed ECG waves is too small or clipped, you can change the size of one or all of the ECG waves on the screen.

Changing the adjustment factor only changes the visual appearance of the ECG wave on the screen. It does not affect the ECG signal analyzed by the monitor.

Comparing the wave size to the 1 mV calibration bar on the ECG wave segment can help you to get an idea of the true ECG signal strength. If you choose a fixed adjustment factor, the 1 mV calibration bar will be the same size for all the displayed ECG waves. If you choose **Auto Size**, or an individual size using the **Size Up/Size Down** keys, the calibration bar may be a different size for each wave.

### To Change the Size of an Individual ECG Wave

- 1 Select the wave segment you want to change. This calls up the lead menu for this segment.
- 2 In the lead menu, select **Size Up** to increase wave size or **Size Down** to decrease the size. Selecting **Auto Size** lets the monitor choose the optimal adjustment factor for all available ECG waves.

### To Change the Size of all the ECG Waves

To change the size of all the ECG waves on the screen by a fixed adjustment factor,

- 1 In the **Setup ECG** menu, select **Adjust Size**.
- 2 Select the required adjustment factor from the line of pop-up keys.
  - **Size X0.5** to halve the wave size
  - **Size X1** to display the wave without zoom
  - **Size X2** to double the wave size
  - **Size X4** to multiply the wave size by four

## Changing the Volume of the QRS Tone

The QRS tone is derived from either the HR or Pulse, depending on which is currently selected as the alarm source. The QRS volume can be set from 0 to 10 (0 means off).

To change the QRS volume, in the **Setup ECG** menu select **QRS Volume** and then select the appropriate volume from the pop-up list.

## Changing the ECG Filter Settings

The ECG filter setting defines how ECG waves are smoothed. An abbreviation indicating the filter type is shown underneath the lead label on the monitor display. Filter settings do not affect ST measurement.

To change the filter setting, in the **Setup ECG** menu, select **Filter** and then select the appropriate setting.

- **Monitor:** Use under normal measurement conditions.
- **Ext. Monitor:** Use when diagnostic quality is required but low frequency interference or a wandering baseline may be expected. The upper edge frequency is the same as the **Diag** setting and the lower edge frequency is the same as the **Monitor** setting.
- **Filter:** The filter reduces interference to the signal. It should be used if the signal is distorted by high frequency or low frequency interference. High frequency interference usually results in large amplitude spikes making the ECG signal look irregular. Low frequency interference usually leads to a wandering or rough baseline. In the operating room, the Filter reduces artifacts and interference from electrosurgical units. Under normal measurement conditions, selecting **Filter** may suppress the QRS complexes too much and thus interfere with the clinical evaluation of the ECG displayed on the monitor. This does not affect the ECG analysis performed by the monitor.

If **AutoFilter** is set to **On** in Configuration Mode, the filter setting will automatically be set to **Filter** if electromagnetic interference is detected.

- **Diag:** Use when diagnostic quality is required. The unfiltered ECG wave is displayed so that changes such as R-wave notching or discrete elevation or depression of the ST segments are visible.

The setting **Diag** selects the highest available ECG bandwidth which is 0.05 to 150 Hz for the Adult, Pedi and Neo patient category. The term "diagnostic" relates only to the ECG bandwidth requirements for diagnostic electrocardiographic devices as outlined in the ANSI/AAMI standard EC11-1991.

When you are using a telemetry transmitter connected via short range radio to the monitor, the upper bandwidth for all filter settings is limited to 40 Hz.

## Selecting Positions of Va and Vb Chest Leads (for 6-lead placement)

The two chest leads for the 6-lead placement can be positioned at any two of the V1 to V6 positions. Select the positions you have used in the **Setup ECG** menu, so that the chest leads will be correctly labeled.

- 1 In the **Setup ECG** menu, select **Va Lead**.
- 2 Select the position used from the list.



- 3 Select **Vb Lead** and select the position used from the list.

## Choosing EASI or Standard Lead Placement

You must enable either standard lead placement or EASI lead placement.

- In the **Setup ECG** menu, select **Placement** and then **Standard** or **EASI**.

**EASI** is shown beside the 1mV calibration bar on the ECG wave on the display, and **EASI** is marked on any printouts.

See the section on “EASI ECG Lead Placement” on page 122 for electrode placement diagrams.

## About ECG Leads

To make it possible to compare measured ECG signals, the electrodes (or lead sets) are placed in standardized positions, forming so-called "leads". To obtain ECG signals optimized for use in diagnosis and patient management in different care environments, different lead sets in varying lead placements can be used. You can use either standard lead placements or EASI lead placements with this monitor.

When placing electrodes, choose a flat, non-muscular site where the signal will not be interfered with by either movement or bones. Correct lead placement is always important for accurate diagnosis. Especially in the precordial leads, which are close to the heart, QRS morphology can be greatly altered if an electrode is moved away from its correct location.

## ECG Leads Monitored

If you are using	these leads are available:	Resp is measured between electrodes:
a 3-electrode set	I, II, III	RA and LL
a 5-electrode set	I, II, III, aVR, aVL, aVF, V and MCL	RA and LL
a 6-electrode set	I, II, III, aVR, aVL, aVF, Va, Vb	RA and LL
a 10-electrode set	I, II, III, aVR, aVL, aVF, V1, V2, V3, V4, V5, V6	RA and LL
an EASI 5-electrode set	I, II, III, aVR, aVL, aVF, V1, V2, V3, V4, V5, V6	I and A

## Changing Lead Sets

To change the ECG lead set,

- **When adding leads:** place the additional electrodes as required - the monitor automatically recognizes the new lead placement.
- **When removing leads:** there are two possibilities - removing the complete chest leads block or removing individual leads. If you unplug the chest lead block from the trunk cable connector, the monitor will automatically recognize the new lead placement. Remove individual leads by removing the electrodes. The monitor will issue a **Lead Off INOP** message; select **New Lead Setup** in the **Setup ECG** menu and the INOP message will disappear.

## ECG Lead Fallback

If fallback is configured on and there is a leads off INOP in the primary lead (and in the secondary lead, if you are using multi-lead monitoring) for longer than 10 seconds, and if another lead is available, this available lead automatically becomes the primary lead. This is known as lead fallback. When the Leads Off condition is corrected, the leads are automatically switched back.

This setting can only be changed in Configuration Mode.

## ECG Lead Placements

The labels and colors of the ECG electrodes differ according to the standards that apply for your hospital. The electrode placement illustrations in this chapter use the AAMI labels and colors.

Electrode labels			Electrode colors	
AAMI	EASI	IEC	AAMI	IEC
RA	I	R	White	Red
LA	S	L	Black	Yellow
LL	A	F	Red	Green
RL	N	N	Green	Black
V	E	C	Brown	White
V1		C1	Brown/Red	White/Red
V2		C2	Brown/Yellow	White/Yellow
V3		C3	Brown/Green	White/Green
V4		C4	Brown/Blue	White/Brown
V5		C5	Brown/Orange	White/Black
V6		C6	Brown/Violet	White/Violet

## Standard 3-Lead Placement

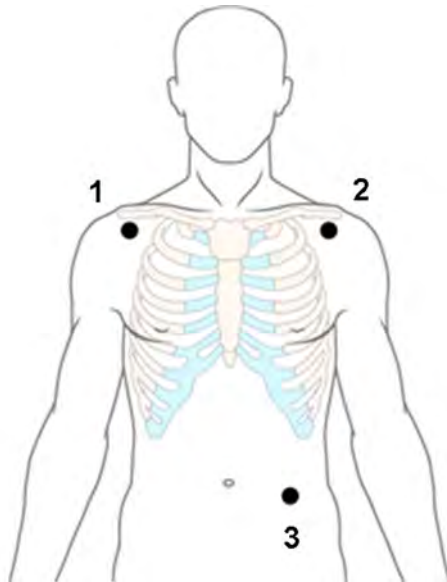

- 1 RA placement: directly below the clavicle and near the right shoulder
- 2 LA placement: directly below the clavicle and near the left shoulder
- 3 LL placement: on the left lower abdomen

## Standard 5-Lead Placement

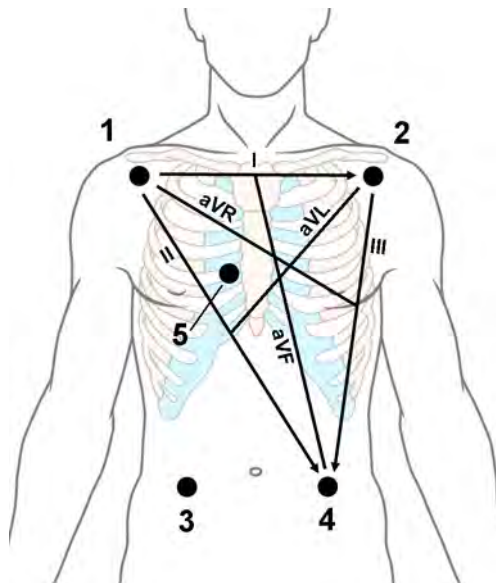

- 1 RA placement: directly below the clavicle and near the right shoulder
- 2 LA placement: directly below the clavicle and near the left shoulder
- 3 RL placement: on the right lower abdomen
- 4 LL placement: on the left lower abdomen
- 5 V placement: on the chest, the position depends on your required lead selection

## 6-Lead Placement

For a 6-lead placement use the positions from the 5-lead diagram above but with two chest leads. The two chest leads, Va and Vb, can be positioned at any two of the V1 to V6 positions shown in the chest electrode diagram below. The Va and Vb lead positions chosen must be selected in the **Setup ECG** Menu to ensure correct labeling.

## Chest Electrode Placement

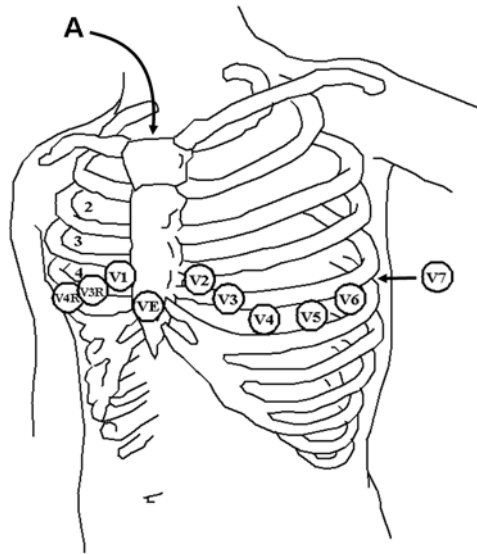

A - Angle of Lewis

V1 on the fourth intercostal space at the right sternal border

V2 on the fourth intercostal space at the left sternal border

V3 midway between the V2 and V4 electrode positions

V4 on the fifth intercostal space at the left midclavicular line

V5 on the left anterior axillary line, horizontal with the V4 electrode position

V6 on the left midaxillary line, horizontal with the V4 electrode position

V3R -V6R on the right side of the chest in positions corresponding to those on the left

VE over the xiphoid process

V7 on posterior chest at the left posterior axillary line in the fifth intercostal space

V7R on posterior chest at the right posterior axillary line in the fifth intercostal space

For accurate chest electrode placement and measurement, it is important to locate the fourth intercostal space.

- 1 Locate the second intercostal space by first palpating the Angle of Lewis (the little bony protuberance where the body of the sternum joins the manubrium). This rise in the sternum is where the second rib is attached, and the space just below this is the second intercostal space.
- 2 Palpate and count down the chest until you locate the fourth intercostal space.

## 10-Lead Placement

When monitoring 12-leads of ECG, using a 10-Electrode Lead Placement, it is important to correctly place electrodes and to label all 12-lead ECG reports with the correct lead placement.

## Conventional 12-Lead ECG

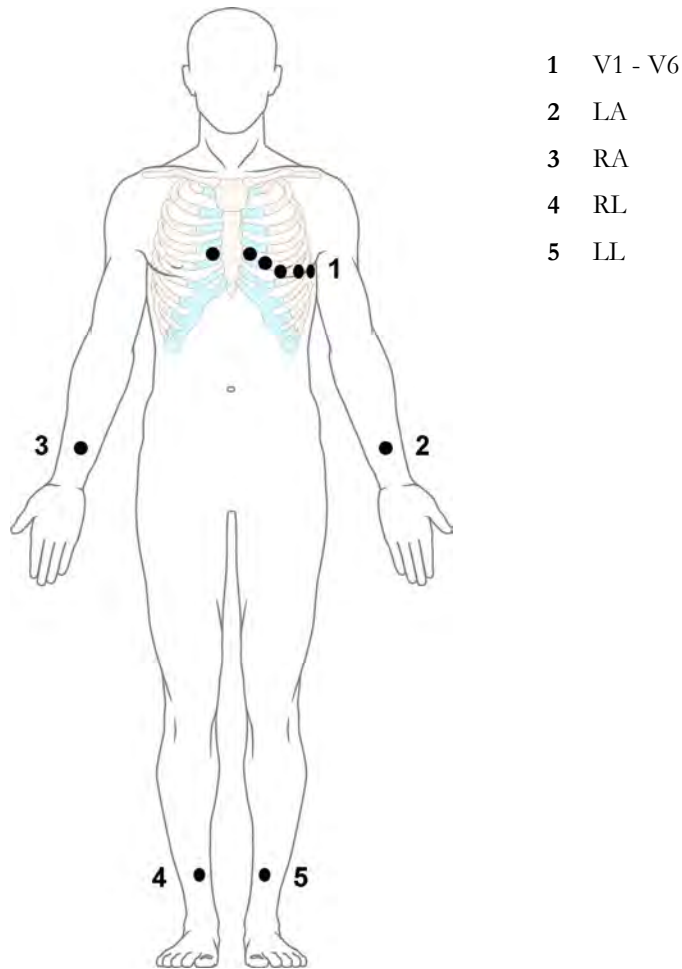

- 1 V1 - V6
- 2 LA
- 3 RA
- 4 RL
- 5 LL

In conventional 12-Lead ECG using 10 electrodes, an electrode is placed on the right arm, left arm, right leg, and left leg. Six V- electrodes are placed on the chest. The right leg electrode is the reference electrode.

Limb electrodes:

- Place arm electrodes on the inside of each arm, between the wrist and the elbow.
- Place leg electrodes inside of each calf, between the knee and the ankle.

Chest electrodes:

V1 - on the 4th intercostal space at the right sternal border

V2 - on the 4th intercostal space at the left sternal border

V3 - midway between the V2 and V4 electrode positions

V4 - on the 5th intercostal space at the left midclavicular line

V5 - on the left anterior axillary line, horizontal with the V4 electrode position

V6 - on the left midaxillary line, horizontal with the V4 electrode position

## Modified 12-Lead ECG

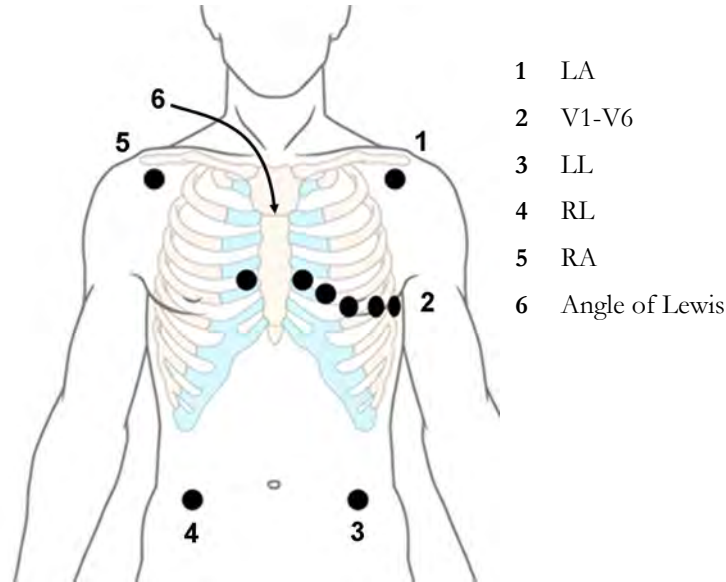

If your institution uses modified 10 Lead ECG electrode placement (the Mason-Likar Lead System), place the four limb electrodes close to the shoulders and lower abdomen.

The six V electrodes are placed on the chest in the same position as the conventional 12-lead placement.

## Choosing Standard or Modified Electrode Placement

If your institution uses modified 10 Lead ECG electrode placement (the Mason-Likar Lead System), you must switch **ModLdPlcmt** to **On** in the monitor.

To do this, in the **Setup ECG** menu, select **ModLdPlcmt** to toggle between **On** and **Off**.

- When **ModLdPlcmt** is set to **On**, 12 Lead ECG Reports will be labeled **12 Lead ECG Report (Mason-Likar)**, and captured 12-lead ECGs will be labeled **Mason-Likar** to the right of the bandwidth annotation at the Information Center.
- When **ModLdPlcmt** is set to **Off**, 12 Lead ECG Reports will be labeled **12 Lead ECG Report (Standard)**, and captured 12-lead ECGs will not be annotated at the Information Center.

---

### WARNING

Do not use ECG analysis interpretation statements and measurements for 12-lead ECGs obtained using the modified (Mason-Likar) limb electrode placement. This may lead to misdiagnosis since the modified (Mason-Likar) limb electrode placement does not look the same as the conventional 12-lead ECG and may mask inferior infarction due to calculated axis, R, P and T wave magnitudes shifts and ST slope.

Do not export 12-lead ECGs obtained using the modified (Mason-Likar) limb electrode placement. Captured 12-Lead ECGs using the modified (Mason-Likar) limb electrode placement exported from the Information Center are not annotated with the Mason-Likar label.

---

## Capture 12-Lead

You can view a 12-Lead ECG on the screen, capture a 12-Lead ECG episode, preview the captured ECG data and then store it and send it to a connected Information Center for analysis. You can download the resulting analysis from the Information Center and also other 12-Lead captures for review at the monitor. A 12-Lead report can be printed that also includes the downloaded analysis results and an ST Map. You can operate the 12-Lead Export function and the 12-Lead Lock/Unlock function at the Information Center remotely from the monitor.

The monitor can store one 12-Lead ECG episode at any time.

## Viewing the Realtime 12-Lead ECG

To open the 12-Lead ECG window and view the realtime ECG waves,

- Select the **Capture 12 Lead** SmartKey, or
- Select the **Main Setup** SmartKey then select **Capture 12 Lead**.

If a previously viewed 12-Lead ECG was not stored, a window will pop up asking whether you want to keep it or not. The title bar of the window shows the date and time when this 12-Lead ECG was captured. If you do not need the ECG, select **No** to discard it, otherwise, select **Yes** and then select **Store & Send** to store that 12-Lead ECG and send it to an Information Center (if one is connected).

If your patient is not admitted, you will be prompted to enter at least the age and gender of the patient. This information is needed for analysis of the 12-Lead ECG at the Information Center but is not essential if you only want to capture the 12-Lead ECG without sending it for analysis. To enter this information:

- 1 Select the **Admit Patient** pop-up key, then
- 2 Enter the information in the **Patient Demographics** window.
- 3 Open the 12-Lead ECG window again as described above.

The age and gender will now be displayed in the title bar of the pop-up keys.

To change the way the realtime waves are displayed, select the **Change View** pop-up key or select the wave area. You can switch between a one or two column display. The two column display lets you see a larger representation of the waves.

While the realtime 12-Lead waves are being viewed in the window, the ECG filter mode (see “Changing the ECG Filter Settings” on page 112) is changed to the 12-Lead filter setting (see “Changing Settings for a Captured 12-Lead ECG” on page 120).

## Capturing the 12-Lead ECG

To capture the last 10 seconds of ECG data, select the **Capture Waves** pop-up key. The pop-up key is active as soon as enough wave data is available; until then a progress bar is displayed in the title bar of the pop-up keys. A preview of the captured data appears on the screen (unless your monitor is connected to an Information Center with software release earlier than Revision M — then the captured data is automatically stored and sent to the Information Center).

The title bar of the pop-up keys will now show the current filter setting and, if you are using EASI lead placement, an EASI indicator (see “EASI ECG Lead Placement” on page 122).

You can at any time return to the realtime 12-Lead ECG view by selecting the **Show Waves** pop-up key. From there, you return to the preview window by selecting the **Review 12 Lead** pop-up key and then selecting the 12-Lead marked with \* from the list.

## Changing Settings for a Captured 12-Lead ECG

Select the **Setup 12 Lead** pop-up key to choose settings for filter, gain, etc., if changes are needed. All changes apply to both the display and the printed 12-Lead report. The changes are only applied temporarily and will not be stored. If you want to change the default settings, see “Setting Up the 12-Lead ECG” on page 122.

<b>High Pass Filter</b>	Sets the high pass filter for the waveforms. Choices are <b>0.05Hz</b> , <b>0.15Hz</b> and <b>0.5Hz</b> .
<b>Low Pass Filter</b>	Sets the low pass filter for the waveforms. Choices are <b>40Hz</b> , <b>100Hz</b> and <b>150Hz</b> .
<b>AC Filter</b>	Switches the AC (line frequency) filter <b>On</b> or <b>Off</b> .
<b>Gain</b>	Defines the gain used for the waveforms. Choices are <b>2.5 mm/mV</b> , <b>5 mm/mV</b> , <b>10 mm/mV</b> and <b>20 mm/mV</b> .
<b>Chest Gain</b>	Defines the gain for the chest leads relative to the standard gain setting. Choices are <b>Full</b> and <b>Half</b> .
<b>Paper Speed</b>	Defines the waveform speed. Choices are <b>25 mm/sec</b> and <b>50 mm/sec</b> .
<b>Format</b>	Defines the page layout. Choices are <b>12X1</b> , <b>6X2</b> , <b>3X4</b> , <b>3X4 1R</b> , <b>3X4 3R</b> , <b>3X4 ST</b> and <b>3X4 1R ST</b> . 1R and 3R refer to 1 or 3 rhythm leads, ST formats contain an ST map.
<b>Time</b>	Defines whether all leads show simultaneous or sequential intervals of time, when displaying or printing 2 or more columns. Choices are <b>Sequential</b> and <b>Simultaneous</b> .
<b>Rhythm Lead 1</b> <b>Rhythm Lead 2</b> <b>Rhythm Lead 3</b>	Defines which lead will be used as rhythm lead 1, 2 or 3. Choices are <b>Primary</b> , <b>Secondary</b> , <b>I</b> , <b>II</b> , <b>III</b> , <b>aVR</b> , <b>aVL</b> , <b>aVF</b> , <b>V1</b> , <b>V2</b> , <b>V3</b> , <b>V4</b> , <b>V5</b> , <b>V</b> . This setting is only relevant when <b>3X4 1R</b> , <b>3X4 1R ST</b> or <b>3X4 3R</b> is selected as <b>Format</b> .
<b>Lead Sequence</b>	Defines the sequence in which the leads are presented. Choices are <b>Cabrera</b> and <b>Internat</b> .

## Storing and Sending the 12-Lead ECG

You can enter an order number that will then be associated with the 12-Lead ECG. To enter an order number, select the **Enter OrderNo.** pop-up key. The order number will be displayed in the title bar of the pop-up keys.

To store the previewed data on the monitor and send it to a connected Information Center for storage and analysis, select the **Store & Send** pop-up key. If the monitor is connected to an Information Center, use the **Store & Send** function before patient transport to store the 12-Lead ECG centrally, as the 12-Lead ECG data will not be uploaded from the MMS to another monitor after transport.

If the connection to the Information Center is not active while storing, the 12-Lead ECG will be automatically sent as soon as the connection is established or restored. If a previously stored 12-Lead ECG is waiting to be sent to the Information Center, it will be overwritten when a new 12-Lead ECG is stored and can then not be sent to the Information Center.



## Printing the 12-Lead ECG

Print a dedicated 12-Lead ECG report by selecting the **Print Report** pop-up key.

When you are working with an Information Center iX that provides 12-Lead analysis, the report contains the 12-Lead analysis results as well as measurement values (e.g. ST values, QT values, HR) which are also downloaded from the Information Center iX. If you work with an Information Center which does not provide any 12-Lead analysis results, the report only contains the measurement values. In this case, however, the values are based on the real-time measurements made at the bedside. Consequently, the measurement values in the report might differ in the two cases, due to the slightly different algorithm approaches of patient monitor (real-time measurement) and Information Center iX (diagnostic interpretation of 12-Lead capture).

## Downloading Analysis Results (PIIC iX only)

Download analysis results from the IntelliVue Information Center by selecting **Show Analysis**. Return to the previous screen by selecting **Hide Analysis**.

## Reviewing Previewed or Stored 12-Lead Captures

To view 12-Lead captures previewed or stored on the monitor or 12-Lead captures stored at the IntelliVue Information Center (PIIC iX only), select **Review 12 Lead**. You can then select from a list of 12-Lead captures available for the current patient.

The 12-Lead captures in the list may be marked with a symbol, for example an open or closed padlock to indicate unlocked or locked status or a \* to indicate preview status.

## Information Center Remote Export (PIIC iX only)

Use the **Export** key to remotely start the 12-Lead export functionality of the IntelliVue Information Center.

## Information Center Remote Lock/Unlock (PIIC iX only)

Use the **Lock** key to remotely lock the 12-Lead capture at the IntelliVue Information Center. If it is already locked, the **Unlock** key will be displayed.

## Capture 12-Lead Pop-up Keys

Here is a summary of all the pop-up keys available during the 12-Lead ECG procedure:

Pop-up Keys	Selecting this pop-up key lets you
<b>Admit Patient</b>	enter the age and gender for the patient, to allow analysis of the 12-Lead ECG.
<b>Change View</b>	switch between the single column and two-column display of the realtime wave data.
<b>Capture Waves</b>	capture the current ECG waves and open the preview window.
<b>Show Waves</b>	return to the realtime 12-Lead ECG view.
<b>Setup 12 Lead</b>	choose settings for filter, gain, display layout, etc.
<b>Enter OrderNo.</b>	enter an order number that is stored with the capture and displayed in the title bar of the pop-up keys.
<b>Print Report</b>	print a 12-Lead report.

Pop-up Keys	Selecting this pop-up key lets you
<b>Store &amp; Send</b>	store the captured 12-Lead ECG in the monitor and send it to the Information Center.
<b>Review 12 Lead</b>	view a list of 12-Lead captures available at the monitor or at the IntelliVue Information Center, and select one for review.
<b>Show Analysis</b>	download analysis results from the IntelliVue Information Center
<b>Export</b>	remotely export 12-Lead ECG data from the IntelliVue Information Center to an ECG management system (see the Information Center Instructions for Use for details).
<b>Lock / Unlock</b>	remotely lock/unlock the 12-Lead capture at the IntelliVue Information Center.

## Setting Up the 12-Lead ECG

You can make settings that will be stored and used in future as default settings for each 12-Lead ECG capture made.

- 1 Select the HR numerics on the screen to enter **Setup ECG**.
- 2 Select **12Lead**.
- 3 The **Setup 12 Lead** window opens for you to make the default settings.

For a description of the available settings, see “Changing Settings for a Captured 12-Lead ECG” on page 120.

## EASI ECG Lead Placement

Using a standard 5-electrode set in EASI lead placement you can monitor up to 12 standard ECG leads simultaneously and continuously at the bedside. EASI provides a monitoring method for trending ST segment changes that can provide an early indication of ischemia.

---

### WARNING

EASI-derived 12-lead ECGs and their measurements are approximations to conventional 12-lead ECGs. As the 12-lead ECG derived with EASI is not exactly identical to the 12-lead conventional ECG obtained from an electrocardiograph, it should not be used for diagnostic interpretations.

---

Respiratory monitoring is also possible with the EASI placement; respiration is measured between the I and A electrodes.

Place the electrodes as accurately as possible to obtain the best quality EASI measurements.

When EASI lead placement is selected, **EASI** is shown beside the 1 mV calibration bar on the ECG wave on the display, and **EASI** is marked on any recorder strips and printouts.

### EASI Monitoring During INOP Conditions

If one of the derived EASI leads has an INOP condition (for example, **Lead Off**), a flat line is displayed. After 10 seconds, the directly acquired EASI AI, AS, or ES lead (depending on which is available) is displayed with the corresponding lead label. This causes an arrhythmia relearn.

## EASI Electrode Placement

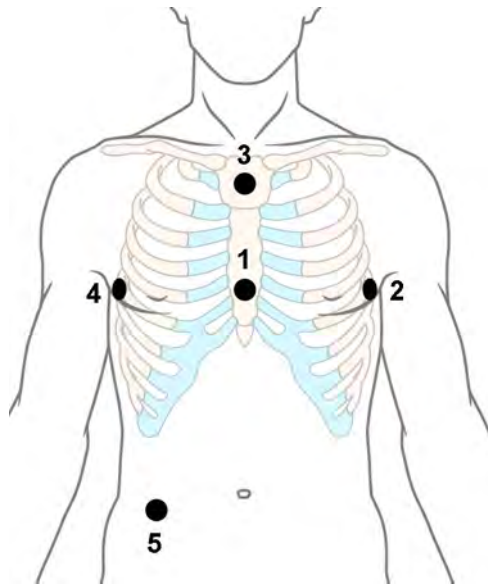

- 1 E (V) - on the lower sternum at the level of the fifth intercostal space
- 2 A (LL) - on the left midaxillary line at the same level as the E electrode
- 3 S (LA) - on the upper sternum
- 4 I (RA) - on the right midaxillary line at the same level as the E electrode
- 5 N - reference electrode - can be anywhere, usually below the sixth rib on the right hip

## ECG and Arrhythmia Alarm Overview

The ECG and arrhythmia alarms available depend on which measurements are switched on, and the arrhythmia option enabled for your monitor.

- Cardiotach alarms are available when HR is on and the active alarm source is ECG, but arrhythmia is switched off
- Basic arrhythmia alarms are available when Arrhythmia is switched on
- Advanced arrhythmia alarms are available when Arrhythmia is switched on and the Advanced Arrhythmia option has been enabled for your monitor

Cardiotach Alarms	Additional Alarms with Basic Arrhythmia Option	Additional Alarms with Enhanced Arrhythmia Option
***Asystole ***Ventricular Fibrillation/ Tachycardia ***Extreme Bradycardia ***Extreme Tachycardia **High heart rate **Low heart rate	***Ventricular Tachycardia **Pacer Not Capture **Pacer Not Pacing **PVCs/min HIGH (PVC > limit/min)	**Afib **End Afib **Supraventricular Tach **Missed Beat **Pause **Irregular HR **End Irregular HR **Ventricular Rhythm **Run PVCs High **Pair PVCs **R-on-T PVCs **Ventricular bigeminy **Ventricular trigeminy **Non-sustain VT **Multiform PVCs

## Using ECG Alarms

ECG alarms can be switched on and off and the high and low alarm limits changed just like other measurement alarms, as described in the “Alarms” chapter. Special alarm features which apply only to ECG are described here.

### Extreme Alarm Limits for Heart Rate

The extreme rate alarms, Extreme Tachy and Extreme Brady, generated by the active alarm source, either HR or Pulse, are set in Configuration Mode by adding a set value (the  $\Delta$  value) to the high and low alarm limits.

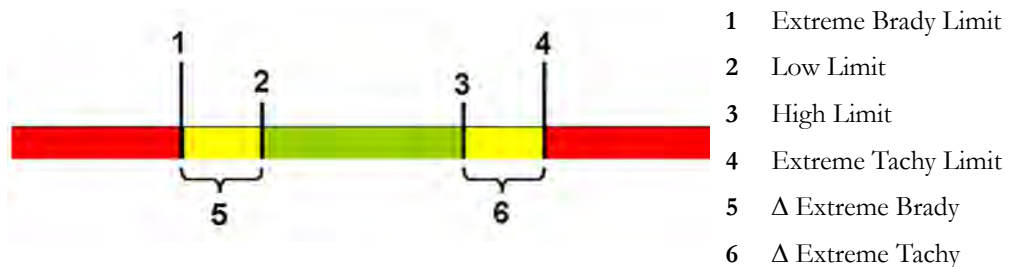

You need to know which value has been configured for your monitor. Changing the high and low alarm limits automatically changes the extreme alarm limits within the allowed range.

To see the extreme rate alarms set for your monitor, in the **Setup ECG** menu, see the menu items  **$\Delta$  ExtrTachy** and  **$\Delta$  ExtrBrady**.

## ECG Alarms Off Disabled

Be aware that your hospital department may have decided to disable the **Alarms Off** setting for ECG in the monitor's Configuration Mode. In this case, HR alarms cannot be switched off in Monitoring Mode. If you try to switch off the HR alarms, you will see the message **To activate enter Config and enable Alarms Off**.

## HR Alarms When Arrhythmia Analysis is Switched Off

When arrhythmia analysis is switched off, only these HR-related alarms will be detected:

- the asystole alarm
- the ventricular fibrillation/tachycardia alarm
- the extreme tachycardia and extreme bradycardia alarms
- the high heart rate and low heart rate alarms.

## Enhanced Asystole Detection

In order to improve alarming on asystole under certain conditions, you can set **Asystole Detect** in Configuration Mode to **Enhanced**. In enhanced mode an asystole alarm will be suppressed for up to five seconds if a valid beat-to-beat Pulse is detected from a Pressure.

## ECG Safety Information

---

### CAUTION

Interference from instruments near the patient and ESU interference can cause problems with the ECG wave. See the monitor specifications for more information.

---

### WARNING

#### Defibrillation and Electrosurgery:

Do not touch the patient, or table, or instruments, during defibrillation.

After defibrillation, the screen display recovers within 10 seconds if the correct electrodes are used and applied in accordance with the manufacturers instructions.

ECG cables can be damaged when connected to a patient during defibrillation. Check cables for functionality before using them again.

According to AAMI specifications the peak of the synchronized defibrillator discharge should be delivered within 60 ms of the peak of the R wave. The signal at the ECG output on the IntelliVue patient monitors is delayed by a maximum of 30 ms. Your biomedical engineer should verify that your ECG/Defibrillator combination does not exceed the recommended maximum delay of 60 ms.

When using electrosurgical (ES) equipment, never place ECG electrodes near to the grounding plate of the ES device, as this can cause a lot of interference on the ECG signal.

#### General:

When you are connecting the electrodes or the patient cable, make sure that the connectors never come into contact with other conductive parts, or with earth. In particular, make sure that all of the ECG electrodes are attached to the patient, to prevent them from contacting conductive parts or earth.

### **During surgery:**

Use the appropriate orange electrode ECG safety cable, or lead cable with an orange connector, for measuring ECG in the operating room. These cables have extra circuitry to protect the patient from burns during cautery, and they decrease electrical interference. This also reduces the hazard of burns in case of a defective neutral electrode at the HF device. These cables cannot be used for measuring respiration.

### **Pacemaker failure:**

During complete heart block or pacemaker failure to pace/capture, tall P-waves (greater than 1/5 of the average R-wave height) may be erroneously counted by the monitor, resulting in missed detection of cardiac arrest.

### **Patients exhibiting intrinsic rhythm:**

When monitoring paced patients who exhibit only intrinsic rhythm, the monitor may erroneously count pace pulses as QRS complexes when the algorithm first encounters them, resulting in missed detection of cardiac arrest.

The risk of missing cardiac arrest may be reduced by monitoring these patients with low heart rate limit at or slightly above the basic/demand pacemaker rate. A low heart rate alarm alerts you when the patient's heart rate drops to a level where pacing is needed. Proper detection and classification of the paced rhythm can then be determined.

### **Filtered ECG signal from external instruments:**

Instruments such as defibrillators or telemetry units produce a filtered ECG signal. When this signal is used as an input to the bedside monitor, it is filtered again. If this twice-filtered signal is passed to the arrhythmia algorithm, it may cause the algorithm to fail to detect pace pulses, pacemaker non-capture, or asystole, thus compromising paced patient monitoring performance.

### **External pacing electrodes:**

When a pacemaker with external pacing electrodes is being used on a patient, arrhythmia monitoring is severely compromised due to the high energy level in the pacer pulse. This may result in the arrhythmia algorithm's failure to detect pacemaker noncapture or asystole.

### **Fusion beat pacemakers:**

Pacemakers that create fusion beats (pace pulse on top of the QRS complex) cannot be detected by the monitor's QRS detector.

### **Rate adaptive pacemakers:**

Implanted pacemakers which can adapt to the Minute Ventilation rate may occasionally react on the Impedance measurement used by patient monitors for the determination of the Resp value and execute pacing with the maximum programmed rate. Switching off the Resp measurement can prevent this.

### **Line isolation monitor transients:**

When electrodes or lead wires are loose or detached, the monitor becomes susceptible to switching transients from some types of line isolation monitors. Line isolation monitor transients may resemble actual cardiac waveforms and thus inhibit heart rate alarms. To minimize the chance of this occurring, always adhere to the instructions for skin preparation and electrode placement given in this chapter.

---

## About Arrhythmia Monitoring

Arrhythmia analysis provides information on your patient's condition, including heart rate, PVC rate, rhythm, and ectopics. The monitor uses the user-selected primary and secondary ECG leads for single-lead or multi-lead arrhythmia analysis. During arrhythmia analysis, the monitor continuously

- optimizes ECG signal quality. This is important for arrhythmia analysis. The monitor continuously filters the ECG signal to remove baseline wander, muscle artifact, and signal irregularities. Also, if the Patient Paced status is set to **Yes**, pace pulses are filtered out to avoid processing them as QRS beats.
- detects beats, for example, QRS complexes, identifying them for further analysis.
- measures signal features such as R-wave height, width, and timing.
- creates beat templates, and classifies and labels beats to aid in rhythm analysis and alarm detection.
- examines the ECG signal for ventricular fibrillation, asystole, and noise.

### Arrhythmia Options

Your monitor has either the basic or the enhanced arrhythmia option. Both options provide rhythm and ectopic status messages and beat labeling. The number of rhythms being classified, events being detected, and alarms generated differs according to the option. The alarms available with the different options are listed in the section “ECG and Arrhythmia Alarm Overview” on page 123, the rhythm and ectopic messages detected are listed in “Arrhythmia Status Messages” on page 130.

### Where Can I Find More Information?

See the Application Notes on ST and Arrhythmia supplied on your documentation DVD for detailed information on the arrhythmia algorithm and its clinical application.

## Switching Arrhythmia Analysis On and Off

- 1 In the **Setup Arrhy** menu, select **Arrhythmia** to toggle between **On** and **Off**.
- 2 Select the **Confirm** pop-up key which appears at the bottom of the screen.

Be aware that when arrhythmia analysis is switched off,

- the message **Arrhythmia Off** appears beside the ECG wave, if configured to do so
- only the HR-related alarms are detected (the asystole alarm, the ventricular fibrillation/tachycardia alarm, the extreme tachycardia and extreme bradycardia alarms, the high heart rate and low heart rate alarms)
- HR High and HR Low alarms behave like normal yellow alarms, no timeout periods are active.

## Choosing an ECG Lead for Arrhythmia Monitoring

It is important to select a suitable lead for arrhythmia monitoring.

Guidelines for non-paced patients are:

- QRS complex should be tall and narrow (recommended amplitude > 0.5 mV)
- R-Wave should be above or below the baseline (but not bi-phasic)
- T-wave should be smaller than 1/3 R-wave height
- the P-wave should be smaller than 1/5 R-wave height.

For paced patients, in addition to the above, the pace pulse should be:

- not wider than the normal QRS
- the QRS complexes should be at least twice the height of pace pulses
- large enough to be detected, with no re-polarization.

To prevent detection of P-waves or baseline noises as QRS complexes, the minimum detection level for QRS complexes is set at 0.15 mV, according to AAMI-EC 13 specifications. Adjusting the ECG wave size on the monitor display (gain adjustment) does not affect the ECG signal which is used for arrhythmia analysis. If the ECG signal is too small, you may get false alarms for pause or asystole.

### Aberrantly-Conducted Beats

As P-waves are not analyzed, it is difficult and sometimes impossible for the monitor to distinguish between an aberrantly-conducted supraventricular beat and a ventricular beat. If the aberrant beat resembles a ventricular beat, it is classified as ventricular. You should always select a lead where the aberrantly-conducted beats have an R-wave that is as narrow as possible to minimize incorrect calls. Ventricular beats should look different from these 'normal beats'. Instead of trying to select two leads with a narrow R-wave, it may be easier to just select one lead and use single lead arrhythmia monitoring. Extra vigilance is required by the clinician for this type of patient.

### Atrial Fibrillation Alarm

The monitor performs atrial fibrillation analysis using information about the RR irregularity, PR interval variability and P wave variability.

In order to generate an Afib alarm the following criteria must be detected for 1 minute:

- normal beat RR intervals must be irregular
- PR interval deviation must be large
- P-wave region must not match well

Atrial fibrillation analysis is only available for adult patients and atrial fibrillation detection cannot be performed on PVCs or Paced beats.

An **\*\* End AFIB** alarm will occur when no atrial fibrillation waveform was detected for a configured delay time.

Since most atrial flutters have regular RR intervals, they cannot be detected by the atrial fibrillation algorithm.

An **\*\* AFIB** can be falsely detected in the presence of:

- sinus arrhythmia,
- muscle noise, or
- electrode motion artifact.

If you also have monitors with earlier software revisions, the **\*\* AFIB** and **\*\* End AFIB** alarms will not be generated after a transfer to one of these monitors. Always leave the Irregular HR alarm switched on, so that this alarm can be generated in such situations.

See the Application Note on Arrhythmia/ST supplied on your documentation DVD for detailed information on the arrhythmia algorithm and ECG analysis.



## Intermittent Bundle Branch Block

Bundle branch and the other fascicular blocks create a challenge for the arrhythmia algorithm. If the QRS during the block changes considerably from the learned normal, the blocked beat may be incorrectly classified as ventricular, causing false PVC alarms. You should always select a lead where the bundle branch block beats have an R-wave that is as narrow as possible to minimize incorrect calls. Ventricular beats should look different from these 'normal beats'. Instead of trying to select two leads with a narrow R-wave, it may be easier to just select one lead and use single lead arrhythmia monitoring. Extra vigilance is required by the clinician for this type of patient.

## Understanding the Arrhythmia Display

Your monitor screen may look slightly different from the illustration.

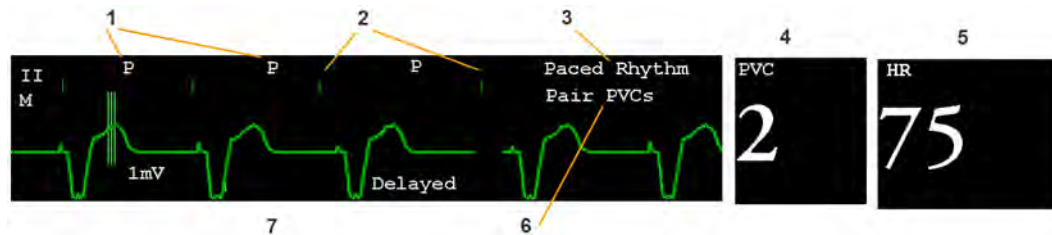

- 1 Beat label
- 2 Pace pulse marks
- 3 Rhythm status message
- 4 PVC Numeric
- 5 HR Numeric
- 6 Ectopic status message
- 7 Delayed arrhythmia wave

## Viewing Arrhythmia Waves

To review arrhythmia beat labels, in the **Setup Arrhy** menu, select **Annotate Arrhy**.

The wave showing the primary ECG lead will be delayed by six seconds and shown on a gray background. Beat labels will be annotated above the ECG wave and **Delayed** will be written beside it.

To return to the normal ECG primary lead display, select **Annotate Arrhy** again.

## Arrhythmia Beat Labels

Arrhythmia beat labels tell you how the monitor is classifying beats.

- N** = Normal
- V** = Ventricular Ectopic
- S** = Supra-ventricular Premature
- P** = Paced
- ' = Pacer spike
- " = Biventricular Pacer Spike
- L** = Learning patient's ECG
- A** = Artifact (noisy episode)
- ?** = Insufficient information to classify beats
- I** = Inoperative condition (e.g., LEADS OFF)
- M** = Pause or missed beat

## Arrhythmia Status Messages

The monitor displays two types of status messages:

- Rhythm Status Messages -- to indicate the patient's rhythm.
- Ectopic Status Messages -- to indicate the presence of ectopic beats.

These status messages are shown on the right hand side of the primary ECG wave. They are updated every second, with the exception of the Sinus and Supraventricular (SV) rhythm messages.

The Sinus and SV rhythm messages are updated based on the current heart rate, taking into account the patient category (adult, pediatric, or neonatal). For the message to change from one rhythm status to another, the HR must be in the new range for five beats.

If you have basic arrhythmia capability, you will get only messages for the alarms provided with this level.

## Rhythm Status Messages

The label B or E indicates basic (B) or enhanced (E) arrhythmia capability.

Rhythm Status Message	Description	B or E
<b>Asystole</b>	No QRS for 4 consecutive seconds in absence of vent fib or chaotic signal	B, E
<b>Vent Fib/Tach</b>	A fibrillatory wave for 4 consecutive seconds	B, E
<b>Vtach</b>	A dominant rhythm of adjacent Vs and a HR > the V-Tach Heart Rate Limit	B, E
<b>Sustained VT</b>	Ventricular tachycardia rhythm for more than 15 seconds	E
<b>Vent Rhythm</b>	A dominant rhythm of adjacent PVCs and a HR ≤ the V-Tach HR Limit	E
<b>Vent Bigeminy</b>	A dominant rhythm of N, V, N, V	E
<b>Vent Trigeminy</b>	A dominant rhythm of N, N, V, N, N, V	E

Rhythm Status Message	Description	B or E
<b>Paced Rhythm</b>	A dominant rhythm of paced beats	B, E
<b>Irregular HR</b>	Consistently irregular rhythm	E
<b>Sinus Brady</b> <b>Sinus Rhythm</b> <b>Sinus Tach</b>	A dominant rhythm of SV beats preceded by P-waves	B, E
<b>SV Brady</b> <b>SV Rhythm</b> <b>SV Tach</b>	A dominant rhythm of SV beats not preceded by P-waves	B, E
<b>Unknown ECG Rhythm</b>	Rhythm cannot be determined	B, E
<b>Learning ECG</b>	Algorithm is learning the ECG beat morphology	B, E
<b>Learning Rhythm</b>	Algorithm is learning the rhythm of the classified beats	B, E
<b>Cannot Analyze ECG</b>	ECG signal is predominantly invalid and therefore cannot be analyzed	B, E

### Ectopic Status Messages

The label B or E indicates basic (B) or enhanced (E) arrhythmia capability.

Ectopic Status Message	Explanation	B or E
(No message displayed)	No ectopic activity within the last minute	
<b>Run PVCs</b>	More than 2 consecutive PVCs within the last minute	E
<b>Pair PVCs</b>	Pair PVCs within the last minute	E
<b>Pacer Not Capt</b>	Pause with pace pulse (paced patient only) within the last minute	B, E
<b>PacerNotPacing</b>	Pause without pace pulse (paced patient only) within the last minute	B, E
<b>Pause</b>	No beat detected for 1.75 x average R-R interval for HR <120, or No beat for 1 second with HR >120 (non-paced patient only), or No beat detected for more than the set pause threshold.	E
<b>R-On-T PVCs</b>	R-ON-T detected within the last minute	E
<b>Multiform PVCs</b>	Multiform PVCs detected within the last minute	E
<b>Frequent SVPBs</b>	SVPB count within last minute is greater than 5	E
<b>SVPBs</b>	1-5 SVPBs in the last minute with a sinus rhythm and no Vs	E
<b>SV Beats</b>	SV count within last minute and rhythm status is paced	B, E
<b>Paced Beats</b>	Paced beat count within last minute and rhythm status is not paced	B, E

# Arrhythmia Relearning

During a learning phase:

- Alarm timeout periods are cleared
- Stored arrhythmia templates are cleared
- Asystole, Vfib, and HR alarms (when there are enough beats to compute the HR) are active. No other alarms are active.

## Initiating Arrhythmia Relearning Manually

To initiate relearning manually, in the **Setup Arrhy** menu, select **Relearn Arrhy**.

- While the monitor is learning, the delayed arrhythmia wave displays the beat label **L** and the rhythm status message **Learning ECG**.
- Next, the monitor determines the dominant rhythm. The beats are labeled **N**, and the rhythm status message changes to **Learning Rhythm**.

After relearning is complete, you should check the delayed arrhythmia wave to ensure that the algorithm is labeling the beats correctly.

If beats are still not classified correctly, check that the ECG is optimized for arrhythmia monitoring. You may need to select a different lead or change the electrodes or electrode positions if there is excessive noise, unstable voltage, low amplitude, or large P- or T-waves.

## Automatic Arrhythmia Relearn

Arrhythmia relearning is initiated automatically whenever:

- ECG monitoring is switched on
- The ECG Lead or Lead Label of the primary/secondary lead is changed manually, or when fallback occurs
- A Leads Off INOP condition (that has been active for > 60 seconds) ends.

If you are monitoring multi-lead arrhythmia and there is a change in one lead only, relearning happens only in the affected lead. During this learning phase, the system will continue monitoring using the other lead. Therefore, the delayed arrhythmia wave is not labeled **L** and there is no **Learning ECG** rhythm status message. In addition, alarm timeout periods are maintained, stored arrhythmia templates are maintained for the operative lead, and all alarms switched on are active.

## Arrhythmia Relearn and Lead Fallback

Lead fallback triggers an automatic arrhythmia relearn.

---

### WARNING

If arrhythmia learning takes place during ventricular rhythm, the ectopics may be incorrectly learned as the normal QRS complex. This may result in missed detection of subsequent events of V-Tach and V-Fib.

For this reason you should:

- take care to initiate arrhythmia relearning only during periods of predominantly normal rhythm and when the ECG signal is relatively noise-free
- be aware that arrhythmia relearning can happen automatically

- respond to any INOP messages (for example, if you are prompted to reconnect electrodes)
- be aware that a disconnected EASI electrode triggers an arrhythmia relearn on all leads
- always ensure that the arrhythmia algorithm is labeling beats correctly.

## Arrhythmia Alarms

Arrhythmia alarms can be switched on and off and the alarm settings changed just like other measurement alarms, as described in the Alarms section. Special alarm features which apply only to arrhythmia are described here.

The different alarms detected and generated by the monitor depend on the level of arrhythmia analysis that is enabled. For a complete list of arrhythmia alarms and INOPs, see the “Alarms” chapter.

The monitor detects arrhythmia alarm conditions by comparing ECG data to a set of pre-defined criteria. An alarm can be triggered by a rate exceeding a threshold (for example, HR >xx), an abnormal rhythm (for example, Ventricular Bigeminy), or an ectopic event (for example, Pair PVCs).

### Yellow Arrhythmia Alarms

Yellow arrhythmia alarms are short yellow alarms specific to arrhythmia-related patient conditions. The heart rate alarms (High HR and Low HR) can be configured as short yellow or standard yellow alarms. When they are standard yellow alarms they exist independently of the other arrhythmia alarms and no timeout periods apply.

#### WARNING

When arrhythmia analysis is on, all yellow ECG and arrhythmia alarms are short yellow alarms (one-star). This means that the yellow alarm lamp and the tones are active for six seconds only, after which the blinking numeric and the alarm message remain for up to three minutes. The only exception to this are the HR High and Low alarms which can be configured as standard yellow alarms. Red alarms behave as usual.

### Arrhythmia Alarms and Latching

When using arrhythmia analysis, **Visual Latching** and **Audible Latching** should be on for red alarms, or at least **Visual Latching** should be on. Because of the transient nature of arrhythmia alarms, many arrhythmia conditions may go unnoticed if alarm latching is off. This setting can only be changed in Configuration Mode.

### Switching Individual Arrhythmia Alarms On and Off

Some arrhythmia alarms can be individually switched on or off:

**Non-Sustain, Vent Rhythm, Run PVCs, Pair PVCs, R-On-T PVCs, V.Bigeminy, V.Trigeminy, Multif.PVCs, Pacer N.Cap, Pacer N.Pac, Pause, SVT, IrregularHR, Missed Beat, PVCs/min and Afib.**

To switch individual alarms on or off, in the **Setup Arrhy** menu, select the alarm from the list to switch between **On** and **Off**. Depending on your configuration, some alarms may not be available in the list and cannot be switched on or off here.

The monitor displays the INOP message **Some ECG AlarmsOff**, if configured, when more alarms are switched off than configured in your active profile.

## Switching All Yellow Arrhythmia Alarms On or Off

All yellow arrhythmia alarms can be switched on and off together. To do this,

- In the **Setup Arrhy** menu, select **All Yellow Off** or **All Yellow On**.

## Adjusting the Arrhythmia Alarm Limits

Some arrhythmia alarms have limits which can be individually adjusted:

**VTach HR, VTach Run, PVCs/min, Vent Rhythm, SVT HR, SVT Run, Asystole Thresh., Pause Threshold, Afib/IHR End Dly.**

- 1 To adjust alarm limits, in the **Setup Arrhy** menu, select the alarm to be adjusted.
- 2 Select the appropriate setting from the pop-up list.

## Arrhythmia Alarm Timeout Periods

Normally, an arrhythmia alarm is announced when an alarm condition is detected. However, there are certain situations that can inhibit the audible and visible indications of the alarm even though the alarm condition was detected. These include:

- if a more serious alarm condition is active in the same chain
- if a timeout period is in effect for a particular alarm
- if a timeout period is in effect for a higher alarm in that chain.

See “Arrhythmia Alarm Chaining” on page 135 for more details on alarm chains.

## What is a Timeout Period?

Timeout periods are automatically started when a yellow arrhythmia alarm is detected. During this period, the same alarm condition will not generate another alarm. Alarm conditions further down the same arrhythmia alarm chain will also not generate an alarm, but alarms further up the chain will: see “Arrhythmia Alarm Chaining” on page 135.

To view the timeout period configured for your monitor, in the **Setup Arrhy** menu, see the menu items **TimeOut 1st** and **TimeOut 2nd**.

This setting can only be changed in Configuration Mode.

**\*\* AFIB** and **\*\* Irregular HR** alarms do not have a timeout period. These alarms can be generated immediately after the corresponding end alarm was generated.

When **\*\* HR High** and **\*\* HR Low** alarms are configured as standard yellow alarms, they do not have a timeout period.

## Resetting the Timeout Period

To reset the timeout period, press the Alarms key and then reselect it.

## How are Yellow Arrhythmia Alarms Indicated?

When a yellow arrhythmia alarm is generated, it triggers visual and audible indicators. Yellow arrhythmia alarms are always set to latch visually for three minutes except HR High/Low alarms, if configured to standard yellow. Depending on the alarm condition, audible and visual alarm indicators will appear as follows:

Alarm Condition	Example	Short yellow alarm tone sounds	Alarm message displayed
Single alarm instance	Non-sustained V-tach	when alarm condition is initially detected	for 3 minutes (latching time)
Continuous alarm condition	PVCs/min HIGH	when alarm condition is initially detected and - as an alarm reminder - every time the configured timeout period has expired	until the alarm condition stops, plus a maximum of three minutes latching time
Same intermittent alarm condition	Pair of PVCs	each time the alarm condition is detected, provided that the configured timeout period has expired	

**If you silence a yellow arrhythmia alarm and the alarm condition still exists**, the visual indicators continue until the condition stops. You will get an alarm reminder every time the configured timeout period has expired.

**If you silence a yellow arrhythmia alarm and the alarm condition has stopped**, the visual indicators are immediately cleared. Silencing an alarm does not reset its timeout period, so you will not get a realarm for the same condition or lower on the chain until the timeout expires.

### Arrhythmia Alarm Chaining

When arrhythmia analysis is switched on, multiple alarm conditions may be present. Announcing all of the detected alarm conditions would be confusing, and might hide a more serious condition. For this reason, arrhythmia alarms are prioritized in three alarm "chains": PVC Alarms; Beat Detection Alarms, and Rate Alarms.

Only the highest priority alarm condition in each chain is announced. Lower priority alarms in the same chain will not be announced while an alarm is active or during the configured timeout period. If alarm conditions of equal severity from different chains are detected, the alarm condition that occurred most recently is announced.

See "ECG and Arrhythmia Alarm Overview" on page 123 for information on which alarms are included in the different arrhythmia options. See "Arrhythmia Alarm Timeout Periods" on page 134 for an explanation of how alarm timeouts work.

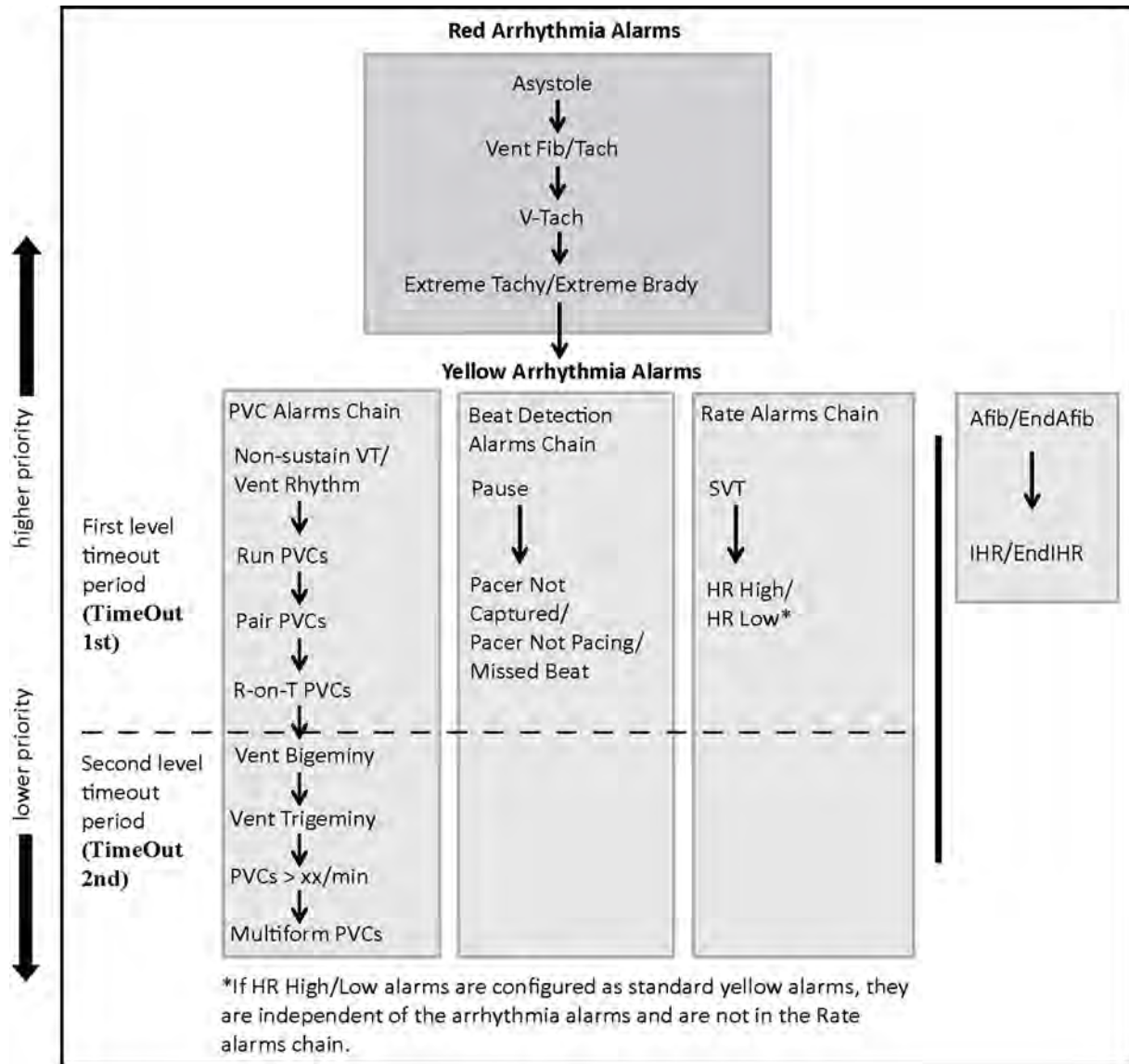

**Examples of Alarm Chaining Logic**

- If there is an active Vent Bigeminy alarm, a PVCs > xx/min will not be triggered because it is lower on the same chain. However, a high HR alarm will become active because it is on a different chain.
- Higher priority alarms supersede previous alarms. For example, if a Vent Trigeminy alarm is active and a Pair PVCs occurs, the Pair alarm will be activated.



## Understanding PVC-Related Alarms

PVC-related alarms are detected on the basis of the current ventricular heart rate and the number of consecutive PVCs counted (referred to as PVC Runs).

Example:

This diagram illustrates the conditions under which PVC alarms would be generated if the Vent Rhythm Run limit is set to 12, the V-Tach Run Limit is set to 8, and the V-Tach HR Limit is set to 100.

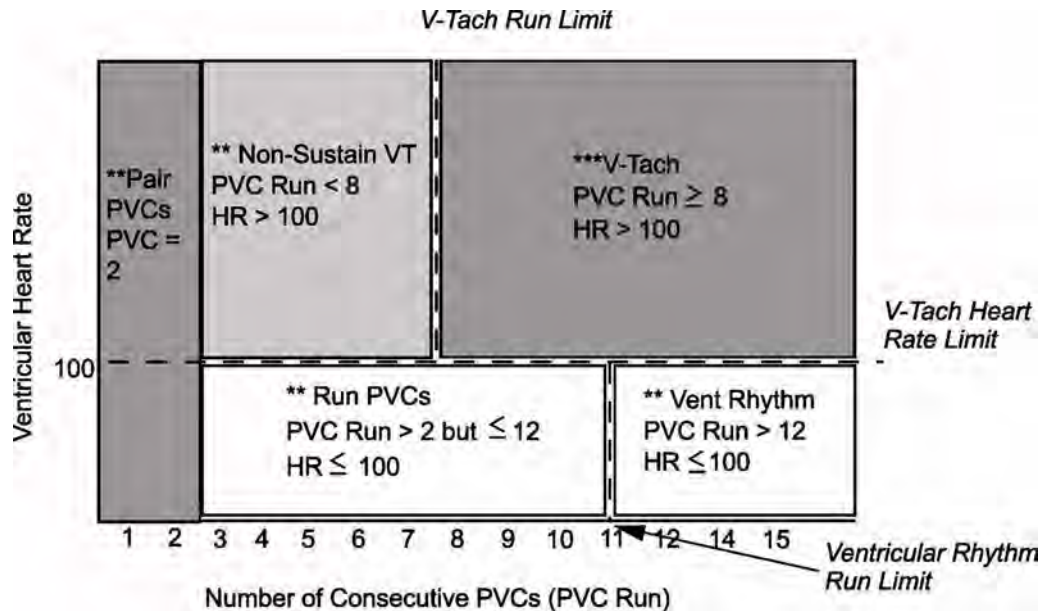

You will see that

- if both the V-Tach Heart Rate Limit and the V-Tach Run Limit are exceeded, a red V-Tach alarm is generated
- if the ventricular heart rate exceeds the V-Tach Heart Rate Limit but not the V-Tach Run Limit, a yellow Non-Sustain VT alarm is generated.

## About ST Monitoring

The monitor performs ST segment analysis on normal and atrially paced beats and calculates ST segment elevations and depressions. This information can be displayed in the form of ST numerics and snippets on the monitor.

The monitor also performs ST Elevation (STE) analysis using automated ISO and J point determination and measuring the ST segment directly at the J point (J +0). This is based on the recommendations for measuring ST Elevation published by the American Heart Association, the American College of Cardiology and the European Society of Cardiology.

All available leads can be monitored continuously. The ECG waveform does not need to be displayed on the monitor for ST Segment analysis.

ST analysis is always performed using a dedicated filter which ensures diagnostic quality. If you are monitoring ECG using an ECG filter mode other than Diagnostic, the ST segment of the ECG wave may look different from the ST segment of the ST snippet for the same wave. For diagnostic evaluation of the ST segment, always switch to Diagnostic filter mode or use the ST snippet.

### WARNING

Some clinical conditions may make it difficult to achieve reliable ST monitoring, for example:

- if you are unable to get a lead that is not noisy
- if arrhythmias such as atrial fib/flutter are present, which may cause an irregular baseline
- if the patient is continuously ventricularly paced
- if the patient has left bundle branch block.

You should consider switching ST monitoring off if these conditions are present.

This monitor provides ST level change information; the clinical significance of the ST level change information should be determined by a physician.

ST segment monitoring is intended for use with adult patients only and is not clinically validated for use with neonatal and pediatric patients. For this reason, the recommended - and default - setting for ST monitoring in neonatal and pediatric modes is **ST Analysis: Off**.

## Switching ST or STE On and Off

ST and STE analysis can be switched on and off independently.

To switch all ST monitoring on or off, in the **Setup ST Analysis** menu, select **ST Analysis** to switch between **On** and **Off**.

To switch all STE monitoring on or off, in the **Setup ST Elevation** menu, select **STE** to switch between **On** and **Off**.

## Selecting Leads for ST Analysis

You select which leads to use for ST analysis in the **Setup ST Analysis** menu.

To see the current list of leads selected for ST analysis:

- 1 Enter the **Setup ST Analysis** menu.
- 2 Select **Setup ST Leads**. This opens the **Setup ST Leads** pop-up window. Leads chosen for ST monitoring are listed here. There are two pop-up keys at the bottom of the screen, **Add** and **Delete**. If all leads are already selected, the **Add** pop-up key is disabled.

To choose a lead for ST monitoring:

- 1 Select the **Add** key at the bottom of the **Setup ST Leads** window. This opens the **Choices** pop-up window.
- 2 Choose a lead from the list for ST monitoring. This closes the **Choices** window and adds the selected lead to the list of chosen leads.

To disable ST monitoring for a lead:

- 1 Choose a lead from the list in the **Setup ST Leads** window.
- 2 Select the **Delete** key. This removes this lead from the list.

### NOTE

The order in which ST leads are listed in the **Setup ST Leads** menu determines the order in which ST leads are displayed on the monitor screen.

To change the order in which ST leads are displayed,

- 1 In the **Setup ST Leads** menu, choose a lead from the list.
- 2 Select the **Sort Up** or **Sort Down** key to move the lead up or down in the list.

## Understanding the ST Display and Windows

Your monitor screen may be configured to look slightly different from the illustrations.

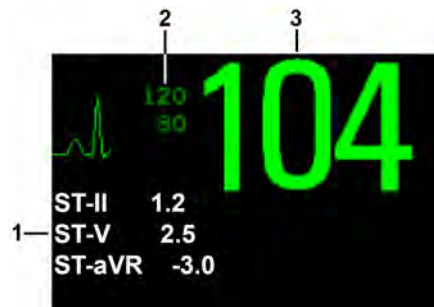

- 1 ST numerics
- 2 Current HR alarm limits
- 3 Current heart rate

### ST Numerics

Up to 12 ST numerics plus the ST index can be displayed on the monitor screen. They can be configured to show beside the measurement numerics, beside the ECG wave, or beside the ST snippet.

A positive ST value indicates ST segment elevation; a negative value indicates depression.

ST numerics are displayed in the order in which you select ST leads for analysis. If there is additional space in the field assigned to ST numerics, the monitor will display extra numerics in the order in which they appear in the list in **Setup ST Leads**, in the **Setup ST Analysis** menu. Any ST leads switched on for analysis that do not fit in the assigned numerics field are shown in succession in place of the last ST numeric.

### ST Index

The ST index numeric (**STindx**) is the sum of the absolute values for the ST leads V2, V5, aVF.

Because it is based on absolute values, it is always a positive number. If you haven't selected one of the leads V2, V5, and aVF for ST analysis, the ST index numeric will display a question mark "?".

To switch the ST index numeric on or off for display, in the **Setup ST Analysis** menu, select **ST-Index** to toggle between **On** and **Off**.

### ST Snippets

ST snippets show a one second wave segment for each measured ST lead. The most recent snippet is drawn in the same color as the ECG wave, usually green, superimposed over the stored baseline snippet, drawn in a different color. The comparison shows any deviation in the measurement since the baseline snippet was stored, for example as a result of a procedure carried out on the patient. The information is updated once per minute.

You can see ST snippets in the **Adjust ST Points** window or the **ST View** window.

### ST View Window

The **ST View** Window shows a current ST snippet and numeric with a baseline snippet and numeric. The two snippets are in different colors, so that you can differentiate between them easily and see at a glance which numerics belong to which snippet. In the upper left corner the current lead and the ISO/J-Point mode for current and baseline snippets is shown. On the right side all available ST numerics are shown. The date and time of the baseline snippet is shown at the bottom of the window.

The **ST View** Window opens with the ST pop-up keys **Current** / **Baseline** / **Overlap** (to select viewing mode), **Show Points** / **Hide Points**, **Update Baseline**, **Record ST**, **STE View**, **Adjust ST Points**, **ST Map**, **Setup ST** and arrow keys for scrolling through the available leads.

- To view the **ST View** window, select the ST numerics, then **ST View**.

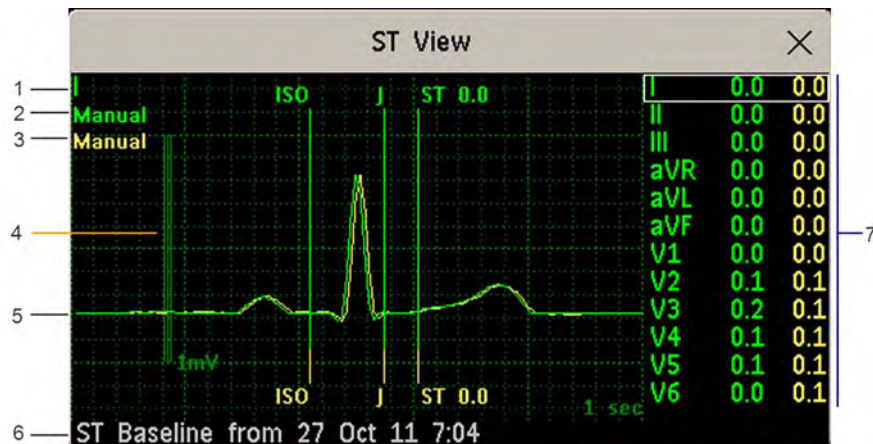

- 1 Current Lead
- 2 ISO/J-point mode for current snippet
- 3 ISO/J-point mode for baseline snippet
- 4 1 mV calibration bar
- 5 Current ST snippet and ST baseline snippet overlapped
- 6 Timestamp of most recently stored baseline snippet
- 7 All available ST numerics for current snippet and baseline snippet

The ST point, J-point and ISO point can be hidden using the **Hide Points** pop-up key.

### STE View Window

The **STE View** window shows a current ST snippet and STE numeric with an ST baseline snippet. The two snippets are in different colors, so that you can differentiate between them easily. In the upper left corner the current lead is shown. On the right side all available STE numerics are shown. The date and time of the ST baseline snippet is shown at the bottom of the window.

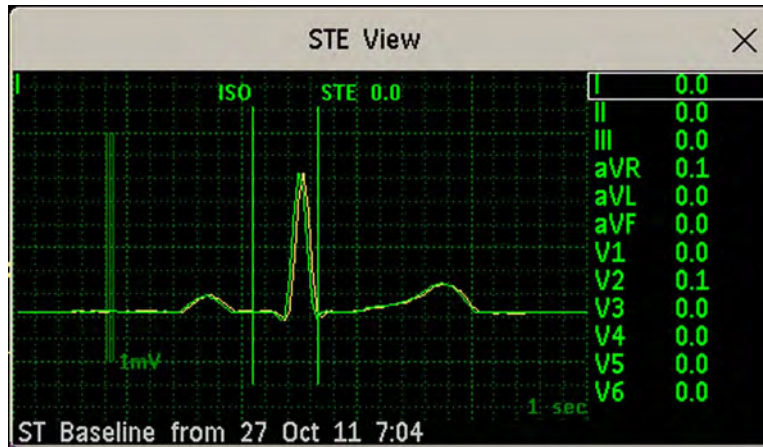

The **STE View** window opens with the pop-up keys **Current / Baseline / Overlap** (to select viewing mode), **Show Points/Hide Points**, **Record STE**, **ST View**, **ST Map**, **Setup ST** and arrow keys for scrolling through the available leads.

The ST point, J-point and ISO point can be hidden using the **Hide Points** pop-up key.

## Updating ST Baseline Snippets

ST analysis requires valid samples to measure and store a snippet. ST Snippets and ST values are updated every minute. If there is artifact in the signal, it may take longer for an ST snippet and an ST value to appear.

The first baseline is stored automatically after ST monitoring is started, or when a new patient is admitted.

To update ST baselines,

- 1 Select the ST numerics then **ST View** to open the **ST View** window.
- 2 In the **ST View** window, select **Update Baseline** to store all current snippets as baselines. This deletes all previously-stored baselines.

## About the ST Measurement Points

The ST value for each beat complex is the vertical difference between the ISO point and the ST point, as shown in the diagram below. The isoelectric (ISO) point provides the baseline, the ST point is at the midpoint of the ST segment. The J point is where the QRS complex changes its slope; as it is a fixed distance away from the ST point, it can be useful to help you position the ST point correctly.

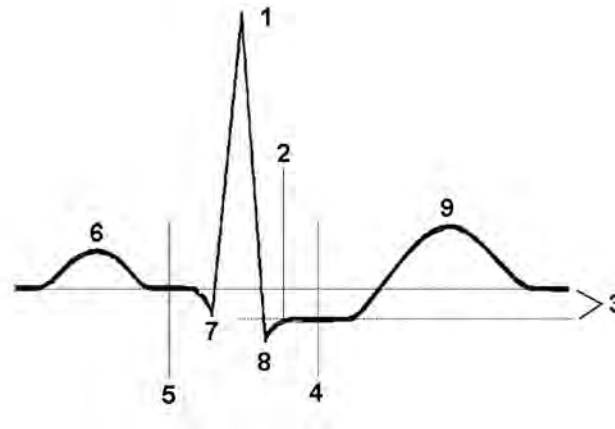

- 1 R-wave peak at 0 msec
- 2 J point, for example, 48 msec
- 3 Difference = ST value
- 4 ST measurement point, for example, J + 60 msec
- 5 Isoelectric point set to -80 msec
- 6 P
- 7 Q
- 8 S
- 9 T

### CAUTION

If using ST analysis, the ST measurement points need to be adjusted when you start monitoring, and if the patient's heart rate or ECG morphology changes significantly, as this may affect the size of the QT interval and thus the placement of the ST point. Artifactual ST segment depression or elevation may occur if the isoelectric point or the ST point is incorrectly set.

Always ensure that ST measurement points are appropriate for your patient.

## Setting ISO and J-Point Detection Mode

There are two modes for ISO and J-point detection: **Auto** and **Manual**. In **Manual** mode you can set the measurement points yourself. In **Auto** mode the measurement points will be determined automatically.

To set the detection mode, in the **Setup ST Analysis** window,

- 1 Select **ISO/J-Pt**.
- 2 Select **Auto** or **Manual** mode.

## Adjusting ST Measurement Points

If the ISO and J-point detection mode is set to **Manual**, all three measurement points can be set. In **Auto** mode, only the ST point can be changed.

To adjust the ST measurement points, in the **Setup ST Analysis** menu,

- 1 Select **Adjust ST Points** to open the **Adjust ST Points** window.  
Alternatively, you can use the **Adjust ST Points** pop-up key in the **ST View** window.
- 2 Select a suitable ECG lead for ST measurement, with a visible J-point and a visible P wave. Use the up and down arrow keys to scroll through the ST snippets for the other ECG leads.

- 3 Select the ST point you need to adjust by touching the appropriate point on the screen. The current choice is highlighted (ISO point -80 in the screen example).

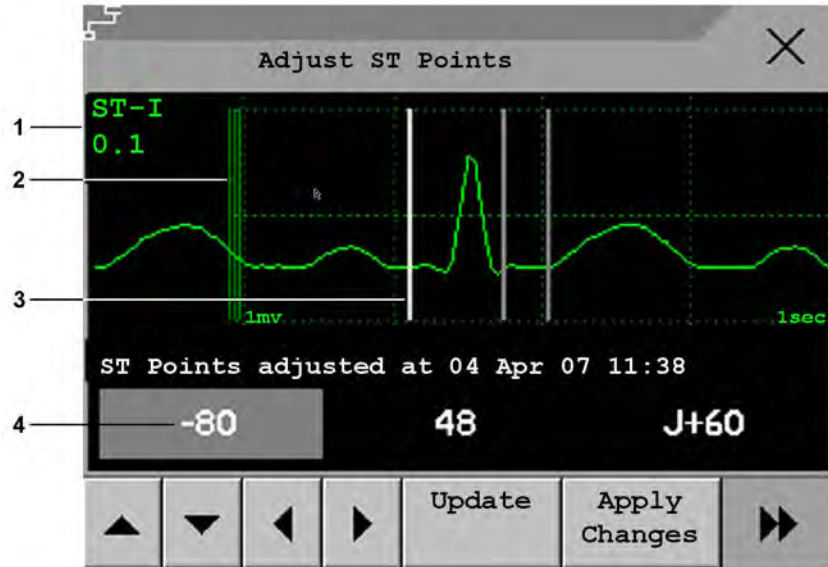

- 1 ST label and the ST numeric that would apply using the current points
- 2 1mV calibration bar
- 3 Cursors for adjusting ST points
- 4 Highlighted ST point

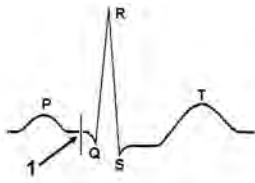

The ISO-point cursor (1) positions the isoelectric point relative to the R-wave peak. The relation is shown beside the ISO-point in milliseconds. Position the ISO-point in the middle of the flattest part of the baseline (between the P and Q waves or in front of the P wave).

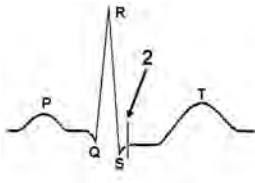

The J-point cursor (2) positions the J-point relative to the R-wave peak. It helps you to correctly position the ST-point. Position the J-point at the end of the QRS complex and the beginning of the ST segment.

The J-point cursor is not available if your monitor is configured to let you set the ST point directly.

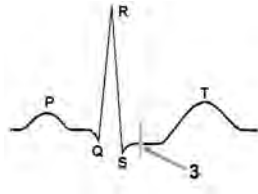

To position the ST-point (3) relative to the J-point:

select either **J+60** or **J+80**. Select **J Point** and use the arrow keys to move the J-Point and position the ST-point at the midpoint of the ST segment.

To position the ST-point directly:

select **ST Point** and use the left and right arrow keys to position the ST point at the midpoint of the ST segment.

- 4 Select the **Apply Changes** pop-up key to activate the new ST measurement points and recalculate all ST values.

The most recent ST Points adjustment time is displayed in the **Adjust ST Points** window. This information is cleared when a patient is discharged or when a new Profile is loaded into the monitor.

- 5 To update the ST snippet shown in the **Adjust ST Points** window, select the **Update** pop-up key.

## ST Alarms

ST alarms are yellow alarms. Each ST lead has its own alarm limit. ST alarms are triggered when an ST value exceeds its alarm limit for more than one minute. Switching ST alarms off switches off alarms for all ST leads.

If more than one ST measurement is in alarm, the monitor only displays the alarm message of the ST lead which is currently furthest from its set alarm limits.

## Changing ST Alarm Limits

The monitor can detect alarms on each ST lead separately, so you can set high and low ST alarm limits individually for each ST lead. When two contiguous leads are available, ST alarms will be generated when ST values of the two contiguous leads are outside the limit. When no contiguous lead is available an ST alarm is generated when the ST value of the single lead is outside the limit.

Set the high and low alarm limits based on your assessment of the patient's clinical condition, unit protocols, physician orders or medication-specified limits. A good guideline is + 1.0 mm or - 1.0 mm from the patients's ST, or follow your hospital protocol.

- 1 In the **Setup ST Analysis** menu, select the alarm to be adjusted.
- 2 Select the appropriate setting.

## STE Alarms

The STE alarm is a yellow alarm. It can be switched on and off in the **Setup ST Elevation** menu but the limits can only be changed in Configuration mode. The STE alarm limits are gender specific and can be set individually for limb leads, V2/V3 leads, and V1/V4/V5/V6 leads. The default values, for example on V2 and V3 1.5 mm for females and 2.0 mm for males, are based on the recommendations from the American Heart Association and American College of Cardiology.



The ST Elevation measurements with automated J-point determination generate ST Elevation alarms, in addition to the ST measurements at the user-defined ST point (J+offset), which may be useful for ST depression alarms. When ST and STE analysis are both in use, this may result in redundant alarms for ST elevations. Because of the different measurement points, there may be different values obtained. Thus there could be an ST alarm and an STE alarm but the STE alarm may announce sooner based upon the values obtained.

## Viewing ST Maps

The monitor can derive a multi-axis portrait (map) from the ST analysis to help you detect changes in ST values. It displays two planes obtained from a multilead ECG in a multi-axis diagram, where each axis represents a lead. The ST value at the J point is given. The position of the axes within the diagram correspond to the placement of the ECG leads. Each ST value is assigned to either a limb lead, or to a chest lead. Every axis shows the polarity of the lead it represents. By joining adjacent ST values, the monitor obtains the ST map. The contour line, and the map shading, is shown in the same color as the ECG parameter.

### Viewing an ST Map

To display an ST map,

- In the **Main Setup** menu, select **ST Map**.

### Current View

In current view, the monitor displays an ST map that corresponds to the current ST values. Three or more leads per plane are necessary to display a map.

The left of the following diagram shows leads I, II, III, aVR, aVL, and aVF on the limb leads. On the right, the V-leads (V1, V2, V3, V4, V5, and V6) are on the chest leads.

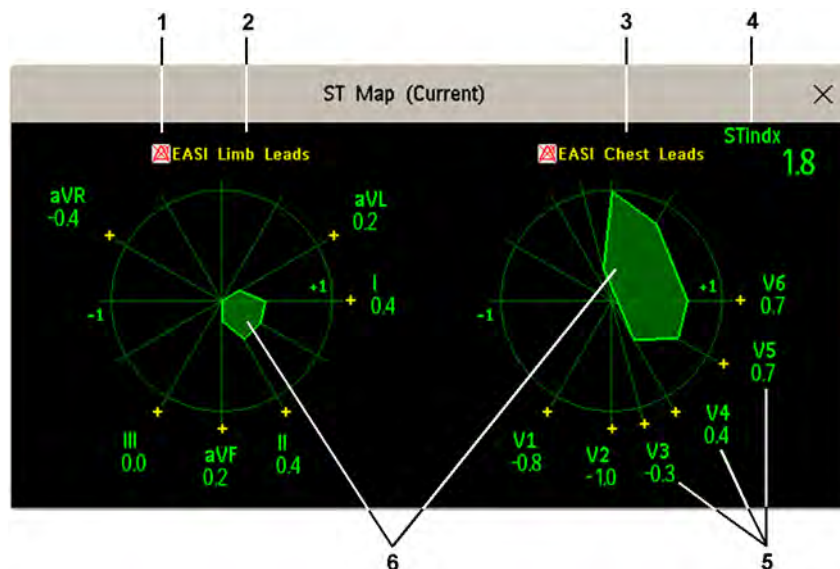

- 1 Alarm status indicator
- 2 **EASI Limb Leads**
- 3 **EASI Chest Leads**

- 4 ST index (for EASI)
- 5 ST label, value and polarity of corresponding lead
- 6 ST map

If an ST lead is switched off, its axis is not shown in the map.



If a lead is in INOP (the value is being measured but is invalid or unavailable because, for example, the corresponding ECG electrode is off), the area formed by the remaining ST leads is left open.



If there is insufficient information (for example, there are less than three chest leads) for a second ST map to be displayed, the currently available ST values are displayed in place of the second ST map.

Additionally, when both ST maps are displayed, you can view the currently available ST values in the **ST Map (Current)** or **ST Map (Trend)** window at any time. To do this, select the **Show Values** pop-up key. The ST values are shown in place of the second ST map, and the pop-up key text changes to **Hide Values**. Select the **Hide Values** Hide Values pop-up key and the display shows both ST maps again.

## Trend View

In trend view, you can see up to four trended ST maps, and the current ST map, simultaneously. You can configure the time interval between trended samples. The most recent map is shown in the same color as the parameter itself. Past values change from white through dark gray. In the diagram below, the time interval between trends is one minute. The first trended sample is white and is one minute old. The second trended sample corresponds to the ST values two minutes ago and so forth. The ST values on the diagrams show the current ST values.

If a lead is turned off, its axis is no longer shown. This has no impact on the presentation of trended values that were recorded while the lead was still on.

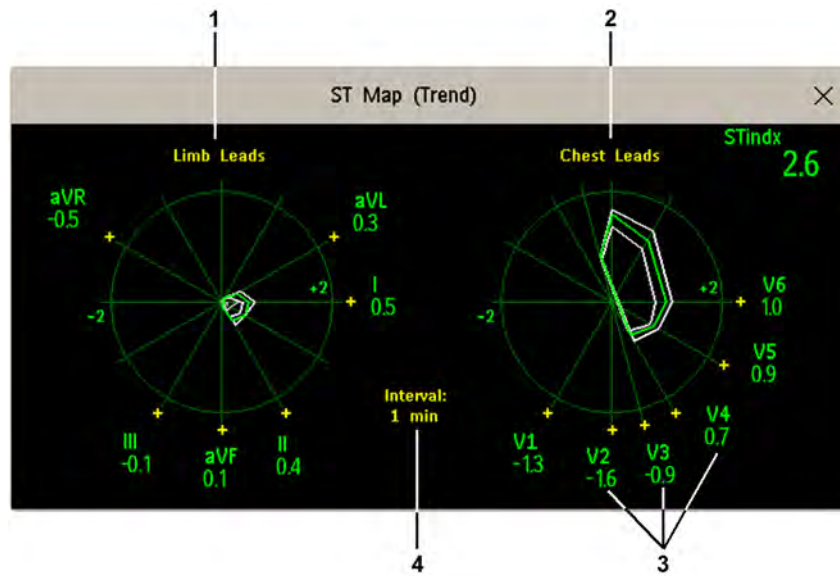

- 1 Limb Leads
- 2 Chest Leads
- 3 current ST values
- 4 trending interval

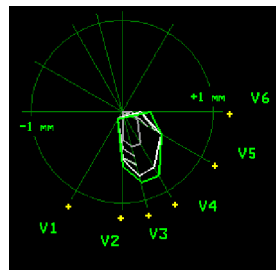

In this diagram, V4 was either temporarily switched off, or in INOP, for around 30 seconds. No data was recorded. Consequently, the affected maps are not closed.

## Working in the ST Map Task Window

You may need to activate the ST map task window to see all the data, and to access the pop-up keys. Select the map view on screen to activate its task window. Once you activate it, you can perform the tasks detailed here.

### Switching Between ST Map Views

To switch between views,

- Select **Current View** or **Trend View** to toggle between views.

If your trend view is empty, you need to adjust the priority of this measurement in the trending priority list. See "Trend Priority" on page 220.

### Displaying an ST Reference Baseline

You can display an ST reference baseline for the current view, or for the trended view. The baseline is shown in yellow. However, if the ECG color is yellow, the baseline is shown in green. Use this baseline to detect ST changes. The baseline is derived automatically whenever the monitor relearns arrhythmia and also on user request.

Select **Show Baseline/Hide Baseline** to toggle between baseline display on and off.

### Updating an ST Map Reference Baseline

To update the baseline,

- In the **Setup ST Analysis** menu, select **ST View** then select **Update Baseline**.

### Changing the Scale of the ST Map

To change scale,

- Select **Size Up** or **Size Down** to alter the size at which monitor displays the map.

### Changing the Trending Interval

To determine how frequently the monitor displays a trended sample,

- 1 In Trend view, select **Select Interval**.
- 2 Select the required interval from the menu. The interval ranges between 12 seconds to 30 minutes.

### Printing an ST Map Report

To print the most recently viewed (current or trend) window,

- 1 Select **Main Setup** then select **Reports**.
- 2 Select **ST Map**.
- 3 Press **Print**.

## About QT/QTc Interval Monitoring

The QT interval is defined as the time between the beginning of the Q-wave and the end of the T-wave. It measures the total duration of the depolarization (QRS duration) and repolarization (ST-T) phases of the ventricular action potential. QT interval monitoring can assist in the detection of prolonged QT interval syndrome.

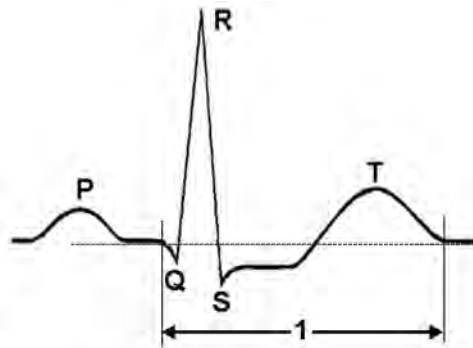

The QT interval (1) has an inverse relationship to heart rate. Faster heart rates shorten the QT interval and slower heart rates prolong the QT interval. Therefore there are several formulas used to correct the QT interval for heart rate. The heart rate corrected QT interval is abbreviated as QTc. The monitor uses as a default the Bazett correction formula and the alternative Fridericia formula can be selected in Configuration Mode.

For QT interval monitoring to be effective, basic or enhanced arrhythmia monitoring should be turned on.

## QT Measurement Algorithm

The QT values are updated every five minutes except in the initial phase (first five minutes) where they are updated once per minute. Normal or atrial paced beats and beats with a similar morphology are averaged to form a representative waveform for further processing. Normal beats followed by a premature QRS will be excluded from the measurements to prevent the premature beat from obscuring the end of the T-wave. If the algorithm cannot form a representative waveform, for example because the morphology of the beats is too varied, a **Cannot Analyze QT** INOP will be generated after 10 minutes. This is also the case if normal beats have been falsely labeled so that the algorithm does not have enough valid beats to make QT measurements. No QT value is calculated if the QT-HR is >150 bpm (Adult) or >180 bpm (Pedi/Neo).

Because of the different algorithm approaches, a QT/QTc measurement from a diagnostic 12-lead program may differ from the realtime measurement on the monitor.

## Where Can I Find More Information?

See the Application Note on QT/QTc Interval Monitoring and the QT Interval Monitoring Quick Guide supplied on your documentation DVD for detailed information on the QT algorithm and performance.

## Indications For Use Of QT Interval Monitoring

Of special concern for QT monitoring is the administration of QT prolonging drugs to patients identified with risk factors for Torsade de Pointe. Females, older patients and patients with bradycardia, impaired left ventricular function (ischemia, left ventricular hypertrophy), hypokalemia and hypomagnesemia are in this increased risk category.

## Limitations For Use Of QT Interval Monitoring

Some conditions may make it difficult to achieve reliable QT monitoring, for example:

- the T-wave is very flat
- T-waves are not well defined due to atrial flutter or atrial fibrillation
- the end of the T-wave is difficult to define because of the presence of U-waves
- a high heart rate causes the P-wave to encroach on the end of the previous T-wave
- noise or high QRS morphology variation

For these cases you should select a lead with a good T-wave amplitude and no visible flutter activity, and without a predominant U-wave or P-wave.

Some conditions such as left or right bundle branch block or hypertrophy can lead to a widened QRS complex. If a long QTc is observed you should verify it to ensure that it is not caused by QRS widening.

Because normal beats followed by ventricular beats are not included in the analysis, no QT measurement will be generated in the presence of a bigeminy rhythm.

If the heart rate is extremely high (over 150 bpm for adults and over 180 bpm for pediatrics and neonates) QT will not be measured.

When the heart rate changes, it can take several minutes for the QT interval to stabilize. For reliable QTc calculation it is important to avoid a region where the heart rate is changing.

---

### WARNING

QT/QTc measurements should always be verified by a qualified clinician.

---

## Selecting The QT Leads

For QT Monitoring you can select one of the following three modes:

- All Leads mode - all available leads (I, II, III, V, MCL, V1 - V6) are used to produce a global QT measurement. For EASI lead placement, directly acquired AI, AS and ES leads are used.
- Primary-Lead mode - the primary lead will be used for QT measurement. If the original primary lead becomes unavailable or is changed, QT measurement will continue with the new primary lead.
- Single-Lead mode - a single lead selected from all available leads (except the augmented leads) will be used for QT measurement. QT measurement will stop if the selected lead becomes unavailable.

To select the mode,

- 1 Select the QT numeric to enter the **Setup QT Analysis** window.
- 2 Select QT Lead and select **All, Primary Lead** or one of the available single leads.

When using the All Leads mode, make sure when you compare QT values that they are based on the same set of leads.

Changing the lead(s) used for QT measurements will not cause the baseline to be reset.

## QT View

In the **QT View** window you can verify that the QT algorithm detects correct Q and T points.



The current waves are shown in the upper half of the window and the baseline waves in a different color below. The Q and T points are marked with a vertical line. By selecting one of the lead labels at the top of the window you can highlight the corresponding wave; the other waves are shown in gray. The underlined lead labels are the leads used for the QT calculation. By selecting the numeric area you can highlight all underlined leads.

### Changing The View To A Single Wave Set

To view one set of waves in a larger scale, you can cycle through the different views,

- 1 Select **Current** view to see the set of current waves.
- 2 Select **Baseline** view to see the set of baseline waves.
- 3 Select **Split** view to return to the combined view with current and baseline waves.

### Setting The QT Baseline

In order to quantify changes in the QTc value, you can set a QTc baseline. For example to assess the effect of medication on the QT interval you can set the current value as the baseline before you begin medication. This baseline will then be used to calculate the  $\Delta QTc$  value.

To set the baseline,

- Select **Set Baseline** and set the value.

If no baseline has been set for this patient, the first five minute value after the start of monitoring is automatically set as baseline. If you set a new baseline the previous baseline is discarded. As the  $\Delta QTc$  alarm is based on the difference between the baseline and the current value, setting an inappropriate new baseline may prevent a  $\Delta QTc$  alarm from being generated. Discharging a patient clears the baseline.

### Printing The QT Waves

To start a printout,

- Select **Print QT**.

## Recording The QT Waves

To start a recording,

- Select **Record QT**.

## QT Alarms

There are two QT alarms, QTc high limit alarm and  $\Delta$ QTc high alarm. The QTc high limit alarm is generated when the QTc value exceeds the set limit for more than 5 minutes. The  $\Delta$ QTc alarm is generated when the difference between the current value and the baseline value exceeds the set limit for more than 5 minutes.

The **Cannot Analyze QT INOP** and the **-?-** will be displayed when no QT measurement could be calculated for 10 minutes. Up to this time the previous valid value will be displayed. The following additional messages on the cause of the invalid measurements may also be displayed.

Additional Message	Cause of Invalid QT Measurement
<b>QT Startup</b>	QT monitoring was just turned on or has been reset
<b>Asystole or Leads Off</b>	<ol style="list-style-type: none"> <li>1 Not all specified leads needed to perform QT analysis are available, or</li> <li>2 Asystole condition is detected</li> </ol>
<b>Too few N labeled beats</b>	Not enough valid QRS complexes to generate a QT measurement
<b>Invalid Rhythm for QTc</b>	Not enough valid RR intervals to generate QT-HR, the averaged HR used for QTc calculation
<b>High QT-HR</b>	QT-HR exceeds the specified upper limit of 150 bpm (for adults) or 180 bpm (for neonates and pediatrics)
<b>Small R Wave</b>	R-wave of the signal is too small
<b>Small T Wave</b>	T-wave of the signal is too small
<b>End of T not Detected</b>	End of the T-Wave cannot be accurately detected
<b>QT out of Range</b>	QT measurement is outside the specified range of valid QT values (200-800 msec)
<b>QTc out of Range</b>	QTc measurement is outside the specified range of valid QTc values (200-800 msec)
<b>QTc Erratic</b>	QTc measurements are not stable

## Switching Individual QTc Alarms On and Off

Each QTc alarm can be switched off individually.

To switch an alarm on or off, in the **Setup QT Analysis** menu, select **QTc Alarm** or  **$\Delta$ QTc Alarm** to toggle between **On** and **Off**.

## Changing QTc Alarm Limits

Set the high alarm limits based on your assessment of the patient's clinical condition, unit protocols, physician orders or medication specified limits.

- 1 In the **Setup QT Analysis** menu, select **High Limit**.
- 2 Select the appropriate setting.



- 3 Select **ΔHighLimit**.
- 4 Select the appropriate setting.

## Switching QT Monitoring On and Off

To switch all QT monitoring on or off, in the **Setup QT Analysis** menu, select **QT Analys.** to switch between **On** and **Off**.



# Monitoring Pulse Rate

The pulse numeric counts the arterial pulsations that result from the mechanical activity of the heart in beats per minute (bpm). You can display a pulse from any measured SpO<sub>2</sub> signal (pleth wave), or any arterial pressure (P, ABP, ART, Ao, PAP, UAP, FAP, BAP: see the “Monitoring Invasive Pressure” chapter for an explanation of the pressure labels). The displayed pulse numeric is labeled and color-coded to match its source wave. If the pulse numeric is not displayed, see the **Setup Pulse** menu to check whether it is switched on.

## Entering the Setup Pulse Menu

If a pulse numeric is displayed on the screen, select it to enter the setup menu for that pulse source. If no pulse numeric is visible, in the **Setup SpO<sub>2</sub>** menu or the setup menu from an arterial pressure, select pulse with the correct source, e.g. **Pulse (HR)**.

## System Pulse Source

The currently selected system pulse source is shown in the setup menus of the pulse source measurements. The pulse rate chosen as system pulse:

- is monitored as system pulse and generates alarms when you select pulse as the active alarm source
- is sent via the network to the Information Center, if available
- is trended in the HighRes Trends and stored in the monitor's databases.

To define which pulse rate is used as system pulse,

- 1 In the **Setup Pulse** menu, select **System Pulse**.
- 2 Select one of the SpO<sub>2</sub> or arterial pressure labels from the pop-up list, or select **Auto**.  
If you select **Auto**, the monitor automatically chooses a pulse rate to be used as system pulse. It looks through the list from top to bottom and activates the first pulse rate that is switched on and available.

If your selected pulse source measurement becomes unavailable or is switched off, the monitor will use the next measurement from the list as system pulse until the selected pulse source measurement becomes available again.

## Switching Pulse On and Off

To switch a particular pulse numeric on or off, enter the **Setup Pulse** menu via the measurement setup menu or wave menu of the pulse source. For example, to switch an SpO<sub>2</sub> pulse numeric on or off,

- 1 Enter the **Setup Pulse** menu by selecting the Pulse numeric or by selecting **Pulse** in the **Setup SpO<sub>2</sub>** menu.
- 2 In the **Setup Pulse** menu, select the correct pulse label, e.g. **Pulse (SpO<sub>2</sub>)**, to toggle between **On** and **Off**.

## Using Pulse Alarms

You can change pulse rate alarm limits in the **ECG/Pulse Alarms** menu which can be accessed from the **Setup Pulse** menu or the **Setup ECG** menu by selecting **AlarmSrc(XXX)** where XXX is the current alarm source. Changing the alarm limits for a specific Pulse numeric changes the alarm limits for all pulse rate alarms and heart rate alarms.

Pulse alarms are only generated when the active alarm source is set to Pulse, a pulse source is set as system pulse and pulse alarms are switched on.

## Selecting the Active Alarm Source: ECG or Pulse?

In most cases the HR and Pulse numerics are identical. In order to avoid simultaneous alarms on HR and Pulse, the monitor uses either ECG or Pulse as its active alarm source. To change the alarm source, select **Al. Source** in the **ECG/Pulse Alarms** menu, then select

- **ECG/Arrhythm**: if you want the HR to be the alarm source for HR/Pulse.
- **Pulse**: If you select Pulse as the active alarm source, the monitor will prompt you to confirm your choice. Be aware that if you select Pulse as the alarm source, all arrhythmia and ECG HR alarms are switched off.
- **Auto**: If the alarm source is set to **Auto**, the monitor will use the heart rate from the ECG measurement as the alarm source whenever the ECG measurement is switched on and at least one ECG lead can be measured without an INOP condition.

The monitor will automatically switch to Pulse as the alarm source if:

- a valid ECG lead can no longer be measured
- and
- a Pulse source is switched on and available,

The monitor then uses the pulse rate from the measurement currently active as system pulse.

While Pulse is the alarm source, all arrhythmia and ECG HR alarms are switched off. If an ECG lead becomes available again, the monitor automatically uses HR as alarm source.

Note:

If ECG is switched off, the monitor will always change to Pulse as alarm source, if a Pulse is available. One exception to this rule can arise when you have a telemetry device paired with your monitor. The monitor ECG is then deactivated but the monitor may be configured to allow only ECG as the active alarm source. In this case the monitor will not switch to Pulse as alarm source and Pulse will not be available as a selection in the **ECG/Pulse Alarms** menu.

**WARNING**

Selecting Pulse as the active alarm source for HR/Pulse switches off the arrhythmia alarms listed in the section “ECG and Arrhythmia Alarm Overview” on page 123, including **Asystole**, **Vfib** and **Vtach** alarms, and the heart rate alarms. This is indicated by the message **ECG/Arrh AlarmsOff** (unless this has been configured off for your monitor), and the crossed-out alarm symbol beside the ECG heart rate numeric. The message **ECG/Arrh AlarmsOff** can be configured off, or to switch to a yellow (medium severity) INOP after a fixed number of hours.

High and low pulse rate and extreme bradycardia and extreme tachycardia alarms from pulse are active.

## Alarm Source Selection Disabled

If you cannot change the alarm source, selection of the alarm source may be disabled. If you try to change the source, the monitor displays the message **To activate enter Config and enable Alarm Source Selection**. This setting can only be changed in Configuration Mode.

## Changing HR/Pulse Alarm Limits

As Pulse and HR share the same high and low alarm limits, if you change the alarm limit in the **Setup Pulse** menu, the high or low alarm limits for HR in the **Setup ECG** menu change automatically, and vice versa. The only exceptions are caused by a low limit clamp for each measurement: the lowest value for Pulse when derived from SpO<sub>2</sub> is 30 bpm; from HR 15 bpm, and from Pressure 25 bpm.

## Extreme Alarm Limits for Heart Rate

The extreme rate alarms, **\*\*\* Extreme Tachy** and **\*\*\* Extreme Brady**, generated by the active alarm source, either HR or Pulse, are set in Configuration Mode by adding a set value to the high and low alarm limits. You need to know what value has been configured for your monitor. Changing the high and low alarm limits automatically changes the extreme alarm limits within the allowed range.

- To see the values added to the high and low limit alarms to create the extreme rate alarms for your monitor, in the **Setup ECG** menu, see the menu items **ΔExtrTachy** and **ΔExtrBrady**.

## QRS Tone

The active alarm source is also used as a source for the QRS tone. You can change the tone volume in the **Setup SpO<sub>2</sub>** and **Setup ECG** menus and the QRS tone modulation in the **Setup SpO<sub>2</sub>** menu.

**WARNING**

The audible QRS tone might be influenced by external interference and is not intended to be used as a substitute for ECG based arrhythmia analysis.

If arrhythmia detection is needed, do not rely on the audible QRS tone.



---

# Monitoring Respiration Rate (Resp)

For the respiratory measurement (Resp), the monitor measures the thoracic impedance between two ECG electrodes on the patient's chest. Changes in the impedance due to thoracic movement produce the Resp waveform on the monitor screen. The monitor counts the waveform cycles to calculate the respiration rate (RR).

## Lead Placement for Monitoring Resp

Correct patient skin preparation techniques for electrode placement are important for Resp measurement: you will find this information in the chapter on ECG.

The Resp measurement uses the standard ECG cable sets and lead placements. You can use any of the different types of ECG cable sets - 3-lead, 5-lead, 6-lead or 10-lead, using either standard or EASI™ placement - to measure Resp, as long as you use ICU ECG cables.

The Resp signal is always measured between two of the ECG electrodes. If you are using standard ECG electrode placement, Resp is measured between the RA and LL electrodes. If you are using EASI™ ECG electrode placement, Resp is measured between the I and A electrodes.

## Optimizing Lead Placement for Resp

If you want to measure Resp and you are already measuring ECG, you may need to optimize placement of the two electrodes between which Resp will be measured for some patients.

Repositioning ECG electrodes from standard positions, especially when you are using EASI™ ECG electrode placement, results in changes in the ECG waveform and may influence ST and arrhythmia interpretation.

## Cardiac Overlay

Cardiac activity that affects the Resp waveform is called cardiac overlay. It happens when the Resp electrodes pick up impedance changes caused by the rhythmic blood flow. Correct electrode placement can help to reduce cardiac overlay: avoid the liver area and the ventricles of the heart in the line between the respiratory electrodes. This is particularly important for neonates.

## Lateral Chest Expansion

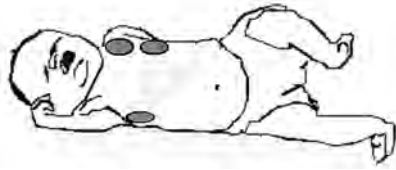

Some patients, especially neonates, expand their chests laterally. In these cases it is best to place the two respiratory electrodes in the right midaxillary and left lateral chest areas at the patient's maximum point of breathing movement to optimize the respiratory wave.

## Abdominal Breathing

Some patients with restricted chest movement breathe mainly abdominally. In these cases, you may need to place the left leg electrode on the left abdomen at the point of maximum abdominal expansion to optimize the respiratory wave.

## Understanding the Resp Display

The Resp measurement is displayed on the monitor as a continuous wave and a numeric respiration rate. If the detected respiration rate is close to the heart rate, this is indicated by the text **HR = RR** next to the respiration wave if you are in manual monitoring mode. Your monitor screen may look slightly different from the illustration.

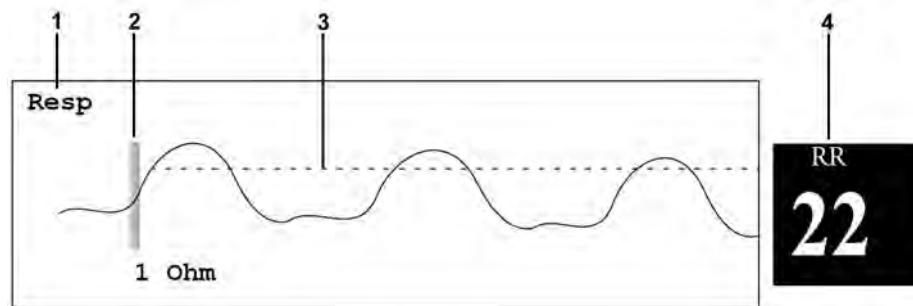

- 1 Resp wave label
- 2 One Ohm calibration bar
- 3 Manually-set Resp detection level
- 4 Resp numeric and label

## Changing Resp Detection Modes

The Resp detection level can be set either automatically or manually.

- To change the resp detection mode, in the **Setup Resp** menu, select **Detection** to toggle between the settings.

## Auto Detection Mode

In Auto Detection Mode, the monitor adjusts the detection level automatically, depending on the wave height and the presence of cardiac artifact. Note that in Auto Detection Mode,



- the detection level (a dotted line) is not displayed on the waveform,
- the algorithm expects a heart rate and therefore needs at least 3 electrodes attached to the patient. If you are monitoring respiration with only two electrodes, the detection algorithm becomes less sensitive which may result in reduced breath detection performance.

Use Auto Detection Mode for situations where:

- the respiration rate is not close to the heart rate
- breathing is spontaneous, with or without continuous positive airway pressure (CPAP)
- patients are ventilated, except patients with Intermittent Mandatory Ventilation (IMV).

## Manual Detection Mode

In Manual Detection Mode you must set the Resp detection level.

- In the **Setup Resp** menu, select **Manual Up** or **Manual Down**. Use the dotted detection level line in the Resp waveform to determine when the desired level is reached.

Once set, the detection level will not adapt automatically to different respiration depths. It is important to remember that if the depth of breathing changes, you may need to change the detection level.

Use Manual Detection Mode for situations where:

- the respiration rate and the heart rate are close.
- patients have Intermittent Mandatory Ventilation.
- respiration is weak. Try repositioning the electrodes to improve the signal.

## Resp Detection Modes and Cardiac Overlay

### In Auto Detection Mode:

If you are monitoring Resp and the ECG is switched off, the monitor cannot compare the ECG and Resp rates to detect cardiac overlay. The respiration detection level is automatically set higher to prevent the detection of cardiac overlay as respiration.

### In Manual Detection Mode:

Cardiac overlay can in certain situations trigger the respiration counter. This may lead to a false indication of a high respiration rate or an undetected apnea condition. If you suspect that cardiac overlay is being registered as breathing activity, raise the detection level above the zone of cardiac overlay. If the Resp wave is so small that raising the detection level is not possible, you may need to optimize the electrode placement as described in the section “Lateral Chest Expansion” on page 160.

## Changing the Size of the Respiration Wave

---

### WARNING

When monitoring in Manual Detection Mode, make sure to check the respiration detection level after you have increased or decreased the size of the respiration wave.

---

- In the **Setup Resp** menu, select **Size Up** to increase the size of the wave or **Size Down** to decrease it.

## Changing the Speed of the Respiration Wave

Resp waveforms are usually viewed at a slower speed than other waveforms. For this reason, the Resp measurement has its own speed control and is not affected by the wave speed settings of the other measurements.

- Select the Resp wave to enter the **Resp Wave** menu, then select **Change Speed**. Choose the required speed from the pop-up list. This defines the speed at which the wave is drawn across the screen in millimeters per second (mm/s).

## Using Resp Alarms

Resp alarms can be switched on and off and the high and low alarm limits can be changed just like other measurement alarms, as described in the Alarms chapter.

## Changing the Apnea Alarm Delay

The apnea alarm is a high priority red alarm used to detect apneas. The apnea alarm delay time defines the time period between the point where the monitor cannot detect any respiration activity and the indication of the apnea alarm.

- 1 In the **Setup Resp** menu, select **Apnea Time**.
- 2 Select the appropriate setting.

## Resp Safety Information

---

### WARNING

#### Respiration detection level

If you do not set the detection level for the respiration correctly in manual detection mode, it may not be possible for the monitor to detect apnea. If you set the detection level too low, the monitor is more likely to detect cardiac activity, and to falsely interpret cardiac activity as respiratory activity in the case of apnea.

#### Apnea

The respiration measurement does not recognize obstructive and mixed apneas - it only indicates an alarm when a pre-adjusted time has elapsed since the last detected breath.

The safety and effectiveness of the respiration measurement method in the detection of apnea, particularly the apnea of prematurity and apnea of infancy, has not been established.

#### Interference

If operating under conditions according to the EMC Standard EN 60601-1-2 (Radiated Immunity 3V/m), field strengths above 1V/m may cause erroneous measurements at various frequencies. Therefore it is recommended to avoid the use of electrically radiating equipment in close proximity to the respiration measurement unit.

#### Resp Accessories

To monitor respiration, use only the non-OR ECG accessories listed in the Resp section of the accessories chapter. You cannot measure respiration if you are using an orange OR ECG cable set.

This is because of the higher internal impedance of the OR cable set, required for use if electrosurgery is being performed.

### **Rate adaptive pacemakers**

Implanted pacemakers which can adapt to the Minute Ventilation rate may occasionally react on the Impedance measurement used by patient monitors for the determination of the Resp value and execute pacing with the maximum programmed rate. Switching off the Resp measurement can prevent this.

---



---

# Monitoring SpO<sub>2</sub>

Philips pulse oximetry uses a motion-tolerant signal processing algorithm, based on Fourier artifact suppression technology (FAST). It provides four measurements:

- Oxygen saturation of arterial blood (SpO<sub>2</sub>) - percentage of oxygenated hemoglobin in relation to the sum of oxyhemoglobin and deoxyhemoglobin (functional arterial oxygen saturation).
- Pleth waveform - visual indication of patient's pulse.
- Pulse rate (derived from pleth wave) - detected pulsations per minute.
- Perfusion indicator - numerical value for the pulsatile portion of the measured signal caused by arterial pulsation.

The monitors are also compatible with SpO<sub>2</sub> technologies from other manufacturers. Refer to the instructions for use provided with these devices for further information.

## SpO<sub>2</sub> Sensors

Familiarize yourself with the instructions for use supplied with your sensor before using it. In particular, check that the sensor being used is appropriate for your patient category and application site.

---

### CAUTION

**Do not use** OxiCliq disposable sensors in a high humidity environment, such as in neonatal incubators or in the presence of fluids, which may contaminate sensor and electrical connections causing unreliable or intermittent measurements. **Do not use** disposable sensors when there is a known allergic reaction to the adhesive.

---

## Applying the Sensor

- 1 Follow the SpO<sub>2</sub> sensor's instructions for use, adhering to all warnings and cautions.
- 2 Remove colored nail polish from the application site.
- 3 Apply the sensor to the patient. The application site should match the sensor size so that the sensor can neither fall off, nor apply excessive pressure.

- 4 When using the M1195A Infant Finger Sensor, select a finger or toe with a diameter of between 7 and 8 mm (0.27" and 0.31"). When applying a M1193A neonatal sensor do not overtighten the strap.
- 5 Check that the light emitter and the photodetector are directly opposite each other. All light from the emitter must pass through the patient's tissue.

---

### WARNING

**Proper Sensor Fit:** If a sensor is too loose, it might compromise the optical alignment or fall off. If it is too tight, for example because the application site is too large or becomes too large due to edema, excessive pressure may be applied. This can result in venous congestion distal from the application site, leading to interstitial edema, hypoxemia and tissue malnutrition. Skin irritations or lacerations may occur as a result of the sensor being attached to one location for too long. To avoid skin irritations and lacerations, periodically inspect the sensor application site and change the application site regularly.

**Venous Pulsation:** Do not apply sensor too tightly as this results in venous pulsation which may severely obstruct circulation and lead to inaccurate measurements.

**Ambient Temperature:** At elevated ambient temperatures be careful with measurement sites that are not well perfused, because this can cause severe burns after prolonged application. All listed sensors operate without risk of exceeding 41°C on the skin if the initial skin temperature does not exceed 35°C.

**Extremities to Avoid:** Avoid placing the sensor on extremities with an arterial catheter, an NBP cuff or an intravascular venous infusion line.

---

## Connecting SpO<sub>2</sub> Cables

- Connect the sensor cable to the color-coded socket on the monitor. You can connect some Philips sensors directly to the monitor. For other sensors, use the corresponding adapter cable.

---

### CAUTION

**Extension cables:** Do not use more than one extension cable (M1941A). Do not use an extension cable with Philips reusable sensors or adapter cables with part numbers ending in -L (indicates "long" cable version).

**Electrical Interference:** Position the sensor cable and connector away from power cables, to avoid electrical interference.

**Humidity:** For neonatal patients, make sure that all sensor connectors and adapter cable connectors are outside the incubator. The humid atmosphere inside can cause inaccurate measurements.

---

## Measuring SpO<sub>2</sub>

- 1 Select the correct patient category setting (adult/pediatric and neonatal), as this is used to optimize the calculation of the SpO<sub>2</sub> and pulse numerics.
- 2 During measurement, ensure that the application site:
  - has a pulsatile flow, ideally with a perfusion indicator value above 1.0.

- has not changed in its thickness (for example, due to edema), causing an improper fit of the sensor.

---

**WARNING**

- For fully conscious pediatric or adult patients, who have a normal function of perfusion and sensory perception at the measurement site:
    - To ensure skin quality and correct optical alignment of the sensor, inspect the application site when the measurement results are suspicious or when the patient complains about pressure at the application site, but at least every 24 hours. Correct the sensor alignment if necessary. Move the sensor to another site, if the skin quality changes.
  - For all other patients:
    - Inspect the application site every two to three hours to ensure skin quality and correct optical alignment. Correct the sensor alignment if necessary. If the skin quality changes, move the sensor to another site.
    - Change the application site at least every four hours.
  - Injected dyes such as methylene blue, or intravascular dyshemoglobins such as methemoglobin and carboxyhemoglobin may lead to inaccurate measurements.
  - Inaccurate measurements may result when the application site for the sensor is deeply pigmented or deeply colored, for example, with nail polish, artificial nails, dye or pigmented cream.
  - Interference can be caused by:
    - High levels of ambient light (including IR warmers) or strobe lights or flashing lights (such as fire alarm lamps). (Hint: cover application site with opaque material.)
    - Another SpO<sub>2</sub> sensor in close proximity (e.g. when more than one SpO<sub>2</sub> measurement is performed on the same patient). Always cover both sensors with opaque material to reduce cross-interference.
    - Electromagnetic interference, especially at perfusion indicator values below 1.0 or signal quality indicator below medium.
    - Excessive patient movement and vibration.
-

## Understanding the SpO2 Numerics



- 1 Measurement Mode (only with the IntelliVue CL SpO<sub>2</sub> Pod, in **Auto** or **Manual** mode)
- 2 Repeat time (only with the IntelliVue CL SpO<sub>2</sub> Pod, in **Auto** mode)
- 3 Timestamp for numerics (only with the IntelliVue CL SpO<sub>2</sub> Pod or a telemetry device)
- 4 Pulse numeric
- 5 Perfusion Numeric
- 6 Alarms off indicator (here for Pulse alarms)
- 7 SpO<sub>2</sub> numeric
- 8 SpO<sub>2</sub> alarm limits
- 9 Signal Quality indicator

In automatic mode, you may see the time until the next measurement instead of the timestamp, depending on your configuration. The time is shown like this:



SpO<sub>2</sub> numerics from intermittent measurements (from the IntelliVue CL SpO<sub>2</sub> Pod or a telemetry device) can be configured to be grayed out or to disappear from the screen after a set time. This avoids older numerics being misinterpreted as current data. The time can be set in Configuration mode.

When an automatic measurement is ongoing, the numerics are replaced by horizontal bars (1, 2 or 3 bars, in turn).

### SpO2 Signal Quality Indicator (Fast SpO2 only)

The SpO<sub>2</sub> numeric is displayed together with a signal quality indicator (if configured and enough space is available) which gives an indication of the reliability of the displayed values.

The level to which the triangle is filled shows the quality of the signal; the indicator below shows a medium signal quality, the signal quality is at a maximum when the triangle is completely filled.





## Assessing a Suspicious SpO<sub>2</sub> Reading

Traditionally, pulse rate from SpO<sub>2</sub> was compared with heart rate from ECG to confirm the validity of the SpO<sub>2</sub> reading. With newer algorithms, such as FAST-SpO<sub>2</sub>, this is no longer a valid criteria because the correct calculation of SpO<sub>2</sub> is not directly linked to the correct detection of each pulse.

When pulse rate is very low, or strong arrhythmia is present, the SpO<sub>2</sub> pulse rate may differ from the heart rate calculated from ECG but this does not indicate an inaccurate SpO<sub>2</sub> value.

If you doubt the measured SpO<sub>2</sub>, use the signal quality indicator (if available) or the pleth wave and perfusion indicator instead to assess the signal quality.

---

### WARNING

With pulse oximetry, sensor movement, ambient light (especially strobe lights or flashing lights) or electromagnetic interference can give unexpected intermittent readings when the sensor is not attached. Especially bandage-type sensor designs are sensitive to minimal sensor movement that might occur when the sensor is dangling.

---

## Changing the Averaging Time

Depending on the monitor configuration, you may be able to change the averaging time for the SpO<sub>2</sub> values.

The averaging time represents the approximate time period used for the calculation. The exact averaging algorithm depends on the SpO<sub>2</sub> technology (option) used and on the signal conditions. The longer the averaging time, the longer the time needed until the SpO<sub>2</sub> value reflects the physiological event. Fast averaging is useful for situations where an extremely fast measurement is required or few artifacts are expected. Use slow averaging where you expect the number of artifacts to be relatively high.

- 1 In the **Setup SpO<sub>2</sub>** menu, select **Average**.
- 2 Select the required averaging time from the list.

## Setting the Measurement Mode

When a telemetry device supplies SpO<sub>2</sub>T to the monitor via short range radio transmission, the monitor will have a **manual** measurement mode available. This allows SpO<sub>2</sub> measurements to be made on request and not continuously, helping to save the telemetry device's battery power.

When an IntelliVue CL SpO<sub>2</sub> Pod is providing SpO<sub>2</sub> measurement data to the monitor via short range radio, the monitor will have **manual** and **automatic** measurement modes available.

To set the measurement mode,

- 1 In the **Setup SpO<sub>2</sub>** menu, select **Mode**.
- 2 Select **Continuous**, **Manual** or **Auto** mode (if available).

**NOTE**

To ensure there is no gap in SpO<sub>2</sub> measurements when moving from standard telemetry transmission to short range radio transmission, the measurement mode will always be set to continuous in this situation unless manual mode is set in both the telemetry device and the monitor.

## Making a Manual Measurement

When the measurement mode is set to manual,

- In the **Setup SpO<sub>2</sub>** menu, select **Start SpO<sub>2</sub>**, or use the **Start SpO<sub>2</sub>** SmartKey.

When manual measurements are made, there will be no continuous SpO<sub>2</sub> monitoring or alarming. The manual measurement value reflects a momentary status. The numerics from SpO<sub>2</sub>T measurements made in manual mode, for example SpO<sub>2</sub>T, PerfT, PulseT, will remain for a time on the main screen. They are annotated with the time that the measurement was made to distinguish them from continuously measured values.

## Making an Automatic Measurement

When automatic mode is selected, to make a measurement:

- 1 Select **Repeat** or **Repeat Time** and select the required interval between measurements.
- 2 In the **Setup SpO<sub>2</sub>** menu, select **Start SpO<sub>2</sub>**, or use the **Start SpO<sub>2</sub>** SmartKey.

You can start a manual measurement between automatic measurements, if required, by selecting **Start SpO<sub>2</sub>** again as described above.

To end an automatic series of measurements, change the measurement mode to **Manual** or **Continuous**.

## Understanding SpO<sub>2</sub> Alarms

This refers to SpO<sub>2</sub> specific alarms. See the “Alarms” chapter for general alarm information. SpO<sub>2</sub> offers high and low limit alarms, and a high priority desat alarm. You cannot set the low alarm limit below the desat alarm limit.

---

### CAUTION

If you measure SpO<sub>2</sub> on a limb that has an inflated noninvasive blood pressure cuff, a non-pulsatile SpO<sub>2</sub> INOP can occur. If the monitor is configured to suppress this alarm there may be a delay of up to 60 seconds in indicating a critical status, such as sudden pulse loss or hypoxia.

---

## Alarm Delays

There is a delay between a change in the oxygen saturation at the measurement site and the corresponding alarm indication at the monitor. This delay has two components:

- **The general measurement delay time is the time between the occurrence of the saturation change and when the new value is represented by the displayed numerical values.** This delay depends on the algorithmic processing and the averaging time configured for SpO<sub>2</sub>. The longer the averaging time configured, the longer the time needed until the numerical values reflect the change in saturation.

- **The time between the displayed numerical values crossing an alarm limit and the alarm indication on the monitor.** This delay is the sum of the alarm delay time configured for SpO<sub>2</sub>, plus the system alarm delay. The system alarm delay is the processing time the system needs for any alarm to be indicated on the monitor, after the measurement has triggered the alarm. See the performance specifications in the Specifications chapter for the system alarm delay specification.

For SpO<sub>2</sub> high and low limit alarms, there are two different types of alarm delay time. The **standard alarm delay** is set to a fixed value. The **Smart Alarm Delay** varies, based on an intelligent algorithm, and can be used instead of the standard alarm delay.

The **Desat** alarm always uses the standard alarm delay.

## Standard Alarm Delay

The standard alarm delay time can be configured to a fixed value between 0 and 30 seconds, in 1 second steps.

## Smart Alarm Delays

The Smart Alarm Delay functionality is currently not available in China or in clinical environments under SFDA control.

When Smart Alarm Delays are used, the delay before the indication of an SpO<sub>2</sub> high or low limit alarm depends on the amount by which the limit is exceeded and for how long. This capability can be used to avoid alarms when the SpO<sub>2</sub> values show a pattern of recovering after a limit violation.

There are three modes available, Short, Medium and Long. All modes have a minimum delay of 10 seconds. The maximum delay is 25 seconds for Short mode, 50 seconds for Medium mode and 100 seconds for Long mode.

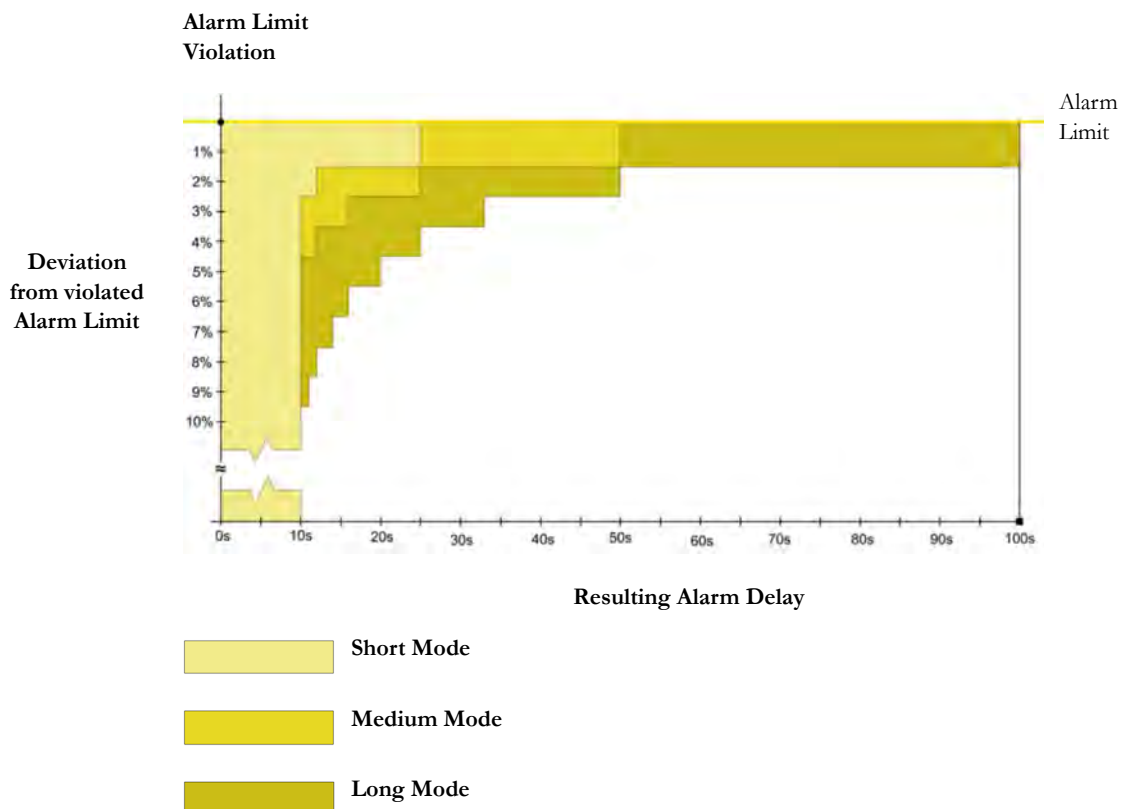

This diagram shows the relationship between the alarm delay and the deviation from the alarm limit. The shaded areas on the diagram show the area in which SpO<sub>2</sub> values can violate the alarm limit without causing an alarm to be indicated. The area is smallest for the Short mode, and is extended for the Medium and Long modes by the corresponding areas shown above.

**WARNING**

Before using Smart Alarm Delays, make sure that you fully understand how the delay is applied and what the consequences are.

**Example With Short Mode**

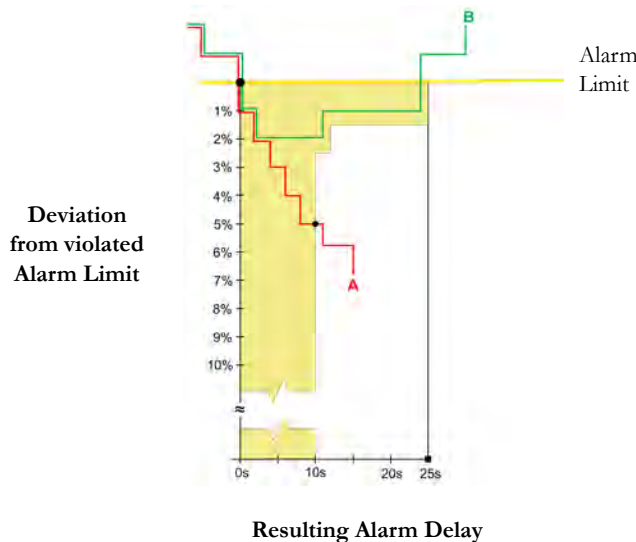

This diagram shows the area for Short mode, with two examples of hypoxia.

**Progressive hypoxia scenario:** SpO<sub>2</sub> value (A) - the values drop steadily and after 10 seconds a value leaves the shaded area. An alarm is indicated immediately.

**Recovery scenario:** SpO<sub>2</sub> value (B) - the values stay within the shaded area for 24 seconds, deviating from the alarm limit by 1% or 2%, before rising again above the alarm limit. No alarm is indicated because the SpO<sub>2</sub> values never leave the shaded area below the alarm limit.

On the basis of the two examples, you can see that the delay depends on how much the value exceeds the limit, and for how long. Changes in the SpO<sub>2</sub> value can be major, but very short, or minor and for a longer time - as long as they stay within the shaded area there will be no alarm indicated.

### Example With Medium Mode

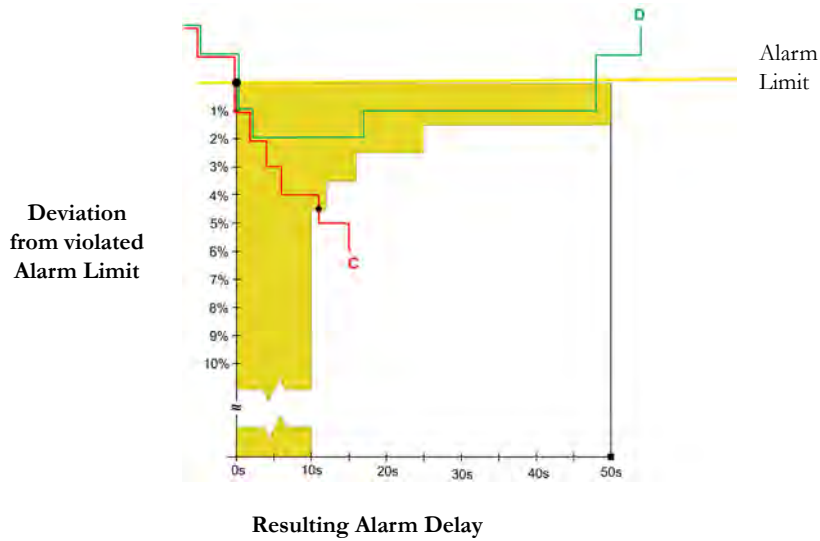

This diagram shows the area for Medium mode, with two examples of hypoxia.

**Progressive hypoxia scenario:** SpO<sub>2</sub> value (C) - the values drop steadily and after 11 seconds a value leaves the shaded area. An alarm is indicated immediately.

**Recovery scenario:** SpO<sub>2</sub> value (D) - the values stay within the shaded area for 48 seconds, deviating from the alarm limit by 1% or 2%, before rising again above the alarm limit. No alarm is indicated because the SpO<sub>2</sub> values never leave the shaded area below the alarm limit.

### Example With Long Mode

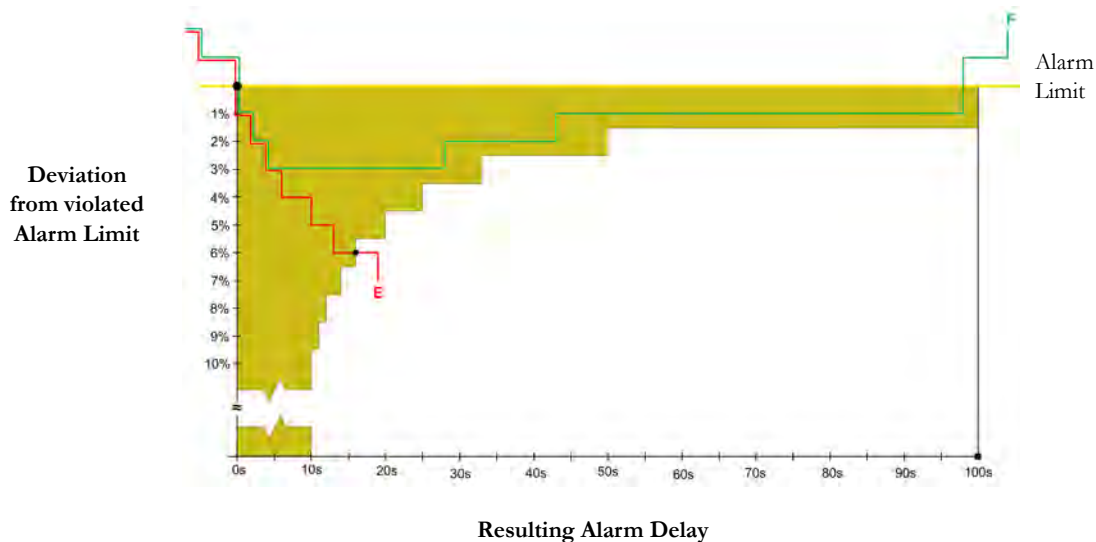

This diagram shows the area for Long mode, with two examples of hypoxia.

**Progressive hypoxia scenario:** SpO<sub>2</sub> value (E) - the values drop steadily and after 16 seconds a value leaves the shaded area. An alarm is indicated immediately.

**Recovery scenario:** SpO<sub>2</sub> value (F) - the values stay within the shaded area for 98 seconds, deviating from the alarm limit by 1% to 3%, before rising again above the alarm limit. No alarm is indicated because the SpO<sub>2</sub> values never leave the shaded area below the alarm limit.

## Setting Smart Alarm Delay Mode

To set the mode for Smart Alarm Delays, in the **Setup SpO<sub>2</sub>** menu,

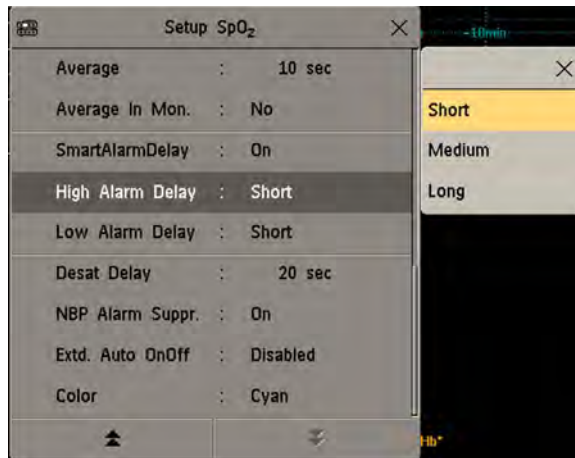

- 1 Check that **SmartAlarmDelay** is set to **On**.  
This setting is made in Configuration mode and will be shown in the menu in gray. If it is set to **Off**, a standard alarm delay is in use.
- 2 Select **High Alarm Delay** and choose **Short**, **Medium**, or **Long** mode.
- 3 Select **Low Alarm Delay** and choose **Short**, **Medium**, or **Long** mode.

If you also use monitors with earlier software revisions, be aware that smart alarm delays will not be used after a transfer to one of these monitors. Monitors with earlier software revisions will always use the standard alarm delay. If you are not sure whether a monitor has the Smart Alarm Delay function, check whether there is a **SmartAlarmDelay** entry in the **Setup SpO<sub>2</sub>** menu.

## Adjusting the Alarm Limits

In the **Setup SpO<sub>2</sub>** menu:

- Touch the high limit on the alarm limits menu button. Choose the high alarm limit from the pop-up list that opens.
- Touch the low limit on the alarm limits menu button. Choose the low alarm limit from the pop-up list that opens.

---

### WARNING

High oxygen levels may predispose a premature infant to retrolental fibroplasia. If this is a consideration do NOT set the high alarm limit to 100%, which is equivalent to switching the high alarm off.

---

## Adjusting the Desat Limit Alarm

The Desat alarm is a high priority (red) alarm notifying you of potentially life threatening drops in oxygen saturation.

- 1 In the **Setup SpO<sub>2</sub>** menu, select **Desat Limit**.
- 2 Adjust the limit.

## Pleth Wave

The Pleth wave is autoscaled to maximum display size. It decreases only when the signal quality becomes marginal. It is NOT directly proportional to the pulse volume. If you need an indication of change in pulse volume, use the perfusion indicator.

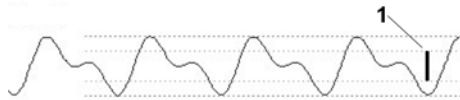

- 1 Minimum size for reliable SpO<sub>2</sub> value

## Perfusion Numeric

The perfusion numeric (**Perf**) gives a value for the pulsatile portion of the measured signal caused by the pulsating arterial blood flow.

As pulse oximetry is based on the pulsatile nature of the signal, you can also use the perfusion numeric as a quality indicator for the SpO<sub>2</sub> measurement. Above 1 is optimal, between 0.3-1 is acceptable. Below 0.3 is marginal; reposition the sensor or find a better site.

## Perfusion Change Indicator

The perfusion change indicator is a graphic symbol which shows the change in the perfusion value, relative to a reference value which you can set.

To set the current perfusion value as the reference value:

- In the **Setup SpO<sub>2</sub>** menu, select **Set Perf Ref.**.

When a reference value has been set, the perfusion change indicator is displayed next to the perfusion numeric.



## Setting SpO<sub>2</sub>/Pleth as Pulse Source

- 1 In the **Setup SpO<sub>2</sub>** menu, select **Pulse (SpO<sub>2</sub>)** to enter the **Setup Pulse** menu.
- 2 In the **Setup Pulse** menu, select **Syst.Pulse** and select **SpO<sub>2</sub>** from the pop-up list.

## Setting Up Tone Modulation

If tone modulation is on, the QRS tone pitch lowers when the SpO<sub>2</sub> level drops. Remember, the QRS tone is derived from either heart rate or pulse depending on which is currently selected as the active alarm source.

- In the **Setup SpO<sub>2</sub>** menu, select **Tone Mod.** to toggle between **Yes** (for on) and **No** (for off).

Tone modulation is licensed under US patent US 4,653,498 from Nellcor Puritan Bennett Incorporated.

## Setting the QRS Volume

In the **Setup SpO<sub>2</sub>** menu, select **QRS Volume** and set the appropriate QRS tone volume.



---

# Monitoring NBP

This monitor uses the oscillometric method for measuring NBP. In adult and pediatric mode, the blood pressure measurements determined with this device comply with the American National Standard for Electronic or Automated Sphygmomanometers (ANSI/AAMI SP10-1992) in relation to mean error and standard deviation, when compared to intra-arterial or auscultatory measurements (depending on the configuration) in a representative patient population. For the auscultatory reference, the fifth Korotkoff sound was used to determine the diastolic pressure.

In neonatal mode, the blood pressure measurements determined with this device comply with the American National Standard for Electronic or Automated Sphygmomanometers (ANSI/AAMI SP10-1992) in relation to mean error and standard deviation, when compared to intra-arterial measurements in a representative patient population.

The NBP measurement is suitable for use in the presence of electrosurgery and during the discharge of a cardiac defibrillator according to IEC 601-2-30:1999/EN 60601-2-30:2000.

A physician must determine the clinical significance of the NBP information.

## Introducing the Oscillometric NBP Measurement

Oscillometric devices measure the amplitude of pressure changes in the occluding cuff as the cuff deflates from above systolic pressure. The amplitude suddenly increases as the pulse breaks through the occlusion in the artery. As the cuff pressure decreases further, the pulsations increase in amplitude, reach a maximum (which approximates to the mean pressure), and then diminish.

Studies show that, especially in critical cases (arrhythmia, vasoconstriction, hypertension, shock), oscillometric devices are more accurate and consistent than devices using other noninvasive measuring techniques.

---

### WARNING

**Patient Category:** Select the correct patient category setting for your patient. Do not apply the higher adult inflation, overpressure limits and measurement duration to neonatal patients.

**Intravenous infusion:** Do not use the NBP cuff on a limb with an intravenous infusion or arterial catheter in place. This could cause tissue damage around the catheter when the infusion is slowed or blocked during cuff inflation.

**Skin Damage:** Do not measure NBP in cases of sickle-cell disease or any condition where skin damage has occurred or is expected.

**Unattended measurement:** Use clinical judgement to decide whether to perform frequent unattended blood pressure measurements in cases of severe blood clotting disorders because of the risk of hematoma in the limb fitted with the cuff.

---

---

### CAUTION

If you spill liquid onto the equipment or accessories, particularly if there is a chance that it can get inside the tubing or the measurement device, contact your service personnel.

---

## Measurement Limitations

Measurements are impossible with heart rate extremes of less than 40 bpm or greater than 300 bpm, or if the patient is on a heart-lung machine.

The measurement may be inaccurate or impossible:

- with excessive and continuous patient movement such as shivering or convulsions
- if a regular arterial pressure pulse is hard to detect
- with cardiac arrhythmias
- with rapid blood pressure changes
- with severe shock or hypothermia that reduces blood flow to the peripheries
- with obesity, where a thick layer of fat surrounding a limb dampens the oscillations coming from the artery
- on an edematous extremity.

The effectiveness of this sphygmomanometer has not been established in pregnant, including pre-eclamptic patients.

## Measurement Modes

There are four modes for measuring NBP:

- **Manual** - measurement on demand.
- **Auto** - continually repeated measurements (between one minute and 24 hours adjustable interval).
- **Sequence** - up to four measurement cycles which will run consecutively, with number of measurements and interval between them configurable for each cycle.
- **STAT** - rapid series of measurements over a five minute period, then the monitor returns to the previous mode. Use only on supervised patients.

## Reference Method

The measurement reference method can be Auscultatory (manual cuff) or Invasive (intra-arterial). For further information, see the Application Note supplied on the monitor documentation DVD.

**In Neonatal mode**, to comply with safety standards, invasive is always used as the reference method. This setting cannot be changed and is not visible in any operating mode.

**In Adult and Pediatric mode**, to check the current setting, select **Main Setup, Measurements**, then **NBP**, and check whether the **Reference** setting is set to **Auscult.** or **Invasive**. This setting can only be changed in Configuration Mode.

## Preparing to Measure NBP

- 1 Connect the cuff to the air tubing.
- 2 Plug the air tubing into the red NBP connector. Avoid compression or restriction of pressure tubes. Air must pass unrestricted through the tubing.
- 3 Make sure that you are using a Philips-approved correct sized cuff and that the bladder inside the cover is not folded or twisted.

A wrong cuff size, and a folded or twisted bladder, can cause inaccurate measurements. The width of the cuff should be in the range from 37% to 47% of the limb circumference. The inflatable part of the cuff should be long enough to encircle at least 80% of the limb.

- 4 Apply the cuff to a limb at the same level as the heart. If it is not, you must use the measurement correction formula to correct the measurement.

The marking on the cuff must match the artery location. Do not wrap the cuff too tightly around the limb. It may cause discoloration, and ischemia of the extremities. Inspect the application site regularly to ensure skin quality and inspect the extremity of the cuffed limb for normal color, warmth and sensitivity. If the skin quality changes, or if the extremity circulation is being affected, move the cuff to another site or stop the blood pressure measurements immediately. Check more frequently when making automatic or stat measurements.

## Correcting the Measurement if Limb is not at Heart Level

To correct the measurement if the limb is not at heart level, to the displayed value

add 0.75 mmHg (0.10 kPa) for each <b>centimeter</b> higher or	deduct 0.75 mmHg (0.10 kPa) for each <b>centimeter</b> lower or
add 1.9 mmHg (0.25 kPa) for each <b>inch</b> higher.	deduct 1.9 mmHg (0.25 kPa) for each <b>inch</b> lower.

## Understanding the NBP Numerics

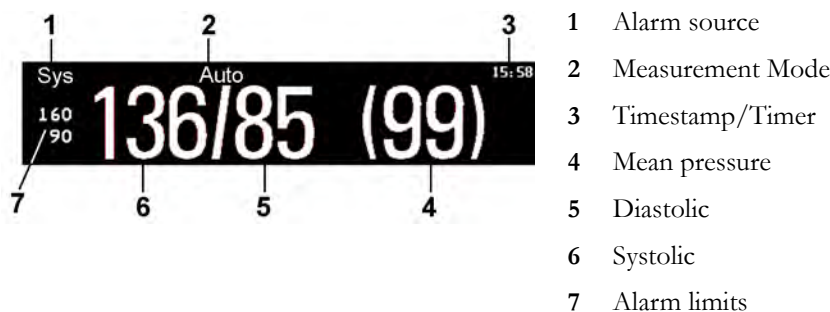

Depending on the NBP numeric size, not all elements may be visible. Your monitor may be configured to display only the systolic and diastolic values. If configured to do so, the pulse from NBP will display with the NBP numeric.

The measured NBP value, together with the corresponding pulse rate if this is switched on, will be displayed for one hour. After that the values are regarded as invalid and are no longer displayed. During this time, measurement values may be grayed out or disappear from the screen after a set time, if configured to do so. This avoids older numerics being misinterpreted as current data. The time can

be set in Configuration mode. In **Auto** mode the measurement values may disappear more quickly (to be replaced by new measurement values), if the repeat time is set to less than one hour.

NBP and SpO<sub>2</sub> numerics from intermittent measurements can be configured to be grayed out or to disappear from the screen after a set time. This avoids older numerics being misinterpreted as current data. The time can be set individually for SpO<sub>2</sub> and NBP in Configuration mode.

### Alarm Sources

If you have parallel alarm sources, the sources are displayed instead of the alarm limits.

### NBP Timestamp

Depending on your configuration, the time shown beside the NBP numeric can be:

- the time of the most recent NBP measurement, also known as the "timestamp", or
- the time until the next measurement in an automatic series, displayed with a graphic representation of the remaining time, as shown here.



The NBP timestamp will normally show the **completion** time of the NBP measurement. Only under the following conditions the timestamp shows the **beginning** of the measurement:













- when in **Auto** or **Sequence** mode, **and**
- the monitor is configured to synchronize the measurements in a measurement series to an "easy-to-document" time. For example, if you start the first measurement at 08:23, and the **Repeat Time** is set to 10 minutes, the monitor automatically performs the next measurement at 8:30, then 8:40 and so on.

### During Measurements

The cuff pressure is displayed instead of the units and the repeat time. An early systolic value gives you a preliminary indication of the systolic blood pressure during measurement.

## Starting and Stopping Measurements

Use the **Setup NBP** menu or SmartKeys to start and stop measurements.

Action to be performed	NBP Setup menu	SmartKeys
Start manual measurement Start Auto series	Start/Stop	 Start/ Stop
		 Start NBP
Start STAT measurement	NBP STAT	 NBP STAT
		 Start STAT
Stop Manual measurements	Start/Stop	 Start/ Stop
		 Stop NBP
Stop current Auto measurement	Start/Stop	 Start/ Stop
		 Stop NBP
Stop current STAT measurement and end series	Start/Stop	 Start/ Stop
	NBP STAT	 NBP STAT
		 Stop NBP
Stop Auto, Manual or STAT measurement AND series	Stop All	 Stop All

**CAUTION**

Use clinical judgment to decide whether to perform repeated series of STAT measurements because of the risk of purpura, ischemia and neuropathy in the limb with the cuff.

## Enabling Automatic Mode and Setting Repetition Time

- 1 In the **Setup NBP** menu, select **Mode** and select **Auto** from the pop-up menu.
- 2 For an automatic measurement, select **Repeat** and set the time interval between two measurements.

## Enabling Sequence Mode and Setting Up The Sequence

- 1 In the **Setup NBP** menu, select **Mode** and select **Sequence** from the pop-up menu.
- 2 Select **Setup Sequence** to open the **Setup Sequence** window.  
Up to four measurement cycles can be setup which will run consecutively. For each cycle you can set the number of measurements and the interval between them. If you want to run less than four cycles in a sequence, you can set the number of measurements for one or more cycles to **Off**.
- 3 Select each sequence in turn and select the number of measurements and the time interval between the measurements.
- 4 To have measurements continue after the sequence, set the number of measurements for your last cycle to **Continuous** and this cycle will run indefinitely.

**CAUTION**

Be aware that, if none of the cycles are set to **Continuous**, NBP monitoring will end after the last measurement of the cycle.

When the NBP measurement mode is set to **Sequence**, the repetition time for **Auto** mode cannot be changed.

## Choosing the NBP Alarm Source

You can monitor for alarm conditions in systolic, diastolic and mean pressure, either singly or in parallel. Only one alarm is given, with the priority of mean, systolic, diastolic.

In the **Setup NBP** menu, select **Al. from** and choose from:

Menu option	Pressure value monitored
<b>Sys.</b>	systolic
<b>Dia.</b>	diastolic
<b>Mean</b>	mean
<b>Sys &amp; Dia</b>	systolic and diastolic in parallel
<b>Dia &amp; Mean</b>	diastolic and mean in parallel
<b>Sys &amp; Mean</b>	systolic and mean in parallel
<b>Sys&amp;Dia&amp;Mean</b>	all three pressures in parallel

If **Mean** is not selected as alarm source (**Sys.**, **Dia.**, or **Sys & Dia** selected), but the monitor can only derive a mean value, mean alarms will nevertheless be announced using the most recent mean alarm limits. Check that the mean alarm limits are appropriate for the patient, even when not using mean as the alarm source. When no value can be derived an **NBP Measure Failed** INOP will be displayed.

## Switching Pulse from NBP On/Off

In the process of making the NBP measurement, a pulse value can be derived and displayed. The pulse value is displayed together with the time the measurement was made. After one hour the value becomes invalid. There are no alarms associated with pulse from NBP.

To switch the display of the pulse value on or off:

- In the **Setup NBP** menu select **Pulse (NBP)**.

## Assisting Venous Puncture

You can use the NBP cuff to cause sub-diastolic pressure. The cuff deflates automatically after a set time (adult/pediatric 170 seconds, neonatal 85 seconds) if you do not deflate it.

- 1 In the **Setup NBP** menu select **VeniPuncture**.
- 2 Puncture vein and draw blood sample.
- 3 Reselect **VeniPuncture** to deflate the cuff.

During measurement, the NBP display shows the inflation pressure of the cuff and the remaining time in venous puncture mode.

### NOTE

Performing a venous puncture while automatic or sequence NBP measurements are being made suspends the measurement series for the duration of the venous puncture inflation and for three minutes afterwards.

## Calibrating NBP

NBP is not user-calibrated. Cuff-pressure transducers must be verified at least once every two years by a qualified service professional, and calibrated, if necessary. See the Service Guide for details.





---

# Monitoring Temperature

---

## WARNING

Measurements from an MMS extension connected to the monitor are not available when the monitor is running on its own battery power. They are only available when the monitor is powered by the external power supply (M8023A) or the Battery Extension (865297).

---

You can measure temperature using the built-in temperature measurement (optional), or one of the MMS extensions.

The Temp measurement automatically switches on when you connect a probe. You can switch the measurement off manually.

## Making a Temp Measurement

- 1 Select the correct type and size of probe for your patient.
- 2 If you are using a disposable probe, connect the probe to the temperature cable.
- 3 Plug the probe or temperature cable into the temperature connector socket.
- 4 Apply the probe to the patient. You are advised to use a protective rubber cover on rectal probes.
- 5 Select an appropriate temperature label.
- 6 Check that the alarm settings (on or off, high and low limits) are appropriate for this patient and this type of temperature measurement.

---

## WARNING

Make sure you set alarm limits for the correct label. The alarm limits you set are stored for that particular label only. Changing the label may change the alarm limits.

---

## Selecting a Temperature for Monitoring

Tell the monitor which temperature you want to monitor by selecting its temperature label. The label is a unique identifier for each type of temperature. When you choose a label, the monitor uses that label's stored color and alarm settings.

- 1 In the **Setup <Temp Label>** menu, select **Label**.
- 2 Select the appropriate label from the list.

<b>Temp</b>	non-specific temperature label	<b>Trect</b>	rectal temperature
<b>Tart</b>	arterial temperature	<b>Tskin</b>	skin temperature
<b>Tcore</b>	core temperature	<b>Tven</b>	venous temperature
<b>Tesoph</b>	esophageal temperature	<b>Tnaso</b>	nasopharyngeal temperature

## Extended Temperature Label Set

The following additional labels are available if **Label Set** is set to **Full**. This setting can only be changed in Configuration Mode.

Note that if your monitor is connected to an Information Center, the additional labels in the extended label set may not be correctly displayed. See the *Configuration Guide* for your monitor for more information.

<b>T1, T2, T3, T4</b>	Non-specific temperature labels
<b>Tamb</b>	ambient temperature
<b>Tcereb</b>	cerebral temperature
<b>Ttym</b>	tympanic temperature
<b>Tvesic</b>	vesical temperature

## Calculating Temp Difference

The monitor can calculate and display the difference between two temperature values by subtracting the second value from the first. The difference is labeled **ΔTemp**.

- 1 In the **Main Setup** menu, select **Measurements**.
- 2 Select **ΔTemp**.
- 3 In the **Setup ΔTemp** menu, select **First Temp**.
- 4 Select the appropriate label for the measurement source.
- 5 Select **Second Temp**.
- 6 Select the appropriate label for the second measurement source.

---

# Monitoring Invasive Pressure

---

## WARNING

Measurements from an MMS extension connected to the monitor are not available when the monitor is running on its own battery power. They are only available when the monitor is powered by the external power supply (M8023A) or the Battery Extension (865297).

---

---

## CAUTION

Do not use a monitor with an M1006A pressure module as an additional monitor for your patient. This may cause interference on the respiration or invasive pressure measurements.

---

You can measure pressure using the monitor's built-in pressure measurement (optional), or one of the MMS extensions.

## Setting up the Pressure Measurement

- 1 Plug in the pressure cable.
- 2 Prepare the flush solution.
- 3 Flush the system to exhaust all air from the tubing. Ensure that the transducer and stopcocks are free of air bubbles.

---

## WARNING

If air bubbles appear in the tubing system, flush the system with the infusion solution again. Air bubbles may lead to a wrong pressure reading.

---

- 4 Connect the pressure line to the patient catheter.
- 5 If you are using an infusion pressure cuff with the pressure line, attach the pressure cuff to the fluid to be infused. Inflate it according to your standard hospital procedure, then start the infusion.
- 6 Position the transducer so that it is level with the heart, approximately at the level of the midaxillary line.

**WARNING**

If measuring intracranial pressure (ICP, IC1 or IC2) with a sitting patient, level the transducer with the top of the patient's ear. Incorrect leveling may give incorrect values.

## Selecting a Pressure for Monitoring

Tell the monitor the source of the pressure you want to monitor by selecting an appropriate pressure label. The label is a unique identifier for each type of pressure. When you choose a label, the monitor uses that label's stored settings, for example color, wave scale and alarm settings. The label also determines which algorithm is used to process the pressure signal, so an incorrect label can lead to incorrect pressure values.

- 1 In the **Setup <Press Label>** menu, select **Label**.
- 2 Select the appropriate label from the list.

Label	Description
ABP	Arterial blood pressure
ART	Arterial blood pressure (alternative)
Ao	Aortic pressure
CVP	Central venous pressure
ICP	Intracranial pressure
LAP	Left atrial pressure
P	Non-specific pressure label
PAP	Pulmonary artery pressure
RAP	Right atrial pressure
UAP	Umbilical arterial pressure
UVP	Umbilical venous pressure

## Extended Pressure Label Set

The following additional labels are available if **Label Set** is set to **Full**. This setting can only be changed in Configuration Mode.

Note that if your monitor is connected to an Information Center, the additional labels in the extended label set may not be correctly displayed. See the *Configuration Guide* for your monitor for more information.

Label	Description
BAP	Brachial arterial pressure
FAP	Femoral arterial pressure
IC1, IC2	Alternative intracranial pressures
P1, P2, P3, P4	Alternative non-specific pressure labels

## Zeroing the Pressure Transducer

To avoid inaccurate pressure readings, the monitor requires a valid zero. Zero the transducer in accordance with your hospital policy. You must perform a zero:

- when you use a new transducer or tubing
- every time you reconnect the transducer cable to the monitor
- if you think the monitor's pressure readings are not correct.

### Zeroing ICP (or IC1/IC2)

Your hospital guidelines may require you to zero the ICP transducer less frequently than other transducers, due to the need for aseptic conditions. When you zero an ICP transducer, the zero values are automatically stored and you will not be prompted to repeat the zero procedure.

If you want to simultaneously zero all pressures except ICP, disconnect the ICP transducer from the monitor while zeroing. Reconnecting the transducer recalls the stored values.

---

#### WARNING

If you select the label ICP (or IC1/IC2), the measurement device uses the most recently stored zero. Therefore, make sure you zeroed the transducer correctly in accordance with the transducer manufacturer's instructions and your hospital policy. When you use a transducer that you cannot rezero after placement, ensure that you keep the measuring device with the patient so that you are certain you have the correct zero data for this patient.

---

### Determining a Pressure's Most Recent Zero

The monitor displays the most recent zero on the status line. If this has "timed-out" after you have performed a zero, redisplay the information in the status line by entering the pressure's setup menu.

### Zeroing a Pressure Measurement

---

#### WARNING

**Invasive pressure alarms** (and pulse alarms, if derived from invasive pressure) are temporarily suppressed until 30 seconds after the transducer finishes zeroing.

---

- 1 Turn off the stopcock to the patient.
- 2 Vent the transducer to atmospheric pressure, to compensate for the static and atmospheric pressure exerted on the transducer.
- 3 In the setup menu for the pressure, select **Zero <Press Label>**.
- 4 When you see the message **<Press Label> zero done at <date and time>** on the status line, close the stopcock to atmospheric pressure, and open the stopcock to the patient.

**CAUTION**

When using high frequency ventilation, ensure that the tubing from the ventilator does not touch the arterial line, or connect with it indirectly, while zeroing the pressure. This could cause small pressure variations which can interfere with the zero procedure.

## Zeroing All Pressures Simultaneously

**WARNING**

**Before** zeroing all pressures, make sure that **all** pressure transducers are vented to atmospheric pressure.

If you are measuring pressures with more than one measuring device, using the **Zero Press** SmartKey to initiate the zeroing calls up a list of all active pressures. Select the pressure you want to zero or select **All Press** to zero all pressures simultaneously.

## Troubleshooting the Zero

The status line lists the probable cause of an unsuccessful zero:

Message	Corrective Action
<Press Label> can't zero; equipment malf.	The hardware is faulty. Contact your service personnel.
<Press Label> can't zero; excessive offset	Make sure the transducer is vented to air and try again. If this fails, the hardware may be faulty. Replace the adapter cable and try again. If it fails, replace the transducer and try again. If it still fails, contact your service personnel.
<Press Label> can't zero – unstable signal	
<Press Label> can't zero – no transducer	Make sure that the transducer is connected and try again. If this fails, exchange the adapter cable and try again. If this fails, exchange the transducer.
<Press Label> can't zero; pulsat. pressure	Make sure that the transducer is vented to air, not to the patient, and try again.
<Press Label> unable to zero – timed out	Try pressing the Zero key again. If this fails, replace the transducer and adapter cable and contact your service personnel.
Switch <Press Label> on first	Pressure measurement is switched off. To switch it on, in the Setup Pressure menu, select the pressure's label.

## Adjusting the Calibration Factor

Each time you use a reusable transducer, compare the calibration factor written on your transducer with the calibration factor shown on the monitor. To ensure accurate measurement, they must be the same.

- 1 In the **Setup <Press Label>** menu, select **Cal. Factor**.  
If the value here does **not** match that on the transducer, select the corresponding value from the list now in accordance with your hospital's procedure.

- 2 To confirm you want to use the new calibration factor, select the **Confirm** pop-up key.

## Displaying a Mean Pressure Value Only

Use this when you want to see only the mean pressure.

In the pressure's setup menu, select **Mean only**. Toggle between **On** to display mean pressure value only, and **Off** to display all pressure values (systolic, diastolic and mean).

## Changing the Pressure Wave Scale

- 1 Select the label of the pressure wave whose scale you want to set to enter the **Setup <Press Label>** menu.
- 2 In the **Setup <Press Label>** menu, (for example **ABP**) select **Scale**.
- 3 Select a value from the pop-up list:
  - a positive value sets the top gridline. The bottom gridline is set at zero.
  - a negative value sets the bottom gridline. The middle gridline is set at zero.

## Optimizing the Waveform

In the **Setup <Press Label>** menu, select **Optimum Scale** to let the monitor select the best minimum and maximum scales for the current wave.

## Non-Physiological Artifact Suppression

Some clinical procedures may affect blood pressure, for example, a flush procedure or a blood sample. Your monitor may be configured to suppress these non-physiological artifacts for a specified duration (**Artifact Suppr.** is configured to **30 sec**, **60 sec**, or **90 sec**). During artifact suppression, the monitor shows the INOP message **<Press Label> Artifact**, and a question mark is shown beside the pressure numerics. Pressure alarms and the **<Press Label> No Pulse INOP** are suppressed during the configured period. The CPP alarms are not suppressed.

## Choosing the Pressure Alarm Source

---

### WARNING

Make sure you set alarm limits for the correct label. The alarm limits you set are stored for that particular label only. Changing the label may change the alarm limits.

---

You can monitor for alarm conditions in systolic, diastolic and mean pressure, either singly or in parallel. Only one alarm is given at a time, in this order of priority: mean, systolic, diastolic.

- In the **Setup <Press Label>** menu, select **Al. from** and choose the source.

Menu option	Pressure value monitored
<b>Sys.</b>	systolic
<b>Dia.</b>	diastolic
<b>Mean</b>	mean
<b>Sys &amp; Dia</b>	systolic and diastolic in parallel
<b>Dia &amp; Mean</b>	diastolic and mean in parallel
<b>Sys &amp; Mean</b>	systolic and mean in parallel
<b>Sys&amp;Dia&amp;Mean</b>	all three pressures in parallel

Select and set the **High Limit** and **Low Limit** for the pressure(s) you have selected.

## Extreme Alarm Limits for Pressure

The extreme pressure alarms, Extreme High and Extreme Low, can be made available for your monitor in Configuration Mode and are additional to the standard High and Low limit alarms. They are generated by the active pressure alarm source, and are setup in Configuration Mode by adding a set value (the  $\Delta$  value) to the high and low alarm limits. This value can be set for each pressure label individually.



- 1 Extreme Low Limit
- 2 Low Limit
- 3 High Limit
- 4 Extreme High Limit
- 5  $\Delta$  Extreme Low
- 6  $\Delta$  Extreme High

You need to know which values have been configured for your monitor. Changing the high and low alarm limits automatically changes the extreme alarm limits within the allowed range.

To see the extreme pressure alarms set for your monitor, in the setup menu for that pressure, see the menu items  **$\Delta$ Extr.High** and  **$\Delta$ Extr. Low**.

The extreme pressure alarms are high priority, red alarms, marked **\*\*\*** in the alarm message.

## Calibrating Reusable Transducer CPJ840J6

Depending on your monitor's configuration, you may be able to perform a calibration in monitoring mode. Perform a mercury calibration when you use a new transducer, and at regular intervals according to your hospital policy. You require:



- standard sphygmomanometer.
- sterile 10cc syringe with heparinised solution.
- 3-way stopcock.
- approximately 25 cm of tubing.

## Making the Pressure Calibration

### WARNING

Never perform the invasive pressure calibration while a patient is being monitored.

- 1 Zero the transducer.
- 2 Connect the syringe and manometer.
  - a. Attach the tubing to the manometer.
  - b. Connect the 3-way stopcock to the stopcock that is not connected to the patient catheter when you measure a patient.
  - c. Attach the syringe to one port and the manometer tubing to the other port.
  - d. Open the port to the manometer.

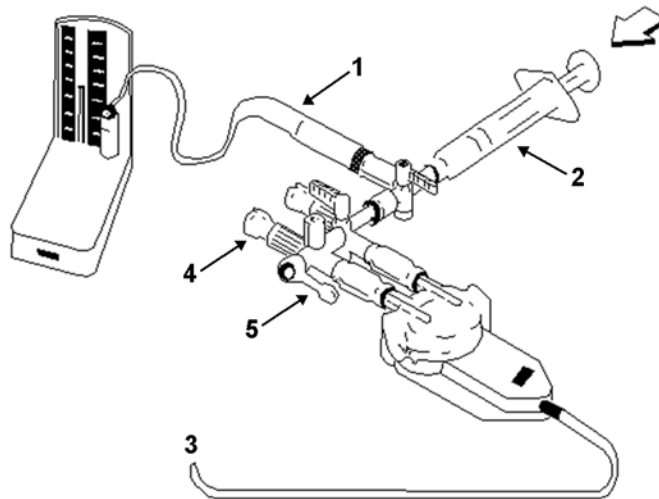

- 1 Tubing to manometer
- 2 Syringe with heparinised solution
- 3 To pressure connector on monitor
- 4 Patient connection stoppered
- 5 Off

- 3 Move the syringe barrel in and raise the mercury to 200 mmHg (30 kPa). 200 mmHg is the recommended calibration pressure.
- 4 In the **Setup <Press Label>** menu, select **Cal. Press**.
- 5 Select the calibration pressure from the list, for example 200 mmHg.
- 6 Select **Confirm** to recalculate the calibration factor using the applied pressure.

- 7 When the monitor displays **<Press Label> mercury calibr. done at <date and time>**, remove the manometer tubing, syringe and extra stopcock. We recommend you replace the transducer dome and tubing with sterile ones.
- 8 Label the transducer with the calibration factor shown in the **Cal. Factor** field in the pressure's setup menu.
- 9 Reconnect the patient and start measuring again.

### Troubleshooting the Pressure Calibration

The status line lists the probable cause of an unsuccessful calibration.

Message	Corrective Action
<b>&lt;Press Label&gt; can't calibr.; equipmt malf.</b>	Contact your service department. The pressure hardware is faulty.
<b>&lt;Press Label&gt; can't calibrate;out of range</b>	Make sure that you have selected the value for <b>Cal. Press</b> that you are applying to the transducer, and repeat the calibration.
<b>&lt;Press Label&gt; can't calibrate; no transd.</b>	Make sure that the transducer is connected and try again.
<b>&lt;Press Label&gt; can't cal.; unstable signal</b>	Make sure there are no disturbances to the transducer, and repeat the calibration.
<b>&lt;Press Label&gt; can't calibr.;do zero first</b>	No valid zero. Zero the transducer.

### Calculating Cerebral Perfusion Pressure

The monitor can calculate the difference between mean arterial pressure and the intracranial pressure. The difference is labeled CPP.

- 1 In the **Main Setup** menu, select **Measurements**.
- 2 Select **CPP**.
- 3 In the **Setup CPP** menu, select which arterial pressure source should be used in the calculation.

---

# Monitoring Carbon Dioxide

---

## WARNING

Measurements from an MMS extension connected to the monitor are not available when the monitor is running on its own battery power. They are only available when the monitor is powered by the external power supply (M8023A) or the Battery Extension (865297).

---

---

## CAUTION

Only one CO<sub>2</sub> measurement at a time is supported.

---

Use the CO<sub>2</sub> measurement to monitor the patient's respiratory status and to control patient ventilation.

There are two methods for measuring carbon dioxide in the patient's airway:

- Mainstream measurement uses a CO<sub>2</sub> sensor attached to an airway adapter directly inserted into the patient's breathing system. This method is available using the monitor's built-in CO<sub>2</sub> measurement (optional), the M3014A Capnography Extension or the M3016A Mainstream Extension.
  - Sidestream measurement takes a sample of the respiratory gas with a constant sample flow from the patient's airway and analyzes it with a remote CO<sub>2</sub> sensor. You can measure sidestream CO<sub>2</sub> using the monitor's built-in CO<sub>2</sub> measurement (optional) or using the M3014A Capnography Extension, or the M3015A/B Microstream CO<sub>2</sub> Extension.
- 

## WARNING

**Correlation:** The etCO<sub>2</sub> readings do not always correlate closely with paCO<sub>2</sub>, especially in neonatal patients and patients with pulmonary disease, pulmonary embolism or inappropriate ventilation.

**Pharmaceuticals in aerosols:** Do not measure CO<sub>2</sub> in the presence of pharmaceuticals in aerosols.

**Explosion Hazard:** Do not use in the presence of flammable anesthetics or gases, such as a flammable anesthetic mixture with air, oxygen or nitrous oxide. Use of the devices in such an environment may present an explosion hazard.

**Failure of operation:** if the measurement or a sensor fails to respond as described, do not use it until the situation has been corrected by qualified personnel.

**Low etCO<sub>2</sub> values:** Leakages in the breathing system or sampling system may cause the displayed etCO<sub>2</sub> values to be significantly too low. Always connect all components securely and check for leaks according to standard clinical procedures. Displacement of the nasal or combined nasal oral cannulas

can cause lower than actual  $\text{etCO}_2$  readings. Even with combined nasal oral cannulas, the  $\text{etCO}_2$  readings may be slightly lower than actual in patients breathing through the mouth only.

## Measurement Principles

For both mainstream and sidestream measurements, the measurement principle is infrared transmission, where the intensity of infrared light passing the respiratory gas is measured with a photo detector. As some of the infrared light is absorbed by the  $\text{CO}_2$  molecules, the amount of light passing the gas probe depends on the concentration of the measured  $\text{CO}_2$ .

When using a wet ventilator circuit, monitor mainstream  $\text{CO}_2$  if available, in preference to sidestream  $\text{CO}_2$ .

The partial pressure is calculated from the gas concentration by multiplying the concentration value with the ambient pressure.

The measurement provides:

- a  $\text{CO}_2$  waveform.
- an end tidal  $\text{CO}_2$  ( $\text{etCO}_2$ ) value: the  $\text{CO}_2$  value measured at the end of the expiration phase.
- an inspired minimum  $\text{CO}_2$  ( $\text{imCO}_2$ ): the smallest value measured during inspiration.
- an airway respiration rate ( $\text{awRR}$ ): the number of breaths per minute, calculated from the  $\text{CO}_2$  waveform.

Depending on the **Max Hold** setting configured for your monitor, the  $\text{etCO}_2$  numeric shows either the highest  $\text{CO}_2$  value measured within the configured time period (**Max Hold** set to **10 sec** or **20 sec**) or the  $\text{etCO}_2$  numeric shows breath-to-breath value (**Max Hold** set to **Off**).

The Microstream method also provides an **Integrated Pulmonary Index** (IPI) numeric, which is an indication of the patient's overall ventilatory status based on four measurement parameters:  $\text{etCO}_2$ ,  $\text{awRR}$ , pulse rate and  $\text{SpO}_2$ . IPI can thus provide an early indication of a change in ventilatory status which may not be shown by the current value of any of these four parameters individually. The IPI is designed to provide additional information regarding patient status, possibly before  $\text{etCO}_2$ ,  $\text{awRR}$ ,  $\text{SpO}_2$ , or pulse rate values reach levels of clinical concern.

The IPI is available for all three groups of pediatric patients (1-3 years, 3-6 years, and 6-12 years), and for adult patients. It is displayed as a single value between 1 and 10.

## Measuring $\text{CO}_2$ using the $\text{CO}_2$ Option or M3014A

The monitor (with the  $\text{CO}_2$  option) or the M3014A Capnography Extension measures partial pressure of carbon dioxide in a patient's expired gas using the mainstream method or the sidestream method.

The mainstream  $\text{CO}_2$  measurement can be used, with appropriate accessories, with intubated adult, pediatric and neonatal patients. The sidestream  $\text{CO}_2$  measurement can be used, with appropriate accessories, with intubated and non-intubated adult, pediatric, infant and neonatal patients. With intubated patients, a sample of the respiratory gas is drawn from the patient's breathing circuit through an airway adapter and a gas sampling tube. With non-intubated patients, the gas sample is drawn through a nasal or oral-nasal cannula.

**WARNING**

**Altitude Setting:** The monitor is not equipped with automatic barometric pressure compensation. Before the CO<sub>2</sub> measurement is used for the first time, the altitude must be set to the correct value. An incorrect altitude setting will result in incorrect CO<sub>2</sub> readings. The CO<sub>2</sub> readings will typically deviate 5% for every 1000 m difference.

**CAUTION**

Use the CO<sub>2</sub> measurement with Philips approved accessories only. Refer to the instructions for use provided with the accessory.

## Preparing to Measure Mainstream CO<sub>2</sub>

You must perform a zero as described in this procedure each time you use a new airway adapter.

- 1 Attach the sensor connector to the CO<sub>2</sub> connector on the monitor (when the optional CO<sub>2</sub> measurement is integrated) or on the extension.
- 2 Wait 2 minutes, allowing the sensor to reach its operating temperature and a stable thermal condition.

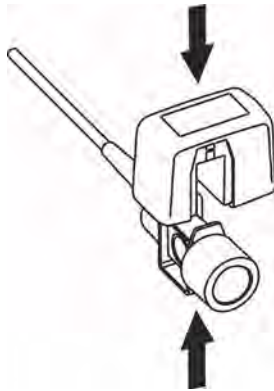

- 3 Choose the appropriate airway adapter and connect it to the sensor head. The airway adapter clicks into place when seated correctly. To zero the sensor:
  - expose the sensor to room air and keep it away from all sources of CO<sub>2</sub> including the ventilator, the patient's breath and your own.
  - in the setup menu for the CO<sub>2</sub>, select **Start Zero Cal.**

- When you see the message **CO<sub>2</sub> calibration done at <date and time>** on the status line, the zero calibration is finished and you can begin monitoring.

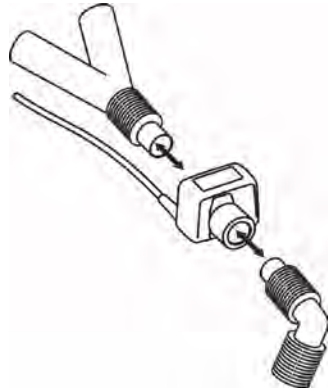

- 4 Install the airway adapter at the proximal end of the circuit between the elbow and the ventilator Y-section.

---

### WARNING

**To prevent stress** on the endotracheal tube, support the sensor and airway adapter.

**Position sensor cables** and tubing carefully to avoid entanglement or potential strangulation. Do not apply excessive tension to any cable.

**Replace the airway adapter**, if excessive moisture or secretions are observed in the tubing or if the CO<sub>2</sub> waveform changes unexpectedly without a change in patient status.

**To avoid infection**, use only sterilized, disinfected or disposable airway adapters.

**Inspect the airway adapters** prior to use. Do not use if airway adapter appears to have been damaged or broken. Observe airway adapter color coding for patient population.

---

## Preparing to Measure Sidestream CO<sub>2</sub>

- 1 Plug the sensor cable into the monitor's CO<sub>2</sub> input connector. Allow the sensor two minutes warm up time



- 2 Connect the cannula, airway adapter, or sample line as appropriate, to the sensor. It will click into place when seated correctly.

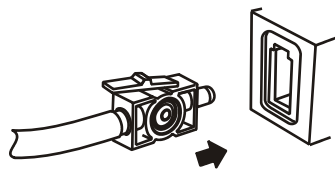

- 3 To zero the sensor:
  - expose the sensor to room air and keep it away from all sources of CO<sub>2</sub> including the ventilator, the patient's breath and your own.
  - in the setup menu for the CO<sub>2</sub>, select **Start Zero Cal.**
  - when you see the message **CO<sub>2</sub> calibration done at <date and time>** on the status line, the zero calibration is finished and you can begin monitoring.
- 4 *For intubated patients requiring an airway adapter:* Install the airway adapter at the proximal end of the circuit between the elbow and the ventilator Y-section.

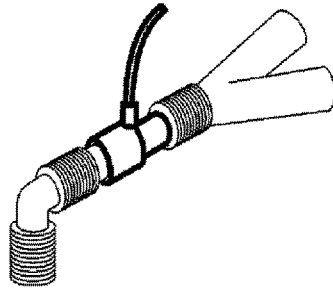

*For intubated patients with an integrated airway adapter in the breathing circuit.:* Connect the male luer connector on the straight sample line to the female port on the airway adapter.

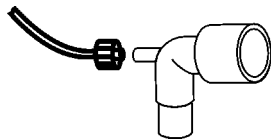

*For non-intubated patients:* Place the nasal cannula onto the patient.

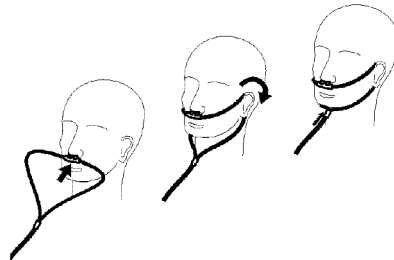

For patients prone to mouth breathing use an oral-nasal cannula.

For nasal or oral-nasal cannulas with oxygen delivery, place the cannula on the patient as shown then attach the oxygen supply tubing to the oxygen delivery system and set the prescribed oxygen flow.

---

### WARNING

Always connect the airway adapter to the sensor before inserting the airway adapter into the breathing circuit. In reverse, always remove the airway adapter from the breathing circuit before removing the sensor.

Make sure that you do not accidentally connect the luer connector of the gas sample line to an infusion link or any other links in the patient vicinity.

---

---

### CAUTION

Always disconnect the cannula, airway adapter or sample line from the sensor when not in use.

---

### Using the Sidestream Sensor Holder

The holder delivered with the sensor can be used to clamp the sensor onto an IV pole or a shelf.

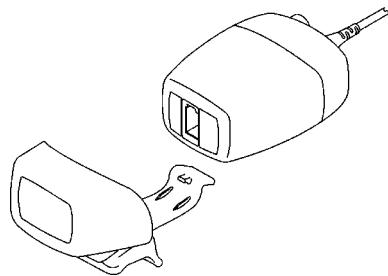

- 1 Push the sensor into the holder until it clicks into position.
- 2 Clamp the holder onto an IV pole, a shelf or another appropriate location.

To remove the sensor from the holder, release the clip and pull the sensor out of the holder.

### Removing Exhaust Gases from the System

---

#### WARNING

**Anesthetics:** When using the sidestream CO<sub>2</sub> measurement on patients who are receiving or have recently received anesthetics, connect the outlet to a scavenging system, to avoid exposing medical staff to anesthetics.

---

Use an exhaust tube to remove the sample gas to a scavenging system. Attach it to the sidestream sensor at the outlet connector.

## Measuring Mainstream CO<sub>2</sub> using M3016A

The M3016A Mainstream CO<sub>2</sub> Extension measures partial pressure of carbon dioxide in a patient's expired gas using the mainstream method. When using the appropriate accessories you can use the mainstream CO<sub>2</sub> measurement with ventilated adults, pediatric and neonatal patients.

---

#### WARNING

**Infra-red radiation:** Do not expose the airway adapter or M1460A transducer to infra-red radiation during use. This may cause incorrect readings.

---



## Preparing to Measure Mainstream CO<sub>2</sub>

- 1 Attach the transducer connector to the CO<sub>2</sub> connector on the M3016A extension.
- 2 Wait 20 minutes, allowing the transducer to reach its operating temperature and a stable thermal condition.
- 3 Perform an accuracy check and then, if necessary, calibrate the transducer.

## Checking Transducer Accuracy

---

### WARNING

Check transducer accuracy at least once a week or if you doubt the CO<sub>2</sub> readings.

---

- 1 In **Setup CO<sub>2</sub>** menu, select **Cal. Mode** to switch on calibration mode.
- 2 Look at the calibration value displayed in the **Setup CO<sub>2</sub>** menu next to **Start CAL1**. Is it the same as the value on the calstick? If not, calibrate the transducer now.
- 3 Place the transducer on the low cell of the calstick (labeled 0.0 mmHg or "ZERO"). The reading on the screen should be zero within  $\pm 1$  mmHg within one minute.
- 4 Place the transducer on the high cell of the calstick. The reading on the screen should be within  $\pm 1$  mmHg of the value on the calstick within one minute.
- 5 If both readings are in range, you can leave calibration mode and begin monitoring. If either of the readings is out of range, calibrate the transducer.

## Calibrating the Transducer

- 1 Check that the windows on the calstick are clean and clear.
- 2 Place the transducer on one of the calstick cells and select **Start CAL1**.
- 3 Enter the calibration value printed on the calstick then press **Confirm** to start calibration.
- 4 When the message **CO<sub>2</sub> CAL1 done; Start CAL2 cal** appears, put the transducer on the other cell and select **Start CAL2** then press **Confirm**.
- 5 When you see the message **CO<sub>2</sub> cal done; leave Cal. Mode**, calibration is complete.
- 6 Select **Cal. Mode** to switch calibration mode off. You cannot monitor in calibration mode.

## Attaching and Removing the CO<sub>2</sub> Transducer

- 1 Open the latch and place the transducer (B) onto the airway adapter (A). Place the airway adapter in the patient's breathing circuit between the endotracheal tube and the Y-piece. You may see the **CO<sub>2</sub> Sens Warmup** message until the transducer reaches operating temperature. Wait until this disappears before starting the measurement.



- 2 To remove the transducer from the airway adapter, open the latch and pull out the airway adapter.



---

### WARNING

To prevent stress on the endotracheal tube, support the transducer and airway adapter.

To avoid infection, use only sterilized airway adapters.

---

## Measuring Microstream CO<sub>2</sub> using M3015A/B

The M3015A/B Microstream CO<sub>2</sub> Extension measures the partial pressure of carbon dioxide in a patient's expired gas using Microstream technology.

The measurement is equipped with an automatic barometric pressure compensation.

---

### WARNING

When using the IPI numeric (available for adult and pediatric patients), always ensure that the patient's date of birth is entered correctly and that the monitor is displaying the current date. These two pieces of information are used to calculate the age of the patient, which affects the algorithm used to provide the IPI numeric.

---

## Preparing to Measure Microstream CO<sub>2</sub>

Use appropriate accessories for:

- the patient type (adult, pediatric or neonatal),
- the ventilation situation (including humidification)
- the duration - short term use, up to 24 hours (typically OR), or long term use (typically ICU).

All accessories are for single patient use only.

## Using Microstream Accessories

The Microstream measurement can be operated with the special Microstream accessories only. Refer to the instructions for use provided with the accessory.

For intubated patient with non-humidified ventilation, you can use a Microstream FilterLine set. For humidified ventilation, use a FilterLine H Set.

For non-intubated patients, the gas sample is taken through a Nasal FilterLine, or a Smart CapnoLine (which is a combined oral-nasal FilterLine). In parallel to the measurement of the CO<sub>2</sub>, oxygen (O<sub>2</sub>) may be delivered to the patient to support gas exchange. This is done by using an O<sub>2</sub>/CO<sub>2</sub> FilterLine, or a Smart CapnoLine O<sub>2</sub> (a combined oral-nasal O<sub>2</sub>/CO<sub>2</sub> FilterLine).

## Using the FilterLine and Airway Adapter

---

### WARNING

Make sure that you do not accidentally connect the luer connector of the gas sample line to an infusion link or any other links in the patient vicinity.

---

- 1 Attach the female Luer connector to the CO<sub>2</sub> inlet connector by pushing the socket cover aside and screwing the connector clockwise into the CO<sub>2</sub> inlet until it can no longer be turned.  
This will assure that there is no leak of gases at the connection point during measurement and that measurement accuracy is not compromised. Following connection of the CO<sub>2</sub> sampling line, check that CO<sub>2</sub> values appear on the monitor display.
- 2 Check that the FilterLine is not kinked.

- 3 Change the FilterLine if a **CO<sub>2</sub> Occlusion INOP** appears on the monitor or if the readings become extremely erratic.

Disconnect the FilterLine during suctioning and nebulizing therapies or suppress sampling by turning off the pump as described in “Suppressing Sampling (not Mainstream CO<sub>2</sub>)” on page 205.

Check the table in the Microstream CO<sub>2</sub> Accessories section of the Accessories chapter for typical usage times for the different Microstream accessories.

CO<sub>2</sub> values for non-intubated patients using Microstream accessories will always tend to be lower than for intubated patients. If values appear extremely low, check whether the patient is breathing through the mouth or whether one nostril is blocked.

## Removing Exhaust Gases from the System

### WARNING

**Anesthetics:** When using the Microstream CO<sub>2</sub> measurement on patients who are receiving or have recently received anesthetics, connect the outlet to a scavenging system, or to the anesthesia machine/ventilator, to avoid exposing medical staff to anesthetics.

Use an exhaust tube to remove the sample gas to a scavenging system. Attach it to the MMS Extension at the outlet connector.

## Suppressing Zero Calibration

To prevent an automatic zero calibration from being started in the next five minutes,

- in the **Setup CO<sub>2</sub>** menu, select **No Zero For 5Min**, or select the **Suppress CO<sub>2</sub> Zero** SmartKey, if configured.

Selecting **No Zero For 5Min** or selecting the **Suppress CO<sub>2</sub> Zero** SmartKey again before the timer has timed out resets the timer to five minutes, unless an AutoZero became due during the previous suppression.

## Setting up all CO<sub>2</sub> Measurements

These tasks are common to all CO<sub>2</sub> measurements except where otherwise noted.

### Adjusting the CO<sub>2</sub> Wave Scale

- 1 In the **CO<sub>2</sub> Wave** menu or the **Setup CO<sub>2</sub>** menu, select **Scale**.
- 2 Choose a suitable scale range from the pop-up list.

### Setting up CO<sub>2</sub> Corrections

Temperature, water vapor in the patient's breath, barometric pressure, and the proportions of O<sub>2</sub>, N<sub>2</sub>O and Helium in the mixture all influence CO<sub>2</sub> absorption. If values seem inaccurately high or low, check that the monitor is using the appropriate corrections.

Correction	
Altitude (M3014A only)	Altitude is set during installation. The monitor automatically applies an appropriate correction.
O <sub>2</sub> (M3014A only)	In the <b>Setup CO<sub>2</sub></b> menu, select <b>Oxy. Corr</b> and select a value between 20% and 100%, the default value is 20%. If you are not measuring the expired O <sub>2</sub> , estimate it by subtracting 5% from the inspired O <sub>2</sub> then select the nearest value from the list.
Humidity	At installation, the monitor is configured to automatically apply either Body Temperature Pressure Saturated (BTPS) or Ambient Temperature Pressure Dry (ATPD). To see which, go to the <b>Setup CO<sub>2</sub></b> menu, and scroll down to look at <b>Hum. Corr</b> or <b>Humidity Corr.</b>
N <sub>2</sub> O (M3016A mainstream and M3015A/B microstream only)	In the <b>Setup CO<sub>2</sub></b> menu, select <b>N<sub>2</sub>O Corr.</b> and turn on or off. If N <sub>2</sub> O is present in the ventilation gas mixture, you must turn this on.  If the N <sub>2</sub> O correction is not available in the <b>Setup CO<sub>2</sub></b> menu, the CO <sub>2</sub> measurement in your MMS Extension does not require N <sub>2</sub> O correction or it is setup with <b>Gas Corr.</b> (see below).
Gas (M3014A only)	In the <b>Setup CO<sub>2</sub></b> menu, select <b>Gas Corr.</b> and select <b>Helium, N<sub>2</sub>O</b> or turn off. If Helium or N <sub>2</sub> O is present in the ventilation gas mixture, you must make the appropriate selection.  If the Gas correction is not available in the <b>Setup CO<sub>2</sub></b> menu, the CO <sub>2</sub> measurement in your MMS Extension does not require N <sub>2</sub> O or Helium correction or the N <sub>2</sub> O correction is setup with <b>N<sub>2</sub>O Corr.</b> (see above).
Agent (M3014A only)	In the <b>Setup CO<sub>2</sub></b> menu, select <b>Ag. Corr</b> and select the concentration of the anesthetic agent (between 0.0% and 20.0%). If an anesthetic agent is present in the ventilation gas mixture, you must select the appropriate concentration.

## Suppressing Sampling (not Mainstream CO<sub>2</sub>)

To temporarily stop sampling, in the **Setup CO<sub>2</sub>** menu, select **Pump 15Min Off** or use the **CO<sub>2</sub> Pump Off** SmartKey if available.

Selecting **Pump 15Min Off** again before fifteen minutes have passed resets the timer to fifteen minutes.

To re-start the pump, in the **Setup CO<sub>2</sub>** menu, select **Pump On**.

## Changing CO<sub>2</sub> Alarms

This refers to CO<sub>2</sub> specific alarms. See the Alarms section for general alarm information.

To change the etCO<sub>2</sub> alarm limits, in the **Setup CO<sub>2</sub>** menu:

- 1 Touch the high limit on the alarm limits menu key.
- 2 Choose the high alarm limit from the pop-up list that opens.
- 3 Touch the low limit on the alarm limits menu key.
- 4 Choose the low alarm limit from the pop-up list that opens.

To change the imCO<sub>2</sub> high limit:

- Select **imCO<sub>2</sub> High** and choose the high alarm limit from the pop-up list that opens.

## Changing the Apnea Alarm Delay

This determines the time limit after which the monitor alarms if the patient stops breathing.

- 1 In the **Setup CO<sub>2</sub>** menu, select **awRR**.
- 2 In **Setup awRR** menu, select **Apnea Time**.
- 3 Choose the apnea alarm delay time.

---

### WARNING

**Safety and effectiveness** of the respiration measurement method in the detection of apnea, particularly the apnea of prematurity and apnea of infancy, has not been established.

**Prolonged delay:** The selected apnea alarm delay may be prolonged by up to 17 seconds, if an apnea occurs during the automatic zero process. This applies to the Microstream (M3015A) measurement only.

---

## Deriving Alarms From awRR

- 1 In the **Setup CO<sub>2</sub>** menu, select **awRR**.
- 2 In the **Setup awRR** menu, select **Alarms**.
- 3 Choose **On** to derive alarms from the airway respiration signal or **Off** to disable them.

## Changing awRR Alarm Limits

- 1 In the **Setup CO<sub>2</sub>** menu, select **awRR**.
- 2 Select **High Limit** to set the upper alarm limit.  
Select **Low Limit** to set the lower alarm limit.
- 3 Select the appropriate setting.

## Changing IPI Alarm Limits

- 1 In the **Setup CO<sub>2</sub>** menu, select **IPI**.
- 2 Select **Low Limit** to set the low alarm limit.
- 3 Select a value between 2 and 9.

If you also have monitors with earlier software revisions than J.0, the IPI low alarm will not be generated after a transfer to one of these monitors, or when a monitor/MMS with the IPI functionality is connected to one of these monitors in companion mode. In this case, do not rely only on the IPI low alarm but leave the individual alarms switched on (etCO<sub>2</sub>, awRR, pulse rate and SpO<sub>2</sub>) so that these alarms can be generated in such situations.

## Understanding the IPI Numeric

The index is modeled on normal healthy patients (ASA Physical Status value of 1 according to the ASA Physical Status Classification System). Patients with ASA Physical Status values of 3 or higher are expected to have low IPI values by definition. Therefore, for patients with an ASA Physical Status value of 3 or higher, the index may have no added value.

The value of the Integrated Pulmonary Index given in the IPI numeric is associated with the patient status as follows:

IPI	Patient Status
10	Normal
8-9	Within normal range
7	Close to normal range; requires attention
5-6	Requires attention and may require intervention
3-4	Requires intervention
1-2	Requires immediate intervention.

#### NOTE

The interpretation of the patient's IPI score may change in different clinical environments. For example, patients with specific respiratory difficulties (in contrast to normally healthy patients who are being monitored during sedation or pain management) may require a lower IPI Low Alarm threshold to reflect their impaired respiratory capacity.

The IPI is available for all three groups of pediatric patients (1-3 years, 3-6 years, and 6-12 years), and for adult patients.

---

#### WARNING

Ensure that the patient category and date of birth are set correctly before monitoring a patient's IPI. An incorrect patient category or date of birth could produce incorrect IPI data.

---





---

# Using a Telemetry Device and a Monitor (PIIC only)

It is possible to assign a monitor and a telemetry device to the same patient, resulting in the information from both devices being combined in one sector at the Information Center. This is called "pairing" and when a telemetry device and a monitor are paired, the measurement data from the telemetry device will be displayed on the monitor screen.

A telemetry device can be:

- any Philips telemetry device (only for indirect connections, see below).
- a TRx/TRx+ Intellivue Telemetry system transceiver.

For complete user information, including accessory listings and specifications, for the M4841A/M4851A TRx/TRx+ IntelliVue Telemetry Transceiver, refer to the Instructions for Use provided with the device.

## How Can You Combine Devices?

- With an **indirect** connection, using standard telemetry transmission - the data are sent to the monitor via the Information Center and arrive with a delay of several seconds at the monitor.
- With a **direct** connection to the monitor, via a short range radio link - the data arrive with a minimal delay on the monitor screen.

## Indirect Connection - Manual Pairing

The telemetry device can be paired with the monitor at the Information Center or at the monitor. For detailed information regarding pairing and configuration at the Information Center, see the Information Center Instructions for Use.

To pair the monitor with a telemetry device at the monitor:

- 1 Select **Main Setup** then **Measurements**
- 2 Select **Telemetry**  
The **Setup Telemetry** menu will appear with only one entry **Paired Equipment**.
- 3 Enter here the equipment label of the telemetry device to be paired.

Pairing at the monitor is only possible when the monitor already has a connection to the Information Center and the Information Center software version allows pairing at the monitor.

## Own Patient Overview Window

The measurements from the telemetry device are shown in the own patient overview window on the monitor when there is no direct connection via short range radio link.

See “Own Patient Overview Window” on page 101.

## Direct Connection - Automatic Pairing

The following direct connections are possible:

- a TRx+4841A/4851A Intellivue Telemetry system transceiver connected via short range radio (SRR) link to an MP2 with SRR capability.

If a telemetry device is assigned to a monitor via a direct short range radio link, the monitor and the telemetry device are automatically paired at the Information Center (if configured).

The measured data from the telemetry device - ECG and, if available, SpO<sub>2</sub>T - will appear on the monitor screen and will be sent through the monitor to the Information Center. The ECG waves and numerics appear in place of the monitor's own ECG, and SpO<sub>2</sub>T is displayed as an additional measurement. When ECG is measured with the telemetry device there will be no Respiration measurement derived.

---

### WARNING

- When ECG is being measured with a telemetry device directly connected to the monitor, there will be no ECG signal available at the ECG analog output or ECG Sync Pulse output and no synchronization marks on the ECG wave. A **No ECG Out** message will appear in the ECG wave channel.
  - When a telemetry device is connected to the monitor, arrhythmia relearning is initiated, and again when the telemetry device is disconnected.
  - Controls on the Telemetry Device (e.g. nurse call) will be inactive when the device is directly connected to the monitor except in the case when the monitor has no network connection and data are transferred via the telemetry device.
- 

See the “Enhancing Telemetry Monitoring with the Monitor” chapter.

## Assigning a Telemetry Transceiver with an SRR Adapter to a Monitor

Monitors which have this capability have a short range radio symbol  on the model label.

A telemetry device with a short range radio adapter can be assigned to a monitor directly. To assign a telemetry device to a monitor:

- 1 Press the Check button on the telemetry device.  
The measurement selection key on the monitor will change to show the "add cableless" symbol .
- 2 Select the symbol.
- 3 In the **Add Cableless** window, select the correct equipment label for the telemetry device.
- 4 Check that the assignment is successful and that transmission has begun:
  - A **Tele Device assigned** message appears on the monitor

- A tone sounds at the telemetry device and the Leads Off indicators light
- The ECG wave appears on the monitor

To confirm that the correct telemetry device has been assigned, open the ECG Setup menu. The title of the menu contains the equipment label of the telemetry device; check that this is the correct label.

If a telemetry device is already assigned to a monitor, you cannot assign a further telemetry device to that monitor.

If the telemetry device goes out-of-range or loses the short range radio connection, it will switch over to standard telemetry transmission to the Information Center. In this case, the telemetry data is displayed in the Own Patient Overview Window as described above.

When a telemetry device with a short range radio adapter is assigned to the patient, the short range radio connection to the monitor is made automatically.

If a telemetry device disappears from the list in the **Add Cableless** menu, press the Check button on the telemetry device again. If the monitor is not configured to be used with a telemetry device, the add cableless symbol will appear crossed out .

If the telemetry device is removed (unassigned), the short range radio connection will be ended.

---

### WARNING

Short range radio connections are subject to interruption due to interference from other radio sources in the vicinity, including microwaves, bluetooth devices and DECT phones. Outside the operating frequency band and 5% above and below, i.e. the exclusion band according IEC 60601-1-2, section 36.202.3a)4), the short range radio connection is immune up to 3V/m in the frequency range from 80 MHz to 2.0 GHz and up to 1V/m in the frequency range from 2.0 to 2.3 GHz. Depending on the strength and duration of the interference, the interruption may occur for an extended period. A loss of connection, due to moving out-of-range, interference, or for other reasons, is indicated with a **Tele Disconnected** INOP.

Correct channel configuration is important, refer to the *Configuration Guide* for details.

---

If a **Tele Disconnected** INOP occurs when the telemetry device goes out-of-range, the INOP will disappear (without being silenced) as soon as the ECG signal from the telemetry device is available at the Information Center via standard telemetry transmission.

## Unpairing the Monitor and Telemetry Device

If the patient will no longer be monitored with the telemetry device, or only with the telemetry device and no longer with the monitor, you need to end the device pairing. After unpairing, the Information Center will receive data exclusively from the monitor or from the telemetry device:

- select the **Unpair To Mon.** SmartKey to end pairing and have the Information Center receive the measurement data from the monitor



- select the **Unpair To Tele** SmartKey to end pairing and have the Information Center receive the measurement data from the telemetry device



or  
use the Unpair function at the Information Center.

**NOTE**

The SmartKeys and pop-up keys for unpairing appear only on the monitor which is directly involved in pairing.

## Temporarily Stopping the Short Range Radio Connection

To temporarily disable the SRR connection for this device, for example, in case of interference:

- 1 Open the **Equipment** window - either directly in **Main Setup** or by selecting the bed label in the information line.
- 2 Select the telemetry device.
- 3 Select **Disable SRR** in the menu displayed.

This closes the SRR connection and the telemetry device switches over to standard telemetry transmission.

To return to SRR use:

- Select **Enable SRR** and press the check button on the telemetry transceiver.

---

# Enhancing Telemetry Monitoring with the Monitor

You can use a monitor without a network connection to view measurement data from a telemetry transceiver at the bedside. You can also use the monitor to make additional measurements and send this measurement data to the Information Center via the telemetry transceiver. The monitor can so be used as a mobile viewer and measurement device, and is set up to simplify the assign/unassign procedures when used with short range radio.

## Monitor and Telemetry Transceiver Requirements

The monitor and the telemetry transceiver need a direct connection via a short range radio link. Not all revisions of the telemetry transceiver can be used directly with the monitor, if you connect a device that cannot be used you will see a **Tele Unsupported** INOP.

## Data Sent to the Information Center

The data sent to the Information Center includes numerics from NBP, SpO<sub>2</sub>, Pulse from SpO<sub>2</sub> and predictive temperature. INOPs from these measurements, battery INOPs and a general INOP generated by alarms from any other measurement (**More Bed Alarms**) will also be transmitted.

### NOTE

The monitor must be configured appropriately to support direct connection to a telemetry transceiver; refer to the *Configuration Guide* for details.

## Changing Assignment to a New Telemetry Transceiver

- 1 Assign the telemetry transceiver to the monitor; see “Assigning a Telemetry Transceiver with an SRR Adapter to a Monitor” on page 102.
- 2 Make the required measurements; the data will be automatically sent to the Information Center via the telemetry transceiver.

It is not necessary to unassign the telemetry transceiver. This will happen automatically when the next telemetry transceiver is assigned. The patient is also discharged (if configured), ensuring that the measurement data is erased before data from the next patient appears. Always assign the telemetry transceiver before you start making measurements.



# Trends

Trends are patient data collected over time and displayed in graphic or tabular form to give you a picture of how your patient's condition is developing. Trend information is stored in the trends database for continuously-monitored measurements, such as ECG, as well as for aperiodically-measured parameters, such as Cardiac Output.

## Viewing Trends

Trend information can be viewed embedded as a screen element on specially-designed Screens, or you can open a trend window over the current Screen.

- To view trends embedded as a screen element, enter the **Change Screen** window, then select a Screen designed to show an embedded trend window.
- To open the tabular trends window over the current Screen, select **Main Setup, Trends**, then

**Vitals Trend**, or select the **Vitals Trend** SmartKey .

- To open the graphic trends window over the current Screen, select the **Graph Trend** SmartKey







The trend windows open displaying the most recent data and are updated as new data is stored. A timescale along the bottom or the top of the screen shows you where you are in the trends database. The preview column on the right-hand side shows the latest available measurement value. The preview column is updated every five minutes or whenever an NBP or other aperiodic measurement is completed.

A question mark (?) beside a value means that the data may not be reliable, due perhaps to an INOP condition in the measurement.

Your monitor screen may look slightly different to the examples shown in this chapter.

## Trends Pop-Up Keys

When you open the graphic, tabular or histogram trends window, a selection of pop-up keys appears to let you navigate through the stored trend data and carry out trends-related tasks.

Pop-Up Keys	Selecting this pop-up key lets you....
<b>Select Group</b>	see a pop-up list of trend groups and select a group for viewing.
<b>Select Interval</b>	see a pop-up list of available data resolution settings and select the level of detail shown in the trend view.
<b>Print/ Record</b>	print a tabular trends report or make a tabular trend recording of the data in the current window. The report will use the current trend interval settings.
<b>Print</b>	print a graphic trends report or histogram report of the data in the current window. The report will use the current trend interval settings.
	move the cursor one step to the left or right to navigate through the trends database timeline.
	move the cursor one page to the left or right to navigate through the trends database timeline.
	jump to the beginning or the end of the trends database to see the most recent or oldest trend information stored.
	scroll up and down the screen to see measurement trends that do not fit in the current view.
<b>Vital Signs</b>	open the current trend view in tabular form. The displayed time period and resolution stay the same.
<b>Graph Trend</b>	open the current trend view in graphic form. The displayed time period and resolution stay the same.
<b>Data Source</b>	select a realtime SpO <sub>2</sub> or realtime system pulse or trended data for display in the histogram.
<b>Period</b>	select a time period for the histogram.
<b>Select Range</b>	define the range of values to be displayed in the histogram by selecting an upper and a lower limit.
<b>Column</b>	select a column width for the histogram. For each width selection the resulting number of columns is shown.
<b>Curve On/Off</b>	switch the display of the cumulative value columns in the histogram on or off.
<b>Adjust Cursor</b>	open a new set of pop-up keys for switching on cursors and setting their positions.



## Viewing Graphic Trends

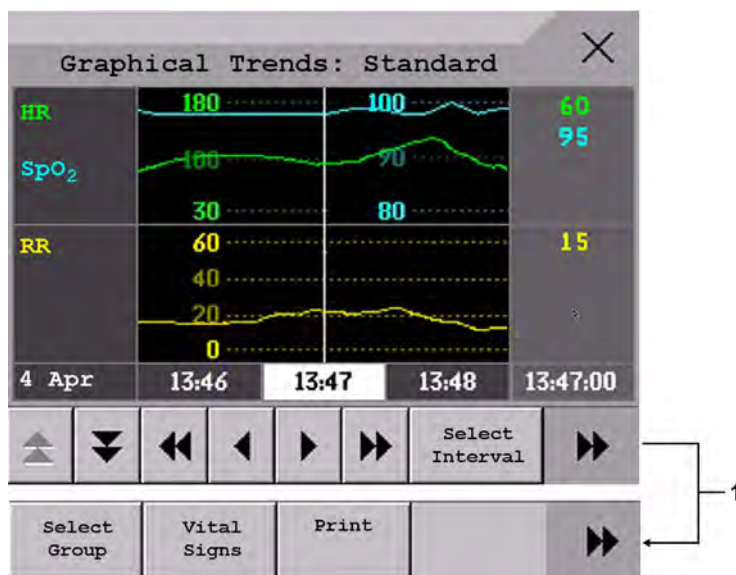

- 1 Scroll to view more pop-up keys

A cursor spanning all measurements in the trend group helps you to navigate through the trends database and shows you your current position in the database. When the cursor is moved across the time line, the values measured at the cursor time are shown in the right hand column.

In graphical trends, aperiodic measurement trends are shown as an asterisk, NBP has a special symbol.

To use the trend cursor to navigate in time through the trends database,

- 1 Select the graphical trend or the arrow pop-up keys to activate the cursor.
- 2 Use the arrow pop-up keys to move the trend cursor backwards and forwards in time, or
- 3 Place the cursor at a specific time by touching the graph.

## Viewing Vital Signs Trends

The screenshot shows a window titled "Vital Signs: Standard" with a close button (X) in the top right. The window contains a table of vital signs and a control panel below it.

Vital Sign	Value 1	Value 2	Value 3	Value 4
HR	80	80	80	80
SpO <sub>2</sub>	90	90	90	90
etCO <sub>2</sub>	32	---	---	32
imCO <sub>2</sub>	0	---	---	---
RR	20	20	20	20
awRR	20	0	0	20
			11:21	
	11:25	11:26	11:27	

Below the table is a control panel with several buttons and a "Select Interval" button. Callout 1 points to the timestamp "11:21" in the table. Callout 2 points to the "Select Interval" button and the "Select Group" button.

- 1 Aperiodic values are shown with a timestamp
- 2 Scroll to view more pop-up keys

The currently-selected column is highlighted. The values can be configured to display in the same colors as the waves and numerics on the realtime display.

Any values available for display before the next scheduled update are shown in the right hand column, with a timestamp in brackets.

If more than one value is available for an aperiodic trend for a certain trend period, all measured values are stored in the database and the value closest to the timestamp is shown in the Vital Signs display marked with an arrow.

To view the Vital Signs trend with one column for each NBP measurement (see “Defining the Column Interval Using the NBP Measurement” on page 221):

- 1 With the Vital Signs trend open, select **Interval**.
- 2 Select **NBP** from the pop-up list.

## Setting Up Trends

Trends are set up in Configuration Mode. You can make temporary changes to trends settings such as trend groups, priorities, or scales in Monitoring Mode. The general settings for all Trends are under **Main Setup, Trends**.

Settings for a single segment in graphical trends or for the corresponding trend group can be made more easily in that segment menu.

## Making Segment Settings

The **Graphical Trends** window is divided into measurement segments, each of which has its own settings.

To enter the segment menu,

- select the left hand column of the segment, where the measurement label is displayed.

## Expanded View

To expand the segment to fill the **Graphical Trends** window,

- in the **Segment** menu, select **Expand** to have that segment enlarged to fill the window.

In the expanded view, you can also highlight a measurement to make it more easily visible (for example when multiple ST trends are in one segment). To highlight a measurement,

- in the **Segment** menu, select **Highlight** repeatedly until the highlight is on the required measurement.

To return the segment to its original size,

- in the **Segment** menu, select **Expand** again.

## Trend Scales for Segment Measurements

To change the trend scales for a measurement in the current segment:

- 1 In the **Segment** menu, select the measurement label.
- 2 Select **Upper** to change the upper limit of the scale or **Lower** to change the lower limit of the scale.

## Optimum Scale

To have the monitor automatically select an optimum scale for viewing, based on current values,

- in the **Segment** menu, select **Optimum Scale**.

This scale change is temporary. When the graphical trend window is closed the scale reverts back to the setting in **Parameter Scales**.

To switch off automatic optimum scaling,

- in the **Segment** menu, select **Optimum Scale** again.

## Trend Group

To add or remove measurements for this trend group or change the order of the existing measurements:

- 1 In the **Segment** menu, select **Change Group**.
- 2 Use the **Add, Change, Sort Up** and **Sort Down** pop-up keys to change or re-order the group as required.

## No. of Segments

In an embedded graphical trend window, you can select the number of segments to be displayed in the **Segment** menu:

- In the **Segment** menu, select **No. Of Segments**.

## Trend Groups

The measurements grouped in trend groups define the trends displayed together in the **Vital Signs** or **Graphical Trends** windows and printed in trends reports and recordings. The sequence of the measurements in the group defines the order in which they are displayed. Measurements listed

between dotted line separators are displayed overlapping. The trend group **All** contains all available measurements, you cannot change the order or selection of this group.

To change the selection of measurements in a trend group, either use the **Change Group** setting in the **Segment** menu or:

- 1 Select **Main Setup, Trends**, then **Trend Groups**.
- 2 Select the Trend Group you want to change and use the pop-up keys to **Add, Change**, or **Delete** the selection of measurements trended.

To temporarily change the order in which the measurements are displayed in a group,

- 1 Select **Main Setup, Trends**, then **Trend Groups**.
- 2 Select the Trend Group and then the measurement you want to move and use the **Sort Up/Sort Down** pop-up keys.

## Trend Interval

The trend interval defines the resolution of trend data shown on the Screen.

To set the trend resolution, in the **Vital Signs** or **Graphical Trends** window,

- Select the **Select Interval** pop-up key and then select the required interval from the list.

## Trend Priority

The monitor stores trend information for all monitored measurements, if configured to do so. If your configuration restricts the number of measurements trended, you must choose which measurements will be included. A priority list is used to select the trended measurements.

To see the measurement priority list for trending,

- 1 In the **Main Setup** menu, select **Trends**.
- 2 Select **Trend Priority**.

To add measurements to the priority list,

- 1 Select the pop-up key **Add** and choose from the pop-up list of available measurements.
- 2 Use the **Sort Up** and **Sort Down** pop-up keys to change the priority order.

## Trend Parameter Scales

Parameter scales define how the trend waveform will appear on the screen and in trend reports. Separate scales can be set for adult, pediatric, and neonatal patient trends.

To change the trend parameter scales settings, either use the **Scale** setting in the **Segment** menu or:

- 1 In the **Main Setup** menu, select **Trends**.
- 2 Select **Parameter Scales**.
- 3 Select the measurement or parameter you want to change from the list.
- 4 Select the pop-up key **Change** to call up the **Scale** menu.
- 5 In the **Scale** menu, select the parameter label you want to define settings for. Select **Adult, Pedi**, and **Neo** and use the pop-up keypad to enter new upper and lower scale definitions.

## Graphical Trend Presentation

Graphical trends and screen trends for measurements with compound values (for example ABP or CO<sub>2</sub>) can be viewed in line or band form.

To change the presentation style,

- 1 Select **Main Setup** then select **Trends**.
- 2 Select **Global Style** and choose
  - **Line** to display the trends as a continuous line
  - **Band** to fill the area between the trend lines, for example, between the systolic and diastolic pressures, with color.

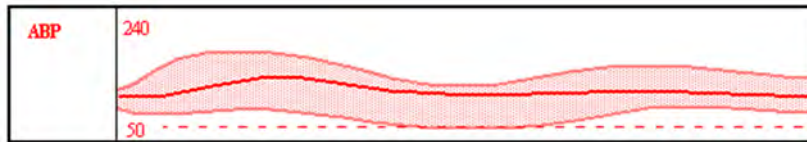

This sample ABP trend shows the continuously-measured values for the systolic, diastolic and mean pressures displayed in band form.

## Defining the Column Interval Using the NBP Measurement

You can have the NBP measurement determine the interval between the columns on the Vital Signs trend. Each NBP measurement will generate a column in the trend table. The values for the other measurements are added to the column to provide a complete vital signs set for the NBP measurement time.

To use the NBP measurement to determine the column interval:

- 1 Select **Main Setup** then **Trends**.
- 2 In the **Trends** menu, select **Setup VitalSigns**.
- 3 In the **Vital Signs** menu, select **Column** and then **NBP** from the pop-up menu.

## Documenting Trends

To print a Vital Signs or Graphical Trends report,

- in the **Vital Signs** or **Graph Trends** window, select the pop-up key **Print** to print a report for the trend group currently on the monitor screen.

Reports include the most recent information in the trends database and extend backwards in time according to the selected trend interval and your monitor's configuration. Trends reports can be printed on central or local printers.

## Trends Databases

The trend databases store information for up to 16 measurements for up to 48 hours.

The values in the trends database are stored as measured by the monitor, they are not averaged values. The trend resolution defines how often a value is stored. In general, if more than one value is available for storage in the trends database, the most recent value is used. Some values in the trends are marked

with arrows. This indicates that for this time period, more values were available and the most recent one is shown.

### Example database configuration

In this example, we see that the monitor stores the most recent data at the highest resolution, older data are stored at a lower resolution.

"4 hours @ 12 second resolution" means that the monitor stores trend data every 12 seconds, for the most recent four hours.

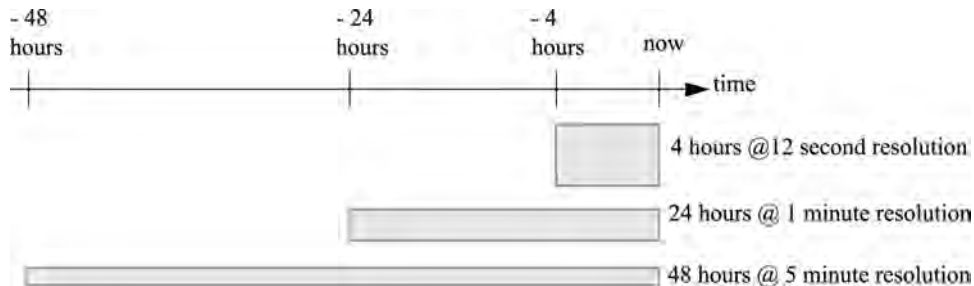

## Aperiodic Trends Database

Aperiodic trends do not count toward the maximum number of trends allowed by the trend configuration. Trend data for aperiodic measurements is stored in a separate database and timestamped with the measurement time.

## Trending Multiple-Value Measurements

Some measurements generate multiple values, for example invasive pressure measurements can provide systolic, diastolic, and mean values. These values are trended as separate measurements.

## Screen Trends

Trends configured to display permanently on special monitor Screens are called screen trends. The selection and number of measurement waves in the Screen Trend segment depends on your monitor configuration. Screen trends are color-coded to match the measurement wave and numerics, and they can be viewed in graphical, tabular, histogram or horizon format.

If you do not see screen trends on the monitor Screen, select a different Screen, one that is configured to show screen trends. Screen trends are only available on specially designed Screens.

Screen Trend information is taken from the Trends database. If you do not see a Screen Trend for a particular measurement on the Screen, check the trend priority list to ensure that this measurement is being trended.

## Setting the Screen Trend Time

To set the **ScreenTrend Time** for all graphical, histogram and horizon screen trends ("global" trend time),

- 1 Select a screen trend then select **Setup Trend**, or select **Main Setup** then select **Trends**.
- 2 Select **ScreenTrend Time** and select the required time: 30 minutes, one, two, four, eight, or twelve hours.

This is now the Global screen trend time and defines the period of trend information shown for all screen trends.

To set a different **ScreenTrend Time** for a screen trend or a group of aligned screen trends,

- 1 Select a screen trend.
- 2 Select **Change TrendTime**.
- 3 Select the required trend time.  
Selecting **Global** leaves the trend time set to the global screen trend time.

## Changing the Selection of Screen Trends Displayed

- 1 Select the screen trend.
- 2 Select **Change Trend** and select the required trend from the list of available trends.  
Select **Blank** to remove the selected trend from the Screen.  
If you do not see **Change Trend** in the screen trend menu, the trend is aligned to display with the measurement wave. Changing the wave automatically changes the trend.

To display two or more screen trends overlapping,

- 1 Select the screen trend to open the screen trend menu,
- 2 Select **Change Trend** followed by **Add Trend** and select a screen trend from the pop-up list.

## Activating the Cursor for Screen Trends

To activate the cursor for Screen Trends:

- 1 Select the screen trend.
- 2 Select **Activate Cursor**.

You can now use the arrow keys to move the cursor across the time line. The values measured at the cursor time are shown next to the cursor.

To de-activate the cursor,

- Press the **Main Screen** key.

## Changing the Screen Trend View

To switch between tabular, graphic, histogram and horizon views, select the screen trend then select **Change View** and select the required view.

### Tabular View

Aperiodic measurements such as NBP, can be viewed as a screen trend in tabular form. The measured values and their timestamps are shown, with the measurement label.

## Horizon View

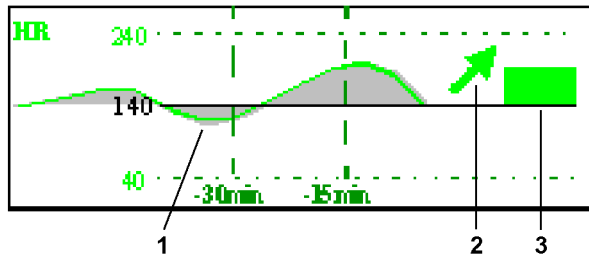

The horizon view presents trend information superimposed over a defined baseline or base range. This helps you visualize changes in your patient's condition since the baseline was set.

The horizon view is made up of:

- a horizon, drawn in white, as a reference point or baseline to help you visualize changes in your patient's condition. The horizon can be set to represent your patient's current condition, or a target condition and can be a single value or a range.
- a graphical trend, displaying patient data for the set TrendTime (1).
- a trend indicator arrow, indicating how the patient trend has developed in the set time period (10 minutes, 5 minutes or 2 minutes) (2).
- a deviation bar, showing how the currently measured value deviates from the set horizon (3). The height of the deviation bar is an indication of the extent of the change in your patient's condition relative to the (horizon) baseline.

Your monitor may not be configured to show all elements of the screen trend horizon view.

## Setting the Horizon

The horizon is the reference value to which deviations in the measurements are compared.

- 1 To set the horizon, select the horizon trend.
- 2 Select
  - **Set High Horizon** to select the upper horizon value. If the high and low horizon values are the same, the horizon is a baseline - if the values are different the horizon is a range.
  - **Set Low Horizon** to select the lower horizon value.
  - **Auto Horizon** to set the horizon for the selected horizon trend to the currently-measured value.
  - **Auto All** to reset the horizon for all horizon screen trends to the currently-measured values.
  - **Set Horizon** to set the horizon to a specific value from a pop-up list.

## Setting the Horizon Trend Scale

The horizon trend scale is defined with respect to the horizon. If your horizon is set to 100 and you select 20 as the horizon scale delta, the upper limit of the horizon scale will be 120 and lower limit 80.

To set the horizon trend scale delta,

- 1 Select the horizon trend.
- 2 Select **Set Scale Delta** and select a value to define the distance between the horizon and the upper and lower scale limits.



Be aware that changing the horizon trend scale can change the angle of the trend indicator, without the patient's condition having changed.

If a measurement exceeds the outer limits of the scale, the wave will be clipped and you must either reset the horizon or the horizon trend scale to display the values outside the scale limits.

### Setting the Time Period for the Trend Indicator Arrow

The time period for which the trend indicator arrow is displayed can be set in the **Trends** window.

- 1 Select **Main Setup** then select **Trends**.
- 2 Select **HorizonArrowTime**.
- 3 Select 10, 5 or 2 minutes.



# Recording

**Central Recording** For central recording from the bedside, your monitor must be connected via a network to an Information Center. You can use either the M1116B 2-Channel Recorder or the standalone M3160A 4-Channel Recorder. Recordings made on the M3160A may look slightly different to those described here. See the documentation supplied with the Information Center for information on the 4-Channel Recorder.

## Starting and Stopping Recordings

The recordings pop-up keys let you start and stop recordings. Select the **Main Setup** SmartKey then select **Recordings** to call up the line of pop-up keys. Scroll right or left to see any pop-up keys not displayed.

<b>Delayed Recordng</b>
<b>RT A Recordng</b>
<b>RT B Recordng</b>
<b>Select Waves</b>
<b>Setup Recordng</b>
<b>Stop All Recordng</b>

## Recording Without a Template

To record without a preconfigured template, selecting the waves you require,

- 1 Select the **Main Setup** SmartKey, then select **Recordings**.
- 2 Select the pop-up key **Select Waves**.
- 3 Use the pop-up keys to choose up to three measurement waves to be printed on the recording. If you want fewer than three waves on the recording, select the waves you want then select the **Continue** pop-up key.
- 4 Select one of the recording speed pop-up keys to set the required recording speed.
- 5 Select the **Start** pop-up key to start the recording.

**Select Waves** recordings use default values for any recorder settings not defined: runtime is continuous, overlapping is set to non-overlapping.

## Overview of Recording Types

	Delayed	Alarm		Realtime (RT)
Type of recording	manual	automatic, triggered by defined alarm conditions		manual
Recording Destination	central	central	printer	central
Information recorded	from the start trigger minus the delay time	from the start trigger minus the delay time	n/a	from the start trigger
Number of waves	up to 2	up to 2	n/a	up to 2
Speed	50, 25, 6.25 mm/sec	25 mm/sec	n/a	50, 25, 6.25 mm/sec
Runtime	n/a	n/a	n/a	continuously
Stops	automatically	automatically	n/a	manually
Delay Time	10, 15 seconds	10, 15 seconds	n/a	none
Overlap	Off On (up to 2 waves)	Off On (up to 2 waves)	n/a	Off On (up to 2 waves)
n/a = not applicable				

## Creating and Changing Recordings Templates

To save you defining recording settings each time you start a recording, you can create templates for commonly-used types of recordings in the **Setup Recordings** menu. You can create templates for one delayed recording, one alarm recording and two realtime recordings (**Realtime A** and **Realtime B**).

Changing recordings templates changes the settings that will be used each time a recording of this name is triggered.

- 1 Select the **Main Setup** SmartKey to call up the **Main Setup** menu.
- 2 Select **Recordings**.
- 3 Select the **Setup Recording** pop-up key to enter the **Setup Recordings** menu.
- 4 Select the name of the template you want to create or change. Each recording name is linked to a recording type: delayed, alarm, and realtime. Recording names can be changed in the monitor's Configuration Mode.
- 5 Design the template by selecting each menu item and entering the information for the template.
  - **Recorder:** choose which recorder the recording will print to (**Central 2-Ch** or **Central 4-Ch** recorder, or a printer (for realtime reports in alarm recording only)).
  - **Channel 1, Channel 2,** etc.: choose which waveform to record in each channel.

In addition to the currently available waves, you can choose from several other settings which make an automatic allocation when the recording starts:

    - **Alarm Par** will always record the measurement in alarm in the chosen recorder channel
    - **Primary Lead** will always record the current primary lead in the chosen recorder channel
    - **SecondaryLead** will always record the current secondary lead in the chosen recorder channel
  - **Overlap:** define whether the recorded waveforms will be printed overlapping or beside each other.

- **Speed:** choose the recording print speed.
- **Delay Time:** Delayed recordings start documenting on the recorder strip from a pre-set time before the recording is started. This interval is called the "Delay Time" and can be set as specified in "Overview of Recording Types" on page 228. This setting can only be changed in Configuration Mode.
- **Run Time:** see how long this type of recording is configured to run. This setting can only be changed in Configuration Mode. Continuous recordings run indefinitely.
- **Central Config** - if available in the **General** menu, select this setting to use the recording settings made for the centrally-connected recorder.

## Maintaining Recording Strips

Recording ink sometimes fades when covered with transparent tape. Avoid covering any part of a recording that is clinically relevant (annotation or waveforms) when taping a recording strip to a patient record or other patient documentation.

## Recorder Status Messages

### CAUTION

If no central recorder is available, alarm recordings may be lost. The message **No alarm recording available** will be displayed. This message is not shown if **Printer** is configured as the alarm recording destination.

Recorder Status Messages	Explanation
<Recording Name> running	The named recording is currently running.
No alarm recording available	No recorder available. Alarm recordings will be lost. Try configuring <b>Printer</b> as the alarm recording destination.
Central Recorder out of paper	The named recorder is out of paper.
Central Recorder door open	The door of the specified recorder is open.



---

# Printing Patient Reports

## Starting Report Printouts

Most patient reports can be printed by selecting **Main Setup** then **Reports** (or the **Print Reports** SmartKey) and then selecting the report name in the top half of the **Reports** menu. Report names are shown only for reports that have been correctly set up.

Data from the time of the print request is printed, even if the print job is delayed in the printer queue.

Your monitor can also be set up to automatically print all reports when a matching printer is available. To set this up

- 1 Select **Main Setup**, then select **Reports**.
- 2 Select **Auto Print Dbs**.
  - **Always** will print all reports when a matching printer is available.
  - **Host Only** will print the reports stored on the host monitor when a matching printer is available. Reports stored in the companion database (shown in gray on the Reports Job List) must be manually sent to the printer. See “Checking Report Status and Printing Manually” on page 236.
  - **Never** will print no reports automatically; all reports stored in the host or companion database must be manually sent to the printer. See “Checking Report Status and Printing Manually” on page 236.

## Printout Location

Depending on availability, reports can be printed:

- on printers connected to the Information Center,
- to an IntelliVue XDS Application print service,
- to an external PC-based print server with Philips server software,
- into the print database.

Print jobs stored in the database are automatically printed when a print device with a matching paper size becomes available.

Print jobs in the print database are **not deleted** after a patient discharge. A new patient can be admitted and their reports are saved in addition to the previous reports. Always admit your patient so that reports can be clearly assigned to a patient.

## Starting the Different Types of Report

Report types	Report contents	How to start printing reports
Vital Signs Report	Depends on selected trend group, data resolution, and period.	In the <b>Vital Signs</b> window, select <b>Print/ Record</b> , then select <b>Print</b> .
Graphic Trends Report		In the <b>Graphical Trends</b> window, select <b>Print</b> .
ECG Reports	Depends on format selected.	Select the <b>ECG Report A</b> , or <b>ECG Report B</b> SmartKeys, if configured, or the <b>Print Reports</b> SmartKey followed by <b>ECG Report A</b> or <b>ECG Report B</b> .
12-Lead Report	Captured ECG waves, measurement values, ST Map (optional) and analysis results from the Information Center (PIIC iX only)	In an active 12-Lead application window, select the <b>Print Report</b> pop-up key.
ST Map Report	ST data in a transversal and/or horizontal multi-axis diagram	In the <b>ST Map (Current)</b> or <b>ST Map (Trend)</b> window, select <b>Print</b> .
Alarm Limits Report	Graphic and numeric report of all current alarm limits	In the <b>Alarm Limits</b> window, select <b>Print Limits</b> .
Realtime Reports	Patient data and numerics, and either: all displayed waves OR all measured waves OR all measured RT waves	Select the <b>Realtime Report</b> SmartKey, if configured.
Battery Report	Battery serial number, information on the currently-measured and potential charge status of the battery	In the <b>Battery Status</b> window, select <b>Print Status</b> .
Central Report A/B/C	These are reports configured at the Information Center. Monitors connected via the IntelliVue Instrument Telemetry wireless network can have these reports available.	In the <b>Main Setup</b> select <b>Reports</b> then <b>Central Report A</b> , <b>Central Report B</b> or <b>Central Report C</b> .

## Stopping Reports Printouts

- To stop Reports printing, in the **Reports** menu, select
  - **Delete Report** to stop the current print job
  - **Delete All Repts** to cancel all queued report printouts
  - **Scheduled Rep.** to select **Off** and switch off scheduled reports.

## Setting Up Reports

The content you define in the individual **Setup Reports** menu will be used in all reports of this type: for example, if you set a print speed of 50 mm/sec in the **ECG Reports** menu, every ECG report will be printed at this speed, irrespective of format.

ECG report layout and Auto Reports settings must be defined in Configuration Mode.

### Setting Up ECG Reports

The settings you choose in the **ECG Reports** menu apply for all ECG-A and ECG-B reports printed. To set up ECG Reports,

- 1 Select **Main Setup, Reports**, then **ECG Reports**. Note the report layout configured for your monitor, either **Internat** or **Cabrera**. This setting is inactive ("grayed-out") in Monitoring Mode and can only be changed in Configuration Mode.



- 2 Select **ECG Gain** and set the required ECG gain to define how ECG waves will appear on the ECG report printouts.
- 3 Select **Speed** and select the report print speed.
- 4 Select **Annotation** and switch to **On** if the printed ECG wave should be annotated with beat labels. See the “ECG, Arrhythmia, ST and QT Monitoring” chapter for a list of beat labels. Pace pulse marks are automatically printed beside the wave for paced patients.

## Setting Up Vital Signs and Graphic Trend Reports

The settings you choose in the **Vital Signs Report** and **Graphical Trend Report** menus apply for all Vital Signs and Graphic Trend reports printed.

To set up Vital Signs and Graphic Trend reports,

Select **Main Setup, Reports**, then **Vital Signs Rep.** or **Graph Trend Rep.**

- 1 Select **Trend Group** and select the group you want to print on the report. The groups available depend on your monitor's trend configuration.
- 2 Select **Period** and select the period of time for which trend data should be printed on the report. If **Automatic Period** is configured to **On**, all trend data for the current patient will be printed, irrespective which trend period is selected.
- 3 Select **Interval** (Vital Signs Reports only) and select the resolution of the trend data printed on the report.

## Setting Up Auto Reports

Auto Reports print automatically when a specified trigger occurs. There are two types of Auto Reports: Scheduled Reports, which print at predefined intervals, and End Case Reports, which print when a patient is discharged using the End Case function. An Auto Report can be both a Scheduled Report and an End Case report.

To set up Auto Reports,

- 1 Select **Main Setup, Reports**, then **Auto Reports** and select the Auto Report you want to set up (A, B, C, or D).
- 2 Select **Report** and assign a report type to the Auto Report.
- 3 Select **End Case Report** and switch to **On** if you want the selected report to print automatically when you select **End Case** to discharge a patient.  
Switch **End Case Report** to **Off** if the report is a Scheduled Report only.
- 4 Select **Scheduled Rep.** and toggle to **On** if you want the selected report to print at predefined intervals, starting at a predefined time of day. The start time you set applies for every following day. For example, if you set a start time of 07:00 and a repeat time of six hours, the first report will print at 07:00 every day, the next at 13:00 and so on.
  - To set the time of day at which you want the report to print every day: select **Start Hour** and **Start Minute** and select the required time from the pop-up list
  - To set the time interval in minutes between two scheduled reports: select **Rep. Freq. (hrs)** and **Rep. Freq. (min)** and select the time interval from the pop-up list.

If you are setting up an end case report, these settings will be inactive ("grayed-out").

Switch **Scheduled Rep.** to **Off** if the report is an End Case Report only.

- 5 Repeat the procedure for all Auto Reports you want to set up.  
All Auto Reports or Scheduled Reports set to **On** print automatically at the predefined trigger.

Be aware that the monitor's memory for reports is limited. If the memory is full, Auto Reports cannot be printed and the information may be lost.

## Setting Up Individual Print Jobs

To adjust the appearance of individual print jobs, in the **Reports** menu,

Select **Main Setup, Reports**, then **Setup Reports** to enter the **Setup Reports** menu.

- 1 Select **Report** and then select the report you want to set up.
- 2 Select **Report Type** and then select the reports template you want the report selected in Step 2 to use. The selection of templates listed depends on the report type selected.  
Each template includes patient demographic data, and each Realtime Report also includes alarm and INOP information. In addition, the templates include:
  - VisibleWaves:** all waves currently visible, in the order they appear on the screen.
  - All Waves:** all measured waves.
  - RT Waves:** all currently measured realtime waves, according to the monitor's priority list.
  - Vital Signs:** trend information in tabular form.
  - Graph Trend:** trend information in graphic form.
  - ECG3X4, ECG6X2, ECG12X1, ECG4X2, ECG8X1, ECG12X1 (2P):** ECG reports.
  - Alarm Limits:** a list of all currently set alarm limits.
- 3 Select **Report Size** to set the paper size to be used for the report: **Unspecified** to use the default size for the template chosen, **Universal, A4, Letter, LrgUniversal, A3, or Ledger**. The list of available sizes depends on the report type selected.
- 4 Select **Orientation** to set the orientation of the report printout: **Unspecified** to use the default size for the template chosen, **Landscape** or **Portrait**.
- 5 Select **Target Device** and choose which printer the print job will be sent to: **Unspecified** to use the default printer, or choose from the list of printer names defined at the Information Center or in the monitor's Configuration Mode (for example, **Remote 1** or **Database**).

Some settings may be inactive ("grayed-out") in this menu for reports that can only be started in a special window.

## Checking Printer Settings

The printer settings for your monitor are defined in Configuration Mode. The printer settings **Paper Size, Resolution, Color Support, and Duplex Option** for the active printer are visible but inactive ("grayed-out") in the **Setup Printers** menu. When **Print Database** is selected as active printer only the **Paper Size** setting will be shown.

- To enter the **Setup Printers** menu, in the **Reports** menu, select **Setup Printers**.

If you are using an IntelliVue XDS Application print service, you may see XDS printers in the **Setup Printers** menu that have "Local" or "Remote" in their name. Their names and settings can only be configured in the XDS Application. Refer to the IntelliVue XDS Application Installation and Configuration Guide for full details about the configuration possibilities.

## Printing a Test Report

A test report can be printed in Configuration mode, refer to the Service Guide for details.

## Switching Printers On or Off for Reports

You can enable or disable printer status to switch individual printers on or off for report printouts.

- 1 In the **Setup Printers** menu, select **Printer** and then select the name of the device you want to switch on or off for Reports printing from the pop-up list.

- 2 Select **Printer Status** to switch between the settings **Enabled** and **Disabled**. If you set this to **Disabled**, no reports will be printed to the named printer.

If the monitor detects that no printer of a particular type is available, the **Printer Status** setting will automatically be set to **Disabled** and "grayed out".

Local printers from the XDS Application print service are always enabled and cannot be disabled here.

## Dashed Lines on Reports

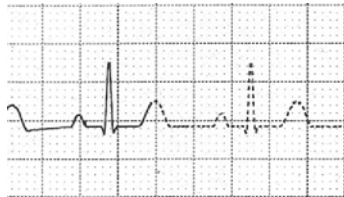

If a section of a wave on a report is drawn with dashed lines, this tells you that a setting that affects the appearance of the wave on the screen was changed while the report was printing.

For example, if you change the wave scale while a report is printing, the wave scale and wave size are changed immediately on the monitor screen and on the report. To indicate that the scale information printed at the beginning of the report no longer matches the currently used scale, the wave will be printed using dashed lines, starting from the moment the change took place.

Some examples of settings that cause dashed lines in reports if changed during printing are: Filter mode, ECG lead placement, wave scale, measurement unit, paced/non-paced setting, and measurement mode. Note that as ECG waves are drawn with a fixed gain on reports (either 10 mm/mV or 20 mm/mV), changing the ECG wave scale will not cause dashed-line reports.

To avoid dashed lines on reports, wait 15 seconds after changing a setting before you trigger a report.

## Unavailable Printer: Re-routing Reports

If you send a report to be printed on a printer that is not available, for example, because it has run out of paper, this print job is suspended and stored in the monitor's memory.

If the target device of this print job was set to **Unspecified**, the monitor will periodically try to resend the print job to the first printer listed in the **Setup Printers** menu under **Printer** that is set to **Enabled** and that has paper of the correct size.

To allow the report to print, you must either solve the problem with the target printer, or re-route the print job to another printer with paper of the correct size. To re-route a print job,

- Enable the new target printer by selecting it in the **Setup Printers** menu and toggling to **Enabled**. As the monitor tries to send the report to the printers in the order they are listed, you must make sure that all the printers above the new target printer are disabled.

If the target device of the print job was set to a specific printer, re-routing is not possible.

## Checking Report Status and Printing Manually

A list of all print requests which are waiting, printing or stored can be viewed in the **Reports Job List**. To view the list, in the **Reports** menu, select **Reports Job List**.

The following information is displayed for each print request:

- Report title
- Patient name (except for system reports such as the battery status report)
- Request date and time
- Report paper format
- Job status: **Preparing, Printing, Waiting, In Database, In Companion, Retry, Cancelling, Error.**

Individual reports can be deleted from the list with the **Delete Report** key, and all reports with the **Delete All Repts** key.

---

### CAUTION

The **Reports Job List** includes privacy information, in the form of the patient name with the related report title and date. It is advisable to provide controlled access to this data to ensure confidentiality.

---

## Printing Manually

Those jobs shown in black will be printed automatically when a matching printer is available. If the **Auto Print Dbs** setting is **Host Only** or **Never**, some or all reports will not be printed automatically and will be shown in gray. Any jobs shown in gray must be printed manually; to do this,

- 1 In the **Reports Job List**, select the required report
- 2 Select **Print Report**.

Selecting **Print All Repts** will send all reports to the printer.

# Printer Status Messages

Printer Status Message	Possible causes and suggested action
Print job queued for <Printer Name>	The report has been placed in the queue for the named printer.
Print job can't queue;resources? Print job can't queue;queue full Print job can't queue;no printer	The printer queue is full and the monitor cannot accept another report request. Wait until some more reports have been printed, then try again, OR A report has been triggered that uses a paper size unavailable with the target printer. Try another printer, if available, or change the paper size of the print request.
Canceling all print jobs	<b>Delete All Reps</b> has been selected in the <b>Reports</b> menu, OR The Operating Mode has been changed from Monitoring Mode to Demonstration or Service Mode.
Canceling the active print job	The current report is being canceled as the result of a user request.
Deleted # print jobs;discharge	When a patient is discharged, all queued reports are canceled except those stored in the print database. "#" is the number of reports canceled.
Deleted # print jobs; hotstart	The monitor has restarted and all report requests have been canceled except those stored in the print database. "#" is the number of reports canceled.
Print failed;No report configurd	A report has been triggered which has not been correctly set up. Enter the setup menu for the report type to set up the report.
Printing on <Printer Name>...	A report is in progress, or the monitor is waiting for the central printer to accept the print job.
NoPrinter <Printer Name>;job susp.	The chosen device is unavailable. Check that the printer is properly connected and that paper is available. The requested report will start printing when the printer becomes available.
Print database full->job suspond.	The requested report does not fit into the print database. You can select another printer to print the report (see "Unavailable Printer: Re-routing Reports" on page 235). Alternatively you can delete another report from the <b>Reports Job List</b> (using the <b>Delete Report</b> key) to create space for your report.
Job <Printer Name> failed; no data Job <Printer Name> fail;no printer Job <Printer Name> fail;data error	A report cannot be started on the requested printer. One of three reasons is shown in the status message: <ul style="list-style-type: none"> <li>• data unavailable - the connected X2 or MP5 has been removed before the data for the report was transferred.</li> <li>• printer unavailable - make sure the printer is plugged in, switched on, and has paper loaded.</li> <li>• data requisition error - an internal error has caused data required for the report to be unavailable, try starting the report again.</li> </ul>
Print job on <Printer Name> done	The report has been printed.

# Sample Report Printouts

Each report header contains the patient's bed label, last name and first name, middle name (if there is enough space) the patient ID, the date and time, and the name of the report. The report footer contains the hospital label and page number, and the last page contains a note to mark the report end.

The monitor may be configured to leave a space on the top left or right of the report printout to enable you to stick a patient address label on it. This setting is called the **Addressograph** and it can only be changed in the monitor's Configuration Mode.

## Alarm Limits Report

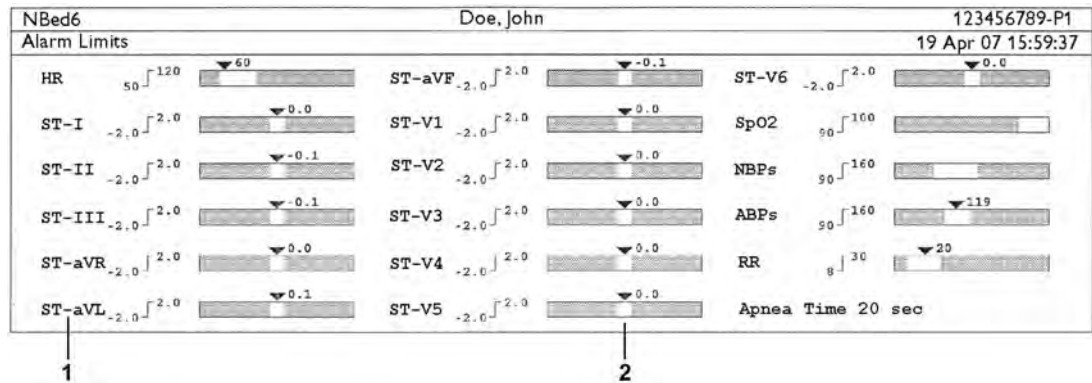

- 1 Measurement labels, with alarms off symbol where alarms are switched off
- 2 Graphic view of current alarm limits in relation to currently monitored measurement value

## Realtime Report

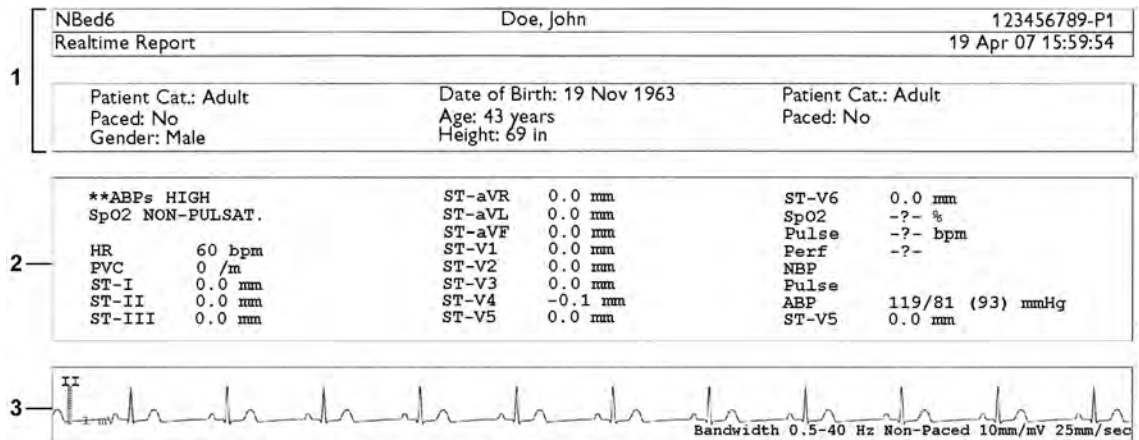

- 1 Patient demographic information, time stamp
- 2 Active Alarms and INOPs, followed by vital signs
- 3 Measurement waves section

## ECG Reports

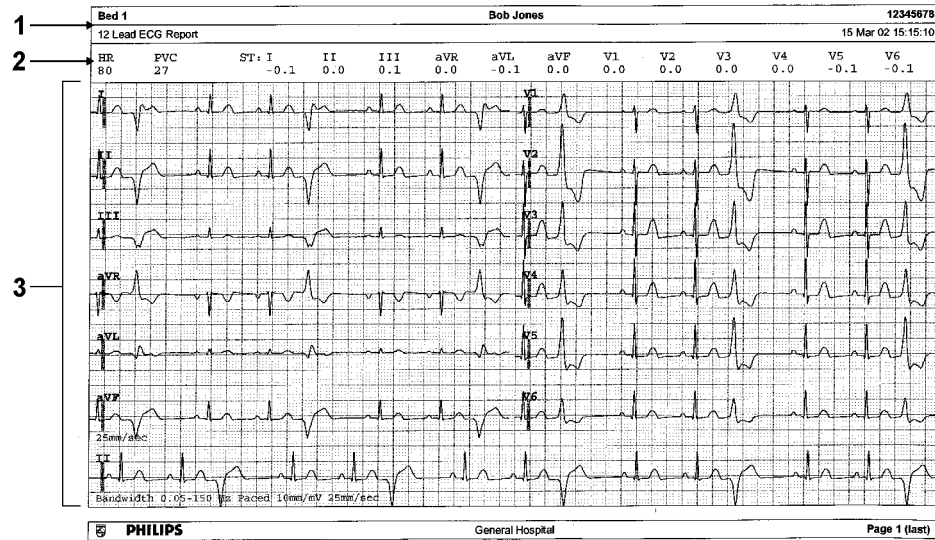

- 1 Patient information
- 2 Numeric block
- 3 Wave area

Below the header on ECG Reports, the numeric block shows the current HR, PVC, and ST values. The wave area shows the printed waves for all available ECG leads. A 1 mV calibration bar is printed at the beginning of each wave. With the 3X4, 6X2, and 2X4 formats, a rhythm stripe prints a longer section of the ECG wave from the primary ECG lead for ECG rhythm evaluation. The ECG signal bandwidth, the patient's paced status, the ECG gain, and the print speed are printed at the bottom of the wave area. Pace pulse marks are automatically printed beside the wave for paced patients. Beat labels can be set to print on the rhythm stripe. The 12X1 (2P) format prints the report over two pages.

ECG Report type	Available Formats	Available Paper Sizes
12-Lead ECG	3X4 landscape	A4, letter, A3, ledger
	6X2 landscape	A4, letter, A3, ledger
	12X1 portrait	A4 and letter only
	12X1 landscape	A4, letter, A3, ledger
	12X1 (2P) landscape	A4, letter (2 pages)
Multi-lead ECG	2X4 landscape	A4, letter, A3, ledger
	8X1 portrait	A4 and letter only
	8X1 landscape	A4, letter, A3, ledger

## 12-Lead ECG Report

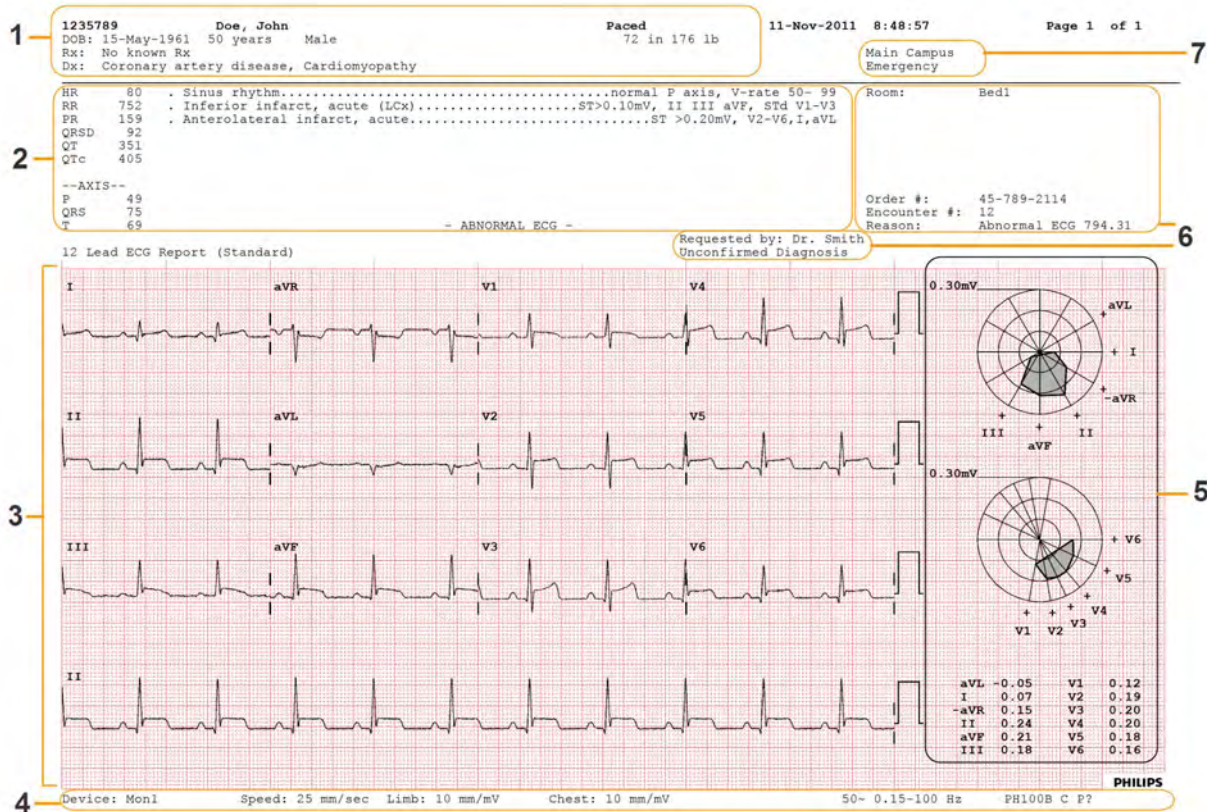

- 1 Patient data
- 2 Analysis data from the Information Center (PIIC iX only)
- 3 12-Lead wave area
- 4 Data related to the wave presentation
- 5 ST Map with related ST numerics (optional)
- 6 Administrative data - including optional custom text fields
- 7 Hospital ID data - Institution, facility and department, if configured

## Other Reports

See the sections on Trends for other example reports.



---

# Care and Cleaning

Use only the Philips-approved substances and methods listed in this chapter to clean or disinfect your equipment. Warranty does not cover damage caused by using unapproved substances or methods.

Philips makes no claims regarding the efficacy of the listed chemicals or methods as a means for controlling infection. Consult your hospital's Infection Control Officer or Epidemiologist. For comprehensive details on cleaning agents and their efficacy refer to "Guidelines for Prevention of Transmission of Human Immunodeficiency Virus and Hepatitis B Virus to Health Care and Public-Safety Workers" issued by the U.S. Department of Health and Human Services, Public Health Service, Centers for Disease Control, Atlanta, Georgia, February 1989. See also any local policies that apply within your hospital, and country.

## General Points

Keep your monitor, cables and accessories free of dust and dirt.

After cleaning and disinfection, check the equipment carefully. Do not use if you see signs of deterioration or damage. If you need to return any equipment to Philips, decontaminate it first.

Observe the following general precautions:

- Always dilute according to the manufacturer's instructions or use lowest possible concentration.
- Do not allow liquid to enter the case.
- Do not immerse any part of the equipment or any accessories in liquid.
- Do not pour liquid onto the system.
- Never use abrasive material (such as steel wool or silver polish).
- Never use bleach.

---

### WARNING

If you spill liquid on the equipment, battery, or accessories, or they are accidentally immersed in liquid, contact your service personnel or Philips service engineer. Do not operate the equipment before it has been tested and approved for further use.

---

## Cleaning the Monitor

Clean with a lint-free cloth, moistened with warm water (40°C/104°F maximum) and soap, a diluted non-caustic detergent, tenside, ammonia- or alcohol-based cleaning agent. Do not use strong solvents such as acetone or trichloroethylene.

Take extra care when cleaning the screen of the monitor because it is more sensitive to rough cleaning methods than the housing. Do not permit any liquid to enter the monitor case and avoid pouring it on the monitor while cleaning. Do not allow water or cleaning solution to enter the measurement connectors. Wipe around, not over, connector sockets.

### CAUTION

To clean the touch-enabled display, disable the touch operation by switching off the monitor during the cleaning procedure, or by pressing and holding the Main Screen key for two seconds. Press the Main Screen key again to re-enable touch operation.

Recommended cleaning agents are:

Tensides (dishwasher detergents)	Edisonite Schnellreiniger <sup>®</sup> , Alconox <sup>®</sup>
Ammonias	Dilution of Ammonia <3%, Window cleaner
Alcohol	Ethanol 70%, Isopropanol 70%, Window cleaner

## Disinfecting the Monitor

### CAUTION

**Solutions:** Do not mix disinfecting solutions (such as bleach and ammonia) as hazardous gases may result.

Clean equipment before disinfecting. Recommended types of disinfecting agents are:

Product Name	Product Type	Ingredients
Isopropanol	liquid	Isopropanol 80%
Bacillol <sup>®</sup> AF	liquid, spray	100 g concentrate contains: Propan-1-ol 45.0 g; Propan-2-ol 25.0 g; Ethanol 4.7 g
Bacillol <sup>®</sup> 25	liquid	Ethanol 100 mg/g Propan-2-ol (= 2-Propanol) 90 mg/g; Propan-1-ol (= 1-Propanol) 60 mg/g
Meliseptol <sup>®</sup>	spray	50% 1-Propanol
Accel TB RTU	liquid	0.5% accelerated hydrogen peroxide
Oxivir <sup>®</sup> Tb Cleaner Disinfectant	spray	0.5% accelerated hydrogen peroxide
Oxivir <sup>®</sup> Tb Wipes	wipes	0.5% accelerated hydrogen peroxide

Product Name	Product Type	Ingredients
Carpe Diem <sup>TM/MC</sup> Tb Ready-to-Use General Virucide, Bactericide, Tuberculocide, Fungicide, Sanitizer	spray	0.5% accelerated hydrogen peroxide
Carpe Diem <sup>TM/MC</sup> Tb Wipes	wipes	0.5% accelerated hydrogen peroxide
Super Sani-Cloth Germicidal Disposable Wipes	wipes	isopropanol 55% quaternary ammonium chlorides 0.5%
SANI-CLOTH <sup>®</sup> PLUS Germicidal Disposable Wipes	wipes	isopropanol 15% quaternary ammonium chlorides 0.25%
SANI-CLOTH <sup>®</sup> HB Germicidal Germicidal Disposable Wipes	wipes	isopropanol < 0.15% quaternary ammonium chlorides 0.14%

## Sterilizing the Monitor

Sterilization is not allowed for this monitor, related products, accessories or supplies unless otherwise indicated in the Instructions for Use that accompany the accessories and supplies.

## Cleaning, Sterilizing and Disinfecting Monitoring Accessories

To clean, disinfect and sterilize reusable transducers, sensors, cables, leads, and so forth, refer to the instructions delivered with the accessory.

## Cleaning Batteries and the Battery Compartment

Wipe with a lint-free cloth, moistened with warm water (40°C/104°F maximum) and soap. Do not use strong solvents. Do not soak the battery.



# Using Batteries

The Lithium Ion batteries used in your monitor store a large amount of energy in a small package. This allows reliable battery-operated monitoring but also requires care in use and handling of the batteries. Follow the instructions in this chapter and refer for further details to the Application Note *Lithium Ion Battery Management and Safety Practices* included on your Documentation DVD.

When monitoring a patient, one Philips M4607A rechargeable Lithium Ion battery must **always** be inserted into the battery compartment on the right side of the monitor. This applies even when you are running the monitor from the external power supply.

The battery seals the battery compartment, preventing the ingress of fluids or foreign bodies. A severe yellow INOP (**!! Insert Battery**) will be issued if the monitor is connected to AC mains without a battery fully inserted in the battery compartment. This INOP will persist until a battery is inserted.



1 Battery compartment

To use the monitor with battery power, disconnect the external power supply, by removing the MSL cable from the monitor.

You can switch between battery-powered and mains-powered (AC) operation without interrupting monitoring.

The battery recharges automatically when the monitor is connected to the external power supply (M8023A).

## Battery Power Indicators

The battery LED and battery status information on the Main Screen, in combination with INOP messages and prompts, help you keep track of the battery power status. The indicators always show the remaining capacity in relation to the battery's actual maximum capacity, which may lessen as the battery ages. You can see the actual capacity in the **Battery Status** window.

### Battery LED

The battery LED on the front panel of the monitor is indicated by a battery symbol.



1 Battery LED

The battery LED is off during regular monitoring, when none of the following situations is present:

Battery LED Colors	If the monitor is connected to the external power supply (M8023A), this means	If the monitor is running on battery power, this means
Yellow	battery charging	
Red, flashing		less than 10 minutes power remaining
Red, flashes intermittently	battery or charger malfunction	battery malfunction

### Battery Status on the Main Screen

Battery status information can be configured to display permanently on all Screens. It shows the status of the battery, with the battery power remaining and, when the battery is not charging, an estimate of the monitoring time this represents.

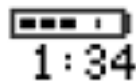

**Battery power gauge:**



This shows the remaining battery power. It is divided into sections, each representing 20% of the total power. If three sections are filled, as in this example, this indicates that 60% battery power remains. If no battery is detected, a blank battery gauge marked with a flashing red X is displayed. If no data is available from the battery, a question mark is shown in the gauge. If the monitor is powered from the

Battery Extension, the battery gauge shows the remaining power for the battery in the Battery Extension.

**Battery status/malfunction indicator:** Normal battery function is indicated by the battery power gauge, together with the remaining operating time, on the Main Screen. However, if there are problems or changes in the status of the battery this is indicated by the battery status/malfunction indicator on the Main Screen. This consists of a blank battery gauge containing a symbol. If the symbol is red, this indicates a critical situation. You can check the specific cause of the problem by looking at the symbol(s) displayed in the **Battery Status** window (see “Battery Status Window” on page 247).

Battery status indicator		Battery malfunction indicator	
	<p>Alternates with the battery gauge on the Main Screen.</p> <p>Check in the <b>Battery Status</b> window to see which status symbol is displayed for which battery to identify the cause.</p>		<p>The red ! flashes. Critical battery situation or malfunction. Check in the <b>Battery Status</b> window to see which malfunction indicator is displayed, or refer to the INOP, to identify the cause.</p>
			<p>Indicator for missing battery (flashing red X). An <b>!! Insert Battery</b> INOP is issued when the battery compartment is empty, and the monitor is connected to external power. This INOP is suppressed for 15 seconds while the monitor is connected to external power, allowing you sufficient time to insert new battery. After silencing, the INOP reappears every 10 seconds until a battery is inserted.</p>

**Monitoring Time Available:** While the monitor is running on battery power, a time is displayed below the battery power gauge. No time is displayed when the monitor is running on external power. This is the estimated monitoring time available with the current battery power. Note that this time fluctuates depending on the system load (the display brightness and how many measurements you carry out). If the remaining operating time is 00:00, the monitor shuts down automatically.

## Battery Status Window

To access the **Battery Status** window and its associated pop-up keys, select the battery status information on the Screen, or select **Main Setup** then select **Battery**.

If you are using a Battery Extension, status information for both batteries will be shown in the **Battery Status** window. If the battery in the Battery Extension is completely discharged, there may be no status information available for it.

**Capacity, remaining** tells you how much power is left in the battery.









**Capacity, fullCharge** tells you how much power the battery can hold when fully charged.

**TimeToEmpty** tells you approximately how long you can continue to use the monitor with this battery. Note that this time fluctuates depending on the system load (the display brightness and how many measurements you carry out).

**TimeToFull** is shown in place of **TimeToEmpty** if the monitor is connected to mains power via a host monitor or the M8023A external power supply, and tells you how much time is left until the battery is charged to 90%. You can use the 865432 Smart Battery Conditioner (previously M8043A) to charge the batteries externally.

**Battery status/malfunction symbols:** If a problem is detected with the battery, an INOP may be issued, and the following symbols are displayed in the **Battery Status** window, where they may be accompanied by a battery status message providing more details. Messages appear in the line where **TimeToFull/TimeToEmpty** is shown.

Symbols indicating critical situations are colored red.

Battery status symbols		Battery malfunction symbols	
	battery is empty		(red) incompatible battery
	battery not charging as the temperature is above or below the specified range		(red) battery malfunction
	battery requires maintenance		(red) battery has no power left
	charging stopped to protect the battery		(red) battery temperature too high

## Printing Battery Reports

To print the information in the **Battery Status** window on a connected printer,

- 1 Select the battery status information on the Screen to open the **Battery Status** window
- 2 Select the **Print Status** pop-up key.

## Checking Battery Charge

To check the charge status of a battery, refer to the battery power gauge on the screen or open the **Battery Status** window.

## When Battery Lifetime is Expired

When the battery is aged, either after 3 years from manufacturing date or after 500 charge/discharge cycles, it is recommended to replace the battery. To remind you of this, a message will appear in the **Battery Status** window. This message will only be displayed at the appropriate time when the date and time on the monitor is correct.



## Replacing a Battery

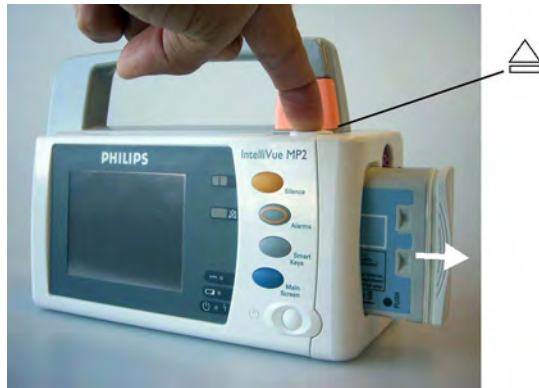

To replace the battery,

- 1 Press the battery eject button (1). This releases the battery.  
The INOP !! **Insert Battery** is suppressed for 15 seconds, allowing you sufficient time to insert a new battery.
- 2 Remove the battery from the compartment.
- 3 Slide the new battery into position with the contacts facing downwards. It should 'click' into position when it is fully inserted.



---

### WARNING

Do not insert your fingers or any objects into the open battery compartment.

---

## Replacing the Battery in the Battery Extension

To replace the battery,

- 1 Push the battery cover downwards, so that it opens.



- 2 Remove the battery from the compartment.

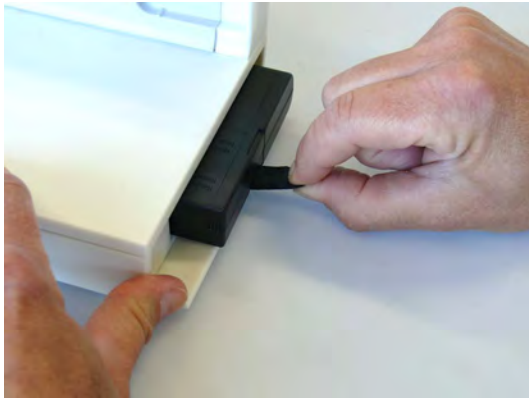

- 3 Slide the new battery firmly into position with the label facing downwards.



- 4 Close the battery cover and push it upwards, so that it remains closed.

## Optimizing Battery Performance

The performance of rechargeable batteries may deteriorate over time. Battery maintenance as recommended here can help to slow down this process.

## Display Brightness Setting

In the **Main Setup** menu, select **User Interface, Brightness**, then **Optimum**. This selects a level of brightness suitable for most monitoring locations that uses less battery power than brighter settings.

Ensure that the current level of brightness is suitable for your monitoring location.

## Charging a Battery

A battery can be charged in a monitor during monitoring. You can also use the 865432 Smart Battery Conditioner (previously M8043A) to charge batteries.

- 1 Insert the battery into a monitor connected to the external power supply (M8023A).
- 2 Charge the battery until it is full, the battery LED goes out, and the battery power gauge is filled.

In certain situations, internal temperature conditions may mean that the battery will not charge. This is sometimes necessary to protect the battery from damage, and does not indicate a malfunction. In this case you must use the 865432 Smart Battery Conditioner (previously M8043A Smart Battery Conditioner) to charge the battery.

## Conditioning a Battery

You must condition a battery when its "battery requires maintenance" symbol shows on the Screen. Do not interrupt the charge or discharge cycle during conditioning. You can condition a battery in a monitor.

---

### CAUTION

Do not use a monitor that is being used to condition batteries to monitor patients. The monitor switches off automatically when there is no battery power left.

---

It is, however, preferable to use the 865432 Smart Battery Conditioner (previously M8043A) for external battery conditioning. The Smart Battery Conditioner automatically performs the correct charge or conditioning process and evaluates the capacity when fully charged. For details please see the Instructions for Use for the Smart Battery Conditioner. Do not use any other battery chargers or conditioners.

To condition a battery using a monitor,

- 1 Insert the battery into a monitor connected to the external power supply (M8023A) that is connected to mains power.
- 2 Switch the monitor power off.
- 3 Charge the battery until it is completely full. Open the **Battery Status** window. Check that the **Batt Fully Charged** message is displayed.
- 4 Disconnect the monitor from mains power and let the monitor run until there is no battery power left and the monitor switches itself off.
- 5 Reconnect the monitor to mains power and charge the battery until it is full for use or charge to 50% for storage.

To condition the battery from a Battery Extension, use the 865432 Smart Battery Conditioner.

## Storing a Battery

A battery should not remain inside the monitor or Battery Extension if it is not used for a longer period of time. Batteries should be charged to a maximum of 50% for storage.

### NOTE

The battery will discharge over time if it is stored inside the monitor or Battery Extension when not connected to AC power via the external power supply (M8023A). The reported values for "remaining capacity" and "runtime" will become less accurate when the battery is stored in this way for a longer period of time (that is, several weeks).

## Disposing of Used Batteries

Dispose of used batteries promptly and in an environmentally-responsible manner. Discharge the batteries and insulate the terminals with tape before disposal. Do not dispose of the battery in normal waste containers. Consult your hospital administrator to find out about local arrangements.

## Battery Safety Information

---

### WARNING

- Use only Philips batteries specified in the chapter on "Accessories". Use of a different battery may present a risk of fire or explosion.
  - Do not open batteries, heat above 60°C (140°F), incinerate batteries, or cause them to short circuit. They may ignite, explode, leak or heat up, causing personal injury.
  - If battery leakage should occur, use caution in removing the battery. Avoid contact with skin. Refer to qualified service personnel.
  - Do not expose batteries to liquids.
  - Do not crush, drop or puncture batteries - mechanical abuse can lead to internal damage and internal short circuits which may not be visible externally.
  - If a battery has been dropped or banged against a hard surface, whether damage is visible externally or not:
    - discontinue use
    - dispose of the battery in accordance with the disposal instructions above.
  - Keep batteries out of the reach of children
  - Keep batteries in their original package until you are ready to use them.
-

---

# Maintenance and Troubleshooting

---

## WARNING

**Schedule:** Failure on the part of the responsible individual hospital or institution employing the use of this equipment to implement a satisfactory maintenance schedule may cause undue equipment failure and possible health hazards.

**Contact:** If you discover a problem with any of the equipment, contact your service personnel, Philips, or your authorized supplier.

---

## Inspecting the Equipment and Accessories

You should perform a visual inspection before every use, and in accordance with your hospital's policy. With the monitor switched off:

- 1 Examine unit exteriors for cleanliness and general physical condition. Make sure that the housings are not cracked or broken, that everything is present, that there are no spilled liquids and that there are no signs of abuse.
- 2 Inspect all accessories (cables, transducers, sensors and so forth). If any show signs of damage, do not use.
- 3 Switch the monitor on and make sure the backlight is bright enough. Check that screen is at its full brightness. If the brightness is not adequate, contact your service personnel or your supplier.

---

## WARNING

**Electrical Shock Hazard:** Do not open the monitor or measurement device. Contact with exposed electrical components may cause electrical shock. Always turn off and remove power before cleaning the sensor, monitor or measurement device. Do not use a damaged sensor or one with exposed electrical contacts. Refer servicing to qualified service personnel.

---

## Inspecting the Cables and Cords

- 1 Examine all system cables, the power plug and cord for damage. Make sure that the prongs of the plug do not move in the casing. If damaged, replace it with an appropriate Philips power cord.
- 2 Inspect the patient cables, leads and their strain reliefs for general condition. Make sure there are no breaks in the insulation. Make sure that the connectors are properly engaged at each end to prevent rotation or other strain.
- 3 Apply the transducer or electrodes to the patient, and with the monitor switched on, flex the patient cables near each end to make sure that there are no intermittent faults.

## Maintenance Task and Test Schedule

The following tasks are for Philips-qualified service professionals only. All maintenance tasks and performance tests are documented in detail in the service documentation supplied on the monitor documentation DVD.

Ensure that these tasks are carried out as indicated by the monitor's maintenance schedule, or as specified by local laws. Contact a Philips-qualified service provider if your monitor needs a safety or performance test. Clean and disinfect equipment to decontaminate it before testing or maintaining it.

Maintenance and Test Schedule	Frequency
Monitor Tests	
Safety checks. Selected tests on the basis of IEC 60601-1	At least once every two years, or as needed, after any repairs where the power supply is removed or replaced, or if the monitor has been dropped.
Monitor Maintenance	
Check ECG synchronization of the monitor and defibrillator (only if hospital protocol requires use of monitor during defibrillation)	At least once every two years, or as needed.
Measurement Tests	
Performance assurance for all measurements not listed below.	At least once every two years, or if you suspect the measurement values are incorrect.
Measurement Maintenance	
NBP calibration	At least once every two years, or as specified by local laws.
Microstream CO <sub>2</sub> calibration and performance test	At least once a year or after 4000 operating hours.
Mainstream and sidestream CO <sub>2</sub> calibration check	At least once a year, or if you suspect the measurement values are incorrect.
Battery Maintenance	
Battery	See the section on Maintaining Batteries

## Troubleshooting

If you suspect a problem with an individual measurement, read the Instructions for Use and double-check that you have set up the measurement correctly.

If you suspect an intermittent, system-wide problem call your service personnel. You may be asked for information from the status log. To view the status log,

In the **Main Setup** menu, select **Revisions**.

- 1 Select **Status Log**.

## Disposing of the Monitor

---

### WARNING

To avoid contaminating or infecting personnel, the environment or other equipment, make sure you disinfect and decontaminate the monitor appropriately before disposing of it in accordance with your country's laws for equipment containing electrical and electronic parts. For disposal of parts and accessories such as thermometers, where not otherwise specified, follow local regulations regarding disposal of hospital waste.

---

You can disassemble the monitor as described in the Service Guide.

You will find detailed disposal information on the following web page:

<http://www.healthcare.philips.com/main/about/Sustainability/Recycling/pm.wpd>

The Recycling Passports located there contain information on the material content of the equipment, including potentially dangerous materials which must be removed before recycling (for example, batteries and parts containing mercury or magnesium).



Do not dispose of waste electrical and electronic equipment as unsorted municipal waste. Collect it separately, so that it can be safely and properly reused, treated, recycled, or recovered.

## Disposing of Empty Calibration Gas Cylinders

- 1 Empty the cylinder completely by pushing in the pin of the regulator valve or by pulling out the pin of the fill valve using a tire valve stem wrench or a pair of needle nose pliers.
- 2 When the cylinder is empty, either remove the valve stem from the fill (or regulator) hole, or drill a hole in the cylinder.
- 3 Write "Empty" on the cylinder and dispose of it appropriately for scrap metal.

---

### WARNING

Ensure that the cylinder is completely empty before trying to remove the valve stem or drill a hole in the cylinder.

---





# Accessories

This chapter lists Philips-approved accessories for use with patient monitors as described in this document. You can order parts and accessories from Philips supplies at [www.medical.philips.com](http://www.medical.philips.com) or consult your local Philips representative for details.

---

## WARNING

**Reuse:** Never reuse disposable transducers, sensors, accessories and so forth that are intended for single use, or single patient use only. Reuse may compromise device functionality and system performance and cause a potential hazard.

**Philips' approval:** Use only Philips-approved accessories. Using non-Philips-approved accessories may compromise device functionality and system performance and cause a potential hazard.

**Packaging:** Do not use a sterilized accessory if its packaging is damaged.

---

## ECG/Resp Accessories



This symbol indicates that the cables and accessories are designed to have special protection against electric shocks (particularly regarding allowable leakage currents), and are defibrillator proof.

The following cables may not all be available in all countries. Please check availability with your local Philips supplier.

### Recommended Cables

#### Trunk Cables

For use with:	Part No.	Length
3-Electrode Cable Set	M1669A	2.7 m
3-Electrode Cable Set, OR	989803170171	2.7 m
5-Electrode Cable Set	M1668A	2.7 m

## 23 Accessories

For use with:	Part No.	Length
5-Electrode Cable Set, OR	989803170181	2.7 m
6-Electrode Cable Set	M1667A	2.7 m
10-Electrode Cable set (5+5)	M1663A	2.7 m
10-Electrode Cable set (6+4)	M1665A	2.7 m

### 3-Electrode Cable Sets

Description	Length	AAMI Part No.	IEC Part No.
OR Grabber shielded	1.0 m	M1675A	M1678A
ICU Grabber shielded	1.0 m	M1671A	M1672A
ICU snap shielded	1.0 m	M1673A	M1674A
ICU Clip non-shielded	0.45 m	M1622A	--
ICU Clip non-shielded	0.7 m	M1624A	M1626A

### Single Patient 3-Electrode Cable Sets

Description	Length	AAMI Part No.	IEC Part No.
ICU Grabber shielded	1.0 m	989803173121	989803174201
ICU Grabber shielded	0.84 m	989803173141	-

### 5-Electrode Cable Sets

Description	Length	AAMI Part No.	IEC Part No.
OR Grabber shielded	1.0 m/1.6 m	M1973A	M1974A
ICU Grabber shielded	1.0 m/1.6 m	M1968A	M1971A
ICU Snap shielded	1.0 m/1.6 m	M1644A	M1645A
ICU Miniclip non-shielded	0.7 m/1.3 m	M1647A	M1648A

### Single Patient 5-Electrode Cable Sets

Description	Length	AAMI Part No.	IEC Part No.
ICU Grabber shielded	1.0 m	989803173131	989803174211
ICU Grabber shielded	0.85 m	989803173151	-

## 6-Electrode Cable Sets

Description	Length	AAMI Part No.	IEC Part No.
OR Grabber	1.0 m/1.6 m	M1684A	M1685A
ICU Grabber	1.0 m/1.6 m	M1680A	M1681A
ICU Snap	1.0 m/1.6 m	M1682A	M1683A

## 10-Electrode (5+5) Cable Sets

Description	Length	AAMI Part No.	IEC Part No.
ICU Grabber, chest, shielded	1.0 m	M1976A	M1978A
ICU Snap, chest, shielded	1.0 m	M1602A	M1604A
OR Grabber, chest, shielded	1.0 m	M1979A	M1984A
For Limb Leads see 5-electrode cable sets			

## 10-Electrode (6+4) Cable Sets

Description	Length	AAMI Part No.	IEC Part No.
ICU Grabber, chest, shielded	1.0 m	M1532A	M1533A
ICU Snap, chest, shielded	1.0 m	M1537A	M1538A
OR Grabber, chest, shielded	1.0 m	M1557A	M1558A
For Limb Leads see 6-electrode cable sets			

## One-piece Cables

Description	Length	AAMI Part No.	IEC Part No.
3-lead Grabber, ICU	1.0 m	989803143181	989803143171
5-lead Grabber, ICU	1.0 m	989803143201	989803143191

## Radio-translucent Cables

Pack of five single wires, radio-translucent, 0.9 m, M1649A

## Set Combiners and Organizers

Description	Part No.	
Set combiner	3-electrode	M1501A
	5-electrode	M1502A
Set organizer for shielded leadsets - grabber and snap	3-electrode	M1503A
	4-electrode	M1664A
	5-electrode	M1504A
	6-electrode	M1679A

## 23 Accessories

Description		Part No.
Set organizer for non-shielded lead sets - miniclip	3-electrode	M1636A
	5-electrode	M1638A
Bedsheet clip		M1509A
Replacement red cover for trunk cable (for 5-electrode cable sets)		989808148861

## Supported Cables

### Trunk Cables

Length	3-Electrode Cable Set		5-Electrode Cable Set	
	AAMI Part No.	IEC Part No.	AAMI Part No.	IEC Part No.
0.9 m	M1540C	M1550C	M1560C	M1570C
2.7 m	M1500A	M1510A	M1520A	M1530A

### 3-Electrode Cable Sets

Description	Length	AAMI Part No.	IEC Part No.
OR	1.0 m	M1601A	M1611A
ICU Grabber shielded	1.0 m	M1603A	M1613A
ICU snap shielded	1.0 m	M1605A	M1615A
ICU Clip non-shielded	0.45 m	M1608A	M1618A
ICU Clip non-shielded	0.7 m	M1609A	M1619A

### 5-Electrode Cable Sets

Description	Length	AAMI Part No.	IEC Part No.
OR Grabber shielded	1.0 m/1.6 m	M1621A	M1631A
ICU Grabber shielded	1.0 m/1.6 m	M1623A	M1633A
ICU Snap shielded	1.0 m/1.6 m	M1625A	M1635A
ICU Clip non-shielded	0.7 m/1.3 m	M1629A	M1639A

### 3-Electrode One Piece Cables

Description	Length	AAMI Part No.	IEC Part No.
OR Grabber	1.9 m	M1970A	M1980A
ICU Snap	1.9 m	M1972A	M1981A

## Invasive Pressure Accessories



These transducers and accessories are designed to have special protection against electric shocks (particularly regarding allowable leakage currents), and are defibrillator proof.

Transducer, accessories, sensor kits	Part No
Reusable pressure transducer 5 mV/.V/mmHg sensitivity	CPJ840J6
Sterile disposable pressure domes for CPJ840J6 (pack of 50)	CPJ84022
Transducer holder for CPJ840J6 (pack of 4)	CPJ84046
IV pole mount for CPJ840J6	CPJ84447
Single channel disposable sensor kit (20) - (EU/EFTA only)	M1567A
Dual channel disposable sensor kit (20) (EU/EFTA only)	M1568A
Transducer holder for M1567/8A (EU/EFTA only)	M2271A
IV pole mount for M1567/8A (EU/EFTA only)	M2272C
Adapter cable for disposable sensor kit 3,0m for M1567/8A	M1634A
Monitoring Line Set	CPJ84026

## 5-Electrode One Piece Cables

Description	Length	AAMI Part No.	IEC Part No.
OR Grabber	2.5 m	M1975A	M1985A
ICU Snap	2.5 m	M1977A	M1986A

## Set Combiners and Organizers

Description	Part No.	
Set combiner	3-electrode	M1501A
	5-electrode	M1502A
Set organizer	Shielded 3-electrode	M1503A
	Shielded 5-electrode	M1504A
Bedsheet clip		M1509A

## NBP Accessories



These cuffs and tubings are designed to have special protection against electric shocks (particularly regarding allowable leakage currents), and are defibrillator proof. You can use them during electrosurgery.

### Adult/Pediatric Reusable Comfort Cuffs

Patient Category	Limb Circumference	Part No.	Tubing
Adult (Thigh)	42 to 54 cm	M1576A	M1598B (1.5 m) or M1599B (3 m)
Large Adult	34 to 43 cm	M1575A	
Adult	27 to 35 cm	M1574A	
Small Adult	20.5 to 28 cm	M1573A	
Pediatric	14 to 21.5 cm	M1572A	
Infant	10 to 15 cm	M1571A	

### Adult/Pediatric Reusable Comfort Cuff Kits

Cuff Kits	Part No.
Infant, pediatric, small adult, adult	M1577A
Small adult, adult, large adult, thigh	M1578A
Infant, pediatric, small adult, adult, large adult, thigh	M1579A

### Adult/Pediatric Reusable EasyCare Cuffs

Patient Category	Limb Circumference	Part No. (Pack of five)	Tubing
Adult Thigh	44 - 56 cm	M4559B (M4559B5)	M1598B (1.5 m) or M1599B (3 m)
Large Adult X-Long	35 - 45 cm	M4558B (M4558B5)	
Large Adult	35 - 45 cm	M4557B (M4557B5)	
Adult X-Long	27.5 - 36 cm	M4556B (M4556B5)	
Adult	27.5 - 36 cm	M4555B (M4555B5)	
Small Adult	20.5 - 28.5 cm	M4554B (M4554B5)	
Pediatric	14 - 21.5 cm	M4553B (M4553B5)	
Infant	10 - 15 cm	M4552B (M4552B5)	

## Adult/Pediatric Single Patient, Soft Cuffs

Patient Category	Limb Circumference	Part No.	Tubing
Adult (Thigh)	44 - 56 cm	M4579B	M1598B (1.5 m) or M1599B (3 m)
Large Adult X-Long	35 - 45 cm	M4578B	
Large Adult	35 - 45 cm	M4577B	
Adult X-Long	27.5 - 36 cm	M4576B	
Adult	27.5 - 36 cm	M4575B	
Small Adult	20.5 - 28.5 cm	M4574B	
Pediatric	14.0 - 21.5 cm	M4573B	
Infant	10 - 15 cm	M4572B	

## Neonatal/Infant Single Patient Cuffs

Cuffs	Limb Circumference	Part No. A - Luer connector B - ISO 80369-1 compliant connector	Tubing
Size 1	3.1 to 5.7 cm	M1866A/B	For A-version cuffs: M1596B (1.5 m) or M1597B (3 m)
Size 2	4.3 to 8.0 cm	M1868A/B	
Size 3	5.8 to 10.9 cm	M1870A/B	For B-version cuffs: M1596C (1.5 m) or M1597C (3 m)
Size 4	7.1 to 13.1 cm	M1872A/B	
Size 5 (Infant)	10 to 15 cm	M1873B	

## Single Patient Cuff Kits

Cuff Kits	Part No.
Neonatal (10 x M1866A, 10 x M1868A, 10 x M1872A and 20 x M1870A)	M1820-60020

## IntelliVue CL NBP Pod Accessories

Order Number	Description	Limb Circumference Range	Bladder Width	Contents
989803163171	Mobile CL Reusable Small Adult Cuff	21 - 27 cm	10.5 cm	1 cuff
989803163191	Mobile CL Reusable Adult Cuff	26.0 - 34.5 cm	13.0 cm	1 cuff
989803163211	Mobile CL Reusable Large Adult Cuff	33.5 - 45.0 cm	16.0 cm	1 cuff
989803163181	Mobile CL Single-Patient Small Adult Cuff	21 - 27 cm	10.5 cm	20 cuffs

Order Number	Description	Limb Circumference Range	Bladder Width	Contents
989803163201	Mobile CL Single-Patient Adult Cuff	26.0 - 34.5 cm	13.0 cm	20 cuffs
989803163221	Mobile CL Single-Patient Large Adult Cuff	33.5 - 45.0 cm	16.0 cm	20 cuffs
989803163251	Mobile CL NBP Cradle Kit	-	-	20 cradles
989803163131	Mobile CL Extension Air Hose, 1.0 m	-	-	1 extension air hose
989803163261	Mobile CL NBP Battery Kit	-	-	1 Battery 1 disassembly tool 1 front housing
989803137831	Telemetry Pouch with window	-	-	50 pouches
989803140371	Telemetry Pouch with window	-	-	4 boxes of 50 pouches
989803101971 (9300-0768-050)	White Telemetry Pouch with Snaps; box of 50.	-	-	50 pouches
989803101981 (9300-0768-200)	White Telemetry Pouch with Snaps; 4 boxes of 50.	-	-	4 boxes of 50 pouches

## SpO2 Accessories

Some Nellcor sensors contain natural rubber latex which may cause allergic reactions. See the Instructions for Use supplied with the sensors for more information.

M1901B, M1902B, M1903B and M1904B disposable sensors are not available in USA from Philips. Purchase Nellcor sensors and adapter cables directly from Nellcor/Covidien.

Do not use more than one extension cable with any sensors or adapter cables. Do not use an extension cable with:

- Masimo adapter cables,
- Philips reusable sensors or adapter cables with part numbers ending in -L (indicates "Long" version) or with a cable longer than 2 m.

All listed sensors operate without risk of exceeding 41°C on the skin, if the initial skin temperature does not exceed 35°C.

Make sure that you use only the accessories that are specified for use with this device, otherwise patient injury can result.



Product Number	Description	Comments
<b>Philips reusable sensors.</b>		
M1191A/B	Adult sensor (2m cable), for patients over 50 kg. Any finger, except thumb.	No adapter cable required.
M1191AL/BL	M1191A/B with longer cable (3 m)	
M1192A	Small adult, pediatric sensor (1.5 m cable) for patients between 15 kg and 50 kg. Any finger except thumb.	
M1193A	Neonatal sensor (1.5 m cable) for patients between 1kg and 4 kg. Hand or foot.	
M1194A	Ear sensor (1.5 m cable) for patients more than 40 kg.	
M1195A	Infant sensor (1.5 m cable) for patients between 4 kg and 15 kg. Any finger except thumb.	
M1196A	Adult clip sensor (3 m cable) for patients over 40 kg. Any finger except thumb.	
M1191T	Adult sensor (0.45 m cable), for patients over 50 kg. Any finger, except thumb.	Requires M1943 (1 m) or M1943AL (3 m) adapter cable.
M1192T	Small adult, pediatric sensor (0.45 m cable) for patients between 15 kg and 50 kg. Any finger except thumb.	
M1193T	Neonatal sensor (0.9 m cable) for patients between 1 kg and 4 kg. Hand or foot.	
M1196T	Adult clip sensor (0.9 m cable) for patients over 40 kg. Any finger except thumb.	
<b>Philips disposable sensors. Not available in the USA and Canada.</b>		
M1904B	Identical to OxiMax MAX-A.	Use adapter cable M1943A or M1943AL.
M1903B	Identical to OxiMax MAX-P.	
M1902B	Identical to OxiMax MAX-I.	
M1901B	Identical to OxiMax MAX-N.	
<b>Philips disposable sensors. Available worldwide.</b>		
M1131A	Adult/Pediatric finger sensor, 0.45 m cable (patient size > 20 kg).	Use adapter cable M1943A or M1943AL.
M1132A	Infant finger or toe sensor, 0.9m cable (patient size 3 - 10 kg).	
M1133A	Adult/Infant/Neonatal, 0.9 m cable Foot or hand for neonates < 3 kg. Big toe or thumb for patients between 10 kg and 20 kg. Any finger except thumb for patients > 40 kg.	
M1134A	Adhesive-free, Adult/Infant/Neonatal, 0.9 m cable. Foot or hand for neonates < 3 kg. Big toe or thumb for patients between 10 kg and 20 kg. Any finger except thumb for patients > 40 kg.	

## 23 Accessories

Product Number	Description	Comments
<b>NELLCOR disposable sensors (must be ordered from Nellcor)</b>		
OxiMax MAX-A	Adult finger sensor (patient size > 30 kg).	Use adapter cable M1943A or M1943AL.
OxiMax MAX-AL	OxiMax MAX-A with long cable.	
OxiMax MAX-P	Pediatric foot/hand sensor (patient size 10-50 kg).	
OxiMax MAX-I	Infant foot/hand sensor (patient size 3-20 kg).	
OxiMax MAX-N	Adult finger or neonatal foot/hand sensor (patient size > 40 kg or < 3 kg).	
Oxisensor II D-25	Adult sensor (patient size > 30 kg).	Use adapter cable M1943A or M1943AL.
Oxisensor II D-20	Pediatric sensor (patient size 10-50 kg).	
Oxisensor II I-20	Infant sensor (patient size 3-20 kg).	
Oxisensor II N-25	Neonatal sensor (patient size < 3 kg or > 40 kg).	
OxiCliq A	See OxiMax MAX-A.	Use adapter cable M1943A or M1943AL together with OC-3 adapter cable.
OxiCliq P	See OxiMax MAX-P.	
OxiCliq I	See OxiMax MAX-I.	
OxiCliq N	See OxiMax MAX-N.	
<b>Extension / Adapter Cables for Philips and Nellcor Sensors</b>		
M1941A	Extension cable (2 m).	For use with Philips reusable sensors (with a cable length ≤ 2 m) and M1943A adapter cable.
M1943A	Adapter cable (1.1 m cable).	Adapter cable for Philips/Nellcor disposable sensors.
M1943AL	Adapter cable (3 m cable).	
OC-3	Adapter Cable for OxiCliq sensors.	Available from Nellcor only.

Product Number	Description	Philips Part Number
<b>MASIMO LNOP<sup>®</sup> reusable sensors</b>		
LNOP DCI	Adult Finger Sensor (> 30 kg)	n/a
LNOP DCIP	Pediatric Finger Sensor (10 - 50 kg)	n/a
LNOP YI	Multi-Site Sensor (> 1kg)	n/a
LNOP TC-I	Ear Sensor (> 30 kg)	n/a
<b>MASIMO LNCS<sup>®</sup> reusable sensors.</b>		
LNCS DCI	Adult Finger Sensor (> 30 kg)	n/a
LNCS DCIP	Pediatric Finger Sensor (10 - 50 kg)	n/a
LNCS YI	Multi-Site Sensor (> 1kg)	n/a
LNCS TC-I	Ear Sensor (> 30 kg)	n/a
<b>MASIMO LNCS<sup>®</sup> disposable adhesive sensors.</b>		
LNOP Adt	Adult Sensor (> 30 kg)	n/a

Product Number	Description	Philips Part Number
LNOP Amtx	Adult Sensor (> 30 kg)	n/a
LNOP Pdt	Pediatric Sensor (10 - 50 kg)	n/a
LNOP Pdtx	Pediatric Sensor (10 - 50 kg)	n/a
LNOP Inf-L	Infant Toe Sensor (3 - 20 kg)	n/a
LNOP Neo-L	Neonatal Sensor (< 3 kg) or Adult adhesive Sensor (> 40 kg)	n/a
LNOP NeoPt-L	Neonatal Pre-Term Sensitive Skin Sensors (< 1 kg)	n/a
<b>MASIMO LNCS<sup>®</sup> disposable adhesive sensors.</b>		
LNCS Amtx	Adult Finger Sensor, 18 inch (> 30 kg)	n/a
LNCS Amtx-3	Adult Finger Sensor, 3 feet (> 30 kg)	n/a
LNCS Pdtx	Pediatric Finger Sensor, 18 inch (10 - 50 kg)	n/a
LNCS Pdtx-3	Pediatric Finger Sensor, 3 feet (10 - 50 kg)	n/a
LNCS Inf	Infant Toe Sensor, 18 inch (3 - 20 kg)	n/a
LNCS Inf-3	Infant Toe Sensor, 3 feet (3 - 20 kg)	n/a
LNCS Neo	Neonatal Foot Sensor, 18 inch (< 3 kg) or Adult Finger Sensor 18 inch(> 40 kg)	n/a
LNCS Neo-3	Neonatal Foot Sensor, 3 feet (< 3 kg) or Adult Finger Sensor, 3 feet(> 40 kg)	n/a
LNCS NeoPt	Neonatal pre-term sensitive skin Sensor 18 inch (< 1 kg)	n/a
LNCS NeoPt-3	Neonatal pre-term sensitive skin Sensor 3 feet (< 1 kg)	n/a
<b>Adapter Cable for MASIMO sensors.</b>		
LNOP MP12	LNOP MP Series Patient Cable (3.6 m) Adapter Cable for Masimo LNOP Sensors	n/a
LNC MP10	LNCS MP Series Patient Cable (3.0 m) Adapter Cable for Masimo LNCS Sensors	n/a

The Philips M8102A with Philips FAST SpO<sub>2</sub> Technology uses Masimo certified pulse oximetry for reduced noise and low perfusion performance with Masimo Sensors under the Masimo NR&LP protocol available from Masimo.



## IntelliVue CL SpO<sub>2</sub> Pod Accessories

All listed sensors operate without risk of exceeding 41°C on the skin, if the initial skin temperature does not exceed 35°C.

Make sure that you use only the accessories that are specified for use with this device, otherwise patient injury can result.

Order Number	Description	Contents
989803165941	Mobile CL 20 <b>single patient</b> SpO <sub>2</sub> Sensors and Cradles for use on pediatric and adult patients >10 kg	20 Single-Patient Mobile CL DSpO <sub>2</sub> -1A Sensors 20 Single-Patient Wristbands 20 Single-Patient Cradles pre-assembled
989803165921	Mobile CL 20 <b>single patient</b> SpO <sub>2</sub> Sensors for use on pediatric and adult patients >10 kg	20 Single-Patient Mobile CL DSpO <sub>2</sub> -1A Sensors
989803165931 <sup>1</sup>	Mobile CL <b>reusable</b> SpO <sub>2</sub> sensor and Cradles for use on pediatric and adult patients > 15 kg	1 Reusable Mobile CL RSpO <sub>2</sub> -1A Sensor 20 Single-Patient Cradles with pre-attached Wristbands
989803165951	Mobile CL 20 SpO <sub>2</sub> Cradles ( <b>single patient</b> )	20 Single-Patient Cradles with pre-attached Wristbands
989803165961	Mobile CL 50 SpO <sub>2</sub> Wristbands ( <b>single patient</b> )	50 Single-Patient Wristbands
989803168861	Mobile CL SpO <sub>2</sub> Battery Kit	1 Battery 1 disassembly tool 1 front housing

<sup>1</sup> May not be available in all geographies

## Temperature Accessories

Temperature Probes	Part No.	Minimum measurement time for accurate readings
<b>Reusable</b>		
General purpose probe	21075A	90 sec
Small flexible vinyl probe (Infant/Pediatric)	21076A	60 sec
Attachable surface probe	21078A	60 sec
<b>Disposable</b>		
General purpose probe	M1837A	90 sec
Skin probe	21091A	60 sec
Esophageal/Stethoscope Probe (French 12)	21093A	180 sec
Esophageal/Stethoscope Probe (French 18)	21094A	210 sec
Esophageal/Stethoscope Probe (French 24)	21095A	310 sec
Esophageal/Rectal Probe (French 12)	21090A	90 sec
Foley Catheter Probe (12 French)	M2255A	180 sec
Foley Catheter Probe (16 French)	21096A	180 sec
Foley Catheter Probe (18 French)	21097A	180 sec
Adapter cable 1.5 m	21082B	--
Adapter cable 3.0 m	21082A	--

## Mainstream CO<sub>2</sub> Accessories

Description	Part No.
CO <sub>2</sub> Sensor	M2501A
Adult/Pediatric Airway Adapter (reusable)	M2513A
Infant Airway Adapter (reusable)	M2516A
Adult Airway Adapter (single-patient use)	M2533A
Infant Airway Adapter (single-patient use)	M2536A

## Sidestream CO<sub>2</sub> Accessories

Description	Part No.
CO <sub>2</sub> Sensor	M2741A
<b>Nasal and Oral-Nasal Cannulas</b>	
CO <sub>2</sub> Nasal Cannula, Adult	M2744A
CO <sub>2</sub> Nasal Cannula, Pediatric	M2745A
CO <sub>2</sub> Nasal Cannula, Infant	M2746A
CO <sub>2</sub> /O <sub>2</sub> Nasal Cannula, Adult	M2750A
CO <sub>2</sub> /O <sub>2</sub> Nasal Cannula, Pediatric	M2751A
CO <sub>2</sub> /O <sub>2</sub> Nasal Cannula, Infant	989803144471
CO <sub>2</sub> Oral-Nasal Cannula, Adult	M2756A
CO <sub>2</sub> Oral-Nasal Cannula, Pediatric	M2757A
CO <sub>2</sub> /O <sub>2</sub> Oral-Nasal Cannula, Adult	M2760A
CO <sub>2</sub> /O <sub>2</sub> Oral-Nasal Cannula, Pediatric	M2761A
<b>Airway Adapters</b>	
Airway Adapter Set, ET > 4.0 mm	M2768A
Airway Adapter Set, ET ≤ 4.0 mm	989803144531
Airway Adapter Set H, ET > 4.0 mm	M2772A
Airway Adapter Set H, ET ≤ 4.0 mm	M2773A
<b>Straight Sample Lines</b>	
Straight Sample Line	M2776A
Straight Sample Line H	M2777A

## Mainstream CO<sub>2</sub> Accessories (for M3016A)

Description	Part No.
CO <sub>2</sub> Sensor	M1460A
Standard Airway Adapter (reusable)	M1465A
Small Airway Adapter (reusable)	14363A

## Microstream CO<sub>2</sub> Accessories

- "FilterLine Set" is a combination of a FilterLine with an Airway Adapter.
- "H" in the accessory name indicates suitability for humidified ventilation and longer usage due to the active removal of humidity from the sample line.
- "Smart CapnoLine" is a combined oral-nasal FilterLine.
- "Smart CapnoLine O<sub>2</sub>" is a combined oral-nasal-O<sub>2</sub>-CO<sub>2</sub> FilterLine.
- "NIV Line" is a nasal FilterLine suitable for mask ventilation (for example, C-PAP).
- The accessories are supplied in packs of 25.

### NOTE

Not all accessories are available in all countries.

Description	Part Number	Part Number for Long Version
<b>Accessories for Intubated Patients</b>		
FilterLine® SET Adult/Pediatric	M1920A	989803160241
FilterLine® H SET Adult/Pediatric	M1921A	989803160251
FilterLine® H SET Infant/Neonatal	M1923A	989803160261
VitaLine™ H SET Adult/Pediatric	989803159571	
VitaLine™ H SET Infant/Neonate	989803159581	
<b>Accessories for Non-Intubated Patients</b>		
CapnoLine® H Adult	M4689A	
CapnoLine® H Pediatric	M4690A	
CapnoLine® H Infant/Neonatal	M4691A	989803178011
CapnoLine® H O <sub>2</sub> Adult	M4680A	
CapnoLine® H O <sub>2</sub> Pediatric	M4681A	
CapnoLine® H O <sub>2</sub> Infant/Neonatal	989803178001	
NIV Line™ Adult	M4686A	
NIV Line™ Pediatric	M4687A	
Nasal FilterLine® Infant/Neonatal	989803178021	
Nasal Filterline® O <sub>2</sub> Adult	989803179101	989803179111
Nasal Filterline® O <sub>2</sub> Pediatric	989803179121	

Description	Part Number	Part Number for Long Version
Smart CapnoLine® O <sub>2</sub> Adult	M2522A	989803160281
Smart CapnoLine® H O <sub>2</sub> Adult	989803177951	989803177961
Smart CapnoLine® O <sub>2</sub> Pediatric	M2520A	989803160271
Smart CapnoLine® H O <sub>2</sub> Pediatric	989803177971	989803177981
Smart CapnoLine® Adult	M2526A	989803160301
Smart CapnoLine® Pediatric	M2524A	
Accessories for Endoscopic Procedures		
Smart CapnoLine® Guard	989803178031	
Smart CapnoLine® Guard O <sub>2</sub>	989803178041	989803178051
Hook and Loop Strap	989803178071	

## Battery Accessories

Description	Part No.
Lithium Ion Smart Battery 1Ah (internal battery for X2/MP2)	M4607A
Lithium Ion Smart Battery 6Ah (for 865297 Battery Extension)	M4605A
Battery Charger and Conditioner (requires size adapter 4512 610 17451 to charge M4607A battery)	865432
Size adapter for M4607A battery	4512 610 17451





---

# Specifications

The specifications in this section apply to the MP2 patient monitor.

## Indications for Use

The monitor is indicated for use by healthcare professionals whenever there is a need for monitoring the physiological parameters of patients.

The monitor is intended to be used for monitoring and recording of, and to generate alarms, for, multiple physiological parameters of adults, pediatrics, and neonates. The monitor is intended for use by trained healthcare professionals in a hospital environment.

The monitor is also intended for use during patient transport inside and outside of the hospital environment.

The monitor is only for use on one patient at a time. It is not intended for home use. Not a therapeutic device. The monitor is for prescription use only.

The ECG measurement is intended to be used for diagnostic recording of rhythm and detailed morphology of complex cardiac complexes (according to AAMI EC 11).

ST segment monitoring is intended for use with adult patients only and is not clinically validated for use with neonatal and pediatric patients.

The Integrated Pulmonary Index (IPI) is intended for use with adult and pediatric (1 to 12 years) patients only. The IPI is an adjunct to and not intended to replace vital sign monitoring.

## Use Environment

### Hospital Environment

The monitor is suitable for use in all medically used rooms which fulfill the requirements regarding electrical installation according to IEC60364-7-710 "Requirements for special installations or locations - Medical locations", or corresponding local regulations.

### EMC Environment

All measurements (except the sidestream CO<sub>2</sub> measurement with M2741A sensor) and system interfaces (except short range radio and wireless LAN) are, in addition, suitable for use in establishments directly connected to the public low-voltage supply network that supplies buildings used for domestic purposes (see table in "Electromagnetic Emissions" on page 300).

The monitor is indicated for use by health care professionals whenever there is a need for monitoring the physiological parameters of patients.

---

### WARNING

The monitor is not intended for use in an MRI environment or in an oxygen-enriched environment (for example, hyperbaric chambers).

---

## Restricted Availability

Following new features and functionality may not be available in all geographies:

- Integrated Pulmonary Index for Microstream CO<sub>2</sub>
- Smart Alarm delays
- IntelliVue Information Center iX

## Manufacturer's Information

You can write to **Philips** at this address

Philips Medizin Systeme Boeblingen GmbH  
Hewlett-Packard-Str. 2  
71034 Boeblingen  
Germany

Visit our website at: [www.healthcare.philips.com/us/](http://www.healthcare.philips.com/us/).

© Copyright 2012. Koninklijke Philips Electronics N.V. All Rights Reserved.

## Trademark Acknowledgement

Microstream<sup>®</sup>, FilterLine<sup>®</sup>, and Smart CapnoLine<sup>®</sup> are trademarks or registered trademarks of Oridion Systems Ltd.













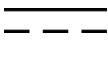

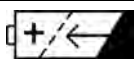













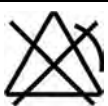

The following are trademarks of Nellcor Puritan Bennett Incorporated: Nellcor<sup>®</sup>, Durasensor<sup>®</sup>, Dura-Y<sup>®</sup>, Oxiband<sup>®</sup>, Oxicliq<sup>®</sup>, OxiMax<sup>®</sup>. MAX-FAST<sup>®</sup> is a trademark of Mallinckrodt Inc.









Masimo<sup>®</sup>, Masimo SET<sup>®</sup>, and LNOP are federally registered trademarks of the Masimo Corporation.

Other product and company names mentioned in this book may be trademarks of their respective owners.

# Symbols

These symbols can appear on the monitor and its associated equipment (depending on options).

Symbols					
	Caution, refer to accompanying documents		On/Off/Standby		DC power source
	Alternating current		Rechargeable battery symbol		Battery Eject
	ECG Sync Pulse Output indicator		Connection direction indicator		Connection direction indicator
	Pressure connector		Temperature connector		Connector has special protection against electric shocks and is defibrillator proof
	NBP connector		SpO <sub>2</sub> connector		Uses FAST SpO <sub>2</sub> algorithm
	Masimo SET technology		Nellcor OxiMax compatible		LAN connection indicator for connection to a wired network
	Silence Alarms		Alarms On/Off		Alarms Switched Off
	ECG connector		Error LED		Identifies year and month of manufacture
	IntelliVue Instrument Telemetry wireless network		Always use separate collection for waste electrical and electronic equipment (WEEE)		Monitor supports 12-lead ECG
	Built-in short range radio interface		Built-in wireless network		Indicates location of the date of manufacture and/or name and address of manufacturer

Symbols					
<b>IP</b>	Followed by two alphanumeric characters, indicates ingress protection grade		Indicates location of serial number		Indicates location of catalog number
	Indicates location of service number		SmartKeys		Main Screen
	Electrical input indicator (In some cases gas input indicator)		Electrical output indicator (In some cases gas output indicator)		LAN connection indicator for connection to a wired network
	Non-ionizing radiation symbol				

## Installation Safety Information

### WARNING

If multiple instruments are connected to a patient, the sum of the leakage currents may exceed the limits given in IEC/EN60601-1, IEC60601-1-1, UL60601-1. Consult your service personnel.

Earthing	The monitor must be earthed during operation. The earthing is for functional purposes and does not provide protection against electric shock. The protection against electric shock in this device is provided by double and/or reinforced insulation. If a three-wire receptacle is not available, consult the hospital electrician. Never use a three-wire to two-wire adapter.
Combining equipment	Combinations of medical equipment with non-medical equipment must comply with IEC 60601-1-1. Never use a multiple portable socket-outlet or extension cord when combining equipment unless the socket outlet is supplied specifically for use with that equipment.
Network Cables	All network cables must be unshielded.

## Connectors

The actual placement of boards and configuration of connections for your monitor depends on how your hardware has been configured. See the symbols table in this chapter to see which symbols are used to mark the connections.

### WARNING

- Connect only medical devices to the ECG output connector socket.
- Connecting the ECG sync out to external equipment should only be done by a qualified user. Do not touch the patient when you have contact to the ECG output connector socket.
- Always connect the ECG sync cable first to the external device and then to the monitor. Wherever possible, pre-install the cable before the patient is brought into the vicinity of the equipment.

## Monitor Mounting Precautions

Mount the monitor using either the Philips Quick Mount or Fix Mount solution or another approved mounting solution. Select the mounting equipment and the mounting position so that no patient, operator or other person can be harmed by a monitor removed intentionally or released accidentally from the mount. When using the Quick Mount, be aware of the danger of accidental activation of the Quick Mount release button when lifting or moving items located under the monitor, such as pole mounts, etc. If in doubt, use the Philips Fix Mount solution to avoid such situations. Refer to the respective IntelliVue Monitor Service Manual, Installation Instructions chapter, for more details.

## Repositioning a Monitor on the Mounting Arm

Attempts to reposition the monitor should only be performed as described in the mounting hardware manufacturer's user documentation. If the mounting arm has a locking mechanism, ensure the locking mechanism is unlocked before attempting to reposition the monitor. Never pull on the monitor to tilt, swivel or otherwise reposition it - always hold on to the mounting hardware itself.

---

### WARNING

Not adhering to these instructions when repositioning the monitor can cause damage to the monitor. In extreme cases, when force is applied to the monitor, it can result in the monitor falling from the mounting arm.

---

If, at any time, the monitor appears to be loose or insecurely mounted, contact your service personnel.

## Altitude Setting

Altitude affects CO<sub>2</sub> measurements. The monitor must be configured at installation to the correct altitude.

## Monitor Safety Specifications



The monitor and MMS Extensions comply with the Medical Device Directive 93/42/EEC.

In addition, the product complies with:

IEC 60601-1:1988 + A1:1991 + A2:1995; EN60601-1:1990 + A1:1993 + A2:1995; UL 60601-1:2003; CAN/CSA C22.2#601.1-M90 +Suppl. No. 1-94 + Am. 2; IEC 60601-1-1:2000; EN 60601-1-1:2001; IEC 60601-1-2:2001 + A1:2004; EN 60601-1-2:2001 + A1:2006.

The possibility of hazards arising from software errors was minimized in compliance with ISO 14971:2007, EN60601-1-4:1996 + A1:1999 and IEC 60601-1-4:1996 + A1:1999.

Classification (according to IEC 60601-1): Class II, Type CF, Continuous Operation.

## EMC And Radio Regulatory Compliance

This ISM device complies with Canadian ICES-001. Cet appareil ISM est conforme à la norme NMB-001 du Canada.

### The MP2 including IntelliVue Instrument Telemetry WMTS (US only))

The MP2 including IntelliVue Instrument Telemetry WMTS complies with part 15 of the FCC Rules. Operation is subject to the condition that this device does not cause harmful interference. Operation of this equipment requires the prior coordination with a frequency coordinator designated by the FCC for the Wireless Medical Telemetry Service.

### The MP2 including IntelliVue Instrument Telemetry ISM (2.4 GHz)

FCC and Industry Canada Radio Compliance: This device complies with Part 15 of the FCC Rules and RSS-210 of Industry Canada. Operation is subject to the following two conditions: (1) this device may not cause harmful interference, and (2) this device must accept any interference received, including interference that may cause undesired operation. Any changes or modifications to this equipment not expressly approved by Philips Medical Systems may cause harmful radiofrequency interference and void your authority to operate this equipment.



The radio device used in this product is in compliance with the essential requirements and other relevant provisions of Directive 1999/5/EC (Radio Equipment and Telecommunications Terminal Equipment Directive). Class 2 radio equipment. Member states may apply restrictions on putting this device into service or placing it on the market. This product is intended to be connected to the Publicly Available Interfaces (PAI) and used throughout the EEA.

### The MP2 Including the IntelliVue 802.11 Wireless Network Adapter

FCC and Industry Canada Radio Compliance: This device complies with Part 15 of the FCC Rules and RSS-210 of Industry Canada. Operation is subject to the following two conditions: (1) this device may not cause harmful interference, and (2) this device must accept any interference received, including interference that may cause undesired operation. Any changes or modifications to this equipment not expressly approved by Philips Medical Systems may cause harmful radiofrequency interference and void your authority to operate this equipment.

The maximum antenna gain permitted (for devices in the 5250-5350 MHz and 5470-5725 MHz bands) complies with the e.i.r.p. limits as stated in RSS-210.

The maximum antenna gain permitted (for devices in the 5725-5825 MHz band) complies with the e.i.r.p. limits specified for point-to-point operation, as stated in RSS-210.

The device for the band 5150-5250 MHz is only for indoor usage to reduce potential for harmful interference to co-channel mobile satellite systems.

---

#### CAUTION

High power radars are allocated as primary users (meaning they have priority) of 5250-5350 MHz and 5650-5850 MHz and these radars could cause interference and /or damage to LE-LAN devices.

---

The radio device used in this product is in compliance with the essential requirements and other relevant provisions of Directive 1999/5/EC. This product is intended to be connected to the Publicly Available Interfaces (PAI) and used throughout the EEA.



The radio component contained in this device is in compliance with Council Directive 1999/5/EC (Radio Equipment and Telecommunications Terminal Equipment Directive)

In addition the product complies with: ETSI EN 300 328; ETSI EN 301 893; AS/NZS 4771+A1; ARIB STD-T66.

### Radiofrequency Radiation Exposure Information

For body worn operation, this equipment has been tested and meets the FCC RF exposure guidelines when used with the accessories supplied or those approved for use with this product. Use of other accessories may not ensure compliance with FCC RF exposure guidelines.

## The MP2 and 865244 Remote Control Including the Short Range Radio Interface

FCC and Industry Canada Radio Compliance: This device complies with Part 15 of the FCC Rules and RSS-210 of Industry Canada. Operation is subject to the following two conditions: (1) this device may not cause harmful interference, and (2) this device must accept any interference received, including interference that may cause undesired operation. Any changes or modifications to this equipment not expressly approved by Philips Medical Systems may cause harmful radiofrequency interference and void your authority to operate this equipment.



The radio component contained in this device is in compliance with the essential requirements and other relevant provisions of Council Directive 1999/5/EC (Radio Equipment and Telecommunications Terminal Equipment Directive)

In addition the product complies with: ETSI EN 300 328; AS/NZS 4771+A1; ARIB STD-T66.

Class 1 radio equipment.

## Out-Of-Hospital Transport - Standards Compliance

The MP2 patient monitor with measurements and interfaces other than those listed below cannot be used for patient transport outside of the hospital environment.

The MP2 patient monitor, with the following measurements and interfaces:

- ECG/Respiration, NBP, SpO<sub>2</sub>, Pressure, Temperature, CO<sub>2</sub> (only Mainstream Sensor M2501A)
- LAN, internal Battery

can be used in a transport environment such as a road ambulance, airplane or helicopter. For this purpose the monitor fulfils the following additional mechanical, EMC and environmental requirements:

- **Shock Tests** according to IEC TR 60721-4-7, Class 7M3. Test procedure according to IEC/EN 60068-2-27 (peak acceleration up to 100g).
- **Random Vibration** according to IEC TR 60721-4-7, Class 7M3. Test procedure according to IEC/EN 60068-2-64 (RMS acceleration 5g).
- **Sinusoidal Vibration** according to IEC TR 60721-4-7, Class 7M3. Test procedure according to IEC/EN 60068-2-6 (acceleration up to amplitude 2g).
- **Bump Test** according to IEC/EN 60068-2-29 (peak acceleration 15 g, 1000 bumps).

- **Free Fall Test** according to EN1789 (covers also IEC TR 60721-4-7 and Class 7M3). Test procedure according to EN 60068-2-32 (height 0.75 m).
- **Specification for degrees of protection** provided by enclosures according to IEC/EN 60529: IP 32.
- EN 1789 +A1:2003 Medical vehicles and their equipment - Road ambulances (chapter 6 - Medical Devices).
- **Radiated susceptibility** 20 V/m according to EN ISO 9919 (SpO<sub>2</sub>) and EN ISO 21647 (CO<sub>2</sub>).
- **Altitude Range** from -500 to 3000 m operating and -500 to 4600 m storage and transportation.
- **Extended radiated susceptibility** tests  
 The MP2 patient monitor with its out-of-hospital parameter set provides a general immunity level of 20 V/m with only few restrictions. Details are as listed below:
  - GSM 900: Immunity at 900 MHz (uplink mobile phone), 20 V/m (ECG:10 V/m), duty cycle 1:8.
  - GSM 1800: Immunity at 1800 MHz (uplink mobile phone), 20 V/m, duty cycle 1:8.
  - DECT: Immunity at 1800 MHz (digital cordless phone), 20 V/m, duty cycle 1:24.
  - AM: 1 kHz Immunity from 80 MHz to 1.0 GHz (any radio communication unit, broadcasting and TV transmitter), 20 V/m, modulation factor 80%. (ECG: 20 V/m except 600-950 MHz where it is 10 V/m and Temperature which holds 3 V/m over the full range).

**CAUTION**

Temperature measurement accuracy may be compromised in the presence of strong electromagnetic fields (>3V/m) in certain small frequency bands.

- **Magnetic Field emission** according to MIL STD 461E, Chapter RE101: Radiated emissions, magnetic field, 30 Hz to 100 kHz. Limit class: Army.
- **Magnetic Field susceptibility:** Radiated susceptibility, magnetic field, 50, 60 and 400 Hz, 18 μT(15 A/m).
- **Operating ambient temperature** testing over the range from 0 to 40°C (32 to 100°F).
- **Operating ambient humidity** testing up to 95 % RH at 40°C (100°F), non condensing.

**NOTE**

There may be additional requirements for transport situations in air, on water or in difficult terrain in certain countries, e.g. EU.

## Physical Specifications

Specification	Comments
Maximum Weight	
1.25 kg (2.8 lb)	including battery, without options
Size (W x H x D)	
188 x 99 x 86 mm 7.4 x 3.9 x 3.4 in	without handle and options



<b>M8023A External Power Supply Weight and Dimensions</b>	
<b>Maximum Weight</b>	
	700 g $\pm$ 10% (1.5 lb $\pm$ 10%)
<b>Size (W x H x D)</b>	
	207 x 70 x 113 mm 8.1 x 2.8 x 4.4 in

<b>865297 Battery Extension Weight and Dimensions</b>	
<b>Maximum Weight</b>	
	1.4 kg $\pm$ 10%, including battery (3.1 lb $\pm$ 10%)
<b>Size (W x H x D)</b>	
	190 x 140 x 135 mm 7.5 x 5.5 x 5.3 in

## Environmental Specifications

The monitor may not meet the performance specifications given here if stored or used outside the specified temperature and humidity ranges.

The monitor is protected against ingress of objects and fluids according to IEC 60529 IP32 (applies to all options intended for out-of-hospital use). However, do not expose the monitor directly to heavy rain.

When the monitor and related products have differing environmental specifications, the effective range for the combined products is that range which is common to the specifications for all products.

<b>Item</b>	<b>Condition</b>	<b>Range</b>
<b>Temperature Range</b>	Operating	0 to 40°C (32 to 104°F)
	Storage including transportation	-20 to 60°C (-4 to 140°F)
<b>Temperature Range with the Wireless IntelliVue Adapter or IntelliVue Instrument Telemetry Wireless Network or when charging the battery</b>	Operating	0 to 35°C (32 to 95°F)
<b>Humidity Range</b>	Operating	15% to 95% Relative Humidity (RH)
	Storage including transportation	5% to 95% Relative Humidity (RH)
<b>Altitude Range</b>	Operating	-500 m to 3000 m (10000 ft)
	Storage including transportation	-500 m to 4600 m (15000 ft) <sup>1</sup>

Item	Condition	Range
Ingress Protection	Monitor	IP32 (protected against ingress of water when the water is dripping vertically and the monitor is tilted up to 15°)
	External Power Supply (M8023A)	IP31(protected against the ingress of solid foreign objects 2.5 mm in diameter or larger, and the ingress of water when the water is dripping vertically) when rested on its rubber feet on a flat, level surface.
		IP32 when mounted as shown in the section "Mounting the External Power Supply (M8023A)" on page 13 in the Installation chapter and as described in the <i>Service Guide</i> .
	Battery Extension (865297)	IP32 (protected against ingress of water when the water is dripping vertically and the monitor is tilted up to 15°, not protected against heavy rain.)

<sup>1</sup> Sufficient for flight altitudes up to 12,000 m with pressurized cabins

## Monitor Performance Specifications

Performance Specifications		
Power Specifications	Power consumption	<12 W average <30 W while battery is loading
	Operating Voltage	36 to 60 V DC floating
Battery Specifications	Operating Time (with new, fully charged battery at 25°C)	Basic monitoring configuration: 2.5 hours <b>(Brightness set to Optimum, ECG/Resp, SpO<sub>2</sub> measurements in use, NBP measurement every 15 minutes)</b>
	Charge Time	When monitor is off: 2 hours When monitor is in use, and connected to the external power supply (M8023A), without MMS extensions: 12 hours approx.
Indicators	Alarms Off	red or yellow LED with crossed out alarms symbol
	Alarms	red/yellow/light blue (cyan) LED
	On/Standby / Error	green / red LED
	AC Power	green LED
	Battery	yellow (charging)/red blinking (empty) LED
External Power		green LED
Sounds	Audible feedback for user input Prompt tone QRS tone, or SpO <sub>2</sub> modulation tone 4 different alarm sounds	
Trends	Resolution	12 or 16 numerics @ 12 sec, 1 minute, 5 minute resolution.
	Information	Multiple choices of number of numerics, resolution and duration depending on trend option and application area. For example: For neonatal, you can choose between 12 and 16 numerics.

Performance Specifications		
<b>Alarm signal</b>	System alarm delay The system alarm delay is the processing time the system needs for any alarm to be indicated on the monitor, after the measurement has triggered the alarm.	less than 4 seconds
	Delay for alarm availability on the network This is the time needed after alarm indication on the monitor until the alarm signal is available on the network, to the IntelliVue Information Center or for transmission to other systems.	less than 4 seconds
	Pause duration	1,2,3 minutes or infinite, depending on configuration
	Extended alarm pause	5 or 10 minutes
	Sound pressure range	min. 0 dB(A) max. 45-85 dB(A)
<b>Review Alarms</b>	Information	all alarms / inops, main alarms on/off, alarm silence and time of occurrence
	Capacity	300 items
<b>Real Time Clock</b>	Range	from: January 1, 1997, 00:00 to: December 31, 2080, 23:59
	Accuracy	<4 seconds per day (typically)
	Hold Time	infinite if powered by external power supply; otherwise at least 48 hours
<b>Buffered Memory</b>	Hold Time	if powered by external power supply: infinite without power: at least 48 hours
	Contents	Active settings, trends, patient data, realtime reports, review alarms

#### M8023A External Power Supply Performance Specifications

<b>Power Specifications</b>	Power consumption	<12 W average <30 W peak
	Line Voltage	100 to 240 V ~
	Current	1.3 to 0.7 A
	Frequency	50/60 Hz ~
<b>Indicators</b>	AC Power	green LED

#### Display Specifications

<b>Integrated QVGA Display</b>	Sweep Speeds	6.25, 12.5, 25 and 50 mm/s
	Resolution	320 x 240
	Refresh frequency	60 Hz
	Useful screen	72 x 54 mm (2.8 x 2.1 in)
	Pixel size	0.22 x 0.22 mm

# Monitor Interface Specifications

Monitor Interface Specifications		
<b>Measurement Link (MSL)</b>	Connectors	Female ODU (Proprietary)
	Power	30 V to 60 V input
	Power Sync.	RS-422 compliant input 78.125kHz (typical)
	LAN signals	IEEE 802.3 10-Base-T compliant
	Serial signals	RS-422 compliant
	Local signals	Provided for connecting measurement extensions
<b>ECG Sync Pulse Output<sup>1</sup></b>	Cable detection	Yes
	Marker In	No
	Wave Output	No
	Connector	Binder Series 709/719
	Output levels	Output low <0.8 V @ I = -4 mA
		Output high >2.4 V @ I = 4 mA
	Isolation	None
	Pulse Width	100 +/-10 ms (high)
	Delay from R-wave peak to start of pulse	20 ms maximum per AAMI EC13
Minimum required R-wave amplitude	0.5 V	
<b>IntelliVue 802.11 Bedside Adapter (Wireless Network Adapter)</b>	Type	Internal wireless adapter
	Technology	IEEE 802.11a/b/g
	Frequency Band	USA: 2.400 - 2.483GHz, 5.15 - 5.35GHz, 5.725 - 5.825GHz
		Europe: 2.400 - 2.483GHz, 5.15 - 5.35GHz, 5.47 - 5.725GHz
		Japan: 2.400 - 2.483GHz, 2.471 - 2.498GHz, 4.900 - 5.091GHz, 5.150 - 5.250GHz, 5.25 - 5.35GHz, 5.470 - 5.725GHz China: 2.400 - 2.483GHz, 5.725 -5.85GHz
Modulation Technique	802.11b/g DSSS (DBPSK, DQPSK, CCK) OFDM (BPSK,QPSK, 16-QAM, 64-QAM) 802.11a OFDM (BPSK,QPSK, 16-QAM, 64-QAM)	
	Effective radiated power	max 18 dBm
<b>Short Range Radio Interface<sup>2</sup></b>	Type	Internal SRR interface
	Technology	IEEE 802.15.4
	Frequency Band	2.4 GHz ISM (2.400 - 2.483 GHz)
	Modulation Technique	DSSS (O -QPSK)
	Effective radiated power	max. 0 dBm (1 mW)
<b>IntelliVue Instrument Telemetry Wireless Network (USA only)</b>		

Monitor Interface Specifications		
Internal WMTS Adapter	Technology	compatible with Philips IntelliVue Telemetry System (ITS), cellular infrastructure
	Frequency Band	WMTS, 1395-1400 MHz and 1427-1432 MHz
IntelliVue Instrument Telemetry Wireless Network		
Internal ISM Adapter	Technology	compatible with Philips IntelliVue Telemetry System (ITS), cellular infrastructure
	Frequency Band	2.4 GHz ISM

<sup>1</sup> See “Connectors” on page 276 for safety-related information)

<sup>2</sup> The short range radio interface is compatible with the IntelliVue Cableless Measurements and the following devices: TRx4841A/TRx4851A IntelliVue Telemetry System Transceiver and MX40 Patient Wearable Monitor.

M8023A External Power Supply Interface Specifications		
Measurement Link (MSL)	Connectors	Male ODU (Proprietary)
	Power	48 V output
	Power Sync.	RS-422 compliant output 78.125 kHz (typical)
	LAN signals	IEEE 802.3 10-Base-T compliant
	Serial signals	RS-422 compliant output 78.125 kHz (typical)
	Local signals	Not connected

865297 Battery Extension Interface Specifications		
Measurement Link (MSL)	Connectors	Male ODU (Proprietary)
	Power	36 -38 V output
	Power Sync.	RS-422 compliant output 78.125 kHz (typical)
	LAN signals	IEEE 802.3 10-Base-T compliant
	Serial signals	RS-422 compliant
	Local signals	Not connected
Measurement Link (MSL)	Connectors	Female ODU (Proprietary)
	Power	30-60 V input
	Power Sync.	RS-422 compliant input 78.125 kHz (typical)
	LAN signals	IEEE 802.3 10-Base-T compliant
	Serial signals	RS-422 compliant
	Local signals	Not connected

## 865297 Battery Extension Specifications

865297 Battery Extension Battery Specifications	
Battery Type	M4605A
Indicators	green power LED and green-yellow-red battery status LED

## M4607A Battery Specifications

One battery is required for battery operation of the monitor.

The battery lifetime is 3 years from manufacturing date or 500 charge/discharge cycles.

M4607A Battery Specifications	
<b>Physical Specifications</b>	
W x D x H	66 mm (2.36 in) x 80 mm (3.15 in) x 20 mm (0.79 in)
Weight	160 g $\pm$ 5%
<b>Performance Specifications</b>	
Nominal Voltage	10.8 Volt
Rated Capacity at discharge C/5	1000 mAh (typical)
<b>Environmental Specifications</b>	
Temperature Range	Discharge 0 to 60°C (32 to 122°F) Charge 0 to 60°C (32 to 122°F) Storage and Transportation: -20 to 65°C (-4 to 140°F)
Humidity Range	Operating: 15% to 95% Relative Humidity (RH) Storage and Transportation: 5% to 95% Relative Humidity (RH)
<b>Battery Type</b>	Lithium Ion Mangan, 10.8 V, 1000 mAh
<b>Safety</b>	complies with UL 2054
<b>Electromagnetic Compatibility (EMC)</b>	complies with the requirements for FCC Type B computing Device, and EN 61000-4-2 and EN 61000-3-2
<b>Communication Standard</b>	complies with the SMBus specification v1.1

## M4605A Battery Specifications

The battery lifetime is 3 years from manufacturing date or 500 charge/discharge cycles.

M4605A Battery Specifications	
<b>Physical Specifications</b>	
W x D x H	149 mm (5.866 in) x 89 mm (3.504 in) x 19.8 mm (0.78 in)
Weight	490 g (1.08 lb) per battery
<b>Performance Specifications</b>	
Nominal Voltage	10.8 Volt
Rated Capacity at discharge C/5	6000 mAh
Continuous Discharge Capability	6.5 A
<b>Environmental Specifications</b>	
Temperature Range	Discharge 0 to 50°C (32 to 122°F) Charge 0 to 50°C (32 to 122°F) Storage and Transportation: -20 to 65°C (-4 to 140°F)
Humidity Range	Operating: 15% to 95% Relative Humidity (RH) Storage and Transportation: 5 % to 95 % Relative Humidity (RH)

M4605A Battery Specifications	
Battery Type	Smart Battery 10.8 V, 6000 mAh, Lithium Ion
Safety	complies with UL 2054
Electromagnetic Compatibility (EMC)	complies with the requirements for FCC Type B computing Device, and EN 61000-4-2 and EN 61000-3-2
Communication Standard	complies with the SMBus specification v 1.1

## Measurement Specifications

See the Appendix on Default Settings for a list of the settings the monitor is initially shipped with.

### ECG/Arrhythmia/ST/QT

Complies with IEC 60601-2-25:1993 + A1:1999 /EN60601-2-25:1995 + A1:1999, IEC 60601-2-27:2005/EN60601-2-27:2006, IEC 60601-2-51:2003 /EN 60601-2-51:2003 and AAMI EC11/EC13:1991/2002.

ECG/Arrhythmia/ST Performance Specifications		
Cardiotach	Range	Adult/pedi: 15 to 300 bpm Neo range: 15 to 350 bpm Note: for rates equal to or less than 15 bpm, the displayed heart rate is 0.
	Accuracy	±1% of range
	Resolution	1 bpm
	Sensitivity	≥200 $\mu\text{V}_{\text{peak}}$
PVC Rate	Range	0 to 300 bpm
	Resolution	1 bpm
ST Numeric	Range	-20 to +20 mm
	Accuracy	±0.5 mm or 15%, whichever is greater
	Resolution	0.1 mm
QT Numeric	Range	200 to 800 ms
	Accuracy	±30 ms
	Resolution	8 ms
QTc Numeric	Range	200 to 800 ms
	Resolution	1 ms
$\Delta\text{QTc}$ Numeric	Range	-600 to +600 ms
	Resolution	1 ms
QT-HR Numeric	Range - adult	15 to 150 bpm
	Range - pediatric and neonatal	15 to 180 bpm

## 24 Specifications

ECG/Arrhythmia/ST Performance Specifications		
Sinus and SV Rhythm Ranges	Brady	Adult: 15 to 59 bpm Pedi: 15 to 79 bpm Neo: 15 to 89 bpm
	Normal	Adult: 60 to 100 bpm Pedi: 80 to 160 bpm Neo: 90 to 180 bpm
	Tachy	Adult: >100 bpm Pedi: >160 bpm Neo: >180 bpm
Bandwidth	Diagnostic Mode	Adult/neo/pedi: 0.05 to 150 Hz
	Extended Monitoring Mode	Adult/neo/pedi: 0.5 to 150 Hz
	Monitoring Mode	Adult: 0.5 to 40 Hz Neo/pedi: 0.5 to 55 Hz
	Filter Mode	Adult/neo/pedi: 0.5 to 20 Hz
Bandwidth when the ECG is transmitted from a telemetry device via short range radio	Diagnostic Mode	Adult/neo/pedi: 0.05 to 40 Hz
	Extended Monitoring Mode	Adult/neo/pedi: 0.5 to 40 Hz
	Monitoring Mode	Adult: 0.5 to 40 Hz Neo/pedi: 0.5 to 40 Hz
	Filter Mode	Adult/neo/pedi: 0.5 to 20 Hz
Differential Input Impedance		>2 M $\Omega$ RA-LL leads (Resp) >5 M $\Omega$ at all other leads (at 10 Hz including patient cable)
Common Mode Rejection Ratio		Diagnostic mode: >86 dB (with a 51 k $\Omega$ /47 nF imbalance). Filter mode: >106 dB (with a 51 k $\Omega$ /47 nF imbalance).
Electrode Offset Potential Tolerance		$\pm$ 500 mV
Auxiliary Current (Leads off Detection)		Active electrode: <100 nA Reference electrode: <900 nA
Input Signal Range		$\pm$ 5 mV

ECG/Arrhythmia/ST/QT Alarm Specifications	Range	Adjustment
HR	15 to 300 bpm maximum delay: 10 seconds according to AAMI EC 13-1992 standard	Adult: 1 bpm steps (15 to 40 bpm) 5 bpm steps (40 to 300 bpm) Pedi/Neo: 1 bpm steps (15 to 50 bpm) 5 bpm steps (50 to 300 bpm)
Extreme Tachy	Difference to high limit 0 to 50 bpm	5 bpm steps
	Clamping at 150 to 300 bpm	5 bpm steps
Extreme Brady	Difference to low limit 0 to 50 bpm	5 bpm steps
	Clamping at 15 to 100 bpm	5 bpm steps
Run PVCs	None, fixed setting 2 PVCs	Not adjustable by user
PVCs Rate	1 to 99 PVCs/minute	1 PVC
Vent Tach HR	20 to 300 bpm	5 bpm
Vent Tach Run	3 to 99 PVCs/minute	1 PVC
Vent Rhythm Run	3 to 99 PVCs/minute	1 PVC
SVT HR	120 to 300 bpm	5 bpm



ECG/Arrhythmia/ST/QT Alarm Specifications	Range	Adjustment
SVT Run	3 to 99 SV beats	1 SV beat
ST High	-19.8 to +20 mm	0.2 mm
ST Low	-20 to +19.8 mm	0.2 mm
STE Limit	-20 to +20 mm	0.2 mm
QTc High	200 ms to 800 ms	10 ms steps
$\Delta$ QTc High	30 ms to 200 ms	10 ms steps

ECG/Arrhythmia/ST Supplemental Information as required by AAMI EC11/13, IEC 60601-2-27		
Respiration Excitation Waveform		Sinusoidal signal, 260 $\mu$ A, 40.5 kHz
Noise Suppression		RL drive gain 44 dB max., max. voltage 1.8 Vrms
Time to Alarm for Tachycardia	Vent Tachycardia 1 mV <sub>pp</sub> , 206 bpm	Gain 0.5, Range 6.5 to 8.4 seconds, Average 7.2 seconds
		Gain 1.0 Range 6.1 to 6.9 seconds, Average 6.5 seconds
		Gain 2.0, Range 5.9 to 6.7 seconds, Average 6.3 seconds
	Vent Tachycardia 2 mV <sub>pp</sub> , 195 bpm	Gain 0.5, Range 5.4 to 6.2 seconds, Average 5.8 seconds
		Gain 1.0, Range 5.7 to 6.5 seconds, Average 6.1 seconds
		Gain 2.0, Range 5.3 to 6.1 seconds, Average 5.7 seconds
Tall T-Wave Rejection Capability		Exceeds ANSI/AAMI EC 13 Sect. 3.1.2.1(c) minimum recommended 1.2 mV T-Wave amplitude
Heart Rate Averaging Method		Three different methods are used: Normally, heart rate is computed by averaging the 12 most recent RR intervals. For runs of PVCs, up to 8 RR intervals are averaged to compute the HR. If each of 3 consecutive RR intervals is greater than 1200 ms (that is, rate less than 50 bpm), then the 4 most recent RR intervals are averaged to compute the HR.
Response Time of Heart Rate Meter to Change in Heart Rate		HR change from 80 to 120 bpm: Range: [6.4 to 7.2 seconds] Average: 6.8 seconds HR change from 80 to 40 bpm: Range: [5.6 to 6.4 sec] Average: 6.0 seconds
Heart Rate Meter Accuracy and Response to Irregular Rhythm		Ventricular bigeminy: 80 bpm Slow alternating ventricular bigeminy: 60 bpm Rapid alternating ventricular bigeminy: 120 bpm Bidirectional systoles: 90 bpm
Accuracy of Input Signal Reproduction		Methods A and D were used to establish overall system error and frequency response.
Pacemaker Pulse Rejection Performance		Rejection of pacemaker pulses with amplitudes from $\pm 2$ mV to $\pm 700$ mV and widths from 0.1 ms to 2.0 ms (Method A)
Pacemaker Pulse Rejection of fast ECG signals		2.2 V/s RTI (Paced Mode)
Minimum input slew rate		2.2 V/s RTI

## Respiration

Respiration Performance Specifications		
Respiration Rate	Range	Adult/pedi: 0 to 120 rpm Neo: 0 to 170 rpm
	Accuracy	at 0 to 120 rpm $\pm 1$ rpm at 120 to 170 rpm $\pm 2$ rpm
	Resolution	1 rpm
Bandwidth		0.3 to 2.5 Hz (-6 dB)
Noise		Less than 25 m $\Omega$ (rms) referred to the input

Respiration Alarm Specifications	Range	Adjustment	Delay
High	Adult/pedi: 10 to 100 rpm Neo: 30 to 150 rpm	under 20 rpm: 1 rpm steps over 20 rpm: 5 rpm steps	max. 14 seconds
Low	Adult/pedi: 0 to 95 rpm Neo: 0 to 145 rpm	under 20 rpm: 1 rpm steps over 20 rpm: 5 rpm steps	for limits from 0 to 20 rpm: max. 4 seconds for limits above 20 rpm: max. 14 seconds
Apnea Alarm	10 to 40 seconds	5 second steps	

## SpO<sub>2</sub>

Complies with ISO 9919:2005 / EN ISO 9919:2009 (except alarm system; alarm system complies with IEC 60601-2-49:2001).

The SpO<sub>2</sub> performance specifications in this section apply to devices with Philips SpO<sub>2</sub> technology. For SpO<sub>2</sub> performance specifications valid for other SpO<sub>2</sub> technologies, refer to the instructions for use provided with these devices.

Measurement Validation: The SpO<sub>2</sub> accuracy has been validated in human studies against arterial blood sample reference measured with a CO-oximeter. Pulse oximeter measurements are statistically distributed, only about two-thirds of the measurements can be expected to fall within the specified accuracy compared to CO-oximeter measurements.

Display Update Period: Typical: 2 seconds, Maximum: 30 seconds. Maximum with NBP INOP suppression on: 60 seconds.

SpO <sub>2</sub> Performance Specifications		
<b>SpO<sub>2</sub></b> The specified accuracy is the root-mean-square (RMS) difference between the measured values and the reference values	Range	0 to 100%
	Accuracy	<b>Philips Reusable Sensors:</b> M1191A, M1191AL, M1191B, M1191BL, M1192A, = 2% (70% to 100%) M1193A, M1194A, M1195A, M1196A = 3% (70% to 100%) M1191T, M1192T, M1193T (Adult), M1196T = 3% (70% to 100%) M1193T (Neonate) = 4% (70% to 100%)  <b>Philips Disposable Sensors with M1943A(L):</b> M1132A, M1133A (adult/infant), M1134A (adult/infant) = 2%  M1901B, M1902B, M1903B, M1904B, M1131A, M1133A (neonate), M1134A (neonate) = 3% (70% to 100%)  <b>NellcorPB<sup>®</sup> Sensors with M1943A(L):</b> MAX-A, MAX-AL, MAX-P, MAX-I, MAX-N, D-25, D-20, I-20, N-25, OxiCliq A, P, I, N = 3% (70% to 100%)  <b>Masimo Reusable Sensors<sup>®</sup> with LNOP MP12 or LNC MP10:</b> LNOP DC-I, LNOP DC-IP, LNOP YI (adult/pedi/infant), LNCS DC-1, LNCS DC-IP, LNCS YI (adult/pedi/infant) = 2% (70% to 100%)  LNOP YI (neonate), LNCS YI (neonate) = 3% (70% to 100%)  LNOP TC-I, LNCS TC-I: 3.5% (70% to 100%)  <b>Masimo Disposable Sensors<sup>®</sup> with LNOP MP12 or LNC MP10:</b> LNOP Adt, LNOP Adtx, LNOP Pdt, LNOP Pdtx, LNOP Inf-L, LNOP Neo-L (adult), LNCS Adtx, LNCS Adtx-3, LNCS Pdtx, LNCS Pdtx-3, LNCS Inf, LNCS Inf-3, LNCS Neo (adult), LNCS Neo-3 (adult) = 2% (70% to 100%)  LNOP Neo-L (neonate), LNOP NeoPt-L, LNCS Neo (neonate), LNCS Neo-3 (neonate), LNCS NeoPt, LNCS NeoPt-3 = 3% (70% to 100%)
	Resolution	1%
<b>Pulse</b>	Range	30 to 300 bpm
	Accuracy	±2% or 1 bpm, whichever is greater
	Resolution	1 bpm
<b>Sensors</b>	Wavelength range: 500 to 1000 nm Emitted Light Energy: ≤15 mW  Information about the wavelength range can be especially useful to clinicians (for instance, when photodynamic therapy is performed)	
<b>Pulse Oximeter Calibration Range</b>	70% to 100%	

SpO <sub>2</sub> Alarm Specifications	Range	Adjustment
<b>SpO<sub>2</sub></b>	Adult: 50 to 100% Pedi/Neo: 30 to 100%	1% steps
<b>Desat</b>	Adult: 50 to Low alarm limit Pedi/Neo: 30 to Low alarm limit	1% steps
<b>Pulse</b>	30 to 300 bpm	Adult: 1 bpm steps (30 to 40 bpm) 5 bpm steps (40 to 300 bpm) Pedi/Neo: 1 bpm steps (30 to 50 bpm) 5 bpm steps (50 to 300 bpm)

## 24 Specifications

SpO <sub>2</sub> Alarm Specifications	Range	Adjustment
Tachycardia	Difference to high limit 0 to 50 bpm	5 bpm steps
	Clamping at 150 to 300 bpm	5 bpm steps
Bradycardia	Difference to low limit 0 to 50 bpm	5 bpm steps
	Clamping at 30 to 100 bpm	5 bpm steps

SpO <sub>2</sub> Alarm Specifications (cont.)	Standard Delay	Smart Alarm Delay (alternative to standard alarm delay)		
		Short Mode	Medium mode	Long Mode
SpO <sub>2</sub> high and low limit alarms	0 to 30 seconds (adjustable in 1 second steps) + system alarm delay <sup>1</sup>	10 to 25 seconds + system alarm delay	10 to 50 seconds + system alarm delay	10 to 100 seconds + system alarm delay
Desat	0 to 30 seconds (adjustable in 1 second steps) + system alarm delay	not supported		
Pulse	10 seconds + system alarm delay			
Tachycardia	10 seconds + system alarm delay			
Bradycardia	10 seconds + system alarm delay			

1. Refer to "Monitor Performance Specifications" on page 282 for system alarm delay specification.

SpO <sub>2</sub> Smart Alarm Delay - Detailed Specifications			
Deviation from violated alarm limit	Resulting alarm delay according to selected mode		
	Short	Medium	Long
1%	25 sec (maximum delay)	50 sec (maximum delay)	100 sec (maximum delay)
2%	12 sec	25 sec	50 sec
3%	10 sec	16 sec	33 sec
4%	10 sec	12 sec	25 sec
5%	10 sec	10 sec	20 sec
6%	10 sec	10 sec	16 sec
7%	10 sec	10 sec	14 sec
8%	10 sec	10 sec	12 sec
9%	10 sec	10 sec	11 sec
>9%	10 sec	10 sec	10 sec

## NBP

Complies with IEC 60601-2-30:1999/EN60601-2-30:2000.

NBP Performance Specifications		
Measurement Ranges	Systolic	Adult: 30 to 270 mmHg (4 to 36 kPa) Pedi: 30 to 180 mmHg (4 to 24 kPa) Neo: 30 to 130 mmHg (4 to 17 kPa)
	Diastolic	Adult: 10 to 245 mmHg (1.5 to 32 kPa) Pedi: 10 to 150 mmHg (1.5 to 20 kPa) Neo: 10 to 100 mmHg (1.5 to 13 kPa)
	Mean	Adult: 20 to 255 mmHg (2.5 to 34 kPa) Pedi: 20 to 160 mmHg (2.5 to 21 kPa) Neo: 20 to 120 mmHg (2.5 to 16 kPa)
	Pulse Rate	Adult: 40 to 300 Pedi: 40 to 300 Neo: 40 to 300
Accuracy	<i>Max. Std. Deviation:</i> 8 mmHg (1.1 kPa) <i>Max. Mean Error:</i> $\pm 5$ mmHg ( $\pm 0.7$ kPa)	
Pulse Rate Measurement Accuracy	40 to 100 bpm: $\pm 5$ bpm 101 to 200 bpm: $\pm 5\%$ of reading 201 to 300 bpm: $\pm 10\%$ of reading (average over NBP measurement cycle)	
Pulse Rate Range	40 to 300 bpm	
Measurement Time	Typical at HR >60 bpm <i>Auto/manual/sequence:</i> 30 seconds (adult) 25 seconds (neonatal) <i>Stat:</i> 20 seconds Maximum time: 180 seconds (adult/pediatric) 90 seconds (neonates)	
Cuff Inflation Time	Typical for normal adult cuff: Less than 10 seconds Typical for neonatal cuff: Less than 2 seconds	
Initial Cuff Inflation Pressure	Adult: $165 \pm 15$ mmHg Pedi: $130 \pm 15$ mmHg Neo: $100 \pm 15$ mmHg	
Auto Mode Repetition Times	1 min, 2 min, 2.5 min, 3 min, 10 min, 15 min, 20 min, 30 min, 45 min, 1h, 2h, 4h, 8h, 12h, 24h	
STAT Mode Cycle Time	5 minutes	
Venipuncture Mode Inflation		
Inflation Pressure	Adult	20 to 120 mmHg (3 to 16 kPa)
	Pediatric	20 to 80 mmHg (3 to 11 kPa)
	Neonatal	20 to 50 mmHg (3 to 7 kPa)
Automatic deflation after	Adult/pediatric	170 seconds
	Neonatal	85 seconds

**Measurement Validation:** In adult and pediatric mode, the blood pressure measurements determined with this device comply with the American National Standard for Electronic or Automated Sphygmomanometers (ANSI/AAMI SP10 - 1992) in relation to mean error and standard deviation, when compared to intra-arterial or auscultatory measurements (depending on the configuration) in a

## 24 Specifications

representative patient population. For the auscultatory reference the 5th Korotkoff sound was used to determine the diastolic pressure.

In neonatal mode, the blood pressure measurements determined with this device comply with the American National Standard for Electronic or Automated Sphygmomanometers (ANSI/AAMI SP10 - 1992 and AAMI/ANSI SP10A -1996) in relation to mean error and standard deviation, when compared to intra-arterial measurements in a representative patient population.

NBP Alarm Specifications	Range	Adjustment
Systolic	Adult: 30 to 270 mmHg (4 to 36 kPa)	10 to 30 mmHg: 2 mmHg (0.5 kPa) >30 mmHg: 5 mmHg (1 kPa)
	Pedi: 30 to 180 mmHg (4 to 24 kPa)	
	Neo: 30 to 130 mmHg (4 to 17 kPa)	
Diastolic	Adult: 10 to 245 mmHg (1.5 to 32 kPa)	
	Pedi: 10 to 150 mmHg (1.5 to 20 kPa)	
	Neo: 10 to 100 mmHg (1.5 to 13 kPa)	
Mean	Adult: 20 to 255 mmHg (2.5 to 34 kPa)	
	Pedi: 20 to 160 mmHg (2.5 to 21 kPa)	
	Neo: 20 to 120 mmHg (2.5 to 16 kPa)	

NBP Overpressure Settings		
Adult	>300 mmHg (40 kPa) >2 sec	not user adjustable
Pediatric	>300 mmHg (40 kPa) >2 sec	
Neonate	>150 mmHg (20 kPa) >2 sec	

## Invasive Pressure and Pulse

Complies with IEC 60601-2-34:2000/EN60601-2-34:2000.

Invasive Pressure Performance Specifications		
Measurement Range		-40 to 360 mmHg
Pulse Rate	Range	25 to 350 bpm
	Accuracy	±1% Full Range
	Resolution	1 bpm
Input Sensitivity		Sensitivity: 5 μV/V/mmHg (37.5 μV/V/kPa) Adjustment range: ±10%
Transducer		Load Impedance: 200 to 2000 Ω (resistive) Output Impedance: ≤3000 Ω (resistive)
Frequency Response		dc to 12.5 Hz or 40 Hz
Zero Adjustment	Range	±200 mmHg (±26 kPa)
	Accuracy	±1 mmHg (±0.1 kPa)
	Drift	Less than 0.1 mmHg/°C (0.013 kPa/°C)
Gain Accuracy	Accuracy	±1%
	Drift	Less than 0.05%/°C
	Non linearity and Hysteresis	Error of ≤0.4 %FS (@CAL 200 mmHg)
Overall Accuracy	(including transducer)	±4% of reading or ±4 mmHg (±0.5 kPa), whichever is greater
Volume displacement of CPJ840J6		0.1 mm <sup>3</sup> /100 mmHg

## Invasive Pressure Alarm Specifications

Invasive Pressure Alarm Specifications	Range	Adjustment	Delay
<b>Pressure</b>	-40 to 360 mmHg (-5.0 to 48 kPa)	-40 to 50 mmHg 2 mmHg (0.5 kPa)  >50 mmHg 5 mmHg (1 kPa)	max. 12 seconds
<b>Extreme High</b>	Difference to high limit 0 to 25 mmHg	5 mmHg steps (0.5 kPa)	
	Clamping at -40 to 360 mmHg	5 mmHg steps (1.0 kPa)	
<b>Extreme Low</b>	Difference to low limit 0 to 25 mmHg	5 mmHg steps (0.5 kPa)	
	Clamping at -40 to 360 mmHg	5 mmHg steps (1.0 kPa)	
<b>Pulse</b>	25 to 300 bpm	Adult: 1 bpm steps (25 to 40 bpm) 5 bpm steps (40 to 300 bpm)  Pedi/Neo: 1 bpm steps (25 to 50 bpm) 5 bpm steps (50 to 300 bpm)	
<b>Tachycardia</b>	Difference to high limit 0 to 50 bpm	5 bpm steps	max. 14 seconds
	Clamping at 150 to 300 bpm	5 bpm steps	
<b>Bradycardia</b>	Difference to low limit 0 to 50 bpm	5 bpm steps	max. 14 seconds
	Clamping at 25 to 100 bpm	5 bpm steps	

## Temp

Complies with EN 12470-4:2000. Specified without transducer.

Temp Performance Specifications		
<b>Temp</b>	Range	-1 to 45°C (30 to 113°F)
	Resolution	0.1°C (0.2°F)
	Accuracy	±0.1°C (±0.2°F)
<b>Average Time Constant</b>		Less than 10 seconds

Temp Alarm Specifications	Range	Adjustment
<b>Temp High/Low Alarms</b>	-1 to 45°C (30 to 113°F)	-1 to 35°C (30 to 95°F), 0.5°C (1.0°F) steps 35 to 45°C (95 to 113°F), 0.1°C (0.2°F) steps

## CO<sub>2</sub>

The CO<sub>2</sub> measurement in the monitor, M3014A and M3015A complies with EN ISO 21647:2004 + Cor.1:2005 (except alarm system; alarm system complies with IEC 60601-2-49:2001).

M3015A Microstream CO <sub>2</sub> Performance Specifications		
CO <sub>2</sub>	Range	0 to 150 mmHg (0 to 20 kPa), or 20% CO <sub>2</sub> , whichever is lower
	Accuracy	Up to 5 minutes during warmup: ±4 mmHg or 12%, whichever is greater After 5 minutes warmup: 0 to 40 mmHg (0 to 5.3 kPa): ±2.2 mmHg (±0.3 kPa) Above 40 mmHg (5.3 kPa): ±(5.5% + (0.08%/mmHg above 40 mmHg)) of reading These specifications are valid for 21% O <sub>2</sub> and N <sub>2</sub> balance, up to 35°C ambient temperature, up to 60 rpm in adult mode and 100 rpm in neonatal mode. Outside of these conditions the accuracy reaches at a minimum ±4 mmHg or ±12% of the reading, whichever is greater.
	Resolution	Numeric: 1.0 mmHg (0.1 kPa) Wave: 0.1 mmHg (0.01 kPa)
	Stability	Included in Accuracy specifications
AwRR	Range	0 to 150 rpm
	Accuracy	0 to 40 rpm: ±1 rpm 41 to 70 rpm: ±2 rpm 71 to 100 rpm: ±3 rpm >100 rpm: ±5% of reading
IPI	Range	1 to 10
	Resolution	1
Warm-up Time		5 minutes for full accuracy specification
Rise Time		190 ms for neonatal mode (measured with FilterLine H for neonatal)  240 ms for adult mode (measured with FilterLine H for adult)
Sample Flow Rate		50 + 15/-7.5 ml/minute
Gas Sampling Delay Time		Maximum: 3 seconds (2m sample lines) 6 seconds (4m sample lines)
Sound Pressure		Acoustic noise: <45 dBA
Total System Response Time		The total system response time is the sum of the delay time and the rise time.

### Microstream CO<sub>2</sub> Humidity Correction Factor

Either BTPS or ATPD can be selected as the humidity correction factor for the Microstream CO<sub>2</sub> readings. The formula for the correction calculation is:

$$P_{\text{BTPS}} = (P_{\text{ATPD}} \cdot 0.94)$$

where:

$P_{\text{BTPS}}$  = partial pressure at body temperature and pressure, saturated

$P_{\text{ATPD}}$  = partial pressure at ambient temperature and pressure, dry



M3014A Mainstream CO <sub>2</sub> Performance Specifications		
CO <sub>2</sub>	Range	0 to 150 mmHg (0 to 20.0 kPa)
	Accuracy	after 2 minutes warmup: For values between 0 and 40 mmHg: ±2.0 mmHg (±0.29 kPa) For values from 41 to 70 mmHg: ±5% of reading For values from 71 to 100 mmHg: ±8% of reading The specifications are valid for standard gas mixtures, balance air, fully hydrated at 35°C, P <sub>abs</sub> = 760 mmHg, flow rate = 2 l/min.
	Resolution	Numeric: 1.0 mmHg (0.1 kPa) Wave: 0.1 mmHg (0.01 kPa)
	Stability: Short term drift Long term drift	±0.8 mmHg over four hours Accuracy specification will be maintained over a 120 hour period
awRR	Range	2 to 150 rpm
	Accuracy	±1 rpm
Warm-up Time		2 minutes with CO <sub>2</sub> transducer attached for full accuracy specification
Response Time		Less than 60 ms (with adult or infant reusable or disposable adapter)

M3014A Sidestream CO <sub>2</sub> Performance Specifications		
CO <sub>2</sub>	Range	0 to 150 mmHg (0 to 20.0 kPa)
	Accuracy	after 2 minutes warmup: For values between 0 and 40 mmHg: ±2.0 mmHg (±0.29 kPa) For values from 41 to 70 mmHg: ±5% of reading For values from 71 to 100 mmHg: ±8% of reading For values from 101 to 150 mmHg: ±10% of reading At respiration rates above 80 rpm, all ranges are ±12% of actual. The specifications are valid for gas mixtures of CO <sub>2</sub> , balance N <sub>2</sub> , dry gas at 760 mmHg within specified operating temperature range.
	Resolution	Numeric: 1.0 mmHg (0.1 kPa) Wave: 0.1 mmHg (0.01 kPa)
	Stability: Short term drift Long term drift	±0.8 mmHg over four hours Accuracy specification will be maintained over a 120 hour period
awRR	Range	2 to 150 rpm
	Accuracy	±1 rpm
Warm-up Time		2 minutes with CO <sub>2</sub> sensor attached for full accuracy specification
Sample Flow Rate		50 ±10 ml/minute
Total System Response Time		3 seconds
Operating Temperature		0 to 40°C (32 to 100°F)

#### M8102A/M3014A Mainstream and Sidestream CO<sub>2</sub> Humidity Correction Factor

Either BTPS or ATPD can be selected as the humidity correction factor for the CO<sub>2</sub> readings. The formula for the correction calculation is:

$$P_{\text{ATPD}} = P_{\text{BTPS}} \cdot \frac{P_{\text{abs}}}{P_{\text{abs}} - P_{\text{H}_2\text{O}}}$$

Where p = partial pressure, P<sub>abs</sub> = absolute pressure, and P<sub>H<sub>2</sub>O</sub> = 42 mmHg @35°C and 100% RH.

M3016A Mainstream CO <sub>2</sub> Performance Specifications		
CO <sub>2</sub>	Range	-4 to 150 mmHg (-0.5 to 20.0 kPa)
	Accuracy	after 20 minutes warmup and calibration: For values between 0 and 40 mmHg: ±2.2 mmHg (±0.29 kPa) For values between 40 and 76 mmHg: ±5.5% of reading The specifications are valid for 45% O <sub>2</sub> and N <sub>2</sub> or N <sub>2</sub> O balance. Outside these conditions the accuracy reaches at a minimum the requirements of EN864/ISO9918.
	Resolution	Numeric: 1.0 mmHg (0.1 kPa) Wave: 0.1 mmHg (0.01 kPa)
	Stability	±1.0 mmHg over a 7 day period
awRR	Range	0 to 150 rpm
	Accuracy	±2 rpm
Warm-up Time		20 minutes with CO <sub>2</sub> transducer attached for full accuracy specification
Response Time		Less than 125 ms (for step from 10% to 90%)

**Mainstream CO<sub>2</sub> Humidity Correction Factor**

Either BTPS or ATPD can be selected as the humidity correction factor for the Mainstream CO<sub>2</sub> readings. The formula for the correction calculation is:

$$P_{ATPD} = P_{BTPS} \cdot \frac{P_{abs}}{P_{abs} - P_{H_2O}}$$

Where p = partial pressure, P<sub>abs</sub> = absolute pressure, and P<sub>H<sub>2</sub>O</sub> = 47 mmHg @37°C and 100% RH.

CO <sub>2</sub> Alarm Specifications	Range	Adjustment	Delay
etCO <sub>2</sub> High	20 to 95 mmHg (2 to 13 kPa)	1 mmHg (0.1 kPa)	M8102A/M3014A/M3016A: less than 14 seconds M3015A: less than 21 seconds.
etCO <sub>2</sub> Low	10 to 90 mmHg (1 to 12 kPa)		
imCO <sub>2</sub> High	2 to 20 mmHg (0.3 to 3.0 kPa)	steps of 1 mmHg (0.1 kPa)	M8102A/M3014A/M3016A: less than 14 seconds M3015A: less than 21 seconds.
awRR High	Adult/pedi: 10 to 100 rpm Neo: 30 to 150 rpm	under 20 rpm: 1 rpm steps over 20 rpm: 5 rpm steps	M8102A/M3014A/M3016A: less than 14 seconds M3015A: less than 21 seconds.
awRR Low	Adult/pedi: 0 to 95 rpm Neo: 0 to 145 rpm		M3015A: settings <20 rpm: less than 8 seconds >20 rpm: less than 21 seconds M8102A/M3014A/M3016A settings <20 rpm: less than 4 seconds >20 rpm: less than 14 seconds
IPI Low (M3015A/B only)	Adult/pedi: 2 to 9	steps of 1	Maximum 14 seconds after displayed value goes below the low alarm limit setting.
Apnea delay	10 to 40 seconds	5 second steps	set apnea delay time + 4 seconds (M8102A/M3014A/M3016A) or 8 seconds (M3015A with 2 m sample lines) or 11 seconds (M3015A with 4 m sample lines).

## Interfering Gas and Vapor Effects On CO2 Measurement Values

The specified deviations for M8102A/M3014A are valid when the appropriate corrections are switched on and set correctly.

Gas or Vapor	Gas Level (% volume fraction)	M8102A/M3014A	M3015A
		Additional deviation due to gas interference, measured at 0 - 40 mmHg CO2	
Nitrous Oxide	60%	±1 mmHg	±5%
Halothane	4%	±2 mmHg	±5%
Enflurane	5%	±2 mmHg	±5%
Isoflurane	5%	±2 mmHg	±5%
Sevoflurane	5%	±2 mmHg	±5%
Xenon	80%	-5 mmHg	±5%
Helium	50%	±1 mmHg	±5%
Metered dose inhaler propellants	-	not specified for use	
Desflurane	15%	+5 mmHg	±5%
Ethanol	0.1%	±1 mmHg	±5%
Isopropanol	0.1%	±1 mmHg	±5%
Acetone	0.1%	±1 mmHg	±5%
Methane	1.0%	±1 mmHg	±5%

## Safety and Performance Tests

You must observe any national regulations on the qualification of the testing personnel and suitable measuring and testing facilities. See the maintenance section for a list of required tests. Safety and performance tests, and what to do if the instrument does not meet these specifications, are described in the Service Guide.

## Electromagnetic Compatibility (EMC) Specifications

Take special precautions regarding electromagnetic compatibility (EMC) when using medical electrical equipment. You must operate your monitoring equipment according to the EMC information provided in this book. Portable and mobile radiofrequency (RF) communications equipment can affect medical electrical equipment.

### Accessories Compliant with EMC Standards

All accessories listed in the accessories section comply, in combination with the monitor, with the requirements of IEC 60601-1-2:2001 + A1:2004.

---

#### WARNING

Using accessories other than those specified may result in increased electromagnetic emission or decreased electromagnetic immunity of the monitoring equipment.

---

## Electromagnetic Emissions

The monitor is suitable for use in the electromagnetic environment specified in the table below. You must ensure that it is used in such an environment.

Emissions test	Compliance	Avoiding Electromagnetic Interference
Radiofrequency (RF) emissions	Group 1	The monitor uses RF energy only for its internal function. Therefore, its RF emissions are very low and are not likely to cause any interference in nearby electronic equipment
RF emissions CISPR 11	Class A	The monitor is suitable for use in all establishments <b>other than</b> those directly connected to the public low-voltage power supply network that supplies buildings used for domestic purposes.
RF emissions CISPR 11	Class B	The monitor, with the following measurements and interfaces: ECG/Respiration, NBP, SpO <sub>2</sub> , Pressure, Temperature, CO <sub>2</sub> (only Mainstream Sensor M2501A), LAN is suitable for use in all establishments <b>including</b> those directly connected to the public low-voltage power supply network that supplies buildings used for domestic purposes.

### Avoiding Electromagnetic Interference (Resp)

The respiration (Resp) measurement is a very sensitive measurement that measures a very small signal. Technological limitations do not allow higher immunity levels than 1 V/m for radiated RF electromagnetic fields and 1 V<sub>rms</sub> for conducted disturbances induced by RF fields. Electromagnetic fields with field strengths above 1 V/m and conducted disturbances above 1 V<sub>rms</sub> may cause erroneous measurements. Therefore Philips recommends that you avoid using electrically radiating equipment in the close proximity of this measurement.

---

#### WARNING

The monitor should not be used next to or stacked with other equipment. If you must stack the monitor, you must check that normal operation is possible in the necessary configuration before you start monitoring patients.

---

## Electromagnetic Immunity

The monitor is suitable for use in the specified electromagnetic environment. The user must ensure that it is used in the appropriate environment as described below.

Immunity test	IEC 60601-1-2 test level	Compliance level	Electromagnetic environment guidance
Electrostatic discharge (ESD) IEC 61000-4-2	±6 kV contact ±8 kV air	±6 kV contact ±8 kV air	Floors should be wood, concrete, or ceramic tile. If floors are covered with synthetic material, the relative humidity should be at least 30%.
Electrical fast transient/burst IEC 61000-4-4	±2 kV for power supply lines ±1 kV for input/output lines	±2 kV for power supply lines ±1 kV for input/output lines	Mains power quality should be that of a typical commercial and/or hospital environment
Surge IEC 61000-4-5	±1 kV differential mode ±2 kV common mode	±1 kV differential mode ±2 kV common mode	Mains power quality should be that of a typical commercial and/or hospital environment
Voltage dips, short interruptions and voltage variations on power supply input lines IEC 61000-4-11	<5% $U_T$ (>95% dip in $U_T$ ) for 0.5 cycles	<5% $U_T$ (>95% dip in $U_T$ ) for 0.5 cycles	Mains power quality should be that of a typical commercial and/or hospital environment. If the user of the monitor requires continued operation during power mains interruptions, it is recommended that the monitor is equipped with an internal battery or is powered from an uninterruptible power supply.
	40% $U_T$ (60% dip in $U_T$ ) for 5 cycles	40% $U_T$ (60% dip in $U_T$ ) for 5 cycles	
	70% $U_T$ (30% dip in $U_T$ ) for 25 cycles	70% $U_T$ (30% dip in $U_T$ ) for 25 cycles	
	<5% $U_T$ (>95% dip in $U_T$ ) for 5 sec	<5% $U_T$ (>95% dip in $U_T$ ) for 5 sec	
Power frequency (50/60 Hz) magnetic field IEC 61000-4-8	3 A/m	3 A/m	Power frequency magnetic fields should be at levels characteristic of a typical location in a typical commercial and/or hospital environment

In this table,  $U_T$  is the a.c. mains voltage prior to application of the test level.

## Recommended Separation Distance

### WARNING

- This equipment generates, uses and radiates radio-frequency energy, and if it is not installed and used in accordance with its accompanying documentation, may cause interference to radio communications.
- The monitor, equipped with a wireless network interface, intentionally receives RF electromagnetic energy for the purpose of its operation. Therefore, other equipment may cause interference, even if that other equipment complies with CISPR emission requirements.

In the following table, P is the maximum output power rating of the transmitter in watts (W) according to the transmitter manufacturer and d is the recommended separation distance in meters (m). The values given in brackets are for respiration.

Portable and mobile RF communications equipment should be used no closer to any part of the monitor, including cables, than the recommended separation distance calculated from the equation appropriate for the frequency of the transmitter.

Field strengths from fixed RF transmitters, as determined by an electromagnetic site survey, should be less than the compliance level in each frequency range.

## 24 Specifications

Interference may occur in the vicinity of equipment marked with this symbol:



Immunity test	IEC 60601-1-2 test level	Compliance level	Electromagnetic environment guidance
Conducted RF IEC 61000-4-6	3 Vrms 150 kHz to 80 MHz	3 Vrms (1 Vrms for respiration)	Recommended separation distance:  $d = 1.2\sqrt{P}$ for respiration:  $d = 3.5\sqrt{P}$
Radiated RF IEC 61000-4-3	3 V/m 80 MHz to 2.5 GHz	3 V/m (1 V/m for respiration) For short range radio, see note <sup>1</sup> .	Recommended separation distance: 80 MHz to 800 MHz $d = 1.2\sqrt{P}$  80 MHz to 800 MHz for respiration $d = 3.5\sqrt{P}$  800 MHz to 2,5 GHz $d = 2.3\sqrt{P}$  800 MHz to 2,5 GHz for respiration $d = 7.0\sqrt{P}$  2.0 to 2,3 GHz for short range radio $d = 7.0\sqrt{P}$

1. If ECG/SpO<sub>2</sub> signals are acquired from a telemetry device via short range radio the compliance level is 3V/m except in the range 2.0 to 2.3 GHz where it is 1 V/m.

Field strengths from fixed transmitters, such as base stations for radio (cellular, cordless) telephones and land mobile radios, amateur radio, AM and FM radio broadcast and TV broadcast cannot be predicted theoretically with accuracy. To assess the electromagnetic environment due to fixed RF transmitters, an electromagnetic site survey should be considered. If the measured field strength in the location in which the monitor is used exceeds the applicable RF compliance level above, the monitor should be observed to verify normal operation. If abnormal performance is observed, additional measures may be necessary, such as reorienting or relocating the monitor.

These guidelines may not apply in all situations. Electromagnetic propagation is affected by absorption and reflection from structures, objects, and people.

## Recommended separation distances from portable and mobile RF communication equipment

The monitor is intended for use in an electromagnetic environment in which radiated RF disturbances are controlled. The customer or user of the monitor can help prevent electromagnetic interference by maintaining a minimum distance between portable and mobile RF communications equipment and the monitor as recommended below, according to the maximum output power of the communications equipment.

In the following table, P is the maximum output power rating of the transmitter in watts (W) according to the transmitter manufacturer and d is the recommended separation distance in meters (m). The values given in brackets are for respiration.

Frequency of transmitter	150 kHz to 80 MHz	80 MHz to 800 MHz	800 MHz to 2,5 GHz
Equation	$d = 1.2\sqrt{P}$ for respiration: $d = 3.5\sqrt{P}$	$d = 1.2\sqrt{P}$ for respiration: $d = 3.5\sqrt{P}$	$d = 2.3\sqrt{P}$ for respiration: $d = 7.0\sqrt{P}$ for short range radio in the range 2.0 to 2.3 GHz: $d = 7.0\sqrt{P}$
Rated max. output power of transmitter	Separation distance	Separation distance	Separation distance
0.01 W	0.1 (0.4) m	0.1 (0.4) m	0.2 (0.7) m
0.1 W	0.4 (1.1) m	0.4 (1.1) m	0.7 (2.2) m
1 W	1.3 (3.5) m	1.3 (3.5) m	2.3 (7.0) m
10 W	3.8 (11.1) m	3.8 (11.1) m	7.3 (22.1) m
100 W	12.0 (35.0) m	12.0 (35.0) m	23.0 (70.0) m

### Electrosurgery Interference/Defibrillation/Electrostatic Discharge

The equipment returns to the previous operating mode within 10 seconds without loss of any stored data. Measurement accuracy may be temporarily decreased while performing electrosurgery or defibrillation. This does not affect patient or equipment safety. Do not expose the equipment to x-ray or strong magnetic fields (MRI).

### Fast Transients/Bursts

The equipment will return to the previous operating mode within 10 seconds without loss of any stored data. If any user interaction is required, the monitor indicates with a technical alarm (INOP).

### Restart time

After power interruption, an ECG wave will be shown on the display after 30 seconds maximum.





# Default Settings Appendix

This appendix documents the most important default settings of your monitor as it is delivered from the factory. For a comprehensive list and explanation of default settings, see the *Configuration Guide* supplied with your monitor. The monitor's default settings can be permanently changed in Configuration Mode.

Note: If your monitor has been ordered pre-configured to your requirements, the settings at delivery will be different from those listed here.

## Country-Specific Default Settings

Certain default settings are specific to a particular country. These are listed here for all countries alphabetically.

Country-Description	Line Frequency 50/60 [Hz]	Units Weight kg, lb	Units Height in, cm	ECG Cable Color IEC, AAMI
Afghanistan	50	kg	cm	AAMI
Åland Islands	50	kg	cm	IEC
Albania	50	kg	cm	IEC
Algeria	50	kg	cm	IEC
American Samoa	60	lb	in	AAMI
Andorra	60	lb	in	AAMI
Angola	50	kg	cm	IEC
Anguilla	60	lb	in	AAMI
Antarctica	60	lb	in	AAMI
Antigua and Barbuda	50	kg	cm	AAMI
Argentina	50	kg	cm	AAMI
Armenia	50	kg	cm	IEC
Aruba	60	kg	cm	AAMI
Australia	50	kg	cm	AAMI
Austria	50	kg	cm	IEC
Azerbaijan	50	kg	cm	IEC

## 25 Default Settings Appendix

Country-Description	Line Frequency 50/60 [Hz]	Units Weight kg, lb	Units Height in, cm	ECG Cable Color IEC, AAMI
Bahamas	60	kg	cm	AAMI
Bahrain	50	kg	cm	AAMI
Bangladesh	50	kg	cm	IEC
Barbados	50	kg	cm	AAMI
Belarus	50	kg	cm	IEC
Belgium	50	kg	cm	IEC
Belize	60	lb	in	AAMI
Benin	60	lb	in	AAMI
Bermuda	60	kg	cm	AAMI
Bhutan	60	lb	in	AAMI
Bolivia	60	kg	cm	AAMI
Bosnia and Herzegovina	50	kg	cm	IEC
Botswana	50	kg	cm	IEC
Bouvet Island	60	lb	in	AAMI
Brazil	60	kg	cm	AAMI
British Indian Ocean Territory	60	lb	in	AAMI
Brunei Darussalam	50	kg	cm	IEC
Bulgaria	50	kg	cm	IEC
Burkina Faso	50	kg	cm	IEC
Burundi	50	kg	cm	IEC
Cambodia	50	kg	cm	IEC
Cameroon	50	kg	cm	IEC
Canada	60	kg	cm	AAMI
Cape Verde	60	lb	in	AAMI
Cayman Islands	60	kg	cm	AAMI
Central African Republic	50	kg	cm	IEC
Chad	60	lb	in	AAMI
Chile	50	kg	cm	AAMI
China	50	kg	cm	AAMI
Christmas Islands	60	lb	in	AAMI
Cocos Keeling Islands	60	lb	in	AAMI
Colombia	60	kg	cm	AAMI
Comoros	60	lb	in	AAMI
Congo	50	kg	cm	IEC
Congo, The Democratic Republic of the	50	kg	cm	IEC

Country-Description	Line Frequency 50/60 [Hz]	Units Weight kg, lb	Units Height in, cm	ECG Cable Color IEC, AAMI
Cook Islands	60	lb	in	AAMI
Costa Rica	60	kg	cm	AAMI
Côte d'Ivoire	50	kg	cm	IEC
Croatia	50	kg	cm	IEC
Cuba	60	kg	cm	IEC
Cyprus	50	kg	cm	IEC
Czech Republic	50	kg	cm	IEC
Denmark	50	kg	cm	IEC
Djibouti	50	kg	cm	IEC
Dominica	50	kg	cm	AAMI
Dominican Republic	60	kg	cm	AAMI
Ecuador	60	kg	cm	AAMI
Egypt	50	kg	cm	IEC
El Salvador	60	kg	cm	AAMI
Equatorial Guinea	50	kg	cm	IEC
Eritrea	50	kg	cm	IEC
Estonia	50	kg	cm	IEC
Ethiopia	50	kg	cm	IEC
Falkland Islands, Malvinas	60	lb	in	AAMI
Faroe Islands	60	lb	in	AAMI
Fiji	60	lb	in	AAMI
Finland	50	kg	cm	IEC
France	50	kg	cm	IEC
French Guiana	50	kg	cm	IEC
French Polynesia	60	lb	in	AAMI
French Southern Territories	60	lb	in	AAMI
Gabon	50	kg	cm	IEC
Gambia	50	kg	cm	IEC
Georgia	60	lb	in	AAMI
Germany	50	kg	cm	IEC
Ghana	50	kg	cm	IEC
Gibraltar	60	lb	in	AAMI
Greece	50	kg	cm	IEC
Greenland	60	lb	in	AAMI
Grenada	50	kg	cm	AAMI
Guadeloupe	50	kg	cm	IEC

## 25 Default Settings Appendix

Country-Description	Line Frequency 50/60 [Hz]	Units Weight kg, lb	Units Height in, cm	ECG Cable Color IEC, AAMI
Guam	60	lb	in	AAMI
Guatemala	60	kg	cm	AAMI
Guernsey	50	kg	cm	IEC
Guinea	60	lb	in	AAMI
Guinea-Bissau	60	lb	in	AAMI
Guyana	60	kg	cm	AAMI
Haiti	60	kg	cm	AAMI
Heard Island and McDonald Islands	60	lb	in	AAMI
Holy See, Vatican City State	60	lb	in	AAMI
Honduras	60	kg	cm	AAMI
Hong Kong	50	kg	cm	IEC
Hungary	50	kg	cm	IEC
Iceland	50	kg	cm	IEC
India	50	kg	cm	IEC
Indonesia	50	kg	cm	IEC
Iran, Islamic Republic of	50	kg	cm	AAMI
Iraq	50	kg	cm	AAMI
Ireland	50	kg	cm	IEC
Isle of Man	50	kg	cm	IEC
Israel	50	kg	cm	IEC
Italy	50	kg	cm	IEC
Jamaica	50	kg	cm	AAMI
Japan	50	kg	cm	IEC
Jersey	50	kg	cm	IEC
Jordan	50	kg	cm	AAMI
Kazakhstan	50	kg	cm	IEC
Kenya	50	kg	cm	IEC
Kiribati	60	lb	in	AAMI
Korea, Democratic People's Republic of	60	lb	in	AAMI
Korea, Republic of	60	kg	cm	AAMI
Kuwait	50	kg	cm	AAMI
Kyrgyzstan	60	lb	in	AAMI
Lao People's Democratic Republic	50	kg	cm	IEC
Latvia	50	kg	cm	IEC

Country-Description	Line Frequency 50/60 [Hz]	Units Weight kg, lb	Units Height in, cm	ECG Cable Color IEC, AAMI
Lebanon	50	kg	cm	AAMI
Lesotho	50	kg	cm	IEC
Liberia	50	kg	cm	IEC
Libyan Arab Jamahiriya	60	lb	in	AAMI
Liechtenstein	60	lb	in	AAMI
Lithuania	50	kg	cm	IEC
Luxembourg	50	kg	cm	IEC
Macao	50	kg	cm	IEC
Macedonia, The former Yugoslavian Republic of	50	kg	cm	IEC
Madagascar	50	kg	cm	IEC
Malawi	50	kg	cm	IEC
Malaysia	50	kg	cm	IEC
Maldives	60	lb	in	AAMI
Mali	50	kg	cm	IEC
Malta	50	kg	cm	IEC
Marshall Islands	60	lb	in	AAMI
Martinique	60	kg	cm	IEC
Mauritania	50	kg	cm	IEC
Mauritius	60	lb	in	AAMI
Mayotte	60	lb	in	AAMI
Mexico	60	kg	cm	AAMI
Micronesia, Federal States of	60	lb	in	AAMI
Moldova, Republic of	60	lb	in	AAMI
Monaco	60	lb	in	AAMI
Mongolia	60	lb	in	AAMI
Montenegro	50	kg	cm	IEC
Montserrat	50	kg	cm	AAMI
Morocco	50	kg	cm	IEC
Mozambique	50	kg	cm	IEC
Myanmar	60	lb	in	AAMI
Namibia	50	kg	cm	IEC
Nauru	60	lb	in	AAMI
Nepal	50	kg	cm	IEC
Netherlands	50	kg	cm	IEC
Netherlands Antilles	50	kg	cm	AAMI

## 25 Default Settings Appendix

Country-Description	Line Frequency 50/60 [Hz]	Units Weight kg, lb	Units Height in, cm	ECG Cable Color IEC, AAMI
New Caledonia	60	lb	in	AAMI
New Zealand	50	kg	cm	AAMI
Nicaragua	60	kg	in	AAMI
Niger	50	kg	cm	IEC
Nigeria	50	kg	cm	IEC
Niue	60	lb	in	AAMI
Norfolk Islands	60	lb	in	AAMI
Northern Mariana Islands	60	lb	in	AAMI
Norway	50	kg	cm	IEC
Oman	50	kg	cm	AAMI
Pakistan	50	kg	cm	IEC
Palau	60	lb	in	AAMI
Palestinian Territory	50	kg	cm	AAMI
Panama	60	lb	in	AAMI
Papua New Guinea	60	lb	in	AAMI
Paraguay	50	kg	cm	AAMI
Peru	60	kg	cm	AAMI
Philippines	60	kg	cm	AAMI
Pitcairn	60	lb	in	AAMI
Poland	50	kg	cm	IEC
Portugal	50	kg	cm	IEC
Puerto Rico	60	lb	in	AAMI
Qatar	50	kg	cm	AAMI
Reunion	60	lb	in	AAMI
Romania	50	kg	cm	IEC
Russian Federation	50	kg	cm	IEC
Rwanda	50	kg	cm	IEC
Saint Helena	60	lb	in	AAMI
Saint Kitts and Nevis	60	kg	cm	AAMI
Saint Lucia	50	kg	cm	AAMI
Saint Pierre and Miquelon	60	lb	in	AAMI
Saint Vincent & the Grenadines	50	kg	cm	AAMI
Samoa	60	lb	in	AAMI
San Marino	60	lb	in	AAMI
Sao Tome and Principe	60	lb	in	AAMI
Saudi Arabia	50	kg	cm	AAMI

Country-Description	Line Frequency 50/60 [Hz]	Units Weight kg, lb	Units Height in, cm	ECG Cable Color IEC, AAMI
Senegal	50	kg	cm	IEC
Serbia	50	kg	cm	IEC
Serbia & Montenegro	50	kg	cm	IEC
Seychelles	60	lb	in	AAMI
Sierra Leone	50	kg	cm	IEC
Singapore	50	kg	cm	IEC
Slovakia	50	kg	cm	IEC
Slovenia	50	kg	cm	IEC
Solomon Islands	60	lb	in	AAMI
Somalia	50	kg	cm	IEC
South Africa	60	lb	in	AAMI
South Georgia and the South Sandwich Islands	60	lb	in	AAMI
Spain	50	kg	cm	IEC
Sri Lanka	50	kg	cm	IEC
Sudan	50	kg	cm	IEC
Suriname	60	kg	cm	AAMI
Svalbard and Jan Mayen	60	lb	in	AAMI
Swaziland	60	lb	in	AAMI
Sweden	50	kg	cm	IEC
Switzerland	50	kg	cm	IEC
Syrian Arab Rep	50	kg	cm	AAMI
Taiwan, Province of China	60	kg	cm	AAMI
Tajikistan	60	lb	in	AAMI
Tanzania, United Republic of	60	lb	in	AAMI
Thailand	50	kg	cm	AAMI
Timor-Leste	60	lb	in	AAMI
Togo	60	lb	in	AAMI
Tokelau	60	lb	in	AAMI
Tonga	60	lb	in	AAMI
Trinidad and Tobago	60	kg	cm	AAMI
Tunisia	50	kg	cm	IEC
Turkey	50	kg	cm	IEC
Turkmenistan	60	lb	in	AAMI
Turks and Caicos Islands	60	kg	cm	AAMI
Tuvalu	60	lb	in	AAMI

## 25 Default Settings Appendix

Country-Description	Line Frequency 50/60 [Hz]	Units Weight kg, lb	Units Height in, cm	ECG Cable Color IEC, AAMI
Uganda	60	lb	in	AAMI
Ukraine	60	lb	in	AAMI
United Arab Emirates	50	kg	cm	AAMI
United Kingdom	50	kg	cm	IEC
United States	60	lb	in	AAMI
United States Minor Outlying Islands	60	lb	in	AAMI
Uruguay	50	kg	cm	AAMI
Uzbekistan	60	lb	in	AAMI
Vanuatu	60	lb	in	AAMI
Venezuela	60	lb	in	AAMI
Viet Nam	50	kg	cm	IEC
Virgin Islands, British	50	kg	cm	AAMI
Virgin Islands, United States	60	lb	in	AAMI
Wallis and Futuna Islands	60	lb	in	AAMI
Western Sahara	50	kg	cm	IEC
Yemen	50	kg	cm	AAMI
Zambia	60	lb	in	AAMI
Zimbabwe	60	lb	in	AAMI



## Alarm and Measurement Default Settings

The default wave speed for all measurements except Respiration is 25 mm/sec. For Respiration the default wave speed is 6.25 mm/sec.

In the following tables, settings may be entered only once per table row if they are the same for all patient categories.

### Alarm Default Settings

Alarm Settings	Factory Default H10/H20/H40	H30 (deviations from H10/H20/H40)
Alarm Volume	5	
Alarms Off	2 min	
Pause Al. 5Min	Enabled	
Pause Al. 10Min	Enabled	
Auto Alarms Off	Off	
AlarmOffReminder	Off	
Visual Latching	Red&Yellow	Red Only
Audible Latching	Red&Yellow	Off
Alarm Reminder	On	
Reminder Time	3 min	
Alarm Sounds	Traditional	
RedAlarmInterval	10 sec	
Yel.Al. Interval	20 sec	
Alarm Low	4	2
Red Alarm Volume	AlarmVol. +2	
Yell.AlarmVolume	AlarmVol. +0	
INOP Volume	AlarmVol. +0	
AutoIncrease Vol	2 Steps	
IncreaseVolDelay	20 sec	
Keep Blinking	No	
Relay1 Sensitiv.	R&Y&C	
Relay2 Sensitiv.	Red&Yellow	
Relay3 Sensitiv.	Red	
CyanRelayLatency	5 sec	
Yel.RelayLatency	2 sec	
Alarm Text	Standard	
NoCentrMonMinVol	On4	

## ECG, Arrhythmia, ST and QT Default Settings

ECG Settings	Factory Defaults		
	Adult	Pedi	Neo
High Limit	120 bpm	160 bpm	200 bpm
Low Limit	50 bpm	75 bpm	100 bpm
ECG/Arrhy Alarms	On	On	On
Alarm Source	Auto	Auto	Auto
ECG	On	On	On
QRS Volume	1	1	1
Primary Lead	II	II	II
Secondary Lead	V	V	V
Analysis Mode	Multi Lead	Multi Lead	Multi Lead
Lead Placement	Standard	Standard	Standard
Mod.LeadPlacment	Off	Off	Off
Filter	Monitor	Monitor	Monitor
AutoFilter	Off	Off	Off
Default ECG Size	Size X1	Size X1	Size X1
Color	Green	Green	Green
Asystole Thresh.	4.0 sec	4.0 sec	3.0 sec
Δ ExtrTachy	20 bpm	20 bpm	20 bpm
Tachy Clamp	200 bpm	220 bpm	240 bpm
Δ ExtrBrady	20 bpm	20 bpm	20 bpm
Brady Clamp	40 bpm	40 bpm	50 bpm
ECG Alm Off INOP	Cyan	Cyan	Cyan
Fallback	On	On	On
Alarms Off	Enabled	Enabled	Enabled
AlarmSource Sel.	Enabled	Enabled	Enabled
Va Lead	V2	V2	V2
Vb Lead	V5	V5	V5
SyncPulse Sensit	Medium	Medium	Medium
SyncPulse Marker	On	On	On
PulseAlarms Tele	Enabled	Enabled	Enabled

## Arrhythmia Default Settings

Arrhythmia Settings	Factory Defaults		
	Adult	Pedi	Neo
Arrhythmia	On	On	Off
Pause Threshold	2.0 sec	2.0 sec	1.5 sec
VTach HR	100	120	150
VTach Run	5	5	5

Arrhythmia Settings	Factory Defaults		
	Adult	Pedi	Neo
Vent Rhythm	14	14	14
SVT HR	180	200	210
SVT Run	5	5	5
PVCs/min	10	5	5
Non-Sustain	On	On	On
Vent Rhythm	On	On	On
Run PVCs	On	On	On
Pair PVCs	On	On	On
R-On-T PVCs	On	On	On
V.Bigeminy	On	On	On
V.Trigeminy	On	On	On
PVCs/min	On	On	On
Multif.PVCs	On	On	On
Pacer N.Cap	On	On	On
Pacer N.Pac	On	On	On
Pause	On	On	On
Missed Beat	On	On	On
SVT	On	On	On
Afib	On	On	On
Irregular HR	On	On	On
HR Alarms	Short Yellow	Short Yellow	Short Yellow
TimeOut 1st	3 min	3 min	3 min
TimeOut 2nd	10 min	10 min	10 min
ArrhyOff Message	Yes	Yes	Yes
Some ECG AI INOP	On	On	On

## ST and QT Default Settings

Lead-independent ST Settings	Factory Defaults		
	Adult	Pedi	Neo
ST Alarm Mode	Single ST	Single ST	Single ST
Alarms	On	On	On
ST Analysis	On	Off	Off
ST-Index	On	Off	Off
ISO Point	-80 ms	-80 ms	-80 ms
J Point	48 ms	48 ms	48 ms
ST Point	J+60	J+60	J+60

Lead I, II, III, V, aVR, aVL, V1-6, MCL Settings	Factory Defaults		
	Adult	Pedi	Neo
ST Analysis	On	Off	Off
For Alarm Mode = Single ST			
ST (Label) High	+2.0 mm	+2.0 mm	+2.0 mm
ST (Label) Low	-2.0 mm	-2.0 mm	-2.0 mm
For Alarm Mode = Multi ST			
ST (Label) High	+1.0 mm	+1.0 mm	+1.0 mm
ST (Label) Low	+1.0 mm	+1.0 mm	+1.0 mm

QT Settings	Factory Defaults		
	Adult	Pedi	Neo
QT Lead	All	All	All
QTc High Limit	500 ms	480 ms	460 ms
$\Delta$ QTc High Limit	60 ms	60 ms	60 ms
QTc High Alarm	On	On	On
$\Delta$ QTc High Alarm	On	On	On
QT Analysis	Off	Off	Off
QTc Formula	Bazett	Bazett	Bazett

## Pulse Default Settings

Pulse Settings	Factory Defaults		
	Adult	Pedi	Neo
Alarm Source	Auto	Auto	Auto
Pulse (source label)	On	On	On
System Pulse	SpO <sub>2</sub>	SpO <sub>2</sub>	SpO <sub>2</sub>
Alarms Off	Enabled	Enabled	Enabled
AlarmSource Sel.	Enabled	Enabled	Enabled

Pulse Alarm Settings	Factory defaults H10/H20/H40		
	Adult	Pedi	Neo
Pulse (SpO <sub>2</sub> )	On	On	On
Pulse Alarms	Off	Off	Off
High Limit	120 bpm	160 bpm	200 bpm
Low Limit	50 bpm	75 bpm	100 bpm

Pulse Alarm Settings	Factory defaults H10/H20/H40		
	Adult	Pedi	Neo
$\Delta$ ExtrBrady	20 bpm	20 bpm	20 bpm
Brady Clamp	40 bpm	40 bpm	50 bpm
$\Delta$ ExtrTachy	20 bpm	20 bpm	20 bpm
Tachy Clamp	200 bpm	220 bpm	240 bpm

Pulse alarms use the settings of the currently selected Pulse alarm source.

## Respiration Default Settings

Respiration Settings	Factory Defaults		
	Adult	Pedi	Neo
High Limit	30 rpm	30 rpm	100 rpm
Low Limit	8 rpm	8 rpm	30 rpm
Apnea Time	20 sec	20 sec	20 sec
Alarms	On	On	On
Resp	On	On	On
Detection	Auto (Trigger Mode)	Auto (Trigger Mode)	Auto (Trigger Mode)
Color	Yellow	Yellow	Yellow

## SpO<sub>2</sub> Default Settings

SpO <sub>2</sub> Settings	Factory Defaults		
	Adult	Pedi	Neo
Mode	Continuous	Continuous	Continuous
Repeat Time	15 min	15 min	15 min
Alarms	On	On	On
QRS Volume	1	1	1
Tone Modulation	Yes	Yes	Yes
Tone Mod. Type	Enhanced	Enhanced	Enhanced
Perfusion	On	On	On
Average	10 sec	10 sec	10 sec
NBP Alarm Suppr.	On	On	On
Extd. Auto OnOff	Disabled	Disabled	Disabled
Color	Cyan (light blue)	Cyan (light blue)	Cyan (light blue)
Average In Mon.	No	No	No
Signal Quality	On	On	On

SpO <sub>2</sub> Alarm Default Settings			
Setting	Adult	Pedi	Neo
Desat Limit	80	80	80
Low Limit	90	90	85
High Limit	100	100	95
Desat Delay	20 sec	20 sec	20 sec
High Alarm Delay	10 sec	10 sec	10 sec
Low Alarm Delay	10 sec	10 sec	10 sec
SmartAlarmDelay (SAD)	Off	Off	Off
High Alarm Delay (SAD)	Short	Short	Short
Low Alarm Delay (SAD)	Short	Short	Short
Label	SpO <sub>2</sub>	SpO <sub>2</sub>	SpO <sub>2</sub>
Pulse settings			
Pulse (SpO <sub>2</sub> )	On	On	On
For all other Pulse default settings, refer to the Pulse Default Settings table.			

## NBP Default Settings

NBP Settings	Factory Defaults		
	Adult	Pedi	Neo
Mode	Auto	Auto	Manual
Alarms from	Sys.	Sys.	Sys.
High Limit	160/90 (110)	120/70 (90)	90/60 (70)
Low Limit	90/50 (60)	70/40 (50)	40/20 (24)
Alarms	On	On	On
NBP	On	On	On
Repeat Time	10 min	10 min	10 min
Pulse (NBP)	On	On	On
Unit	mmHg	mmHg	mmHg
Done Tone	Off	Off	Off
Start Time	Synchronized	Synchronized	Synchronized
VP Pressure	60 mmHg	40 mmHg	30 mmHg
Reference	Auscultatory	Auscultatory	Invasive
Color	Red	Red	Red

## Temperature Default Settings

Temp Settings	Factory Defaults		
	Adult	Pedi	Neo
Low Limit	36	36	36
High Limit	39	39	39
Alarms	On	On	On
Unit	°C	°C	°C
Range	35...43	35...43	35...43
Color	Green	Green	Green

## Invasive Pressure Default Settings

ABP, ART, Ao, BAP, FAPP,P P1, P2, P3, P4, UAP Settings	Factory Defaults		
	Adult	Pedi	Neo
Alarms from	Sys.	Sys.	Sys.
High Limit	160/90 (110)	120/70 (90)	90/60 (70)
Low Limit	90/50 (70)	70/40 (50)	55/20 (36)
Alarms	On	On	On
Extreme Alarms	Disabled	Disabled	Disabled
Δ Extreme High	15	10	5
Δ Extreme Low	15	10	5
Sys. High Clamp	190/100 (125)	140/80 (100)	105/75 (75)
Sys. Low Clamp	80/45 (65)	60/35 (45)	45/15 (30)
Scale	150	100	100
Mean only	No	No	No
Filter	12 Hz	12 Hz	12 Hz
Mercury Cal	Yes	Yes	Yes
Artifact Suppr.	60 sec	60 sec	60 sec
Unit	mmHg	mmHg	mmHg
Color	Red	Red	Red

CVP, RAP, LAP, UVP Settings	Factory Defaults		
	Adult	Pedi	Neo
Alarms from	Mean	Mean	Mean
High Limit	14/6 (10)	10/2 (4)	10/2 (4)
Low Limit	6/-4 (0)	2/-4 (0)	2/-4 (0)
Alarms	On	On	On
Extreme Alarms	Enabled	Enabled	Enabled
Δ Extreme High	5	5	5

## 25 Default Settings Appendix

CVP, RAP, LAP, UVP Settings	Factory Defaults		
	Adult	Pedi	Neo
<b>Δ Extreme Low</b>	5	5	5
<b>Mean High Clamp</b>	20/10 (15)	15/5 (10)	15/5 (10)
<b>Mean Low Clamp</b>	0/-5 (-5)	0/-5 (-5)	0/-5 (-5)
<b>Scale</b>	30	30	30
<b>Mean only</b>	<b>Yes</b>	<b>Yes</b>	<b>Yes</b>
<b>Filter</b>	<b>12 Hz</b>	<b>12 Hz</b>	<b>12 Hz</b>
<b>Mercury Cal</b>	<b>Yes</b>	<b>Yes</b>	<b>Yes</b>
<b>Artifact Suppr.</b>	60 sec	60 sec	60 sec
<b>Unit</b>	<b>mmHg</b>	<b>mmHg</b>	<b>mmHg</b>
<b>Color</b>	<b>Cyan</b> (light blue)	<b>Cyan</b> (light blue)	<b>Cyan</b> (light blue)

PAP Settings	Factory Defaults		
	Adult	Pedi	Neo
<b>Alarms from</b>	<b>Dia.</b>	<b>Dia.</b>	<b>Dia.</b>
<b>High Limit</b>	34/16 (20)	60/4 (26)	60/4 (26)
<b>Low Limit</b>	10/0 (0)	24/-4 (12)	24/-4 (12)
<b>Alarms</b>	<b>On</b>	<b>On</b>	<b>On</b>
<b>Extreme Alarms</b>	<b>Enabled</b>	<b>Enabled</b>	<b>Enabled</b>
<b>Δ Extreme High</b>	5	5	5
<b>Δ Extreme Low</b>	5	5	5
<b>Dia. High Clamp</b>	45/20 (25)	65/5 (35)	65/5 (35)
<b>Dia. Low Clamp</b>	5/-5 (-5)	15/-5 (5)	15/-5 (5)
<b>Scale</b>	30	30	30
<b>Mean only</b>	<b>No</b>	<b>No</b>	<b>No</b>
<b>Filter</b>	<b>12 Hz</b>	<b>12 Hz</b>	<b>12 Hz</b>
<b>Mercury Cal</b>	<b>Yes</b>	<b>Yes</b>	<b>Yes</b>
<b>Artifact Suppr.</b>	60 sec	60 sec	60 sec
<b>Unit</b>	<b>mmHg</b>	<b>mmHg</b>	<b>mmHg</b>
<b>Color</b>	<b>Yellow</b>	<b>Yellow</b>	<b>Yellow</b>

ICP, IC1, IC2 Settings	Factory Defaults		
	Adult	Pedi	Neo
<b>Alarms from</b>	<b>Mean</b>	<b>Mean</b>	<b>Mean</b>
<b>High Limit</b>	14/6 (10)	10/2 (4)	10/2 (4)
<b>Low Limit</b>	6/-4 (0)	2/-4 (0)	2/-4 (0)
<b>Alarms</b>	<b>On</b>	<b>On</b>	<b>On</b>
<b>Extreme Alarms</b>	<b>Enabled</b>	<b>Enabled</b>	<b>Enabled</b>
<b>Δ Extreme High</b>	10	10	10



ICP, IC1, IC2 Settings	Factory Defaults		
	Adult	Pedi	Neo
<b>Δ Extreme Low</b>	10	10	10
<b>Mean Low Clamp</b>	20/10 (-5)	15/5 (-5)	15/5 (-5)
<b>Mean High Clamp</b>	0/-5 (0)	0/-5 (0)	0/-5 (0)
<b>Scale</b>	30	30	30
<b>Mean only</b>	<b>Yes</b>	<b>Yes</b>	<b>Yes</b>
<b>Filter</b>	12 Hz	12 Hz	12 Hz
<b>Mercury Cal</b>	<b>Yes</b>	<b>Yes</b>	<b>Yes</b>
<b>Artifact Suppr.</b>	60 sec	60 sec	60 sec
<b>Unit</b>	<b>mmHg</b>	<b>mmHg</b>	<b>mmHg</b>
<b>Color</b>	<b>Magenta</b>	<b>Magenta</b>	<b>Magenta</b>

## CO<sub>2</sub> Default Settings

CO <sub>2</sub> Settings	Factory Defaults		
	Adult	Pedi	Neo
<b>etCO<sub>2</sub> Low</b>	30	30	30
<b>etCO<sub>2</sub> High</b>	50	50	50
<b>imCO<sub>2</sub> High</b>	4	4	4
<b>CO<sub>2</sub> Alarms</b>	<b>On</b>	<b>On</b>	<b>On</b>
<b>Unit</b>	mmHg	mmHg	mmHg
<b>Scale</b>	40 mmHg	40 mmHg	40 mmHg
<b>imCO<sub>2</sub></b>	<b>On</b>	<b>On</b>	<b>On</b>
<b>N<sub>2</sub>O Corr.</b> (only M3015A/M3016A)	<b>Off</b>	<b>Off</b>	<b>Off</b>
<b>Oxygen Corr.</b> (only M3014A)	16%	16%	16%
<b>Gas Corr.</b> (only M3014A)	<b>Off</b>	<b>Off</b>	<b>Off</b>
<b>Humidity Corr.</b>	<b>BTPS</b>	<b>BTPS</b>	<b>BTPS</b>
<b>Max Hold</b>	<b>Off</b>	<b>Off</b>	<b>Off</b>
<b>awRR</b>	<b>On</b>	<b>On</b>	<b>On</b>
<b>awRR Alarms</b>	<b>On</b>	<b>On</b>	<b>On</b>
<b>High Limit</b> (awRR)	30	30	60
<b>Low Limit</b> (awRR)	8	8	30
<b>Apnea Time</b>	<b>20 sec</b>	<b>20 sec</b>	<b>20 sec</b>
<b>Color</b>	<b>Yellow</b>	<b>Yellow</b>	<b>Yellow</b>



# Index

## #

---

- 10-lead placement (ECG) 116
- 12-lead placement (ECG) 116
- 3-lead placement (ECG) 115
- 5-lead placement (ECG) 115

## A

---

- AAMI ECG lead labels 114
- abdominal breathing 160
  - and Resp electrode placement 160
- aberrantly conducted beats 128
- accessories
  - 10-electrode cable sets 259
  - 3-electrode cable sets 258, 260
  - 5-electrode cable sets 258, 260
  - 5-electrode one piece cables 261
  - 6-electrode cable sets 259
  - CO2 201, 202, 203
  - CO2 (mainstream) 269, 270
  - ECG 107
  - NBP 177
    - adult cuffs 263
    - comfort cuffs 262
    - disposable cuffs 263
    - multi-patient comfort cuff kits 262
    - neonatal/infant cuffs (single patient) 263
    - reusable cuffs 262
    - single patient, adult/pediatric soft cuffs 263
  - resp 257
  - set combiners and organizers 259, 261
  - SpO2 165
  - trunk cables 257, 260
- active alarms 51
- address, Philips 274
- addressograph (printer configuration setting) 238
- adjusting ST measurement points 142
- adjusting wave scale (pressure) 191
- adjusting wave size (CO2) 204
- admitting a patient
  - quick admit 92
- airway adapter 203
  - CO2, microstream accessory 203
- alarm latching 62, 63, 133
- alarm limits 58, 60
  - checking 58
  - narrow 60
  - report 216
  - ST 137
  - switching auto limits on/off 60
  - using automatic limits 60
  - wide 60
- alarm source selection, disabled 157
- alarms 51
  - active 51
  - alphabetical listing 65
  - apnea delay time (Resp) 162
  - arrhythmia 127
  - awrr limits 206
  - chaining 135
  - CO2, awRR 206
  - desat, SpO2 175
  - effect on pressure alarms during zero 189
  - high priority 51
  - INOP 51
  - ISO/IEC standard 54
  - limit, SpO2 290
  - patient messages 65
  - physiological 65
  - recordings 64
  - red 51
  - selftest 63
  - SpO2 specific 170
  - ST 144
  - testing 63
  - tone configuration 53
  - traditional 54
  - yellow 51
- alphabetical listing of alarms 65
- analog output
  - ECG 107
- apnea alarm delay
  - CO2 201, 202, 203
- apnea alarm delay time (RESP) 162
- apnea alarms 162
  - and Resp detection modes 161
- arrhythmia 127
  - aberrantly conducted beats 128
  - analysis, how it works 127
  - atrial fibrillation and flutter 128
  - beat labels 130
  - initiating learning 132
  - intermittent bundle branch block 129
  - learning during ventricular rhythm 132
  - levels of analysis 123, 127
  - monitoring non-paced patients 127
  - monitoring paced patients 127
  - options 127
  - relearning 132
  - relearning and lead fallback 132
  - status messages 130
  - switching on/off 60
  - understanding the display 129

- arrhythmia alarms 51, 133, 135, 137, 287
  - adjusting alarm limits 134
  - all yellow on/off 134
  - chaining 135
  - latching 62, 63
  - multiple 135
  - PVC-related alarms 137
  - sinus and SV rhythm ranges 290
  - switching on/off 60
  - timeout periods 134
- arrhythmia monitoring 125
  - and defibrillation 125
- arrhythmia options 123
- arrhythmia relearning 122
  - with EASI INOP 122
- arterial pressure source 194
- arterial pulsation 165
- artifact suppression (pressure) 191
- atrial fibrillation and flutter 128
- audible latching (arrhythmia alarms) 133
- auto alarm limits 60
  - switching on/off 60
- auto detection mode (Resp) 160
- automatic arrhythmia relearn 132
- automatic default setting 36
- automatic NBP
  - repeat time 179
- autosize 111
  - ECG wave 111
- awRR alarm 206
  - limits 206
- awRR alarms 206
  - CO2 201, 202, 203

## B

---

- baseline 148
  - ST map, updating 148
- basic arrhythmia option 123, 127
- battery 245, 248, 249, 251, 275
  - and display brightness 251
  - battery reports 248

- charge status 248
- conserving power 251
- indicators 51
- malfunction indicator 246
- monitoring time 246
- safety information 125, 162
- status indicator 246
- symbol 275
- time to empty 247
- time to full 247
- battery eject symbol 275
- battery performance 250
  - optimizing 250
- beat labels 130
  - arrhythmia 127
- blood pressure. See also NBP (non-invasive) or PRESS (invasive) 177

## C

- calculating cerebral perfusion 194
- calculating temperature difference 186
- calibrating 183
- calibration 183, 192, 193
  - NBP 177
  - pressure transducer 192
- cardiac overlay 159, 161
  - and Resp detection modes 161
  - when measuring Resp 159
- cardiotach alarms 123
- cerebral perfusion 194
- chaining 135
- change screen window 34
- changing ECG lead sets 113
- changing Resp detection mode 160
- changing Resp wave size 161
- changing Resp wave speed 162
- checking battery charge 248
- checklist 11, 12
  - delivery 12
  - installation 11
- cleaning 241
  - infection control 241
  - monitoring accessories 243
- CO2 201, 202, 203
  - airway adapter 203
  - alarms, awRR 206
  - awRR alarm limits 206
  - checking transducer accuracy 201
  - correction, humidity 204
  - correction, N2O 204
  - corrections 204
  - FilterLine 203
  - measuring mainstream 201
  - measuring microstream 203
  - microstream accessories 203

- microstream extension 203
- removing exhaust gases 200, 204
- transducer, using 202
- wave scale, adjusting 204
- CO2 (mainstream) 269, 270
- configuration mode
  - entering 17
- connecting power 13
- connecting temperature probe 185
- connection direction symbol 275
- connectors 276
- conventional 12-lead ECG 117
- correcting the NBP measurement 179
- CPAP (RESP) 160
- cuff 179
  - pressure, NBP 179
  - selection, NBP 179
- current view
  - ST map 145

## D

- damage claims 12
- DC power symbol 275
- default profile 36
- default settings 305
  - checking country-specific 17
- defibrillation 125
  - and arrhythmia monitoring 125
  - and ECG monitoring 125
- defibrillator proof symbol 275
- desat alarm, SpO2 175
- detection modes (Resp) 160
- disinfecting 241
  - infection control 241
- display 129, 139, 160, 179
  - arrhythmia 127
  - ECG 107
  - NBP 177
  - Resp 160
  - ST 137
- display brightness 251
- display settings 35
- dual Temp measurement 186
- dyshemoglobins 166
  - intravascular (SpO2) 166

## E

- early systolic blood pressure, NBP 179
- EASI 122
  - ECG monitoring 122
  - lead placement 159
- EASI ECG lead labels 114
- ECG 107

- alarms off (Config Mode) 125
- changing lead sets 113
- choosing electrode sites 113
- conventional 12-lead 117
- external pacing electrodes 125
- fusion beat pacemakers 125
- intrinsic rhythm 125
- modified 12-lead 117
- New Lead Setup 113
- pacemaker failure 125
- rate adaptive pacemakers 125
- wave size 111
- ECG cable 125
  - for operating room 125
- ECG cables, connecting 107
- ECG connector 107
- ECG electrode colors 114
- ECG electrode placement 125
  - during electrosurgery 125
- ECG gain 232
- ECG lead labels 114
- ECG leads monitored 113
- ECG report 232, 239
  - lead layout 232
- ECG safety information 125
- ECG source tracking 104
- ECG wave 111
  - autosize 111
  - calibration bar 111
- ectopic status messages (arrhythmia monitoring) 131
- electrical output symbol 275
- electrode placement (ECG) 107, 117
  - conventional 12-lead 117
  - modified 12-lead 117
- electrode placement (Resp) 159, 160
  - with abdominal breathing 160
  - with lateral chest expansion 160
- electrosurgery 125
  - and ECG 125
- EMC interference 162
  - Resp 160
- end case reports 233
- enhanced arrhythmia option 123, 127
- exclamation mark symbol 275
- exhaust gases, removing 200, 204
- external pacing electrodes 125
  - and ECG monitoring 125
- extreme bradycardia alarm 124
- extreme rate alarms 124
- extreme tachycardia alarm 124

## F

- fallback (ECG) 114

FAST 165  
Fourier artefact suppression  
technology 165  
FilterLine 203  
CO<sub>2</sub>, microstream accessory 203  
flushing invasive pressure accessories 187  
functional arterial oxygen saturation 165  
fusion beat pacemakers 125  
and ECG monitoring 125

## G

---

gas cylinder  
empty, disposing of 255  
getting started 42  
global trend time 222

## H

---

horizon trend 222  
trend time 222  
HR = RR (Resp) 160  
HR alarms 125  
when arrhythmia off 125  
HR alarms off (Config Mode) 125  
HR and pulse alarm source selection 157  
humidity correction 204  
CO<sub>2</sub> 201, 202, 203

## I

---

IEC ECG lead labels 114  
IMV (Resp) 160  
indicators 51  
battery malfunction 246  
infection control 241  
disinfecting 241  
Information Center 96  
central recording 227  
transferring patients 96  
INOPs 51  
indicators 51  
installation 11  
checklist 11, 12  
connectors 276  
personnel 11  
intermittent bundle branch block 129  
intermittent mandatory ventilation  
(Resp) 160  
interruption symbol 275  
intravascular dyshemoglobins (SpO<sub>2</sub>) 166  
intrinsic rhythm 125  
ISO point (ST) 142

## J

---

J point (ST) 142

## K

---

keyboard, on screen 33  
keys 32  
alarms 51  
pop-up 32

## L

---

latching 62, 63  
alarms 51  
alarms, behavior 63  
latching arrhythmia alarms 133  
lateral chest expansion (neonates) 160  
monitoring Resp 160  
lead fallback 132  
and arrhythmia relearning 132  
lead fallback (ECG) 114  
lead labels (ECG) 114  
lead placement 159  
for Resp measurement 159  
leads monitored (ECG) 113  
Leads Off INOP (ECG) 114  
levels of arrhythmia analysis 127

## M

---

main setup 31  
mains power  
connecting to 13  
mainstream CO<sub>2</sub> 201  
measuring 201  
maintenance 253  
schedule 253  
malfunction symbols  
battery 248, 251  
manual detection mode (Resp) 161, 162  
and apnea alarms 162  
manufacture date symbol 275  
manufacturer's information 274  
map 145  
ST 137  
Mason-Likar lead system 117  
measurement points, ST 142  
measurement server  
ECG connector 107  
measurement settings 35  
measurement setup menu 30  
measurements 37, 43  
menu 30, 31  
main setup 31  
measurement setup 30  
messages  
INOP 51  
methemoglobin (SpO<sub>2</sub>) 166

microstream CO<sub>2</sub> 203  
measuring 201  
modified 12-lead ECG 117  
monitor defaults 305  
monitor revision 42  
how to find 42  
monitoring  
starting 42  
mounting 13  
power supply 13

## N

---

N<sub>2</sub>O correction 204  
CO<sub>2</sub> 201, 202, 203  
narrow alarm limits 60  
NBP 177  
adult cuffs 263  
ANSI/AAMI SP10-1992 177  
calibrating 183  
comfort cuff kits 262  
comfort cuffs 262  
cuff pressure 179  
cuff, applying 179  
cuff, selecting 179  
cuff, tightness 179  
disposable cuffs 263  
how the measurement works 177  
measurement correction 179  
measurement limitations 178  
measurement methods, auto 178  
measurement methods, manual 178  
measurement methods, sequence 178  
measurement methods, stat 178  
neonatal cuffs (disposable) 263  
numerics 179  
oscillometric method 177  
pediatric cuffs 263  
preparing to measure 179  
repeat time 179  
reusable cuffs 262  
single patient, adult/pediatric soft  
cuffs 263  
site inspection 166  
time of last measurement 179  
units 179  
venous puncture 183  
neonates 160  
Resp electrode placement 160  
new features 45  
non-invasive blood pressure. See NBP 177  
non-paced patients 127  
arrhythmia monitoring 125  
numerics 179  
explanation of NBP display 179

## O

---

- on-screen keyboard 33
- operating room ECG cable 125
- orange ECG cable 125
- organizers 259, 261
- oscillometric NBP measurement method 177
- overlapping screen trends 223

## P

---

- pace pulse rejection (ECG) 108, 110
  - about 36
  - switching on/off 60
- paced patients 111, 125, 127
  - arrhythmia monitoring 125
  - repolarization tails 111
  - safety information 125, 162
  - setting status 125
- paced status
  - checking 58
- pacemaker failure 125
- parameter scales 220
- patient 177
  - category, NBP 177
- patient alarm messages 65
- patient reports 238
  - contents 238
- performance specifications 287
- performance test 299
- perfusion indicator 165, 166, 175
- Philips contact information 274
- physiological alarms 51
- pleth wave 175
- pleth waveform 165
- pop-up keys 32
- power
  - connection 13
- power supply 13
  - mounting 13
- preparing skin 107
  - for ECG 107
- pressure
  - alarms during zero 189
  - arterial source 194
  - calibration pressure 193
  - cerebral perfusion, calculating 194
  - performance specifications 287
  - wave scale 191
  - wave size 111
- pressure artifact suppression 191
- pressure of NBP cuff 179
- pressure transducer 192
  - calibration 183, 192, 193

- print job 235
  - suspended 235
- printer 235
  - settings 36, 104, 305
  - status messages 130
  - unavailable 235
- printing 231
  - ST map reports 148
- probes 185
  - disposable temperature 185
- profiles 35, 36
  - default profile 36
  - patient category 35
  - swapping a complete profile 36
- pulse 155
  - alarms 51
  - system pulse source 155
- pulse numerics for SpO2 166
- PVC-related alarms 137

## Q

---

- QRS volume, changing 112
- QT alarms 152
- QT baseline 151
- QT measurement algorithm 149
- QT monitoring 149
  - limitations 149
- QT/QTc monitoring 148
- quick admit 92

## R

---

- radiated field immunity 162
  - Resp 160
- rate adaptive pacemakers 125
  - and ECG monitoring 125
- recording
  - preventing fading ink 229
- recording alarms 64
- relearning arrhythmia 132
- repolarization tails 111
- reports 231
  - alarm limits 58, 60
  - battery reports 248
  - contents 238
  - ECG 107
  - re-routing 235
  - scheduled 233
  - ST map 145
  - stopping printouts 232
- re-routing reports 235
- resp accessories 257
- Resp alarms 162
  - apnea alarm delay time 162
- Resp detection level 162

- and apnea detection 162
- Resp detection modes 160, 161
  - and cardiac overlay 159
- Resp display 160
- Resp monitoring 159
  - and cardiac overlay 159
- Resp safety information 162
- Resp wave 161, 162
  - changing size 161
- rhythm status messages (arrhythmia monitoring) 130

## S

---

- safety information 125, 162
  - batteries 252
  - ECG 107
  - Resp 160
- safety test 299
- safety tests 15
  - performance tests 15
  - power on test 15
  - system 15
  - visual inspection 253
- scale 111, 161
  - ECG wave 111
  - Resp wave 161, 162
- scales 220
  - for trends waveforms 220
- scheduled reports 233
- screen trend 222
  - trend time 222
- selftest 63
  - alarms 51
- sequence mode 182
- set combiners 259, 261
- setting up the sequence 182
- settings 36, 104, 305
  - about 36
  - default 305
  - screen settings 36
  - synchronized telemetry and monitor 104
- settings blocks 35
- short yellow alarms on/off 134
- signal quality of SpO2 169
- sinus and SV rhythm ranges 290
- skin preparation 107
  - ECG 107
- SmartKeys symbol 275
- source tracking 104
  - ECG 107
- specifications 287
  - arrhythmia 127
- SpO2 165

- alarms specific to SpO2 170
- arterial pulsation 165
- assessing suspicious reading 169
- FAST technology 165
- perfusion indicator 165, 166, 175
- pleth wave 175
- pleth waveform 165
- pulse numerics 166
- signal quality 169
- site inspection 166
- site selection 165
- SpO2 desat alarm 175
- ST 137
  - adjusting alarm limits 134
  - alarms 51
  - ensuring diagnostic quality 137
  - filtering 137
  - measurement points, adjusting 142
  - snippets 139
- ST display 139
- ST map 145
  - report, printing
    - printing 231
    - ST map report 148
  - scale, changing 148
    - scale 111, 161
    - ST map 145
  - task window 147
  - trending interval, changing 148
  - trending priority 147
- ST maps 145
- ST point 142
- standard 10-lead placement 116
- standard 3-lead placement 115
- standard 5-lead placement (ECG) 115
- standby symbol 275
- status log
  - printing 231
- status messages 130
  - printer 235
- status messages (arrhythmia) 130, 131
  - ectopic 131
  - rhythm 130
- sterilizing 241
  - infection control 241
- stopping reports printouts 232
- surgical ECG cable 125
- suspicious SpO2 reading 169
- symbols 275
  - battery 248, 251
- system pulse 155
- systolic blood pressure, NBP, early 179

---

## T

Tamb 186

- task window for ST map 147
- Tcereb 186
- telemetry alarms 103
  - suspending at bedside 103
- telemetry device
  - unpairing 211
- temperature
  - alarm settings 185
  - connecting probe to monitor 185
  - difference, calculating 186
  - dual Temp measurement 186
  - extended label set 186
  - first 186
  - making a measurement 185
  - probe, disposable 185
  - probe, selecting 185
  - second 186
- temperature probe 185
- test blocks, how to perform 15
- testing alarms 63
- tone configuration, alarm 53
- transducer 201
  - CO2, accuracy 201
- transferring centrally-monitored patients 96
- transport brightness setting 251
- trend time 222
  - global 222
- trend view
  - ST map 145
- trending interval 148
  - ST map 145
- trends
  - setting parameter scales 220
- trends pop-up keys 216
- trends priority list
  - ST map 145
- troubleshooting
  - CO2 201, 202, 203
- trunk cables 257, 260
- Tt ymp 186
- Tvesic 186

---

## U

- unpacking 12
- unpairing 211

---

## V

- V electrode placement (ECG) 116
- venous puncture 183
- visual latching (arrhythmia alarms) 133
- voltage setting 13

---

## W

- wave 191, 204
  - scale (CO2) 204
  - scale (pressure) 191
  - size (CO2) 204
  - size (pressure) 191
- wave size 111
  - Resp 160
- wave size (ECG) 111
- wave speed (Resp) 162
- what's new 45
- wide alarms limits 60
- wired network connection symbol 275

---

## Z

- zero 189
  - effect on pressure alarms 189
- zeroing
  - pressure transducer 192







Part Number 453564306381  
Published in Germany 03/2012



**PHILIPS**