

Registre su producto y obtenga asistencia en  
[www.philips.com/welcome](http://www.philips.com/welcome)

# Guía Rápida

4100 series - LED TV

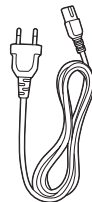
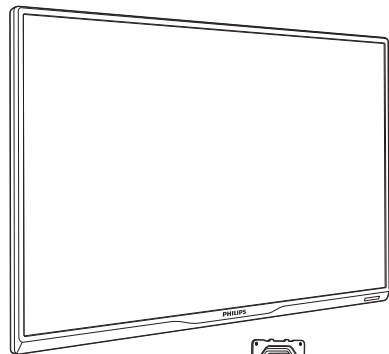

(BR)



(AR)

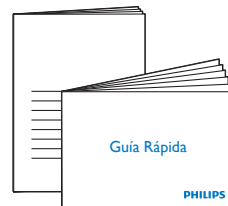

x8

(40''/47''/50'')



x4 x4

(32''/39'')

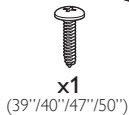
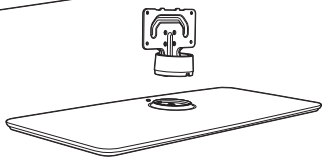

x1

(39''/40''/47''/50'')



# PHILIPS



p.3

or

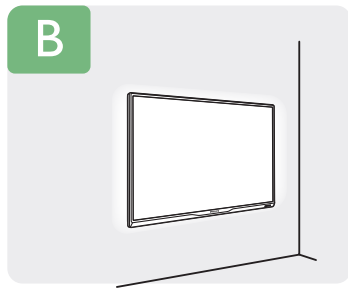

p.5



**English** Read the safety instructions.

**Português** Leia as instruções de segurança.

**Español** Lea la información de seguridad.

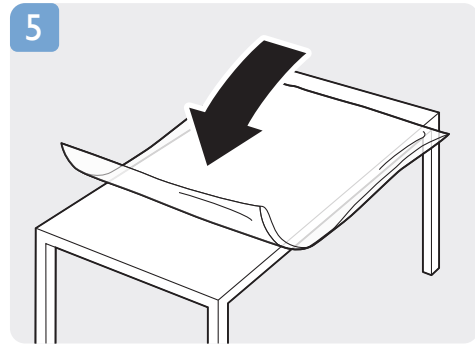
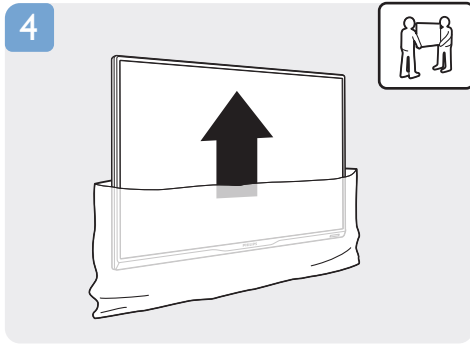
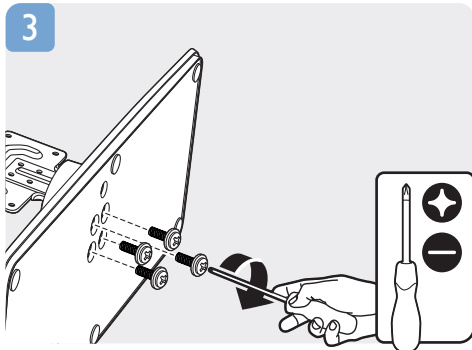
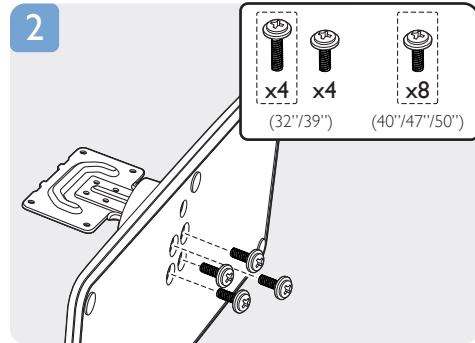
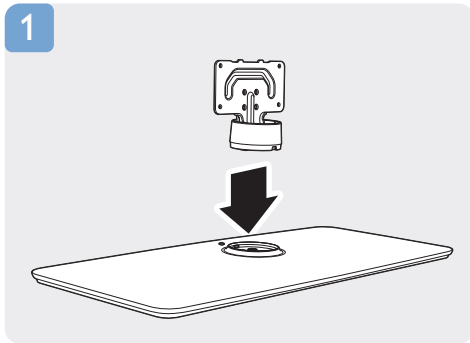
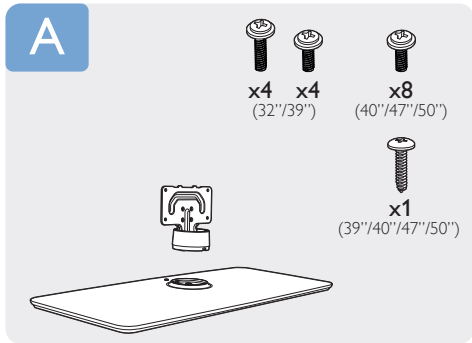

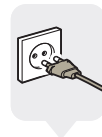
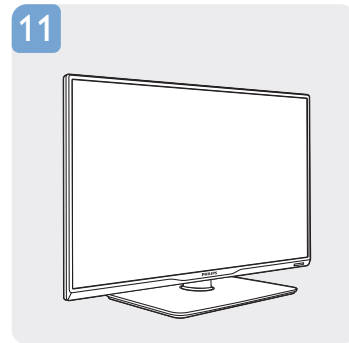
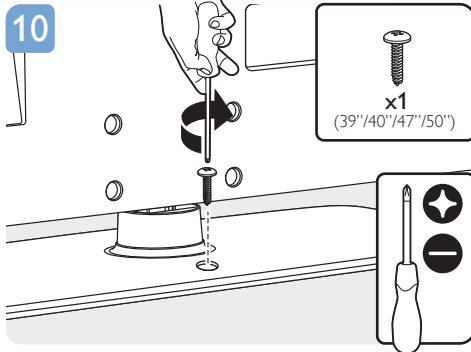
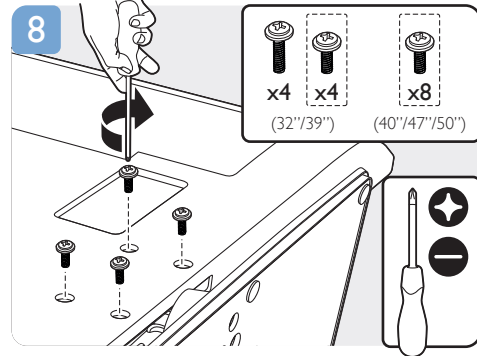
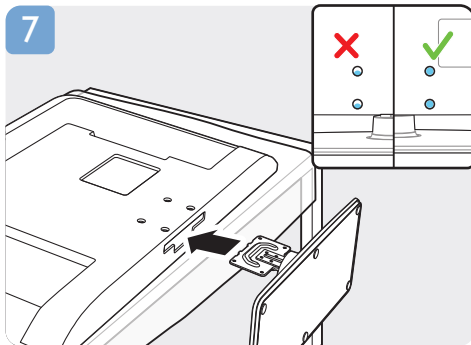
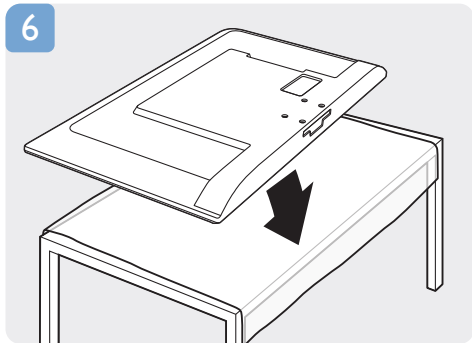

p.6

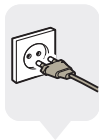
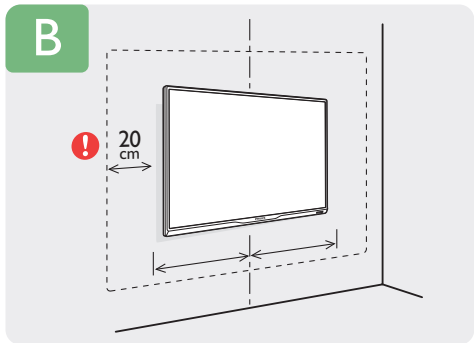

p.6

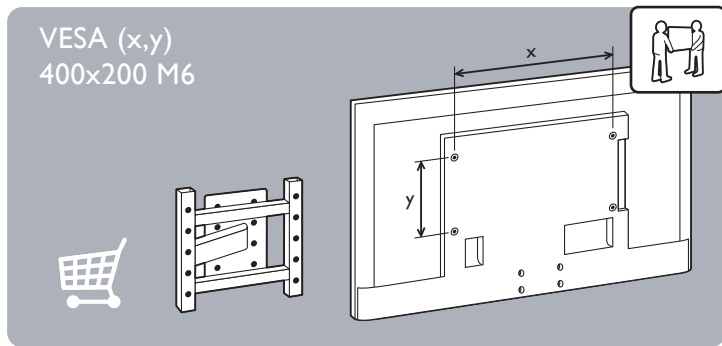

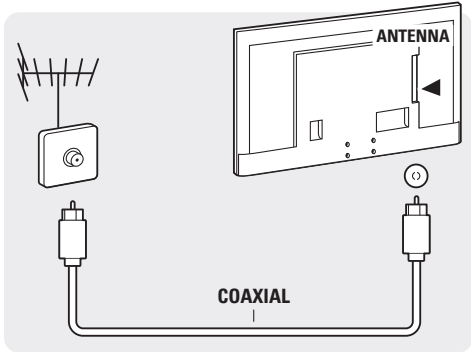
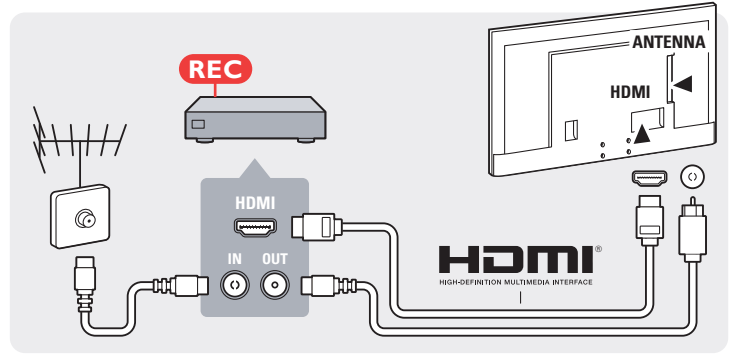
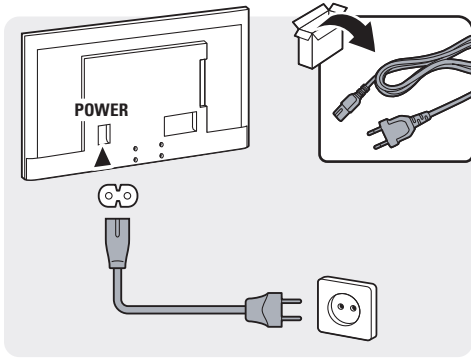
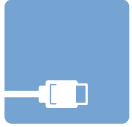

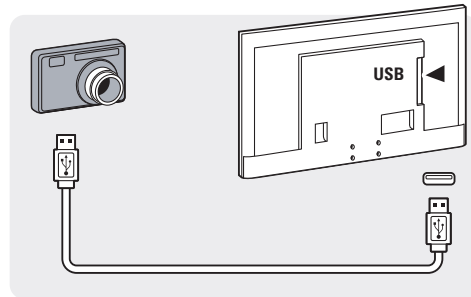
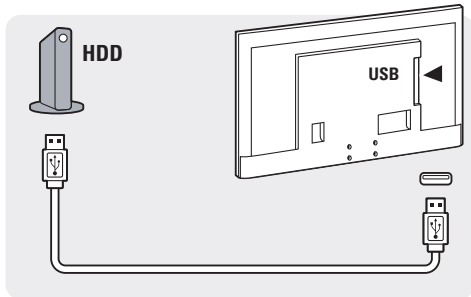
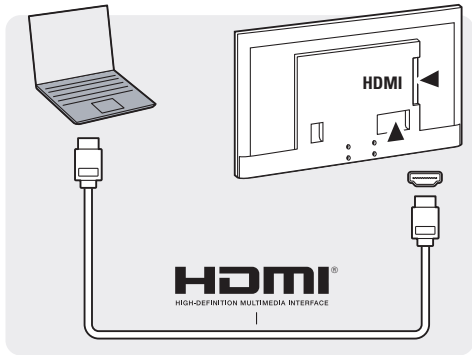
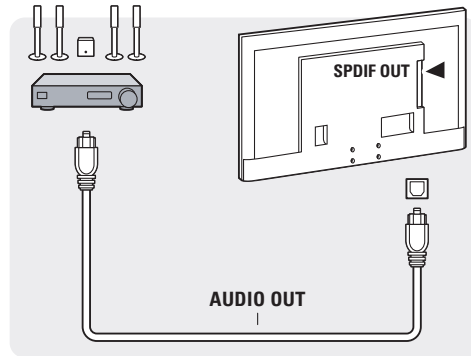
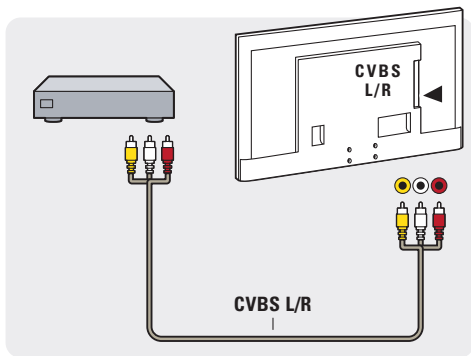
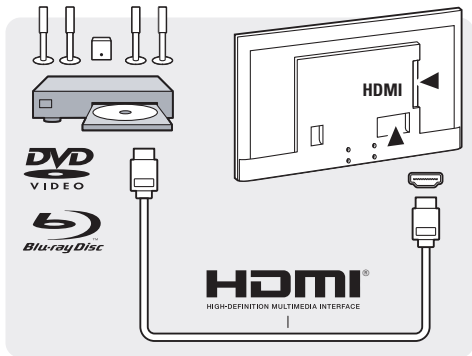

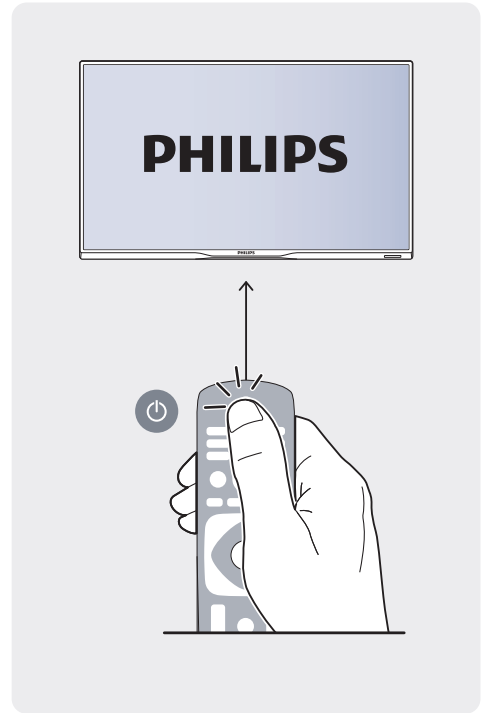
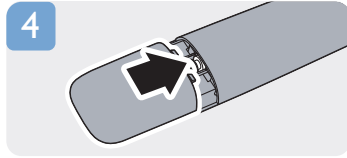
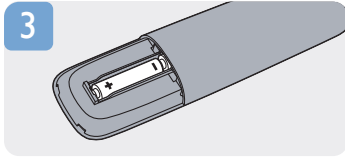
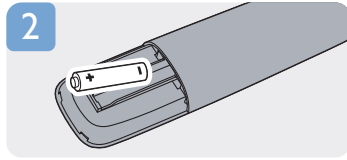
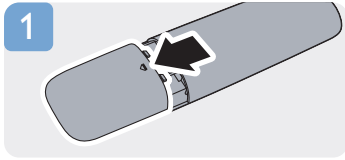





[philips.com/support](https://philips.com/support)









Preguntas/  
Contacto  
Philips

# Siempre acá para ayudarte

[www.philips.com/support](http://www.philips.com/support)



Manual del  
Usuario



Preguntas  
realizadas con  
frecuencia



Garantía



Foro de soporte  
Philips (en inglés)



Chat en vivo  
(en inglés)



Call Center



Email

## Bulgaria

Грижа за клиента

02 4916 273

(Национален номер)

## België/Belgique

Klantenservice/  
Service Consommateurs

070 700 035

(0,15€/min.)

## Bosna i Hercegovina

Potpora potrošačima

033 941 251

(Lokalni poziv)

## Србија

Potpora potrošačima

011 321 6840

(Lokalni poziv)

## Česká republika

Zákaznická podpora

228 880 895

(Místní tarif)

## Danmark

Kundeservice

3525 8314

## Deutschland

Kundendienst

069 66 80 10 10

(Zum Festnetztarif ihres Anbieters)

## Ελλάδα

Τμήμα καταναλωτών

2111983028

(Διεθνής κλήση)

## Eesti

Klienditugi

6683061

(Kohalikul kõned)

## España

Atención al consumidor

902 88 10 83

(0,10€ + 0,08€/min.)

## France

Service Consommateurs

01 57 32 40 50

(coût d'un appel local sauf surcoût éventuel selon opérateur réseau)

## Hrvatska

Potpora potrošačima

01 777 66 01

(Lokalni poziv)

## Ireland

Consumer Care

0818 210 140

(National call)

## Italia

Servizio Consumatori

02 45287014

(Chiamata nazionale)

## Қазақстан Республикасы

байланыс орталығы

810 800 2000 00 04

(стационарлық нөмірлерден  
Қазақстан Республикасы бойынша  
конфирма шалу тегін)

## Latvija

Klientu atbalsts

6616 3263

(Vietēlais tarifs)

## Lietuva

Klientų palaikymo tarnyba

8 52140293

(Vietiniais tarifais)

## Luxembourg

Service Consommateurs

2487 1100

(Appel national)/(Nationale Ruf)

## Magyarország

Ügyfélszolgálat

(06 1) 700 8151

(Belföldi hívás)

## Nederland

Klantenservice

0900 202 08 71

(0,10€/min.)

## Norge

Forbrukerstøtte

22 97 19 14

## Österreich

Kundendienst

0820 40 11 33

(0,145€/Min.)

## Республика Беларусь

Контакт Цэнтр

8 10 (800) 2000 00 04

(бесплатный звонок по  
Республике Беларусь со стационарных  
номеров)

## Российская Федерация

Контакт Центр

8 (800) 220 00 04

бесплатный звонок по России

## Polska

Wsparcie Klienta

22 3971504

(Poleczenie lokalne)

## Portugal

Assistência a clientes

707 78 02 25

(0,12€/min. – Móvel 0,30€/min.)

## România

Serviciul Clienti

031 6300042

(Tarif local)

## Schweiz/Suisse/Svizzera

Kundendienst/Service Consommateurs/  
Servizio Consumatori

0848 000 291

(0,081 CHF/Min)

## Slovenija

Skrb za potrošnike

01 8888 312

(Lokalni klic)

## Slovensko

Zákaznická podpora

02 - 33215493

(vnútroštátny hovor)

## Suomi

Finland Kuluttajapalvelu

09 8862 5040

## Sverige

Kundtjänst

08-5792 9096

## Türkiye

Tüketici Hizmetleri

444 8 445

## Україна

Служба підтримки споживачів

0-800-500-480

(звонки зі стаціонарних телефонів  
безкоштовні)

## United Kingdom

Consumer Care

0844 338 04 88

(5p/min BT landline)

## Argentina

Consumer Care

0800 444 7749

## Buenos Aires

Consumer Care

0810 444 7782

## Brasil

Suporte ao Consumidor

0800 701 0245

## Brasil (São Paulo)

Suporte ao Consumidor

2938 0245



All registered and unregistered trademarks are the property of their respective owners.

Specifications are subject to change without notice.

Philips and the Philips' Shield Emblem are registered trademarks of Koninklijke Philips N.V. and are used under license from Koninklijke Philips N.V.

2014 © TP Vision Europe B.V. All rights reserved. [www.philips.com](http://www.philips.com)

