

# User Manual

49HFL7011T  
55HFL7011T  
65HFL7011T

**PHILIPS**

---

# Contents

<b>1 TV Tour</b>	<b>4</b>
1.1 Ultra HD TV	4
1.2 Ambilight	4
1.3 Bluetooth Connection	4
<b>2 Setting Up</b>	<b>5</b>
2.1 Read Safety	5
2.2 TV Stand and Wall Mounting	5
2.3 Tips on Placement	5
2.4 Power Cable	5
2.5 Antenna Cable	5
<b>3 Connect your Android TV</b>	<b>7</b>
3.1 Network and Internet	7
<b>4 Connect Devices</b>	<b>11</b>
4.1 About Connections	11
4.2 CAM with Smart Card - CI+	13
4.3 Receiver - Set-Top Box	14
4.4 Home Theatre System - HTS	14
4.5 Smartphones and Tablets	16
4.6 Blu-ray Disc Player	16
4.7 DVD Player	17
4.8 Headphones	17
4.9 USB Flash Drive	17
4.10 Photo Camera	17
4.11 Camcorder	17
4.12 Computer	18
<b>5 Switching On and Off</b>	<b>19</b>
5.1 On, Standby or Off	19
5.2 Word mark brightness	19
5.3 Keys on TV	19
<b>6 Remote Control</b>	<b>20</b>
6.1 Key overview	20
6.2 IR Sensor	21
6.3 Batteries	21
6.4 Cleaning	21
<b>7 Channels</b>	<b>22</b>
7.1 Watching TV channels	22
7.2 Text / Teletext	23
7.3 Interactive TV	24
<b>8 TV Guide</b>	<b>26</b>
8.1 What You Need	26
8.2 Using the TV Guide	26
<b>9 Home Menu</b>	<b>27</b>
9.1 About the Home Menu	27
9.2 Open the Home Menu	27
<b>10 Sources</b>	<b>28</b>
10.1 Switch to a device	28
10.2 Options for a TV Input	28
10.3 Device Name and Type	28
10.4 Game or Computer	28
10.5 Rescan Connections	29
<b>11 Apps</b>	<b>30</b>
11.1 About Apps	30
11.2 Start or Stop an App	30
<b>12 Internet</b>	<b>31</b>
12.1 Start Internet	31
12.2 Options on Internet	31
<b>13 Videos, Photos and Music</b>	<b>32</b>
13.1 From a USB Connection	32
13.2 Play your Videos	32
13.3 View your Photos	32
13.4 Play your Music	33
<b>14 Smartphones and Tablets</b>	<b>34</b>
14.1 Miracast	34
14.2 MHL	35
<b>15 Ambilight</b>	<b>36</b>
15.1 Ambilight Style	36
15.2 Ambilight Off	36
<b>16 Settings</b>	<b>38</b>
16.1 Picture	38
16.2 Sound	42
16.3 Ambilight Settings	45
16.4 Eco Settings	46
16.5 General Settings	47
16.6 Clock, Region and Language	48
16.7 Universal Access	51
<b>17 Channel Installation</b>	<b>53</b>
17.1 Antenna/Cable Installation	53
<b>18 Software</b>	<b>55</b>
18.1 Update Software	55
18.2 Open Source Software	55
18.3 Open Source License Statement	55
18.4 Open Source License	55
<b>19 Specifications</b>	<b>89</b>
19.1 Environmental	89
19.2 Power	89
19.3 Operating System	90
19.4 Reception	90
19.5 Display Type	90
19.6 Display Input Resolution	90
19.7 Dimensions and Weights	90
19.8 Connectivity	90
19.9 Sound	91
19.10 Multimedia	91
<b>20 Help and Support</b>	<b>92</b>
20.1 Register your TV	92
20.2 Troubleshooting	92
20.3 Online Help	93
20.4 Support and Repair	94
<b>21 Safety and Care</b>	<b>95</b>
21.1 Safety	95
21.2 Screen Care	96
<b>22 Terms of Use</b>	<b>97</b>
22.1 Terms of Use - TV	97
22.2 Terms of Use - Smart TV	97
<b>23 Copyrights</b>	<b>98</b>
23.1 MHL	98
23.2 Ultra HD	98
23.3 HDMI	98
23.4 Dolby Digital Plus	98
23.5 DTS Premium Sound™	98
23.6 DLNA Certified®	98

23.7 Microsoft	98
23.8 Wi-Fi Alliance	99
23.9 Kensington	99
23.10 Other Trademarks	99
<b>Index</b>	<b>100</b>

# TV Tour

---

## 1.1

### Ultra HD TV

This TV has an **Ultra HD** display. Its resolution is four times as much as normal HD displays. Ultra HD means 8 million pixels for the most refined and lifelike picture on TV.

On top, the new **Ultra Pixel HD Engine** continuously converts any incoming TV signal into Ultra HD resolution. So you can enjoy this stunning picture quality the moment you switch on the TV. Or you can watch native Ultra HD videos through an HDMI connection. Ultra HD offers TV viewing that is crisp and sharp even on a big screen.



---

## 1.2

### Ambilight

Ambilight is the most elegant and exclusive feature of your new Philips TV.

A subtle glow of coloured light that shines from behind the screen - expanding your visual experience. With Ambilight your eyes relax but your mind is fully taken up by what you see.

With **Ambilight+hue** you even expand Ambilight further. Bringing in the wireless controlled bulbs of **Philips Hue\***. All of them setup to fill your room with colours that fit what's on TV.

You will miss Ambilight when you switch it off.

\* Separately available.

---

## 1.3

### Bluetooth Connection

Your TV has **Bluetooth** technology inside.

You can connect extra wireless speakers or a wireless headphone. Forget connecting cables, pairing your device with the TV is enough.

# Setting Up

## 2.1

### Read Safety

Read the safety instructions first before you use the TV.

## 2.2

### TV Stand and Wall Mounting

#### TV Stand

You can find the instructions for mounting the TV stand in the Quick Start Guide. The Quick Start Guide can be downloaded from [www.philips.com](http://www.philips.com).

Use the product type number of the TV to look for the Quick Start Guide to download.

#### Wall Mounting

Your TV is also prepared for a VESA-compliant wall mount bracket (sold separately).

Use the following VESA code when purchasing the wall mount . . .

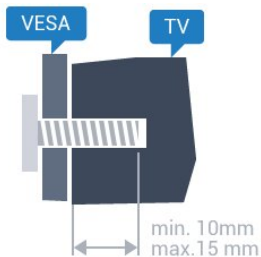

- 49HFL7011T  
VESA MIS-F 200x200, M6
- 55HFL7011T  
VESA MIS-F 200x200, M6
- 65HFL7011T  
VESA MIS-F 400x200, M6

#### Preparation

First remove the 4 plastic screw caps out of the threaded bushes on the back of the TV.

Make sure that the metal screws, to mount the TV to the VESA-compliant bracket, go about 10mm deep inside the threaded bushes of the TV.

#### Caution

Wall mounting the TV requires special skills and should only be performed by qualified personnel. The TV wall mounting should meet safety standards

according to the TV's weight. Also read the safety precautions before positioning the TV. TP Vision Europe B.V. bears no responsibility for improper mounting or any mounting that results in accident or injury.

## 2.3

### Tips on Placement

- Position the TV where light does not shine directly on the screen.
- Position the TV up to 15 cm away from the wall.
- The ideal distance to watch TV is 3 times its diagonal screen size. When seated, your eyes should be level with the centre of the screen.

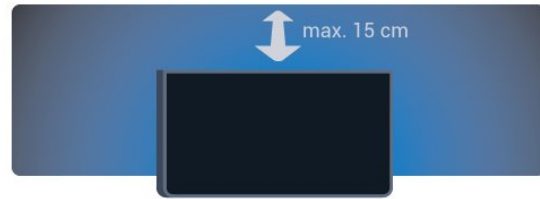

## 2.4

### Power Cable

- Insert the power cable into the **POWER** connector on the back of the TV.
- Make sure the power cable is securely inserted in the connector.
- Make sure that the power plug, in the wall socket, is accessible at all times.
- When you unplug the power cable, always pull the plug, never pull the cable.

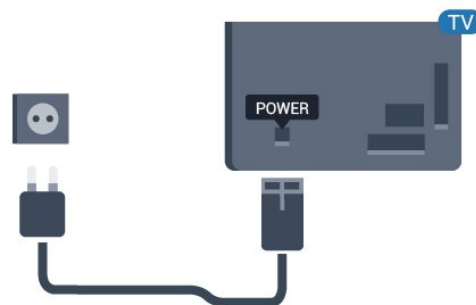

Although this TV has a very low standby power consumption, unplug the power cable to save energy if you do not use the TV for a long period of time.

## Antenna Cable

Insert the antenna plug firmly into the **Antenna** socket at the back of the TV.

You can connect your own antenna or an antenna signal from an antenna distribution system. Use an IEC Coax 75 Ohm RF antenna connector.

Use this antenna connection for DVB-T and DVB-C input signals.

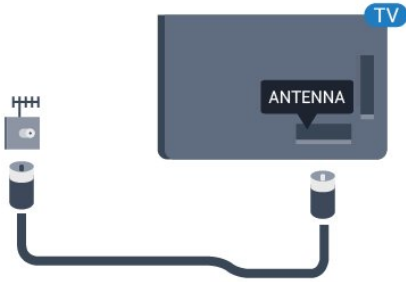

# Connect your Android TV

## Network and Internet

### Home Network

To enjoy the full capabilities of your Philips Android TV, your TV must be connected to the Internet.

Connect the TV to a home network with a high-speed Internet connection. You can connect your TV wirelessly or wired to your network router.

### Connect to Network

#### Wireless Connection

##### What you need

To connect the TV to the Internet wirelessly, you need a Wi-Fi router with a connection to the Internet.

Use a high-speed (broadband) connection to the Internet.



#### Make the Connection

##### Wireless

Follow steps 1 to 5.

**Step 1** - Make sure that the router of your wireless network is switched on.

**Step 2** - Consumer Mode:

On – Press HOME and select **Features** and press **OK**.

Guest Mode: On – Guest Menu: Not available in this mode.

(For professional mode information, please refer to

Installation manual)

**Step 3** - Select **Wireless and Networks > Connect to network** and press **OK**.

**Step 4** - Select **Connect to network** and press **OK**.

**Step 5** - Select **Wireless** and press **OK**.

#### WPS

If your router has WPS, you can directly connect to the router without scanning for networks. Go to the router, press the WPS button and return to the TV within 2 minutes. Then press **Connect** to make the connection.

If you have devices in your wireless network that use the WEP security encryption system, you cannot use WPS.

1 - Consumer Mode: On – Press HOME and select **Features** and press **OK**.

Guest Mode: On – Guest Menu: Not available in this mode.

(For professional mode information, please refer to Installation manual)

2 - Select **Wireless and Networks > Settings** and press **OK**.

3 - Select **Network type > WPS** then press **OK**.

4 - Go to the router, press the WPS button and return to the TV within 2 minutes.

5 - Select **Connect** to make the connection.

6 - A message will be shown when the connection is successful.

#### WPS with PIN Code

If your router has WPS with a PIN code, you can directly connect to the router without scanning for networks. If you have devices in your wireless network that use the WEP security encryption system, you cannot use WPS.

1 - Consumer Mode: On – Press HOME and select **Features** and press **OK**.

Guest Mode: On – Guest Menu: Not available in this mode.

(For professional mode information, please refer to Installation manual)

2 - Select **Wireless and Networks > Settings** and press **OK**.

3 - Select **Network type > WPS with PIN code** and press **OK**.

4 - Write down the 8-digit PIN code shown on screen and enter it in the router software on your PC. Consult the router manual on where to enter the PIN

code in the router software.

5 - Select **Connect** to make the connection.

6 - A message will be shown when the connection is successful.

---

## Problems

### Wireless network not found or distorted

- Microwave ovens, DECT phones or other Wi-Fi 802.11b/g/n devices in your proximity might disturb the wireless network.

- Make sure that the firewalls in your network allow access to the TV's wireless connection.

- If the wireless network does not work properly in your home, try the wired network installation.

### Internet does not work

- If the connection to the router is OK, check the router connection to the Internet.

### The PC and Internet connection are slow

- Look in your wireless router's user manual for information on indoor range, transfer rate and other factors of signal quality.
- Use a high-speed (broadband) Internet connection for your router.

### DHCP

- If the connection fails, you can check the DHCP (Dynamic Host Configuration Protocol) setting of the router. DHCP should be switched on.

---

## Wired Connection

### What You Need

To connect the TV to the Internet, you need a network router with a connection to the Internet. Use a high-speed (broadband) connection to the Internet.

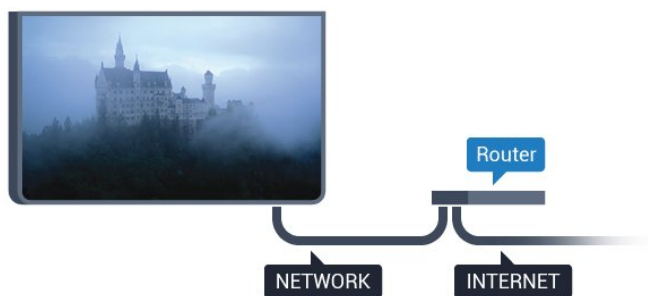

---

## Make the Connection

To make a wired connection...

1 - Connect the router to the TV with a network cable (Ethernet cable\*\*).

2 - Make sure that the router is switched on.

3 - Consumer Mode: On – Press **HOME** and select **Features** and press **OK**.

Guest Mode: On – Guest Menu: Not available in this mode.

(For professional mode information, please refer to Installation manual)

4 - Select **Wireless and Networks** > **Connect to network** and press **OK**.

5 - Select **Wired** then press **OK**.

6 - The TV constantly searches for the network connection. A message will be shown when the connection is successful.

### Network configuration

If the connection fails, you can check the DHCP setting of the router. DHCP should be switched on. Alternatively, if you are an advanced user and want to install your network with static IP addressing, set the TV to Static IP.

To set the TV to Static IP:

Consumer Mode: On – Press **HOME** and select **Features** and press **OK**.

Guest Mode: On – Guest Menu: Not available in this mode.

(For professional mode information, please refer to Installation manual)

Select **Wireless and Networks** > **Settings** > **Network configuration** > **Static IP**. With Static IP selected in the menu, you can set the IP address and other necessary settings in **Static IP configuration** in the same menu.

\*\*To fulfill EMC regulations, use a shielded FTP Cat. 5E Ethernet cable.

---

## Network Settings

### View Network Settings

You can view all current network settings here. The IP and MAC address, signal strength, speed, encryption method, etc.

To view the current network settings...

1 - Consumer Mode: On – Press **HOME** and select **Features** and press **OK**.

Guest Mode: On – Guest Menu: Not available in this mode.

(For professional mode information, please refer to Installation manual)

2 - Select **Wireless and Networks** and press **OK**.

3 - Select **Settings** > **View Network Settings** and press **OK**.

4 - Press **BACK** repeatedly if necessary, to close the menu.



---

## Network Configuration

If you are an advanced user and want to install your network with Static IP addressing, set the TV to **Static IP**.

To set the TV to Static IP...

- 1 - Consumer Mode: On – Press  HOME and select **Features** and press **OK**.  
Guest Mode: On – Guest Menu: Not available in this mode.  
(For professional mode information, please refer to Installation manual)
- 2 - Select **Wireless and Networks** and press **OK**.
- 3 - Select **Settings > Network Configuration** and press **OK**.
- 4 - Select **Static IP** and press **OK** to enable **Static IP Configuration**.
- 5 - Press **← BACK** to go back to previous level.
- 6 - Select **Static IP Configuration** and configure the connection.
- 7 - You can set the number for **IP Address, Netmask, Gateway, DNS 1, or DNS 2**.
- 8 - Press **← BACK** repeatedly if necessary, to close the menu.

---

## Switch On with LAN (WoL)

To switch on WoL...

- 1 - Consumer Mode: On – Press  HOME and select **Features** and press **OK**.  
Guest Mode: On – Guest Menu: Not available in this mode.  
(For professional mode information, please refer to Installation manual)
- 2 - Select **Wireless and Networks** and press **OK**.
- 3 - Select **Settings > Wake on LAN (WoL)** and press **OK**.
- 4 - Select **On** to enable **Wake on LAN (WoL)**.
- 5 - Press **← BACK** repeatedly if necessary, to close the menu.

---

## Switch On with Wi-Fi (WoWLAN)

You can switch this TV on from your smartphone or tablet if the TV is in Standby. The setting **Wake On Wi-Fi (WoWLAN)** must be switched on.

To switch on WoWLAN...

- 1 - Consumer Mode: On – Press  HOME and select **Features** and press **OK**.  
Guest Mode: On – Guest Menu: Not available in this mode.  
(For professional mode information, please refer to Installation manual)
- 2 - Select **Wireless and Networks** and press **OK**.
- 3 - Select **Settings > Wake on Wi-Fi (WoWLAN)** and press **OK**.

4 - Select **On** to enable **Wake on Wi-Fi (WoWLAN)**.

5 - Press **← BACK** repeatedly if necessary, to close the menu.

---

## Switch on Wi-Fi connection

You can switch on or off Wi-Fi connection on your TV.

To switch on Wi-Fi...

- 1 - Consumer Mode: On – Press  HOME and select **Features** and press **OK**.  
Guest Mode: On – Guest Menu: Not available in this mode.  
(For professional mode information, please refer to Installation manual)
- 2 - Select **Wireless and Networks** and press **OK**.
- 3 - Select **Connect to Network** and press **OK**.
- 4 - Select **Connect** and press **OK**.
- 5 - Select **Wireless** and press **OK**.
- 6 - Press **← BACK** repeatedly if necessary, to close the menu.

---

## Digital Media Renderer - DMR

If your media files do not play on your TV, make sure that the Digital Media Renderer is switched on. As a factory setting, DMR is switched on.

To switch on DMR...

- 1 - Consumer Mode: On – Press  HOME and select **Features** and press **OK**.  
Guest Mode: On – Guest Menu: Not available in this mode.  
(For professional mode information, please refer to Installation manual)
- 2 - Select **Wireless and Networks** and press **OK**.
- 3 - Select **Features > PTA** and press **OK**.
- 4 - Select **Digital Media Renderer - DMR** and press **OK**.
- 5 - Select **On** and press **OK**.
- 6 - Press **← BACK** repeatedly if necessary, to close the menu.

---

## Switch on Wi-Fi Miracast

Switch on Wi-Fi Miracast to share the screen of your smartphone, tablet or computer on the TV.

To switch on Miracast...

- 1 - Consumer Mode: On – Press  HOME and select **Features** and press **OK**.  
Guest Mode: On – Guest Menu: Not available in this mode.  
(For professional mode information, please refer to Installation manual)

- 2 - Select **Wireless and Networks** > **Miracast** and press **OK**.
- 3 - Select **Features** > **Wi-Fi Miracast** and press **OK**.
- 4 - Select **Enable** and press **OK**.
- 5 - Select **Yes** and press **OK**.
- 6 - Press **← BACK** repeatedly if necessary, to close the menu.

---

### Clear Wi-Fi Miracast connection

Clear the list of connected and blocked devices that are used with Miracast.

To clear Miracast connections...

- 1 - Consumer Mode: On – Press **HOME** and select **Features** and press **OK**.  
Guest Mode: On – Guest Menu: Not available in this mode.  
(For professional mode information, please refer to Installation manual)
- 2 - Select **Wireless and Networks** and press **OK**.
- 3 - Select **Features** > **Wi-Fi Miracast** and press **OK**.
- 4 - Select **Wi-Fi Miracast Connections** > **Clear All** and press **OK**.
- 5 - Press **← BACK** repeatedly if necessary, to close the menu.

# Connect Devices

## 4.1

### About Connections

#### Connectivity Guide

Always connect a device to the TV with the highest quality connection available. Also, use good quality cables to ensure a good transfer of picture and sound.

When you connect a device, the TV recognizes its type and gives each device a correct type name. You can change the type name if you wish. If a correct type name for a device is set, the TV automatically switches to the ideal TV settings when you switch to this device in the Sources menu.

If you need help to connect several devices to the TV, you can visit the Philips TV connectivity guide. The guide offers information on how to connect and which cables to use.

Go to [www.connectivityguide.philips.com](http://www.connectivityguide.philips.com)

#### Antenna port

If you have a Set-top box (a digital receiver) or Recorder, connect the antenna cables to run the antenna signal through the Set-top box and/or Recorder first before it enters the TV. In this way, the antenna and the Set-top box can send possible additional channels to the Recorder to record.

#### HDMI ports

##### HDMI Quality

An HDMI connection has the best picture and sound quality. One HDMI cable combines video and audio signals. Use an HDMI cable for TV signal.

For best signal quality transfer, use a High speed HDMI cable and do not use an HDMI cable longer than 5 m.

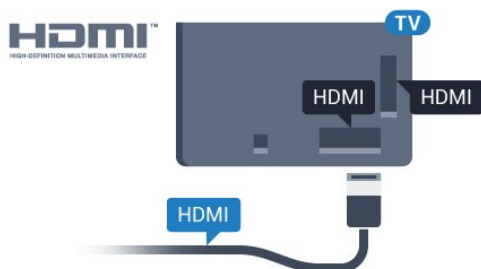

#### Copy protection

HDMI cables support HDCP (High-bandwidth Digital Content Protection). HDCP is a copy protection signal that prevents copying content from a DVD disc or Blu-ray Disc. Also referred to as DRM (Digital Rights Management).

#### HDMI ARC

All of the HDMI connections on the TV have **HDMI ARC** (Audio Return Channel).

If the device, typically a Home Theatre System (HTS), also has the HDMI ARC connection, connect it to any of the HDMI connections on this TV. With the HDMI ARC connection, you do not need to connect the extra audio cable that sends the sound of the TV picture to the HTS. The HDMI ARC connection combines both signals.

You can use any HDMI connection on this TV to connect the HTS but ARC is only available for 1 device/connection at a time.

#### HDMI MHL

With **HDMI MHL**, you can send what you see on your Android smartphone or tablet to a TV screen.

The **HDMI 4** connection on this TV incorporates **MHL 2.0** (Mobile High-Definition Link).

This wired connection offers great stability and bandwidth, low latency, no wireless interference and good quality sound reproduction. On top of that, the MHL connection will charge the battery of your smartphone or tablet. Although connected, your mobile device will not be charging when the TV is on standby.

Inform yourself about what passive MHL cable is suited for your mobile device. In particular, with the HDMI connector for the TV on one side, the type of connector you need to connect to your smartphone or tablet.

MHL, Mobile High-Definition Link and the MHL Logo are trademarks or registered trademarks of the MHL, LLC.

#### HDMI CEC - EasyLink

##### EasyLink

An HDMI connection has the best picture and sound quality. One HDMI cable combines video and audio signals. Use an HDMI cable for High Definition (HD) TV signals. For best signal quality transfer, use a High speed HDMI cable and do not use an HDMI cable longer than 5 m.

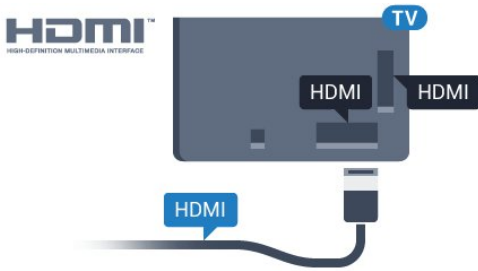

## EasyLink HDMI CEC

If your devices are connected with HDMI and have EasyLink, you can operate them with the TV remote control. EasyLink HDMI CEC must be switched On on the TV and the connected device.

With EasyLink you can operate a connected device with the TV remote control. EasyLink uses HDMI CEC (Consumer Electronics Control) to communicate with the connected devices. Devices must support HDMI CEC and must be connected with an HDMI connection.

## EasyLink setup

The TV comes with EasyLink switched on. Make sure that all HDMI CEC settings are properly set up on the connected EasyLink devices. EasyLink might not work with devices from other brands.

## HDMI CEC on other brands

The HDMI CEC functionality has different names on different brands. Some examples are: Anynet, Aquos Link, Bravia Theatre Sync, Kuro Link, Simplink and Viera Link. Not all brands are fully compatible with EasyLink.

Example HDMI CEC branding names are property of their respective owners.

---

## Operate Devices

To operate a device connected to HDMI and set up with EasyLink, select the device or its activity in the list of TV connections. Press **SOURCES**, select a device connected to an HDMI connection and press **OK**.

Once the device is selected, the TV remote control can control the device. However the keys **HOME** and **OPTIONS** and some other TV keys, are not forwarded to the device.

If the key you need is not on the TV remote control, you can select the key in the Options menu.

Press **OPTIONS** and select **Controls** in the menu bar. On the screen, select the device key you need and press **OK**.

Some very specific device keys might not be available in the Controls menu.

Only devices that support **EasyLink Remote Control** function will respond to the TV remote control.

---

## EasyLink On or Off

You can switch EasyLink on or off. The TV comes with the EasyLink settings switched on.

To switch off EasyLink completely...

1 - Consumer Mode:

On – Press **HOME** and select **Features** and press **OK**.

Guest Mode: On – Guest Menu: Not available in this mode.

(For professional mode information, please refer to Installation manual)

2 - Select **Sources > Advanced > EasyLink**, and press **OK**.

3 - Select **EasyLink**, and press **OK**.

4 - Select **Off** and press **OK**.

5 - Press **BACK**, repeatedly if necessary, to close the menu.

---

## EasyLink Remote Control

If you want devices to communicate but you don't want to operate them with the TV remote control, you can switch off EasyLink Remote Control separately.

To switch EasyLink Remote Control on or off...

1 - Consumer Mode:

On – Press **HOME** and select **Features** and press **OK**.

Guest Mode: On – Guest Menu: Not available in this mode.

(For professional mode information, please refer to Installation manual)

2 - Select **Sources > Advanced > EasyLink**, and press **OK**.

3 - Select **EasyLink Remote Control** and press **OK**.

4 - Select **On** or **Off** and press **OK**.

5 - Press **BACK**, repeatedly if necessary, to close the menu.

---

## DVI to HDMI

If you still own a device that only has a DVI connection, you can connect the device to any of the **HDMI** connection with a DVI to HDMI adapter.

Use a DVI to HDMI adapter if your device only has a DVI connection. Use one of the HDMI connections and add an Audio L/R cable (mini-jack 3.5mm) to Audio In for sound, on the back of the TV.

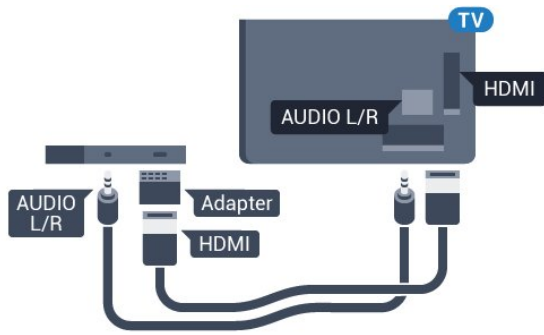

## Copy protection

DVI and HDMI cables support HDCP (High-bandwidth Digital Content Protection). HDCP is a copy protection signal that prevents copying content from a DVD disc or Blu-ray Disc. Also referred to as DRM (Digital Rights Management).

## Y Pb Pr - Component

Y Pb Pr - Component Video is a high quality connection.

The YPbPr connection can be used for High Definition (HD) TV signals. Next to the Y, Pb and Pr signals add the Audio Left and Right signals for sound.

Match the YPbPr (green, blue, red) connector colours with the cable plugs when you connect. Use an Audio L/R cinch cable if your device also has sound.

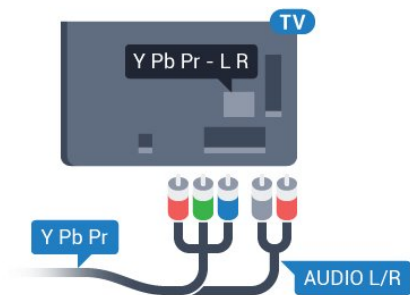

## Scart

SCART is a good quality connection.

The SCART connection can be used for CVBS and RGB video signals but cannot be used for High Definition (HD) TV signals. The SCART connection combines video and audio signals. The SCART connection also supports NTSC playback.

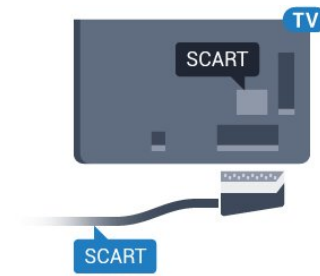

## Audio Out - Optical

Audio Out - Optical is a high quality sound connection.

This optical connection can carry 5.1 audio channels. If your device, typically a Home Theatre System (HTS), has no HDMI ARC connection, you can use this connection with the Audio In - Optical connection on the HTS. The Audio Out - Optical connection sends the sound from the TV to the HTS.

You can set the type of the audio out signal to fit the audio capabilities of your Home Theatre System.

If the sound does not match the video on screen, you can adjust the audio to video synchronisation.

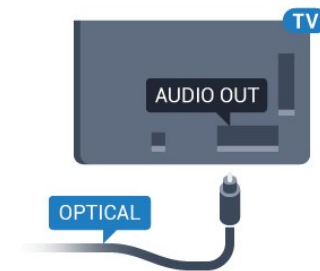

4.2

## CAM with Smart Card - CI+

### CI+

This TV is ready for the CI+ Conditional Access.

With CI+ you can watch premium HD programmes, like movies and sports, offered by digital TV operators in your region. These programmes are scrambled by the TV operator and descrambled with a prepaid CI+ module.

Digital TV operators provide a CI+ module (Conditional Access Module - CAM) and an accompanying smart card, when you subscribe to their premium programmes. These programmes have a high level of copy protection.

Contact a digital TV operator for more information on terms & conditions.



## Smart Card

Digital TV operators provide a CI+ module (Conditional Access Module - CAM) and an accompanying smart card, when you subscribe to their premium programmes.

Insert the smart card into the CAM module. See the instruction you received from the operator.

To insert the CAM in the TV...

- 1 - Look on the CAM for the correct method of insertion. Incorrect insertion can damage the CAM and TV.
- 2 - While looking at the back of the TV, with the front of the CAM facing towards you, gently insert the CAM into the slot **COMMON INTERFACE**.
- 3 - Push the CAM in as far as it will go. Leave it in the slot permanently.

When you switch on the TV, it may take a few minutes before the CAM is activated. If a CAM is inserted and subscription fees are paid (subscription methods can differ), you can watch the scrambled channels supported by the CAM smart card.

The CAM and smart card are exclusively for your TV. If you remove the CAM, you will no longer be able to watch the scrambled channels supported by the CAM.

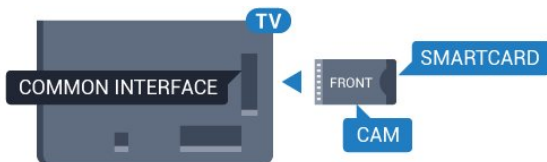

## Passwords and PIN codes

For some CAMs, you must enter a PIN code to watch its channels. When you set the PIN code for the CAM, we recommend you to use the same code you are using to unlock the TV.

To set the PIN code for the CAM...

- 1 - Press **SOURCES**.
- 2 - Select the channel type you are using the CAM for.
- 3 - Press **≡** **OPTIONS** and select **Common Interface**.
- 4 - Select the TV operator of the CAM. The following

screens come from the TV operator. Follow the on-screen instruction to look up the PIN code setting.

4.3

## Receiver - Set-Top Box

### Cable Box

Use 2 antenna cables to connect the antenna to the Set-top box (a digital receiver) and the TV.

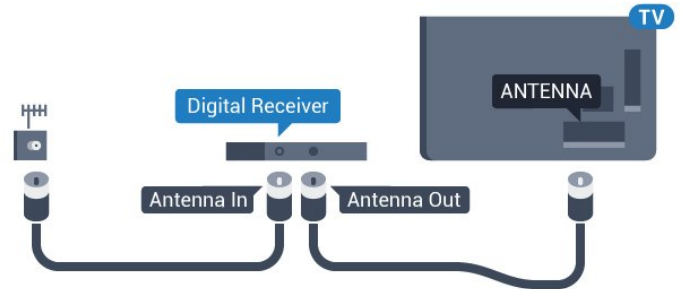

Next to the antenna connections, add an HDMI cable to connect the Set-top box to the TV. Alternatively, you can use a SCART cable if the Set-top box has no HDMI connection.

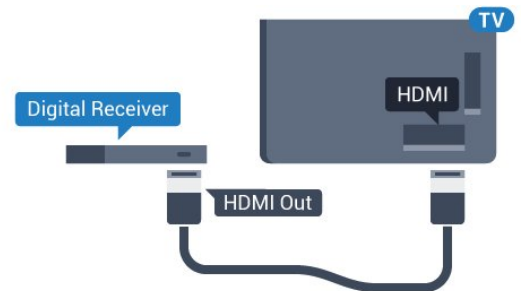

4.4

## Home Theatre System - HTS

### Connect with HDMI ARC

Use an HDMI cable to connect a Home Theatre System (HTS) to the TV. You can connect a Philips Soundbar or an HTS with a built-in disc player.

#### HDMI ARC

If your Home Theatre System has an HDMI ARC connection, you can use any HDMI connection on the TV to connect. With HDMI ARC, you do not need to connect the extra audio cable. The HDMI ARC connection combines both signals. All HDMI connections on the TV can offer the Audio Return Channel (ARC) signal. But once you have connected the Home Theatre System, the TV can

only send the ARC signal to this HDMI connection.

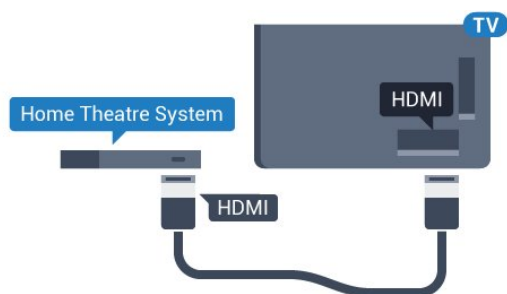

### Audio to video synchronisation (sync)

If the sound does not match the video on screen, you can set a delay on most Home Theatre Systems with a disc player to match the sound with the video.

---

## Connect with HDMI

Use an HDMI cable to connect a Home Theatre System (HTS) to the TV. You can connect a Philips Soundbar or an HTS with a built-in disc player.

If the Home Theatre System has no HDMI ARC connection, add an optical audio cable (Toslink) to send the sound of the TV picture to the Home Theatre System.

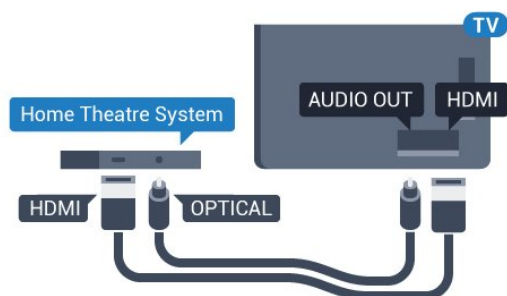

### Audio to video synchronisation (sync)

If the sound does not match the video on screen, you can set a delay on most Home Theatre Systems with a disc player to match the sound with the video.

---

## Audio Out Settings

### Audio Out Delay

With a Home Theatre System (HTS) connected to the TV, the picture on TV and the sound from the HTS should be synchronised.

### Automatic audio to video sync

With recent Philips Home Theatre Systems, the audio to video sync is done automatically and always correct.

### Audio sync delay

For some Home Theatre Systems you might need to adjust the audio sync delay to synchronise the audio to the video. On the HTS, increase the delay value until there is a match between picture and sound. A delay value of 180ms may be required. Read the user manual of the HTS. With a delay value set up on the HTS, you need to switch off Audio Out Delay on the TV.

To switch off the Audio Out delay . . .

1 - Consumer Mode:

On – Press HOME and select **Features** and press **OK**.

Guest Mode: On – Guest Menu: Not available in this mode.

(For professional mode information, please refer to Installation manual)

2 - Select **Sound > Advanced > Audio out delay**.

3 - Select **Off** and press **OK**.

4 - Press **BACK**, repeatedly if necessary, to close the menu.

---

### Audio Out Offset

If you cannot set a delay on the Home Theatre System, you can set the TV to sync the sound. You can set an offset that compensates for the time necessary for the Home Theatre System to process the sound of the TV picture. You can set the value in steps of 5ms. Maximum setting is -60ms.

The **Audio Out Delay** setting should be switched on.

To synchronise the sound on the TV...

1 - Consumer Mode:

On – Press HOME and select **Features** and press **OK**.

Guest Mode: On – Guest Menu: Not available in this mode.

(For professional mode information, please refer to Installation manual)

2 - Select **Sound > Advanced > Audio out offset**.

3 - Use the slider bar to set the sound offset and press **OK**.



4 - Press **BACK**, repeatedly if necessary, to close the menu.

---

### Audio Out Format

If you have a Home Theatre System (HTS) with multichannel sound processing capabilities like Dolby Digital, DTS® or similar, set the Audio Out Format to Multichannel. With Multichannel, the TV can send the compressed multichannel sound signal from a TV channel or connected player to the Home Theatre System. If you have a Home Theatre System without multichannel sound processing, select Stereo.

To set **Audio Out Format**...



- 1 - Consumer Mode:  
On – Press  HOME and select **Features** and press **OK**.  
Guest Mode: On – Guest Menu: Not available in this mode.  
(For professional mode information, please refer to Installation manual)
- 2 - Select **Sound** > **Advanced** > **Audio out format**.  
3 - Select **Multichannel** or **Stereo**.  
4 - Press  BACK, repeatedly if necessary, to close the menu.

---

## Audio Out Levelling

Use the Audio Out Levelling setting to level the volume (loudness) of the TV and the Home Theatre System when you switch over from one to another. Volume differences can be caused by differences in sound processing.

To level the difference in volume...

- 1 - Consumer Mode:  
On – Press  HOME and select **Features** and press **OK**.  
Guest Mode: On – Guest Menu: Not available in this mode.  
(For professional mode information, please refer to Installation manual)
- 2 - Select **Sound** > **Advanced** > **Audio out levelling**.  
3 - If the volume difference is large, select **More**. If the volume difference is small, select **Less**.  
4 - Press  BACK, repeatedly if necessary, to close the menu.

Audio Out Levelling affects both the Audio Out - Optical and HDMI ARC sound signals.

---

## Problems with HTS sound



### Sound with loud noise

If you watch a video from a plugged in USB flash drive or connected computer, the sound from your Home Theatre System might be distorted. This noise is heard when the audio or video file has DTS sound but the Home Theatre System has no DTS sound processing. You can fix this by setting the **Audio Out Format** of the TV to **Stereo (uncompressed)**.

- 1 - Consumer Mode:  
On – Press  HOME and select **Features** and press **OK**.  
Guest Mode: On – Guest Menu: Not available in this mode.  
(For professional mode information, please refer to Installation manual)
- 2 - Select **Sound** > **Advanced** > **Audio out format**.
- ### No sound

If you cannot hear the sound from the TV on your Home Theatre System, check if you connected the HDMI cable to an **HDMI ARC** connection on the Home Theatre System. All HDMI connections on the TV are HDMI ARC connections.

- Check if you connected the HDMI cable to an **HDMI ARC** connection on the Home Theatre System. All HDMI connections on the TV are HDMI ARC connections.
- Check if the **HDMI ARC** setting on the TV is switched **On**.

- 1 - Consumer Mode:  
On – Press  HOME and select **Features** and press **OK**.  
Guest Mode: On – Guest Menu: Press  HOME and select **Features** and press **OK**.  
(For professional mode information, please refer to Installation manual)
- 2 - Select **Sound** > **Advanced** > **HDMI ARC**.

---

## 4.5

# Smartphones and Tablets

To connect a smartphone or tablet to the TV, you can use a wireless or wired connection.

### Wireless

For a wireless connection, on your smartphone or tablet download the Philips TV Remote App from your favourite app store.

Note: Philips TV Remote App can only be used by making connection to TV. Use function in **Features** to make the connection.

### Wired

For a wired connection, use the HDMI 4 MHL connection on the back of the TV.

---

## 4.6

# Blu-ray Disc Player

Use a **High speed HDMI** cable to connect the Blu-ray Disc player to the TV.



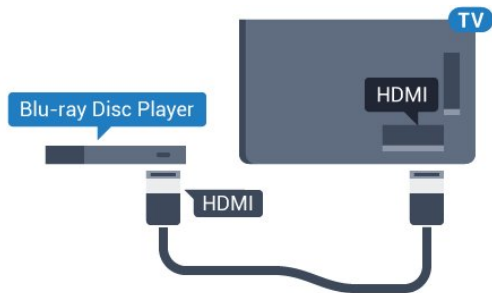

If the Blu-ray Disc player has EasyLink HDMI CEC, you can operate the player with the TV remote control.

4.7

## DVD Player

Use an HDMI cable to connect the DVD player to the TV.

Alternatively, you can use a SCART cable, if the device has no HDMI connection.

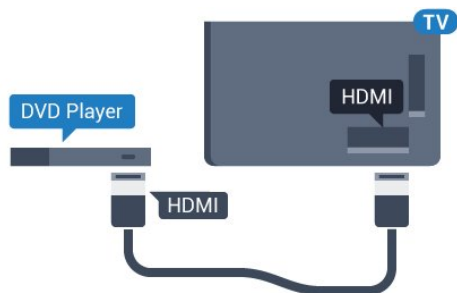

If the DVD player is connected with HDMI and has EasyLink CEC, you can operate the player with the TV remote control.

4.8

## Headphones

You can connect a set of headphones to the  connection on the back of the TV. The connection is a mini-jack 3.5mm. You can adjust the volume of the headphones separately.

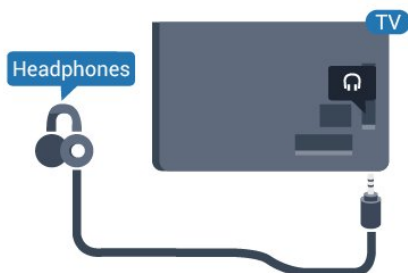

4.9

## USB Flash Drive

You can view photos or play your music and videos from a connected USB flash drive.

Insert a USB flash drive in one of the **USB** connections on the TV while the TV is switched on.



The TV detects the flash drive and opens a list showing its content.

If the contents list does not appear automatically, press **SOURCES** and select **USB**.

To stop watching the USB flash drive content, press **TV** or select another activity.

To disconnect the USB flash drive, you can pull out the flash drive anytime.

4.10

## Photo Camera

To view photos stored on your digital photo camera, you can connect the camera directly to the TV.

Use one of the **USB** connections on the TV to connect. Switch on the camera after you made the connection.

If the contents list does not appear automatically, press **SOURCES**, and select **USB**.

Your camera might need to be set to transfer its content with PTP (Picture Transfer Protocol). Read the user manual of the digital photo camera.

4.11

## Camcorder

### HDMI

For best quality, use an HDMI cable to connect the camcorder to the TV.

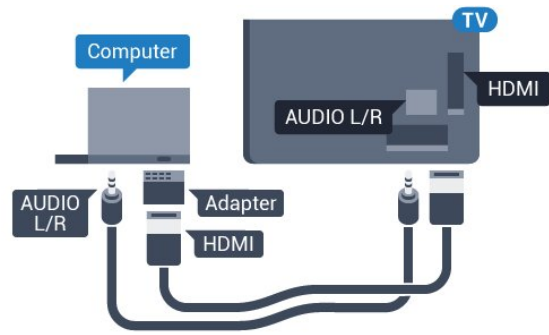
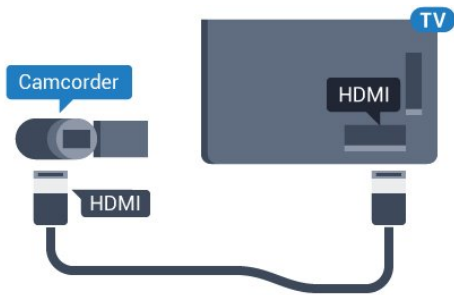

---

## Audio Video LR / Scart

You can use an HDMI, YPbPr or SCART connection to connect your camcorder. If your camcorder only has Video (CVBS) and Audio L/R output, use a Video Audio L/R to SCART adapter (sold separately) to connect to the SCART connection.

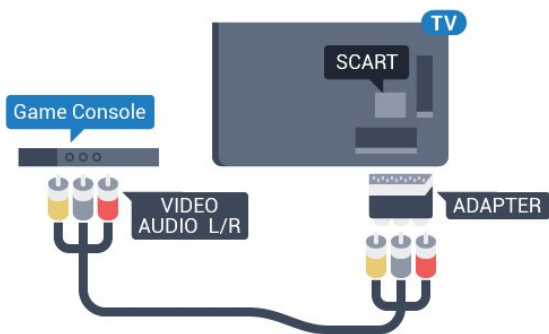

---

4.12

## Computer

---

### Connect

You can connect your computer to the TV and use the TV as a PC monitor.

#### With HDMI

Use an HDMI cable to connect the computer to the TV.

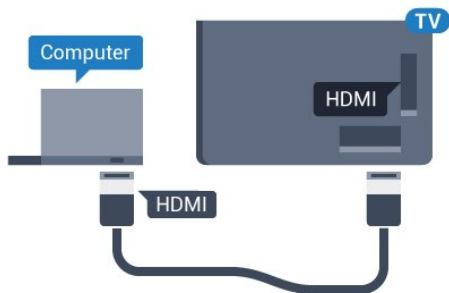

#### With DVI to HDMI

Alternatively, you can use a DVI to HDMI adapter (sold separately) to connect the PC to HDMI and an audio L/R cable (mini-jack 3.5mm) to AUDIO IN L/R on the back of the TV.



# Switching On and Off

## 5.1

### On, Standby or Off

Make sure the TV is connected to the mains AC power. Connect the supplied power cord to the AC in connector at the back of the TV. The indicator light at the bottom of the TV lights up.

#### Switch on

Press  on the remote control to switch the TV on. Alternatively, press  HOME. You can also press the small joystick key on the back of the TV to switch the TV on in case you can't find the remote control or its batteries are empty.

#### Switch to standby

To switch the TV to standby, press  on the remote control. You can also press the small joystick key on the back of the TV.



In standby mode, the TV is still connected to the mains power but consumes very little energy.

To switch off the TV completely, disconnect the power plug.

When disconnecting the power plug, always pull the power plug, never the cord. Ensure that you have full access to the power plug, power cord and outlet socket at all times.



## 5.2

### Word mark brightness



You can switch off or adjust the brightness of the Philips logo on the front of the TV.

To adjust or switch off...

1 - Consumer Mode:

On – Press  HOME and select  Features and press **OK**.

Guest Mode: On – Guest Menu:

Press  HOME and select  Features and press **OK**.

(For professional mode information, please refer to Installation manual)

- 2 - Select **Eco Settings > Philips Wordmark** and press **OK**.
- 3 - Select **Maximum, Medium, Minimum** or select **Off** to switch off the lighting of the word mark.
- 4 - Press  **BACK**, repeatedly if necessary, to close the menu.





\*Only available for 65HFL7011.

## 5.3

### Keys on TV

If you lost the remote control or its batteries are empty, you can still do some basic TV operations.

To open the basic menu...

- 1 - With the TV switched on, press the joystick key on the back of the TV to bring up the basic menu.
- 2 - Press left or right to select  Volume,  Channel or  Sources.
- 3 - Press up or down to adjust the volume or tune to the next or previous channel. Press up or down to go through the list of sources, including the tuner selection.
- 4 - The menu will disappear automatically.

To switch the TV on standby, select  and press the joystick key.



# Remote Control

## Key overview

### Top

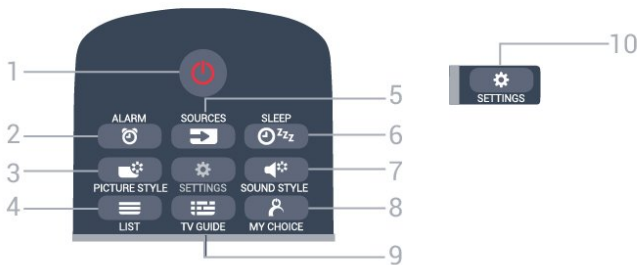

1 - Standby / On

To switch the TV on or back to Standby.

2 - ALARM

To set the alarm.

3 - PICTURE STYLE

To select one of the picture style.

4 - LIST

To open the channel list.

5 - SOURCES

To open or close the Sources menu.

6 - SLEEP

To open the Sleep Timer list.

7 - SOUND STYLE

To select one of the sound style.

8 - MY CHOICE

To switch on mychoice.

9 - TV GUIDE

To open or close the TV Guide.

10 - SETTINGS

To open the Frequent Settings menu and All Settings.

### Middle



1 - SMART INFO

To open the smart information page.

2 - Colour keys

Direct selection of options. Blue key , opens **Help**.

3 - INFO

To open or close programme info.

4 - BACK

To switch back to the previous channel you selected.

To close a menu without changing a setting.

To go back to the previous App/Internet page.

5 - TV

To switch back to watching TV. To leave an interactive TV application.

6 - APPS

To open the App gallery.

7 - OPTIONS

To open or close the Options menu.

8 - OK key

To confirm a selection or setting.

9 - Arrow / navigation keys

To navigate up, down, left or right.

10 - HOME

To open the Home menu.

### Bottom

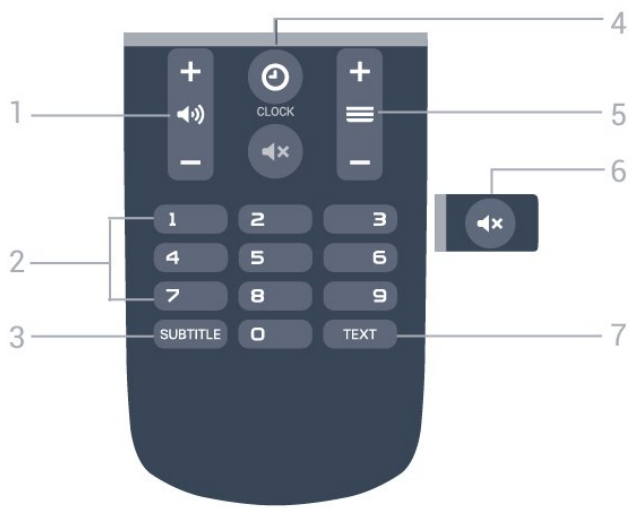

- 1 - **Volume**  
To adjust the volume level.
- 2 - **Number keys**  
To select a channel directly.
- 3 - **SUBTITLE**  
To switch Subtitles on, off or on during mute.
- 4 - **CLOCK**  
To display the clock.
- 5 - **Channel**  
To switch to the next or previous channel in the channel list. To open the next or previous page in Text/Teletext. To start the next or previous chapter on a disc.
- 6 - **Mute**  
To mute the sound or to restore it.
- 7 - **TEXT**  
To open or close Text/Teletext.

---

## 6.2

### IR Sensor

The TV can receive commands from a remote control that uses IR (infrared) to send commands. If you use such a remote control, always make sure you point the remote control at the infrared sensor on the front of the TV.

---

## 6.3

### Batteries

If the TV does not react on a key press on the remote control, the batteries might be empty.

To replace the batteries, open the battery compartment on the back of the remote control.

- 1 - Slide the battery door in the direction shown by

the arrow.

- 2 - Replace the old batteries with 2 type **AAA-R03-1.5V** batteries. Make sure the + and the - ends of the batteries line up correctly.
- 3 - Reposition the battery door and slide it back until it clicks.

Remove the batteries if you are not using the remote control for a long time.

Safely dispose of your old batteries according to the end of use directions.

---

## 6.4

### Cleaning

Your remote control is treated with a scratch-resistant coating.

To clean the remote control, use a soft damp cloth. Never use substances such as alcohol, chemicals or household cleaners on the remote control.

# Channels

## Watching TV channels

### Switch channels

To watch TV channels, press **TV**. The TV tunes to the TV channel you last watched.

Alternatively, press **HOME** to open the Home menu and press **▶** to select the desired channel.

To switch channels, press **≡ +** or **≡ -**. If you know the channel number, type in the number with the number keys. Press **OK** after you entered the number to switch channels.

To switch back to the previously tuned channel, press **← BACK**.

To switch to a channel from a channel list

While watching a TV channel, press **≡ LIST** to open the channel grid.

The channel grid can have several pages with channels. To view the next or previous page, press **≡ +** or **≡ -**.

To close the channel lists without switching channels, press **≡ LIST** again.

### Radio channels

If digital broadcasting is available, digital radio stations are installed during installation. Switch to a radio channel just like you switch to a TV channel.

## Channel list

### Channel list views

In the channel lists, you can find all installed TV and radio channels.

Next to the channel list **All**, which holds all installed channels where you can view the installed **Radio** stations separately or discover the newly added channels in **New**.

### Channel logos

In some countries, the TV can show the channel logos. If you do not want these logos to appear, you can switch them off.

To switch off Channel logos . . .

1 - Consumer Mode:

On - Press **HOME** and select **Features** and press **OK**.

Guest Mode: On - Guest Menu: Not available in

Guest Menu.

(For professional mode information, please refer to Installation manual)

2 - Select **Channels > Channel settings >**

**Enable Channel logos** and press **OK**.

3 - Select **No** and press **OK**.

4 - Press **← BACK**, repeatedly if necessary, to close the menu.

## Options for channels

While watching a channel, depending on the type of channel (analogue or digital) you are watching or depending on the TV settings you made, some options are available.

### Open the options menu

While watching a channel, press **OPTIONS**.

### Universal access

With Universal access switched on, you can set some options for hearing impaired and visually impaired people.

### Video selection

Digital TV channels can offer multi video signals (multi-feed broadcast), different camera viewpoints or angles of the same event or different programmes on one TV channel. The TV shows a message if any such TV channels are available.

### Subtitles

Switch **Subtitles on** or **Subtitles off** with this options. Select **Automatic** to show subtitles only when the sound is muted with **⏸**.

### Subtitle language

For digital broadcast, you can select an available subtitle language temporarily if none of your preferred languages are available.

### Audio languages

For digital broadcast, you can select an available audio language temporarily if none of your preferred languages are available.

### Dual I-II

If an audio signal contains two audio languages but one language — or both — has no language indication, this option is available.

### Common interface

If prepaid premium content is available from a CAM, you can set the provider settings with this option.

## HbbTV on this channel

You can block the HbbTV pages from a channel that offers HbbTV.

## MHP applications

Enable or disable the MHP applications.

## Status

Select **Status** to view technical information on the channel (if it is analogue or digital) or a connected device you are watching.

## Share

Enables the user to communicate his activity with his social networks (such as Twitter or email).

\*For Smart TVs only.

---

## Picture format

If black bars appear on top and bottom or on both sides of the picture, you can adjust the picture format to a format that fills the screen.

To change the picture format . . .

1 - Consumer Mode:

On – Press  HOME and select **Features** and press **OK**.

Guest Mode: On – Guest Menu:

Press  HOME and select **Features** and press **OK**.

(For professional mode information, please refer to Installation manual)

2 - Select **Picture** > **Picture Format** and press **OK**.

3 - Select a format from the list and press **OK**.

4 - Press  BACK, repeatedly if necessary, to close the menu.

The following format can be available according the picture on screen . . .

- Fill screen
- Fit to screen
- Super zoom
- Movie expand 16:9
- Wide screen
- Unscaled
- 4:3

---

7.2

## Text / Teletext

---

## Text Pages

To open Text/Teletext press **TEXT**, while you are watching TV channels.

To close Text, press **TEXT** again.

### Select a Text page

To select a page . . .



1 - Enter the page number with the number keys.

2 - Use the arrow keys to navigate.

3 - Press a colour key to select a colour-coded subject at the bottom of the screen.

### Text sub-pages

A Text page number can hold several subpages. The subpage numbers are shown on a bar next to the main page number.

To select a subpage, press  or .

### T.O.P. Text pages



Some broadcasters offer T.O.P. Text.

To open T.O.P. Text pages within Text, press  **OPTIONS** and select **T.O.P. overview**.

### Favourite pages

The TV makes a list of the last 10 Text pages you opened. You can easily reopen them again in the Favourite Text pages column.

1 - In Text, select the star in the top left corner of the screen to show the column of favourite pages.

2 - Press  (down) or  (up) to select a page number and press **OK** to open the page.

You can clear the list with the option **Clear favourite pages**.

### Search Text

You can select a word and scan Text for all occurrences of this word.

1 - Open a Text page and press **OK**.

2 - Select a word or number with the arrow keys.

3 - Press **OK** again to jump immediately to the next occurrence of this word or number.

4 - Press **OK** again to jump to the subsequent occurrence.



5 - To stop searching, press  (up) until nothing is selected.

### Text from a connected device

Some devices that receive TV channels can also offer Text.

To open Text from a connected device . . .

1 - Press **SOURCES** select the device and press **OK**.

2 - While watching a channel on the device, press  **OPTIONS**, select **Show device keys** and select the  key and press **OK**.

3 - Press  BACK to hide the device keys.

4 - To close Text, press  BACK again.

## Digital Text (UK only)

Some digital broadcasters offer dedicated Digital Text or interactive TV on their digital TV channels. This includes normal Text using the number, colour and arrow keys to select and navigate.

To close Digital Text, press **← BACK**.

---

## Text Options

In Text/Teletext, press **≡ OPTIONS** to select the following...

- **Freeze page**

To stop the automatic rotation of subpages.

- **Dual screen / Full screen**

To show the TV channel and Text alongside each other.

- **T.O.P. overview**

To open T.O.P. Text.

- **Enlarge**

To enlarge the Text page for comfortable reading.

- **Reveal**

To unhide hidden information on a page.

- **Cycle subpages**

To cycle subpages when these are available.

- **Language**

To switch the group of characters that Text uses to display correctly.

- **Text 2.5**

To activate the Text 2.5 for more colours and better graphics.

---

## Text Setup

### Text language

Some digital TV broadcasters have several Text languages available.

To set your primary and secondary Text language . . .

1 - Consumer Mode:

On – Press **🏠 HOME** and select **Features** and press **OK**.

Guest Mode: On – Guest Menu: Not available in this mode.

(For professional mode information, please refer to Installation manual)

2 - Select **Region and Language** and press **OK**.

3 - Select **Languages > Primary**

**Text** or **Secondary Text** and press **OK**.

4 - Select your preferred Text languages.

5 - Press **← BACK** repeatedly if necessary, to close the menu.

### Text 2.5

If available, Text 2.5 offers more colours and better

graphics. Text 2.5 is activated as a standard factory setting.

To switch off Text 2.5...

1 - Press **TEXT**.

2 - With Text/Teletext open on screen, press **≡ OPTIONS**.

3 - Select **Text 2.5 > Off**.

4 - Press **◀ (left)** repeatedly if necessary, to close the menu.

---

7.3

## Interactive TV

---

### About iTV

With interactive TV, some digital broadcasters combine their normal TV programme with information or entertainment pages. On some pages, you can respond to a programme or vote, do online shopping or pay for a video-on-demand programme.

### HbbTV, MHEG, . . .

Broadcasters use various interactive TV systems : HbbTV (Hybrid Broadcast Broadband TV) or iTV (Interactive TV - MHEG). Interactive TV is sometimes referred to as Digital Text or Red button. But each system is distinct.

Visit the broadcaster's Internet website for more information.

---

### What You Need

Interactive TV is only available on digital TV channels. To enjoy the full benefits of Interactive TV, you need a high-speed (broadband) Internet connection to the TV.

### HbbTV

If a TV channel offers HbbTV pages, you must first switch on HbbTV in the TV settings to view the pages.

1 - Consumer Mode:

On – Press **🏠 HOME** and select **Features** and press **OK**.

Guest Mode: On – Guest Menu: Not available in this mode.

(For professional mode information, please refer to Installation manual)

2 - Select **Channels > Channel settings >**

**Enable Hbb TV** and press **OK**.

3 - Select **Yes**.

4 - Press **← BACK** repeatedly if necessary, to close the menu.

If you want to avoid access to HbbTV pages on a specific channel, you can block the HbbTV pages for this channel only.



- 1 - Tune to the channel of which you want to block the HbbTV pages.
- 2 - Press **≡** **OPTIONS** and select **HbbTV on This Channel**.
- 3 - Select **Off**.

---

## Use iTV

### Open iTV pages

Most channels that offer HbbTV or iTV invite you to press the colour key **■** (red) or **OK** key to open their interactive programme.

### Navigate iTV pages

You can use the arrow and colour keys, the number keys and the **←** **BACK** key to navigate the iTV pages. You can use the **▶** (Play), **⏸** (Pause) and **■** (Stop) keys to watch videos within iTV pages.

### Digital Text (UK only)

To open Digital Text, press **TEXT**. To close, press **←** **BACK**.

### Close iTV pages

Most iTV pages inform you which key to use to close. To force an iTV page to close, switch to the next TV channel and press **←**.

---

# TV Guide

---

## What You Need

With the TV Guide you can view a list of the current and scheduled TV programmes of your channels. Depending on where the TV guide information (data) is coming from, analogue and digital channels or only digital channels are shown. Not all channels offer TV Guide information.

The TV can collect TV Guide information for the channels that are installed on the TV. The TV cannot collect the TV Guide information for channels viewed from a digital receiver or decoder.

---

## Using the TV Guide

---

### Open the TV Guide

To open the TV Guide, press  TV GUIDE. The TV Guide shows the channels of the selected tuner.

Press  TV GUIDE again to close.

The first time you open the TV Guide, the TV scans all TV channels for programme information. This may take several minutes. TV Guide data is stored on TV.

---

### Tune to a Programme

From the TV Guide, you can tune to a current programme.

To switch to the programme (channel), select the programme and press **OK**.

#### View programme details

To call up the details of the selected programme...

1 - Press  **INFO**.

2 - Press  **BACK** to close.

---

### Change Day

The TV Guide can show the scheduled programmes for the upcoming days (maximum up to 8 days).

Press the colour key  **Day** and select the day you need.

---

## Search by Genre

If the information is available, you can look up scheduled programmes by genre like movies, sports, etc.

To search for programmes by genre...

1 - Press  **TV GUIDE**.

2 - Press  **OPTIONS**.

3 - Select **Search by Genre** and press **OK**.

4 - Select the genre you want and press **OK**. A list with the found programmes appears.

5 - You can set reminders or schedule a recording on a selected programme.

6 - Press  **BACK**, repeatedly if necessary, to close the menu.

---

# Home Menu

---

## 9.1

### About the Home Menu

To enjoy the benefits of your Android TV, connect the TV to the Internet.

Like on your Android smartphone or tablet, the Home menu is the centre of your TV. From the Home menu you can start any application, switch to a TV channel, open a website or switch to a connected device. Depending on your TV setup and your country the Home menu can contain different items.

The Home menu is organised in rows...

#### LIST

The first row shows a selection of channels. Select the channel that you want to watch.

#### Smart Info

This row allows user to customise the hotel information on TV.

#### Apps

The row of Apps contain all Apps that come with the TV. In this row you will also find the Apps for TV, like **Watch TV**, **Sources**, **Media** and others. Apps you started recently will appear in front of the row.

#### Features

From this row, you can open a selection of settings.

#### Language



User can set the language of the TV in this row.

---

## 9.2

### Open the Home Menu

To open the Home menu and open an item...

- 1 - Press  HOME.
- 2 - Select an item and press **OK** to open or start it.
- 3 - Press  **BACK**, to close the Home menu without starting anything.

# Sources

## 10.1

### Switch to a device

From the list of Sources, you can switch to any of the connected devices. You can switch to a tuner to watch TV, open the content of a connected USB Flash Drive or see the recordings you made on a connected USB Hard Drive. You can switch to your connected devices to watch their programme, a digital receiver or a Blu-ray Disc player.

To switch to a connected device...

- 1 - Press **SOURCES** to open the Sources menu.
- 2 - Select one of the item in the source list and press **OK**. The TV will show the programme or content of the device.
- 3 - Press **SOURCES** again to close the menu.

#### One Touch Play

With the TV in standby, you can switch on a disc player with your TV remote control.

To switch on both disc player and TV from standby and start playing the disc immediately, press **▶** (play) on the TV remote control. The device must be connected with an HDMI cable and both TV and device must have HDMI CEC switched on.

## 10.2

### Options for a TV Input

Some TV input devices offer specific settings.

To set the options for a specific TV input...

- 1 - Press **SOURCES**.
- 2 - Select the TV input in the list and press **OK**.
- 3 - Press **≡** **OPTIONS**. You can set the options for the selected TV input here.
- 4 - Press **≡** **OPTIONS** again to close the Options menu.

Possible options...

#### Controls

With this option you can operate the connected device with the TV remote control. The device must be connected with an HDMI cable and both TV and device must have HDMI CEC switched on.

#### Device Info

Open this option to view information on the connected device.

### Device Name and Type

When you connect a new device to the TV and the TV detects the device, you can assign an icon that fits the device type. If you connect a device with an HDMI cable and HDMI CEC, the TV detects the device type automatically and the device gets an appropriate icon.

The device type determines picture and sound styles, resolution values, specific settings or the position within the Sources menu. You don't have to worry about the ideal settings.

#### Rename or Change Type

You can always change the name or change the type of a connected device. Look for the  icon at the right of the device name in the Sources menu. Some TV input sources do not allow a name change.

To change the device type...

- 1 - Select the device in the Sources menu.
- 2 - Press **▶** (right) to select the  icon and press **OK**.
- 3 - Press **←** **BACK** to hide the onscreen keyboard.
- 4 - Press **▼** (down) to find all available device types. Select the type you want and press **OK**.
- 5 - If you want to reset the type of the device to the original connector type, select **Reset** and press **OK**.
- 6 - Select **Close** and press **OK** to close this menu.

To change the device name...

- 1 - Select the device in the Sources menu.
- 2 - Press **▶** (right) to select the  icon and press **OK**.
- 3 - Use the on-screen Keyboard to delete the current name and enter a new one. Press **✓** to confirm.
- 4 - Press **←** **BACK** to hide the onscreen keyboard.
- 5 - If you want to reset the name of the device to the original connector name, select **Reset** and press **OK**.
- 6 - Select **Close** and press **OK** to close this menu.

## 10.4

### Game or Computer

The device type determines picture and sound styles, resolution values and other specifics. You don't have to worry about the ideal settings.

For some devices the type of the device is not that clear. A game console can have a built-in Blu-ray Disc player and the type is set to Player because it is used as a disc player most of the time. For this kind of devices, you can temporarily switch to the ideal

settings for gaming. Or alternatively, switch to the ideal settings for a connected computer.

You can only use the setting **Game** or **Computer** when you switch to a connected device in the Sources menu. The Game or Computer setting is stored for the selected device.

To switch to the ideal settings for gaming or computer manually...

1 - Consumer Mode:

On – Press  HOME and select **Features** and press **OK**.



Guest Mode: On – Guest Menu: Not available in this mode.

(For professional mode information, please refer to Installation manual)

2 - Select **Picture** > **Advanced** and press **OK**.

3 - Select **Game** or **Computer** and press **OK**.

4 - Select **Game**, **Computer** or **Off**.

5 - Press  (left) to go back one step or press  **BACK** to close the menu.

Remember to set this setting back to **Off** when you stop playing the game.

---



10.5

## Rescan Connections

You can rescan all TV connections to update the Sources menu with recently connected devices.

To rescan the connections...

1 - Press **SOURCES** to open the Sources menu.

2 - Press  (up) to select the  icon at the top right of the Sources menu.

3 - Press **OK** to start scanning the connections.

Newly connected devices will be added to the Sources menu.

# Apps

---

## About Apps

All the apps can be found by pressing  **Apps** on your remote control. These TV apps offer entertainments to enrich your hotel stay experience. Apps can also be accessed in **Apps** section in the **Apps** menu.

## Start or Stop an App

You can start an app from the Home menu.

To start an app...

1 - Consumer Mode:



On – Press  HOME and select **Apps** and press **OK**.

Guest Mode: On – Guest

Menu: Press  HOME and select **Apps** and press **OK**.

(For professional mode information, please refer to Installation manual)

2 - Select the app you want and press **OK**.

3 - To stop an app, press  **BACK** or press  **TV** or stop the app with its dedicated exit/stop button.

---

# Internet

---

## 12.1



## Start Internet

You can browse the Internet on your TV. You can view any Internet website but most of them are not prepared for a TV screen.



- Some plug-ins (e.g. to view pages or videos) are not available on your TV.
- You cannot send or download files.
- Internet pages are shown one page at a time and full screen.

To start the Internet browser...

1 - Consumer Mode:

On – Press  HOME and select Features and press  (right).

Guest Mode: On – Guest

Menu: Press  HOME and select Features and press  (right).

(For professional mode information, please refer to Installation manual)

2 - Select  Internet and press OK.

3 - Enter an Internet address and select , press OK.

4 - To close Internet, press  HOME or TV.

## 12.2

---

## Options on Internet

Some extras are available for the Internet.

To open the extras...

1 - With the website open, press  OPTIONS.

2 - Select one of the items and press OK.

3 - Press  BACK repeatedly if necessary, to close the menu.

### Enter Address

To enter a new Internet address.

### Show Favourites

To view the pages you marked as favourites.

### Reload Page

To load the Internet page again.

### Zoom Page

Use the slider bar to set the zoom percentage.

### Security Info

To view the security level of the current page.

### Mark as Favourite

To mark the current page as a favourite.

### Subtitles

To select subtitles if available.

# Videos, Photos and Music

## From a USB Connection

You can view your photos or play your music and videos from a connected USB flash drive or USB Hard Drive.

With the TV switched on, plug in a USB flash drive or a USB Hard Drive to one of the USB connections. The TV detects the device and will list your media files.

If the list of files does not appear automatically...

- 1 - Press **SOURCES**, select **USB** and press **OK**.
- 2 - Select **USB Devices** and press **▶** (right) to select the USB device you need.
- 3 - You can browse your files in the folder structure you have organised on the drive.
- 4 - To stop playing videos, photos and music, press **TV**.

## Play your Videos

### Play Videos

How you open the list of your media files on TV depends on the type of device where the files are stored. See the chapters above.

To play a video on TV...

Select **Videos**, and select the file name and press **OK**.

- To rewind or go fast forward, press **▶▶** or **◀◀**. Press the keys several times to speed up - 2x, 4x, 8x, 16x, 32x.
- To jump to the next video in a folder, press **OK** to pause and select **▶** on screen and press **OK**.
- To stop the video playback, press **■** (Stop).
- To go back to the folder, press **←** **BACK**.

### Progress Bar

To show the progress bar when a video is playing (playhead position, duration, title, date, etc.), press **ℹ** **INFO**.  
Press again to hide the info.

## Video Options

During the video playback, press **≡** **OPTIONS** to...

- **Mark as Favourite** – Set the selected video as favourite.
- **Play All** – Play all video files in this folder.
- **Play One** – Play this video only.
- **Subtitles** – If available, you can switch subtitles **On**, **Off** or **On During Mute**.
- **Audio Language** – If available, select an Audio Language.
- **Shuffle** – Play your files in a random order.
- **Repeat** – Plays all videos in this folder once or continuously.

## View your Photos

### View Photos

How you open the list of your media files on TV depends on the type of device where the files are stored. See the chapters above.

To view all photos on TV...

Select **Photos**, and select **All** and press **OK**.

To view a photo on TV...

Select **Photos**, and select the file name and press **OK**.

To start a slide show on TV...

If there are several photos in a folder, you can start a slide show.

To start a slide show...

- 1 - Select the folder with photos.
- 2 - Press the colour key **Slide Show**.
- To jump to the next or previous photo, press **▶** (right - next) or **◀** (left - previous).
- To pause the slide show, press **OK**. To start again, press **OK** again.
- To stop the slide show, press **OK** and press **←** **BACK**.

### Info

To view info on a photo (size, creation date, file path, etc.), select a photo and press **ℹ** **INFO**.  
Press again to hide the info.



---

## Slideshow with Music

You can watch a slideshow of your photos and listen to your music at the same time. You must start the music before you start the photo slideshow.

To play music with the slide show...

- 1 - Select a song or a folder with songs and press **OK**.
- 2 - Press **i** **INFO** to hide file info and progress bar.
- 3 - Press **←** **BACK**.
- 4 - Now use the navigation arrows to select the folder with photos.
- 5 - Select the folder with photos and press **→** **Slide Show**.
- 6 - To stop the slideshow, press **←** **BACK**.

---

## Photo Options

With a photo on screen, press **≡** **OPTIONS** to...

- **Mark as Favourite** – Set the selected photo as favourite.
- **Slide Show** – Show photos one after the other.
  
- **Rotate** – Rotate the photo to landscape or portrait format.
- **Shuffle** – Play your files in a random order.
- **Repeat** – Play the slide show once or continuously.
  
- **Stop Music** – Stop the music playing in the background.
- **Slide Show Speed** – Set the speed of the slide show.
- **Slide Show Transition** – Set the style of the photo transitions.

---

13.4

## Play your Music

---

### Play Music

How you open the list of your media files on TV depends on the type of device where the files are stored. See the chapters above.

To play a song on TV...

Select **🎵** **Music** , and select the file name and press **OK**

If there are several songs in a folder, you can listen to them one after the other.

- To pause a song, press **OK**. Press **OK** again to continue.
- To rewind or go fast forward, press **⏮** or **⏭**. Press the keys several times to speed up – 2x, 4x, 8x, 16x, 32x.

- To jump to the next song in a folder, press **OK** to pause and select **▶** on screen and press **OK**.
- To go back to the folder, press **←** **BACK**, the music will keep on playing.
- To stop the music playback, press **■** (Stop).

### Progress Bar

To show the progress bar when a song is playing (playhead position, duration, title, date, etc.), press **i** **INFO** . Press again to hide the info.

---

## Music Options

Options for playing music...

- **Mark as Favourite** – Set the selected song as favourite.
- **Play All** – Play all songs in this folder.
- **Play One** – Play this song only.
  
- **Shuffle** – Play your files in a random order.
  
- **Repeat** – Plays all songs in this folder once or continuously.

# Smartphones and Tablets

## Miracast

### About Wi-Fi Miracast

You can view your photos or play your music and videos from a mobile device on your TV with Wi-Fi Miracast™. The mobile device and the TV should be within range, which usually means being in the same room.

Check if your mobile device is ready for Miracast.

Your TV is a **Wi-Fi CERTIFIED Miracast™** device. With Miracast™, you can watch and share the screen of your smartphone, tablet or computer on your TV screen wirelessly. You can stream videos (audio and video), share photos or anything else that's on screen of the device. No need to connect the device to your home network. Both the TV and the device must be Wi-Fi CERTIFIED Miracast™ devices and have Miracast switched on.



Miracast on this TV is subject to the HDCP protocol and cannot display copy-protected premium content sent by a device. The maximum video resolution supported is 720p for 2.4GHz Wi-Fi or 1080p for 5GHz Wi-Fi.

For more information on Wi-Fi CERTIFIED Miracast™ go to [www.wi-fi.org](http://www.wi-fi.org)

Wi-Fi®, the Wi-Fi CERTIFIED logo, the Wi-Fi logo are registered trademarks of the Wi-Fi Alliance. **Wi-Fi CERTIFIED Miracast™**, **Miracast™** are trademarks of the Wi-Fi Alliance.

### Share a Screen on TV

To share the screen of your smartphone, tablet or computer on the TV . . .

- 1 - Switch on the TV.
- 2 - Consumer Mode: On – Press  HOME > Features and then press  (right).
- 3 - Select **Miracast** and press **OK**.
- 4 - On the device, open an application such as Wi-Fi Miracast, Wi-Fi Direct™, Intel® Wireless Display\* or similar and start scanning for other Miracast devices.
- 5 - In the list of found devices, select the TV and connect.
- 6 - On the TV, agree to the request to connect to the TV. If you connect, the TV will show the screen of the device.

7 - On the device, select the videos, photos or files you want to watch on TV.

\* Miracast is supported by WiDi 3.5 onwards.

### Stop Sharing

You can stop sharing a screen from the TV or from the mobile device.

#### From the device

With the application you use to start Miracast, you can disconnect and stop watching the screen of the device on TV. The TV will switch back to the last selected programme.

#### From the TV

To stop watching the screen of the device on TV, you can . . .

- press **TV** to watch a TV broadcast
- press  **HOME** to start another activity on TV
- press **SOURCES** to open the Sources menu and select a connected device.

### Block a Device

The first time you receive a request to connect from a device, you can block the device. The request from this device and all its requests in the future, will be ignored.



To block a device...

Select **Block...** and press **OK**.

#### Unblock all devices

All previously connected and also blocked devices are stored in the Wi-Fi Miracast list of connections. If you clear this list, all blocked devices will be unblocked.

To unblock all blocked devices...

- 1 - Consumer Mode: On – Press  HOME and select **Features** and press **OK**.  
Guest Mode: On – Guest Menu: Not available in this mode.  
(For professional mode information, please refer to Installation manual)
- 2 - Select **Wireless and Networks** > **Features** and press **OK**.
- 3 - Select **Wi-Fi Miracast** > **Wi-Fi Miracast Connections** and press **OK**. The list is cleared.
- 4 - Press  **BACK** repeatedly if necessary, to close the menu.

#### Blocking a previously connected device

If you want to block a device that you previously connected, you need to clear the Wi-Fi Miracast

connections list first. If you clear this list, you will have to confirm or block the connection for every device again.

---

## Screen Delay

The normal delay when sharing a screen with Miracast is about 1 second. The delay might be longer if you are using older devices with less processing power.

---

14.2

## MHL

This TV is MHL™ compliant.

If your mobile device is also MHL compliant, you can connect your mobile device with a MHL cable to the TV. With the MHL cable connected you can share what's on your mobile device on the TV screen. Your mobile device charges its battery at the same time. The MHL connection is ideal for watching movies or playing games from your mobile device on TV for a longer time.

### Charging

With the MHL cable connected, your device will charge while the TV is switched on (not in standby).

### MHL Cable

You need a passive MHL cable (HDMI to Micro USB) to connect your mobile device to the TV. You might need an extra adapter to connect to your mobile device. To connect the MHL cable to the TV use the HDMI 4 MHL connection.



MHL, Mobile High-Definition Link and the MHL Logo are trademarks or registered trademarks of the MHL, LLC.

---

# Ambilight

---

## Ambilight Style

---

### Follow Video

You can set Ambilight to follow the video dynamics or to show a preset colour style. Alternatively, you can switch Ambilight off.

If you select **Follow Video**, you can select one of the styles that follow the dynamics of the picture on your TV screen.

To set the Ambilight Style...

1 - Consumer Mode: On – Press  HOME and select **Features** and press **OK**.

Guest Mode: On – Guest

Menu: Press  HOME and select **Features** and press **OK**.

(For professional mode information, please refer to Installation manual)

2 - Select **Ambilight > Ambilight style** and press **OK**.

3 - Select **Follow Video** and press **OK**.

4 - Select the style you want and press **OK**.

5 - Press  **BACK** repeatedly if necessary, to close the menu.

The available **Follow Video** styles are...

- **Standard** - Ideal for day to day TV watching
- **Natural** - Follows the picture or sound as truthful as possible
- **Immersive** - Ideal for action movies
- **Vivid** - Ideal for daylight conditions
- **Game** - Ideal for gaming
- **Comfort** - Ideal for a quiet evening
- **Relax** - Ideal for a lounge feeling

---

### Follow Audio

You can set Ambilight to follow the video or the audio dynamics of a TV programme. Alternatively, you can set Ambilight to show a preset colour style or you can switch Ambilight off.

If you select **Follow Audio**, you can select one of the styles that follow the dynamics of the sound.

To set the Ambilight Style...

1 - Consumer Mode: On – Press  HOME and select **Features** and press **OK**.

Guest Mode: On – Guest

Menu: Press  HOME and select **Features** and press **OK**.

(For professional mode information, please refer to Installation manual)

2 - Select **Ambilight > Ambilight style** and press **OK**.

3 - Select **Follow Audio** and press **OK**.

4 - Select the style you want and press **OK**.

5 - Press  **BACK** repeatedly if necessary, to close the menu.

The available **Follow Audio** styles are...

- **Lumina** - Mixes audio dynamics with video colours
- **Colora** - Based on audio dynamics
- **Retro** - Based on audio dynamics
- **Spectrum** - Based on audio dynamics
- **Scanner** - Based on audio dynamics
- **Rhythm** - Based on audio dynamics
- **Party** - A mix of all Follow Audio styles, one after the other

---

### Follow Colour

You can set Ambilight to follow the video dynamics or to show a preset colour style. Alternatively, you can switch Ambilight off.

If you select **Follow Colour**, you can select one of the preset colour styles.

To set the Ambilight Style...

1 - Consumer Mode: On – Press  HOME and select **Features** and press **OK**.

Guest Mode: On – Guest

Menu: Press  HOME and select **Features** and press **OK**.

(For professional mode information, please refer to Installation manual)

2 - Select **Ambilight > Ambilight style** and press **OK**.

3 - Select **Follow Colour** and press **OK**.

4 - Select the style you want and press **OK**.

5 - Press  **BACK** repeatedly if necessary, to close the menu.

The available **Follow Colour** styles are...

- **Hot Lava** - Red colour variations
- **Deep Water** - Blue colour variations
- **Fresh Nature** - Green colour variations
- **Warm White/ISF** - Static colour
- **Cool White** - Static colour

## Ambilight Off

To switch off Ambilight...

1 - Consumer Mode: On – Press  HOME and select **Features** and press **OK**.

Guest Mode: On – Guest

Menu: Press  HOME and select **Features** and press **OK**.

(For professional mode information, please refer to Installation manual)

2 - Select **Ambilight** > **Ambilight style** and press **OK**.

3 - Select **Off** and press **OK**.

4 - Press  **BACK** repeatedly if necessary, to close the menu

# Settings

16.1

## Picture

### Picture Style

#### Select a Style

For easy picture adjustment, you can select a preset Picture Style.

1 - Consumer Mode: On – Press  HOME and select **Features** and press **OK**.

Guest Mode: On – Guest

Menu: Press  HOME and select **Features** and press **OK**.

(For professional mode information, please refer to Installation manual)

2 - Select **Picture > Picture Style** and press **OK**.

3 - Select one of the styles in the list.

4 - Press  BACK repeatedly if necessary, to close the menu.

The available styles are...

- **Personal** - The picture preferences you set during the first start up.
- **Vivid** - Ideal for daylight viewing
- **Natural** - Natural picture settings
- **Standard** - Most energy conscious setting - Factory setting
- **Movie** - Ideal for watching movies
  
- **Photo** - Ideal for viewing photos
  
- **Game** - Ideal for playing games
- **Computer** - Ideal for viewing computer

#### Customise a Style

Any picture setting you adjust, like Colour or Contrast, is stored in the currently selected **Picture Style**. It allows you to customize each style.

Only the style **Personal** can save its settings for each connected device in the Sources menu.

#### Restore a Style

With a Picture Style selected, you can adjust any picture setting in **All Settings > Picture...**

The selected style will store the changes you made. We recommend to adjust the picture settings for the style **Personal** only. The Picture Style - Personal can save its settings for each individual connected device

in Sources menu.

To restore the style to its original setting...

1 - Consumer Mode: On – Press  HOME and select **Features** and press **OK**.

Guest Mode: On – Guest

Menu: Press  HOME and select **Features** and press **OK**.

(For professional mode information, please refer to Installation manual)

2 - Select **Picture > Picture Style**, and select the Picture Style you want to restore.

3 - Press the colour key  Restore Style , and press **OK**. The style is restored.

4 - Press  BACK repeatedly if necessary, to close the menu.

### Picture Settings

#### Colour

With **Colour**, you can adjust the colour saturation of the picture.

To adjust the colour...



1 - Consumer Mode: On – Press  HOME and select **Features** and press **OK**.

Guest Mode: On – Guest

Menu: Press  HOME and select **Features** and press **OK**.

(For professional mode information, please refer to Installation manual)

2 - Select **Picture > Colour** press **OK**.

3 - Adjust the value with  (up) or  (down).

4 - Press  BACK repeatedly if necessary, to close the menu.

#### Contrast

With **Contrast**, you can adjust the contrast of the picture.

To adjust the contrast...

1 - Consumer Mode: On – Press  HOME and select **Features** and press **OK**.

Guest Mode: On – Guest

Menu: Press  HOME and select **Features** and press **OK**.

(For professional mode information, please refer to Installation manual)

2 - Select **Picture > Contrast** press **OK**.

3 - Adjust the value with  (up) or  (down).

4 - Press  BACK repeatedly if necessary, to close the menu.

---

## Sharpness

With **Sharpness**, you can adjust the contrast of the picture.

To adjust the contrast...

1 - Consumer Mode: On – Press  HOME and select **Features** and press **OK**.

Guest Mode: On – Guest

Menu: Press  HOME and select **Features** and press **OK**.

(For professional mode information, please refer to Installation manual)

2 - Select **Picture > Sharpness** press **OK**.

3 - Adjust the value with  (up) or  (down).

4 - Press  **BACK** repeatedly if necessary, to close the menu.

---

## Advanced Picture Settings

---

### Game or Computer

When you connect a device, the TV recognizes its type and gives each device a correct type name. You can change the type name if you wish. If a correct type name for a device is set, the TV automatically switches to the ideal TV settings when you switch to this device in the Sources menu.

If you have a game console with a built-in Blu-ray Disc player, you might have set the type name to Blu-ray Disc. With **Game or Computer** you can switch to the ideal settings for gaming manually. Don't forget to switch the Game or Computer setting off, when you return to watch TV.

To switch the setting manually...

1 - Consumer Mode: On – Press  HOME and select **Features** and press **OK**.

Guest Mode: On – Guest Menu: Not available in this mode.

(For professional mode information, please refer to Installation manual)

2 - Select **Picture > Advanced** press **OK**.

3 - Select **Game or Computer**, and select the device type you want to use. To switch back to TV, select **Off**.

4 - Press  **BACK** repeatedly if necessary, to close the menu.

---

### Colour Settings

---

#### Tint

With **Tint**, you can adjust the level of tint in fine detail of the picture.

To adjust the tint...



1 - Consumer Mode: On – Press  HOME and select **Features** and press **OK**.

Guest Mode: On – Guest Menu: Not available in this mode.

(For professional mode information, please refer to Installation manual)

2 - Select **Picture > Advanced** and press **OK**.

3 - Select **Colour > Tint** and press **OK**.

4 - Adjust the value with  (up) or  (down).

5 - Press  **BACK** repeatedly if necessary, to close the menu.

---

### Colour Enhancement

With **Colour Enhancement**, you can enhance the colour intensity and the details in bright colours.

To adjust the level...

1 - Consumer Mode: On – Press  HOME and select **Features** and press **OK**.

Guest Mode: On – Guest Menu: Not available in this mode.

(For professional mode information, please refer to Installation manual)

2 - Select **Picture > Advanced** and press **OK**.

3 - Select **Colour > Colour**

**Enhancement** and press **OK**.

4 - Select **Maximum, Medium, Minimum** or **Off**.

5 - Press  **BACK** repeatedly if necessary, to close the menu.

---

### Colour Temperature

With **Colour Temperature**, you can set the picture to a preset colour temperature or select **Custom** to set a temperature setting yourself with **Custom Colour Temperature**. Colour Temperature and Custom Colour Temperature are settings intended for expert users.

To select a preset...

1 - Consumer Mode: On – Press  HOME and select **Features** and press **OK**.

Guest Mode: On – Guest Menu: Not available in this mode.

(For professional mode information, please refer to Installation manual)

2 - Select **Picture > Advanced** and press **OK**.

3 - Select **Colour > Colour**

**Temperature** and press **OK**.

4 - Select **Normal, Warm** or **Cool**. Or

select **Custom** if you want to customise a colour temperature yourself.

5 - Press  **BACK** repeatedly if necessary, to close the menu.

---

## Custom Colour Temperature

With **Custom Colour Temperature**, you can set a colour temperature yourself. To set a custom colour temperature, first select **Custom** in the Colour Temperature menu. Custom Colour Temperature is a setting intended for expert users.

To set a custom colour temperature...

- 1 - Consumer Mode: On – Press  HOME and select **Features** and press **OK**.  
Guest Mode: On – Guest Menu: Not available in this mode.  
(For professional mode information, please refer to Installation manual)
- 2 - Select **Picture > Advanced** and press **OK**.
- 3 - Select **Colour > Custom Colour Temperature** and press **OK**.
- 4 - Select one of the options and press **OK**. WP is white point and BL is black level.
- 5 - Press the arrows **▲** (up) or **▼** (down) to adjust the value.
- 6 - Press **← BACK** repeatedly if necessary, to close the menu.

---

## Contrast Settings

---

### Contrast Modes

With **Contrast Mode**, you can set the level at which power consumption can be reduced by dimming the intensity of the screen. Choose for the best power consumption or for the picture with the best intensity.

To adjust the level...

- 1 - Consumer Mode: On – Press  HOME and select **Features** and press **OK**.  
Guest Mode: On – Guest Menu: Not available in this mode.  
(For professional mode information, please refer to Installation manual)
- 2 - Select **Picture > Advanced** and press **OK**.
- 3 - Select **Contrast > Contrast mode** and press **OK**.
- 4 - Select **Off, Standard, Best power** or **Best picture**.
- 5 - Press **← BACK** repeatedly if necessary, to close the menu.

---

### Dynamic Contrast

With **Dynamic Contrast**, you can set the level at which the TV automatically enhances the details in the dark, middle and light areas of the picture.

To adjust the level...

- 1 - Consumer Mode: On – Press  HOME and select **Features** and press **OK**.

Guest Mode: On – Guest Menu: Not available in this mode.

(For professional mode information, please refer to Installation manual)

- 2 - Select **Picture > Advanced** and press **OK**.
- 3 - Select **Contrast > Dynamic contrast** and press **OK**.
- 4 - Select **Off, Minimum, Medium** or **Maximum**.
- 5 - Press **← BACK** repeatedly if necessary, to close the menu.

---

### Perfect Contrast

With **Perfect Contrast**, you can set the level at which the TV automatically enhances the details in the dark, middle and light areas of the picture.

To adjust the level...

- 1 - Consumer Mode: On – Press  HOME and select **Features** and press **OK**.  
Guest Mode: On – Guest Menu: Not available in this mode.  
(For professional mode information, please refer to Installation manual)
- 2 - Select **Picture > Advanced** and press **OK**.
- 3 - Select **Contrast > Perfect contrast** and press **OK**.
- 4 - Select **Off, Minimum, Medium** or **Maximum**.
- 5 - Press **← BACK** repeatedly if necessary, to close the menu.

---

### Brightness

With **Brightness**, you can set the level of brightness of the picture signal. Brightness is a setting intended for expert users. We recommend non-expert users to adjust the brightness of the picture with the **Contrast** setting.

To adjust the level...

- 1 - Consumer Mode: On – Press  HOME and select **Features** and press **OK**.  
Guest Mode: On – Guest Menu: Not available in this mode.  
(For professional mode information, please refer to Installation manual)
- 2 - Select **Picture > Advanced** and press **OK**.
- 3 - Select **Contrast > Brightness** and press **OK**.
- 4 - Press the arrows **▲** (up) or **▼** (down) to adjust the value.
- 5 - Press **← BACK** repeatedly if necessary, to close the menu.



---

## Video Contrast

With **Video Contrast**, you can decrease the range of the video contrast.

To adjust the level...

- 1 - Consumer Mode: On – Press  **HOME** and select **Features** and press **OK**.  
Guest Mode: On – Guest Menu: Not available in this mode.  
(For professional mode information, please refer to Installation manual)
- 2 - Select **Picture > Advanced** and press **OK**.
- 3 - Select **Contrast > Video contrast** and press **OK**.
- 4 - Press the arrows **▲** (up) or **▼** (down) to adjust the value.
- 5 - Press **← BACK** repeatedly if necessary, to close the menu.

---

## Gamma

With **Gamma**, you can set a non-linear setting for picture luminance and contrast. Gamma is a setting intended for expert users.

To adjust the level...

- 1 - Consumer Mode: On – Press  **HOME** and select **Features** and press **OK**.  
Guest Mode: On – Guest Menu: Not available in this mode.  
(For professional mode information, please refer to Installation manual)
- 2 - Select **Picture > Advanced** and press **OK**.
- 3 - Select **Contrast > Gamma** and press **OK**.
- 4 - Press the arrows **▲** (up) or **▼** (down) to adjust the value.
- 5 - Press **← BACK** repeatedly if necessary, to close the menu.

---

## Sharpness Settings

### Super Resolution

With **Super Resolution**, you switch on a superior sharpness in line edges and contours.

To switch on or off...

- 1 - Consumer Mode: On – Press  **HOME** and select **Features** and press **OK**.  
Guest Mode: On – Guest Menu: Not available in this mode.  
(For professional mode information, please refer to Installation manual)
- 2 - Select **Picture > Advanced** and press **OK**.
- 3 - Select **Sharpness > Super resolution** and press **OK**.
- 4 - Select **On** or **Off**.

5 - Press **← BACK** repeatedly if necessary, to close the menu.

---

## Ultra Resolution

With **Ultra Resolution**, you switch on a superior sharpness in line edges and contours.

To switch on or off...

- 1 - Consumer Mode: On – Press  **HOME** and select **Features** and press **OK**.  
Guest Mode: On – Guest Menu: Not available in this mode.  
(For professional mode information, please refer to Installation manual)
- 2 - Select **Picture > Advanced** and press **OK**.
- 3 - Select **Sharpness > Ultra resolution** and press **OK**.
- 4 - Select **On** or **Off**.
- 5 - Press **← BACK** repeatedly if necessary, to close the menu.

---

## Noise Reduction

With **Noise Reduction**, you can filter out and reduce the level of image noise.

To adjust the noise reduction...

- 1 - Consumer Mode: On – Press  **HOME** and select **Features** and press **OK**.  
Guest Mode: On – Guest Menu: Not available in this mode.  
(For professional mode information, please refer to Installation manual)
- 2 - Select **Picture > Advanced** and press **OK**.
- 3 - Select **Sharpness > Noise reduction** and press **OK**.
- 4 - Select **Maximum**, **Medium**, **Minimum** or **Off**.
- 5 - Press **← BACK** repeatedly if necessary, to close the menu.

---

## MPEG Artefact Reduction

With **MPEG Artefact Reduction**, you can smoothen the digital transitions in the picture. MPEG artefacts are mostly visible as small blocks or jagged edges in images.

To reduce the MPEG artefacts...

- 1 - Consumer Mode: On – Press  **HOME** and select **Features** and press **OK**.  
Guest Mode: On – Guest Menu: Not available in this mode.  
(For professional mode information, please refer to Installation manual)
- 2 - Select **Picture > Advanced** and press **OK**.
- 3 - Select **Sharpness > MPEG Artefact**

Reduction and press **OK**.

4 - Select **Maximum**, **Medium**, **Minimum** or **Off**.

5 - Press **← BACK** repeatedly if necessary, to close the menu.

---

## Motion Settings

---

### Perfect Natural Motion

With **Perfect Natural Motion**, you can reduce the motion judder, visible in movies on TV. Perfect Natural Motion makes any movement smooth and fluent.

To adjust the motion judder...

1 - Consumer Mode: On – Press **HOME** and select **Features** and press **OK**.

Guest Mode: On – Guest Menu: Not available in this mode.

(For professional mode information, please refer to Installation manual)

2 - Select **Picture > Advanced** and press **OK**.

3 - Select **Motion > Perfect Natural**

**Motion** and press **OK**.

4 - Select **Maximum**, **Medium**, **Minimum** or **Off**.

5 - Press **← BACK** repeatedly if necessary, to close the menu.

---

### Natural Motion

With **Natural Motion**, you can reduce the motion judder, visible in movies on TV. Natural Motion makes any movement smooth and fluent.

To adjust the motion judder...

1 - Consumer Mode: On – Press **HOME** and select **Features** and press **OK**.

Guest Mode: On – Guest Menu: Not available in this mode.

(For professional mode information, please refer to Installation manual)

2 - Select **Picture > Advanced** and press **OK**.

3 - Select **Motion > Digital Natural**

**Motion** and press **OK**.

4 - Select **Maximum**, **Medium**, **Minimum** or **Off**.

5 - Press **← BACK** repeatedly if necessary, to close the menu.

---

### Clear LCD

With **Clear LCD**, you switch on a superior motion sharpness, better black level, high contrast with a flicker-free, quiet image and a larger viewing angle.

To switch on or off...

1 - Consumer Mode: On – Press **HOME** and select **Features** and press **OK**.

Guest Mode: On – Guest Menu: Not available in this

mode.

(For professional mode information, please refer to Installation manual)

2 - Select **Picture > Advanced** and press **OK**.

3 - Select **Motion > Clear LCD** and press **OK**.

4 - Select **On** or **Off**.

5 - Press **← BACK** repeatedly if necessary, to close the menu.

---

## 16.2

# Sound

---

## Sound Style

---

### Select a Style

For easy sound adjustment, you can select a preset setting with Sound Style.

1 - Consumer Mode: On – Press **HOME** and select **Features** and press **OK**.

Guest Mode: On – Guest

Menu: Press **HOME** and select **Features** and press **OK**.

(For professional mode information, please refer to Installation manual)

2 - Select **Sound > Sound Style** and press **OK**.

3 - Select one of the styles in the list.

4 - Press **← BACK** repeatedly if necessary, to close the menu.

The available styles are...

- **Personal** - The sound preferences you set during the first start up.
- **Original** - Most neutral sound setting
- **Movie** - Ideal for watching movies
- **Music** - Ideal for listening to music
- **Game** - Ideal for gaming
  
- **News** - Ideal for speech

---

### Restore a Style

With a Sound Style selected, you can adjust any sound setting in **Setup > Sound...**

The selected style will store the changes you made. We recommend to adjust the sound settings for the style **Personal** only. The Sound Style - Personal can save its settings for each individual connected device in Sources menu.

To restore the style to its original setting...

1 - Consumer Mode: On – Press **HOME** and select **Features** and press **OK**.

Guest Mode: On – Guest

Menu: Press **HOME** and select **Features** and press **OK**.

(For professional mode information, please refer to Installation manual)

2 - Select **Sound** > **Sound Style**, and select the Sound Style you want to restore.

3 - Press the colour key **Restore Style**, and press **OK**. The style is restored.

4 - Press **← BACK** repeatedly if necessary, to close the menu.

---

## Sound Settings

---

### Bass

With **Bass**, you can adjust the level of low tones in the sound.

To adjust the level...

1 - Consumer Mode: On – Press **HOME** and select **Features** and press **OK**.

Guest Mode: On – Guest

Menu: Press **HOME** and select **Features** and press **OK**.

(For professional mode information, please refer to Installation manual)

2 - Select **Sound** > **Bass** press **OK**.

3 - Adjust the value with **▲** (up) or **▼** (down).

4 - Press **← BACK** repeatedly if necessary, to close the menu.

---

### Treble

With **Treble**, you can adjust the level of high tones in the sound.

To adjust the level...

1 - Consumer Mode: On – Press **HOME** and select **Features** and press **OK**.

Guest Mode: On – Guest

Menu: Press **HOME** and select **Features** and press **OK**.

(For professional mode information, please refer to Installation manual)

2 - Select **Sound** > **Treble** press **OK**.

3 - Adjust the value with **▲** (up) or **▼** (down).

4 - Press **← BACK** repeatedly if necessary, to close the menu.

---

## Advanced Sound Settings

---

### Surround mode

With **Surround Mode**, you can set the sound effect of the TV speakers.

To set the surround mode...

1 - Consumer Mode: On – Press **HOME** and select **Features** and press **OK**.

Guest Mode: On – Guest Menu: Not available in this mode.

(For professional mode information, please refer to Installation manual)

2 - Select **Sound** > **Advanced** press **OK**.

3 - Select **Surround mode** and press **OK**.

4 - Select **Stereo** or **Incredible surround**.

5 - Press **← BACK** repeatedly if necessary, to close the menu.

---

### Auto Volume Levelling

With **Auto Volume Levelling**, you can set the TV to automatically level out sudden volume differences. Typically at the beginning of adverts or when you are switching channels.

To switch on or off...

1 - Consumer Mode: On – Press **HOME** and select **Features** and press **OK**.

Guest Mode: On – Guest Menu: Not available in this mode.

(For professional mode information, please refer to Installation manual)

2 - Select **Sound** > **Advanced** press **OK**.

3 - Select **Auto volume levelling** and press **OK**.

4 - Select **On** or **Off**.

5 - Press **← BACK** repeatedly if necessary, to close the menu.

---

### Clear Sound

With **Clear Sound**, you improve the sound for speech. Ideal for news programmes. You can switch the speech improvement on or off.

To switch on or off...

1 - Consumer Mode: On – Press **HOME** and select **Features** and press **OK**.

Guest Mode: On – Guest Menu: Not available in this mode.

(For professional mode information, please refer to Installation manual)

2 - Select **Sound** > **Advanced** press **OK**.

3 - Select **Clear sound** and press **OK**.

4 - Select **On** or **Off**.

5 - Press **← BACK** repeatedly if necessary, to close the menu.

---

### Audio Out Format

1 - Consumer Mode: On – Press **HOME** and select **Features** and press **OK**.

Guest Mode: On – Guest Menu: Not available in this mode.

(For professional mode information, please refer to

Installation manual)

- 2 - Select **Sound** > **Advanced** press **OK**.
- 3 - Select **Audio Out Format** and press **OK**.
- 4 - Select **Multichannel** or **Stereo**.
- 5 - Press **← BACK** repeatedly if necessary, to close the menu.

---

## Audio Out Levelling

- 1 - Consumer Mode: On – Press **HOME** and select **Features** and press **OK**.  
Guest Mode: On – Guest Menu: Not available in this mode.  
(For professional mode information, please refer to Installation manual)
- 2 - Select **Sound** > **Advanced** press **OK**.
- 3 - Select **Audio Out Levelling** and press **OK**.
- 4 - Select **More**, **Medium** or **Less**.
- 5 - Press **← BACK** repeatedly if necessary, to close the menu.

---

## Audio Out Delay

If you set an Audio sync delay on your Home Theatre System, to synchronise the sound with the picture, you must switch off **Audio Out Delay** on the TV.

To switch off Audio Out Delay...

- 1 - Consumer Mode: On – Press **HOME** and select **Features** and press **OK**.  
Guest Mode: On – Guest Menu: Not available in this mode.  
(For professional mode information, please refer to Installation manual)
- 2 - Select **Sound** > **Advanced** press **OK**.
- 3 - Select **Audio Out Delay** and press **OK**.
- 4 - Select **Off** or **On**.
- 5 - Press **← BACK** repeatedly if necessary, to close the menu.

---

## Audio Out Offset

If you cannot set a delay on the Home Theatre System, you can set a delay on the TV with **Audio Out Offset**.

To synchronise the sound on the TV...

- 1 - Consumer Mode: On – Press **HOME** and select **Features** and press **OK**.  
Guest Mode: On – Guest Menu: Not available in this mode.  
(For professional mode information, please refer to Installation manual)

- 2 - Select **Sound** > **Advanced** press **OK**.
- 3 - Select **Audio Out Offset** and press **OK**.
- 4 - Use the slider bar to set the sound offset and press **OK**.
- 5 - Press **← BACK** repeatedly if necessary, to close the menu.

---

## Speakers

---

### Wireless Speakers

---

#### What You Need

You can connect a wireless device with Bluetooth® to this TV – a wireless speaker, a subwoofer, a sound bar or headphones. You can also connect a wireless gamepad with Bluetooth LE.

To play the TV sound on a wireless speaker, you must pair the wireless speaker with the TV. You can pair some wireless speakers and a maximum of 4 Bluetooth LE (low energy) devices. The TV can only play the sound on one wireless audio speaker at a time. If you connect a subwoofer, the sound is played on the TV and the subwoofer. If you connect a sound bar the sound is played on the sound bar only.

#### Attention - Audio to Video synchronisation

Many Bluetooth speaker systems have a high, so called, 'latency'. High latency means that the audio lags behind the video, causing unsynchronised 'lip sync'. Before you purchase a wireless Bluetooth speaker system, inform yourself about the newest models and look for a device with a low latency rating. Ask your dealer for advice.

A range of selected Philips wireless speaker products can connect and play the TV sound. Consult the Philips website for suited wireless audio products for this TV - [www.philips.com/tv](http://www.philips.com/tv)

---

#### Select a Speaker



To connect a wireless speaker...

- 1 - Consumer Mode: On – Press **HOME** and select **Features** and press **OK**.  
Guest Mode: On – Guest Menu: Press **HOME** and select **Features** and press **OK**.  
(For professional mode information, please refer to Installation manual)
- 2 - Select **Sound** > **Bluetooth Audio** press **OK**.
- 3 - Select **Connect** and press **OK**.
- 4 - Press **← BACK** repeatedly if necessary, to close the menu.

---

## Remove a Speaker

To remove a wireless speaker...



- 1 - Consumer Mode: On – Press  HOME and select **Features** and press **OK**.  
Guest Mode: On – Guest  
Menu: Press  HOME and select **Features** and press **OK**.  
(For professional mode information, please refer to Installation manual)
- 2 - Select **Sound** > **Bluetooth Audio** press **OK**.
- 3 - Select **Remove** and press **OK**.
- 4 - Press  BACK repeatedly if necessary, to close the menu.

---

## Wireless Headphone

To connect wireless Bluetooth devices such as wireless Bluetooth headphone, make sure Bluetooth is switched on.





To switch Bluetooth on...

- 1 - Consumer Mode: On – Press  HOME and select **Features** and press **OK**.  
Guest Mode: On – Guest  
Menu: Press  HOME and select **Features** and press **OK**.  
(For professional mode information, please refer to Installation manual)
- 2 - Select **Sound** and press **OK**.
- 3 - Select **Bluetooth Audio** and press **OK**.
- 4 - Select **Connect** and press **OK**.
- 5 - Press  BACK repeatedly if necessary, to close the menu.

---

## Subwoofer Volume

To adjust the volume of wireless speaker...

- 1 - Consumer Mode: On – Press  HOME and select **Features** and press **OK**.  
Guest Mode: On – Guest Menu: Not available in this mode.  
(For professional mode information, please refer to Installation manual)
- 2 - Select **Sound** > **Bluetooth Audio** press **OK**.
- 3 - Select **Subwoofer-level** and press **OK**.
- 4 - Adjust the value with  (up) or  (down).
- 5 - Press  BACK repeatedly if necessary, to close the menu.

---

## Problems

### Lost connection

- Position the wireless speaker within a range of 5 meters from the TV.
- Places with a high amount of wireless activity -

apartments with lots of wireless routers - can hamper the wireless connection. Keep the router and wireless speaker as close to the TV as possible.

### Audio and video mismatch

- Some wireless speakers systems might have audio and video sync problems. We recommend using Philips wireless audio products.

---

16.3

## Ambilight Settings





---

### Ambilight Settings

#### Ambilight Brightness

With **Ambilight Brightness**, you can set the level of brightness of the Ambilight.





To adjust the level...

- 1 - Consumer Mode: On – Press  HOME and select **Features** and press **OK**.  
Guest Mode: On – Guest  
Menu: Press  HOME and select **Features** and press **OK**.  
(For professional mode information, please refer to Installation manual)
- 2 - Select **Ambilight** > **Brightness** and press **OK**.
- 3 - Adjust the value with  (up) or  (down).
- 4 - Press  BACK repeatedly if necessary, to close the menu.

---

#### Ambilight bottom side

To adjust the brightness at the bottom side of ambilight...

- 1 - Consumer Mode: On – Press  HOME and select **Features** and press **OK**.  
Guest Mode: On – Guest Menu: Not available in this mode.  
(For professional mode information, please refer to Installation manual)
- 2 - Select **Ambilight** > **Brightness bottom side** and press **OK**.
- 3 - Adjust the value with  (up) or  (down).
- 4 - Press  BACK repeatedly if necessary, to close the menu.

---

#### Halo Size

You can adjust the size of Ambilight halo.

To set the Halo Size...

- 1 - Consumer Mode: On – Press  HOME and select **Features** and press **OK**.  
Guest Mode: On – Guest

Menu: Press  HOME and select **Features** and press **OK**.

(For professional mode information, please refer to Installation manual)





- 2 - Select **Ambilight** > **Halo size** and press **OK**.
- 3 - Select **Small**, **Medium** or **Large** and press **OK**.
- 4 - Press  **BACK** repeatedly if necessary, to close the menu.

---

## Ambilight Saturation

With **Ambilight Saturation**, you can set the level of colour saturation of the Ambilight.

To adjust the level...

- 1 - Consumer Mode: On – Press  HOME and select **Features** and press **OK**.  
Guest Mode: On – Guest Menu: Not available in this mode.  
(For professional mode information, please refer to Installation manual)
- 2 - Select **Ambilight** > **Saturation** and press **OK**.
- 3 - Adjust the value with  (up) or  (down).
- 4 - Press  **BACK** repeatedly if necessary, to close the menu.



---

## Advanced Ambilight Settings

### Wall Colour

With **Wall Colour**, you can neutralise the influence of a coloured wall on the Ambilight colours. Select the colour of the wall behind the TV and the TV will modify the Ambilight colours to appear as they are intended.

To select the colour of the wall . . .

- 1 - Consumer Mode: On – Press  HOME and select **Features** and press **OK**.  
Guest Mode: On – Guest Menu: Not available in this mode.  
(For professional mode information, please refer to Installation manual)
- 2 - Select **Ambilight** > **Advanced** and press **OK**.
- 3 - Select **Wall Colour** and press **OK**.
- 4 - In the colour palette, select the colour that matches the colour of the wall behind the TV.
- 5 - Press  **BACK** repeatedly if necessary, to close the menu.

---

### TV Switch Off

With **TV Switch Off**, you can set Ambilight to switch off immediately or slowly fade out when you switch off the TV. The slow fade out gives you some time to switch on the lights in your living room.

To select the way how Ambilight switches off...

1 - Consumer Mode: On – Press  HOME and select **Features** and press **OK**.

Guest Mode: On – Guest Menu: Not available in this mode.

(For professional mode information, please refer to Installation manual)

- 2 - Select **Ambilight** > **Advanced** and press **OK**.
- 3 - Select **TV Switch Off** and press **OK**.
- 4 - Select **Fade Out to Off** or **Immediate Switch Off**.
- 5 - Press  **BACK** repeatedly if necessary, to close the menu.

---

16.4



## Eco Settings

---

### Screen Off

If you only listen to music, you can switch off the TV screen to save energy.

To only switch off the TV screen...

- 1 - Consumer Mode: On – Press  HOME and select **Features** and press **OK**.  
Guest Mode: On – Guest Menu: Not available in this mode.  
Menu: Press  HOME and select **Features** and press **OK**.  
(For professional mode information, please refer to Installation manual)
- 2 - Select **Eco Settings** > **Screen Off**.
- 3 - Press  **BACK** repeatedly if necessary, to close the menu.



To switch the screen back on, press any key on the remote control.

---

### Sleep timer

With the sleep timer, you can set the TV to switch to standby automatically after a preset time.

To set the sleep timer . . .

- 1 - Press  HOME and select **Features\*** and press **OK**.  
\*Consumer Mode: On – Setup  
\*Guest Mode: On – Guest Menu  
(For professional mode information, please refer to Installation manual)
  - 2 - Select **Eco settings\*** > **Sleep timer**.  
\*Consumer Mode : On –  HOME > **Eco settings**  
\*Guest Mode: On – Select **Eco settings** > **Sleep timer**.  
(For professional mode information, please refer to Installation manual)
- With the slider bar you can set the time to up to 240 minutes in increments of 30 minutes. If set to **Off**, the

sleep timer is switched off. You can always switch off your TV earlier or reset the time during the countdown.

3 - Press **← BACK**, repeatedly if necessary, to close the menu.

---

16.5

## General Settings

---

### EasyLink

---

#### EasyLink

To switch off EasyLink completely...

- 1 - Consumer Mode: On – Press **🏠 HOME** and select **Features** and press **OK**.
- Guest Mode: On – Guest Menu: Not available in this mode.
- (For professional mode information, please refer to Installation manual)
- 2 - Select **Sources > Advanced** and press **OK**.
- 3 - Select **EasyLink** and press **OK**, then select **EasyLink** one step further.
- 4 - Select **Off**.
- 5 - Press **← BACK** repeatedly if necessary, to close the menu.

---

#### EasyLink Remote Control

To switch off EasyLink remote control...

- 1 - Consumer Mode: On – Press **🏠 HOME** and select **Features** and press **OK**.
- Guest Mode: On – Guest Menu: Not available in this mode.
- (For professional mode information, please refer to Installation manual)
- 2 - Select **Sources > Advanced** and press **OK**.
- 3 - Select **EasyLink** and press **OK**, then select **EasyLink** one step further.
- 4 - Select **Easylink Remote Control** and press **OK**.
- 5 - Select **Off**.
- 6 - Press **← BACK** repeatedly if necessary, to close the menu.

---

## Android Settings

You can set or view several Android specific settings or information. You can find the list of apps installed on your TV and the storage space they need. You can configure the onscreen keyboard or allow apps to use your location. Explore the different Android settings. You can go to [www.support.google.com/androidtv](http://www.support.google.com/androidtv) for more information on these settings.

To open these settings...

- 1 - Consumer Mode: On – Press **🏠 HOME** and select **Features** and press **OK**.
- Guest Mode: On – Guest Menu: Not available in this mode.
- (For professional mode information, please refer to Installation manual)
- 2 - Select **Android Settings**, and press **OK**.
- 3 - Explore the different Android settings.
- 4 - Press **← BACK** repeatedly if necessary, to close the menu.

---

## USB Keyboard Settings

To install the USB keyboard, switch on the TV and connect the USB keyboard to one of the **USB** connections on the TV. When the TV detects the keyboard for the first time, you can select your keyboard lay-out and test your selection. If you select a Cyrillic or Greek keyboard layout first, you can select a secondary Latin keyboard layout.

To change the keyboard layout setting when a layout was selected...

- Consumer Mode: On – Not available in this mode.  
Guest Mode: On – Guest Menu: Not available in this mode.
- (For professional mode information, please refer to Installation manual)

---

## HbbTV

If a TV channel offers HbbTV pages, you must first switch on HbbTV in the TV settings to view the pages.

- 1 - Consumer Mode: On – Press **🏠 HOME** and select **Features** and press **OK**.
- Guest Mode: On – Guest Menu: Not available in this mode.
- (For professional mode information, please refer to Installation manual)
- 2 - Select **Channels > Channel Settings** and press **OK**.
- 3 - Select **Enable Hbb TV**, and press **OK**.
- 4 - Select **Yes**.
- 5 - Press **← BACK** repeatedly if necessary, to close

the menu.

If you want to avoid access to HbbTV pages on a specific channel, you can block the HbbTV pages for this channel only.

- 1 - Tune to the channel of which you want to block the HbbTV pages.
- 2 - Press **≡** **OPTIONS** and select **HBB TV on This Channel** and press **OK**.
- 3 - Select **Off** and press **OK**.

---

## TV Placement

As part of the first installation, this setting is set to either **On a TV stand** or **Hang on the Wall**. If you have changed the placement of the TV since then, adjust this setting accordingly for best sound reproduction.

- 1 - Consumer Mode: On – Press **🏠 HOME** and select **Features** and press **OK**.  
Guest Mode: On – Guest Menu: Not available in this mode.  
(For professional mode information, please refer to Installation manual)
- 2 - Select **Sound > TV Placement** and press **OK**.
- 3 - Select **On a TV stand** or **Hang on the Wall**.
- 4 - Press **← BACK** repeatedly if necessary, to close the menu.

---

## Channel Logos

In some countries, the TV can show the channel logos.

If you do not want these logos to appear, you can switch them off.

To switch off the logos...

- 1 - Consumer Mode: On – Press **🏠 HOME** and select **Features** and press **OK**.  
Guest Mode: On – Guest Menu: Not available in this mode.  
(For professional mode information, please refer to Installation manual)
- 2 - Select **Channels > Channel Settings** and press **OK**.
- 3 - Select **Enable Channel Logos**, and press **OK**.
- 4 - Select **No**.
- 5 - Press **← BACK** repeatedly if necessary, to close the menu.

---

## Reinstall TV

You can redo a full TV installation. The TV is completely reinstalled.

To redo a full TV installation...

- 1 - Consumer Mode: On – Press **🏠 HOME** and select **Features** and press **OK**.  
Guest Mode: On – Guest Menu: Not available in this mode.  
(For professional mode information, please refer to Installation manual)
- 2 - Select **Reset > Reinstall TV** and press **OK**.
- 3 - Follow the instructions on screen. The installation may take a few minutes.

---

16.6

## Clock, Region and Language

---

### Menu Language

To change the language of the TV menus and messages...

- 1 - Consumer Mode: On – Press **🏠 HOME** and select **Features** and press **OK**.  
Guest Mode: On – Guest Menu: Not available in this mode.  
(For professional mode information, please refer to Installation manual)
- 2 - Select **Region and Language > Languages > Menu Language** and press **OK**.
- 3 - Select **Languages List** and press **OK**.
- 4 - Select on the language you need.
- 5 - Press **← BACK** repeatedly if necessary, to close the menu.

---

## Language preferences

---

### Audio Language Settings

Digital TV channels can broadcast audio with several spoken languages for a programme. You can set a preferred primary and secondary audio language. If audio in one of these languages is available, the TV will switch to this audio.

If none of the preferred audio languages is available, you can select another audio language which is available.

To set the primary and secondary audio language...

- 1 - Consumer Mode: On – Press **🏠 HOME** and select **Features** and press **OK**.  
Guest Mode: On – Guest Menu: Not available in this mode.  
(For professional mode information, please refer to



Installation manual)

2 - Select **Region and**

**Language** > **Languages** > **Primary**

**Audio** or **Secondary Audio** and press **OK**.

3 - Select on the language you need.

4 - Press **← BACK** repeatedly if necessary, to close the menu.

To select an audio language when none of your preferred audio language is available...

1 - Press **≡ OPTIONS** .

2 - Select **Audio Language** and select on the audio language you want temporarily.

---

## Subtitles

---

### Switch On

To switch on Subtitles, press **SUBTITLE**.

You can switch subtitles **On**, **Off** or **On During Mute**.

Or to show subtitles automatically when the broadcasted programme is not in language – the language set for the TV – select **Automatic**. This setting will also show Subtitles automatically when you mute the sound.

---

## Subtitle Language Settings

Digital channels can offer several subtitle languages for a programme. You can set a preferred primary and secondary subtitle language. If subtitles in one of these languages are available, the TV will show the subtitles you selected.

If none of the preferred subtitle languages are available, you can select another subtitle language which is available.

To set the primary and secondary subtitle language...

1 - Consumer Mode: On – Press **🏠 HOME** and select **Features** and press **OK**.

Guest Mode: On – Guest Menu: Not available in this mode.

(For professional mode information, please refer to Installation manual)

2 - Select **Region and**

**Language** > **Languages** > **Primary**

**Subtitle** or **Secondary Subtitle** and press **OK**.

3 - Select on the language you need.

4 - Press **← BACK** repeatedly if necessary, to close the menu.

To select a subtitle language when none of your preferred languages are available...

1 - Press **≡ OPTIONS** .

2 - Select **Subtitle Language** and select on the language you want temporarily.

---

## Subtitles from Text

If you tune to an analogue channel, you need to make the subtitles available for each channel manually.

1 - Switch to a channel and press **TEXT** to open Text.

2 - Enter the page number for subtitles, usually **888**.

3 - Press **TEXT** again, to close Text.

If you select **On** in the Subtitle menu when watching this analogue channel, subtitles will be shown if available.

To know if a channel is analogue or digital, switch to the channel and open **Channel**

**Info** in **≡ OPTIONS**.

---

## Text / Teletex Languages

---

### Text Pages

To open Text/Teletext press **TEXT**, while you are watching TV channels.

To close Text, press **TEXT** again.

### Select a Text page

To select a page . . .

1 - Enter the page number with the number keys.

2 - Use the arrow keys to navigate.

3 - Press a colour key to select a colour-coded subject at the bottom of the screen.

### Text sub-pages

A Text page number can hold several subpages. The subpage numbers are shown on a bar next to the main page number.

To select a subpage, press **◀** or **▶**.

### T.O.P. Text pages

Some broadcasters offer T.O.P. Text.

To open T.O.P. Text pages within Text, press **≡ OPTIONS** and select **T.O.P. overview**.

### Favourite pages

The TV makes a list of the last 10 Text pages you opened. You can easily reopen them again in the Favourite Text pages column.

1 - In Text, select the star in the top left corner of the screen to show the column of favourite pages.

2 - Press **▼** (down) or **▲** (up) to select a page number and press **OK** to open the page.

You can clear the list with the option **Clear favourite pages**.

### Search Text

You can select a word and scan Text for all occurrences of this word.

- 1 - Open a Text page and press **OK**.
- 2 - Select a word or number with the arrow keys.
- 3 - Press **OK** again to jump immediately to the next occurrence of this word or number.
- 4 - Press **OK** again to jump to the subsequent occurrence.
- 5 - To stop searching, press **▲** (up) until nothing is selected.

#### Text from a connected device

Some devices that receive TV channels can also offer Text.

To open Text from a connected device . . .

- 1 - Press **SOURCES** select the device and press **OK**.
- 2 - While watching a channel on the device, press **≡** **OPTIONS** , select **Show device keys** and select the **☰** key and press **OK**.
- 3 - Press **←** **BACK** to hide the device keys.
- 4 - To close Text, press **←** **BACK** again.

#### Digital Text (UK only)

Some digital broadcasters offer dedicated Digital Text or interactive TV on their digital TV channels. This includes normal Text using the number, colour and arrow keys to select and navigate.

To close Digital Text, press **←** **BACK**.

### Text Options

In Text/Teletext, press **≡** **OPTIONS** to select the following...

- **Freeze page**  
To stop the automatic rotation of subpages.
- **Dual screen / Full screen**  
To show the TV channel and Text alongside each other.
- **T.O.P. overview**  
To open T.O.P. Text.
- **Enlarge**  
To enlarge the Text page for comfortable reading.
- **Reveal**  
To unhide hidden information on a page.
- **Cycle subpages**  
To cycle subpages when these are available.
- **Language**  
To switch the group of characters that Text uses to display correctly.
- **Text 2.5**  
To activate the Text 2.5 for more colours and better graphics.

### Text Setup

#### Text language

Some digital TV broadcasters have several Text languages available.

To set your primary and secondary Text language . . .

- 1 - Consumer Mode: On – Press **🏠** **HOME** and select **Features** and press **OK**.  
Guest Mode: On – Guest Menu: Not available in this mode.  
(For professional mode information, please refer to Installation manual)
- 2 - Select **Region and Language > Languages > Primary Text** or **Secondary Text** and press **OK**.
- 3 - Select your preferred Text languages.
- 4 - Press **←** **BACK** repeatedly if necessary, to close the menu.

#### Text 2.5

If available, Text 2.5 offers more colours and better graphics. Text 2.5 is activated as a standard factory setting.

To switch off Text 2.5...

- 1 - Press **TEXT**.
- 2 - With Text/Teletext open on screen, press **≡** **OPTIONS**.
- 3 - Select **Text 2.5 > Off**.
- 4 - Press **←** **BACK** repeatedly if necessary, to close the menu.

## Clock

### Date and Time

#### Automatic

To know what time it is, press **🏠** **HOME**. The **Home Menu** always shows what time it is.

In some countries, digital broadcasts do not send UTC - Coordinated Universal Time information. The daylight saving change might be ignored and the TV might show an incorrect time.

When you record programmes - scheduled in the TV Guide, we recommend not to change the time and date manually. In some countries, for some network operators, the **Clock** setting is hidden to avoid an incorrect clock setting.



To correct the TV clock automatically...

- 1 - Consumer Mode: On – Press **🏠** **HOME** and select **Features** and press **OK**.  
Guest Mode: On – Guest Menu: Not available in this mode.  
(For professional mode information, please refer to Installation manual)
- 2 - Select **Date and Time > Source** and press **OK**.
- 3 - Select **Automatic NTP**.
- 4 - Press **←** **BACK** repeatedly if necessary, to close the menu.

---

## Manual



To set the TV clock manually...

- 1 - Consumer Mode: On – Press  HOME and select **Features** and press **OK**.
- Guest Mode: On – Guest Menu: Not available in this mode.
- (For professional mode information, please refer to Installation manual)
- 2 - Select **Date and Time > Manual Date and Time Setting** and press **OK**.
- 3 - Select **Date** and **Time** to adjust.
- 4 - Press  BACK repeatedly if necessary, to close the menu.

---

## Time Zone

To set the time zone...

- 1 - Consumer Mode: On – Press  HOME and select **Features** and press **OK**.
- Guest Mode: On – Guest Menu: Not available in this mode.
- (For professional mode information, please refer to Installation manual)
- 2 - Select **Date and Time > Time Zone Settings** and press **OK**.
- 3 - Select **Time Zone Country** or **Time Zone Region** and press **OK**.
- 4 - Select one of the time zones.
- 5 - Press  BACK repeatedly if necessary, to close the menu.

---

16.7

## Universal Access

---

### Switch On

With **Universal Access** switched on, the TV is prepared for use for the deaf, hard of hearing, blind or partially sighted people.

#### Switch on

If you did not switch on **Universal Access** during the installation, you can still switch it on in **Universal Access** menu.

To switch on Accessibility...

- 1 - Consumer Mode: On – Press  HOME and select **Features** and press **OK**.
- Guest Mode: On – Guest Menu: Not available in this mode.
- (For professional mode information, please refer to Installation manual)
- 2 - Select **Accessibility > Universal Access** and press **OK**.
- 3 - Select **On** and press **OK**.

4 - Press  BACK repeatedly if necessary, to close the menu.



With **Universal Access** switched on, the option **Universal Access** is added in the **Options** menu.

---

## Hard of Hearing



Some digital TV channels broadcast special audio and subtitles adapted for the hard of hearing or deaf people. With **Hearing impaired** switched on, the TV automatically switches to the adapted audio and subtitles, if available. Before you can switch on **Hearing impaired**, you have to switch on **Universal Access**.

To switch on **Hearing impaired**...

- 1 - Consumer Mode: On – Press  HOME and select **Features** and press **OK**.
- Guest Mode: On – Guest Menu: Not available in this mode.
- (For professional mode information, please refer to Installation manual)
- 2 - Select **Accessibility > Hearing impaired** and press **OK**.
- 3 - Select **On** and press **OK**.
- 4 - Press  BACK repeatedly if necessary, to close the menu.

To switch on **Hearing impaired** while watching TV...

- 1 - While watching a TV channel, press  OPTIONS, select **Universal Access** and press **OK**.
- 2 - Select **Hearing impaired**, and select **On**.

To check whether a hearing impaired audio language is available, press  OPTIONS, select **Audio Language** and look for an audio language marked with a .

If **Accessibility** does not appear in the **Options** menu, switch on **Universal Access** in setup menu.

---

## Audio Description

---

### Switch On

Digital TV channels can broadcast special audio commentary describing what is happening on screen.

To be able to set the visually impaired audio and effects, you have to switch on **Audio Description** first.

Also, before you can switch on **Audio Description**, you have to switch on **Universal Access** in setup menu.

With **Audio Description**, a narrator's commentary is added to the normal audio.

To switch on the commentary (if available)...

To switch on **Audio Description**...

1 - Consumer Mode: On – Press  **HOME** and select **Features** and press **OK**.

Guest Mode: On – Guest Menu: Not available in this mode.

(For professional mode information, please refer to Installation manual)

2 - Select **Accessibility** > **Audio Description** and press **OK**.

3 - Select **Audio Description** one step further.

4 - Select **On** and press **OK**.

5 - Press **← BACK** repeatedly if necessary, to close the menu.

To switch on **Audio Description** while watching TV...

1 - While watching a TV channel, press  **OPTIONS**, select **Universal Access** and press **OK**.

2 - Select **Audio Description**, and select **On**.

You can check if an audio commentary is available. In the Options menu, select **Audio Language** and look for an audio language marked with a .

---

## Speakers/Headphones

With **Speakers/Headphones**, you can select where you want to hear the audio commentary. On the TV speakers only, on the headphones only or on both.

To set **Speakers/Headphones**...

1 - Consumer Mode: On – Press  **HOME** and select **Features** and press **OK**.

Guest Mode: On – Guest Menu: Not available in this mode.

(For professional mode information, please refer to Installation manual)

2 - Select **Accessibility** > **Audio Description** and press **OK**.

3 - Select **Speakers/Headphones** and press **OK**.

4 - Select **Speakers**, **Headphones** or **Speakers + Headphones** and press **OK**.

5 - Press **← BACK** repeatedly if necessary, to close the menu.

---

## Mixed Volume

You can mix the volume of the normal audio with the audio commentary.

To mix the volume...

1 - Consumer Mode: On – Press  **HOME** and

select **Features** and press **OK**.

Guest Mode: On – Guest Menu: Not available in this mode.

(For professional mode information, please refer to Installation manual)

2 - Select **Accessibility** > **Audio Description** and press **OK**.

3 - Select **Mixed Volume** and press **OK**.

4 - Adjust the value with **▲** (up) or **▼** (down).

5 - Press **← BACK** repeatedly if necessary, to close the menu.

If an audio language with added audio commentary is available, you can also find this setting in  **OPTIONS** > **Universal Access** > **Mixed Volume**.

---

## Audio Effect

Some audio commentary can hold extra audio effects, like stereo or fading sound.

To switch on **Audio effects** (if available)...

1 - Consumer Mode: On – Press  **HOME** and select **Features** and press **OK**.

Guest Mode: On – Guest Menu: Not available in this mode.

(For professional mode information, please refer to Installation manual)

2 - Select **Accessibility** > **Audio Description** and press **OK**.

3 - Select **Audio Effect** and press **OK**.

4 - Select **On** and press **OK**.

5 - Press **← BACK** repeatedly if necessary, to close the menu.

---

## Speech

The audio commentary can also hold subtitles for the words which are spoken.

To switch on these subtitles (if available) . . .

1 - Consumer Mode: On – Press  **HOME** and select **Features** and press **OK**.

Guest Mode: On – Guest Menu: Not available in this mode.

(For professional mode information, please refer to Installation manual)

2 - Select **Accessibility** > **Audio Description** and press **OK**.

3 - Select **Speech** and press **OK**.

4 - Select **Descriptive** or **Subtitles** and press **OK**.

5 - Press **← BACK** repeatedly if necessary, to close the menu.

---

# Channel Installation

---

## 17.1

### Antenna/Cable Installation

---

#### Update Channels

---

##### Automatic Channel Update

If you receive digital channels, you can set the TV to automatically update these channels.

Once a day, at 4 AM, the TV updates the channels and stores new channels. New channels are stored in the Channels List and are marked with a ★. Channels without a signal are removed. The TV must be in standby to automatically update channels. You can switch off Automatic Channel Update.

To switch off the automatic update...

- 1 - Consumer Mode: On – Not available in this mode.
  - Guest Mode: On – Guest Menu: Not available in this mode.
- (For professional mode information, please refer to Installation manual)

When new channels are found or if channels are updated or removed, a message is shown at TV start up. To avoid this message to appear after every channel update, you can switch it off.

To switch off the message...

- 1 - Consumer Mode: On – Not available in this mode.
  - Guest Mode: On – Guest Menu: Not available in this mode.
- (For professional mode information, please refer to Installation manual)

In certain countries, the Automatic channel update is done while watching TV or on any moment when the TV is in standby.

---

#### Reception Quality

You can check the quality and signal strength of a digital channel. If you have your own antenna, you can reposition the antenna to try and improve the reception.

To check the reception quality of a digital channel...

- 1 - Consumer Mode: On – Press  HOME and select **Features** and press **OK**.
  - Guest Mode: On – Guest Menu: Not available in this mode.
- (For professional mode information, please refer to

Installation manual)

2 - Select **Channels > RF Channel Installation** and press **OK**.

3 - Enter your PIN code if necessary.

4 - Select **Digital: Reception Test** and press **OK**.

5 - Select **DVB-T Search** or **DVB-C Search** and press **OK**. The digital frequency is shown for this channel.

6 - Select **Search** again and press **OK** to check the signal quality of this frequency. The test result is shown on screen. You can reposition the antenna or check the connections to possibly improve the reception.

7 - You can also change the frequency yourself. Select the frequency number one by one and use the **▲** (up) or **▼** (down) keys to change the value. Select **Search** and press **OK** to test the reception again.

8 - Press **← BACK** repeatedly if necessary, to close the menu.

---

#### Reinstall Channels

---

##### Reinstall All Channels

You can reinstall all channels and leave all other TV settings untouched.

If a PIN code is set, you will need to enter this code before you can reinstall channels.

To reinstall channels...

- 1 - Consumer Mode: On – Press  HOME and select **Features** and press **OK**.
  - Guest Mode: On – Guest Menu: Not available in this mode.
- (For professional mode information, please refer to Installation manual)

2 - Select **Channels > RF Channel Installation** and press **OK**.

3 - Enter your PIN code if necessary.

4 - Select **Search for Channels** and press **OK**.

5 - Select **Start** and press **OK**.

6 - Select **Reinstall Channels**, select **Next** and press **OK**.

7 - Select the country where you are now and press **OK**.

8 - Select **Next** and press **OK**.

9 - Select the type of installation you want, **Antenna (DVB-T)** or **Cable (DVB-C)** and press **OK**.

8 - Select **Next** and press **OK**.

11 - Select the type of channels you want, **Digital and Analogue Channels** or **Only Digital Channels** and press **OK**.

8 - Select **Next** and press **OK**.

13 - Select **Start** and press **OK** to update the digital channels. This can take a few minutes.



14 - Press **← BACK** repeatedly if necessary, to close the menu.

---

## Reinstall TV

You can redo a full TV installation. The TV is completely reinstalled.

To redo a full TV installation...

- 1 - Consumer Mode: On – Press  HOME and select **Features** and press **OK**.  
Guest Mode: On – Guest Menu: Not available in this mode.  
(For professional mode information, please refer to Installation manual)
- 2 - Select **Reset** and press **OK**.
- 3 - Select **Reinstall TV** and press **OK**.
- 4 - Enter your PIN code if necessary.
- 5 - Select **Yes** and press **OK** to confirm.
- 6 - The TV will reinstall completely. All settings will be reset and installed channels will be replaced. The installation can take a few minutes.
- 7 - Press  **BACK** repeatedly if necessary, to close the menu.

shown briefly.

You can redo these steps until you have found all available analogue TV channels.

---

## Manual Installation

Analogue TV channels can be manually installed, channel by channel.

To install analogue channels manually...

- 1 - Consumer Mode: On – Press  HOME and select **Features** and press **OK**.  
Guest Mode: On – Guest Menu: Not available in this mode.  
(For professional mode information, please refer to Installation manual)
- 2 - Select **Channels > RF Channel Installation** and press **OK**.
- 3 - Enter your PIN code if necessary.
- 4 - Select **Analogue: Manual Installation** and press **OK**.

- **System**

To set up the TV system, select **System**.  
Select your country or the part of the world where you are now and press **OK**.

- **Search Channel**

To find a channel, select **Search Channel** and press **OK**. You can enter a frequency yourself to find a channel or let the TV search for a channel.  
Press  (right) to select **Search** and press **OK** to search for a channel automatically. The found channel is shown on screen and if the reception is poor, press **Search** again. If you want to store the channel, select **Done** and press **OK**.

- **Store**

You can store the channel on the current channel number or as a new channel number.  
Select **Store Current Channel** or **Store as New Channel** and press **OK**. The new channel number is

---

# Software

---

## 18.1

### Update Software

---

#### Update from USB

It might be necessary to update the TV software. You need a computer with an high-speed Internet connection and a USB flash drive to upload the software on the TV. Use a USB flash drive with at least 500MB free space. Make sure that write protection is switched off.

To update the TV software...

1 - Consumer Mode: On – Press  HOME and select **Features** and press **OK**.

Guest Mode: On – Guest Menu: Not available in this mode.

(For professional mode information, please refer to Installation manual)

2 - Select **Upgrade and Clone** > **Firmware Upgrade from USB** and press **OK**.

#### Download the software

1 - Insert the USB flash drive into your computer.

2 - On the USB flash drive, locate the file **update.htm** and double click it.

3 - Click **Send ID**.

4 - If new software is available, download the .zip file.

5 - After the download, unzip the file and copy the file **autorun.upg** onto the USB flash drive. Do not place this file in a folder.

#### Update the TV software

1 - Insert the USB flash drive into the TV again. The update starts automatically.

2 - A software update can take several minutes. Do not press the  key on the TV or remote control. Do not remove the USB flash drive.

3 - When the update is done, the TV will return to the channel you were watching.

If a power cut occurs during the update, never remove the USB flash drive from the TV. When the power returns, the update will continue.

To prevent an accidental update of the TV software, delete the autorun.upg file from the USB flash drive.

## Open Source Software

This television contains open source software. TP Vision Europe B.V. hereby offers to deliver, upon request, a copy of the complete corresponding source code for the copyrighted open source software packages used in this product for which such offer is requested by the respective licences.

This offer is valid up to three years after product purchase to anyone in receipt of this information. To obtain the source code, please write in English to .

..

[open.source@tpvision.com](mailto:open.source@tpvision.com)

## Open Source License Statement

README for the source code of the parts of TP Vision Netherlands B.V. TV software that fall under open source licenses.

This is a document describing the distribution of the source code used on the TP Vision Netherlands B.V. TV, which fall either under the GNU General Public License (the GPL), or the GNU Lesser General Public License (the LGPL), or any other open source license. Instructions to obtain copies of this software can be found in the Directions For Use.

TP Vision Netherlands B.V. MAKES NO WARRANTIES WHATSOEVER, EITHER EXPRESS OR IMPLIED, INCLUDING ANY WARRANTIES OF MERCHANTABILITY OR FITNESS FOR A PARTICULAR PURPOSE, REGARDING THIS SOFTWARE. TP Vision Netherlands B.V. offers no support for this software. The preceding does not affect your warranties and statutory rights regarding any TP Vision Netherlands B.V. product(s) you purchased. It only applies to this source code made available to you.

## Open Source License

Android (5.1.0)

This TV contains the Android Lollipop Software. Android is a Linux-based operating system designed primarily for touch screen mobile devices such as smartphones and tablet computers. This software will also be reused in TPVision Android based TV's. The original download site for this software is : <https://android.google.com>/This piece of software is made available under the terms and

conditions of the Apache license version 2, which can be found below. Android APACHE License Version 2 (<http://source.android.com/source/licenses.html>)

#### Toolbox (N/A)

The original download site for this software is : <https://android.googlesource.com/>This piece of software is made available under the terms and conditions of the Apache license version 2, which can be found below. Android APACHE License Version 2 (<http://source.android.com/source/licenses.html>)

#### linux kernel (3.10.27)

This TV contains the Linux Kernel. The original download site for this software is : <http://www.kernel.org/>.This piece of software is made available under the terms and conditions of the GPL v2 license, which can be found below. Additionally, following exception applies : "NOTE! This copyright does \*not\* cover user programs that use kernel services by normal system calls - this is merely considered normal use of the kernel, and does \*not\* fall under the heading of "derived work". Also note that the GPL below is copyrighted by the Free Software Foundation, but the instance of code that it refers to (the linux kernel) is copyrighted by me and others who actually wrote it. Also note that the only valid version of the GPL as far as the kernel is concerned is `_this_` particular version of the license (ie v2, not v2.2 or v3.x or whatever), unless explicitly otherwise stated. Linus Torvalds"

#### libcurl (7.21.7)

libcurl is a free and easy-to-use client-side URL transfer library, supporting DICT, FILE, FTP, FTPS, Gopher, HTTP, HTTPS, IMAP, IMAPS, LDAP, LDAPS, POP3, POP3S, RTMP, RTSP, SCP, SFTP, SMTP, SMTPS, Telnet and TFTP. libcurl supports SSL certificates, HTTP POST, HTTP PUT, FTP uploading, HTTP form based upload, proxies, cookies, user+password authentication (Basic, Digest, NTLM, Negotiate, Kerberos), file transfer resume, http proxy tunneling and more! The original download site for this software is :

<http://curl.haxx.se/libcurl/COPYRIGHT AND PERMISSION NOTICE>

Copyright (c) 1996 - 2010, Daniel Stenberg, [daniel@haxx.se](mailto:daniel@haxx.se). All rights reserved. Permission to use, copy, modify, and distribute this software for any purpose with or without fee is hereby granted, provided that the above copyright notice and this permission notice appear in all copies. THE SOFTWARE IS PROVIDED "AS IS", WITHOUT WARRANTY OF ANY KIND, EXPRESS OR IMPLIED, INCLUDING BUT NOT LIMITED TO THE WARRANTIES

OF MERCHANTABILITY, FITNESS FOR A PARTICULAR PURPOSE AND NON-INFRINGEMENT OF THIRD PARTY RIGHTS. INNO EVENT SHALL THE AUTHORS OR COPYRIGHT HOLDERS BE LIABLE FOR ANY CLAIM, DAMAGES OR OTHER LIABILITY, WHETHER IN AN ACTION OF CONTRACT, TORT OR OTHERWISE, ARISING FROM, OUT OF OR IN CONNECTION WITH THE SOFTWARE OR THE USE OR OTHER DEALINGS IN THE SOFTWARE. Except as contained in this notice, the name of a copyright holder shall not be used in advertising or otherwise to promote the sale, use or other dealings in this Software without prior written authorization of the copyright holder.

#### libfreetype (2.4.2)

FreeType is a software development library, available in source and binary forms, used to render text on to bitmaps and provides support for other font-related operations

The original download site for this software is : <https://github.com/julienr/libfreetype-android>FreeType License

#### libjpeg (8a)

This package contains C software to implement JPEG image encoding, decoding, and transcoding. This software is based in part on the work of the Independent JPEG Group.

The authors make NO WARRANTY or representation, either express or implied, with respect to this software, its quality, accuracy, merchantability, or fitness for a particular purpose. This software is provided "AS IS", and you, its user, assume the entire risk as to its quality and accuracy. This software is copyright (C) 1991-1998, Thomas G. Lane. All Rights Reserved except as specified below. Permission is hereby granted to use, copy, modify, and distribute this software (or portions thereof) for any purpose, without fee, subject to these conditions:(1) If any part of the source code for this software is distributed, then this README file must be included, with this copyright and no-warranty notice unaltered; and any additions, deletions, or changes to the original files must be clearly indicated in accompanying documentation.(2) If only executable code is distributed, then the accompanying documentation must state that "this software is based in part on the work of the Independent JPEG Group".(3) Permission for use of this software is granted only if the user accepts full responsibility for any undesirable consequences; the authors accept NO LIABILITY for damages of any kind. These conditions apply to any software derived from or based on the IJG code, not just to the unmodified library. If you use our work, you ought to acknowledge us. Permission is NOT granted for the use of any IJG author's name or company



name in advertising or publicity relating to this software or products derived from it. This software may be referred to only as "the Independent JPEG Group's software". We specifically permit and encourage the use of this software as the basis of commercial products, provided that all warranty or liability claims are assumed by the product vendor.

#### libpng (1.4.1)

libpng is the official Portable Network Graphics (PNG) reference library (originally called pnglib). It is a platform-independent library that contains C functions for handling PNG images. It supports almost all of PNG's features, is extensible. The original download site for this software is :

<https://github.com/julienr/libpng-androidlibpng>  
license

#### openssl (1.0.1j)

OpenSSL is an open-source implementation of the SSL and TLS protocols. The core library, written in the C programming language, implements the basic cryptographic functions and provides various utility functions. The original download site for this software is : <http://openssl.org/OpenSSL> license

#### Zlib compression library (1.2.7)

zlib is a general purpose data compression library. All the code is thread safe. The data format used by the zlib library is described by RFCs (Request for Comments) 1950 to 1952 in the files <http://tools.ietf.org/html/rfc1950> (zlib format), [rfc1951](http://tools.ietf.org/html/rfc1951) (deflate format) and [rfc1952](http://tools.ietf.org/html/rfc1952) (gzip format) Developed by Jean-loup Gailly and Mark Adler(C) 1995-2012 Jean-loup Gailly and Mark Adler This software is provided 'as-is', without any express or implied warranty. In no event will the authors be held liable for any damages arising from the use of this software. Permission is granted to anyone to use this software for any purpose, including commercial applications, and to alter it and redistribute it freely, subject to the following restrictions: 1. The origin of this software must not be misrepresented; you must not claim that you wrote the original software. If you use this software in a product, an acknowledgment in the product documentation would be appreciated but is not required. 2. Altered source versions must be plainly marked as such, and must not be misrepresented as being the original software. 3. This notice may not be removed or altered from any source distribution. Jean-loup Gailly Mark Adler [jloup@gzip.org](mailto:jloup@gzip.org) [madler@alumni.caltech.edu](mailto:madler@alumni.caltech.edu)

#### dvbsnoop (1.2)

dvbsnoop is a DVB / MPEG stream analyzer program. For generating CRC32 values required for composing PAT, PMT, EIT sections

The original download site for this software is : <https://github.com/a4tunado/dvbsnoop/blob/master/src/misc/crc32.cGPL> v2  
<http://dvbsnoop.sourceforge.net/dvbsnoop.html>

#### ezxml (0.8.6)

ezXML is a C library for parsing XML documents.

The original download site for this software is : <http://ezxml.sourceforge.net>. Copyright 2004, 2005 Aaron Voisine. This piece of software is made available under the terms and conditions of the MIT license, which can be found below.

#### gSoap (2.7.15)

The gSOAP toolkit is an open source C and C++ software development toolkit for SOAP/XML Web services and generic (non-SOAP) C/C++ XML data bindings. Part of the software embedded in this product is gSOAP software. Portions created by gSOAP are Copyright 2001-2009 Robert A. van Engelen, Genivia inc. All Rights Reserved. THE SOFTWARE IN THIS PRODUCT WAS IN PART PROVIDED BY GENIVIA INC AND ANY EXPRESS OR IMPLIED WARRANTIES, INCLUDING, BUT NOT LIMITED TO, THE IMPLIED WARRANTIES OF MERCHANTABILITY AND FITNESS FOR A PARTICULAR PURPOSE ARE DISCLAIMED. IN NO EVENT SHALL THE AUTHOR BE LIABLE FOR ANY DIRECT, INDIRECT, INCIDENTAL, SPECIAL, EXEMPLARY, OR CONSEQUENTIAL DAMAGES (INCLUDING, BUT NOT LIMITED TO, PROCUREMENT OF SUBSTITUTE GOODS OR SERVICES; LOSS OF USE, DATA, OR PROFITS; OR BUSINESS INTERRUPTION) HOWEVER CAUSED AND ON ANY THEORY OF LIABILITY, WHETHER IN CONTRACT, STRICT LIABILITY, OR TORT (INCLUDING NEGLIGENCE OR OTHERWISE) ARISING IN ANY WAY OUT OF THE USE OF THIS SOFTWARE, EVEN IF ADVISED OF THE POSSIBILITY OF SUCH DAMAGE.

#### restlet (2.1.7)

Restlet is a lightweight, comprehensive, open source REST framework for the Java platform. Rest let is suitable for both server and client Web applications. It supports major Internet transport, data format, and service description standards like HTTP and HTTPS, SMTP, XML, JSON, Atom, and WADL. The original download site for this software is : <http://restlet.org> This piece of software is made available under the terms and conditions of the Apache License version 2.

Opera Web Browser (SDK 3.5)

This TV contains Opera Browser Software.

dmalloc (2.7.2)

Opera uses Doug Lea's memory allocator

The original download site for this software is :

<http://gee.cs.oswego.edu/dl/html/malloc.html>

double-conversion

Opera uses double-conversion library by Florian Loitsch, faster double : string conversions (dtoa and strtod). The original download site for this software is : <http://code.google.com/p/double-conversion> Copyright 2006-2011, the V8 project authors. All rights reserved. Redistribution and use in source and binary forms, with or without modification, are permitted provided that the following conditions are met: \* Redistributions of source code must retain the above copyright notice, this list of conditions and the following disclaimer. \* Redistributions in binary form must reproduce the above copyright notice, this list of conditions and the following disclaimer in the documentation and/or other materials provided with the distribution. \* Neither the name of Google Inc. nor the names of its contributors may be used to endorse or promote products derived from this software without specific prior written permission. THIS SOFTWARE IS PROVIDED BY THE COPYRIGHT HOLDERS AND CONTRIBUTORS "AS IS" AND ANY EXPRESS OR IMPLIED WARRANTIES, INCLUDING, BUT NOT LIMITED TO, THE IMPLIED WARRANTIES OF MERCHANTABILITY AND FITNESS FOR A PARTICULAR PURPOSE ARE DISCLAIMED. IN NO EVENT SHALL THE COPYRIGHT OWNER OR CONTRIBUTORS BE LIABLE FOR ANY DIRECT, INDIRECT, INCIDENTAL, SPECIAL, EXEMPLARY, OR CONSEQUENTIAL DAMAGES (INCLUDING, BUT NOT LIMITED TO, PROCUREMENT OF SUBSTITUTE GOODS OR SERVICES; LOSS OF USE, DATA, OR PROFITS; OR BUSINESS INTERRUPTION) HOWEVER CAUSED AND ON ANY THEORY OF LIABILITY, WHETHER IN CONTRACT, STRICT LIABILITY, OR TORT (INCLUDING NEGLIGENCE OR OTHERWISE) ARISING IN ANY WAY OUT OF THE USE OF THIS SOFTWARE, EVEN IF ADVISED OF THE POSSIBILITY OF SUCH DAMAGE.

EMX (0.9c)

Opera uses EMX, which is an OS/2 port of the gcc suite. Opera uses modified versions of the sprintf and scanf methods from this C library.\* The emx libraries are not distributed under the GPL. Linking an \* application with the emx libraries does not cause the

executable \* to be covered by the GNU General Public License. You are allowed \* to change and copy the emx library sources if you keep the copyright \* message intact. If you improve the emx libraries, please send your \* enhancements to the emx author (you should copyright your \* enhancements similar to the existing emx libraries).

freetype (2.4.8)

Opera uses freetype FreeType 2 is a software-font engine that is designed to be small, efficient, highly customizable and portable, while capable of producing high-quality output (glyph images). The original download site for this software is : <http://www.freetype.org/freetype2/index.html> Freetype License

HKSCS (2008)

Opera uses HKSCS: The Government of the Hong Kong Special Administrative Region HKSCS mappings The original download site for this software is : <http://www.ogcio.gov.hk> Before downloading the Software or Document provided on this Web page, you should read the following terms (Terms of Use). By downloading the Software and Document, you are deemed to agree to these terms. 1. The Government of the Hong Kong Special Administrative Region (HKSARG) has the right to amend or vary the terms under this Terms of Use from time to time at its sole discretion. 2. By using the Software and Document, you irrevocably agree that the HKSARG may from time to time vary this Terms of Use without further notice to you and you also irrevocably agree to be bound by the most updated version of the Terms of Use. 3. You have the sole responsibility of obtaining the most updated version of the Terms of Use which is available in the "Digital 21" Web site ([http://www.ogcio.gov.hk/en/business/tech\\_promotion/ccli/terms/terms.htm](http://www.ogcio.gov.hk/en/business/tech_promotion/ccli/terms/terms.htm)). 4. By accepting this Terms of Use, HKSARG shall grant you a non-exclusive license to use the Software and Document for any purpose, subject to clause 5 below. 5. You are not allowed to make copies of the Software and Document except it is incidental to and necessary for the normal use of the Software. You are not allowed to adapt or modify the Software and Document or to distribute, sell, rent, or make available to the public the Software and Document, including copies or an adaptation of them. 6. The Software and Document are protected by copyright. The licensors of the Government of Hong Kong Special Administrative Region are the owners of all copyright works in the Software and Document. All rights reserved. 7. You understand and agree that use of the Software and Document are at your sole risk, that any material and/or data downloaded or otherwise obtained in relation to the Software and Document is at your discretion and risk and that you will be solely responsible for any damage caused to

your computer system or loss of data or any other loss that results from the download and use of the Software and Document in any manner whatsoever.8. In relation to the Software and Document, HKSARG hereby disclaims all warranties and conditions, including all implied warranties and conditions of merchantability, fitness for a particular purpose and non-infringement.9. HKSARG will not be liable for any direct, indirect, incidental, special or consequential loss of any kind resulting from the use of or the inability to use the Software and Document even if HKSARG has been advised of the possibility of such loss.10. You agree not to sue HKSARG and agree to indemnify, defend and hold harmless HKSARG, its officers and employees from any and all third party claims, liability, damages and/or costs (including, but not limited to, legal fees) arising from your use of the Software and Document, your violation of the Terms of Use or infringement of any intellectual property or other right of any person or entity.11. The Terms of Use will be governed by and construed in accordance with the laws of Hong Kong.12. Any waiver of any provision of the Terms of Use will be effective only if in writing and signed by HKSARG or its representative.13. If for any reason a court of competent jurisdiction finds any provision or portion of the Terms of Use to be unenforceable, the remainder of the Terms of Use will continue in full force and effect.14. The Terms of Use constitute the entire agreement between the parties with respect to the subject matter hereof and supersedes and replaces all prior or contemporaneous understandings or agreements, written or oral, regarding such subject matter.15. In addition to the licence granted in Clause 4, HKSARG hereby grants you a non-exclusive limited licence to reproduce and distribute the Software and Document with the following conditions:(i) not for financial gain unless it is incidental;(ii) reproduction and distribution of the Software and Document in complete and unmodified form; and(iii) when you distribute the Software and Document, you agree to attach the Terms of Use and a statement that the latest version of the Terms of Use is available from the "Office of the Government Chief Information Officer" Web site ([http://www.ogcio.gov.hk/en/business/tech\\_promotion/ccli/terms/terms.htm](http://www.ogcio.gov.hk/en/business/tech_promotion/ccli/terms/terms.htm)).

#### IANA (Dec 30 2013)

Opera uses Internet Assigned Numbers Authority: Character encoding tag names and numbers. The original download site for this software is : <https://www.iana.org>

#### ICU (3)

Opera uses ICU : International Components for Unicode: Mapping table for GB18030The original

download site for this software is : <http://site.icu-project.org/http://source.icu-project.org/repos/icu/icu/trunk/license.html>

#### MozTW (1.0)

Opera uses MoxTW : MozTW project: Big5-2003 mapping tables. The original download site for this software is : <https://moztw.org>This piece of software is made available under the terms and conditions of CCPL

#### NPAPI (0.27)

Opera uses NPAPI : Netscape 4 Plugin API: npapi.h, npfunctions.h, npruntime.h and nptypes.h. Distributed as part of the Netscape 4 Plugin SDK.The original download site for this software is : [wiki.mozilla.org](http://wiki.mozilla.org)This piece of software is made available under the terms and conditions of mozilla licence as described below.

#### Unicode (4.0)

Opera uses Unicode : Data from the Unicode character database. The original download site for this software is : [www.unicode.org](http://www.unicode.org)<http://www.unicode.org/copyright.html>

#### Webp (0.2.0)

Opera uses Webp : libwebp is a library for decoding images in the WebP format. Products may use it to decode WebP images. The turbo servers will eventually re-decode images to WebP. The original download site for this software is : <https://developers.google.com/speed/webp/?csw=1> <https://chromium.googlesource.com/webm/libwebp/> Additional IP Rights Grant (Patents)"This implementation" means the copyrightable works distributed by Google as part of the WebM Project.Google hereby grants to you a perpetual, worldwide, non-exclusive, no-charge, royalty-free, irrevocable (except as stated in this section)patent license to make, have made, use, offer to sell, sell, import, transfer, and otherwise run, modify and propagate the contents of this implementation of VP8, where such license applies only to those patent claims, both currently owned by Google and acquired in the future, licensable by Google that are necessarily infringed by this implementation of VP8. This grant does not include claims that would be infringed only as a consequence of further modification of this implementation. If you or your agent or exclusive licensee institute or order or agree to the institution of patent litigation against any entity (including a cross-claim or counterclaim in a lawsuit) alleging that this implementation of VP8 or any code

incorporated within this implementation of VP8 constitutes direct or contributory patent infringement, or inducement of patent infringement, then any patent rights granted to you under this License for this implementation of VP8 shall terminate as of the date such litigation is filed.

#### FaceBook SDK (3.0.1)

This TV contains Facebook SDK. The Facebook SDK for Android is the easiest way to integrate your Android app with Facebook's platform. The SDK provides support for Login with Facebook authentication, reading and writing to Facebook APIs and support for UI elements such as pickers and dialogs. The original download site for this software is : <https://developer.facebook.com/docs/android> This piece of software is made available under the terms and conditions of the Apache License version 2.

#### iptables (1.4.7)

iptables is a user space application program that allows a system administrator to configure the tables provided by the Linux kernel firewall (implemented as different Netfilter modules) and the chains and rules it stores. Different kernel modules and programs are currently used for different protocols; iptables applies to IPv4. The original download site for this software is : <https://android.googlesource.com> This piece of software is made available under the terms and conditions of the GPL v2.

#### libyuv (814)

libyuv is an open source project that includes YUV conversion and scaling functionality. The original download site for this software is : <http://code.google.com/p/libyuv> This piece of software is made available under the terms and conditions BSD.

#### ffmpeg (2.1.3)

This TV uses FFmpeg. FFmpeg is a complete, cross-platform solution to record, convert and stream audio and video. The original download site for this software is : <http://ffmpeg.org> This piece of software is made available under the terms and conditions of the GPL v2 license, which can be found below.

#### u-boot (2011-12)

U-boot is a boot loader for embedded boards based on ARM, MIPS and other processors, which can be installed in a boot ROM and used to initialize and test the hardware or to download and run application code

This piece of software is made available under the terms and conditions of the GPL v2 license, which can be found below.

#### live555 (0.82)

Live555 provides RTP/RTCP/RTSP client. The original download site for this software is : <http://www.live555.com> This piece of software is made available under the terms and conditions of the LGPL v2.1 license, which can be found below.

#### Bluetooth Stack (Bluedroid)

This TV uses Bluetooth stack. The original download site for this software is : This piece of software is made available under the terms and conditions of Android Apache License Version 2.

#### EXIF (NA)

Exif JPEG header manipulation tool. The original download site for this software is : <http://www.sentex.net/~mwandel/jhead/> Portions of this source code are in the public domain

Copyright (c) 2008, The Android Open Source Project

All rights reserved. Redistribution and use in source and binary forms, with or without modification, are permitted provided that the following conditions are met: \* Redistributions of source code must retain the above copyright notice, this list of conditions and the following disclaimer. \* Redistributions in binary form must reproduce the above copyright notice, this list of conditions and the following disclaimer in the documentation and/or other materials provided with the distribution. \* Neither the name of The Android Open Source Project nor the names of its contributors may be used to endorse or promote products derived from this software without specific prior written permission. THIS SOFTWARE IS PROVIDED BY THE COPYRIGHT HOLDERS AND CONTRIBUTORS "AS IS" AND ANY EXPRESS OR IMPLIED WARRANTIES, INCLUDING, BUT NOT LIMITED TO, THE IMPLIED WARRANTIES OF MERCHANTABILITY AND FITNESS FOR A PARTICULAR PURPOSE ARE DISCLAIMED. IN NO EVENT SHALL THE COPYRIGHT OWNER OR CONTRIBUTORS BE LIABLE FOR ANY DIRECT, INDIRECT, INCIDENTAL, SPECIAL, EXEMPLARY, OR CONSEQUENTIAL DAMAGES (INCLUDING, BUT NOT LIMITED TO, PROCUREMENT OF SUBSTITUTE GOODS OR SERVICES; LOSS OF USE, DATA, OR PROFITS; OR BUSINESS INTERRUPTION) HOWEVER CAUSED AND ON ANY THEORY OF LIABILITY, WHETHER IN CONTRACT, STRICT LIABILITY, OR TORT (INCLUDING NEGLIGENCE OR OTHERWISE) ARISING IN ANY WAY OUT OF THE USE OF THIS SOFTWARE, EVEN IF ADVISED OF THE POSSIBILITY OF SUCH DAMAGE.

## EXPAT (2.1.0)

EXPAT is a XML Parser. The original download site for this software is :

<http://expat.sourceforge.net> Copyright (c) 1998, 1999, 2000 Thai Open Source Software Center Ltd and Clark Cooper

Copyright (c) 2001, 2002, 2003, 2004, 2005, 2006 Expat maintainers. Permission is hereby granted, free of charge, to any person obtaining a copy of this software and associated documentation files (the "Software"), to deal in the Software without restriction, including without limitation the rights to use, copy, modify, merge, publish, distribute, sublicense, and/or sell copies of the Software, and to permit persons to whom the Software is furnished to do so, subject to the following conditions: The above copyright notice and this permission notice shall be included in all copies or substantial portions of the Software. THE SOFTWARE IS PROVIDED "AS IS", WITHOUT WARRANTY OF ANY KIND, EXPRESS OR IMPLIED, INCLUDING BUT NOT LIMITED TO THE WARRANTIES OF MERCHANTABILITY, FITNESS FOR A PARTICULAR PURPOSE AND NONINFRINGEMENT. IN NO EVENT SHALL THE AUTHORS OR COPYRIGHT HOLDERS BE LIABLE FOR ANY CLAIM, DAMAGES OR OTHER LIABILITY, WHETHER IN AN ACTION OF CONTRACT, TORT OR OTHERWISE, ARISING FROM, OUT OF OR IN CONNECTION WITH THE SOFTWARE OR THE USE OR OTHER DEALINGS IN THE SOFTWARE.

## neven face recognition library (NA)

This TV uses neven face recognition library which is used for face recognition This piece of software is made available under the terms and conditions of Android Apache License version 2.

## Unicode (4.8.1.1)

This TV uses Unicode which specifies the representation of text

The original download site for this software is : <http://icu-project.org/> ICU License - ICU 1.8.1 and later

### COPYRIGHT AND PERMISSION NOTICE

Copyright (c) 1995-2008 International Business Machines Corporation and others

All rights reserved. Permission is hereby granted, free of charge, to any person obtaining a copy of this software and associated documentation files (the "Software"), to deal in the Software without restriction, including without limitation the rights to use, copy, modify, merge, publish, distribute, and/or sell copies of the Software, and to permit persons to whom the Software is furnished to do so, provided

that the above copyright notice(s) and this permission notice appear in all copies of the Software and that both the above copyright notice(s) and this permission notice appear in supporting documentation. THE SOFTWARE IS PROVIDED "AS IS", WITHOUT WARRANTY OF ANY KIND, EXPRESS OR IMPLIED, INCLUDING BUT NOT LIMITED TO THE WARRANTIES OF MERCHANTABILITY, FITNESS FOR A PARTICULAR PURPOSE AND NONINFRINGEMENT OF THIRD PARTY RIGHTS. IN NO EVENT SHALL THE COPYRIGHT HOLDER OR HOLDERS INCLUDED IN THIS NOTICE BE LIABLE FOR ANY CLAIM, OR ANY SPECIAL INDIRECT OR CONSEQUENTIAL DAMAGES, OR ANY DAMAGES WHATSOEVER RESULTING FROM LOSS OF USE, DATA OR PROFITS, WHETHER IN AN ACTION OF CONTRACT, NEGLIGENCE OR OTHER TORTIOUS ACTION, ARISING OUT OF OR IN CONNECTION WITH THE USE OR PERFORMANCE OF THIS SOFTWARE. Except as contained in this notice, the name of a copyright holder shall not be used in advertising or otherwise to promote the sale, use or other dealings in this Software without prior written authorization of the copyright holder. All trademarks and registered trademarks mentioned herein are the property of their respective owners.

## IPRoute2 (NA)

IPRoute2 is used for TCP/IP, Networking and Traffic control. The original download site for this software is : <http://www.linuxfoundation.org/collaborate/workgroups/networking/iproute2> This piece of software is made available under the terms and conditions of GPL V2.

## mtpd (NA)

mtpd is used for VPN Network. The original download site for this software is : <http://libmtp.sourceforge.net/> This piece of software is made available under the terms and conditions of Apache License version 2.0.

## MDNS Responder (NA)

MDNS Responder. The Mdns Responder project is a component of Bonjour, Apple's ease-of-use IP networking initiative. The original download site for this software is : <http://www.opensource.apple.com/tarballs/mDNSResponder/> This piece of software is made available under the terms and conditions of Apache License version 2.0.

## NFC (NA)

NFC Semiconductor's NFC Library. Near Field Communication (NFC) is a set of short-range wireless technologies, typically requiring a distance of 4cm or

less to initiate a connection. NFC allows you to share small payloads of data between an NFC tag and an Android-powered device, or between two Android-powered devices. This piece of software is made available under the terms and conditions of Apache License version 2.0.

#### Skia (NA)

Skia is a complete 2D graphic library for drawing Text, Geometries, and Images. The original download site for this software is :

<http://code.google.com/p/skia/> Copyright (c) 2011 Google Inc. All rights reserved. Redistribution and use in source and binary forms, with or without modification, are permitted provided that the following conditions are met: \* Redistributions of source code must retain the above copyright notice, this list of conditions and the following disclaimer. \* Redistributions in binary form must reproduce the above copyright notice, this list of conditions and the following disclaimer in the documentation and/or other materials provided with the distribution. \* Neither the name of Google Inc. nor the names of its contributors may be used to endorse or promote products derived from this software without specific prior written permission. THIS SOFTWARE IS PROVIDED BY THE COPYRIGHT HOLDERS AND CONTRIBUTORS "AS IS" AND ANY EXPRESS OR IMPLIED WARRANTIES, INCLUDING, BUT NOT LIMITED TO, THE IMPLIED WARRANTIES OF MERCHANTABILITY AND FITNESS FOR A PARTICULAR PURPOSE ARE DISCLAIMED. IN NO EVENT SHALL THE COPYRIGHT OWNER OR CONTRIBUTORS BE LIABLE FOR ANY DIRECT, INDIRECT, INCIDENTAL, SPECIAL, EXEMPLARY, OR CONSEQUENTIAL DAMAGES (INCLUDING, BUT NOT LIMITED TO, PROCUREMENT OF SUBSTITUTE GOODS OR SERVICES; LOSS OF USE, DATA, OR PROFITS; OR BUSINESS INTERRUPTION) HOWEVER CAUSED AND ON ANY THEORY OF LIABILITY, WHETHER IN CONTRACT, STRICT LIABILITY, OR TORT (INCLUDING NEGLIGENCE OR OTHERWISE) ARISING IN ANY WAY OUT OF THE USE OF THIS SOFTWARE, EVEN IF ADVISED OF THE POSSIBILITY OF SUCH DAMAGE.

#### Sonic Audio Synthesis library (NA)

The original download site for this software is : <http://www.sonivoxmi.com/> This piece of software is made available under the terms and conditions of Apache License version 2.0.

#### Sqlite (3071100)

The original download site for this software is : [www.sqlite.org](http://www.sqlite.org). This piece of software is made available under the terms and conditions of Apache

License version 2.0.

#### Nuance Speech Recognition engine (NA)

The original download site for this software is : <http://www.nuance.com/> This piece of software is made available under the terms and conditions of Apache License version 2.0.

#### C++Standard Template Library library (5)

This TV uses Implementation of the C++ Standard Template Library. The original download site for this software is : <http://stlport.sourceforge.net> Boris Fomitchev grants Licensee a non-exclusive, non-transferable, royalty-free license to use STLport and its documentation without fee. By downloading, using, or copying STLport or any portion thereof, Licensee agrees to abide by the intellectual property laws and all other applicable laws of the United States of America, and to all of the terms and conditions of this Agreement. Licensee shall maintain the following copyright and permission notices on STLport sources and its documentation unchanged : Copyright 1999,2000 Boris Fomitchev

This material is provided "as is", with absolutely no warranty expressed or implied. Any use is at your own risk. Permission to use or copy this software for any purpose is hereby granted without fee, provided the above notices are retained on all copies. Permission to modify the code and to distribute modified code is granted, provided the above notices are retained, and a notice that the code was modified is included with the above copyright notice. The Licensee may distribute binaries compiled with STLport (whether original or modified) without any royalties or restrictions. The Licensee may distribute original or modified STLport sources, provided that: The conditions indicated in the above permission notice are met; The following copyright notices are retained when present, and conditions provided in accompanying permission notices are met : Copyright 1994 Hewlett-Packard Company Copyright 1996,97 Silicon Graphics Computer Systems, Inc. Copyright 1997 Moscow Center for SPARC Technology. Permission to use, copy, modify, distribute and sell this software and its documentation for any purpose is hereby granted without fee, provided that the above copyright notice appear in all copies and that both that copyright notice and this permission notice appear in supporting documentation. Hewlett-Packard Company makes no representations about the suitability of this software for any purpose. It is provided "as is" without express or implied warranty. Permission to use, copy, modify, distribute and sell this software and its documentation for any purpose is hereby granted without fee, provided that the above copyright notice appear in all copies and that both that copyright notice and this permission notice

appear in supporting documentation. Silicon Graphics makes no representations about the suitability of this software for any purpose. It is provided "as is" without express or implied warranty. Permission to use, copy, modify, distribute and sell this software and its documentation for any purpose is hereby granted without fee, provided that the above copyright notice appear in all copies and that both that copyright notice and this permission notice appear in supporting documentation. Moscow Center for SPARC Technology makes no representations about the suitability of this software for any purpose. It is provided "as is" without express or implied warranty

#### svox (NA)

The original download site for this software is :  
<http://www.nuance.com/>This piece of software is made available under the terms and conditions of Apache License version 2.0.

#### tinyalsa (NA)

This TV uses tinyalsa: a small library to interface with ALSA in the Linux kernel The original download site for this software is :  
<http://github.com/tinyalsa>Copyright 2011, The Android Open Source Project Redistribution and use in source and binary forms, with or without modification, are permitted provided that the following conditions are met: \* Redistributions of source code must retain the above copyright notice, this list of conditions and the following disclaimer. \* Redistributions in binary form must reproduce the above copyright notice, this list of conditions and the following disclaimer in the documentation and/or other materials provided with the distribution. \* Neither the name of The Android Open Source Project nor the names of its contributors may be used to endorse or promote products derived from this software without specific prior written permission. THIS SOFTWARE IS PROVIDED BY The Android Open Source Project "AS IS" AND ANY EXPRESS OR IMPLIED WARRANTIES, INCLUDING, BUT NOT LIMITED TO, THE IMPLIED WARRANTIES OF MERCHANTABILITY AND FITNESS FOR A PARTICULAR PURPOSE ARE DISCLAIMED. IN NO EVENT SHALL The Android Open Source Project BE LIABLE FOR ANY DIRECT, INDIRECT, INCIDENTAL, SPECIAL, EXEMPLARY, OR CONSEQUENTIAL DAMAGES (INCLUDING, BUT NOT LIMITED TO, PROCUREMENT OF SUBSTITUTE GOODS OR SERVICES; LOSS OF USE, DATA, OR PROFITS; OR BUSINESS INTERRUPTION) HOWEVER CAUSED AND ON ANY THEORY OF LIABILITY, WHETHER IN CONTRACT, STRICT LIABILITY, OR TORT (INCLUDING NEGLIGENCE OR OTHERWISE) ARISING IN ANY WAY OUT OF THE USE OF THIS SOFTWARE, EVEN IF

ADVISED OF THE POSSIBILITY OF SUCH DAMAGE.

#### Vorbis Decompression Library (NA)

This TV uses Tremolo ARM-optimized Ogg Vorbis decompression library. Vorbis is a general purpose audio and music encoding format contemporary to MPEG-4's AAC and TwinVQ, the next generation beyond MPEG audio layer 3The original download site for this software is :  
<http://wss.co.uk/pinknoise/tremo>Copyright (c) 2002-2008 Xiph.org Foundation Redistribution and use in source and binary forms, with or without modification, are permitted provided that the following conditions are met:- Redistributions of source code must retain the above copyright notice, this list of conditions and the following disclaimer.- Redistributions in binary form must reproduce the above copy right notice, this list of conditions and the following disclaimer in the documentation and/or other materials provided with the distribution.- Neither the name of the Xiph.org Foundation nor the names of its contributors may be used to endorse or promote products derived from this software without specific prior written permission. THIS SOFTWARE IS PROVIDED BY THE COPYRIGHT HOLDERS AND CONTRIBUTORS "AS IS" AND ANY EXPRESS OR IMPLIED WARRANTIES, INCLUDING, BUT NOT LIMITED TO, THE IMPLIED WARRANTIES OF MERCHANTABILITY AND FITNESS FOR A PARTICULAR PURPOSE ARE DISCLAIMED. IN NO EVENT SHALL THE FOUNDATION OR CONTRIBUTORS BE LIABLE FOR ANY DIRECT, INDIRECT, INCIDENTAL, SPECIAL, EXEMPLARY, OR CONSEQUENTIAL DAMAGES (INCLUDING, BUT NOT LIMITED TO, PROCUREMENT OF SUBSTITUTE GOODS OR SERVICES; LOSS OF USE, DATA, OR PROFITS; OR BUSINESS INTERRUPTION) HOWEVER CAUSED AND ON ANY THEORY OF LIABILITY, WHETHER IN CONTRACT, STRICT LIABILITY, OR TORT (INCLUDING NEGLIGENCE OR OTHERWISE) ARISING IN ANY WAY OUT OF THE USE OF THIS SOFTWARE, EVEN IF ADVISED OF THE POSSIBILITY OF SUCH DAMAGE.

#### wpa\_supplicant\_Daemon (v0.8)

Library used by legacy HAL to talk to wpa\_supplicant daemonThe original download site for this software is :  
[http://hostap.epitest.fi/wpa\\_supplicant/](http://hostap.epitest.fi/wpa_supplicant/)This piece of software is made available under the terms and conditions of GPL version 2.

#### gson (2.3)

Gson is a Java library that can be used to convert Java Objects into their JSON representation. It can also be used to convert a JSON string to an equivalent Java object. Gson can work with arbitrary

Java objects including pre-existing objects that you do not have source-code of. The original download site for this software is :  
<https://code.google.com/p/google-gson/>This piece of software is made available under the terms and conditions of the Apache License 2.0

This software includes an implementation of the AES Cipher, licensed by Brian Gladman

The original download site for this software is :  
<http://www.gladman.me.uk/>This piece of software is licensed by Brian Gladman

#### libUpNp (1.2.1)

The original download site for this software is :  
<http://upnp.sourceforge.net/>This piece of software is made available under the terms and conditions of the BSD.

#### dnsmasq

Dnsmasq is a lightweight, easy to configure DNS forwarder and DHCP server

The original download site for this software is : <https://android.googlesource.com/platform/external/dnsmasq/>This piece of software is made available under the terms and conditions of the GPL v2 license, which can be found below.

#### TomCrypt (1.1)

iwedia stack is using tomcrypt for sw decryption

The original download site for this software is : <http://manpages.ubuntu.com/manpages/saucy/man3/libtomcrypt.3.html>This piece of software is made available under the terms and conditions of the DO WHAT THE FUCK YOU WANT TO PUBLIC LICENSE

#### AsyncHttpClient (1.4.6)

The original download site for this software is :  
<http://loopj.com/android-async-http/>This piece of software is made available under the terms and conditions of the APACHE LICENSE 2.0

#### Jackson Parser (2.x)

Ipepg client uses Jackson Parser for string manipulation. The original download site for this software is : <https://github.com/FasterXML/jackson-core>This piece of software is made available under the terms and conditions of the APACHE LICENSE 2.0

TP Vision Netherlands B.V. is grateful to the groups and individuals above for their contributions.

---

#### GNU GENERAL PUBLIC LICENSE

Version 2, June 1991

Copyright (C) 1989, 1991 Free Software Foundation, Inc.

51 Franklin Street, Fifth Floor, Boston, MA 02110-1301, USA

Everyone is permitted to copy and distribute verbatim copies

of this license document, but changing it is not allowed.

#### Preamble

The licenses for most software are designed to take away your freedom to share and change it. By contrast, the GNU General Public License is intended to guarantee your freedom to share and change free software--to make sure the software is free for all its users. This General Public License applies to most of the Free Software Foundation's software and to any other program whose authors commit to using it. (Some other Free Software Foundation software is covered by the GNU Lesser General Public License instead.) You can apply it to your programs, too.

When we speak of free software, we are referring to freedom, not price. Our General Public Licenses are designed to make sure that you have the freedom to distribute copies of free software (and charge for this service if you wish), that you receive source code or can get it if you want it, that you can change the software or use pieces of it in new free programs; and that you know you can do these things.

To protect your rights, we need to make restrictions that forbid anyone to deny you these rights or to ask you to surrender the rights. These restrictions translate to certain responsibilities for you if you distribute copies of the software, or if you modify it.

For example, if you distribute copies of such a program, whether gratis or for a fee, you must give the recipients all the rights that you have. You must make sure that they, too, receive or can get the source code. And you must show them these terms so they know their rights.

We protect your rights with two steps: (1) copyright the software, and (2) offer you this license which gives you legal permission to copy, distribute and/or modify the software.

Also, for each author's protection and ours, we want



to make certain that everyone understands that there is no warranty for this free software. If the software is modified by someone else and passed on, we want its recipients to know that what they have is not the original, so that any problems introduced by others will not reflect on the original authors' reputations.

Finally, any free program is threatened constantly by software patents. We wish to avoid the danger that redistributors of a free program will individually obtain patent licenses, in effect making the program proprietary. To prevent this, we have made it clear that any patent must be licensed for everyone's free use or not licensed at all.

The precise terms and conditions for copying, distribution and modification follow.

#### TERMS AND CONDITIONS FOR COPYING, DISTRIBUTION AND MODIFICATION

Activities other than copying, distribution and modification are not covered by this License; they are outside its scope. The act of running the Program is not restricted, and the output from the Program is covered only if its contents constitute a work based on the Program (independent of having been made by running the Program). Whether that is true depends on what the Program does.

You may charge a fee for the physical act of transferring a copy, and you may at your option offer warranty protection in exchange for a fee.

- a) You must cause the modified files to carry prominent notices stating that you changed the files and the date of any change.
- b) You must cause any work that you distribute or publish, that in whole or in part contains or is derived from the Program or any part thereof, to be licensed as a whole at no charge to all third parties under the terms of this License.
- c) If the modified program normally reads commands interactively when run, you must cause it, when started running for such interactive use in the most ordinary way, to print or display an announcement including an appropriate copyright notice and a notice that there is no warranty (or else, saying that you provide a warranty) and that users may redistribute the program under these conditions, and telling the user how to view a copy of this License. (Exception: if the Program itself is interactive but does not normally print such an announcement, your work based on the Program is not required to print an announcement.)

These requirements apply to the modified work as a whole. If identifiable sections of that work are not derived from the Program, and can be reasonably considered independent and separate works in themselves, then this License, and its terms, do not apply to those sections when you distribute them as separate works. But when you distribute the same

sections as part of a whole which is a work based on the Program, the distribution of the whole must be on the terms of this License, whose permissions for other licensees extend to the entire whole, and thus to each and every part regardless of who wrote it.

Thus, it is not the intent of this section to claim rights or contest your rights to work written entirely by you; rather, the intent is to exercise the right to control the distribution of derivative or collective works based on the Program.

In addition, mere aggregation of another work not based on the Program with the Program (or with a work based on the Program) on a volume of a storage or distribution medium does not bring the other work under the scope of this License.

- a) Accompany it with the complete corresponding machine-readable source code, which must be distributed under the terms of Sections 1 and 2 above on a medium customarily used for software interchange; or,
- b) Accompany it with a written offer, valid for at least three years, to give any third party, for a charge no more than your cost of physically performing source distribution, a complete machine-readable copy of the corresponding source code, to be distributed under the terms of Sections 1 and 2 above on a medium customarily used for software interchange; or,
- c) Accompany it with the information you received as to the offer to distribute corresponding source code. (This alternative is allowed only for noncommercial distribution and only if you received the program in object code or executable form with such an offer, in accord with Subsection b above.)

The source code for a work means the preferred form of the work for making modifications to it. For an executable work, complete source code means all the source code for all modules it contains, plus any associated interface definition files, plus the scripts used to control compilation and installation of the executable. However, as a special exception, the source code distributed need not include anything that is normally distributed (in either source or binary form) with the major components (compiler, kernel, and so on) of the operating system on which the executable runs, unless that component itself accompanies the executable.

If distribution of executable or object code is made by offering access to copy from a designated place, then offering equivalent access to copy the source code from the same place counts as distribution of the source code, even though third parties are not compelled to copy the source along with the object code.

If any portion of this section is held invalid or unenforceable under any particular circumstance, the

balance of the section is intended to apply and the section as a whole is intended to apply in other circumstances.

It is not the purpose of this section to induce you to infringe any patents or other property right claims or to contest validity of any such claims; this section has the sole purpose of protecting the integrity of the free software distribution system, which is implemented by public license practices. Many people have made generous contributions to the wide range of software distributed through that system in reliance on consistent application of that system; it is up to the author/donor to decide if he or she is willing to distribute software through any other system and a licensee cannot impose that choice.

This section is intended to make thoroughly clear what is believed to be a consequence of the rest of this License.

Each version is given a distinguishing version number. If the Program specifies a version number of this License which applies to it and "any later version", you have the option of following the terms and conditions either of that version or of any later version published by the Free Software Foundation. If the Program does not specify a version number of this License, you may choose any version ever published by the Free Software Foundation.

NO WARRANTY

-----  
GNU LESSER GENERAL PUBLIC LICENSE

Version 2.1, February 1999

Copyright (C) 1991, 1999 Free Software Foundation, Inc.

51 Franklin Street, Fifth Floor, Boston, MA 02110-1301 USA

Everyone is permitted to copy and distribute verbatim copies

of this license document, but changing it is not allowed.

[This is the first released version of the Lesser GPL. It also counts as the successor of the GNU Library Public License, version 2, hence the version number 2.1.]

Preamble

The licenses for most software are designed to take away your freedom to share and change it. By contrast, the GNU General Public Licenses are intended to guarantee your freedom to share and change free software--to make sure the software is

free for all its users.

This license, the Lesser General Public License, applies to some specially designated software packages--typically libraries--of the Free Software Foundation and other authors who decide to use it. You can use it too, but we suggest you first think carefully about whether this license or the ordinary General Public License is the better strategy to use in any particular case, based on the explanations below.

When we speak of free software, we are referring to freedom of use, not price. Our General Public Licenses are designed to make sure that you have the freedom to distribute copies of free software (and charge for this service if you wish); that you receive source code or can get it if you want it; that you can change the software and use pieces of it in new free programs; and that you are informed that you can do these things.

To protect your rights, we need to make restrictions that forbid distributors to deny you these rights or to ask you to surrender these rights. These restrictions translate to certain responsibilities for you if you distribute copies of the library or if you modify it.

For example, if you distribute copies of the library, whether gratis or for a fee, you must give the recipients all the rights that we gave you. You must make sure that they, too, receive or can get the source code. If you link other code with the library, you must provide complete object files to the recipients, so that they can relink them with the library after making changes to the library and recompiling it. And you must show them these terms so they know their rights.

We protect your rights with a two-step method: (1) we copyright the library, and (2) we offer you this license, which gives you legal permission to copy, distribute and/or modify the library.

To protect each distributor, we want to make it very clear that there is no warranty for the free library. Also, if the library is modified by someone else and passed on, the recipients should know that what they have is not the original version, so that the original author's reputation will not be affected by problems that might be introduced by others.

Finally, software patents pose a constant threat to the existence of any free program. We wish to make sure that a company cannot effectively restrict the users of a free program by obtaining a restrictive license from a patent holder. Therefore, we insist that any patent license obtained for a version of the library must be consistent with the full freedom of use specified in this license.

Most GNU software, including some libraries, is covered by the ordinary GNU General Public License. This license, the GNU Lesser General Public License, applies to certain designated libraries, and is quite

different from the ordinary General Public License. We use this license for certain libraries in order to permit linking those libraries into non-free programs.

When a program is linked with a library, whether statically or using a shared library, the combination of the two is legally speaking a combined work, a derivative of the original library. The ordinary General Public License therefore permits such linking only if the entire combination fits its criteria of freedom. The Lesser General Public License permits more lax criteria for linking other code with the library.

We call this license the "Lesser" General Public License because it does Less to protect the user's freedom than the ordinary General Public License. It also provides other free software developers Less of an advantage over competing non-free programs. These disadvantages are the reason we use the ordinary General Public License for many libraries. However, the Lesser license provides advantages in certain special circumstances.

For example, on rare occasions, there may be a special need to encourage the widest possible use of a certain library, so that it becomes a de-facto standard. To achieve this, non-free programs must be allowed to use the library. A more frequent case is that a free library does the same job as widely used non-free libraries. In this case, there is little to gain by limiting the free library to free software only, so we use the Lesser General Public License.

In other cases, permission to use a particular library in non-free programs enables a greater number of people to use a large body of free software. For example, permission to use the GNU C Library in non-free programs enables many more people to use the whole GNU operating system, as well as its variant, the GNU/Linux operating system.

Although the Lesser General Public License is Less protective of the users' freedom, it does ensure that the user of a program that is linked with the Library has the freedom and the wherewithal to run that program using a modified version of the Library.

The precise terms and conditions for copying, distribution and modification follow. Pay close attention to the difference between a "work based on the library" and a "work that uses the library". The former contains code derived from the library, whereas the latter must be combined with the library in order to run.

#### TERMS AND CONDITIONS FOR COPYING, DISTRIBUTION AND MODIFICATION

A "library" means a collection of software functions and/or data prepared so as to be conveniently linked with application programs (which use some of those functions and data) to form executables.

The "Library", below, refers to any such software library or work which has been distributed under

these terms. A "work based on the Library" means either the Library or any derivative work under copyright law: that is to say, a work containing the Library or a portion of it, either verbatim or with modifications and/or translated straightforwardly into another language. (Hereinafter, translation is included without limitation in the term "modification".)

"Source code" for a work means the preferred form of the work for making modifications to it. For a library, complete source code means all the source code for all modules it contains, plus any associated interface definition files, plus the scripts used to control compilation and installation of the library.

Activities other than copying, distribution and modification are not covered by this License; they are outside its scope. The act of running a program using the Library is not restricted, and output from such a program is covered only if its contents constitute a work based on the Library (independent of the use of the Library in a tool for writing it). Whether that is true depends on what the Library does and what the program that uses the Library does.

You may charge a fee for the physical act of transferring a copy, and you may at your option offer warranty protection in exchange for a fee.

?a) The modified work must itself be a software library.

?b) You must cause the files modified to carry prominent notices stating that you changed the files and the date of any change.

?c) You must cause the whole of the work to be licensed at no charge to all third parties under the terms of this License.

?d) If a facility in the modified Library refers to a function or a table of data to be supplied by an application program that uses the facility, other than as an argument passed when the facility is invoked, then you must make a good faith effort to ensure that, in the event an application does not supply such function or table, the facility still operates, and performs whatever part of its purpose remains meaningful.

(For example, a function in a library to compute square roots has a purpose that is entirely well-defined independent of the application. Therefore, Subsection 2d requires that any application-supplied function or table used by this function must be optional: if the application does not supply it, the square root function must still compute square roots.)

These requirements apply to the modified work as a whole. If identifiable sections of that work are not derived from the Library, and can be reasonably considered independent and separate works in themselves, then this License, and its terms, do not apply to those sections when you distribute them as separate works. But when you distribute the same

sections as part of a whole which is a work based on the Library, the distribution of the whole must be on the terms of this License, whose permissions for other licensees extend to the entire whole, and thus to each and every part regardless of who wrote it.

Thus, it is not the intent of this section to claim rights or contest your rights to work written entirely by you; rather, the intent is to exercise the right to control the distribution of derivative or collective works based on the Library.

In addition, mere aggregation of another work not based on the Library with the Library (or with a work based on the Library) on a volume of a storage or distribution medium does not bring the other work under the scope of this License.

Once this change is made in a given copy, it is irreversible for that copy, so the ordinary GNU General Public License applies to all subsequent copies and derivative works made from that copy.

This option is useful when you wish to copy part of the code of the Library into a program that is not a library.

If distribution of object code is made by offering access to copy from a designated place, then offering equivalent access to copy the source code from the same place satisfies the requirement to distribute the source code, even though third parties are not compelled to copy the source along with the object code.

However, linking a "work that uses the Library" with the Library creates an executable that is a derivative of the Library (because it contains portions of the Library), rather than a "work that uses the library". The executable is therefore covered by this License. Section 6 states terms for distribution of such executables.

When a "work that uses the Library" uses material from a header file that is part of the Library, the object code for the work may be a derivative work of the Library even though the source code is not. Whether this is true is especially significant if the work can be linked without the Library, or if the work is itself a library. The threshold for this to be true is not precisely defined by law.

If such an object file uses only numerical parameters, data structure layouts and accessors, and small macros and small inline functions (ten lines or less in length), then the use of the object file is unrestricted, regardless of whether it is legally a derivative work. (Executables containing this object code plus portions of the Library will still fall under Section 6.)

Otherwise, if the work is a derivative of the Library, you may distribute the object code for the work under the terms of Section 6. Any executables containing that work also fall under Section 6, whether or not they are linked directly with the Library itself.

You must give prominent notice with each copy of the work that the Library is used in it and that the Library and its use are covered by this License. You must supply a copy of this License. If the work during execution displays copyright notices, you must include the copyright notice for the Library among them, as well as a reference directing the user to the copy of this License. Also, you must do one of these things:

?a) Accompany the work with the complete corresponding machine-readable source code for the Library including whatever changes were used in the work (which must be distributed under Sections 1 and 2 above); and, if the work is an executable linked with the Library, with the complete machine-readable "work that uses the Library", as object code and/or source code, so that the user can modify the Library and then relink to produce a modified executable containing the modified Library. (It is understood that the user who changes the contents of definitions files in the Library will not necessarily be able to recompile the application to use the modified definitions.)

?b) Use a suitable shared library mechanism for linking with the Library. A suitable mechanism is one that (1) uses at run time a copy of the library already present on the user's computer system, rather than copying library functions into the executable, and (2) will operate properly with a modified version of the library, if the user installs one, as long as the modified version is interface-compatible with the version that the work was made with.

?c) Accompany the work with a written offer, valid for at least three years, to give the same user the materials specified in Subsection 6a, above, for a charge no more than the cost of performing this distribution.

?d) If distribution of the work is made by offering access to copy from a designated place, offer equivalent access to copy the above specified materials from the same place.

?e) Verify that the user has already received a copy of these materials or that you have already sent this user a copy.

For an executable, the required form of the "work that uses the Library" must include any data and utility programs needed for reproducing the executable from it. However, as a special exception, the materials to be distributed need not include anything that is normally distributed (in either source or binary form) with the major components (compiler, kernel, and so on) of the operating system on which the executable runs, unless that component itself accompanies the executable.

It may happen that this requirement contradicts the license restrictions of other proprietary libraries that do not normally accompany the operating system. Such a contradiction means you cannot use both

them and the Library together in an executable that you distribute.

?a) Accompany the combined library with a copy of the same work based on the Library, uncombined with any other library facilities. This must be distributed under the terms of the Sections above.

?b) Give prominent notice with the combined library of the fact that part of it is a work based on the Library, and explaining where to find the accompanying uncombined form of the same work.

If any portion of this section is held invalid or unenforceable under any particular circumstance, the balance of the section is intended to apply, and the section as a whole is intended to apply in other circumstances.

It is not the purpose of this section to induce you to infringe any patents or other property right claims or to contest validity of any such claims; this section has the sole purpose of protecting the integrity of the free software distribution system which is implemented by public license practices. Many people have made generous contributions to the wide range of software distributed through that system in reliance on consistent application of that system; it is up to the author/donor to decide if he or she is willing to distribute software through any other system and a licensee cannot impose that choice.

This section is intended to make thoroughly clear what is believed to be a consequence of the rest of this License.

Each version is given a distinguishing version number. If the Library specifies a version number of this License which applies to it and "any later version", you have the option of following the terms and conditions either of that version or of any later version published by the Free Software Foundation. If the Library does not specify a license version number, you may choose any version ever published by the Free Software Foundation.

#### NO WARRANTY

#### BSD LICENSE

Redistribution and use in source and binary forms, with or without modification, are permitted provided that the following conditions are met:

THIS SOFTWARE IS PROVIDED BY THE REGENTS AND CONTRIBUTORS "AS IS" AND ANY EXPRESS OR IMPLIED WARRANTIES, INCLUDING, BUT NOT LIMITED TO, THE IMPLIED WARRANTIES OF MERCHANTABILITY AND FITNESS FOR A PARTICULAR PURPOSE ARE DISCLAIMED. IN NO EVENT SHALL THE REGENTS OR CONTRIBUTORS BE

LIABLE FOR ANY DIRECT, INDIRECT, INCIDENTAL, SPECIAL, EXEMPLARY, OR CONSEQUENTIAL DAMAGES (INCLUDING, BUT NOT LIMITED TO, PROCUREMENT OF SUBSTITUTE GOODS OR SERVICES; LOSS OF USE, DATA, OR PROFITS; OR BUSINESS INTERRUPTION) HOWEVER CAUSED AND ON ANY THEORY OF LIABILITY, WHETHER IN CONTRACT, STRICT LIABILITY, OR TORT (INCLUDING NEGLIGENCE OR OTHERWISE) ARISING IN ANY WAY OUT OF THE USE OF THIS SOFTWARE, EVEN IF ADVISED OF THE POSSIBILITY OF SUCH DAMAGE.

#### MIT LICENSE

Permission is hereby granted, free of charge, to any person obtaining

a copy of this software and associated documentation files (the

"Software"), to deal in the Software without restriction, including

without limitation the rights to use, copy, modify, merge, publish,

distribute, sublicense, and/or sell copies of the Software, and to

permit persons to whom the Software is furnished to do so, subject to

the following conditions:

The above copyright notice and this permission notice shall be included

in all copies or substantial portions of the Software.

THE SOFTWARE IS PROVIDED "AS IS", WITHOUT WARRANTY OF ANY KIND,

EXPRESS OR IMPLIED, INCLUDING BUT NOT LIMITED TO THE WARRANTIES OF

MERCHANTABILITY, FITNESS FOR A PARTICULAR PURPOSE AND NONINFRINGEMENT.

IN NO EVENT SHALL THE AUTHORS OR COPYRIGHT HOLDERS BE LIABLE FOR ANY

CLAIM, DAMAGES OR OTHER LIABILITY, WHETHER IN AN ACTION OF CONTRACT,

TORT OR OTHERWISE, ARISING FROM, OUT OF OR IN CONNECTION WITH THE

SOFTWARE OR THE USE OR OTHER DEALINGS IN THE SOFTWARE.

-----  
License  
January 2004

Apache  
Version 2.0,

<http://www.apache.org/licenses/>

## TERMS AND CONDITIONS FOR USE, REPRODUCTION, AND DISTRIBUTION

### 1. Definitions.

"License" shall mean the terms and conditions for use, reproduction,

and distribution as defined by Sections 1 through 9 of this document.

"Licensor" shall mean the copyright owner or entity authorized by

the copyright owner that is granting the License.

"Legal Entity" shall mean the union of the acting entity and all

other entities that control, are controlled by, or are under common

control with that entity. For the purposes of this definition,

"control" means (i) the power, direct or indirect, to cause the

direction or management of such entity, whether by contract or

otherwise, or (ii) ownership of fifty percent (50%) or more of the

outstanding shares, or (iii) beneficial ownership of such entity.

"You" (or "Your") shall mean an individual or Legal Entity

exercising permissions granted by this License.

"Source" form shall mean the preferred form for making modifications,

including but not limited to software source code, documentation

source, and configuration files.

"Object" form shall mean any form resulting from mechanical

transformation or translation of a Source form, including but

not limited to compiled object code, generated documentation,

and conversions to other media types.

"Work" shall mean the work of authorship, whether in Source or

Object form, made available under the License, as indicated by a

copyright notice that is included in or attached to the work

(an example is provided in the Appendix below).

"Derivative Works" shall mean any work, whether in Source or Object

form, that is based on (or derived from) the Work and for which the

editorial revisions, annotations, elaborations, or other modifications

represent, as a whole, an original work of authorship. For the purposes

of this License, Derivative Works shall not include works that remain

separable from, or merely link (or bind by name) to the interfaces of,

the Work and Derivative Works thereof.

"Contribution" shall mean any work of authorship, including

the original version of the Work and any modifications or additions

to that Work or Derivative Works thereof, that is intentionally

submitted to Licensor for inclusion in the Work by the copyright owner

or by an individual or Legal Entity authorized to submit on behalf of

the copyright owner. For the purposes of this definition, "submitted"

means any form of electronic, verbal, or written communication sent

to the Licensor or its representatives, including but not limited to

communication on electronic mailing lists, source code control systems, and issue tracking systems that are managed by, or on behalf of, the

Licensors for the purpose of discussing and improving the Work, but

excluding communication that is conspicuously marked or otherwise

designated in writing by the copyright owner as "Not a Contribution."

"Contributor" shall mean Licensor and any individual or Legal Entity

on behalf of whom a Contribution has been received by Licensor and

subsequently incorporated within the Work.

2. Grant of Copyright License. Subject to the terms and conditions of

this License, each Contributor hereby grants to You a perpetual,

worldwide, non-exclusive, no-charge, royalty-free, irrevocable

copyright license to reproduce, prepare Derivative Works of,

publicly display, publicly perform, sublicense, and distribute the

Work and such Derivative Works in Source or Object form.

3. Grant of Patent License. Subject to the terms and conditions of

this License, each Contributor hereby grants to You a perpetual,

worldwide, non-exclusive, no-charge, royalty-free, irrevocable

(except as stated in this section) patent license to make, have made,

use, offer to sell, sell, import, and otherwise transfer the Work,

where such license applies only to those patent claims licensable

by such Contributor that are necessarily infringed by their

Contribution(s) alone or by combination of their Contribution(s)

with the Work to which such Contribution(s) was submitted. If You

institute patent litigation against any entity (including a

cross-claim or counterclaim in a lawsuit) alleging that the Work

or a Contribution incorporated within the Work constitutes direct

or contributory patent infringement, then any patent licenses

granted to You under this License for that Work shall terminate

as of the date such litigation is filed.

4. Redistribution. You may reproduce and distribute copies of the

Work or Derivative Works thereof in any medium, with or without

modifications, and in Source or Object form, provided that You

meet the following conditions:

(a) You must give any other recipients of the Work or

Derivative Works a copy of this License; and

(b) You must cause any modified files to carry prominent notices

stating that You changed the files; and

(c) You must retain, in the Source form of any Derivative Works

that You distribute, all copyright, patent, trademark, and

attribution notices from the Source form of the Work,

excluding those notices that do not pertain to any part of

the Derivative Works; and

(d) If the Work includes a "NOTICE" text file as part of its

distribution, then any Derivative Works that You distribute must

include a readable copy of the attribution notices contained

within such NOTICE file, excluding those notices that do not

pertain to any part of the Derivative Works, in at least one

of the following places: within a NOTICE text file distributed

as part of the Derivative Works; within the Source form or

documentation, if provided along with the Derivative Works; or,

within a display generated by the Derivative Works, if and

wherever such third-party notices normally appear. The contents

of the NOTICE file are for informational purposes only and

do not modify the License. You may add Your own attribution

notices within Derivative Works that You distribute, alongside

or as an addendum to the NOTICE text from the Work, provided

that such additional attribution notices cannot be construed

as modifying the License.

You may add Your own copyright statement to Your modifications and

may provide additional or different license terms and conditions

for use, reproduction, or distribution of Your modifications, or

for any such Derivative Works as a whole, provided Your use,

reproduction, and distribution of the Work otherwise complies with

the conditions stated in this License.

5. Submission of Contributions. Unless You explicitly state otherwise,

any Contribution intentionally submitted for inclusion in the Work

by You to the Licensor shall be under the terms and conditions of

this License, without any additional terms or conditions.

Notwithstanding the above, nothing herein shall supersede or modify

the terms of any separate license agreement you may have executed

with Licensor regarding such Contributions.

6. Trademarks. This License does not grant permission to use the trade

names, trademarks, service marks, or product names of the Licensor,

except as required for reasonable and customary use in describing the

origin of the Work and reproducing the content of the NOTICE file.

7. Disclaimer of Warranty. Unless required by applicable law or

agreed to in writing, Licensor provides the Work (and each

Contributor provides its Contributions) on an "AS IS" BASIS,

WITHOUT WARRANTIES OR CONDITIONS OF ANY KIND, either express or

implied, including, without limitation, any warranties or conditions

of TITLE, NON-INFRINGEMENT, MERCHANTABILITY, or FITNESS FOR A

PARTICULAR PURPOSE. You are solely responsible for determining the

appropriateness of using or redistributing the Work and assume any

risks associated with Your exercise of permissions under this License.

8. Limitation of Liability. In no event and under no legal theory,

whether in tort (including negligence), contract, or otherwise,

unless required by applicable law (such as deliberate and grossly

negligent acts) or agreed to in writing, shall any Contributor be

liable to You for damages, including any direct, indirect, special,

incidental, or consequential damages of any character arising as a

result of this License or out of the use or inability to use the

Work (including but not limited to damages for loss of goodwill,

work stoppage, computer failure or malfunction, or any and all



other commercial damages or losses), even if such Contributor

has been advised of the possibility of such damages.

9. Accepting Warranty or Additional Liability. While redistributing

the Work or Derivative Works thereof, You may choose to offer,

and charge a fee for, acceptance of support, warranty, indemnity,

or other liability obligations and/or rights consistent with this

License. However, in accepting such obligations, You may act only

on Your own behalf and on Your sole responsibility, not on behalf

of any other Contributor, and only if You agree to indemnify,

defend, and hold each Contributor harmless for any liability

incurred by, or claims asserted against, such Contributor by reason

of your accepting any such warranty or additional liability.

END OF TERMS AND CONDITIONS

APPENDIX: How to apply the Apache License to your work.

To apply the Apache License to your work, attach the following

boilerplate notice, with the fields enclosed by brackets "[ ]"

replaced with your own identifying information. (Don't include

the brackets!) The text should be enclosed in the appropriate

comment syntax for the file format. We also recommend that a

file or class name and description of purpose be included on the

same "printed page" as the copyright notice for easier

identification within third-party archives.

Copyright [yyyy] [name of copyright owner]

Licensed under the Apache License, Version 2.0 (the "License");

you may not use this file except in compliance with the License.

You may obtain a copy of the License at

<http://www.apache.org/licenses/LICENSE-2.0>

Unless required by applicable law or agreed to in writing, software

distributed under the License is distributed on an "AS IS" BASIS,

WITHOUT WARRANTIES OR CONDITIONS OF ANY KIND, either express or implied.

See the License for the specific language governing permissions and

limitations under the License.

-----  
This copy of the libpng notices is provided for your convenience. In case of

any discrepancy between this copy and the notices in the file png.h that is

included in the libpng distribution, the latter shall prevail.

COPYRIGHT NOTICE, DISCLAIMER, and LICENSE:

If you modify libpng you may insert additional notices immediately following

this sentence.

This code is released under the libpng license.

libpng versions 1.2.6, August 15, 2004, through 1.4.1, February 25, 2010, are

Copyright (c) 2004, 2006-2007 Glenn Randers-Pehrson, and are

distributed according to the same disclaimer and license as libpng-1.2.5

with the following individual added to the list of

## Contributing Authors

Cosmin Truta

libpng versions 1.0.7, July 1, 2000, through 1.2.5 - October 3, 2002, are

Copyright (c) 2000-2002 Glenn Randers-Pehrson, and are

distributed according to the same disclaimer and license as libpng-1.0.6

with the following individuals added to the list of Contributing Authors

Simon-Pierre Cadieux

Eric S. Raymond

Gilles Vollant

and with the following additions to the disclaimer:

There is no warranty against interference with your enjoyment of the

library or against infringement. There is no warranty that our

efforts or the library will fulfill any of your particular purposes

or needs. This library is provided with all faults, and the entire

risk of satisfactory quality, performance, accuracy, and effort is with

the user.

libpng versions 0.97, January 1998, through 1.0.6, March 20, 2000, are

Copyright (c) 1998, 1999 Glenn Randers-Pehrson, and are

distributed according to the same disclaimer and license as libpng-0.96,

with the following individuals added to the list of Contributing Authors:

Tom Lane

Glenn Randers-Pehrson

Willem van Schaik

libpng versions 0.89, June 1996, through 0.96, May 1997, are

Copyright (c) 1996, 1997 Andreas Dilger

Distributed according to the same disclaimer and license as libpng-0.88,

with the following individuals added to the list of Contributing Authors:

John Bowler

Kevin Bracey

Sam Bushell

Magnus Holmgren

Greg Roelofs

Tom Tanner

libpng versions 0.5, May 1995, through 0.88, January 1996, are

Copyright (c) 1995, 1996 Guy Eric Schalnat, Group 42, Inc.

For the purposes of this copyright and license, "Contributing Authors"

is defined as the following set of individuals:

Andreas Dilger

Dave Martindale

Guy Eric Schalnat

Paul Schmidt

Tim Wegner

The PNG Reference Library is supplied "AS IS". The Contributing Authors

and Group 42, Inc. disclaim all warranties, expressed or implied,

including, without limitation, the warranties of merchantability and of

fitness for any purpose. The Contributing Authors and Group 42, Inc.

assume no liability for direct, indirect, incidental, special, exemplary,

or consequential damages, which may result from the use of the PNG

Reference Library, even if advised of the possibility of such damage.

Permission is hereby granted to use, copy, modify, and distribute this

source code, or portions hereof, for any purpose,  
without fee, subject

to the following restrictions:

be misrepresented as being the original source.

source or altered source distribution.

The Contributing Authors and Group 42, Inc.  
specifically permit, without

fee, and encourage the use of this source code as a  
component to

supporting the PNG file format in commercial  
products. If you use this

source code in a product, acknowledgment is not  
required but would be

A "png\_get\_copyright" function is available, for  
convenient use in "about"

boxes and the like:

```
printf("%s",png_get_copyright(NULL));
```

Also, the PNG logo (in PNG format, of course) is  
supplied in the

files "pngbar.png.jpg" and "pngbar.jpg (88x31) and  
"pngnow.png.jpg" (98x31).

Libpng is OSI Certified Open Source Software. OSI  
Certified Open Source is a

certification mark of the Open Source Initiative.

Glenn Randers-Pehrson

glennrp at users.sourceforge.net

February 25, 2010

-----  
This software is based in part on the work of the  
FreeType Team.  
-----

The FreeType Project  
LICENSE

-----  
2006-Jan-27

Copyright 1996-2002,  
2006 by

David Turner, Robert Wilhelm, and  
Werner Lemberg

Introduction  
=====

The FreeType Project is distributed in several  
archive packages;

some of them may contain, in addition to the  
FreeType font engine,

various tools and contributions which rely on, or  
relate to, the

FreeType Project.

This license applies to all files found in such  
packages, and

which do not fall under their own explicit  
license. The license

affects thus the FreeType font engine,  
the test programs,

documentation and makefiles, at the very least.

This license was inspired by the BSD,  
Artistic, and IJG

(Independent JPEG Group) licenses, which all  
encourage inclusion

and use of free software in commercial and  
freeware products

alike. As a consequence, its main points are that:

o We don't promise that this software works.  
However, we will be

interested in any kind of bug reports. ('as is'  
distribution)

o You can use this software for whatever you want, in parts or full form, without having to pay us. ('royalty-free' usage)

o You may not pretend that you wrote this software. If you use it, or only parts of it, in a program, you must acknowledge somewhere in your documentation that you have used the FreeType code. ('credits')

We specifically permit and encourage the inclusion of this software, with or without modifications, in commercial products. We disclaim all warranties covering The FreeType Project and assume no liability related to The FreeType Project.

Finally, many people asked us for a preferred form for a credit/disclaimer to use in compliance with this license. We thus encourage you to use the following text:

""

Portions of this software are copyright ?<year> The FreeType Project (www.freetype.org). All rights reserved.

""

Please replace <year> with the value from the FreeType version you actually use.

## Legal Terms

=====

-----

Throughout this license, the terms 'package', 'FreeType Project',

and 'FreeType archive' refer to the set of files originally

distributed by the authors (David Turner, Robert Wilhelm, and

Werner Lemberg) as the 'FreeType Project', be they named as alpha,

beta or final release.

'You' refers to the licensee, or person using the project, where

'using' is a generic term including compiling the project's source

code as well as linking it to form a 'program' or 'executable'.

This program is referred to as 'a program using the FreeType engine'.

This license applies to all files distributed in the original

FreeType Project, including all source code, binaries and

documentation, unless otherwise stated in the file in its

original, unmodified form as distributed in the original archive.

If you are unsure whether or not a particular file is covered by

this license, you must contact us to verify this.

The FreeType Project is copyright (C) 1996-2000 by David Turner,

Robert Wilhelm, and Werner Lemberg. All rights reserved except as

specified below.

-----

THE FREETYPE PROJECT IS PROVIDED 'AS IS' WITHOUT WARRANTY OF ANY

KIND, EITHER EXPRESS OR IMPLIED, INCLUDING, BUT NOT LIMITED TO,

WARRANTIES OF MERCHANTABILITY AND FITNESS FOR A PARTICULAR

PURPOSE. IN NO EVENT WILL ANY OF THE

AUTHORS OR COPYRIGHT HOLDERS

BE LIABLE FOR ANY DAMAGES CAUSED BY THE  
USE OR THE INABILITY TO  
USE, OF THE FREETYPE PROJECT.

-----

This license grants a worldwide, royalty-free, perpetual and irrevocable right and license to use, execute, perform, compile, display, copy, create derivative works of, distribute and sublicense the FreeType Project (in both source and object code forms) and derivative works thereof for any purpose; and to authorize others to exercise some or all of the rights granted herein, subject to the following conditions:

- o Redistribution of source code must retain this license file ('FTL.TXT') unaltered; any additions, deletions or changes to the original files must be clearly indicated in accompanying documentation. The copyright notices of the unaltered, original files must be preserved in all copies of source files.

- o Redistribution in binary form must provide a disclaimer that states that the software is based in part of the work of the FreeType Team, in the distribution documentation. We also encourage you to put an URL to the FreeType web page in your documentation, though this isn't mandatory.

These conditions apply to any software derived from or based on the FreeType Project, not just the unmodified files. If you use

our work, you must acknowledge us. However, no fee need be paid to us.

-----

Neither the FreeType authors and contributors nor you shall use the name of the other for commercial, advertising, or promotional purposes without specific prior written permission.

We suggest, but do not require, that you use one or more of the following phrases to refer to this software in your documentation or advertising materials: 'FreeType Project', 'FreeType Engine', 'FreeType library', or 'FreeType Distribution'.

As you have not signed this license, you are not required to accept it. However, as the FreeType Project is copyrighted material, only this license, or another one contracted with the authors, grants you the right to use, distribute, and modify it. Therefore, by using, distributing, or modifying the FreeType Project, you indicate that you understand and accept all the terms of this license.

-----

There are two mailing lists related to FreeType:

- o [freetype@nongnu.org](mailto:freetype@nongnu.org)

Discusses general use and applications of FreeType, as well as

future and wanted additions to the library and distribution.

If you are looking for support, start in this list if you

haven't found anything to help you in the documentation.

o freetype-devel@nongnu.org

Discusses bugs, as well as engine internals, design issues, specific licenses, porting, etc.

Our home page can be found at

<http://www.freetype.org>

--- end of FTL.TXT ---

-----  
LICENSE ISSUES  
=====

The OpenSSL toolkit stays under a dual license, i.e. both the conditions of

the OpenSSL License and the original SSLeay license apply to the toolkit.

See below for the actual license texts. Actually both licenses are BSD-style

Open Source licenses. In case of any license issues related to OpenSSL

please contact [openssl-core@openssl.org](mailto:openssl-core@openssl.org).

OpenSSL License  
-----

/\*

=====

\* Copyright (c) 1998-2011 The OpenSSL Project. All rights reserved.

\*

\* Redistribution and use in source and binary forms, with or without

\* modification, are permitted provided that the following conditions

\* are met:

\*

\* 1. Redistributions of source code must retain the above copyright

\* notice, this list of conditions and the following disclaimer.

\*

\* 2. Redistributions in binary form must reproduce the above copyright

\* notice, this list of conditions and the following disclaimer in

\* the documentation and/or other materials provided with the

\* distribution.

\*

\* 3. All advertising materials mentioning features or use of this

\* software must display the following acknowledgment:

\* "This product includes software developed by the OpenSSL Project

\* for use in the OpenSSL Toolkit.  
(<http://www.openssl.org/>)"

\*

\* 4. The names "OpenSSL Toolkit" and "OpenSSL Project" must not be used to

\* endorse or promote products derived from this software without

\* prior written permission. For written permission, please contact

\* [openssl-core@openssl.org](mailto:openssl-core@openssl.org).

\*

\* 5. Products derived from this software may not be called "OpenSSL"

\* nor may "OpenSSL" appear in their names without prior written

\* permission of the OpenSSL Project.

\*

\* 6. Redistributions of any form whatsoever must retain the following

\* acknowledgment:

\* "This product includes software developed by the OpenSSL Project

\* for use in the OpenSSL Toolkit  
(<http://www.openssl.org/>)"

\*

\* THIS SOFTWARE IS PROVIDED BY THE OpenSSL

PROJECT "AS IS" AND ANY

- \* EXPRESSED OR IMPLIED WARRANTIES, INCLUDING, BUT NOT LIMITED TO, THE
- \* IMPLIED WARRANTIES OF MERCHANTABILITY AND FITNESS FOR A PARTICULAR
- \* PURPOSE ARE DISCLAIMED. IN NO EVENT SHALL THE OpenSSL PROJECT OR
- \* ITS CONTRIBUTORS BE LIABLE FOR ANY DIRECT, INDIRECT, INCIDENTAL,
- \* SPECIAL, EXEMPLARY, OR CONSEQUENTIAL DAMAGES (INCLUDING, BUT
- \* NOT LIMITED TO, PROCUREMENT OF SUBSTITUTE GOODS OR SERVICES;
- \* LOSS OF USE, DATA, OR PROFITS; OR BUSINESS INTERRUPTION)
- \* HOWEVER CAUSED AND ON ANY THEORY OF LIABILITY, WHETHER IN CONTRACT,
- \* STRICT LIABILITY, OR TORT (INCLUDING NEGLIGENCE OR OTHERWISE)
- \* ARISING IN ANY WAY OUT OF THE USE OF THIS SOFTWARE, EVEN IF ADVISED
- \* OF THE POSSIBILITY OF SUCH DAMAGE.

=====  
\*

- \* This product includes cryptographic software written by Eric Young
- \* (eay@cryptsoft.com). This product includes software written by Tim
- \* Hudson (tjh@cryptsoft.com).

\*/

Original SSLeay License

-----

/\* Copyright (C) 1995-1998 Eric Young  
(eay@cryptsoft.com)

- \* All rights reserved.
- \* This package is an SSL implementation written
- \* by Eric Young (eay@cryptsoft.com).
- \* The implementation was written so as to conform with Netscapes SSL.
- \* This library is free for commercial and non-

commercial use as long as

- \* the following conditions are adhered to. The following conditions
- \* apply to all code found in this distribution, be it the RC4, RSA,
- \* lhash, DES, etc., code; not just the SSL code. The SSL documentation
- \* included with this distribution is covered by the same copyright terms
- \* except that the holder is Tim Hudson (tjh@cryptsoft.com).
- \* Copyright remains Eric Young's, and as such any Copyright notices in
- \* the code are not to be removed.
- \* If this package is used in a product, Eric Young should be given attribution
- \* as the author of the parts of the library used.
- \* This can be in the form of a textual message at program startup or
- \* in documentation (online or textual) provided with the package.
- \* Redistribution and use in source and binary forms, with or without
- \* modification, are permitted provided that the following conditions
- \* are met:
- \* 1. Redistributions of source code must retain the copyright
- \* notice, this list of conditions and the following disclaimer.
- \* 2. Redistributions in binary form must reproduce the above copyright
- \* notice, this list of conditions and the following disclaimer in the
- \* documentation and/or other materials provided with the distribution.
- \* 3. All advertising materials mentioning features or use of this software
- \* must display the following acknowledgement:
- \* "This product includes cryptographic software written by
- \* Eric Young (eay@cryptsoft.com)"
- \* The word 'cryptographic' can be left out if the routines from the library
- \* being used are not cryptographic related :-).

\* 4. If you include any Windows specific code (or a derivative thereof) from

- \* the apps directory (application code) you must include an acknowledgement:
- \* "This product includes software written by Tim Hudson (tjh@cryptsoft.com)"
- \*
- \* THIS SOFTWARE IS PROVIDED BY ERIC YOUNG ``AS IS'' AND
- \* ANY EXPRESS OR IMPLIED WARRANTIES, INCLUDING, BUT NOT LIMITED TO, THE
- \* IMPLIED WARRANTIES OF MERCHANTABILITY AND FITNESS FOR A PARTICULAR PURPOSE
- \* ARE DISCLAIMED. IN NO EVENT SHALL THE AUTHOR OR CONTRIBUTORS BE LIABLE
- \* FOR ANY DIRECT, INDIRECT, INCIDENTAL, SPECIAL, EXEMPLARY, OR CONSEQUENTIAL
- \* DAMAGES (INCLUDING, BUT NOT LIMITED TO, PROCUREMENT OF SUBSTITUTE GOODS
- \* OR SERVICES; LOSS OF USE, DATA, OR PROFITS; OR BUSINESS INTERRUPTION)
- \* HOWEVER CAUSED AND ON ANY THEORY OF LIABILITY, WHETHER IN CONTRACT, STRICT
- \* LIABILITY, OR TORT (INCLUDING NEGLIGENCE OR OTHERWISE) ARISING IN ANY WAY
- \* OUT OF THE USE OF THIS SOFTWARE, EVEN IF ADVISED OF THE POSSIBILITY OF
- \* SUCH DAMAGE.
- \*
- \* The licence and distribution terms for any publically available version or
- \* derivative of this code cannot be changed. i.e. this code cannot simply be
- \* copied and put under another distribution licence
- \* [including the GNU Public Licence.]
- \*/

-----  
 MOZILLA PUBLIC  
 LICENSE  
 Version 1.1  
 -----

1.0.1. "Commercial Use" means distribution or otherwise making the Covered Code available to a third party.

1.1. "Contributor" means each entity that creates or contributes to the creation of Modifications.

1.2. "Contributor Version" means the combination of the Original Code, prior Modifications used by a Contributor, and the Modifications made by that particular Contributor.

1.3. "Covered Code" means the Original Code or Modifications or the combination of the Original Code and Modifications, in each case including portions thereof.

1.4. "Electronic Distribution Mechanism" means a mechanism generally accepted in the software development community for the electronic transfer of data.

1.5. "Executable" means Covered Code in any form other than Source Code.

1.6. "Initial Developer" means the individual or entity identified as the Initial Developer in the Source Code notice required by Exhibit A.

1.7. "Larger Work" means a work which combines Covered Code or portions thereof with code not governed by the terms of this License.

1.8. "License" means this document.

1.8.1. "Licensable" means having the right to grant, to the maximum



extent possible, whether at the time of the initial grant or

subsequently acquired, any and all of the rights conveyed herein.

1.9. "Modifications" means any addition to or deletion from the

substance or structure of either the Original Code or any previous

Modifications. When Covered Code is released as a series of files, a

Modification is:

A. Any addition to or deletion from the contents of a file

containing Original Code or previous Modifications.

B. Any new file that contains any part of the Original Code or

previous Modifications.

1.10. "Original Code" means Source Code of computer software code

which is described in the Source Code notice required by Exhibit A as

Original Code, and which, at the time of its release under this

License is not already Covered Code governed by this License.

1.10.1. "Patent Claims" means any patent claim(s), now owned or

hereafter acquired, including without limitation, method, process,

and apparatus claims, in any patent Licensable by grantor.

1.11. "Source Code" means the preferred form of the Covered Code for

making modifications to it, including all modules it contains, plus

any associated interface definition files, scripts used to control

compilation and installation of an Executable, or source code

differential comparisons against either the Original Code or another

well known, available Covered Code of the

Contributor's choice. The

Source Code can be in a compressed or archival form, provided the

appropriate decompression or de-archiving software is widely available

for no charge.

1.12. "You" (or "Your") means an individual or a legal entity

exercising rights under, and complying with all of the terms of, this

License or a future version of this License issued under Section 6.1.

For legal entities, "You" includes any entity which controls, is

controlled by, or is under common control with You. For purposes of

this definition, "control" means (a) the power, direct or indirect,

to cause the direction or management of such entity, whether by

contract or otherwise, or (b) ownership of more than fifty percent

(50%) of the outstanding shares or beneficial ownership of such

entity.

## 2.1. The Initial Developer Grant.

The Initial Developer hereby grants You a world-wide, royalty-free,

non-exclusive license, subject to third party intellectual property

claims:

(a) under intellectual property rights (other than patent or

trademark) Licensable by Initial Developer to use, reproduce,

modify, display, perform, sublicense and distribute the Original

Code (or portions thereof) with or without Modifications, and/or

as part of a Larger Work; and

(b) under Patents Claims infringed by the making, using or

selling of Original Code, to make, have

made, use, practice,  
sell, and offer for sale, and/or otherwise  
dispose of the  
Original Code (or portions thereof).

(c) the licenses granted in this Section  
2.1(a) and (b) are

effective on the date Initial Developer  
first distributes

Original Code under the terms of this  
License.

(d) Notwithstanding Section 2.1(b) above,  
no patent license is

granted: 1) for code that You delete from  
the Original Code; 2)

separate from the Original Code; or 3)  
for infringements caused

by: i) the modification of the Original  
Code or ii) the

combination of the Original Code with  
other software or devices.

## 2.2. Contributor Grant.

Subject to third party intellectual property  
claims, each Contributor

hereby grants You a world-wide, royalty-free,  
non-exclusive license

(a) under intellectual property rights  
(other than patent or

trademark) Licensable by Contributor, to  
use, reproduce, modify,

display, perform, sublicense and  
distribute the Modifications

created by such Contributor (or portions  
thereof) either on an

unmodified basis, with other  
Modifications, as Covered Code

and/or as part of a Larger Work; and

(b) under Patent Claims infringed by the  
making, using, or

selling of Modifications made by that  
Contributor either alone

and/or in combination with its  
Contributor Version (or portions

of such combination), to make, use, sell,  
offer for sale, have

made, and/or otherwise dispose of: 1)  
Modifications made by that

Contributor (or portions thereof); and 2)  
the combination of

Modifications made by that Contributor  
with its Contributor

Version (or portions of such  
combination).

(c) the licenses granted in Sections 2.2(a)  
and 2.2(b) are

effective on the date Contributor first  
makes Commercial Use of

the Covered Code.

(d) Notwithstanding Section 2.2(b)  
above, no patent license is

granted: 1) for any code that Contributor  
has deleted from the

Contributor Version; 2) separate from  
the Contributor Version;

3) for infringements caused by: i) third  
party modifications of

Contributor Version or ii) the  
combination of Modifications made

by that Contributor with other software  
(except as part of the

Contributor Version) or other devices; or  
4) under Patent Claims

infringed by Covered Code in the  
absence of Modifications made by

that Contributor.

## 3.1. Application of License.

The Modifications which You create or to which  
You contribute are

governed by the terms of this License, including  
without limitation

Section 2.2. The Source Code version of  
Covered Code may be

distributed only under the terms of this License  
or a future version

of this License released under Section 6.1, and  
You must include a

copy of this License with every copy of the

Source Code You

distribute. You may not offer or impose any terms on any Source Code

version that alters or restricts the applicable version of this

License or the recipients' rights hereunder. However, You may include

an additional document offering the additional rights described in

Section 3.5.

### 3.2. Availability of Source Code.

Any Modification which You create or to which You contribute must be

made available in Source Code form under the terms of this License

either on the same media as an Executable version or via an accepted

Electronic Distribution Mechanism to anyone to whom you made an

Executable version available; and if made available via Electronic

Distribution Mechanism, must remain available for at least twelve (12)

months after the date it initially became available, or at least six

(6) months after a subsequent version of that particular Modification

has been made available to such recipients. You are responsible for

ensuring that the Source Code version remains available even if the

Electronic Distribution Mechanism is maintained by a third party.

### 3.3. Description of Modifications.

You must cause all Covered Code to which You contribute to contain a

file documenting the changes You made to create that Covered Code and

the date of any change. You must include a prominent statement that

the Modification is derived, directly or indirectly, from Original

Code provided by the Initial Developer and including the name of the

Initial Developer in (a) the Source Code, and (b) in any notice in an

Executable version or related documentation in which You describe the

origin or ownership of the Covered Code.

### 3.4. Intellectual Property Matters

#### (a) Third Party Claims.

If Contributor has knowledge that a license under a third party's

intellectual property rights is required to exercise the rights

granted by such Contributor under Sections 2.1 or 2.2,

Contributor must include a text file with the Source Code

distribution titled "LEGAL" which describes the claim and the

party making the claim in sufficient detail that a recipient will

know whom to contact. If Contributor obtains such knowledge after

the Modification is made available as described in Section 3.2,

Contributor shall promptly modify the LEGAL file in all copies

Contributor makes available thereafter and shall take other steps

(such as notifying appropriate mailing lists or newsgroups)

reasonably calculated to inform those who received the Covered

Code that new knowledge has been obtained.

#### (b) Contributor APIs.

If Contributor's Modifications include an application programming

interface and Contributor has knowledge of patent licenses which

are reasonably necessary to implement that API, Contributor must

also include this information in the LEGAL file.

#### (c) Representations.

Contributor represents that, except as disclosed pursuant to

Section 3.4(a) above, Contributor believes that Contributor's

Modifications are Contributor's original creation(s) and/or

Contributor has sufficient rights to grant the rights conveyed by this License.

### 3.5. Required Notices.

You must duplicate the notice in Exhibit A in each file of the Source

Code. If it is not possible to put such notice in a particular Source

Code file due to its structure, then You must include such notice in a

location (such as a relevant directory) where a user would be likely

to look for such a notice. If You created one or more Modification(s)

You may add your name as a Contributor to the notice described in

Exhibit A. You must also duplicate this License in any documentation

for the Source Code where You describe recipients' rights or ownership

rights relating to Covered Code. You may choose to offer, and to

charge a fee for, warranty, support, indemnity or liability

obligations to one or more recipients of Covered Code. However, You

may do so only on Your own behalf, and not on behalf of the Initial

Developer or any Contributor. You must make it absolutely clear than

any such warranty, support, indemnity or liability obligation is

offered by You alone, and You hereby agree to indemnify the Initial

Developer and every Contributor for any liability incurred by the

Initial Developer or such Contributor as a result of warranty,

support, indemnity or liability terms You offer.

### 3.6. Distribution of Executable Versions.

You may distribute Covered Code in Executable form only if the

requirements of Section 3.1-3.5 have been met for that Covered Code,

and if You include a notice stating that the Source Code version of

the Covered Code is available under the terms of this License,

including a description of how and where You have fulfilled the

obligations of Section 3.2. The notice must be conspicuously included

in any notice in an Executable version, related documentation or

collateral in which You describe recipients' rights relating to the

Covered Code. You may distribute the Executable version of Covered

Code or ownership rights under a license of Your choice, which may

contain terms different from this License, provided that You are in

compliance with the terms of this License and that the license for the

Executable version does not attempt to limit or alter the recipient's

rights in the Source Code version from the rights set forth in this

License. If You distribute the Executable version under a different

license You must make it absolutely clear that any terms which differ

from this License are offered by You alone, not by the Initial

Developer or any Contributor. You hereby agree to indemnify the

Initial Developer and every Contributor for any liability incurred by

the Initial Developer or such Contributor as a result of any such

terms You offer.

### 3.7. Larger Works.

You may create a Larger Work by combining Covered Code with other code

not governed by the terms of this License and distribute the Larger

Work as a single product. In such a case, You must make sure the

requirements of this License are fulfilled for the Covered Code.

If it is impossible for You to comply with any of the terms of this

License with respect to some or all of the Covered Code due to statute, judicial order, or regulation then You must: (a) comply with the terms of this License to the maximum extent possible; and (b) describe the limitations and the code they affect. Such description must be included in the LEGAL file described in Section 3.4 and must be included with all distributions of the Source Code. Except to the extent prohibited by statute or regulation, such description must be sufficiently detailed for a recipient of ordinary skill to be able to understand it.

This License applies to code to which the Initial Developer has attached the notice in Exhibit A and to related Covered Code.

### 6.1. New Versions.

Netscape Communications Corporation ("Netscape") may publish revised and/or new versions of the License from time to time. Each version will be given a distinguishing version number.

### 6.2. Effect of New Versions.

Once Covered Code has been published under a particular version of the License, You may always continue to use it under the terms of that version. You may also choose to use such Covered Code under the terms of any subsequent version of the License published by Netscape. No one other than Netscape has the right to modify the terms applicable to Covered Code created under this License.

### 6.3. Derivative Works.

If You create or use a modified version of this License (which you may only do in order to apply it to code which is not already Covered Code governed by this License), You must (a) rename Your license so that the phrases "Mozilla", "MOZILLAPL", "MOZPL", "Netscape", "MPL", "NPL" or any confusingly similar phrase do not appear in your license (except to note that your license differs from this License) and (b) otherwise make it clear that Your version of the license contains terms which differ from the Mozilla Public License and Netscape Public License. (Filling in the name of the Initial Developer, Original Code or Contributor in the notice described in Exhibit A shall not of themselves be deemed to be modifications of this License.)

COVERED CODE IS PROVIDED UNDER THIS LICENSE ON AN "AS IS" BASIS,

WITHOUT WARRANTY OF ANY KIND, EITHER EXPRESSED OR IMPLIED, INCLUDING,

WITHOUT LIMITATION, WARRANTIES THAT THE COVERED CODE IS FREE OF

DEFECTS, MERCHANTABILITY, FIT FOR A PARTICULAR PURPOSE OR NON-INFRINGEMENT.

THE ENTIRE RISK AS TO THE QUALITY AND PERFORMANCE OF THE COVERED CODE

IS WITH YOU. SHOULD ANY COVERED CODE PROVE DEFECTIVE IN ANY RESPECT,

YOU (NOT THE INITIAL DEVELOPER OR ANY OTHER CONTRIBUTOR) ASSUME THE

COST OF ANY NECESSARY SERVICING, REPAIR OR CORRECTION. THIS DISCLAIMER

OF WARRANTY CONSTITUTES AN ESSENTIAL PART OF THIS LICENSE. NO USE OF

ANY COVERED CODE IS AUTHORIZED HEREUNDER EXCEPT UNDER THIS DISCLAIMER.

8.1. This License and the rights granted hereunder will terminate automatically if You fail to comply with terms herein and fail to cure such breach within 30 days of becoming aware of the breach. All sublicenses to the Covered Code which are properly granted shall survive any termination of this License. Provisions which, by their nature, must remain in effect beyond the termination of this License shall survive.

8.2. If You initiate litigation by asserting a patent infringement claim (excluding declaratory judgment actions) against Initial Developer or a Contributor (the Initial Developer or Contributor against whom You file such action is referred to as "Participant") alleging that:

(a) such Participant's Contributor Version directly or indirectly infringes any patent, then any and all rights granted by such Participant to You under Sections 2.1 and/or 2.2 of this License shall, upon 60 days notice from Participant terminate prospectively, unless if within 60 days after receipt of notice You either: (i) agree in writing to pay Participant a mutually agreeable reasonable royalty for Your past and future use of Modifications made by such Participant, or (ii) withdraw Your litigation claim with respect to the Contributor Version against such Participant. If within 60 days of notice, a reasonable royalty and payment arrangement are not mutually agreed upon in writing by the parties or the litigation claim is not withdrawn, the rights granted by Participant to You under

Sections 2.1 and/or 2.2 automatically terminate at the expiration of the 60 day notice period specified above.

(b) any software, hardware, or device, other than such Participant's Contributor Version, directly or indirectly infringes any patent, then any rights granted to You by such Participant under Sections 2.1(b) and 2.2(b) are revoked effective as of the date You first made, used, sold, distributed, or had made, Modifications made by that Participant.

8.3. If You assert a patent infringement claim against Participant alleging that such Participant's Contributor Version directly or indirectly infringes any patent where such claim is resolved (such as by license or settlement) prior to the initiation of patent infringement litigation, then the reasonable value of the licenses granted by such Participant under Sections 2.1 or 2.2 shall be taken into account in determining the amount or value of any payment or license.

8.4. In the event of termination under Sections 8.1 or 8.2 above, all end user license agreements (excluding distributors and resellers) which have been validly granted by You or any distributor hereunder prior to termination shall survive termination.

UNDER NO CIRCUMSTANCES AND UNDER NO LEGAL THEORY, WHETHER TORT (INCLUDING NEGLIGENCE), CONTRACT, OR OTHERWISE, SHALL YOU, THE INITIAL DEVELOPER, ANY OTHER CONTRIBUTOR, OR ANY DISTRIBUTOR OF COVERED CODE,

OR ANY SUPPLIER OF ANY OF SUCH PARTIES, BE LIABLE TO ANY PERSON FOR ANY INDIRECT, SPECIAL, INCIDENTAL, OR CONSEQUENTIAL DAMAGES OF ANY CHARACTER INCLUDING, WITHOUT LIMITATION, DAMAGES FOR LOSS OF GOODWILL, WORK STOPPAGE, COMPUTER FAILURE OR MALFUNCTION, OR ANY AND ALL OTHER COMMERCIAL DAMAGES OR LOSSES, EVEN IF SUCH PARTY SHALL HAVE BEEN INFORMED OF THE POSSIBILITY OF SUCH DAMAGES. THIS LIMITATION OF LIABILITY SHALL NOT APPLY TO LIABILITY FOR DEATH OR PERSONAL INJURY RESULTING FROM SUCH PARTY'S NEGLIGENCE TO THE EXTENT APPLICABLE LAW PROHIBITS SUCH LIMITATION. SOME JURISDICTIONS DO NOT ALLOW THE EXCLUSION OR LIMITATION OF INCIDENTAL OR CONSEQUENTIAL DAMAGES, SO THIS EXCLUSION AND LIMITATION MAY NOT APPLY TO YOU.

The Covered Code is a "commercial item," as that term is defined in 48 C.F.R. 2.101 (Oct. 1995), consisting of "commercial computer software" and "commercial computer software documentation," as such terms are used in 48 C.F.R. 12.212 (Sept. 1995). Consistent with 48 C.F.R. 12.212 and 48 C.F.R. 227.7202-1 through 227.7202-4 (June 1995), all U.S. Government End Users acquire Covered Code with only those rights set forth herein.

This License represents the complete agreement concerning subject matter hereof. If any provision of this License is held to be unenforceable, such provision shall be reformed only to the extent necessary to make it enforceable. This License shall be governed by California law provisions (except to the extent

applicable law, if any, provides otherwise), excluding its conflict-of-law provisions. With respect to disputes in which at least one party is a citizen of, or an entity chartered or registered to do business in the United States of America, any litigation relating to this License shall be subject to the jurisdiction of the Federal Courts of the Northern District of California, with venue lying in Santa Clara County, California, with the losing party responsible for costs, including without limitation, court costs and reasonable attorneys' fees and expenses. The application of the United Nations Convention on Contracts for the International Sale of Goods is expressly excluded.

Any law or regulation which provides that the language of a contract shall be construed against the drafter shall not apply to this License.

As between Initial Developer and the Contributors, each party is responsible for claims and damages arising, directly or indirectly, out of its utilization of rights under this License and You agree to work with Initial Developer and Contributors to distribute such responsibility on an equitable basis. Nothing herein is intended or shall be deemed to constitute any admission of liability.

Initial Developer may designate portions of the Covered Code as "Multiple-Licensed". "Multiple-Licensed" means that the Initial Developer permits you to utilize portions of the Covered Code under

Your choice of the NPL or the alternative licenses, if any, specified by the Initial Developer in the file described in Exhibit A.

EXHIBIT A -Mozilla Public License.

"The contents of this file are subject to the Mozilla Public License Version 1.1 (the "License"); you may not use this file except in compliance with the License. You may obtain a copy of the License at

<http://www.mozilla.org/MPL/>

Software distributed under the License is distributed on an "AS IS" basis, WITHOUT WARRANTY OF ANY KIND, either express or implied. See the License for the specific language governing rights and limitations under the License.

The Original Code is \_\_\_\_\_.

The Initial Developer of the Original Code is \_\_\_\_\_.

Portions created by \_\_\_\_\_ are Copyright (C) \_\_\_\_\_. All Rights Reserved.

Contributor(s): \_\_\_\_\_.

Alternatively, the contents of this file may be used under the terms

of the \_\_\_\_\_ license (the "[\_\_\_\_\_] License"), in which case the

provisions of [\_\_\_\_\_] License are applicable instead of those

above. If you wish to allow use of your version of this file only

under the terms of the [\_\_\_\_\_] License and not to allow others to use

your version of this file under the MPL, indicate your decision by

deleting the provisions above and replace them with the notice and

other provisions required by the [\_\_\_\_\_] License.

If you do not delete

the provisions above, a recipient may use your version of this file

under either the MPL or the [\_\_\_\_\_] License."

[NOTE: The text of this Exhibit A may differ slightly from the text of

the notices in the Source Code files of the Original Code. You should

use the text of this Exhibit A rather than the text found in the

Original Code Source Code for Your Modifications.]



# Specifications

19.1

## Environmental

### European Energy Label

The European Energy Label informs you on the energy efficiency class of this product. The greener the energy efficiency class of this product is, the lower the energy it consumes.

On the label, you can find the energy efficiency class, the average power consumption of this product in use and the average energy consumption for 1 year. You can also find the power consumption values for this product on the Philips website for your country at [www.philips.com/TV](http://www.philips.com/TV)

### Product Fiche

#### 49HFL7011

- Energy Efficiency Class : A
- Visible Screen Size : 123 cm / 49 inch
- On Mode Power Consumption (W) : 86 W
- Annual Energy Consumption (kWh) \* : 125 kWh
- Standby Power Consumption (W) \*\* : <0.50 W
- Display Resolution (Pixels) : 3840 x 2160
- Network Standby : <3W

#### 55HFL7011

- Energy Efficiency Class : A
- Visible Screen Size : 139 cm / 55 inch
- On Mode Power Consumption (W) : 97 W
- Annual Energy Consumption (kWh) \* : 141 kWh
- Standby Power Consumption (W) \*\* : <0.50 W
- Display Resolution (Pixels) : 3840 x 2160
- Network Standby : <3W

#### 65HFL7011

- Energy Efficiency Class : A
- Visible Screen Size : 164 cm / 65 inch
- On Mode Power Consumption (W) : 126 W
- Annual Energy Consumption (kWh) \* : 184 kWh
- Standby Power Consumption (W) \*\* : <0.50 W
- Display Resolution (Pixels) : 3840 x 2160
- Network Standby : <3W

\* Energy consumption kWh per year, based on the power consumption of the television operating 4 hours per day for 365 days. The actual energy consumption depends on how the television is used.

\*\* When the TV is turned off with the remote control and no function is active.

## End of Use

### Disposal of your old product and batteries

Your product is designed and manufactured with high quality materials and components, which can be recycled and reused.



When this crossed-out wheeled bin symbol is attached to a product it means that the product is covered by the European Directive 2012/19/EU.



Disposal of Waste Equipment by Users in Private Household in the European Union.

This symbol on the product or on its packaging indicates that this product must not be disposed of with your other household waste. Instead, it is your responsibility to dispose of your waste equipment by handing it over to a designated collection point for the recycling of waste electrical and electronic equipment. The separate collection and recycling of your waste equipment at the time of disposal will help to conserve natural resources and ensure that it is recycled in a manner that protects human health and the environment. For more information about where you can drop off your waste equipment for recycling, please contact your local city office, your household waste disposal service or the shop where you purchased the product.

Please inform yourself about the local separate collection system for electrical and electronic products.

Please act according to your local rules and do not dispose of your old products with your normal household waste. Correct disposal of your old product helps to prevent potential negative consequences for the environment and human health.

Your product contains batteries covered by the European Directive 2006/66/EC, which cannot be disposed with normal household waste.



Please find out for yourself about the local rules on separate collection of batteries because correct disposal will help to prevent negative consequences for the environment and human health.

## Power

Product specifications are subject to change without notice. For more specification details of this product, see [www.philips.com/support](http://www.philips.com/support)

### Power

- Mains power : AC 220-240V +/-10%
- Ambient temperature : 5°C to 35°C
- Power saving features : Eco mode, Picture mute (for radio), Auto switch-off timer, Eco settings menu.

The power rating stated on the product typeplate is the power consumption for this product during normal household use (IEC 62087 Ed.2). The maximum power rating, stated between brackets, is used for electrical safety (IEC 60065 Ed. 7.2).

## Operating System

Android OS :

Android Lollipop 5.1

## Reception

- Aerial input : 75 ohm coaxial (IEC75)
- Tuner bands : Hyperband, S-Channel, UHF, VHF
- DVB : DVB-T (terrestrial, antenna) COFDM 2K/8K, DVB-T2, DVB-C (cable) QAM
- Analogue video playback : SECAM, PAL
- Digital video playback : MPEG2 SD/HD (ISO/IEC 13818-2), MPEG4 SD/HD (ISO/IEC 14496-10)
- Digital audio playback (ISO/IEC 13818-3)

## Display Type

### Diagonal screen size

- 49HFx7011 : 123 cm / 49 inch
- 55HFx7011 : 139 cm / 55 inch
- 65HFx7011 : 164 cm / 65 inch

### Display resolution

- 3840 x 2160p

## Display Input Resolution

### Video formats

Resolution — Refresh rate

- 480i - 60 Hz
- 480p - 60 Hz
- 576i - 50 Hz
- 576p - 50 Hz
- 720p - 50 Hz, 60 Hz
- 1080i - 50 Hz, 60 Hz
- 1080p - 24 Hz, 25 Hz, 30 Hz
- 2160p - 24 Hz, 25 Hz, 30 Hz, 50 Hz, 60 Hz

### Computer formats

Resolutions (amongst others)

- 640 x 480 - 60 Hz
- 800 x 600 - 60 Hz
- 1024 x 768 - 60 Hz
- 1280 x 768 - 60 Hz
- 1360 x 765 - 60 Hz
- 1360 x 768 - 60 Hz
- 1280 x 1024 - 60 Hz
- 1920 x 1080 - 60 Hz
- 3840 x 2160 - 60 Hz

## Dimensions and Weights

### 49HFL7011

- without TV stand:  
Width 1093.3 mm - Height 660.9 mm - Depth 45 mm - Weight ± 14.5 kg
- with TV stand:  
Width 1093.3 mm - Height 709 mm - Depth 205.1 mm - Weight ± 18.5 kg

### 55HFL7011

- without TV stand:  
Width 1233.2 mm - Height 739.7 mm - Depth 45 mm - Weight ± 21.5 kg
- with TV stand:  
Width 1233.2 mm - Height 787.7 mm - Depth 205.1 mm - Weight ± 25.5 kg

### 65HFL7011

- without TV stand:  
Width 1452.9 mm - Height 836.4 mm - Depth 45 mm - Weight ± 28.05 kg
- with TV stand:  
Width 1452.9 mm - Height 915.6 mm - Depth 262.2 mm - Weight ± 28.85 kg

## Connectivity

### TV Side

- HDMI 3 in - ARC
- HDMI 4 in - MHL - ARC
- USB 2 - USB 2.0
- USB 3 - USB 3.0 (blue)
- 1x Common Interface slot: CI+/CAM
- Headphones - Stereo mini-jack 3.5mm

### TV Rear

- Audio In (DVI to HDMI) - Stereo mini-jack 3.5mm
- SCART: Audio L/R, CVBS in, RGB
- YPbPr : Y Pb Pr, Audio L/R

### TV Bottom

- HDMI 1 in - ARC
- HDMI 2 in - ARC
- USB 1 - USB 2.0
- Audio out - Optical Toslink
- Network LAN - RJ45
- Antenna (75Ω)

## Sound

- HD Stereo

Output power (RMS) : 45W (49HFL7011T/  
55HFL7011T)

Output power (RMS) : 30W (65HFL7011T)

- Dolby® Digital Plus
- DTS Premium Sound™

## Multimedia

### Connections

- USB 2.0
- Ethernet LAN RJ-45
- Wi-Fi 802.11a/b/g/n/ac (built-in)
- BT2.1 with EDR & BT4.0 with BLE

### Supported USB file systems

- FAT 16, FAT 32, NTFS

### Playback formats

- Containers : 3GP, AVCHD, AVI, MPEG-PS, MPEG-TS, MPEG-4, Matroska (MKV), Quicktime (MOV, M4V, M4A), Windows Media (ASF/WMV/WMA)
- Video Codecs : MPEG-1, MPEG-2, MPEG-4 Part 2, MPEG-4 Part 10 AVC (H264), H.265 (HEVC), VC-1, WMV9, VP9
- Audio Codecs : AAC, HE-AAC (v1/v2), AMR-NB, Dolby Digital, Dolby Digital Plus, DTS Premium Sound™, MPEG-1/2/2.5 Layer I/II/III (includes MP3), WMA (v2 to v9.2), WMA Pro (v9/v10)
- Subtitles :
  - Formats : SAMI, SubRip (SRT), SubViewer (SUB),

MicroDVD (TXT), mplayer2 (TXT), TMPlayer (TXT)  
– Character encodings : UTF-8, Central Europe and Eastern Europe (Windows-1250), Cyrillic (Windows-1251), Greek (Windows-1253), Turkish (Windows-1254), Western Europe (Windows-1252)

- Image Codecs : JPEG, JPS, MPO

- Limitations :

– Maximum supported total bit rate for a media file is 30Mbps.

– Maximum supported video bit rate for a media file is 20Mbps.

– MPEG-4 AVC (H.264) is supported up to High Profile @ L5.1.

– H.265 (HEVC) is supported upto Main / Main 10 Profile up to Level 5.1

– VC-1 is supported up to Advanced Profile @ L3.

### Wi-Fi Certified

This TV supports Miracast certified devices.

### Supported media server software (DMS)

- You can use any DLNA V1.5 certified media server software (DMS class).
- You can use the Philips TV Remote app (iOS and Android) on mobile devices.

Performance may vary, depending on the capabilities of the mobile device and the software used.

### ESD regulations

This apparatus meets performance criteria B for ESD. In case the apparatus does not recover in file sharing mode due to electrostatic discharge, user interference is required.

---

# Help and Support

---

## 20.1

## Register your TV

Register your TV and enjoy a range of benefits including full support (including downloads), privileged access to information about new products, exclusive offers and discounts, the chance to win prizes and even participate in special surveys about new releases.

Go to [www.philips.com/welcome](http://www.philips.com/welcome)

## 20.2

## Troubleshooting

### Switch On and Remote Control

#### The TV does not switch on

- Disconnect the power cable from the power outlet. Wait for one minute then reconnect it.
- Make sure that the power cable is securely connected.

#### Creaking sound at startup or switch off

When you are switching the TV on, off or to standby, you hear a creaking sound from the TV chassis. The creaking sound is due to the normal expansion and contraction of the TV as it cools and warms up. This does not affect performance.

#### TV does not respond to the remote control

The TV requires some time to start up. During this time, the TV does not respond to the remote control or TV controls. This is normal behaviour. If the TV continues to be unresponsive to the remote control, you can check if the remote control is working by means of a mobile phone camera. Put the phone in camera mode and point the remote control to the camera lens. If you press any key on the remote control and you notice the infra red LED flicker through the camera, the remote control is working. The TV needs to be checked. If you do not notice the flickering, the remote control might be broken or its batteries are low. This method of checking the remote control is not possible with remote controls which are wirelessly paired with the TV.

#### The TV goes back to standby after showing the Philips startup screen

When the TV is in standby, a Philips startup screen is displayed, then the TV returns to standby mode. This is normal behaviour. When the TV is disconnected

and reconnected to the power supply, the startup screen is displayed at the next startup. To switch on the TV from standby, press **⏻** on the remote control or on the TV.

#### The standby light keeps on blinking

Disconnect the power cable from the power outlet. Wait 5 minutes before you reconnect the power cable. If the blinking reoccurs, contact Philips TV Consumer Care.

---

## Channels

#### No digital channels found during the installation

See the technical specifications to make sure that your TV supports DVB-T or DVB-C in your country. Make sure that all cables are properly connected and that the correct network is selected.

#### Previously installed channels are not in the channel list

Make sure that the correct channel list is selected.

---

## Picture

#### No picture / distorted picture

- Make sure that the antenna is properly connected to the TV.
- Make sure that the correct device is selected as the display source.
- Make sure that the external device or source is properly connected.

#### Sound but no picture

- Make sure that the picture settings are set correctly.

#### Poor antenna reception

- Make sure that the antenna is properly connected to the TV.
- Loud speakers, unearthed audio devices, neon lights, high buildings and other large objects can influence reception quality. If possible, try to improve the reception quality by changing the antenna direction or moving devices away from the TV.
- If reception on only one channel is poor, fine-tune this channel with Manual Installation.

#### Poor picture from a device

- Make sure that the device is connected properly.
- Make sure that the picture settings are set correctly.

#### Picture settings change after a while

Make sure that **Location** is set to **Home**. You can change and save settings in this mode.

#### A commercial banner appears

Make sure that **Location** is set to **Home**.

#### Picture does not fit the screen

Change to a different picture format.

#### Picture format keeps changing with different channels

Select a non 'Auto' picture format.

#### Picture position is incorrect

Picture signals from some devices may not fit the screen correctly. Check the signal output of the connected device.

#### Computer picture is not stable

Make sure that your PC uses the supported resolution and refresh rate.

---

## Sound

#### No sound or poor sound quality

If no audio signal is detected, the TV automatically switches the audio output off — this does not indicate malfunction.

- Make sure that the sound settings are correctly set.
- Make sure that all cables are properly connected.
- Make sure that the volume is not muted or set to zero.
- Make sure that the TV audio output is connected to the audio input on the Home Theatre System. Sound should be heard from the HTS speakers.
- Some devices may require you to manually enable HDMI audio output. If HDMI audio is already enabled, but you still do not hear audio, try changing the digital audio format of the device to PCM (Pulse Code Modulation). Refer to the documentation accompanying your device for instructions.

---

## HDMI and USB

#### HDMI

- Note that HDCP (High-bandwidth Digital Content Protection) support can delay the time taken for a TV to display content from an HDMI device.
- If the TV does not recognise the HDMI device and no picture is displayed, switch the source from one device to another and back again.
- If the picture and sound of a device connected with HDMI is distorted, check if a different **HDMI Ultra HD** setting can solve this problem.
- If there are intermittent sound disruptions, make sure that output settings from the HDMI device are correct.
- If you use an HDMI-to-DVI adapter or HDMI-to-DVI cable, make sure that an additional audio cable is connected to AUDIO IN (mini-jack only), if available.

#### HDMI EasyLink does not work

- Make sure that your HDMI devices are HDMI-CEC

compatible. EasyLink features only work with devices that are HDMI-CEC compatible.

#### No volume icon shown

- When an HDMI-CEC audio device is connected and you use the TV Remote Control to adjust the volume level from the device, this behaviour is normal.

#### Photos, videos and music from a USB device do not show

- Make sure that the USB storage device is set to Mass Storage Class compliant, as described in the storage device's documentation.
- Make sure that the USB storage device is compatible with the TV.
- Make sure that the audio and picture file formats are supported by the TV.

#### Choppy playback of USB files

- The transfer performance of the USB storage device may limit the data transfer rate to the TV which causes poor playback.

---

## Wi-Fi, Internet and Bluetooth

#### Wi-Fi network not found or distorted

- Microwave ovens, DECT phones or other Wi-Fi 802.11b/g/n devices in your proximity might disturb the wireless network.
- Make sure that the firewalls in your network allow access to the TV's wireless connection.
- If the wireless network does not work properly in your home, try the wired network installation.

#### Internet does not work

- If the connection to the router is OK, check the router connection to the Internet.

#### The PC and Internet connection are slow

- Look in your wireless router's user manual for information on indoor range, transfer rate and other factors of signal quality.
- Use a high-speed (broadband) Internet connection for your router.

#### DHCP

- If the connection fails, you can check the DHCP (Dynamic Host Configuration Protocol) setting of the router. DHCP should be switched on.

#### Bluetooth lost connection

- Position the wireless speaker within a range of 5 meters from the TV.
- Places with a high amount of wireless activity – apartments with lots of wireless routers – can hamper the wireless connection. Keep the router and wireless speaker as close to the TV as possible.

#### Bluetooth Audio and Video synchronisation

- Before you purchase a wireless Bluetooth speaker, inform yourself about its quality of Audio to Video synchronisation, commonly called 'lip sync'. Not all Bluetooth devices perform correctly. Ask your dealer for advice.

## Online Help

To solve any Philips TV related problem, you can consult our online support. You can select your language and enter your product model number.

Go to [www.philips.com/support](http://www.philips.com/support) .

On the support site you can find your country's telephone number to contact us as well as answers to frequently asked questions (FAQs). In some countries, you can chat with one of our collaborators and ask your question directly or send a question by email. You can download new TV software or the manual to read on your computer.

## Support and Repair

For support and repair, call the Consumer Care hotline in your country. Our service engineers will take care of a repair, if necessary.

Find the telephone number in the printed documentation that came with the TV.

Or consult our website [www.philips.com/support](http://www.philips.com/support) and select your country if needed.

### Support app

You can also look up the **Support** app in the Apps row of the Home menu.

Open this app to find the telephone number to contact us.

### TV model number and serial number

You might be asked to provide the TV product model number and serial number. Find these numbers on the packaging label or on the type label on the back or bottom of the TV.

### Warning

Do not attempt to repair the TV yourself. This may cause severe injury, irreparable damage to your TV or void your warranty.

---

# Safety and Care

---

## 21.1

## Safety

---

### Important

Read and understand all safety instructions before you use the TV. If damage is caused by failure to follow instructions, the warranty does not apply.

---

### Secure the TV from Falling Over

Always use the supplied wall bracket to secure the TV from falling over. Mount the bracket and secure the TV onto the bracket, even if you put the TV on the floor.

You can find the mounting instructions in the Quick Start Guide that came with the TV. In case you lost this guide, you can download the guide from [www.philips.com](http://www.philips.com). Use the product type number of the TV to look for the Quick Start Guide to download.

---

### Risk of Electric Shock or Fire

- Never expose the TV to rain or water. Never place liquid containers, such as vases, near the TV. If liquids are spilt on or into the TV, disconnect the TV from the power outlet immediately. Contact Philips TV Consumer Care to have the TV checked before use.
- Never expose the TV, remote control or batteries to excessive heat. Never place them near burning candles, naked flames or other heat sources, including direct sunlight.
- Never insert objects into the ventilation slots or other openings on the TV.
- Never place heavy objects on the power cord.
- Avoid force coming onto power plugs. Loose power plugs can cause arcing or fire. Ensure that no strain is exerted on the power cord when you swivel the TV screen.
- To disconnect the TV from the mains power, the power plug of the TV must be disconnected. When disconnecting the power, always pull the power plug, never the cord. Ensure that you have full access to the power plug, power cord and outlet socket at all times.

---

### Risk of Injury or Damage to the TV

- Two people are required to lift and carry a TV that weighs more than 25 kg or 55 lbs.
- If you mount the TV on a stand, only use the supplied stand. Secure the stand to the TV tightly. Place the TV on a flat, level surface that can support the weight of the TV and the stand.
- When wall mounted, ensure that the wall mount can safely bear the weight of the TV set. TP Vision bears no responsibility for improper wall mounting that results in accident, injury or damage.
- Parts of this product are made of glass. Handle with care to avoid injury or damage.

#### Risk of damage to the TV !

Before you connect the TV to the power outlet, ensure that the power voltage matches the value printed on the back of the TV. Never connect the TV to the power outlet if the voltage is different.

---

### Risk of Injury to Children

Follow these precautions to prevent the TV from toppling over and causing injury to children:

- Never place the TV on a surface covered by a cloth or other material that can be pulled away.
- Ensure that no part of the TV hangs over the edge of the mounting surface.
- Never place the TV on tall furniture, such as a bookcase, without anchoring both the furniture and TV to the wall or a suitable support.
- Teach children about the dangers of climbing on furniture to reach the TV.

#### Risk of swallowing batteries !

The remote control may contain coin-type batteries which can easily be swallowed by small children. Keep these batteries out of reach of children at all times.

---

### Risk of Overheating

Never install the TV in a confined space. Always leave a space of at least 10 cm or 4 inches around the TV for ventilation. Ensure curtains or other objects never cover the ventilation slots on the TV.

---

## Lightning Storms

Disconnect the TV from the power outlet and antenna before lightning storms.

During lightning storms, never touch any part of the TV, power cord or antenna cable.

---

## Risk of Hearing Damage

Avoid using earphones or headphones at high volumes or for prolonged periods of time.

---

## Low Temperatures

If the TV is transported in temperatures below 5°C or 41°F, unpack the TV and wait until the TV temperature reaches room temperature before connecting the TV to the power outlet.

---

## Humidity

In rare occasions, depending on temperature and humidity, minor condensation can occur on the inside of the TV glass front (on some models). To prevent this, do not expose the TV to direct sunlight, heat or extreme humidity. If condensation occurs, it will disappear spontaneously while the TV is playing for a few hours.

The condensation moisture will not harm the TV or cause malfunction.

---

21.2

## Screen Care

- Never touch, push, rub or strike the screen with any object.
- Unplug the TV before cleaning.
- Clean the TV and frame with a soft damp cloth and wipe gently. Avoid touching the Ambilight LEDs on the backside of the TV. Never use substances such as alcohol, chemicals or household cleaners on the TV.
- To avoid deformations and colour fading, wipe off water drops as quickly as possible.
- Avoid stationary images as much as possible.

Stationary images are images that remain onscreen for extended periods of time. Stationary images include onscreen menus, black bars, time displays, etc. If you must use stationary images, reduce screen contrast and brightness to avoid screen damage.



# Terms of Use

## 22.1

### Terms of Use – TV

2016 © TP Vision Europe B.V. All rights reserved.

This product was brought to the market by TP Vision Europe B.V. or one of its affiliates, hereinafter referred to as TP Vision, which is the manufacturer of the product. TP Vision is the warrantor in relation to the TV with which this booklet was packaged. Philips and the Philips Shield Emblem are registered trademarks of Koninklijke Philips N.V.

Specifications are subject to change without notice. Trademarks are the property of Koninklijke Philips N.V or their respective owners. TP Vision reserves the right to change products at any time without being obliged to adjust earlier supplies accordingly.

The written material packaged with the TV and the manual stored in the memory of the TV or downloaded from the Philips website [www.philips.com/support](http://www.philips.com/support) are believed to be adequate for the intended use of the system.

The material in this manual is believed adequate for the intended use of the system. If the product, or its individual modules or procedures, are used for purposes other than those specified herein, confirmation of their validity and suitability must be obtained. TP Vision warrants that the material itself does not infringe any United States patents. No further warranty is expressed or implied. TP Vision cannot be held responsible neither for any errors in the content of this document nor for any problems as a result of the content in this document. Errors reported to Philips will be adapted and published on the Philips support website as soon as possible.

Terms of warranty – Risk of injury, damage to TV or void of warranty!

Never attempt to repair the TV yourself. Use the TV and accessories only as intended by the manufacturer. The caution sign printed on the back of the TV indicates risk of electric shock. Never remove the TV cover. Always contact Philips TV Customer Care for service or repairs. Find the telephone number in the printed documentation that came with the TV. Or consult our website [www.philips.com/support](http://www.philips.com/support) and select your country if needed. Any operation expressly prohibited in this manual, or any adjustments and assembly procedures not recommended or authorised in this manual, shall void the warranty.

Pixel characteristics

This LCD/LED product has a high number of colour pixels. Although it has effective pixels of 99.999% or

more, black dots or bright points of light (red, green or blue) may appear constantly on the screen. This is a structural property of the display (within common industry standards) and is not a malfunction.

CE compliance

Hereby, TP Vision Europe B.V. declares that this television is in compliance with the essential requirements and other relevant provisions of Directives 1999/5/EC (RTTE), 2004/108/EC (EMC), 2006/95/EC (Low Voltage), 2009/125/EC (Energy Labelling) and 2011/65/EC (RoHS). From June 2016 onwards the following Directives are valid 2014/53/EU (RED), 2009/125/EC (Eco Design), 2010/30/EU (Energy Labelling) and 2011/65/EC (RoHS).

Compliance with EMF

TP Vision manufactures and sells many products targeted at consumers which, like any electronic apparatus, in general have the ability to emit and receive electromagnetic signals. One of TP Vision's leading business principles is to take all necessary health and safety measures for our products, to comply with all applicable legal requirements and to stay well within the Electro Magnetic Field (EMF) standards applicable at the time of producing the products.

TP Vision is committed to developing, producing and marketing products that cause no adverse health effects. TP Vision confirms that, as long as its products are handled properly for their intended use, they are safe to use according to scientific evidence available today. TP Vision plays an active role in the development of international EMF and safety standards, enabling TP Vision to anticipate further developments in standardisation for early integration in its products.



Türkiye Cumhuriyeti: EEE Yönetmeliğine Uygundur

## 22.2

### Terms of Use – Smart TV

You can see the terms of use, privacy policy, and also set privacy settings of your Smart TV.

To open the terms of use of Smart TV page...

- 1 - Press  HOME to open the Home menu.
- 2 - Select  Apps to open Apps.
- 3 - Select Support.

---

# Copyrights

---

## MHL

MHL, Mobile High-Definition Link and the MHL Logo are trademarks or registered trademarks of the MHL, LLC.



## Ultra HD

The DIGITALEUROPE UHD Display Logo is a trademark of DIGITALEUROPE.



## HDMI



### HDMI®

The terms HDMI and HDMI High-Definition Multimedia Interface, and the HDMI Logo are trademarks or registered trademarks of HDMI Licensing LLC in the United States and other countries.

## Dolby Digital Plus



### Dolby®

Manufactured under license from Dolby Laboratories. Dolby and the double-D symbol are trademarks of Dolby Laboratories.

## DTS Premium Sound™



### DTS Premium Sound™

For DTS patents, see <http://patents.dts.com>. Manufactured under license from DTS Licensing Limited. DTS, the Symbol, & DTS and the Symbol together are registered trademarks, and DTS 2.0 Channel is a trademark of DTS, Inc. © DTS, Inc. All Rights Reserved.

## DLNA Certified®

(If applicable)



DLNA®, the DLNA Logo and DLNA CERTIFIED® are trademarks, service marks, or certification marks of the Digital Living Network Alliance.

## Microsoft



Windows Media

Windows Media is either a registered trademark or trademark of Microsoft Corporation in the United States and/or other countries.

### Microsoft PlayReady

Content owners use Microsoft PlayReady™ content access technology to protect their intellectual property, including copyrighted content.

This device uses PlayReady technology to access PlayReady-protected content and/or WMDRM-protected content. If the device fails to properly enforce restrictions on content usage, content owners may require Microsoft to revoke the device's ability to consume PlayReady-protected content. Revocation should not affect unprotected content or content protected by other content access technologies.

Content owners may require you to upgrade PlayReady to access their content. If you decline an upgrade, you will not be able to access content that requires the upgrade.

---

23.8

## Wi-Fi Alliance



Wi-Fi®, the Wi-Fi CERTIFIED logo, the Wi-Fi logo are registered trademarks of the Wi-Fi Alliance.

---

23.9

## Kensington

(If applicable)



Kensington and Micro Saver are registered US trademarks of ACCO World Corporation with issued registrations and pending applications in other countries throughout the world.

---

23.10

## Other Trademarks

All other registered and unregistered trademarks are the property of their respective owners.

---

# Index

## A

- Ambilight Style 36
- Ambilight, Settings 45
- Ambilight, TV Switch Off 46
- Ambilight, Wall Colour 46
- Antenna connection 6
- Antenna, Manual Installation 54
- Apps 30
- Audio commentary 51
- Audio Description 51
- Audio Out - Optical, tips 13
- Audio Out Delay 15
- Audio Out Format 15
- Audio Out Levelling 16
- Audio Out Offset 15
- Audio Out Settings 15
- Audio to Video Sync 15
- Auto Volume Levelling 43
- Automatic Channel Update 53

## B

- Backlight Contrast 38
- Bass 43
- Blu-ray Disc player, connect 16
- Brightness, Philips Logo 19

## C

- Cable, Manual Installation 54
- CAM, Conditional Access Module 13
- Camcorder, connect 17
- Channel 22
- Channel logos 48
- Channel Update Message 53
- Channel, Antenna Installation 53
- Channel, Automatic Channel Update 53
- Channel, Cable Installation 53
- Channel, Reinstall 53
- Channel, TV guide 26
- CI+ 13
- Clear LCD 42
- Clear Miracast connection 10
- Clear Sound 43
- Colour 38
- Colour, Colour enhancement 39
- Colour, colour temperature 39
- Colour, custom colour temperature 40
- Colour, Tint 39
- Common Interface Slot 13
- Computer, connect 18
- Connectivity Guide 11
- Consumer Care 94
- Contact Philips 94
- Contrast 38
- Contrast, Contrast Mode 40
- Contrast, Dynamic Contrast 40
- Contrast, Gamma 41
- Contrast, Perfect Contrast 40
- Contrast, Video Contrast 41

## D

- Digital Text 23
- Disposal of TV or batteries 89

- DMR, Digital Media Renderer 9
- DVD player 17

## E

- EasyLink 11
- EasyLink, On or Off 12
- EasyLink, Remote control 12
- Eco Settings 46
- End of use 89
- European Ecolabel 89

## G

- Game or Computer 28
- Game or Computer, setting 39
- Gamma 41

## H

- Halo size, Ambilight 45
- Hard of hearing 51
- HbbTV 24
- HDMI MHL 11
- HDMI, ARC 11
- HDMI, DVI connection 12
- Headphones, connect 17
- Hearing impaired 51
- Home Menu 27
- Home Theatre System, Multichannel 15
- Home Theatre System, problems 16
- Home Theatre System, volume levelling 16

## I

- Incredible Surround 43
- Interactive TV 25
- Interactive TV, about 24
- Internet memory, clear 8

## I

- iTV 24

## K

- Keys on TV 19

## M

- Media 32
- Media files, from a USB drive 32
- Motion, Clear LCD 42
- Motion, Natural Motion 42
- Motion, Perfect Natural Motion 42
- MPEG Artefact Reduction 41

## N

- Natural Motion 42
- Network Installation 7
- Network, Clear Wi-Fi Miracast connection 10
- Network, connect 7
- Network, settings 8
- Network, Static IP 9
- Network, Switch on Wi-Fi 9
- Network, View Settings 8
- Network, Wired 8
- Network, Wireless 7
- Network, WoWLAN 9
- Network, WPS 7
- Network, WPS with PIN code 7

Noise Reduction 41

## O

On a TV stand, TV Placement 48

On and Off 19

On the wall, TV Placement 48

Online support 94

Open Source software 55

## P

Partially sighted 51

Perfect Natural Motion 42

Philips Logo, Brightness 19

Photo camera, connect 17

Photos, Videos and Music 32

Picture Style 38

Picture, Backlight Contrast 38

Picture, Colour 38

Picture, Sharpness 39

Placement, TV placement 5

Placement, Viewing distance 5

Power connection 5

Power consumption check 46

Problems 92

Problems, Channels 92

Problems, Connection, HDMI 93

Problems, Connection, Internet 93

Problems, Connection, USB 93

Problems, Connection, Wi-Fi 93

Problems, Picture 92

Problems, Remote control 92

Problems, Sound 93

Product Fiche 89

## R

Reception Quality 53

Register your product 92

Reinstall TV 54

Remote control and batteries 21

Repair 94

## S

Safety Instructions 95

SCART connection, tips 13

Screen care 96

Sharpness 39

Sharpness, MPEG Artefact Reduction 41

Sharpness, Noise reduction 41

Sharpness, Super Resolution 41

Sharpness, Ultra Resolution 41

Smart Card, CAM 13

Software, Update 55

Sound Style 42

Sound, Auto Volume Levelling 43

Sound, Bass 43

Sound, Clear Sound 43

Sound, surround mode 43

Sound, Treble 43

Speakers, Wireless 44

Standby 19

Support, online 94

Surround Mode 43

Synchronise Audio and Video 15

## T

Teletext 23

Terms of Use 97

Test Reception 53

Text 23

Text language, Primary 24

Text language, Secondary 24

Treble 43

TV Guide 26

TV Installation 54

TV network name 8

## U

Universal Access 51

Universal Access, Hard of hearing 51

Universal Access, Speakers/Headphones 52

USB Flash Drive, connect 17

## V

Visually impaired 51

## W

Wi-Fi 7

Wired Network 8

Wireless Audio 44

Wireless Network 7

Wireless Speakers, about 44

Wireless Speakers, select 44

WoWLAN 9

## Y

YPbPr connection, tips 13



## Contact information

**Armenia**  
0-800-01-004

**Austria/Österreich**  
0150 2842133

**Belarus/Беларусь**  
8 10 800 2000 00 04

**Belgium/België/Belgique**  
02 7007360

**Bulgaria/България**  
0 0800 1154426  
+359 2 4916273

**Croatia/Hrvatska**  
0800 222 782

**Czech Republic/Česká republika**  
800 142100

**Denmark/Danmark**  
352 587 61

**Estonia/Eesti Vabariik**  
800 0044 307

**Finland/Suomi**  
09 229 019 08

**France**  
01 57324070

**Germany**  
0696 640 4383

**Greece/Ελλάδα**  
0 0800 3122 1223

**Greece Cyprus**  
800 92 256

**Hungary/Magyarország**  
068 001 85 44  
(06 1) 700 8151

**Republic of Ireland/Poblacht na hÉireann**  
1 601 1161

**Northern Ireland/Tuaisceart Éireann**  
1 601 1161

**Italy/Italia**  
02 4528 7030

**Kazakhstan/Қазақстан**  
8 10 800 1000 00 04

**Latvia/Latvija**  
800 03 448

**Lithuania/Lietuva**  
880 030 049

**Luxembourg/Luxemburg**  
26 84 3000

**Netherlands/Nederlands**  
010 4289533

**Norway/Norge**  
22 70 82 50

**Poland/Polska**  
022 349 1505

**Portugal**  
0800 780 902

**Romania/România**  
03 727 66905  
031 6300042

**Russia/Россия**  
8 (800) 220 0004

**Serbia/Srbija**  
11 321 68 40

**Slovakia/Slovensko**  
0800 0045 51

**Slovenia**  
0800 80 255

**Spain/España**  
915 909 335

**Sweden/Sverige**  
08 6320 016

**Switzerland/Schweiz/Suisse**  
223 102 116

**Turkey/Türkiye**  
0 850 222 44 66

**Ukraine/Україна**  
0 800 500 480

**United Kingdom**  
020 7949 0069

This information is correct at the time of print. For updated information, see [www.philips.com/support](http://www.philips.com/support).



Specifications are subject to change without notice.

Trademarks are the property of Koninklijke Philips N.V. or their respective owners.

2016 © TP Vision Europe B.V. All rights reserved.

[www.philips.com](http://www.philips.com)

