

**PHILIPS**

Televisions

6000 series

75PFL6621  
65PFL6621



Register your product and get support at

[www.philips.com/support](http://www.philips.com/support)

---

EN **User Manual**

---

ES **Manual del Usuario**

---

EN **For further assistance, call the customer support service in your country.**

- To obtain assistance, contact Philips Customer Care Center;  
México D.F. and Área Metropolitana; **58 87 97 36**  
Interior de la Republica; **01 800 839 19 89**  
Colombia; **01 800 952 0640**  
Costa Rica; **0800 052 1564**  
Guatemala; **1 800 835 0351**  
El Salvador; **1 800 6141**  
Honduras; **01 800 122 6276**

ES **Para obtener más información, llame al servicio de soporte al cliente de su país.**

- Para obtener asistencia, póngase en contacto con el CENTRO DE INFORMACION AL CLIENTE,  
México D.F. y Área Metropolitana; **58 87 97 36**  
Interior de la Republica; **01 800 839 19 89**  
Colombia; **01 800 952 0640**  
Costa Rica; **0800 052 1564**  
Guatemala; **1 800 835 0351**  
El Salvador; **1 800 6141**  
Honduras; **01 800 122 6276**

# Contents

<b>1 Notice</b>	5	<b>Search for channels</b>	37
		Install channels	37
<b>2 Important</b>	6	<b>Channel settings</b>	37
Positioning the TV	6	Channel installation	37
Regulatory Notices	6	Child lock	38
Environmental Care	6	Change PIN	39
▲ Batteries usage	6	Digital audio language	39
Preparing to Move/Ship the Unit	6	Mono/Stereo	39
		<b>Update software</b>	40
<b>3 Getting Started</b>	7	Preparing for the Software upgrade	40
Features	7	Downloading the Software	40
Supplied Accessories	7	USB upgrade	40
Symbols used in this User Manual	7	Network updates	41
Unpacking	8	<b>Software settings</b>	41
Installing the Stands	10	Software	41
Lifting the TV Set	10		
Removing Cardboard	10	<b>6 Useful tips</b>	42
Installing the Remote Control Batteries	10	FAQ	42
Remote Control	11	Troubleshooting Tips	43
Control Panel	12		
Terminals	12	<b>7 Information</b>	45
Connecting Antenna or Cable / Satellite / IPTV Set-top Box	13	Glossary	45
Plugging in the AC Power Cord	13	Maintenance	45
Selecting your Connection quality	14		
Connecting your Devices	14	<b>8 Specifications</b>	46
TV Initial Setup	18		
Google Cast Setup	20	<b>9 Warranty</b>	47
		License	end of book
<b>4 Use your TV</b>	21		
Switching on your TV and putting it in Standby mode	21		
Adjusting Volume	21		
Switching Channels	21		
Watching Channels from an External Device	22		
Create a list of favorite channels	22		
Changing Picture Format	23		
TV Screen information	24		
Using Options menu	24		
USB	25		
<b>5 Making more use with your TV</b>	28		
Picture and sound setup	29		
<b>TV settings</b>	29		
Picture	29		
Sound	31		
Cast TV settings	32		
Features	32		
Installation	34		

• Displays and illustrations may differ depending on the product you purchase.

## Know these **safety** symbols



The caution marking is located on the rear or bottom of the cabinet.



The lightning flash with arrowhead symbol, within an equilateral triangle, is intended to alert the user to the presence of uninsulated “dangerous voltage” within the apparatus’s enclosure that may be of sufficient magnitude to constitute a risk of electric shock to persons.



The exclamation point within an equilateral triangle is intended to alert the user to the presence of important operating and maintenance (servicing) instructions in the literature accompanying the apparatus.

**WARNING:** To reduce the risk of fire or electric shock, do not expose this apparatus to rain or moisture. Apparatus shall not be exposed to dripping or splashing and no objects filled with liquids, such as vases, shall be placed on the apparatus.

**CAUTION:** To prevent electric shock, match wide blade of plug to wide slot, fully insert.

**ATTENTION:** Pour éviter les choc électriques, introduire la lame la plus large de la fiche dans la borne correspondante de la prise et pousser jusqu’au fond.

**PHILIPS** Visit our World Wide Web Site at [www.philips.com/support](http://www.philips.com/support)

## CHILD SAFETY:

### PROPER TELEVISION PLACEMENT MATTERS

#### THE CONSUMER ELECTRONICS INDUSTRY CARES

- Manufacturers, retailers and the rest of the consumer electronics industry are committed to making home entertainment safe and enjoyable.
- As you enjoy your television, please note that all televisions – new and old- must be supported on proper stands or installed according to the manufacturer’s recommendations. Televisions that are inappropriately situated on dressers, bookcases, shelves, desks, speakers, chests, carts, etc., may fall over, resulting in injury.

#### TUNE IN TO SAFETY

- **ALWAYS** follow the manufacturer’s recommendations for the safe installation of your television.
- **ALWAYS** read and follow all instructions for proper use of your television.
- **NEVER** allow children to climb on or play on the television or the furniture on which the television is placed.
- **NEVER** place the television on furniture that can easily be used as steps, such as a chest of drawers.
- **ALWAYS** install the television where it cannot be pushed, pulled over or knocked down.
- **ALWAYS** route cords and cables connected to the television so that they cannot be tripped over, pulled or grabbed.

#### WALL OR CEILING MOUNT YOUR TELEVISION

- **ALWAYS** contact your retailer about professional installation if you have any doubts about your ability to safely mount your television.
- **ALWAYS** use a mount that has been recommended by the television manufacturer and has a safety certification by an independent laboratory (such as UL, CSA, ETL).
- **ALWAYS** follow all instructions supplied by the television and mount manufacturers.
- **ALWAYS** make sure that the wall or ceiling where you are mounting the television is appropriate. Some mounts are not designed to be mounted to walls and ceilings with steel studs or cinder block construction. If you are unsure, contact a professional installer.
- Televisions can be heavy. A minimum of two people is required for a wall or ceiling mount installation.

#### MOVING AN OLDER TELEVISION TO A NEW PLACE IN YOUR HOME

- Many new television buyers move their older CRT televisions into a secondary room after the purchase of a flat-panel television. Special care should be made in the placement of older CRT televisions.
- **ALWAYS** place your older CRT television on furniture that is sturdy and appropriate for its size and weight.
- **NEVER** place your older CRT television on a dresser where children may be tempted to use the drawers to climb.
- **ALWAYS** make sure your older CRT television does not hang over the edge of your furniture.

**CTA.tech/safety** Consumer Technology Association™

# Important Safety Instructions

1. Read these instructions.
2. Keep these instructions.
3. Heed all warnings.
4. Follow all instructions.
5. Do not use this apparatus near water.
6. Clean only with dry cloth.
7. Do not block any ventilation openings. Install in accordance with the manufacturer's instructions.
8. Do not install near any heat sources such as radiators, heat registers, stoves, or other apparatus (including amplifiers) that produce heat.
9. Do not defeat the safety purpose of the polarized or grounding type plug. A polarized plug has two blades with one wider than the other. A grounding type plug has two blades and a third grounding prong. The wide blade or the third prong are provided for your safety. If the provided plug does not fit into your outlet, consult an electrician for replacement of the obsolete outlet.
10. Protect the power cord from being walked on or pinched particularly at plugs, convenience receptacles, and the point where they exit from the apparatus.
11. Only use attachments / accessories specified by the manufacturer.
12. Use only with the cart, stand, tripod, bracket, or table specified by the manufacturer, or sold with the apparatus. When a cart is used, use caution when moving the cart / apparatus combination to avoid injury from tip-over.



13. Unplug this apparatus during lightning storms or when unused for long periods of time.
14. Refer all servicing to qualified service personnel. Servicing is required when the apparatus has been damaged in any way, such as power-supply cord or plug is damaged, liquid has been spilled or objects have fallen into the apparatus, the apparatus has been exposed to rain or moisture, does not operate normally, or has been dropped.

## Note to the CATV system installer:

This reminder is provided to call the CATV system installer's attention to Article 820-40 of the NEC that provides guidelines for proper grounding and, in particular, specifies that the cable ground shall be connected to the grounding system of the building, as close to the point of cable entry as practical.

## Example of Antenna Grounding as per NEC - National Electric Code

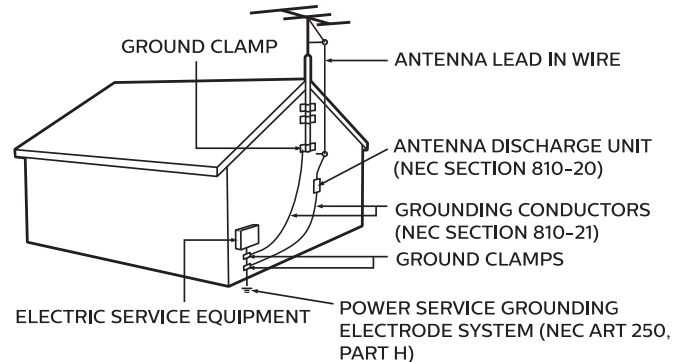

### Wall Mount Bracket Kit

	Brand	Model #	Screw dimension
75PFL6621	SANUS	VMPL3	M6 x 12mm (0.472")
65PFL6621			

- Your TV meets the VESA standard for wall mounting. Consult with your local dealer for a wall mount bracket which is compatible with your TV model.
- The recommended Wall Mount Bracket Kit (sold separately) allows the mounting of the TV on the wall.
- For detailed information on installing the wall mount, refer to the Wall Mount Instruction Book.
- P&F Mexicana is not responsible for any damage to the product or injury to yourself or others if you elect to install the TV Wall Mount Bracket or mount the TV onto the Bracket on your own.
- The Wall Mount Bracket must be installed by experts.

### P&F Mexicana is not liable for these types of accidents or injuries noted below.

- Install the Wall Mount Bracket on a sturdy vertical wall.
- If installed onto a ceiling or slanted wall, the TV and Wall Mount Bracket may fall which could result in a severe injury.
- Do not use screws that are longer or shorter than their specified length. If screws too long are used this may cause mechanical or electrical damage inside the TV set. If screws too short are used this may cause the TV set to fall.
- Do not fasten the screws by excessive force. This may damage the product or cause the product to fall, leading to an injury.
- For safety reasons use 2 people to mount the TV onto a Wall Mounting Bracket.
- Do not mount the TV onto the Wall Mounting Bracket while your TV is plugged in or Turned On. It may result in an electrical shock injury.

### When installing the unit on the wall, allow this much space.

Top:	11.8 inches (30cm)
Left and right side:	5.9 inches (15cm)
Bottom:	3.9 inches (10cm)

# 1 Notice

Trademarks are the property of Koninklijke Philips N.V. or their respective owners.

P&F Mexicana reserves the right to change products at any time without being obliged to adjust earlier supplies accordingly.

The material in this manual is believed adequate for the intended use of the system. If the product or its individual modules or procedures are used for purposes other than those specified herein, confirmation of their validity and suitability must be obtained. P&F Mexicana warrants that the material itself does not infringe any United States patents. No further warranty is expressed or implied.

P&F Mexicana cannot be held responsible neither for any errors in the content of this document nor for any problems as a result of the content in this document. Errors reported to P&F Mexicana will be adapted and published on the P&F Mexicana support website as soon as possible.

## Pixel characteristics

This LCD product has a high number of color pixels. Although it has effective pixels of 99.999% or more, black dots or bright points of light (red, green or blue) may appear constantly on the screen. This is a structural property of the display (within common industry standards) and is not a malfunction.

## Warranty

No components are user serviceable. Do not open or remove covers to the inside of the product. Repairs may only be done by Service Centers and official repair shops. Failure to do so shall void any warranty, stated or implied.

Any operation expressly prohibited in this manual, any adjustments or assembly procedures not recommended or authorized in this manual shall void the warranty.

## Copyright

All other registered and unregistered trademarks are the property of their respective owners.



The terms HDMI and HDMI High-Definition Multimedia Interface, and the HDMI Logo are trademarks or registered trademarks of HDMI Licensing LLC in the United States and other countries.



Dolby, Dolby Audio, and the double-D symbol are trademarks of Dolby Laboratories.



Sonic Emotion and the Sonic Emotion logo symbol are registered trademarks of sonic emotion ag.

Portions of this software are copyright © The FreeType Project ([www.freetype.org](http://www.freetype.org)).

The American Academy of Pediatrics discourages television viewing for children younger than two years of age.

Some features may require an always-on broadband internet connection, firmware update and/or a minimum bandwidth. Internet services vary by location.

P&F USA Inc./P&F MEXICANA, S.A.de C.V. do not warrant access to the Portal or to any of the services, content, software and advertising. P&F USA Inc./P&F MEXICANA, S.A. de C.V. may, in its sole discretion, add or remove access to any specific services, content, software and advertising at any time. Although P&F USA Inc./P&F MEXICANA, S.A. de C.V. will strive to provide a good selection of services, content or software, P&F USA Inc./P&F MEXICANA, S.A. de C.V. do not warrant continued access to any specific services, and content or software.

## 2 Important

### Positioning the TV

- Large screen TVs are heavy. 2 people are required to carry and handle a large screen TV.
- Make sure to hold the upper and bottom frames of the Unit firmly as illustrated.
- Install the Unit in a horizontal and stable position.
- Do not install the Unit in direct sunlight or in a place subject to dust or strong vibration.
- Depending on the environment, the temperature of this Unit may increase slightly. This is not a malfunction.
- Avoid a place with drastic temperature changes.
- Do not place anything directly on top or bottom of the Unit.
- Depending on your external devices, noise or disturbance of the picture and / or sound may be generated if the Unit is placed too close to them. In this case, please ensure enough space between the external devices and the Unit.
- Do not insert the AC power cord into the power socket outlet before all the connections are made.
- Ensure that you always have easy access to the AC Power Cord and Outlet to disconnect the TV from the AC Outlet.
- Before you move the TV, disconnect attached Cables to prevent damage to Connectors, especially the TV Tuner.
- Be sure to Unplug the AC Power Plug from the AC outlet before moving or carrying the Unit.
- When moving the TV and then Setting it down, please be careful not to pinch the AC Power Cord under the Unit.

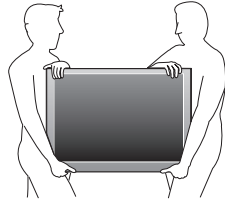

### Regulatory Notices

Do not place the Unit on the furniture that is capable of being tilted by a child and an adult leaning, pulling, standing or climbing on it. A falling Unit can cause serious injury or even death.

This apparatus should not be placed in a built-in installation such as a bookcase or rack unless proper ventilation is provided. Make sure to leave a space of 4 inches (10cm) or more around this apparatus.

Press **⏻** to turn the Unit On and go into Standby mode.

To completely turn Off the Unit, you must unplug the AC power Plug from the AC Power Outlet.

Disconnect the AC Power Plug to shut the Unit Off when trouble is found or not in use. The AC Plug shall remain readily available.

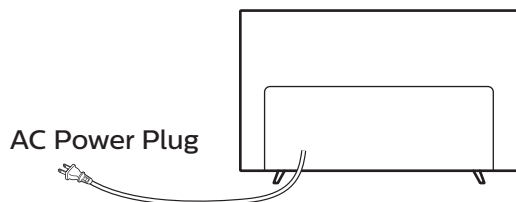

Never use a gas duster on this TV.  
The gas trapped inside of this Unit may cause ignition and explosion.

- CAUTION:** Danger of explosion if battery is incorrectly replaced. Replace only with the same or equivalent type.
- WARNING:** Batteries (battery pack or battery installed) should not be exposed to excessive heat such as sunshine, fire or the like.
- WARNING:** To prevent injury, this apparatus must be securely attached to the furniture / wall in accordance with the instructions. Tipping, shaking or rocking the unit may cause injury / death.

### Environmental Care



The packaging of this product is intended to be recycled. Contact your local authorities for information about how to recycle the packaging.

For product recycling information, please visit - [www.recycle.philips.com](http://www.recycle.philips.com)

#### End of Life Directives

Philips pays a lot of attention to produce environmental-friendly products in green focal areas. Your new TV contains materials which can be recycled and reused. At the end of its life, specialized companies can dismantle the discarded TV to concentrate the reusable materials and to minimize the amount of materials to be disposed of. Please ensure you dispose of your old TV according to local regulations.

#### Disposal of Used Batteries

The batteries supplied do not contain the heavy metals mercury and cadmium, however in certain localities, disposing batteries with household waste is not permitted. Please ensure you dispose of batteries according to local regulations.

#### ⚠ Batteries usage

- Do not mix old and new batteries.
- Do not mix alkaline, standard (carbon-zinc) or rechargeable (ni-cad, ni-mh, Li-ion, etc.) batteries.

### Preparing to Move/Ship the Unit

Please pack the Unit properly by following the Diagram on the Carton (as noted below).

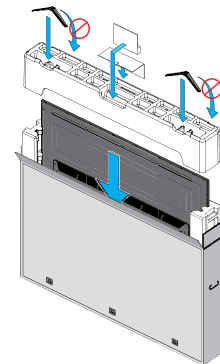

- To avoid damage to the Screen, do not pack the Stand\* on the same side as the TV screen, refer to the illustration above.

\* 75PFL6621 comes with the Stand pre-installed.

# 3 Getting Started

## Features

- **DTV / Analog TV / CATV**  
You can use your Remote Control to Select channels which are Broadcast in Digital format and conventional Analog format. Also, Cable and Satellite subscribers can access their TV channels.
- **Information display**  
This Unit Automatically scans and memorizes channels available in your area, Eliminating difficult Setup procedures.
- **Autoprogram**  
This feature allows you to Block children's access to inappropriate Programs.
- **Closed Caption decoder**  
Built-in Closed Caption decoder displays text for Closed Caption supported Programs.
- **MTS / SAP tuner**  
Audio can be selected from the Remote Control.
- **Auto Standby**  
If there is No Input Signal and No Operation for 15 minutes, the Unit will go into Standby mode Automatically.
- **Sleep Timer**  
You can set the Unit to go into Standby mode after a specific amount of time.
- **Choices for On-screen language**  
Select your On-screen language: English, Spanish or French.
- **Stereo sound function**
- **PLL frequency synthesized tuning**  
Provides free and easy channel selection and lets you tune directly to any channel using the number and decimal point "\*" keys on the Remote Control.
- **Various adjustments for Picture and Sound**  
Customizes picture quality suitable for your room and sets your sound preference.
- **EasyLink via HDMI link**  
EasyLink allows your other HDMI link devices to be controlled by the HDMI cable connected to your TV.
- **HDMI Input**
- **HDMI-DVI Input**  
If your Video Device has a DVI Output jack, use an HDMI-DVI Conversion Cable to connect the Unit.
- **Component Video Input**
- **PC Input**
- **AV Input**  
Audio and Video Input from an External Device.
- **USB terminal**  
The Picture, Music and Video files stored on a USB Memory Stick can be played back on this unit.
- **Digital Audio Output**
- **Headphone Audio Output**  
Headphone 3.5mm Stereo jack for personal listening.

## Supplied Accessories

User Manual

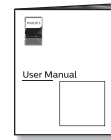

Quick Start Guide



Caution Sheet



Google Cast Setup Guide  
for Initial Installation



TV base and Screws \*

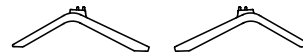

Screws packed with 65PFL6621 is;  
M4 x 14mm (0.551" ) x 4pcs.

\* 75PFL6621 comes with the Stand  
pre-installed.

Remote Control  
and Batteries  
(AAA, 1.5V x 2)

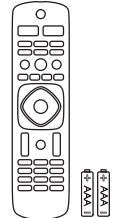

### Note(s)

- If you lose the Screws, please purchase the above-mentioned Phillips head Screws at your local store.
- If you need to replace these accessories, please refer to the part name or No. with the illustrations and call our toll free customer support line found on the cover of this User Manual.

#### When using a Universal Remote Control to operate this Unit.

- Make sure the component code on your Universal Remote Control is set to our brand. Refer to the instruction book accompanying your Remote Control for more details.
- We Do Not guarantee 100% interoperability with All Universal Remote Controls.

## Symbols used in this User Manual

The following is the description for the symbols used in this User Manual.  
Description refers to:

Digital TV Operation

Cable / NTSC (Analog) TV Operation

- If neither symbol appears, the operation is applicable to both.

## Unpacking

It is recommended that two or more people remove the TV set from the box. Be careful not to injure your fingers and keep children away during assembly.

(75PFL6621)

- 1 Open the top flaps of the box.

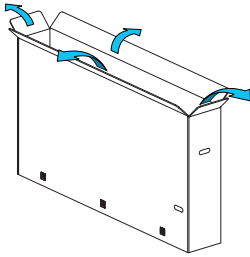

- 2 Remove all Accessories.

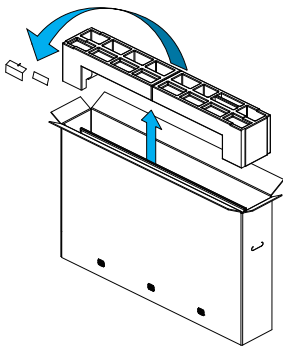

### ! Caution(s)

- DO NOT take the TV set out of the box yet.

- 3 Remove the packing joints from the box.

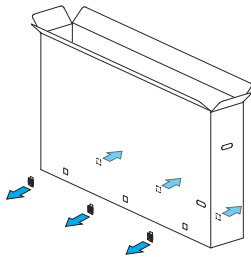

- 4 Remove the outer slipbox with care.

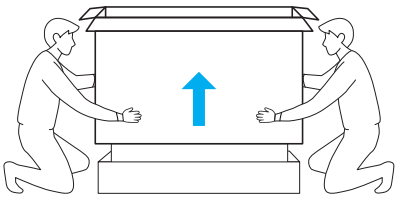

- 5 Unfold the left and right side of the bottom packaging.

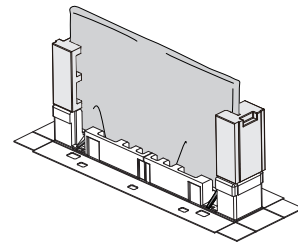

- 6 Remove the left and right side of the polystyrene foams.

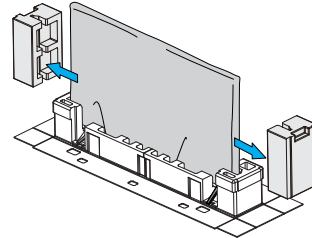

- 7 When removing the bottom packaging, support both sides of the TV set to prevent it from falling.

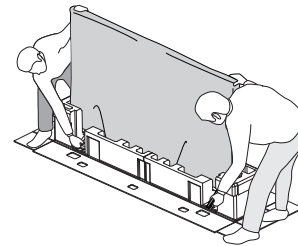

- 8 Remove the tape on the bottom of the TV set and the plastic bag.

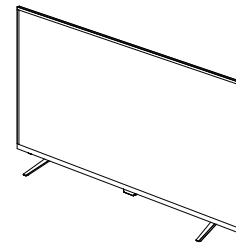



(65PFL6621)

- 1 Open the top flaps of the box.

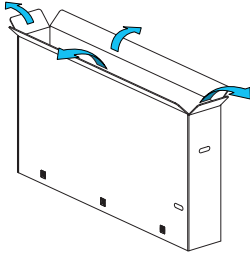

- 2 Remove all Accessories.

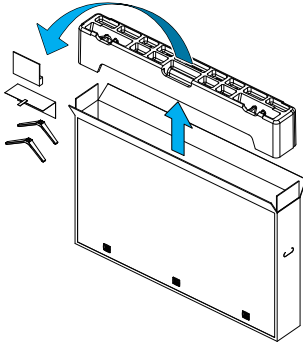

**!** Caution(s)

- DO NOT take the TV set out of the box yet.

- 3 Remove the packing joints from the box.

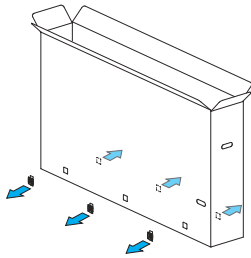

- 4 Remove the outer slipbox with care.

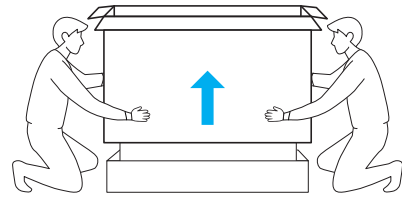

- 5 Prepare a table and cover the top of it with a table cloth, blanket or such to avoid damage to the TV set. Support both sides of the TV set and, move it onto the table.

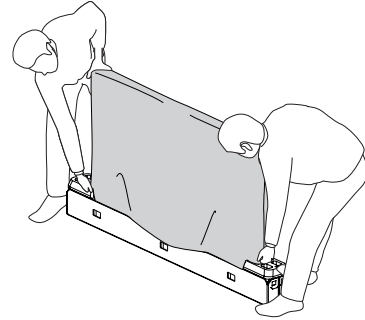

- 6 Carefully lay the TV set, with the screen side down, on the table.

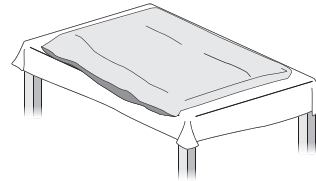

## Installing the Stands

(65PFL6621 Only)

- 1 Remove the tape on the bottom of the TV set and the plastic bag.

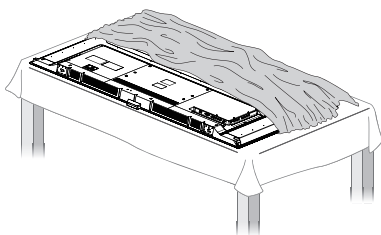

- 2 Fasten the matching stand to the TV with 2 screws (included). While fastening the screws, hold the stand to prevent it from falling. Also, make sure to attach the stand parallel to the bottom of the TV set, as shown in the enlarged illustration.

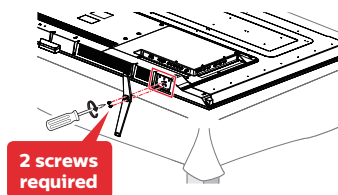

- 3 Fasten the other stand to the TV with 2 screws. While fastening the screws, hold the stand to prevent it from falling.

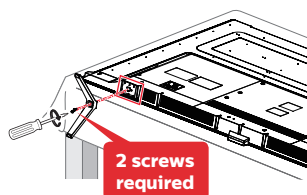

- 4 Both stands should now be securely fastened.

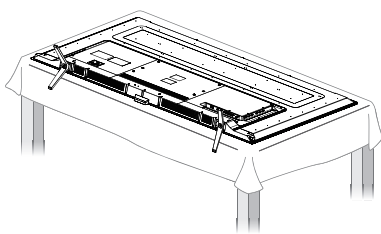

### Note(s)

- A wide open space is recommended for assembly.
- A Phillips-head screwdriver is required to fasten the stands to the TV set.
- When attaching the Stand, ensure that All Screws are tightly fastened. If the Stand is not properly attached, it could cause the Unit to fall, resulting in injuries as well as damage to the Unit.
- To remove the Stand from this Unit, unscrew the Phillips-head screws by reversing the procedure. Be careful not to drop the Stand when you remove it.

## Lifting the TV Set

Carefully lift the TV set as shown in the illustration and place it onto a stable, level surface.

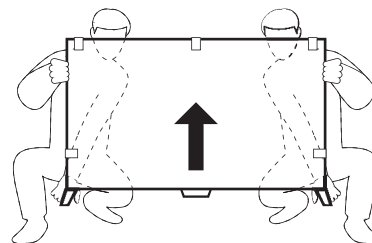

## Removing Cardboard

Remove the cardboard attached to the screen. You are now ready to set up and enjoy your Philips TV.

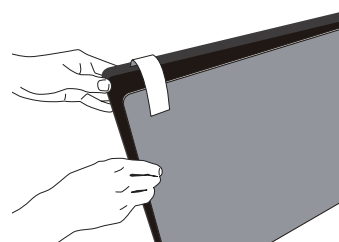

## Installing the Remote Control Batteries

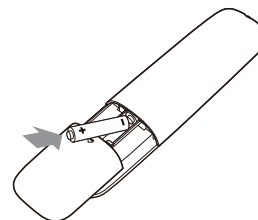

- 1 Slide the battery cover off the back of the Remote Control.
- 2 Insert the two supplied batteries (AAA, 1.5V). Be sure the + and – ends of the Batteries line up with the markings inside the case.
- 3 Slide the cover back into position.

### Note(s)

- Remove the Batteries if not using the Remote Control for an extended period of time.

## Remote Control

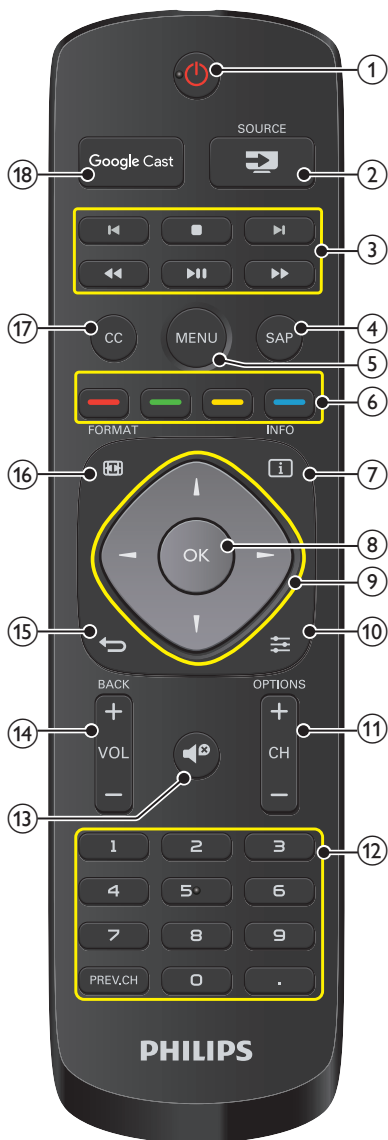

- ① **⏻ (POWER)**  
Turns the TV On from Standby or Off to Standby.
- ② **➔ SOURCE**  
Selects Connected devices.
- ③ **EasyLink buttons**
  - ⏮/⏭ : Searches Backward or Forward through the disc.
  - ⏸ : Starts, pauses or resumes playback.
  - : Stops the Disc playback.
  - ⏮/⏭ : Skips Backward or Forward Chapters, Titles or Tracks on a Disc.

### Note(s)

- Pause may not work properly on some devices even if they are EasyLink (HDMI CEC) compliant.

- ④ **SAP**  
Selects Audio mode (MONO / STEREO / SAP) / Audio language.
- ⑤ **MENU**  
Displays the main menu.
- ⑥ **Apps buttons**  
Works as direct access to user specified net apps.
- ⑦ **i INFO**  
Displays Information about the current program.
- ⑧ **OK**  
Press to decide the command of setting when the Main menu is displayed.
- ⑨ **▲▼◀▶ (NAVIGATION buttons)**  
Moves the cursor, Selects the On-screen Menu items.
- ⑩ **☰ OPTIONS**  
Displays a list of menu items applicable to the highlighted object or screen.
- ⑪ **CH + / -**  
Selects a Channel.
- ⑫ **0 - 9 (NUMBER buttons)**  
Used to enter a Channel / Program number.
  - **(DOT)** : Use with **0-9** to Select digital channels. For example, to enter 2.1, press

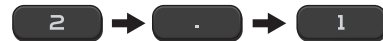

**PREV.CH** : Returns to the previously viewed Channel.

- ⑬ **🔇 (MUTE)**  
Turns the Sound On and Off.
- ⑭ **VOL + / -**  
Adjusts the Volume.
- ⑮ **↶ BACK**  
Returns to the previous Menu operation.
- ⑯ **🖼️ FORMAT**  
Adjusts the Picture size on the TV screen.
- ⑰ **CC**  
Selects Closed caption settings (**Off, On, CC w/ mute**).
- ⑱ **Google Cast**  
Switches to Google Cast input source.

## Control Panel

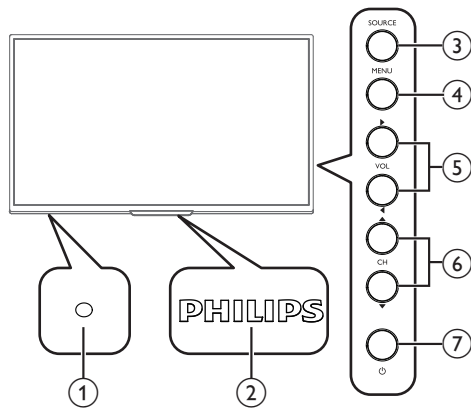

- ① **Remote Control Sensor**  
Receives IR signal from Remote control.
- ② **Power On / Standby Indicator**  
(On : lights in white, Standby : no light)
- ③ **SOURCE**  
Selects Connected Devices.
- ④ **MENU**  
Opens the Main On-screen Menu.
- ⑤ **VOL ◀/▶**  
Adjusts the Volume. In the Menu screen, moves the Cursor Left (◀) / Right (▶).  
VOL ◀ : Volume Down  
VOL ▶ : Volume Up
- ⑥ **CH ▲/▼**  
Selects a Channel. In the Menu screen, moves the Cursor Up (▲) / Down (▼).
- ⑦ **⏻ (POWER)**  
Turns the TV On and Off.

## Terminals

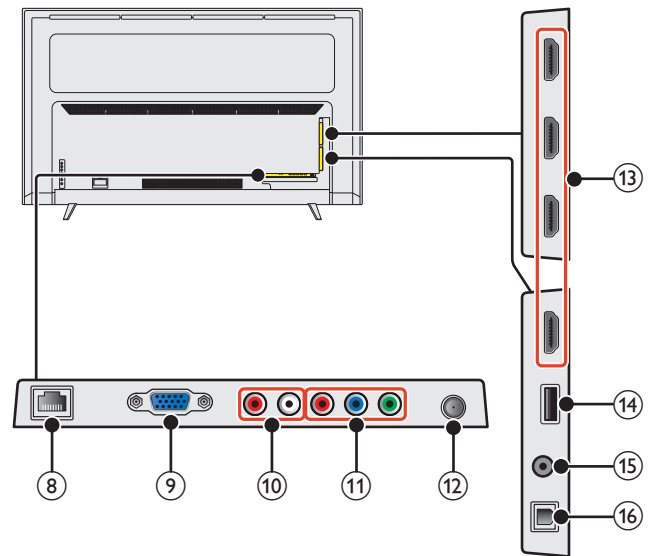

- ⑧ **Ethernet port**  
For Internet connection using an Ethernet Cable with an RJ-45 connector.
- ⑨ **PC Input jack**  
VGA cable connection for PC.
- ⑩ **Analog Audio (L/R) Input jacks**  
Connect Analog Audio signals from;
  - HDMI-DVI / Analog Audio (L/R) jacks signal
  - Component Video / Analog Audio (L/R) jacks signal
  - Composite Video / Analog Audio (L/R) jacks signal
  - PC Connection / Analog Audio (L/R) jacks signal with Stereo mini 3.5mm plug Audio cable on PC
- ⑪ **Component (Y/Pb/Pr) / Composite Video (VIDEO) Input jack(s) for VIDEO**  
Composite Video Input (VIDEO) jack is a shared jack with Component Video Input (Y) jack. Green / Yellow color orientation depends on model.
- ⑫ **75 ohm Cable / Antenna connection**  
Signal Input from an Antenna or Cable / Satellite Set-top Boxes.
- ⑬ **HDMI Input jack(s)**  
Digital Audio and Video Input from high definition Digital devices such as DVD / Blu-ray disc players, Cable / Satellite Set-top Boxes, PC's, etc.  
\* For HDMI 1 only  
In addition to normal HDMI and HDMI-DVI functionality, it outputs TV Audio to an HDMI-ARC-compliant device, such as a home theater system.
- ⑭ **USB terminal**  
Data Input from USB Memory Stick only.  
Do not connect any device to this terminal such as Digital camera, keyboard, mouse, etc.
- ⑮ **Headphone Audio Output jack**  
Headphone 3.5mm stereo jack for personal listening.
- ⑯ **Digital Audio Output jack**  
Digital Audio (S/PDIF) Output to home theaters and other Digital Audio systems.

## Connecting Antenna or Cable / Satellite / IPTV Set-top Box

Be sure your Antenna or another Device is connected properly before plugging in the AC Power Cord.

### If connecting to an Antenna through an RF cable

Any DTV Programs that are Broadcast in your area can be received for free through an Antenna Connection.

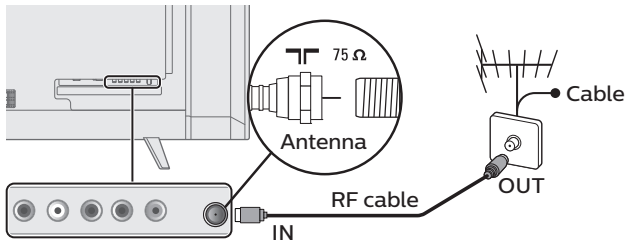

### If connecting Cable / Satellite / IPTV Set-top Box using an RF cable

If the TV is connected to a Cable or Set-top Box via a Coaxial Connection, set the TV to channel 3/4 or the channel specified by the service provider.

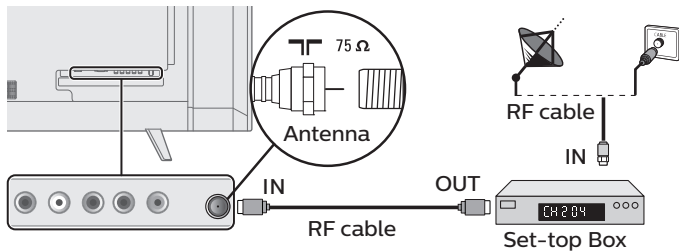

### If connecting Cable / Satellite / IPTV Set-top Box using an HDMI cable

If the TV is connected to a Cable / Satellite Set-top Box via an HDMI cable, make sure you select the correct Source by using **SOURCE**.

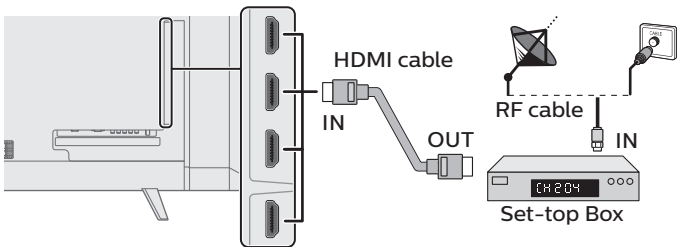

### If connecting Cable / Satellite / IPTV Set-top Box using Component Video Input

If the TV is connected to a Cable / Satellite Set-top Box via Component Video Input, make sure you select the correct Component Video Source by using **SOURCE**.

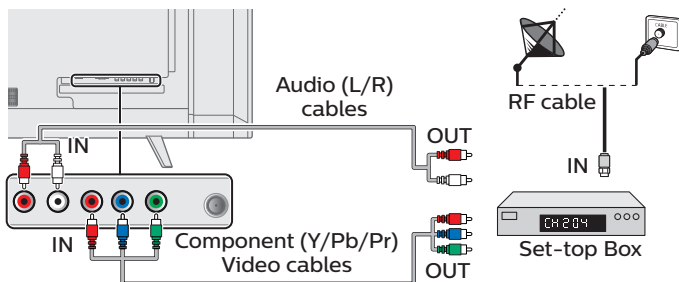

## Connecting a Cable / Satellite / IPTV Set-top Box, Blu-ray Disc / DVD Recorder via Composite Connectors and Analog Audio

Do Not place your Recorder too close to the Screen because some Recorders can be susceptible to harmful interference from the TV.

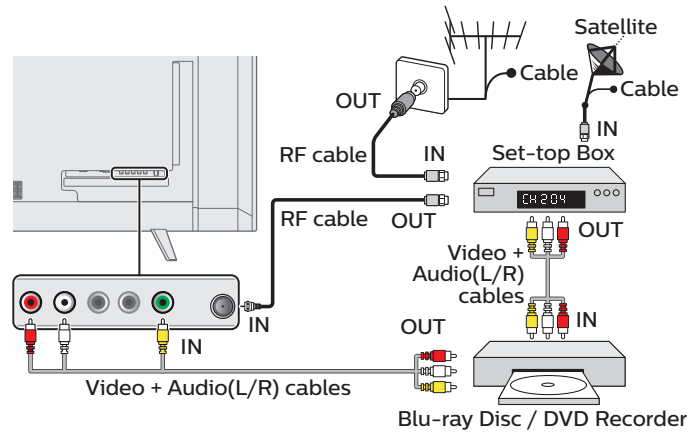

### Note(s)

- If you have any question about the DTV's Antenna, visit [www.antennaweb.org](http://www.antennaweb.org) for further information.
- Depending on your Antenna system, you may need different types of combiners (mixers) or separators (splitters) for HDTV Signal. The minimum RF bandpass on these Devices is 2,000MHz or 2GHz.
- For your safety and to avoid damage to this Unit, please unplug the RF Coaxial Cable from the Antenna Input jack before moving the Unit.
- If you did use an Antenna to receive Analog TV, it should also work for DTV reception. Outdoor or attic Antennas will be more effective than a Set-top Box or inside Antenna.
- To Turn On your reception source easily between Antenna and Cable, Install an Antenna selector.
- If you are not receiving a Signal from your Cable service, contact the Cable provider.

## Plugging in the AC Power Cord

Make sure that the AC power cord must be plugged to an AC outlet after all the necessary connections are made.

### Caution(s)

- Connect the Analog Audio signal cables from the external device to the Analog Audio L/R Input jacks.
- If you have an amplifier, connect the HDMI cable to the HDMI input via your amplifier.

### Note(s)

- Each time you plug in the AC Power Cord, no operations will be performed for several seconds. This is not a malfunction.

**No supplied cables are used with these connections:**

- Please purchase the Necessary Cables at your local store.

**Before you connect the AC Power Cord:**

Be sure other Devices are connected properly before plugging in the AC Power Cord.

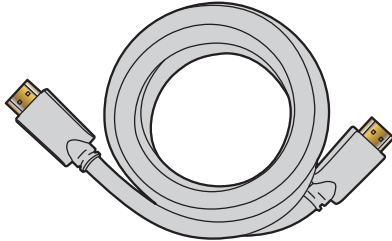
**Selecting your Connection quality****HDMI - Highest quality**

Supports high-definition Digital signals and gives highest picture and sound quality. Video and Audio signals are combined in one cable. You must use HDMI for full high-definition Video and to enable EasyLink(HDMI CEC).

**Note(s)**

- Philips HDMI supports HDCP (High-bandwidth Digital Contents Protection). HDCP is a form of Digital Rights Management that protects High-Definition content in Blu-ray Discs or DVDs.
- The HDMI-ARC connector on the TV features HDMI-ARC functionality. This allows output of TV Audio to an HDMI-ARC-compliant Device.

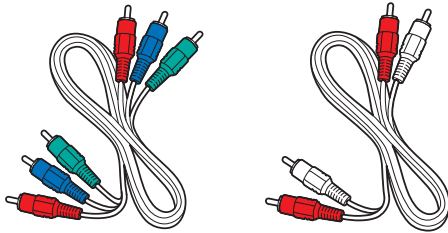
**Component (Y Pb Pr) - High quality**

Supports High-Definition Analog signals but gives lower picture quality than HDMI. Component (Y/Pb/Pr) Video cables combine red / green / blue Video cables with red / white Audio (L/R) Cables. Match the cable colors when you connect to the TV.

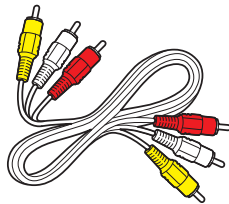
**Composite - Basic quality**

For Analog Connections. Composite Video / Audio Analog cable usually combine a yellow Video Cable with red / white Audio (L/R) Cables. With this Unit, yellow cable must be connected to Y (green) jack on the Component Video Input jacks.

**Connecting your Devices****HDMI Digital Connection**

HDMI Connection offers the Highest Picture quality. HDMI (High-Definition Multimedia Interface) transports High-Definition Digital Video and multi-channel Digital Audio through a single cable.

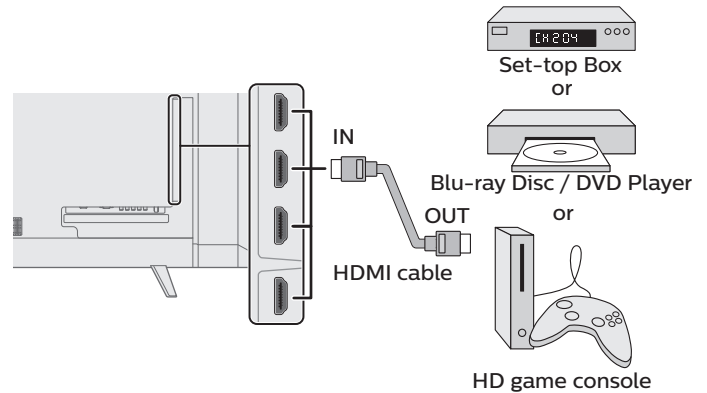
**Note(s)**

- If there are issues with picture/color and/or sound when connecting an external device using the HDMI port, please try switching the **HDMI mode** (Refer to **HDMI mode** → p. 35)
- Some HDMI cables and devices may not be compatible with the TV due to different HDMI specifications.
- Use an HDMI cable with the HDMI logo (a certified HDMI cable). High Speed HDMI cable is recommended for the Better compatibility.
- The Unit accepts 480i / 480p / 720p / 1080i, 1080p, 2160p 24/30/60Hz of Video signals, 32kHz / 44.1kHz and 48kHz of Audio signals.
- This Unit accepts LPCM, AC-3, DD+ Audio signal.
- This Unit accepts only signals in compliance with EIA861.

**HDMI-DVI Connection**

This Unit can be connected to your Device that has a DVI Terminal. Use an HDMI-DVI Conversion Cable for this Connection and it requires Audio Cable for Analog Audio signal as well.

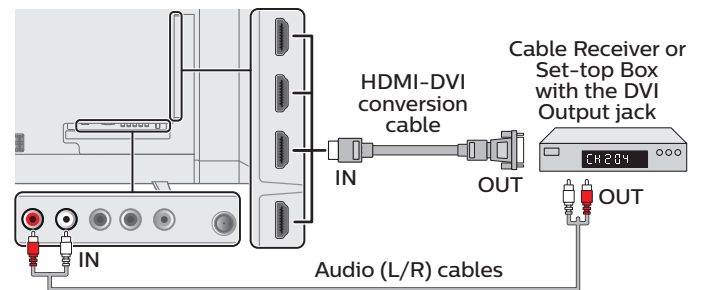
**Note(s)**

- Some HDMI cables and devices may not be compatible with the TV due to different HDMI specifications.
- Use an HDMI cable with the HDMI logo (a certified HDMI cable). High Speed HDMI cable is recommended for the Better compatibility.
- The Unit accepts 480i, 480p, 720p, 1080i, 1080p and 2160p Video signals.
- HDMI-DVI Connection requires separate Audio Connections as well and the Audio signals are Output as Analog (L/R) Audio.
- DVI does not display 480i image which is not in compliance with EIA/CEA-861/861B.

## HDMI-ARC Connection

HDMI-ARC allows you to use EasyLink to output TV Audio directly to a connected Audio device, without the need for an additional Digital Audio cable.

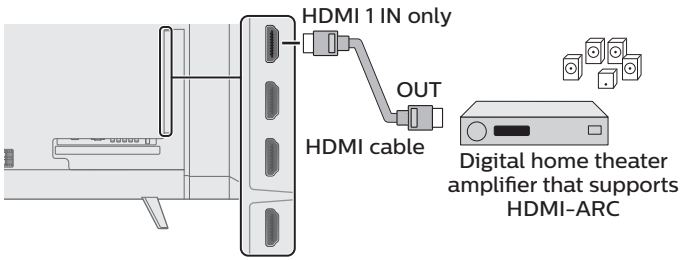

### Note(s)

- The HDMI 1 connector is HDMI Audio Return Channel (ARC) compliant. Use it to output Digital Audio to an HDMI home theater system.
- Be sure that the device is HDMI CEC and ARC compliant and that the TV is connected to the device using an HDMI cable attached to HDMI-ARC connectors.

## Component Analog Video Connection

Component Analog Video Connection offers Better Picture quality for Video Devices connected to the Unit.

If you connect to the Unit's Component Video (Y/Pb/Pr) Input jacks, connect Analog Audio Cables to the Analog Audio (L/R) Input jacks.

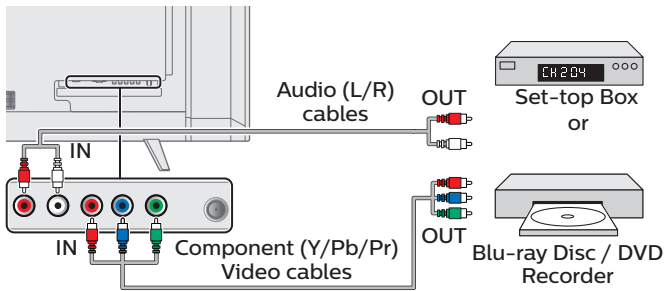

### Note(s)

- The Unit accepts 480i, 480p, 720p, 1080i and 1080p of Video signals for this Connection.

## Composite Analog Video Connection

Composite Analog Video Connection offers Standard Picture quality for Video Devices connected to the Unit.

If you connect to the Unit's Component/Composite Video (Y/VIDEO) Input jack (green), connect Audio Cables to the Audio (L/R) Input jacks. When the Audio is monaural, then only connect to the Audio L Input jack.

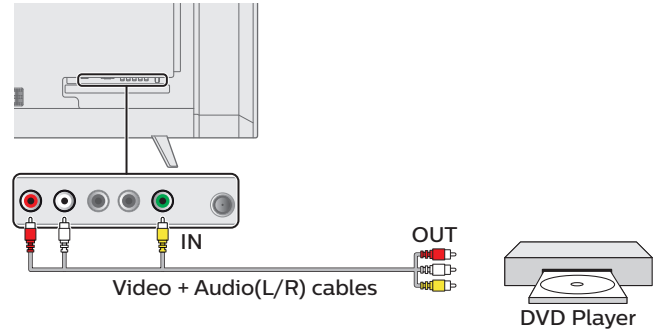

### Note(s)

- With this Unit, yellow cable must be connected to Y (green) jack on the Component Video Input jacks.
- Whenever you connect to the Composite Video Input jack (Y/VIDEO), you must disconnect the Component Video Input jacks (Pb and Pr). If you leave those jacks connected, it may cause an unstable picture.

## Connecting the TV to the Internet using an Ethernet cable

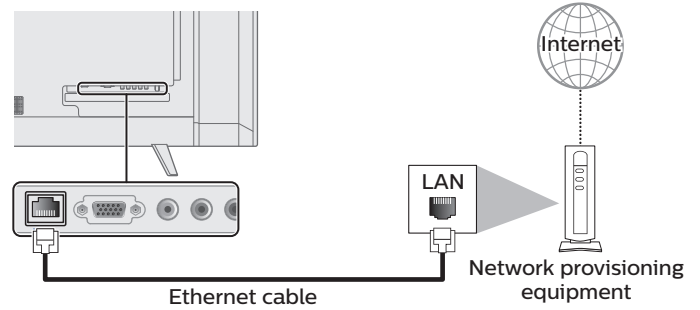

### Note(s)

- Please purchase Shielded Ethernet Cables at your local store and use them when you Connect to Network equipment.
- Do not insert any cable other than an Ethernet Cable to the Ethernet port to avoid damaging the unit.
- If your telecommunications equipment (modem, etc.) does not have Broadband Router functions, connect a Broadband Router.
- If your telecommunications equipment (modem, etc.) has Broadband Router functions but there is no vacant port, then add a hub.
- For a Broadband Router, use a Router which supports 10BASE-T / 100BASE-TX.
- Do not connect your PC directly to the Ethernet port of this unit.

## Connecting the TV to the Internet using a Wireless LAN

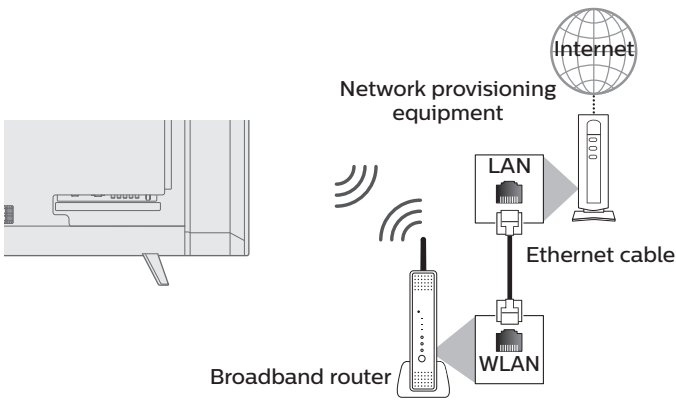

### Note(s)

- Use a Wireless LAN Access Point (AP) (e.g. Broadband Wireless Router) which supports IEEE 802.11 b/g/n. (n is recommended for stable operation of the wireless network)
- This unit does not support Ad-hoc mode.
- Other radio devices or obstacles may cause interference to the wireless network connection.

## Digital Audio Output Connection

If you connect this Unit to an External Digital Audio Device, you can enjoy multi-channel Audio like 5.1ch Digital Broadcasting sound.

Use a Digital Audio Optical Cable to connect the Unit to External Digital Audio Devices.

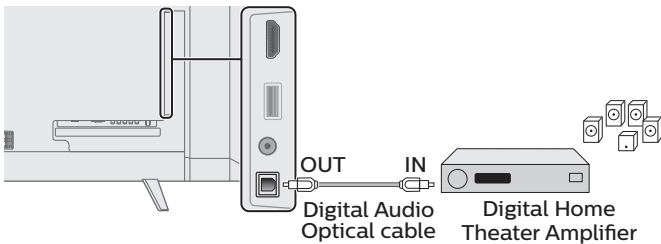

## PC Connection

### HDMI Connection

This Unit can be connected to your PC that has an HDMI terminal. Use an HDMI cable for this Digital Connection.

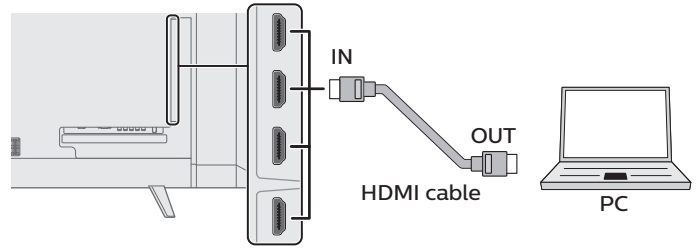

### HDMI-DVI Connection

This Unit can be connected to your PC that has a DVI Terminal. Use an HDMI-DVI Conversion Cable for this Video Digital Connection and it requires Stereo mini 3.5mm Plug Audio Cable for Analog Audio signal as well.

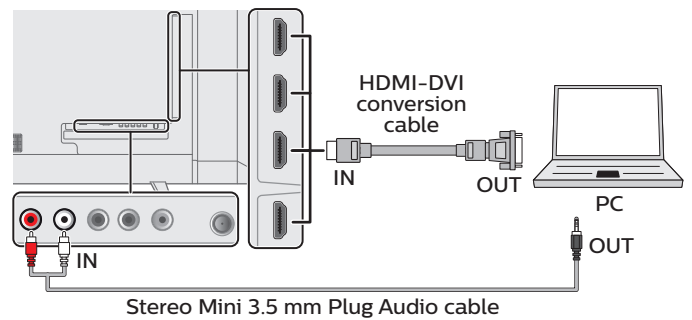

### VGA Connection

This unit is equipped with a PC Input jack. If you connect this Unit to your PC, you can use this Unit as a PC monitor.

Use a VGA cable for this Video Connection and it requires a Stereo mini 3.5mm Plug Audio Cable for Analog Audio signal as well.

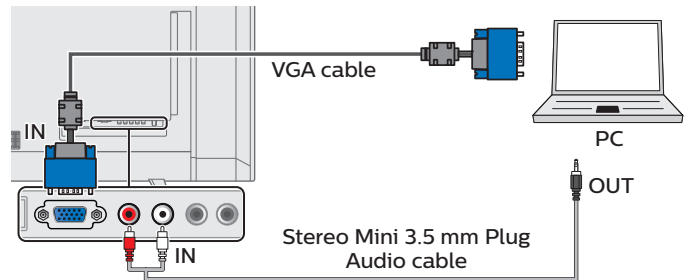



The following PC-Input Video signals can be displayed:

Format	Resolution	Refresh rate
VGA	640 x 480	60Hz
SVGA	800 x 600	
XGA	1,024 x 768	
WXGA	1,280 x 768	
	1,360 x 768	
FHD	1,920 x 1,080	24/30/60Hz *2
UHD *1	3,840 x 2,160	
	4,096 x 2,160	

Other formats or non-standard signals will not be displayed correctly.

\*1 UHD format is available only when using the HDMI Connection and HDMI-DVI Connection.

\*2 Refresh rate for VGA Connection is only 60Hz.

#### Note(s)

- Please purchase a VGA cable that has a ferrite core (0.6 inches (15mm) or more in diameter).
- Please purchase a HDMI-DVI Conversion Cable that has a ferrite core.
- The following operations may reduce noise.
  - Attach a ferrite core to the AC Power Cord of your PC.
  - Unplug the AC Power Cord and use the built-in battery of your Portable / Laptop PC.
- Some HDMI cables and devices may not be compatible with the TV due to different HDMI specifications.
- Use an HDMI cable with the HDMI logo (a certified HDMI cable). High Speed HDMI cable is recommended for the Better compatibility.
- The Unit accepts 480i, 480p, 720p, 1080i, 1080p and 2160p Video signals only when using the HDMI Connection and HDMI-DVI Connection.
- HDMI-DVI Connection requires separate Audio Connections as well and the Audio signals are Output as Analog (L/R) Audio.
- DVI does not display 480i image which is not in compliance with EIA/CEA-861/861B.

## USB Memory Stick

This unit offers easy playback of Picture, Music and Video files.

Insert the USB Memory Stick into the USB terminal shown below.

USB → p. 25

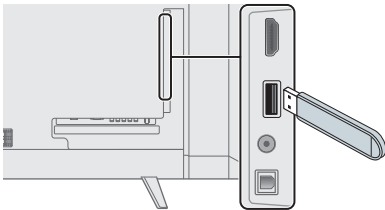

#### Note(s)

- The Unit recognizes only a USB Memory Stick.
- Do Not use a USB hub or an extension cable to connect an External hard disk drive to the Unit. (Not Supported.)
- Always insert a USB Memory Stick directly to this Unit.
- A USB Memory Stick is Not Supplied with this Unit.
- We Do Not guarantee that All USB Memory Sticks can be supported by this Unit.
- Be sure to keep a Backup Copy of the Original files on your USB device before you Play them back on this Unit. We have no responsibilities for damage or loss of your USB Stored Data.
- To protect your USB Memory Stick files from being erased place the write protect sliding tab in the protect position (if available).
- When you are ready to remove a USB Memory Stick, set the Unit to go into Standby mode to avoid any damage to your data and the Unit.
- A USB Memory Stick that requires its own driver or the Device with a special system such as fingerprint recognition are Not Supported.
- This unit is not allowed to use the USB Memory Stick which requires an External Power Supply (500mA or more).

*These Operations are accessible by Remote Control.  
Some may also be accessible by the Main Unit's Control Panel.*

## TV Initial Setup



This section will guide you through the Unit's Initial setting which includes selecting a Language for your On-screen Menu, country, location and Autoprogram, which Automatically scans and memorizes viewable channels. You can also set the network connection in this setting.

### Before you begin:

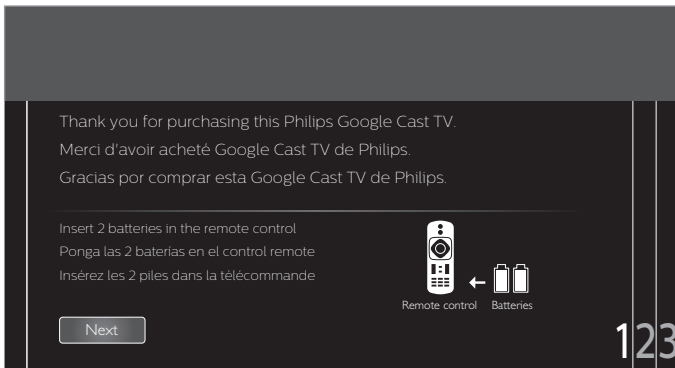

Make sure the Unit is connected to an Antenna or Cable.

- 1 After making All the Necessary Connections, press  to Turn On the Unit.
  - It may take a few moments to Turn On the Unit for the first time.
  - **TV Initial Setup** menu appears Automatically after the Unit is Turned On.
- 2 Follow the On-screen Instructions to begin your TV Initial Setup.



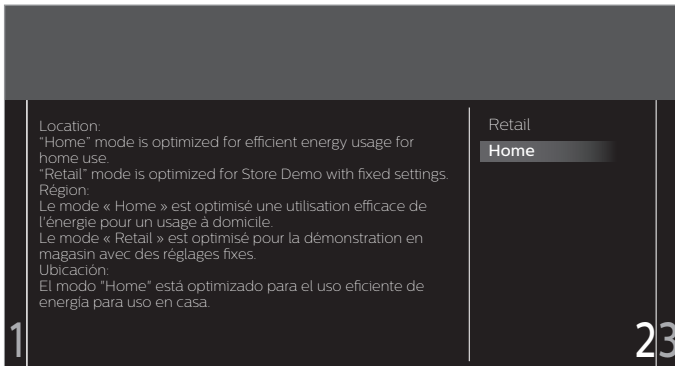





- 3 Use   to Select the location in the middle of the TV screen, then press **OK**.

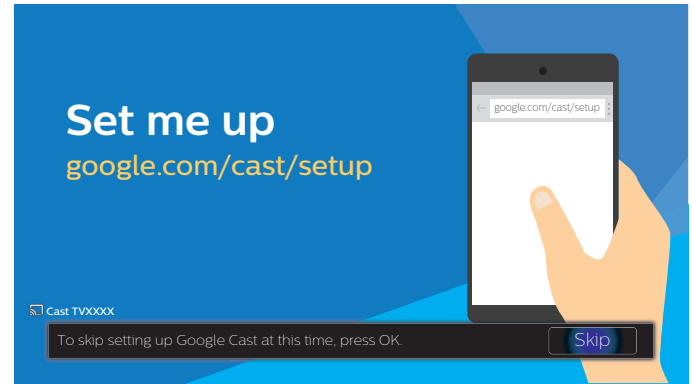

- Selecting **Location** to **Retail** will display Retail Demo on the Screen. If you wish to turn off this demo in a retail environment, please refer to **Retail Demo**  **p. 35**.
- 4 Use   to Select the standby mode in the middle of the TV screen, then press **OK**.
    - **Active standby** enables the TV to turn On fast, whereas **ECO standby** is low energy consumption mode.

- 5 After the standby mode setting is completed, Google Cast Setup screen will appear.



- For Google Cast Setup, refer to **Google Cast Setup**  **p. 20**.
  - Google cast is controlled from devices on the same Wi-Fi network, such as smartphones, tablets, or computers.
  - After Google Cast Setup is completed, if you press any button except Google cast (button), TV Initial Setup resumes.
- 6 In Google Cast Setup screen, if you press **MENU**, Select **OK** and Press **OK** to continue with the TV Initial Setup.
  - 7 Use   to Select the on-screen language and TV placement in the middle of the TV screen, then press **OK**.
  - 8 Use   to Select the signal type.
    - If the TV is connected to a Cable or Satellite Set-top Box, select the 2nd one and skip to step **9**.

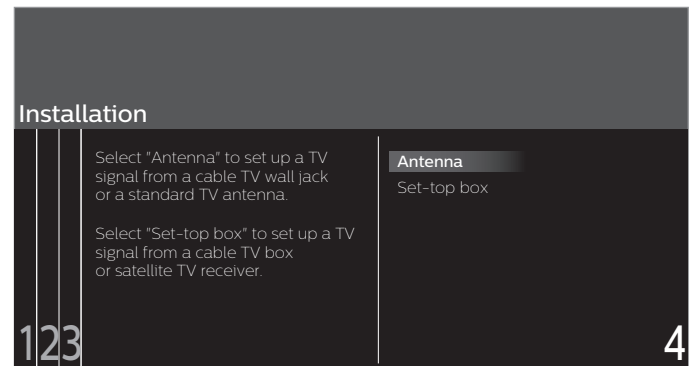

- 9 Use ▲▼ to Select **Antenna** for TV channels or **Cable** for CATV channels, then press **OK**.

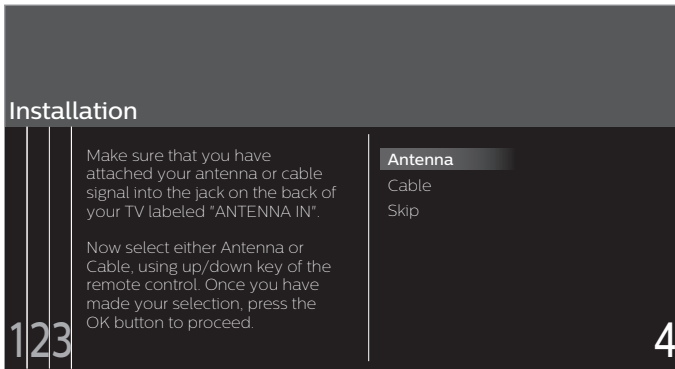

- When **Antenna** is selected, the TV detects Antenna signals. It searches for DTV and Analog TV channels available in your area.
- When **Cable** is selected, the TV detects signals supplied by cable. It searches for DTV, Analog TV and Cable channels available in your area.
- Auto programming will begin.

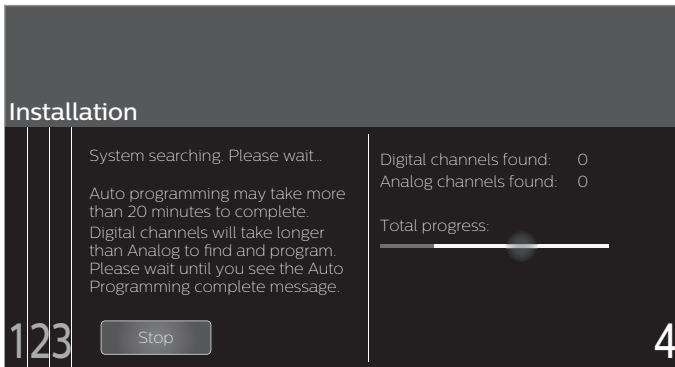

- 10 Use ▲▼ to Select your preferred picture setting, then press **OK**.

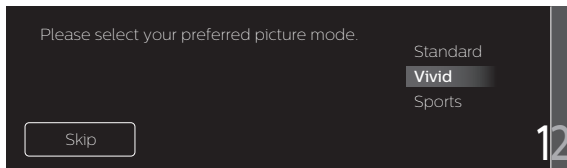

- 11 Use ▲▼ to Select your preferred sound setting, then press **OK**.

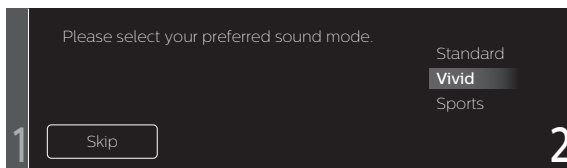

- 12 After **TV Initial Setup** is completed, A message will appear if there is the latest software on the network server.

#### ☰ Note(s)

- If you are not receiving a signal from your Cable service, contact the Cable provider.
- If you press ⏻ during autoprogram, this setup of TV channels will be cancelled.
- The Initial Autoprogram function can be executed for either **Antenna** or **Cable** only once. When you change the connection (Antenna / Cable), select **Search for channels** again. → p. 37

#### **After an TV Initial Setup is completed...**

- If you want to scan the channels Automatically again.  
**Search for channels** → p. 37
- If you want to change to another Language.  
**Language** → p. 34
- If you want to change the Location setting.  
**Location** → p. 35
- If you want to restore the picture and sound setting.  
**Picture and sound setup** → p. 29
- If you want to change the Google cast setting.  
**Google Cast Setup** → p. 20

# Google Cast Setup

## Needed for Google Cast Setup

- iOS or Android smartphone / tablet with Bluetooth and Location services on.
- Have your Wireless Router's SSID and Password handy.

### 1 During TV Initial Installation

- As the TV Initial Installation proceeds, the "Set me up" screen for Google Cast Setup will appear. Refer to the Step 4 in **TV Initial Setup** → p. 18.
- **From here on, you need to use your Mobile Device to set up Google Cast.**

### 2 App Download/Installation

- On your mobile device, access the URL to download and install the Google Cast App.  
<http://www.google.com/cast/setup>



### 3 App Configuration

- Run the Google Cast App. Select "DEVICES", then select the same device name (CastTV\*\*\*\*) as the one shown at the bottom left corner of the TV screen.

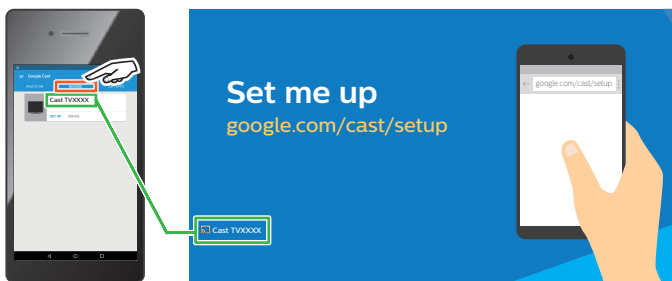

- The "SET ME UP" button appears on your mobile device. **Pressing it moves to the 4-letter code screen.** Confirm that the code on your mobile device matches the code shown on the TV screen. If they match, press the "I see the Code" button on your mobile device.

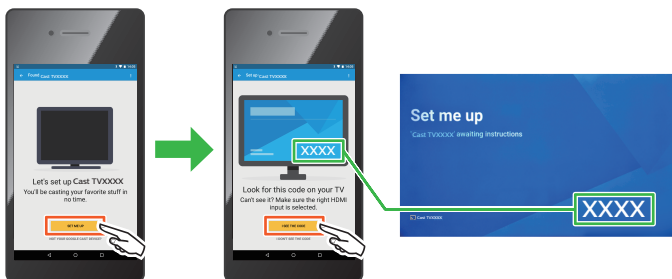

### 4 Network Configuration

- The "SET NAME" button appears on your mobile device, complete settings on this screen and then touch "SET NAME" to proceed. Pressing it moves to the Wireless Network setting screen. Select your wireless network name (SSID) and enter the password to proceed.

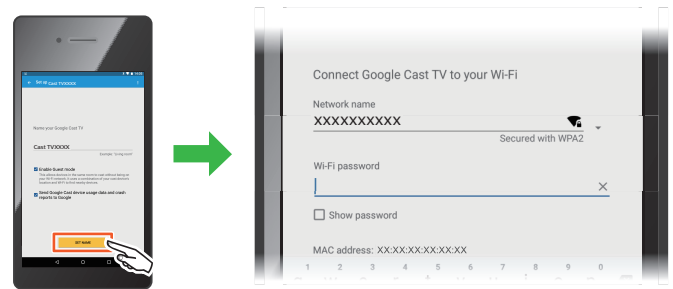

### 5 Ready to Cast

- Google Cast Setup has completed. Now, your TV is ready to receive a Cast from your mobile device. If a newer firmware is available, update will start.

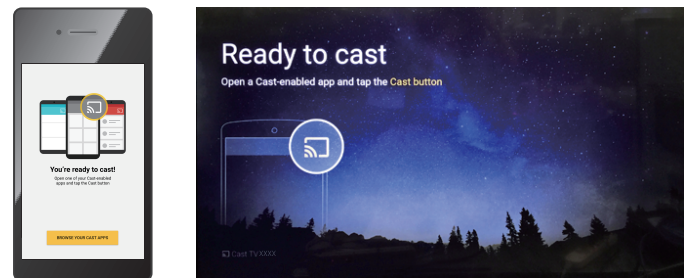

### 6 Casting a Video

- On a Cast-enabled App such as YouTube™, tap the Cast icon to cast the video to your TV.



### 7 For TV Viewing

- In order to view TV, the TV Initial Installation needs to be completed after the Google Cast Setup. On the TV Remote Control, press **SOURCE** and select any Input other than **Google Cast**. The screen will switch to the selected source and prompt you to complete the remainder of the Initial Setup Wizard.

**Note(s)**

- For more info, [www.google.com/cast/learn/](http://www.google.com/cast/learn/)  
[www.philips.com/support](http://www.philips.com/support)

## 4 Use your TV

### Switching on your TV and putting it in Standby mode

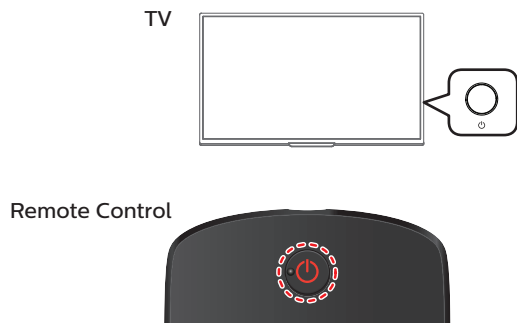

#### To Turn the TV On from Standby or Off to Standby

- Press on the Side panel or the Remote Control.

#### Note(s)

- Energy Consumption contributes to air and water pollution. When the AC Power Cord is plugged in, your TV consumes energy with a very low Standby Power Consumption.

### Adjusting Volume

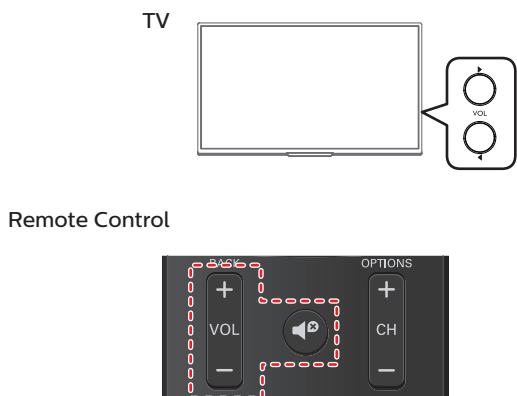

#### To decrease or increase Volume

- Press **VOL** / on the Side panel or press **VOL + / -** on the Remote Control.

**VOL** (-): Volume Down

**VOL** (+): Volume Up

#### To mute or unmute sound

- Press on the Remote Control to mute the sound.
- Press again or **VOL + / -** to recover the original sound.

### Switching Channels

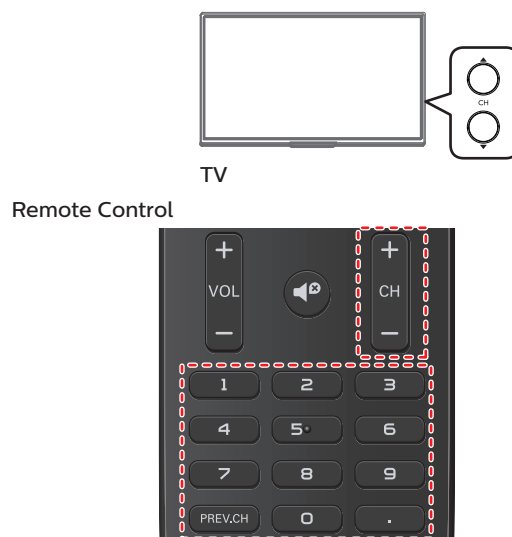

#### To Select Channels by using CH / or CH + / -

- Press **CH** (Up) / (Down) on the side panel or press **CH + / -** on the Remote Control.

#### To Select Channels by using the NUMBER buttons

##### Digital TV Operation

- For Digital channels, press a number followed by a dot “.” and the corresponding sub channel number.

– When selecting Digital channel 11.1

Be sure to press **.** before entering the subchannel number.



##### Cable / NTSC (Analog) TV Operation

– When selecting Cable or Analog channel 11



Press **PREV.CH** to return to the previously viewed channel.

#### Note(s)

- To Select the non-memorized channels, use the **NUMBER** buttons
- **Channel not available** or **No signal** will appear on the TV screen after the subchannel broadcast is over.
- **Audio only** message will appear on the TV screen, when you receive only sound signal.

## Watching Channels from an External Device

Switching Each Input Mode can easily switch with the Remote Control between TV and external devices when they are connected to the unit.

- 1 Turn On the Set-top Box or the Connected Device.



- 1 Press **SOURCE** and use **◀▶** to Select the Set-top Box or the Connected Device and wait a few seconds till the Picture appears.

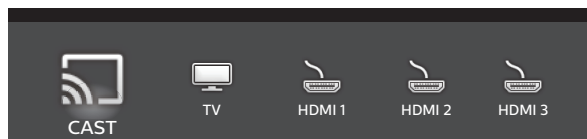

- 2 Use the Remote Control of the Set-top Box or the Connected Device to Select Channels.

## Lock or unlock your device from the menu

This section describes how to lock or unlock specified device.

- 1 Press **SOURCE** on the Remote Control.
- 2 Use **◀▶** to Select a device to lock or unlock.
- 3 Press **≡** **OPTIONS** on the Remote Control.
- 4 Use **▲▼** to Select **Lock** or **Unlock**, then press **OK**.
  - If device lock is unlocked, **Lock** will be displayed. If device lock is locked, **Unlock** will be displayed at the top right of the device icons.
- 5 Enter your PIN. **Change PIN** ➔ p. 39

## Changing device type

You can change device icons displayed in the source list.

- 1 Press **SOURCE** on the Remote Control.
- 2 Use **◀▶** to Select the desired device.
- 3 Press **red** button on the Remote Control.
- 4 Use **▲▼** to Select the desired type, then press **OK**.

### To reset the type

- Press **≡** **OPTIONS** on the Remote Control at step 3, then select **Original icon**.

## Scan connections

You can rescan TV connections and update the source list.

### Before you begin:

You must set **On** in **Master EasyLink** ➔ p. 36

- 1 Press **SOURCE** on the Remote Control.
- 2 Use **◀▶** to move the cursor to any device.
- 3 Press **≡** **OPTIONS** on the Remote Control.
- 4 Use **▲▼** to Select **Scan connections**, then press **OK**.

## Create a list of favorite channels

You can create lists of your preferred TV channels so that you can find those channels easily.

- 1 Press **OK** while viewing a TV program.
- 2 Use **▲▼◀▶** to Select the desired channel, then press **yellow** button.
- 3 Use **▲▼** to Select the desired favorite list (**Favorites 1 - Favorites 4**), then press **OK** to add or remove on the list of favorite channels.
  - indicates that the channel is added.
  - indicates that the channel is removed.
  - The channel will be marked with **◆** Icon.

## Display the list of favorite channels

- 1 Press **OK** while viewing a TV program.
  - 2 Use **▲▼◀▶** to Select **Favorites**
- To change the favorite list**
- 1 Press **blue** button.
  - 2 Use **▲▼** to Select the desired favorite list (**Favorites 1 - Favorites 4**).

### To remove a channel from the favorite list

- 1 Select the desired channel, then press **yellow** button.
- 2 Use **◀▶** to Select **Yes**, then press **OK**.

# Changing Picture Format

Display Modes can be Selected when your TV receives a 16:9 or 4:3 Video Signal.

Three types of Display Modes can be Selected for a PC Input Signal.

Press **FORMAT** Repeatedly to Switch the TV Aspect Ratio.



## For 16:9 Video signal (4096 x 2160p)

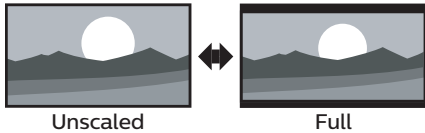

## For 16:9 Video signal (3840 x 2160p)

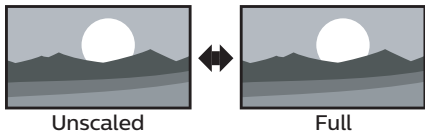

## For 16:9 Video signal (not 2160p)

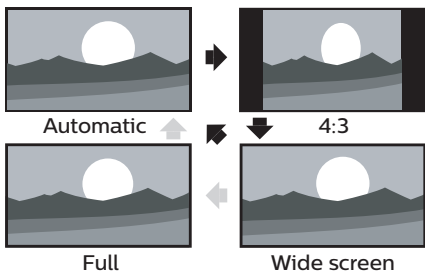

<b>Automatic</b>	Other than DTV and HDMI connected devices, enlarges the picture to Best fit the screen. DTV and HDMI connected devices display the picture at its original size. The subtitles may remain visible.
<b>4:3</b>	Displays a 16:9 picture at a 4:3 size; the picture is shortened horizontally. Sidebars appear on both edges of the screen.
<b>Wide screen</b>	Displays a 16:9 picture that is stretched horizontally and vertically.
<b>Unscaled</b>	Displays a 16:9 picture at its original size.
<b>Full</b>	Displays a scaled 16:9 picture. Bars appear on both the Upper and Lower portions of the screen depending on the type of video signal.

## For 4:3 Video signal

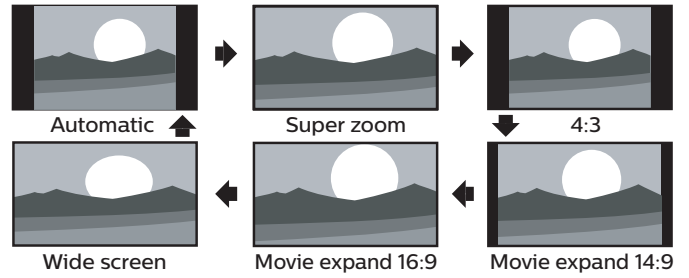

<b>Automatic</b>	Other than DTV and HDMI connected devices, enlarges the picture to Best fit the screen. DTV and HDMI connected devices display the picture at its original size. The subtitles may remain visible.
<b>Super zoom</b>	Displays a 4:3 picture at a 16:9 size; the picture is stretched horizontally and vertically and its left and right edges are enlarged. This crops out some of the top and bottom of the picture.
<b>4:3</b>	Displays a 4:3 picture at its original size. Sidebars appear on both edges of the screen.
<b>Movie expand 14:9</b>	Displays a 4:3 picture at a 14:9 size; the picture is stretched horizontally and vertically. This crops out some of the top and bottom of the picture. Sidebars appear on both edges of the screen.
<b>Movie expand 16:9</b>	Displays a 4:3 picture at a 16:9 size; the picture is stretched horizontally and vertically. This crops out some of the top and bottom of the picture.
<b>Wide screen</b>	Displays a picture that is stretched out of proportion to fill the screen.

## For PC Input signal

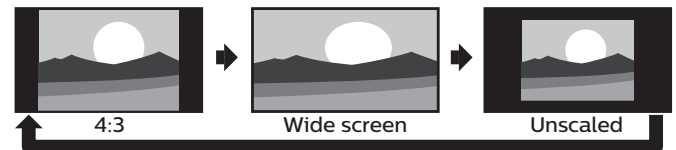

- This unit can also be connected to your PC that has a DVI Terminal. Use an HDMI-DVI Conversion Cable for this Video Connection and it requires Stereo Mini 3.5mm Plug Audio Cable for Analog Audio signal as well.
- Refer to 16:9 Video Signal on this page if the PC has HDMI Output.

<b>4:3</b>	Displays a proportionately stretched picture. Sidebars appear on both edges of the screen.
<b>Wide screen</b>	Displays a picture that is stretched out of proportion to fill the screen.
<b>Unscaled</b>	Displays a picture in its original size.

If the signal source has side or top-bottom bars inserted into the picture, the Picture Format function will not eliminate them.

## TV Screen information

You can display the currently selected channel or other information such as the aspect ratio on the TV screen.

In the Digital mode, the detailed broadcasting information for the current off-the-air channel such as program title and program guides are displayed.

- 1 Press **INFO**.

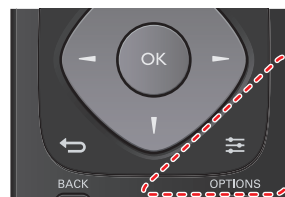

- 2 Use **▲▼◀▶** to Select a desired setting, then press **OK**.

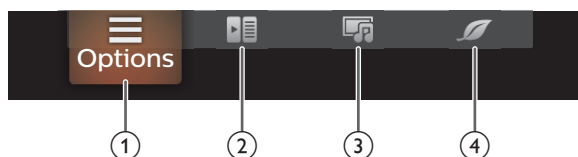

- 1 **Options**  
Following settings can be configured.

<b>Closed captions</b>	To choose the Closed captions display setting. <b>Closed captions</b> → p. 32
<b>Digital audio language</b>	To Select the language according to your preference. (It differs depending on the program.) <b>Digital audio language</b> → p. 39
<b>Mono/Stereo</b>	To Select an audio format. <b>Mono/Stereo</b> → p. 39

- 2 **Controls**  
If you have our brand products such as Blu-ray disc player or DVD recorder that are compatible with EasyLink functions, connect them to this unit via an HDMI cable so you can simply operate various items from this unit's Remote Control.  
**Before you begin:**  
select a device connected to an HDMI connection. → p. 22  
You must set **On** in **Master EasyLink**. → p. 36  
Otherwise, LINK does not work even if you connected our brand devices to this unit.

- 1 Press **≡** **OPTIONS** to display options menu.
- 2 Use **◀▶** to Select **Controls** then press **OK**.
- 3 Use **▲▼** to Select the desired item, then press **OK**.

<b>Device-menu</b>	Controls the menu of your connected EasyLink device.
<b>Device-contents</b>	Controls the top menu of your DVD or Blu-ray discs.
<b>Device-favorite</b>	Controls the pop-up menu of your Blu-ray discs.

**Note(s)**

- Some of EasyLink functions may not be available depending on your EasyLink devices or discs.
- You must connect this unit to our brand EasyLink devices and be sure its EasyLink (HDMI CEC) setting is also set to On.
- We do not guarantee 100% interoperability with other brands of HDMI link compliant devices.

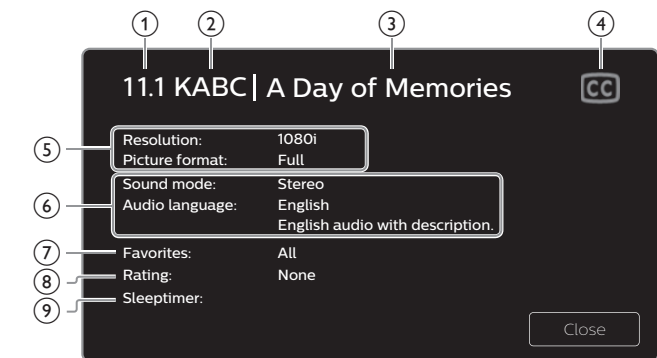

- 1 Channel number / Input mode  
**Switching Channels** → p. 21  
**Watching Channels from an External Device** → p. 22
- 2 Broadcast station
- 3 Program title (for DTV only)
- 4 CC (not available if Closed Caption is set to **Off**)  
**Caption settings** → p. 32
- 5 Program's image Aspect Ratio  
**Changing Picture Format** → p. 23
- 6 Audio Language (DTV) / Audio mode (Analog TV)  
**Sound** → p. 31
- 7 Favorites  
**Create a list of favorite channels** → p. 22
- 8 Child lock rating  
**Child lock** → p. 38
- 9 Remaining time on Sleep timer  
**Sleeptimer** → p. 33

- 2 Press **INFO** to hide the information.

**Note(s)**

- While the program guide is displayed, the Closed Caption function is interrupted.
- The information display will automatically disappear in 5 seconds.



③ Picture and sound

Following settings can be configured.

Auto picture	To set predefined picture mode. <b>Picture</b> → p. 29
Auto sound	To set predefined sound mode. <b>Sound</b> → p. 31
Headphone volume	To adjust headphone volume. <b>Sound</b> → p. 31
TV speakers	To Select the audio output from the unit's speakers or not. <b>Sound</b> → p. 31
Picture format	To switch the TV aspect ratio. <b>Changing Picture Format</b> → p. 23
Setup	To display setup menu.

④ ECO settings

Following settings can be configured.

Switch off timer	You can turn off the unit automatically when there is no operation for specified time. In spite of this setting, the unit goes into standby mode automatically if there is no signal input and no user operation for 15 minutes.
	Press ▲ repeatedly to change the amount of time (increases the time by 30 minutes up to 240 minutes).
	Each press of ▼ will decrease the time by 30 minutes.
	To cancel the timer, press ▼ repeatedly until "0" is displayed.

USB

Your TV is fitted with a USB connection that enables you to view Photos, listen to Music or watch Video files stored on a USB Memory Stick.

- 1 Press **SOURCE** and use ◀▶ to Select **USB**, then press **OK**.
- 2 Use ▲▼◀▶ to Select the desired File, then press **OK**.

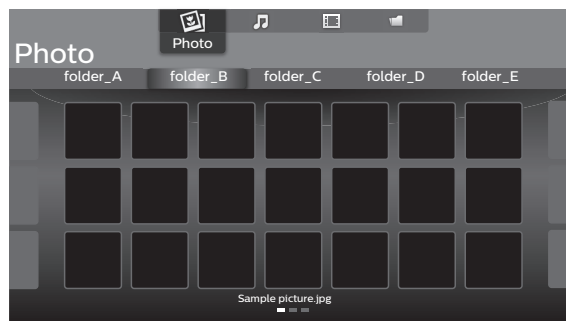

• These Recorded Files must meet Specifications shown below:

Picture (JPEG / Progressive JPEG)						
JPEG	Upper limit	4000x4000 pixels				
Progressive JPEG	Upper limit	1024x768 pixels				
Music (MP3 / WAV / AAC)						
MP3	Sampling frequency	16 kHz - 48 kHz				
	Constant bit rate	8 kbps - 320 kbps				
WAV	Sampling frequency	8 kHz - 48 kHz				
	Constant bit rate	64 kbps - 1.5 Mbps				
AAC	Sampling frequency	8 kHz - 48 kHz				
	Constant bit rate	-				
Video (MPEG / VOB / AVI / MP4)						
Maximum Video	H.264, H.265/HEVC: 3840x2160@30fps, MPEG: 1920x1080@60fps					
Extension	.avi	.mpg, .mpeg	.ts, .trp, .tp	.vob	.mp4	.mkv
Video codec	MPEG1, MPEG2, MPEG4, H.264	MPEG1, MPEG2, MPEG4	MPEG1, MPEG2, H.264, H.265/HEVC	MPEG1, MPEG2	MPEG1, MPEG2, MPEG4, H.264, H.265/HEVC	MPEG1, MPEG2, MPEG4, H.264, H.265/HEVC
Audio codec						
Dolby Digital	YES	YES	YES	YES	YES	YES
MPEG1/2 audio layer1/2/3	YES	YES	YES	YES	NO	YES
LPCM	YES	YES	YES	YES	YES	YES
AAC-LC	YES	YES	YES	YES	YES	YES

## Note(s)

- This unit accepts USB Memory Stick only. Other storage devices such as external HDD by USB Bus Power will not work.
- Do not use an Extension Cord and/or USB Hub to connect devices to this Unit. Always Directly insert the USB Flash Memory Stick to this Unit directly.
- We cannot be held responsible if your USB Memory Stick is Not Supported, nor will we accept any liability for damage or loss of stored data.
- The USB Memory Stick is Not Supplied with this TV.
- A maximum of 1,023 folders or files can be recognized.
- A File Name exceeding 256 characters or contains a Dot character is Not Supported on this TV.
- A USB Memory Stick that required its own driver or the device with a special system such as fingerprint recognition are not supported.
- Be sure to keep a Backup Copy of the Original files on your USB device before you Play them back on this Unit. We have no responsibilities for damage or loss of your USB Stored Data.
- To avoid damaging the USB Memory Stick and the Unit always Turn Off the Unit before you remove the USB Memory Stick.
- This Unit is not allowed to use the USB Memory Stick which requires external power supply (500 mA or more).
- This Unit does not support MTP (Media Transfer Protocol) or the file other than FAT16 and FAT32 file system. If the file is not supported, an error message appears.
- When the Unit does not recognize the USB Memory Stick, try reconnecting it.
- Playing the files recorded with high bit rates, the images can be interrupted in some occasions.
- This Unit does not support external subtitles.
- This Unit cannot play back a file which goes over the limit of File Restriction Limit.

## Viewing photos

- 1 Use ◀▶ to Select **Photo**, then press **OK**.
- 2 Use ◀▶ to Select the desired item, then press **OK**.
- 3 Press **OK** or ▶|| to start a Slide show of the files.
  - Press **OK** or ▶|| to pause the Slide show.
  - The || icon appears.
  - Press ◀◀ or ▶▶ to move between images.
  - Press ↶ **BACK** or ■ to stop the Slide show.
  - Press ≡ **OPTIONS** to display the optional menu, then use ▲▼ to Select the desired item.

<b>Repeat</b> *1	<b>Off</b>	Sets repeat playback to Off.
	<b>One</b>	Sets repeat playback for a selected Image file.
	<b>All</b>	Sets repeat playback for all Image files in the current folder.
<b>Slide time</b> *1	<b>Short</b>	Switches to the next image in 5 seconds.
	<b>Medium</b>	Switches to the next image in 10 seconds.
	<b>Long</b>	Switches to the next image in 15 seconds.
<b>Transitions</b> *1	<b>None</b>	No effect when switching images.
	<b>Dissolve</b>	Overlaps the next image on the current image.
	<b>Wipe right</b>	Pushes the current image out from left.
	<b>Wipe left</b>	Pushes the current image out from right.
	<b>Wipe up</b>	Pushes the current image out from bottom.
	<b>Wipe down</b>	Pushes the current image out from top.
	<b>Box in</b>	The next image comes to the center from the outside.
<b>Rotate</b> *2	<b>0</b>	Displays an image in its original direction.
	<b>90</b>	Rotates an image 90 degrees clockwise.
	<b>180</b>	Rotates an image 180 degrees clockwise.
	<b>270</b>	Rotates an image 270 degrees clockwise.
<b>Zoom</b> *2	<b>1X</b>	Displays an image in its original size.
	<b>2X</b>	Magnifies a current image by 2 times.
	<b>4X</b>	Magnifies a current image by 4 times.
<b>Auto picture</b> *1	Selects the picture mode according to your preference. ( <b>Standard, Natural, Vivid, Sports, Movie, Game, Energy saving and Internet video</b> )	

\*1 You can set **Repeat**, **Slide time**, **Transitions** and **Auto picture** when images are in Slide show.

\*2 You can set **Rotate** and **Zoom** when Slide show is in Pause mode.

## Playing music

- 1 Use ◀▶ to Select **Music**, then press **OK**.
- 2 Use ◀▶ to Select the desired item, then press **OK**.
- 3 Press **OK** or ▶|| to play the selected files.
  - Press **OK** or ▶|| to pause, then press **OK** or ▶|| again to resume.
  - Press ▶▶ to fast-forward search.
  - Press ◀◀ to fast-backward search.
  - Press ■ to stop playback.
  - Press ≡ **OPTIONS** to display the optional menu, then use ▲▼ to Select the desired item.

Repeat	Off	Sets repeat playback to Off.
	One	Sets repeat playback for a selected Music file.
	All	Sets repeat playback for all Music files in the current folder.
Shuffle	Off	Sets shuffle playback to Off.
	On	Sets shuffle playback for all Music files in the current folder.
TV Speakers	Off	The Sound will not be output from the unit's speakers.
	On	The Sound will be output from the unit's speakers.
	Speakers EasyLink	You can control Audio Output from your connected EasyLink Compliant Devices with <b>VOL + / -</b> by using this unit's Remote control.
Auto sound	Selects the sound mode according to your preference. (Standard, Vivid, Sports, Movie, Music and News)	

## Playing movies

- 1 Use ◀▶ to Select **Movie**, then press **OK**.
- 2 Use ◀▶ to Select the desired item, then press **OK**.
- 3 Press **OK** or ▶|| to play the selected files.
  - Press **OK** or ▶|| to pause, then press **OK** or ▶|| again to resume.
  - Press ▶▶ to fast-forward search.
  - Press ◀◀ to fast-backward search.
  - Press ■ to stop playback.
 Press ▶|| to resume from the point at which playback was stopped. Press **OK** to play from the beginning of the file.
  - Press ≡ **OPTIONS** to display the optional menu, then use ▲▼ to Select the desired item.

Repeat	Off	Sets repeat playback to Off.
	One	Sets repeat playback for a selected Video file.
	All	Sets repeat playback for all Video files in the current folder.
TV speakers	Off	The Sound will not be output from the unit's speakers.
	On	The Sound will be output from the unit's speakers.
	Speakers EasyLink	You can control Audio Output from your connected EasyLink Compliant Devices with <b>VOL + / -</b> by using this unit's Remote control.
Auto picture	Selects the picture mode according to your preference. (Standard, Natural, Vivid, Sports, Movie, Game, Energy saving and Internet video)	
Auto sound	Selects the sound mode according to your preference. (Standard, Vivid, Sports, Movie, Music and News)	

### ≡ Note(s)

- The Resume information will be kept even when the unit is Turned Off.
- If you play another file while the previously viewed file is being resumed, the Resume information of the previously viewed file will be Deleted.
- The file or the folder in Resume Stop mode will be highlighted in gray on **List** or **Thumbnails**.

## 5 Making more use with your TV

This section describes the overview of the Main menu displayed when you press **MENU**.

The Main menu consists of the function setting items below.

- 1 Press **MENU** to display the Main menus.



- 2 Use **▲▼◀▶** to Select the desired Menu and an item, then press **OK**.

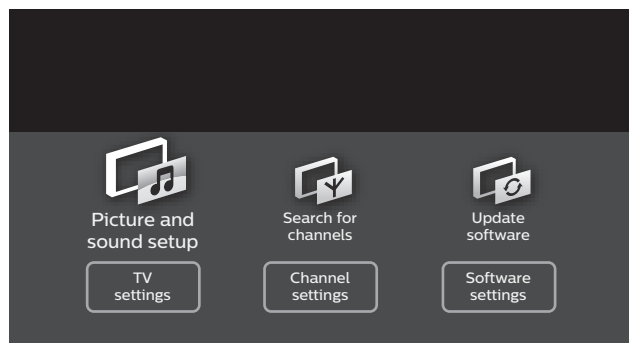

### Note(s)

- If you press **MENU** in Google Cast mode, opening screen is not the Main menus, but the TV settings.

### Picture and sound setup → p. 29

Guides you to get the best picture and sound settings.

### TV settings → p. 29

Accesses menus that allow you to change picture, sound and TV usage settings.

### Search for channels → p. 37

Guides you through channel installation.

### Channel settings → p. 37

Accesses menus that allow you to change channel settings.

### Update software → p. 40

Guides you through an update of the TV Software.

### Software settings → p. 41

Accesses menus that allow you to change Software settings.

## Picture and sound setup

### Before you begin:

You must set **Home** in **Location**. ➔ p. 35

Otherwise, personalized Picture and Sound settings will not be memorized after the Unit goes into Standby Mode.

- 1 Press **MENU** and use ▲▼◀▶ to Select **Picture and sound setup**, then press **OK**.
- 2 Follow steps **10** to **11** in **TV Initial Setup** ➔ p. 19

## TV settings

### Picture

#### Before you begin:

You must set **Home** in **Location**. ➔ p. 35

Otherwise, personalized Picture and Sound settings will not be memorized after the Unit goes into Standby Mode.

- 1 Press **MENU** and use ▲▼◀▶ to Select **TV settings**, then press **OK**.
- 2 Use ▲▼ to Select **Picture**, then press **OK**.

<b>Picture</b>	Auto picture
Sound	Backlight
Cast TV settings	Contrast
Features	Brightness
Installation	Color
	Tint
	Sharpness
	Advanced settings
	Picture format
	Mode selection
	Auto adjustment
	Clock

- 3 Use ▲▼◀▶ to Select the item you want to adjust, then press **OK**.

The following picture settings can be configured. Depending on the format of the picture Source, some picture settings are not available.

Auto picture	to set your TV to a predefined picture setting.	
	<b>Personal</b>	The customized settings you defined using the <b>Picture</b> menu.
	<b>Standard</b>	For normal TV viewing.
	<b>Natural</b>	Ideal picture mode for viewing high quality content without any picture enhancements.
	<b>Vivid</b>	Enhanced picture contrast and sharpness for viewing in a well-lit room.
	<b>Sports</b>	Brilliant picture settings for high action.
	<b>Movie</b>	Deep picture settings for a cinematic experience.
	<b>Game</b>	Optimized for PCs and game consoles.
	<b>Energy saving</b>	Eco TV settings for low power consumption.
<b>Internet video</b>	Optimized for low bit-rate Internet video.	

When you adjust the following settings, **Personal** picture will be set automatically.

	Cursor ▼	Cursor ▲
<b>Backlight</b>	to Reduce Power Consumption and Brightness	to Increase Power Consumption and Brightness
<b>Contrast</b>	to Decrease Contrast	to Increase Contrast
<b>Brightness</b>	to Decrease Brightness	to Increase Brightness
<b>Color</b>	to Decrease Color Intensity	to Increase Color Intensity
<b>Tint</b>	to Add Green	to Add Red
<b>Sharpness</b>	to Soften	to Sharpen
<b>Advanced settings</b>	Enters sub-menus to adjust the following settings: (Color alignment, Noise reduction, Black stretch, Dynamic contrast, Gamma, Perfect Motion Rate, 4K UHD Upscaling, Micro Dimming, MPEG artifact reduction, Color enhancement, Custom color management, Blue stretch, Film mode and HDR mode)	
<b>Picture format</b>	<b>Automatic</b>	<b>Changing Picture Format</b> ➔ p. 23
	<b>Super zoom</b>	
	<b>4:3</b>	
	<b>Movie expand 14:9</b>	
	<b>Movie expand 16:9</b>	
	<b>Wide screen</b>	
<b>Mode selection</b>	<b>Unscaled</b>	to Turn Off image enhancement features which makes the TV to act purely as a monitor
	<b>Full</b>	
	<b>PC</b>	
<b>Auto adjustment</b>	<b>HDTV</b>	to enable image enhancement features to improve picture quality
		to adjust the Horizontal / Vertical position, Clock and Phase of the PC screen automatically
	Cursor ▼	Cursor ▲
<b>Clock</b>	to Decrease setting value	to Increase setting value
<b>Phase</b>		
<b>Horizontal position</b>	to move PC screen left	to move PC screen right
<b>Vertical position</b>	to move PC screen down	to move PC screen up

You may adjust picture quality and enhancement settings using **Advanced settings** sub menus. These settings allow for advanced and precise color and picture quality adjustment. Some of them can degrade the picture quality if not configured properly. We recommend leaving these as set if you are unsure of what they affect.

Auto picture	<b>Color alignment</b>	Mode
Backlight	Noise reduction	Red gain
Contrast	Black stretch	Green gain
Brightness	Dynamic contrast	Blue gain
Color	Gamma	Red offset
Tint	Perfect Motion Rate	Green offset
Sharpness	4K UHD Upscaling	Blue offset
<b>Advanced settings</b>	Micro Dimming	
Picture format	MPEG artifact reduction	
Mode selection	Color enhancement	
Auto adjustment	Custom color management	
Clock	Blue stretch	
	Film mode	
	HDR mode	

<b>Color alignment</b>	<b>Mode</b>	to set the color temperature to <b>Personal, Cool, Normal</b> and <b>Warm</b> . When you adjust the following settings, <b>Personal</b> will be set automatically.	
		<b>Cursor ▼</b>	<b>Cursor ▲</b>
	<b>Red gain</b>	to Decrease Red Contrast	to Increase Red Contrast
	<b>Green gain</b>	to Decrease Green Contrast	to Increase Green Contrast
	<b>Blue gain</b>	to Decrease Blue Contrast	to Increase Blue Contrast
	<b>Red offset</b>	to Decrease Red Brightness	to Increase Red Brightness
	<b>Green offset</b>	to Decrease Green Brightness	to Increase Green Brightness
	<b>Blue offset</b>	to Decrease Blue Brightness	to Increase Blue Brightness
<b>Noise reduction</b>	to Select the desired setting, then press <b>OK</b> ( <b>Off, Minimum, Medium</b> and <b>Maximum</b> )		
<b>Black stretch</b>	to Select the desired setting, then press <b>OK</b> ( <b>Off, Minimum, Medium</b> and <b>Maximum</b> )		
<b>Dynamic contrast</b>	to Select the desired setting, then press <b>OK</b> ( <b>Off, Minimum, Medium</b> and <b>Maximum</b> )		
<b>Gamma</b>	to Select the desired setting, then press <b>OK</b> ( <b>Very Dark Room, Dark Room, Normal, Bright Room</b> and <b>Very Bright Room</b> )		
<b>Perfect Motion Rate</b>	to Select the desired setting, then press <b>OK</b> ( <b>Off, Minimum, Medium</b> and <b>Maximum</b> )		
<b>4K UHD Upscaling</b>	to Select the desired setting, then press <b>OK</b> ( <b>Off, Minimum, Medium</b> and <b>Maximum</b> )		
<b>Micro Dimming</b>	to Select the desired setting, then press <b>OK</b> ( <b>Off, Minimum, Medium</b> and <b>Maximum</b> )		
<b>MPEG artifact reduction</b>	to Select the desired setting, then press <b>OK</b> ( <b>Off, Minimum, Medium</b> and <b>Maximum</b> )		

<b>Color enhancement</b>	<b>Off</b>	to set color enhancement to Off	
	<b>On</b>	to make colors more vivid and bright	
<b>Custom color management</b>	to Select the desired setting, then press <b>OK</b> ( <b>Red, Yellow, Green, Cyan, Blue</b> and <b>Magenta</b> )		
		<b>Cursor ▼</b>	<b>Cursor ▲</b>
	<b>Tint</b>	to rotate only selected color tint in clockwise direction	to rotate only selected color tint in counterclockwise direction
	<b>Saturation</b>	to decrease color with only selected color	to increase color with only selected color
	<b>Brightness</b>	to decrease brightness with only selected color	to increase brightness with only selected color
<b>Blue stretch</b>	to Select the desired setting, then press <b>OK</b> ( <b>Off, Minimum, Medium</b> and <b>Maximum</b> )		
<b>Film mode</b>	<b>Off</b>	to set film mode to Off	
	<b>Auto</b>	to optimize the picture recorded by the original film	
<b>HDR mode</b>	<b>Off</b>	to set HDR mode to Off	
	<b>Auto</b>	Automatically switches to a dedicated picture quality setting when receiving HDR signal	

#### Note(s)

- **Mode selection** is available only if
  - the external Input modes are selected HDMI 1, HDMI 2, HDMI 3 or HDMI 4.
  - the connected HDMI device is outputting a video signal.

## Sound

### Before you begin:

You must set **Home** in **Location**. ➔ p. 35

Otherwise, personalized Picture and Sound settings will not be memorized after the Unit goes into Standby Mode.

1 Press **MENU** and use ▲▼◀▶ to Select **TV settings**, then press **OK**.

2 Use ▲▼ to Select **Sound**, then press **OK**.

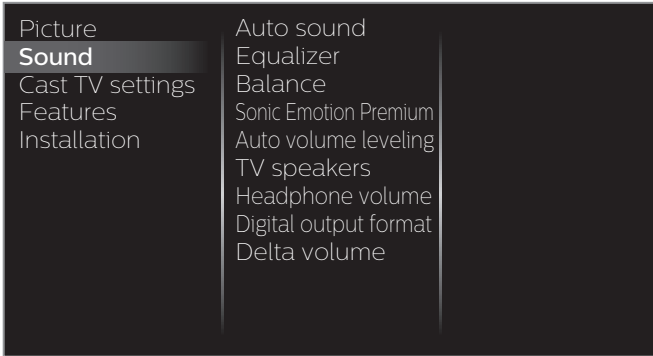

3 Use ▲▼◀▶ to Select the item you want to adjust, then press **OK**.

The following sound settings can be configured. Depending on the format of the broadcasting, some sound settings are not available.

Auto sound	to set your TV to a predefined sound setting. When you adjust the following settings ( <b>Equalizer</b> , <b>Sonic Emotion Premium</b> and <b>Auto volume leveling</b> ), <b>Personal</b> sound will be set automatically.	
	<b>Personal</b>	The customized settings you defined using the <b>Sound</b> menu.
	<b>Standard</b>	For normal TV viewing.
	<b>Vivid</b>	Enhanced sound.
	<b>Sports</b>	Clear sound for high action.
	<b>Movie</b>	Powerful sound settings for a cinematic experience.
	<b>Music</b>	Optimized for music playback.
	<b>News</b>	Set the anchor's voice at a comfortable volume.

Adjust the tonal quality for each frequency.

<b>Equalizer</b>	<b>Cursor ▲</b>	<b>Cursor ▼</b>
	to adjust each level of tonal quality Press ⬅ <b>BACK</b> to go back to the previous menu.	

Adjust the speakers to suit your listening preference.

<b>Balance</b>	<b>Cursor ▲</b>	<b>Cursor ▼</b>
	to adjust the balance of the right and left speakers	

This selects Sound modes for more Spatial or Surround sound reproduction.

<b>Sonic Emotion Premium</b>	<b>Sonic Emotion</b>	<b>Off</b>	to set Sonic Emotion to Off
		<b>On</b>	to set Sonic Emotion to On
	<b>Dialog Enhancement</b>	<b>Off</b>	to set Dialog Enhancement to Off
		<b>On</b>	to set Dialog Enhancement to On
	<b>Bass Enhancement</b>	<b>Off</b>	to set Bass Enhancement to Off
		<b>On</b>	to set Bass Enhancement to On
	<b>Absolute 3D Sound</b>	<b>Off</b>	to set Absolute 3D Sound to Off
		<b>On</b>	to set Absolute 3D Sound to On

This function keeps a constant Loudness differential between the TV Commercials and the Programs.

<b>Auto volume leveling</b>	<b>Off</b>	to Remove the Auto volume leveling
	<b>On</b>	to Reduce Volume Differences between the TV Commercials and the Programs

You can select the Audio Output from the unit's speakers or not. If your amplifier is HDMI link function compatible and connected by an HDMI cable to this unit, some sound operations such as volume up can be changed by using this unit's remote control. Make sure **Master EasyLink** is set to **On**. ➔ p. 36

<b>TV speakers</b>	<b>Off</b>	No Output Sound from the Unit's Speakers
	<b>On</b>	to Output Sound from the Unit's Speakers
	<b>Speakers EasyLink</b>	to control Audio Output from your connected EasyLink Compliant Devices with <b>VOL + / -</b> by using this Unit's remote control.

Adjust Headphone volume.

<b>Headphone volume</b>	<b>Cursor ▲</b>	<b>Cursor ▼</b>
	to Decrease or Increase volume	

You can set the Digital Audio output format from SPDIF/ARC.

<b>Digital output format</b>	<b>PCM</b>	to Output PCM format
	<b>Bitstream</b>	to Output Audio in its native format as Bitstream to connected Audio receiver

If a Channel or Input device is too loud or too soft, navigate to that Channel or Input device.

<b>Delta volume</b>	<b>Cursor ▲</b>	<b>Cursor ▼</b>
	Provides the ability to set a custom volume level for the current channel or input source. If the source volume is too loud, set a negative value (-1 to -12) If the source volume is too soft, set a positive value (+1 to +12)	

## Cast TV settings

Displays Cast TV Settings. If you set Wake on Cast (LAN) to On, you can turn your TV on when you use your smartphone, tablet or PC via your home network.

- 1 Press **MENU** and use **▲▼◀▶** to Select **TV settings**, then press **OK**.
- 2 Use **▲▼** to Select **Cast TV settings**, then press **OK**.

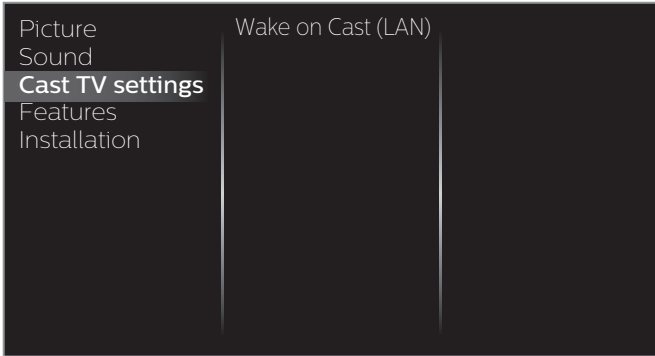

- 3 Use **▲▼** to Select **Wake on Cast (LAN)**, then press **OK**.
- 4 Use **▲▼** to Select **On** or **Off**, then press **OK**.

Wake on Cast (LAN)	Off	to set Wake on Cast (LAN) to Off
	On	to set Wake on Cast (LAN) to On

## Features

- 1 Press **MENU** and use **▲▼◀▶** to Select **TV settings**, then press **OK**.
- 2 Use **▲▼** to Select **Features**, then press **OK**.

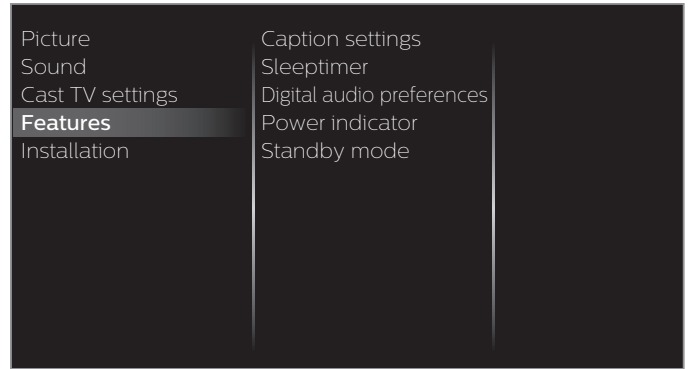

- 3 Adjust the following items.

## Caption settings

Closed Captions displays the Audio portion of the Program as Superimposed Text over the Video.

- 1 Use **▲▼** to Select **Caption settings**, then press **OK**.

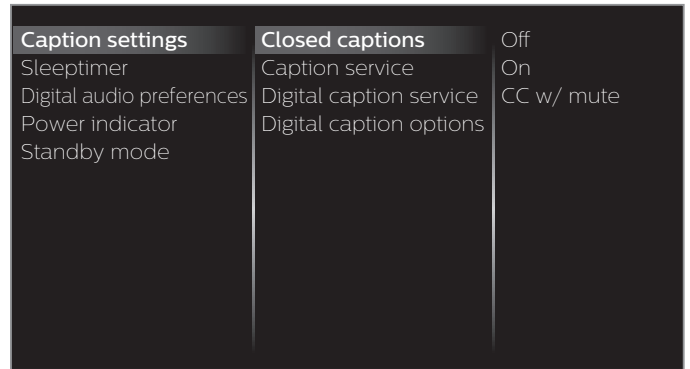

Closed captions	Off	Closed Caption is not displayed.
	On	Closed Caption is always displayed.
	CC w/ mute	Closed Caption is displayed when the Sound is Off.

### Digital TV Operation

In addition to the basic Closed Caption, DTV has its own Closed Caption called Digital caption service. Use this menu to change the settings for Digital caption service.

Digital caption service	CS-1 to CS-6	Select one of these before changing any other item in <b>Caption settings</b> menu. Choose <b>CS-1</b> under normal conditions.
-------------------------	--------------	---



You can choose the Size, Font, Color, Background and other characteristics of the Caption Text.

<b>Digital caption options</b>	<b>Reset to default</b>	You can reset the status of Digital caption options.
		You can change Closed Captioning font style, size, color and transparency. <b>(Font style, Font size, Font color and Font opacity)</b>
		You can change background color and transparency of the displayed caption. <b>(Background color and Background opacity)</b>
		You can change edge color and type of the displayed caption text. <b>(Edge color and Edge type)</b>

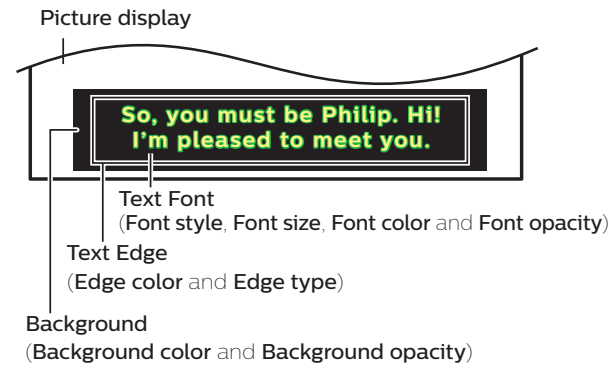

- Review your setting choice made above by looking in the upper left corner of the displayed setting box (not All selections show the differences selected).

Cable / NTSC (Analog) TV Operation

<b>Caption service</b>	<b>CC-1 and T-1</b>	The primary Closed Captions and Text Services. The Closed Captions or Text is Displayed in the same Language as the Program's Dialog (up to 4 lines of script on the TV Screen).
	<b>CC-3 and T-3</b>	Serve as the preferred Data Channels. The Closed Captions or Text is often a Secondary Language.
	<b>CC-2, CC-4, T-2 and T-4</b>	Rarely available and Broadcasters use them only in Special conditions, such as when <b>CC-1</b> and <b>CC-3</b> or <b>T-1</b> and <b>T-3</b> are Not available.

- There are 3 Display modes according to Programs:

<b>Paint-on</b>	Displays Characters on the TV screen immediately.
<b>Pop-on</b>	Once Characters are Stored in Memory, they are Displayed All at Once.
<b>Roll-up</b>	Displays the Characters Continuously by Scrolling (max. 4 lines).

**Note(s)**

- **Digital caption service** that you can switch differs depending on the broadcast description.
- Closed Captioning service may not be controlled by this unit's menu options if you are watching television through an external Cable or Satellite Set-top Box. In which case you will need to use the menu options on the external set-top box to control Closed Captioning.
- The captions do not always use correct spelling and grammar.
- Not all TV programs and product commercials include Closed Caption information. Refer to your area TV program listings for the TV channels and times of Closed Caption shows. The captioned programs are usually noted in the TV listings with service marks such as **CC**.
- Not all captioning services are used by a TV channel during the transmission of a Closed Caption program.
- Closed Caption will NOT be displayed when you are using an HDMI or a Component connection.
- To show the Closed Caption on your TV screen, broadcast signal must contain the Closed Caption data.
- Not all TV programs and commercials have the Closed Caption or all types of the Closed Caption.
- Caption's and Text may not exactly match the TV voice.
- Changing channels may delay the Closed Caption for a few seconds.
- Adjusting or muting the volume may delay the Closed Caption for a few seconds.
- Abbreviations, symbols and other grammatical shortcuts may be used in order to keep pace with the on-screen action. This is not a malfunction.
- The caption or text characters will not be displayed while the Home menu or functions display is shown.
- If a black box appears on the TV screen, this means that the Closed Caption is set to the text mode. To clear the box, select **CC-1, CC-2, CC-3** or **CC-4**.
- If the unit receives poor quality television signals, the captions may contain errors or there might be no captions at all. Some possible causes of poor quality signals are:
  - Automobile ignition noise
  - Electric motor noise
  - Weak signal reception
  - Multiplex signal reception (ghosts or screen flutter)
  - Data dropout and Pixelation (for DTV only)
- The unit retains the Closed Caption setting if the power fails.
- When the unit receives special effects playback signal (e.g. Search, Slow and Still) from a VCR's video Output channel (ch3 or ch4), the unit may not display the correct caption or text.
- The EUT setting that satisfies § 79.102 (e) is as follows:
  - Font: Mono-font
  - Character size: Large

**Sleptimer**

Sleep timer can set the unit to go into Standby mode after an incremental period of time.

- 1 Use **▲▼** to Select **Sleptimer**, then press **OK**.
- 2 Use **▲** repeatedly to change the amount of time (increases the time by 5 minutes up to 180 minutes).
  - Each press of **▼** will decrease the time by 5 minutes.
  - Press **INFO** once to call up the display for checking the remaining time.
  - To cancel the sleep timer, press **▲▼** repeatedly until "0" is displayed.

**Digital audio preferences**

You can set the interpretive broadcasting by an audio explanation.

- 1 Use **▲▼** to Select **Digital audio preferences**, then press **OK**

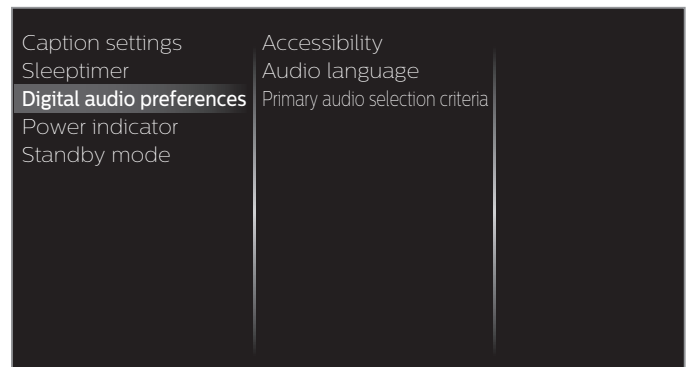

<b>Accessibility</b>	to prioritize VI-Visually Impaired Streaming or HI-Hearing Impaired Streaming: The setting for Handicapped users ( <b>Main audio</b> , <b>Visually Impaired</b> or <b>Hearing Impaired</b> ).
<b>Audio language</b>	to set your Preferred language in the Audio Streaming ( <b>English</b> , <b>Spanish</b> or <b>French</b> ).
<b>Primary audio selection criteria</b>	to set TV Priority based on either of the above Settings: ( <b>Accessibility</b> or <b>Audio language</b> ).

## Installation

- 1 Press **MENU** and use **▲▼◀▶** to Select **TV settings**, then press **OK**.
- 2 Use **▲▼** to Select **Installation**, then press **OK**.

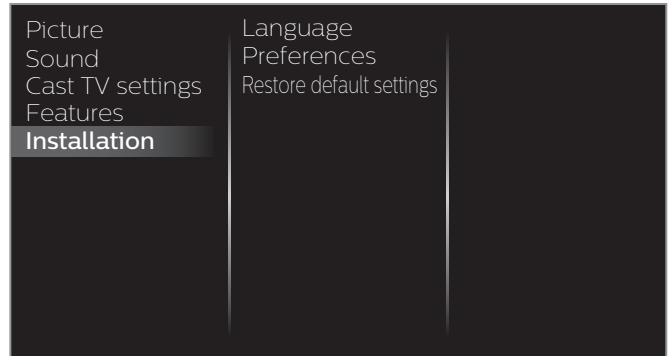

- 3 Adjust the following items.

## Language

You can set the language for the On-screen display.

- 1 Use **▲▼** to Select **Language**, then press **OK**.

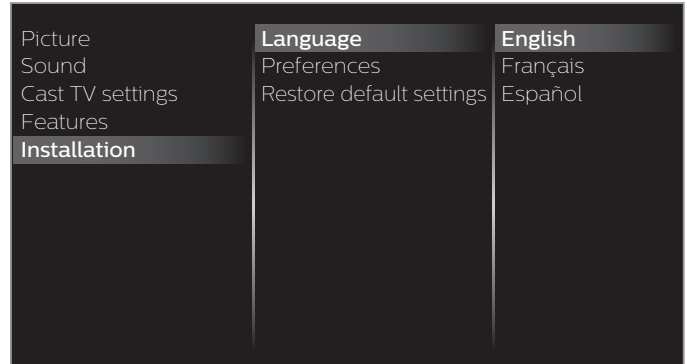

- 2 Use **▲▼** to Select **English**, **Español** or **Français**, then press **OK**.

### Note(s)

- If you need the English menu instead of the Spanish or French menu's, press **MENU**. Use **▲▼◀▶** to Select **Ajustes de TV** or **Réglages de la télévision**, then press **OK**. Use **▲▼** to Select **Instalación** or **Installation**, then press **OK**. Use **▲▼** to Select **Idioma** or **Langue**, then press **OK**. Use **▲▼** to Select **English**, then press **OK**. Press **MENU** to exit the Main menu.

## Power indicator

To set power indicator.

- 1 Use **▲▼** to Select **Power indicator**, then press **OK**.

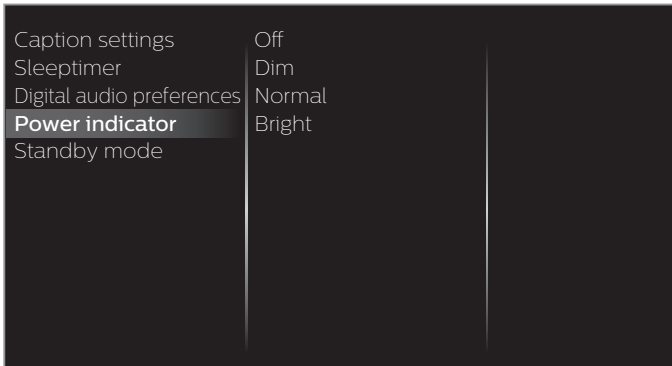

<b>Off</b>	to turn off the Power indicator.
<b>Dim</b>	to turn on the Power indicator.
<b>Normal</b>	The light of the Power indicator brightens in the order of <b>Dim</b> , <b>Normal</b> and <b>Bright</b> .
<b>Bright</b>	

## Standby mode

You can set the standby mode.

- 1 Use **▲▼** to Select **Standby mode**, then press **OK**.

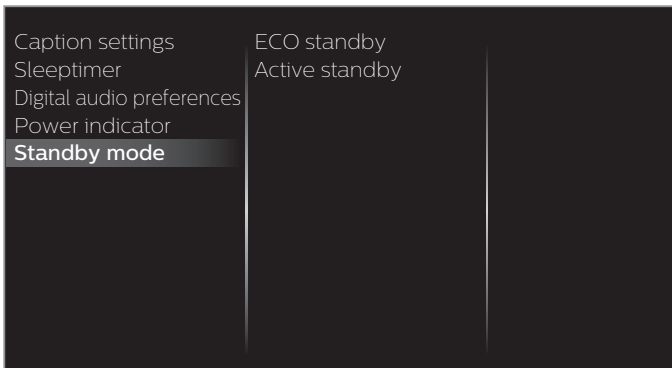

<b>ECO standby</b>	to set low energy consumption mode.
<b>Active standby</b>	to enable the TV to turn On fast.

## Preferences

You can set the unit to reduce the power consumption or adjust the backlight brightness in **Location** setting.

**EasyLink** allows you to operate your connected EasyLink device.

### Setting your location to home

Choosing **Home** gives you full flexibility to change predefined settings for picture and sound.

- 1 Use ▲▼ to Select **Preferences**, then press **OK**.
- 2 Use ▲▼ to Select **Location**, then press **OK**.

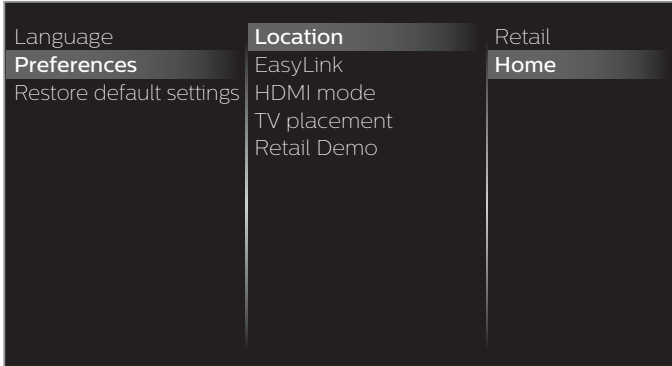

- 3 Use ▲▼ to Select **Home**, then press **OK**.

<b>Retail</b>	The Unit will be set up with predefined settings for retail displays. In this setting, you can set the backlight brighter.
<b>Home</b>	The Unit is set to maximize the energy efficiency for Home setting and it can be adjusted through a choice of Picture and Sound quality selections according to your preference.

#### Note(s)

- You must set **Home** in the Menu. Otherwise, personalized Picture and Sound Settings will Not Be Memorized after the Unit goes into Standby Mode.

## HDMI mode

If there are issues with picture/color and/or sound when connecting an external device using the HDMI port, please try switching the HDMI mode following the instructions below.

- 1 Press **MENU** and use ▲▼◀▶ to Select **TV settings**, then press **OK**.
- 2 Use ▲▼ to Select **Installation**, then press **OK**.
- 3 Use ▲▼ to Select **Preferences**, then press **OK**.
- 4 Use ▲▼ to Select **HDMI mode**, then press **OK**.
- 5 Use ▲▼ to Select **HDMI1**, **HDMI2**, **HDMI3** or **HDMI4**, then press **OK**.
- 6 Use ▲▼ to Select **Max 4K@60Hz + HDR**, **Max 4K@60Hz** or **Max 4K@30Hz (Compatibility)** depending on the output capabilities of the external device, then press **OK**.

- When switching the HDMI configuration, the screen will black out for a moment, then come back on.

#### Note(s)

- The HDMI connector with **HDMI mode** set to **Max 4K@30Hz (Compatibility)** supports up to UHD 30P, while The HDMI connector with **HDMI mode** set to **Max 4K@60Hz** supports up to UHD 60P. The HDMI connector with **HDMI mode** set to **Max 4K@60Hz + HDR** supports up to UHD 60P with HDR signal.
- Switching the **HDMI mode** may cause loss of HDMI CEC functionality in certain cases.

## TV placement

To apply the best settings for your TV, select wall mount or stand mount.

- 1 Use ▲▼ to Select **Preferences**, then press **OK**.
- 2 Use ▲▼ to Select **TV placement**, then press **OK**.
- 3 Use ▲▼ to Select **Wall mounted** or **On a TV stand**, then press **OK**.

## Retail Demo

When you set **Location** to **Retail**, E-sticker (Electronic Sticker) is displayed. E-sticker can be Turned Off using procedure below.

- 1 Use ▲▼ to Select **Preferences**, then press **OK**.
- 2 Use ▲▼ to Select **Retail Demo**, then press **OK**.
- 3 Use ▲▼ to Select **Off**, then press **OK**.

## Use Philips EasyLink

Your TV supports Philips EasyLink, which enables one-touch play and one-touch Standby between EasyLink-compliant devices. Compliant devices must be connected via an HDMI connector.

### One-touch play

When you connect your TV to devices that support one-touch play, you can control your TV and the devices with one remote control. For example, when you press ► (Play) on your DVD remote control, your TV automatically switches to the correct channel to show the DVD content.

### One-touch Standby

When you connect your TV to devices that support Standby, you can use your TV remote control to put your TV and all connected HDMI devices in Standby mode. You can perform one-touch Standby using the remote control from any of the connected HDMI devices.

### System audio control

When you connect your TV to HDMI CEC compliant devices, your TV can switch automatically to play audio from the connected device. To use one-touch audio, you must map the audio input from the connected device to your TV. You can use the remote control from the connected device to adjust the volume.

### Remote control (RC) key forwarding

RC key forwarding allows you to control EasyLink-compliant devices using your TV remote control.

### HDMI-ARC (Audio Return Channel) (HDMI 1 only)

HDMI-ARC allows you to use Philips EasyLink to output TV audio directly to a connected Audio device, without the need for an additional Digital Audio cable. Be sure that the device is HDMI CEC and ARC compliant, and that the TV is connected to the device using an HDMI cable attached to both HDMI-ARC connectors.

#### Note(s)

- Philips does not guarantee 100% interoperability with all HDMI CEC devices.
- The EasyLink-compliant device must be Switched On and selected as the source.

### EasyLink (HDMI CEC)

This function allows you to operate the linked functions between our brand Devices with a EasyLink feature and this unit connecting through an HDMI cable. You must connect this unit to our brand EasyLink devices and be sure its EasyLink (HDMI CEC) setting is also set to On.

- 1 Use ▲▼ to Select **Preferences**, then press **OK**.
- 2 Use ▲▼ to Select **EasyLink**, then press **OK**.
- 3 Use ▲▼◀▶ to Select the item you want to adjust, then press **OK**.

Location	Master EasyLink	Off
<b>EasyLink</b>	Auto TV On	On
HDMI mode	RC key forwarding	
TV placement	HDMI-ARC	
Retail Demo		

Set the **Master EasyLink** to **On** or **Off**. The following additional settings will be grayed out when you set them to **Off**.

Master EasyLink	Off	On
	Disables All EasyLink.	
		Selects if you have connected an External Device that is compatible with the EasyLink function.

This unit will Turn On when the Power On signal is sent from your connected EasyLink device.

Auto TV On	Off	On
	This unit stays in Standby mode even if you Turn On your connected EasyLink device.	
		This unit Turns On Automatically when you Turn On your connected EasyLink device.

You can operate some functions such as disc playback or call up the menu of the connected devices, by using this unit's remote control.

RC key forwarding	Off	On
	Disable RC key forwarding.	
		PLAY, PAUSE ►   / STOP ■ / SKIP ►  / SKIP ◀◀ / FWD ►► / REV ◀◀ / VOL + / - / MUTE / OPTIONS / ▲▼◀▶ / OK / BACK / the NUMBER buttons can be used to control your connected EasyLink devices by this unit's remote control.

#### Note(s)

- Pause may not work properly on some devices even if they are EasyLink (HDMI CEC) compliant.

HDMI-ARC allows you to use Philips EasyLink to output TV Audio directly to a connected Audio device, without the need for an additional Digital Audio cable.

HDMI-ARC (HDMI 1 only)	Off	On
	Disable HDMI-ARC.	
		You can output TV Audio through the HDMI cable solely, provided both the TV and device are HDMI-ARC compliant.

## Return your settings to default values

You can return settings to their default values.

- 1 Use ▲▼ to Select **Restore default settings**, then press **OK**.
- 2 Use ▲▼ to Select **Reset AV settings** or **Reset all settings**, then press **OK**.

<b>Reset AV settings</b>	Return picture and sound settings to their default values. The channel installation settings are not affected.
<b>Reset all settings</b>	Return all the settings to their default values.

## Search for channels

Be sure the RF cable is correctly connected to this Unit and you are registered with your Cable TV provider when you Install Cable channels.

- 1 Press **MENU** and use **▲▼◀▶** to Select **Search for channels**, then press **OK**.
- 2 Use **◀▶** to Select **Start**, then press **OK**.

## Install channels

You can search and store all channels. If you move the unit to a different area after the initial setting, it is recommended to perform Autoprogramming.

- 4 Use **▲▼** to Select **Antenna** or **Cable**, then press **OK**.
- 5 Press **OK** on **Start**.
  - When the Scanning and Memorizing of Available Channels is Completed, the Lowest Memorized Channel will be Displayed.
- 6 Follow the On-screen Instructions to Complete the Installation.

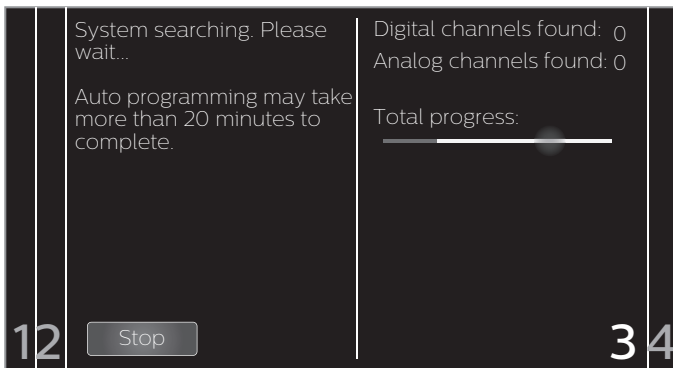

## Channel installation

Be sure the RF cable is correctly connected to this Unit and you are registered with your Cable TV provider when you Install Cable channels.

### Installation mode

- 1 Use **▲▼** to Select **Channel installation**, then press **OK**.
- 2 Use **▲▼** to Select **Installation mode**, then press **OK**.
- 3 Use **▲▼** to Select **Antenna** or **Cable**, then press **OK**.
  - When **Antenna** is selected, the TV detects antenna signals. It searches for DTV and Analog TV channels available in your area.
  - When **Cable** is selected, the TV detects signals supplied by cable. It searches for DTV, Analog TV and Cable channels available in your area.

### Uninstall channels

The channels selected here can be skipped when selecting the channels using **CH + / -**.

Those channels can still be selected with **the NUMBER buttons**.

- 1 Use **▲▼** to Select **Channel installation**, then press **OK**.
- 2 Use **▲▼** to Select **Uninstall channels**, then press **OK**.
- 3 Use **▲▼** to Select the channel you want to remove, then press **OK**.
  - The removed channels are not displayed on the list of Favorite channels.
  - To reactivate a removed channel, use **▲▼** then press **OK**.

## Channel settings

- 1 Press **MENU** and use **▲▼◀▶** to Select **Channel settings**, then press **OK**.
- 2 Adjust the following items.

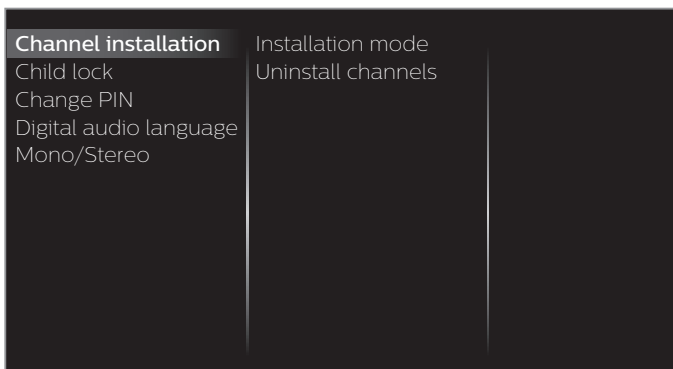

## Child lock

You can prevent your children from watching certain Programs or certain Channels by locking the TV Controls and by using Ratings.

1 Use ▲▼ to Select **Child lock**, then press **OK**.

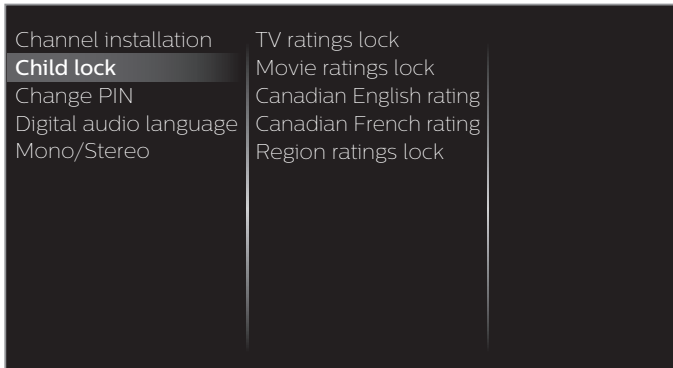

2 Use the **NUMBER** buttons to enter the 4-digit numbers for your PIN code.

- When you have not set up your PIN code, enter **0, 0, 0, 0**.
- When the PIN code is correct, **Child lock** menu is displayed. See the following description for setting each item.

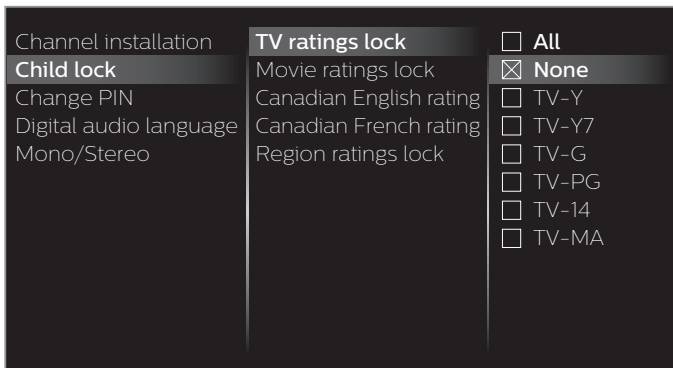

### Note(s)

- When you select the higher rating and set it to  the lower ratings will be blocked automatically.
- When you set the **All** to  all ratings return to  automatically.
- **Region ratings lock** will be available when the unit receives a Digital Broadcast using the new rating system.
- To block any inappropriate programs, set your limits in **TV ratings lock**, **Movie ratings lock** and **Region ratings lock**.
- For the United States, the unit may download the Region Ratings Lock Table, if required.
- The Canadian rating systems on this unit are based on CEA-766-A and CRTc policy.

## Setting TV and movie ratings

Movie ratings lock is the rating system created by MPAA. TV ratings lock has controlled access to individual programs based on their age ratings and content rating.

3 Use ▲▼ to Select **TV ratings lock** or **Movie ratings lock**, then press **OK**.

4 Use ▲▼ to Select the Desired Rating, then press **OK** Repeatedly to Switch between Block and View.

- indicates that the Rating is Locked (Blocked).
- indicates that the Sub Rating is Locked (Blocked).
- indicates that the Rating is Not Locked (Viewable).

## TV ratings lock

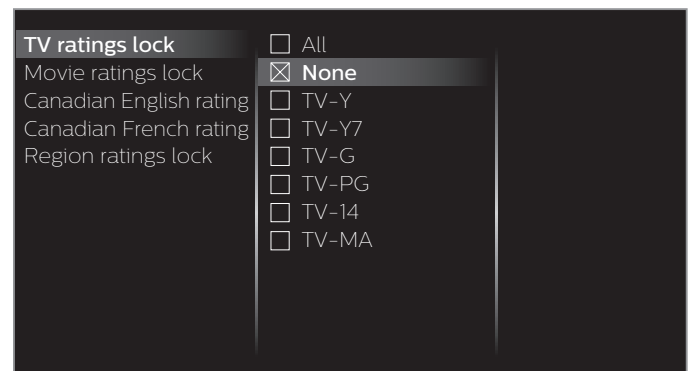

## Movie ratings lock

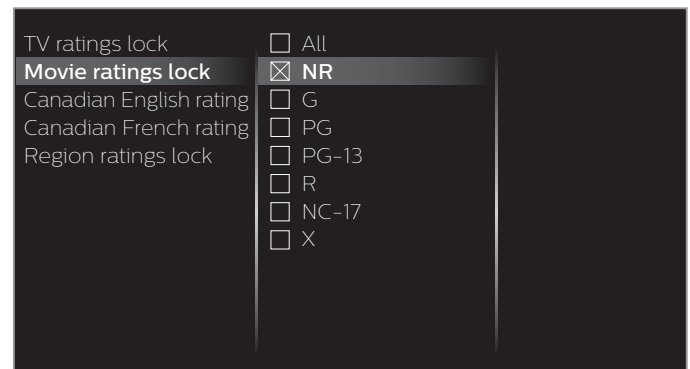

US Movie ratings	US TV ratings	Description
All		All Ratings Locked including No Rating
NR	None	No Rating
–	TV-Y	Appropriate for All Children
–	TV-Y7	Appropriate for All Children 7 and Older
G	TV-G	General Audience
PG	TV-PG	Parental Guidance Suggested
PG-13	–	Unsuitable for children under 13
–	TV-14	Unsuitable for children under 14
R	–	Restricted under 17 Requires Accompanying Parent or Adult Guardian
NC-17	–	No One under 17 Admitted
X	TV-MA	Mature Audience Only

### To set the Sub ratings (displayed in the right column)

For TV ratings lock, you can further set the Sub ratings to Block Specific Elements of programming. To set the Sub ratings, follow the step below.

Use ▲▼◀▶ to Select the desired rating, then press **OK** Repeatedly to switch between  and .

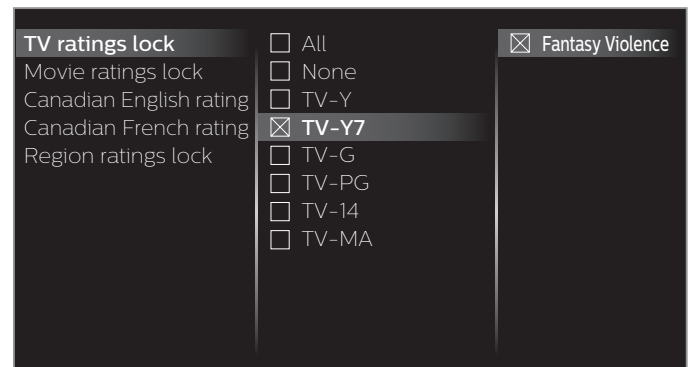

US TV ratings	Sub rating
TV-Y7	Fantasy Violence
TV-PG	Violence Sex
TV-14	Language Dialog
TV-MA	Violence Sex Language

#### Note(s)

- Blocked Sub Rating's will appear beside the Main Rating category in **TV ratings lock** Menu.
- You cannot Block a Sub Rating if the Main Rating is set to
- Changing the Category to  or  automatically changes All its Sub Ratings to the  or .

## Canadian English or Canadian French Ratings

You can select the Rating for Canadian English or Canadian French broadcasting.

- Use **▲▼** to Select **Canadian English rating** or **Canadian French rating**, then press **OK**.
- Use **▲▼** to Select the Desired Rating, then press **OK** Repeatedly to Switch between Block and View.
  - indicates that the Rating is Locked (Blocked).
  - indicates that the Rating is Not Locked (Viewable).

Canadian English rating	Canadian French rating	Description
All		Locked All Ratings
E		Exempt Program
C	–	For All Children
C8+	–	For All Children 8 and Older
G		General Audience
–	8 ans+	Unsuitable for Ages under 8
PG	–	Parental Guidance Suggested
–	13 ans+	Unsuitable for Ages under 13
14+	–	Unsuitable for Ages under 14
–	16 ans+	Unsuitable for Ages under 16
18+	18 ans+	Adult Audience Only

#### Note(s)

- The V-Chip can Block Non Rated Programs as per "CEA-608-E sec. L3". If the Option to Block **NR**, **None** or **E** Programs are used in **Movie ratings lock**, **TV ratings lock**, **Canadian English rating** or **Canadian French rating** accordingly "unusual results may occur and the Unit may not Receive Emergency Bulletins or other Types of Programming"; / Emergency Bulletins (Such as EAS messages, Weather Warnings and Others) / Locally originated Programming / News / Political / Public Service Announcements / Religious / Sports / Weather.

## Change PIN

Although the default PIN code (0000) is supplied with the Unit, you can set your own PIN code.

- Use **▲▼** to Select **Change PIN**, then press **OK**.
- Press the **NUMBER buttons** to enter the Current 4-digit PIN code.
- Press the **NUMBER buttons** to enter the New 4-digit PIN code.
  - Enter PIN code again to confirm.

#### Note(s)

- Make sure new PIN code and confirm PIN code must be exactly the same. If they are different, the space is cleared for reentering.
- If you have forgotten your PIN code, enter **0711** to reset the PIN code.

## Digital audio language

You can select the Audio language while your TV is receiving the Digital broadcasting.

- Use **▲▼** to Select **Digital audio language**, then press **OK**.

<b>Digital audio language</b>	to Select the language according to your preference. (It differs depending on the program.)
-------------------------------	--

## Mono/Stereo

### Cable / NTSC (Analog) TV Operation

You can select an audio format while your TV is receiving the Analog broadcasting.

- Use **▲▼** to Select **Mono/Stereo**, then press **OK**.
- Use **▲▼** to Select **Mono**, **Stereo** or **SAP** (Second Audio Program), then press **OK**.

## Update software

Philips continuously tries to improve its products and we strongly recommend that you upgrade the TV software when upgrades are available.

New software can be downloaded from our website at [www.philips.com/support](http://www.philips.com/support) using the model number of your TV to find information.

You can update the software through these methods:

- update with USB Memory Stick

This section describes how to upgrade the software by using USB Memory Stick.

## Preparing for the Software upgrade

You require the following equipment:

- A PC with web browsing capability
- An archive utility that supports the ZIP-format (e.g. WinZip for Windows or Stuffit for Mac OS)
- An empty clean formatted USB Memory Stick

### Note(s)

- Only FAT / DOS-formatted portable memory is supported.
- Use only software upgrades that can be found on the Philips web site.

### Warning

- When the software upgrade is running, don't press any buttons.
- Do not remove the USB Memory Stick during the software upgrade.
- If an error occurs during the upgrade, retry the procedure or for further assistance, please contact Call Center.

## Downloading the Software

Find information and software related to your TV and download the latest software upgrade file to your PC.

Prepare a blank USB memory stick for Software Update. Access [www.philips.com/support](http://www.philips.com/support) and download the latest version software to a blank USB memory stick using a PC by following the Directions described on the website.

- Use a blank USB memory stick, download the software on your PC and write the software in the root directory of the USB memory stick.
- For more details on how to download the software, please refer to the website.

## USB upgrade

You can upgrade the software by using USB Memory Stick.

- 1 Connect your USB Memory Stick with the upgrade file to the USB terminal on the side of your TV.

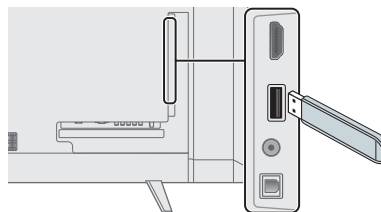

- 2 Press **MENU** and use **▲▼◀▶** to Select **Update software**, then press **OK**.
- 3 Use **▲▼** to Select **USB**, then press **OK**.
- 4 Use **▲▼◀▶** to Select the desired update file, then press **OK**.
- 5 Use **◀▶** to Select **Yes**, then press **OK**.
  - Read the on-screen instructions and confirm that you want to continue with the installation.

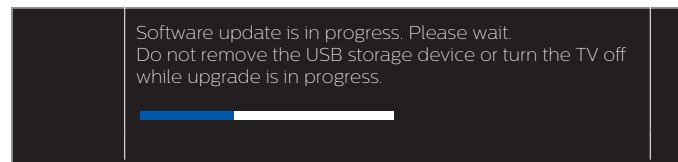

- 6 When the software upgrade is completed, press **⏻** to set the unit into Standby mode, then remove the USB Memory Stick.
- 7 Unplug the AC power cord for a few seconds from AC outlet and plug it again.
- 8 Press **⏻** again to Turn the unit On.
  - The TV starts up with the new software.
  - For further assistance, please contact Call Center.



## Network updates

You can update the software by connecting the unit to the Internet.

- 1 Press **MENU** and use **▲▼◀▶** to Select **Update software**, then press **OK**.
- 2 Use **▲▼** to Select **Network**, then press **OK**.
- 3 Use **◀▶** to Select **Yes**, then press **OK**.
  - This unit will then start checking for the latest FirmWare (software) version.
- 4 Confirmation message will appear.
  - Use **◀▶** to Select **Yes**, then press **OK**.
    - The unit will start downloading the latest FirmWare (software) version.
    - The unit will start updating the FirmWare (software) version.
    - It may take a while to complete the updating.
- 5 When the software update is complete, press **⏻** to make sure the unit goes to Standby mode.
- 6 Unplug the AC power cord for a few seconds from AC outlet and plug it again.
- 7 Press **⏻** again to Turn the unit On.
  - The TV starts up with the new software.

For further assistance, please contact Call Center.

### Note(s)

- Please do not unplug the AC power cord or Ethernet Cable while executing the **Network updates**.
- All settings will remain the same even if you update the software version.
- The version of Net service will also be updated if newer version of Net service is available when updating the firmware.
- When you start up the TV or a net service after executing the software update, a message may appear on the screen prompting for software update again. In this case, please select **Update** to start USB update or network update. For further assistance, please contact call center.

## Software settings

### Software

- 1 Press **MENU** and use **▲▼◀▶** to Select **Software settings**, then press **OK**.
- 2 Use **▲▼** to Select **Software**, then press **OK**.

### Checking your current Software version number

- 1 Use **▲▼** to Select **Software information**, then press **OK**.
  - The version and a description of the current software is displayed.

### Checking your current Cast software version number

- 1 Use **▲▼** to Select **Cast software version**, then press **OK**.
  - The Cast software version is displayed.

### License

Displays the Licenses of Open Source Software used in this unit.

- 1 Use **▲▼** to Select **License**, then press **OK**.
  - Licenses of Open Source Software used in this unit are displayed.

### Digital rights management

This product contains technology subject to certain intellectual property rights of Microsoft. Use or distribution of this technology outside of this product is prohibited without the appropriate license(s) from Microsoft.

- 1 Use **▲▼** to Select **Digital rights management**, then press **OK**.
  - Digital rights management is displayed.

# 6 Useful tips

## FAQ

Question	Answer
My Remote Control does not work. What should I do?	<ul style="list-style-type: none"> <li>• Check the Antenna or Cable Connection to the Main Unit.</li> <li>• Check the Batteries on the Remote Control.</li> <li>• Check if there is an obstacle between the infrared sensor window and the Remote Control.</li> <li>• Test the IR Signal Output use <b>IR Signal Check</b>. ➔ p. 45 If okay, then possible Infrared Sensor trouble.</li> <li>• Aim the Remote Control directly at the infrared sensor window on the front of the Unit.</li> <li>• Reduce the distance to the Unit.</li> <li>• Re-insert or replace the AAA Batteries with their Polarities (+/-) as indicated on the Remote Control Battery area.</li> <li>• When there is an infrared-equipped device such as PC near this Unit, it may interrupt the Remote Control signal on this Unit. Move the infrared-equipped device away from this Unit, change the angle of the Device's infrared sensor or Turn Off the infrared communication function.</li> </ul>
How come the Initial Setup appears every time I Turn On this Unit?	<ul style="list-style-type: none"> <li>• Make sure to complete the Initial Setup before the Unit goes into Standby mode.</li> </ul>
Why can I not watch some RF signal TV Programs?	<ul style="list-style-type: none"> <li>• Autoprogram must be completed when you Set Up the Unit for the First time or Move it to a location where previously unavailable channels are broadcast.</li> <li>• Make sure Auto programming has been completed. ➔ p. 37</li> <li>• The selected channel may not be broadcasting.</li> <li>• When Auto programming is interrupted and not completed, some channels will not be received. Make sure to complete the Autoprogram. ➔ p. 37</li> <li>• The selected channel cannot be viewed by the <b>Child lock</b> setting. ➔ p. 38</li> <li>• The Unit requires some kind of Antenna Input. An indoor Antenna (Digital or VHF / UHF), an External Antenna (Digital or VHF / UHF) or an RF Coaxial Cable from your wall Cable or Set-top Box needs to be plugged into the Unit.</li> </ul>
How come there is no image from the Connected External Devices?	<ul style="list-style-type: none"> <li>• Check if the correct Input mode is selected by pressing <b>SOURCE</b>. ➔ p. 22</li> <li>• Check the Antenna, Cable or other Input Connection to the Unit.</li> <li>• When using the Component Video Connection check that the Green (Y), Blue (Pb/Cb) and Red (Pr/Cr) connectors are connected to their corresponding colored jacks on the Unit.</li> </ul>
When I enter a channel number, why does it change Automatically?	<ul style="list-style-type: none"> <li>• Many Digital channels have alternate channel numbers. The Unit changes the numbers Automatically to the ones signifying the Broadcasting Station's channel number. These basic numbers used for the previous Analog Broadcasts. (e.g., Input Digital ch# 30 Automatically changes to Digital ch# 8.1)</li> </ul>
Why are captions not displayed Entirely? Or why are captions delayed behind the dialog?	<ul style="list-style-type: none"> <li>• Closed Captions that are delayed a few seconds behind the actual dialog are common for Live broadcasts. Most captioning production companies can display a dialog to maximum of 220 words per minute. If a dialog exceeds that rate, selective editing is used to insure that the Closed Captions remain up-to-date with the current TV screen dialog.</li> </ul>
How can I set the clock?	<ul style="list-style-type: none"> <li>• There is No clock function on this Unit.</li> </ul>
My PIN code no longer works, how can I change the Child Lock setting?	<ul style="list-style-type: none"> <li>• Although the default PIN code (0000) is supplied with the Unit, the PIN code will be required once you set a PIN code in <b>Child lock</b>. ➔ p. 38 When you forget your PIN code, enter 07 1 1 in <b>Change PIN</b> to reset the PIN code. ➔ p. 39</li> </ul>
When I start up the TV or a net service, a message appears on the screen prompting for software update again.	<ul style="list-style-type: none"> <li>• When you start up the TV or a net service after executing the software update, a message may appear on the screen prompting for software update again. In this case, please select <b>Update</b> to start USB update or network update. ➔ p. 40</li> </ul>

## Troubleshooting Tips

If the Unit does not perform properly when operated as instructed in this User Manual,

**Please check the following Troubleshooting Tips and All Connections Once before calling for Service.**

### Power

#### No Power

- Make sure the AC Power Cord is plugged in.
- Make sure that the AC outlet supplies the proper voltage, plug another electrical appliance into the AC outlet to ensure that the AC outlet operates normally.
- If a Power Failure occurs, Unplug the AC Power Cord for 1 minute to allow the Unit to Reset Itself.

### Remote

#### Control buttons do not work.

- Do NOT press more than one button at the same time.
- Ensure that no buttons on the Remote Control are depressed and move freely.

#### Universal Remote Control does not work properly.

- Refer to the user manual of the universal remote control for the Philips code.

### Picture

#### Power is ON but no screen image.

- Check whether the Connection for the Antenna, Cable or Set-top Box is Connected Correctly.
- Check whether All the Cables to the Unit are connected to the correct Output Jack on your device like Blu-ray / DVD recorder.
- Make sure that the selected Input mode is connected to the working Input jack.
- Check if your computer is NOT in Sleep Mode when the Input mode of this unit is in PC mode. Tap any key on the Computer Keyboard to Wake it up.
- Check if the correct input mode is selected by pressing **SOURCE**.

#### No Color

- View other TV channels. The problem might be limited to the broadcasting station.
- Adjust **Color** in **Picture** settings. **→ p. 29**

#### Picture Poor

- Adjust **Contrast** and **Brightness** in **Picture** settings. **→ p. 29**
- For the Best Picture Quality, watch "High Definition" wide screen Programs. If the HD content is Not available, watch "Standard Definition" Programs instead.

#### You see Pixelation on the Screen.

- When the capabilities of the Unit exceed the capabilities of the Digital Broadcasting, the signal will be increased to match the capabilities of the Display on the Unit. This may cause Pixelation, Noise or Trash.

#### Unusual picture appears and the TV does Not operate.

- Press the power button first. If it does not solve, follow the procedure below.
  - ① Press the buttons on the remote control in the order shown below.  
**▶→▲→▼→▶→⏻**
  - ② Unplug the AC Power Cord, then wait for 1 minute, and then plug it in again.

### Sound

#### No sound is heard when using the HDMI Digital Connection.

- Some HDMI cables and devices may not be compatible with the TV due to different HDMI specifications.

#### No sound, distorted sound or incorrect Audio Sound is heard when using the HDMI-DVI Connections.

- Make sure that the Analog Audio signals from the HDMI-DVI device are connected to the Analog Audio L/R Input jacks.
- When using Component Analog Video, Composite Analog Video or PC VGA Video, make sure that the Analog Audio (L/R) connectors are mounted into the Audio (L/R) Input jacks.

#### Sound Intermittent or No Sound.

- Check if the Audio Cable is connected into the Unit correctly.

#### You Switch to a Different Input and the Volume Changes.

- This Unit will Memorize the Volume Level from the last time you adjusted it.
- If the Volume of the Sound from another Device is Higher or Lower, then the Loudness will Change.
- Make sure **Auto volume leveling** is set to **On**. **→ p. 31**

### Picture & Sound

#### No sound with distorted picture occurs when using the HDMI Digital Connection.

- Some HDMI cables and devices may not be compatible with the TV due to different HDMI specifications.

#### No Picture or Sound

- Check if the Power is on.
- Check whether All the cables to the Unit are connected to the correct Output jack of your device like Blu-ray / DVD Recorder.
- Check whether All the Cables to the Unit are connected to the correct Output Jack on your separate Device like Blu-ray Disc / DVD Recorder.
- View other TV channels. The problem might be limited to the Broadcasting Station or Weak Signal Strength.
- Unplug the AC Power Cord and wait for about 1 minute, then Plug the AC Power Cord and turn On the Unit again.
- Check whether the connection of the Antenna or Cable / Satellite Set-top Box is connected correctly.
- Make sure that the selected Input mode is connected to the working Input jack.
- Check if your computer is NOT in sleep mode when the Input mode of this Unit is in PC mode. Tap any key on the keyboard to wake up your computer.
- Make sure that the sound is not muted. Press **MUTE** so that the volume bar and current volume level will appear on the TV screen.
- Make sure that the volume is NOT set to **0** or **MUTE**. If so, use **VOL + / -** to adjust to the desired volume.
- Make sure that the headphone is NOT connected to the Headphone Audio Output jack.
- Make sure that the **TV speakers** is NOT set to **Off**.
- If there are issues with picture/color and/or sound when connecting an external device using the HDMI port, please try switching the **HDMI mode**. (Refer to **HDMI mode** **→ p. 35**)

#### Adjusted Picture or Sound settings are not effective every time the Unit is turned On.

- You must set **Home** in **Location**. **→ p. 35** (Otherwise, the settings you adjusted will not be memorized after the Unit goes into Standby Mode.)

#### You see a Distorted Picture or Hear an Unusual Sound. (Analog TV - NTSC signal)

- You may be getting NTSC (Analog) TV signal (not HDTV signal) interference from electrical appliances, automobiles, motorcycles or fluorescent lights.
- Try moving the Unit to another Location to see if this is the Cause of the Problem.

#### Ghosts, lines or streaks in picture.

- Electrical Interference from nearby appliances may affect Picture Quality.
- View other TV channels. The problem might be limited to the broadcasting station or weak signal strength.

#### Picture Poor, Sound Intermittent or No Sound

- View other TV channels. The problem might be limited to the broadcasting station or weak signal strength.

### Child and Rating Lock

#### Forgotten PIN code.

- Enter "0711" to clear your password.

### Screen

#### You Switch to a different Input and the Screen Size changes.

- This unit will memorize the viewing mode from the last time you used the particular input modes.

#### The display image does not cover the entire screen.

- If you are using the Unit as a PC Monitor, make sure that **Horizontal position** and **Vertical position** in **Picture** are set correctly. **→ p. 29**
- If you are watching TV or using the Composite Video, Component Video or HDMI with 480i Input, press **FORMAT** Repeatedly to Switch to various Screen Modes.

#### Different color marks on the TV screen

- View other TV channels. The problem might be limited to the broadcasting station, missing data or pixelation due to weak signal strength.

## Closed Captions

**Closed Captions are displayed as a white box. No Closed Captions are displayed in the Closed Captions-Supported Program.**

- Interference from buildings or weather conditions may cause Closed Captions to be incomplete if watching Analog TV signals.
- Broadcasting Station may shorten the program to insert advertisements. The Closed Caption Decoder cannot read the information of the shortened program.

**Black Box is displayed on the TV Screen.**

- The text mode is selected for caption. Select **CC-1**, **CC-2**, **CC-3** or **CC-4**.

## Software update

**A message appears on the screen prompting for software update again.**

- When you start up the TV or a net service after executing the software update, a message may appear on the screen prompting for software update again. In this case, please select **Update** to start USB update or network update. ➔ **p. 40**

## Network

**Cannot connect to the network.**

- Check if the Ethernet Cable connection is properly made. Turn On the Broadband Router and/or Modem.
- Check the Network Settings.
- Check if the Broadband Router and/or Modem is correctly connected.

**Sometimes video quality is poor when using the wireless LAN.**

- The wireless network connection quality varies depending on the distance or obstacles (e.g. wall, basement, 2nd floor) between the TV Wireless LAN Adapter and the Wireless Router (access point), from other wireless networks, and brand and type of the Wireless Router (access point). When using the Wireless LAN of the TV, it is suggested to place the Wireless Router as close as possible to the Television.

**Wireless LAN connection fails or wireless connection is poor.**

- Check the installation location of the TV and Wireless Router (access point). Signal quality may be affected for the following reasons.
  - Interference of other wireless devices, microwaves, fluorescent lights, etc., are placed nearby.
  - There are floors or walls between the Wireless Router and TV.
  - If the problems continue even after checking the above, try making a wired LAN connection.

**Cannot use the wireless connection.**

- Check if the Wireless LAN Access Point (AP) (e.g. Wireless Router) is oriented properly or not placed too close between them.
- Once you have activated the wireless connection please wait 30 seconds for the connection to be established after Turning On the Unit, before trying to access network features such as Net TV.



### Note(s)

- The LCD screen is manufactured to provide many years of useful life. Occasionally a few non active pixels may appear as a fixed point of blue, green or red. This is not to be considered a defect in the LCD screen.
- Some functions are not available in specific modes, but this is not a malfunction. Read the description in this User Manual for more details on correct operations.

For additional troubleshooting, refer to the Frequently Asked Questions or FAQs on [www.philips.com/support](http://www.philips.com/support).

# 7 Information

## Glossary

### Analog TV (NTSC)

Acronym that stands for National Television Systems Committee and the name of Analog broadcasting standards. Off the air Analog TV signals are no longer being sent by major broadcasting stations in the USA.

### ARC (Audio Return Channel) (HDMI 1 only)

HDMI-ARC allows you to use Philips EasyLink to output TV audio directly to a connected Audio device, without the need for an additional Digital Audio cable. Be sure that the device is HDMI CEC and ARC compliant, and that the TV is connected to the device using an HDMI cable attached to both HDMI-ARC connectors.

### Aspect ratio

The width of a TV screen relative to its height. Conventional TVs are 4:3 (in other words, the TV screen is almost square); widescreen models are 16:9 (the TV screen is almost twice as wide as its height).

### CEC (Consumer Electronics Control)

This allows you to operate the linked functions between our brand devices with CEC feature and this Unit. We Do Not guarantee 100% interoperability with other brands of CEC compliant devices.

### Component Video

This is a Video signal format that conveys each of 3 principal colors of light (red, blue and green) through different signal lines. This allows the viewers to experience picture colors as original as it is. There are several signal formats, including Y / Pb / Pr and Y / Cb / Cr.

### Dolby Digital

The system developed by Dolby Laboratories to compress Digital sound. It offers Stereo Sound (2ch) or multi-channel Audio.

### DTV (ATSC)

Abbreviation that stands for Advanced Television Systems Committee and the name of the Digital broadcasting standards.

### HDMI (High-Definition Multimedia Interface)

Interface that supports All uncompressed, Digital Audio / Video formats including Set-top Box, Blu-ray / DVD Recorder or Digital television, over a single cable.

### HDR

HDR stands for High Dynamic Range. By using additional data encoded with the source signal, HDR capable products offer greater contrast through an expansion of the range of the image's color luminance. The source, cable and display must all support HDR.

### HDTV (High-Definition TV)

Ultimate Digital format that produces high resolution and high picture quality.

### PIN code

A stored 4-digit number that allows access to Parental control features.

### SAP (Secondary Audio Program)

Second-Audio channel delivered separately from the Main-Audio channel. This Audio channel is used as an alternate in bilingual broadcasting.

### SDTV (Standard Definition TV)

Standard Digital format that is similar to the Analog TV picture quality.

### Sonic Emotion Premium

Sonic Emotion Premium fills your surroundings with the right ambience, clarifies voice, and details the sound stage, making your experience more immersive and enjoyable.

## Maintenance

### Cabinet Cleaning

- Wipe the front panel and other exterior surfaces of the Unit with a soft cloth.
- Never use a solvent or alcohol. Do Not spray insecticide liquid near the Unit. Such chemicals may cause damage and discoloration to the exposed surfaces.

### Panel Cleaning

Wipe the panel of the Unit with a soft cloth. Before cleaning the panel, disconnect the AC Power Cord.

### Servicing

Should your unit become inoperative, do not try to correct the problem yourself. There are no user serviceable parts inside. Call our toll free customer support line found on the cover of this User Manual to locate an authorized service center.

### IR Signal Check

If the Remote Control is not working properly, you can use a Digital or Cell Phone Camera to see if it is sending out an infrared signal.



e.g.) With a Digital Camera:  
Point the Digital Camera towards the Remote Control infrared diode at the front of the Remote Control. Press and Hold any Key on the Remote Control and look at the Camera Display. If an infrared pulsating light appears on the Display, the Remote Control is sending out an IR signal.

**Note:** Some Cameras may have an IR Filter or Dual Camera Cell Phones may have an IR Filter in one of the Camera's and both will not Display the IR signal.

# 8 Specifications

Model #		75PFL6621	65PFL6621
<b>Picture</b>			
Type	UHD (Ultra HD) (3840 x 2160 pixels 60Hz)		
Diagonal screen size / Aspect ratio	74.5" / 16:9	64.5" / 16:9	
Viewing Angles	178° (V) by 178° (H)		
Built-in Digital / Analog Tuner	ATSC (Digital) / NTSC (Analog)		
<b>Sound</b>			
Mono / Stereo	Mono, Stereo, Sonic Emotion Premium		
Power Output (RMS watts)	10W x 2		
Equalizer	5 Band		
<b>Ease of Use</b>			
Picture Format	SD (4:3 Source)	: Automatic / Super zoom / 4:3 / Movie expand 14:9 / Movie expand 16:9 / Wide screen	
	HD (16:9 Source)	: Automatic / 4:3 / Wide screen / Full / Unscaled	
	UHD	: Full / Unscaled	
Photo Slide Show	JPEG, Progressive JPEG		
Music Playback	MP3, WAV, AAC		
Video Playback	MPEG1, MPEG2, H.264, MPEG4, H.265/HEVC		
<b>Channel</b>			
Channel Coverage	Over-the-Air DTV (ATSC)	: VHF: 2~13 UHF: 14~69 (Each Channel may have e.g. 2.1~2.9, 3.1~3.9, etc)	
	Over-the-Air Analog (NTSC)	: VHF: 2~13 UHF: 14~69	
CATV (Analog NTSC)	2~13, A~W W+1~W+94 (Analog W+1~W+84), A-5~A-1, 5A		
Tuning System	Channel Frequency Synthesized Tuning System		
Channel Access	Direct Access Number Keyboard, Programmable Scan, Channel +(up) / -(down) and PREV. CH (Previous Channel)		
<b>Connectivity</b>			
Component Video Input (Y/Pb/Pr)	1 Supporting Video Signals : 480i/p, 720p, 1080i/p @60Hz		
Composite Video Input (Shared Y Green Terminal with Component Video)	1		
HDMI Input	4 (selectable HDMI modes)		
	Supporting HDMI Video Signals : 480i/p, 720p, 1080i @60Hz, 1080p, 2160p @24/30/60Hz		
	Supporting HDMI Digital Audio Signals : LPCM, AC3, DD+ Supporting PC-Input Video Signal up to 4096 x 2160		
Analog Audio L/R Input	1 (L Audio / R Audio)		
PC Input	Via VGA, HDMI and HDMI-DVI + Analog Audio L/R		
USB	1		
Wireless LAN	Supporting wireless standards : IEEE 802.11a/b/g/n/ac (2.4GHz/5GHz)		
Ethernet port	1		
Digital Audio Output	1 Supporting Dolby Audio (Dolby Digital and Dolby Digital Plus)		
Headphone Output	1 3.5mm (1/8 inch)		
<b>Power</b>			
Power Requirements	120V~ +/- 10%, 50/60Hz +/- 0.5%		
<b>Temperature</b>			
Operating Temperature	41 °F (5 °C) to 104 °F (40 °C)		

• Specifications are Subject to Change without Prior Notice.

# 9 Warranty

## POLIZA DE GARANTÍA

### ESTA PÓLIZA ES GRATUITA

Este aparato ha sido cuidadosamente diseñado y se ha fabricado con los mejores materiales bajo un estricto control de calidad, garantizando su buen funcionamiento por los periodos establecidos según el aparato (ver lista en la parte inferior) **a partir de la entrega del aparato al consumidor.**

**Esta póliza incluye la reparación o reposición gratuita de cualquier parte o componente que eventualmente fallase y la mano de obra necesaria para su reparación, así como los gastos de transportación razonablemente erogados dentro de nuestro centro de servicio, misma que se hará efectiva en cualquiera de nuestros centros de servicio autorizados en el país.**

Si tu aparato llegase a requerir de nuestro servicio de garantía, acuda al centro de servicio más cercano a su domicilio, de tener alguna duda por favor llame a nuestro **CENTRO DE INFORMACIÓN AL CLIENTE LADA** sin costo en toda la republica al **01 800 839 19 89** en donde con gusto le indicaremos el centro de servicio autorizado más cercano a su domicilio.

P&F MEXICANA S.A. de C.V. a través de sus centros de servicio autorizados **reparará y devolverá a usted su aparato en un plazo no mayor a 20 días hábiles** contados a partir de la fecha de ingreso, impresa en la orden de servicio de cualquiera de nuestros centros de servicio autorizados.

**La garantía de esta póliza cubre cualquier desperfecto o daño eventualmente ocasionado por los trabajos de reparación y/o traslado del aparato en el interior de nuestros centros de servicio autorizados.**

**Esta póliza sólo tendrá validez, si está debidamente requisitada, sellada por la casa vendedora, en caso de extravío de esta póliza, podrá hacer efectiva su garantía con la presentación de su factura de compra.**

### ESTA PÓLIZA NO SE HARÁ EFECTIVA EN LOS SIGUIENTES CASOS:

-Cuando el aparato sea utilizado en condiciones distintas a las normales.

-Cuando el aparato no haya sido operado de acuerdo con el instructivo de uso que se le acompaña.

-Cuando la causa de la falla o mal funcionamiento sea consecuencia de una reparación inadecuada o alteración producida por personas no autorizadas por P&F MEXICANA S.A.de C.V.

### PERIODOS DE GARANTÍA

12 meses – Televisores con y sin reproductor de video digital DVD, reproductores de discos de video digital DVD, reproductores de disco de video digital BLU-RAY, grabadores reproductores de discos de video digital DVD, sistemas de cine en casa, radiograbadoras con y sin reproductor de disco compacto, video proyector (excepto la lámpara), mini sistemas de audio, equipos modulares, antenas de recepción de satélite, teléfonos, teléfonos inalámbricos, auto estéreos, tabletas electrónicas, Base para iPod y bocinas inalámbricas (Bluetooth).

6 meses.– Radio relojes, radios A.M./F.M, batería recargables y reproductores de audio digital MP3 (internet).

90 días.– Accesorios, controles remotos, bocinas, micrófonos, audifonos y aparatos reconstruidos de LCD TV, DVD, Blu-ray, Barras de audio y Sistemas de Teatro en casa.



# License

P&F Mexicana, S.A. de C.V. hereby offers to deliver, upon request, a copy of the complete corresponding source code for the copyrighted open source code packages, on an "AS IS" basis, used in this product for which such offer is requested by the respective licenses. This offer is valid up to three years after the product purchase to anyone in receipt of this information. To obtain source code, please contact P&F USA, Inc. You should write to "Open Source Team, P&F USA, Inc., PO Box 2248, Alpharetta, GA 30023-2248. P&F USA, Inc. disclaims any and all warranties and representations with respect to such software and related source code including quality, reliability, usability, and accuracy, and further disclaim all express, implied, statutory or otherwise, including without limitation, any implied warranties of title, non-infringement, merchantability, or fitness for a particular purpose. P&F Mexicana, S.A. de C.V. shall not be liable to make any corrections to the open source software or source code or to provide any support or assistance with respect to it. P&F Mexicana, S.A. de C.V. disclaims any and all liability arising out of or in connection with the use of this software and/or source code.





P&F Mexicana, S.A. de C.V.  
Av. La Palma No. 6, Col. San Fernando La Herradura.  
Huixquilucan, Edo. de México. C.P. 52787

This product has been manufactured by and is sold under the responsibility of P&F Mexicana, S.A. de C.V., and P&F Mexicana, S.A. de C.V. is the warrantor in relation to this product.

The Philips trademark and the Philips Shield Emblem are registered trademarks of Koninklijke Philips N.V. used under license.

A619DM2 / A618DMH  
★★★★★