

Register your product and get support at

www.philips.com/welcome

AS111



User manual

PHILIPS

Contents

1	Important	4
	Safety	4

2	Your docking speaker for Android™	5
	Introduction	5
	What's in the box	5
	Overview of main unit	5

3	Get started	6
	Connect power	6
	Turn on	6
	Adjust brightness of display panel	6
	Adjust brightness of night light	7

4	Play and charge	8
	Compatible with Android™	8
	Play music through Bluetooth	8
	Play audio through auto Bluetooth connection with Fidelio app	10
	Install "Songbird app" to enjoy music	16
	Dock and charge Android-powered device	19

5	Other features	21
	Set time	21
	Listen to internet radio	21
	Set sleep timer	22
	Set alarm timer	23

6	Product information	25
	Specification	25

7	Notice	26
	Disposal of your old product and batteries	26

8	Troubleshooting	27
----------	------------------------	-----------

1 Important



Warning

- Never remove the casing of this apparatus.
- Never lubricate any part of this apparatus.
- Never place this apparatus on other electrical equipment.

Safety

- Read these instructions.
- Keep these instructions.
- Heed all warnings.
- Follow all instructions.
- Do not use this apparatus near water.
- Clean only with dry cloth.
- Install in accordance with the manufacturer's instructions.
- Do not install near any heat sources such as radiators, heat registers, stoves, or other apparatus (including amplifiers) that produce heat.
- Protect the power cord from being walked on or pinched, particularly at plugs, convenience receptacles, and the point where they exit from the apparatus.
- Only use attachments/accessories specified by the manufacturer.
- Unplug this apparatus during lightning storms or when unused for long periods of time.
- Refer all servicing to qualified service personnel. Servicing is required when the apparatus has been damaged in any way, such as power-supply cord or plug is damaged, liquid has been spilled or objects have fallen into the apparatus, the apparatus has been exposed to rain or moisture, does not operate normally, or has been dropped.
- Apparatus shall not be exposed to dripping or splashing.
- Do not place any sources of danger on the apparatus (e.g. liquid filled objects, lighted candles).
- Where the MAINS plug or an appliance coupler is used as the disconnect device, the disconnect device shall remain readily operable.

2 Your docking speaker for Android™

Congratulations on your purchase, and welcome to Philips! To fully benefit from the support that Philips offers, register your product at www.philips.com/welcome.

Introduction

With this docking speaker, you may enjoy following features:

- Enjoy audio from your Bluetooth-enabled portable device;
- Charge your device with micro USB connector;
- Know the time;
- Experience various features brought by Philips Fidelio app and Songbird app.

What's in the box

Check and identify the contents of your package:

- Main unit
- Power adapter
- Dock extension
- Quick start guide
- Safety sheet

Overview of main unit

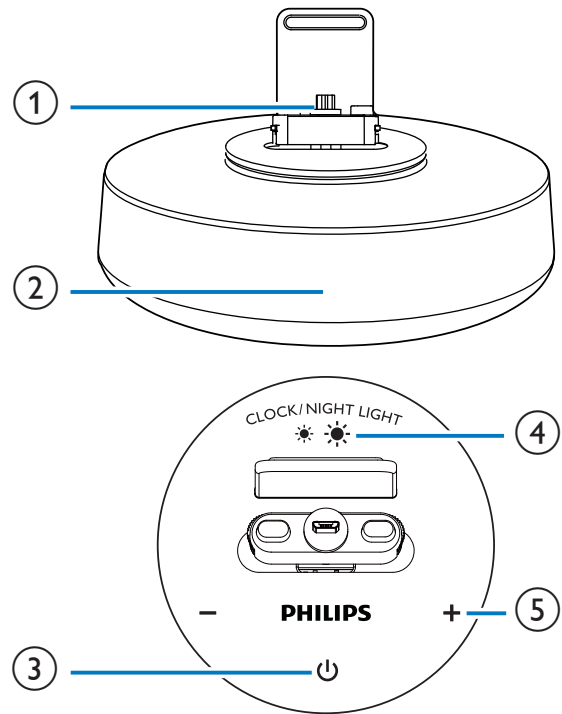

① Dock base

② Display panel

- Show time.
- Show Bluetooth status.

③

- Turn Bluetooth on/off.

④ CLOCK/NIGHT LIGHT

- Set time.
- Adjust the brightness of display panel or night light.

⑤ +/-

- Adjust volume.
- Adjust time.

3 Get started

Always follow the instructions in this chapter in sequence.

Connect power

! Caution

- Risk of product damage! Make sure that the power voltage corresponds to the voltage printed on the back or underside of the device.
- Risk of electric shock! When you unplug the power adapter, always pull the plug from the socket. Never pull the power cord.

Connect one end of the power adapter to the rear socket of the docking speaker, and the other to the power outlet.

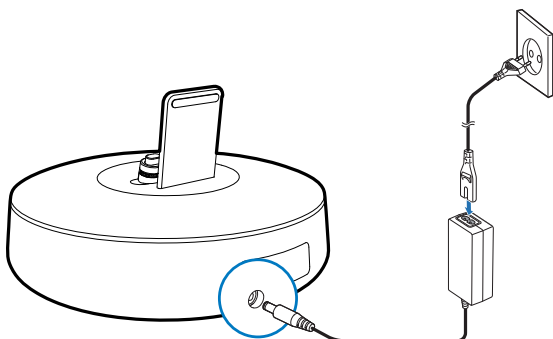

Turn on

Press **⏻**.

- ↳ The Bluetooth indicator **Ⓜ** on the display panel begins to blink.

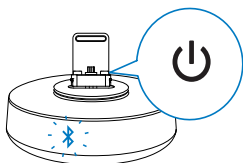

Switch to standby mode

Press **⏻** again to switch the docking speaker to standby mode.

- ↳ The Bluetooth indicator **Ⓜ** on the display panel goes off.

Adjust brightness of display panel

In standby mode, press **CLOCK/NIGHT LIGHT** repeatedly to adjust the brightness of display panel.

- ↳ The brightness of the time digits on the display panel toggles between high, medium, and low level.

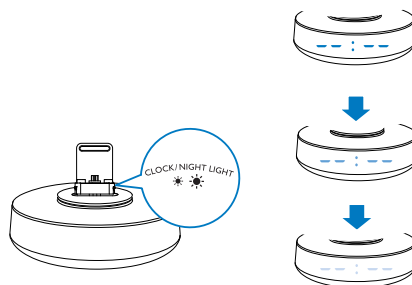

Adjust brightness of night light

In power-on mode, press **CLOCK/NIGHT LIGHT** repeatedly to adjust the brightness of the night light at the bottom.

- ↳ The brightness of the night light toggles between high level, normal level, and off mode.

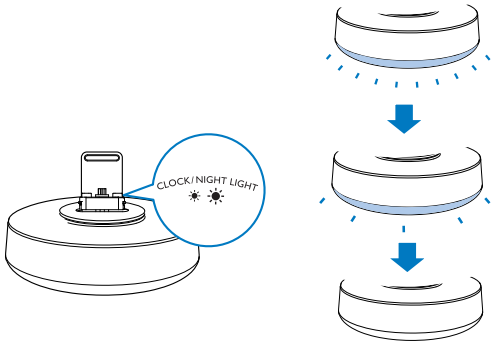

4 Play and charge

With this docking system, you can enjoy audio in two ways:

- through manual Bluetooth connection;
- through automatic Bluetooth connection with Philips Fidelio app.

Compatible with Android™

To make full use of your docking speaker, your phone should satisfy the following requirements:

- With Android operation system (Version 2.1 or above);
- With Bluetooth software (Version 2.1 or above); and
- With a micro USB connector.

For other non Android-powered smartphone with micro USB connector and Bluetooth, you can still use the docking speaker to do the following:



- Charge your phone through the connector;
- Enjoy audio through Bluetooth.



Tip

- For more details, visit www.philips.com/flexidock.

Play music through Bluetooth

- 1 Press  to activate Bluetooth on the device.
↳ The Bluetooth indicator  begins to blink.
- 2 On your phone, go to **[Settings]** (Settings) > **[Wireless and networks]** (Wireless and networks) > **[Bluetooth settings]** (Bluetooth settings).

- 3 Tap **[Bluetooth]** (Bluetooth) to turn on Bluetooth on your phone.

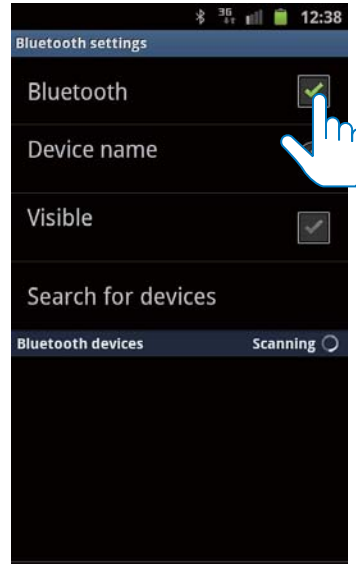

- 4 Tap **[Search for devices]** (Search for devices).

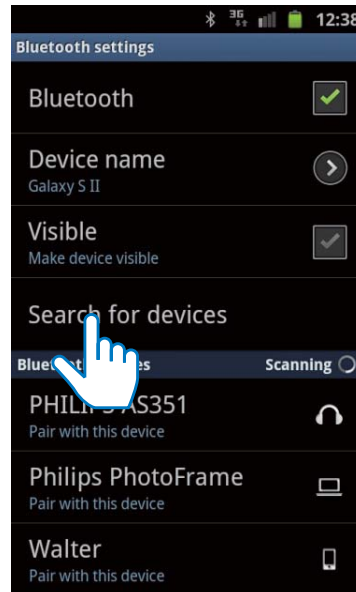

5 Tap [PHILIPS AS111].

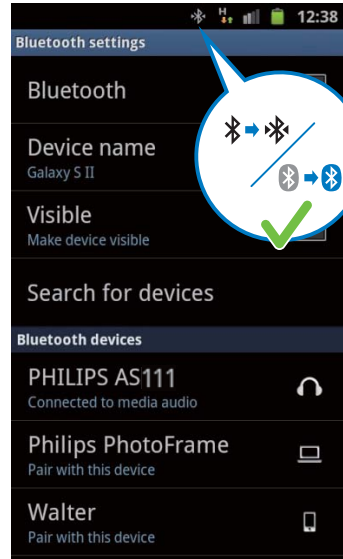
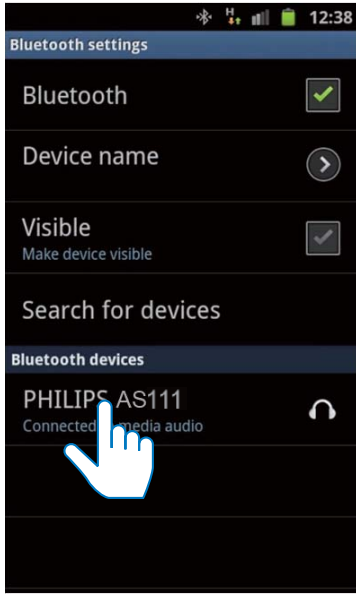

7 Play music through audio player on your portable device.

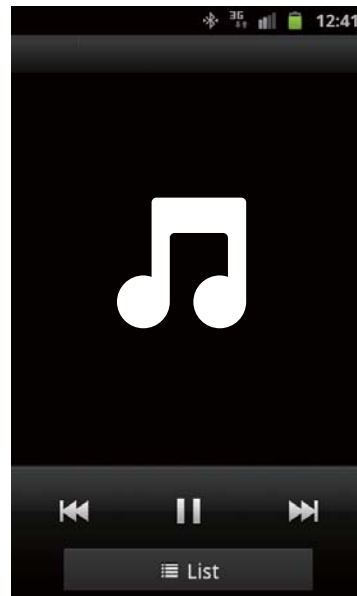

↳ A Bluetooth pairing request appears.

6 Tap [Accept] (Accept) to start pairing your portable device with the docking speaker.

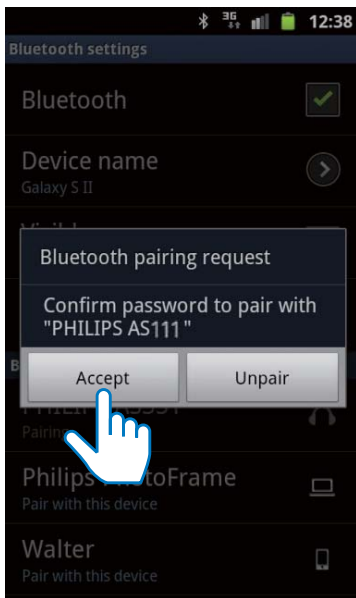

↳ The music comes out through the docking speaker.

↳ A different Bluetooth icon can be found on the top of the screen and the device are connected through Bluetooth.

Note

- The settings on the phone may vary from model to model.
- To keep constant Bluetooth connection, keep your portable device within 10 m to the docking speaker.

Play audio through auto Bluetooth connection with Fidelio app

Philips Fidelio app brings a suite of new features to your docking system, including automatic Bluetooth connection, Songbird music player, Internet radio and a multi-function alarm clock. To enjoy more features, you are recommended to download and install free "Fidelio app".

Install "Fidelio app" onto Android powered device

You have two ways to install "Fidelio app" on your Android-powered device.

Install "Fidelio" through QR code

Note

- Make sure that your Android powered device is connected to the Internet.
- Make sure that your Android powered device has a scanning software application. If you do not have one, download one from Android market.

- 1 Use the scanning software to scan the QR code.

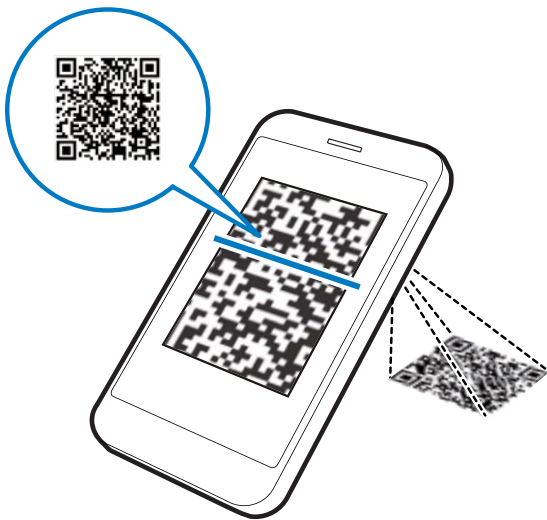

- 2 Tap [Install] (Install).



- 3 Tap [Accept & download] (Accept & download).

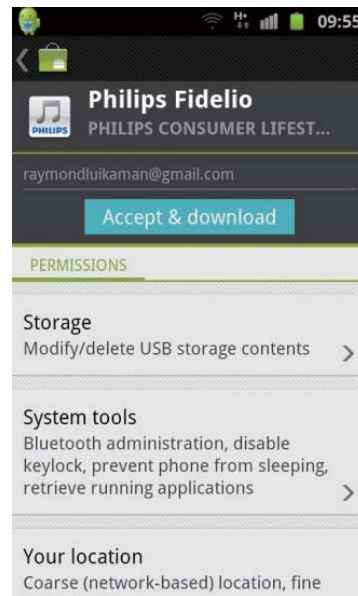

↳ Fidelio app downloading and installation starts.

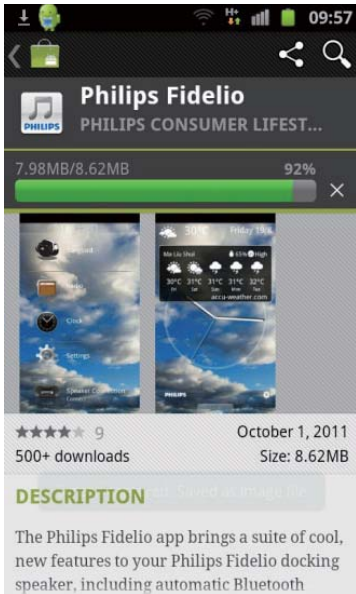

↳ Fidelio app is installed.

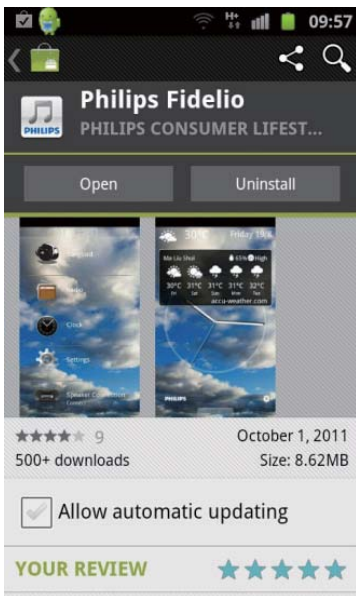

↳ Fidelio app's icon is displayed on the home page.

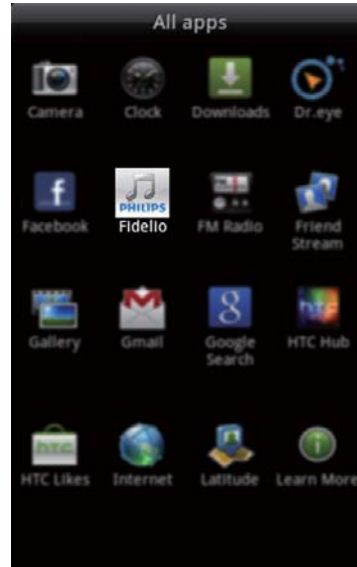

Install "Fidelio" through Anroid Market

Note

- Make sure that your Android powered device is connected to the Internet.
- Make sure that you Android powered device is equipped with Android Market.

1 Tap the Android Market icon on the main screen.



- 2 Tap the search icon on the screen to access search bar:

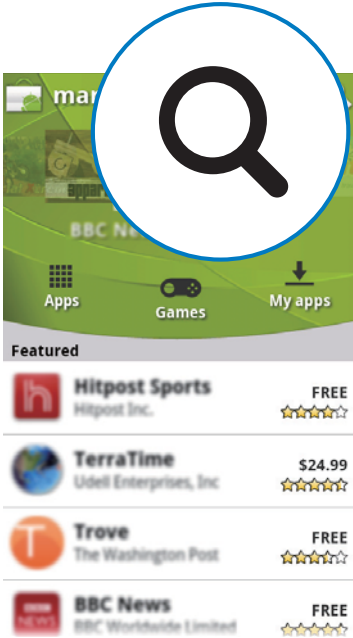

- 3 In the search bar, type in the "Fidelio" and search for "Fidelio app".



- 4 In the search result list, find and tap "Fidelio app" to start Fidelio app download.

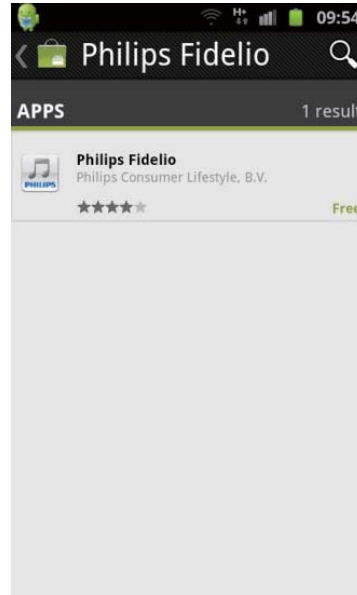

- 5 Tap [Install] (Install).

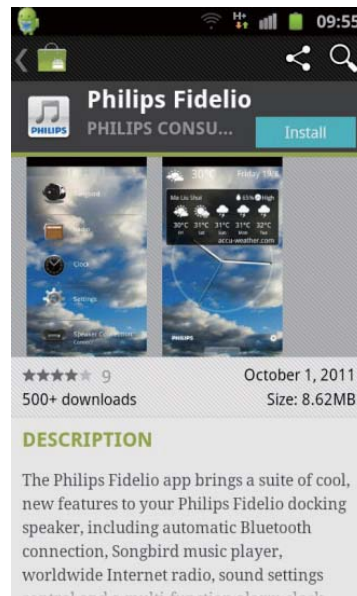

6 Tap [Accept & download] (Accept & download).

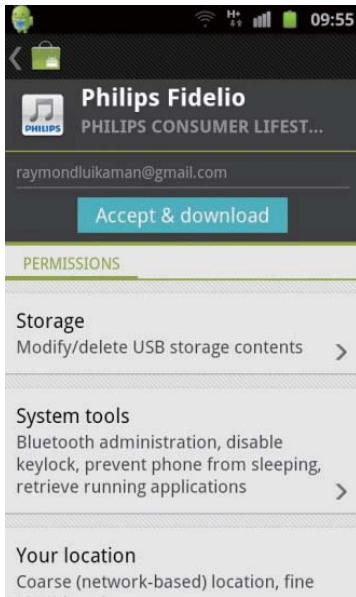

↳ Fidelio app downloading and installation starts.

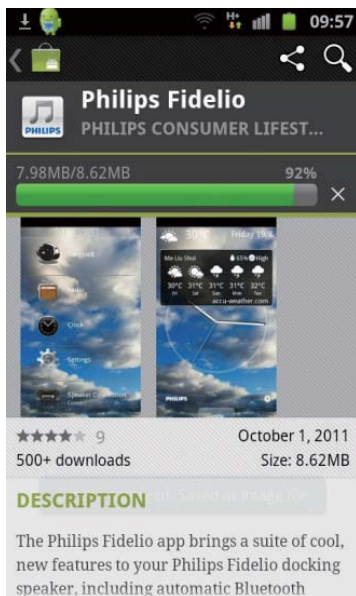

↳ Fidelio app is installed.

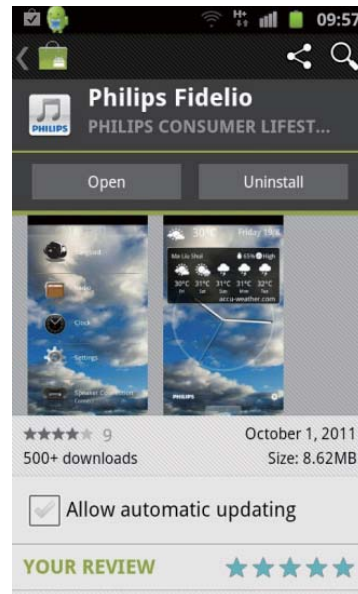

↳ Fidelio app's icon is displayed on the home page.

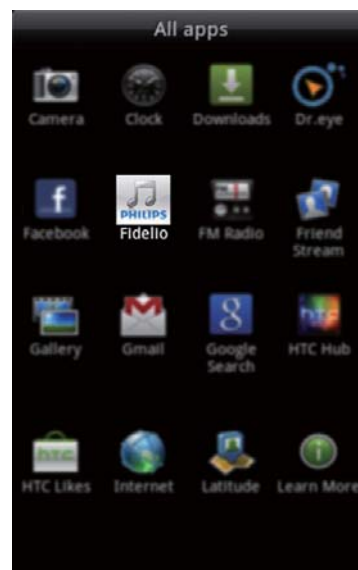

Play music with Fidelio app

Philips Fidelio app helps to connect your Android-powered device and docking system through Bluetooth automatically.

- 1 Press Φ to activate Bluetooth on the device.
 - ↳ The Bluetooth indicator Φ begins to blink.
- 2 Tap the Fidelio app icon on the home page to open Fidelio application, and go to the main menu.

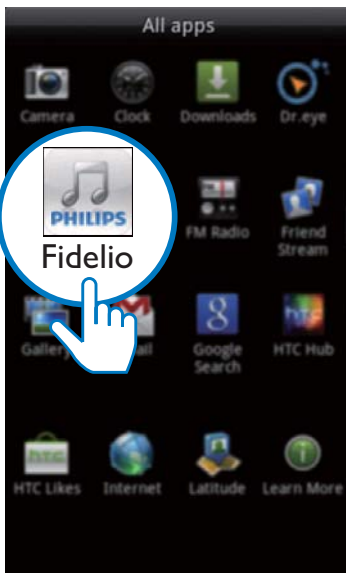

- 3 Tap [Speaker Connection] (Speaker Connection).

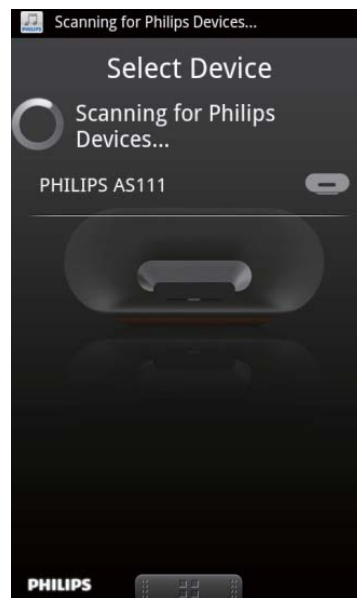
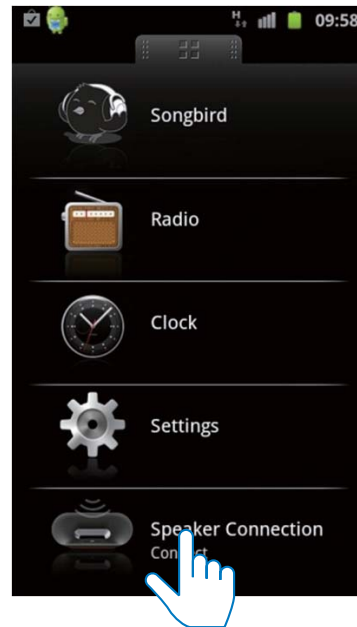



4 Tap [PHILIPS AS111].



5 Select your desired song, and tap ►.



↳ AS111 is connected to the device through Bluetooth.

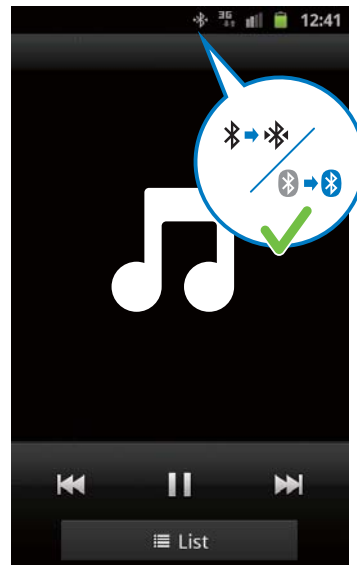

↳ You now can enjoy your music through the device.

Auto time synchronization

When you activate Bluetooth connection through Fidelio app, the time displayed on the docking speaker is synchronized with the time on your Bluetooth-enabled device automatically.

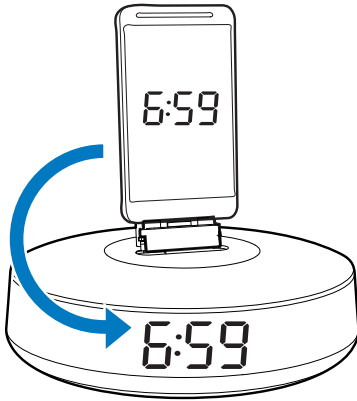

Install "Songbird app" to enjoy music

Philips Songbird is a simple, easy-to-use PC program and Android app. It lets you discover, play and sync your media from PC to your Android-powered devices seamlessly.

Install songbird app on portable device

- 1 Tap the Fidelio app icon on the main screen to open Fidelio app.



- 2 Tap the [songbird] on the main menu of Fidelio app.

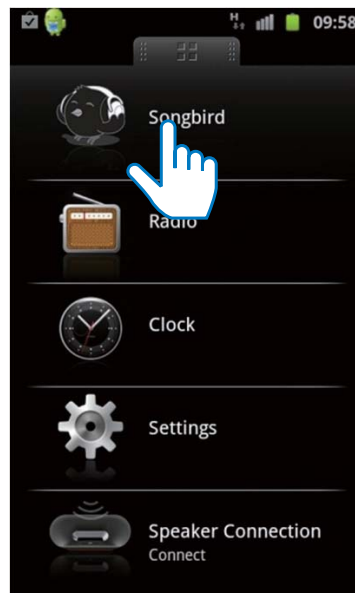

↳ You are requested to download Songbird.

3 Tap **[download]** (download).



↳ Songbird is downloaded.

4 Tap the downloaded Songbird app.

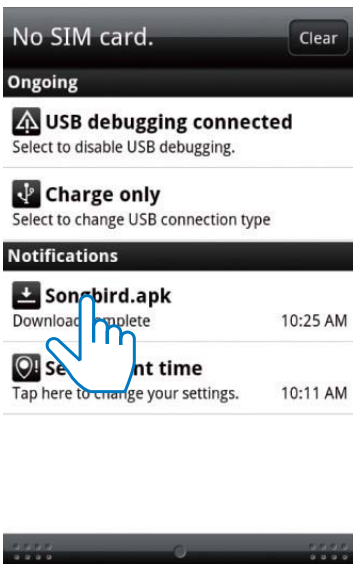

↳ The system asks whether you want to install Songbird.

5 Tap **[Install]** (Install).



↳ Songbird is installed.

6 Tap **[Open]** (Open) to access Songbird menu.



- 7 Select your desired song through Songbird app from your portable device, and tap ▶.

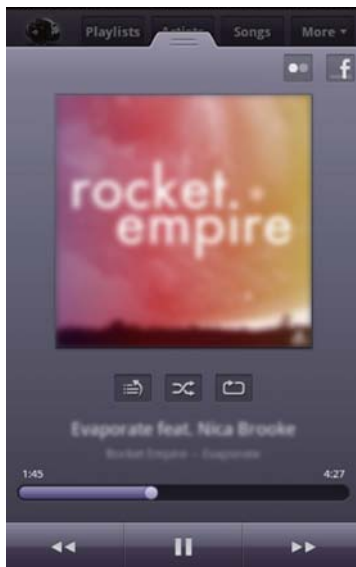
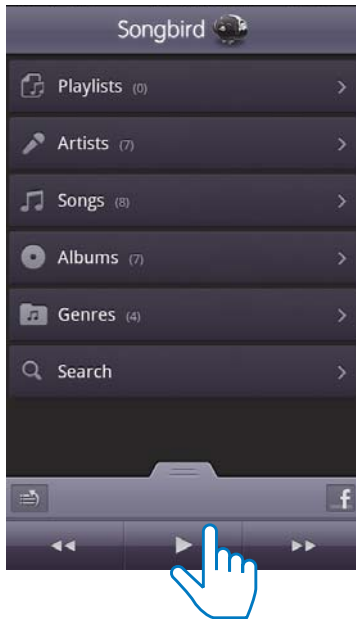

↳ You now can enjoy your music through the device.

Install Songbird on your computer

- 1 Go to www.philips.com/songbird.
- 2 Download the latest Songbird application.
- 3 Follow on-screen instructions to install Songbird on your computer.

Sync music from PC to Android powered device

Note

- Make sure that both your computer and Android powered device are installed with Songbird app.

- 1 Connect your Android powered device to the computer with a USB cable.
↳ A prompt window appears.
- 2 Select **[Managing device using Philips Songbird]** (Managing device using Philips Songbird).



↳ The Songbird user interface is displayed.

- 3 Select **[Auto Sync Music]** (Auto Sync Music) and **[Sync all music and playlists]** (Sync all music and playlists).

- 4 Click [**Sync**] (Sync) on the top right of the interface.
- ↳ The music on your computer is synchronized into Android powered device.



Tip

- Next time when Android powered device is connected to this computer, music is synchronized from PC to the device automatically.

Dock and charge Android-powered device

You can charge your Android-powered device by docking the device onto the docking speaker.

Dock your portable device

- 1 Check the orientation of the micro USB connector on your portable device, and rotate the micro USB connector on the docking speaker if necessary. Then dock your Android powered device onto the device.

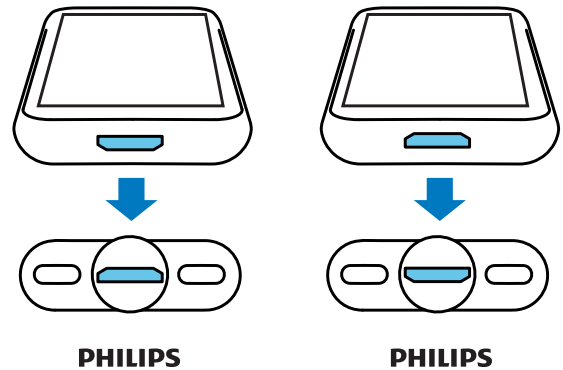
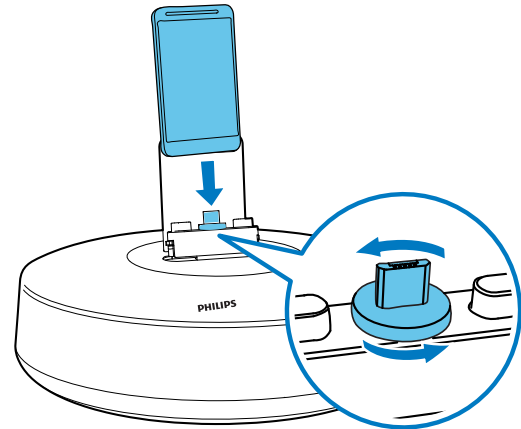

- 2 Slide the connector to the center of the device.

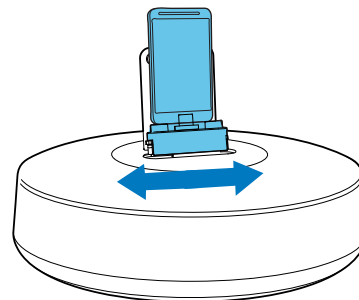

- 3 Adjust the bumpers on both sides to stabilize the portable device.

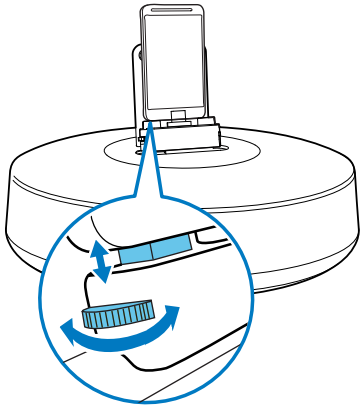

Note

- If the micro USB connector is located at the top, and you are using Android system of version 2.3 or above, screen auto-rotation is available.

Charge your portable device

When the docking speaker is connected to power, the portable device starts charging automatically.

Tip

- This function is also available for non Android-powered device that has a micro-USB connector.

Use dock extension

If the USB connector on your portable device is close to the edge, use the supplied dock extension to balance the device, as illustrated.

- 1 Adjust the bumpers on both sides to the lowest position.
- 2 Put on the dock extension.
- 3 Dock your portable device.

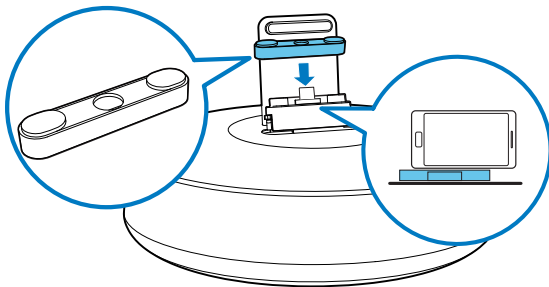

5 Other features

If you installed Fidelio app (see Chapter 4) onto your Android-powered device, you can use it to listen to Internet radio and to set timer.

Set time

- 1 Press **⏻** to switch the system to standby mode.

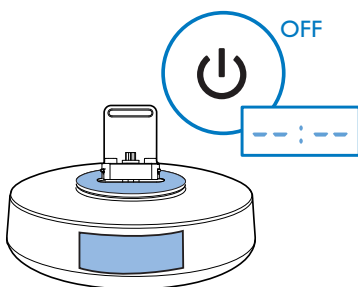

- 2 Press and hold **CLOCK/NIGHT LIGHT** for two seconds to activate clock setting mode.
↳ The **[24H]** begins to blink.
- 3 Press **+/-** to set the 12/24 hour format.
- 4 Press **CLOCK/NIGHT LIGHT** to confirm.
↳ The hour digit begins to blink.

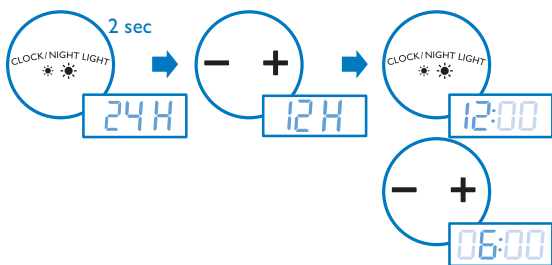

- 5 Repeat step 3 and 4 to set the hour and minute.
↳ The set time is displayed.

Listen to internet radio

- 1 Connect your portable device and the docking speaker through Bluetooth.
- 2 Open Fidelio app and go to the main menu.

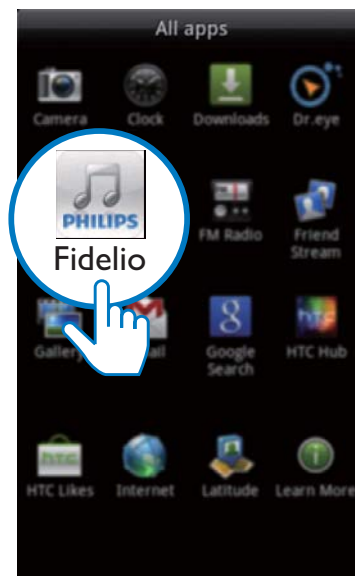

- 3 Tap **[Radio]** (Radio) on the main menu.

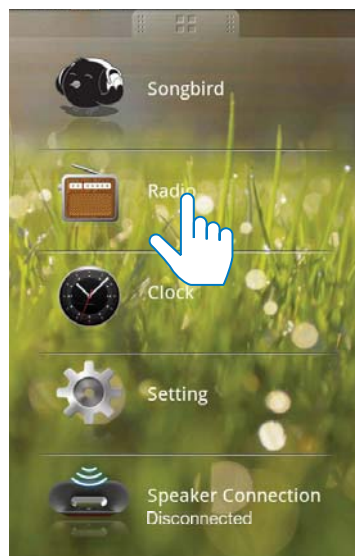

- 4 Type in the radio station you desired in the search bar:



- 2 Tap the icon ⚙️ to access clock setting Menu.

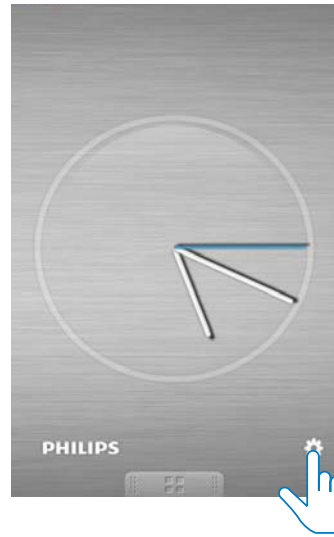

- 5 Tap the desired radio station.
↳ Your desired radio station begins to broadcast.

Set sleep timer

- 1 Open Fidelio app.

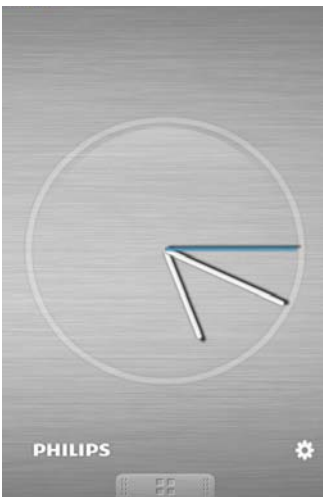

- 3 Tap [Sleep Timer] (Sleep timer).

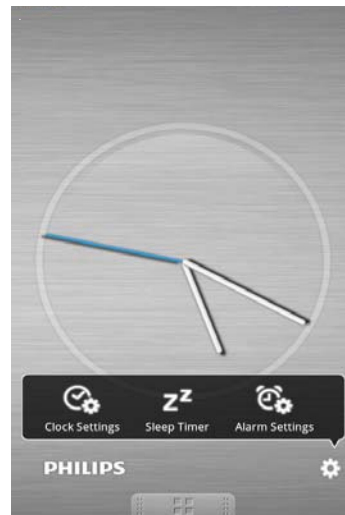

- 4 Select 10/15/20/30/45/60/90 min, then tap [Start] (Start).

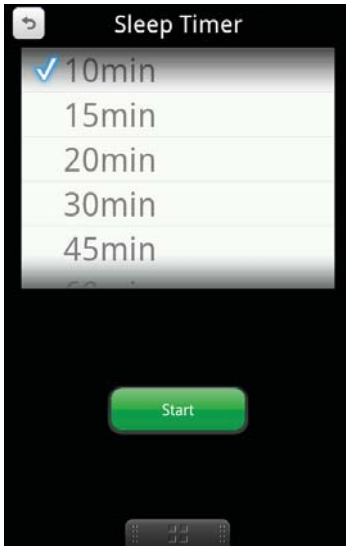

Note

- Sleep timer only works with Songbird app.

Set alarm timer

- 1 Open Fidelio app.

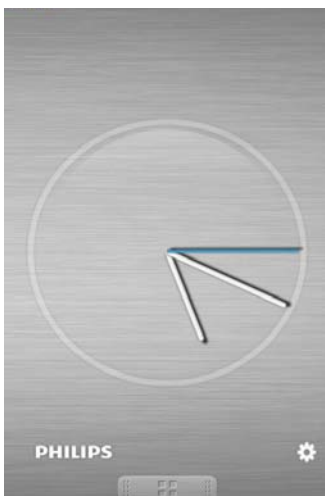

- 2 Tap the icon ⚙️ to access clock setting Menu.

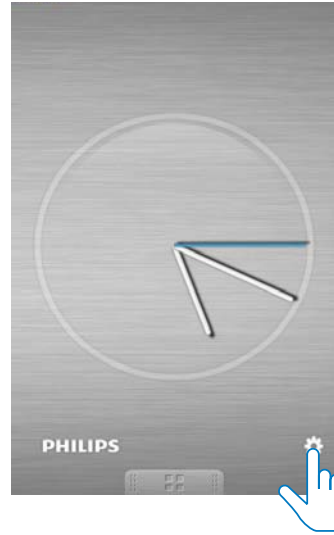

- 3 Tap Alarm settings.



4 Tap **+** to access alarm configuration page.



 Tip

- You can set an alarm for your favorite outdoor sport with weather specified. Go to Lifestyle to select your sport and preferred weather(excellent, good, or fair).The alarm won't ring if the weather is not good enough.
- You can go to Sound, and select your favorite music as your alarm sound.

5 Set the alarm time, and tap Save on the top right of the screen.



↳ The new alarm is saved and displayed on the screen.

6 Product information



Note

- Product information is subject to change without prior notice.

Specification

Amplifier

Rated Output Power: 2X2 W

Signal to Noise Ratio: 75 dBA

General information

AC power (power adaptor): OH-1018A0592400U (Philips);
Input:
100-240V~50/60Hz
650mA
Output: 5.9V \equiv 2.4A

Operation Power Consumption: 8W

Eco Standby Power Consumption: <1W

Charging: maximum 1A for micro USB

Dimensions - Main Unit (W x H x D): 171 X 102.6 X 171 mm

Weight - Main Unit: 0.605kg

If micro USB connector located at the top, screen auto-rotation is available(Android 2.3 or above) Visit www.philips.com/FlexiDock for more details.

7 Notice

Any changes or modifications made to this device that are not expressly approved by Philips Consumer Lifestyle may void the user's authority to operate the equipment.

Note

- The type plate is located on the bottom of the apparatus.

Disposal of your old product and batteries

Your product is designed and manufactured with high quality materials and components, which can be recycled and reused.

Never dispose of your product with other household waste. Please inform yourself about the local rules on the separate collection of electrical and electronic products and batteries. The correct disposal of these products helps prevent potentially negative consequences on the environment and human health.

Your product contains batteries, which cannot be disposed of with normal household waste. Please inform yourself about the local rules on separate collection of batteries. The correct disposal of batteries helps prevent potentially negative consequences on the environment and human health.

Please visit www.recycle.philips.com for additional information on a recycling center in your area.

Environmental information

All unnecessary packaging has been omitted. We have tried to make the packaging easy to separate into three materials: cardboard (box), polystyrene foam (buffer) and polyethylene (bags, protective foam sheet.)

Your system consists of materials which can be recycled and reused if disassembled by a specialized company. Please observe the local regulations regarding the disposal of packaging materials, exhausted batteries and old equipment.

8 Troubleshooting



Warning

- Never remove the casing of this apparatus.

To keep the warranty valid, never try to repair the system yourself.

If you encounter problems when using this apparatus, check the following points before requesting service. If the problem remains unsolved, go to the Philips web site (www.philips.com/welcome). When you contact Philips, ensure that the apparatus is nearby and the model number and serial number are available.

No power

- Make sure that the AC power adaptor of the device is connected properly.
- Make sure that there is power at the AC outlet.
- Make sure that the batteries are inserted correctly.

No sound or poor sound

- Adjust the volume of the docking system.
- Adjust the volume of your phone.

Clock/timer setting erased

- Power has been interrupted or the power plug has been disconnected.
- Reset the clock/timer.

Buttons do not work

- Unplug the device from the power supply, wait for five minutes, connect the device back to the power, and switch on the device.



Specifications are subject to change without notice
© 2011 Koninklijke Philips Electronics N.V.
All rights reserved.

AS111_CCR_98_V1.0

