

**PHILIPS**

4K Ultra HD  
Blu-ray Player

BDP7501



Register your product and get support at  
[www.philips.com/welcome](http://www.philips.com/welcome)

---

User Manual

---

**For further assistance, call the customer support service in your country.**

- To obtain assistance, contact Philips Customer Care Center;  
In the U.S.A., Canada, Puerto Rico, or the U.S. Virgin Islands; **1-866-202-5960**

# 1. INTRODUCTION

## 1.1. Safety Instruction

**Register online at [www.philips.com/welcome](http://www.philips.com/welcome) today to get the most benefits from your purchase.**

Registering your model with Philips makes you eligible for all of the valuable benefits listed below, so don't miss out. Register online at [www.philips.com/welcome](http://www.philips.com/welcome) to ensure:



### \* Product Safety Notification

By registering your product, you'll receive notification - directly from the manufacturer - in the rare case of a product recall or safety defect.

### \* Additional Benefits

Registering your product guarantees that you'll receive all of the privileges to which you're entitled, including special money-saving offers.

Know these  
**safety** symbols

	<b>CAUTION</b> RISK OF ELECTRIC SHOCK DO NOT OPEN	
<b>CAUTION for UHD Blu-ray Disc™ Player and AC/DC adapter:</b> TO REDUCE THE RISK OF ELECTRIC SHOCK, DO NOT REMOVE COVER (OR BACK). NO USER SERVICEABLE PARTS INSIDE. REFER SERVICING TO QUALIFIED SERVICE PERSONNEL.		
<b>CAUTION for AC/DC adapter:</b> FOR INDOOR USE ONLY. DRY LOCATION USE ONLY. USE WITH THE SPECIFIED AC POWER CORD ONLY. MAY BECOME HOT DURING USE. THIS IS NOT A MALFUNCTION. DO NOT USE OR CONNECT WITH OTHER DEVICES.		

The lightning flash with arrowhead symbol, within an equilateral triangle, is intended to alert the user to the presence of uninsulated "dangerous voltage" within the product's enclosure that may be of sufficient magnitude to constitute a risk of electric shock to persons.

The exclamation point within an equilateral triangle is intended to alert the user to the presence of important operating and maintenance (servicing) instructions in the literature accompanying the appliance.

**WARNING:** TO REDUCE THE RISK OF FIRE OR ELECTRIC SHOCK, DO NOT EXPOSE THIS APPARATUS TO RAIN OR MOISTURE. APPARATUS SHALL NOT BE EXPOSED TO DRIPPING OR SPLASHING AND NO OBJECTS FILLED WITH LIQUIDS, SUCH AS VASES, SHALL BE PLACED ON THE APPARATUS.

**CAUTION:** To prevent electric shock, match wide blade of plug to wide slot, fully insert.

**ATTENTION:** Pour éviter les chocs électriques, introduire la lame la plus large de la fiche dans la borne correspondante de la prise et pousser jusqu'au fond.

 The symbol for CLASS II (Double Insulation)

**The important note and rating are located on the rear or bottom of the cabinet.**

<p><b>For Customer Use</b></p> <p>The Model and Serial Numbers of this Unit may be found on the cabinet. You should Record and Retain those Letters / Numbers for future reference. Please refer to the LIMITED WARRANTY for more information.</p> <p>Model No. _____</p> <p>Serial No. _____</p>
---

**PHILIPS**

For fastest support visit us online at [www.philips.com/support](http://www.philips.com/support) for chat and self service solutions.

## IMPORTANT SAFETY INSTRUCTIONS

1. Read these instructions.
2. Keep these instructions.
3. Heed all warnings.
4. Follow all instructions.
5. Do not use this apparatus near water.
6. Clean only with dry cloth.
7. Do not block any ventilation openings. Install in accordance with the manufacturer's instructions.
8. Do not install near any heat sources such as radiators, heat registers, stoves, or other apparatus (including amplifiers) that produce heat.
9. Do not defeat the safety purpose of the polarized or grounding-type plug. A polarized plug has two blades with one wider than the other. A grounding type plug has two blades and a third grounding prong. The wide blade or the third prong are provided for your safety. If the provided plug does not fit into your outlet, consult an electrician for replacement of the obsolete outlet.
10. Protect the power cord from being walked on or pinched particularly at plugs, convenience receptacles, and the point where they exit from the apparatus.
11. Only use attachments/accessories specified by the manufacturer.
12. Use only with the cart, stand, tripod, bracket, or table specified by the manufacturer, or sold with the apparatus. When a cart is used, use caution when moving the cart / apparatus combination to avoid injury from tip-over.
13. Unplug this apparatus during lightning storms or when unused for long periods of time.
14. Refer all servicing to qualified service personnel. Servicing is required when the apparatus has been damaged in any way, such as power-supply cord or plug is damaged, liquid has been spilled or objects have fallen into the apparatus, the apparatus has been exposed to rain or moisture, does not operate normally, or has been dropped.



### Federal Communications Commission Notice

This equipment has been tested and found to comply with the limits for a Class B digital device, pursuant to Part 15 of the FCC Rules. These limits are designed to provide reasonable protection against harmful interference in a residential installation. This equipment generates, uses, and can radiate radio frequency energy and, if not installed and used in accordance with the instructions, may cause harmful interference to radio communications. However, there is no guarantee that interference will not occur in a particular installation. If this equipment does cause harmful interference to radio or television reception, which can be determined by turning the equipment off and on, the user is encouraged to try to correct the interference by one or more of the following measures:

- Reorient or relocate the receiving antenna.
- Increase the separation between the equipment and receiver.
- Connect the equipment into an outlet on a circuit different from that to which the receiver is connected.
- Consult the dealer or an experienced radio / TV technician for help.

This equipment may generate or use radio frequency energy. Changes or modifications to this equipment may cause harmful interference unless the modifications are expressly approved in the manual. The user could lose the authority to operate this equipment if an unauthorized change or modification is made.

### Notice for CANADA: CAN ICES-3 (B)/NMB-3(B)

**Disconnect the mains (AC) plug to shut the unit Off when trouble is found or not in use. The mains (AC) plug shall remain readily available. To completely turn Off the unit, you must unplug the mains (AC) power cord.**

**CAUTION:** Danger of explosion if battery is incorrectly replaced. Replace only with the same or equivalent type.

**WARNING:** Batteries (Battery pack or battery installed) shall not be exposed to excessive heat such as sunshine, fire or the like.

### LASER SAFETY

This apparatus is classified as a CLASS 1 LASER PRODUCT. This apparatus employs a laser. Only a qualified service person should remove the cover or attempt to service this apparatus, due to possible eye injury.

**CAUTION:** Use of controls or adjustments or performance of procedures other than those specified herein may result in hazardous radiation exposure.



### IMPORTANT COPYRIGHT INFORMATION

Unauthorized copying, broadcasting, public performance and lending of discs are prohibited.

This item incorporates copy protection technology that is protected by U.S. patents and other intellectual property rights of Rovi Corporation. Reverse engineering and disassembly are prohibited.

Do not place the unit on the furniture that is capable of being tilted by a child and an adult leaning, pulling, standing or climbing on it. A falling unit can cause serious injury or even death.

This apparatus should not be placed in a built-in installation such as a bookcase or rack unless proper ventilation is provided. Make sure to leave a space of 5.9 inches (15cm) or more around this apparatus.

Never use a gas duster on this unit. The gas trapped inside of this unit may cause ignition and explosion.

#### To Avoid the Hazards of Electrical Shock and Fire

- Do not handle the AC Power cord with wet hands.
- Do not pull on the AC Power cord when disconnecting it from an AC outlet. Grasp it by the plug.
- Do not put your fingers or objects into the unit.

#### Location and Handling

- Do not install the unit in direct sunlight, near strong magnetic fields, or in a place subject to dust or strong vibration.
- Avoid a place with drastic temperature changes.
- Install the unit in a horizontal and stable position. Do not place anything directly on top or bottom of the unit. Depending on your external devices, noise or disturbance in the picture and/or sound may be generated if the unit is placed too close to them. In this case, please ensure enough space between the external devices and the unit.
- Depending on the environment, the temperature of this unit may increase slightly. This is not a malfunction.
- Be sure to remove the disc and unplug the AC Power cord from the outlet before carrying the unit.

#### Dew Condensation Warning

- Dew condensation may form inside the unit in the following conditions. If so, do not use this unit at least for a few hours until its inside gets dry.
  - The unit is moved from a cold place to a warm place.
  - Under conditions of high humidity.
  - After heating a cold room.

#### Notice for Progressive Scan Output

- Consumers should note that not all high definition television sets are fully compatible with this product and may cause artifacts to be displayed in the picture. In case of picture problems with 525(480) progressive scan output, it is recommended that the user switch the connection to the 'standard definition' output. If there are questions regarding your TV set compatibility with this 525p(480p) Blu-ray Disc™/DVD player, please contact our customer service center.

---

## 1.2. Maintenance

### ■ Servicing

- Please refer to relevant topics in "TROUBLESHOOTING" on page 51 before returning the product.
- If you need to call a customer service representative, please know the model number and serial number of your product before you call. This information is displayed on the back of the product. Also, please take a moment to identify the problem you are having, and be prepared to explain this to the representative. If you believe the representative will need to help you with operations, please stay near the product. Our representatives will be happy to assist you. For online reference, please visit our website at [www.philips.com/support](http://www.philips.com/support)

### ■ Cleaning the Cabinet

- Wipe the front panel and other exterior surfaces of the unit with a soft cloth.
- Never use a solvent, thinner, benzene or alcohol to clean the unit. Do not spray insecticide liquid near the unit. Such chemicals may discolor the surface or damage the unit.

### ■ Cleaning Discs

- When a disc becomes dirty, clean it with a cleaning cloth. Wipe the disc from the center to outside. Do not wipe in a circular motion.
- Do not use solvents such as benzene, thinner, commercially available cleaners, detergent, abrasive cleaning agents or antistatic spray intended for analog records.

## ■ Cleaning the Disc Lens

- If this unit still does not perform properly although you refer to the relevant sections and to “TROUBLESHOOTING” in this user manual, the laser optical pickup unit may be dirty. Consult your dealer or an Authorized Service Center for inspection and cleaning of the laser optical pickup unit.

## ■ Disc Handling

- Handle the discs so that fingerprints and dust do not adhere to the surfaces of the discs.
- Always store the disc in its protective case when it is not used.
- Note that discs with special shapes (heart-shaped discs, octagonal discs, etc.) cannot be played back on this unit. Do not attempt to play such discs, as they may damage the unit.

## ■ Testing the Remote Control

- If the remote control is not working properly, you can use a digital camera (including a cellular phone with built-in camera) to see if it is sending out an infrared signal.

## ■ How to perform the test



1. Point the IR transmitter of the remote control towards the lens of the digital camera (or cell phone camera).
2. Turn on the digital camera and look at the IR transmitter of the remote control through the LCD display of the digital camera.
3. While looking at the LCD, press the buttons on your remote control you want to test.
  - a. If your remote control is working properly, the IR transmitter of the remote control will create a noticeable flash on the LCD of the digital camera.
  - b. If it does not flash, replace the batteries in your remote with new batteries and try again. If it still does not flash, your remote control may be damaged or defective. Please contact customer service for replacement options.

## ⊖ Note

- Some modern digital cameras have IR filters, in which case you will not be able to see the flash in the LCD of the camera even if the remote is working. For certain cell phones you can try using the front facing camera instead of the rear facing camera. You may also verify the behavior of your camera by comparing results with another remote which you know is working.

## 1.3. Notice

Specifications are subject to change without notice.

Trademarks are the property of Koninklijke Philips Electronics N.V. or their respective owners.

P&F USA/P&F MEXICANA reserves the right to change products at any time without being obliged to adjust earlier supplies accordingly.

The material in this manual is believed adequate for the intended use of the system. If the product, or its individual modules or procedures, are used for purposes other than those specified herein, confirmation of their validity and suitability must be obtained. P&F USA/P&F MEXICANA warrants that the material itself does not infringe any United States patents. No further warranty is expressed or implied.

P&F USA/P&F MEXICANA cannot be held responsible neither for any errors in the content of this document nor for any problems as a result of the content in this document. Errors reported to P&F USA/P&F MEXICANA will be adapted and published on the P&F USA/P&F MEXICANA support website as soon as possible.

## ■ Warranty

No components are user serviceable. Do not open or remove covers to the inside of the product. Repairs may only be done by Service Centers and official repair shops. Failure to do so shall void any warranty, stated or implied. Any operation expressly prohibited in this manual, any adjustments, or assembly procedures not recommended or authorized in this manual shall void the warranty.

## 1.4. Important

Registering your model with Philips makes you eligible for all of the valuable benefits listed below, so don't miss out. Complete and return your Product Registration Card at once, or register online at [www.philips.com/support](http://www.philips.com/support) to ensure :

### Product Safety Notification

By registering your product you receive notification - directly from the manufacturer - in the rare case of a product recall or safety defect.

### Additional Benefits of Product Ownership

Registering your product guarantees that you receive all of the privileges to which you're entitled, including special money-saving offers.

### For further assistance

For further assistance, call the customer support service in your country.

- To obtain assistance in the U.S.A., Canada, Puerto Rico, or the U.S. Virgin Islands, contact Philips Customer Care Center at 1-866-202-5960

## ■ Environmental Care



The packaging of this product is intended to be recycled. Contact your local authorities for information about how to recycle the packaging.

For Product recycling information, please visit -

[www.recycle.philips.com](http://www.recycle.philips.com)

## ■ End of life directives



Philips pays a lot of attention to produce environment-friendly products in green focal areas. Your new Blu-ray Disc™ Player contains materials which can be recycled and reused. At the end of its life, specialized companies can dismantle the discarded Blu-ray Disc™ Player to concentrate the reusable materials and to minimize the amount of materials to be disposed of. Please ensure you dispose of your old Blu-ray Disc™ Player according to local regulations.

## ■ Disposal of used batteries

The batteries supplied do not contain the heavy metals mercury and cadmium. Nevertheless, in many areas batteries may not be disposed of with your household waste. Please ensure you dispose of batteries according to local regulations.

---

## 1.5. Supplied Accessories

- Quick Start Guide
- Remote Control (NC280UH)
- Batteries (AAA, 1.5V x 2)
- HDMI cable
- AC/DC Adapter (N1070UH)

---

## 1.6. Trademark Information



Manufactured under license from Dolby Laboratories. Dolby, Dolby Audio and the double-D symbol are trademarks of Dolby Laboratories.



For DTS patents, see <http://patents.dts.com>. Manufactured under license from DTS Licensing Limited. DTS, DTS-HD, the Symbol, & DTS and the Symbol together are registered trademarks, and DTSHD Master Audio | Essential is a trademark of DTS, Inc. © DTS, Inc. All Rights Reserved.



The terms HDMI and HDMI High-Definition Multimedia Interface, and the HDMI Logo are trademarks or registered trademarks of HDMI Licensing LLC in the United States and other countries.

## x.v.Color

"x.v.Color" and "x.v.Color" logo are trademarks of Sony Corporation.



Java and all Java based trademarks and logos are trademarks or registered trademarks of Oracle and/or its affiliates.



"AVCHD" and the "AVCHD" logo are trademarks of Panasonic Corporation and Sony Corporation.

## BONUSVIEW™

“BONUSVIEW™” and “BONUSVIEW™” logo are trademarks of the Blu-ray Disc Association.



“BD-Live™” and “BD-Live™” logo are trademarks of the Blu-ray Disc Association.

## NETFLIX

Netflix and the Netflix logo are trademarks or registered trademarks of Netflix, Inc.



YouTube and the YouTube logo are trademarks of Google Inc.



“Ultra HD Blu-ray™” and “Ultra HD Blu-ray™” logo are trademarks of the Blu-ray Disc Association.



“Blu-ray 3D™”, “Blu-ray 3D™” logo are trademarks of the Blu-ray Disc Association.



“Blu-ray Disc™”, “Blu-ray” and “Blu-ray Disc™” logo are trademarks of the Blu-ray Disc Association.

**DVD** is a trademark of DVD Format/Logo Licensing Corporation.

THIS PRODUCT IS LICENSED UNDER THE AVC PATENT PORTFOLIO LICENSE FOR THE PERSONAL AND NON-COMMERCIAL USE OF A CONSUMER TO (i) ENCODE VIDEO IN COMPLIANCE WITH THE AVC STANDARD (“AVC VIDEO”) AND/OR (ii) DECODE AVC VIDEO THAT WAS ENCODED BY A CONSUMER ENGAGED IN A PERSONAL AND NON-COMMERCIAL ACTIVITY AND/OR WAS OBTAINED FROM A VIDEO PROVIDER LICENSED TO PROVIDE AVC VIDEO. NO LICENSE IS GRANTED OR SHALL BE IMPLIED FOR ANY OTHER USE. ADDITIONAL INFORMATION MAY BE OBTAINED FROM MPEG LA, L. L. C. SEE [HTTP://WWW.MPEGLA.COM](http://WWW.MPEGLA.COM)

THIS PRODUCT IS LICENSED UNDER THE VC-1 PATENT PORTFOLIO LICENSE FOR THE PERSONAL AND NON-COMMERCIAL USE OF A CONSUMER TO (i) ENCODE VIDEO IN COMPLIANCE WITH THE VC-1 STANDARD (“VC-1 VIDEO”) AND/OR (ii) DECODE VC-1 VIDEO THAT WAS ENCODED BY A CONSUMER ENGAGED IN A PERSONAL AND NON-COMMERCIAL ACTIVITY AND/OR WAS OBTAINED FROM A VIDEO PROVIDER LICENSED TO PROVIDE VC-1 VIDEO. NO LICENSE IS GRANTED OR SHALL BE IMPLIED FOR ANY OTHER USE. ADDITIONAL INFORMATION MAY BE OBTAINED FROM MPEG LA, L.L.C. SEE [HTTP://WWW.MPEGLA.COM](http://WWW.MPEGLA.COM)

Some features may require an always-on broadband internet connection, firmware update and/or a minimum bandwidth. Internet services vary by location.

P&F USA Inc./P&F MEXICANA, S.A.de C.V. do not warrant access to the Portal or to any of the services, content, software and advertising.

P&F USA Inc./P&F MEXICANA, S.A. de C.V. may, in its sole discretion, add or remove access to any specific services, content, software and advertising at any time.

Although P&F USA Inc./P&F MEXICANA, S.A. de C.V. will strive to provide a good selection of services, content or software, P&F USA Inc./P&F MEXICANA, S.A. de C.V. do not warrant continued access to any specific services, and content or software.

# CONTENTS

<b>INTRODUCTION</b> .....	<b>2</b>	<b>SPECIAL PLAYBACK</b> .....	<b>30</b>
Safety Instruction.....	2	Fast Forward / Fast Reverse .....	30
Maintenance .....	4	Slow Forward Playback .....	30
Notice .....	5	Slow Reverse Playback.....	30
Important.....	5	Frame by frame Playback.....	30
Supplied Accessories.....	6	Frame Return Playback .....	30
Trademark Information .....	6	Repeat Playback .....	31
<b>FEATURES</b> .....	<b>9</b>	Slide Show .....	31
Features .....	9	PiP (BONUSVIEW™) Setting .....	32
Firmware Version Information .....	10	Enjoying BD-Live™ Discs Using the Internet.....	32
Symbols Used in this User Manual.....	10	Title / Chapter Search.....	33
<b>FUNCTIONAL OVERVIEW</b> .....	<b>11</b>	Track Search .....	33
Top and Front Panel.....	11	Switching Subtitles .....	33
Rear Panel.....	11	Switching Audio Soundtrack .....	34
Remote Control.....	12	Switching Camera Angles .....	34
Guide to On-Screen Display.....	13	JPEG Status.....	35
<b>Connections</b> .....	<b>14</b>	JPEG Rotation .....	35
HDMI Video /Audio Connection.....	14	Playback Information Window .....	35
Connection to an Audio System.....	16	Reception .....	36
Connection to the Network.....	17	Closed Caption.....	36
<b>BEFORE YOU START</b> .....	<b>19</b>	Luminance/Color Adjustment.....	37
Finding the Viewing Channel /Source on Your TV.....	19	Progressive .....	37
Initial Setup.....	19	Reset to Default Picture Settings .....	37
<b>INFORMATION ON PLAYBACK</b> .....	<b>20</b>	Dialogue Enhancer .....	37
Information on Playback.....	20	<b>NETWORK SERVICES</b> .....	<b>38</b>
Guide to File List.....	23	Before Using Network Services.....	38
How to Insert a Disc .....	24	Information on Network Services.....	38
<b>BASIC PLAYBACK</b> .....	<b>25</b>	<b>LIST OF SETTINGS</b> .....	<b>39</b>
Playing Back a Disc .....	25	<b>SETUPS</b> .....	<b>42</b>
Playing Back an Ultra HD Blu-ray™ Disc .....	26	HDMI Video .....	42
Playing Back a Blu-ray 3D™ Disc.....	27	High Dynamic Range Output.....	42
Playing Back Contents on a USB Storage Device .....	28	Network Installation.....	43
Using the Title / Disc / Pop-up Menu .....	28	EasyLink Setup.....	47
Playing back from the File list.....	29	BD-Video Ratings .....	48
		DVD-Video Ratings .....	48
		Software Update .....	49
		Restore Default Settings.....	50
		License & Digital Rights Mgmt .....	50
		<b>OTHER FUNCTION</b> .....	<b>50</b>
		Special mode.....	50
		<b>TROUBLESHOOTING</b> .....	<b>51</b>
		Downloading an Electronic Copy .....	53
		Contact Us.....	53
		<b>GLOSSARY</b> .....	<b>54</b>
		<b>LANGUAGE CODE LIST</b> .....	<b>56</b>
		<b>SPECIFICATIONS</b> .....	<b>57</b>
		<b>IMPORTANT HEALTH AND SAFETY</b>	
		<b>INFORMATION FOR 3D TELEVISIONS</b> .....	<b>58</b>
		<b>ONE (1) YEAR LIMITED WARRANTY</b> .....	<b>59</b>



---

## 2. FEATURES

---

### 2.1. Features

#### Ultra HD Blu-ray™

Compared to the existing Blu-ray Disc™, ULTRA HD Blu-ray™ has much better in Resolution, Color gamut, and Luminance. ULTRA HD Blu-ray™ also supports up to triple layer discs - 50 GB (double layer), 66 GB (double layer), and 100 GB (triple layer).

#### Blu-ray Disc™

You can enjoy Blu-ray Disc™ which is capable of storing five times more data than a conventional DVD. Upscaling will increase the resolution of a Blu-ray Disc™ to 4K Ultra HD over an HDMI connection when connected to a 4K Ultra HD TV.

#### Playing back Blu-ray 3D™ Disc

This unit can play back Blu-ray 3D™ discs which contain stereoscopic 3D video. In order to enjoy 3D video, connect this unit to a 3D capable TV using a 3D compatible HDMI cable.

#### BD-J

With some Blu-ray™ discs which contain Java applications, you can enjoy interactive functions such as games or interactive menus.

#### DVD upscaling for enhanced picture quality

Your current DVD will look even better than before thanks to video upscaling. Upscaling will increase the resolution of standard definition DVD to high definition up to 4K over an HDMI connection. The picture will be less jagged and more realistic for a near high definition experience.

#### Enjoy your content on different kinds of media

Full backwards compatibility with DVD, CD and USB storage device ensures that you can continue to enjoy your current audio-video collection. Additionally, you can enjoy AVCHD / MP3 / AAC / WAV /FLAC/ MP4 / JPEG files.

#### Listen to rich multi-channel surround sound

Multi-channel surround sound, which realizes real-to-life sound and makes you feel that you are really there.

#### Intuitive user interface and remote control

The Philips logical user interface allows you to easily navigate through your content and settings, so you can quickly find what you are looking for.

#### Easy and simple connection to your HDTV via HDMI

Connect this unit to your HDTV with one single HDMI (High-Definition Multimedia Interface) cable. Philips recommends High Speed HDMI cable for better compatibility. The high definition video output signal will be transferred to your HDTV without conversion to analog signals, so you will get excellent picture and sound quality completely free from noise. Thanks to other multiple outputs, you can also easily connect to your home theater system or amplifier.

- For 4K/HDR content viewing:
  - The connected TV must be 4K/HDR compatible.
  - An 18 Gbps high-speed HDMI cable is required to connect this unit and the TV.

#### About EasyLink (HDMI CEC) (Consumer Electronics Control)

EasyLink allows you to operate the linked functions of this player with Philips brand TV with EasyLink feature. *Philips does not guarantee 100 % interoperability with other brands of HDMI CEC compliant devices.*

#### PiP (BONUSVIEW™)

Some BD-videos have the PiP function which enables you to display the secondary video in the primary video. You can call up the secondary video by selecting [OPTIONS] ➔ "Secondary Video" whenever the scene contains it.

#### BD-Live™

BD-Live™ (BD-ROM version 2 Profile 2.0) that allows interactive functions to be used when this unit is connected to the Internet in addition to the BONUSVIEW™ function. The various functions differ depending on the disc.

#### Pop-up menu

Some BD-videos have a pop-up menu which is a navigation menu that can be called up and be operated on the TV screen without interrupting playback. You can call up the pop-up menu by pressing [TOP MENU]. Contents in the pop-up menu vary depending on the disc.

#### HDMI Deep Color

Deep Color reduces posterization (color banding) effect of the playback image. Refer to the setting item "Deep Color Output" on page 39

#### 4K output with ULTRA HD Blu-ray

24p or 60p output in 4K resolution is available. Refer to "HDMI Video /Audio Connection" on page 14.

## Playing back contents on a USB storage device

You can play back MP3 / AAC / MP4 / FLAC / WAV / MPEG-2 / JPEG files stored in a USB storage device. BD-ROM Profile 2.0 (BD-Live™) and Profile 1.1 discs sometimes store picture-in-picture commentary, subtitles or other extras in the USB storage device for use during playback with the BD-video.

## Playing back AVCHD files

This unit supports playback of AVCHD format files (new format for high definition video camcorders) recorded on disc. Your high definition personal archive is playable in HD quality.

## x.v.Color

This unit supports playback of video contents on discs recorded with “x.v.Color” technology. To watch this video content with the “x.v.Color” space, a TV or other display device supporting both video image reproduction using “x.v.Color” standard and capability of manual switching of its color space setting is required. Please refer to the user manual of your display device for further information.

## Enjoy contents stored on DLNA certified home media servers

This unit is a DLNA certified media player that can play video, music and photo files stored on DLNA certified home media servers connected to your home network. (not warranted for wireless environment)

## Netflix

With this unit, you can enjoy movies and TV episodes streamed instantly from Netflix via the Internet. In order to use this feature, you must visit [www.netflix.com/](http://www.netflix.com/) on your PC and become a Netflix member.

(This feature is available only in the United States.)

## YouTube™

This unit enables you to access YouTube™.

On your TV screen, you can enjoy a large number of video clips streamed from YouTube™.

## Digital Rights Management

This product contains technology subject to certain intellectual property rights of Microsoft.

Use or distribution of this technology outside of this product is prohibited without the appropriate license(s) from Microsoft.

## HDR (High Dynamic Range)

HDR is the technology which processes picture colors so that colors appear close to the natural view of the naked eye, by controlling the difference between the lightest and the darkest colors.

## 2.2. Firmware Version Information

















“Firmware Version Information” screen provides information about this unit’s software version. The current version of software on your unit can be seen on the “Firmware Version Information” screen.

To access “Firmware Version Information”, follow the procedure below.

1. Press [**Home**].
2. Use [**Left/Right**] to select “Setup”, then press [**OK**].
3. Use [**Up/Down**] to select “Player Settings”, then press [**OK**].
4. Use [**Up/Down**] to select “System”, then press [**OK**].
5. Use [**Up/Down**] to select “System Information”, then press [**OK**].
6. Use [**Up/Down**] to select “Firmware Version Information”, then press [**OK**].

## 2.3. Symbols Used in this User Manual

To specify which media type each function is applicable to, we put the following symbols at the beginning of each item to operate.

Symbol	Description
	Description refers to Ultra HD Blu-ray
	Description refers to BD-video
	Description refers to DVD-video
	Description refers to DVD-RW/-R with VR mode
	Description refers to audio CD / DTS-CD
	Description refers to DVD-RW/-R, DVD+RW/+R with AVCHD files
	Description refers to BD-RE/-R, DVD-RW/-R, CD-RW/-R and USB storage device with JPEG files
	Description refers to DVD-RW/-R, CD-RW/-R and USB storage device with MP3 files
	Description refers to DVD-RW/-R, CD-RW/-R and USB storage device with MPEG-2 files
	Description refers to DVD-RW/-R, CD-RW/-R and USB storage device with MP4 files
	Description refers to DVD-RW/-R, CD-RW/-R and USB storage device with AAC files
	Description refers to DVD-RW/-R, CD-RW/-R and USB storage device with WAV files
	Description refers to DVD-RW/-R, CD-RW/-R and USB storage device with FLAC files
	Description refers to video files in the DLNA Media Server
	Description refers to music files in the DLNA Media Server
	Description refers to photo files in the DLNA Media Server

## 3. FUNCTIONAL OVERVIEW

### 3.1. Top and Front Panel

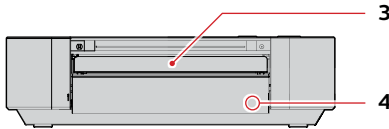
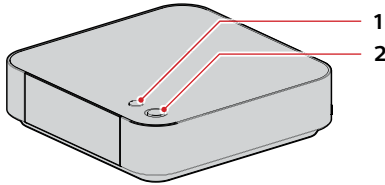

- ▲ (open/close) button**
  - Press to open or close the disc tray.
- ⏻ (standby/on) button / LED**
  - Press to turn on the unit, or to switch the unit into standby mode. (To completely turn off the unit, you must unplug the AC/DC Adapter.)
  - The **⏻ (standby/on)** LED lights up when the unit is On, and goes out when the unit is Off.
- Disc tray**
  - Place a disc after opening the disc tray.
- Infrared sensor window**
  - Receives signals from your remote control so that you can control the unit from a distance.

### 3.2. Rear Panel

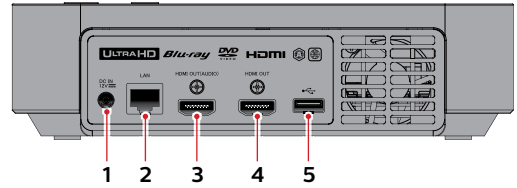

- DC IN jack**
  - Connect to the included AC/DC Adapter to supply power to this unit.
  - Unplug the AC Power cord from the AC outlet to completely turn off the unit.
- LAN port**
  - Used to connect to network provisioning equipment such as a router or a modem, using a LAN cable.
- HDMI OUT (AUDIO) port**
  - Used to connect to an AV receiver/amplifier with an HDMI compatible port, using an HDMI cable.
  - Audio output only.
- HDMI OUT port**
  - Used to connect to a display with an HDMI compatible port, using an HDMI cable. This HDMI port will only output images when the HDMI OUT (AUDIO) port is in use.
- USB input port**
  - Connect a USB storage device or USB card reader.

#### ⚠ Caution

- Do not connect any device other than USB storage device or USB card reader into USB input. (e.g. PC, external HDD, MP3 player, digital camera, keyboard, mouse, etc.)
- Do not use an extension cord or USB hub to connect devices to this unit. Always connect one single USB storage device or USB card reader into USB input directly.

### 3.3. Remote Control

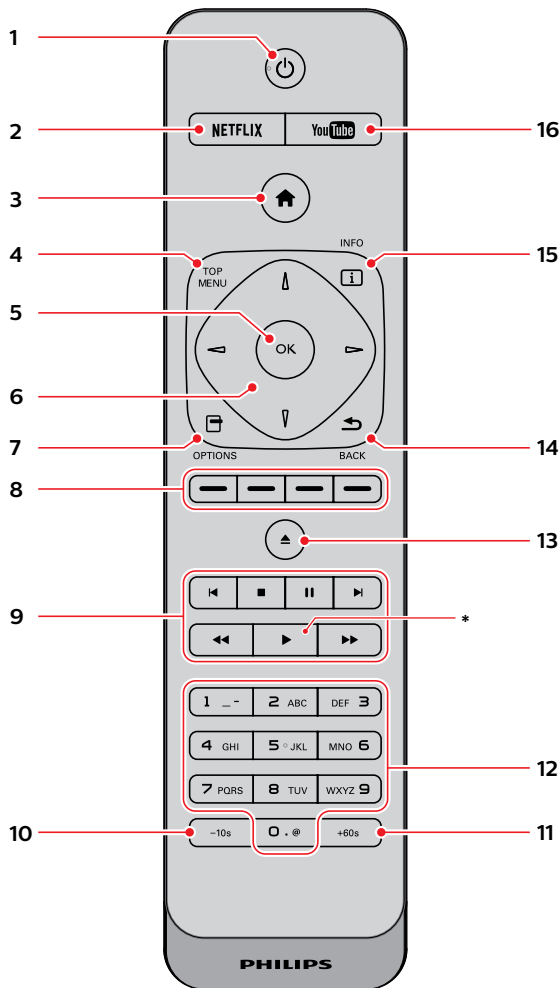

\* The unit can also be turned on by pressing these buttons.

1. **⏻ (standby/on) button**
  - Press to turn on the unit, or to switch the unit into standby mode. (To completely turn off the unit, you must unplug the AC Power cord.)
2. **NETFLIX button\***
  - Press to launch Netflix.
3. **🏠 (home) button**
  - Press to display the home menu.
4. **TOP MENU button\***
  - Ultra HD Blu-ray™, Blu-ray Disc™:**
    - Press to display the top menu or pop-up menu.
  - DVD:**
    - Press to display the title menu or disc menu.
5. **OK button**
  - Press to confirm or select menu items.

6. **▲/▼/◀/▶ buttons**
  - Press to select items or settings.
  - When playback is in pause mode, press [▶] to forward the playback picture by picture.
  - When playback is in pause mode, press [◀] to reverse the playback picture by picture.
7. **OPTIONS button**
  - During playback, press to display the play menu.
8. **Red / Green / Yellow / Blue buttons**
  - Press to activate shortcut keys on some BD-video functions.
9. **◀ (previous) button**
  - During playback, press once to return to the beginning of the current title, chapter, track or file.
  - During playback, press twice to return to the previous title, chapter, track or file.
  - During the JPEG playback, press to return to the previous file.
- (stop) button**
  - Press to stop playback.
- ⏸ (pause) button**
  - Press to pause playback.
- ▶ (next) button**
  - During playback, press to skip to the next chapter, track or file.
- ◀◀ (reverse) button**
  - During playback, press to fast reverse the playback.
- ▶ (play) button\***
  - Press to start playback or resume playback.
- ▶▶ (forward) button**
  - During playback, press to fast forward the playback.
  - When playback is in pause, press to slow forward the playback.
10. **-10s button**
  - Press to reverse the playback by 10 seconds.
11. **+60s button**
  - Press to forward the playback by 60 seconds.
12. **Number buttons**
  - Press to select a chapter during playback.
  - Press to enter numbers and letters in the input field.
13. **▲ (open/close) button\***
  - Press to open or close the disc tray.
14. **BACK button**
  - Press to return to the previously displayed menu or screen function.
15. **INFO button**
  - Press to display the information display.
16. **YouTube button\***
  - Press to launch YouTube™.

## ■ Installing the Batteries in the Remote Control

Install 2 AAA (1.5V) batteries matching the polarity indicated inside battery compartment of the remote control.

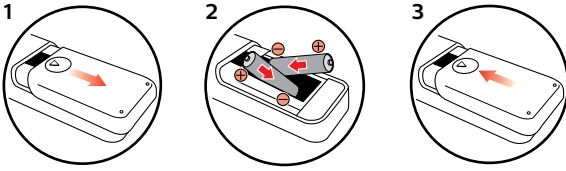

### ⚠ Caution

Incorrect use of batteries can result in hazards such as leakage and bursting. Please observe the following:

- Do not mix alkaline, standard (carbon-zinc), or rechargeable (ni-cad, ni-mh, etc) batteries.
- Do not mix new and old batteries together.
- Do not use different kinds of batteries together. Although they may look similar, different batteries may have different voltages.
- Make sure that the + and - ends of each battery match the indications in the battery compartment.
- Remove batteries from battery compartment, when the remote is not going to be used for a month or more.
- When disposing of used batteries, please comply with governmental regulations or environmental public rules that apply in your country or area.
- Do not recharge, short-circuit, heat, burn or disassemble batteries.

## ■ Using the Remote Control

Remote Control Usage Guidelines:

- Make sure that there are no obstacles between the remote control and the infrared sensor window on the unit.
- Remote operation may become unreliable if strong sunlight or fluorescent light is shining on the infrared sensor window of the unit.
- Remote controls of different devices can interfere with each other. Avoid using a remote control from another device which is located close to the unit.
- Replace the batteries when you notice a fall-off in the operating range of the remote control.
- The maximum operable ranges from the unit are as follows.

- **Line of sight:**  
approx. 23 feet (7 m)
- **Either side of the center:**  
approx. 16 feet (5 m) within 30°
- **Above:**  
approx. 16 feet (5 m) within 15°
- **Below:**  
approx. 10 feet (3 m) within 30°

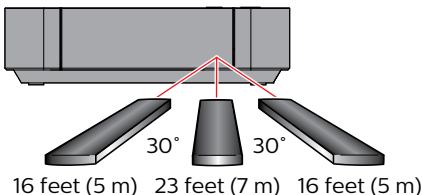

## 3.4. Guide to On-Screen Display

### ■ Home Menu

When you turn on the unit, the Home Menu will appear automatically. Otherwise, press [**Home**].

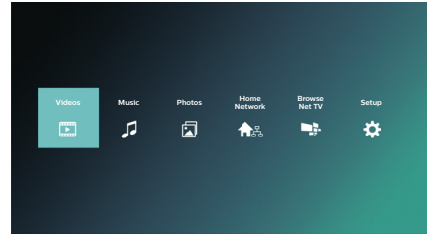

**Videos:** Accesses the Video menu

**Music:** Accesses the Music menu

**Photos:** Accesses the Photo menu

**Home Network:** Accesses the DLNA Server menu

**Browse Net TV:** Accesses the Network Services menu

**Setup:** Accesses the Setup Menu

### ■ Setup Menu

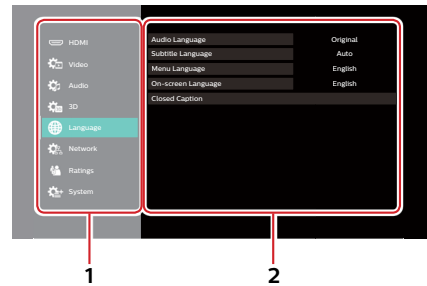

#### 1. Category

#### 2. Menus / Options :

Displays options for the highlighted item on the left whenever available.

### ■ Play Menu

During playback, press [**Options**] to display the play menu.

e.g.) Blu-ray Disc™



## 4. Connections

- When you change the connections, all devices should be turned off.
- When making connections with external devices, please refer to their user manuals for additional setup help.

### 4.1. HDMI Video /Audio Connection

(Supports up to 1080i, 1080p, 1080p/24, 4K resolution.)

No analog audio connection required.

#### ■ Connecting with the HDMI OUT Port Only

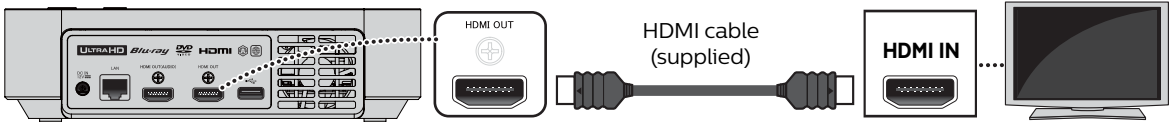

OR

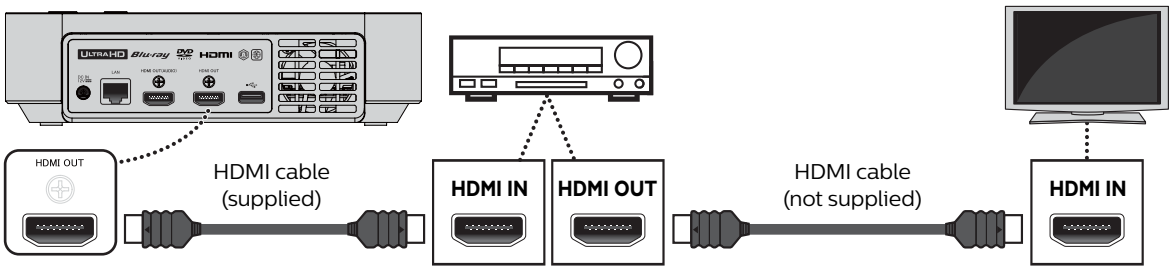

- With this connection, the HDMI OUT port outputs both video and audio.
- In order for Ultra HD Blu-ray™ video playback to work with this connection, a 4K/HDR compatible AV receiver/ amplifier and 18 Gbps high-speed HDMI cables are required.
- In order for Blu-ray 3D™ video playback to work with this connection, a 3D compatible AV receiver/amplifier and 3D compatible HDMI cables are required.

#### ■ Connecting with the HDMI OUT and HDMI OUT (AUDIO) Ports

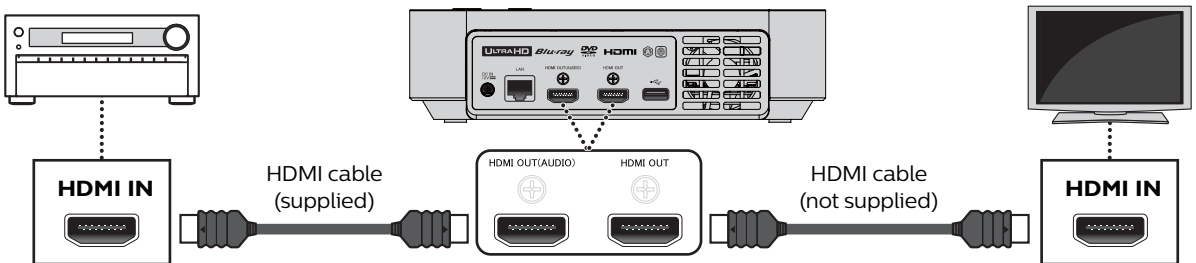

- With this connection, the **HDMI OUT** port only outputs video, and the **HDMI OUT (AUDIO)** port only outputs audio.
- The EasyLink function is only available for the **HDMI OUT** port.
- In order for Ultra HD Blu-ray™ content playback to work on this unit, a 4K/HDR compatible display device and AV receiver/amplifier must be connected to this unit. Otherwise, the Audio will not be output.
- In order for 3D content playback to work on this unit, a 3D compatible display device and AV receiver/amplifier must be connected to this unit. Otherwise, the Audio will not be output.

In order to play 4K/HDR content, this unit must be connected to a 4K/60p/4:4:4 and Ultra HD Blu-ray HDR compliant device.

- For 4K/60p/4:4:4, an 18Gbps high-speed HDMI cable is required.

Required TV Specifications	Playback Content		Recommended Settings			Video Signals from the Unit		
			HDMI Resolution	4K60p Output	24p Output	High Dynamic Range Output	Output Resolution	Frame Rate / Color Space
Up to 4K 60p 4:4:4	BD-Video	24p	Auto	4K/60p (4:4:4)	Auto	Auto	4K	24p/4:4:4
		24p						24p/4:4:4
	60p	60p/4:2:2						
	Ultra HD Blu-ray	24p			Off			60p/4:4:4
		24p						60p/4:2:2
	60p	60p			60p/4:2:2			
Up to 4K 60p 4:2:0	BD-Video	24p	Auto	4K/60p (4:2:0)	Auto	Auto	4K	24p/4:4:4
		24p						24p/4:2:2
	60p	60p/4:2:0						
	Ultra HD Blu-ray	24p			Off			60p/4:2:0
		24p						60p/4:2:0
	60p	60p			60p/4:2:0			
Up to 4K 24p/30p	BD-Video	24p	Auto	Off	Auto	Auto	4K	24p/4:4:4
		24p						24p/4:2:2
	60p	60p/4:4:4						
	Ultra HD Blu-ray	24p			Off		2K	60p/4:4:4
		24p						60p/4:4:4
	30p	60p			60p/4:4:4			

- Ultra HD Blu-ray content is created in 4K resolution.
- TVs supporting 4K60p are compatible with HDCP 2.2.

### Note

- Do not tilt the HDMI connector when inserting it into the HDMI port, and make sure the shapes of the HDMI port and the HDMI cable's connector match.
- If this unit is connected to an HDCP incompatible display device, video will not be displayed properly.
- Use a certified HDMI cable (an HDMI cable with the HDMI logo) for this connection. High-Speed HDMI cable (also known as HDMI category 2 cable) is recommended for better compatibility.
- In order for Ultra HD Blu-ray™ video playback, connect this unit to a 4K/HDR compatible display device using an 18 Gbps high-speed HDMI cable.
- In order for Blu-ray 3D™ video playback, connect this unit to a 3D compatible display device using a 3D compatible HDMI cable.

## 4.2. Connection to an Audio System

### ■ HDMI Audio Connection

AV receiver / amplifier with an HDMI input jack

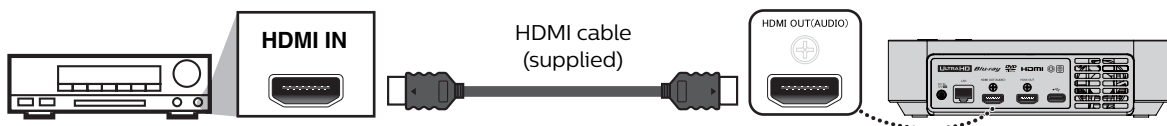

### ■ Audio Output from HDMI OUT jack

Media	"DD/DD+/DTHD" Setting → "DTS/DTS-HD" Setting → "BD-Video Secondary Output" Setting →	"Bitstream"		"LPCM"	
		Off	On	Off	On
	Audio Source	Which audio format can be output depends on the compatibility of the connected device.			
Ultra HD Blu-ray Blu-ray	Dolby Digital	Dolby Digital		Multi LPCM	
	Dolby Digital Plus	Dolby Digital Plus	Dolby Digital	Multi LPCM*1	Multi LPCM*2
	Dolby TrueHD	Dolby TrueHD	Dolby Digital	Multi LPCM*3	Multi LPCM*4
	DTS	DTS		Multi LPCM	
	DTS-HD	DTS-HD	DTS	Multi LPCM*1	Multi LPCM*5
DVD-Video	LPCM	Multi LPCM		Multi LPCM	
	Dolby Digital	Dolby Digital		Multi LPCM	
	DTS	DTS		Multi LPCM	
DTS-CD	LPCM	Multi LPCM		Multi LPCM	
	Dolby Digital	Dolby Digital		Multi LPCM	
AVCHD	LPCM	Multi LPCM		Multi LPCM	
	Dolby Digital	Dolby Digital		Multi LPCM	
Audio CD	LPCM	2ch LPCM		2ch LPCM	
MP3	MP3	2ch LPCM		2ch LPCM	
AAC	AAC	2ch LPCM		2ch LPCM	
FLAC	FLAC	2ch/Multi LPCM		2ch LPCM	
WAV	WAV	2ch LPCM		2ch LPCM	
MPEG2(TS/PS)	Dolby Digital	Dolby Digital		Multi LPCM	
	Dolby Digital Plus	Dolby Digital Plus	Dolby Digital	Multi LPCM*1	Multi LPCM*2
	LPCM	Multi LPCM		Multi LPCM	
Netflix	Dolby Digital Plus	Dolby Digital Plus		Multi LPCM*1	
	HE-AAC	2ch LPCM		2ch LPCM	
YouTube™	HE-AAC	2ch LPCM		2ch LPCM	

\*1 Fully decoded.

\*2 Only the independent substream is decoded.

\*3 Dolby TrueHD stream is decoded.

\*4 Only the Dolby Digital substream is decoded.

\*5 Only the core substream is decoded.

### ⓘ Note

- If the connected device is not compatible with HDMI BITSTREAM, audio will be output as multi LPCM or 2-channel down-mixed LPCM depending on the capability of the connected device even if you select "Bitstream" in "HDMI Audio" setting.
- When playing back a BD-video which only contains the primary audio, the audio output will be the same case as "Off" even if "BD-Video Secondary Audio" is set to "On".
- Discs containing DTS audio with over 5.1ch surround signals at the sampling rate of 192kHz may not play correctly on this unit.  
When playing such discs while this unit is connected to an Audio System (over 5.1ch) such as an A/V amplifier, HDMI receiver, etc., select "Bitstream" under the "DTS/DTS-HD" in "Digital Audio Output" of "Audio" setting of this unit. (If "PCM" is selected, audio with over 5.1ch surround signals may not be output correctly.)



### 4.3. Connection to the Network

By connecting this unit to the Internet, you can update the software via the Internet or access BD-Live™, Netflix, and YouTube™ services.

- For a stable connection, wired connection is recommended when using following features. (Using following features with Wireless LAN connection can be affected by other devices using radio frequencies.)
  - Video streaming services (Netflix / YouTube™)
  - Network update

#### ■ Wired Connection

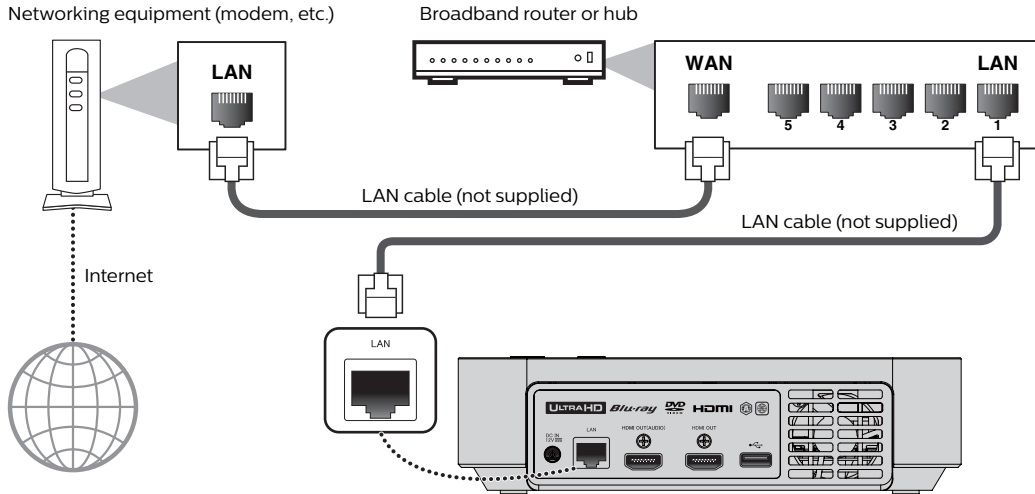

#### ⚠ Caution

- Do not insert any cable other than a LAN cable to the LAN terminal to avoid damaging the unit.
- Do not connect your PC directly to the LAN terminal of this unit.

#### ⓘ Note

- After you make a wired connection, set up necessary network settings. (For network setting of wired connection, refer to “Wired” on page 44.)
- If your modem does not have router functions, connect a wired router.
- If your modem has router functions but there is no vacant port, add a hub.
- For a wired router, use a router which supports 10BASE-T / 100BASE-TX / 1000BASE-T ETHERNET standard.
- Please purchase shielded LAN cables at your local store and use them when you connect to network equipment.

## ■ Wireless LAN Connection

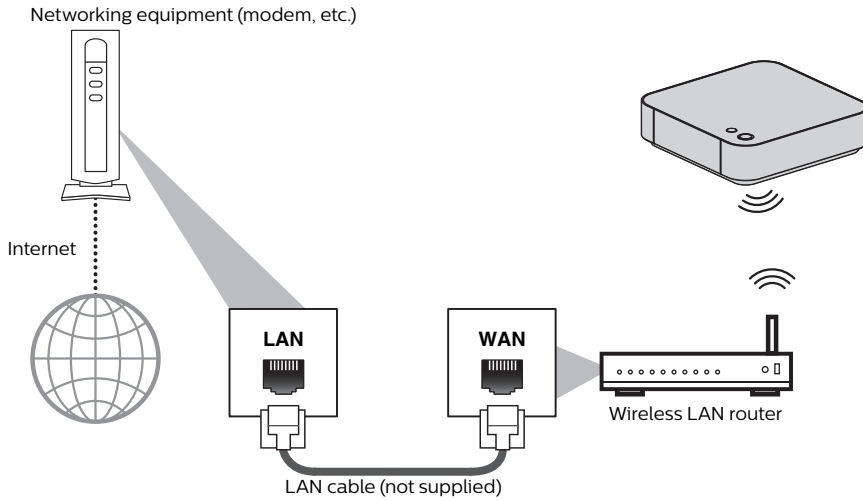

### ⓘ Note

- After you made the Wireless LAN connection, set up necessary network settings.  
(For the network setting of Wireless LAN connection, refer to “Wireless” on page 46.)
- For a Wireless LAN router, use a router which supports IEEE 802.11 b/g/n/ac.  
(“ac” type is recommended for stable operation of the Wireless LAN network.)
- Set the Wireless LAN router to Infrastructure mode. This unit does not support Ad-hoc mode.
- Other radio devices or obstacles may cause interference to the Wireless LAN network connection.
- With a 2.4GHz wireless router (access point), using a USB3.0 compatible device with this unit may cause wireless connection instability. Place the wireless router as far away as possible from this unit.
- When using a 5GHz compatible wireless router (access point), 5GHz bandwidth use is recommended.

## 5. BEFORE YOU START

### 5.1. Finding the Viewing Channel /Source on Your TV

After you have completed all the connections, you must find the viewing channel (external input source) on your TV.

1. After you have made all the necessary connections, press [**⏻** (standby/on)] to turn on the unit.
2. Turn on your TV.
3. Press the button on the TV's remote control that accesses the external input channel. It may be labeled "SOURCE", "AV", "AUX" or "SELECT" (refer to your TV's user manual). Or press "2" on the TV's remote control, then press channel down button.

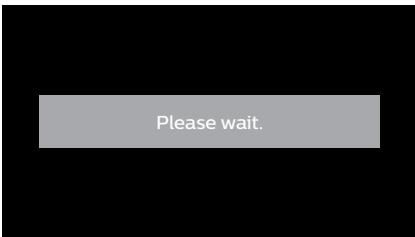

This is the correct viewing channel (external input source).

- If the TV is connected by an HDMI cable, it may take a while for the Philips splash screen to come up.
- If a certain amount of time has passed since you turned on the unit, welcome screen appears the first time you turn on this unit.

### 5.2. Initial Setup

Please follow the instructions below to complete the initial setup.

1. While "On-Screen Language" screen is displayed, use [**▲/▼**] to select your language, then press [**OK**].

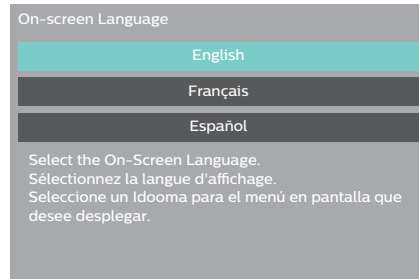

- When this unit is connected to a 4K-compatible TV, the "4K/60p Output" screen will appear. Otherwise, move on to step 3.
2. Follow the on-screen instructions, and if the "Is this message displayed?" screen is displayed, select "Yes", then press [**OK**].
    - If a confirmation screen\* appears, select "Yes", then press [**OK**].
      - \* It takes some time until the confirmation screen appears.
  3. The "Quick start" screen will appear. Use [**▲/▼**] to select "On" or "Off", then press [**OK**].
    - "On": In order to make the unit start faster, then set to "On". If done then this will increase the Power Consumption during Standby mode.
    - "Off": "Off" will reduce the Power Consumption during Standby mode rather than "On".
  4. Press [**OK**].
    - "Easy Settings" is finished.
  5. "Easy Network Setting" screen will appear. Use [**▲/▼**] to select the desired mode, then press [**OK**].
    - If you select "Wired", refer to "Wired" on page 43 for further operation.
    - If you select "Wireless", refer to "Wireless" on page 45 for further operation.
  6. The Home menu will appear.

## 6. INFORMATION ON PLAYBACK

### 6.1. Information on Playback

Before you start playing back a disc, read the following information.

#### ■ Playable Discs and Files

Playable Discs	Logo
Blu-ray Disc™ <ul style="list-style-type: none"> <li>- Ultra HD Blu-ray™</li> <li>- BD-video</li> <li>- Blu-ray 3D™ Disc</li> <li>- Blu-ray 3D™ only Disc</li> <li>- BD-RE* (ver. 2.1/3.0) (Recorded in BDMV format)</li> <li>- BD-R* (ver. 1.1 / 1.2 / 1.3/2.0) (Recorded in BDMV format) (Unfinalized disc may not be played back.)</li> </ul>	   
DVD-video	
DVD-RW (finalized VR mode discs only)	
DVD-R (finalized VR mode discs only)	
CD-DA (audio CD)	
CD-RW	 
CD-R	 
DTS-CD	-

\* Due to the intentional progression of the Blu-ray Disc™ format by its standard setting authority, the company cannot guarantee or warrant the playability of future extensions of the Blu-ray Disc™ format with this product.

Playable Files	Media
AVCHD	DVD-RW/-R, DVD+RW/+R
MP3	
FLAC	
WAV	DVD-R, CD-RW/-R, USB storage device
AAC	
JPEG	BD-RE/-R, DVD-R, CD-RW/-R, USB storage device

Readable devices	Media
USB storage devices supporting USB2.0 / USB3.0	MP4, MPEG2, MP3, FLAC, WAV, AAC, JPEG, Picture-in-Picture commentary, subtitles or other extras for BD-ROM ver. 2 (Profile 2.0 / Profile 1.1)

#### ■ Recommended Specifications

##### AVCHD

This unit cannot play back standalone AVCHD files (\*.m2ts, \*.mts or \*.m2t) written to a DVD. The DVD containing AVCHD files must have a proper file and folder structure meeting AVCHD format specifications.

Please use AVCHD compliant device / software to burn or copy AVCHD files to DVD. (Please refer to user manuals of the device / software for more information.)

##### MP3

- Maximum sampling frequency: 48kHz
- Maximum constant bit rate: 320kbps
- File extension: .mp3

##### JPEG

- Resplution
  - Upper limit: 4,096 x 4,096 dots (sub sampling: 4:4:4)
  - 8,192 x 8,192 dots (sub sampling: 4:2:2)
  - 8,192 x 8,192 dots (sub sampling: up to 4:2:0)
  - Lower limit: 34 x 34 dots (sub sampling: 4:4:4)
  - 34 x 34 dots (sub sampling: 4:2:2)
  - 34 x 34 dots (sub sampling: up to 4:2:0)

- File extension: .jpg

##### FLAC

- Maximum sampling frequency: 192 kHz
- Correspond sampling frequency: Maximum 192 kHz
- Maximum quantization bit rate: 24 bit
- File extension: .flac

##### AAC

- Maximum sampling frequency: 48 kHz
- Correspond sampling frequency: Maximum 48 kHz
- Maximum constant bit rate: 320 kbps
- File extension: .m4a

##### WAV

- Maximum sampling frequency: 192 kHz
- Correspond sampling frequency: Maximum 192 kHz
- Maximum quantization bit rate: 24 bit
- File extension: .wav

##### MP4

- File extension: .mp4, .mov

##### MPEG2(TS/PS)

- File extension: .mpg, .mpeg, .m2ts, .mts, .ts

##### DLNA - PCM

- Maximum sampling frequency: 44.1, 48 kHz
- Correspond sampling frequency: Maximum 48 kHz

## ■ Folder / File Number Limitations

A total of 10,000 folders/files on any type of media can be displayed.

## Caution / Note for USB Storage Devices

### ⚠ Caution

- Philips is not responsible if the USB storage device is not supported nor is it responsible for damage or loss of data from the device.
- Do not try to open or modify the USB storage device.
- Do not touch the terminal surface with your fingers or any metals.

### 📌 Note

- This unit supports USB storage devices with FAT16 / FAT32 / NTFS / exFAT file system.
- Please keep the USB storage devices in their cases when you are not using them.
- Some USB storage devices may not work with this unit.
- This unit can read SD cards using a USB card reader (not supplied).  
Readable cards:

SD Memory Card (8 MB - 2 GB)
miniSD Card (16 MB - 2 GB)
microSD Card (256 MB - 2 GB)
SDHC Memory Card (4 GB - 32 GB)
miniSDHC Card (4 GB - 8 GB)
microSDHC Card (4 GB - 16 GB)
SDXC Memory Card (64 GB - 2 TB)

## ■ Unplayable Discs and Files

The following discs cannot be played on this unit.

- CD-ROM
- CD-I (compact disc-interactive)
- DVD-RAM
- VSD (video single disc)
- DVD-audio
- video CD
- HD DVD
- SVCD
- unfinalized disc
- BD-RE (ver.1.0)
- BD-RE (ver.2.1 / 3.0) (Recorded in BDAV format)
- BD-R (ver.1.1 / 1.2 / 1.3 / 2.0) (Recorded in BDAV format)
- Blu-ray Disc™ containing AVCHD files
- Blu-ray Disc™ / DVD / CD / USB storage device / SD card containing DivX® files
- Blu-ray Disc™ / DVD hybrid disc (played back as a BD-video only)
- DVD-RW/-R recorded in non compatible recording format
- Super Audio CD - Only the sound on the CD layer can be heard. The sound on the high-density Super Audio CD layer cannot be heard.
- Playability of dual discs is not guaranteed.
- This unit cannot play back the disc content protected by Windows Media™ Digital Rights Management (DRM).

## ■ Region Codes

This unit has been designed to play back BD-video with region "A", DVD-video with region "ALL" or "1". You cannot play back BD-video or DVD-video that are labeled for other regions. Look for the symbols on the right on your BD-video or DVD-video. If these region symbols do not appear on your BD-video or DVD-video, you cannot play back the disc in this unit. The letter or number inside the globe refers to region of the world. A BD-video or DVD-video labeled for a specific region can only be played back in the unit with the same region code.

BD-video



DVD-video



DVD-video



### 📌 Note



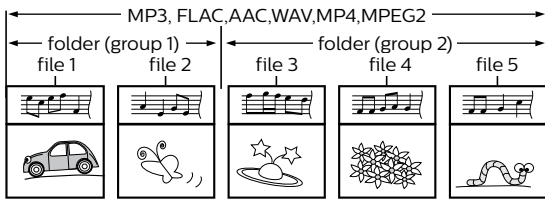
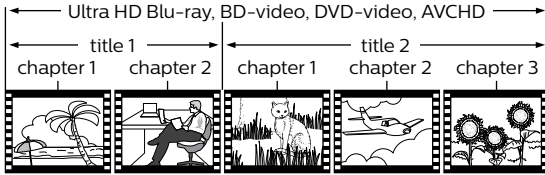

- Ultra HD Blu-ray™ discs have no region codes.

## ■ Hint for Disc Playback

The contents of a disc are generally divided into sections or folders (groups of titles / files) as shown below.



## ■ Description for Icons

-  : group (folder) icon
-  : music file icon
-  : video file icon
-  : photo file icon

- “Folders” refers to the groups of files.
- “Tracks” refers to the contents recorded on the audio CD.
- “Files” refers to the contents on a disc which are recorded in AVCHD, MP3, FLAC, AAC, WAV, MP4, MPEG2, JPEG file format.

## ⊖ Note

- If there is an unrecognizable character in a file name, the next recognizable character(s) moves over to the place for the unrecognizable character.

## 6.2. Guide to File List

### ■ Video File List

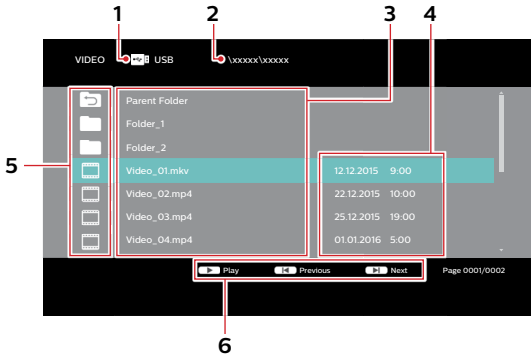

- 1 Media type
- 2 Full path to the target directory
- 3 Folder/File List
- 4 Date and time at which this file was created
- 5 Folder/File icon
- 6 Operation guide

### ■ Music File List

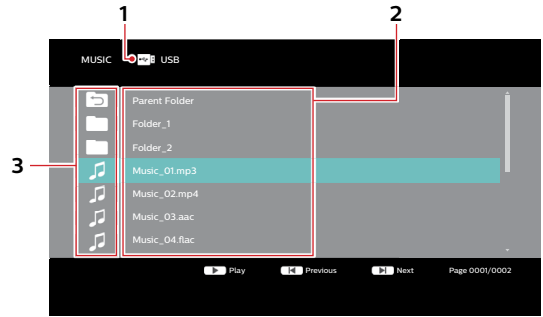

- 1 Media type
- 2 Folder/File List
- 3 Folder/File icon

### ■ Photo File List

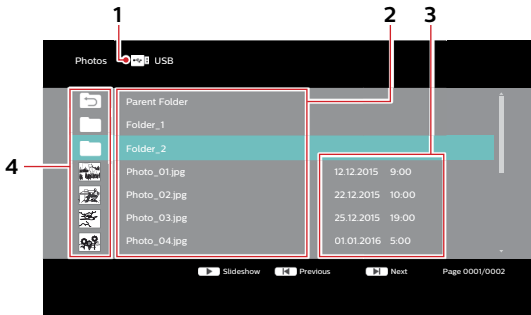

- 1 Media type
- 2 Folder/File List
- 3 Date and time at which this file was created
- 4 Folder icon / Thumbnail

### ■ Music List (CD-DA)

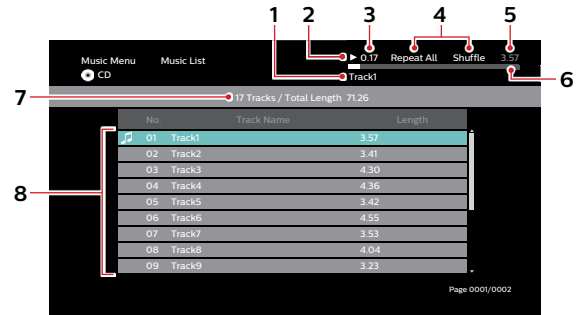

- 1 Current track number
- 2 Playback status
- 3 Elapsed time of the current track
- 4 Playback options (Repeat mode/Shuffle)
- 5 Total play time of the current truck
- 6 Playback progress bar
- 7 Total truck numbers/total play time of the Disc
- 8 Music List

## ■ Title/Play/Chapter List (VR)

### Title List (VR)

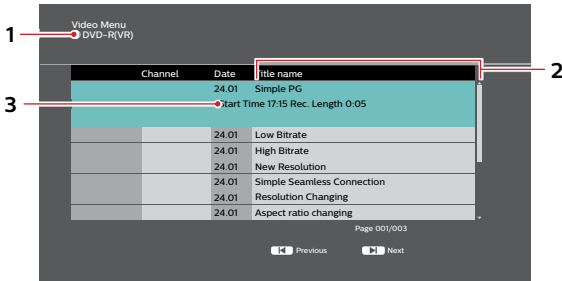

#### 1 Media type

#### 2 Title List

#### 3 Recording start time/Recording length of the selected Title

### Playlist (VR)

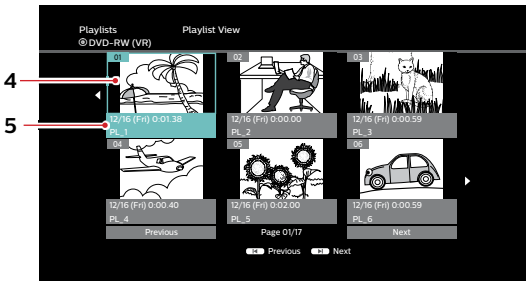

#### 4 Thumbnail

#### 5 Title information

When a Disc containing the Playlist is inserted, and the Home menu is displayed, select “Videos” ➔ “Disc” to display the Title/Playlist selection screen, then select “Playlist”.

### Chapter List (VR)

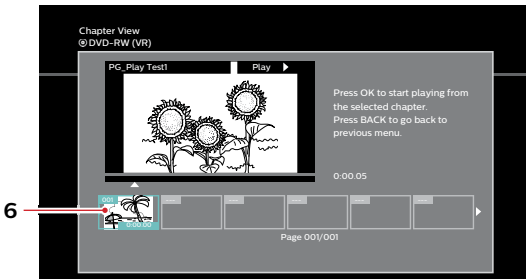

#### 6 Chapter thumbnail

### How to Navigate through the Track / File List

- Use [▲/▼] to move the highlight up and down in the list.
- To access the files in a group (folder), select the desired group (folder), then press [OK].
- Press [BACK ↵] to go back to the previous hierarchy.
- Press [◀ (previous)] or [▶ (next)] to change the page of the list.
- Press [🏠 (home)] to go back to the home menu.

## 6.3. How to Insert a Disc

1. Press [▲ (open/close)] to open the disc tray.
2. Place the disc on the disc tray with its label side facing up.

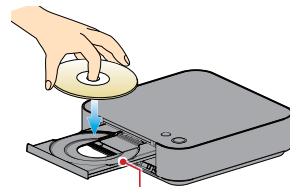

Align the disc to the disc tray guide.

3. Press [▲ (open/close)] to close the disc tray.
  - It may take a while to load the disc.



## 7. BASIC PLAYBACK

### 7.1. Playing Back a Disc

1. Insert a disc (refer to “How to Insert a Disc” on page 24).
  - For Blu-ray Disc™ / DVD or a disc containing only one type of file, playback will start automatically. If not, press [▶ (play)].
  - For audio CD, CD-DA List will appear.
  - Some discs may show a title or a disc menu. In this case, refer to “Using the Title / Disc / Pop-up Menu” on page 28.
  - Media filter screen will appear.
2. Select the type of the file you want to play back, then press [OK].



3. Select the desired item.

#### For “Play Video”, file list will be displayed.

- Refer to “Photo File List” on page 23 and “How to Navigate through the Track / File List” on page 24.

#### For “View Photos”, thumbnail screen will appear.

- Refer to “Photo File List” on page 23 and “How to Navigate through the Track / File List” on page 24.

#### For “Play Music”, track / file list will be displayed.

Select a group (folder) or track / file you want to play back then press [▶ (play)] or [OK] to start playback.

- Refer to “Music File List” on page 23 and “How to Navigate through the Track / File List” on page 24.

#### To skip to the next track / file :

Press [▶| (next)].

#### To skip to the previous track / file :

Press [◀| (previous)].

#### To pause playback :

Press [⏸ (pause)].

#### To return to normal playback :

Press [▶ (play)].

#### To stop playback :

Press [■ (stop)].

Playback will be in Resume-On-Stop mode.

#### ■ Resume-On-Stop Mode

Ultra HD Blu-ray Disc™ / Blu-ray Disc™ / DVD / AVCHD / DVD-VR / MP4 / MPEG2:

When you press [▶ (play)] next time, the playback will start from the point where it has been stopped.

Audio CD / JPEG / AAC / WAV / FLAC / MP3

Playback will start from the beginning of the current track/file next time you press [▶ (play)] or [OK].

#### ⓘ Note

- Playback will also stop and the home menu will appear when you press [⬆ (home)]
- For BD-J application, the Resume-On-Stop may not be available.
- Resume-On-Stop mode remains in effect even after power is turned off, but will be canceled once the disc is ejected.
- With regard to the multi-border BD-RE/-R, additionally recorded sections cannot be recognized.
- With regard to the multi-border DVD-RW/-R, additionally recorded sections may not be recognized.

#### ⚠ Tips for JPEG viewing

- Some unplayable folders or files may be listed due to the recording status.
- High-resolution JPEG files take longer to be displayed.
- Progressive JPEG files (JPEG files saved in progressive format) are not supported.

## 7.2. Playing Back an Ultra HD Blu-ray™ Disc



This unit can play back Ultra HD Blu-ray™ discs. In order to view Ultra HD Blu-ray™ videos, you need to have the following:

- **4K/60p (color space 4:4:4) and HDCP 2.2 compatible device.**
- **HDR compatible device**
- **18 Gbps high-speed HDMI cable**
- **Ultra HD Blu-ray™ Disc**

### 1. Connect this unit to a 4K/60p (4:4:4) compatible TV using an 18 Gbps high-speed HDMI cable.

- Refer to “HDMI Video /Audio Connection” on page 14

### 2. Insert an Ultra HD Blu-ray™ Disc.

- Refer to “How to Insert a Disc” on page 24.

### 3. Playback may start automatically. If not, press [▶ (play)].

- Some discs may show a title or a disc menu. In this case, refer to “Using the Title / Disc / Pop-up Menu” on page 28.

#### To pause playback:

Press [⏸ (pause)].

#### To return to normal playback:

Press [▶ (play)].

#### To stop playback:

Press [■ (stop)].

Playback will be in Resume-On-Stop mode, and the background screen will appear.

### ■ Resume-On-Stop mode

When you press [▶ (play)] next time, the playback will start from the point where it has been stopped.

### ⓘ Note

- If this unit is connected to a non-HDCP 2.2 compatible device, HDR signals will be dynamically converted and output in 2K resolution. Some discs may not be played correctly.
- If this unit is connected to a non-4K/60p (color space 4:2:0) compatible device, and a 60p video is played, HDR signals will be dynamically converted and output.
- If this unit is connected to a non-4K/60p compatible device, HDR signals will be dynamically converted and output in 2K resolution.
- If this unit is connected to a non-HDR compatible device, HDR signals will be dynamically converted and output. Some discs may output images in 2K resolution or may not be played correctly.

## 7.3. Playing Back a Blu-ray 3D™ Disc



This unit can play back Blu-ray 3D™ discs which contain stereoscopic 3D video. In order to view Blu-ray 3D™ videos, you need to have the following:

- 3D capable TV
- 3D compatible HDMI cable
- 3D glasses
- Blu-ray 3D™ Disc or Blu-ray 3D™ only Disc

### 1. Connect this unit to a 3D-compatible TV using a 3D-compatible HDMI cable.

- Refer to “HDMI Video /Audio Connection” on page 14.

### 2. Insert a Blu-ray 3D™ Disc or a Blu-ray 3D™ only Disc.

- Refer to “How to Insert a Disc” on page 24.

### 3. Playback may start automatically. If not, press **[▶ (play)]**.

- Some discs may show a title or a disc menu. In this case, refer to “Using the Title / Disc / Pop-up Menu” on page 28.

#### To pause playback:

Press **[⏸ (pause)]**.

#### To return to normal playback:

Press **[▶ (play)]**.

#### To stop playback:

Press **[■ (stop)]**.

Playback will be in Resume-On-Stop mode, and the background screen will appear.

### ■ Resume-On-Stop mode

When you press **[▶ (play)]** next time, the playback will start from the point where it has been stopped.

### ⚠ Caution

- Watching 3D videos may cause headache, dizziness or tiredness. To avoid such consequences, do not watch 3D videos for a long period of time.
- Watching 3D videos is not recommended for the following people:
  - People who are susceptible to motion sickness
  - Children from walking age to seven years
  - Pregnant woman

For more information, refer to “IMPORTANT HEALTH AND SAFETY INFORMATION FOR 3D TELEVISIONS” on page 58.

### ⓘ Note

- For more information, refer to the 3D TV’s manual.
- When “3D BD-Video Playback” is set to “3D Playback” and your TV is not 3D capable, playback of Blu-ray 3D™ discs will revert to 2D depending on the disc.
- For some Blu-ray 3D™ only discs, playback in 2D mode is not possible.
- You can check the current output mode (2D or 3D) by pressing **[INFO ⓘ]** during playback.

## 7.4. Playing Back Contents on a USB Storage Device

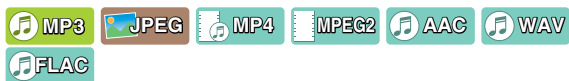

You can play back MP3 / JPEG / MP4 / MPEG2 / AAC / WAV / FLAC files from a USB storage device. With the USB storage device, you can also enjoy the following functions.

- Special additional contents for BD-ROM Profile 1 ver.1.1. (For more information about the special additional contents, refer to the instruction book that came with the disc.)
- BD-Live™ function (BD-ROM ver. 2 Profile 2.0). (For more information about BD-Live™, refer to page 32.)

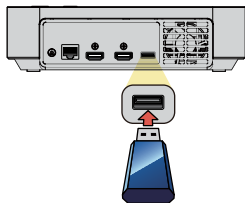

1. Connect a USB storage device to the USB input.
2. Use [▲/▼] to select “Play Video”, “View Photos” or “Play Music”, then press [OK].
3. Follow steps 3 in “Playing Back a Disc” on page 25.

### To remove the USB storage device:

In stop mode, pull it out slowly.

### ⚠ Caution

- Do not remove the USB storage device or switch the unit to standby mode while the contents of the device are being accessed. It may result in malfunction or loss of the device data.
- Philips cannot be held responsible if your USB storage device is not supported, nor will Philips accept any liability for damage or loss of stored data.
- If a USB card reader is connected, files in an SD card which is connected first to the slot of the reader will be displayed.

### ⓘ Note

- The resume information will be cleared when:
  - the USB storage device is removed.
  - the unit is switched to standby mode.
- Do not delete the folders or files in the USB storage device with your computer. This unit may not read USB storage devices formatted on a computer.
- This unit can read MP3 / JPEG / MP4 / MPEG2 / AAC / WAV / FLAC files in an SD card by using USB card reader (not supplied).

## 7.5. Using the Title / Disc / Pop-up Menu



Some discs may contain a title menu which describes the contents of the disc, or a disc menu which guides you through the available functions in the disc.

With such discs, a title menu or a disc menu may appear automatically when you insert the disc. Otherwise, press [TOP MENU] to call up the menu. Refer to the disc’s manual on how to navigate through the menu.

### ⓘ Note

- Menus vary among discs. Refer to the information accompanying the disc for details.
- [TOP MENU] may not work with some discs.
- You can also call up the Title/Disc/Pop-up Menu from the play menu. Play menu can be called up by pressing [OPTIONS].
  - **Ultra HD Blu-ray/BD-Video/DVD-V/AVCHD:**  
[OPTIONS] ⇒ “Operation Menu” ⇒ “Top Menu”
  - **Ultra HD Blu-ray/BD-Video:**  
[OPTIONS] ⇒ “Operation Menu” ⇒ “Pop-up Menu”
  - **DVD-Video:**  
[OPTIONS] ⇒ “Operation Menu” ⇒ “Menu”

## 7.6. Playing back from the File list

If **[▶ (play)]** or **[OK]** is pressed while the File list is displayed, this unit will operate as follows:



### In stop mode:

**[▶ (play)] / [OK]:**

Starts playing from the beginning of the Track/File being highlighted.

### While highlighting the Track/File being played:

**[▶ (play)] / [OK]:** N/A

### While highlighting any Track/File not being played:

**[▶ (play)] / [OK]:**

Starts playing from the beginning of the Track/File being highlighted.

### While highlighting the Track/File being paused:

**[▶ (play)]:** Resumes playback from where it was paused.

**[OK]:** N/A

### While highlighting any Track/File not being paused:

**[▶ (play)]:** Resumes playback from where it was paused.

**[OK]:** Starts playing from the beginning of the Track/File being highlighted.

### While highlighting the Track/File being FF/FR:

**[▶ (play)]:** Cancels FF/FR and resumes playback.

**[OK]:** N/A

### While highlighting any Track/File not being FF/FR:

**[▶ (play)]:** Cancels FF/FR and resumes playback.

**[OK]:** Starts playing from the beginning of the Track/File being highlighted.



### In stop mode:

**[▶ (play)]:** Starts Slideshow from the file being highlighted. (Files in the root directory will be shown as well.)

**[OK]:** Displays the file being highlighted. (If **[▶ (play)]** is pressed here, Slideshow will start.)



### In stop mode, while any File is highlighted:

**[▶ (play)] / [OK]:**

Starts playing from the beginning of the Track/File being highlighted.

### While highlighting the Track being in Resume stop mode:

**[▶ (play)] / [OK]:**

Resumes playback from where it was stopped.



### In stop mode:

**[▶ (play)] / [OK]:**

Starts playing from the beginning of the Track/File being highlighted.

### While highlighting the Track/File being played:

**[▶ (play)]:** N/A

**[OK]:** Pauses playback.

**[◀] or [◀ (previous)]:** Skips back to the beginning of the Track/File.

**[▶] or [▶ (next)]:** Skips to the next Track/File.

### While highlighting the Track/File being paused:

**[▶ (play)] / [OK]:**

Resumes playback from where it was paused.



### In stop mode, while any File is highlighted:

**[▶ (play)] / [OK]:**

Displays the the highlighted file.

### In stop mode, while any Folder is highlighted:

**[▶ (play)]:** Starts Slideshow with files in the Folder being highlighted\*.

**[OK]:** Moves into the Folder being highlighted.

\* If there is no Photo File in the highlighted folder, photo browsing will not start.



### In stop mode, while any File is highlighted:

**[▶ (play)] / [OK]:**

Starts playing from the beginning of the Track/File being highlighted.

### While highlighting the Track being in Resume stop mode:

**[▶ (play)] / [OK]:**

Resumes playback from where it was stopped.

---

## 8. SPECIAL PLAYBACK

---

### 8.1. Fast Forward / Fast Reverse



1. During playback, press [▶▶ (forward)] repeatedly for fast forward.

During playback, press [◀◀ (reverse)] repeatedly for fast reverse.

Every time you press [▶▶ (forward)] or [◀◀ (reverse)], the playback speed will change.

2. Press [▶ (play)] to return to normal playback.

#### ⓘ Note

- For Ultra HD Blu-ray Disc™, Blu-ray Disc™, DVD, DVD-VR, AVCHD, MP4 and MPEG2, speed changes in 5 different levels.
- For audio CD, MP3, AAC, FLAC and WAV, speed increases 1 level.
- For audio CD, fast forward / fast reverse search between different tracks are not available during random playback.
- For MP3, AAC, FLAC and WAV, fast forward / fast reverse search between different files are not available. When searching reaches the beginning/ending of the track, it will return to normal playback.

---

### 8.2. Slow Forward Playback



1. During playback, press [⏸ (pause)], then press [▶▶ (forward)].

Every time you press [▶▶ (forward)], the playback speed changes in 5 different levels.

2. Press [▶ (play)] to return to normal playback.

#### ⓘ Note

- For Ultra HD Blu-ray Disc™, Blu-ray Disc™, AVCHD, only slow forward is available.

---

### 8.3. Slow Reverse Playback



1. During playback, press [⏸ (pause)], then press [◀◀ (reverse)].

Every time you press [◀◀ (reverse)], the playback speed changes in 5 different levels.

2. Press [▶ (play)] to return to normal playback.

---

### 8.4. Frame by frame Playback



1. In pause mode, press [▶] repeatedly.

Every time you press [▶], playback will advance one step at a time.

2. Press [▶ (play)] or [⏸ (pause)] to return to normal playback.

#### ⓘ Note

- For Ultra HD Blu-ray Disc™, Blu-ray Disc™, AVCHD, only frame by frame is available.

---

### 8.5. Frame Return Playback



1. During playback, press [⏸ (pause)], then press [◀].































Every time you press [◀], playback will reverse by 1 frame.

2. Press [▶ (play)] or [⏸ (pause)] to return to normal playback.

## 8.6. Repeat Playback

Available repeat function varies depending on the disc.

1. During playback, press [OPTIONS ].
2. Use [▲/▼] to select “Operation Menu”, then press [OK].
3. Use [▲/▼] to select “Repeat Play”, then press [OK].
4. Use [▲/▼] to select the desired repeat mode.

REPEAT MODE	AVAILABLE MEDIA
<b>Chapter Repeat</b> The current chapter will be played back repeatedly.	    
<b>Title Repeat</b> The current title will be played back repeatedly.	      
<b>One Track Repeat</b> The current track or file will be played back repeatedly.	    
<b>All Repeat</b> All tracks in the media will be played back repeatedly.	    
<b>Playlist Repeat</b> Playlist in the media will be played back repeatedly.	
<b>Folder Repeat</b> The current group (folder) will be played back repeatedly.	 
<b>Shuffle Repeat (Audio CD)</b> Repeats the random playback.	
<b>Shuffle Repeat (MP3 / FLAC / AAC)</b> Repeats the random playback in a folder.	   

5. Press [OPTIONS ] to exit.

### Note

- The repeat setting will be canceled when you stop playback.
- When the repeat setting is set for an audio CD track, the repeat setting will be canceled if you select other track to play back.
- When the repeat setting is set for an MP3, FLAC, AAC or WAV folder (file), the repeat setting will be canceled if you select other MP3, FLAC, AAC or WAV folder (file) to play back.

## 8.7. Slide Show



1. Follow steps 1 to 2 in “Playing Back a Disc” on page 25.
2. Open the folder which contains the desired JPEG files.
3. Use [▲/▼/◀/▶] to select a desired file to be played back, then press [▶ (play)].

- An image will be played back from the selected file and go to the next one in turn every 10 seconds.
- If [OK] is pressed instead of [▶ (play)], only selected files will be repeatedly displayed.  
If [▶ (play)] is pressed or [OPTIONS ] → “Operation Menu” → “Start Slideshow” is selected, Slideshow will start.

### Note

- Large-size JPEG files take a few moments to be displayed.

## 8.8. PiP (BONUSVIEW™) Setting



Some BD-videos have the PiP function which enables you to display the secondary video in the primary video.

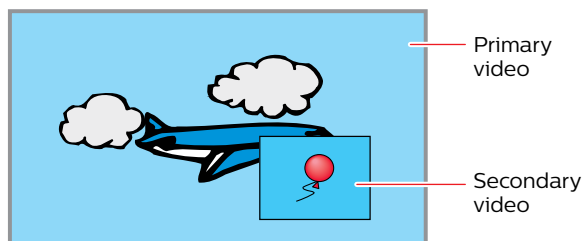

1. During playback, press [OPTIONS 

## 8.9. Enjoying BD-Live™ Discs Using the Internet



You can enjoy BD-Live™ which enables you to use interactive features when the unit is connected to the Internet.

Examples of BD-Live™ features:

- Online access to additional content such as movie trailers, subtitles, BD-J applications, etc.
- While downloading, special video data may be played back.
  - **Service and functions differ depending on the disc. Follow the instructions given by the disc when using the BD-Live™ function.**
  - **Insert a USB storage device of at least 1GB capacity before using BD-Live™ features on a Blu-ray Disc™.**
  - **Do not remove the USB storage device while using BD-Live™ features.**

### Note

- You must connect the unit to the Internet and set up necessary settings in order to use BD-Live™.
- For the network connection, refer to “Connection to the Network” on page 17.
- For the network setup, refer to “Network Installation” on page 43.
- Depending on your connection environment, it may take time to connect to the Internet or the Internet may not be connected.
- When BD-Live™ functions are used and the unit is connected to the Internet, you may be charged for this communication.
- Some discs with BD-Live™ function require memory when playing back the content. If you cannot play back a disc with BD-Live™ function, insert a USB storage device (1 GB or more) which is formatted on this unit.

### Note for AAC Online

- The player or disc IDs may be sent to the content provider when playing back a disc with BD-Live™ function.
- If you save your viewing history on the server by using these IDs, you will be introduced to other similar movies.



## 8.10. Title / Chapter Search



### ■ Using [◀ (previous)] / [▶ (next)]

1. During playback, press [▶ (next)] to skip the current title or chapter and move to the next.

The title or chapter will move forward one at a time.

- If there is no chapter in one title, the current title may be skipped.

To go back to the beginning of the current title or chapter, press [◀ (previous)].

Press [◀ (previous)] repeatedly to go to the previous title or chapter. The title or chapter may move backward one at a time.

### ■ Using [the Number buttons] (Direct Search)

#### Chapter Search

1. During playback of a title, enter the chapter number you want to search using [the Number buttons].
2. Press [OK].

#### Title Search

1. While the background screen is displayed, enter the title number to search using [the Number buttons].
2. Press [OK].

### ⊖ Note

- Playback of the title/chapter will start in a few seconds.
- As for the BD-video, how it performs will be strongly determined by the disc, and may not perform as described.
- If a non-existent chapter is specified, it jumps to the last chapter.

## 8.11. Track Search



1. During playback, press [▶ (next)] to skip the current track or file and move to the next.

The track / file will move forward one at a time. To go back to the beginning of the current track / file, press [◀ (previous)].

Press it repeatedly to go to the previous track / file. The track / file will move backward one at a time.

## 8.12. Switching Subtitles

Some video materials may have subtitles in one or more languages. For commercially available discs, the supported languages can be found on the disc case. Follow the steps below to switch the subtitle language during playback.



1. During playback, press [OPTIONS ⏻].
2. Use [▲/▼] to select “Operation Menu”, then press [OK].
3. Use [▲/▼] to select “Subtitle Settings”, then press [OK].
4. Use [▲/▼] to select “Subtitle” or “Subtitle Style”, then press [OK].

“Subtitle”: Sets the subtitle for the primary/secondary video.

“Subtitle Style”: Sets style of the subtitle.

5. Use [▲/▼] to select your desired subtitle or style.
6. Press [OPTIONS ⏻] to exit.



1. During playback, press [OPTIONS ⏻].
2. Use [▲/▼] to select “Operation Menu”, then press [OK].
3. Use [▲/▼] to select “Subtitle Settings”, then press [OK].
4. Use [▲/▼] to select “Subtitle”, then press [OK].
5. Use [▲/▼] to select your desired subtitle.
6. Press [OPTIONS ⏻] to exit.

### ⊖ Note

- Some discs will only allow you to change the subtitles from the disc menu or pop-up menu. Press [TOP MENU] to display the disc menu or pop-up menu.
- If the disc has no subtitle language, “Off” will be displayed on the TV screen.
- If the disc has no subtitle style, “None” will be displayed on the TV screen.

## 8.13. Switching Audio Soundtrack

When playing back video material recorded with two or more soundtracks (these are often in different audio languages or audio formats), you can switch them during playback. For Blu-ray Disc™, available audio varies depending on the “BD-Video Secondary Audio” setting. Refer to page 39 for more information.



### ■ Primary setting

1. During playback, press [OPTIONS ▢].
2. Use [▲/▼] to select “Operation Menu”, then press [OK].
3. Use [▲/▼] to select “Soundtrack”, then press [OK].
4. Use [▲/▼] to select your desired audio stream channel.
5. Press [OPTIONS ▢] to exit.

### ■ Secondary setting

1. During playback, press [OPTIONS ▢].
2. Use [▲/▼] to select “Operation Menu”, then press [OK].
3. Use [▲/▼] to select “Secondary Video”, then press [OK].
4. Use [▲/▼] to select “Soundtrack”, then press [OK].
5. Use [▲/▼] to select your desired audio stream channel.
6. Press [OPTIONS ▢] to exit.



1. During playback, press [OPTIONS ▢].
2. Use [▲/▼] to select “Operation Menu”, then press [OK].
3. Use [▲/▼] to select “Soundtrack”, then press [OK].
4. Use [▲/▼] to select your desired audio stream channel.
5. Press [OPTIONS ▢] to exit.



1. During playback, press [OPTIONS ▢].
2. Use [▲/▼] to select “Operation Menu”, then press [OK].
3. Use [▲/▼] to select “Audio Channel”, then press [OK].
4. Use [▲/▼] to select your desired audio channel.  
“LR”: Both right and left channels are active (stereo).  
“L”: Only left channel is active.  
“R”: Only right channel is active.
5. Press [OPTIONS ▢] to exit.

### ⓘ Note

- The secondary audio will not be output when the secondary video is not displayed or when “BD-Video Secondary Audio” is set to “Off”. (For some Blu-ray™ discs, secondary audio will be output even when secondary video is off.)
- The sound mode cannot be changed during playback of discs not recorded in multiple audio mode.
- Some discs allow changing the audio language setting on the disc menu. (Operation varies depending on the discs. Refer to the manual accompanying the disc.)
- If the disc has no audio language, “Off” will be displayed on the TV screen.

## 8.14. Switching Camera Angles



Some BD-videos and DVD-videos contain scenes which have been shot simultaneously from various angles. You can change the camera angle.

1. During playback, press [OPTIONS ▢].
2. Use [▲/▼] to select “Operation Menu”, then press [OK].
3. Use [▲/▼] to select “Angle”, then press [OK].
4. Use [▲/▼] to select your desired angle.
5. Press [OPTIONS ▢] to exit.

## 8.15. JPEG Status



You can confirm the status of the JPEG file being displayed.

1. During playback, press [OPTIONS ].
2. Use [▲/▼] to select “Operation Menu”, then press [OK].
3. Use [▲/▼] to select “Status”, then press [OK].
4. Use [▲/▼] to select your desired setting.

“Off”: Date and detailed information will not be displayed.

“Date”: The date and time at which this picture file was created

“Details”: Detailed information on the picture file

- **Date:**  
The date and time at which this picture was taken
- **Size:**  
The size of this picture (width x height)
- **Manufacturer:**  
The manufacturer's name of the device used to shoot this picture
- **Equipment:**  
The model name of the device used to shoot this picture
- **Track Number:**  
The Track number of the picture file being displayed

5. Press [OPTIONS ] to exit.

## 8.16. JPEG Rotation



You can rotate the JPEG picture 90 degrees to the Left/Right.

1. While viewing, press [OPTIONS ].
2. Use [▲/▼] to select “Operation Menu”, then press [OK].
3. Use [▲/▼] to select “Rotate Left” or “Rotate Right”, then press [OK].

“Rotate Left”: Turns the picture 90 degrees to the Left.

“Rotate Right”: Turns the picture 90 degrees to the Right.

### Note

- Rotation setting will be cleared when viewing is stopped.

## 8.17. Playback Information Window



You can confirm the information on the video being played.

1. During playback, press [OPTIONS ].
2. Use [▲/▼] to select “Operation Menu”, then press [OK].
3. Use [▲/▼] to select “Playback Information Window”, then press [OK].

### ■ Playback Information Window

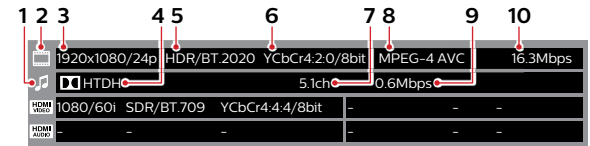

- 1 Audio icon
- 2 Video icon
- 3 Video Resolution / Video Frame Rate
- 4 Stream Type
- 5 Dynamic Range Information / Color Gamut
- 6 Chroma Sampling / Bits per Primary Color
- 7 Number of Audio Channels
- 8 Video Codec
- 9 Audio Bit Rate
- 10 Video Bit Rate

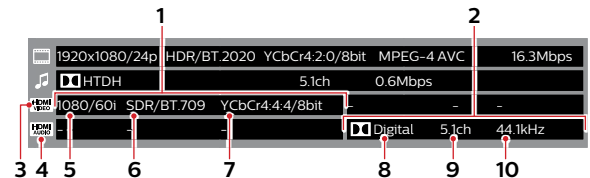

- 1 Video information from the **HDMI OUT** port
- 2 Audio information from the **HDMI OUT (AUDIO)** port
- 3 HDMI Video icon
- 4 HDMI Audio icon
- 5 HDMI Video Resolution / HDMI Video Frame Rate
- 6 Dynamic Range Information/Color Gamut
- 7 Chroma Sampling / Bits per Primary Color
- 8 Audio Codec
- 9 Number of Audio Channels
- 10 Audio Sampling Frequency

## 8.18. Reception



You can confirm the wireless network status.

1. During playback, press [OPTIONS ⏻].
2. Use [▲/▼] to select “Operation Menu”, then press [OK].
3. Use [▲/▼] to select “Reception”, then press [OK].
  - It is not available for wired connection.
4. Press [BACK ⏪] to exit.

## 8.19. Closed Caption

This unit supports Closed Caption. Available media are as follows:

BD	BD-RE (BDMV)
	BD-R (BDMV)
	Ultra HD Blu-ray, Blu-ray
DVD	DVD-R (Video Format/VR/AVCHD)
	DVD-RW (Video Format/VR/AVCHD)
	+R (AVCHD)
	+RW (AVCHD)
	DVD-Video
USB storage device	MP4/MPEG2 (TS/PS)
DLNA	MP4/MPEG2 (TS/PS)
Network Service	Netflix/YouTube™

Closed Caption will be displayed when:

- “Closed Caption Display” is set to “On”
- The video being played has Closed Caption
- Playing in normal speed

### ■ Closed Caption Display

Enables/Disables Closed Caption.

1. During playback, press [OPTIONS ⏻].
2. Use [▲/▼] to select “Operation Menu”, then press [OK].
3. Use [▲/▼] to select “Closed Caption Display” then press [OK].
4. Use [▲/▼] to select “On” or “Off”, then press [OK].

“On”: Enables Closed Caption

“Off”: Disables Closed Caption

5. Press [OPTIONS ⏻] to exit.

### ■ Closed Caption Type

Configures the Closed Caption Type.

1. During playback, press [OPTIONS ⏻].
2. Use [▲/▼] to select “Operation Menu”, then press [OK].
3. Use [▲/▼] to select “Closed Caption Type”, then press [OK].
4. Use [▲/▼] to select “Analog CC” or “Digital CC”, then press [OK].

“Analog CC”: Enables Analog Closed Caption. It is effective for disc, USB, DLNA playback.

“Digital CC”: Enables Digital Closed Caption. It is effective for content playback on the network services, disc, USB, DLNA.
5. Press [OPTIONS ⏻] to exit.

### ■ Analog CC

Configures Analog Closed Caption settings.

1. During playback, press [OPTIONS ⏻].
2. Use [▲/▼] to select “Operation Menu”, then press [OK].
3. Use [▲/▼] to select “Analog CC”, then press [OK].
4. Use [▲/▼] to select “CC1”-“CC4”, then press [OK].
5. Press [OPTIONS ⏻] to exit.

### ■ Digital CC

Configures Digital Closed Caption settings.

1. During playback, press [OPTIONS ⏻].
2. Use [▲/▼] to select “Operation Menu”, then press [OK].
3. Use [▲/▼] to select “Digital CC”, then press [OK].
4. Use [▲/▼] to select “CC1”-“CC6”, then press [OK].
5. Press [OPTIONS ⏻] to exit.

---

## 8.20. Luminance/Color Adjustment



Adjusts the picture quality.

1. During playback, press [OPTIONS ⏻].
2. Use [▲/▼] to select “Video Settings”, then press [OK].
3. Use [▲/▼] to select “Luminance/Color Adjustment”, then press [OK].
4. Use [▲/▼] to select “Contrast”, “Brightness”, “Color Saturation” or “Hue”, then press [OK].
5. Use [◀/▶] to change the value.
6. After completion of value change, then press [BACK ⏪].
7. Press [OPTIONS ⏻] to exit.

---

## 8.21. Progressive



Configures the optimal picture output method for progressive videos.

1. During playback, press [OPTIONS ⏻].
2. Use [▲/▼] to select “Video Settings”, then press [OK].
3. Use [▲/▼] to select “Progressive”, then press [OK].
4. Use [▲/▼] to select “Auto” or “Video”, then press [OK].
  - “Auto”: Automatically adjusts the picture.
  - “Video”: Used if the picture is flickering or blurred with “Auto”.
5. Press [OPTIONS ⏻] to exit.

---

## 8.22. Reset to Default Picture Settings



Resets the picture quality settings to their default settings.

1. During playback, press [OPTIONS ⏻].
2. Use [▲/▼] to select “Video Settings”, then press [OK].
3. Use [▲/▼] to select “Reset to Default Picture Settings”, then press [OK].
4. Use [◀/▶] to select “Yes” or “No”, then press [OK].
  - “Yes”: Resets the picture settings.
  - “No”: Will not reset the picture settings.
5. Press [OPTIONS ⏻] to exit.

---

## 8.23. Dialogue Enhancer



Enhances voices in movies.

1. During playback, press [OPTIONS ⏻].
2. Use [▲/▼] to select “Audio Settings”, then press [OK].
3. Use [▲/▼] to select “Dialogue Enhancer”, then press [OK].
4. Use [▲/▼] to select “On” or “Off”, then press [OK].
  - “On”: Enables “Dialogue Enhancer”.
  - “Off”: Disables “Dialogue Enhancer”.
5. Press [OPTIONS ⏻] to exit.

---

## 9. NETWORK SERVICES

---

### 9.1. Before Using Network Services

Please follow the instructions below before using network features.

1. Connect this unit to the Internet.
  - Refer to “Connection to the Network” on page 17.
2. Set up the necessary network connection settings.
  - Refer to “Network Installation” on page 43.
3. Press **[NETFLIX]** or **[YouTube]**.
  - Net TV screen will appear.
  - Network Services can also be accessed by **[🏠(home)]** → “Browse Net TV”.  
When Net TV is launched from “Browse Net TV” in the Home menu for the first time, the Terms of Use message screen will appear.
4. Press **[🏠(home)]** to exit.

#### ■ Guide to Net TV menu screen

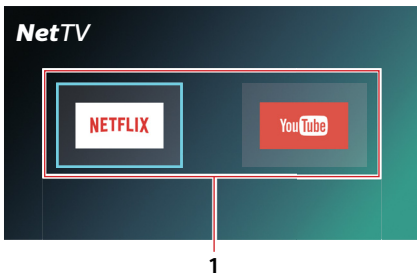

#### 1 Network Service icons:

- Display service icons

---

## 9.2. Information on Network Services

For detailed information on 3rd party Internet services, please visit the service providers website:

**Netflix:** <http://www.netflix.com/HowItWorks>

**YouTube:** <http://www.youtube.com>

## 10. LIST OF SETTINGS

In the setup menu, you can customize various kinds of settings as you prefer. Refer to the following instructions to navigate through the setup menu.

1. Press [**⬆️**(home)] to access the home menu.
2. Use [**▲**/**▼**/**◀**/**▶**] to select “Setup”, then press [**OK**].
3. Use [**▲**/**▼**] to select the desired setting, then press [**OK**].
4. Use [**▲**/**▼**] to move the highlight up and down in the list.
5. To make a selection or to access options of an item, select the desired item, then press [**OK**].
  - To go back to the previous screen, press [**BACK** **↩**].
6. Press [**⬆️**(home)] to exit.

Refer to the following table for the types of settings you can customize.

The item with the grey  is the default setting.

Category	Menus / Options	
HDMI	Resolution	Auto / 480p / 1080i / 1080p / 4K
	4k/60p Output	4K/60p(4:4:4) / 4K/60p(4:2:0) / <b>Off</b>
	24p Output	Auto / Off
	Advanced Settings	
	Deep Color Output	Auto / Off
	High Dynamic Range Output	Auto / Off
	Contents Type Flag	Auto / Off
	7.1ch Audio Reformatting	Auto / Off
Video	Still Mode (paused video)	Auto / Field / Frame
Audio	Dynamic Range Compression	On / Off / Auto
	Digital Audio Output	
	DD/DD+/DTHD	Bitstream / PCM
	DTS/DTS-HD	Bitstream / PCM
	BD-Video Secondary Audio	On / Off
	Downmix	Stereo / Surround encoded
	Audio Delay	0 - 250ms (by 10ms)
3D	3D BD-Video Playback	Auto / Set before play

Category	Menus / Options	
Language	Audio Language	English / French / Spanish / <b>Original</b> / Other
	Subtitle Language	Auto / English / French / Spanish / Other
	Menu Language	<b>English</b> / French / Spanish / Other
	On-screen Language	<b>English</b> / French / Spanish
	Closed Caption	
	Closed Caption Display	<b>On</b> / Off
	Closed Caption Type	<b>Analog CC</b> / Digital CC
	Analog CC	<b>CC1</b> - CC4
	Digital CC	<b>CC1</b> - CC6
	Manual setting	
	Font Color	Auto / White / Black / Red / Green / Blue / Yellow / Magenta / Cyan
	Font Size	Auto / Normal / Small / Large
	Font Style	Auto / Monospaced with serifs / Proportionally spaced with serifs / Monospaced without serifs / Proportionally spaced without serifs / Casual font type / Cursive font type / Small capitals
	Font Opacity	Auto / Solid / Translucent / Transparent
	Font Edge	Auto / None / Raised / Depressed / Uniform / Left drop shadowed / Right drop shadowed
	Font Edge Color	Auto / White / Black / Red / Green / Blue / Yellow / Magenta / Cyan
	BG Color	Auto / White / Black / Red / Green / Blue / Yellow / Magenta / Cyan
	BG Opacity	Auto / Solid / Translucent / Transparent
	Window Color (*)	Auto / White / Black / Red / Green / Blue / Yellow / Magenta / Cyan
	Window Opacity (*)	Auto / Solid / Translucent / Transparent
CC Reset		
Network	Easy Network Setting	
	Network Settings	
	LAN Connection Mode	<b>Wired</b> / Wireless
	Wireless Settings	
	IP Address/DNS Settings	
	Connection Test	
	IP Address Auto Configuration	<b>On</b> / Off
	IP Address	Displays the input screen.
	Subnet Mask	Displays the input screen.
	Default Gateway	Displays the input screen.
	DNS Auto Configuration	<b>On</b> / Off
	Primary DNS	Displays the input screen.
	Secondary DNS	Displays the input screen.
	Proxy Server Settings	
	Reset to factory preset	Yes / <b>No</b>
	Proxy Address	
	Proxy Port Number	Displays the input screen.
	Connection Test	
	Network Service Settings	
	Setting Unit Name	
Audio Auto Gain Control	<b>On</b> / Off	
Terms of Use		
BD-Live Internet Access	Allow (ALL) / Allow (Limited) / Prohibit	
Ratings	DVD-Video Ratings	<b>8 No Limit</b> / 7 / 6 / 5 / 4 / 3 / 2 / 1 / 0 Lock All
	BD-Video Ratings	<b>No Limit</b> / 0-21 year(s) / Enter year(s)

(\*) These settings are not available for the analog closed captioning.



Category	Menus / Options	
System		
	Easy Setting	Yes / No
	Display Settings	
	Status Message	Auto / Off
	EasyLink	On / Off
	Quick Start	On / Off
	Firmware Update	
	Automatic Update Check	On / Off
	Update Now	
	System Information	
	License & Digital Rights Mgmt	
	Firmware Version Information	Main Version:
		Wireless LAN module:
		ESN:
	Restore Default Settings	Yes / No

# 11. SETUPS

## 11.1. HDMI Video

🏠(home) ➡ "Setup" ➡ "Player Settings" ➡ "HDMI" ➡ "Resolution"

Set the resolution of the video signal being output from the HDMI OUT jack.

You can select the desired "HDMI Video" among the settings listed below:

**"Auto", "480p", "1080i", "1080p", "4K"**

### Actual Output Resolution:

Setting in the "HDMI Video"	Source							
	720 x 480 (30i)	1280 x 720 (60p)	1920 x 1080 (30i)	1920 x 1080 (24p)	1920 x 1080 (60p)	3840 x 2160 (24p)	3840 x 2160 (60p)	
480p	720x480 (60p)	720x480 (60p)	720x480 (60p)	720x480 (60p)	720x480 (60p)	720x480 (60p)	720x480 (60p)	
1080i	1920x1080 (60i)	1920x1080 (60i)	1920x1080 (60i)	1920x1080 (24p)	1920x1080 (60i)	1920x1080 (24p)	1920x1080 (60i)	
1080p	1920x1080 (60p)	1920x1080 (60p)	1920x1080 (60p)	1920x1080 (24p)	1920x1080 (60p)	1920x1080 (24p)	1920x1080 (60p)	
4K	3840x2160 (60p)	3840x2160 (60p)	3840x2160 (60p)	3840x2160 (24p)	3840x2160 (60p)	3840x2160 (24p)	3840x2160 (60p)	
Auto	The highest resolution supported by your display device will be in effect automatically.							

- The resolution listed in the above chart will be enabled on this unit when the "4K/60p Output" is set to "4K/60p(4:4:4)", and the "24p Output" is set to "Auto".
- For AVCHD, outputting the video in 24 frames per second (1080p/24) is not available.

### 🔊 Note

- The selected resolution must also be supported by your display device.
- Even if "HDMI Resolution" is set to "4K", the video of a non-4K compatible Blu-ray Disc™ will be output in the video resolution that is specified by the Disc and supported by the display device.
- Refer also to your TV's manual.
- When connected to an HDCP incompatible display device, the picture will not be displayed properly.
- The audio signals from the HDMI OUT jack (including the sampling frequency, the number of channels and bit length) may be limited by the device that is connected.
- Among the display device(s) that support HDMI, some do not support audio output (for example, projectors). While connected to a device such as a projector, audio will not be output from the HDMI OUT jack.
- When this unit's HDMI OUT jack is connected to a DVI-D compatible display device(s) (HDCP compatible) with an HDMI-DVI converter cable, the signals are output in digital RGB.
- When playing back a Frame Sequential 3D Disc, video resolution of output picture will depend on contents on the disc. ("HDMI Video" setting is not applicable for Frame Sequential 3D Discs.)

### Copyright protection system

To play back the digital video images of a BD-video or DVD-video via an HDMI connection, it is necessary that both the player and the display device (or an AV receiver / amplifier) support a copyright protection system called HDCP (high-bandwidth digital content protection system). HDCP is copy protection technology that comprises data encryption and authentication of the connected AV device. This unit supports HDCP. Please read the operating instructions of your display device (or an AV receiver / amplifier) for more information. Note that 4K content viewing requires an HDCP 2.2 compatible TV and cables.

## 11.2. High Dynamic Range Output

🏠(home) ➡ "Setup" ➡ "Player Settings" ➡ "HDMI" ➡ "Advanced Settings" ➡ "High Dynamic Range Output"

This setting is only available during Ultra HD Blu-ray playback.

**"Auto"**: outputs an HDR-enhanced video according to the video and the connected devices' specifications. Note that the display device must also be HDR-compatible.

**"Off"**: Outputs a video in 2K quality.

### 🔊 Note

- If a video does not display correctly, select "Off".

## 11.3. Network Installation

🏠(home) ➔ "Setup" ➔ "Player Settings" ➔ "Network" ➔ "Network Settings"

Set up network connection settings in order to use the BD-Live™, Netflix / YouTube™ or network update function.

### ■ Connection Test

After you enable a network connection or change the network settings, always perform the connection test to check if the connection is correctly made.

1. Use [◀/▶] to select "Setup" in the home menu, then press [OK].
2. Use [▲/▼] to select "Player Settings", then press [OK].
3. Use [▲/▼] to select "Network", then press [OK].
4. Use [▲/▼] to select "Network Settings", then press [OK].
5. Use [▲/▼] to select "IP Address/DNS Settings" or "Proxy Server Settings", then press [OK].
6. Use [▲/▼] to select "Connection Test", then press [OK].

- Connection test will start automatically and the test result will appear right after the connection test finishes.
  - "Testing...": The test is in progress.
  - "Pass": Connection test is successfully completed.
  - "Failed": Connection test failed. Check the connection settings.

7. Press [OK] to go back to the setup menu, or press [🏠(home)] to exit.

### ⊖ Note

- If the connection test passes, you are ready to use the BD-Live™, Netflix / YouTube™ or network update function, using the Internet without making any additional settings.
- If the connection test fails, you may need to check your router settings and make sure the physical connection is secure. If you need the MAC address of this unit to complete your router settings you can view it on the "Network Settings" screen.
- When connecting this unit directly to a modem for the first time or connecting it to a modem which was previously connected to any other network device (e.g. a router, PC, etc.), you may have to power cycle the modem to reset the settings on the modem.

### ■ Wired

#### Easy Network Setting

Select "Easy Network Setting" to set the network setting automatically.

1. Press [🏠(home)] and select "Setup" ➔ "Player Settings" ➔ "Network", then press [OK].
2. Use [▲/▼] to select "Easy Network Setting", then press [OK].
3. Use [▲/▼] to select "Wired", then press [OK].
  - The unit will start the connection test automatically and the test result will appear right after the connection test finishes.
4. Press [OK].

#### Network Settings

In following cases, select "Network Settings" to configure each setting as necessary.

- When connection test failed with the setting of "Easy Network Setting".
  - When instructed by your Internet service provider to make specific settings in accordance with your network environment.
1. Press [🏠(home)] and select "Setup" ➔ "Player Settings" ➔ "Network", then press [OK].
  2. Use [▲/▼] to select "Network Setting", then press [OK].
  3. Use [▲/▼] to select "Wired", then press [OK].
  4. Use [▲/▼] to select "IP Address/DNS Settings" ➔ "IP Address Auto Configuration" ➔ "Off", then press [OK].
  5. Use [▲/▼] to select "IP Address", then press [OK].
  6. "IP Address" setting screen will appear. Enter IP address with cursor buttons and number buttons.

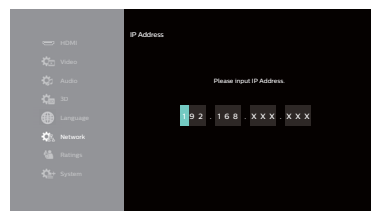

- Enter the IP address after checking the specifications of your router.
- If the IP address is unknown, check the IP address of other devices. (e.g. PC connected via LAN cable) and assign a different number from those of other devices.

7. After completion of value entry, press **[OK]**.
8. A confirmation screen will appear. Select “Yes”, then press **[OK]**.
9. Select “Subnet Mask”, “Default Gateway”, “DNS Auto Configuration”, “Primary DNS” and “Secondary DNS” in turn, and enter each address number with cursor buttons and number buttons, then press **[OK]**.
  - Enter the DNS addresses provided by your Internet provider.
  - If the DNS address is unknown, check the DNS address of other devices (e.g. PC connected via LAN cable) and assign the same DNS address.

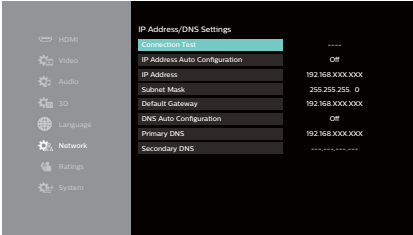

10. After completing this series of settings, perform the “Connection Test”.

**If your Internet connection requires Proxy Server settings, perform the following:**

1. Select “Network” ➔ “Network Settings”, then press **[OK]**.
2. Use **[▲/▼]** to select “Proxy Server Settings”, then press **[OK]**.
3. Use **[▲/▼]** to select “Proxy Address”, then press **[OK]**.
4. The “Proxy Address” setting screen will appear. Enter a proxy address with cursor buttons, number buttons and color key.

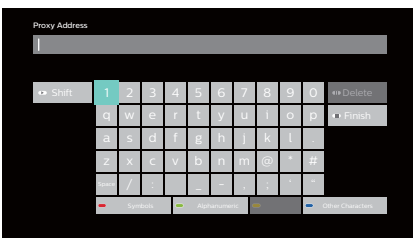

- [▲/▼/◀/▶]** : Move the highlight.
- [OK]** : Enter the highlighted number / letter.
- \*[Red]** : Switches the Software Keyboard to Symbol mark mode.
- [Green]** : Switches the Software Keyboard to Number/Alphabet mode.
- \*[Blue]** : Switches the Software Keyboard to External character mode.

\* These buttons can be used in other network settings.

5. After completion of address entry, select “Finish”, then press **[OK]**.
6. If necessary, select “Proxy Port Number” using **[▲/▼]**, then press **[OK]**
7. The “Proxy Port Number” setting screen will appear. Enter a number using **[▲/▼/◀/▶]**.

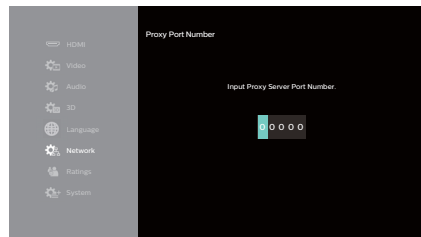

8. After completion of value entry, press **[OK]**.
9. A confirmation screen will appear. Select “Yes”, then press **[OK]**.
10. Use **[▲/▼]** to select “Connection Test”, then press **[OK]**.
11. Press **[OK]** to go back to the setup menu, or press **[Home]** to exit.

**Note for “IP Address”, “Subnet Mask”, “Default Gateway”, “Primary DNS” and “Secondary DNS”**

- The range of input numbers is between 0 and 255.
- If you enter a number larger than 255, the number will automatically be reset to 255.

**Note for “Proxy Address” and “Proxy Port”**

- The range of input numbers for the port number is between 0 and 65535. (If you enter a number larger than 65535, it will be regarded as 65535.)
- For proxy port, certain ports might be closed, blocked or unusable depending on your network environment.
- Choose a connection speed in accordance with your network environment.
- When the settings are changed, the network connection may be disabled depending on the device.

**Wireless**

Please make a note of your Wireless LAN network name (SSID) and its WEP / TKIP+AES key before proceeding with the setup.

**Easy Network Setting**

Search for Wireless LAN networks automatically and select the Wireless LAN network name (SSID) from the list.

1. Press [**↑**(home)] and select “Setup” ➔ “Player Settings” ➔ “Network”, then press [OK].
2. Use [**▲**/**▼**] to select “Easy Network Setting”, then press [OK].
3. Use [**▲**/**▼**] to select “Wireless”, then press [OK].
  - This unit will start searching for Wireless LAN networks automatically.
4. The result of Wireless LAN network searching will be displayed.
 

Use [**▲**/**▼**] to select the appropriate Wireless LAN network name (SSID), then press [OK].

  - If you select an SSID without “**🔒**”, please go to step 7.

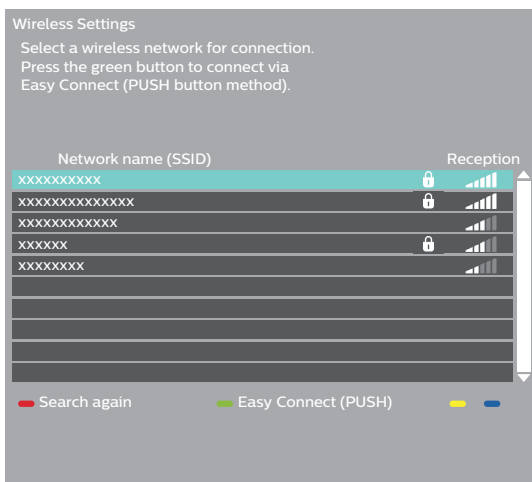

5. “Encryption Key” screen will appear. Enter the Encryption Key of the selected Wireless LAN network using cursor buttons, number buttons and color key.

- If you do not know the Encryption Key for your Wireless LAN network, ask your ISP or the person who set up your Wireless LAN Network.

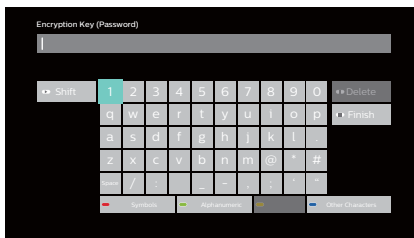

6. Use [**▲**/**▼**/**◀**/**▶**] to select “Finish”, then press [OK].
7. Confirmation screen will appear. Press [OK].
  - Network configuration will start automatically.
8. The connection result screen will appear. Press [OK].

**Note**

- The internal wireless LAN supports following specifications
  - Wireless LAN standards: IEEE 802.11 b / g / n / ac
  - Frequency spectrum: 2.4 / 5 GHz
  - Security protocol: WEP / TKIP+AES (Strong) / TKIP+AES (Weak)
- With a 2.4GHz wireless router (access point), using a USB3.0 compatible device with this unit may cause wireless connection instability. Place the wireless router as far away as possible from this unit.
- When using a 5GHz compatible wireless router (access point), 5GHz bandwidth use is recommended.

## Network Settings

Set up the connection to the Wireless LAN network manually by entering the Wireless LAN network name (SSID).

1. Press [**Home**] and select “Setup” ➔ “Player Settings” ➔ “Network”, then press [OK].
2. Use [**Up/Down**] to select “Network Settings”, then press [OK].
3. Use [**Up/Down**] to select “Wireless”, then press [OK].
4. Use [**Up/Down**] to select “Wireless Settings”, then press [OK].
5. Use [**Up/Down**] to select “Manual Setting”, then press [OK].
6. “SSID” screen will appear.  
Enter the SSID using cursor buttons, number buttons and color key.
7. Use [**Up/Down/Left/Right**] to select “Finish”, then press [OK].
8. Encryption type selection screen will appear.  
Select the Encryption type of the entered SSID, then press [OK].

- If you select “No encryption”, please go to step .
- If you select “AES”, select “TKIP+AES(Strong)” or “TKIP+AES(Weak)”, then press [OK].

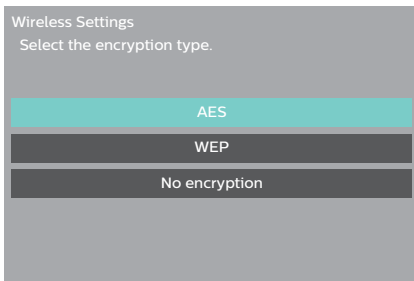

9. “Encryption Key” screen will appear.  
Enter the Encryption Key of the Wireless LAN network using cursor buttons, number buttons and color key.
  - If you do not know the Encryption Key for your Wireless LAN network, ask your ISP or the person who set up your Wireless LAN Network.
10. Use [**Up/Down/Left/Right**] to select “Finish”, then press [OK].
11. The connection result screen will appear. Press [OK].

## Easy Connect

You can set up the Wireless LAN connection quickly. (Easy Connect is only available when your router supports it. For details, please refer to the user manual of your Wireless LAN router.)

### Push Button Method

Please confirm your Wireless LAN router has a PBC button.

1. Press [**Home**] and select “Setup” ➔ “Player Settings” ➔ “Network”, then press [OK].
2. Use [**Up/Down**] to select “Easy Network Setting”, then press [OK].
3. Use [**Up/Down**] to select “Wireless”, then press [OK].
4. Use [**Up/Down**] to select the appropriate Wireless LAN network name (SSID), then press [GREEN].

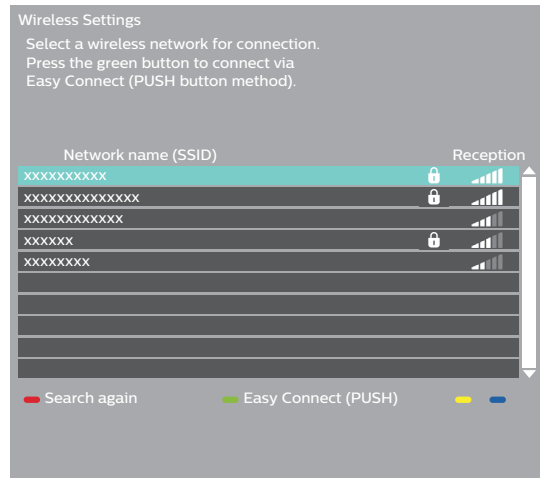

5. Push the PBC (Push Button Configuration) on your Wireless LAN router.
6. Select “Start”, then press [OK].
  - The unit will start the connection test automatically and the test result will appear right after the connection test finishes.
7. The connection result screen will appear. Press [OK].

## PIN Code Method

1. Press [**home**] and select “Setup” ➔ “Player Settings” ➔ “Network”, then press [OK].
2. Use [**▲/▼**] to select “Network Settings”, then press [OK].
3. Use [**▲/▼**] to select “Wireless”, then press [OK].
4. Use [**▲/▼**] to select “Wireless Settings”, then press [OK].
5. Use [**▲/▼**] to select “Easy Connect (PIN code method)”, then press [OK].
6. Use [**▲/▼**] to select the appropriate router, then press [OK].
7. Set up your Wireless LAN router with PIN code shown on the TV screen.
  - For details about setting method of your Wireless LAN router, please refer to the user manual of the router.
8. Select “Start”, then press [OK].
9. The unit will start the connection test automatically and the test result will appear right after the connection test finishes.
10. The connection result screen will appear. Press [OK].

### ■ Netflix ESN

You can view the ESN number which is a serial number used by Netflix to identify a device. Netflix customer service might ask you for this number during troubleshooting.

1. Use [**◀/▶**] to select “Setup” in the home menu, then press [OK].
2. Use [**▲/▼**] to select “Player Settings”, then press [OK].
3. Use [**▲/▼**] to select “System”, then press [OK].
4. Use [**▲/▼**] to select “System Information”, then press [OK].
5. Use [**▲/▼**] to select “Firmware Version Information”, then press [OK].
6. Press [**home**] to exit.

## 11.4. EasyLink Setup

**home** ➔ “Setup” ➔ “Player Settings” ➔ “System” ➔ “Display Settings” ➔ “Easy Link”

This unit supports Philips EasyLink, which enables your TV (limited to Philips brand EasyLink TV) to act in conjunction with this unit, or vice versa. Compliant TV must be connected to the HDMI OUT jack.

When “EasyLink” setting is set to “On”, functions listed below will be available.

### One Touch Play

When the operations with following buttons of the remote control of this unit are performed, the TV will automatically be turned on and switched to the appropriate input channel. (“One Touch Play” can be turned off by setting it to “Off”).

#### Buttons for one touch play:

- [**▶ (play)**]
- [**TOP MENU**]  
(when a disc is inserted in the unit)

### System Information

#### Get & Set Menu Language

The unit recognizes the OSD language set of the TV, and automatically sets the same language as the player menu language (OSD menu language) for this unit.

- This function is only available when this unit supports the language set on the TV.

## 11.5. BD-Video Ratings

🏠(home) ➔ "Setup" ➔ "Player Settings" ➔ "Ratings" ➔ "BD-Video Ratings"

Some BD-videos support parental lock which prevents your children from viewing inappropriate videos. If the video rating exceeds the parental lock level you have set on your unit, playback will automatically stop. In order to continue playback, enter your password to unlock the function.

### For the first time only:

1. Use [**◀/▶**] to select "Setup" in the home menu, then press [**OK**].
2. Use [**▲/▼**] to select "Player Settings", then press [**OK**].
3. Use [**▲/▼**] to select "Ratings", then press [**OK**].
4. Use [**▲/▼**] to select "BD-Video Ratings", then press [**OK**].
5. Use [**▲/▼**] to select "No Limit", "1 year"–"21 year(s)", "Enter Limit", then press [**OK**].
6. Set any level.
7. Use [**the Number buttons**] to enter any 4-digit number for your password.

### Once a password is set:

1. Use [**◀/▶**] to select "Setup" in the home menu, then press [**OK**].
2. Use [**▲/▼**] to select "Player Settings", then press [**OK**].
3. Use [**▲/▼**] to select "Ratings", then press [**OK**].
4. Use [**▲/▼**] to select "BD-Video Ratings", then press [**OK**].
5. The Password entry screen will appear. Enter a Password using [**the Number Buttons**].
6. Use [**▲/▼**] to select "No Limit", "1 year" – "21 year(s)", "Enter Limit", then press [**OK**].
7. Use [**▲/▼**] to select "Unlock Player", "Change Password", "Change Level" or "Temporary Unlock", then press [**OK**].
  - "Unlock Player": Sets the Parental Level to "No Limit".
  - "Change Password": Changes the current Password.
  - "Change Level": Changes the Parental Level.
  - "Temporary Unlock": Temporarily changes the Parental Level to "No Limit". (Turning this unit Off resets it to the level previously set.)
8. Use [**▲/▼**] to select any level, then press [**OK**].

## 11.6. DVD-Video Ratings

### For the first time only:

1. Use [**◀/▶**] to select "Setup" in the home menu, then press [**OK**].
2. Use [**▲/▼**] to select "Player Settings", then press [**OK**].
3. Use [**▲/▼**] to select "Ratings", then press [**OK**].
4. Use [**▲/▼**] to select "DVD-Video Ratings", then press [**OK**].
5. Use [**▲/▼**] to select "8 No Limit" – "0 Lock All", then press [**OK**].
6. If an option other than "8 No Limit" is selected, the Password entry screen will appear. Use [**the Number buttons**] to enter any 4-digit number for your password.

### Once a password is set :

1. Use [**◀/▶**] to select "Setup" in the home menu, then press [**OK**].
2. Use [**▲/▼**] to select "Player Settings", then press [**OK**].
3. Use [**▲/▼**] to select "Ratings", then press [**OK**].
4. Use [**▲/▼**] to select "DVD-Video Ratings", then press [**OK**].
5. The Password entry screen will appear. Enter a Password using [**the Number Buttons**].
6. Use [**▲/▼**] to select "8 No Limit" – "0 Lock All", then press [**OK**].
  - If an option with a lower number than the current setting is selected, the Password entry screen will appear. Enter a Password using [**the Number Buttons**].
7. Use [**▲/▼**] to select "Unlock Player", "Change Password", "Change Level" or "Temporary Unlock", then press [**OK**].
  - "Unlock Player": Sets the Parental Level to "No Limit".
  - "Change Password": Changes the current Password.
  - "Change Level": Changes the Parental Level.
  - "Temporary Unlock": Temporarily changes the Parental Level to "No Limit". (Turning this unit Off resets it to the level previously set.)
8. Use [**▲/▼**] to select any level, then press [**OK**].



RATING EXPLANATIONS	
8 No Limit	Parental control is inactive; all discs can play back.
7	DVD software of any grades (adult / general / children) can be played back.
6	No one under 17
5	Restricted; under 17
4	Parental Guidance Recommended
3	Unsuitable for children under 13
2	Parental Guidance suggested
1	General Audience
0 Lock All	Suitable for children

#### To cancel parental lock temporarily:

Some discs allow you to cancel parental lock temporarily. With these discs, the message below will appear when you try to play them back.

“Enter current password.”

Follow the instruction which appears on the TV screen to cancel parental lock. After entering the password, “Parental Control” appears. Select desired parental lock level, then press **[OK]**.

## 11.7. Software Update

🏠(home) ➔ “Setup” ➔ “Player Settings” ➔ “System” ➔ Firmware Update

Philips continuously tries to improve its products and we strongly recommend that you update the software when updates are available.

### ■ Network Update

You can update the software by connecting the unit to the Internet.

1. Use **[◀/▶]** to select “Setup” in the home menu, then press **[OK]**.
2. Use **[▲/▼]** to select “Player Settings”, then press **[OK]**.
3. Use **[▲/▼]** to select “System”, then press **[OK]**.
4. Use **[▲/▼]** to select “Firmware Update”, then press **[OK]**.
5. Use **[▲/▼]** to select “Update Now”, then press **[OK]**.
6. Use **[◀/▶]** to select “Yes”, then press **[OK]**.
  - This unit will then start checking for the latest software version.
7. Confirmation message will appear. Select “Yes”, then press **[OK]**.
  - This unit will start downloading the latest software version.
  - When the download completes, the unit will start updating the software version.
  - It may take a while to complete the update.
8. After updating finishes, this unit will restart automatically.

### ⚠ Caution

- Please do not unplug the AC Power cord or LAN cable while executing the network update.

### 📌 Note

- In order to update the software via the Internet, you must connect the unit to the Internet and set up necessary settings.
- For the network connection, refer to “Connection to the Network” on page 17.
- For the network setup, refer to “Network Installation” on page 43.
- All settings will remain the same even if you update the software version.
- The version of Netflix/YouTube™ will also be updated if newer version of Netflix/YouTube™ is available when updating the software.

---

## 11.8. Restore Default Settings

🏠(home) ➔ "Setup" ➔ "Player Settings" ➔ "System" ➔ "Default Settings"

This unit can be reset to its factory default state.

1. Use [**◀/▶**] to select "Setup" in the home menu, then press [**OK**].
2. Use [**▲/▼**] to select "Player Settings", then press [**OK**].
3. Use [**▲/▼**] to select "System", then press [**OK**].
4. Use [**▲/▼**] to select "Default Settings", then press [**OK**].
5. Use [**◀/▶**] to select "Yes", then press [**OK**].
  - Confirmation message will appear. Press [**OK**] to complete the setting.
6. Press [**🏠(home)**] to exit.

---

## 11.9. License & Digital Rights Mgmt

🏠(home) ➔ "Setup" ➔ "Player Settings" ➔ "System" ➔ "System Information" ➔ "License & Digital Rights Mgmt"

This product includes some open source software that is subject to the GNU General Public License (GPL), GNU Lesser General Public License (LGPL) and/or copyright licenses, disclaims and notices. You can confirm further information about these in the "License & Digital Rights Mgmt" section in "Setup" of this product. If you are interested in obtaining GPL source code used in this product, please contact

Open Source Team  
P&F USA, Inc., PO Box 2248, Alpharetta, GA 30023-2248  
USA

P&F USA Inc. does not warrant access to the Portal or to any of the services, content, software and advertising. P&F USA Inc. may, in its sole discretion, add or remove access to any specific services, content, software and advertising at any time. Although P&F USA Inc. will strive to provide a good selection of services, content or software, P&F USA Inc. does not warrant continued access to any specific services, and content or software.

---

## 12. OTHER FUNCTION

---

### 12.1. Special mode

In Special mode, BD/DVD-Video Ratings (Parental Lock settings), Progressive settings, and 4K60p Output settings can be initialized.

1. With no Disc inserted in the unit, press [**▶ (next)**] ➔ [**1**] ➔ [**2**] ➔ [**3**] on the Remote Control.
  - This unit will go into Special mode, and the **⏻ (standby/on)** LED on the unit will start blinking.
2. Press [**2**], [**3**], or [**4**] on the Remote Control.
  - [**2**]: Initializes the Parental Lock setting.
  - [**3**]: Initializes the Progressive setting.
  - [**4**]: Initializes the 4K60p Output setting.
  - After initializing any of above, or If [**1**] is pressed, this unit will exit Special mode.

#### 🗨 Note

- This unit will automatically exit Special mode when:
  - there is no button operation for 2 minutes.
  - an invalid button is pressed on the unit or Remote Control.

## 13. TROUBLESHOOTING

Problem	Tip
No reaction to the remote control.	Connect the product to the power outlet.
	Point the remote control at the product.
	Insert the batteries with the correct polarity.
	Insert new batteries in the remote control.
No video signal on the display device.	Turn on the TV.
	Set the TV to the correct external input.
	Ensure that the HDMI OUT (AUDIO) is NOT used to connect to the TV. The HDMI OUT (AUDIO) port outputs the Audio only.
No audio / video signal on the display device via HDMI cable.	If the unit is connected to the unauthorized display device with an HDMI cable, the audio / video signal may not be output.
	Perform an HDMI cable hotplug, wherein you disconnect the HDMI cable from the TV and this unit and then reconnect it to both the devices while they are Powered On.
	Ensure that your HDMI cable is certified.
No high-definition video signal on the TV screen.	Does the disc contain high-definition video? High-definition video is not available when the disc does not contain it.
	Does the TV support high-definition video? High-definition video is not available when the TV does not support it.
No Ultra HD video on the TV screen.	Check if your TV is 4K/HDR capable.
	Use an 18Gbps high-speed HDMI cable to connect the 4K/HDR capable TV.
	Set "4k/60p Output" to "4K/60p(4:4:4)". (Refer to page 39)
	Depending on the content, it may take some time for the 4K/60p Output setting to become effective. If the image is not output correctly after changing this setting, stop playback, then start playback again.
	Refer to your 4K/HDR TV's user manual for more information.
No 3D video on the TV screen.	Check if your TV is 3D capable.
	Use a 3D compatible HDMI cable to connect the 3D capable TV.
	Set "3D BD-Video Playback" to "Auto". (Refer to page 39)
	Wear 3D glasses and make sure they are switched on and in sync with your TV.
	Check the battery levels of your glasses.
No audio signal from the loudspeakers of the TV screen.	Assign the audio input of the TV to the corresponding video input.
	Ensure that the TV's speakers are turned on in the TV menu.
	Ensure that the TV's speakers are not muted.
No audio signal from the loudspeakers of the audio system.	Turn on the audio system.
	Set the audio system to the correct external audio input.
	Increase the volume level of the audio system.
Cannot play back a disc.	Make sure that the product supports the disc.
	Check the region code of the disc. This unit supports following region codes. – Blu-ray Disc™: "A" – DVD: "ALL" or "1"
	For DVD-RW/-R, make sure that the disc is finalized.
	Clean the disc.
USB storage device cannot be read.	The format of the device is not accepted by this unit or the device is not compatible.
Cannot play back JPEG files from a disc.	Make sure that the disc was recorded in the UDF, ISO9660 or JOLIET format.

<b>Problem</b>	<b>Tip</b>
Cannot play back MP3/WAV/AAC/FLAC files from a disc.	Make sure that the disc was recorded in the ISO9660 or JOLIET format. Refer to "Recommended Specifications" on page 20
Cannot find a JPEG file.	Make sure that the selected group (folder) does not contain more than 10,001 files for Blu-ray Disc™, DVD, CD, and USB storage device. Make sure that the file extension is .jpg.
Cannot find an MP3 and WAV, AAC, and FLAC Audio file.	Make sure that the selected group (folder) does not contain more than 10,001 files for DVD-R, CD-RW/-R, and USB storage device. Make sure that the file extension is .mp3 for MP3, and .wav for WAV, and .m4a for AAC, and .flac for FLAC.
Cannot play back AVCHD file.	This unit cannot play back standalone AVCHD files (*.m2ts, *.mts or *.m2t) written to a DVD. The DVD containing AVCHD files must have a proper file and folder structure meeting AVCHD format specifications. Please use AVCHD compliant device / software to burn or copy AVCHD files to DVD. (Please refer to user manuals of the device / software for more information.)
Cannot find an mp4 and MPEG2 video file.	Make sure that the selected group (folder) does not contain more than 10,001 files for USB storage device. Make sure that the file extension is .mp4 / .mov for MP4, and .mpg / .mpeg / .m2ts / .mts / .ts for MPEG2.
Cannot connect to the network.	Check if the network connection is properly made. Turn on the modem or router. Check the network settings. Check if the router and/or modem is correctly connected. Check the BD-Live™ setting in "BD-Live Internet Access" on page 40. When connecting directly to a modem via a LAN cable, you might need to power cycle the modem to reset settings on the modem. Turn Off this unit and the modem/router (if it has a Power button), then unplug their AC Power cords. After 30 seconds, plug them back in and turn the devices back On. If you have a telephone / Internet modem with your cable service, then you may have to use its reset button or remove the backup battery to reset this type of modem. Now wait for the lights to show activity and try reconnecting.
Cannot use the Wireless LAN connection.	Once you have activated the Wireless LAN connection, please wait for 30 seconds for the connection to be established after turning on the unit, before trying to access network features such as BD-Live™, Netflix, and YouTube™.
With Netflix, 4K titles are not displayed, or 4K images are not output correctly during playback.	Images may not be output correctly after changing the 4K60p Output setting. In this case, turn Off the unit, then turn it back On.
Cannot connect to the network while my PC is connected to the network.	Check the content of your Internet service contract to see if your Internet Service Provider prevents multiple terminals connecting at the same time.
The capacity of the USB storage device decreased.	Data may be written to the USB storage device when a BD-video that supports the virtual package is used and a USB storage device is connected.
The contents of the USB storage device cannot be read.	The USB storage device is not compatible or the contents on the USB storage device may be damaged. Turn off and then turn the unit on again.
Cannot use the BD-Live™ function or download of data does not perform properly.	Insert a USB storage device with enough capacity (1GB or more). Check if a USB storage device is correctly inserted.
Cannot play back BD-video (BDROM Profile 2.0).	Insert a USB storage device (1GB or more) which is formatted on this unit. Some discs with BD-Live™ function require memory when playing back the content. Do not remove the USB storage device during playback.
YouTube™ videos do not play correctly.	Performance of this unit may decrease due to defects in video sources. In such cases, turn the unit Off and turn it back On, then play a YouTube™ video again.

---

## 13.1. Downloading an Electronic Copy

To obtain an electronic copy of this manual :

1. Point your browser to [www.philips.com/support](http://www.philips.com/support)
2. Choose your country of location.
3. Enter the model number or a keyword in the “Find your product” field.  
Alternatively, you can browse the catalog.
4. Click the description or model.
5. Under Product support, click “User manuals”.

---

## 13.2. Contact Us

- If you cannot resolve your problem, refer to the FAQ for this Blu-ray Disc™ Player at [www.philips.com/support](http://www.philips.com/support)  
If the problem remains unresolved, contact the Customer Support Center in your country.

### Note

- Do not attempt to repair the Blu-ray Disc™ Player yourself. This may cause severe injury, irreparable damage to your Blu-ray Disc™ Player or void your warranty.
- Please have your Blu-ray Disc™ Player model and serial number available before contacting us.  
These numbers are available on the cabinet, as well as on the packaging.

---

## 14. GLOSSARY

---

### Aspect Ratio

The width of a TV screen relative to its height. Conventional TVs are 4:3 (in other words, the TV screen is almost square); widescreen models are 16:9 (the TV screen is almost twice as wide as its height).

---

### AVCHD

AVCHD is a new format for high definition video camcorders which can record and play high-resolution HD images.

---

### BD-Live™

BD-Live™ is a BD-video (BD-ROM version 2 Profile 2.0) which contains new functions (e.g. Internet connection), in addition to the BONUSVIEW™ function.

---

### Blu-ray Disc™

Blu-ray Disc™ is a next generation optical video disc which is capable of storing much more data than a conventional DVD. The large capacity makes it possible to benefit from the features such as high-definition videos, multi-channel surround sounds, interactive menus and so on.

---

### Chapter

Just as a book is split up into several chapters, a title on a BD-video or DVD-video is usually divided into chapters. See also "Title".

---

### Cinavia™

Cinavia Notice

This product uses Cinavia technology to limit the use of unauthorized copies of some commercially-produced film and videos and their soundtracks. When a prohibited use of an unauthorized copy is detected, a message will be displayed and playback or copying will be interrupted. More information about Cinavia technology is provided at the Cinavia Online Consumer Information Center at <http://www.cinavia.com>

To request additional information about Cinavia by mail, send a postcard with your mailing address to: Cinavia Consumer Information Center, P.O. Box 86851, San Diego, CA, 92138, USA.

This product incorporates proprietary technology under license from Verance Corporation and is protected by U.S. Patent 7,369,677 and other U.S. and worldwide patents issued and pending as well as copyright and trade secret protection for certain aspects of such technology. Cinavia is a trademark of Verance Corporation. Copyright 2004-2016 Verance Corporation. All rights reserved by Verance. Reverse engineering or disassembly is prohibited.

---

### DNS Server

A server which translates Internet domain names into IP addresses.

---

### Dolby Audio - Dolby Digital

The system to compress digital sound developed by Dolby Laboratories. It offers you sound of stereo (2ch) or multichannel audio.

---

### Dolby Audio - Dolby Digital Plus

Dolby Audio - Dolby Digital Plus is the next generation digital audio compression technology developed as an extension to Dolby Audio - Dolby Digital. Blu-ray Disc™ supports 7.1 multi-channel surround sound output.

---

### Dolby Audio - Dolby TrueHD

Dolby Audio - Dolby TrueHD is a lossless coding technology developed for next generation optical discs. Blu-ray Disc™ supports 7.1 multi-channel surround sound output.

---

### DTS® (Digital Theater System)

DTS® is a multi channel surround sound system. You can enjoy movie dynamic and realistic sound like movie theater. DTS surround sound technologies were developed by DTS, Inc.

---

### DTS-HD®

DTS-HD® is a lossless coding technology developed as an extension of the original DTS Coherent Acoustics format. Blu-ray Disc™ supports 7.1 multi-channel surround sound output.

---

### Gateway

IP address of the electronic devices (such as router) which provide Internet access.

---

### HDMI (High-Definition Multimedia Interface)

A digital interface between audio and video source. It can transmit component video, audio, and control signal with one cable connection.

---

### HDR (High Dynamic Range)

HDR is a color enhancement technology which expands the range of the image's color luminance.

---

### Hub

A device used for connecting multiple device to the network.

---

### IP Address

A set of numbers which are assigned to devices participating in a computer network.

---

### JPEG (Joint Photographic Experts Group)

JPEG is a method of compressing still picture files. You can copy JPEG files on BD-RE/-R, DVD-RW/-R, CD-RW/-R, or USB storage device from a computer and play back the files on this unit.

---

**LAN (Local Area Network)**

---

A group of computer networks covering a small area like a company, school or home.

---

**Local Storage**

---

A storage area of sub contents for playing virtual packages on BD-video.

---

**MP3 (MPEG audio layer 3)**

---

MP3 is a method of compressing files. You can copy MP3 files on DVD-R, CD-RW/-R, or USB storage device from the computer and play back the files on this unit.

---

**Netflix**

---

Netflix is online movie rental service, offering online streaming to customers in the United States.

---

**PCM (Pulse Code Modulation)**

---

The most common system of encoding digital audio, found on CD and DAT. Excellent quality, but requires a lot of data compared to formats such as Dolby Digital and MPEG audio. For compatibility with digital audio recorders (CD, MD and DAT) and AV amplifiers with digital inputs, this unit can convert Dolby Digital, DTS, and MPEG audio to PCM.

---

**Proxy Server**

---

Proxy server is a server which acts as an intermediary between a workstation user and the Internet to ensure security.

---

**Region Code**

---

Regions associate discs and players with particular areas of the world. This unit will only play back discs that have compatible region codes. You can find the region code of your unit by looking on the rear panel. Some discs are compatible with more than one region (or all regions).

---

**Router**

---

A networking device which distinguishes the IP address assigned to each device and routing and forwarding information in the computer network.

---

**Sampling Frequency**

---

The rate which sound is measured by a specified interval to turn into digital audio data. The numbers of sampling in one second defines as sampling frequency. The higher the rate, the better the sound quality.

---

**Subnet Mask**

---

A mask which is used to determine what subnet an IP address belongs to.

---

**Title**

---

A collection of chapters on BD-video or DVD-video. See also "Chapter".

---

**Track**

---

Audio CD uses tracks to divide up the content of a disc. The BD-video or DVD-video equivalent is called a chapter. See also "Chapter".

---

**UHD (Ultra High Definition)**

---

Compared to HD, 4K UHD has four times the HD pixel count.

---

**Virtual Package**

---

The function which copies data to other media (local storage) from the Internet and plays secondary video, secondary audio and subtitles at the same time. The method of the playback varies depending on discs.

---

**x.v.Color**

---

"x.v.Color" is a promotion name given to the products that have the capability to realize a wide color space based on the xvYCC specifications and is a trademark of Sony Corporation.

## 15. LANGUAGE CODE LIST

In order to change the Language, select **⬆️(home)** ➔ “Setup” ➔ “Player Settings” ➔ “Language”, then select “Other” from “Audio Language” / “Subtitle Language” / “Menu Language”. Use [▲/▼] to select a number and use [◀/▶] to select a digit for the Language Code.

Language: Code		Language: Code		Language: Code		Language: Code	
Abkhazian:	6566	Finnish:	7073	Macedonian:	7775	Somali:	8379
Afar:	6565	French:	7082	Malagasy:	7771	Spanish:	6983
Afrikaans:	6570	Frisian:	7089	Malay:	7783	Sundanese:	8385
Albanian:	8381	Galician:	7176	Malayalam:	7776	Swahili:	8387
Amharic:	6577	Georgian:	7565	Maltese:	7784	Swedish:	8386
Arabic:	6577	German:	6869	Maori:	7773	Tagalog:	8476
Armenian:	7289	Greek:	6976	Marathi:	7782	Tajik:	8471
Assamese:	6583	Greenlandic:	7576	Moldavian:	7779	Tamil:	8465
Aymara:	6589	Guarani:	7178	Mongolian:	7778	Tatar:	8484
Azerbaijani:	6590	Gujarati:	7185	Nauru:	7865	Telugu:	8469
Bashkir:	6665	Hausa:	7265	Nepali:	7869	Thai:	8472
Basque:	6985	Hebrew:	7387	Norwegian:	7879	Tibetan:	6679
Bengali; Bangla:	6678	Hindi:	7273	Oriya:	7982	Tigrinya:	8473
Bhutani:	6890	Hungarian:	7285	Pashto; Pushto:	8083	Tonga:	8479
Bihari:	6672	Icelandic:	7383	Persian:	7065	Turkish:	8482
Breton:	6682	Indonesian:	7378	Polish:	8076	Turkmen:	8475
Bulgarian:	6671	Interlingua:	7365	Portuguese:	8084	Twi:	8487
Burmese:	7789	Irish:	7165	Punjabi:	8065	Ukrainian:	8575
Byelorussian:	6669	Italian:	7384	Quechua:	8185	Urdu:	8582
Cambodian:	7577	Japanese:	7465	Rhaeto-Romance:	8277	Uzbek:	8590
Catalan:	6765	Javanese:	7487	Romanian:	8279	Vietnamese:	8673
Chinese:	9072	Kannada:	7578	Russian:	8285	Volapük:	8679
Corsican:	6779	Kashmiri:	7583	Samoan:	8377	Welsh:	6789
Croatian:	7282	Kazakh:	7575	Sanskrit:	8365	Wolof:	8779
Czech:	6783	Kirghiz:	7589	Scots Gaelic:	7168	Xhosa:	8872
Danish:	6865	Korean:	7579	Serbian:	8382	Yiddish:	7473
Dutch:	7876	Kurdish:	7585	Serbo-Croatian:	8372	Yoruba:	8979
English:	6978	Laotian:	7679	Shona:	8378	Zulu:	9085
Esperanto:	6979	Latin:	7665	Sindhi:	8368		
Estonian:	6984	Latvian; Lettish:	7686	Singhalese:	8373		
Faroese:	7079	Lingala:	7678	Slovak:	8375		
Fiji:	7074	Lithuanian:	7684	Slovenian:	8376		



## 16. SPECIFICATIONS

### General

Signal System	NTSC Color
Power requirements	120 V AC, 60 Hz
Power consumption	26 W (standby: 0.2 W) when using included AC/DC Adapter (N1070UH)
Dimensions (width x height x depth)	220 x 59.5 x 220mm (8.7 x 2.4 x 8.7 inches)
Weight	3.53 lbs. (1.6 kg)
Operating temperature	41°F (5°C) to 95°F (35°C)
Operating humidity	Less than 80 % (no condensation)

### Terminals

<b>USB input</b>	
TYPE A	USB 3.0 Bus power current: MAX. 900mA
<b>HDMI OUT port</b>	
HDMI jack	Video: 480p, 720p, 1080i, 1080p, 1080p24, 4K/Audio
<b>HDMI OUT (Audio) port</b>	
HDMI jack	Audio
<b>LAN terminal</b>	10BASE-T / 100BASE-TX / 1000BASE-T
<b>Wireless LAN (Internal)</b>	IEEE 802.11 b/g/n/ac

### Note

- The specifications and design of this product are subject to change without notice.

---

## 17. IMPORTANT HEALTH AND SAFETY INFORMATION FOR 3D TELEVISIONS

Read the following information before viewing 3D television images.

### CAUTION NOTICE:

1. Ambient fluorescent lighting may cause a flickering effect and direct sunlight may adversely affect the operation of your 3D glasses.
2. DO NOT place your television near open stairwells, balconies or other objects as viewing in 3D images may cause disorientation for some viewers resulting in falls, tripping or walking into objects.
3. If you experience (1) altered vision; (2) lightheadedness; (3) dizziness; (4) involuntary movements such as eye or muscle twitching; (5) confusion; (6) nausea; (7) loss of awareness; (8) convulsions; (9) cramps; and/or (10) disorientation, immediately stop watching 3D images and consult your doctor.
4. Parents should regularly monitor their children concerning the above symptoms as children and teenagers may be more likely to experience these symptoms more frequently than adults. Watching 3D television is not recommended for children under the age of 6 as their visual system is not yet fully developed.
5. Prolonged viewing of 3D images might cause discomfort, dizziness, eye strain, headaches or disorientation.

### WARNING NOTICE:

1. Some viewers may experience an epileptic seizure or stroke when exposed to certain flashing images or lights contained in certain television pictures or video games. If you or any of your family has a history of epilepsy or stroke, please consult your doctor before viewing 3D images.
2. DO NOT watch 3D television if you are pregnant, elderly, sleep-deprived, suffering from serious medical conditions, in poor physical condition or under the influence of alcohol.
3. Sitting too close to the screen for an extended period of time may damage your eyesight. The ideal distance should be at least three times the height of the TV screen and at the viewer's eyes level.
4. Wearing the 3D glasses for any reason other than viewing 3D television (as general spectacles, sunglasses, protective goggles, etc.) may physically harm you or weaken your eyesight.
5. If you experience any discomfort while viewing 3D images, stop and do not immediately engage in any potentially hazardous activity such as driving a car until your symptoms have disappeared. If your symptoms persist, do not resume watching 3D images without consulting your doctor.

# 18. ONE (1) YEAR LIMITED WARRANTY

## WARRANTY COVERAGE:

This warranty obligation is limited to the terms set forth below.

## WHO IS COVERED:

This product is warranted to the original purchaser or the person receiving the product as a gift against defects in materials and workmanship as based on the date of original purchase ("Warranty Period") from an Authorized Dealer. The original sales receipt showing the product name and the purchase date from an authorized retailer is considered such proof.

## WHAT IS COVERED:

This warranty covers new products if a defect in material or workmanship occurs and a valid claim is received within the Warranty Period. At its option, the company will either (1) repair the product at no charge, using new or refurbished replacement parts, or (2) exchange the product with a product that is new or which has been manufactured from new, or serviceable used parts and is at least functionally equivalent or most comparable to the original product in current inventory, or (3) refund the original purchase price of the product.

The Company warrants replacement products or parts provided under this warranty against defects in materials and workmanship from the date of the replacement or repair for ninety (90) days or for the remaining portion of the original product's warranty, whichever provides longer coverage for you. When a product or part is exchanged, any replacement item becomes your property and the replaced item becomes the company's property. When a refund is given, your product becomes the company's property.

**Note: Any product sold and identified as refurbished or renewed carries a ninety (90) day limited warranty.**

**Replacement product can only be sent if all warranty requirements are met. Failure to follow all requirements can result in delay.**

## WHAT IS NOT COVERED - EXCLUSIONS AND LIMITATIONS:

This Limited Warranty applies only to the new products that can be identified by the trademark, trade name, or logo affixed to it. This Limited Warranty does not apply to any non-Philips hardware product or any software, even if packaged or sold with the product. Non-Philips manufacturers, suppliers, or publishers may provide a separate warranty for their own products packaged with the bundled product.

The Company is not liable for any damage to or loss of any programs, data, or other information stored on any media contained within the product, or any non-Philips product or part not covered by this warranty. Recovery or reinstallation of programs, data or other information is not covered under this Limited Warranty.

This warranty does not apply (a) to damage caused by accident, abuse, misuse, neglect, misapplication, or non-Philips product, (b) to damage caused by service performed by anyone other than an Authorized Service Location, (c) to a product or a part that has been modified without written permission, or (d) if any serial number has been removed or defaced, or (e) product, accessories or consumables sold "AS IS" without warranty of any kind by including refurbished Philips product sold "AS IS" by some retailers.

## This Limited Warranty does not cover:

- Shipping charges to return defective product.
- Labor charges for installation or setup of the product, adjustment of customer controls on the product, and installation or repair of antenna/signal source systems outside of the product.
- Product repair and/or part replacement because of improper installation or maintenance, connections to improper voltage supply, power line surge, lightning damage, retained images or screen markings resulting from viewing fixed stationary content for extended periods, product cosmetic appearance items due to normal wear and tear, unauthorized repair or other cause not within the control of the company.
- Damage or claims for products not being available for use, or for lost data or lost software.
- Damage from mishandled shipments or transit accidents when returning product.
- A product that requires modification or adaptation to enable it to operate in any country other than the country for which it was designed, manufactured, approved and/or authorized, or repair of products damaged by these modifications.
- A product used for commercial or institutional purposes (including but not limited to rental purposes).
- Product lost in shipment and no signature verification receipt can be provided.
- Failure to operate per Owner's Manual.

## TO OBTAIN ASSISTANCE IN THE U.S.A., CANADA, PUERTO RICO, OR U.S. VIRGIN ISLANDS...

Contact Customer Care Center at:  
1-866-202-5960

REPAIR OR REPLACEMENT AS PROVIDED UNDER THIS WARRANTY IS THE EXCLUSIVE REMEDY FOR THE CONSUMER. PHILIPS SHALL NOT BE LIABLE FOR ANY INCIDENTAL OR CONSEQUENTIAL DAMAGES FOR BREACH OF ANY EXPRESS OR IMPLIED WARRANTY ON THIS PRODUCT. EXCEPT TO THE EXTENT PROHIBITED BY APPLICABLE LAW, ANY IMPLIED WARRANTY OF MERCHANTABILITY OR FITNESS FOR A PARTICULAR PURPOSE ON THIS PRODUCT IS LIMITED IN DURATION TO THE DURATION OF THIS WARRANTY.

Some states do not allow the exclusions or limitation of incidental or consequential damages, or allow limitations on how long an implied warranty lasts, so the above limitations or exclusions may not apply to you.

This warranty gives you specific legal rights. You may have other rights which vary from state/province to state/province.

P&F USA, Inc.

PO Box 2248 Alpharetta, GA 30023-2248



P&F USA, Inc.  
PO Box 2248 Alpharetta, GA 30023-2248 U.S.A.

P&F Mexicana, S.A. de C.V.  
Av. La Palma No. 6, Col. San Fernando La Herradura.  
Huixquilucan, Edo. de México. C.P. 52787

This product has been manufactured by and is sold under the responsibility of P&F USA, Inc., and P&F USA, Inc. is the warrantor in relation to this product.

The Philips trademark and the Philips Shield Emblem are registered trademarks of Koninklijke Philips N.V. used under license.

★★★★★  
EGA20UH