

Register your product and get support at  
[www.philips.com/welcome](http://www.philips.com/welcome)

02

English

# INTELIA EVO

Type HD8751 / HD8880

USER MANUAL



EN

02

PLEASE READ THIS USER MANUAL CAREFULLY BEFORE USING THE MACHINE.

CE

 **Saeco**

# IMPORTANT SAFEGUARDS

When using electrical appliances, basic safety precautions should always be followed, including the following:

1. Read all instructions.
2. Do not touch hot surfaces. Use handles or knobs.
3. To protect against fire, electric shock and injury to persons do not immerse cord, plugs, or appliance in water or other liquid.
4. Close supervision is necessary when the appliance is used by or near children.
5. Unplug from outlet when not in use and before cleaning. Allow to cool before putting on or taking off parts, and before cleaning the appliance.
6. Do not operate any appliance with a damaged cord or plug or after the appliance malfunctions, or has been damaged in any manner. Return appliance to the nearest authorized service facility for examination, repair or adjustment.
7. The use of accessory attachments not recommended by the appliance manufacturer may result in fire, electric shock or injury to persons.
8. Do not use outdoors.
9. Do not let cord hang over edge of table or counter, or touch hot surfaces.
10. Do not place on or near a hot gas or electric burner, or in a heated oven.
11. Always attach plug to appliance first, then plug cord into wall outlet. To disconnect, turn any control to "off", then remove plug from wall outlet.
12. Do not use appliance for other than intended use.
13. Save these instructions.

## SAVE THESE INSTRUCTIONS

# CAUTION

This appliance is for household use only. Any servicing, other than cleaning and user maintenance, should be performed by an authorized service center. Do not immerse machine in water. To reduce the risk of fire or electric shock, do not disassemble the machine. There are no parts inside the machine serviceable by the user. Repair should be done by authorized service personnel only.

1. Check voltage to be sure that the voltage indicated on the nameplate corresponds with your voltage.
2. Never use warm or hot water to fill the water tank. Use cold water only.
3. Keep your hands and the cord away from hot parts of the appliance during operation.
4. Never clean with scrubbing powders or harsh cleaners. Simply use a soft cloth dampened with water.
5. For optimal taste of your coffee, use purified or bottled water. Periodic descaling is still recommended every 2-3 months.
6. Do not use caramelized or flavored coffee beans.

## INSTRUCTIONS FOR THE POWER SUPPLY CORD

- A. A short power-supply cord (or detachable power-supply cord) is to be provided to reduce risks resulting from becoming entangled in or tripping over a longer cord.
- B. Longer detachable power-supply cords or extension cords are available and may be used if care is exercised in their use.
- C. If a long detachable power-supply cord or extension cord is used,
  1. The marked electrical rating of the detachable power-supply cord or extension cord should be at least as great as the electrical rating of the appliance
  2. If the appliance is of the grounded type, the extension cord should be a grounding-type 3-wire cord, and
  3. The longer cord should be arranged so that it will not drape over the counter top or table top where it can be pulled on by children or tripped over.

*Congratulations on your purchase of a Saeco Intelia EVO Focus fully automatic coffee machine!*

*To fully benefit from the support that Saeco offers, please register your product at **[www.philips.com/welcome](http://www.philips.com/welcome)**.*

*This user manual applies to HD8751 and HD8880.*

*The machine is made for preparing espresso coffee using whole coffee beans and for dispensing steam and hot water. In this user manual you will find all the information you need to install, use, clean and descale your machine.*

## CONTENTS

<b>IMPORTANT</b> .....	<b>4</b>
Safety Instructions .....	4
Warning .....	4
Cautions .....	6
Compliance with Standards .....	7
<b>INSTALLATION</b> .....	<b>8</b>
Product Overview .....	8
General Description .....	9
<b>PREPARING FOR USE</b> .....	<b>10</b>
Machine Packaging .....	10
Machine Installation .....	10
<b>USING THE MACHINE FOR THE FIRST TIME</b> .....	<b>12</b>
Circuit Priming .....	12
Automatic Rinse/Self-Cleaning Cycle.....	13
Manual Rinse Cycle.....	14
Measuring and Programming Water Hardness .....	16
“INTENZA+” Water Filter Installation .....	17
Replacing the “INTENZA+” Water Filter .....	19
<b>ADJUSTMENTS</b> .....	<b>20</b>
Saeco Adapting System .....	20
Adjusting the Ceramic Coffee Grinder .....	20
Adjusting the Aroma (Coffee Strength) .....	21
Adjusting the Dispensing Spout .....	22
Adjusting the Coffee Length .....	23
<b>ESPRESSO AND COFFEE BREWING</b> .....	<b>24</b>
Espresso and Coffee Brewing Using Coffee Beans .....	24
Espresso and Coffee Brewing Using Pre-Ground Coffee .....	25
<b>DISPENSING STEAM/CAPPUCCINO BREWING</b> .....	<b>26</b>
<b>HOT WATER DISPENSING</b> .....	<b>27</b>
<b>CLEANING AND MAINTENANCE</b> .....	<b>28</b>
Daily Cleaning of the Machine .....	28
Daily Cleaning of the Water Tank .....	29
Daily Cleaning of the Classic Milk Frother .....	30
Weekly Cleaning of the Machine .....	30
Weekly Cleaning of the Classic Milk Frother .....	31
Weekly Cleaning of the Brew Group .....	31
Monthly Lubrication of the Brew Group .....	34
Monthly Cleaning of the Brew Group with “Coffee Oil Remover” .....	35
Monthly Cleaning of the Coffee Bean Hopper .....	37
<b>DESCALING</b> .....	<b>38</b>
<b>MEANING OF THE DISPLAY ICONS</b> .....	<b>42</b>
<b>TROUBLESHOOTING</b> .....	<b>45</b>
<b>ENERGY SAVING</b> .....	<b>47</b>
Stand-by .....	47
Disposal .....	47
<b>TECHNICAL SPECIFICATIONS</b> .....	<b>48</b>
<b>WARRANTY AND SERVICE</b> .....	<b>48</b>
Warranty .....	48
Service .....	48
<b>ORDERING MAINTENANCE PRODUCTS</b> .....	<b>49</b>

## IMPORTANT

### Safety Instructions

---

This machine is equipped with safety features. Nevertheless read the safety instructions carefully and only use the machine as described in these instructions to avoid accidental injury or damage.

Keep this user manual for future reference.



The term **WARNING** and this icon warn against possible severe injuries, danger to life and/or damage to the machine.



The term **CAUTION** and this icon warn against slight injuries and/or damage to the machine.



This icon requests to read carefully this instruction manual, before performing any use or maintenance operation.

### Warning

---

- Connect the machine to a wall socket with a voltage matching the technical specifications of the machine.
- Do not let the power cord hang over the edge of a table or counter, or touch hot surfaces.
- Never immerse the machine, mains plug or power cord in water (danger of electrical shock!).
- Never direct the hot water jet towards body parts: danger of burning!
- Do not touch hot surfaces. Use handles and knobs.

- Remove the mains plug from the wall socket:
  - If a malfunction occurs.
  - If the machine will not be used for a long time.
  - Before cleaning the machine.

Pull on the plug, not on the power cord. Do not touch the mains plug with wet hands.

- Do not use the machine if the mains plug, the power cord or the machine itself is damaged.
- Do not make any modifications to the machine or its power cord. Only have repairs carried out by a service centre authorised by Philips to avoid a hazard.
- The machine should not be used by children younger than 8 years old.
- The machine can be used by children of 8 years and upwards if they have previously been instructed on the correct use of the machine and made aware of the associated dangers or if they are supervised by an adult.
- Cleaning and maintenance should not be carried out by children unless they are more than 8 years old and supervised by an adult.
- Keep the machine and its power cord out of reach of children under 8 years old.
- The machine may be used by persons with reduced physical, sensory or mental capabilities or lacking sufficient experience and/or skills if they have previously been instructed on the correct use of the machine and made aware of the associated dangers or if they are supervised by an adult.

- Children should be supervised to ensure that they do not play with the machine.
- Never insert fingers or other objects into the coffee grinder.

---

## Cautions

- The machine is for household use only. It is not intended for use in environments such as canteens, shop staff kitchens, offices, farms or other work environments.
- Always put the machine on a flat and stable surface.
- Do not place the machine on hot surfaces, directly next to a hot oven, heater units or similar sources of heat.
- Only put coffee beans into the coffee bean hopper. If ground coffee, instant coffee or any other substance is put in the coffee bean hopper, it may damage the machine.
- Let the machine cool down before inserting or removing any parts.
- Never use warm or hot water to fill the water tank. Use only cold non sparkling drinking water.
- Never clean with scrubbing powders or harsh cleaners. Simply use a soft cloth dampened with water.
- Descale your machine regularly. The machine indicates when descaling is needed. Not doing this will make your appliance stop working properly. In this case repair is not covered under your warranty!
- Do not keep the machine at temperature below 0 °C. Residue water in the heating system may freeze and cause damage.



- Do not leave water in the water tank when the machine is not used over a long period of time. The water can be contaminated. Use fresh water every time you use the machine.

---

## **Compliance with Standards**

The machine complies with art.13 of the Italian Legislative Decree dated 25 July 2005, no. 151 "Implementation of the Directives 2005/95/EC, 2002/96/EC and 2003/108/EC on the restriction of the use of certain hazardous substances in electrical and electronic equipment, as well as waste disposal".

This machine complies with EU Directive 2002/96/EC.

This Philips appliance complies with all the applicable standards and regulations relating to the exposure to electromagnetic fields.

# INSTALLATION

## Product Overview

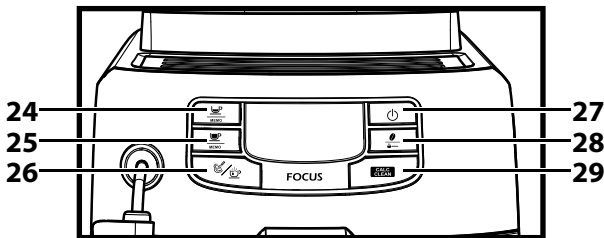
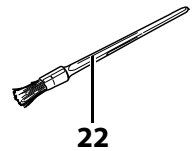
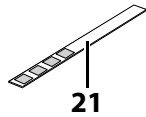
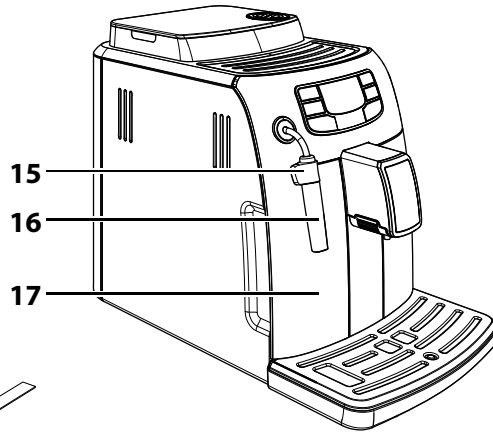
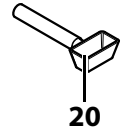
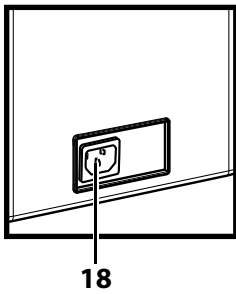
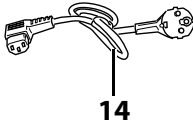
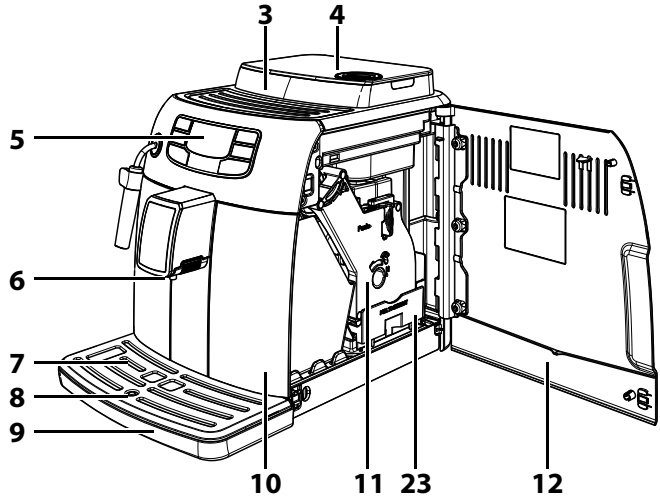
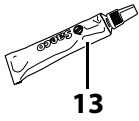
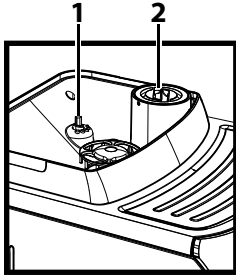

---

**General Description**

---

1. Grinder adjustment knob
2. Pre-ground coffee compartment
3. Coffee bean hopper
4. Coffee bean hopper lid
5. Control panel
6. Coffee dispensing spout
7. Cup holder grill
8. Full drip tray indicator
9. Drip tray
10. Coffee grounds drawer
11. Brew group
12. Service door
13. Grease for the brew group - to be purchased separately
14. Power cord
15. Wand protective gripper
16. Classic Milk Frother (for hot water/steam wand)
17. Water tank
18. Power cord socket
19. Descaling solution- to be purchased separately
20. Coffee grinder adjustment key + Pre-ground coffee measuring scoop
21. Water hardness test strip
22. Cleaning brush - to be purchased separately
23. Coffee residues drawer
24. Espresso brew button
25. Coffee brew button
26. Hot water/steam selection button
27. ON/OFF button
28. "Aroma" - Pre-ground coffee button
29. Descaling button

## PREPARING FOR USE

### Machine Packaging

The original packaging has been designed and constructed to protect the machine during transport. We recommend keeping the packaging material for possible future transport.

### Machine Installation

**1** Remove the drip tray with grill from the packaging.

**2** Remove the machine from the packaging.

**3** For best use, it is recommended to:

- Choose a safe, level surface, where there will be no danger of overturning the machine or being injured.
- Choose a location that is sufficiently well-lit, clean and near an easily reachable socket.
- Allow for a minimum distance from the sides of the machine as shown in the illustration.

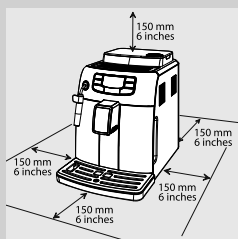

**4** Insert the drip tray with grill into the machine. Make sure it is fully inserted.

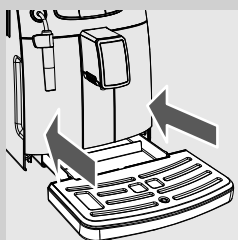

#### Note:

The drip tray collects the water that comes out of the dispensing spout during each rinse/self-cleaning cycle, as well as any coffee that might be spilled during beverage brewing. Empty and wash the drip tray daily and each time the full drip tray indicator is raised.



#### Caution:

**NEVER** remove the drip tray when the machine has just been turned on. Wait a couple of minutes for the machine to carry out a rinse/self-cleaning cycle.

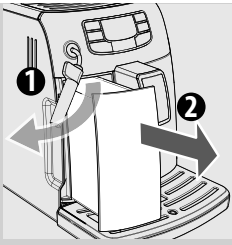

**5** Remove the water tank.

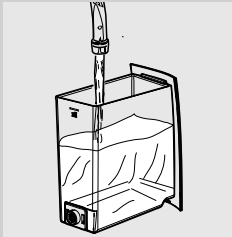

**6** Rinse the water tank with fresh water.

**7** Fill the water tank with fresh water up to the MAX level and reinsert it into the machine. Make sure it is fully inserted.



**Caution:**

**Never fill the water tank with warm, hot, sparkling water or any other liquid, as this may cause damage to the water tank and the machine.**

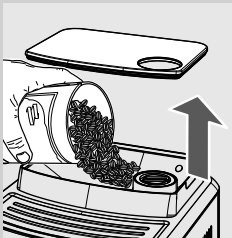

**8** Remove the coffee bean hopper lid and slowly pour the coffee beans into the coffee bean hopper.



**Note:**

Do not pour too many coffee beans into the coffee bean hopper as this will reduce the grinding performance of the machine.



**Caution:**

**Only coffee beans must be put into the coffee bean hopper. Ground coffee, instant coffee, caramelized coffee or any other object may damage the machine.**

**9** Put the lid on the coffee bean hopper.

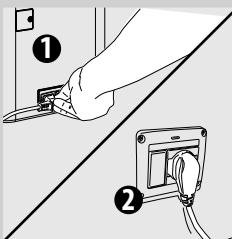

**10** Insert the plug into the socket located on the back of the machine.

**11** Insert the plug at the other end of the power cord into a wall socket with suitable power voltage.

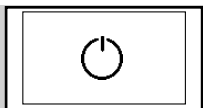

Black

**12** The display shows the stand-by icon.

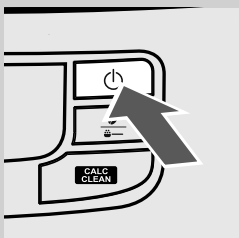

**13** To turn on the machine simply press the “” button. The display indicates that the circuit must be primed.

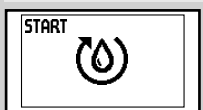

Yellow

## USING THE MACHINE FOR THE FIRST TIME

When using the machine for the first time, the following activities need to happen:

- 1) You need to prime the circuit.
- 2) The machine will perform an automatic rinse/self-cleaning cycle.
- 3) You need to initiate a manual rinse cycle.

### Circuit Priming

During this process fresh water flows through the internal circuit of the machine and the machine warms up. This takes a few minutes.



**1** Insert a container under the Classic Milk Frother.

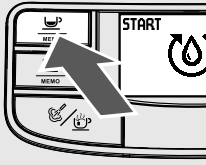

- Press the “” button to start the cycle. The machine starts the automatic priming of the circuit by dispensing some water through the Classic Milk Frother.



Yellow

- The bar under the icon shows the operation progress. When the process is completed, the machine stops dispensing automatically.

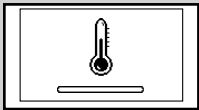

Yellow

- Then the display shows the machine warm-up icon.

### Automatic Rinse/Self-Cleaning Cycle

When warm-up is complete, the machine automatically performs a rinse/self-cleaning cycle of the internal circuit with fresh water. This takes less than a minute.

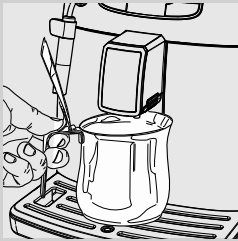

- Place a container under the dispensing spout to catch the small amount of dispensed water.



Yellow

- The machine shows this display. Wait for the cycle to finish automatically.

 **Note:**

You can stop dispensing by pressing the “” button.

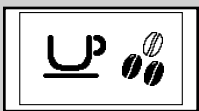

Green

- When the above steps are complete, the machine shows this display.

## Manual Rinse Cycle

During this process you activate the coffee brewing cycle and fresh water flows through the steam/hot water circuit. This takes a few minutes.

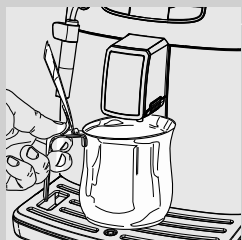

- 1 Place a container under the dispensing spout.

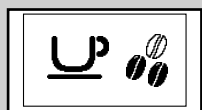

Green

- 2 Check that the machine shows this display.

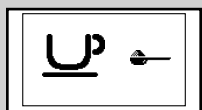

Green

- 3 Select the pre-ground coffee brewing function by pressing the "☕" button. The machine shows this display.



### Note:

Do not add pre-ground coffee to the compartment.

- 4 Press the "☕ MEMO" button. The machine starts dispensing water.

- 5 When the dispensing has finished, empty the container. Repeat the operations from step 1 to step 4 twice, then continue with step 6.



- 6 Insert a container under the Classic Milk Frother.

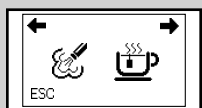

Green

- 7 Press the "☕/☕" button. The following icon is displayed.



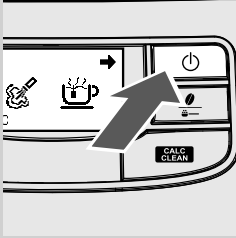

8 Press the “” button to start dispensing hot water.



Red

9 Dispense water until the no water icon appears.

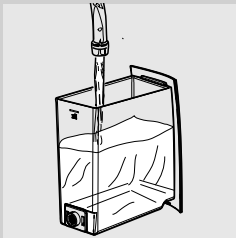

Green

10 At the end, fill the water tank again up to the MAX level. Now the machine is ready for coffee brewing. The display to the left will be shown.



**Note:**

When you haven't used the machine for 2 or more weeks, the machine will automatically perform an automatic rinse/self-cleaning cycle after you switch it on. Following this, you need to initiate a manual rinse cycle as described above.

The automatic rinse/self-cleaning cycle starts automatically when the machine has been in stand-by mode or turned off for more than 15 minutes. At the end of the cycle, it is possible to brew a coffee.

### Measuring and Programming Water Hardness

Water hardness measuring is very important in order to define the descaling frequency and to install the "INTENZA+" water filter (for more detail on the water filter, see next chapter).

To measure the water hardness follow the steps below:

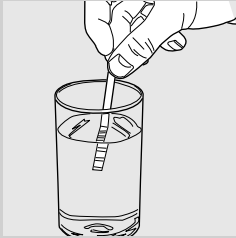

- 1 Immerse the water hardness test strip (supplied with the machine) in water for 1 second.



**Note:**

The test strip can only be used for one single measurement.

- 2 Wait for one minute.

- 3 Check how many squares have changed the colour to red and then refer to the table.



**Note:**

The numbers on the water hardness test strip correspond to the water hardness adjustment settings.

More precisely:

- 1 = 1 (very soft water)
- 2 = 2 (soft water)
- 3 = 3 (hard water)
- 4 = 4 (very hard water)

The letters correspond to the references that are located at the base of the "INTENZA+" water filter (see next chapter).

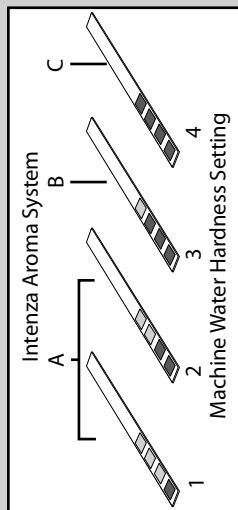

Yellow

- 4 Now you can program the water hardness setting. Press the "CALC CLEAN" button and scroll the pages by pressing the " " button until the following icon is displayed.



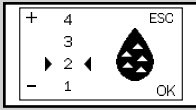

**Note:**

The machine is supplied with a standard water hardness setting, suitable for most types of water.



Yellow

**5** Press the “” button to increase the value or the “” button to decrease the value.

**6** Press the “” button to confirm the setting.



Green

**7** Press the “” button to exit the programming MENU.

### “INTENZA+” Water Filter Installation

We recommend installing the “INTENZA+” water filter as this prevents limescale build-ups and preserves a more intense aroma to your espresso coffee.



The INTENZA+ water filter can be purchased separately. Please refer to the maintenance product page in this user manual for further details. Water is a crucial part of every espresso, so it's most important to always have it professionally filtered. Using the “INTENZA+” water filter will prevent mineral deposits from building up and improve your water quality.

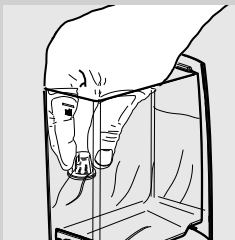

**1** Remove the small white filter from the water tank and store it in a dry place.



**2** Remove the “INTENZA+” water filter from its packaging, immerse it vertically (with the opening positioned upwards) in cold water and gently press the sides so as to let the air bubbles out.

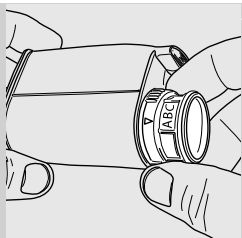

- 3** Set the filter according to the measurements performed (see previous chapter) and indicated on the base of the filter:  
 A = soft water – equals 1 or 2 on the test strip  
 B = hard water (standard) – equals 3 on the test strip  
 C = very hard water – equals 4 on the test strip

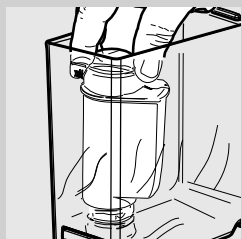

- 4** Insert the filter into the empty water tank. Press it down until it cannot move any further.  
**5** Fill the water tank with fresh water and reinsert it into the machine.  
**6** Dispense all the water of the tank by using the hot water function (see the "Hot Water Dispensing" chapter).  
**7** Fill the water tank again.

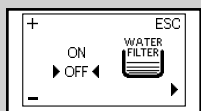

Yellow

- 8** Press the "CALC CLEAN" button and scroll the pages by pressing the "MEMO" button until the following screen is displayed.

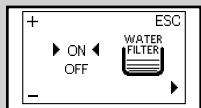

Yellow

- 9** Press the "MEMO" button to select "ON" and press the "MEMO" button to confirm.

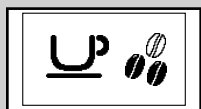

Green

- 10** To exit, press the "POWER" button.

In this way the machine has been programmed to inform the user of the need to replace the "INTENZA+" water filter.

## Replacing the "INTENZA+" Water Filter

When the "INTENZA+" water filter needs to be replaced with a new one, the following icon is displayed.



Yellow

- 1 Replace the filter as described in the previous chapter.



Yellow

- 2 Press the "CALC CLEAN" button and scroll through the pages by pressing the " " button until the following icon is displayed.

- 3 Select the "RESET" option. Press the " " button to confirm.

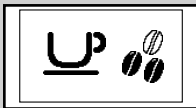

Green

- 4 To exit, press the " " button.

The machine is now programmed to manage a new filter.

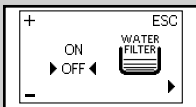

Yellow

### Note:

If the filter is already installed and you want to remove, but not replace it, select the "OFF" option instead.

If there is no "INTENZA+" water filter installed, insert the small white filter previously removed into the water tank.

## ADJUSTMENTS

The machine allows for certain adjustments so that you can brew the best tasting coffee possible.

### Saeco Adapting System

---

Coffee is a natural product and its characteristics may change according to its origin, blend and roast. The machine is equipped with a self-adjusting system that allows the use of all types of coffee beans available on the market (not for caramelized beans).

The machine automatically adjusts itself after brewing several cups of coffee to optimise the extraction of the coffee in relation to the compactness of the ground coffee.

### Adjusting the Ceramic Coffee Grinder

---

Ceramic coffee grinders always guarantee accurate and perfect grinding and coarseness for every coffee speciality.

This technology provides for full aroma preservation, delivering the truly Italian taste in every cup.



**Warning:**

**The ceramic coffee grinder contains moving parts that may be dangerous. Do not insert fingers or other objects. Only adjust the ceramic coffee grinder using the grinder adjustment key.**

You can adjust the ceramic grinders to set the coffee grinding to your personal taste.



**Warning:**

**Only turn the grinder adjustment knob inside the coffee bean hopper when the ceramic coffee grinder is in use.**

This adjustment can be carried out by pressing and turning the grinder adjustment knob inside the coffee bean hopper, using the appropriate key provided with the machine.



### Adjusting the Dispensing Spout

---

The height of the dispensing spout can be adjusted to better fit the dimensions of the cups that you wish to use.

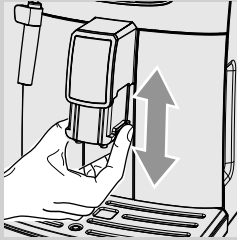

Move the dispensing spout up or down with your fingers to adjust its height as shown in the image.

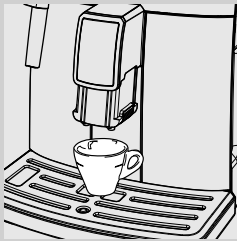

The recommended positions are:  
For the use of small cups.

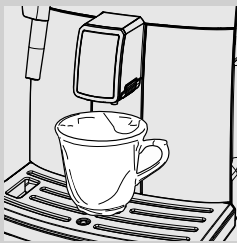

For the use of large cups.





Two cups can be placed under the dispensing spout to brew two coffees at the same time.



## Adjusting the Coffee Length

The machine allows you to adjust the amount of brewed coffee according to your taste and the size of your cups.

Each time the “” or “” button is pressed, the machine brews a pre-set amount of coffee. Each button may be individually programmed for a specific brew setting.

The following procedure describes the programming of the “” button.



- 1 Place a cup under the dispensing spout.





Green

- 2 Press and hold the “” button until the “**MEMO**” icon is displayed. Then release the button. The machine has now entered programming mode. The machine starts brewing coffee.





Green

- 3 When the “**STOP**” icon is displayed, press the “” button as soon as the desired amount of coffee is reached.

Now the “” button is programmed; each time it is pressed, the machine will brew the same amount of espresso that was just programmed.



### Note:

Follow the same steps to program the “” brew button. You should always use the “” button to stop brewing coffee when the desired amount of coffee is reached even when you are programming the “” brew button.

## ESPRESSO AND COFFEE BREWING

Before brewing coffee, make sure that there are no warnings shown on the display, and that the water tank and coffee bean hopper are filled.

### Espresso and Coffee Brewing Using Coffee Beans



- 1 Place 1 or 2 cups under the dispensing spout.



Green

- 2 To brew an espresso or a coffee, press the "☕" button to select the desired aroma.
- 3 Press the "☕ MEMO" button for an espresso or the "☕ MEMO" button for a coffee.

- 4 To brew 1 cup of espresso or coffee, press the desired button once. This icon will be displayed.



Green

- 5 To brew 2 cups of espresso or coffee, press the desired button twice consecutively. This icon will be displayed.



#### Note:

In this operating mode, the machine automatically grinds and doses the correct amount of coffee. Brewing two espressos requires two grinding and brewing cycles, automatically carried out by the machine.

- 6 After the prebrewing cycle, coffee begins to pour out of the dispensing spout.
- 7 Coffee brewing stops automatically when the set level is reached. However, it is possible to stop the coffee brewing earlier by pressing the "☕ MEMO" button.

## Espresso and Coffee Brewing Using Pre-Ground Coffee

This function allows you to use pre-ground and decaffeinated coffee.

With the pre-ground coffee function you can only brew one coffee at a time.



Green

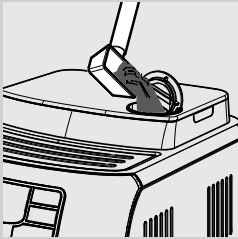



- 1 Press the “” button one or more times to select the pre-ground coffee function.

- 2 Lift the pre-ground coffee compartment lid and add one measuring scoop of pre-ground coffee to the compartment. Use only the measuring scoop supplied with the machine. Then close the pre-ground coffee compartment lid.



### Warning:

**Add only pre-ground coffee to the pre-ground coffee compartment. Other substances and objects may cause severe damage to the machine. Such damage will not be covered by warranty.**

- 3 Press the “” button for an espresso or the “” button for a coffee. The brewing cycle starts.
- 4 After the prebrewing cycle, coffee begins to pour out of the dispensing spout.
- 5 Coffee brewing stops automatically when the set level is reached. However, it is possible to stop the coffee brewing earlier by pressing the “” button.

After brewing the product, the machine returns to the main menu.

Repeat the steps described above to brew more coffees using pre-ground coffee.



### Note:

If no pre-ground coffee is poured into the compartment, only water will be dispensed.

If the dose is excessive or 2 or more measuring scoops of coffee are used, the machine will not brew the product. Only water will be dispensed and the ground coffee will be discharged into the coffee grounds drawer.

## DISPENSING STEAM/CAPPUCCINO BREWING

**Warning:**

**Danger of burning! Dispensing may be preceded by small jets of hot water. The steam/hot water wand may reach high temperatures. Never touch it with bare hands. Use the appropriate protective handle only.**

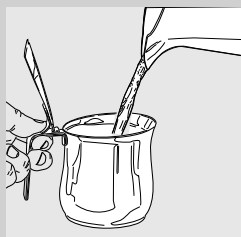

- 1 Fill 1/3 of a container with cold milk.

**Note:**

When preparing your cappuccino, use cold (~5 °C / 41 °F) milk with a protein content of at least 3% to ensure optimum results. Whole milk or skimmed milk may be used depending on individual taste.



- 2 Immerse the Classic Milk Frother in milk.



Green

- 3 Press the "☕" button. The following icon is displayed. Press the "MEMO" button to start dispensing steam.

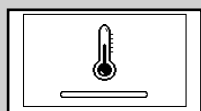

Yellow

- 4 The following icon is displayed during preheating time required by the machine.

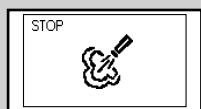

Green

- 5 Froth the milk by gently swirling the container and moving it up and down.
- 6 When the milk froth has the desired consistency, press the "MEMO" button to stop steam dispensing.

**Caution:**

**After frothing the milk, clean the Classic Milk Frother by dispensing a small quantity of hot water into a container. For detailed cleaning in-**

structions please see the “Cleaning and Maintenance” chapter.



**Note:**

After dispensing steam, it is possible to brew an espresso or dispense hot water straight after.

## HOT WATER DISPENSING



**Warning:**

**Danger of burning! Dispensing may be preceded by small jets of hot water. The steam/hot water wand may reach high temperatures: never touch it with bare hands. Use the appropriate protective handle only.**

Before dispensing hot water, make sure that the machine is ready to use and the water tank is filled.



Green

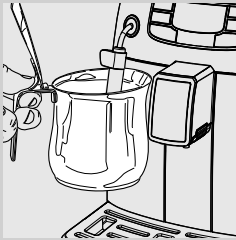



- 1 Insert a container under the Classic Milk Frother.

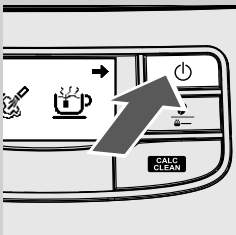

Green

- 2 Press the “” button. The following icon is displayed.



- 3 Press the “” button to start dispensing hot water.

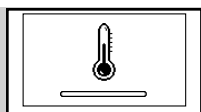

Yellow



Green

**4** The following icon is displayed during preheating time required by the machine.

**5** Pour the desired amount of hot water. To stop the hot water dispensing, press the “” button.

## CLEANING AND MAINTENANCE

### Daily Cleaning of the Machine



#### Caution:

**Timely cleaning and maintenance of your machine is very important as it prolongs the life of your machine. Your machine is continuously exposed to moisture, coffee and limescale! The activities you need to perform and their frequency are described in detail in this chapter. Not doing this will ultimately make your machine stop working properly. This repair is NOT covered by your warranty!**



#### Note:

- Use a soft, dampened cloth to clean the machine.
- Do not wash any removable part in the dishwasher.
- Do not immerse the machine in water.
- Do not use alcohol, solvents, and/or abrasive objects to clean the machine.
- Do not dry the machine and/or its components using a microwave and/or standard oven.

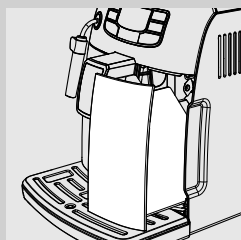

**1** Empty and clean the coffee grounds drawer daily with the machine turned on.

Other maintenance operations can only be carried out when the machine is turned off and unplugged.

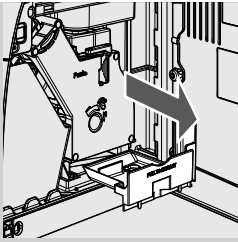

- 2** Empty and clean the coffee residues drawer located on the side of the machine. Open the service door, remove the drawer and empty the coffee residues.

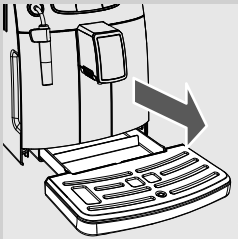

- 3** Empty and clean the drip tray. Perform this operation also when the full drip tray indicator is raised.

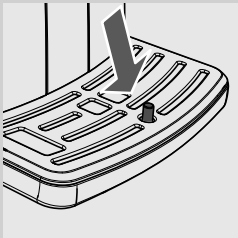

### Daily Cleaning of the Water Tank

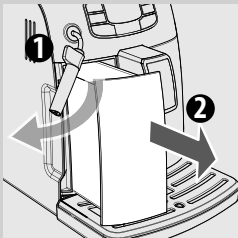

- 1** Remove the small white filter or the INTENZA+ water filter (if installed) from the water tank and wash it with fresh water.
- 2** Put the small white filter back or the INTENZA+ water filter (if installed) in its housing by gently pressing and turning it at the same time.
- 3** Fill the water tank with fresh water.

### Daily Cleaning of the Classic Milk Frother

---

It is important that you clean the Classic Milk Frother daily or after each use as it preserves hygiene and ensures perfect milk froth consistency.

After each milk frothing, always remove the external part of the Classic Milk Frother and wash it with fresh water.

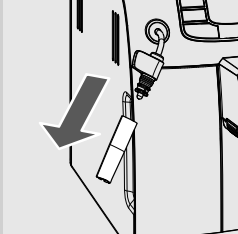

### Weekly Cleaning of the Machine

---

- 1 Clean the seat of the drip tray.

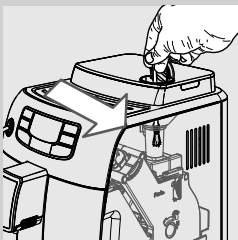
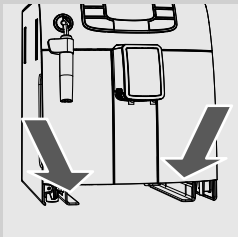

- 2 Clean the pre-ground coffee compartment with the brush (purchased separately) or the handle of a utensil.

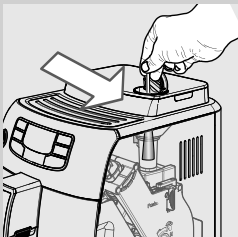



### Weekly Cleaning of the Classic Milk Frother

The weekly cleaning is more thorough, since you need to disassemble all the Classic Milk Frother components.

The following cleaning operations are required:

- 1** Remove the external part of the Classic Milk Frother. Wash it with fresh water.
- 2** Remove the upper part of the Classic Milk Frother from the steam/hot water wand.
- 3** Wash the upper part of the Classic Milk Frother with fresh water.
- 4** Clean the steam/hot water wand with a wet cloth to remove milk residues.
- 5** Put the upper part back into the steam/hot water wand (make sure it is completely inserted).
- 6** Reassemble the external part of the Classic Milk Frother.

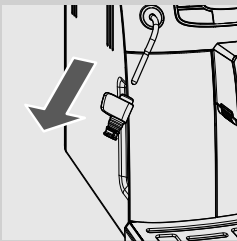
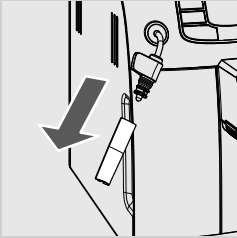

### Weekly Cleaning of the Brew Group

The brew group should be cleaned every time the coffee bean hopper is filled or at least once a week.

- 1** Turn off the machine by pressing the button and remove the plug from the socket.

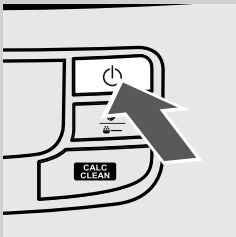

- 2** Remove the coffee grounds drawer. Open the service door.

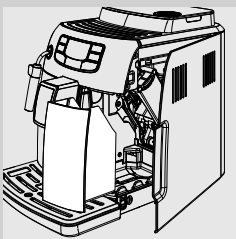

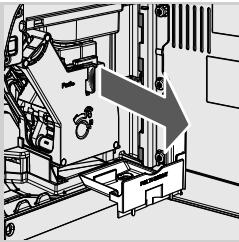

**3** Remove and clean the coffee residues drawer.

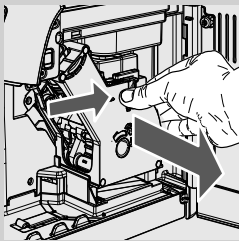

**4** To remove the brew group, press the «PUSH» button and pull it by the handle.

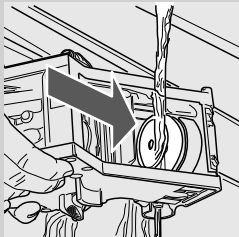

**5** Thoroughly wash the brew group with fresh, lukewarm water and carefully clean the upper filter.



**Caution:**

**Do not use detergent or soap to clean the brew group.**

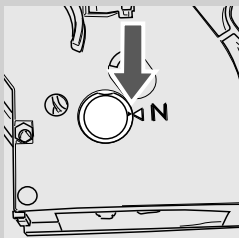

**8** Make sure the brew group is in the off position; the two reference signs must match. If they do not match, proceed as described in step (9).

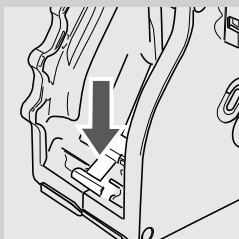

**9** Gently pull down the lever until it is in contact with the brew group base and the two reference signs on the side of the brew group match.

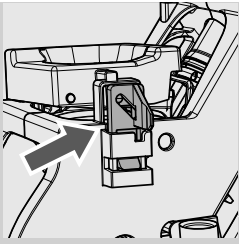

**10** Make sure the hook to lock the brew group is in the correct position by firmly pressing the "PUSH" button until it locks into place. Check if the hook is at the top end position. If it is not, please try again.

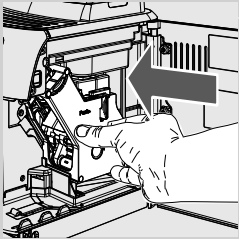
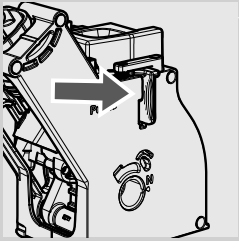

**11** Insert the brew group in its seat again until it locks into place without pressing the "PUSH" button.

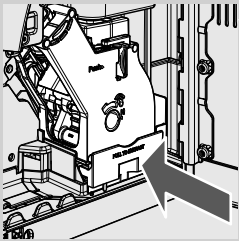

**12** Insert the coffee residues drawer and close the service door.

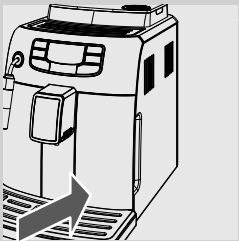

**13** Insert the coffee grounds drawer.

### Monthly Lubrication of the Brew Group

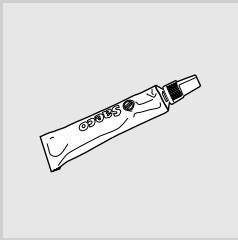

Lubricate the brew group after approximately 500 cups of coffee or once a month.

The Saeco grease for lubrication of the brew group can be purchased separately. For further details, please refer to the maintenance products page in this user manual.



**Caution:**

**Before lubricating the brew group, clean it with fresh water and let it dry, as described in the "Weekly Cleaning of the Brew Group" chapter.**

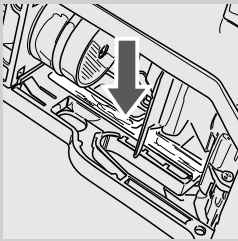

**1** Apply the grease evenly on both side guides.

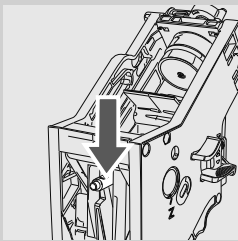
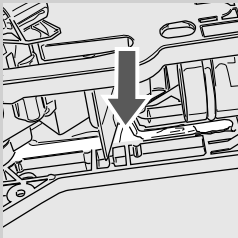

**2** Also lubricate the shaft.

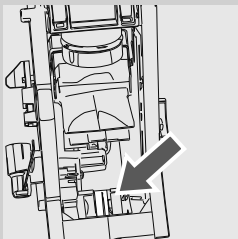

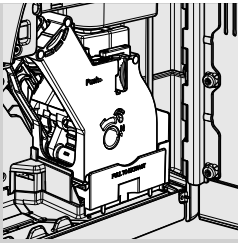

**3** Insert the brew group in its seat until it locks into place (see the “Weekly Cleaning of the Brew Group” chapter). Insert the coffee residues drawer.

**4** Close the service door and insert the coffee grounds drawer.

### Monthly Cleaning of the Brew Group with “Coffee Oil Remover”



Besides weekly cleaning, we recommend running the cleaning cycle with “Coffee Oil Remover” after approximately 500 cups of coffee or once a month. This operation completes the maintenance process for the brew group.

You can purchase separately the “Coffee Oil Remover”. Please refer to the maintenance product page in this user manual for further details.



#### Caution:

**The “Coffee Oil Remover” tablets are to be used for cleaning only and do not have a descaling function. For the descaling procedure use the Saeco descaling solution and follow the procedure described in the “Descaling” chapter.**



**1** Place a container under the dispensing spout.

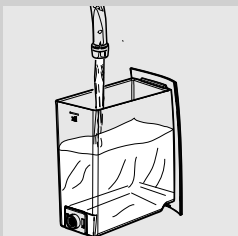

**2** Make sure the water tank is filled with fresh water up to the “MAX” level.

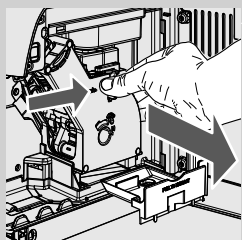
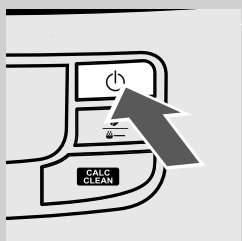
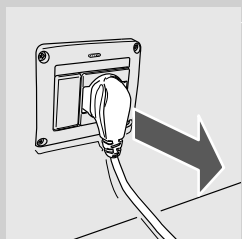
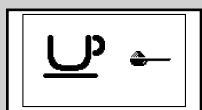
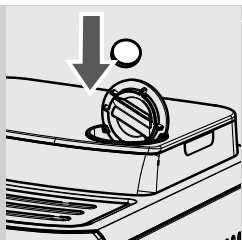

**3** Put a “Coffee Oil Remover” tablet in the pre-ground coffee compartment.

**4** Press the “☕” button to select the pre-ground coffee function without adding pre-ground coffee to the compartment.

**5** Press the “☕ MEMO” button to start the coffee brewing cycle.

**6** Wait until the machine has dispensed half a cup of water.

**7** Remove the plug of the power cord from the wall socket.

**8** Let the solution take effect for approximately 15 minutes. Make sure you discard the dispensed water.

**9** Reinsert the plug of the power cord into the wall socket. Turn on the machine by pressing the “⏻” button. Wait for the automatic rinse cycle to be completed.

**10** Remove the coffee grounds drawer and open the service door. Remove the coffee residues drawer and then the brew group.

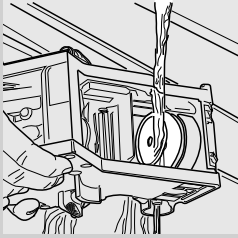

**11** Wash the brew group thoroughly with fresh water.

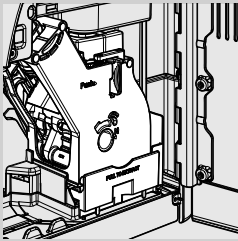

**12** After rinsing the brew group, insert it again in its seat until it locks into place (see the "Weekly Cleaning of the Brew Group" chapter). Insert the coffee residues drawer and the coffee grounds drawer. Close the service door.



Green

**13** Press the "☕" button to select the pre-ground coffee function without adding pre-ground coffee to the compartment.

**14** Press the "☕" button to start the coffee brewing cycle.

**15** Repeat steps 13 to 14 twice. Make sure you discard the dispensed water.

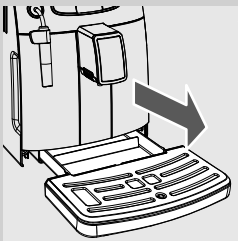

**16** To clean the drip tray, place "Coffee Oil Remover" tablet inside and fill it 2/3rds full with hot water. Let the cleaning solution take effect for about 30 minutes, then rinse thoroughly.

### Monthly Cleaning of the Coffee Bean Hopper

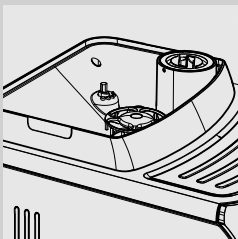

Clean the coffee bean hopper once a month when it is empty with a damp cloth to remove coffee oil. Thereafter refill it with coffee beans.

## DESCALING

The descaling process takes approx. 35 minutes.

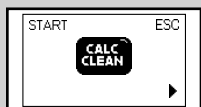

Yellow

Limescale builds up inside the machine during use. It needs to be removed regularly as it may clog the water and coffee circuit of your machine. The machine indicates when descaling is needed. If the machine display shows the **CALC CLEAN** icon, it means that you need to descale it.

**Caution:**

**Not doing this will ultimately make your machine stop working properly, and in this case repair is NOT covered by your warranty.**



Always use only Saeco descaling solution, since it has been designed to optimize machine performance.

You can purchase separately the SAECO descaling solution. Please refer to the maintenance product page in this user manual for further details.

**Warning:**

**Never drink the descaling solution or any products dispensed until the cycle has been carried out to the end. Never use vinegar as a descaling solution.**

**Note:**

Do not turn off the machine during the descaling cycle. Otherwise you will need to restart the descaling cycle from the very beginning.

To execute the descaling cycle, follow the steps below:

Before descaling:

- 1 Empty the drip tray.

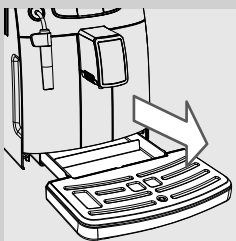



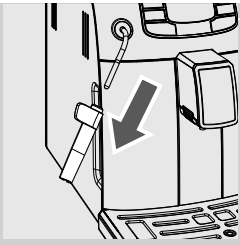

**2** Remove the Classic Milk Frother from the steam/hot water wand.

**3** Remove the "INTENZA+" water filter (if installed) from the water tank if it was installed.



Yellow

**4** Press the "CALC CLEAN" button. Press the "☺" button until the following display is shown.

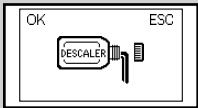

Red

**5** Press the "☺" button to enter the descaling menu.



**Note:**

If you press the "☺" button by mistake, press the "⏻" button to quit.

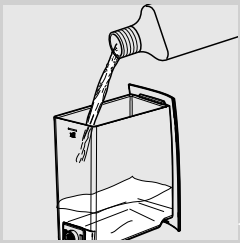

**6** Remove the water tank and pour the entire content of the Saeco descaling solution. Fill the water tank with fresh water up to the MAX level.

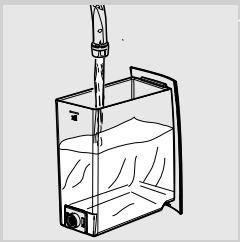

**7** Place the water tank back into the machine.



**8** Place a large container (1.5 l) under both the steam/hot water wand and the dispensing spout.

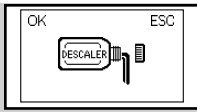

Red

**9** Press the “” button to start the descaling cycle.





Red

**10** The machine will start dispensing the descaling solution at regular intervals. The bar on the display shows the cycle progress.



**Note:**

The descaling cycle may be paused by pressing the “” button. To resume the cycle, press the “” button again. This allows you to empty the container or to leave the machine unattended for a short time.



Red



Red

**11** When this icon is displayed, the water tank is empty.

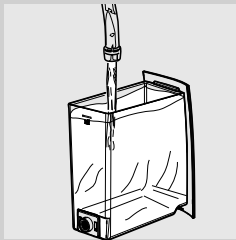

**12** Remove the water tank, rinse it and fill it up to the MAX level with fresh water. Place it back into the machine.

**13** Empty the drip tray and place it back.

**14** Empty the container and place it back under both the steam/hot water wand and the dispensing spout.



Red

**15** When inserting the water tank into the machine, this icon is displayed. Press the “” button to start the rinse cycle.



Red

**16** When this icon is displayed, the water tank is empty. Repeat steps 12 to 15. Then continue with step 17.

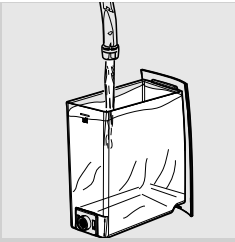

**17** When the water tank is empty, remove it, rinse it and fill it up to the MAX level with fresh water. Place it back into the machine.

**18** Empty the container and place it back under the dispensing spout.

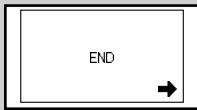

Red

**19** When the amount of water needed for the rinse cycle has been completely dispensed, this icon on the side is displayed. Press the "☰" button to quit the descaling cycle.



Yellow

**20** The machine automatically primes the circuit.

**21** The machine now carries out the warm-up and automatic rinse cycle to prepare for product brewing.

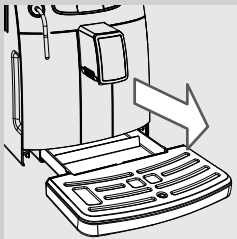

**22** Empty the drip tray and place it back.

**23** Remove and empty the container.

**24** The descaling cycle is now complete.

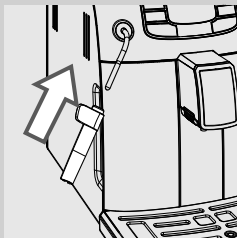

**25** Place the "INTENZA+" water filter (if installed) back in the tank and reinsert the Classic Milk Frother.

**Note:**

At the end of the descaling cycle, wash the brew group as described in the "Weekly Cleaning of the Brew Group" chapter.

The two rinse cycles are performed in order to have the circuit cleaned with a pre-set amount of water to ensure proper machine performance. If the water tank is not filled up to MAX level, the machine might require three or more cycles.

### MEANING OF THE DISPLAY ICONS

This machine is equipped with a colour-coded system to make the user's understanding of the display signals easier. The icons are colour-coded according to the traffic light principle.

#### Ready Signals (Green Colour)

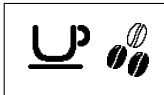

The machine is ready to brew products.

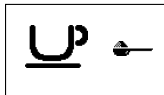

The machine is ready to brew pre-ground coffee.

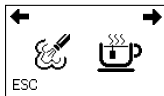

Steam or hot water selection.



Hot water dispensing.



Steam dispensing.

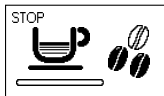

The machine is brewing one cup of espresso.

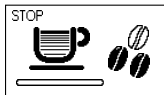

The machine is brewing one cup of coffee.

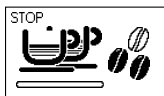

The machine is brewing two cups of espresso.

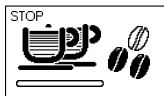

The machine is brewing two cups of coffee.

**Ready Signals (Green Colour)**

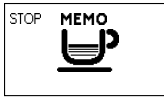

The machine is programming the amount of coffee to be brewed.

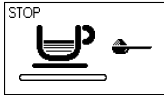

Coffee brewing using pre-ground coffee in progress.

**Warning Signals (Yellow Colour)**

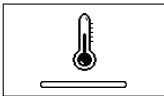

The machine is in warm-up phase to brew beverages or dispense hot water.

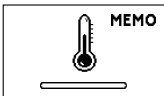

The machine is in warm-up phase during beverages programming.



The machine is performing the rinse phase. Wait until the machine has completed the cycle.

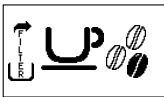

The machine needs the "INTENZA+" water filter to be replaced.



The brew group is being reset due to machine reset.



Refill the coffee bean hopper with coffee beans and restart the cycle.



Prime the circuit.



The machine needs to be descaled. Press the "MEMO" button to enter the descaling menu. Follow the steps described in the "Descaling" chapter of this manual.

If you want to descale later, press the "Power" button to continue using the machine.

Please note that not descaling your machine will ultimately make it stop working properly. In this case repair is NOT covered under your warranty.

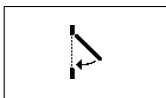
**Warning Signals (Red Colour)**

Close the service door.



Fill the coffee bean hopper.

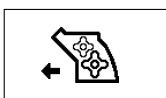

The brew group must be inserted into the machine.

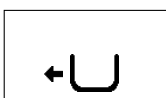

Insert the coffee grounds drawer.

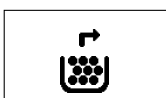

Empty the coffee grounds drawer and the coffee residues drawer.

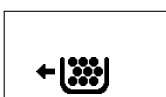

Fully insert the coffee grounds drawer before turning the machine off.



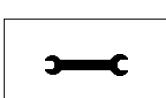

Fill the water tank.



Turn off the machine. Turn it back on after 30 seconds. Try this 2 or 3 times. If the machine does not start, contact the Philips SAECO hotline in your country. The contact details can be found in the warranty booklet packed separately or on [www.philips.com/support](http://www.philips.com/support).

## TROUBLESHOOTING

This chapter summarizes the most common problems you could encounter with your machine. If you are unable to solve the problem with the information below, visit [www.philips.com/support](http://www.philips.com/support) for a list of frequently asked questions or contact the Philips Saeco hotline in your country. The contact details can be found in the warranty booklet packed separately or on [www.philips.com/support](http://www.philips.com/support).

Machine actions	Causes	Solutions
The machine does not turn on.	The machine is not connected to the electric network.	Connect the machine to the electric network.
The drip tray gets filled although no water is drained.	Sometimes water is drained automatically by the machine into the drip tray to manage the rinsing of the circuits and ensure optimum machine performance.	This is a standard operating procedure.
The red  icon is always displayed on the machine.	The coffee grounds drawer was emptied with the machine off.	The coffee grounds drawer must always be emptied with the machine on. Wait until the  icon is displayed before refitting the drawer.
Coffee is not hot enough.	The cups are cold.	Preheat the cups with hot water.
No hot water or steam is dispensed.	The hole of the steam wand is clogged.	Clean the hole of the steam wand using a pin. <b>Make sure that the machine is off and has cooled down before performing this operation.</b>
	The Classic Milk Frother is dirty.	Clean the Classic Milk Frother.
Coffee does not have enough crema. (See note)	The blend is unsuitable, coffee is not freshly roasted or the grind is too coarse.	Change coffee blend or adjust the grind as explained in the section "Adjusting the Ceramic Coffee Grinder".
The machine takes a long time to warm up or the amount of water dispensed is too little.	The machine circuit is clogged by limescale.	Descale the machine.
The brew group cannot be removed.	The brew group is out of place.	Turn on the machine. Close the service door. The brew group automatically returns to the initial position.
	The coffee grounds drawer is inserted.	Remove the coffee grounds drawer before removing the brew group.
There is a lot of ground coffee under the brew group.	Coffee is not suitable for automatic machines.	It may be necessary to change the type of coffee or the coffee grinder settings.

Machine actions	Causes	Solutions
The machine grinds the coffee beans but no coffee comes out. (See note)	There is no water.	Fill the water tank and prime the circuit (see the "Using the Machine for the First Time" chapter).
	The brew group is dirty.	Clean the brew group (see the "Weekly Cleaning of the Brew Group" chapter).
	The circuit is not primed.	Prime the circuit (see the "Using the Machine for the First Time" chapter).
	This might occur when the machine is automatically adjusting the dose.	Brew a few cups of coffee as described in the "Saeco Adapting System" chapter.
Coffee is too weak. (See note)	The dispensing spout is dirty.	Clean the dispensing spout.
	This might occur when the machine is automatically adjusting the dose.	Brew a few cups of coffee as described in the "Saeco Adapting System" chapter.
Coffee is brewed slowly. (See note)	The coffee grind is too fine.	Change coffee blend or adjust the grind as explained in chapter "Adjusting the Ceramic Coffee Grinder".
	The circuit is not primed.	Prime the circuit (see the "Using the Machine for the First Time" chapter).
	The brew group is dirty.	Clean the brew group (see the "Weekly Cleaning of the Brew Group" chapter).
Coffee leaks out of the dispensing spout.	The dispensing spout is clogged.	Clean the dispensing spout and its holes.

**Note:**

These problems can be considered normal if the coffee blend has been changed or if the machine has just been installed. In this case wait until the machine performs a self-adjusting operation as described in the "Saeco Adapting System" chapter.



## ENERGY SAVING

### Stand-by

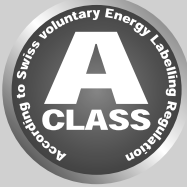

Black

The Saeco fully automatic espresso machine is designed for energy saving proven by the Class A energy label.

After 30 minutes of inactivity, the machine turns off automatically. If a product has been brewed the machine performs a rinse cycle.

In stand-by mode, the energy consumption is below 1Wh.

To turn on the machine, press the "⏻" button (if the power button on the back of the machine is set to "I"). If the boiler is cold the machine performs a rinse cycle.

### Disposal



Do not throw away the machine with the normal household waste at the end of its life, but hand it in at an official collection point for recycling. By doing this, you help to preserve the environment.

- Packaging materials can be recycled.
- Machine: unplug the machine and cut the power cord.
- Deliver the appliance and power cord to a service centre or public waste disposal facility.

This product complies with EU Directive 2002/96/EC.

The symbol on the product or on its packaging indicates that this product may not be treated as household waste. Instead, it shall be handed over to the applicable collection point for the recycling of electrical and electronic equipment.

By ensuring this product is disposed of correctly, you will help prevent potential negative consequences for the environment and human health, which could otherwise be caused by inappropriate waste handling of this product. For more detailed information about recycling of this product, please contact your local city office, your household waste disposal service or the shop where you purchased the product.

## TECHNICAL SPECIFICATIONS

The manufacturer reserves the right to make changes to the technical specifications of the product.

Nominal Voltage - Power Rating - Power Supply	See label on the inside of the service door
Housing material	Thermoplastic material
Size (w x h x d)	265.5 x 341 x 449 mm
Weight	9 kg
Power cord length	800 - 1200 mm
Control panel	Front panel
Classic Milk Frother	Special for cappuccino
Cup size	110 mm
Water tank	1.5 litres - Removable type
Coffee bean hopper capacity	300 g
Coffee grounds drawer capacity	10
Pump pressure	15 bar
Boiler	Stainless steel type
Safety devices	Thermal fuse

## WARRANTY AND SERVICE

### Warranty

For detailed information on your warranty and related conditions, please read the warranty booklet supplied separately.

### Service

We want to ensure that you remain satisfied with your machine. If not done already, please register your purchase at **[www.philips.com/welcome](http://www.philips.com/welcome)**. This will enable us to stay in contact with you and send you cleaning and descaling reminders.

If you need service or support, please visit the Philips website at [www.philips.com/support](http://www.philips.com/support) or contact the Philips Saeco hotline in your country. The contact number can be found in the warranty booklet packed separately or on **[www.philips.com/support](http://www.philips.com/support)**.

## ORDERING MAINTENANCE PRODUCTS

For cleaning and descaling, use Saeco maintenance products only. You can purchase the products at the Philips online shop (if available in your country) at [www.shop.philips.com/service](http://www.shop.philips.com/service), from your local dealer or authorised service centres.

If you have any difficulties obtaining maintenance products for your machine, please contact the Philips Saeco hotline in your country.

The contact details can be found in the warranty booklet supplied separately or on [www.philips.com/support](http://www.philips.com/support).

Overview of maintenance products



- Descaling solution CA6700



- Intenza+ water filter CA6702

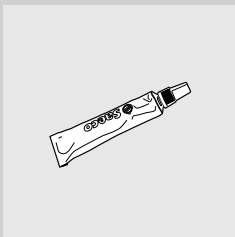

- Grease HD5061









02

Rev.00 del 15-11-13



421946009331

EN

02

The manufacturer reserves the right to make changes without prior notice.



[www.philips.com/saeco](http://www.philips.com/saeco)