



Important!
Return your
Warranty
Registration Card
within 10 days.
See why inside.



NEED HELP? CALL US!

PHILIPS REPRESENTATIVES ARE READY TO HELP YOU WITH ANY QUESTIONS ABOUT YOUR NEW PRODUCT. WE CAN GUIDE YOU THROUGH CONNECTIONS, FIRST-TIME SETUP, AND ANY OF THE FEATURES. WE WANT YOU TO START ENJOYING YOUR NEW PRODUCT RIGHT AWAY.

**CALL US BEFORE YOU CONSIDER
RETURNING THE PRODUCT.
1-800-531-0039**

OR VISIT US ON THE WEB AT WWW.PHILIPS.COM

Let's make things better.



PHILIPS

Return your Warranty Registration card today to ensure you receive all the benefits you're entitled to.

Once your PHILIPS purchase is registered, you're eligible to receive all the privileges of owning a PHILIPS product. So complete and return the Warranty Registration Card enclosed with your purchase at once. And take advantage of these important benefits.

Warranty Verification

Registering your product within 10 days confirms your right to maximum protection under the terms and conditions of your PHILIPS warranty.

Owner Confirmation

Your completed Warranty Registration Card serves as verification of ownership in the event of product theft or loss.

Model Registration

Returning your Warranty Registration Card right away guarantees you'll receive all the information and special offers which you qualify for as the owner of your model.

PHILIPS

Congratulations on your purchase, and welcome to the "family!"

Dear PHILIPS product owner:

Thank you for your confidence in PHILIPS. You've selected one of the best-built, best-backed products available today. We'll do everything in our power to keep you happy with your purchase for many years to come.

As a member of the PHILIPS "family," you're entitled to protection by one of the most comprehensive warranties and outstanding service networks in the industry. What's more, your purchase guarantees you'll receive all the information and special offers for which you qualify, plus easy access to accessories from our convenient home shopping network.

Most importantly, you can count on our uncompromising commitment to your total satisfaction. All of this is our way of saying welcome - and thanks for investing in a PHILIPS product.

Sincerely,



Lawrence J. Blanford
President and Chief Executive Officer

P.S. Remember, to get the most from your PHILIPS product, you must return your Warranty Registration Card within 10 days. So please mail it to us right now!



Know these safety symbols



 This "bolt of lightning" indicates uninsulated material within your unit may cause an electrical shock. For the safety of everyone in your household, please do not remove product covering.

 The "exclamation point" calls attention to features for which you should read the enclosed literature closely to prevent operating and maintenance problems.

WARNING: TO PREVENT FIRE OR SHOCK HAZARD, DO NOT EXPOSE THIS EQUIPMENT TO RAIN OR MOISTURE.

CAUTION: To prevent electric shock, match wide blade of plug to wide slot, fully insert.

ATTENTION: Pour éviter les chocs électriques, introduire la lame la plus large de la fiche dans la borne correspondante de la prise et pousser jusqu'au fond.

For Customer Use

Enter below the Model No. and Serial No., which are located on the rear of the cabinet. Retain this information for future reference.

Model No. _____
Serial No. _____



PHILIPS

Visit our World Wide Web Site at <http://www.philips.com>

Getting Started

Contents	3
Safety Information	4-5
Introduction	6
Playable Discs	7
General Information	8
Hookups	9-15

Quick Disc Playback

Quick Disc Playback	16
-------------------------------	----

DVD Player Controls

Remote Control Buttons	17
Front Panel	18
Rear Panel	19

Disc Playback and Features

Title/Disc Menus, Chapter/Track Selection	20
Slow Motion, Fast Forward and Fast Reverse	21
Still Picture/Frame-by-Frame Playback, Time Search	22
Zoom/Reduce, Camera Angle	23
Repeat/Shuffle, Repeat A-B	24
DVD Audio Language	25
DVD Subtitle Language	26
DVD Disc Menu Language	27
Parental Password	28
Disc Lock	29
Parental Levels	30
Program	31
Preview	32
Navigator	33
JPEG and MP3 Features	34

DVD Player Setup Options

TV Display	35
Smart Picture™, Picture Setting	36-37
TV Type, Progressive Scan	38
Display Dim, Analog Output	39
Digital Output, LPCM Output	40
Sound Mode, 3D Sound	41
Display Language, Closed Captions	42
Screen Saver, DVD Player Defaults	43
Setting the Remote to Operate Your TV	44-45

Information You May Need

Helpful Hints	46-47
Glossary	48
Specifications, Language Codes	49
Limited Warranty	50
Information Index	51

4 Safety Information

Safety Precautions

Warning: To prevent fire or shock hazard, do not expose this equipment to rain or moisture.

Federal Communications Commission (FCC) Warning: Any unauthorized changes or modifications to this equipment void the user's authority to operate it.

Laser Safety

This unit employs a laser. Only a qualified service person should remove the cover or attempt to service this device, due to possible eye injury.

CAUTION: USE OF CONTROLS OR ADJUSTMENTS OR PERFORMANCE OF PROCEDURES OTHER THAN THOSE SPECIFIED HEREIN MAY RESULT IN HAZARDOUS RADIATION EXPOSURE.

CAUTION: VISIBLE AND INVISIBLE LASER RADIATION WHEN OPEN AND INTERLOCK DEFEATED. DO NOT STARE INTO BEAM. THE BEAM IS LOCATED INSIDE, NEAR THE DECK MECHANISM.

Special Information for Canadian Users

This Class B digital apparatus complies with Canadian ICES-003.

Cet appareil numérique de la classe B est conforme à la norme NMB-003 du Canada.

Radio/TV Interference

This equipment has been tested and found to comply with the limits for a Class B digital device, pursuant to Part 15 of the FCC Rules. These limits are designed to provide reasonable protection against harmful interference in a residential installation. This equipment generates, uses, and can radiate radio frequency energy and, if not installed and used in accordance with the instructions, may cause harmful interference to radio communications. However, there is no guarantee that interference will not occur in a particular installation. If this equipment does cause harmful interference to radio or television reception, which can be determined by turning the equipment off and on, the user is encouraged to try to correct the interference by one or more of the following measures:

- 1) Reorient or relocate the receiving antenna.
- 2) Increase the separation between the equipment and the receiver.
- 3) Connect the equipment into an outlet on a circuit different from that to which the receiver is connected.
- 4) Consult the dealer or an experienced radio/TV technician for help.

Copyright Protection

Unauthorized copying, broadcasting, public performance and lending of Discs are prohibited.

This product incorporates copyright protection technology that is protected by method claims of certain U.S. patents and other intellectual property rights owned by Macrovision Corporation and other rights owners. Use of this copyright protection technology must be authorized by Macrovision Corporation and is intended for home and other limited viewing uses only unless otherwise authorized by Macrovision Corporation. Reverse engineering or disassembly is prohibited.

Declaration of Conformity

Model Number: DVD727
Trade Name: Philips
Responsible Party: Philips Consumer Electronics
P.O. Box 14810
Knoxville, TN 37914-1810
(865) 521-4316

IMPORTANT SAFETY INSTRUCTIONS

1. Read instructions. Read all the safety and operating instructions before operating the product.
2. Retain instructions. Keep the safety and operating instructions for future reference.
3. Heed warnings. Adhere to all warnings on the product and in the operating instructions.
4. Follow instructions. Follow all operating and use instructions.
5. Cleaning – Unplug this product from the wall outlet before cleaning. Do not use liquid cleaners or aerosol cleaners. Use a damp cloth for cleaning.
6. Attachments – Do not use attachments not recommended by the product manufacturer as they may cause hazards.
7. Water and Moisture – Do not use this product near water - for example, near a bathtub, washbowl, kitchen sink, or laundry tub, in a wet basement, near a swimming pool, etc.
8. Accessories – Do not place this product on an unstable cart, stand, tripod, bracket, or table. The product may fall, causing serious injury to a child or adult, and serious damage to the product. Use only with a cart, stand, tripod, bracket, or table recommended by the manufacturer or sold with the product. Any mounting of the product should follow the manufacturer's instructions and should use a mounting accessory recommended by the manufacturer.
9.  Move a product and cart combination with care. Quick stops, excessive force, and uneven surfaces may cause the product and cart combination to overturn.
10. Ventilation – Slots and openings in the cabinet provide ventilation, ensure reliable operation of the product, and protect it from overheating. Do not block or cover these openings. The openings should never be blocked by placing the product on a bed, sofa, rug, or other similar surface. Do not place this product in a built-in installation such as a bookcase or rack unless proper ventilation is provided or the manufacturer's instructions have been adhered to.
11. Power Sources – This product should be operated only from the type of power source indicated on the marking label. If you are not sure of the type of power supply to your home, consult your product dealer or local power company. For products intended to operate from battery power, or other sources, refer to the operating instructions.
12. Grounding or Polarization – This product may be equipped with a polarized alternating-current line plug (a plug having one blade wider than the other). This plug will fit into the power outlet only one way. This is a safety feature. If you are unable to insert the plug fully into the outlet, try reversing the plug. If the plug still fails to fit, contact your electrician to replace your obsolete outlet. Do not defeat the safety purpose of the polarized plug.
13. Power-Cord Protection – Route power supply cords so they are not likely to be walked on or pinched by items placed upon or against them, paying particular attention to cords at plugs, convenience receptacles, and the point where they exit from the product.
14. Outdoor Antenna Grounding – If an outside antenna or cable system is connected to the product, be sure the antenna or cable system is grounded so as to provide some protection against voltage surges and built-up static charges. Article 810 of the National Electrical Code, ANSI/NFPA 70, provides information with regard to proper grounding of the mast and supporting structure, grounding of the lead-in wire to an antenna discharge unit, size of grounding conductors, location of antenna-discharge unit, connection to grounding electrodes, and requirements for the grounding electrode. See figure at right.
15. Lightning – For added protection for this product during a lightning storm, or when it is left unattended and unused for long periods of time, unplug it from the wall outlet and disconnect the antenna or cable system. This will prevent damage to the product due to lightning and power-line surges.

16. Power Lines – An outside antenna system should not be located in the vicinity of overhead power lines or other electric light or power circuits, or where it can fall into such power lines or circuits. When installing an outside antenna system, take extreme care to keep it from touching such power lines or circuits; contact with them might be fatal.
17. Overloading – Do not overload wall outlets, extension cords, or integral convenience receptacles. This can result in a risk of fire or electric shock.
18. Object and Liquid Entry – Never push objects of any kind into this product through openings; they may touch dangerous voltage points or short out parts, resulting in a fire or electric shock. Never spill liquid of any kind on the product.
19. Servicing – Do not attempt to service this product yourself. Opening or removing covers may expose you to dangerous voltage or other hazards. Refer all servicing to qualified service personnel.
20. Damage Requiring Service – Unplug this product from the wall outlet and refer servicing to qualified service personnel under the following conditions:
 - a) When the power supply cord or plug is damaged,
 - b) If liquid has spilled or objects have fallen into the product,
 - c) If the product has been exposed to rain or water,
 - d) If the product does not operate normally by following the operating instructions. Adjust only those controls covered by the operating instructions. An improper adjustment of other controls may result in damage and will often require extensive work by a qualified technician to restore the product to its normal operation,
 - e) If the product has been dropped or damaged in any way,
 - f) When the product exhibits a distinct change in performance. This indicates a need for service.
21. Replacement Parts – When replacement parts are required, be sure the service technician uses replacement parts specified by the manufacturer or having the same characteristics as the original part. Unauthorized substitutions may result in fire, electric shock, or other hazards.
22. Safety Check – Upon completion of any service or repairs to this product, ask the service technician to perform safety checks to determine that the product is in proper operating condition.
23. Wall or Ceiling Mounting – Mount the product to a wall or ceiling only as recommended by the manufacturer.
24. Heat - Situate this product away from heat sources, such as radiators, heat registers, stoves, or other products (including amplifiers) that produce heat.
25. Battery usage CAUTION - To prevent battery leakage that may result in bodily injury, property damage, or damage to the unit:
 - Install all batteries correctly, with + and - aligned as marked on the unit.
 - Do not mix batteries (old/new, carbon/alkaline, etc.).
 - Remove batteries when the unit is not used for a long time.

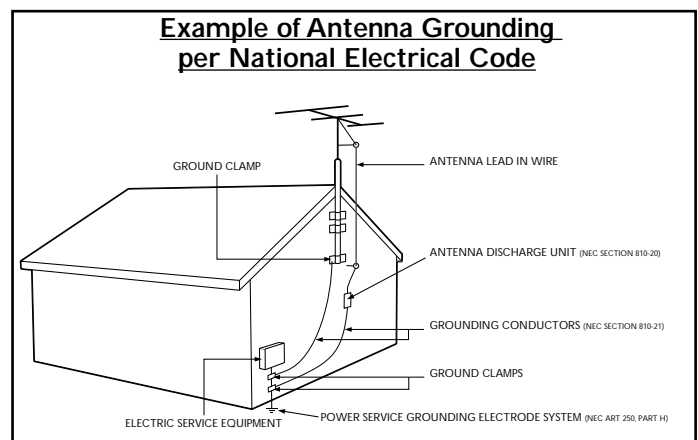

6 Introduction

Welcome!

This Digital Video Disc Player will allow you to enjoy better picture quality, clearer sound, and endless playback features on Digital Video Discs (DVDs). Expanding technology allows you to add options to your viewing - watch a director's cut of a movie, listen to the producer's comments, or play your favorite scene repeatedly. Hear a movie in different languages, or listen only to the soundtrack. The possibilities are limited only by your choices and the materials available on the DVD.

We hope you enjoy this DVD Player and learn to use its features. To get the most from the DVD Player, read this manual carefully. It will describe how you can access these features.

Features

- Closed Captions
- Disc Lock
- Language options for Audio, Subtitles, and Disc Menus
- MP3 and JPEG file playback with menu Navigator
- Parental controls
- Paused/Fast/Slow/Frame-by-Frame/Zoomed/Reduced playback
- Preview (Video CDs)
- Programmed playback
- Repeat and Repeat A-B Playback
- Screen Saver

Package Contents

- DVD Player
- Universal Remote control with two AA batteries
- One set of audio cables (red and white)
- One video cable (yellow)
- This owner's manual and registration materials
- Quick-Use Guide

Environmental Information

Your system has materials that can be recycled and reused if disassembled by a specialized company. Please observe the local regulations regarding the disposal of packaging materials, exhausted batteries, and old equipment.

Safety Information

- Do not expose the system to excessive moisture, rain, sand, heat, or humidity.
- Place the DVD Player on a firm, flat surface.
- Keep the DVD Player away from domestic heating equipment and direct sunlight.
- When placing the DVD Player in a cabinet, allow about one inch of space all around the DVD Player for ventilation. Leave enough room in front of the DVD Player for the disc tray to open completely.
- If the DVD Player is brought directly from a cold to a warm location, or is placed in a very damp room, moisture may condense on the lens inside the DVD Player. If this occurs, the DVD Player will not operate normally. Leave the power on for about one hour with no disc in the DVD Player until normal playback is possible.
- The mechanical parts of the Player contain self-lubricating bearings and must not be oiled or lubricated.
- When the DVD Player is turned off, it is still consuming some power. To disconnect the system from the power supply completely, remove the AC power plug from the power outlet.
- Always keep the disc tray closed to avoid dust on the lens.

Cleaning Discs

- When a Disc becomes dirty, clean it with a cleaning cloth. Wipe the Disc from the center to the edge in a straight line. Do not wipe the Disc in a circular pattern.

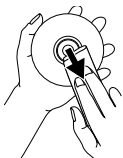

- Do not use solvents such as benzene, thinner, commercially available cleaners, or anti-static spray intended for analog discs.

Playable Discs

This DVD Player will play various types of Discs. Look for these logos on your Discs to determine whether the Disc will play on this Player.



DVD (Digital Video Disc)



Audio CD (Compact Disc Digital Audio)



Video CD and Super Video CD



CD-R (CD-Recordable) and CD-RW (CD-Rewritable)

Finalize CD-Rs when you record them. Otherwise, you cannot play them on this Player.



DVD+R (DVD + Recordable) and DVD+RW (DVD + Rewritable)

Finalize these Discs when you record them. Otherwise, you cannot play them on this DVD Player.

Region Codes and Color Systems

DVDs must meet the requirements for Region Codes and Color Systems before you can use them with the DVD Player. DVDs must be labeled for **ALL regions or for Region 1** in order to play on this DVD Player. You cannot play Discs that are labeled for other regions. These symbols must appear on your DVDs, or you cannot play the DVD in this Player.



The number inside the globe refers to a region of the world. Region 1 represents the United States, Canada, upper regions of North America, Bermuda, the U.S. Virgin Islands, and small regions near Australia.

Furthermore, recordings are made according to different color systems throughout the world. The most common color systems are NTSC (which is used primarily in the United States and North America), PAL, and SECAM.

This DVD Player is compatible with **NTSC and PAL**. Make sure the Discs you play were recorded in NTSC or PAL and your TV is NTSC or PAL compatible. You must set the DVD Player's TV TYPE to match your TV and your DVDs. *Details are on page 38.* The color system of the DVD may appear on the DVD or on the Disc case.

DVD Player Upgrades

If a DVD does not play properly, please contact Philips at 1-800-531-0039 for assistance. Due to the inconsistency of Disc formats provided by various Disc manufacturers, your DVD Player may require a playability enhancement. As DVD technology has advanced, these enhancements have become both common and easy to complete.

8 General Information

Battery Installation

- 1** Remove the **battery compartment lid** on the rear of the remote control by pressing in the tab, then lifting off the lid.
- 2** Place two **AA batteries inside the battery compartment with their + and – ends aligned as indicated**. Do not mix old and new batteries or different types of batteries (standard, alkaline, etc.).
- 3** Replace the **battery compartment lid**.

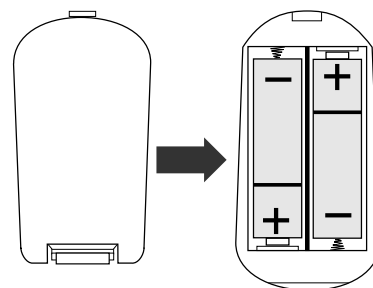

Using the Remote Control

When using the remote control to operate the DVD Player, aim the remote toward the front of the Player (not toward the TV). This remote may operate some features of your television. When using the remote to work the TV, aim the remote at the TV. *Details about TV operations are on pages 17 and 44-45.*

When referring to this manual, remember...

- | | |
|----------|--|
| DVD | The feature is available on some Digital Video Discs. |
| AUDIO CD | The feature is available on some Audio Compact Discs. |
| VIDEO CD | The feature is available on some Video Compact Discs or Super Video CDs. |

DVD Disc Menus...

Some explanations in this manual describe the DVD Disc Menus, which vary among DVDs. Movie producers set these menus, and not all DVDs have menus. If the DVD has a menu, access the Disc Menu by pressing the DISC MENU button on the remote control. *Details are on page 20.*

DVD Player Menus...

Some instructions explain how to use the DVD Player's Setup menu to set features of the Player or the Disc. You get to the Setup Menu by pressing SYSTEM MENU on the remote control. Even if a feature is set in the Player's menu, it will not be available if the current Disc does not include that feature.

Available Disc Features...

Features in this manual may not be available on every Disc. If the feature is not available, you cannot use the DVD Player to make the feature available. The ∅ will appear in the top left corner of the TV screen if you try to access a feature that is not available. For example, the feature may not be available at the present time. Some features are only available during playback, while other items can be accessed only when play is stopped. Try stopping or starting playback, then try the feature again.

Determining the best possible connection...

The capabilities of your existing equipment, especially your TV, will determine your connection possibilities. However, the following guidelines describe which options provide the best picture and sound quality.

- ★★★★ Component Video provides the best picture quality. *Details are on page 13.*
If your TV accepts Progressive Scan through the Component Video connection, set PROGRESSIVE to ON at the Player. *Details are on page 38.*
- ★★★ S-Video provides excellent picture quality. *Details are on page 12.*
- ★★ Composite Video (a yellow Video jack) provides good picture quality. *Details are on page 11.*
- ★★ **Your TV may have only an RF-style jack, usually labeled Antenna In or 75 ohm or RF In. You will need an RF modulator in order to view the DVD Player at your TV.**
Details are on page 10.

- ★★★★ Digital audio connections provide the clearest sound, but you must have a digital stereo
Connect the DVD Player's COAXIAL or OPTICAL digital audio out jack to your Stereo for the best sound quality. *Details are on page 15.*
- ★★★ If digital connections are not possible, connect the DVD Player's red and white AUDIO OUT jacks to the Audio In jacks of your Stereo, TV, or RF modulator. *Details are on pages 10-14.*

Before you begin...

- Refer to the manuals of your TV, Stereo, or other equipment as necessary. Note the style of jacks and connectors on the other equipment. Determine how to choose different Audio and Video In channels/sources on your other equipment so you can see and hear the DVD Player on the TV, Stereo, etc.
- Disconnect all equipment from the power outlets. Connect the equipment to the power outlets only after you have finished hooking up everything. Never make or change connections with equipment connected to the power outlet.

Remember...

- Connect the DVD Player directly to the TV. For example, do not connect the DVD Player to a VCR, then connect the VCR to a TV. This type of connection may distort the picture and sound. Also, your VCR might have the copy protection system, which could distort the DVD image or prevent playback of some Discs.
- Set the TV to the correct Video In channel. Such channels may be called AUX or AUXILIARY IN, AUDIO/VIDEO or A/V IN, EXT1 or EXT2 or External In, etc. These channels are often near channel 00. See your TV manual for details. Go to your lowest TV channel (01 or 02) and change TV channels downward until you see the DVD screen saver on the TV. Or, your TV's remote may have a button or switch that selects Video In channels. Check your TV manual for details.
If you are using an RF modulator, set the TV to channel 3 or 4.
- Set the Stereo to the correct channel or "source" mode.
- Do not connect the DVD Player's AUDIO OUT jacks to the PHONO IN jack of your Stereo.
- You only need one audio connection and one video connection between the DVD Player and your TV and/or Stereo. So, you will not use all the jacks on the DVD Player.

Once you determine the best option, find your choice on pages 10-15. Follow the steps for the hookup you choose.

10 Hookups (cont'd)

Connecting to a TV Only TV has only a single Antenna In or RF In jack

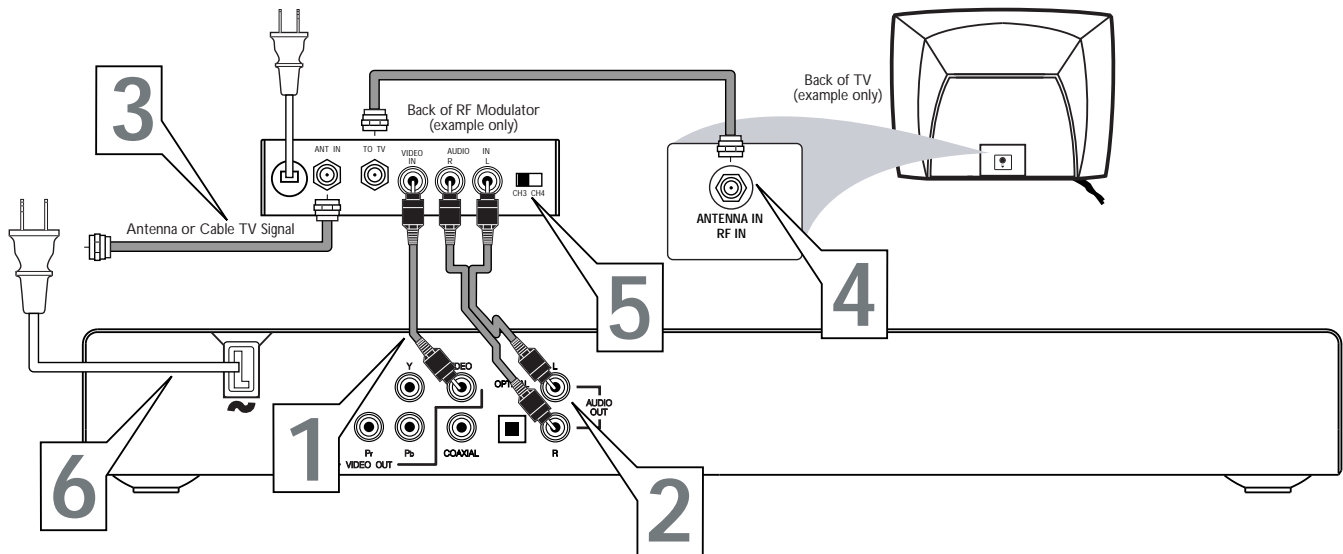

Before you begin, make sure you have an RF modulator and extra RF coaxial cables. These are not supplied with the Player, but are available from Philips or most consumer electronics retailers.

- 1** Connect the supplied video cable (which has yellow markings) to the Player's yellow VIDEO (VIDEO OUT) jack. Connect the other end of the cable to the VIDEO IN jack on the RF modulator. The VIDEO IN jack on the RF modulator is usually yellow and might be labelled VIDEO, CVBS, COMPOSITE, or BASEBAND.
- 2** Connect the supplied audio cable (which has red and white markings) to the Player's AUDIO OUT (left and right) jacks. Connect the other ends of the audio cable to the AUDIO IN jacks on the RF modulator. Audio jacks on the RF modulator usually are red (right) and white (left). Match the cable colors to the jack colors.
- 3** You probably already have an Antenna or Cable TV signal connected to the ANTENNA IN jack on your TV. **Disconnect it now from the TV. Reconnect the Antenna or Cable TV signal to the ANTENNA IN jack on your RF modulator.**
- 4** Connect an RF coaxial cable (not supplied) to the RF OUT, ANTENNA OUT, or TO TV jack on the RF modulator. The RF OUT jack may be labelled differently among different brands. Refer to the instructions provided with your RF modulator. **Connect the other end of the same RF coaxial cable to the ANTENNA IN or RF IN jack on your Television.**
- 5** Your RF Modulator should have a Channel 3/4 switch. The setting of this switch determines the TV channel on which you will watch materials playing on the DVD Player. **Set the RF Modulator's Channel 3/4 switch to either 3 or 4, whichever TV channel is least used in your area.** If your RF modulator has a Modulator/Antenna switch, set it accordingly. Refer to the instructions that came with the RF Modulator.
- 6** Connect the power cords of all the equipment to a power outlet.
- 7** Turn on your TV and choose channel 3 or 4. Choose the same channel to which you set the RF Modulator's Channel 3/4 switch.
- 8** Turn on the DVD Player by pressing **STANDBY-ON** \odot . You should see the Player's blue DVD screen on the TV.

Connecting to a TV Only TV has a yellow Video In jack

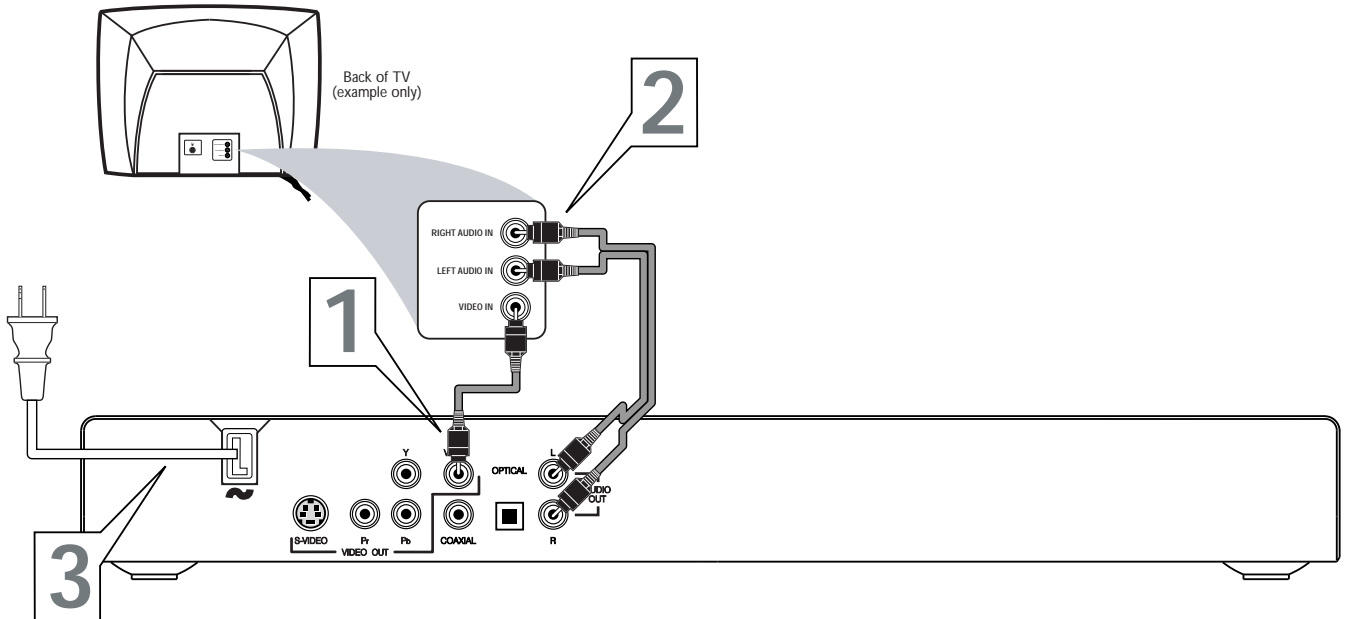

- 1** Connect the yellow VIDEO (VIDEO OUT) jack of the DVD Player to the corresponding VIDEO IN jack on your TV. Use the supplied video cable, which has yellow markings.
- 2** Connect the supplied audio cable to the red and white AUDIO OUT (left and right) jacks on the DVD Player and to the left/right AUDIO IN jacks on the TV. The supplied audio cables have red and white markings. Match the cable colors to the jack colors.
- 3** Plug the power cords of the DVD Player and the TV into an active power outlet. Press STANDBY-ON  on the front of the DVD Player to turn it on.
- 4** Turn on the TV. Set it to the correct Video In channel. See your TV owner's manual for details. Or, go to your lowest TV channel (01 or 02) and change channels downward until you see the blue DVD screen on the TV.

Helpful Hints

- On the TV, the Video In jack is usually yellow and might be labeled video, CVBS, composite, or baseband.
- If your TV has a single Audio In jack instead of separate left/right Audio In jacks, you will need a different audio cable. You need a "splitter" audio cable to go from the left/right AUDIO OUT jacks of the DVD Player to the single Audio In jack on your TV. See your electronics retailer for details.

12 Hookups (cont'd)

Connecting to a TV Only TV has an S-Video In Jack

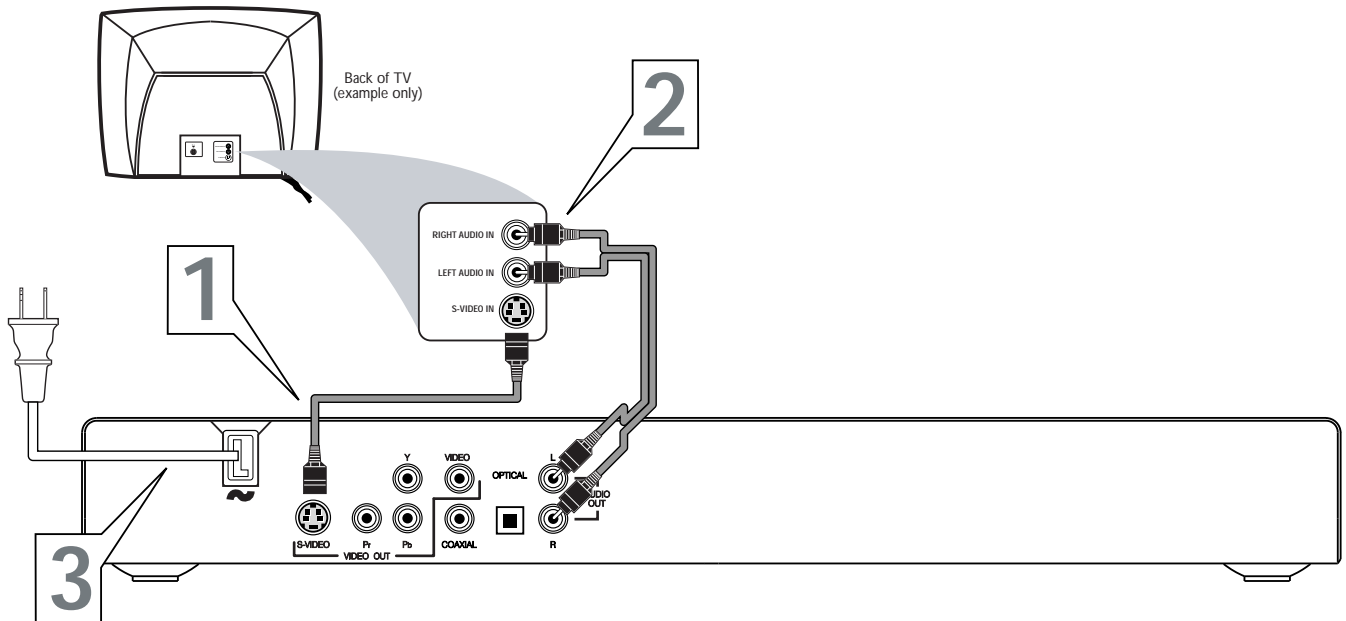



- 1** Connect an S-Video cable (not supplied) to the S-VIDEO (VIDEO OUT) jack of the DVD Player and to the TV's S-VIDEO In jack.
- 2** Connect the supplied audio cable to the red and white AUDIO OUT (left and right) jacks on the DVD Player and to the left/right AUDIO IN jacks on the TV. The supplied audio cable has red and white markings. Match the cable colors to the jack colors.
- 3** Plug the power cords of the DVD Player and the TV into an active power outlet. Press **STANDBY-ON**  on the front of the DVD Player to turn it on.
- 4** Turn on the TV. Set it to the correct S-Video In channel. See your TV owner's manual for details. Or, go to your lowest TV channel (01 or 02) and change channels downward until you see the blue DVD screen on the TV.

Helpful Hints

- On the TV, the S-Video In jack may be labeled Y/C, S-Video, or S-VHS (super video).
- If your TV has a single Audio In jack instead of separate left/right Audio In jacks, you will need a different audio cable. You need a "splitter" audio cable to go from the left/right AUDIO OUT jacks of the DVD Player to the single Audio In jack on your TV. See your electronics retailer for details.

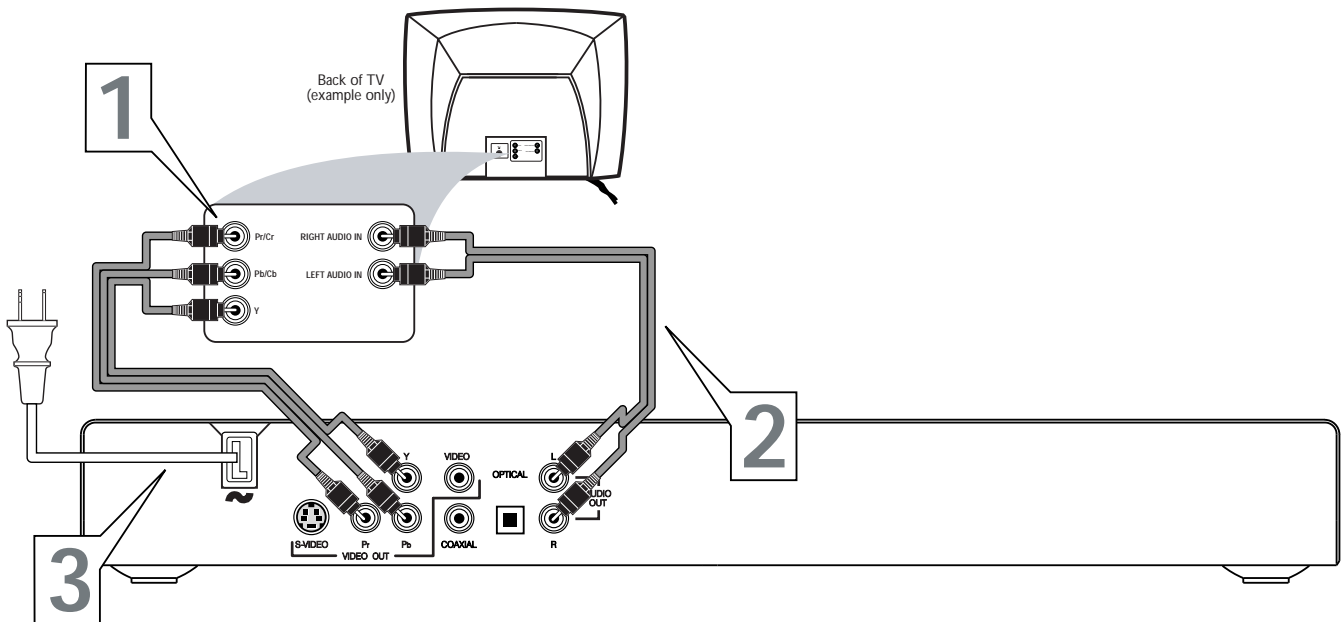
Connecting to a TV Only TV has Component Video In Jacks (red, green, and blue)



- 1** Connect the DVD Player's Y Pb Pr (VIDEO OUT) jacks to the corresponding COMPONENT VIDEO IN jacks on the TV. Use component video cables (not supplied). The Component Video jacks are red, green, and blue.
On your TV, you may have additional Component Video In jacks that are specifically labelled Progressive Scan. If you use these instead, set PROGRESSIVE to ON at the Player. (See step 5.)
- 2** Connect the DVD Player's red and white AUDIO OUT (left and right) jacks to the left/right AUDIO IN jacks on the TV. Use the supplied audio cables, which have red and white markings. Match the cable colors to the jack colors.
- 3** Plug the power cords of the DVD Player and the TV into an active power outlet. Press STANDBY-ON  on the front of the DVD Player to turn it on.
- 4** Turn on the TV. Set it to the correct Component Video In channel. See your TV owner's manual for details. Or, go to your lowest TV channel (01 or 02) and change channels downward until you see the blue DVD screen on the TV.
- 5** If your TV has Progressive Scan, set PROGRESSIVE to ON at the DVD Player. Details are on page 38.
Select Progressive Scan at your TV also if necessary. See your TV owner's manual for details.
Only set PROGRESSIVE to ON if you are certain your TV has Progressive Scan. You will not see the DVD Player's picture at the TV if PROGRESSIVE is set incorrectly.

Helpful Hints

- On the TV, the component video in jacks may be labeled YUV or Pr/Cr Pb/Cb Y and may be green, blue, and red.
- If your TV has a single Audio In jack instead of separate left/right Audio In jacks, you will need a different audio cable. You need a "splitter" audio cable to go from the left/right AUDIO OUT jacks of the DVD Player to the single Audio In jack on your TV. See your electronics retailer for details.
- You can deactivate Progressive Scan so you can use a different connection. For example you may want to change TVs later. To cancel Progressive Scan at the DVD Player, open the disc tray. Press  on the remote, then press MUTE.

14 Hookups (cont'd)

Connecting to a TV and a two-channel Stereo (Stereo has Dolby Pro Logic or right/left Audio In jacks)

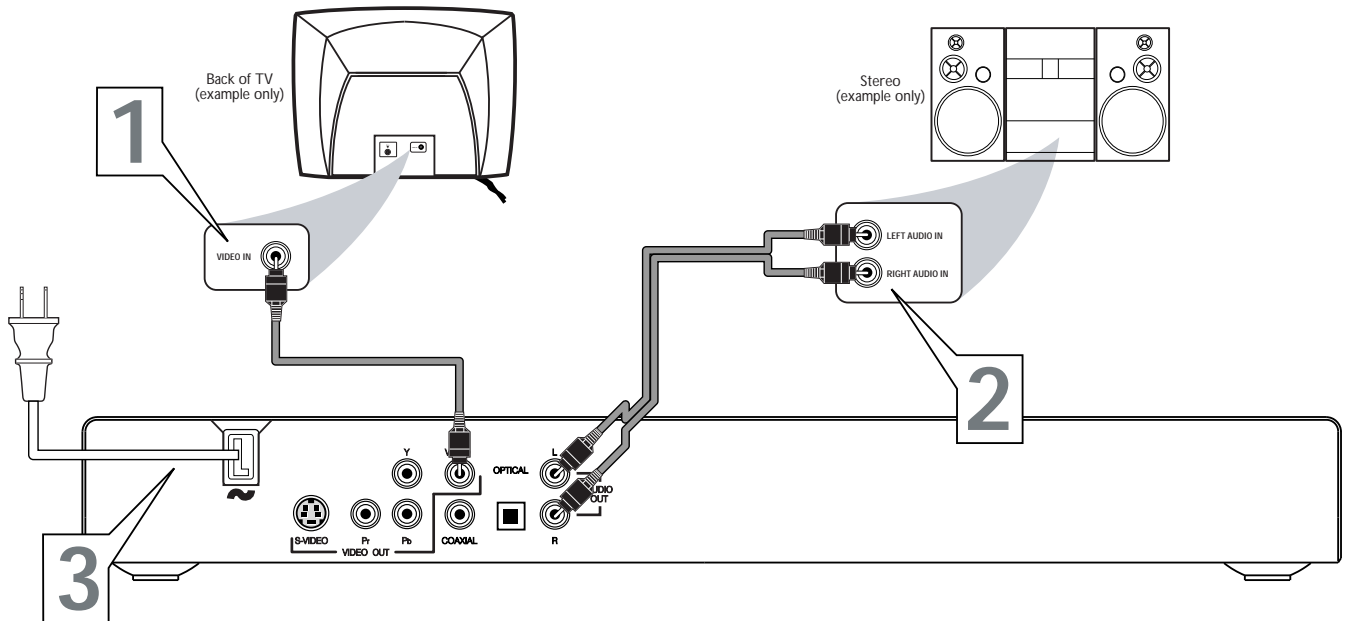



- 1** Connect the supplied video cable to the yellow **VIDEO OUT** jack of the DVD Player and to the TV's **VIDEO IN** jack. The supplied video cable has yellow markings.
- 2** Connect the supplied audio cable to the red and white **AUDIO OUT** (left and right) jacks on the DVD Player and to the left/right **AUDIO IN** jacks on the Stereo. Match the cable colors to the jack colors.
- 3** Plug the power cords of the DVD Player, Stereo, and TV into an active power outlet. Press **STANDBY-ON**  on the front of the DVD Player to turn it on.
- 4** Turn on the Stereo and set it to the correct **Audio In** channel or sound source. Refer to the Stereo owner's manual for details.
- 5** Turn on the TV. Set it to the correct **Video In** channel. See your TV owner's manual for details. Or, go to your lowest TV channel (01 or 02) and change channels downward until you see the blue DVD screen on the TV.

Helpful Hint

- If you prefer or need to use the **S-VIDEO** or **Y Pb Pr** jacks instead, see pages 12-13. You only need one video connection between the TV and the DVD Player.

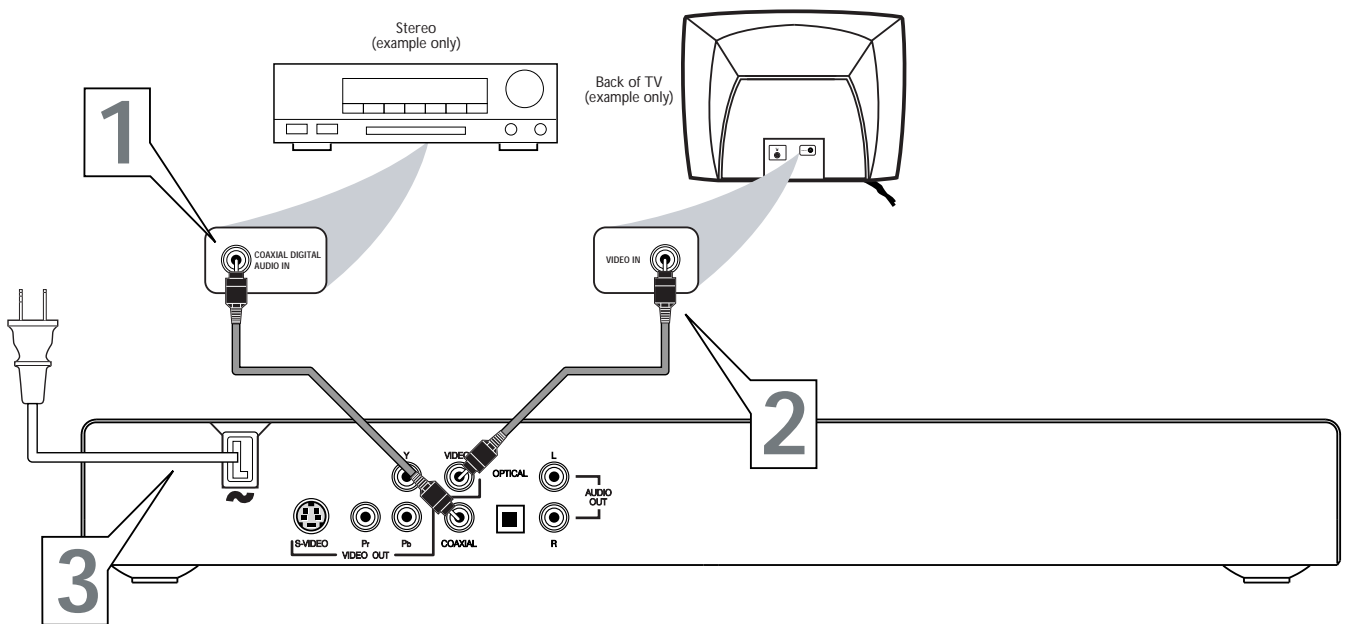
Connecting to a TV and a Stereo (Stereo has Dolby Digital™ or MPEG2)



- 1** Connect the Player's **COAXIAL** jack *or* **OPTICAL** jack to the Stereo's **COAXIAL DIGITAL AUDIO IN** jack *or* **OPTICAL DIGITAL AUDIO IN** jack. You only need to use one of the jacks, not both.
Use an appropriate digital audio cable (not supplied). See your electronics retailer for details and availability.
- 2** Connect the supplied video cable to the Player's yellow **VIDEO (VIDEO OUT)** jack and to the TV's **VIDEO IN** jack. The supplied video cable has yellow markings.
- 3** Plug the power cords of the DVD Player, Stereo, and TV into an active power outlet. Press **STANDBY-ON**  on the front of the DVD Player to turn it on.
- 4** Turn on the Stereo and set it to the correct **Audio In channel** or **sound source**. Refer to the Stereo owner's manual for details.
- 5** Turn on the TV. Set it to the correct **Video In channel**. See your TV owner's manual for details. Or, go to your lowest TV channel (01 or 02) and change channels downward until you see the blue DVD screen on the TV.

Helpful Hints

- Set **DIGITAL OUTPUT** and **LPCM OUTPUT** accordingly. Details are on page 40.
- Your Stereo must support **MPEG2** or **Dolby Digital™**. Check the Stereo's manual.
- If you prefer or need to use the **S-VIDEO** or **Y Pb Pr** jacks instead, see pages 12-13.

16 Quick Disc Playback

DVD

AUDIO CD



VIDEO CD



1

2-3

There are many playback features and options available on Discs. After familiarizing yourself with the DVD Player as described on pages 17-19, see pages 20 and following to try additional features.





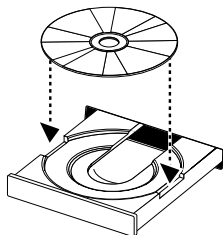





1 Press **STANDBY-ON**  or **POWER**  to turn on the DVD Player. Turn on your TV. Set it to the correct Video In channel. You should see the blue DVD screen on the TV.







2 Press **OPEN/CLOSE**  to open the disc tray. Load your Disc in the tray, with the label facing up. If the Disc (DVD) is two-sided, make sure the label of the side you want to play is facing up.



3 Press **OPEN/CLOSE**  again to close the tray.

4 Play may start automatically. If not:

- If you are playing a DVD, a Disc menu may appear. If the Title or Chapter selections are numbered, press a Number button to select an item. Or, press     to select an item, then press **OK**. Playback will begin. Or, follow the on-screen instructions as detailed in the DVD Disc menu.
- If you are playing an Audio CD, press **PLAY**  to start play.
- If a Video CD has Playback Control, press **DISC MENU** to access its menu while play is stopped. Or, press **TITLE** to see the menu during playback. Press the Previous , Next , , , , or Number buttons to select an item, then press **OK**. Follow the instructions provided by the Video CD. Not all Video CDs have Playback Control. See the Disc case or menus for details.

5 To stop play at any time, press **STOP** . If you press **STOP**  only once, play will resume at the same point if you press **PLAY**  later to restart play. This is known as the Resume feature. Resume applies to the last five Discs. Press **PLAY**  immediately after inserting the Disc in the Player (while **LOADING** shows on the TV screen). **RESUME PLAY** will appear on the TV screen briefly. If you press **STOP**  more than once to stop playback, play will start at the beginning of the Disc again if you press **PLAY**  later to restart playback.

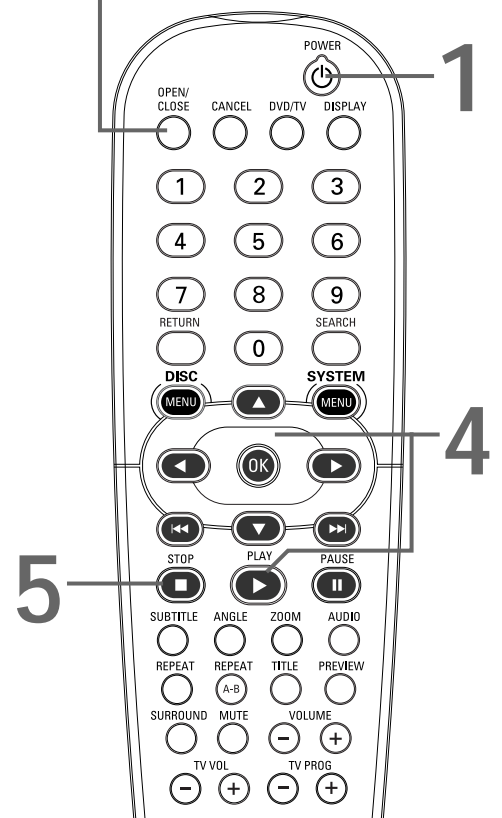

Helpful Hints

- If the Disc is locked by Parental controls, you must enter your password or unlock the Disc. Details are on pages 28-30.
- DVDs have a region code. This Player will play only DVDs of Region 1 or ALL. Details are on page seven.
- If there is no activity at the Player or its remote for 15 minutes, the Player will turn itself off. Press **STANDBY-ON**  on the Player or **POWER**  or **PLAY**  on the remote to turn on the Player.

Remote Control Buttons 17

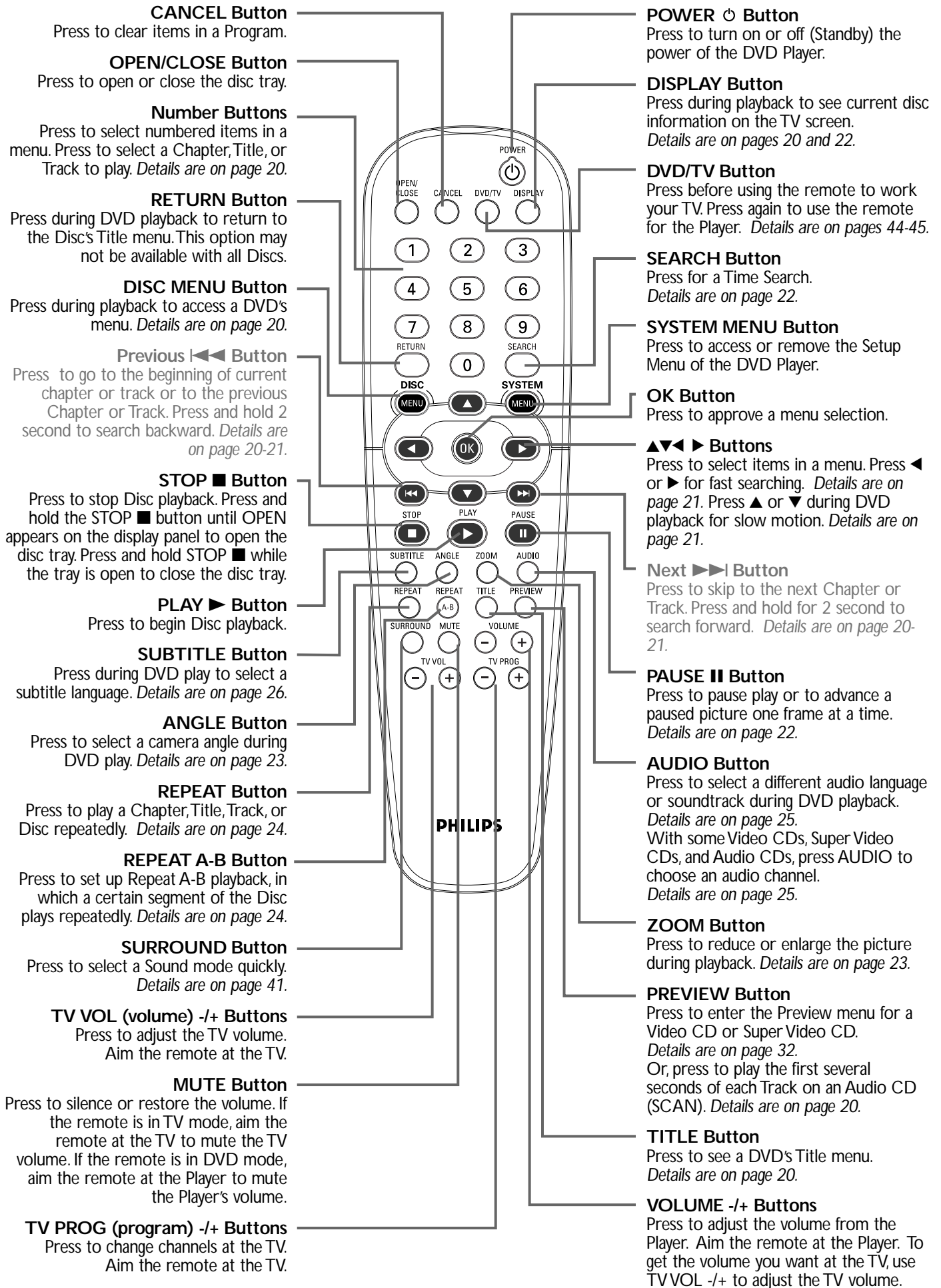

18 Front Panel

STANDBY-ON Button

Press to turn the DVD Player on or off (Standby). A red light will appear on the front of the Player when the power is off (Standby).

Disc Tray

Insert a Disc here. Load the Disc with the label facing up and the shiny side facing down. If the Disc is two-sided, place the Disc in the tray with the label of the side you want to play facing up. *Details are on page 16.*

Display Panel

Current Disc details appear here, including the elapsed playing time of a Disc. SEARCH, PAUSE, STOP (play is stopped), MUTE (ON or OFF), OPEN, CLOSE, LOAD, OFF (power is turning off), ROOT, or Repeat messages also appear here to indicate the current status of the Player or Discs.

To adjust the brightness of the display panel, set DISPLAY DIM. *Details are on page 39.*

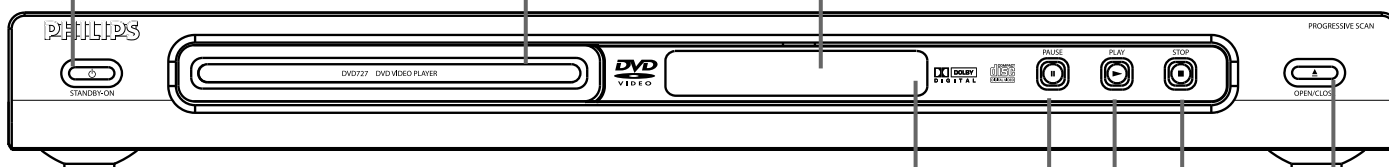

Remote sensor

This sensor receives the commands from the DVD Player's remote control. When using the Player's remote to operate the Player, point the remote here (not toward your TV).

PAUSE button

Press during playback to pause play; press again to resume play from the same point.

PLAY button

Press to start playing a Disc.

STOP button

Press once to stop Disc playback. Play will resume from the same point the next time you start playback. *Details are on page 16.*

Or press STOP  twice to stop Disc playback. Play will resume from the beginning of the Disc the next time you start playback.

You must stop playback by pressing STOP  twice in order to access PREFERENCE SETUP in the DVD Player's Setup menu.

OPEN/CLOSE button

Press to open or close the Disc tray.

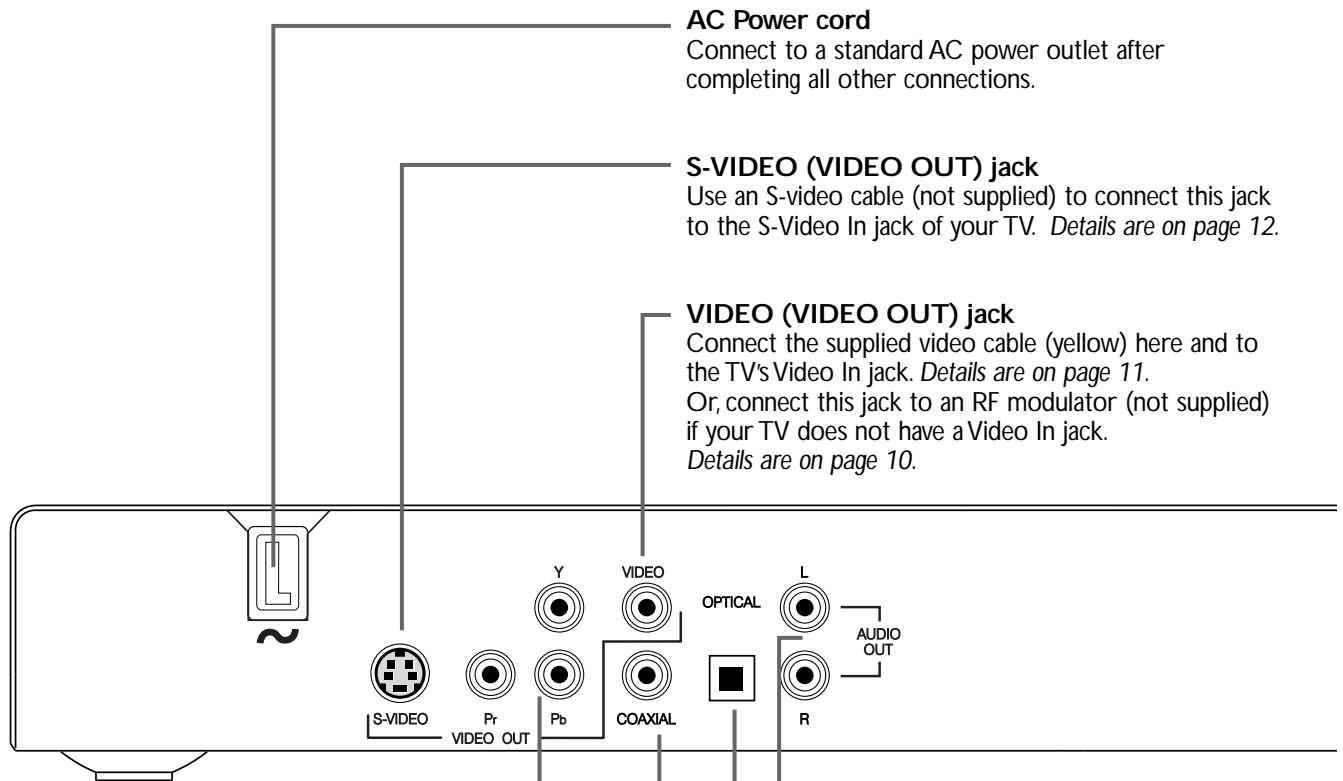

AC Power cord

Connect to a standard AC power outlet after completing all other connections.

S-VIDEO (VIDEO OUT) jack

Use an S-video cable (not supplied) to connect this jack to the S-Video In jack of your TV. *Details are on page 12.*

VIDEO (VIDEO OUT) jack

Connect the supplied video cable (yellow) here and to the TV's Video In jack. *Details are on page 11.*
Or, connect this jack to an RF modulator (not supplied) if your TV does not have a Video In jack. *Details are on page 10.*

Y Pb Pr (VIDEO OUT) jacks

Connect component video cables (not supplied) here and to the Component Video In jacks of a TV. The jacks are usually green, blue, and red. *Details are on page 13.*
If your TV has Progressive Scan, set PROGRESSIVE to ON at the Player for the best picture. *Details are on page 38.*

COAXIAL jack

Connect a digital audio coaxial cable (not supplied) here and to the Digital Audio Coaxial In jack of a Stereo. *Details are on page 15.*

OPTICAL jack

Connect a digital audio optical cable here and to the digital audio optical In jack of a Stereo. *Details are on page 15.*

AUDIO OUT (left/right) jacks

Connect the supplied audio cables (red and white) here and to the AUDIO IN jacks on your TV, Stereo, or RF Modulator. *Details are on pages 10-14.*

Helpful Hint

- You only need one audio and one video connection between a TV and the Player, so you will not use all the jacks on the Player.

20 Title/Disc Menus, Chapter/Track Selection

DVD

Title/Disc menus

- 1 Press **DISC MENU** during DVD playback. The main Disc menu (or Root menu) will appear. The menu may list camera angles, spoken language and subtitle options, and Chapters for the Title.
Or, if the current Title has a specific Title menu, press the **TITLE** button to access the Title menu. Title menus are not available on all Discs.
- 2 Press **▲▼◀▶** to select items in the menu, then press **OK**. Continue until you set up all the features you want or until playback begins. If Chapters or options are numbered, press the appropriate Number button to select the item. Some DVDs may not allow you to operate the Disc menu this way. Follow the instructions on the Disc.

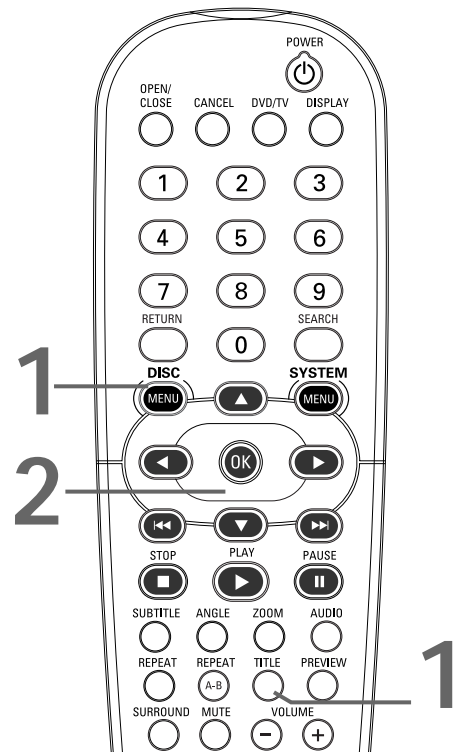

DVD AUDIO CD VIDEO CD

Chapter/Track Selection

- A Press **Next ▶▶** during playback to go to the next Track/Chapter. Press **Previous ◀◀** to go to the beginning of the current Tracks/Chapters, press **Previous ◀◀** again within two seconds to go to previous Tracks/Chapters.
- B To go directly to any Track/Chapter during playback, press the **Number** buttons to enter the Track/Chapter number. Precede single-digit numbers with a zero. For example, for Track six, press 0,6. Play will resume from the beginning of the Track/Chapter you selected.
If you enter an invalid number, the current Track/Chapter will continue to play. Make sure the Track/Chapter number you enter is available on the Disc. Make sure a Chapter is available within the current Title.
- C During DVD or Video CD play only, you can select a Track, Title, or Chapter in the display. Press **DISPLAY**, then press **▼** to select **TITLE**, **CHAPTER**, or **TRACK**. Then press **OK**. Press the **Number** buttons to enter the Title, Chapter, or Track number you want. Precede single-digit numbers with a zero. (The zero may be entered for you already in the display.) Play will resume at the beginning of the Title, Chapter, or Track you selected. Press **DISPLAY** again to remove the display.

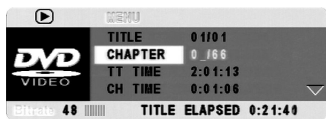
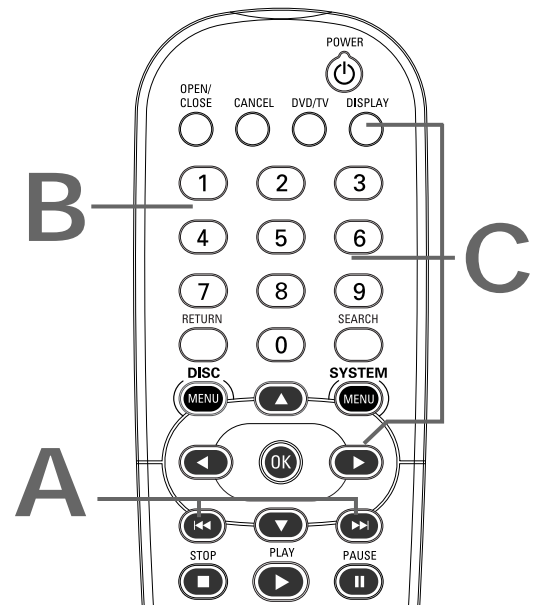

DVD example

Helpful Hints

- To scan all the Tracks on an Audio CD, press **PREVIEW**. The first several seconds of each Track will play. After each Track is introduced, Disc play will start from the first Track. Or, to start play at a Track you find during scanning, press **PREVIEW** again. **SCAN** will appear in the top left corner of the TV screen during Track scanning.
- The Display method of Track selection is not available for Audio CDs.
- When DVD play is stopped, press the **Number** buttons, then **OK**, to select a Title to play.

Slow Motion, Fast Forward and Fast Reverse 21

DVD

VIDEO CD

Slow Motion

- 1** During Disc playback, press **▼** to play the Disc forward at 1/2, 1/4, 1/8, or 1/16 the normal speed. The sound will be mute during slow motion playback.
Or, press **▲** to play a DVD backward at 1/2, 1/4, 1/8, or 1/16 the normal speed. Slow reverse is not possible on Video CDs.
- 2** To return to normal playback, press **PLAY ►**.

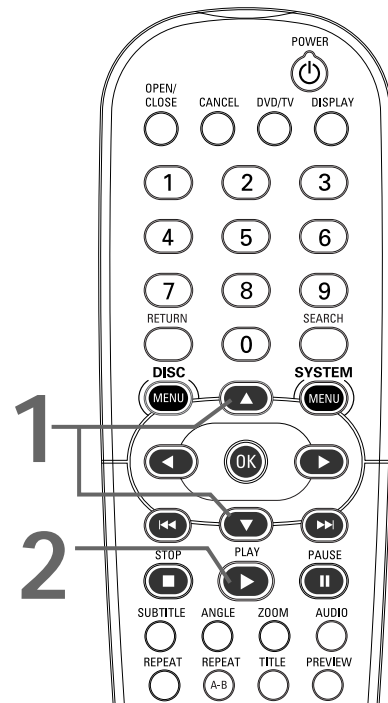

DVD

VIDEO CD

AUDIO CD

Fast Forward and Fast Reverse

- 1** To fast forward a DVD or Video CD, press **►** repeatedly to select two, four, eight, 16, or 32 times the normal speed. Or, press and hold Next **►►** until the Fast Forward icon shows on the TV. Then, press and hold Next **►►** repeatedly to select different searching speeds. Sound will be mute.

Or, press **◄** repeatedly to play the DVD or Video CD backward at two, four, eight, 16, or 32 times the normal speed. Or, press and hold Previous **◄◄** until the Fast Reverse icon shows on the TV. Press and hold Previous **◄◄** repeatedly to select different searching speeds. The sound will be mute.

To fast forward an Audio CD at two, four, eight, 16, or 32 times the normal playback speed, press **►** repeatedly during playback. Or press and hold Next **►►** for two seconds to select a fast forward speed until the Fast Forward icon shows on the TV. Then press and hold Next **►►** to select different searching speeds. Sound will be intermittent.

To fast reverse an Audio CD at two, four, eight, 16, or 32 times the normal speed, press **◄** repeatedly. Or press and hold Previous **◄◄** for two seconds until the Fast Reverse icon shows on the TV. Then press and hold Previous **◄◄** to select different searching speeds. Sound will be intermittent.

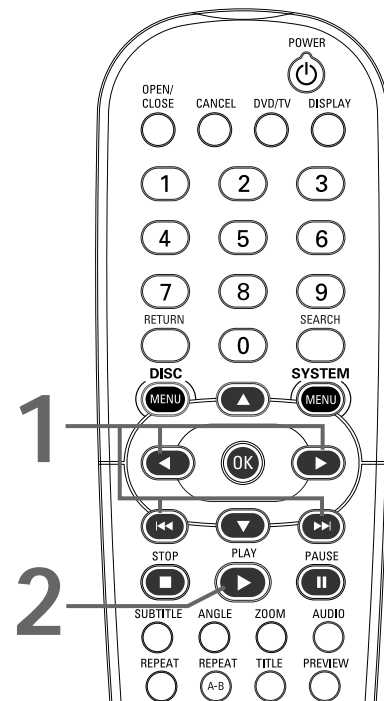

- 2** To return to normal playback, press **PLAY ►**.

22 Still Picture/Frame-by-Frame Playback, Time Search

DVD VIDEO CD

Still Picture/Frame-by-Frame Playback

- 1 To pause a DVD or Video CD picture, press PAUSE **||** on the remote control during playback.
- 2 Press PAUSE **||** repeatedly to advance the still picture one frame at a time.
- 3 Press PLAY **▶** to resume regular playback.

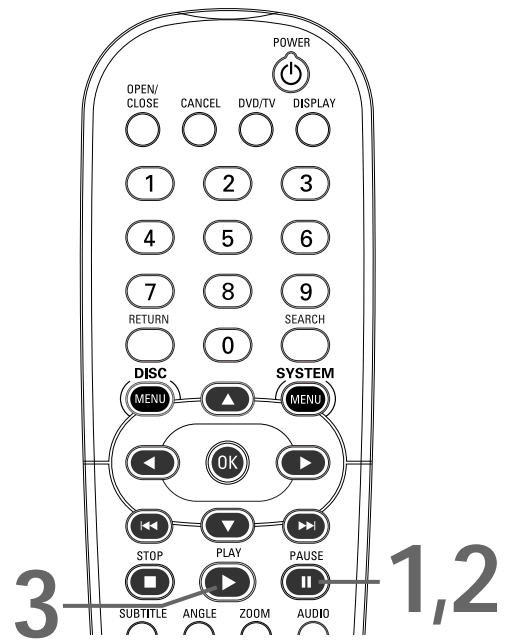

DVD VIDEO CD

Time Search

- 1 Press DISPLAY or SEARCH during playback. Current playback information will appear at the bottom of the TV screen.

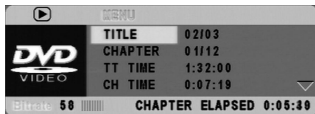

DVD example

- 2 Press **▲** or **▼** to select TIME DISP. Press OK. Press **▲** or **▼** to highlight a display type (see Helpful Hints), then press OK. The display type and its counter will appear at the bottom of the screen.

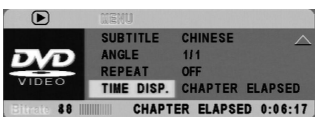

- 3 Press **▲** or **▼** to select TT TIME or CH TIME (DVD), or DISC TIME (Video CD), for example. This shows the total amount of time that the Title, Chapter, or Disc contains.

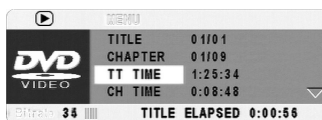

- 4 Press OK to select the time counter beside TT TIME, CH TIME, TRACK TIME, or DISC TIME.
- 5 Press the Number buttons to enter the playing time at which you want to resume playback. (Press **◀** to quit and reselect TT TIME, CH TIME, TRACK TIME, or DISC TIME.) Enter the time in hours, minutes, and seconds. Play will start at that point.
- 6 Press DISPLAY or SEARCH to remove the information.

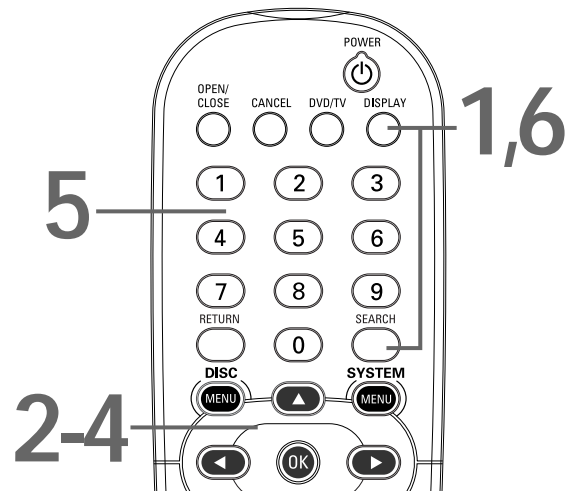

Helpful Hints

- If you pause a picture for more than five minutes, the screen saver will appear (if it is on). Details are on page 43.
- The following display types will be available, depending on the Disc in the Player.
 CHAPTER ELAPSED - elapsed playing time of current Chapter;
 CHAPTER REMAIN - remaining playing time of current Chapter;
 TITLE ELAPSED - elapsed playing time of current Title;
 TITLE REMAIN - remaining playing time of current Title;
 TOTAL ELAPSED - elapsed playing time of current Disc;
 TOTAL REMAIN - remaining playing time of current Disc.
 SINGLE ELAPSED - elapsed playing time of current Track;
 SINGLE REMAIN - remaining playing time of current Track.
- During the Audio CD play, press SEARCH or DISPLAY repeatedly to change the counter among SINGLE ELAPSED, SINGLE REMAIN, TOTAL ELAPSED or TOTAL REMAIN, the counter you select appears on the top of the TV screen
- You can not access the Display during programmed play.

DVD

VIDEO CD

Zoom/Reduce

You can reduce or enlarge the video image during playback.

- 1 Press **ZOOM** repeatedly during **Disc playback** to make the picture two, three, or four times larger. Or, keep pressing **ZOOM** to reduce the picture to 1/2, 1/3, or 1/4 its normal size.
- 2 Press **▲▼◀▶** to move around in the enlarged picture. The blue box within a larger gray box that appears during zoomed play indicates the position of the zoomed area within the overall picture.
- 3 To return the picture to regular size, press **ZOOM** until the picture returns to its normal size.

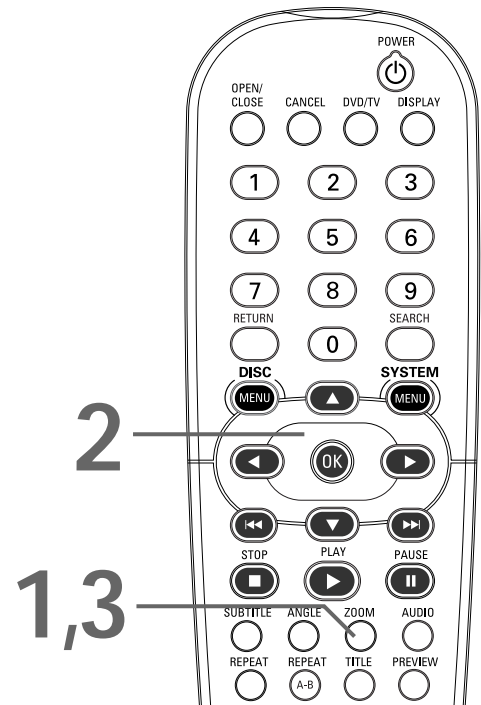

DVD

Camera Angle

Some DVDs include scenes recorded from different angles. To watch segments from a different angle, follow these steps. The DVD must have multiple angles available. Check the DVD Disc case or Disc menu for details and availability.

- 1 During **DVD playback**, press the **ANGLE** button repeatedly to select a different angle.
- 2 In a few seconds, playback changes to the selected angle. If multiple angles are not available, ∅ may appear in the top left corner of the TV screen when you press **ANGLE**.

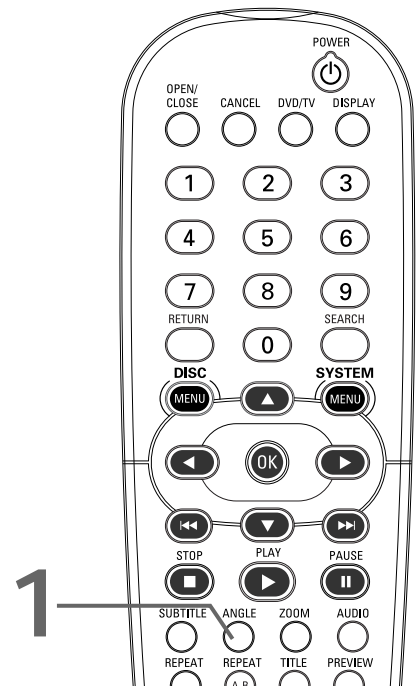

Helpful Hints

- You also can change Angle in the Display. During DVD play, press **DISPLAY** on the remote to access the Display Screen. Press or to highlight **ANGLE**, then press **OK**, use the Number buttons to choose an available angle. Press **DISPLAY** on the remote to remove the display. This feature is not possible on all DVDs.
- Zooming is not available on DVDs that have the PAL color system. Details are on page 7.

24 Repeat/Shuffle, Repeat A-B

DVD

VIDEO CD

AUDIO CD

Repeat/Shuffle

You may play a Chapter, Track, Title, or entire Disc repeatedly.

1 During Disc playback, press **REPEAT** to choose a Repeat option. Depending on the type of Disc, you may choose to play the Chapter, Track, Title, or ALL (Disc) repeatedly. Or, continue to press **REPEAT** to choose **SHUFFLE** or **SHUFFLE REPEAT**. The Tracks, Chapters, and/or Titles will play in random order (**SHUFFLE**) instead of the order recorded (1, 2, 3, etc.). If you choose **SHUFFLE REPEAT**, all the Tracks, Chapters, and/or Titles will play in random order repeatedly.

2 To cancel repeat or shuffled playback, press **REPEAT** until all the repeat and shuffle modes disappear from the TV screen.

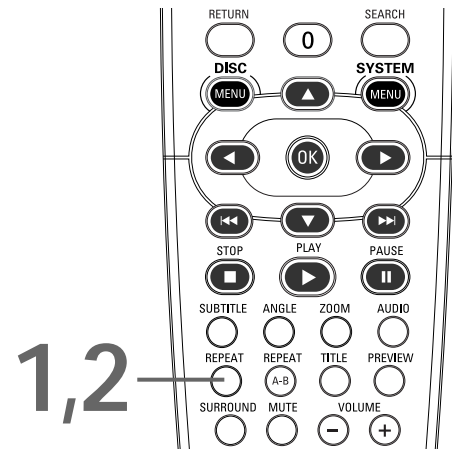

DVD

VIDEO CD

AUDIO CD

Repeat A-B

You also may set the Player to play only a specific portion of a Disc repeatedly. Follow these steps.

1 Press **PLAY** ► to start Disc playback.

2 When the Disc reaches the point at which you want repeated playback to begin, press **REPEAT A-B**.

3 When the Disc reaches the point at which you want to end the segment, press **REPEAT A-B** again. The segment will begin playing repeatedly.

On a DVD, make sure the entire A-B segment is within a single Title. On a Video CD or Audio CD, the A-B segment should be within a single Track. If you do not enter the B setting before the end of the Title or Track is reached, Repeat A-B will be cancelled.

4 To resume regular playback, press **REPEAT A-B** until the repeat mode disappears from the TV screen.

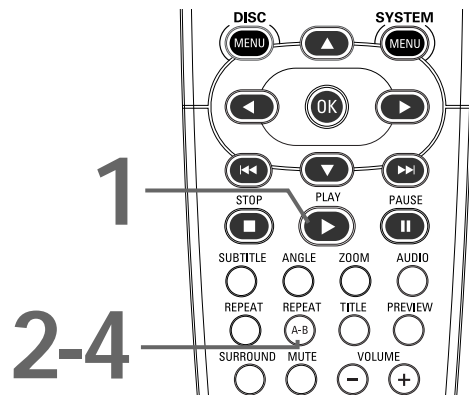

Helpful Hints

- You can not use the Number buttons to play a different Track or Chapter during Shuffled playback.
- If you press **STOP** ■ to stop repeat or shuffled play, when you resume play, **REPEAT** or **SHUFFLE** will be cancelled. On an Audio CD, play will stop at the end of the current Track. When you start play again, play will start at the beginning of the Audio CD.
- You also can set up Repeat Play in the Display. During DVD or Video CD play, press **DISPLAY** on the remote to access the display screen. Press ▲ or ▼ to highlight **REPEAT**, then press **OK**. Press ▲ or ▼ to choose a Repeat mode, then press **OK**. Press **DISPLAY** on the remote to remove the display. This feature is not available with all Discs.

DVD

Some DVDs are recorded in multiple languages; some may have extra audio options such as a director's commentary or a music soundtrack. You can choose the language or the soundtrack that you want to hear by adjusting AUDIO in the PREFERENCE PAGE. To do so, follow the steps below. The easiest way to choose a different audio language or soundtrack is to press the AUDIO button on the remote during DVD playback. The audio will change to the language or soundtrack you select.

- 1 Press **STOP** ■ *twice* to stop DVD playback.
- 2 Press **SYSTEM MENU**.
- 3 Press **▶** to select the **PREFERENCE PAGE** icon at the top of the menu, then press **OK** or **▼**. You can select the PREFERENCE PAGE icon only if you have completely stopped DVD playback by pressing **STOP** ■ twice as directed in step 1.
- 4 **AUDIO** will be selected in green. Press **▶**.



- 5 Language options will appear to the right of AUDIO. Press **▲** or **▼** to choose the language you want, then press **OK**. The selected language will be highlighted in brown. You can only hear these languages if the language is recorded on the DVD.
If there is another language on the DVD that does not show in this AUDIO menu, choose OTHERS, then press OK. At the next screen, press the Number buttons to enter the four-digit language code for the language you want. Use the codes listed on page 49 of this manual. Then, press OK. The PREFERENCE PAGE menu will reappear with a different feature selected.

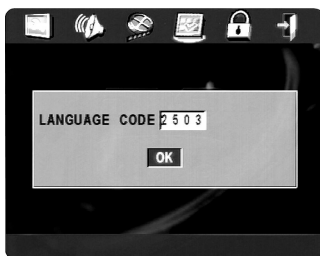

- 6 Press **SYSTEM MENU** to remove the menus.

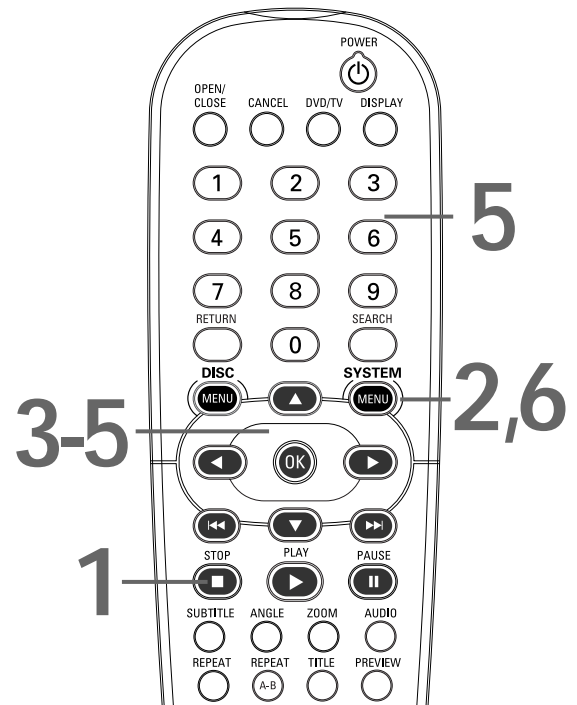

Helpful Hints

- Some Audio CDs, Video CDs, or Super Video CDs are recorded on multiple audio channels. For example, a Karaoke Disc may record music on the left channel and vocals on the right channel. Press **AUDIO** during playback to choose which channels you want to hear. Options may include **MONO LEFT**, **MONO RIGHT**, **MIX-MONO**, or **STEREO**. Check your Disc case for details. If **DIGITAL OUTPUT** is set to **ALL**, you may not be able to select **MONO LEFT** or **MONO RIGHT**. Details are on page 40.
- If adjusting the Audio language as described on this page does not change the Audio, change the settings in the DVD's Disc menu or by pressing the **AUDIO** button repeatedly during DVD playback. Make sure the language you want is available on the current DVD.
- When you press **STOP** twice to stop playback and adjust **AUDIO**, this cancels the Resume feature. When you play the DVD again, playback starts at the beginning of the DVD.
- You also can change the Audio in the Display. During playback, press **DISPLAY** on the remote to access the display screen. Press **▲** or **▼** to highlight **AUDIO**, then press **OK**. Press **▲** or **▼** to choose an audio option, then press **OK**. Press **DISPLAY** on the remote to remove the display. This feature is not available with all DVDs.

26 DVD Subtitle Language

DVD

Some DVDs include subtitles. Choose the language you want for available subtitles by adjusting SUBTITLE in the PREFERENCE PAGE. To do so, follow the steps below.

Or, the easiest way to choose subtitles is to press the SUBTITLE button on the remote repeatedly during DVD playback. The subtitles will appear in the language you select.

- 1 Press **STOP** ■ *twice* to stop DVD playback.
- 2 Press **SYSTEM MENU**.
- 3 Press **▶** to select the **PREFERENCE PAGE** icon at the top of the menu, then press **OK** or **▼**. You can select the PREFERENCE PAGE icon only if you have completely stopped DVD playback by pressing **STOP** ■ twice as directed in step 1.
- 4 Press **▼** to select **SUBTITLE**, then press **▶**.



- 5 Language options will appear to the right of **SUBTITLE**. Press **▲** or **▼** to choose the language in which you want subtitles to appear. Then, press **OK**. The selected language will be highlighted in brown.

You can see subtitles in these languages only if available on the current DVD. Check the DVD case for details on available subtitle languages.

If there is a subtitle language on the DVD that does not show in the Player's SUBTITLE menu, choose **OTHERS** and press **OK**.

At the next screen, press the **Number** buttons to enter the **four-digit language code** for the language you want. Use the codes listed on page 49 of this manual. Then, press **OK**. The PREFERENCE PAGE menu will reappear with a different feature selected.

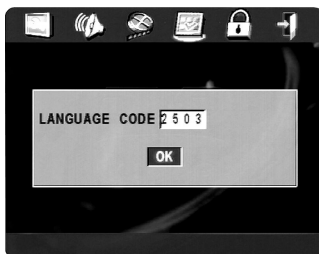

- 6 Press **SYSTEM MENU** to remove the menus.

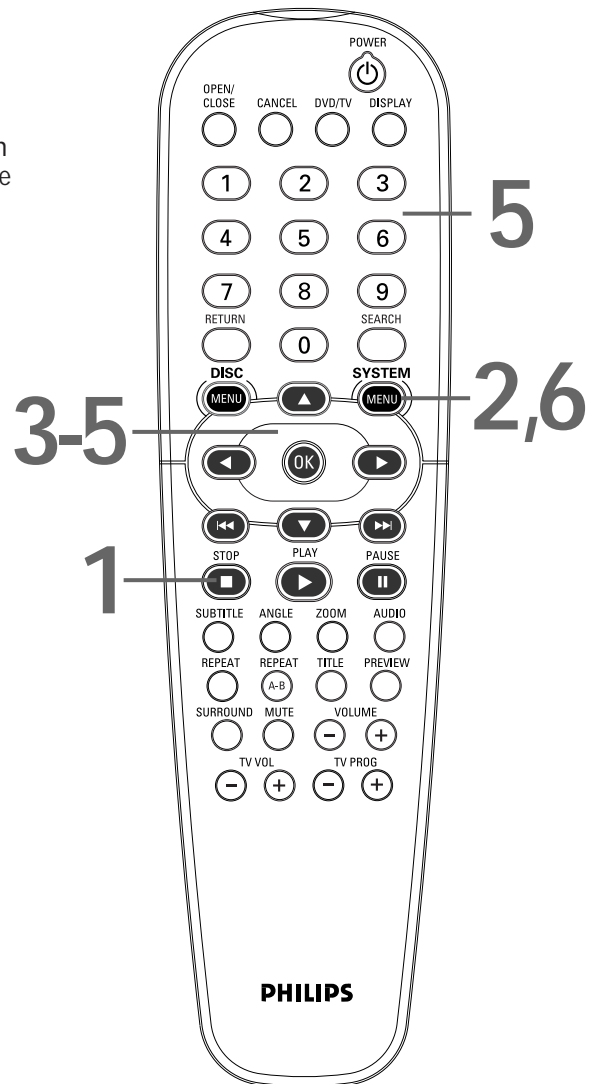

Helpful Hints

- Some DVDs only allow you to choose Subtitle languages in the DVD Disc menu. If adjusting the Subtitle language as described on this page does not change the Subtitles during DVD playback, change the settings in the DVD's Disc menu or by pressing the SUBTITLE button repeatedly during DVD playback. Make sure the language you want is available on the current DVD.
- When you press **STOP** ■ twice to stop playback and adjust SUBTITLE, this cancels the Resume feature. When you start to play the DVD again, playback automatically starts at the beginning of the DVD.
- You also can change the Subtitle language in the Display. During playback, press **DISPLAY** on the remote to access the display screen. Press **▲** or **▼** to highlight SUBTITLE, then press **OK**. Press **▲** or **▼** to choose a subtitle language option, then press **OK**. Press **DISPLAY** on the remote to remove the display. This feature is not available with all DVDs.

DVD

DVDs have a Disc menu that allows you to choose options such as Audio Language, Subtitles, or other special features. Features vary among DVDs, so the menus are different for every DVD.

Some menus may be available in multiple languages. To choose a language for a Disc menu using the PREFERENCE PAGE, follow these steps.

- 1 Press **STOP** ■ twice to stop DVD playback.
- 2 Press **SYSTEM MENU**.
- 3 Press **▶** to select the **PREFERENCE PAGE** icon at the top of the menu, then press **OK** or **▼**. You can select the PREFERENCE PAGE icon only if you have completely stopped DVD playback by pressing **STOP** ■ twice as directed in step 1.
- 4 Press **▼** to select **DISC MENU**, then press **▶**.



- 5 Language options will appear to the right of **DISC MENU**. Press **▲** or **▼** to choose the language in which you want the DVD Disc menu to appear. Then, press **OK**. The selected language will be highlighted in brown.

You can see Disc menus in these languages only if available on the current DVD. Check the DVD case for details on available menu languages.

If there is a menu language on the DVD that does not show in the Player's **DISC MENU** list, choose **OTHERS** and press **OK**.

At the next screen, press the **Number** buttons to enter the **four-digit language code** for the language you want. Use the codes listed on page 49 of this manual. Then, press **OK**. The **PREFERENCE PAGE** menu will reappear with a different feature selected.

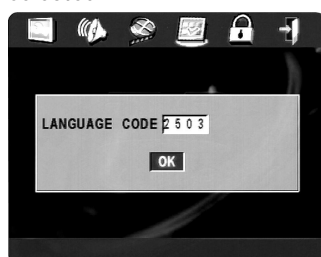

- 6 Press **SYSTEM MENU** to remove the menus.

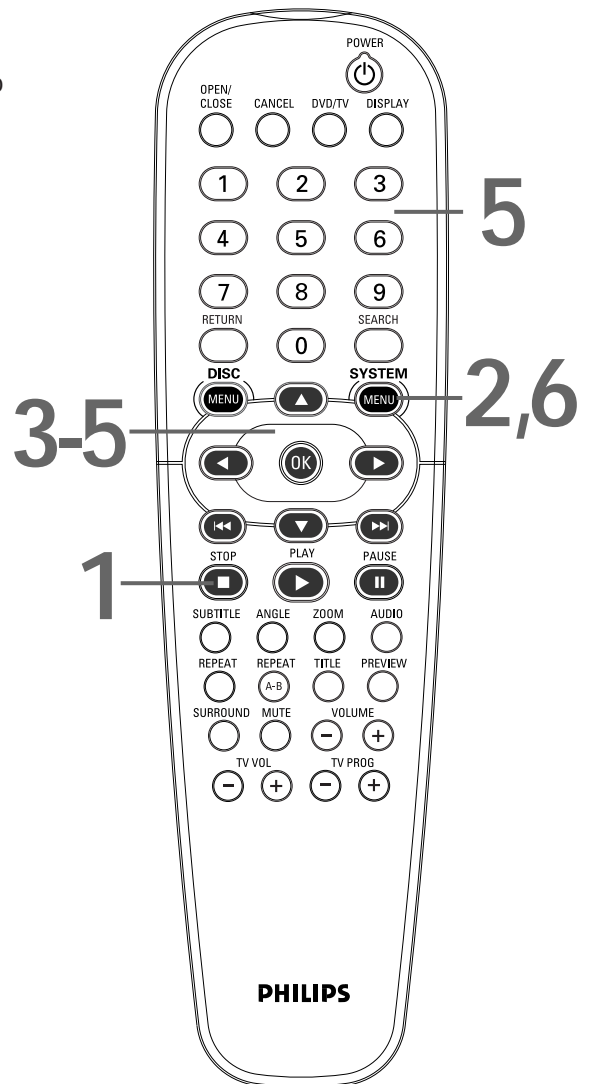

Helpful Hints

- If adjusting the Disc menu language as described on this page does not change the language as you preferred, change the settings in the DVD's Disc menu. Make sure the language you want is available on the current DVD.
- When you press **STOP** ■ twice to stop DVD playback so you can adjust **DISC MENU**, play automatically starts at the beginning of the DVD when you start play again.

28 Parental Password

DVD

The PARENTAL feature limits viewing of DVDs. You need a password to change the PARENTAL settings or to play Locked Discs. To set your password, follow the steps below.

To adjust the PARENTAL level so DVDs cannot play if they exceed that level, see page 30.

To prevent specific DVDs from playing, regardless of how you set the PARENTAL level, see page 29.

- 1 Press **SYSTEM MENU**.
- 2 Press **▶** to select the **PASSWORD SETUP PAGE** icon at the top of the menu, then press **OK** or **▼**. **PASSWORD** will be highlighted in green.

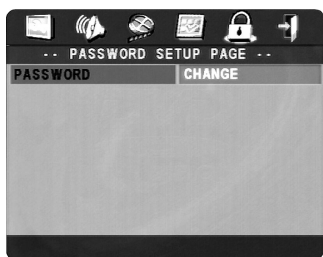

- 3 Press **▶** to highlight **CHANGE** in green, then press **OK**.
- 4 A box beside **OLD PASSWORD** will be highlighted. Press the **Number** buttons to enter your old six-digit password in the **OLD PASSWORD** box. (If this is the first time you have set a password, you do not have to enter an **OLD PASSWORD**. The numbers you enter will go into the **NEW PASSWORD** box automatically instead.) Next, press the **Number** buttons to enter a new six-digit password of your choice in the **NEW PASSWORD** box. Then, press the **Number** buttons to enter the same new six-digit password in the **CONFIRM PWD** box.



- 5 Press **OK** to save the new password. The previous menu will appear.
- 6 Press **SYSTEM MENU** to remove the menus.

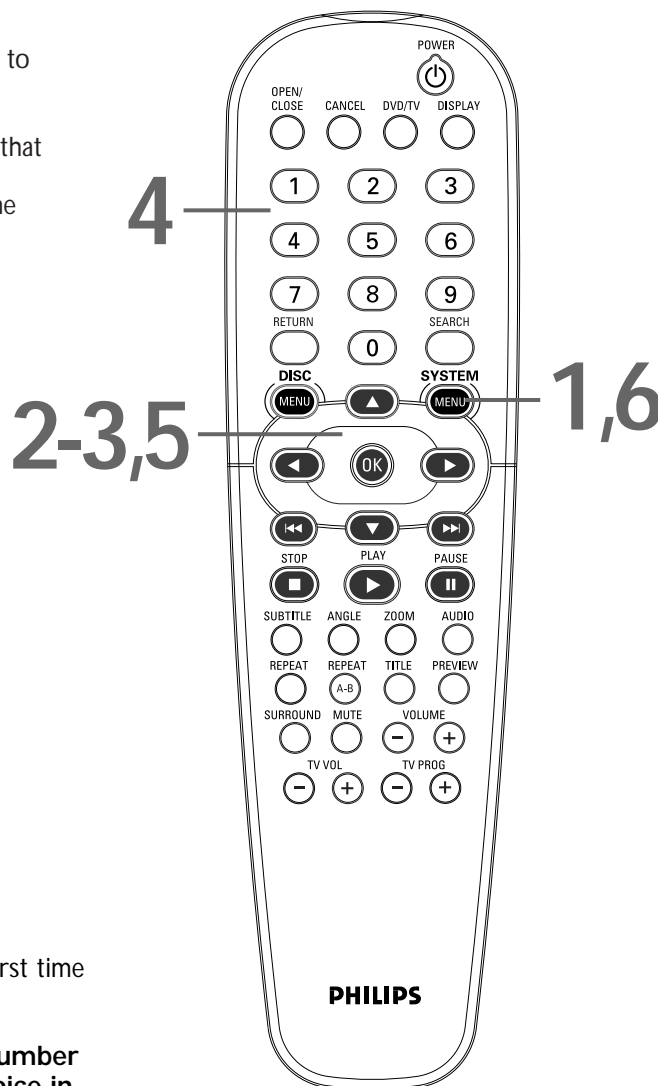

Helpful Hints

- The default or factory preset password is 842100. You can use it to play a Locked Disc or enter it as the old password. The 842100 password is acceptable even after you set your own personal password.
- Philips denies any liability associated with unintended watching of Discs. Make sure your Discs play according to your PARENTAL settings before you allow children access to the Player.
- Your password must have exactly six digits. A series of *s will appear instead of your actual password to protect the password's identity.
- If you make a mistake or can not remember the new password when you get to the **CONFIRM PWD** box, press **SYSTEM MENU** to quit. Then, start again at step 1.

Not all DVDs are rated or coded by the Disc maker. You can specifically lock or unlock a DVD, regardless of its rating. If you lock a specific DVD, you must enter your password before you can watch the DVD. *Password details are on page 28.*

- 1 Press **SYSTEM MENU**.
- 2 The **GENERAL SETUP PAGE** icon will be selected at the top of the menu. Press **OK** or **▼**.
- 3 Press **▼** to select **DISC LOCK**, then press **▶**.

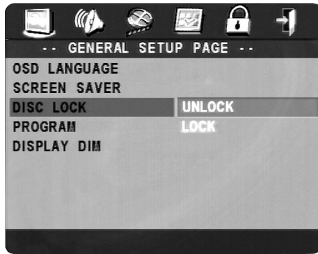

- 4 Press **▲** or **▼** to select **UNLOCK** or **LOCK**, then press **OK**. Your selection will be highlighted in brown. If you choose **UNLOCK**, the DVD that is currently in the DVD Player will be unlocked for future viewing. You can view the Disc without having to enter your six-digit password.
If you choose **LOCK**, the DVD that is currently in the DVD Player cannot play unless you enter your six-digit password. **PLEASE ENTER PASSWORD** will appear on the TV screen to prompt you to enter your password the next time you play the disc. **Press the Number buttons to enter your password, then press OK.** Your password will not appear on the TV screen. This protects its identity. *Password details are on page 28.*
You may need to turn the DVD player off, then on again, for the lock setting to take effect.

- 5 Press **SYSTEM MENU** to remove the menus.

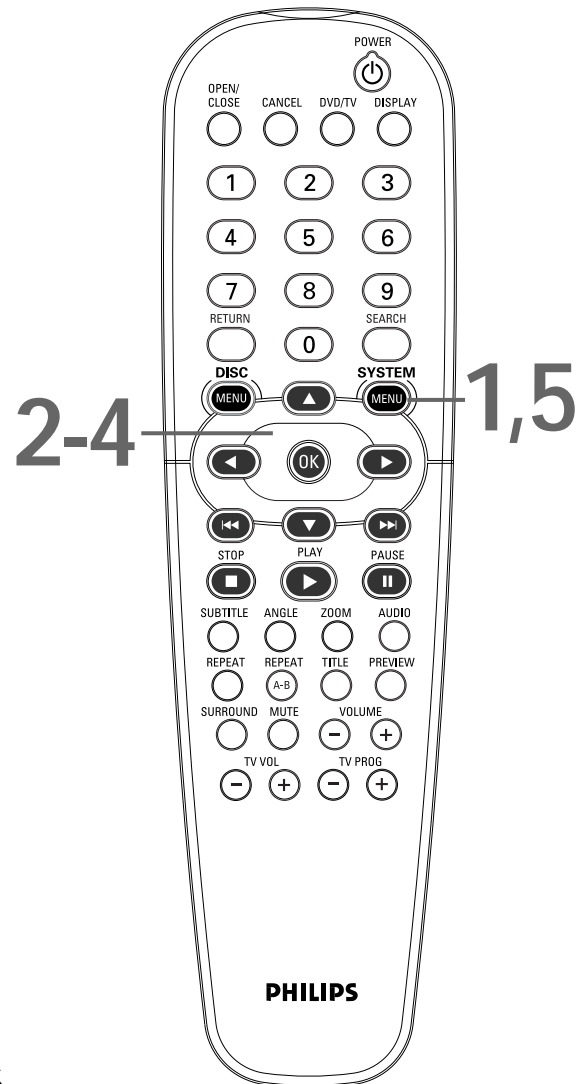

Helpful Hints
<ul style="list-style-type: none"> • <i>Two-sided DVDs may have a different ID for each side. To unlock the entire Disc, unlock each side.</i> • <i>Multi-volume Video CDs or DVD sets may have a different ID for each volume or Disc. To unlock the set, unlock each volume or Disc.</i> • <i>Once you enter your password to play a Locked Disc, you can stop and resume playback without reentering the password every time you resume play. However, if you open the disc tray or turn off the DVD Player, you will have to enter the password to play the Disc again.</i> • <i>You cannot select DISC LOCK if there is no Disc in the Player.</i>

30 Parental Levels

You can set the Player to block or allow playback according to the DVD movie rating. Some DVDs may give you the option of entering your password to allow playback. If not, change the PARENTAL setting so you can watch the Disc.

Not all DVDs conform to the levels you select, as not all DVDs are coded or protected by the DVD manufacturer. Therefore, make sure the DVD plays according to your PARENTAL setting before you allow children unlimited access to the Player or DVDs.

To prevent specific DVDs from playing, regardless of how you set the PARENTAL level, see page 29.

1 Press **STOP** ■ **twice** to stop DVD playback.

2 Press **SYSTEM MENU**.

3 Press **▶** to select the **PREFERENCE PAGE** icon at the top of the menu, then press **OK** or **▼**. You can select the PREFERENCE PAGE icon only if you have completely stopped DVD playback by pressing **STOP** ■ twice as directed in step 1.

4 Press **▼** to select **PARENTAL**, then press **▶**.

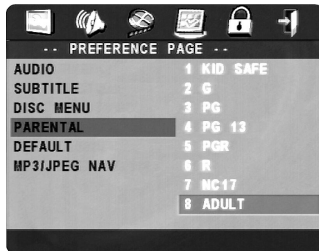

5 Press **▲** or **▼** to choose the Parental level at which you want to restrict playback, then press **OK**.

For example, if you do not want children to watch movies rated above PG, select 3 PG. DVDs rated PG can play without entering a password; however, DVDs rated PG-13, R, NC-17, or X (ADULT) cannot play unless you enter your password.

RATING EXPLANATIONS

- ADULT - Mature material; should be viewed only by adults due to graphic sexual material, violence, or language.
- NC-17 - No children under age 17; not recommended viewing for children under age 17.
- R - Restricted; recommended that parents restrict children under age 17 from viewing or allow children to view only when supervised by a parent or adult guardian.
- PGR - Parental Guidance Required
- PG 13 - Material is unsuitable for children under age 13.
- PG - Parental Guidance suggested.
- G - General Audience; recommended as acceptable for viewers of all ages.
- KID SAFE - Safe for children to view

6 A screen will prompt you to enter your password. Press the **Number buttons** to enter your **six-digit password**, then press **OK**. The Parental settings will appear, with the level you selected highlighted in brown. Your password will not appear on the TV screen, but Xs will show as you enter each digit. Password details are on page 28.

7 Press **SYSTEM MENU** to remove the menus.

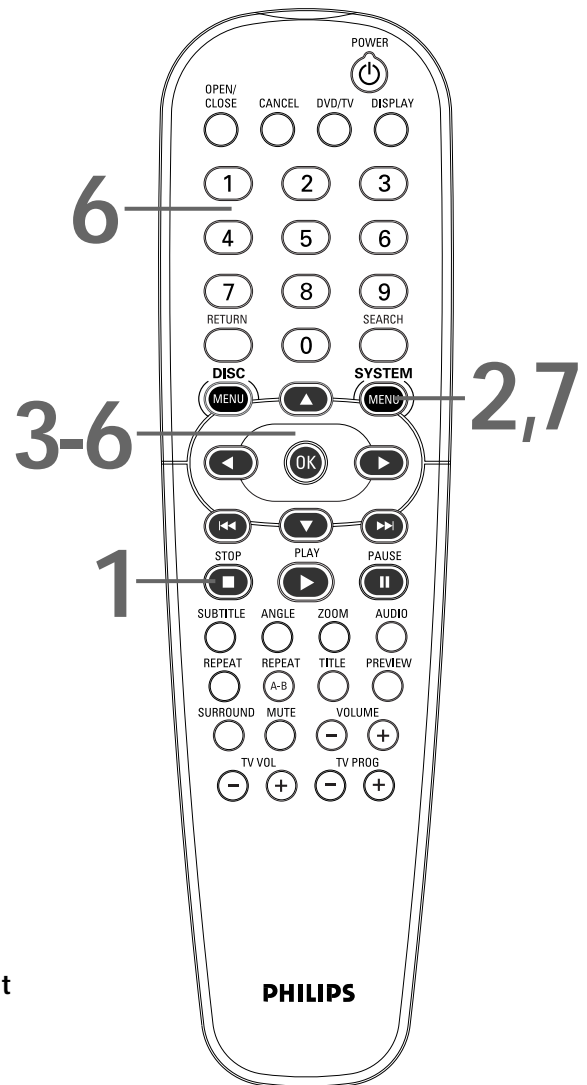

Helpful Hints

- When you press **STOP** ■ twice to stop DVD play so you can adjust the PARENTAL level, play starts at the beginning of the DVD when you resume play.
- The PARENTAL settings do not affect Video CDs, Super Video CDs, or Audio CDs. PARENTAL only affects DVD playback.

DVD

AUDIO CD

VIDEO CD

You may play Tracks or Chapters in an order you specify instead of normal order (1, 2, 3, etc.). The order you set is a Program. For example, if you want to set up an Audio CD so Track 12 will play first, put Track 12 in Program position number one (1).

To set up a Program, follow these steps.

- 1 Press **SYSTEM MENU**.
- 2 The GENERAL SETUP PAGE icon will be selected. Press **OK** or **▼**.
- 3 Press **▼** to select **PROGRAM**.

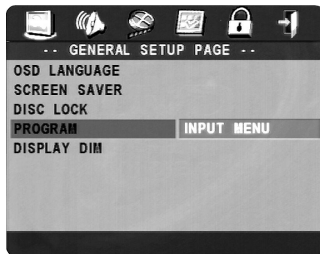

- 4 Press **▶** to select **INPUT MENU**, then press **OK**. The PROGRAM menu will appear. This is where you enter the Track/Chapter numbers in the order in which you want to play them. The Number 1 space will be selected automatically as your starting point. **While the Number 1 space is highlighted, press the Number buttons to enter the Title and/or Chapter/Track number you want to play first.** The number of available Titles, Chapters, or Tracks will appear at the top of the screen.

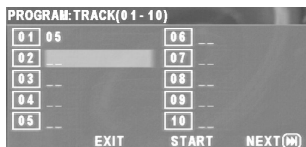

Audio CD example

- 5 Use the **Number** buttons on the remote to enter other Titles/Chapters/Tracks. Use the **▲ ▼ ◀ ▶** buttons to move to other Program positions. Repeat this process to fill the Program.

If you enter an incorrect Title/Chapter/Track number, press **▲ ▼ ◀ ▶** to select the Program position. Use the Number buttons to reenter the correct Title/Chapter/Track number.

To delete an item from the Program, use the **▲ ▼ ◀ ▶** buttons to select it. Then, press **OK** or **PLAY ▶** to erase the item.

- 6 **When you have entered all the items you want, press ▼, ◀, and/or ▶ to select START at the bottom of the screen. Then, press OK.** This will store the Tracks in the Program. The Program will start playing automatically. You can start playing a Program only from the Program menu.

To resume normal playback, press **STOP ■** twice to stop playing the Program. Press **PLAY ▶** to start play at the beginning of the Disc.

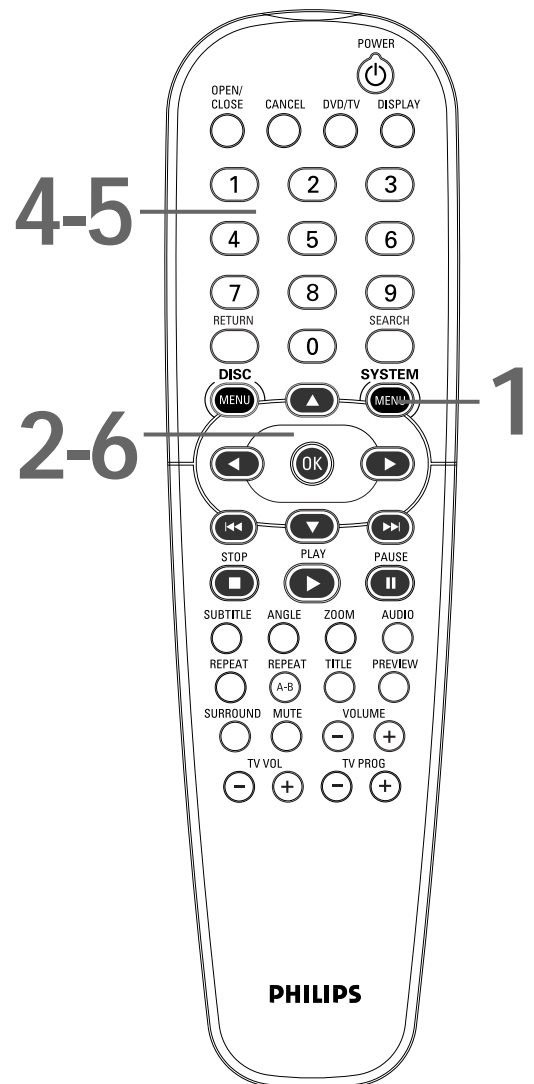

Helpful Hints

- To access other Program pages, press Previous **◀◀** or Next **▶▶**.
- To stop entering Tracks in the Program, press **▼** and **◀** or **▶** to select **EXIT** at the bottom of the screen, then press **OK**. The Disc will resume play in normal order.
- The Program will accept a Title/Chapter/Track number only if it is on the current Disc.
- A Program can have up to 20 Tracks/Chapters.

32 Preview

VIDEO CD

Some Video CDs or Super Video CDs may contain preview or introductory information. If you are not sure of the contents of a Video CD or its Tracks, use the Preview features to see the content of the Tracks. Not all Video CDs contain this information. See your Disc case for details.

1 Press the PREVIEW button to see the Preview menu.

```
SELECT DIGEST TYPE:
TRACK DIGEST
DISC INTERVAL
TRACK INTERVAL
```

2 Press ▲ or ▼ to select TRACK DIGEST, DISC INTERVAL, or TRACK INTERVAL, then press OK.

- If you select **TRACK DIGEST**, the first five seconds of each Track will play. This introduces you to the contents of each Track on the Disc.

Six Tracks will show on one screen. To see other Tracks, press Previous ◀◀ or Next ▶▶ on the remote.

To play a certain Track, press ▲ to go to the SELECT line in the display at the bottom of the TV screen. Press the Number buttons to enter the Track you want. Then, press OK to start playback.

```
TYPE: TRACK
SELECT (01-09) : --
EXIT MENU
```

- If you select **DISC INTERVAL**, the Disc contents will be divided into six segments. This helps you preview the contents of the entire Disc. To start playing the Disc from a certain interval, press ▲ to go to the SELECT line in the display at the bottom of the screen. Press the Number buttons to choose a segment (1-6), then press OK to start play from that point.

```
TYPE: DISC INTERVAL
SELECT (01-06) : --
EXIT MENU
```

- If you select **TRACK INTERVAL**, the current Track will be divided into six parts. This helps you see the contents of the current Track. To play the Track from a certain interval, press ▲ to go to the SELECT line in the display at the bottom of the screen. Press the Number buttons (1-6) to choose a segment, then press OK to start play from that point.

```
TYPE: TRACK 01 INTERVAL
SELECT (01-06) : --
EXIT MENU
```

3 To remove the PREVIEW menus, press PREVIEW again or press ▼ and/or ◀ to choose EXIT, then press OK.

To go to the first PREVIEW screen, press ▼ and/or ▶ to select MENU, then press OK.

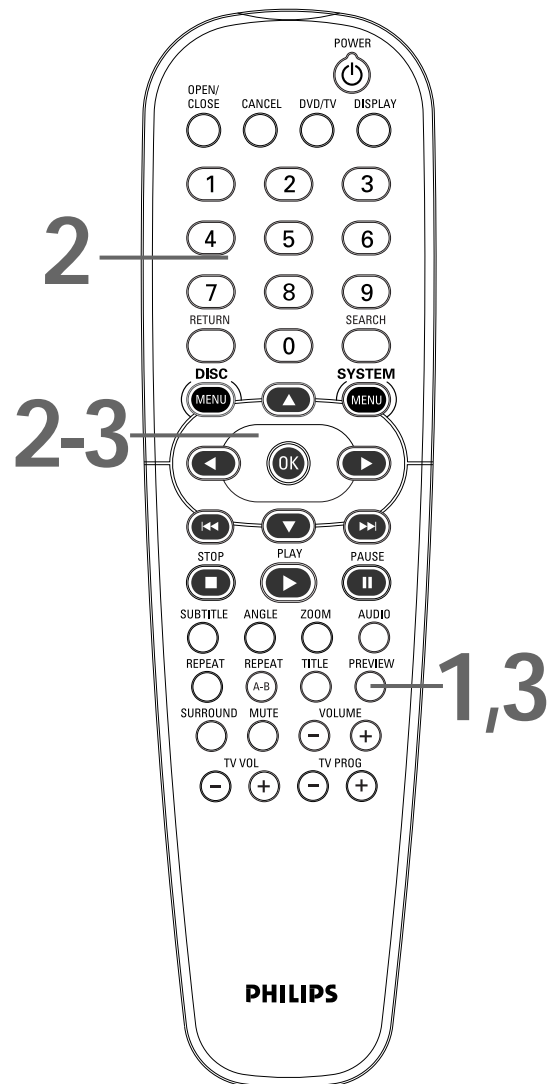

This DVD Player can play some Compact Disc-Recordable (CD-R) discs that you record on your computer. These CD-Rs may contain pictures in a JPEG format or audio files/tracks in an MP3 format. For example, you may have photographic film developed by a retailer that places the pictures on a CD-R for you. These pictures may be in JPEG format. Or, you may copy or download MP3 music files from certain legal Internet sites, then copy those files onto a CD-R. (You cannot make or record such CD-Rs using this DVD Player. See your computer manual for details on making CD-R recordings.)

If you are playing a CD-R on this Player and the CD-R contains JPEG or MP3 files, you may want to access the CD-R menu using Navigator.

- 1** Press **STOP** ■ during MP3 playback or press **DISC MENU** during JPEG playback to stop Disc playback completely.
- 2** Press **SYSTEM MENU**.
- 3** Press **▶** to select the **PREFERENCE PAGE** icon at the top of the menu, then press **OK** or **▼**. You can select the PREFERENCE PAGE only if Disc play is stopped.
- 4** Press **▼** to select **MP3/JPEG NAV (Navigator)**, then press **▶**.
- 5** Press **▲** or **▼** to select **WITHOUT MENU** or **WITH MENU**, then press **OK**. Your selection will be highlighted in brown. If you select **WITHOUT MENU**, all individual Tracks will be listed in order in the menu. If you select **WITH MENU**, both Folders and Individual Tracks show in the menu. You must open the Folders (by selecting and pressing **OK**) to see the Tracks that are available inside the Folders.

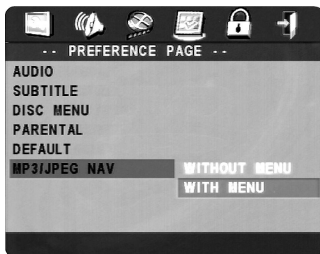

- 6** Press **SYSTEM MENU** to remove the menus.

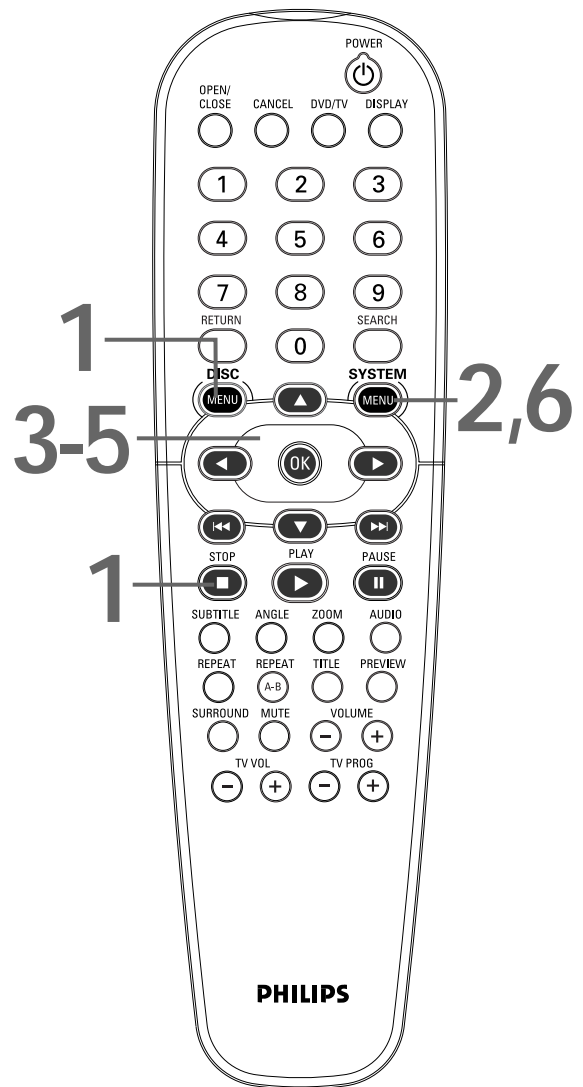

34 JPEG and MP3 Features

General Information on CD-R and CD-RWs

- When you make CDs to play on this DVD Player, the Disc should have at least 6-10 pictures or 2-3 MP3 music files. Make sure there are at least 3 MB (three megabytes) of information on the Disc. The maximum number of files per folder is 500.
- JPEG file names should end with the ".jpg" extension.
- To select a JPEG or MP3 file for playback, press the Number buttons to select an item, then press OK. Or, press ▲ or ▼ to select an item, then press OK.

JPEG features

- Press ▲ or ▼ to highlight an item in the Disc's menu, then the picture will be previewed on the right side of the menu.
- While playback is stopped, you will see miniature images of the pictures. A maximum of 12 images will appear. Press Previous ◀◀ or Next ▶▶ to see the other pictures on the Disc.
- Press ZOOM to enlarge a JPEG image. Press ▲, ▼, ◀, or ▶ to move or pan through the picture.
- When play is stopped, press ▼ and ◀ to select the filmstrip icon at the bottom of the screen, then press OK. This will start play at the first picture on the current page.
- During JPEG playback, press ▲, ▼, ◀, or ▶ to flip or rotate the image.
- Press the ANGLE button repeatedly during playback to determine how the images will progress or "scan" in and out.

Repeat/Shuffle

- During JPEG play, press REPEAT to choose:
 - REPEAT ONE - Keep the current JPEG image still on the screen.
 - REPEAT ALL - Play all files on the Disc repeatedly.
 - SHUFFLE - Play files in random order.
 - REPEAT OFF - Cancel all repeat options and resume normal playback.
- While the menu is on the screen, press REPEAT to choose:
 - FOLDER - All files in the current folder will play once.
 - REPEAT ONE - Keep a JPEG image still on the screen or play an MP3 file repeatedly.
 - REPEAT FOLDER - Play files in the selected folder repeatedly.
 - SHUFFLE - Play files in random order.

MP3 Program

- 1 While the Disc menu is on the screen and play is stopped, press ◀ to switch into the FILELIST. FILELIST will flash briefly at the bottom of the screen.
- 2 Press ▲ or ▼ to choose a Track to add to the playlist, then press ▶. ADD TO PLAYLIST will appear briefly at the bottom of the screen. (To remove an item from the Program, press ◀ to go to the PLAYLIST. Press ▲ or ▼ to choose the item, then press ▶ to remove it. REMOVE FROM PLAYLIST will appear briefly at the bottom of the screen.) The maximum number of files for a Program is 100.
- 3 To play the Program, press ◀ to go to the PLAYLIST. PLAYLIST will flash briefly at the bottom of the screen. press ▲ or ▼ to select any item in the PLAYLIST, then press OK to start playing the Program from that point.

Playing MP3 and JPEG files simultaneously

"Setting your pictures to music"

- 1 Start playing the MP3 file as described above.
- 2 Select a JPEG for playback as described above.
- 3 To stop simultaneous playback, press DISC MENU to stop JPEG playback. Then press STOP ■ to stop MP3 playback.

You may set the DVD Player to display video in one of three formats: Letter Box, Pan & Scan, or Widescreen (16:9). To choose a format, follow these steps. The format you select must be available on the DVD. If it is not, the settings for TV DISPLAY will not affect the picture during DVD playback.

- 1 Press **SYSTEM MENU**.
- 2 Press **▶** to select the **VIDEO SETUP** icon at the top of the menu, then press **OK** or **▼**.
- 3 Press **▼** to select **TV DISPLAY**. Then press **▶**.
- 4 Press **▲** or **▼** to select **4:3 PANSCAN**, **4:3 LETTER BOX**, or **16:9 (widescreen)**, then press **OK**. Your selection will be highlighted in brown.

Select **4:3 PAN SCAN** if you want the picture to be trimmed or formatted to fit your TV screen. This setting is possible only if the DVD is recorded in pan & scan or regular format. Check the Disc case for details.

Select **4:3 LETTER BOX** if you want to see the entire, widened picture with black bars at the top and bottom of the screen. This looks like the picture you see when watching movies in a theater. This setting is possible only if the DVD was recorded in the letterbox or widescreen format. Check the Disc case for details.

Select **16:9 (widescreen)** if you connected the DVD Player to a widescreen TV.

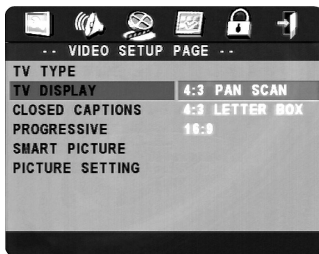

- 5 Press **SYSTEM MENU** to remove the menus.

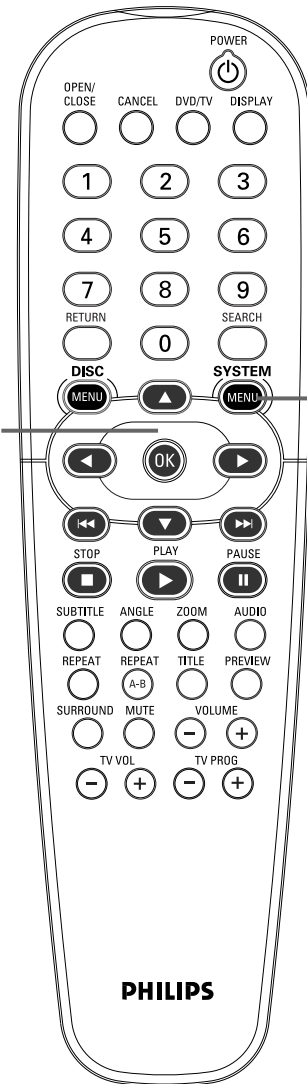
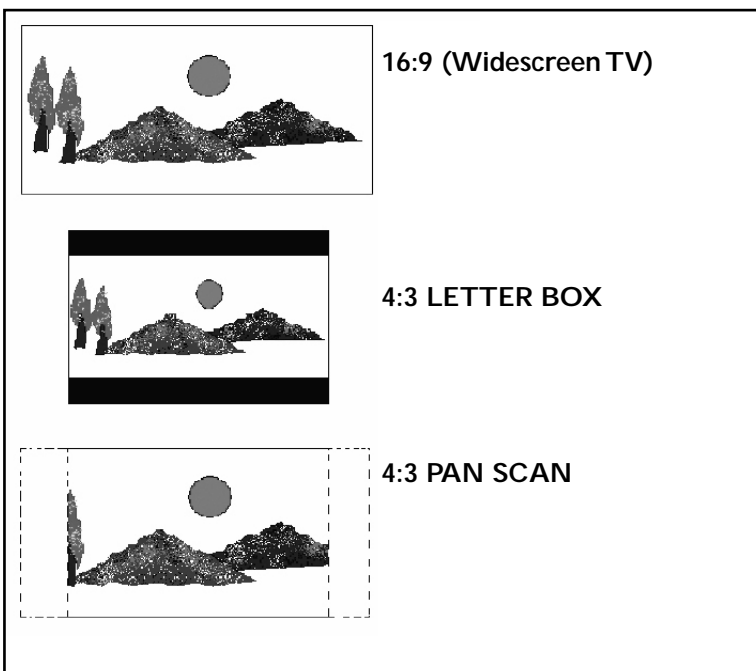

Helpful Hints

- DVDs only play in the format in which they were recorded. For example, if the DVD case says the DVD is recorded in Letterbox or Widescreen format, you may play the DVD only with the black bars showing at the top and bottom of the widened picture. Even if you set TV DISPLAY to 4:3 PAN SCAN, the picture will show in the widened format.
- Some widescreen TVs may show only part of the DVD Player's menu. Adjust the screen mode on your TV. See your TV owner's manual for details.

36 Smart Picture, Picture Setting

Just as you can adjust your picture on your TV, you can adjust some picture elements at the DVD Player. Choose a picture setting that best displays the Disc you are playing. This feature is known as Smart Picture and can be adjusted by following these steps.

- 1 Press **SYSTEM MENU**.
- 2 Press **▶** to select the **VIDEO SETUP** icon at the top of the menu, then press **OK** or **▼**.
- 3 Press **▼** to select **SMART PICTURE**. Press **▶**.
- 4 Press **▲** or **▼** to select **STANDARD**, **BRIGHT**, **SOFT**, or **PERSONAL**, then press **OK**. Your selection will be highlighted in brown.

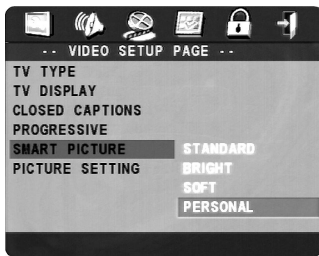

- 5 If you selected **BRIGHT**, **STANDARD**, or **SOFT**, you are finished. Press **SYSTEM MENU** to remove the menus. You may want to play a Disc for a few minutes in each setting to decide which you prefer.

If you selected **PERSONAL**, you can adjust specific picture elements for your preference. Go to step 6 to adjust these items.

- 6 Press **◀** to reselect **SMART PICTURE**. **SMART PICTURE** will be highlighted in green. Press **▼** to select **PICTURE SETTING**, then press **OK**.

- 7 Press **▲** or **▼** to select **BRIGHTNESS**, **CONTRAST**, **TINT**, or **COLOR**, then press **▶**.

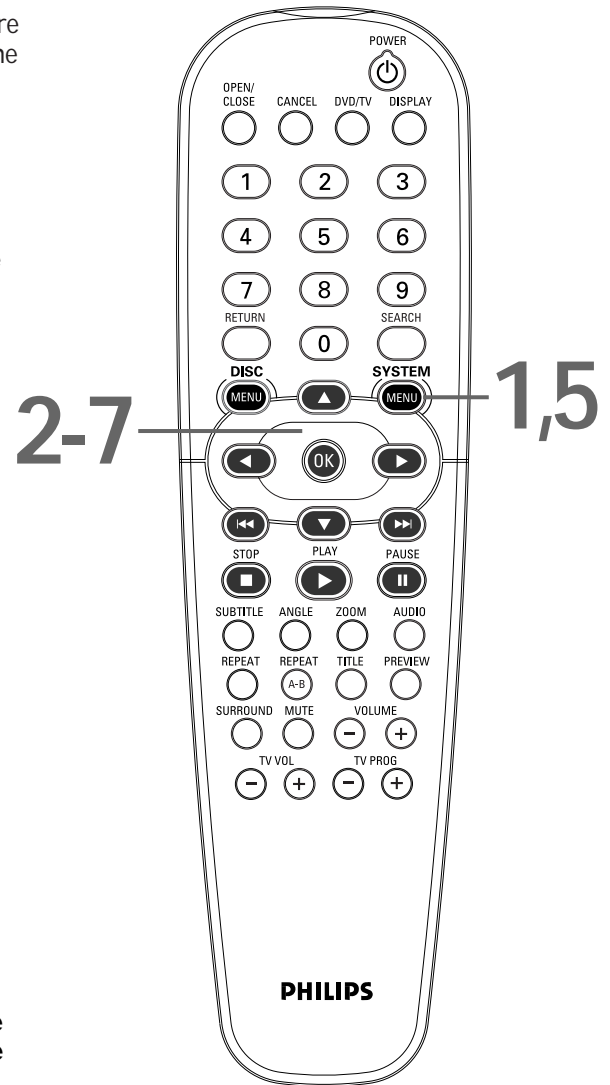
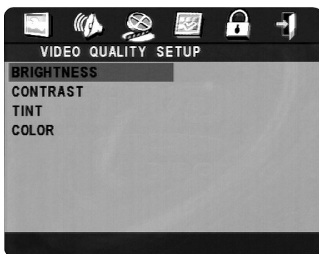

8 An adjustment scale will appear on the TV screen. Press ◀ or ▶ to **adjust** the element you selected.

- For **BRIGHTNESS**, choosing a more positive value brightens the color on the screen and seems to add white to the picture. Choosing a more negative value darkens the colors in the picture. Choose zero (0) for the average setting.
- For **CONTRAST**, choosing a more positive value adds more noticeable difference between the black and white in your picture and sharpens the picture. Choose a more negative **CONTRAST** value to blur the distinction between black and white in the picture. The picture will not seem as sharp.
- For **TINT**, choose a more positive value to add red to the picture. Choose a negative value to add yellow to the picture. Choose zero (0) to balance the reds and yellows in the picture. You can adjust **TINT** when you need people's skin tones to look more natural.
- For **COLOR**, choose a more positive value to increase the color in your picture. To decrease the color in the picture, choose a more negative value. As you decrease the **COLOR**, the picture becomes more black and white. Choose zero (0) to balance the color.

9 Press **OK** to save the setting and return to the **PICTURE SETTING** menu. Repeat steps 7-8 as necessary to adjust all the elements you want.

10 When you are finished, press **SYSTEM MENU**.

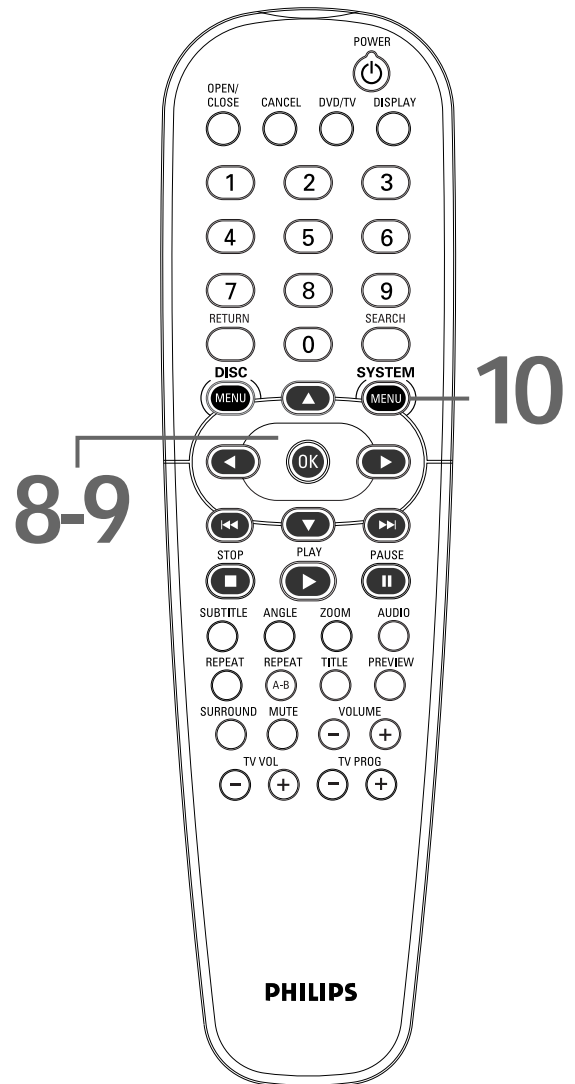

38 TV Type, Progressive Scan

TV Type

DVDs are recorded in a color system, usually NTSC or PAL. NTSC is the most common in the United States. Your TV also has a color system. This Player is compatible with NTSC and PAL. However, the color system of the DVD, the TV, and the Player should match. If all three are not the same, the DVD may play in only black and white, the picture may roll continuously, or the picture may appear distorted. TV TYPE lets you set the Player to match the color systems of your DVDs and your TV.

- 1 Press **SYSTEM MENU**.
- 2 Press **▶** to select the **VIDEO SETUP PAGE** icon at the top of the menu, then press **OK** or **▼**.
- 3 TV TYPE will be highlighted in green. Press **▶**.

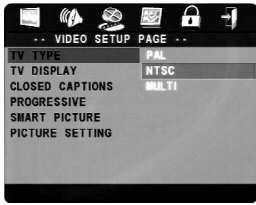

- 4 Press **▲** or **▼** to select **MULTI**, **NTSC**, or **PAL**, then press **OK**. Your selection will be highlighted in brown. Choose NTSC if your TV is NTSC-compatible and your DVDs are recorded in NTSC. Choose PAL if your TV is PAL-compatible and your DVDs are recorded in PAL. Choose MULTI if your TV is compatible with both NTSC and PAL and you want the DVD Player to automatically select the color system of the current DVD.

- 5 Press **SYSTEM MENU** to remove the menus.

Progressive Scan

If you connected the Player to a TV using the Y Pb Pr jacks and your TV has Progressive Scan, set PROGRESSIVE to ON. Otherwise, set PROGRESSIVE to OFF.

- 1 Press **SYSTEM MENU**.
- 2 Press **▶** to select the **VIDEO SETUP PAGE** icon at the top of the menu, then press **OK** or **▼**.
- 3 Press **▼** to select **PROGRESSIVE**, then press **▶**.
- 4 Press **▲** or **▼** to choose **ON** or **OFF**, then press **OK** on the remote. Choose ON only if your TV has Progressive Scan.



- 5 A message will ask you to verify your hookups and the availability of Progressive Scan. Press **▶** or **◀** to choose **OK**, then press **OK**. If Progressive Scan is not detected, the VIDEO SETUP PAGE will reappear. Set PROGRESSIVE to OFF. Or, if you realize you do not have Progressive Scan, choose **CANCEL** and press **OK**. Set PROGRESSIVE to OFF.

- 6 Press **SYSTEM MENU** to remove the menus.

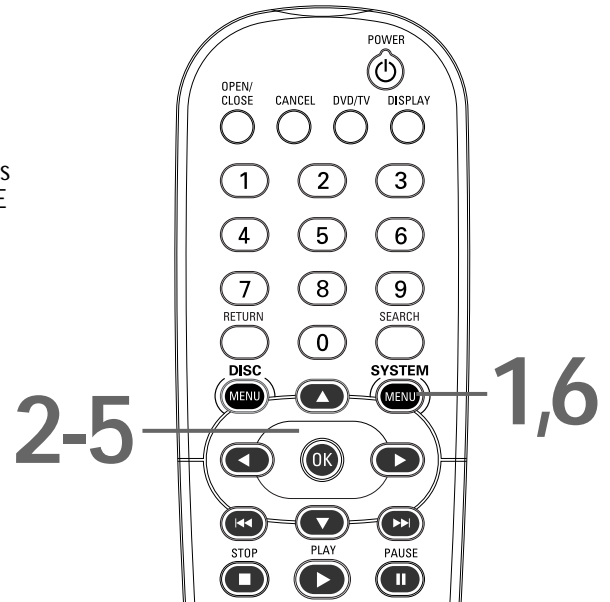
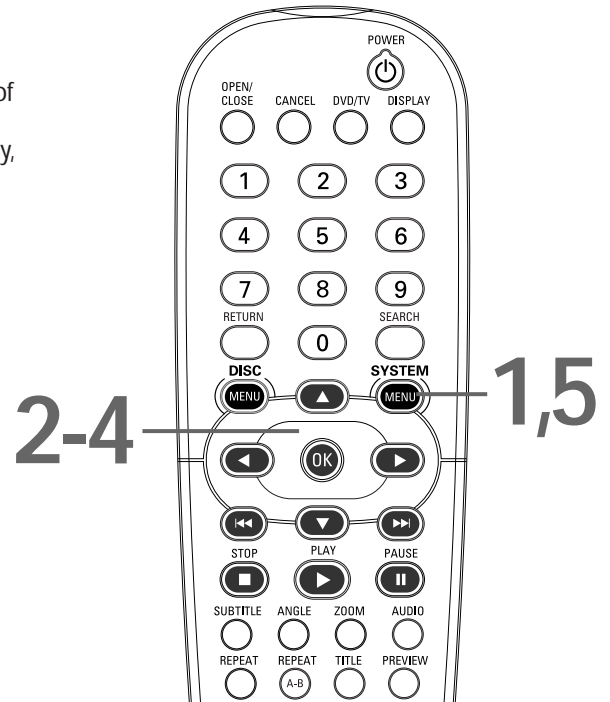

Helpful Hints

- Your DVD must be recorded in NTSC or PAL. Discs recorded in other color systems will not play on this Player. Check the Disc case for details. NTSC or PAL may appear on the inside ring of the DVD.
- You can deactivate Progressive Scan so you can use a different hookup. For example, you may want to change TVs later. To cancel Progressive Scan at the DVD player, open the disc tray. Press **◀** on the remote, then press **MUTE**.

Display Dim

You can adjust the brightness of the display panel on the front of the Player by following these steps.

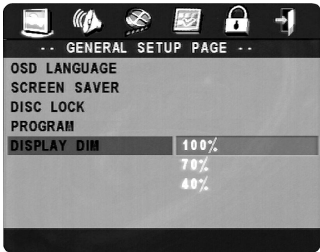
- 1 Press **SYSTEM MENU**.
- 2 The **GENERAL SETUP PAGE** icon will be selected. Press **OK** or **▼**.
- 3 Press **▼** to select **DISPLAY DIM**, then press **►**.
 
- 4 Press **▲** or **▼** to select **100%**, **70%**, or **40%**, then press **OK**. Your selection will be highlighted in brown. The display panel will dim or brighten according to your choice.
- 5 Press **SYSTEM MENU** to remove the menus.

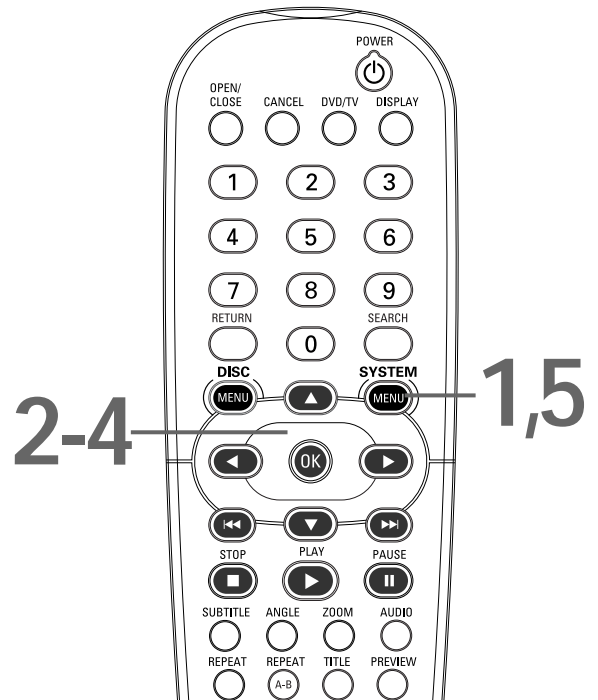

Analog Output

Use the **AUDIO SETUP PAGE** to adjust some of the Player's audio settings. Adjust **DOWNMIX** according to how you connected the Player to your TV and/or Stereo. Balance the volume during playback by adjusting **Dynamic Range Control (D.R.C.)**.

- 1 Press **SYSTEM MENU**.
- 2 Press **►** to select the **AUDIO OUTPUT PAGE** icon at the top of the menu. Press **OK** or **▼**.
- 3 **ANALOG AUDIO SETUP** will be highlighted in green. Press **►**.
- 4 Press **▲** or **▼** to select **DOWNMIX** or **D.R.C.**, then press **►** and follow step 5 according to your choice.
- 5
 - If you selected **DOWNMIX**, press **▲** or **▼** to select **LT/RT (left/right)** or **STEREO**, then press **OK**. Choose **LT/RT** if you connected the Player to a stereo that has Dolby Pro Logic. *Details are on page 14.* Select **STEREO** if you connected the Player to a TV or Stereo that has left and right Audio In jacks but does not have Dolby Pro Logic.
 - If you selected **D.R.C.**, press **▲** or **▼** to select **ON** or **OFF**, then press **OK**. To level the volume during Disc playback, choose **ON**. There will not be such a large range between the loudest and softest parts of the sound. To hear the highs and lows of the volume, set **D.R.C.** to **OFF**.

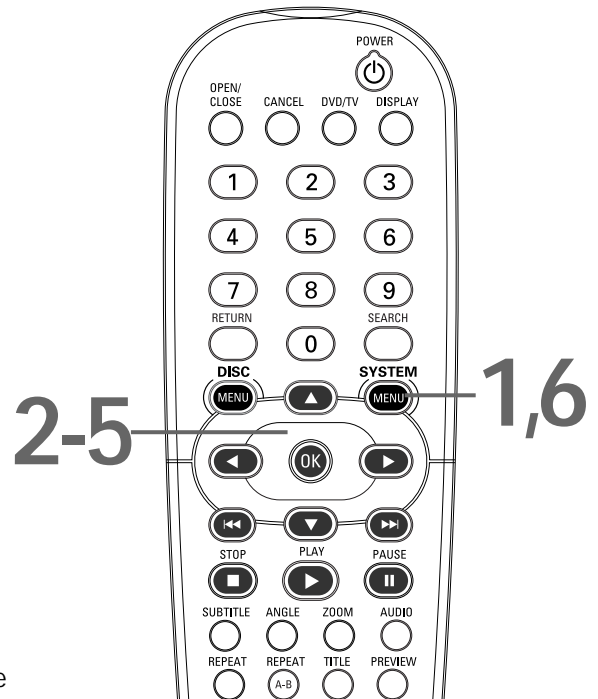
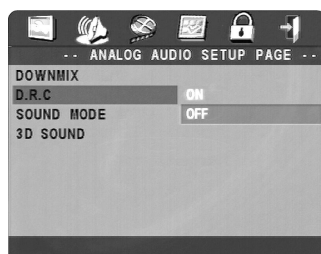

- 6 Press **SYSTEM MENU** to remove the menus.

40 Digital Output, LPCM Output

Digital Output

If you connected the Player to a Stereo using the COAXIAL jack as shown on page 15, adjust DIGITAL OUTPUT (audio) as described below. If you are not using the COAXIAL jack, no adjustment is necessary.

- 1 Press **SYSTEM MENU**.
- 2 Press **▶** to select the **AUDIO SETUP PAGE** icon at the top of the menu. Press **OK** or **▼**.
- 3 Press **▼** to select **DIGITAL AUDIO SETUP**, then press **OK**. **DIGITAL OUTPUT** will be highlighted in green. Press **▶**.
- 4 Press **▲** or **▼** to select **ALL** or **PCM ONLY**, then press **OK**. Choose **ALL** to select the original default audio settings as received by most Stereos. If the sound is distorted, your Stereo may need to receive audio in the PCM format (pulse code modulation, contains only left and right audio signals). Choose **PCM ONLY** if your Stereo is PCM-compatible or cannot decode MPEG-2 or DTS audio. Refer to your Stereo owner's manual for details.

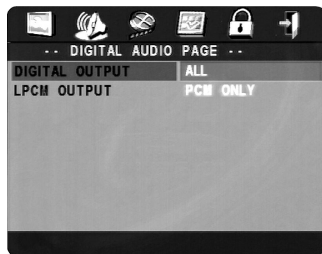

- 5 Press **SYSTEM MENU** to remove the menus.

LPCM Output

If you connected the Player to a Stereo using the COAXIAL or OPTICAL jack as shown on page 15, adjust LPCM OUTPUT. Discs are recorded in a certain sampling rate. The higher the sampling rate, the better the sound quality. Some Discs are recorded in a high sampling rate of 96 kHz. Set LPCM OUTPUT to 96K if you are playing Discs recorded at this high rate. Otherwise, set LPCM OUTPUT to 48K.

- 1 Press **SYSTEM MENU**.
- 2 Press **▶** to select the **AUDIO SETUP PAGE** icon at the top of the menu. Press **OK** or **▼**.
- 3 Press **▲** or **▼** to select **DIGITAL AUDIO SETUP**, then press **OK**. Press **▼** to select **LPCM OUTPUT**, then press **▶**.
- 4 Press **▲** or **▼** to select **48K** or **96K**, then press **OK**. Your selection will be highlighted in brown.



- 5 Press **SYSTEM MENU** to remove the menus.

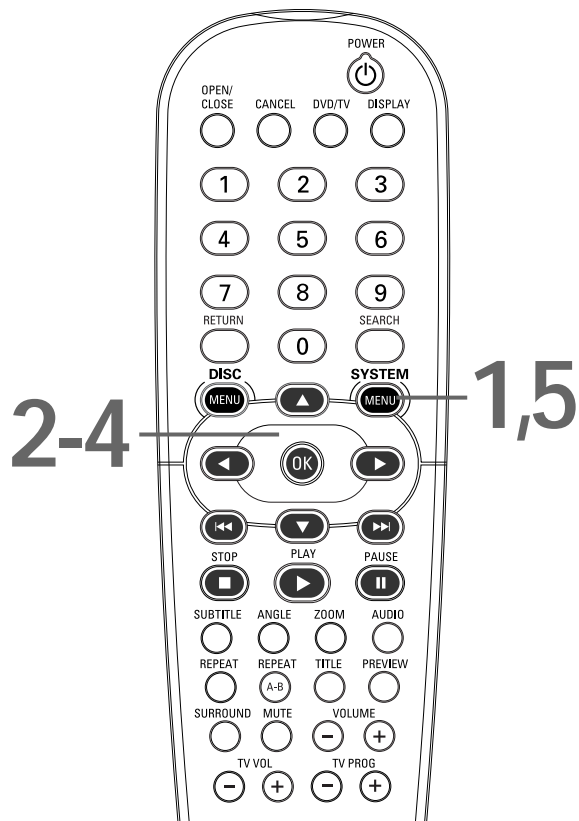
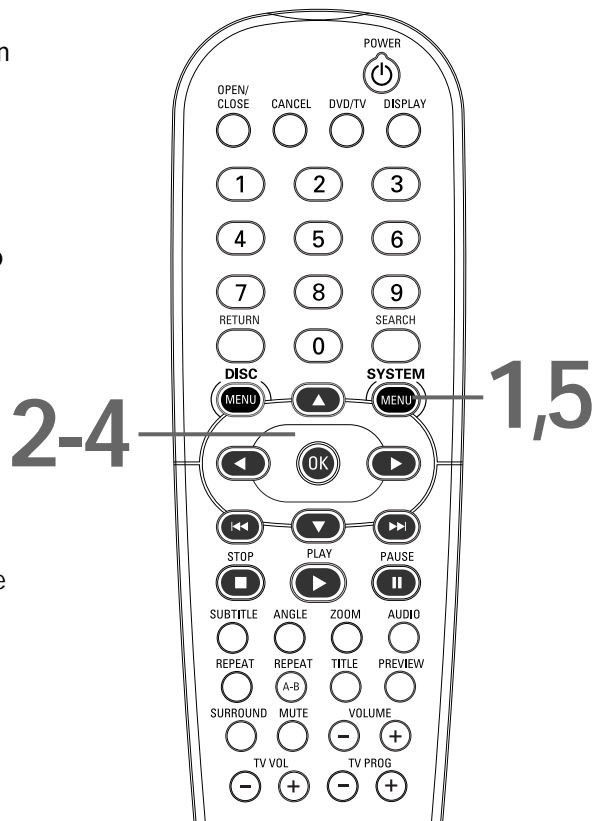

Sound Mode

Select the sound mode that matches the type of music you play most often. These preset sound modes adjust the frequency bands of the audio to enhance your favorite music style.

Or, you can choose a Sound Mode quickly by pressing the SURROUND button on the remote during DVD playback.

- 1 Press **SYSTEM MENU**.
- 2 Press **▶** to select the **AUDIO SETUP PAGE** icon at the top of the menu. Press **OK** or **▼**. **ANALOG AUDIO SETUP** will be highlighted in green. Press **OK**.
- 3 Press **▼** to select **SOUND MODE**, then press **▶**.

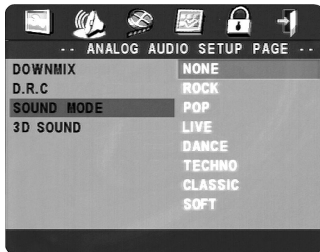

- 4 Press **▲** or **▼** to select **NONE, ROCK, POP, LIVE, DANCE, TECHNO, CLASSIC, or SOFT**, then press **OK**. Your selection will be highlighted in brown. Choose **NONE** to play the Disc with its original sound effects.
- 5 Press **SYSTEM MENU** to remove the menus.

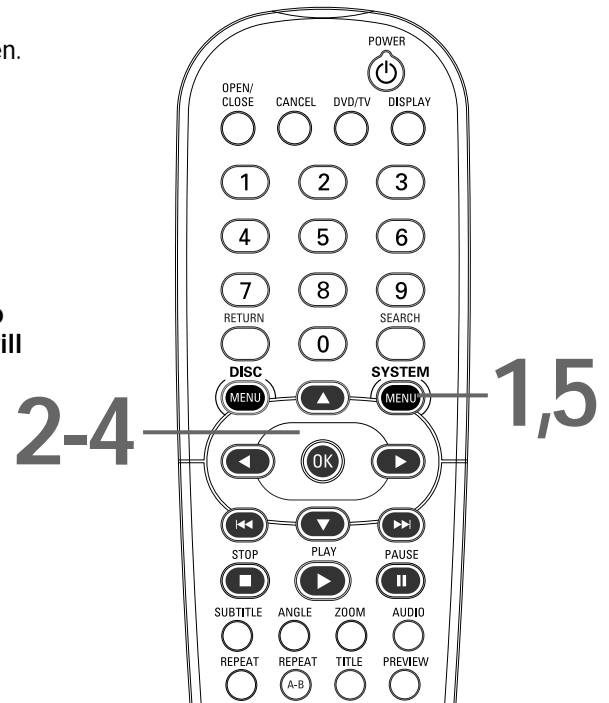

3D Sound

During music playback, this feature simulates echoes and frequencies that may be available in a particular environment. Choose the environment that you would like to recreate by changing the 3D SOUND setting.

- 1 Press **SYSTEM MENU**.
- 2 Press **▶** to select the **AUDIO SETUP PAGE** icon at the top of the menu. Press **OK** or **▼**. **ANALOG AUDIO SETUP** will be highlighted in green. Press **OK**.
- 3 Press **▼** to select **3D SOUND**, then press **▶**.

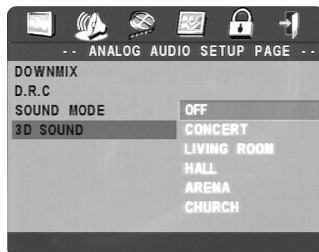

- 4 Press **▲** or **▼** to select **OFF, CONCERT, LIVING ROOM, HALL, ARENA, or CHURCH**, then press **OK**. Your selection will be highlighted in brown. Choose **OFF** to play the Disc with its original sound effects.
- 5 Press **SYSTEM MENU** to remove the menus.

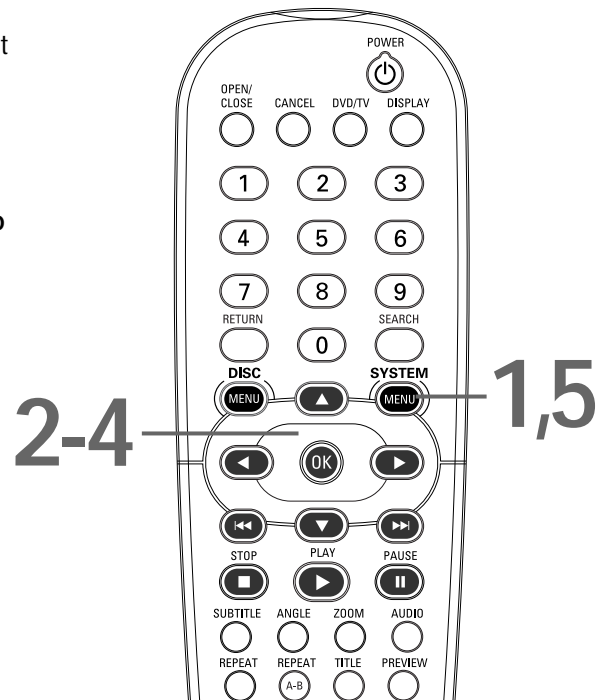

42 Display Language, Closed Captions

Display Language

You can set the DVD Player's Setup menus and on-screen messages to appear in English, Spanish, or French. These are the only three languages available. This language selection will not affect the languages of DVD Disc or Title menus or any audio, subtitle, or Closed Caption languages. To change the DVD Player's menu language, follow these steps.

- 1 Press **SYSTEM MENU**.
- 2 The **GENERAL SETUP PAGE** will be selected. Press **OK** or **▼**.
- 3 **OSD LANGUAGE** (on-screen display) will be highlighted in green. Press **▶**.



- 4 Press **▲** or **▼** to select **ENGLISH, ESPAÑOL (Spanish), or FRANCAIS (French)**, then press **OK**. Your selection will be highlighted in brown. The menu will change to the language you selected.

- 5 Press **SYSTEM MENU** to remove the menus.

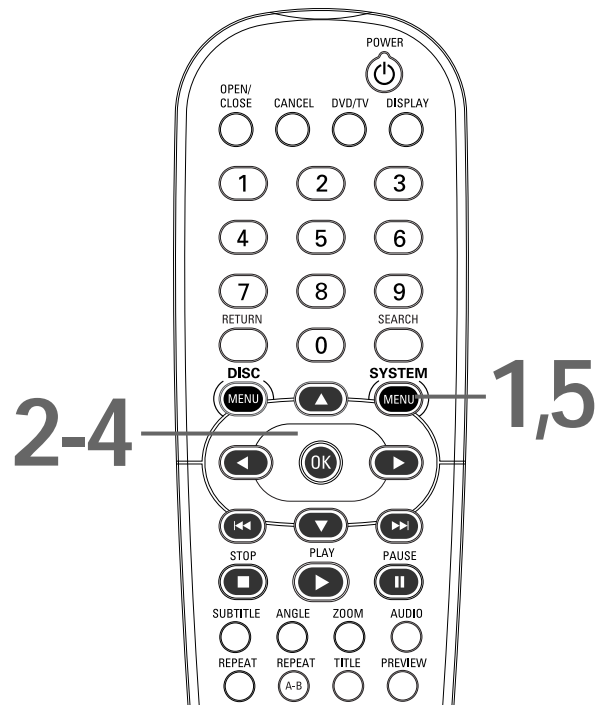

Closed Captions

Closed captions are hidden in the video signal of some Discs. Different than subtitles, closed captions are intended for the hearing impaired and also show sound effects. For example, closed captions may include information such as "phone ringing" or "footsteps approaching," while a subtitle would only show spoken text.

Though you can turn on Closed Captions in the DVD Player's menu, the captions must be available on the Disc. Also make sure you turn on Closed Captioning on your TV. Otherwise, the captions will not appear.

- 1 Press **SYSTEM MENU**.
- 2 Press **▶** to select the **VIDEO SETUP PAGE** icon at the top of the menu. Press **OK** or **▼**.
- 3 Press **▼** to select **CLOSED CAPTIONS**. Press **▶**.

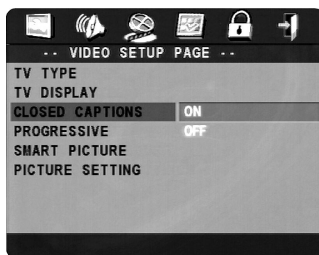

- 4 Press **▲** or **▼** to select **ON** or **OFF**, then press **OK**. Your selection will be highlighted in brown.

- 5 Press **SYSTEM MENU** to remove the menus.

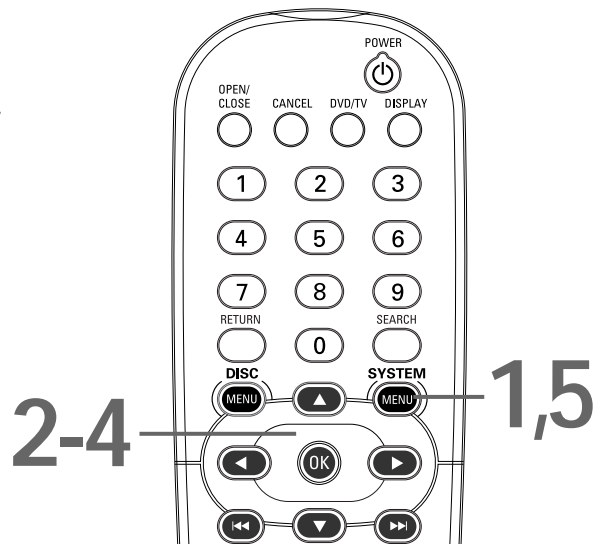

Helpful Hint

- If you have French or Spanish menus and need English:
 - 1) Press **SYSTEM MENU**. 2) The first icon on the left (**PAG.CONFIG.GENERAL** or **PAGE REGLAGES GENERAUX**) will be selected. Press **OK**.
 - 3) With **LANGUE OSD** or **IDIOMA MENUS** highlighted in green, press **▶**.
 - 4) Press **▲** to select **ENGLISH**, (or **INGLES**), then press **OK**.
 - 5) Press **SYSTEM MENU**.

Screen Saver, DVD Player Defaults 43

Screen Saver

The Screen Saver is the moving DVD logo that appears on your TV screen when playback is stopped. It prevents damage to your TV screen caused by leaving a still image on the TV too long.

- 1 Press **SYSTEM MENU**.
- 2 The **GENERAL SETUP PAGE** will be selected. Press **OK** or **▼**.
- 3 Press **▼** to select **SCREEN SAVER**, then press **▶**.

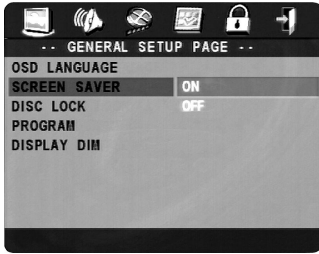

- 4 Press **▲** or **▼** to select **ON** or **OFF**, then press **OK**. Your selection will be highlighted in brown. Choose **ON** to have the Screen Saver appear on your TV screen when you have not used the Player or its remote for approximately five minutes and playback is stopped or paused. To disable the screen saver, choose **OFF**. A dark blue DVD screen will appear when playback is stopped.

- 5 Press **SYSTEM MENU** to remove the menus.

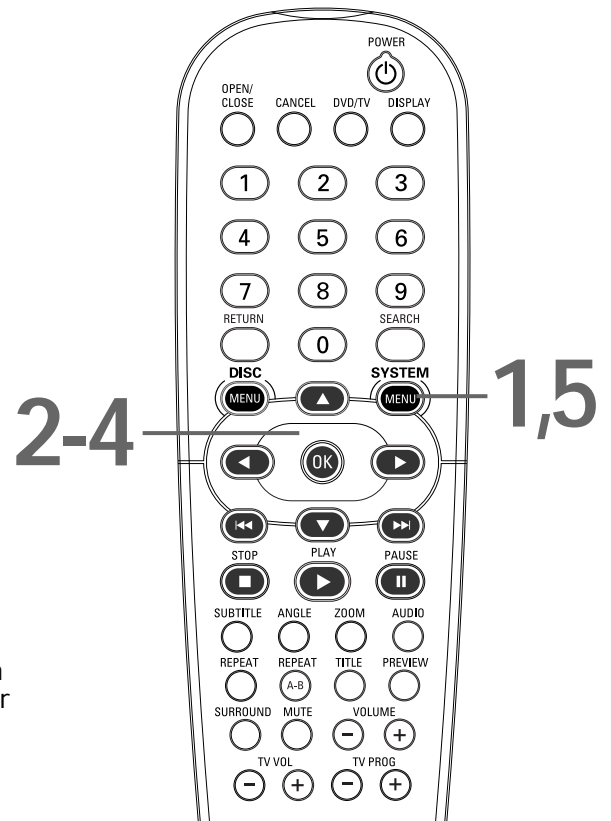

DVD Player Defaults

To restore the original settings of the DVD Player, follow the steps below.

- 1 Press **STOP** ■ twice to stop Disc playback completely.
- 2 Press **SYSTEM MENU**.
- 3 Press **▶** to select the **PREFERENCE PAGE** icon at the top of the menu, then press **OK** or **▼**.
- 4 Press **▼** to select **DEFAULT**. Press **▶** to highlight **RESET** in green, then press **OK**. The original settings of the DVD Player will be restored. The menus will disappear automatically.

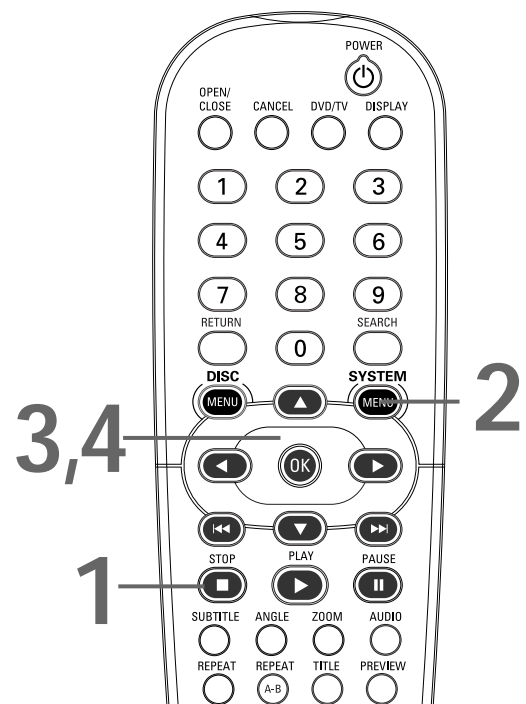
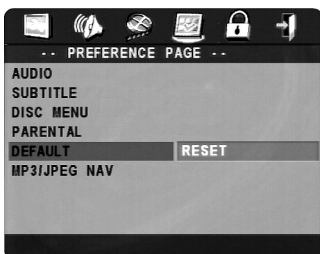

Helpful Hint

- Restoring the Defaults will reset the Player's menus to English.

44 Setting the Remote to Operate Your TV

The DVD Player's remote can operate some features of some televisions. First, you must tell the remote your brand of TV using the codes on pages 44-45.

- 1** Press and hold RETURN and OK on the remote for three seconds, then release.
- 2** Immediately press the Number buttons to enter the code for your brand of TV.
- 3** Press DVD/TV to put the remote in TV mode when you want it to control TV features. Press DVD/TV again to return to using the remote to work the DVD Player.

A	AOC0046, 0057	CTC0274	Fujitsu0206, 0099,
	ASA0114	CXC02070233, 0710
	AWA0036	Candle0213, 0057, 0083	Funai0207, 0321, 0198,
	Acura0036	Carnivale00570206, 0291
	Admiral0114, 0120,	Carrefour0063	Futuretech0207
0190, 0490	Carver0081, 0197	
	Adyson0244	Cascade0036	G
	Aiko0119	Century0114	GE .0048, 0074, 0078, 0205,
	Aiwa0728	Cimline00360478, 0120, 0309
	Aikai0036, 0057, 0235,	Cineral0478, 0119	GEC0099, 0244
0245, 0629	Citizen0213, 0083,	GPM0245
	Akura0245, 02910057, 0087, 0119	Geloso0036
	Alaron0206, 0243	Clatronic0274, 0397	General0213
	Alba0036, 0245, 0063,	Concerto0083	Genexxa0190, 0245
0398, 0695	Condor0397	Gibraltar .0044, 0046, 0057
	Allorgan0321	Contec0036, 0063,0057, 0244, 0083, 0136
	Ambassador02040207, 0243	Goodmans0099, 0206,
	America Action0207	Craig0207, 01880398, 0651, 0063,
	Amplivision0244	Crosley0101, 0114, 00810244, 0401
	Ampro0778	Crown0397, 0036,	Gorenje0397
	Amstrad0204, 0198,0207, 0445	Gradiente0083,
0398, 0036	Curtis Mathes0087,0080, 0197
	Anam0188, 0207,0057, 0043, 0074, 0078,	Graetz0190
0277, 00360081, 0083, 0120, 0172,	Granada .0099, 0235, 0244
	Anam National .0188, 02770181, 0193, 0478, 0493	Grandin0309, 0637
	Anitech0036	Cybertron0245	Grundig0097, 0222,
	Arcam0243, 0244	D0514, 0583, 0614
	Asuka0245	Daewoo0119, 0650,	Grunpy0206, 0207
	Atlantic02330046, 0651, 0401,	H
	Audiosonic01360478, 0036, 0181	HCM0036, 0309
	Audiovox0119, 0207,	Dainichi0245	Hallmark0205
0478, 0650	Dayton0036	Hanseatic0583
	Autovox0233, 0114	Daytron0046	Harley Davidson0206
B	BPL0309	De Graaf0235	Harman/Kardon0081
	BSR0321	Decca0099	Harvard0207
	BTC0245	Denon0172	Hinari0036, 0063,
	Bang & Olufsen0114	Dixi00360245, 0206
	Basic Line0036, 0245	Dual Tec0244	Hisawa0309, 0482
	Baur0037	Dumont0114, 0044,	Hitachi0172, 0190,
	Baysonic02070046, 00970178, 0136, 0244,
	Beaumarck0205	Dwin0747, 08010063, 0083, 0043, 0605
	Beko0397, 0741	E	Huanyu0243, 0401
	Belcor0046	Elite0245	Hypson0291, 0309
	Bell & Howell .0043, 0181	Elta0036	I
	Binatone0244	Emerson0263, 0207,	ICE0244, 0291, 0398
	Blaupunkt02220205, 0206, 0490, 0204,	ICeS0245
	Blue Sky0245, 06950309, 0114, 0651, 0650,	ITS0398
	Blue Star03090046, 0181	ITT0190
	Bondstec0274	Envision0057	Imperial0274, 0101,
	Boots0244	Erres00390445, 0397
	Bradford0207	Etron0036	Infinity0081
	Brandt0136	Expert0233	Ingelen0190
	Briovvega0114	F	Inno Hit0099
	Britannia0243	Ferguson0100, 0136	Inteq0044
	Brockwood0046	Fidelity0243	Interfunk0190, 0274
	Broksonic0263, 0490	Finlandia0235	Intervision0244, 0291
	Brunns0114	Finlux0114, 0097,	Isukai0245
	Bush0398, 0695, 0245,0099, 0206	J
0036, 0063, 0309,	Firstline0036, 0243,	JBL0081
0321, 0382, 04010244, 0274, 0321, 0695	JVC0080, 0063,
C	CCE0244	Fisher0181, 0244,0187, 0398
	CGE0101, 02740235, 0397	K
	CS Electronics0243	Flint0482	KEC0207
		Formenti0114	KTV0207, 0244, 0057
		Fortress0120	Kaisui0245, 0244, 0036,
		Frontech .0190, 0274, 02910243, 0309

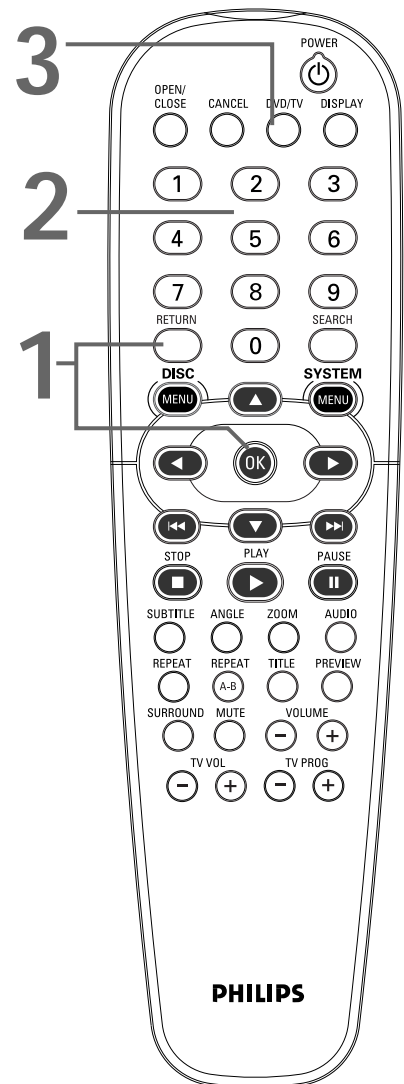

Helpful Hint

- The MUTE and TV VOL +/- buttons control the TV's volume. Use the TV PROG +/- buttons to change TV channels.

Setting the Remote to Operate Your TV 45

Kamp	.0243	.0063, 0244, 0583	Sharp	.0120, 0063,	
Kapsch	.0190, 0233			.0715, 0283	
Karcher	.0637	P	Shogun	.0046	
Kathrein	.0583	Palladium	.0397, 0445	Shorai	.0321
Kawasho	.0243	Panama	.0244, 0291	Siarem	.0114
Kenwood	.0057, 0046	Panasonic	.0078, 0277,	Siemens	.0222
Kingsley	.0243		.0188, 0253, 0190	Signature	.0043
Konka	.0734, 0659, 0655,	Pathe Cinema	.0243	Silver	.0063
	.0665, 0730	Pausa	.0036	Simpson	.0213
Korting	.0114	Penney	.0074, 0087,	Singer	.0114
Koyoda	.0036		.0057, 0048, 0205,	Sinudyne	.0037, 0114,
			.0078, 0046, 0083		.0204, 0321
L		Philco	.0114, 0101,	Solavox	.0190
LG	.0083		.0274, 0172, 0046,	Sonitron	.0235
LXI	.0181, 0074, 0081, 0205		.0057, 0081, 0490	Sonoko	.0036
Leyco	.0099, 0291, 0321	Philips	.0583, 0039,	Sonolor	.0190, 0235
Loewe	.0114		.0081, 0114, 0401	Sony	.0037, 0063, 0038
Logik	.0043	Phoenix	.0114	Soundesign	.0205, 0206,
Luma	.0233	Phonola	.0039, 0114		.0207, 0213
Luxman	.0083	Pilot	.0046, 0057	Soundwave	.0445
M		Pioneer	.0193, 0136,	Squareview	.0198
M Electronic	.0244, 0036,		.0190, 0706	Standard	.0244, 0245, 0036
	.0136, 0190, 0401, 0507	Portland	.0046, 0119	Starlite	.0207
MGA	.0177, 0046,	Princeton	.0744	Stern	.0233, 0190
	.0057, 0205	Prism	.0078	Sunkai	.0321, 0382
MTC	.0087, 0057,	Profex	.0036	SuperTech	.0243
	.0046, 0083, 0243	Proscan	.0074	Supra	.0083
Magnadyne	.0114, 0274	Protech	.0036, 0695, 0244,	Susumu	.0245
Magnavox	.0081, 0057,		.0274, 0291, 0445	Sylvania	.0081, 0057
	.0063, 0206, 0213	Proton	.0493, 0205	Symphonic	.0198, 0207
Majestic	.0043	Pulsar	.0044, 0046	T	
Manesth	.0244, 0291	Pye	.0039	TMK	.0083, 0204, 0205
Marantz	.0081, 0583, 0057	Q		TNCi	.0044
Marelli	.0114	Quasar	.0078, 0277	Tandy	.0190, 0245,
Matsui	.0036, 0204,	Quelle	.0097, 0101,		.0099, 0244, 0120
	.0382, 0235, 0244, 0398,	Questa	.0037, 0038	Tashiko	.0063, 0244
	.0038, 0062, 0063, 0099,	R	.0063	Tatung	.0099, 0244
	.0321, 0514	RBM	.0097	TEC	.0244, 0274
Matsushita	.0277	RCA	.0074, 0706,	Technics	.0078, 0277
Mediator	.0039		.0046, 0078, 0120	Technol Ace	.0206
Medion	.0695	RFT	.0114	Techwood	.0078, 0083
Megatron	.0172, 0205	Radio Shack	.0207, 0057,	Teknika	.0213, 0043, 0081,
Memorex	.0206, 0490,		.0205, 0181, 0046, 0074, 0083		.0206, 0207, 0046, 0119,
	.0205, 0036, 0043, 0083,	Radiola	.0039		.0083, 0087, 0177
	.0177, 0181, 0277	Radiomarelli	.0114	Telefunken	.0136, 0652,
Metz	.0114	Rank Arena	.0063		.0083, 0101
Midland	.0044, 0074, 0078	Realistic	.0207, 0181, 0057,	Teletech	.0036
Minerva	.0514, 0097		.0205, 0046, 0083	Teleton	.0233, 0063,
Minutz	.0048	Rex	.0233, 0190, 0291		.0213, 0244
Mitsubishi	.0177, 0063,	Rhapsody	.0243	Tensai	.0245, 0321
	.0135, 0205, 0046,	Roadstar	.0036, 0291,	Texet	.0243, 0245
	.0120, 0114		.0245, 0445	Thomson	.0136
Mivar	.0243	Runco	.0630, 0044, 0057	Thorn	.0062, 0101, 0099
Motorola	.0120	S		Tomashi	.0309
Multitech	.0036, 0207,	SBR	.0039	Toshiba	.0062, 0535, 0097,
	.0243, 0244	SEG	.0244, 0695, 0063, 0291		.0087, 0063, 0181
Myryad	.0583	SEI	.0037, 0114, 0204, 0321	Triumph	.0204
N		SSS	.0046, 0207	U	
NAD	.0193, 0205	Saba	.0136, 0114, 0190	Uher	.0233
NEC	.0057, 0197, 0063,	Sagem	.0637	Universum	.0291, 0397
	.0046, 0083, 0482	Saisho0038, 0204, 0036, 0291		V	
NTC	.0119	Salora	.0190	Vector Research	.0057
National	.0253	Sampo	.0057	Victor0063, 0080, 0187, 0277	
Neckermann	.0114, 0583	Samsung	.0087, 0046, 0205,	Videosat	.0274
Nesco	.0206		.0244, 0291, 0397, 0036,	Videotechnic	.0244
Nicamagic	.0243		.0057, 0083, 0583, 0614	Vidikron	.0081
Nikkai	.0062, 0245,	Sandra	.0243	Vidtech	.0046, 0063, 0205
	.0099, 0243, 0291	Sansei	.0478	Voxson	.0114, 0190
Nikko	.0205, 0057, 0119	Sansui	.0490	W	
Nokia	.0507	Sanyo	.0181, 0063, 0235,	Waltham	.0244
Nordmende	.0136		.0038, 0099, 0451	Wards	.0081, 0205, 0043,
O		Schneider	.0245, 0274,		.0046, 0048, 0057, 0083, 0206
Oceanic	.0190		.0398, 0695	Wega	.0114, 0063
Onwa	.0207	Scimitsu	.0046	White Westinghouse	.0651,
Optimus	.0277, 0193, 0181	Scotch	.0205		.0650, 0243, 0490
Optonica	.0120	Scott	.0263, 0046,	Y	
Orion	.0204, 0321, 0490,		.0205, 0206, 0207	Yamaha	.0046, 0057
	.0206, 0263, 0382	Sears	.0181, 0083, 0074,	Yoko	.0244, 0291
Osaki	.0099, 0244,		.0081, 0198, 0205, 0206	Z	
	.0245, 0291	Seleco	.0233, 0190	Zanussi	.0233
Oso	.0245	Semivox	.0207	Zenith	.0044, 0651,
Osume	.0099	Sentra	.0062		.0043, 0119, 0490
Otto Versand	.0037,				

Helpful Hints

- Before using the remote with the TV, press the DVD/TV button to put the remote in TV mode.
- If the remote does not operate your TV after the first attempt, try the other codes. Repeat these steps until you have tried all the codes for your brand of TV.
- The remote is not guaranteed to be compatible with all TVs.

46 Helpful Hints

If you are having problems with your product, check this list of problems and possible solutions before requesting service. You may be able to solve the problem yourself.

If you need to call a customer service representative, please know the model number and serial number of your product before you call. This information is on the rear of the product. Also, please take a moment to identify the problem you are having, and be prepared to explain this to the representative. If you believe the representative will need to help you with operations, please stay near the product. Our representatives will be happy to assist you.

No power

- Press the STANDBY-ON \odot button on the front of the DVD Player or POWER \odot on the remote. A red light appears on the front of the Player if the DVD Player is in Standby mode (power off).
- Make sure you connected the DVD Player's power cord to an AC power outlet.
- Make sure the AC outlet has power by trying another appliance in the same outlet.

No picture

- Make sure the TV power is on.
- Check the video cables. Make sure the cable(s) are fastened securely to the DVD Player and to the TV.
- Set your TV to the correct Video In channel. These channels are usually near channel zero. Or, you may have a button on the TV remote control that selects an Auxiliary, A/V IN, or Video channel. See your TV owner's manual for details. Or, go to your lowest TV channel (01 or 02), then change channels down until you see DVD playback or the blue DVD screen on the TV. If you are using an RF modulator as described on page 10, set the TV to channel 3 or 4 instead.
- You only need one video connection between the DVD Player and the TV. *Details are on page nine.*
- If you did not connect the DVD player using Progressive Scan jacks on the TV, make sure the DVD player is not set to Progressive Scan. Details are on page 38.

Distorted picture

- Check the Disc for fingerprints or scratches. Clean the Disc with a soft cloth, wiping from the center to the edge in a straight line. Do not wipe the Disc in a circular motion.
- Sometimes a small amount of picture distortion may appear. This is not a malfunction.

The picture is distorted, the picture rolls, or the picture is only black and white.

- TVs have a color system standard, usually NTSC in the United States. If the Disc's or DVD Player's color system is different than your TV's color system, the picture may be distorted or colorless. Set the Player's TV TYPE to match your TV and your DVDs. *Details are on page 38.*
- A DVD or Video CD picture may become distorted or black and white if you switch among PAL and NTSC (for TV TYPE). If so, set SMART PICTURE to STANDARD to correct the picture. *Details are on page 36.*

The sound is distorted or there is no sound during Disc playback.

- Make sure you did not connect any cables from the DVD Player to a Stereo's "PHONO IN" jack.
- Make sure you did not connect the Player's COAXIAL or OPTICAL digital audio out jack to an analog jack on the Stereo. (Analog audio jacks are usually labeled as such and are usually red and white. The COAXIAL jack of the DVD player is black. The OPTICAL jack is square.)

No sound

- Check the audio connections. *Details are on pages 10-15.* Remember, you only need one audio connection. See page nine to see what connection best suits your situation.
- Make sure cables are connected firmly to all equipment.
- Select another channel, sound source, or Auxiliary station at your Stereo or TV. See your Stereo or TV manual for details. Or, continue selecting the different sound sources or modes on the Stereo or TV until you hear sound from the Disc that is in the DVD Player. *Details are on pages 10-15.*
- Make sure your DOWNMIX, DIGITAL OUTPUT, and LPCM OUTPUT settings match the capabilities of your Stereo or TV. *Details are on pages 39-40.*
- Check the Audio setting of a DVD in the DVD Disc Menu, if available, and adjust as necessary.
- Deactivate mute at both the DVD Player and your TV.

Disc will not play.

- Make sure the Disc label is facing up. If you are playing a two-sided Disc, make sure the label of the side you want to play is facing up. *Details are on page 16.*
- Check the Parental controls. *Details are on pages 28-30.*
- Check the Region Code of the DVD. The DVD must be coded for All regions or Region 1 in order to play on this DVD Player. *Details are on page seven.*
- See if the Disc is defective by trying another Disc. Make sure the Disc is not scratched or warped. Carefully clean the Disc. *Details are on page six.*
- You must finalize CD-R, DVD+R, and DVD+RW discs before playing them on this Player.
- If you are playing a CD-R or CD-RW you made, make sure it contains at least 3 MB of data. *Details are on page 34.*

An Audio CD will not play.

- Some Audio CDs available on the market are copy protected. These discs will not play on this DVD Player. See your retailer for options regarding non-protected Audio CDs.

The DVD logo does not appear on the TV screen after you remove a Disc.

- Reset the DVD Player by switching it off, then on again.

The DVD Player does not respond to the remote control.

- Aim the remote at the remote sensor on the front of the Player (not toward the TV).
- Remove any obstacles between the DVD Player and the remote control. Move closer to the Player and try the remote again.
- Inspect or replace the batteries in the remote control. *Details are on page eight.*
- Press the DVD/TV button on the remote once, then try the remote again. If the remote is in TV mode, it cannot control the Player. Pressing DVD/TV switches the remote between TV and DVD Player modes.



The DVD Player will not select some features, such as Angles, Subtitles, or multi-language Audio.

- The feature may not be available on the Disc. If it is not, the ∅ will appear on the TV screen. Check the Disc case to see if the Disc has the feature. If the Disc does not have the feature, the DVD Player cannot create the feature. This is not a malfunction of the Player.
Or, the feature may not be available at the present time. Some features are only available during playback, while other items can be accessed only when play is stopped. Try stopping or starting playback, then try the feature again.

The DVD Player does not work.

- Disconnect the power cord from the power outlet for a few minutes. Reconnect the power cord and try to operate the Player again as usual.

The DVD Player turns itself off.

- If there is no activity at the DVD Player or with its remote control for 15 minutes and playback is stopped, the Player will turn itself off. This is an energy-saving feature that cannot be altered. Press STANDBY-ON  on the Player or POWER  or PLAY  on the remote to turn on the Player.

Disc play is irregular or DVD Disc menu operation is faulty.

- Due to the inconsistency of Disc formats provided by various Disc manufacturers, your DVD Player may require a playability enhancement or upgrade. As DVD technology has advanced, these enhancements have become both common and easy to complete.
Please contact Philips at 1-800-531-0039 for assistance.

48 Glossary

Analog: Sound that has not been turned into numbers. Analog sound varies, while digital sound has specific numerical values. Analog sound is available when you use the red and white audio jacks on your equipment. These jacks send audio through two channels, the left and right.

AUDIO OUT Jacks: Jacks on the rear of the DVD Player that send audio to another system (TV, Stereo, etc.). The jacks are red and white.

CD: Compact Disc.

Chapter: A part of a Title.

COAXIAL jack: Sends digital audio to a Stereo, allowing you to adjust the volume at the Stereo. The Stereo must have a Coaxial In jack. This connection provides the 5.1 channel surround sound as heard in movie theaters. The COAXIAL jack on the DVD Player is black.

Color system: There are various systems for transmitting television signals, for example PAL, SECAM, and NTSC. NTSC is the most common color system in the United States of America.

Component Video Y Pb Pr Jacks: The Video Out jacks on the rear of the DVD Player that send high-quality video to a TV that has Component Video In jacks. The jacks on the DVD Player are red, blue, and green.

Digital: Sound that has been converted into numerical values. Digital sound is available when you use the Player's COAXIAL or OPTICAL jack, which sends audio through multiple channels instead of two channels as analog does.

Dolby Digital: A surround sound system that provides 5.1 channel sound as used in movie theaters.

DVD: Digital Video Disc.

Letter Box: Widescreen format; a TV aspect ratio setting (4:3). Displays the video in full-width, with black bars at the top and bottom of the TV screen. This format is similar to seeing a movie in a theater. If the Disc does not include a letter box format, selecting letter box may have no effect. Some DVDs are two-sided, with one side playing in widescreen format and the other side playing in a normal (pan & scan) format.

Optical Jack: Converts electrical signals into optical signals before sending the audio to the Stereo. Optical audio is not prone to external electrical influences and has less noise. Keep the protective cap on the jack when it is not in use; this keeps dust out of the jack.

Pan & Scan: A TV aspect ratio setting (4:3). Displays the video with full-height picture with one or both sides of the picture trimmed to fit on your TV screen. Some movie companies refer to this as "reformatting the picture to fit your TV screen."

PBC: Playback Control. A special feature on some Video CDs/Super Video CDs that enables interactive use.

PCM: Pulse Code Modulation. A digital audio encoding system.

RGB: Red-Green-Blue. A top-quality video connection where red, green, and blue components of the picture are carried through separate wires. This also is referred to as the component video connection.

S-Video: Produces a clear picture by sending separate signals for the luminance and the color.

Title: A unit of recording on a DVD.

VCD: Video Compact Disc.

VIDEO OUT Jack: Yellow jack on the rear of the DVD Player that sends video (picture) to a TV.

Widescreen: A TV aspect ratio setting (16:9). Displays the video appropriately when you connect the DVD Player to a widescreen TV.

Specifications, Language Codes 49

Specifications

PLAYABLE DISCS

DVD-Video	Audio CD
Video CD	Super Video CD
Picture CD	MP3-CD
CD Recordable (CD-R)	CD Rewritable (CD-RW)
DVD Recordable (DVD+R)	DVD Rewritable (DVD+RW)

TV STANDARD

	PAL/50Hz	NTSC/60Hz
Number of lines	625	525
Playback	Multistandard	(PAL/NTSC)

VIDEO PERFORMANCE

VIDEO OUT	1Vpp---75Ω
S-VIDEO OUT	Y: 1.00Vpp---75Ω C: 0.30Vpp---75Ω
Y Pb Pr	Y: 1.00Vpp---75Ω Pb: 0.7Vpp---75Ω Pr: 0.7Vpp---75Ω

CABINET

Dimensions (w x h x d):	17.1 x 1.7 x 11.8 inches
Weight:	Approximately 6.6 lbs.

REAR CONNECTIONS

Component Video Out	Cinch (green/blue/red)
S-Video Out	Mini DIN 4-pins
Video Out	Cinch (yellow)
Audio Out	Cinch (white/red)
Digital Audio Out	One coaxial, one optical IEC958 for CDDA/LPCM/MPEG1 IEC1937 for MPEG2, Dolby Digital, and DTS

AUDIO FORMAT

Digital	Mpeg/ AC-3/ DTS PCM	compressed Digital 16, 20, 24 bits fs, 44.1, 48, 96 kHz 24, 32, 56, 64, 96, 128, 256 kbps & variable bit rate fs, 16, 22.05, 24, 32, 44.1, 48kHz
	MP3(ISO 9660)	
Analog Sound Stereo		

AUDIO PERFORMANCE

DA Converter	24 bit
Signal to Noise (1kHz)	100dB
Dynamic range (1kHz)	> 90 dB
DVD	fs 96 kHz 4 Hz -44 kHz fs 48 kHz 4 Hz -22 kHz
Super Video CD	fs 48 kHz 4 Hz -22 kHz fs 44.1 kHz 4 Hz -20 kHz
Video CD/Audio CD	fs 44.1 kHz 4 Hz -20 kHz

LASER

Type	Semiconductor laser GaAlAs
Wavelength	650nm (DVD) 780nm (Video CD/Audio CD)
Output power	7mW (DVD) 10mW (Video CD/Audio CD)
Beam divergence	60 degree

Language Codes

You will need these codes if you want a different language for Subtitles, Audio, or Disc menus. Details are on pages 25-27.

A	Slavonic6785	Hiri Motu7279	Limburgish7673	P	Tajik8471
Abkhazian6566	Chuvash6786	Hungarian7285	Lingala7678	Pali8073	Tamil8465
Afar6565	Cornish7587	I	Lithuanian7684	Panjabi8065	Tatar8484
Afrikaans6570	Corsican6779	Icelandic7383	Luxembourgish .7666	Persian7065	Telugu8469
Albanian8381	Croatian7282	Ido7379	M	Polish8076	Thai8472
Amharic6577	Czech6783	Indonesian7368	Macedonian7775	Portuguese8084	Tibetan6679
Arabic6582	D	Interlingua,	Malagasy7771	Provençal7967	Tigrinya8473
Armenian7289	Danish6865	International	Malay7783	Pushto8083	Tonga
Assamese6583	Dutch7876	Interlingue 7365, 7369	Malayalam7776	Q	(Tonga Islands) 8479
Avestan6569	Dzongkha6890	Inuktitut7385	Maltese7784	Quechua8185	Tsonga8483
Aymara6589	E	Inupiaq7375	Manx7186	R	Tswana8478
Azerbaijani6590	English6978	Irish7165	Maori7773	Raeto-Romance 8277	Turkish8482
B	Esperanto6979	Italian7384	Marathi7782	Romanian8279	Turkmen8475
Bashkir6665	Estonian6984	J	Marshallese7772	Rundi8278	Twi8487
Basque6985	F	Japanese7465	Moldavian7779	Russian8285	U
Belarusian6669	Faroese7079	Javanese7486	Mongolian7778	S	Uighur8571
Bengali6678	Fijian7074	K	N	Samoan8377	Ukrainian8575
Bihari6672	Finnish7073	Kalaallisut7576	Nauru7865	Sango8371	Urdu8582
Bislama6673	French7082	Kannada7578	Navaho, Navajo .7886	Sanskrit8365	Uzbek8590
Bokmal,7866	Frisian7089	Kashmiri7583	Ndebele, North .7868	Sardinian8367	V
Norwegian7866	G	Kazakh7575	Ndebele, South .7882	Serbian8382	Vietnamese8673
Bosnian6683	Gaelic,	Khmer7577	Ndonga7871	Shona8378	Volapuk8679
Breton6682	Scottish Gaelic .7168	Kinyarwanda . . .8287	Nepali7869	Sindhi8368	W
Bulgarian6671	Gallegan7176	Kirghiz7589	Northern Sami .8369	Sinhalese8373	Walloon8765
Burmese7789	Georgian7565	Komi7586	Norwegian7879	Slovak8375	Welsh6789
C	German6869	Korean7579	Nynorsk,	Slovenian8376	Wolof8779
Castilian, Spanish 6983	Gikuyu, Kikuyu .7573	Kuanyama,	Norwegian7878	Somali8379	X
Catalan6765	Greek6976	Kwanyama7574	O	Sotho, Southern 8384	Xhosa8872
Chamorro6772	Guarani7178	Kurdish7585	Occitan, Proven 7967	Sundanese8385	Y
Chechen6769	Gujarati7185	L	Old Bulgarian, Old	Swahili8387	Yiddish8973
Chewa, Chichewa,	H	Lao7679	Slavonic, Old Church	Swati8383	Yoruba8979
Nyanja7889	Hausa7265	Latin7665	Slavonic6785	Swedish8386	Z
Chinese9072	Hebrew7269	Latvian7686	Oriya7982	Tagalog8476	Zulu9085
Chuang, Zhuang 9065	Herero7290	Letzeburgesch .7666	Oromo7977	Tahitian8489	
Church Slavc,	Hindi7273	Limburgan, Limburger,	Ossetian, Ossetic 7983		

**RENEWED
90 DAY
LIMITED WARRANTY**

52 Information Index

AC power cord	19	Number buttons	17, 20
ALL (Digital output)	40	OK button	17
Analog audio setup	39, 41	OPEN/CLOSE button	17-18
ANGLE button	17, 23	OPTICAL jack	15, 19
Arrow ▲▼◀▶ buttons	17, 20-21	OSD LANGUAGE	42
AUDIO button	17, 25	Package contents	6
AUDIO OUT (left/right) jacks	10-14, 19	PAL	7, 38
Battery installation	8	PanScan	35
BRIGHT	36	Parental levels	30
Camera angle	23	Parental password	28
Chapter selection	20	PAUSE button	17, 22
Cleaning discs	6	PCM only	40
Closed Captions	42	PERSONAL	36-37
COAXIAL jack	15, 19, 40	Picture setting	36-37
COLOR	36-37	PLAY button	16-18
Color systems	7, 38	Playable discs	7
Component Video	13	POWER ⏻ button	17
CONTRAST	36-37	Preview	32
Defaults	43	PREVIEW button	17, 20, 32
Digital Audio Setup	40	Previous ◀◀ button	16-17, 20-21
Digital Output	40	Program	31
Disc lock	29	Progressive Scan	13, 38
DISC MENU button	17, 20	Quick disc playback	16
Disc menus	20	Rear panel	19
Disc tray	16, 18	Reduce	23
DISPLAY button	17, 20, 22	Region codes	7
Display dim	39	Remote control batteries	8
Downmix	39	Remote control buttons	17
Dynamic Range Control (D.R.C.)	39	Repeat	24, 34
Environmental information	6	REPEAT button	17, 24, 34
Exchange instructions/exchange form	50-51	Repeat A-B	24
Fast forward and fast reverse	21	REPEAT A-B button	17, 24
Features	6	RETURN button	17
Frame-by-frame playback	22	3D Sound	41
Front panel	18	Safety information	4-5
Glossary	48	Scan	20
Hookups	9-15	Screen saver	43
Component Video	13	SEARCH button	17, 22
Composite or CVBS (yellow) video	11	Slow motion	21
Connecting to a TV and a digital stereo	15	SOFT	36
Connecting to a TV and a two-channel stereo	14	Sound mode	41
Determining the best possible connection	9	Specifications	49
Progressive Scan	13, 38	STANDARD	36
RF Modulator	10	Standby-On ⏻ button	18
S-Video	12	Still picture	22
TV has ANTENNA IN or RF IN jack only	10	STOP button	17, 18
JPEG	33-34	SUBTITLE button	17, 26
Language codes	49	Subtitles	26
Language settings		S-VIDEO (video out) jack	12, 19
Audio	25	SYSTEM MENU button	17
Disc menu	27	Time search	22
Player display	42	TINT	36-37
Subtitles	26	TITLE button	20
Letter Box	35	Title menus	20
Limited warranty	50-51	Track selection	20
LPCM OUTPUT	40	TV display	35
MP3	33-34	TV type	38
MP3/JPEG NAV	33	VIDEO (video out) jack	10, 11, 19
MUTE button	17	Warranty	50
Navigator	33	Widescreen (16:9)	35
Next ▶▶ button	16-17, 20-21	Y Pb Pr (component video out) jacks	13, 19, 38
NTSC	7, 38	Zoom	23
		ZOOM button	17, 23

