

IntelliVue MP20/30, MP40/50 and MP60/70/80/90

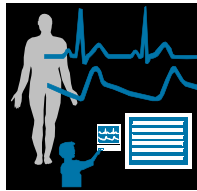

INSTRUCTIONS FOR USE

IntelliVue Patient Monitor

MP20/30, MP40/50, MP60/70/80/90

Release D.0 with Software Revision D.00.xx

Patient Monitoring



PHILIPS

Part Number M8000-9001G
Printed in Germany 02/06
4512 610 13551



PHILIPS

Table Of Contents

1 Basic Operation

1

Introducing the IntelliVue Family	1
IntelliVue MP20/MP30	2
MP20/MP30 Major Parts and Keys	3
IntelliVue MP40/MP50	4
MP40/MP50 Major Parts and Keys	4
IntelliVue MP60/MP70	5
MP60/MP70 Major Parts and Keys	6
IntelliVue MP80/MP90	6
MP80/MP90 Major Parts and Keys	7
D80 Intelligent Display	7
Remote Alarm Device	7
Docking Station	8
Related Products	8
Flexible Module Server (M8048A)	8
Measurement Modules	9
Multi-Measurement Server (M3001A)	10
Measurement Server Extensions	11
M3014A, M3015A and M3016A Capnography Extensions	12
M3012A Hemodynamic Measurement Server Extension	13
Operating and Navigating	14
Selecting Screen Elements	15
Using the Setup Menu	15
Using the Touchscreen	15
Disabling Touchscreen Operation	15
Using the SpeedPoint	16
Using the Navigation Point	17
Using a Mouse or Trackball	17
Using Keys	17
Permanent Keys	17
SmartKeys	18
Hardkeys	19
Pop-Up Keys	19
Using the On-Screen Keyboard	20
Using the On-Screen Calculator	20
Operating Modes	21
Standby Mode	21
Understanding Screens	22
Switching to a Different Screen	22
Changing a Screen's Content	22
Using Additional Displays	23
Using the Visitor Screen	24

Understanding Profiles	24
Swapping a Complete Profile	25
Swapping a Settings Block	26
Default Profile	26
Locked Profiles	26
Understanding Settings	26
Changing Measurement Settings	26
Switching a Measurement On and Off	27
Switching Numerics On and Off	27
Adjusting a Measurement Wave	27
Changing Wave Speeds	27
Changing the Wave Group Speed	27
Changing Wave Speed for a Channel	28
Freezing Waves	28
Freezing An Individual Wave	28
Freezing All Waves	28
Measuring Frozen Waves	28
Changing The Wave Speed	29
Updating The Frozen Wave	29
Releasing Frozen Waves	29
Using Labels	29
About Label Sets	29
Changing Measurement Labels (e.g. Pressure)	29
Resolving Label Conflicts	30
Changing Monitor Settings	31
Adjusting the Screen Brightness	31
Adjusting Touch Tone Volume	31
Setting the Date and Time	31
Checking Your Monitor Revision	32
Getting Started	32
Inspecting the Monitor	32
Switching On	32
Setting up the Measurement Servers and Modules	32
Starting Monitoring	33
Disconnecting from Power	33
Monitoring After a Power Failure	33
Networked Monitoring	33
Using Remote Applications	33
Remote Application Popup Keys	34

2 What's New?

35

What's New in Release D.0?	35
What's New in Release C.0?	36
What's New in Release B.1?	37
What's New in Release B.0?	38
What's New in Release A.2?	39

3 Alarms

41

Visual Alarm Indicators	42
Audible Alarm Indicators	42
Alarm Tone Configuration	42
Traditional Audible Alarms (HP/Agilent/Philips/Carenet)	43
ISO/IEC Standard 9703-2 Audible Alarms	43
Changing the Alarm Tone Volume	43
Minimum Volume for No Central Monitoring INOP	43
Acknowledging Alarms	44
Acknowledging Disconnect INOPs	44
Alarm Reminder (ReAlarm)	44
Pausing or Switching Off Alarms	44
To Pause All Alarms	45
To Switch All Alarms Off	45
To Switch Individual Measurement Alarms On or Off	45
While Alarms are Paused or Off	45
Restarting Paused Alarms	46
Resetting Arrhythmia Alarm Timeouts	46
Extending the Alarm Pause Time	46
Alarm Limits	46
Viewing Individual Alarm Limits	46
Viewing All Alarm Limits	47
Changing Alarm Limits	48
About Automatic Alarm Limits (AutoLimits)	49
Documenting Alarm Limits	49
Reviewing Alarms	50
Alarm Messages Window	50
Review Alarms Window	50
Understanding Alarm Messages	51
Latching Alarms	51
Viewing the Alarm Latching Settings	51
Alarm Latching Behavior	52
Testing Alarms	52
Alarm Behavior at On/Off	52

4 Patient Alarms and INOPs

53

Patient Alarm Messages	53
Technical Alarm Messages (INOPs)	59

5 Managing Patients

77

Admitting a Patient	77
Patient Category and Paced Status	78
Admitting a Centrally-Monitored Patient	78
Quick Admitting a Patient	78
Editing Patient Information	79

Discharging a Patient	79
Transferring Patients	80
Transferring a Centrally-Monitored Patient	80
Transferring a Patient with an MMS (no Central Station)	81
Data Upload from an MMS	81
Data Exchange Between Information Centers	82
Resolving Patient Information Mismatch	82
Manually Resolving Patient Mismatch	82
Patient Mismatch - If One Set of Patient Data is Correct	83
Patient Mismatch - If Neither Patient Data Set is Correct	83
Patient Mismatch - If Both Patient Data Sets Are Correct	84
Automatically Resolving Patient Mismatch	84
Care Groups	84
Understanding the Care Group Overview Bar	85
Viewing the My Care Group Window	86
Viewing the Other Bed Window	87
Other Bed Pop-Up Keys	88
Visual Alarm Status Information in the Other Bed Window	88
Care Group Alarms	88
Telemetry Data Overview	89
Unpairing a Telemetry Device	89
Telemetry Data Overview Screen Element	90
Silencing Telemetry Alarms from the Bedside	90
Suspending Telemetry Alarms	90
Using Standby	90

6 ECG, Arrhythmia, and ST Monitoring

91

Skin Preparation for Electrode Placement	91
Connecting ECG Cables	91
Selecting the Primary and Secondary ECG Leads	92
Checking Paced Status	92
Understanding the ECG Display	93
Monitoring Paced Patients	93
Setting the Paced Status (Pace Pulse Rejection)	94
Avoiding Pace Pulse Repolarization Tails	94
Changing the Size of the ECG Wave	94
To Change the Size of an Individual ECG Wave	94
To Change the Size of all the ECG Waves	95
Changing the Volume of the QRS Tone	95
Changing the ECG Filter Settings	95
Choosing EASI or Standard Lead Placement	96
About ECG Leads	96
ECG Leads Monitored	96
Changing Lead Sets	96
ECG Lead Fallback	97
ECG Lead Placements	97

Standard 3-Lead Placement	98
Standard 5-Lead Placement	98
Chest Electrode Placement	99
10-Lead Placement	100
Conventional 12-Lead ECG	100
Modified 12-Lead ECG	101
Choosing Standard or Modified Electrode Placement	101
Labelling 12-Lead ECG Reports	101
Capture 12-Lead	102
EASI ECG Lead Placement	102
ECG, Arrhythmia, and ST Alarm Overview	104
Using ECG Alarms	105
Extreme Alarm Limits	105
ECG Alarms Off Disabled	105
HR Alarms When Arrhythmia Analysis is Switched Off	105
HR Alarms When Arrhythmia Analysis is Switched On	105
ECG Safety Information	105
About Arrhythmia Monitoring	107
Arrhythmia Options	107
Where Can I Find More Information?	107
Switching Arrhythmia Analysis On and Off	108
Choosing an ECG Lead for Arrhythmia Monitoring	108
Aberrantly-Conducted Beats	108
Atrial Fibrillation and Flutter	108
Intermittent Bundle Branch Block	109
Understanding the Arrhythmia Display	109
Viewing Arrhythmia Waves	109
Arrhythmia Beat Labels	109
Arrhythmia Status Messages	110
Rhythm Status Messages	110
Ectopic Status Messages	111
Arrhythmia Relearning	111
Initiating Arrhythmia Relearning Manually	111
Automatic Arrhythmia Relearn	112
Arrhythmia Relearn and Lead Fallback	112
Arrhythmia Alarms	112
Yellow Arrhythmia Alarms	113
Arrhythmia Alarms and Latching	113
Switching Individual Arrhythmia Alarms On and Off	113
Switching All Yellow Arrhythmia Alarms On or Off	113
Adjusting the Arrhythmia Alarm Limits	113
Arrhythmia Alarm Timeout Periods	113
What is a Timeout Period?	114
Resetting the Timeout Period	114
How are Yellow Arrhythmia Alarms Indicated?	114
Behavior of Unsilenced Arrhythmia Alarms	114

Behavior of Silenced Arrhythmia Alarms	114	
Arrhythmia Alarm Chaining	115	
Understanding PVC-Related Alarms	116	
About ST Monitoring	117	
Switching ST On and Off	117	
Selecting ST Leads for Analysis	117	
Understanding the ST Display	118	
Updating ST Baseline Snippets	119	
Recording ST Segments	119	
About the ST Measurement Points	120	
Adjusting ST Measurement Points	120	
ST Alarms	122	
Single- or Multi-lead ST Alarming	122	
Changing ST Alarm Limits	122	
Viewing ST Maps	122	
Current View	122	
Trend View	123	
Viewing an ST Map	124	
Working in the ST Map Task Window	124	
Switching Between ST Map Views	124	
Displaying an ST Reference Baseline	125	
Updating an ST Map Reference Baseline	125	
Changing the Scale of the ST Map	125	
Changing the Trending Interval	125	
Printing an ST Map Report	125	
7 Monitoring Pulse Rate		127
<hr/>		
Entering the Setup Pulse Menu	127	
System Pulse Source	127	
Switching Pulse On and Off	128	
Using Pulse Alarms	128	
Selecting the Active Alarm Source: HR or Pulse?	128	
Alarm Source Selection Disabled	129	
Changing HR/Pulse Alarm Limits	129	
Extreme Alarm Limits	129	
QRS Tone	129	
8 Monitoring Respiration Rate (Resp)		131
<hr/>		
Lead Placement for Monitoring Resp	131	
Optimizing Lead Placement for Resp	131	
Cardiac Overlay	131	
Lateral Chest Expansion	132	
Abdominal Breathing	132	
Understanding the Resp Display	132	
Changing Resp Detection Modes	132	
Auto Detection Mode	132	

Manual Detection Mode	133	
Resp Detection Modes and Cardiac Overlay	133	
Changing the Size of the Respiration Wave	133	
Changing the Speed of the Respiration Wave	134	
Using Resp Alarms	134	
Changing the Apnea Alarm Delay	134	
Resp Safety Information	134	
9 Monitoring SpO₂		137
<hr/>		
SpO ₂ Sensors	137	
Applying the Sensor	137	
Connecting SpO ₂ Cables	138	
Measuring SpO ₂	138	
Assessing a Suspicious SpO ₂ Reading	139	
Understanding SpO ₂ Alarms	140	
Alarm Delays	140	
Adjusting the Alarm Limits	140	
Adjusting the Desat Limit Alarm	140	
Pleth Wave	140	
Perfusion (Pleth) Indicator	141	
Setting SpO ₂ /Pleth as Pulse Source	141	
Setting Up Tone Modulation	141	
Setting the QRS Volume	141	
Calculating SpO ₂ Difference	141	
10 Monitoring NBP		143
<hr/>		
Introducing the Oscillometric NBP Measurement	143	
Measurement Limitations	144	
Measurement Methods	144	
Reference Method	144	
Preparing to Measure NBP	144	
Correcting the Measurement if Limb is not at Heart Level	145	
Understanding the NBP Numerics	145	
Starting and Stopping Measurements	146	
Enabling Automatic Mode and Setting Repetition Time	146	
Choosing the NBP Alarm Source	147	
Assisting Venous Puncture	147	
Calibrating NBP	147	
11 Monitoring Temperature		149
<hr/>		
Making a Temp Measurement	149	
Selecting a Temperature for Monitoring	149	
Extended Temperature Label Set	150	
Calculating Temp Difference	150	

12 Monitoring Invasive Pressure

151

Setting up the Pressure Measurement	151
Selecting a Pressure for Monitoring	152
Extended Pressure Label Set	152
Zeroing the Pressure Transducer	152
Zeroing ICP (or IC1/IC2)	153
Determining a Pressure's Most Recent Zero	153
Zeroing a Pressure Measurement	153
Using the Zero Hardkey	153
Zeroing All Pressures Simultaneously	153
Troubleshooting the Zero	154
Adjusting the Calibration Factor	154
Displaying a Mean Pressure Value Only	154
Changing the Pressure Wave Scale	154
Optimizing the Waveform	155
Non-Physiological Artifact Suppression	155
Choosing the Pressure Alarm Source	155
Calibrating Reusable Transducer CPJ840J6	156
Making the Pressure Calibration	156
Troubleshooting the Pressure Calibration	157
Calculating Cerebral Perfusion	157
Calculating Pulse Pressure Variation	157
Measuring Pulmonary Artery Wedge Pressure	158
Editing the Wedge	159
Identifying the Pressure Analog Output Connector	160

13 Monitoring Cardiac Output

161

Hemodynamic Parameters	162
Using the C.O. Procedure Window	163
Accessing the Setup C.O. and Setup CCO Menus	164
Entering the HemoCalc Window	164
Measuring C. O. Using the PiCCO Method	164
Measuring Continuous Cardiac Output	164
Measuring Systemic Vascular Resistance	164
Setting Up the PiCCO C.O. Measurement	165
Performing PiCCO C.O. Measurements	166
Editing PiCCO C.O. Measurements	166
Saving and Calibrating PiCCO C.O. Measurements	167
CCO Calibration Status Indicators	167
Measuring C.O. Using the Right Heart Thermodilution Method	168
Setting up RH C.O. Measurements	168
Ice-Bath Setup for RH Thermodilution C.O. Measurements	168
Setting the Computation Constant	169
Performing RH C.O. Measurements	169
Editing and Saving RH C.O. Measurements	169

Documenting C.O. Measurements	169
C.O. Injectate Guidelines	170
Guidelines for Right Heart Thermodilution C.O. Injectate	170
Guidelines for PiCCO C.O. Injectate	170
Injectate Volume, Patient Weight and ETVI Values (PiCCO Only)	170
C.O./CCO Curve Alert Messages	171
C.O./CCO Prompt Messages	172
C.O./CCO Warning Messages	173
C.O./CCO Safety Information	173

14 Monitoring Carbon Dioxide

175

Using the Capnography Extension (M3014A)	176
Preparing to Measure Mainstream CO ₂	176
Preparing to Measure Sidestream CO ₂	177
Using the Sidestream Sensor Holder	178
Removing Exhaust Gases from the System	179
Using the Mainstream CO ₂ Extension (M3016A)	179
Preparing to Measure Mainstream CO ₂	179
Checking Transducer Accuracy	179
Calibrating the Transducer	180
Attaching and Removing the CO ₂ Transducer	180
Using the Microstream CO ₂ Extension (M3015A)	181
Preparing to Measure Microstream CO ₂	181
Using Microstream Accessories	181
Using the FilterLine and Airway Adapter	182
Removing Exhaust Gases from the System	182
Suppressing Zero Calibration	183
Setting up Mainstream and Sidestream CO ₂	183
Adjusting the CO ₂ Wave Scale	183
Setting up CO ₂ Corrections	183
Suppressing Sampling (not Mainstream CO ₂)	184
Changing CO ₂ Alarms	184
Changing the Apnea Alarm Delay	184
Deriving Alarms From awRR	184
Changing awRR Alarm Limits	184

15 Monitoring Airway Flow, Volume and Pressure

187

Attaching the Flow Sensor	188
Zero Calibration	190
Automatic Purging	190
Adult Mode	191
Neonatal and Pediatric Modes	191
Manual Purging	191
Gas Compensation	191
Setting up Spirometry	192
Optimizing Scale Settings	192

Spirometry Values Window	192
Alarms and Alarm Limits	192
Changing the Apnea Alarm Delay	192
Automatic Alarm Suppression	193
Choosing Measured AWW Components	193
Setting the Gas Compensation Mode	193
Changing the Type of Balance Gas	193
Changing the Concentration of Inspired O ₂ and the Inspired Agents	193
Changing the Temperature of the Inspired Gas	194

16 Monitoring tcGas

195

Identifying tcGas Module Components	195
Setting the tcGas Sensor Temperature	196
Using the tcGas Site Timer	196
Setting the tcGas Site Timer	196
Restarting the tcGas Site Timer	197
Disabling the tcGas Site Timer	197
Setting the tcGas Barometric Pressure	197
Remembraning the tcGas Transducer	197
New/Dried Out Transducers	198
Storing tcGas Transducers	198
Calibrating the tcGas Transducer	199
Calibration Failure	200
Troubleshooting tcGas Calibration	200
Applying the tcGas Transducer	201
Selecting the tcGas HeatPowerDisplay Mode	202
Zeroing the tcGas Relative Heat Power	202
Finishing tcGas Monitoring	202
TcGas Corrections	202
Temperature Correction for tcpCO ₂	202
Metabolism Correction for tcpCO ₂	202

17 Monitoring SvO₂

203

Preparing to Monitor SvO ₂	204
Carrying out a Pre-insertion Calibration	204
Inserting the Catheter	205
Performing a Light Intensity Calibration	205
Performing In-Vivo Calibration	206
Setting Up the In-Vivo Calibration	206
Making the In-Vivo Calibration	206
Calculating Oxygen Extraction	206

18 Monitoring EEG

207

EEG Monitoring Setup	208
Using the EEG Impedance/Montage Window	208
Choosing an EEG Electrode Montage	209

Changing the Impedance Limit	209	
About Electrode-to-Skin Impedance	210	
Impedance Indicators	210	
About Compressed Spectral Arrays (CSA)	211	
Changing CSA Settings	212	
Changing EEG Settings	212	
Switching EEG Numerics On and Off	212	
Changing the Scale of the EEG Waves for Display	212	
Changing Filter Frequencies	213	
Changing the Speed of the EEG Wave	213	
EEG Reports	213	
EEG Safety Information	214	
EEG and Electrical Interference	214	
19 Monitoring BIS		215
<hr/>		
BIS Monitoring Setup	216	
Monitoring BIS Using the DSC and BIS Engine	216	
Monitoring BIS using the BISx	217	
Manufacturer's Information	218	
BIS Continuous Impedance Check	218	
BIS Cyclic Impedance Check	218	
Starting a Cyclic Impedance Check	218	
Stopping a Cyclic Impedance Check	218	
BIS Window	219	
BIS Impedance Indicators	219	
Changing the BIS Smoothing Rate	220	
Switching BIS and Individual Numerics On and Off	220	
Changing the Scale of the EEG Wave	220	
Switching BIS Filters On or Off	220	
BIS Safety Information	221	
20 Trends		223
<hr/>		
Viewing Trends	223	
Viewing Graphic Trends	224	
Viewing Vital Signs Trends	224	
Trends Pop-Up Keys	225	
Setting Up Trends	225	
Making Segment Settings	226	
Expanded View	226	
Trend Scales for Segment Measurements	226	
Optimum Scale	226	
Trend Group	226	
No. of Segments	226	
Trend Groups	227	
Trend Interval	227	
Trend Priority	227	

Trend Parameter Scales	227	
Graphical Trend Presentation	228	
Documenting Trends	228	
Trends Databases	229	
Aperiodic Trends Database	229	
Trending Multiple-Value Measurements	229	
Screen Trends	229	
Setting the Screen Trend Time	230	
Changing the Selection of Screen Trends Displayed	231	
Activating the Cursor for Screen Trends	231	
Changing the Screen Trend View	231	
Tabular View	231	
Horizon View	232	
Setting the Horizon	232	
Setting the Horizon Trend Scale	232	
21 Calculations		233
<hr/>		
Viewing Calculations	233	
Calculations Windows	234	
Calculations Pop-Up Keys	234	
Reviewing Calculations	235	
Performing Calculations	235	
Entering Values for Calculations	236	
Automatic Value Substitution	236	
Automatic Unit Conversion	236	
Manual Unit Conversion	236	
BSA Formula	236	
Documenting Calculations	237	
22 High Resolution Trend Waves		239
<hr/>		
Changing the Hi-Res Trend Waves Displayed	239	
Hi-Res Trend Wave Scales	239	
Hi-Res Trend Waves and OxyCRG	239	
Printing Hi-Res Trend Wave Reports	240	
Hi-Res Trend Wave Recordings	240	
23 Event Surveillance		241
<hr/>		
Levels of Event Surveillance	241	
Event Groups	242	
Event Episodes	242	
Events Pop-Up Keys	243	
Event Triggers	244	
Event Retriggering	245	
Event Notification	245	
Setting Triggers for NER and Basic Event Surveillance	245	
Setting Triggers and Notification for Advanced Event Surveillance	246	

Triggering Events Manually	246
The Events Database	247
Viewing Events	247
Event Counter	247
Counting Combi-Events	248
Counting Neonatal Event Review (NER) Events	248
Event Summary Window	249
Event Review Window	249
Event Episode Window	250
Annotating Events	251
Documenting Events	251
Documenting Event Review	251
Documenting an Event Episode	252
Event Recordings	252
Event Review Recordings	252
Event Episode Recordings	253
Event Reports	253
Event Review Reports	254
Event Episode Reports	255
Event Summary Reports	255

24 Recording

257

Starting and Stopping Recordings	258
Quickstarting Recordings	258
Extending Recordings	259
Stopping Recordings	259
Recording Without a Template	259
Overview of Recording Types	259
All ECG Waves Recordings	260
Creating and Changing Recordings Templates	260
Changing ECG Wave Gain	261
Recording Priorities	262
Sample Recording Strip	262
Recording Strip Code	262
Recorded Waveforms	263
Maintaining Recording Strips	263
Reloading Paper	264
Recorder Status Messages	265

25 Printing Patient Reports

267

Starting Reports Printouts	267
Stopping Reports Printouts	268
Setting Up Reports	268
Setting Up ECG Reports	268
Setting Up Vital Signs and Graphic Trend Reports	269
Setting Up Auto Reports	269

Setting Up Individual Print Jobs	270	
Checking Printer Settings	270	
Printing a Test Report	271	
Switching Printers On Or Off for Reports	271	
Dashed Lines on Reports	271	
Unavailable Printer: Re-routing Reports	271	
Printer Status Messages	272	
Sample Report Printouts	272	
Alarm Limits Report	273	
Realtime Report	274	
Cardiac Output Report	275	
ECG Reports	276	
Other Reports	276	
26 Using the Drug Calculator		277
<hr/>		
Accessing the Drug Calculator	277	
Performing Drug Calculations	278	
About the Rule of Six	278	
Performing Calculations for a Non-Specific Drug	278	
Performing Calculations for a Specific Drug	279	
Charting Infusion Progress	280	
Using the Titration Table	280	
Documenting Drug Calculations	280	
27 VueLink Modules		281
<hr/>		
Connecting an External Device	282	
Changing VueLink Waves and Numerics Displayed	282	
Viewing the VueLink Device Data Window	282	
Using VueLink Screens	283	
Switching VueLink On and Off	283	
Alarms/INOPs From External Devices	283	
Language Conflict with External Device Drivers	284	
28 Using Timers		285
<hr/>		
Viewing Timers	285	
Notification	285	
Timer Types	286	
Timer Setup Pop-up Keys	286	
Setting Up Timers	286	
Timer Label	286	
Run Time	287	
Timer Counting Direction	287	
Displaying Timers On The Main Screen	287	
Main Screen Timer Pop-up Keys	288	
Displaying A Clock On The Main Screen	288	

29 Respiratory Loops	289
Viewing Loops	289
Capturing and Deleting Loops	290
Showing/Hiding Loops	290
Changing Loops Display Size	291
Using the Loops Cursor	291
Changing Loops Type	291
Setting Up Source Device	291
Documenting Loops	292
30 Care and Cleaning	293
General Points	293
Cleaning	294
Disinfecting	294
Cleaning Monitoring Accessories	294
Sterilizing	295
Cleaning the Recorder Printhead (M1116B only)	295
Cleaning the Batteries and Battery Compartment	295
31 Using the Batteries	297
Battery Power Indicators	298
Battery LED	298
Battery Status on the Main Screen	298
Battery Status Window	300
Viewing Individual Battery Status	300
Recording Battery Status	300
Printing Battery Reports	300
Checking Battery Charge	300
Replacing Batteries	301
Optimizing Battery Performance	301
Display Brightness Setting	302
Charging Batteries	302
Conditioning Batteries	302
Unequally-Charged Batteries	302
Battery Safety Information	303
32 Maintenance and Troubleshooting	305
Inspecting the Equipment and Accessories	305
Inspecting the Cables and Cords	305
Maintenance Task and Test Schedule	306
Troubleshooting	307
Disposing of the Monitor	307
Disposing of Empty Calibration Gas Cylinders	307

33 Accessories

309

ECG/Resp Accessories	309
Trunk Cables	309
3-Electrode Cable Sets	309
5-Electrode Cable Sets	310
10-Electrode Cable Sets	310
3-Electrode One Piece Cables	310
5-Electrode One Piece Cables	310
Set Combiners and Organizers	311
NBP Accessories	311
Adult/Pediatric Multi-Patient Comfort Cuffs and Disposable Cuffs	311
Reusable Cuff Kits	311
Adult/Pediatric Antimicrobial Coated Reusable cuffs	312
Adult/Pediatric Soft Single Patient Single-Hose Disposable Cuffs	312
Neonatal/Infant Cuffs (Disposable, non-sterile)	312
Invasive Pressure Accessories	313
SpO ₂ Accessories	313
Temperature Accessories	318
Cardiac Output (C.O.) Accessories	319
Mainstream CO ₂ Accessories (for M3014A)	320
Sidestream CO ₂ Accessories (for M3014A)	320
Mainstream CO ₂ Accessories (for M3016A)	320
Microstream CO ₂ Accessories	321
Spirometry Accessories	321
tcGas Accessories	322
EEG Accessories	322
BIS Accessories	322
BIS Sensors	323
Other BIS Accessories	323
SvO ₂ Accessories	323
Recorder Accessories	324

34 Installation and Specifications

325

Intended Use	325
Indication for Use	325
Manufacturer's Information	326
BIS Manufacturer's Information	326
Trademark Acknowledgement	327
Symbols	328
Installation Safety Information	329
Connectors	329
MP20/MP30	330
MP40/MP50	331
MP60/MP70	332
MP80/MP90	334

802.11 Bedside Adapter (Wireless Network Adapter)	335
Altitude Setting	336
Monitor Safety Specifications	336
Physical Specifications	337
Environmental Specifications	339
M4605A Battery Specifications	341
Monitor Performance Specifications	342
Measurement Specifications	348
ECG/Arrhythmia/ST	348
Respiration	350
SpO ₂	350
NBP	352
Invasive Pressure and Pulse	354
Temp	355
CO ₂	356
Interfering Gas and Vapor Effects On CO ₂ Measurement Values	359
Spirometry	359
Cardiac Output / Continuous Cardiac Output	361
tcGas	362
SvO ₂	363
EEG	363
BIS	364
Safety and Performance Tests	365
Electromagnetic Compatibility (EMC) Specifications	365
Accessories Compliant with EMC Standards	365
Electromagnetic Emissions	365
Avoiding Electromagnetic Interference (Resp and BIS)	365
Electromagnetic Immunity	366
Recommended Separation Distance	366
Recommended separation distances from portable and mobile RF communication equipment	367
Electrosurgery Interference/Defibrillation/Electrostatic Discharge	368
Fast Transients/Bursts	368
Restart time	368

35 Default Settings Appendix

369

Alarm Default Settings	370
ECG, Arrhythmia, and ST Default Settings	370
Pulse Default Settings	373
Respiration Default Settings	374
SpO ₂ Default Settings	374
NBP Default Settings	375
Temperature Default Settings	375
Invasive Pressure Default Settings	376
Cardiac Output Default Settings	377
CO ₂ Default Settings	378
Spirometry Default Settings	378



tcGas Default Settings	379
SvO ₂ Default Settings	379
EEG Default Settings	380
BIS Default Settings	380
VueLink Default Settings	381

Basic Operation

These Instructions for Use are for clinical professionals using the IntelliVue MP20/MP30 (M8001A/M8002A), MP40/50 (M8003A/M8004A) and MP60/70/80/90 (M8005A/M8007A/M8008A/M8010A) patient monitors. Unless otherwise specified, the information here is valid for all the above IntelliVue patient monitors.

The basic operation section gives you an overview of the monitor and its functions. It tells you how to perform tasks that are common to all measurements (such as entering data, switching a measurement on and off, setting up and adjusting wave speeds, working with profiles). The alarms section gives an overview of alarms. The remaining sections tell you how to perform individual measurements, and how to care for and maintain the equipment.

Familiarize yourself with all instructions including warnings and cautions before starting to monitor patients. Read and keep the Instructions for Use that come with any accessories, as these contain important information about care and cleaning that is not repeated here.

This guide describes all features and options. Your monitor may not have all of them; they are not all available in all geographies. Your monitor is highly configurable. What you see on the screen, how the menus appear and so forth, depends on the way it has been tailored for your hospital and may not be exactly as shown here.

In this guide:

- A **warning** alerts you to a potential serious outcome, adverse event or safety hazard. Failure to observe a warning may result in death or serious injury to the user or patient.
- A **caution** alerts you to where special care is necessary for the safe and effective use of the product. Failure to observe a caution may result in minor or moderate personal injury or damage to the product or other property, and possibly in a remote risk of more serious injury.
- **Monitor** refers to the entire patient monitor. **Display** refers to the physical display unit. **Display Screen** and **Screen** refer to everything you see on monitor's display, such as measurements, alarms, patient data and so forth.

Introducing the IntelliVue Family

The Philips IntelliVue family of patient monitors offers a monitoring solution optimized for the surgical, cardiac, medical and neonatal care environments. Combining patient surveillance and data management, it allows multi-measurement monitoring by linking separate modules with “plug-and-play” convenience.

Your monitor stores data in trend, event, and calculation databases. You can see tabular trends (vital signs) and document them on a local or remote printer. You can view measurement trend graphs, with up to three measurements combined in each graph, to help you identify changes in the patient's physiological condition. You can view fast-changing measurement trends with beat to beat resolution and see up to four high resolution trend segments. Event surveillance enhances documentation and review of physiologically significant events by automatically detecting and storing up to 50 user-defined clinical events over a 24 hour period.

There is a choice of monitor configurations, as explained below. All models can also use computer devices such as a mouse, a trackball and a keyboard.

IntelliVue MP20/MP30

The IntelliVue MP20/MP30 (M8001A/M8002A) patient monitor has a 10-inch TFT LCD flat panel SVGA display. The standard input devices for the MP30 are the Touchscreen and integrated navigation point; the MP20 is supplied with an integrated navigation point only. Up to six waves can be shown on MP20/MP30 Screens (USA - up to four waves). 12 ECG traces can be shown on the 12-Lead ECG Screen.

The MP20/MP30 can be connected to one Multi-Measurement Server (MMS) and any one of the measurement server extensions. There is an optional built-in recorder. The Flexible Module Server (M8048A) and all plug-in modules cannot be used with the MP20/MP30. With an optional Interface board Bispectral Index (BIS) monitoring is possible.

MP20*Junior* and MP20L are options of MP20 (M8001A) and are not referred to separately in these Instructions for Use.



MP20/MP30 Major Parts and Keys

MP20/MP30 left side

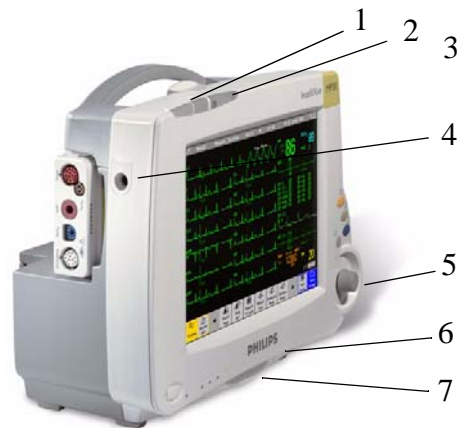

- 1 Color-coded alarm lamps
- 2 Alarms off lamp
- 3 Model indicator
- 4 ECG out
- 5 Navigation Point
- 6 Part number and serial number
- 7 Mounting quick-release lever

MP20/MP30 front panel

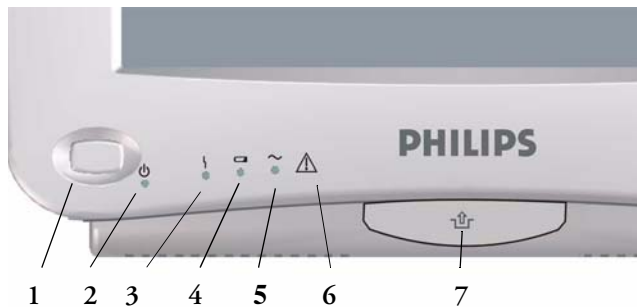

- 1 On/Standby switch
- 2 On/Standby LED
- 3 Error LED
- 4 Battery status LED
- 5 AC power operation LED
- 6 “read the documentation” symbol
- 7 Mounting quick-release lever

MP20/MP30 LED Colors and their Meanings	
On/Standby LED	Green when monitor is switched on
Error LED	Red if there is a problem with the monitor
Battery LED	Green, yellow, and red. See the section on Using the Batteries for details
AC Power LED	Green while the monitor is connected to AC power (mains)

IntelliVue MP40/MP50

The IntelliVue MP40/MP50 (M8003A/M8004A) patient monitor has a 12-inch TFT LCD flat panel SVGA display. The standard input devices for the MP50 are the Touchscreen and integrated navigation point; the MP40 is supplied with an integrated navigation point only. Up to six waves can be shown on MP40/MP50 Screens, 12 ECG traces can be shown on the 12-Lead ECG Screen.

The MP40/MP50 can be connected to one Multi-Measurement Server (MMS) and any one of the measurement server extensions. The IntelliVue family plug-in measurement modules can be connected to its four integrated plug-in module slots with plug-and-play convenience (the only exception is the SvO₂ module, M1021A, which cannot be used with the MP40/MP50). The Flexible Module Server (M8048A) cannot be used with the MP40/MP50.



MP40/MP50 Major Parts and Keys

MP40/MP50 left side

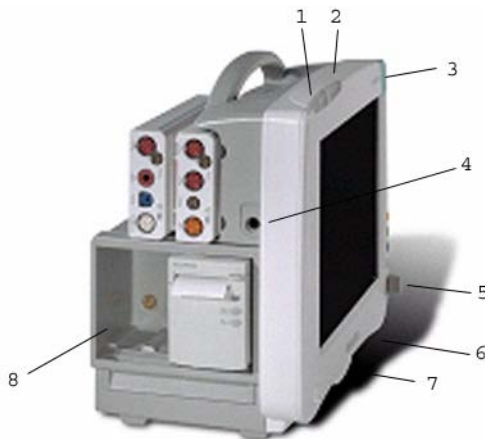

- 1 Color-coded alarm lamps
- 2 Alarms off lamp
- 3 Model indicator
- 4 ECG out
- 5 Navigation Point
- 6 Part number and serial number
- 7 Mounting quick-release lever
- 8 Plug-in module slots

MP40/MP50 front panel

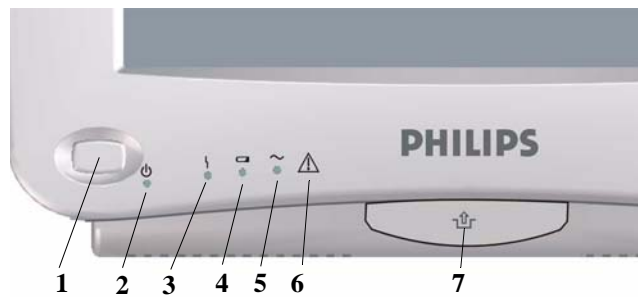

- 1 On/Standby switch
- 2 On/Standby LED
- 3 Error LED
- 4 Battery status LED
- 5 AC power operation LED
- 6 “read the documentation” symbol
- 7 Mounting quick-release lever

MP40/MP50 LED Colors and their Meanings	
On/Standby LED	Green when monitor is switched on
Error LED	Red if there is a problem with the monitor
Battery LED	Green, yellow, and red. See the section on Using the Batteries for details
AC Power LED	Green while the monitor is connected to AC power (mains)

IntelliVue MP60/MP70

The IntelliVue MP60/MP70 (M8005A/M8007A) patient monitors integrate the display unit, with a 15” color LCD display, and the data processing unit into one. Up to eight waves can be shown on the screens, as well as the 12-Lead ECG Screen. The MP60 uses the SpeedPoint as its primary input device while the MP70 uses touch screen operation but may have an optional SpeedPoint.

The monitors can be connected to the Multi-Measurement Server (MMS) and any one of the measurement server extensions, and to the Flexible Module Server (M8048A). The IntelliVue family plug-in measurement modules can be connected to its FMS module slots with plug-and-play convenience.

The MP60/MP70 has two integrated slots for plug-in modules. You can combine one each of the following modules in these slots: Pressure, Temperature, C.O., SpO₂ and VueLink. Two of the same type of module cannot be used. You can also use the two-slot recorder module in the integrated slots.

MP60/MP70 Major Parts and Keys

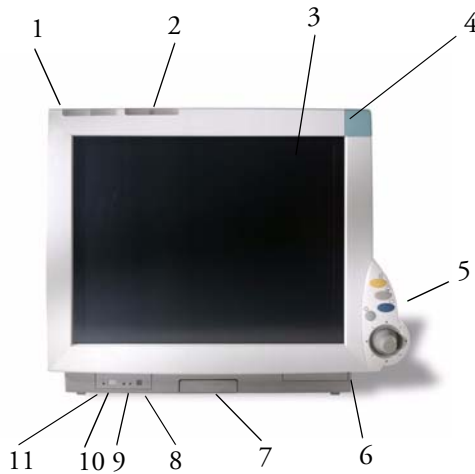

- 1 Color coded alarm lamps
- 2 Alarms Off lamp
- 3 Display
- 4 Model indicator
- 5 SpeedPoint (optional for MP70)
- 6 Part number and serial number
- 7 Mounting quick-release lever
- 8 AC power LED
- 9 Error LED
- 10 Power on/standby switch
- 11 Power on LED

IntelliVue MP80/MP90

Note: The MP80 monitor (M8008A) is not available in the USA.

The IntelliVue MP80/MP90 (M8008A/M8010A) patient monitors have the display and the processing unit as separate components. They offer both touchscreen and the Remote SpeedPoint as standard input devices. The MP80 can display up to 8 waves simultaneously and the MP90 up to 12 waves.

The monitors can be connected to the Multi-Measurement Server (MMS) and any one of the measurement server extensions, and to the Flexible Module Server (M8048A). The IntelliVue family plug-in measurement modules can be connected to its FMS module slots. The MP90 can be connected to two Flexible Module Servers (FMS). The MP90 has the capability for two displays and can have a third main display with the D80 Intelligent Display.

MP80/MP90 Major Parts and Keys



Display Unit

AC Power LED

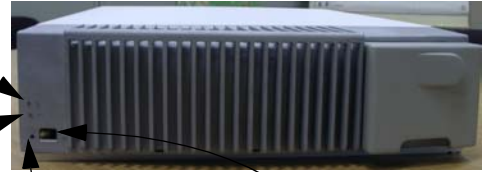

Error LED

Power on LED

Power on Switch

Processing Unit

D80 Intelligent Display

The D80 Intelligent Display can be used as a third main display with the MP90 monitor. You then have three displays able to be configured individually and to be operated independently.

Remote Alarm Device

The Remote Alarm Device provides audio and visual indicators of alarms, in addition to those shown on the display.

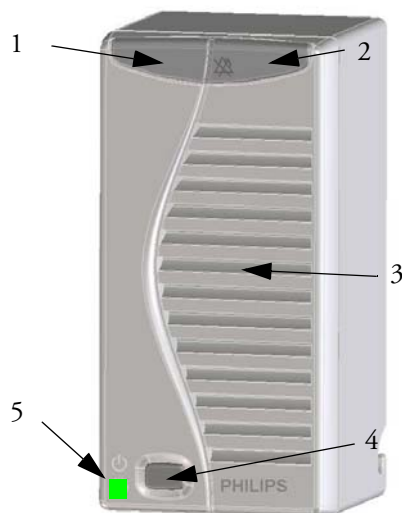

- 1 Two color coded alarm lamps (right-hand lamp flashes red or yellow for patient alarms, left-hand lamp flashes light blue for INOPs)
- 2 Alarms off lamp - when illuminated it indicates that all alarms are deactivated.
- 3 Speaker - for alarm tones, QRS tones and so forth
- 4 Monitor power on /standby switch. Press to switch monitor on remotely. Press and hold for one second to turn monitor off.
- 5 Power on LED - green when monitor is on

Docking Station

MP20/30/40/50 only The docking station provides quick mounting and connections in a one-step operation. By placing the monitor on the docking station and closing the lever you can make the connection to power and to a wired network, if present.

WARNING If the docking station is in a tilted position, you must hold the monitor in place while closing the locking lever.

When using the monitor for transport directly after use on the docking station, insert the batteries before placing the monitor on the docking station.

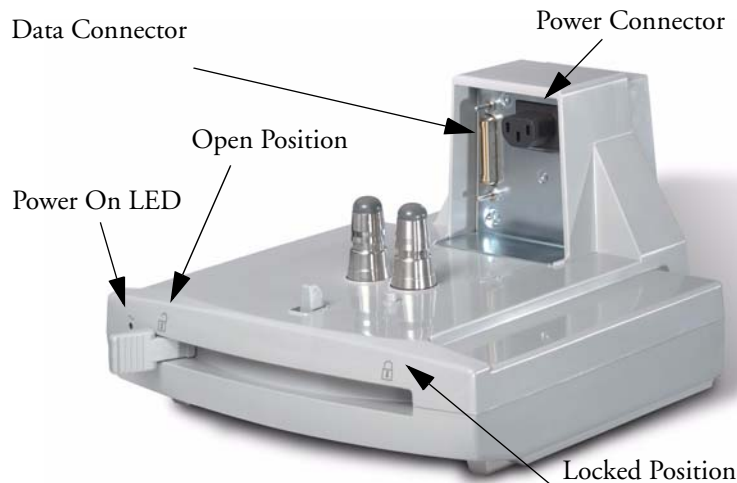

Related Products

Related products extend the measurement capabilities of your monitor. None of the related devices have their own power on/standby switches. They take their power from the monitor, and switch on automatically when you turn on the monitor. A green power-on LED indicates when they are drawing power from the monitor. A permanently illuminated, or flashing, red LED indicates a problem with the unit that requires the attention of qualified service personnel.

Flexible Module Server (M8048A)

MP60/70/80/90 only The flexible module server (FMS) lets you use up to eight plug-in physiological measurement modules. With the MP60/70/80 you can connect only one FMS. With the MP90 (M8010A) you can connect two FMSs to use up to 10 measurement modules. For individual modules, the maximum that can be used simultaneously in an FMS is: five pressure modules, four temperature modules, four VueLink modules.

Connect the FMS to the monitor via the measurement server link cable (MSL). Use the MSL connector on the left-hand side to connect additional measurement servers. Use the connector on the right to connect to the monitor.



- 1 Multi-Measurement Server
- 2 Measurement server mount
- 3 Flexible Module Server
- 4 Power on LED
- 5 Interruption indicator

Measurement Modules

You can use up to eight measurement modules with the Flexible Module Server (M8048A), two additional modules in the integrated module slots in the MP60/MP70, and up to four in the integrated slots in the MP40/MP50. Available modules are:

- Invasive blood pressure (M1006B)
- Temperature (M1029A)
- Oxygen saturation of arterial blood (SpO₂) (M1020B)
- Cardiac output (M1012A), and Continuous cardiac output with M1012A Option #C10
- Transcutaneous gas (M1018A)
- Mixed venous oxygen saturation - SvO₂ (M1021A) MP60/70/80/90 monitor only
- Recorder (M1116B)
- VueLink device interface (M1032A)
- EEG (M1027A)
- Bispectral Index - BIS (M1034A)
- Spirometry (M1014A)

You can plug and unplug modules during monitoring. Insert the module until the lever on the module clicks into place. Remove a module by pressing the lever upwards and pulling the module out.

Reconnecting a module to the same monitor restores its label and measurement settings, such as alarms limits. If you connect it to a different monitor, the module remembers only its label.

The connector socket on the front of each module is the same color as the corresponding connector plug on the transducer or patient cable.

Press the Setup key on the module's front to display the measurement's setup menu on the monitor screen. When the setup menu is open, a light appears above the key. Some modules have a second key. On the pressure module, for example, it initiates a zeroing procedure.

Example Module (Pressure)



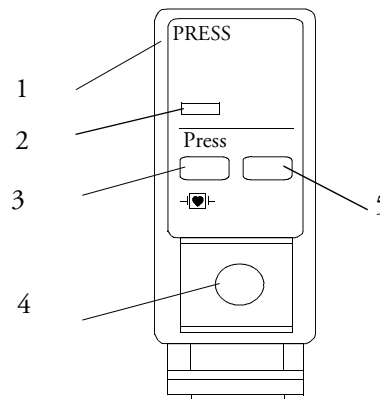

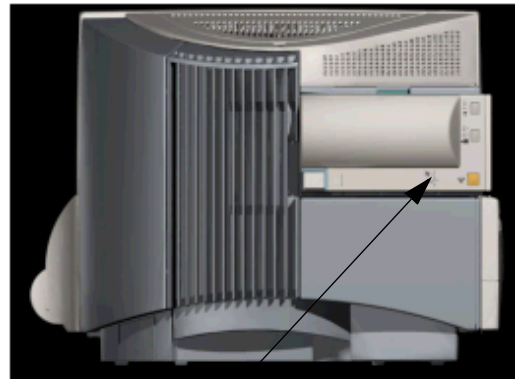
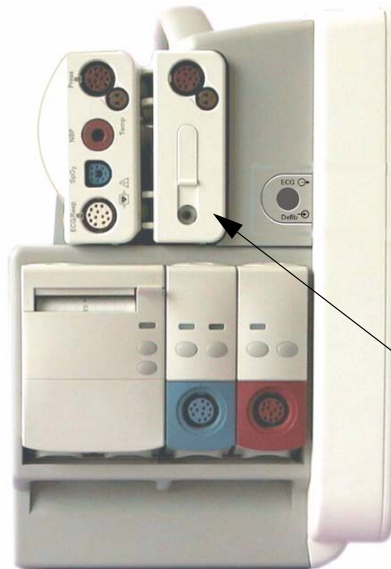

- 1 Module name
- 2 Setup key LED
- 3 Setup key to enter setup menu of measurement modules or VueLink device data window
- 4 Connector socket for patient cable/transducer
- 5 Second module-specific key, for example Zero

**Multi-Measurement Server (M3001A)**

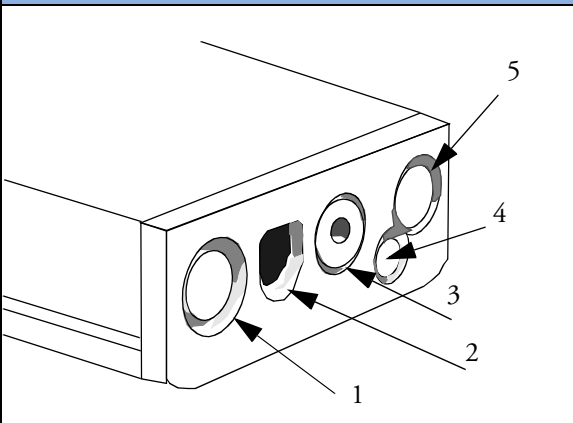
The Multi-Measurement Server (MMS) can simultaneously monitor 3-, 5- or 10-lead ECG (including arrhythmia and ST monitoring), respiration, SpO₂, NBP and either invasive pressure or temperature. Depending on the monitor model, you can connect it to the monitor via a cable or mount it either on the left side of the FMS or on the back of the monitor, as shown here.

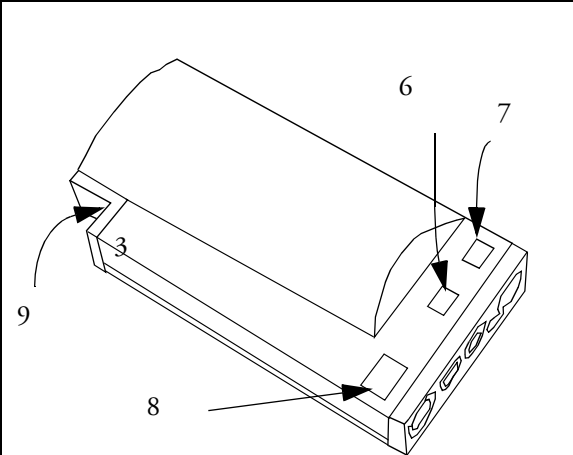

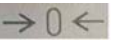
MMS mounted on rear of MP40/MP50 (left) and MP60/MP70

M3001A Connectors and Symbols		
	1	White ECG/Resp connector
	2	Blue SpO ₂ connector
	3	Red NBP connector
	4 & 5	Combined pressure (red) and temperature (brown) connector - connect either invasive pressure transducer or temperature probe. You might have a version of the MMS that does not have this connector.
	6	NBP Start/Stop key - 
	7	NBP STAT key - starts NBP STAT series of measurements 
		OR  Zero key - initiates a zero procedure for the connected pressure transducer when pressed and held for a second
	8	Silence: acknowledges all active alarms by switching off audible alarm indicators and lamps 
	9	MSL cable connector to the monitor

Measurement Server Extensions

The measurement server extensions connect to the MMS and use the MMS settings and power. Trend data and measurement settings from the measurements in the extensions are stored in the measurement server. To separate an extension from the MMS, press the release lever down, and push the server forward.

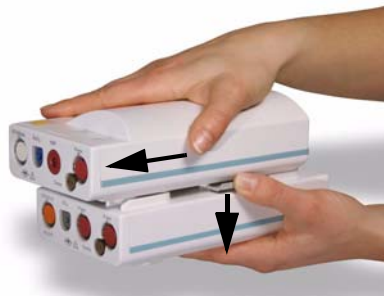

WARNING The measurement server extensions can only function when they are connected to a measurement server. If the measurement server is removed during monitoring, the measurements from both the measurement server **and** the measurement server extension are lost.

M3014A, M3015A and M3016A Capnography Extensions

The M3014A Capnography Extension adds mainstream capnography, and optionally one pressure plus either a pressure or a temperature, Cardiac Output and Continuous Cardiac Output to the MMS. The optional M3015A Microstream CO₂ Extension adds microstream capnography and optionally either pressure or temperature to the MMS. The optional M3016A Mainstream CO₂ Extension adds mainstream capnography and optionally either pressure or temperature to the MMS.

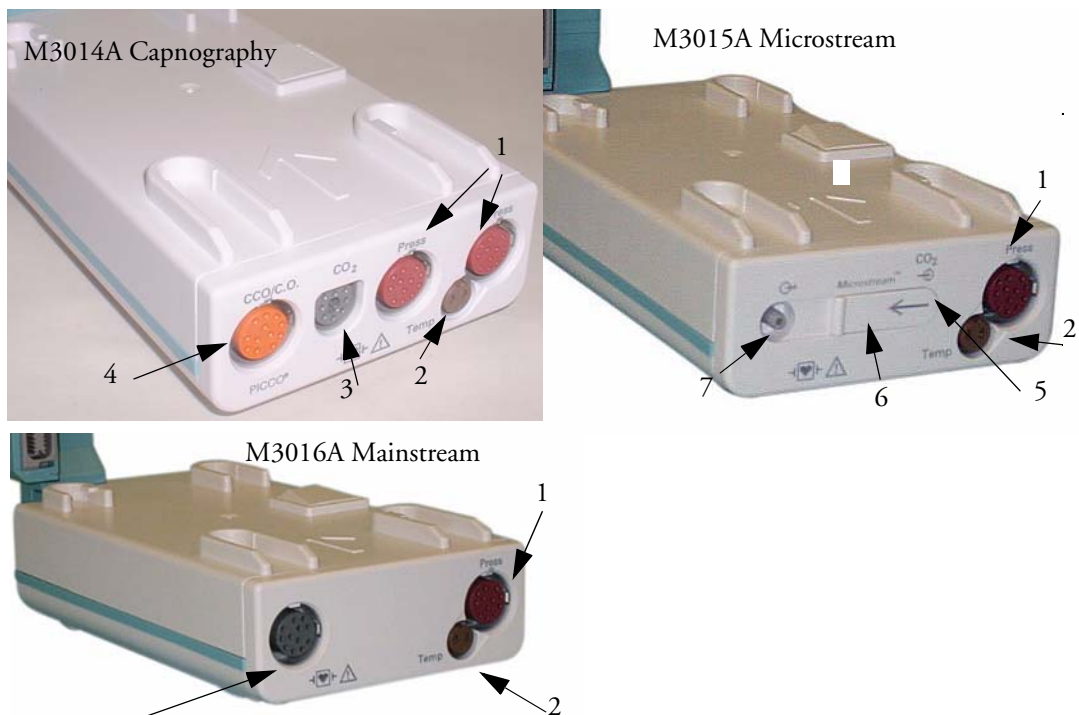

- | | | | |
|---|---|---|---------------------------------------|
| 1 | Pressure connectors (red) | 5 | Inlet |
| 2 | Temperature connector (brown) | 6 | Microstream connector CO ₂ |
| 3 | Mainstream connector CO ₂ (optional) | 7 | Gas sample outlet |
| 4 | Cardiac Output connector | | |

M3012A Hemodynamic Measurement Server Extension

The M3012A Hemodynamic Measurement Server Extension (HMSE) can be connected to the M3001A Multi-Measurement Server to provide the following additional measurements: Temperature, Pressure, an additional Pressure or Temperature, and C.O. and CCO measurements.

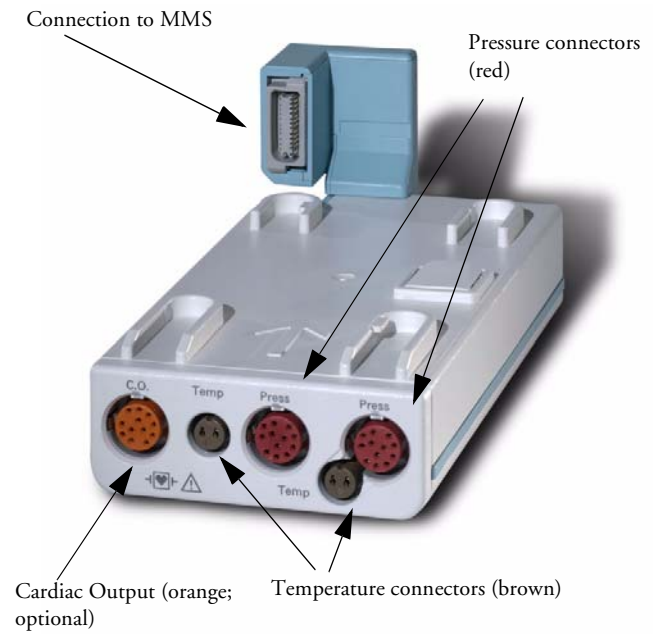

Operating and Navigating

Everything you need to operate the monitor is contained on its screen. Almost every element on the screen is interactive. Screen elements include measurement numerics, waveforms, screen keys, information fields, alarms fields and menus.

The configurability of the monitor means that often you can access the same element in different ways. For example, you might be able to access an item through its on-screen setup menu, via a hard key, or via a SmartKey. These Instructions for Use always describe how to access items via an on-screen menu. You may use whichever way you find most convenient.

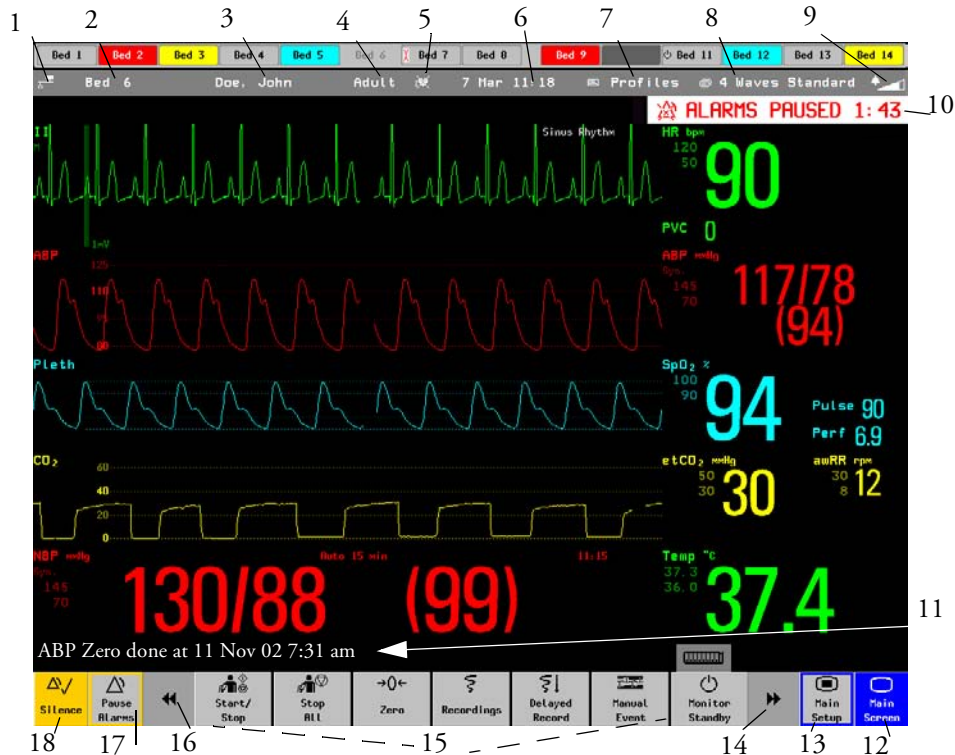

Monitor information line		Other screen elements	
1	network connection indicator (documented in Information Center Instructions for Use)	10	alarm status area - shows active alarm messages
2	bed label	11	status line - shows information messages and prompting you for action
3	patient identification	12	close all open menus and windows and return to main screen
4	patient category	13	enter Main Setup menu
5	paced status	14	scroll right to display more SmartKeys
6	date and time	15	SmartKeys - these change according to your monitor's configuration
7	access the profiles menu	16	scroll left to display more SmartKeys
8	current screen name/enter change screen menu	17	Pause Alarms - pauses alarm indicators. Pause duration depends on monitor configuration. If pause duration is infinite, this key is labeled Alarms Off . Select again to immediately re-enable alarm indicators.
9	adjust alarm volume/level indicator	18	Silence - acknowledges all active alarms by switching off audible alarm indicators and lamps permanently or temporarily, if alarm reminder (ReAlarm) is configured on.

Selecting Screen Elements

Select a screen element to tell the monitor to carry out the actions linked to the element. For example, select the Patient Identification element to call up the **Patient Demographics** window, or select the HR numeric to call up the Setup ECG menu. Select the ECG wave segment to call up the ECG lead menu.

Note that the space between each line of a menu may be configured to wide or narrow to facilitate your most common method of operation, either touch, Speedpoint or navigation point, or mouse.

Using the Setup Menu

MP20/MP30/
MP40/MP50
Only

Setup
Alarm Messages
Alarm Limits
Alarm Volume
My Care Group
Change Screens
Profiles
Admit/Dischrg
Paced No
Network
Bed Information
Date, Time

For the MP20/MP30 and MP40/MP50 monitors, the elements at the top of the Screen are grouped together for ease of navigation. Select any item at the top of the Screen to open the **Setup** menu; scroll down the menu to highlight the element you want then press the navigation point to select the element.

Using the Touchscreen

Select screen elements by pressing them directly on the monitor's screen.

Disabling Touchscreen Operation

- ◆ To temporarily disable touchscreen operation of the monitor, press and hold the Main Screen permanent key. A padlock will appear on the Main Screen permanent key.
- ◆ Press and hold the **Main Screen** permanent key again to re-enable the touchscreen operation.



Using the SpeedPoint

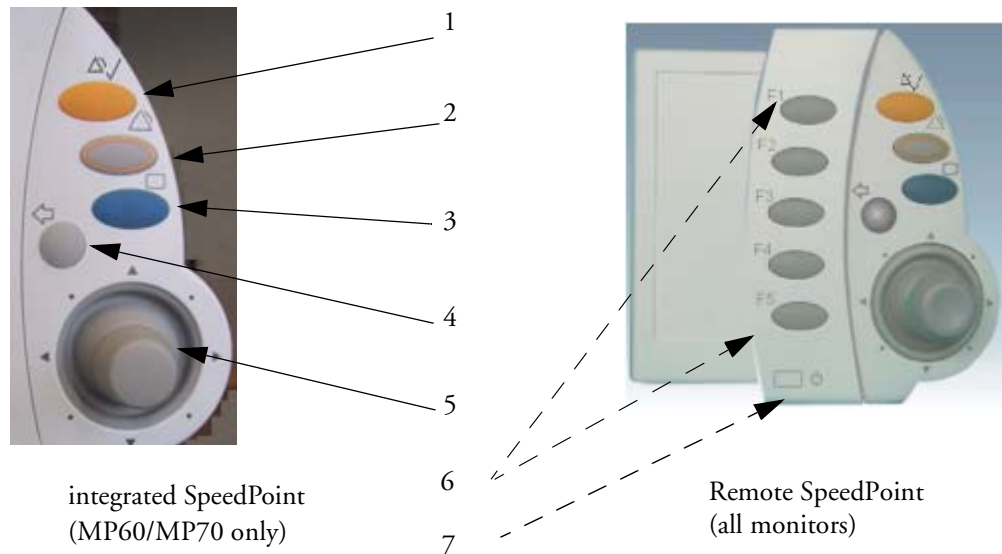

1	Silence - acknowledges all active alarms by switching off audible alarm indicators and lamps. Behavior follows the Silence permanent key configuration.
2	Alarms Off/Pause Alarms - pauses alarm indicators. Behavior follows the Pause Alarms permanent key configuration.
3	Main Screen - close all open menus and windows and return to the main screen.
4	Back - go back one step to the previous menu.
5	SpeedPoint knob - rotate and tilt to highlight elements. Press to select.
6	Function keys on remote SpeedPoint - function identical to the first five SmartKeys configured for a screen.
7	On/standby key

Rotate the SpeedPoint knob left or right. With each click, the highlight jumps to the neighboring screen element. Alternatively, tilt the knob to move it in the direction of a screen element. A cursor moves across the screen, following the direction of the knob. Any screen element under the cursor is highlighted. When you reach the screen element you want, press the knob to select the element.

Using the remote SpeedPoint, you can operate the monitor from a distant location such as at the foot of the bed. The remote SpeedPoint can be used with all monitors.

Using the Navigation Point

MP20/MP30/
MP40/MP50
Only

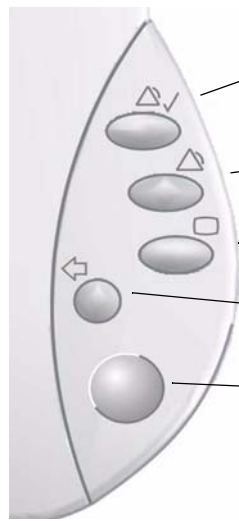

- 1 **Silence** - acknowledges all active alarms by switching off audible alarm indicators and lamps. Exact behavior depends on permanent key configuration
- 2 **Alarms Off/Pause Alarms** - pauses alarm indicators. Exact behavior depends on Pause Alarms permanent key configuration
- 3 **Main Screen** - closes all open menus and windows and return to the main screen.
- 4 **Back** - takes you back one step to the previous menu.
- 5 **Navigation Point knob**

To use the navigation point, rotate it left or right. With each click, the highlight jumps to the neighboring screen element. The element under the cursor is highlighted. When you reach the screen element you want, press the knob to select the element.

Using a Mouse or Trackball

If you are using a mouse or trackball, select screen elements by clicking on them (press and release the left mouse button). While you are moving the mouse, a cursor appears and a highlight shows your current position.

Using Keys

The monitor has four different types of keys.

Permanent Keys

A permanent key is a graphical key that remains on the screen all the time to give you fast access to functions.



Pause Alarms - pauses alarm indicators. Pause duration depends on monitor configuration. If pause duration is infinite, this key is labeled **Alarms Off**. Select again to immediately re-enable alarm indicators.



Silence - acknowledges all active alarms by switching off audible alarm indicators and lamps.



Main Screen - close all open menus and windows and return to the main screen.























Main Setup - enter main setup menu.

SmartKeys

A SmartKey is a configurable graphical key, located at the bottom of the main screen. It gives you fast access to functions. The selection of SmartKeys available on your monitor depends on your monitor configuration and on the options purchased.

	enter profile menu, or revert to default profile		change Screen, or revert to default screen
	show BIS Sensor		previous Screen
	freeze waves		quick admit a patient
	set alarm limits		enter patient identification menu to admit/discharge/transfer
	change alarm volume		end case to discharge a patient
	change QRS volume		view information for patients in other beds
	enter standby mode - suspends patient monitoring. All waves and numerics disappear from the display. All settings and patient data information are retained.		change screen brightness (not for independent displays)
	review beat labels (annotate arrhythmia wave)		re-learn arrhythmia
	change amplitude (size) of ECG wave		enter cardiac output procedure
	- start/stop manual NBP measurement - start auto series - stop current automatic measurement within series		start NBP STAT measurement
			stop automatic or STAT NBP measurement and measurement series
	start veni puncture (inflate cuff to subdiastolic pressure)		set the NBP repeat time
	access patient reports		zero invasive pressure transducer

	start a delayed recording		Realtime Record SmartKey to access pop-up recording keys
	set wide automatic alarm limits		set narrow automatic alarm limits
	access wedge procedure window		access the Loops window
	review vital signs trend		review graph trend
	access event surveillance		access calculations
	access the calculator		access the Drug Calculator
	gas analyzer - exit standby mode		suppress zero for all gas measurements
	unpair equipment		access ST Map application
	start 12-Lead Capture (only available if Information Center is connected)		access remote applications (if Application Server is connected)
	access EEG CSA		access the EEG montage
	display VueLink information		access timers
	access the spirometry data window		switch CO ₂ pump off

Hardkeys

A hardkey is a physical key on a monitoring device, such as the zero pressure key on the MMS or a setup key on a module.

Pop-Up Keys

Pop-up keys are task-related graphical keys that appear automatically on the monitor screen when required. For example, the confirm pop-up key appears only when you need to confirm a change.

Using the On-Screen Keyboard

Use this as you would a conventional keyboard. Enter the information by selecting one character after another. Use the **Shift** and capital **Lock** keys to access uppercase letters. Use the **Back** key to delete single characters, or use the **Clr** key to delete entire entries. Select **Enter** to confirm what you have entered and close the on-screen keyboard.

If a conventional keyboard is connected to the monitor, you can use this instead of or in combination with the on-screen keyboard.

Using the On-Screen Calculator

You can use the on-screen calculator to perform any of the standard operations for which you would normally use a handheld calculator.

- ◆ To access the on-screen calculator, select the **Calculator** SmartKey, or select **Main Setup** -> **Calculations** -> **Calculator**.

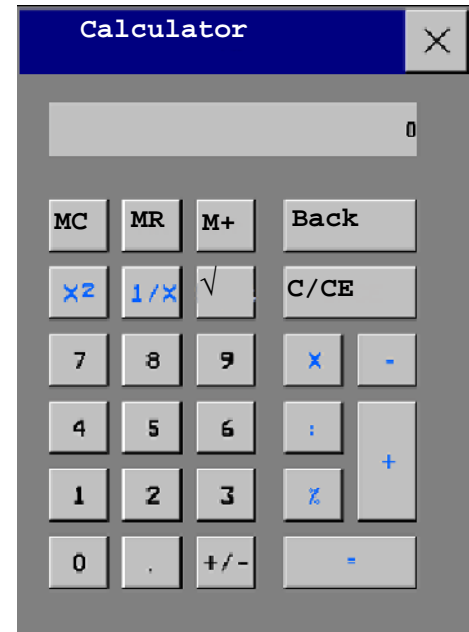

Operating Modes

When you switch the monitor on, it starts up in monitoring mode. To change to a different mode:

- 1 Select the **Main Setup** menu.
- 2 Select **Operating Modes** and choose the mode you require.

Your monitor has four operating modes. Some are passcode protected.

- **Monitoring Mode:** This is the normal, every day working mode that you use for monitoring patients. You can change elements such as alarm limits, patient category and so forth. When you discharge the patient, these elements return to their default values. Changes can be stored permanently only in Configuration Mode. You may see items, such as some menu options or the altitude setting, that are visible but 'grayed out' so that you can neither select nor change them. These are for your information and can be changed only in Configuration Mode.
- **Demonstration Mode:** Passcode protected, this is for demonstration purposes only. You must not change into Demonstration Mode during monitoring. In Demonstration Mode, all stored trend information is deleted from the monitor's memory.
- **Configuration Mode:** Passcode protected, this mode is for personnel trained in configuration tasks. These tasks are described in the Configuration Guide. During installation the monitor is configured for use in your environment. This configuration defines the default settings you work with when you switch on, the number of waves you see and so forth.
- **Service Mode:** Passcode protected, this is for trained service personnel.

When the monitor is in Demonstration Mode, Configuration Mode, or Service Mode, this is indicated by a box with the mode name in the center of the Screen and in the bottom right-hand corner. Select this field to change to a different mode.



Standby Mode

Standby mode can be used when you want to temporarily interrupt monitoring.

To enter Standby mode,

- ◆ select the **Monitor Standby** SmartKey or
- ◆ select **Main Setup**, followed by **Monitor Standby**.

The monitor enters Standby mode automatically after the End Case function is used to discharge a patient.

Standby suspends patient monitoring. All waves and numerics disappear from the display but all settings and patient data information are retained. A special **Standby** screen is displayed. If a patient location is entered at the Information Center, this will also be displayed on the **Standby** screen (availability depends on Information Center revision).

To resume monitoring,

- ◆ Select anything on the screen or press any key.

Understanding Screens

Your monitor comes with a set of preconfigured Screens, optimized for common monitoring scenarios such as OR adult, or ICU neonatal. A Screen defines the overall selection, size and position of waves, numerics and SmartKeys on the monitor screen when you switch on. You can easily switch between different Screens during monitoring. Screens do NOT affect alarm settings, patient category and so forth.

When you switch from a complex to a less complex Screen layout, some measurements may not be visible but are still monitored in the background. If you switch to a more complex Screen with, for example, four invasive pressure waves but you have only two pressures connected to the monitor, the “missing” two pressures are either left blank or the available space is filled by another measurement.

Switching to a Different Screen

- 1 To switch to a different Screen, select the current Screen name in the monitor info line, or select the **Change Screen** SmartKey.
- 2 Choose the new Screen from the pop-up list.



Changing a Screen's Content

If you do not want to change the entire Screen content, but only some parts of it, you can substitute individual waves, numerics, high-res waves, or trends. Be aware that these changes cannot be stored permanently in Monitoring Mode.

To change the selection of elements on a Screen,

- 1 Select the element you want to change.
- 2 From the menu that appears, select **Change Wave**, **Change Numeric**, or **Change HiResTrend**, and then select the wave or numeric you want, or select the high-resolution trend wave you want from the list of available waves.

If you do not see **Change Numeric** in the menu, this Screen may be configured to always display the numeric beside its wave. Changing the wave will automatically change the numeric.

The changed Screen is shown with an asterisk in the monitor info line.

In the **Change Screen** menu, the changed Screen is shown linked to the original Screen and marked with an asterisk.

Up to three modified Screens can be accessed via the **Change Screen** menu.

To recall Screens, either

- ◆ select the name of the Screen in the **Change Screen** menu

or

- ◆ use the previous/next arrows at the top of the Change Screen menu to move back and forth in the Screen history. The ten most recently-used Screens including up to three modified Screens can be accessed.

After a patient discharge, the monitor's default Screen is shown. Modified Screens are still available in the **Change Screen** menu.

If the monitor is switched off and then on again, modified Screens are erased from the monitor's memory and cannot be recalled. If a modified Screen was the last active Screen when the monitor was switched off, it is retained (unless **Automat. Default** is configured to **Yes**).

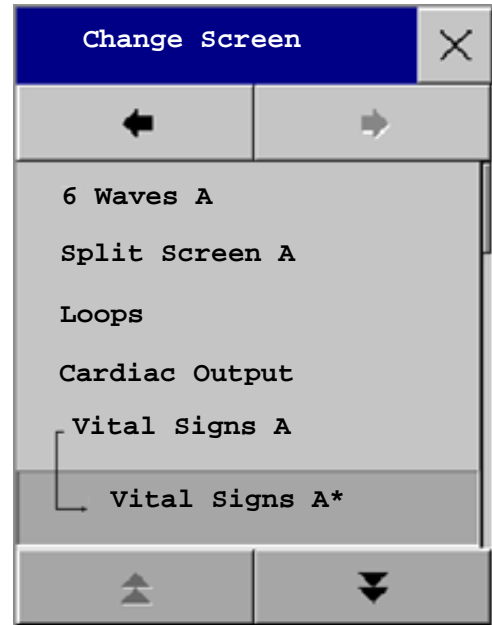

Using Additional Displays

A second display, showing the same Screen as the main display, can be connected to any of the monitors, for **viewing** only.

The MP90 can have two main displays and additionally, as a third main display, the D80 Intelligent Display connected. All main displays can be configured and operated individually using standard input devices.

For MP90 monitors with multiple displays and multiple input devices, the usage and behavior can be configured according to specific requirements at installation (for example, use for two independent operators or tracking of mouse input across two displays). For details refer to the Service Guide.

When two operators are using two displays, the scope of an action depends on the type of operation:

- Patient monitoring operations such as **Silence** or **Pause** alarms take effect for the monitor as a whole, the results will be seen on both displays.
- Display operations such as the **Main Screen** key and Back hardkey will take effect only on the display being operated.

If you are operating two displays with one remote SpeedPoint, to navigate from one display to another:

- 1 Move the highlight to the **Main Screen** key and then turn one click further.
The highlighting moves to a special “jump” field at the edge of the Screen
- 2 Press the knob on the SpeedPoint to confirm; the highlighting will automatically move to the other display.

The content of each Screen can be changed individually as described in the previous section. If you are operating two or three displays, you can choose Screens for all displays from one location:

- 1 Select **Profiles** in the monitor info line of the first display,
- 2 Select **Display 1, Display 2,** or **Display 3** then select the Screen you want to display on the that display from the list of available Screens.

When two displays are mounted next to each other or one above the other, a special Screen can be assigned which spans across both displays. The Screen content for these Tall and Wide Screens can then use the increased area available with two displays. These Screens appear in the Screen list with a special Tall Screen or Wide Screen symbol.

Certain windows (for example: cardiac output procedure) can only be shown on one display at a time. If you try to open one of these windows when it is already shown on another display, you will see a blank grey window with a cross through it.

Using the Visitor Screen

If a visitor Screen is configured for your monitor, you can use it to clear the screen of all waves and numerics but continue to monitor the patient with active alarms and trend storage at the bedside and Information Center. You can change the name of the visitor Screen in Configuration Mode.

- ◆ To activate this Screen, select the Screen name in the monitor info line to open the **Screen** menu, then select the name of the visitor Screen configured for your monitor from the list of available Screens.
- ◆ Select any element on the Screen to open the **Screen** menu and select a different Screen to show waves and numerics again.

Understanding Profiles

Profiles are predefined monitor configurations. They let you change the configuration of the whole monitor so you can adapt it to different monitoring situations. The changes that occur when you change a complete profile are more far reaching than those made when you change a Screen. Screens affect only what is shown on the display. Profiles affect all monitor and measurement settings.

The settings that are defined by Profiles are grouped into three categories. Each category offers a choice of 'settings blocks' customized for specific monitoring situations. These categories are:

- **Display (screens)**
 - Each profile can have a choice of many different predefined screens. If you are using a second display, each display can have its own individual screen selection. When you change the profile, the screen selection configured for the new profile becomes active.
- **Measurement Settings**
 - Each profile can have a choice of different predefined measurement settings. These relate directly to individual measurements, for example, measurement on/off, measurement color, alarms limits, NBP alarm source, NBP repeat time, temperature unit (°F or °C) pressure unit (mmHg or kPa).
- **Monitor Settings**
 - Each profile can have a choice of different predefined monitor settings. These relate to the monitor as a whole; for example, display brightness, alarms off/paused, alarm volume, QRS tone volume, tone modulation, prompt tone volume, wave speed, resp wave speed, pulse source.

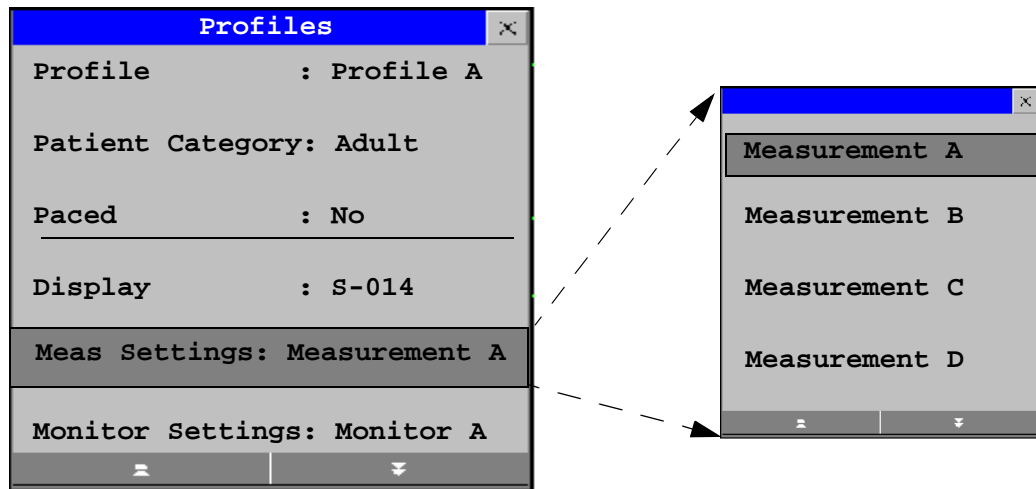

Profiles Menu, showing current settings

Available choices in measurement menu

You can change from one complete profile to another or swap individual settings blocks (display screen/monitor settings/measurement settings) to change a subset of a profile. Changes you make to any element within the settings blocks are not saved when you discharge the patient, unless you save them in Configuration Mode.

You might find it helpful to think of the three categories in terms of a restaurant menu. The Screens are like the first course, offering you a choice of “starters” (many different screen configurations from which you can choose the one that best suits your requirements). The Monitor Settings category is like the main course, offering a choice of different “main dishes” from which you can pick one. The Measurement Settings are like the dessert course. From these you build your meal. You can choose one from the “starters”, one from the main course, then one from the dessert or simply pick one or two courses without having a full meal.

Depending on your monitor configuration, when you switch on or discharge a patient the monitor either continues with the previous profile, or resets to the default profile configured for that monitor.

WARNING If you switch to a different profile, the patient category and paced status normally change to the setting specified in the new profile. However some profiles may be setup to leave the patient category and paced status unchanged. Always check the patient category, paced status, and all alarms and settings, when you change profiles.

When you leave Demonstration Mode, the monitor uses the default profile.

Swapping a Complete Profile

- 1 Select **Profiles** in the monitor info line, or select the Profiles SmartKey.
- 2 In the **Profiles** menu, select **Profile**.
- 3 Chose a profile from the pop-up list.
- 4 Confirm your selection.



Swapping a Settings Block

- 1 Select **Profiles** in the monitor info line, or select the Profiles SmartKey.
- 2 In the **Profiles** menu, select **Display** or **Measmnt. Settings** or **Monitor Settings** to call up a list of the settings blocks in each category.
- 3 Choose a settings block from the pop-up list.
- 4 Confirm your selection.



Default Profile

Your monitor has a default profile that it uses when you leave Demonstration, or Service modes, or when you discharge a patient. This profile is indicated by a diamond .

Locked Profiles



Some profiles are locked, so that you cannot change them, even in Configuration Mode. These are indicated by this lock symbol.

Understanding Settings

Each aspect of how the monitor works and looks is defined by a setting. There are a number of different categories of settings, including,

Screen Settings, to define the selection and appearance of elements on each individual Screen

Measurement settings, to define settings unique to each measurement, for example, high and low alarm limits

Monitor settings, including settings that affect more than one measurement or Screen and define general aspects of how the monitor works, for example, alarm volume, reports and recordings, and display brightness.

You must be aware that, although many settings can be changed in Monitoring Mode, permanent changes to settings can only be done in the monitor's Configuration Mode. All settings are reset to the stored defaults:

- when you discharge a patient
- when you load a Profile
- when the monitor is switched off for more than one minute (if **Automat. Default** is set to **Yes**).

Changing Measurement Settings

Each measurement has a setup menu in which you can adjust all of its settings. You can enter a setup menu:

- via the measurement numeric - select the measurement numeric to enter its setup menu. For example, to enter the **Setup ECG** menu, select the HR (heart rate) numeric.
- via the Setup hardkey (on plug-in modules) - press the Setup hardkey on the module front.

- via the **Main Setup** SmartKey - if you want to setup a measurement when the measurement is switched off, use the **Main Setup** SmartKey and select **Measurements**. Then select the measurement name from the popup list. With this SmartKey you can access any setup menu in the monitor.
- via the Measurement Selection key.

This guide always describes the entry method using the setup menu. But you can use any method you prefer.

Switching a Measurement On and Off

When a measurement is off, its waves and numerics are removed from the monitor's screen. The monitor stops data acquisition and alarming for this measurement. A measurement automatically switches off if you disconnect its module or measurement server. If you disconnect a transducer, the monitor replaces the measurement numeric with question marks.

- 1 Enter the measurement's setup menu and select the measurement.
- 2 Select the measurement name to toggle between on and off. The screen display indicates the active setting.

Switching Numerics On and Off

For some measurements, such as EEG, you can choose which numerics to view on the screen.

- ◆ In the measurement's setup menu, select the numeric name to toggle between on and off.

For example in the **Setup EEG** menu, select the EEG numeric name to toggle between on and off.

Adjusting a Measurement Wave

- ◆ To quickly adjust wave-related measurement settings (such as speed or size), select the measurement wave itself. This displays the measurement **Wave** menu, which has only wave-related measurement settings.

Changing Wave Speeds

Lowering the wave speed compresses the wave and lets you view a longer time period. Increasing the speed expands the waveform, giving you a more detailed view.

The monitor distinguishes three groups of wave speed settings,

- **RespiratorySpeed**, for all respiratory waves: CO₂, Resp. anesthetic agents and O₂
- **EEG Speed**, for all EEG and BIS waves
- **Global Speed**, for all waves not included in the other two groups.

Changing the Wave Group Speed

The wave speed group setting defines the speed of all the waves in the group.

To change the wave speed of a wave speed group,

- 1 Select **Main Setup** -> **User Interface**
- 2 Select **Global Speed**, **RespiratorySpeed**, or **EEG Speed** as required

- 3 Select a value from the list of available speeds.

Changing Wave Speed for a Channel

To change the wave speed of an individual wave channel,

- 1 Enter the **Wave** menu for a measurement by selecting its wave.
- 2 Select **Change Speed**.
- 3 To set the speed to the wave group speed, select **RespiratorySpeed**, **EEG Speed**, or **Global Speed**.

To set an individual channel speed, select a numeric value from the list of available speeds. This overrides the wave group speed setting and set the speed for the individual wave channel on the monitor Screen. The wave channel speed is independent of the wave (label) depicted in the channel, if you change the wave, the new wave will retain the set channel speed.

Freezing Waves

You can freeze waves on the screen and measure parts of the wave using cursors. The waves are frozen with a history of 20 seconds so that you can go back and measure what you have seen.

Freezing An Individual Wave

To freeze a wave,

- 1 Enter the **Wave** menu for the measurement by selecting the wave on the screen.
- 2 Select **Freeze Wave**.

The realtime wave is replaced with the frozen wave.

Freezing All Waves

To freeze all waves on the screen,

- 1 Select the **Freeze Waves** SmartKey.

All realtime waves are replaced with frozen waves.



Measuring Frozen Waves

To measure a frozen wave,

- 1 Select the frozen wave.

If you are using touch, this automatically positions the vertical cursor. The cursor can be repositioned by touching the required point on the wave, **or**
- 2 Using the Speedpoint or another pointing device or touch: use the right/left arrow keys to move the vertical cursor.

The vertical cursor moves through the time axis and the current value is displayed next to the cursor.
- 3 Use the up/down arrow keys to activate and move the horizontal cursor.

The horizontal cursor measures the wave value, which is displayed above the cursor line.

Changing The Wave Speed

Lowering the wave speed compresses the wave and lets you view a longer time period. Increasing the speed expands the waveform, giving you a more detailed view.

To change the wave speed:

- 1 Select the frozen wave.
- 2 Select **Change Speed**.
- 3 Select a speed from the list.

Updating The Frozen Wave

To update the wave, that is freeze the current wave:

- 1 Select the frozen wave.
- 2 Select **Freeze Again**.

Releasing Frozen Waves

To release frozen waves,

- 1 Select a frozen wave.
- 2 Select **Unfreeze Waves**.

All frozen waves are released.

Using Labels

You can measure multiple invasive pressures, temperatures, and SpO₂ simultaneously. The monitor uses labels to distinguish between them. The default settings defined in the profile (such as measurement color, wave scale, and alarm settings) are stored within each label. When you assign a label to a measurement, the monitor automatically applies these default settings to the measurement. The labels assigned are used throughout the monitor, in reports, recordings, and in trends.

About Label Sets

Your monitor may be configured to use a **Restricted** or **Full** label set. The **Full** label set provides extra labels for Pressure and Temp. See the sections in this Instructions for Use on Pressure and Temp for more information.

If you connect a measurement server from a monitor using a **Full** label set to an IntelliVue monitor using a **Restricted** label set or an M3/M4 monitor, any additional labels switch to labels available in the target monitor. This may cause a label conflict with other monitored measurements.

Be aware that connecting a monitor using the **Full** label set to an Information Center with certain software revisions may affect the availability of measurement information from the additional labels on the Information Center. See the Information Center documentation and your monitor's Configuration Guide for information on label set compatibility.

Changing Measurement Labels (e.g. Pressure)

To change a measurement label of a measurement with multiple labels (invasive pressure, temperature, or SpO₂),

- 1 Enter the **Wave** menu of the measurement.
- 2 Select **Label**.
- 3 Choose a label from the list.

The monitor automatically applies the scale, color, etc. settings stored in the Profile for the label you select. You can change scale settings in Monitoring Mode, but color can only be changed in the monitor's Configuration Mode.

Any labels already being used in the monitor are shown “grayed-out” in the list and cannot be selected.

Give me an example Let's imagine you used a Press module to monitor your previous patient's CVP. Now you want to use the same module to measure ABP with a new patient. You've set up your arterial line. When you connect the pressure transducer to the module, the pressure shown on the screen still uses the CVP color and wave scale and is labeled CVP. To rectify this, just change the pressure label to ABP. Now the pressure has the correct color, the wave is shown in the correct scale, and the appropriate alarm limits for ABP are active.

Resolving Label Conflicts

Each label must be unique, that is, it can only be assigned once. You cannot monitor two pressures labelled “ICP” at the same time. If you need to use two identical pressures, you must assign different labels to them, for example, P and ICP.

Measurement labels are stored in the measurement device (module or measurement server). If you try to use two measurement devices that have identical labels, this causes a label conflict in the monitor.

Depending on your configuration, the monitor will either

- resolve the conflict automatically, by assigning a new, generic label to the most recently connected conflicting label (e.g. a second FAP label could be changed to ABP)
- display the **Measurement Selection** window automatically for you to resolve the conflict
- take no action, you must enter the **Measurement Selection** window and resolve the conflict



measurement selection key with question marks indicating a label conflict

All the currently available measurement devices are depicted in the **Measurement Selection** window. Any measurement labels causing a label conflict are shown in red. If a measurement device is connected but currently unavailable, for example, because it was deactivated due to a label conflict, the device is shown “grayed-out”.

Conflicting measurement labels are shown in red

De-activated labels are grayed-out



To resolve a label conflict,

- 1 Select the measurement selection key or select **Main Setup -> Measurement Selection** to display the **Measurement Selection** window.

- 2 Select the device whose label you want to correct.
- 3 Use the measurement selection pop-up keys to resolve the conflict. Select either:
 - **Change Label** to assign a different label to the conflicting label
 - **De-activate:** to disable the conflicting device. It retains its label for future use but becomes invisible to the monitor, as though it had been unplugged. When the device has been deactivated the question marks under the measurement selection key will be replaced by **XXX**.
 - **Setup <Measurement label>:** to enter the Setup menu for the measurement and change the conflicting device's label to a different label.
 - **Modify Driver** (VueLink only) - change the VueLink device driver.

Changing Monitor Settings

- ♦ To change monitor settings such as date and time, brightness, or QRS tone volume, select the **Main Setup** SmartKey and then select the setting you want to change, or select **User Interface** to enter a submenu where you can change user interface settings.

Adjusting the Screen Brightness

- 1 Select the **Brightness** SmartKey.
- 2 Select the appropriate setting for the screen brightness. 10 is the brightest, 1 is the least bright.



Your monitor may be configured with a lower brightness for Standby mode and also (for battery powered monitors) for transport to conserve battery power. These settings can only be changed in the monitor's Configuration Mode.

If you are using an MP80 or MP90 with an external display, the **Brightness** SmartKey does not adjust the brightness of this display. See the instructions supplied with the external display for instructions.

Adjusting Touch Tone Volume

The touch tone volume is the tone you hear when you select any field on the monitor screen. To adjust the touch tone volume,

- 1 In the **Main Setup** menu, select **User Interface**
- 2 Select **TouchToneVolume**, then select the appropriate setting for the touch tone volume: 10 is the loudest and 1 is the quietest. Selecting zero switches the touch tone volume off.

Setting the Date and Time

If your monitor is connected to an Information Center, the date and time are automatically taken from this. Once it is set, the internal clock retains the setting even when you switch off the monitor.

WARNING Changing the date or time will affect the storage of trends and events.

- 1 Select the **Date, Time** screen element from the monitor's info line to enter the **Date, Time** menu.

- 2 Select, in turn, the **Year**, **Month**, **Day**, **Hour** (in 24 hour format, only) and **Minute** as necessary. Select the correct values from the pop-up list.
- 3 Select **Store Date**, **Time** to change the date and time.

Checking Your Monitor Revision

- 1 Select **Main Setup** -> **Revision** to open the **Monitor Revision** menu.
- 2 Select the correct device from the device pop-up keys.
- 3 From the **Monitor Revision** menu, select the monitor component for which you need revision information.

Getting Started

Once you understand the basic operation principles, you can get ready for monitoring.

Inspecting the Monitor

WARNING If the monitor is mechanically damaged, or if it is not working properly, do not use it for any monitoring procedure on a patient. Contact your service personnel.

- 1 Before you start to make measurements, carry out the following checks on the monitor including all connected Measurement Servers, modules, or measurement server extensions.
 - Check for any mechanical damage.
 - Check all the external cables, plug-ins and accessories.
- 2 Plug the power cord into the AC power source. If you are using battery power, ensure that the battery has sufficient power for monitoring. When you use a battery for the first time, you must charge it, following the instructions given in the section on Charging Batteries.
- 3 Check all the functions of the instrument that you need to monitor the patient, and ensure that the instrument is in good working order.

Switching On

- ♦ Press the on/off switch on the monitor for one second. The monitor performs a self test and is then ready to use. If you see a message such as **CO2 Sensor Warmup** wait until it disappears before starting monitoring that measurement. Connected devices usually take their power from the monitor. External devices such as gas monitors and those connected via VueLink have their own power switches.

CAUTION When using an MP90 monitor with a D80 Intelligent Display, always switch power on directly at the MP90 or at a remote SpeedPoint or remote alarm device directly connected to the MP90.

Setting up the Measurement Servers and Modules

- 1 Decide which measurements you want to make.

- 2 Connect the required modules, Measurement Servers, or measurement server extensions.
- 3 Check that you have the correct patient cables and transducers plugged in. The connectors are color-coded to the patient cables and transducers for easy identification.

Starting Monitoring

After you switch on the monitor,

- 1 Admit your patient to the monitor.
- 2 Check that the profile, alarm limits, alarm and QRS volumes, patient category and paced status and so forth are appropriate for your patient. Change them if necessary.
- 3 Refer to the appropriate measurement section for details of how to perform the measurements you require.

Disconnecting from Power

The On/Standby switch does not disconnect the monitor from the ac power source. To disconnect, unplug the power cable.

Monitoring After a Power Failure

If the monitor is without power for less than one minute, monitoring will resume with all active settings unchanged. If the monitor is without power for more than one minute, the behavior depends on your configuration. If **Automat. Default** is set to **Yes**, the default profile will be loaded when power is restored. If **Automat. Default** is set to **No**, all active settings are retained, if power is restored within 48 hours. The **Automat. Default** setting is made in Configuration Mode.

Networked Monitoring

If your monitor is connected to a network, a network symbol is displayed in the upper left corner next to the bed label. To see details about the Care Group, the monitoring equipment, and technical information about the network,

- ♦ MP20/MP30/MP40/MP50 - select the monitor info line to enter the **Setup** menu, then select **Bed Information**.
- ♦ MP60/MP70/MP80/MP90 - in the monitor info line, select the bed label.

Be aware that some network-based functions may be limited for monitors on wireless networks in comparison to those on wired networks.

Using Remote Applications

If your monitor is connected to a Philips Application Server, you can access applications hosted remotely on the Application Server and display and operate them on the bedside monitor screen. The Application Server provides portal technology to allow information access through a web browser, terminal emulation, or served applications. The applications available depend on the Application Server configuration: see the device documentation for details. A Remote Application window can also be embedded in a monitoring Screen.

To display remote applications on the monitor,

- 1 In the **Main Setup** menu, select **Remote Applics**, or select the **Remote Applications** SmartKey.
- 2 Select the required application from the pop-up list of available applications.
- 3 Operate the application with your preferred monitor input device: touchscreen, SpeedPoint, navigation point, keyboard or mouse.



Remote Application Popup Keys

Pop-Up Keys	Selecting this pop-up key lets you....
Minimize	minimize the Remote Application window; the session continues running in the background. Select the Remote Application symbol to show the window at full size again.
Keyboard	start a keyboard application to show a keyboard on the display. This key is not available if the keyboard application is not installed or not supported on the Philips Application Server.
Refresh	update the content of the Remote Application window.
Close	close the Remote Application session.

The Remote Application window occupies a pre-defined area on the monitor Screen. The maximum size of the area depends on the resolution of your display. If the pre-defined area for the Remote Application covers the full monitor Screen (on independent second displays only), the pop-up keys are not displayed. In this case a small window appears with two keys: one (with the Remote Application symbol) to display the pop-up keys and another to move the small window if it is obstructing viewing. If you change the monitor Screen while a Remote Application is running, and the pre-defined area on the second Screen is smaller, the Remote Application cannot be shown at full size. You must select a suitable monitor Screen to display the Remote Application again.

What's New?

This section lists the most important new features and improvements to the monitor and its user interface introduced with each release. Further information is provided in other sections of this book.

You may not have all of these features, depending on the monitor configuration purchased by your hospital.

What's New in Release D.0?

M1014A Spirometry Module

The spirometry module produces a real time wave for flow, volume and pressure of respiratory gases together with numerics for analysis of ventilatory mechanics. It is designed to be used in combination with Philips-branded airway flow sensors and combined CO₂/airway flow sensors.

M3014A Capnography Extension

The M3014A Capnography Extension offers an additional measurement method - sidestream CO₂ with the M2741A sensor.

M8016A D80 Intelligent Display

The D80 Intelligent Display can be used as a third main display with the MP90 monitor. You then have three displays able to be configured individually and to be operated independently.

IntelliVue 802.11 Bedside Adapter

The 802.11 Bedside Adapter is a wireless ethernet adapter which can be built in to the patient monitor (option J35). It provides wireless connectivity to standard IEEE 802.11a/b/g wireless networks.

Improved Multiple Display Support

- Wide and Tall screen layouts are supported which allow screen content to be spread over two screens next to each other (wide screen) or one above the other (tall screen).
- An additional main display used for a surgeon can be configured not to show alarm information. The permanent keys and SmartKeys can also be configured not to display.
- Input devices can be assigned to an operator, independent of physical connector location.

New SmartKeys

For the new spirometry module there is a SmartKey to provide direct access to the spirometry data window. For microstream and sidestream CO₂, sampling can now be suppressed directly with the SmartKey **CO₂ Pump Off**.

What's New in Release C.0?

IntelliVue MP80

The MP80 patient monitor is a new addition to the IntelliVue patient monitor family. The functionality is similar to that of the MP70 but with the flexibility of component modularity as in the MP90.

M3014A Capnography Extension

The M3014A Capnography Extension offers a new measurement combination - mainstream CO₂, cardiac output, invasive pressure and invasive pressure/temperature.

M8045A Docking Station

The docking station provides quick mounting and connections for the MP20/MP30/MP40/MP50 in a one-step operation. By placing the monitor on the docking station and closing the lever you can make the connection to AC power and to a network, if present.

BIS Interface Board

This interface board allows use of Bispectral Index monitoring with the MP20 and MP30.

Timers Application

The new Timers application allows you to set timers to notify you when a specific time period has expired. The timers can have varying characteristics and can be located on the Main screen for easy viewing.

IntelliVue Instrument Telemetry (USA only)

Wireless network capabilities via the IntelliVue Instrument Telemetry network using a built-in interface (MP20/MP30) or an external adapter (MP40/MP50).

Remote Applications

Remote applications can now be embedded in a monitoring Screen. The display colors for remote applications have been enhanced.

Basic Operation

- Selection and order of SmartKeys can now be configured in the monitor's Configuration mode.
- A new SmartKey exits Standby mode at the gas monitor.
- Direct operation of a second independent display with the MP90, using standard input devices.
- Networked monitors can now show Telemetry information for the "Own Bed" in an overview window or embedded in a Screen.
- Overview bed information can be configured to display in the colors used at the Information Center (with Information Center System G or higher).
- Support for Unit-based Care Group model for up to 64 beds (with Information Center System G or higher).
- Battery status information on the main screen now includes estimated monitoring time available during battery charging.
- Barcode reader support during patient admission.
- Direct entry to graphical trends when a limit alarm is selected in alarm review and to the event episode window when an event alarm is selected.
- MP90: screen trends can now also be viewed on the second display.

Trends

- In graphical trends, a segment menu allows direct adjustment of trend scales, automatic scale optimization, expanded view for an individual segment.
- In graphical and horizon Screen Trends a cursor is available.
- In the Vital Signs window, the values can be shown with the parameter color.

Events

- Events can be configured to be signaled as alarms (advanced event surveillance only).
- Deviation triggers can be set which trigger an event when measured values change by a defined amount over a set time (advanced event surveillance only).
- Up to six event groups can be active simultaneously (advanced event surveillance only).

Measurements

- Pulse Pressure Variation is a new derived measurement calculated from beat-to-beat arterial pressure values.
- MAC value calculations

Applications

- Improved Drug Calculator meeting JCAHO requirements.
- The ST Map application shows ST changes over time in two multi-axis spider diagrams.
- Freeze and measure waves on the Main Screen.

What's New in Release B.1?

IntelliVue MP20/MP30

The MP20/MP30 patient monitor is a new addition to the IntelliVue patient monitor family. It is smaller and lighter than the MP40/MP50 monitors and can be powered by battery. It can be used with the measurement server and server extensions and has a built-in recorder.

Basic Operation

- New Measurement Selection window makes it easier to resolve measurement label conflicts
- New Previous/Next Screen function provides access to the ten most recently modified Screens
- Wave speeds can now be set for individual wave channels

Trends

- Cursor in graphical trend window improves navigation in the trends database
- Vital Signs and Graphical Trend screen elements can be embedded on a Screen
- New band style format for displaying trends of measurements with multiple numerics
- Horizon trend is a new format for screen trends, showing the deviation from a stored baseline
- Aperiodic measurements now stored with a timestamp in Vital Signs
- New symbol representing NBP measurements in Graphical Trends

Measurements

- ST numerics in the Alarm Limits window can be shown and hidden

- ST Point can be set directly by selecting a numeric value
- New NBP countdown timer shows the time remaining until the next NBP measurement in a series
- Networked monitors can now show Other Bed information embedded on Screen
- Additional labels available for Pressure and Temp
- Additional options for SpO₂, support for an extended list of accessories
- Suppress Zero function for Microstream CO₂

Applications

- Drug Calculator can now be configured to include a list of commonly-used drugs
- Cursor in the Loops window improves navigation through the stored loops
- Volume-flow loops added to the list of respiratory loops types
- Loops Report for documentation of stored loops
- EEG CSA can now be called up and viewed in a window over the currently displayed Screen

What's New in Release B.0?

IntelliVue MP40/MP50 The MP40/MP50 patient monitor is a new addition to the IntelliVue patient monitor family. It uses the same measurement devices as the MP60/MP70/MP90 monitors and shares the same technological platform and user interface, but is more compact in size and can be operated by battery.

M3012A Measurement Server Extension The new Hemodynamic Measurement Server Extension extends measurement capability by adding two additional pressures and Cardiac Output.

M1020B SpO₂ Module New SpO₂ measurement module, M1020B, enables dual SpO₂ measurement without the need to use the VueLink module. Two options are available:

- Option A01 for use with Philips reusable and disposable sensors and Nellcor “R-Cal” disposable sensors.
- Option A02 for use with Nellcor OxiMax sensors, including the MAX-FAST forehead sensor.

M1020B Option A02 for use with Nellcor OxiMax sensors may not be available in all countries.

PV Loops: compares graphic representations of airway waves to help detect changes in the patient airway condition.

High-resolution waves per Screen: the number of high-resolution waves that can be shown on a Screen is increased, limited only by the Axx Option purchased.

Alarms symbols: New alarm symbols are introduced, and “short” yellow alarms were renamed “one-star” yellow alarms (yellow arrhythmia alarms).

Aperiodic measurements available as Screen Trends: patient trend information for NBP, C.O., C.I., and Wedge can now be permanently displayed on the Screen in tabular and graphical form.

What's New in Release A.2?

12-Lead ECG recordings: 12-Lead ECG waves and numerics can be sent to a connected recorder

High-Resolution Trend Report: high-resolution trend report can be sent to a connected printer

ST Snippets ST snippets, showing a one second wave segment for each measured ST lead, can be permanently displayed on the Screen or called up as required.

EEG Wave Speed: new EEG-specific wave speeds have been added to the list of wave speeds available

Drug Calculator: this new feature helps you to calculate drug dosages for your patients

On-Screen Calculator: a mathematics calculator can be used on the Screen

Visitor Screen: this new Screen is designed to hide sensitive patient information from the Screen. Monitoring and alarm generation function as usual.

Touch selection volume control: The volume of the audio prompt given when a screen element is selected is now adjustable

VueLink interface: the VueLink on-screen appearance and controls are improved

M3001A: Trend upload from the Multi-Measurement Server (M3001A) improved

Screen Trends: lets you display patient trend information in graphic form permanently on the Screen

Alarm Limits Page: lets you view and control alarm settings for all measurements in one window

New Option for Event Surveillance: a new neonatal event review option #C04 is introduced

Second display To simultaneously show two different Screens, a second display can be connected to the MP90. The second display is for viewing only.

Alarms

The alarm information here applies to all measurements. Measurement-specific alarm information is discussed in the sections on individual measurements.

The monitor has three alarm levels: red, yellow, and INOP.

Red and yellow alarms are patient alarms. A red alarm indicates a high priority patient alarm such as a potentially life threatening situation (for example, asystole). A yellow alarm indicates a lower priority patient alarm (for example, a respiration alarm limit violation). Yellow arrhythmia alarms are specific to arrhythmia-related patient conditions (for example, ventricular bigeminy).

INOPs are technical alarms, they indicate that the monitor cannot measure or detect alarm conditions reliably. If an INOP interrupts monitoring and alarm detection (for example, LEADS OFF), the monitor places a question mark in place of the measurement numeric and an audible indicator tone will be sounded. INOPs without this audible indicator indicate that there may be a problem with the reliability of the data, but that monitoring is not interrupted.

Alarms are indicated after the alarm delay time. This is made up of the system delay time plus the trigger delay time for the individual measurement. See the specifications section for details.

If more than one alarm is active, the alarm messages are shown in the alarm status area in succession. An arrow symbol next to the alarm message informs you that more than one message is active.



↑ ** HR HIGH

The monitor sounds an audible indicator for the highest priority alarm. If more than one alarm condition is active in the same measurement, the monitor announces the most severe. Your monitor may be configured to increase alarm indicator volume automatically during the time when the alarm is not acknowledged.

Visual Alarm Indicators

Alarm message: An alarm message text appears in the alarm status area at the top of the screen indicating the source of the alarm. If more than one measurement is in an alarm condition, the message changes every two seconds, and has an arrow (↑) at the side. The background color of the alarm message matches the alarm priority: red for red alarms, yellow for yellow alarms, and light blue for INOPs. The asterisk symbols (*) beside the alarm message match the alarm priority: *** for red alarms, ** for yellow alarms, * for yellow arrhythmia alarms. INOPs are displayed without asterisks.

Depending on how your monitor is configured, it may display alarm limit violation messages

- in text form, for example “**SpO2 LOW” or
- in numeric form, for example “**SpO2 94<96”, where the first number shows the maximum deviation from the alarm limit, and the second number shows the currently set limit.

Flashing numeric: The numeric of the measurement in alarm flashes.

Bright alarm limits: If the alarm was triggered by an alarm limit violation, the corresponding alarm limit on the monitor screen is shown more brightly.

Alarm lamp: A lamp on the monitor’s front panel flashes. This has the same color as the alarm priority.

Nurse call systems: Alarm conditions are indicated on any device connected to the nurse call relay, if configured to do so.

Audible Alarm Indicators

The audible alarm indicators configured for your monitor depend on which alarm standard applies in your hospital. Audible alarm indicator patterns are repeated until you acknowledge the alarm by switching it off or pausing it. or until the alarm condition ceases (if audible alarm indication is set to non-latching).

WARNING Do not rely exclusively on the audible alarm system for patient monitoring. Adjustment of alarm volume to a low level or off during patient monitoring may result in patient danger. Remember that the most reliable method of patient monitoring combines close personal surveillance with correct operation of monitoring equipment.

Alarm Tone Configuration

The audible alarm indicators of your monitor are configurable. In the monitor’s Configuration Mode, you can:

- increase the alarm volume of unacknowledged alarms at regular intervals
- change the interval between alarm sounds (ISO/IEC Standard 9703-2 alarms only)
- change the base volume of the red and yellow alarm tones and the INOP tones
- change the alarm sound to suit the different alarm standards valid in different countries.



Traditional Audible Alarms (HP/Agilent/Philips/Carenet)

- Red alarms: A high pitched sound is repeated once a second.
- Two-star yellow alarms: A lower pitched sound is repeated every two seconds.
- One-star yellow alarms (arrhythmia alarms): The audible indicator is the same as for yellow alarms, but of shorter duration.
- INOPs: an INOP tone is repeated every two seconds.

ISO/IEC Standard 9703-2 Audible Alarms

- Red alarms: A high pitched tone is repeated five times, followed by a pause.
- Two-star yellow alarms: A lower pitched tone is repeated three times, followed by a pause.
- One-star yellow alarms (arrhythmia alarms): The audible indicator is the same as for yellow alarms, but of shorter duration.
- INOPs: a lower pitched tone is repeated twice, followed by a pause.

Changing the Alarm Tone Volume

- ◆ The alarm volume symbol at the top right of the monitor screen gives you an indication of the current volume. To change the volume, select the volume symbol and then select the required volume from the pop-up selection. 
- ◆ If you want to see a numerical indication of the current alarm volume on a scale from zero to 10, select the **Alarm Volume** SmartKey. The volume scale pops up. The current setting is indented. To change the setting, select the required number on the scale. Any settings that are inactive (“grayed out”) have been disabled in the monitor’s Configuration Mode. 

When the alarm volume is set to zero (off), the alarm volume symbol reflects this. If you switch the alarm volume off, you will not get any audible indication of alarm conditions. 

Minimum Volume for No Central Monitoring INOP

If your monitor is connected to an Information Center, and the connection is interrupted, the INOP message **No Central Monit.** will appear within 30 seconds, accompanied by an INOP tone. To help ensure that this INOP, and any other active alarm, is not overlooked, the INOP and alarm tones may be configured to have a minimum volume. In this case, INOP and alarm tones will sound even if the monitor alarm volume is set to zero.

Acknowledging Alarms

To acknowledge all active alarms and INOPs, select the **Silence** permanent key. This switches off the audible alarm indicators and alarm lamps. Alternatively, you can acknowledge alarms by pressing the **Silence** hardkey on the MMS or on the SpeedPoint. The hardkeys follow the behavior configured for the permanent key.



A check mark beside the alarm message indicates that the alarm has been acknowledged. If the monitor is configured to re-alarm, a dashed check mark will be shown.



If the condition that triggered the alarm is still present after the alarm has been acknowledged, the alarm message stays on the screen with a check mark symbol beside it.



If the alarm condition is no longer present, all alarm indicators stop and the alarm is reset.

Switching off the alarms for the measurement in alarm, or switching off the measurement itself, also stops alarm indication.

Acknowledging Disconnect INOPs

Acknowledging an INOP that results from a disconnected transducer switches off the associated measurement. The only exception is ECG/Resp: acknowledging a disconnect INOP for ECG leads does not switch off the ECG and Resp measurements. Acknowledging a disconnect INOP at the Information Center switches off the audible INOP indicator but does not switch off the measurement. Unplugging an MMS or a plug-in module automatically switches off its measurements.

Alarm Reminder (ReAlarm)

If Alarm Reminder is configured on for your monitor, you will get an audible reminder of alarm conditions that remain active after you have acknowledged the alarm. This reminder may take the form of a repetition of the alarm tone for a limited time, or an unlimited repetition of the alarm tone (this is the same as a new alarm). There is no alarm reminder for INOPs.

In Configuration Mode, you can set the interval between silencing the alarm and sounding the reminder tone to one, two, or three minutes.

Pausing or Switching Off Alarms

If you want to temporarily prevent alarms from sounding, for example while you are moving a patient, you can pause alarms. Depending on your monitor configuration, alarms are paused for one, two, or three minutes, or infinitely.

To view the alarm pause setting chosen for your unit,

- 1 Select **Main Setup** -> **Alarm Settings**
- 2 Check the **Alarms Off** setting.

This setting can only be changed in Configuration Mode.

To Pause All Alarms

- ◆ Select the **Pause Alarms** permanent key. If your monitor is configured to infinite pause time, the permanent key is labelled **Alarms Off**, and selecting it switches alarms off.
- ◆ Or press the Alarms hardkey on the SpeedPoint or Navigation Point. The hardkey follows the behavior configured for the permanent key.

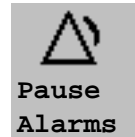

To Switch All Alarms Off

You can only switch alarms off permanently if your monitor is configured to allow infinite alarms pause and the permanent key is labelled **Alarms Off**.

- ◆ Select the **Alarms Off** permanent key.
- ◆ Or press the Alarms hardkey on the SpeedPoint or Navigation Point. The hardkey follows the behavior configured for the permanent key.



Pausing alarms infinitely is the same as switching them off.

To Switch Individual Measurement Alarms On or Off

- 1 Select the measurement numeric to enter its setup menu.
- 2 Select **Alarms** to toggle between **On** and **Off**.

The alarms off symbol is shown beside the measurement numeric.



While Alarms are Paused or Off

- The red Alarms Paused lamp on the monitor front panel is lit.

- In the alarm field, the monitor displays the message **Alarms Paused** or **Alarms Off**, together with the alarms paused symbol and the remaining pause time in minutes and seconds, or alarms off symbol.



ALARMS PAUSED 1:28

- No alarms are sounded and no alarm messages are shown.
- INOP messages are shown but no INOP tones are sounded.



ALARMS OFF

The only exceptions are the INOPs **Battery/Batteries Empty**, **Battery/Batteries Malfunction**, **Batt 1/2 Missing**, and **NBP Cuff Overpressure**. These INOPs are sounded even if alarms are paused or off.

- The nurse call relay is not active.

If a disconnect INOP is present and alarms are paused or switched off, the measurement in question is switched off.

Restarting Paused Alarms

- ◆ To manually switch on alarm indication again after a pause, select the permanent key **Pause Alarms** (or **Alarms Off**) again.

Alarm indication starts again automatically after the pause period expires. If the monitor is configured to stay paused infinitely, you must select **Alarms Off** again to restart alarm indication.

Resetting Arrhythmia Alarm Timeouts

- ◆ To reset the arrhythmia alarm timeout period, select the **Alarms Off** or **Pause Alarms** permanent key and then reselect it.

Extending the Alarm Pause Time

If your monitor has extended alarm pause enabled, you can extend the alarm pause time. Use this to prevent alarms being indicated, for example, while you are washing a patient or carrying out a procedure. Only extend the alarm pause time when you are sure that clinical personnel are available to monitor the patient's condition closely.

To extend the alarm pause time to five or 10 minutes,

- 1 Select one of the alarm fields. This calls up the **Alarm Messages** window.
- 2 Select either the pop-up key **Pause Al. 5 min** or the pop-up key **Pause Al. 10 min**. Each time you select one of these pop-up keys, the Alarm Pause Time is reset to five (or 10) minutes.

Alarm Limits

The alarm limits you set determine the conditions that trigger yellow and red limit alarms. For some measurements (for example, BIS and SpO₂), where the value ranges from 100 to 0, setting the high alarm limit to 100 switches the high alarm off, and setting the low alarm limit to 0 switches it off. In these cases, the alarms off symbol is not displayed.

WARNING Be aware that the monitors in your care area may each have different alarm settings, to suit different patients. Always check that the alarm settings are appropriate for your patient before you start monitoring.

Viewing Individual Alarm Limits



Alarm limits

You can usually see the alarm limits set for each measurement next to the measurement numeric on the main screen.

If your monitor is not configured to show the alarm limits next to the numeric, you can see them in the appropriate measurement setup menu. Select the measurement numeric to enter the menu and check the limits.

Viewing All Alarm Limits

The **Alarm Limits** overview window lists the currently set alarm limits for all measurements. If an Apnea alarm delay time is set, this is also shown. The **Alarms Off** symbol is shown beside the measurement label of any measurement whose alarm switched off.

To open the **Alarm Limits** window, either select any alarm field to open the **Alarm Messages** window, then select the **Alarm Limits** pop-up key, or select the **Alarm Limits** SmartKey, if configured.

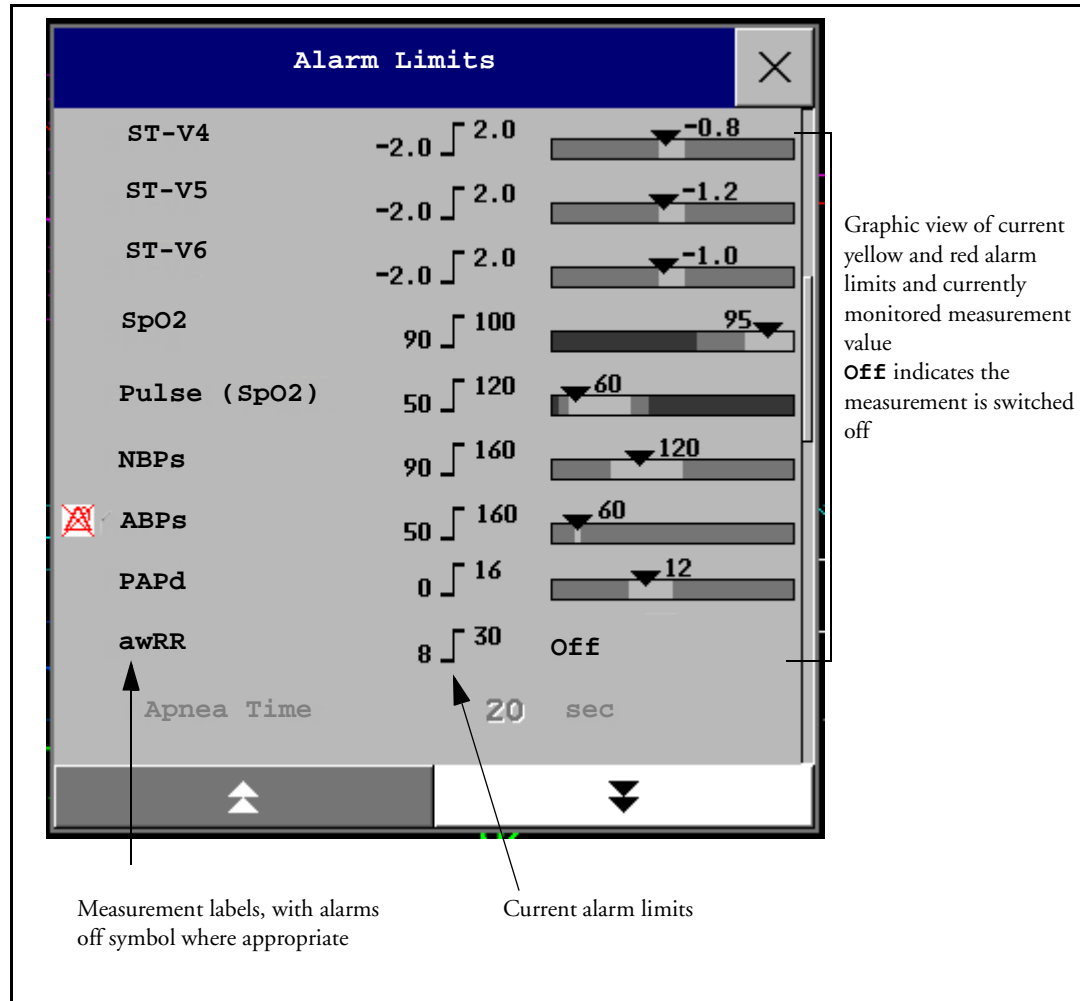

- ◆ Select **Show ST Limits** to expand the list of ST leads and view the currently set alarm limits. Selecting **Hide ST Limits** hides the list again.

You can use the pop-up keys that open with the **Alarm Limits** window to perform common tasks:

- **All Al. On/All Al. Off**,
- **All Lim. Narrow/All Lim. Wide** to set narrow or wide alarm AutoLimits for all measurements.
- **Print Limits/Record Limits** to print a list of all current alarm limit settings on a connected printer or recorder.

These pop-up keys are not available in the window for changing individual alarm limits which you access by selecting the measurement label in the **Alarm Limits** window.

Changing Alarm Limits

To change individual measurement alarm limits using the measurement's Setup Menu,

- 1 in the measurement's setup menu, select the alarm limit you want to change. This calls up a list of available values for the alarm limit.
- 2 Select a value from the list to adjust the alarm limit.

Alternatively, you can use the keys in the measurement Change Limits window, which you access by selecting the measurement label in the **Alarm Limits** window.

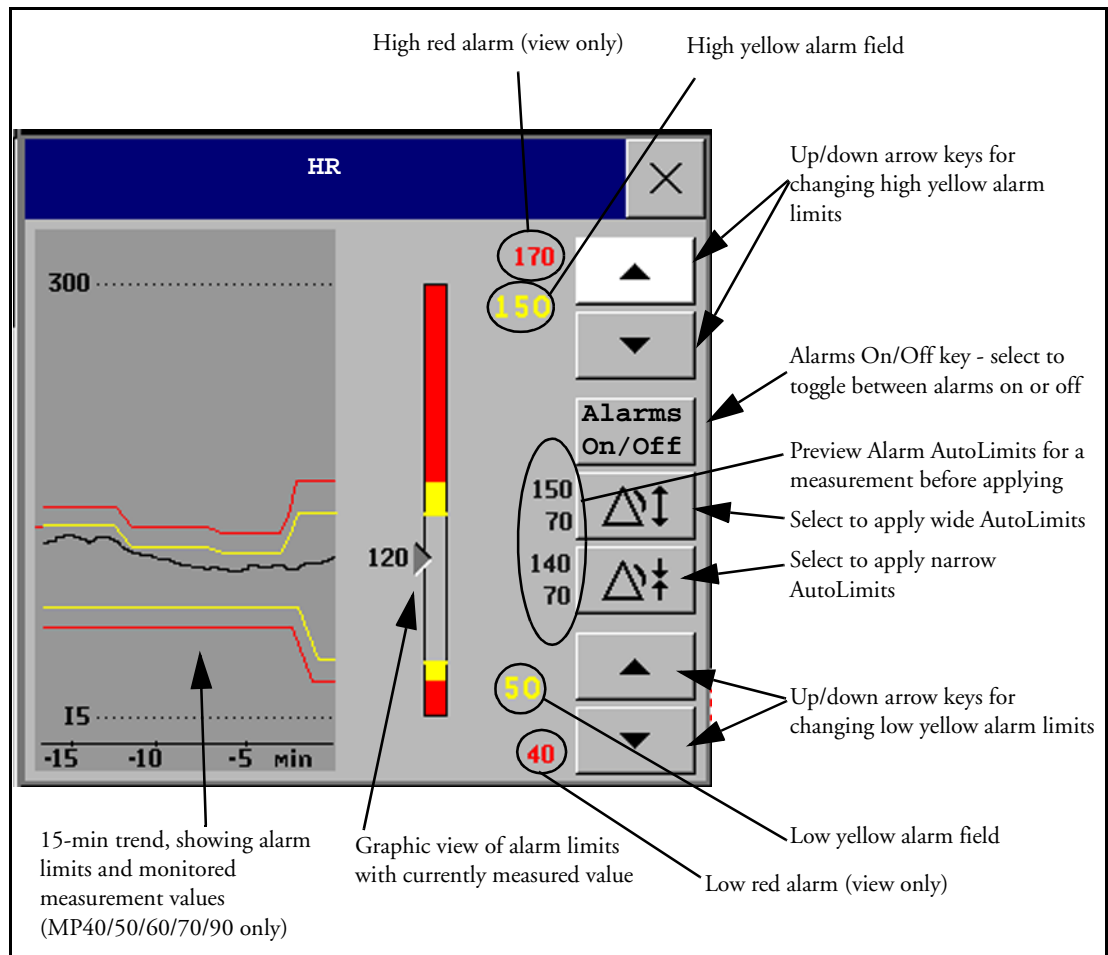

To change alarm limits,

- 1 In the **Change Limits** window,
 - if you are using touch, select the up or down arrow buttons to adjust the high and low alarm limits as required.
 - if you are using a SpeedPoint or Navigation Point, position the cursor in the high yellow alarm field, then press the knob inwards. Rotate the knob to the left or right to adjust the limit. Press the knob again to set the displayed limit.
- 2 Repeat to set the low yellow alarm limit.

If you set the yellow alarm limit outside the red alarm limit, the monitor will automatically set the red alarm to the yellow alarm limit.

When an ST measurement is in the **Change Limits** window there are also two pop-up keys available labeled **All ST Narrow/All ST Wide**. With these keys you can set Auto Limits for all ST Leads.

About Automatic Alarm Limits (AutoLimits)

The monitor can automatically set alarm limits suited to your individual patient, using the Automatic Alarm Limits function. This tells the monitor to adapt the alarm limits of selected measurements to the measured vital signs within a defined safe limit. The monitor calculates safe AutoLimits for each patient based on the measured values from the last 12 seconds.

The defined safe limits never exceed the non-pathological range.

Limits Narrow sets limits close to the currently measured values for situations where it is critical for you to be informed about small changes in your patient's vital signs.

Limits Wide sets limits further away from the currently measured values for situations where small changes are not so critical.

- ◆ Use the keys in the **Change Limits** window to apply AutoLimits for individual measurements. These keys are not available if AutoLimits have been disabled for the measurement in the monitor's Configuration Mode.

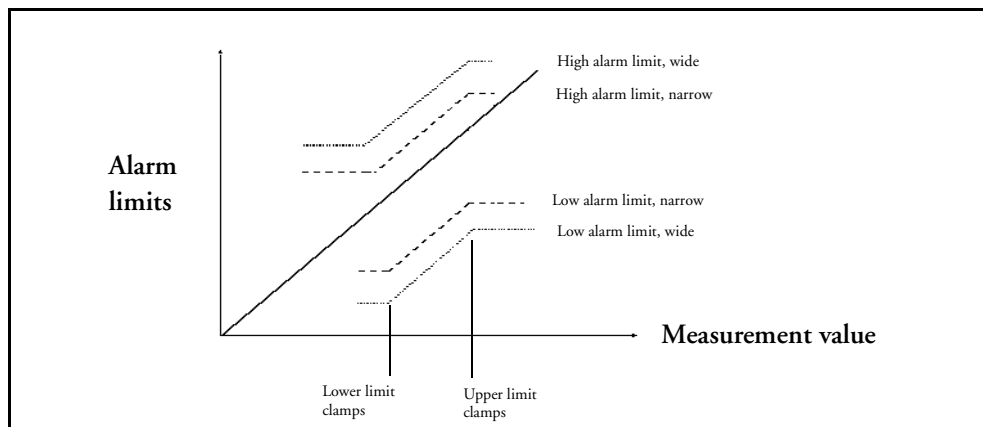

AutoLimits are not available for all measurements. The list of measurements for which AutoLimits can be used is defined in the monitor's Configuration mode.

Use the Change Limits window to check AutoLimits before you apply them to ensure that they are appropriate for your individual patient and their clinical condition. Once applied, AutoLimits are shown on the monitor screen just like manually-set alarm limits. If the AutoLimits are not appropriate for your patient, you must set alarm limits manually. The limits remain unchanged until you set them again or change them manually.

Documenting Alarm Limits

The alarm limits pop-up keys appear with the **Alarm Limits** and **Change Limits** windows.

- ◆ Select the **Print Limits** pop-up key to print an overview of all alarm limits on a connected printer.
- ◆ Select the **Record Limits** pop-up key to send a recording of the alarm limits to a recorder.

Reviewing Alarms

To review the currently active alarms and INOPs, select any of the alarm status areas on the monitor screen. The **Alarm Messages** window pops up. All alarms and INOPs are erased from the monitor's alarm history when you discharge a patient, or if you change to Demonstration Mode.

Alarm Messages Window

The **Alarm Messages** window shows all the currently active alarms and INOPs in chronological order, beginning at the top with the most recent. INOPs are shown on the left hand side and patient alarms are shown on the right hand side. Any active red alarms are shown first, followed by yellow alarms. Acknowledged alarms or INOPs are shown with the check mark symbol.

The Alarm Messages window pop-up keys appear when the window is opened. If alarm pause extension is disabled, the pause pop-up keys are inactive ("grayed-out"). Selecting the **Review Alarms** pop-up key opens the **Review Alarms** window.

Alarm Limits	Review Alarms		Pause Al. 5 Min.	Pause Al. 10 Min.
--------------	---------------	--	------------------	-------------------

Review Alarms Window

The **Review Alarms** window contains a list of up to 100 of the most recent alarms and INOPs with date and time information. If configured to do so, each alarm is shown with the alarm limit active when the alarm was triggered and the maximum value measured beyond this limit. The **Review Alarms** window also shows any changes made to the Alarms On/Off or Silence status.

If you select a high or low limit alarm in the list, the **Graphical Trends** window will open to provide further data. If you select an alarm resulting

from an event alarm notification, the **Event Episode** window for that event will open. When you close these windows you will return to the **Review Alarms** window.

The information in the Review Alarms window is deleted when a patient is discharged, when the monitor is switched off for longer than one minute, and when you leave Demonstration Mode.

The **Review Alarms** window pop-up keys appear when the window is opened. If alarm pause extension is disabled, the pause pop-up keys are inactive. Selecting the **Active Alarms** pop-up key opens the **Alarm Messages** window.

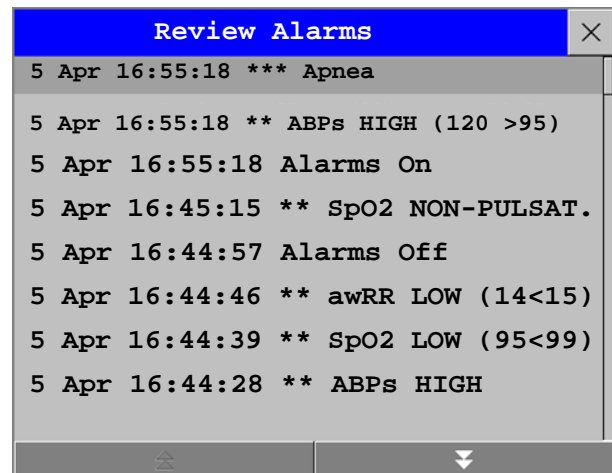

Review Alarms		X
5 Apr 16:55:18	*** Apnea	
5 Apr 16:55:18	** ABPs HIGH (120 >95)	
5 Apr 16:55:18	Alarms On	
5 Apr 16:45:15	** SpO2 NON-PULSAT.	
5 Apr 16:44:57	Alarms Off	
5 Apr 16:44:46	** awRR LOW (14<15)	
5 Apr 16:44:39	** SpO2 LOW (95<99)	
5 Apr 16:44:28	** ABPs HIGH	

Alarm Limits	Active Alarms		Pause Al. 5 Min.	Pause Al. 10 Min.
--------------	---------------	--	------------------	-------------------

Understanding Alarm Messages

If you do not immediately understand an INOP or alarm message, refer to its help text.

- ◆ In the **Alarm Messages** window, select the INOP message. This calls up a help window with an explanation of the INOP message and, where appropriate, a suggested solution for the problem.

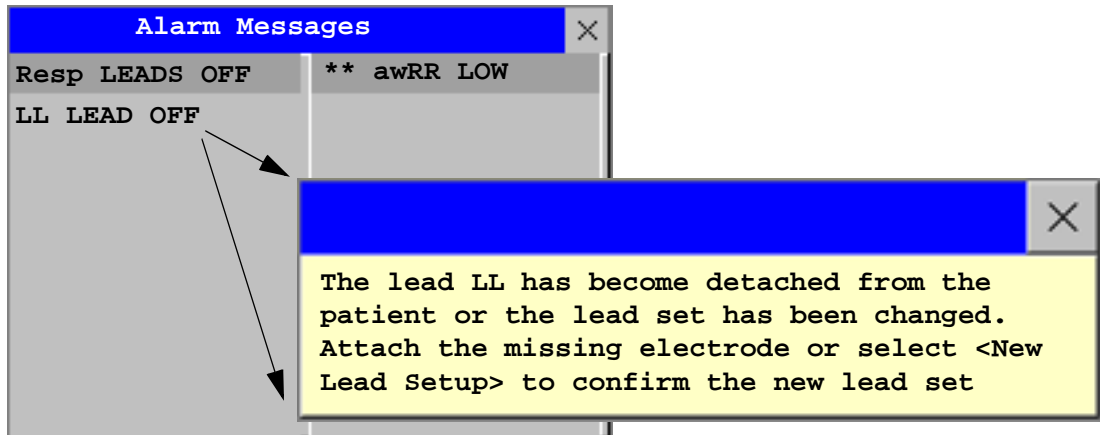

Latching Alarms

The alarm latching setting for your monitor defines how the alarm indicators behave when you do not acknowledge them. When alarms are set to non-latching, their indicators end when the alarm condition ends. Switching alarm latching on means that visual and/or audible alarm indications are still displayed or announced by the monitor after the alarm condition ends. The indication lasts until you acknowledge the alarm.

Viewing the Alarm Latching Settings

To see the alarm latching setting for your monitor

- 1 In the monitor's **Main Setup** menu, select **Alarms**.
- 2 Select **Alarm Settings**, and see the **Visual Latching** and **Audible Latching** settings.

This setting can only be changed in Configuration Mode. You should be aware of the settings chosen for your unit. There are three possible choices each for visual and audible latching, Red, Red and Yellow, and Off. These choices can be combined to give the following settings:

Visual Latching	R&Y	R&Y	R&Y	R	R	Off
Audible latching	R&Y	R	Off	R	Off	Off

R = red alarms, Y = yellow alarms

Alarm Latching Behavior

Red and Yellow Measurement Alarms		Non-latching alarms	Visual and audible latching	Visual latching, audible non-latching
Alarm has not been acknowledged.	Alarm condition still present.	Alarm tone on. Alarm lamp on. Alarm message. Flashing numerics.		
	Alarm condition no longer present.	All audible and visual alarm indicators automatically stop.	Alarm tone on. Alarm lamp on. Alarm message. Flashing numerics.	Alarm message. Flashing numerics. Audible alarm indicators automatically stop.
Alarm has been acknowledged.	Alarm condition still present.	Audible alarm acknowledged. Alarm lamp off. Alarm message. Flashing numerics. Audible alarm reminder (if configured).		
	Alarm condition no longer present.	Audible and visual alarm indicators automatically stop.		

All INOPs except **DISCONNECT** and **UNPLUGGED** INOPs from measurement servers and modules are non-latching. See “Yellow Arrhythmia Alarms” on page 113 for information on short yellow arrhythmia alarms latching behavior.

Testing Alarms

When you switch the monitor on, a selftest is started. You must check that the alarms lamps light, one after the other, and that you hear a single tone. This indicates that the visible and audible alarm indicators are functioning correctly. For further testing of individual measurement alarms, perform the measurement on yourself (for example SpO₂ or CO₂) or use a simulator. Adjust alarm limits and check that appropriate alarm behavior is observed.

Alarm Behavior at On/Off

When you switch alarms on, the settings defined in the currently active Profile are used.

If the monitor is switched off for longer than one minute and then switched on again, or after a loss of power lasting longer than one minute, or when a patient is discharged, the monitor can be configured to restore either the alarm settings from the monitor's configured default Profile, or the most recently used alarm settings. After any of these situations, you should check that the alarm settings are appropriate for your patient, and if necessary, select the correct Profile and patient category.

If power is lost for less than one minute, the alarm settings prior to the power loss are restored.

Patient Alarms and INOPs

This chapter lists patient alarms and technical alarms (INOPs) alphabetically, irrespective of their priority. INOPs start on page 59.

For information on alarms and INOPs from the gas modules refer to your Gas Module Instructions for Use.

Patient Alarm Messages

The measurement labels and abbreviations for pressure, temperature, SpO₂, and anesthetic agent alarms are explained in the individual chapters.

Some alarms may be shown at the Information Center in shortened form, when transferred through IntelliVue Instrument Telemetry (USA only). These shortened alarm texts are included in the list and identified with the note “at Information Center”.

Note that yellow arrhythmia alarms (“short yellow alarms”) may be shown with one or with two stars, depending on your monitor configuration and the Information Center revision you are using.

Refer to your Gas Module Instructions for Use for patient alarms and INOPs from the gas modules.

Alarm Message	From	Condition	Indication
***APNEA or ***APNEA xxx sec	CO ₂ , Resp, AGM	Respiration has stopped for longer than the preset apnea time. “xxx” denotes the Apnea duration.	numeric flashes, red alarm lamp, alarm tone.
***ASYSTOLE	ECG	No QRS detected for a period greater than the asystole threshold (in the absence of Vfib or chaotic ECG).	numeric flashes, red alarm lamp, alarm tone.
**awRR HIGH	CO ₂ , Resp, AGM	The airway respiration rate has exceeded the high alarm limit.	numeric flashes and high limit is highlighted, yellow alarm lamp, alarm tone.
**awRR LOW	CO ₂ , Resp, AGM	The airway respiration rate has dropped below the low alarm limit.	numeric flashes and low limit is highlighted, yellow alarm lamp, alarm tone.
**BIS HIGH	BIS	The Bispectral Index value has exceeded the high alarm limit.	numeric flashes and high limit is highlighted, yellow alarm lamp, alarm tone.
**BIS LOW	BIS	The Bispectral Index value has dropped below the low alarm limit.	numeric flashes and low limit is highlighted, yellow alarm lamp, alarm tone.

Alarm Message	From	Condition	Indication
***BRADY (Pulse) or ***BRADY xxx<yyy	Press, SpO ₂	The heart rate from the Pulse signal has fallen below the bradycardia limit. xxx denotes the lowest measured value; yyy is the bradycardia limit.	numeric flashes and alarm limit is highlighted, red alarm lamp, alarm tone.
**CCO/CCI HIGH	CCO	Continuous Cardiac Output or CC Index is above the high alarm limit.	numeric flashes and high alarm limit is highlighted, yellow alarm lamp, alarm tone.
**CCO/CCI LOW	CCO	Continuous Cardiac Output or CC Index is below the low alarm limit.	numeric flashes and low alarm limit is highlighted, yellow alarm lamp, alarm tone.
**CPP HIGH	CPP	The CPP value has exceeded the high alarm limit.	numeric flashes and high limit is highlighted, yellow alarm lamp, alarm tone
**CPP LOW	CPP	The CPP value has fallen below the low alarm limit.	numeric flashes and low limit is highlighted, yellow alarm lamp, alarm tone.
***DESAT or ***DESAT xxx<yyy	SpO ₂	The SpO ₂ value has fallen below the desaturation alarm limit. xxx denotes the lowest measured value, and yyy is the desaturation limit.	numeric flashes, red alarm lamp, alarm tone.
**et <Agent label> HIGH	AGM	The end tidal agent high alarm limit has been exceeded.	numeric flashes and high limit is highlighted, yellow alarm lamp, alarm tone.
**et <Agent label> LOW	AGM	The end tidal agent value has fallen below the low alarm limit.	numeric flashes and low alarm limit is highlighted, yellow alarm lamp, alarm tone.
**etCO₂ HIGH	CO ₂ , Resp, AGM	The end tidal CO ₂ high alarm limit has been exceeded.	numeric flashes and high limit is highlighted, yellow alarm lamp, alarm tone.
**etCO₂ LOW	CO ₂ , Resp, AGM	The end tidal CO ₂ value has fallen below the low alarm limit.	numeric flashes and low limit is highlighted, yellow alarm lamp, alarm tone.
**etO₂ HIGH	O ₂ , AGM	The end tidal O ₂ high alarm limit has been exceeded.	numeric flashes and high limit is highlighted, yellow alarm lamp, alarm tone.
**etO₂ LOW	O ₂ , AGM	The end tidal O ₂ value has fallen below the low alarm limit.	numeric flashes, and low limit is highlighted, yellow alarm lamp, alarm tone.
* / ** / *** EVENT : <GRP>	Event surveillance	An event has occurred and the event notification is configured to alarm. <GRP> is the event group	event group name flashes, yellow or red alarm lamp and alarm tone
* / ** / *** EVENT at Information center	Event surveillance	An event has occurred and the event notification is configured to alarm. Check on the monitor for more details on event group.	(on monitor) event group name flashes, yellow or red alarm lamp and alarm tone
***EXTREME BRADY	ECG	The bradycardia limit has been exceeded.	numeric flashes and alarm limit is highlighted, red alarm lamp, alarm tone.
***EXTREME TACHY	ECG	The tachycardia limit has been exceeded.	numeric flashes and alarm limit is highlighted, red alarm lamp, alarm tone.

Alarm Message	From	Condition	Indication
**HR HIGH	ECG	The heart rate high alarm limit has been exceeded.	numeric flashes and high limit is highlighted, yellow alarm lamp, alarm tone. The sound switches off after 5 seconds if Arrhythmia is On.
**HR LOW	ECG	The heart rate has fallen below the low alarm limit.	numeric flashes and low limit is highlighted, yellow alarm lamp, alarm tone. The sound switches off after 5 seconds if Arrhythmia is On.
**imCO2 HIGH	CO ₂ , Resp, AGM	The inspired minimum CO ₂ high alarm limit has been exceeded.	numeric flashes and high limit is highlighted, yellow alarm lamp, alarm tone.
**in <Agent label> HIGH	AGM	The inspired agent high alarm limit has been exceeded.	numeric flashes, high limit is highlighted, yellow alarm lamp, alarm tone.
**in <Agent label> LOW	AGM	The inspired agent value has fallen below the AGT low alarm limit.	numeric flashes, low limit is highlighted, yellow alarm lamp, alarm tone.
**inN2O HIGH	N ₂ O, AGM	The inspired N ₂ O high alarm limit has been exceeded.	numeric flashes, high limit is highlighted, yellow alarm lamp, alarm tone.
**inO2 HIGH	O ₂ , AGM	The inspired O ₂ high alarm limit has been exceeded.	numeric flashes, high limit is highlighted, yellow alarm lamp, alarm tone.
**inO2 LOW	O ₂ , AGM	The inspired O ₂ value has fallen below the low alarm limit.	numeric flashes, low limit is highlighted, yellow alarm lamp, alarm tone.
***inO2 LOW OXYGEN	O ₂ , AGM	The inspired O ₂ value has fallen below 18 vol.%.	numeric flashes, low limit is highlighted, red alarm lamp, alarm tone.
*/**IRREGULAR HR	ECG/ Arrhythmia	Consistently irregular heart rhythm.	numeric flashes, yellow alarm lamp, short yellow audible alarm.
*/**MISSED BEAT	ECG/ Arrhythmia	No beat detected for 1.75*R-R interval, or if HR>120bpm no beat detected for one second (non-paced patients only).	numeric flashes, yellow alarm lamp, short yellow audible alarm.
*/**MULTIFORM PVCs	ECG/ Arrhythmia	Two differently shaped Vs detected, each occurring at least twice within the last 300 beats and at least once within the last 60 beats.	numeric flashes, yellow alarm lamp, short yellow audible alarm.
**NBP HIGH	NBP	The measured NBP value is above the high alarm limit. s, d, or m after the label indicates whether the systolic, diastolic or mean pressure has crossed the limit.	numeric flashes and high limit is highlighted, yellow alarm lamp, alarm tone.
**NBP LOW	NBP	The measured NBP value is below the low alarm limit. s, d, or m after the label indicates whether the systolic, diastolic or mean pressure has crossed the limit.	numeric flashes and low limit is highlighted, yellow alarm lamp, alarm tone.

Alarm Message	From	Condition	Indication
*/**NON-SUSTAIN VT	ECG/ Arrhythmia	A run of Vs having a ventricular HR>V-Tach HR limit, but lasting for less than the V-Tach Run limit has been detected.	numeric flashes, yellow alarm lamp, short yellow audible alarm.
*/**PACER NOT CAPT	ECG/ Arrhythmia (paced patients only)	A missed beat with a pace pulse was detected.	numeric flashes, yellow alarm lamp, short yellow audible alarm.
*/**PACER NT PACING	ECG/ Arrhythmia (paced patients only)	A missed beat without a pace pulse was detected.	numeric flashes, yellow alarm lamp, short yellow audible alarm.
*/**PAIR PVCs	ECG/ Arrhythmia	A non-ventricular contraction, followed by two ventricular contractions, followed by a non-ventricular contraction has been detected.	numeric flashes, yellow alarm lamp, short yellow audible alarm.
*/**PAUSE	ECG/ Arrhythmia	No beat detected for a period greater than the pause threshold.	numeric flashes, yellow alarm lamp, short yellow audible alarm.
***<Pressure> DISCONNECT	PRESS	The pressure is non-pulsatile and the mean pressure is continuously less than 10mmHg (1.3kPa). This alarm occurs only with arterial pressures (P, ABP, ART, Ao, BAP, FAP, PAP, UAP).	numeric flashes, red alarm lamp, alarm tone.
**<Pressure> HIGH	PRESS	The measured pressure value is above the high alarm limit. s , d , or m after the label indicates whether the systolic, diastolic or mean pressure has crossed the limit.	numeric flashes, high limit is highlighted, yellow alarm lamp, alarm tone.
**<Pressure> LOW	PRESS	The measured pressure value is below the low alarm limit. s , d , or m after the label indicates whether the systolic, diastolic or mean pressure has crossed the limit.	numeric flashes and low limit is highlighted, yellow alarm lamp, alarm tone.
**PULSE HIGH	PRESS SpO ₂	The pulse rate has exceeded the high alarm limit.	numeric flashes and high limit is highlighted, yellow alarm lamp, alarm tone.
**PULSE LOW	PRESS SpO ₂	The pulse rate has dropped below the low alarm limit.	numeric flashes and low limit is highlighted, yellow alarm lamp, alarm tone.
*/**PVCs/min HIGH	ECG/ Arrhythmia	More premature ventricular contractions have been detected in a minute than the limit.	numeric flashes, yellow alarm lamp, short yellow audible alarm.
*/**R-ON-T PVCs	ECG/ Arrhythmia	For HR <100, a PVC with R-R interval < 1/3 the average interval followed by a compensatory pause of 1.25 x average R-R interval or two such Vs without compensatory pause occurring within 5 minutes of each other. (When HR >100, 1/3 R-R interval is too short for detection.).	numeric flashes, yellow alarm lamp, short yellow audible alarm.

Alarm Message	From	Condition	Indication
**RR HIGH	RESP	The respiration rate has exceeded the high alarm limit.	numeric flashes and high limit is highlighted, yellow alarm lamp, alarm tone.
**RR LOW	RESP	The respiration rate has dropped below the low alarm limit.	numeric flashes and low limit is highlighted, yellow alarm lamp, alarm tone.
*/**RUN PVCs HIGH	ECG/ Arrhythmia	A run of PVCs greater than 2 was detected.	numeric flashes, yellow alarm lamp, short yellow audible alarm.
**<SpO2 label> HIGH	SpO ₂	The arterial oxygen saturation has exceeded the high alarm limit.	numeric flashes and high limit is highlighted, yellow alarm lamp, alarm tone.
**<SpO2 label> LOW	SpO ₂	The arterial oxygen saturation has fallen below the low alarm limit.	numeric flashes and low limit is highlighted, yellow alarm lamp, alarm tone.
**ST<n> HIGH	ECG/ Arrhythmia	The ST elevation in lead <n> is higher than the limit.	numeric flashes and high alarm limit is highlighted, yellow alarm lamp, alarm tone.
**ST<n> LOW	ECG/ Arrhythmia	The ST depression in lead <n> is lower than the limit.	numeric flashes and low alarm limit is highlighted, yellow alarm lamp, alarm tone.
**ST MULTI <n>, <n>	ECG/ Arrhythmia	The ST depression or elevation is outside of the limit in two or more leads <n> and <n>	numeric flashes, yellow alarm lamp, alarm tone
**ST MULTI at Information Center	ECG/ Arrhythmia	The ST depression or elevation is outside of the limit in two or more leads. Check on the monitor for more details about which leads are affected.	(on monitor) numeric flashes, yellow alarm lamp, alarm tone
**SvO2 HIGH	SvO ₂	The SvO ₂ value has exceeded the high limit.	numeric flashes and high alarm limit is highlighted, yellow alarm lamp, alarm tone.
**SvO2 LOW	SvO ₂	The SvO ₂ value has fallen below the low limit.	numeric flashes and low alarm limit is highlighted, yellow alarm lamp, alarm tone.
*/**SVT	ECG/ Arrhythmia	A run of supraventricular beats greater than the SVT run limit has been detected and the HR has exceeded the SVT HR limit.	numeric flashes, yellow alarm lamp, alarm tone.
***TACHY (Pulse) or ***TACHY xxx>yyy	Press, SpO ₂	The heart rate from the Pulse signal has exceeded the tachycardia limit. xxx denotes the highest measured value; yyy is the tachycardia limit.	numeric flashes, alarm limit is highlighted, red alarm lamp, alarm tone.
**Tblood HIGH	C.O.	The blood temperature value has exceeded the high alarm limit.	numeric flashes, high alarm limit is highlighted, yellow alarm lamp, alarm tone.
**Tblood LOW	C.O.	The blood temperature value has fallen below the low alarm limit.	numeric flashes, low alarm limit is highlighted, yellow alarm lamp, alarm tone.
**tcpO2 HIGH/ **tcpCO2 HIGH	tcGas	The tcpO ₂ or tcpCO ₂ value has exceeded the high alarm limit.	numeric flashes, high alarm limit is highlighted, yellow alarm lamp, alarm tone.

Alarm Message	From	Condition	Indication
**tcpO2 LOW/ **tcpCO2 LOW	tcGas	The tcpO ₂ or tcpCO ₂ value has fallen below the low alarm limit.	numeric flashes, low alarm limit is highlighted, yellow alarm lamp, alarm tone.
**<Temperature label> HIGH	TEMP	The temperature has exceeded the high alarm limit.	numeric flashes and high limit is highlighted, yellow alarm lamp, alarm tone.
**<Temperature label> LOW	TEMP	The temperature has fallen below the low alarm limit.	numeric flashes and low limit is highlighted, yellow alarm lamp, alarm tone.
*/**VENT BIGEMINY	ECG/ Arrhythmia	A dominant rhythm of N, V, N, V (N = supraventricular beat, V = ventricular beat) was detected.	numeric flashes, yellow alarm lamp, short yellow audible alarm.
***VENT FIB/TACH	ECG	A fibrillatory waveform for 4 consecutive seconds was detected.	numeric flashes, red alarm lamp, alarm tone.
*/**VENT RHYTHM	ECG/ Arrhythmia	A dominant rhythm of adjacent Vs > vent rhythm limit and ventricular HR < VTach HR limit was detected.	numeric flashes, yellow alarm lamp, short yellow audible alarm.
*/**VENT TRIGEMINY	ECG/ Arrhythmia	A dominant rhythm of N, N, V, N, N, V (N = supraventricular beat, V = ventricular beat) was detected.	numeric flashes, yellow alarm lamp, short yellow audible alarm.
***VTACH	ECG, Arrhythmia	Ventricular tachycardia has been detected (Consecutive PVCs exceed V-Tach Run limit and HR exceeds V-Tach HR limit).	numeric flashes, yellow alarm lamp, short yellow audible alarm.
/VueLink ALARM at Information Center	VueLink	A yellow (**) or red (***) patient alarm is present on the VueLink module. Check the monitor display for more detailed alarm information.	(on monitor) yellow or red alarm lamp, alarm tone

Technical Alarm Messages (INOPs)

The measurement labels and abbreviations for pressure, temperature, SpO₂, anesthetic agent, and VueLink INOP messages are explained in the individual chapters.

INOP Message, Indication	Source	What to do
ABP INOPS	PRESS	See <Pressure label> INOPS (under Pressure).
ALL ECG ALARMS OFF	ECG/ Arrhythmia	All ECG alarms have been switched off, or the HR alarm source is not ECG. To resume ECG alarm generation, switch ECG alarms on or select ECG as the alarms source.
Ao INOPS	PRESS	See <Pressure label> INOPS (under Pressure).
ART INOPS	PRESS	See <Pressure label> INOPS (under Pressure).
AWF CHANGE SCALE	Spirometry	Airway flow signal exceeds range of selected scale. Adjust scale to display complete wave.
AWP CHANGE SCALE	Spirometry	Airway pressure signal exceeds range of selected scale. Adjust scale to display complete wave
AWV CHANGE SCALE	Spirometry	Airway volume signal exceeds range of selected scale. Adjust scale to display complete wave.
Bad Serverlink INOP tone	Monitor	1) An MMS with an incompatible software revision is connected to the monitor. This combination does not allow monitoring, OR 2) You cannot use this combination of monitor, MMS and cable. Switch off the monitor and contact your service personnel.
BAP INOPS	PRESS	See <Pressure label> INOPS (under Pressure).
BATTERIES EMPTY or BATT 1/ BATT 2 EMPTY INOP tone, battery LED flashes During this INOP, alarms cannot be paused or switched off.	Batteries	The estimated remaining battery-powered operating time of the indicated battery or batteries is less than 10 minutes. Replace the batteries immediately. If the condition persists and the monitor is not connected to mains power, this INOP is re-issued two minutes after you acknowledge it.
BATTERIES INCOMPAT or BATT 1/ BATT 2 INCOMPAT INOP tone	Batteries	The indicated battery or batteries cannot be used with this monitor. Replace with the correct batteries (M4605A).
BATTERIES LOW or BATT 1/ BATT 2 LOW INOP tone	Batteries	The estimated battery-powered operating time remaining is less than 20 minutes.
BATTERIES MALF or BATT 1/ BATT 2 MALFUNCTION INOP tone, battery LED flashes During this INOP, alarms cannot be paused or switched off unless the monitor is connected to mains power.	Batteries	The monitor cannot determine the battery status. If this INOP persists, replace the faulty battery or batteries. If the condition persists and the monitor is not connected to mains power, this INOP is re-issued two minutes after you acknowledge it. Place the batteries in a different monitor or in a battery charger. If the same INOP is shown, contact your service personnel.
BATT 1/BATT 2 MISSING INOP tone. During this INOP, alarms cannot be paused or switched off.	Batteries	The monitor requires two batteries but can detect only one battery. Insert the missing battery immediately.

INOP Message, Indication	Source	What to do
BIS CABLE INCOMPAT INOP tone.	BIS	The semi-reusable sensor cable connected is unknown or not supported by your software revision. Replace it with a Philips-supported sensor cable.
BIS CABLE USAGE INOP tone.	BIS	The semi-reusable sensor cable has exceeded the maximum number of uses. Replace the cable.
BIS DSC DISCONN INOP tone	BIS	DSC is not properly connected OR either DSC or BIS engine may be faulty. Make sure that the DSC is properly connected to the BIS Engine. If INOP persists, replace DSC with a known good one of the same type. If INOP persists replace BIS engine. Silencing this INOP switches the measurement off.
BIS DSC INCOMPT INOP tone	BIS	DSC is not supported by the BIS engine or new DSC connected to an old BIS engine. A software upgrade may be required. Contact your service personnel.
BIS DSC MALFUNC	BIS	Electrocautery used during self-test OR malfunction in the DSC hardware. Make sure not to use electrocautery during the self-test procedure. Disconnect and reconnect the DSC to the BIS engine. If the INOP persists, replace the DSC or contact your service personnel.
BIS DSC UPDATE INOP tone	BIS	DSC update currently being carried out. This INOP will disappear when the DSC update is finished. Do not disconnect the DSC during the update. No action is needed.
BIS ELECTR. DISC INOP tone.	BIS	One or more electrodes are not connected to the semi-reusable sensor cable. Check all electrode connections.
BIS ENGINE DISC. INOP tone	BIS	BIS engine not connected OR Module Cable defective. Make sure that the Module Cable is properly connected. If INOP persists, replace the Module Cable. Silencing this INOP switches the measurement off.
BIS ENGINE INCOMPT INOP tone	BIS	BIS engine software is not supported. A software upgrade may be required. Contact your service personnel. MP20/30 - BIS engine not supported.
BIS ENGINE MALFUNC INOP tone	BIS	Malfunction in the BIS engine hardware. Disconnect and reconnect the BIS engine. If the INOP persists, replace BIS engine.
BIS EQUIP MALF INOP tone	BIS	There is a malfunction in the BIS hardware. Unplug and replug the BIS module. If the INOP persists, contact your service personnel.
BIS HIGH IMPEDANCE INOP tone may sound	BIS	Impedance of one or more electrode(s) is above the valid range, most often caused by bad skin preparation. Check the sensor montage and press the electrode pads firmly. If this INOP persists, replace the sensor(s) in question using correct skin preparation. If INOP persists, contact your service personnel.
BIS IMPEDANCE CHCK INOP tone may sound	BIS	The Cyclic Impedance check is running. It will stop automatically if all impedances are within the valid range. If any electrodes do not pass the impedance test, check the sensor montage and press the electrode pads firmly. To manually stop the Cyclic Impedance Check, select Cyclic Check Off in the Setup BIS menu.

INOP Message, Indication	Source	What to do
BIS ISOELECTRC EEG	BIS	No discernible EEG activity is detected for longer than one minute. Check the patient. Check that the electrodes are properly connected.
BIS LEAD OFF INOP tone may sound	BIS	One or more electrodes have no skin contact and therefore impedances cannot be measured. Check the sensor montage and press the electrode pads firmly. If this INOP persists, replace the sensor(s) in question, using correct skin preparation.
BIS OVERCURRENT INOP tone	BIS	Unplug and replug the BIS module or, f or the MP20/MP30, disconnect and reconnect the BISx from the Interface board. If the INOP persists, contact your service personnel.
BIS SENSOR DISCONN INOP tone	BIS	The sensor is not properly connected to the patient interface cable (PIC) and/or the PIC is not properly connected to the DSC or BISx, or the sensor or PIC or DSC or BISx may be faulty. Check all the connections. Disconnect and reconnect the sensor, PIC, DSC, BISx. If the INOP persists, replace the sensor. If the INOP persists, replace PIC. If INOP persists, contact your service personnel. Silencing this INOP switches the measurement off.
BIS SENSOR INCOMPAT INOP tone	BIS	Unsupported sensor connected or sensor type unknown or not supported by your software revision. Replace the sensor, using only Philips supported sensors.
BIS SENSOR MALFUNC INOP tone	BIS	Malfunction in the sensor hardware, most often caused by liquids permeating into the connectors OR patient interface cable (PIC) or DSC or BISx may be faulty. Replace the sensor. Manually initiate a Cyclic Impedance Check. Make sure all electrodes pass the test. Make sure that the both sides of the PIC connector (between PIC and sensor) are dry. If you are not sure that the connector is dry, replace the PIC until it has dried. If this INOP persists, contact your service personnel.
BIS SENSOR USAGE INOP tone	BIS	Excessive sensor usage. Replace sensor. A Cyclic Impedance Check will start automatically.
BIS SQI < 15% (INOP tone) OR BIS SQI < 50% (no INOP tone)	BIS	If the signal quality is below 50%, BIS numerics cannot be reliably derived. If the signal quality is below 15%, no BIS numerics can be derived. This may occur as a result of artifacts such as those generated from motion or the presence of electrocautery devices. Make sure the sensor is properly attached to the patient. Manually initiate a Cyclic Impedance Check. Make sure all electrodes pass the test. Make sure the patient is completely relaxed (even small motions of the facial muscles affect the signal quality).
BIS UNPLUGGED INOP tone	BIS	Plug in the BIS module. Silencing this INOP switches off the measurement.
BISx DISCONNECTED INOP tone	BIS	The BISx is not connected to the BIS module or the BIS interface board. Silencing this INOP switches the measurement off.

INOP Message, Indication	Source	What to do
BISx INCOMPATIBLE INOP tone	BIS	The BISx software is not compatible with the BIS module or with the MP20/MP30 monitor software. A software upgrade may be required. Contact your service personnel.
BISx MALFUNCTION INOP tone	BIS	The BISx is faulty. Disconnect and reconnect it to the module or BIS interface board. If the INOP persists, replace the BISx. MP20/MP30 - Malfunction on interface board. If the INOP persists, contact your service personnel.
CANNOT ANALYZE ECG	ECG/ Arrhythmia	The arrhythmia algorithm cannot reliably analyze the ECG data. Check the ECG signal quality of the selected primary and secondary leads. If necessary, improve lead position or reduce patient motion. If you have arrhythmia analysis on, and you are not getting a reliable HR because the signal is below a minimum amplitude, unstable, or contains artifact, <i>and</i> you have tried to improve the system performance by choosing another lead and changing electrodes, you should consider turning arrhythmia analysis off.
CANNOT ANALYZE ST	ST	The ST algorithm cannot generate a valid ST value. Possible causes are large variations in the measured ST values for consecutive beats, or ventricular paced beats. Review the ECG signal quality and the ST measurement points. If the patient has a ventricular pacemaker, ST analysis is not possible.
CCI NO BSA CCI numeric unavailable INOP tone	C.O.	CCI cannot be calculated because the patient's body surface area is unknown. Enter the patient weight and height to provide the BSA for CCI calculation.
CCO BAD PRESS SIGN numeric is replaced by -?- INOP tone	C.O.	The arterial pressure wave can currently not be used for pulse contour calculation for CCO or CCI measurement. Possible causes are air bubbles in the tubing or a physiological condition, for example severe arrhythmia.
CCO NO <Pressure label> numeric is replaced by -?- INOP tone may sound	C.O.	CCO/CCI cannot be calculated. Make sure that the pressure chosen in the Setup CCO menu under CCO From matches the pressure measured with the arterial catheter for CCO measurement. A VueLink pressure cannot be used. Select another pressure label, either ABP, Ao, ART, BAP, FAP, or UAP.
CCO NO CALIBRATION numeric is replaced by -?-	C.O.	The CCO measurement is currently not calibrated.
CCO NO PRESS at Information Center	C.O.	CCO/CCI cannot be calculated. Make sure that the pressure chosen in the Setup CCO menu under CCO From matches the pressure measured with the arterial catheter for CCO measurement. A VueLink pressure cannot be used. Select another pressure label, either ABP, Ao, ART, BAP, FAP, or UAP.
CCO NOT SUPPORTED numeric is replaced by -?- INOP tone	C.O.	A catheter for transpulmonary C.O. measurements has been unplugged and replaced with a Right Heart C.O. catheter, or the measurement mode has been changed manually. Silencing this INOP switches the measurement off.
CCO/CCI OVERRANGE numeric is replaced by -?- INOP tone	C.O.	The measured CCO or CCI value is not within the specified range for CCO/CCI measurement.
CCO <Pressure label> INVALID numeric is replaced by -?- INOP tone may sound	C.O.	The arterial pressure selected for pulse contour calculation for CCO is available but currently invalid. Make sure the pressure transducer is connected and the zero calibration is valid.

INOP Message, Indication	Source	What to do
CCO PRESS INVALID at Information Center	C.O.	The arterial pressure selected for pulse contour calculation for CCO is available but currently invalid. Make sure the pressure transducer is connected and the zero calibration is valid.
CCO PRESS OVERRANG numeric is replaced by -?- INOP tone	C.O.	The mean value of the arterial pressure values used for pulse contour calculation for CCO is below 0 mmHg or above 300 mmHg.
CCO PULSE OVERRANG numeric is replaced by -?- INOP tone	C.O.	The pulse rate of the pressure used for pulse contour calculation for CCO is below 30 bpm or above 240 bpm.
CCO/Tb1 NO TRANSD Numeric is replaced by -?- INOP tone	C.O.	No transducer attached to the module or catheter disconnected.
CCO RECALIBRATE numeric is replaced by -?-	C.O.	The most recent CCO or CCI calibration was made over 8 hours ago. You should recalibrate CCO or CCI with transpulmonary C.O. measurements at least every 8 hours or when the hemodynamic condition of the patient has changed.
Charge BATT1/BATT2 now INOP tone	Batteries	Battery must be charged. Connect the monitor to mains power or exchange the battery.
CHARGER MALFUNCT INOP tone, battery LED may flash	Batteries	There is a problem with the battery charger in the monitor. Connect the monitor to mains power and contact your service personnel.
Check Alarm Lamps INOP tone.	Monitor	Perform a visual check of the alarm lamp to establish whether there is a problem. Contact your service personnel to check the internal connections to the alarm lamps.
CHECK BATT TEMP INOP tone	Battery	The temperature of one or both batteries is too high. Check that ventilation openings are not blocked and monitor is not exposed to heat.
Check Flex Texts INOP tone	Monitor	Check the names of the monitor menus, for example the labels for screens, profiles, event or trend group names, before you resume monitoring. If they are unexpected, there may be a problem with the monitor software. Contact your service personnel.
CheckInternVoltage at Information Center	Monitor	Potential problem with alarm lamps, display or interfaces detected. Contact your service personnel. This INOP will appear on the monitor as Check Monitor Func.
Check Keyboard INOP tone	Monitor	Perform a visual and functional check of the keyboard. Contact your service personnel.
Check Main Board 2 INOP tone.	Monitor	There is a problem with the second main board in the monitor. Contact your service personnel.
Check MCC	Monitor	The monitor cannot communicate with the D80 Intelligent Display. Check the MSL coupling cable. The end with the grey connector must be connected to the Intelligent Display.
Check Monitor Func INOP tone.	Monitor	Potential problem with alarm lamps, display or interfaces detected. Contact your service personnel. This INOP may appear on the Information Center as CheckInternVoltage.
Check Monitor Temp INOP tone	Monitor	The temperature inside the monitor is too high. Check that the monitor ventilation is not obstructed. If the situation continues, contact your service personnel.

INOP Message, Indication	Source	What to do
Check Mouse Device INOP tone.	Monitor	Perform a visual and functional check of the mouse input device. Contact your service personnel.
Check MSL Voltage INOP tone	Monitor/ Measuremt Server	There is a problem with the voltage of the Measurement Server Link (MSL). Contact your service personnel.
Check Network Conf INOP tone	Monitor	The monitor is receiving network topology information from more than one source, e.g.the Database Server and an Application Server. Contact your service personnel.
Check Nurse Relay INOP tone	Monitor	There is a problem with the connection to the nurse relay. Contact your service personnel.
Check Screen Res INOP tone	Monitor	The Screen you have selected uses a resolution which is not supported by the display. The monitor will show a generic Screen instead until you select a different Screen. Contact your service personnel if you want the Screen deleted from the Profile(s) to avoid this in future.
Check Settings INOP tone	Monitor	If this INOP appears, check the monitor and patient settings before you resume monitoring. If the settings are unexpected, there may be a problem with the monitor software. Contact your service personnel.
Check Speedpoint INOP tone.	Monitor	Perform a visual and functional check of the SpeedPoint input device. Contact your service personnel.
Check Touch Input	Monitor	Perform a visual and functional check of the touch input device. Contact your service personnel.
Check Waves INOP tone	Monitor	The options purchased with this monitor may not support the number of waves required to show the selected Screen, so some waves or high resolution trends are missing from the Screen. Select a different Screen with fewer waves. Contact your service personnel if you want the Screen deleted from the Profile(s) to avoid this in future.
Chk IndepDsp Cable	Monitor	The monitor cannot communicate with the D80 Intelligent Display. Check the MSL coupling cable. The end with the grey connector must be connected to the Intelligent Display.
C LEAD OFF HR Numeric is replaced by -?- for 10 seconds. INOP tone.	ECG	The C electrode (AAMI: V electrode) has become detached from the patient or the lead set has been changed. Reattach the electrode or select New Lead Setup in the Setup ECG menu to confirm the new lead set.
CO₂ AUTO ZERO Numeric is replaced by a - ? - if the Autozero lasts >15 sec, INOP tone sounds.	CO ₂	The automatic zero calibration is in progress. This typically takes 10 seconds. During this time the CO ₂ values may not be updated, or they may be replaced by -?-. Wait until the zero calibration is complete to resume monitoring.
CO₂ CAL MODE CO ₂ numeric displays current CO ₂ value for accuracy check	CO ₂	Currently no calibration is running. Accuracy can be checked by placing the transducer on the two cells of the calstick and starting calibration. To start monitoring, leave Cal. Mode.
CO₂ CAL RUNNING Numeric is replaced by a - ? -	CO ₂	Wait until calibration is finished.
CO₂ CHANGE SCALE	CO ₂	The CO ₂ wave is clipped. Select a more appropriate wave scale to display the whole wave.
CO₂ CHECK ADAPTER Numeric is replaced by a - ? - INOP tone.	CO ₂	Check that the sensor is connected to the airway adapter, clean the airway adapter, if necessary. Perform a zero calibration. If the INOP persists, contact your service personnel.

INOP Message, Indication	Source	What to do
CO₂ CHECK CAL Numeric is replaced by a - ? - INOP tone.	CO ₂	The CO ₂ value is outside the measurement range. Perform an accuracy check for both calstick cells and, if necessary, recalibrate the transducer.
C.O. EQUIP MALF Numeric is replaced by a - ? - INOP tone.	C.O.	There is a problem with the C.O. hardware. Contact your service personnel.
CO₂ EQUIP MALF Numeric is replaced by - ? - INOP tone.	CO ₂	The Measurement Server Extension is faulty. Unplug and replug the Measurement Server with Extension. If you are using the mainstream method, unplug and replug the transducer or try another transducer. If the INOP persists, contact your service personnel.
CO₂ FAILED CAL Numeric is replaced by -?- INOP tone.	CO ₂	Make sure that the Cal cell was changed between CAL1 and CAL2. Repeat the calibration. If the INOP reappears, try another transducer. If the INOP persists, contact your service personnel.
CO₂ NO SENSOR Numeric is replaced by - ? - INOP tone.	CO ₂	There is no CO ₂ sensor connected. If you silence this INOP the CO ₂ measurement will be switched off.
CO₂ NO TRANSDUC Numeric is replaced by - ? - INOP tone.	CO ₂	There is no CO ₂ transducer connected. If you replace the transducer, the new transducer must be calibrated. If you silence this INOP the CO ₂ measurement will be switched off.
CO₂ NO TUBING Numeric is replaced by - ? - INOP tone.	CO ₂	Either the FilterLine is disconnected, or an incorrect line is attached. Check the connection. If necessary, connect another Microstream® Filterline (only Microstream accessories can be used). If you silence this INOP, the measurement will be switched off.
CO₂ OCCLUSION Numeric is replaced by a - ? - INOP tone.	CO ₂	The FilterLine or exhaust tube is blocked. Check the FilterLine and exhaust tube, then disconnect and reconnect the FilterLine. If the INOP persists, connect a new FilterLine.
CO₂ OVERRANGE Numeric is replaced by - ? - INOP tone.	CO ₂	The CO ₂ value is higher than the measurement range. If you suspect a false high value, contact your service personnel.
CO₂ PUMP OFF Numeric is replaced by a - ? -.	CO ₂	The pump has been switched off for fifteen minutes. To switch it on again, select Pump On in the Setup CO ₂ menu.
CO₂ PURGING Numeric is replaced by a - ? - INOP tone.	CO ₂	The Filterline is being purged to remove an occlusion in the line or airway adapter. If the occlusion is removed, the INOP will disappear. If not, the INOP CO₂ OCCLUSION is displayed.
CO₂ SENSOR WARMUP Numeric is displayed with a - ? - Microstream CO ₂ : INOP tone. Mainstream CO ₂ : no INOP tone	CO ₂	Wait until the sensor reaches operating temperature and the INOP disappears.
C.O. UNPLUGGED numeric is replaced by -?- INOP tone.	C.O.	Plug in the C.O. module. Silencing this INOP switches off the measurement.
CO₂ UPDATE FW Numeric is replaced by a - ? - INOP tone.	CO ₂	The software in the Measurement Server Extension does not match the software in the MMS. Contact your service personnel.
CO₂ WAIT CAL2 Numeric is replaced by a - ? -	CO ₂	Calibration on the first calstick cell is complete. Place the transducer on the other calstick cell and start the CAL2 calibration cycle.

INOP Message, Indication	Source	What to do
CO₂ ZERO FAILED Numeric is replaced by a - ? - INOP tone.	CO ₂	An error occurred during the last zero calibration. Check the airway adapter and clean, if necessary. Perform another zero calibration. If the INOP persists, contact your service personnel.
CO₂ ZERO REQUIRED Numeric is replaced by a - ? - INOP tone	CO ₂	Perform zero calibration for the CO ₂ sensor. If the INOP persists, contact your service personnel.
CO₂ ZERO RUNNING	CO ₂	Wait until zero calibration is finished.
CPP CHK SOURCES Numeric is replaced by a - ? -	CPP	Not all measurements or values required to perform the calculation are available. Check the measurement sources.
CPP CHK UNITS Numeric is replaced by a - ? -	CPP	The monitor has detected a conflict in the units used for this calculation. Check the unit settings.
CUFF NOT DEFLATED Numeric is displayed with a - ? - INOP tone. During this INOP, alarms cannot be paused or switched off.	NBP	Remove the cuff from the patient. Make sure that the tubing is not kinked or twisted and that the correct patient category is selected. Try repeating the measurement. You can silence the INOP, but the INOP message remains visible until the next NBP measurement is started or the Stop All SmartKey is selected. <i>[Adult or pediatric patients:</i> The NBP cuff pressure has exceeded 15mmHg (2kPa) for more than 3 minutes. <i>Neonatal patients:</i> The NBP cuff pressure has exceeded 5mmHg (0.7kPa) for more than 90 seconds.]
CVP INOPS	PRESS	See <Pressure label> INOPS (under Pressure).
ECG EQUIP MALF Numeric is displayed with a - ? - INOP tone.	ECG	Contact your service personnel. The ECG hardware is faulty.
<ECG LEAD> LEAD OFF Numeric is displayed with a - ? - INOP tone.	ECG	Not all the required leads for ECG monitoring are connected. Check the ECG connections and make sure that the electrode indicated by <ECG lead> [RA, LA, LL, RL, V or C] electrodes is attached. In EASI mode, all 5 electrodes must be connected.
ECG EL. NOISY <ECG LEAD>	ECG	The ECG signal from the named ECG electrodes [RA, LA, LL, RL, V (or C)] is noisy. Check the ECG connections and make sure that the electrode indicated is attached.
ECG NOISY SIGN. INOP tone.	ECG	The ECG signal is too noisy. Check that the electrodes are properly placed and have not dried out. Remove any possible sources of signal noise (such as power cords) from the area around the cable and the patient. The ECG signal may be saturated or overloaded.
EcgOut EQUIP MALF INOP tone	ECG	Check that the ECG out cable is securely connected. Contact your service personnel.
EEG EQUIP MALFUNC INOP tone	EEG	The EEG hardware is faulty. Contact your service personnel.
EEG IMPEDANCE HIGH or EEG1 and/or EEG2 IMPED. HIGH	EEG	The signal electrode in one or both channels exceeds the user-selected impedance limit, or the impedance of a single electrode exceeds the limit. Check the impedance. If the impedance is too high, reconnect the electrodes according to the EEG monitoring setup guidelines. If the INOP persists, contact your service personnel.
EEG<X> LEAD OFF <n> [X = channel, n = electrode]	EEG	Reconnect specified electrode.

INOP Message, Indication	Source	What to do
EEG<X> LEAD OFF [X = <i>channel</i>] at Information Center	EEG	One or more electrodes are not connected. Check in the EEG Impedance/Montage window on the monitor which electrode(s) are affected and reconnect the electrodes.
EEG<X> LEADS OFF [X = <i>channel</i>]	EEG	Two or more electrodes are not connected. Check in the EEG Impedance/Montage window which electrodes are affected and reconnect the electrodes.
EEG LINE NOISE EEG 1 or 2 LINE NOISE	EEG	Excessive line noise has been detected in either channel EEG1 or EEG2, or in both EEG channels. Keep all cables together and away from metallic bodies, other cables & radiated fields.
EEG MUSCLE NOISE EEG 1 or 2 MUSCLE NOISE	EEG	Too much power above 30 Hz has been detected in channel EEG1 or EEG2, or both. Check the Electrode-to-Skin Impedance and reposition the electrode away from possible muscle activity, if necessary.
EEG NO TRANSDUCER INOP tone	EEG	The trunk cable is disconnected from the EEG plug-in module. Reconnect the trunk cable. Silencing this INOP switches the measurement off.
EEG UNPLUGGED INOP tone	EEG	Plug in module. Silencing this INOP switches off the measurement.
EEG OVERRANGE , or EEG<X> OVERRANGE	EEG	Input signal is too high in one or both channels. This is usually caused by interfering signals such as line noise or electrosurgery. X denotes the EEG channel.
FAP INOPS	PRESS	See <Pressure label> INOPS (under Pressure).
FMS UNPLUGGED INOP tone.	FMS	Make sure that the Flexible Module Server is connected to the monitor. All FMS measurements are off while the FMS is unplugged.
FMS UNSUPPORTED INOP tone.	FMS	The Flexible Module Server is not supported by your monitor. Contact your service personnel.
IC1/IC2INOPS	PRESS	See <Pressure label> INOPS (under Pressure).
ICP INOPs	PRESS	See <Pressure label> INOPS (under Pressure).
Indep.Dsp Malfunc.	Display	A problem has occurred with the second main display. Contact your service personnel.
Indep.Dsp NotSupp.	Display	The monitor does not support a second main display. The monitor software is incompatible. Contact your service personnel.
Intell.Dsp Malf. INOP tone	Display	There is a problem with the Intelligent Display. Check the MSL coupling cable then contact your service personnel.
Intell.Dsp Missing	Display	The monitor has lost contact with the connected Intelligent Display. Contact your service personnel.
Intell.Dsp Unsupp.	Display	The monitor does not support the connected Intelligent Display. The monitor software is incompatible.
Internal.Comm.Malf INOP tone	Monitor	There is a problem with I2C Bus communication in the monitor. Contact your service personnel.
LA LEAD OFF Numeric is replaced by -?- for 10 seconds; INOP tone.	ECG	The LA electrode has become detached from the patient or the lead set has been changed. Reattach the electrode or select New Lead Setup in the Setup ECG menu to confirm the new lead set.
LAP INOPs	PRESS	See <Pressure label> INOPS (under Pressure).

INOP Message, Indication	Source	What to do
LEADS OFF Numeric is replaced by -?- for 10 seconds; INOP tone.	ECG	Check that all of the required ECG leads are attached, and that none of the electrodes have been displaced.
LL LEAD OFF Numeric is replaced by -?- for 10 seconds; INOP tone.	ECG	The LL electrode has become detached from the patient or the lead set has been changed. Reattach the electrode or select New Lead Setup in the Setup ECG menu to confirm the new lead set.
MCC Reversed	Monitor	The MSL coupling cable is reversed. Connect the end with the grey connector to the Intelligent Display.
MCC Unsupported	Monitor	An MSL coupling cable has been connected to a device which does not support MSL coupling.
Measserv Unsupported	Monitor	The measurement server is not supported by the monitor. Contact your service personnel.
MMS UNPLUGGED INOP tone.	MMS	Make sure that the Multi-Measurement Server is connected to the monitor. All MMS measurements are off while the MMS is unplugged.
MMS UNSUPPORTED INOP tone.	MMS	The Multi-measurement Server is not supported by your monitor. Contact your service personnel.
MSL Power High	Monitor	The power consumption of the devices connected to the Measurement Server Link (MSL) cable is too high. If this situation continues, the MSL will be switched off. Contact your service personnel.
MSL Power Off INOP tone.	Monitor	The power consumption of the devices connected to the Measurement Server Link (MSL) cable was too high for too long and the MSL has been switched off. Contact your service personnel.
MSL Power Overload INOP tone.	Monitor	The power consumption of the devices connected to the Measurement Server Link (MSL) cable is much too high or there has been a short circuit. The MSL has been switched off. Contact your service personnel.
NBP CUFF OVERPRESS Numeric displayed with -?- ; INOP tone. During this INOP, alarms cannot be paused or switched off.	NBP	The NBP cuff pressure exceeds the overpressure safety limits. Remove the cuff from the patient. Make sure that the tubing is not kinked or twisted and that the correct patient category is selected. Try restarting the measurement. You can silence this INOP, but the INOP message remains visible until the next measurement is started or the Stop All SmartKey is selected.
NBP EQUIP MALF Numeric is replaced by -?- INOP tone.	NBP	Remove the cuff from the patient. The NBP hardware is faulty. Contact your service personnel. You can silence this INOP, but the INOP message remains visible until the next measurement is started or the Stop All SmartKey is selected.

INOP Message, Indication	Source	What to do
<p>NBP INTERRUPTED Numeric is replaced by -?- INOP tone.</p>	<p>NBP</p>	<p>Check the tubing and cuff for leakages or kinks. Check that you are using the correct cuff size and placement, and that the correct patient category is selected. Try restarting the measurement.</p> <p>If the INOP occurs repeatedly, contact your service personnel. You can silence this INOP, but the INOP message remains visible until the next measurement is started or the Stop All SmartKey is selected.</p> <p>This INOP arises when the measurement needed longer than the maximum time for inflation, deflation or the total measurement.</p>
<p>NBP MEASURE FAILED Numeric may be displayed with a -?- INOP tone.</p>	<p>NBP</p>	<p>Check that you are using the correct cuff size and placement, and that the correct patient category is selected. Try restarting the measurement.</p> <p>If numerics are displayed, the monitor is able to measure mean only and the alarm source is set to S, D or S&D. You can silence this INOP, but the INOP message remains visible until the next measurement is started or the Stop All SmartKey is selected.</p> <p>Check the condition and suitability of the patient for NBP monitoring. Use another cuff to continue measuring.</p>
<p>No Central Monit. INOP tone</p>	<p>Monitor</p>	<p>There is a problem with the communication to the network. Central monitoring is currently not possible (no patient alarms or information). Check the connection. Contact your service personnel.</p>
<p>NO PPV FROM MeasSrv at Information Center</p>	<p>MMS or FMS</p>	<p>The measurement server does not supply a beat-to-beat arterial pressure value. Contact your service personnel.</p>
<p>NO PPV FROM <Server></p>	<p>MMS or FMS</p>	<p>The measurement server does not supply a beat-to-beat arterial pressure value. Contact your service personnel.</p>
<p>P/P1/P2/P3/P4 INOPS</p>	<p>PRESS</p>	<p>See <Pressure label> INOPS (under Pressure).</p>
<p>PAP INOPS</p>	<p>PRESS</p>	<p>See <Pressure label> INOPS (under Pressure).</p>
<p>PPV BAD <Pressure Label> SIGNAL</p>	<p>PRESS</p>	<p>The arterial pressure source selected for PPV is not providing a pulsatile signal.</p>
<p>PPV BAD SIGNAL at Information Center</p>	<p>PRESS</p>	<p>The arterial pressure source selected for PPV is not providing a pulsatile signal.</p>
<p>PPV CHK SOURCES</p>	<p>PRESS</p>	<p>The arterial pressure source selected for PPV is unplugged or switched off. When this INOP has displayed for 1 minute PPV will be switched off.</p>
<p><Pressure label> ARTIFACT Numeric displayed with -?-</p>	<p>PRESS</p>	<p>A non-physiological event is detected (for example, a flush or blood sample). A resulting high limit alarm will be suppressed.</p>
<p><Pressure label> DEACTIVATED INOP tone</p>	<p>PRESS</p>	<p>A Pressure measurement label in the measurement server or extension has been deactivated, either by connecting a Temp transducer in the shared Press/Temp socket, or by deactivating the label in the Measurement Selection window.</p> <p>The measurement automatically disappears from the display.</p> <p>To switch the measurement on again, either reconnect a Pressure transducer or reactivate the measurement label in the Measurement Selection window.</p>

INOP Message, Indication	Source	What to do
<Pressure label> EQUIP MALF Numeric displayed with -?- INOP tone.	PRESS	Contact your service personnel. The pressure hardware is faulty.
<Pressure label> NO TRANSDUCER Numeric is replaced by -?- INOP tone.	PRESS	Make sure that the pressure transducer is connected to the measurement server or module server. If you silence this INOP, the measurement will be switched off.
<Pressure label> NOISY SIGNAL Pulse numeric is replaced by -?- INOP tone.	PRESS	This INOP can only arise when a pressure is selected as the pulse source. It occurs when the pulse detector finds a pulse rate above 350bpm. This is usually caused by movement artifact or electrical interference.
<Pressure label> NON-PULSATILE Pulse numeric is replaced by -?- INOP tone.	PRESS	This INOP can only arise when a pressure is selected as the pulse source. It occurs when the pulse rate being measured is less than 25 beats per minute or the amplitude is less than three mmHg. Check the catheter and connections to the patient.
<Pressure label> OVERRANGE Numeric is replaced by -?- INOP tone.	PRESS	Make sure that the measurement has been properly prepared and zeroed, and that the transducer is level with the heart. If this INOP persists, try another transducer. Possible causes are a measured pressure outside the allowed pressure range, or a broken wire to the transducer.
<Pressure label> REDUCE SIZE	PRESS	Increase the scale for the pressure wave.
<Pressure label> TRANSDUC MALF Numeric is replaced by -?- INOP tone.	PRESS	Contact your service personnel. The transducer is faulty.
<Pressure label> UNPLUGGED	PRESS	A Pressure measurement label has been deactivated, either by unplugging a module, or by deactivating the label in the Measurement Selection window. The measurement automatically disappears from the display. To switch the measurement on again, either replug the module or reactivate the measurement label in the Measurement Selection window.
<Pressure label> ZERO+CHECK CAL Numeric is replaced by -?-	PRESS	Perform a zero and check the calibration of the transducer.
RA LEAD OFF Numeric is replaced by -?- INOP tone.	ECG	The RA electrode has become detached from the patient or the lead set has been changed. Reattach the electrode or select New Lead Setup in the Setup ECG menu to confirm the new lead set.
RAP INOPS	PRESS	See <Pressure label> INOPS (under Pressure).
Rem.Alarmdev.Malf INOP tone	Monitor	There is a problem with the connection to the remote alert device. Contact your service personnel to check the remote alert device and its connections.
RESP EQUIP MALF Numeric is replaced by -?- INOP tone.	RESP	Contact your service personnel. The RESP hardware is faulty.

INOP Message, Indication	Source	What to do
RESP ERRATIC Numeric is replaced by -?-	RESP	The monitor has detected too many artifacts in the measured Resp signal. Check that the RA and LL electrodes are correctly attached and have not dried out.
RESP LEADS OFF Numeric is replaced by -?- INOP tone.	RESP	Not all the required leads for Resp monitoring are attached. Make sure that the RA and LL leads are attached.
RL LEAD OFF Numeric is replaced by -?- for 10 seconds; INOP tone.	ECG	The RL electrode has become detached from the patient or the lead set has been changed. Reattach the electrode or select New Lead Setup in the Setup ECG menu to confirm the new lead set.
Settings Malfunc. INOP tone.	Monitor	The monitor cannot use the predefined settings for monitoring. Contact your service personnel.
SOME ECG ALARMS OFF	Arrhythmia	This message appears (if configured to do so) when the on/off settings of the yellow arrhythmia alarms differ from the current Profile.
Speaker Malfunc. INOP tone	Monitor	Contact your service personnel to check the speaker and the connection to the speaker.
SPIRO MALFUNCTION	Spirometry	Module failure detected. Contact your service personnel.
SPIRO INCOMPATIBLE	Spirometry	Module revision not compatible with the host monitor software revision. Contact your service personnel.
SPIRO UPGRADE	Spirometry	The module is running a firmware upgrade. Wait until upgrade is completed before resuming monitoring.
SPIRO CANNOT MEAS	Spirometry	Measurement is at its limit, e.g. ambient pressure out of range.
SPIRO PURGE FAILED	Spirometry	The purge operation could not be completed successfully. Check for kinked sensor tubings, hard occlusions and make sure that the pump is running and all valves are switching.
SPIRO UNKN. SENSOR	Spirometry	An unknown sensor ID code was detected. Use only the sensors listed in the Accessories chapter.
SPIRO ALARMS SUPPR	Spirometry	Alarming is suppressed for the spirometry module.
SPIRO PURGING	Spirometry	A purge operation is in progress - no data update on the screen. Wait until purge is complete.
SPIRO NO SENSOR	Spirometry	No sensor detected. Make sure the correct sensor is attached to the breathing circuit.
SPIRO NO BREATH	Spirometry	No breath was detected for more than 25 seconds. Breath derived numerics are not available.
SPIRO GAS COMPENS?	Spirometry	Gas compensation is set to "gas analyzer" but not all gases necessary for compensation are measured by a gas monitor. Some of the fall-back values provided by the user are used. Measurement accuracy might be reduced.
SPIRO PATIENT CAT.	Spirometry	Mismatch of patient size configured in the host monitor and sensor type plugged into the module. Check the instructions on selecting the correct sensor in the Spirometry chapter.
ΔSpO₂ CHK SOURCES Numeric is replaced by -?-	SpO ₂ Difference	Not all measurements or values required to perform the calculation are available. Check measurement sources.
ΔSpO₂ CHK UNITS Numeric is replaced by -?-	SpO ₂ Difference	The monitor has detected a conflict in the units used for this calculation. Check the unit settings.

INOP Message, Indication	Source	What to do
<SpO ₂ label> DEACTIVATED INOP tone	SpO ₂	You have connected a measurement server that uses a label the monitor has already assigned to a different source. To activate the new source, choose a new label in the Measurement Selection window.
<SpO ₂ label> EQUIP MALF Numeric is replaced by -?- INOP tone.	SpO ₂	The MMS is faulty. Unplug and replug the MMS. If the INOP persists, contact your service personnel.
<SpO ₂ label> ERRATIC Numeric is replaced by -?- INOP tone.	SpO ₂	Check the sensor placement. Try another adapter cable and sensor. If the INOP persists, contact your service personnel.
<SpO ₂ label> EXTD. UPDATE Label is displayed with a -?- (questionable numeric)	SpO ₂	The update period of displayed values is extended due to an NBP measurement on the same limb or an excessively noisy signal.
<SpO ₂ label> INTERFERNCE Numeric is replaced by -?- INOP tone.	SpO ₂	There is too much interference, caused by a high level of ambient light and/or electrical interference. Cover the sensor to minimize ambient light. If the INOP persists, make sure that the sensor cable is not damaged or positioned too close to power cables.
<SpO ₂ label> LOW PERF Label is displayed with a -?- (questionable numeric)	SpO ₂	Accuracy may be compromised due to very low perfusion. Stimulate circulation at sensor site. If INOP persists, change the measurement site.
<SpO ₂ label> NOISY SIGN. Numeric is replaced by -?- INOP tone.	SpO ₂	Excessive patient movement or electrical interference is causing irregular pulse patterns. Try to reduce patient movement or to relieve the cable strain on the sensor.
<SpO ₂ label> NON-PULSAT. Numeric is replaced by -?- INOP tone.	SpO ₂	Check the perfusion at measurement site. If necessary, stimulate circulation or change measurement site. If the INOP is due to NBP measurement on the same limb, wait until the NBP measurement is finished.
<SpO ₂ label> NO SENSOR Numeric is replaced by -?- INOP tone.	SpO ₂	Make sure the SpO ₂ sensor is connected. If the INOP persists, try another adapter cable and sensor. If you silence this INOP, the measurement will be switched off.
<SpO ₂ LABEL> POOR SIGNAL Label is displayed with a - ? - (questionable numeric)	SpO ₂	The signal condition of the SpO ₂ measurement is poor and measurement accuracy may be compromised.
<SpO ₂ LABEL> PULSE? Numeric is replaced by -?- INOP tone	SpO ₂	The detectable pulsations of the SpO ₂ signal are outside the specified pulse rate range.
<SpO ₂ LABEL> SEARCHING Numeric unavailable	SpO ₂	SpO ₂ is analyzing the patient signal to derive Pulse, SpO ₂ and Perf values. Please wait until the search analysis is complete.
<SpO ₂ label> SENSOR MALF Numeric is replaced by -?- INOP tone.	SpO ₂	The SpO ₂ sensor or adapter cable is faulty. Try another adapter cable and sensor. If the INOP persists, contact your service personnel.
<SpO ₂ LABEL> SENSOR OFF Numeric is replaced by -?- INOP tone	SpO ₂	The SpO ₂ sensor is not properly applied to the patient. Apply the sensor following the instructions supplied by the manufacturer.
<SpO ₂ LABEL> UNKN. SENSOR Numeric is replaced by a - ? -	SpO ₂	The connected sensor or adapter cable is not supported by the SpO ₂ measurement. Use only specified sensors and cables.

INOP Message, Indication	Source	What to do
<SpO₂ LABEL> UPGRADE Label is displayed with a -?-, numeric is unavailable	SpO ₂	The SpO ₂ measurement is currently in UPGRADE mode. Monitoring is not possible in this mode.
Sp - vO₂ CHK SOURCES Numeric is replaced by -?-	Sp - vO ₂	Not all measurements or values required to perform the calculation are available. Check measurement sources.
Sp - vO₂ CHK UNITS Numeric is replaced by -?-	Sp - vO ₂	The monitor has detected a conflict in the units used for this calculation. Check the unit settings.
SvO₂ CAL FAILED SvO ₂ numeric is displayed with ?	SvO ₂	The calibration failed. Check the catheter-to-Optical-Module connection. Manually restart the calibration. Try another catheter and Optical Module. If the catheter is already inserted, perform an in-vivo calibration.
SvO₂ CAL MODE SvO ₂ numeric is replaced by -?-	SvO ₂	Pre-insertion calibration is complete, but the catheter tip is still inside the optical reference. The catheter is now ready for insertion.
SvO₂ CAL REQUIRED SvO ₂ numeric is replaced by -?-. INOP tone may sound	SvO ₂	There is no valid calibration data in the Optical Module. Perform either a pre-insertion or an in-vivo calibration.
SvO₂ CONFIGURATION SvO ₂ numeric is replaced by -?-. INOP tone	SvO ₂	The Optical Module has been configured to SaO ₂ Mode. Use Change to SvO2 in the Setup SvO2 menu to reconfigure to SvO ₂ Mode.
SvO₂ CONNCT OPTMOD SvO ₂ numeric is replaced by -?-. INOP tone	SvO ₂	The Optical Module was disconnected during data storage. Reconnect the Optical Module for at least 20 seconds.
SvO₂ EQUIP MALF SvO ₂ numeric is replaced by -?-. INOP tone	SvO ₂	The SvO ₂ Module or Optical Module is faulty. Unplug and replug the Optical Module and SvO ₂ module. Exchange the modules. If the INOP persists, contact your service personnel.
SvO₂ IN-VIVO CALIB SvO ₂ numeric is replaced by -?-. INOP tone	SvO ₂	The in-vivo calibration is not yet complete. Lab values must be stored to the Optical Module to complete the calibration. Either continue with the next steps of the current calibration or recall the previous calibration.
SvO₂ LIGHT INTENS SvO ₂ numeric is replaced by -?- or numeric is displayed with ? INOP tone with -?- display	SvO ₂	The intensity changed considerably since the last light intensity calibration. This may indicate that the catheter tip is positioned against a blood vessel wall or that there is low blood flow. Reposition the catheter and perform a light intensity calibration.
SvO₂ LOW LIGHT SvO ₂ numeric is replaced by -?- or numeric is displayed with ? INOP tone may sound	SvO ₂	The optical signal levels are too low. Check that the catheter is either in the optical reference or inserted into the patient. Check the catheter-to-Optical Module connection. If INOP persists, try another catheter and Optical Module.
SvO₂ NO OPTMOD SvO ₂ numeric is replaced by -?-. INOP tone	SvO ₂	Connect the Optical Module. If the INOP persists, try another Optical Module. Silencing this INOP switches the measurement off.
SvO₂ OPTMOD DEFECT	SvO ₂	The Optical Module memory is faulty, and calibration data cannot be stored for transport or during power failure. If this feature is needed, use another Optical Module.
SvO₂ OPTMOD WARMUP SvO ₂ numeric is displayed with ?	SvO ₂	The Optical Module has not yet reached the operating temperature. Wait a few minutes until warm-up is finished.
SvO₂ PRE-INS CALIB SvO ₂ numeric is replaced by -?-. INOP tone	SvO ₂	The pre-insertion calibration is running. This typically takes one minute. During this time SvO ₂ alarms are switched off. Wait until the calibration is complete.

INOP Message, Indication	Source	What to do
SvO₂ UNABL TO MEAS SvO ₂ numeric is replaced by -?-. INOP tone	SvO ₂	The signal is out of the normal range, and no SvO ₂ value can be derived. Perform an in-vivo calibration. If the INOP persists, try another Optical Module and catheter.
SvO₂ UNPLUGGED SvO ₂ numeric is replaced by -?-. INOP tone	SvO ₂	Measurement switched on and SvO ₂ module unplugged from the rack. The measurement automatically disappears from the display. Silencing this INOP switches off the measurement.
SVR/SVRI CHK SOURCES Numeric is replaced by -?-	SVR/SVRI	Not all measurements or values required to perform the calculation are available. Check measurement sources.
SVR/SVRI CHK UNITS Numeric is replaced by -?-	SVR/SVRI	The monitor has detected a conflict in the units used for this calculation. Check the unit settings.
SVR/SVRI SET CVP USED Numeric is replaced by -?-	SVR/SVRI	A CVP value is required for this calculation, but is not currently being measured. The monitor is using the CVP value preset in the Setup SVR menu.
T/T1/T2/T3/T4 INOPs	TEMP	See <Temp label> INOPs (under Temp)
Tamb INOPs	TEMP	See <Temp label> INOPs (under Temp)
Tart INOPs	TEMP	See <Temp label> INOPs (under Temp)
Tblood NO TRANSDUC Numeric is replaced by -?-. INOP tone	C.O.	No transducer attached to the module or catheter disconnected.
Tblood OVERRANGE Numeric is replaced by -?-	C.O.	Tblood out of range 17°C - 43°C.
Tcereb INOPs	TEMP	See <Temp label> INOPs (under Temp)
Tcore INOPs	TEMP	See <Temp label> INOPs (under Temp).
tcpO₂ (or tcpCO₂ or tcGas) CAL FAILED Numeric is replaced by -?-. INOP tone.	tcGas	A calibration failed. Check the cal. unit, gas pressure, and tubing connections, then restart the cal. If the cal. has failed more than once, remembrane the transducer and restart the calibration. If this INOP persists, contact your service personnel.
tcpO₂ (or tcpCO₂ or tcGas) CAL REQUIRD Numeric is replaced by -?-. INOP tone.	tcGas	Calibration is required before applying the transducer to the patient. Insert a membraned transducer into the cal. chamber on the module, connect the cal. unit to the cal. chamber, open the gas valve and start the calibration. If this INOP occurs during a calibration, there may be a module or transducer malfunction: contact your service personnel.
tcpO₂ (or tcpCO₂ or tcGas) CAL RUNNING Numeric displays first -?- , then numeric is displayed with a ?	tcGas	Wait until the tcpO ₂ /tcpCO ₂ calibration is finished.
tcpO₂ (or tcpCO₂ or tcGas) CHECK TIME	tcGas	Site Timer due to time out in 15 minutes or less.
tcpO₂ (or tcpCO₂ or tcGas) CHANGE SITE If Heat Switch Off is configured to Yes, numeric is replaced by -?-. INOP tone.	tcGas	Site Timer has timed out. Change the application site to avoid skin burns. To reset the Site Timer, either calibrate and change the measurement site, or change the measurement site and reset the Site Timer manually by selecting the appropriate site time from the Setup TCGas menu.

INOP Message, Indication	Source	What to do
tcpO₂ (or tcpCO₂ or tcGas) EQUIP MALF Numeric is replaced by -?- INOP tone.	tcGas	There is a malfunction in the transducer or module. Connect another transducer. If this INOP persists, contact your service personnel.
tcpO₂ (or tcpCO₂ or tcGas) NO TRANSDUC Numeric is replaced by -?- INOP tone.	tcGas	No transducer is connected to the tcpO ₂ /tcpCO ₂ module. Silencing the alarm switches off the measurement.
tcpO₂ (or tcpCO₂ or tcGas) STABILIZING Numeric is displayed with a ?	tcGas	The transducer has not yet reached the selected temperature and/or skin hyperemization is not yet finished. This INOP will disappear within three minutes.
tcpO₂ (or tcpCO₂ or tcGas) UNPLUGGED Numeric is replaced by -?- INOP tone.	tcGas	The measurement is switched on but the module is unplugged. The measurement automatically disappears from the display. Silencing this INOP switches off the measurement.
<ΔTemp> CHK SOURCES Numeric is replaced by -?-	TEMP Difference	Not all measurements or values required to perform the calculation are available. Check measurement sources.
<ΔTemp> CHK UNITS Numeric is replaced by -?-	TEMP Difference	The monitor has detected a conflict in the units used for this calculation. Check the unit settings.
<Temp label> DEACTIVATED INOP tone	TEMP	A Temp measurement label in the measurement server or extension has been deactivated, either by connecting a Pressure transducer in the shared Press/Temp socket, or by deactivating the label in the Measurement Selection window. The measurement automatically disappears from the display. To switch the measurement on again, either reconnect a Temp transducer or reactivate the measurement label in the Measurement Selection window.
<Temp label> EQUIP MALF Numeric is replaced by -?- INOP tone.	TEMP	Contact your service personnel. The temperature hardware is faulty.
<Temp label> NO TRANSDUCER Numeric is replaced by -?- INOP tone.	TEMP	Make sure the TEMP probe is connected to the MMS or module. If you silence this INOP, the measurement will be switched off.
<Temp label> UNPLUGGED INOP tone	TEMP	A Temp measurement label has been deactivated, either by unplugging a module, or by deactivating the label in the Measurement Selection window. The measurement automatically disappears from the display. To switch the measurement on again, either replug the module or reactivate the measurement label in the Measurement Selection window.
<Temp label> OVERRANGE Numeric is replaced by -?- INOP tone.	TEMP	Try changing the application site of the transducer. [The temperature is less than -1°C, or greater than 45°C.]
Tesoph INOPS	TEMP	See <Temp label> INOPs (under Temp).
TimeExpired:<timer label> INOP tone	Monitor	The time has expired for the timer indicated in the INOP text. Clearing the timer clears the INOP.
Tnaso INOPS	TEMP	See <Temp label> INOPs (under Temp).
Trect INOPS	TEMP	See <Temp label> INOPs (under Temp).
Tskin INOPS	TEMP	See <Temp label> INOPs (under Temp).

INOP Message, Indication	Source	What to do
Tttmp INOPS	TEMP	See <Temp label> INOPs (under Temp)
Tven INOPS	TEMP	See <Temp label> INOPs (under Temp).
Tvesic INOPS	TEMP	See <Temp label> INOPs (under Temp)
UAP INOPS	PRESS	See <Pressure label> INOPS (under Pressure).
Unsupported LAN INOP tone	Monitor	There is a problem with the communication to the network and central monitoring is currently not possible. Check the connection. If the INOP persists, switch off the monitor and contact your service personnel.
User I/F Malfunct. INOP tone.	Monitor	Perform a visual and functional check of all the monitor input devices. Contact your service personnel.
UVP INOPS	PRESS	See <Pressure label> INOPS (under Pressure).
V LEAD OFF Numeric is replaced by -?- for 10 seconds; INOP tone.	ECG	The V electrode (IEC: C electrode) has become detached from the patient or the lead set has been changed. Reattach the electrode or select New Lead Setup in the Setup ECG menu to confirm the new lead set.
<VueLink option> CHK CABLE INOP tone.	VueLink	No cable or the wrong cable connected to the VueLink module, or incorrect device selected. Silencing this INOP switches the measurement off. VueLink INOP abbreviations may differ slightly depending on the device category.
<VueLink option> CHK CONF. INOP tone.	VueLink	The wrong external device has been selected on the VueLink module, or the external device has not been correctly setup, or the wrong cable has been used to connect the device to the VueLink module. VueLink INOP abbreviations may differ slightly depending on the device category.
<VueLink option> CHECK SETUP INOP tone.	VueLink	No information was received from the external device. The device may be switched off or disconnected. VueLink INOP abbreviations may differ slightly depending on the device category.
VueLnk EQUIP MALF INOP tone.	VueLink	Malfunction in the VueLink module. If this message appears repeatedly, the module must be replaced. Contact your service personnel. VueLink INOP abbreviations may differ slightly depending on the device category.
VueLnk NO CONFIG INOP tone.	VueLink	The VueLink module has not been configured during installation. The installation process should be completed by either your biomedical engineering department or the Philips service engineer. VueLink INOP abbreviations may differ slightly depending on the device category.
VueLnk UNPLUGGED INOP tone.	VueLink	The VueLink module has been unplugged from the rack, or the whole rack has been disconnected. The measurement automatically disappears from the display. Silencing this INOP switches off the measurement. VueLink INOP abbreviations may differ slightly depending on the device category.

Managing Patients

Use the Patient Demographics window and its associated pop-up keys to admit, discharge, and transfer (ADT) patients.

All patient demographic and ADT information is shared between the patient monitor and the Information Center, for example, patients admitted to the monitor are automatically admitted to a connected Information Center.

Admitting a Patient

The monitor displays physiological data and stores it in the trends as soon as a patient is connected. This lets you monitor a patient who is not yet admitted. It is however important to admit patients properly so that you can identify your patient on recordings, reports, and networked devices.

During admission you enter data that the monitor needs for safe and accurate operation. For example, the patient category setting determines the algorithm the monitor uses to process and calculate some measurements, the safety limits that apply for some measurements, and the alarm limit ranges.

To admit a patient,

- 1 Select the patient name field or select the **Admit/Discharge** SmartKey to open the **Patient Demographics** window.
- 2 Clear any previous patient data by selecting the **Discharge Patient** or **End Case** pop-up key and then **Confirm**.
If you do not discharge the previous patient, you will not be able to distinguish data from the previous and current patients, for example, in the trend database.
- 3 Select **Admit Patient**.
- 4 Enter the patient information: select each field and use the on-screen keyboard or choose from the pop-up list of alternatives to input information. If a conventional keyboard or a barcode scanner is connected to the monitor you can use this to enter patient information.

- **Last name:** Enter the patient's last name (family name), for example **Smith**.

Patient Demographics	
Last Name	
First Name	
MRN	
Patient Cat.	Adult
Paced	No
Height	
Weight	
BSA (D)	
Date of Birth	
Age	
Gender	
Notes (1):	
Notes (2):	

- **First name:** Enter the patient’s first name, for example **Joseph**.
 - **MRN:** Enter the patient’s medical record number (MRN), for example **12345678**.
 - **Patient Cat:** Choose the patient category, either Adult, Pediatric, or Neonatal.
 - **Paced:** Choose **Yes** or **No** (You must use “Yes” if your patient has a pacemaker).
 - **Height:** Enter the patient’s height.
 - **Weight:** Enter the patient’s weight.
 - **BSA:** The monitor calculates the body surface area automatically.
 - **Date Of Birth:** Enter the patient’s date of birth. Enter this in the form dd/mm/yyyy.
 - **Age:** The monitor calculates the patient age automatically.
 - **Gender:** Choose **Male** or **Female**.
 - **Notes:** Enter any extra information about the patient or treatment.
- 5 Select **Confirm**. The patient status changes to admitted.

Patient Category and Paced Status

The patient category setting determines the algorithm the monitor uses to process and calculate some measurements, the safety limits that apply for some measurements, and the alarm limit ranges.

The paced setting determines whether the monitor shows pacemaker pulses or not. When **Paced** is set to **No**, pace pulses are filtered and therefore do not show in the ECG wave.

WARNING **Patient Category** and **Paced** status will always contain a value, regardless of whether the patient is fully admitted or not. If you do not specify settings for these fields, the monitor uses the default settings from the current profile, which might not be correct for your patient.

Patient category Changing the patient category may change the arrhythmia and NBP alarm limits. Always check alarm limits to make sure that they are appropriate for your patient.

Paced status For paced patients, you must set **Paced** to **Yes**. If it is incorrectly set to **No**, the monitor could mistake a pace pulse for a QRS and fail to alarm during asystole.

Admitting a Centrally-Monitored Patient

You can admit a patient at either the bedside or the Information Center. When you admit a patient, the patient’s name appears on the bedside monitor and the Information Center.

If you do not fill in all patient information required by the Information Center, the Information Center may reject the admission. Complete all the required fields and try again to admit the patient.

Quick Admitting a Patient

Use Quick Admit only if you do not have the time or information to fully admit a patient. Complete the rest of the patient demographic details later. If you do not, the patient name will not be written on reports and on information stored in the database or sent to an Information Center.

- 1 Select the **Quick Admit** SmartKey.
- 2 Enter the required data (MRN or Last Name depending on configuration) with the keyboard or a barcode scanner.

- 3 Select **Enter**.
- 4 In the confirmation window, select **Confirm** to discharge the previous patient (if confirmation is configured).
- 5 Check that patient category and paced status are correct for the new patient.

If the monitor is connected to an Information Center and only the MRN is entered, the patient name is set to - - -. The patient name field on the monitor shows **Not Admitted** and the patient name space on printed reports is blank. To fully admit this patient, select **Admit Patient** again and complete all required fields.

Editing Patient Information

To edit the patient information after a patient has been admitted, select the patient name field on the Main Screen to open the **Patient Demographics** window, and make the required changes.

Discharging a Patient

You should always perform a discharge even if your previous patient was not admitted. A discharge:

- clears the information in the **Patient Demographics** window
- erases all patient data (such as trend, event, and calculation data) from the monitor, measurement servers and Information Center. This ensures that data from a previous patient are not mixed with data from the new patient.
- resets patient category and paced settings to the settings defined in the default Profile
- resets all monitor and measurement settings as well as the active Screen to the settings defined in the default Profile
- discharges the patient from the Information Center.

When a patient is discharged from the monitor or from an Information Center, all patient data is deleted. Make sure that you have printed out any required reports before discharging. Check that a functioning local or central printer is available before you use **End Case**.

To discharge a patient,

- 1 Select the patient name field to display the **Patient Demographics** window and associated pop-up keys.
- 2 Select the pop-up key for either:
 - **End Case** - to print any configured end case reports or vital signs recording, discharge the patient and clear the patient database, then enter standby mode. If an **End Case** SmartKey is configured for your monitor, you can also select this instead and then confirm.
To see which end case reports are set up for your monitor, select **Main Setup -> Reports -> Auto Reports**. For each auto report, if **End Case Report** is set to **On**, this report will be printed when you select **End Case**. See the section on AutoReports for information on setting up end case reports.
 - **Discharge Patient** - to discharge the patient without printing any reports.

Transferring Patients

To save you from having to enter the same patient data multiple times and enable patient transfer without loss of data, information can be shared between measurement servers, patient monitors, and Information Centers.

- patient demographic information is shared between connected measurement servers, patient monitors, and Information Centers
- measurement settings and calibration data can be uploaded from an MMS to a patient monitor, if configured
- trend information can be uploaded from an MMS to a patient monitor, if configured.

Different sets of patient- and measurement-related data are stored in the monitor and the Multi-Measurement Server. Understanding this will help you to understand what happens to patient data when you transfer patients.

Patient Information	Stored in Monitor	Stored in MMS and extensions
Patient demographics (name, DOB, MRN)	yes	yes
Monitor settings (alarm pause time, alarm volume)	yes	no
Measurement settings for all measurements (alarm limits, measurement on/off, etc.)	yes	yes, for all MMS and extensions measurements
Trend data	yes, for all MMS and extensions measurements (up to a maximum of 16 or 32, depending on your database configuration)	most recent 8 hours of information, for all MMS and extensions measurements
Calculation data (HemoCalc data)	yes	no
Events data	yes	no

WARNING If the monitor is not battery-powered, you cannot monitor during transport.

Transferring a Centrally-Monitored Patient

Scenario: A centrally-monitored patient is moved to another monitoring location on the same Information Center database server without interrupting the collection of patient trend information.

- 1 Before you disconnect the MMS from the monitor, select the patient name in the monitor info line to enter the **Patient Demographics** window, then select the **Transfer** pop-up key. If the patient is not admitted or not monitored by an Information Center, the **Transfer** key is inactive (“grayed-out”).
This step preserves the patient’s demographic data during the transfer.
- 2 Remove the MMS and any connected extensions from the monitor.
- 3 Connect the MMS to the transfer monitor and monitor your patient during the move.

- 4 At the new location, connect the MMS to the monitor. If the monitor detects a patient conflict, the patient selection window will be displayed.
- 5 Select **Continue MMS** and **Confirm** your selection. This re-admits the patient from the transfer list to the new monitor, completing the transfer. This will upload the patient demographics, and, if configured, the measurement settings and trend data stored in the MMS to the receiving monitor.
- 6 Verify that the settings for patient category and paced mode are correct.

If you accidentally transfer a patient, use **Re-admit** to restore this patient's data to the Information Center. If you are not connected to the network, select **Clear Transfer** to leave transfer mode. The patient data remains in the monitor.

Transferring a Patient with an MMS (no Central Station)

Scenario: A patient is moved to another monitoring location using a transport monitor and re-admitted at the new monitor.

- 1 Disconnect the MMS from the original monitor and silence the resulting **MMS UNPLUGGED INOP**.
If you are sure that the patient will not be returning to this monitor, you should perform a discharge or end-case. This prevents data from the next patient accidentally being mixed up with your current patient's data.
- 2 Connect the MMS to the transport monitor and move the patient.
- 3 At the new monitoring location, remove the MMS from the transport monitor and connect it to the new monitor.
- 4 If prompted, re-admit the patient to the new monitor: in the **Patient Selection** window, select **Continue MMS** to retain the data in the MMS. This will upload the patient demographics, and, if configured, the measurement settings and trend data stored in the MMS to the monitor. Verify that the settings for patient category and paced mode are correct.

Data Upload from an MMS

The Multi-Measurement Server stores eight hours of patient trend data at one-minute resolution. It also stores patient demographic information and the measurement settings and calibration data for the measurements carried out by the MMS and any connected extensions. This data can be uploaded to an IntelliVue patient monitor, if your monitor is configured to do so and if at least five minutes of trend information is stored in the MMS.

Your monitor's data upload settings are defined in Configuration Mode to suit your patient transfer use model.

How data is uploaded to the host monitor depends on the configuration mode settings **MMS Trend Upload** and **MMS Settings Upload**.

If there is a patient conflict and you select Continue Monitor, no data will be uploaded from the MMS.

Data Exchange Between Information Centers

You can transfer demographic data and trend data from one IIC to another by selecting **Transfer** on the patient monitor. Trend data is not shared between Information Centers and monitors.

Resolving Patient Information Mismatch

When you connect an MMS to a monitor, or a monitor to the network, the monitor compares patient category, paced status, and a unique patient identification number that is internally stored in both the MMS and the monitor. The monitor indicates a mismatch if the information is not identical.

Depending on your monitor's configuration, this mismatch may be automatically resolved or you may have to resolve it manually. If your monitor is configured to resolve mismatches automatically, depending on the configuration, either the monitor or the Multi-Measurement Server data is automatically retained.

WARNING USA only When a monitor is connected to an Information Center by the wireless IntelliVue Instrument Telemetry interface, the patient data will automatically be merged in the case of a transfer. This means there is no patient discharge at the monitor and settings and trend data will be retained. You will see a message on the monitor and the Patient Demographics window will automatically appear so that you can check the data and change it if necessary.

Manually Resolving Patient Mismatch

The patient mismatch is indicated by question marks (???) beside the questionable fields in the Monitor Info Line and in the **Patient Demographics** window. The monitor displays a message such as **Different patients in Central and Monitor**. The **Patient Selection** window automatically opens so you can decide which patient data to use. You do not have to resolve the mismatch immediately, however, the indicators remain until you do. There can be up to three columns of data in the **Patient Selection** window if the patient is different in the Information Center, monitor, and MMS.

After you resolve the mismatch, the monitor displays a confirmation window that explains the consequences of your choice, telling you where the patient will be continued/discontinued. Confirm your choice. The monitor automatically displays the **Patient Demographics** window after confirmation. Verify that the settings shown are correct for the patient.

Gender, date of birth, height, weight, and nursing notes do not generate a mismatch. If these fields are different on different devices, the monitor resolves them itself. For example, it may take date of birth from the Information Center, whilst taking gender from the MMS. Always check the Patient Demographics after combining patients, to ensure that you are satisfied with the results. Change them if necessary.

WARNING After resolving a patient mismatch, check that the monitor settings (especially patient category, paced status and alarm limits) are correct for the patient.

Patient Mismatch - If One Set of Patient Data is Correct

- ◆ If there is a mismatch between an Information Center and a monitor, choose the data set you want to continue using for this patient, either:

Continue Central: to continue with the patient demographics from the Information Center, discharge the patient in the monitor, and use the default monitor profile.

Continue Monitor: to continue with the patient in the monitor and discharge the patient in the Information Center, permanently deleting all data in the Information Center.

Patient Selection		
	Central	Monitor
Last name	DOE	MILLER
First name	JOHN	
MRN	1234HG9556	
Patient Cat	Adult	Neo
Paced	No	Yes

Continue Central	Continue Monitor	New Patient	Same Patient

- ◆ If there is a mismatch between a monitor and a measurement server, choose the data set you want to continue using for this patient, either:

Continue Monitor: to continue with the patient demographics, trend data, and settings in the monitor. This discharges the patient in the measurement server, and resets all MMS settings to the defaults currently active for the monitor.

Continue MMS: to upload the data - patient demographics, trend data (if configured), and measurement settings (if configured) - stored in the MMS to the monitor. This clears all data in the monitor, resets the monitor to the default Profile, and discharges the patient in the monitor.

Patient Selection		
	Monitor	MeasServ
Last name	MILLER	ADAMS
First name		PETER
MRN		
Patient Cat	Neo	Neo
Paced	Yes	No

Continue Monitor	Continue MMS	New Patient	Same Patient

Patient Mismatch - If Neither Patient Data Set is Correct

A patient mismatch where neither set of patient data is correct might occur if you connect a new MMS to a monitor in order to prepare for a new patient, before you actually start measuring.

- ◆ Select **New Patient** if you are sure that none of the information is correct. This discharges all patients, erases all data in both the monitor and MMS, resets all settings to the default Profile, and lets you admit a new patient.

Patient Mismatch - If Both Patient Data Sets Are Correct

A patient mismatch where both sets of patient data are correct might occur if you admit a new patient at the monitor (or Information Center) before the patient arrives at your unit and then connect the MMS that was used during the patient transport to the monitor.

- ◆ Select **Same Patient** if the patient information is different, but you are sure it is the same patient. This merges the demographics and updates them in the Information Center, monitor, and MMS, according to this table. Be aware that your monitor may be configured to merge trend data from the MMS and the monitor, and to upload measurement settings from the MMS to the monitor.

Patient Information	This information is taken from...
Patient name	the monitor, if the patient was admitted there. For centrally-admitted patients, this information is taken from the Information Center.
MRN	
Screen Notes	
Patient Category	the Multi-Measurement Server. if connected, otherwise the data is taken from the monitor.
Date of Birth	
Height	
Weight	
Gender	
Paced Status	Paced status is always set to Yes where there is a conflict in patient information.
Trend data	if there is newer trend data stored in the MMS, it is uploaded to the monitor.

Automatically Resolving Patient Mismatch

Your monitor can be configured to automatically resolve mismatches in one of two ways.

- continue using the patient in the MMS, and delete the old data in the monitor. This is suitable for transport monitors.
- continue with the patient in the monitor, and delete the data in the MMS.

Care Groups

If your monitor is connected to an Information Center, you can group bedside monitors into Care Groups. This lets you:

- view information on the monitor screen from another bed in the same or in a different Care Group.
- be notified of yellow or red alarm conditions at the other beds in the Care Group.
- see the alarm status of all the beds in the Care Group on each monitor screen.

There are two main types of Care Groups:

- standard care group (**Bed-based Care Group**) - up to 12 patients monitored by up to 4 Information Centers
- unit group (**Unit-based Care Group**) - for a complete unit with up to 64 patients monitored by up to 4 Information Centers

Monitors must be assigned to these Care Groups at the Information Center. There is a third care group which can be assigned locally at the bedside. This is the My Central care group which includes all beds (up to 16) from the Information Center your bed is connected to. This care group setting is typically used in facilities with only one Information center. The selection of beds is automatic and cannot be changed.

The functions available with Care Groups depend on the Information Center revision your monitors are connected to. See your Information Center Instructions for Use for further details.





Understanding the Care Group Overview Bar

The Care Group monitors' status is shown in symbol form in the Care Group overview bar. Flashing symbols indicate active alarms, symbols that are not flashing indicate alarms that have been acknowledged. Selecting a bed symbol calls up the **Other Patient** window for that bed.



The Care Group overview bar must be configured to display on the monitor Screen. If it is not visible on your monitor, select a Screen which has been configured to show the bar.

Care Group Symbols (four alternative display possibilities depending on space available)				
				No data from this bed
		Bed 8	Bed 8	The alarms are on but there are no currently active alarms at this monitor
	- ? -	Bed 5	- ? - Bed 5	The highest priority alarm at this monitor is an INOP condition
	**	Bed 14	** Bed 14	The highest priority alarm at this monitor is a yellow alarm
	***	Bed 9	*** Bed 9	The highest priority alarm at this monitor is a red alarm
		Bed 7	Bed 7	The alarms at this monitor are suspended
		Bed 11	Bed 11	The monitor is in standby mode
	DEMO	DEMO	DEMO	The monitor is in Demonstration mode
				The current monitor

Care Group Symbols (used in the Care Group overview bar and the My Care Group window)	
	This is a telemetry bed
	This bed is on a wireless network
	This bed is on a wired network
	This is a “paired” bed, with a bedside monitor and a telemetry transmitter assigned.

Viewing the My Care Group Window

This window shows the alarm status, bed name, and patient name for every bed in the Care Group.

The window for the Unit group (shown here) shows first the beds of the Information Center this bed is connected to. By selecting the Information Center name you can display a list of all Information Centers associated with the Unit group, and select another Information Center to view.

To enter the **My Care Group** window,

- ◆ select the **Other Patients** SmartKey, if configured, or
- ◆ in the **Main Setup** menu, select **My Care Group**.

Use the My Care Group pop-up keys to navigate through the Care Groups:

My Unit lets you view a list of all the Information Centers in your Care Unit. Select an Information Center to see a list of the monitors connected to it. Select any monitor to see the Other Patient window for that bed.

Other Units lets you view a list of all the Care Units in your Care Domain. Select any Care Unit to view a list of the Information Centers connected to it. Select an Information Center to see a list of the monitors connected to it. Select any monitor to see the Other Patient window for that bed.

Alarming Beds lets you view a list of all beds in your care group with an unacknowledged alarm. The beds are listed in order of alarm severity.



Viewing the Other Bed Window

The Other Bed window lets you view a subset of the waveform and numeric information from another bed on the same network. Waves and numeric information from another bed are delayed. If configured, Other Bed information is displayed in color, using the colors defined by the Information Center.

To open the Other Bed window,

- ◆ MP60/MP70/MP80/MP90: select the required bed label or patient name in the Care Group Overview Bar. If you are in a Unit Group with many beds, the My Care Group window may open for you to select the bed.

MP20/MP30/MP40/MP50: select any field in the monitor info line to enter the **Setup** menu, then select **My CareGroup** and select the required bed, or

- ◆ Select the **Other Patients** SmartKey, if configured, and select the required bed.

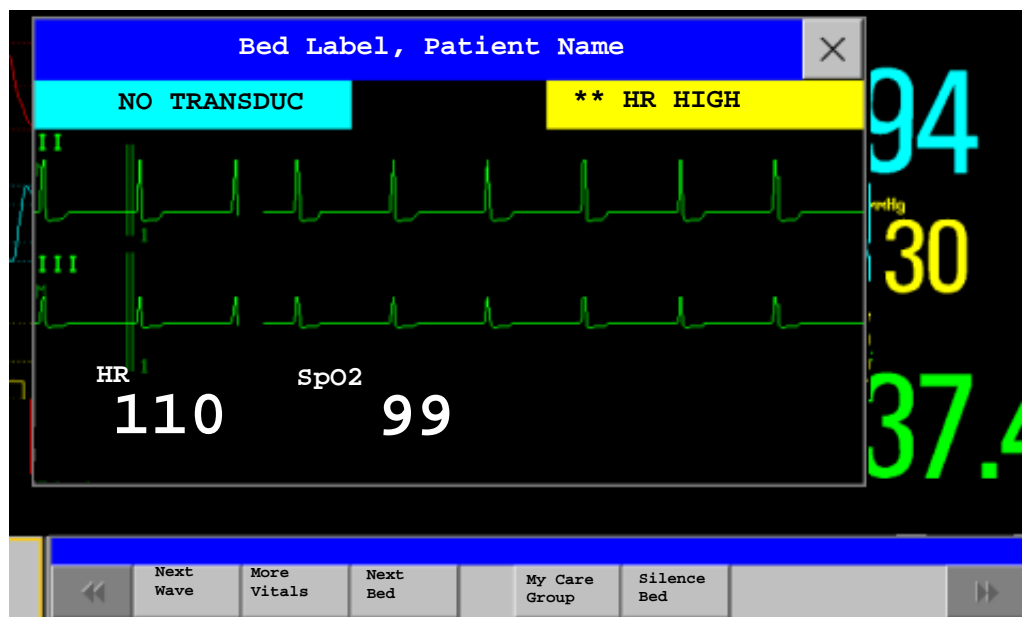

The Other Bed window may be configured to display embedded in a specially designed Screen.

- ◆ To display the embedded Other Bed screen element, in the Change Screen menu, select a Screen designed to show the Other Bed information permanently.

Note that a Screen with an embedded Other Bed screen element cannot be displayed on the D80 Intelligent Display.

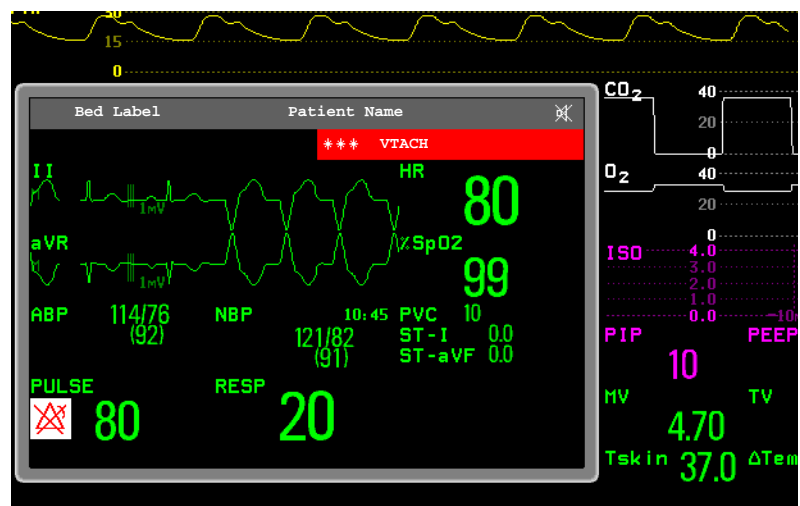

Note that changing the Screen may automatically change the bed shown in the other bed window. If you switch to a different Screen, you should check if the correct other bed is displayed.

Other Bed Pop-Up Keys

Select the **Other Patients** SmartKey or the Other Bed window or embedded screen element to access the associated pop-up keys:

- Next Wave** lets you view waveforms not currently shown in the other bed window.
- More Vitals** lets you view more numerics not currently shown in the other bed window.
- Next Bed** lets you view waveforms and numerics from the next available bed in the Care Group.
- My Care Group** lets you call up the Care Group window to select another bed.
- Alarming Beds** lets you view a list of all beds in your care group with an unacknowledged alarm. The beds are listed in order of alarm severity.
- Silence Bed** lets you silence active alarms at the other bed. (Whether you see this key depends on the revision and configuration of the Information Center your monitors are connected to.)

WARNING The **Silence Bed** pop-up key in the Other Bed window silences alarms at a remote bed. Be aware that accidental use of this key could silence alarms for the wrong patient.

To silence own bed alarms use the Silence permanent key on screen or the Silence hardkey.

Visual Alarm Status Information in the Other Bed Window

- If individual alarms are switched off at the other bed, this is indicated by the crossed alarm symbol beside the measurement numeric.
- If alarms are switched off at the other bed, the message **Alarms Off** is shown in the other bed window.
- In the embedded Other Bed window, the crossed speaker symbol in the upper right hand indicates that the volume of the audible alarm status change notification for the other beds in the care group is set to zero at the overview monitor.

Care Group Alarms

Changes in the alarm status of beds in a Care Group are announced visually and audibly at all other beds in the same Care Group. The visual and audible indicators used depend on the monitor and Information Center configuration.

When an alarm is detected at another bed in the Care Group,

- the alarm status is shown in the Care Group overview bar as an icon.
- a message informing you about the care group alarm is shown in the monitor status line.
- if configured, the Other Bed window, the Alarming Beds window or the My Care Group window may pop up on the Screen (if automatic alarm notification is enabled at the bedside monitor and at the Information Center). The automatic alarm notification is suppressed when a window, menu or pop-up keys are active.
- if configured, an audible status change notification is issued. The tone type and volume can be configured.

Automatic alarm notification can be switched off permanently in the monitor's Configuration Mode or at the Information Center. To temporarily disable and re-enable automatic alarm notification at the bedside monitor, for example if you want to carry out a procedure, in Monitoring Mode:

- 1 Select the network symbol on the monitor screen to call up the Network menu.
- 2 Select **Auto Window** to toggle between the settings **Enabled** and **Disabled**.

This setting resets to the default at discharge and when the monitor is switched on. Always re-enable the Auto Window as soon as possible.

Telemetry Data Overview

You can assign a monitor and a telemetry device to the same patient. This is called “pairing” and is done at the Information Center. In paired mode, the telemetry data can be displayed as a permanent overview session on the monitor. To do this, one of the available Screens must have the Telemetry Data Overview screen element embedded. If configured, this Screen will automatically display when the monitor is paired with a telemetry device at the Information Center. Be aware that the data from a paired telemetry device is stored at the Information Center and not in the monitor.

Unpairing a Telemetry Device

To disconnect the patient from the telemetry device and reconnect them to the monitor (for example, to see realtime waves),



- ◆ select the **Unpair Equipment** SmartKey to have the Information Center receive the ECG data from the monitor again. In this case data from the telemetry device will no longer be monitored at the Information Center. (Behavior depends on the revision of your Information Center.)

or

- ◆ use the Unpair function at the Information Center. In this case you can decide whether the Information Center will continue to monitor data from the telemetry device.

Telemetry Data Overview Screen Element

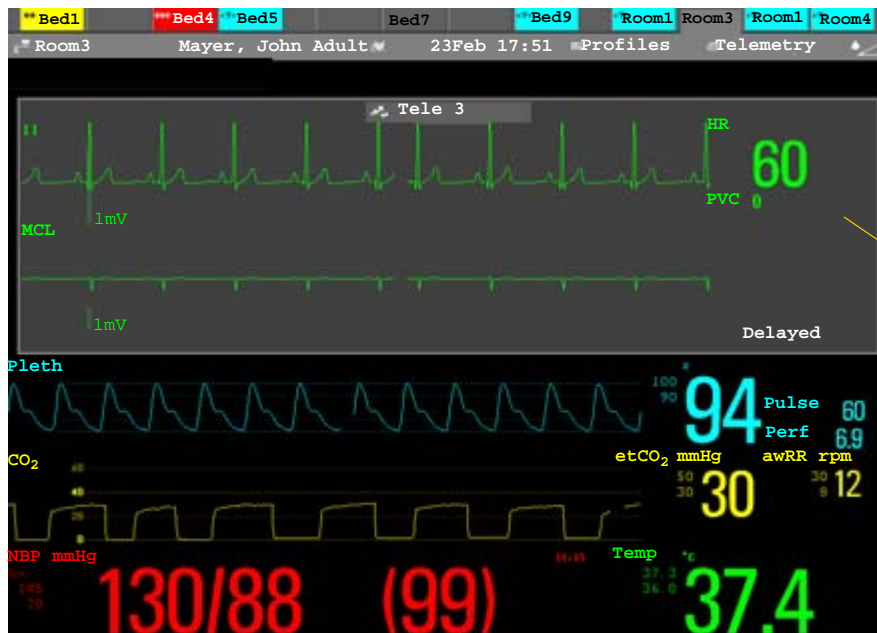

Telemetry data overview screen element

WARNING Waves and numeric information on the telemetry screen element are delayed for several seconds. If you need realtime data, for example for defibrillation, always use the monitor ECG instead of telemetry.

Silencing Telemetry Alarms from the Bedside

When a telemetry device is paired with the monitor, an audible status change notification is issued for new telemetry alarms. The volume can be configured.

If configured, alarms generated from a paired telemetry device can be silenced at the bedside.

To silence telemetry alarms from the bedside,

- 1 select the telemetry screen element
- 2 select the **Silence Bed** pop-up key

Depending on your configuration, the **Silence Bed** key may silence both telemetry alarms and bedside alarms.

Suspending Telemetry Alarms

When you select **Pause Alarms** or **Alarms Off** at the monitor, the alarms are off or paused for the bedside measurements.

Refer to the Information Center Instructions for Use for the Suspend/Pause alarms behavior of the Information Center and telemetry device.

Using Standby

When you select Standby mode at the monitor, the bedside goes into Standby mode.

Refer to the Information Center Instructions for Use for the Standby behavior of the Information Center and telemetry device.

ECG, Arrhythmia, and ST Monitoring

The electrocardiogram (ECG) measures the electrical activity of the heart and displays it on the monitor as a waveform and a numeric. This section also tells you about arrhythmia monitoring (see page 107) and ST monitoring (see page 117).

Skin Preparation for Electrode Placement

Good electrode-to-skin contact is important for a good ECG signal, as the skin is a poor conductor of electricity.

- 1 Select sites with intact skin, without impairment of any kind.
- 2 Clip or shave hair from sites as necessary.
- 3 Wash sites thoroughly with soap and water, leaving no soap residue.
We do not recommend using ether or pure alcohol, because this dries the skin and increases the resistance.
- 4 Dry skin thoroughly.
- 5 Gently abrade the skin using ECG skin preparation paper to remove dead skin cells to improve the conductivity of the electrode site.

Connecting ECG Cables

- 1 Attach the clips or snaps to the electrodes before placing them. If you are not using pre-gelled electrodes, apply electrode gel to the electrodes before placement.
- 2 Place the electrodes on the patient according to the lead placement you have chosen.

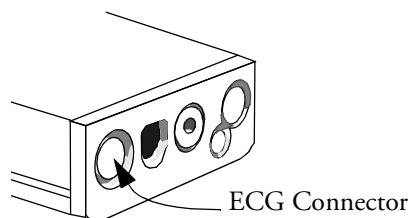

- 3 Attach the electrode cable to the patient cable.
- 4 Plug the patient cable into the white ECG connector on the measurement server. An ECG waveform and numeric appears on the monitor display.

CAUTION To protect the monitor from damage during defibrillation, for accurate ECG information and to protect against noise and other interference, use only ECG electrodes and cables specified by Philips.

Selecting the Primary and Secondary ECG Leads

The monitor uses the primary and secondary lead to compute HR and to analyze and detect cardiac arrhythmias. They are also available for recordings and for display on the Information Center.

The secondary lead setting is used only if your monitor is configured for multi-lead (instead of single-lead) arrhythmia analysis. It determines which additional lead will be used for arrhythmia analysis.



You should choose a lead as primary or secondary lead that has the following characteristics:

- the QRS should be either completely above or below the baseline and it should not be biphasic
- the QRS should be tall and narrow
- the P-waves and T-waves should be less than 0.2 mV

To select a lead as primary or secondary lead:

- ♦ In the **Setup ECG** menu, select **Primary Lead** or **Secondary Lead**, then select the appropriate lead. You can assign any available lead whether it is currently displayed or not.

Checking Paced Status

It is important to set the paced status correctly when you start monitoring ECG.

- ♦ To change the paced status in the **Setup ECG** menu, select **Paced**, then select **Yes** or **No**.

WARNING Pace pulse rejection must be switched on for paced patients by setting “Paced” to Yes. Switching pace pulse rejection off for paced patients may result in pace pulses being counted as regular QRS complexes, which could prevent an asystole alarm from being detected. When changing profiles, and at admission/discharge, always check that paced status is correct for the patient.

Some pace pulses can be difficult to reject. When this happens, the pulses are counted as a QRS complex, and could result in an incorrect HR and failure to detect cardiac arrest or some arrhythmias. Keep pacemaker patients under close observation.

Understanding the ECG Display

Your display may be configured to look slightly different.

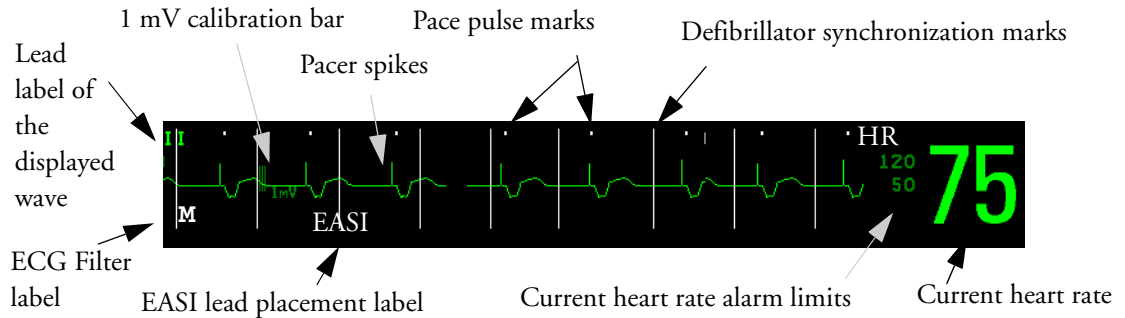

ECG numeric: This is derived from the monitored ECG.

Pace pulse markers: These are shown if the **Paced** status has been set to **Yes** and the patient has a paced signal.

Defibrillator synchronization marks: If an HP/Agilent/Philips defibrillator is connected, the synchronization marks (vertical lines on the ECG wave) are shown on the ECG wave.

ST numerics in ECG wave: ST numerics can be configured to show underneath the ECG wave on the bottom left.

Monitoring Paced Patients

An ECG optimized for monitoring a paced patient should look like this:

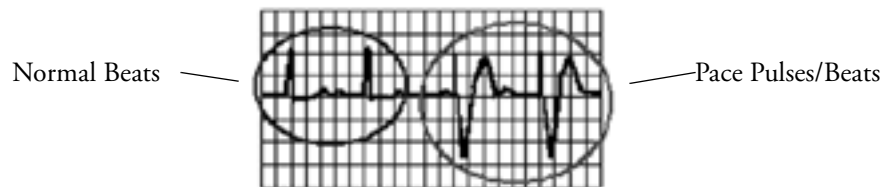

You should choose a lead as primary or secondary lead that has these characteristics:

- the normal QRS should be either completely above or below the baseline and it should not be biphasic. For paced patients, the QRS complexes should be at least twice the height of pace pulses.
- the QRS should be tall and narrow
- the P-waves and the T-waves should be less than 0.2 mV.

Setting the Paced Status (Pace Pulse Rejection)

- ◆ In the **Setup ECG** menu, select **Paced** to toggle between **Yes** and **No**.
You can also change the paced status in the Patient Demographics window.

When **Paced** is set to **Yes**:

- Pace Pulse Rejection is switched on. This means that pacemaker pulses are not counted as extra QRS complexes.
- pace pulse marks are shown on the ECG wave as a small dash
- the paced symbol is displayed on the main screen.

When **Paced** is set to **No**, pacer spikes are not shown in the ECG wave. Be aware that switching pace pulse rejection off for paced patients may result in pace pulses being counted as regular QRS complexes, which could prevent an asystole alarm from being detected.

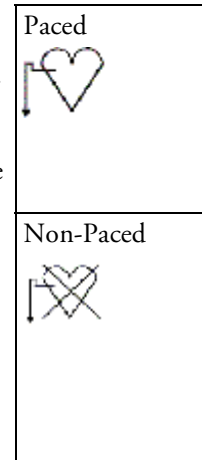

Avoiding Pace Pulse Repolarization Tails

Some unipolar pacemakers display pace pulses with repolarization tails. These tails may be counted as QRSs in the event of cardiac arrest or other arrhythmias.

If you note a visible repolarization tail, choose a lead that decreases the size of the repolarization tail.

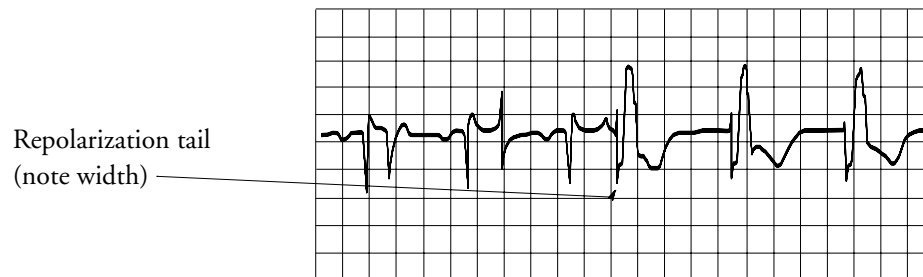

Changing the Size of the ECG Wave

If any of the displayed ECG waves is too small or clipped, you can change the size of one or all of the ECG waves on the screen.

Changing the adjustment factor only changes the visual appearance of the ECG wave on the screen. It does not affect the ECG signal analyzed by the monitor.

Comparing the wave size to the 1 mV calibration bar on the ECG wave segment can help you to get an idea of the true ECG signal strength. If you choose a fixed adjustment factor, the 1 mV calibration bar will be the same size for all the displayed ECG waves. If you choose **AutoSize**, the calibration bar may be a different size for each wave.

To Change the Size of an Individual ECG Wave

- 1 Select the wave segment you want to change. This calls up the lead menu for this segment.
- 2 In the lead menu, select **Size Up** to increase wave size or **Size Down** to decrease the size.
Selecting **AutoSize** lets the monitor choose the optimal adjustment factor for all displayed ECG waves.

To Change the Size of all the ECG Waves

To change the size of all the ECG waves on the screen by a fixed adjustment factor,

- 1 In the **Setup ECG Lead** menu, select **Adjust Size**.
- 2 Select the required adjustment factor from the line of pop-up keys.
 - **Size x0.5** to halve the wave size
 - **Size x1** to display the wave without zoom
 - **Size x2** to double the wave size
 - **Size x4:** to multiply the wave size by four
 - **Previous Size:** to return one step to the previous size
 - **Auto Size:** to let the monitor choose the optimal adjustment factor for all the ECG waves.

Changing the Volume of the QRS Tone

The QRS tone is derived from either the HR or Pulse, depending on which is currently selected as the alarm source. The QRS volume can be set from 0 to 10 (0 means off).

- ♦ To change the QRS volume, in the **Setup ECG** menu select **QRS Volume** and then select the appropriate volume from the pop-up list.

Changing the ECG Filter Settings

The ECG filter setting defines how ECG waves are smoothed. A letter indicating the filter type is shown underneath the lead label on the monitor display. Filter settings do not affect ST measurement. 12-Lead ECG captures are analyzed in the PIC using the diagnostic filter and displayed on the Information Center using the filter setting from the bedside monitor. Any changes you make to the filter setting at the bedside monitor may take up to a minute to be reflected at a connected Information Center. For this reason, you should wait one minute between changing the filter setting and sending a 12-lead capture to an Information Center.

- ♦ To change the filter setting, in the **Setup ECG** menu, select **Filter** and then select the appropriate setting.
 - **Monitor:** Use under normal measurement conditions.
 - **Filter:** The filter reduces interference to the signal. It should be used if the signal is distorted by high frequency or low frequency interference. High frequency interference usually results in large amplitude spikes making the ECG signal look irregular. Low frequency interference usually leads to a wandering or rough baseline. In the operating room, the Filter reduces artifacts and interference from electrosurgical units. Under normal measurement conditions, selecting **Filter** may suppress the QRS complexes too much and thus interfere with the clinical evaluation of the ECG displayed on the monitor. This does not affect the ECG analysis performed by the monitor.

If **AutoFilter** is set to **On** in Configuration Mode, the filter setting will automatically be set to **Filter** if electromagnetic interference is detected.

- **Diag** (Diagnostic): Use when diagnostic quality is required. The unfiltered ECG wave is displayed so that changes such as R-wave notching or discrete elevation or depression of the ST segments are visible.

The setting **Diag** selects the highest available ECG bandwidth which is 0.05 to 150 Hz for the Adult and 0.5 to 150 Hz for the Pedi and Neo patient category. The term “diagnostic” relates only to the ECG bandwidth requirements for diagnostic electrocardiographic devices as outlined in the ANSI/AAMI standard EC11-1991.

Choosing EASI or Standard Lead Placement

If EASI™ monitoring is available on your monitor, you must enable either standard lead placement or EASI lead placement.

- ♦ In the **Setup ECG** menu, select **Lead Placement** and then **Standard** or **EASI**.

EASI is shown beside the 1mV calibration bar on the ECG wave on the display, and **EASI** is marked on any recorder strips and printouts.

See the section on EASI ECG Lead Placement for electrode placement diagrams.

About ECG Leads

To make it possible to compare measured ECG signals, the electrodes (or lead sets) are placed in standardized positions, forming so-called “leads.” To obtain ECG signals optimized for use in diagnosis and patient management in different care environments, different lead sets in varying lead placements can be used. You can use either standard lead placements or EASI lead placements with this monitor.

When placing electrodes, choose a flat, non-muscular site where the signal will not be interfered with by either movement or bones. Correct lead placement is always important for accurate diagnosis. Especially in the precordial leads, which are close to the heart, QRS morphology can be greatly altered if an electrode is moved away from its correct location.

ECG Leads Monitored

If you are using	these leads are available:	Resp is measured between electrodes:
a 3-electrode set	I, II, III	RA and LL
a 5-electrode set	I, II, III, aVR, aVL, aVF, V and MCL	RA and LL
a 10-electrode set	I, II, III, aVR, aVL, aVF, V1, V2, V3, V4, V5, V6	RA and LL
an EASI 5-electrode set	I, II, III, aVR, aVL, aVF, V1, V2, V3, V4, V5, V6	I and A

Changing Lead Sets

To change the ECG lead set,

- 1 Remove the electrodes and then replace them as required.
- 2 If the new lead set has more leads than the previous, the monitor automatically recognizes the new lead placement. If the new lead set has fewer leads, then you must select **New Lead Setup** in the **Setup ECG** menu. If you remove electrodes and do not select **New Lead Setup**, the monitor

will issue a Lead Off INOP message. Select **New Lead Setup** and the INOP message will disappear.

ECG Lead Fallback

If fallback is configured on and there is a leads off INOP in the primary lead (and in the secondary lead, if you are using multi-lead monitoring) for longer than 10 seconds, and if another lead is available, this available lead automatically becomes the primary lead. This is known as lead fallback. When the Leads Off condition is corrected, the leads are automatically switched back.

This setting can only be changed in Configuration Mode.

ECG Lead Placements

The labels and colors of the ECG electrodes differ according to the standards that apply for your hospital. The electrode placement illustrations in this chapter use the AAMI labels and colors.

Electrode labels			Electrode colors	
AAMI	EASI	IEC	AAMI	IEC
RA	I	R	White	Red
LA	S	L	Black	Yellow
LL	A	F	Red	Green
RL	N	N	Green	Black
V	E	C	Brown	White
V1		C1	Brown/Red	White/Red
V2		C2	Brown/Yellow	White/Yellow
V3		C3	Brown/Green	White/Green
V4		C4	Brown/Blue	White/Brown
V5		C5	Brown/Orange	White/Black
V6		C6	Brown/Violet	White/Violet

Standard 3-Lead Placement

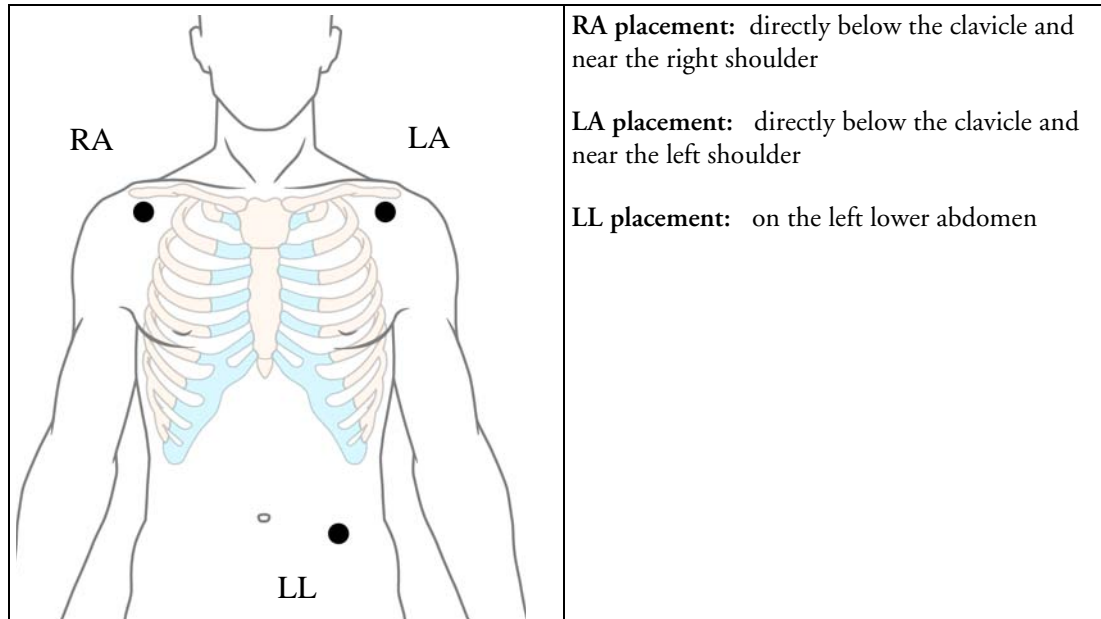

Standard 5-Lead Placement

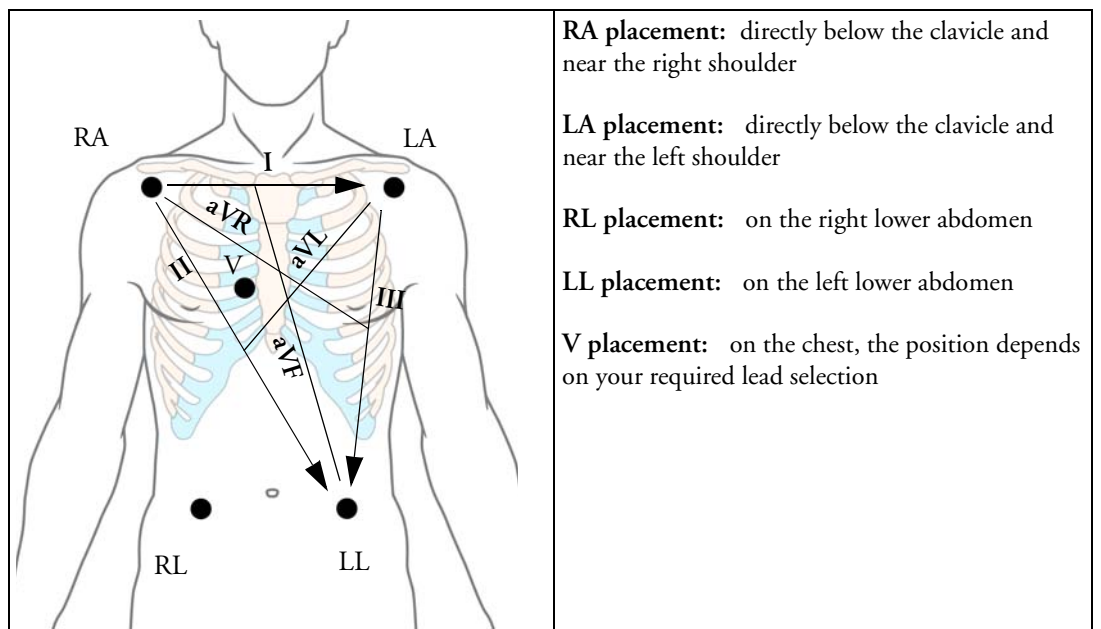

Chest Electrode Placement

For accurate chest electrode placement and measurement, it is important to locate the fourth intercostal space.

- 1 Locate the second intercostal space by first palpating the Angle of Lewis (the little bony protuberance where the body of the sternum joins the manubrium). This rise in the sternum is where the second rib is attached, and the space just below this is the second intercostal space.
- 2 Palpate and count down the chest until you locate the fourth intercostal space.

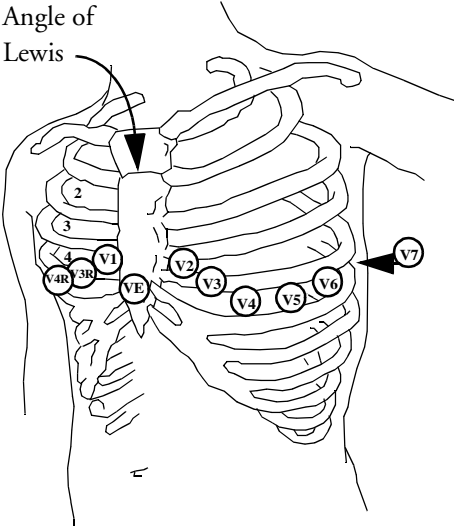
	<p>V1 placement: on the fourth intercostal space at the right sternal border</p> <p>V2 placement: on the fourth intercostal space at the left sternal border</p> <p>V3 placement: midway between the V2 and V4 electrode positions</p> <p>V4 placement: on the fifth intercostal space at the left midclavicular line</p> <p>V5 placement: on the left anterior axillary line, horizontal with the V4 electrode position</p>
<p>V6 placement: on the left midaxillary line, horizontal with the V4 electrode position</p> <p>V3R to V6R placement: on the right side of the chest in positions corresponding to those on the left</p> <p>VE placement: over the xiphoid process</p> <p>V7 placement: on posterior chest at the left posterior axillary line in the fifth intercostal space</p> <p>V7R placement: on posterior chest at the right posterior axillary line in the fifth intercostal space</p>	

10-Lead Placement

When monitoring 12-leads of ECG, using a 10-Electrode Lead Placement, it is important to correctly place electrodes and to label all 12-lead ECG reports with the correct lead placement.

Conventional 12-Lead ECG

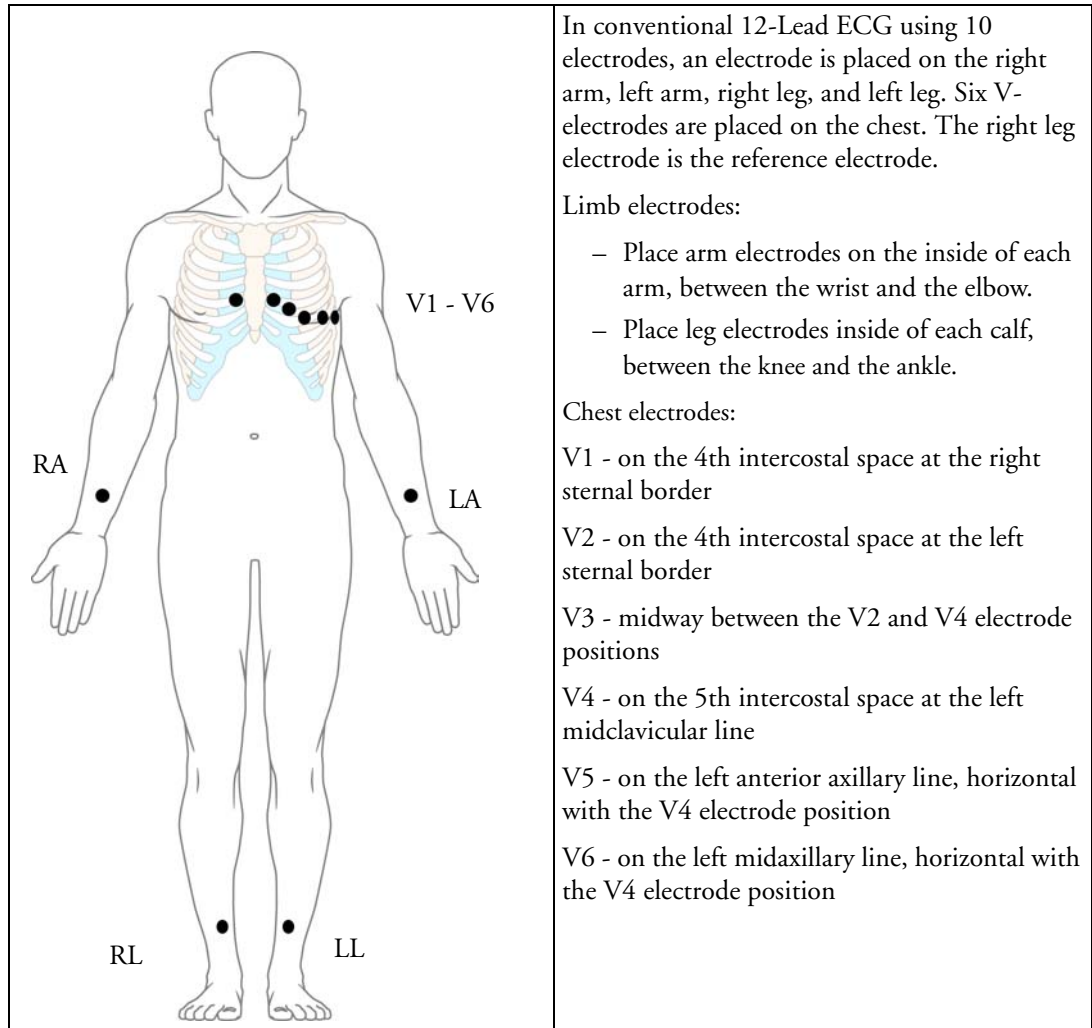

Modified 12-Lead ECG

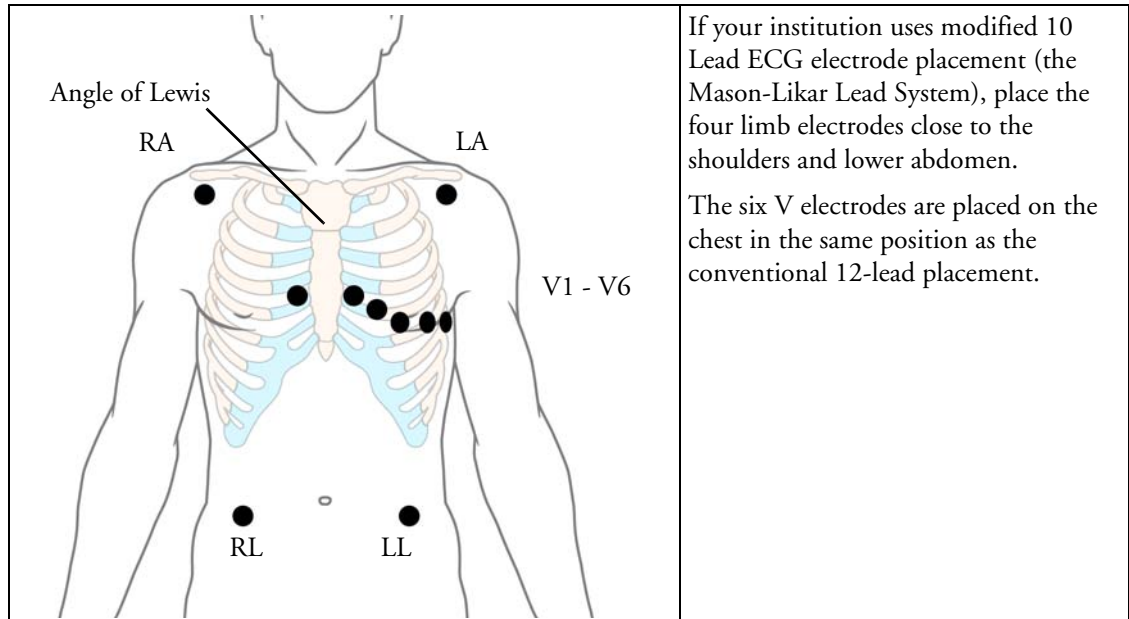

Choosing Standard or Modified Electrode Placement

If your institution uses modified 10 Lead ECG electrode placement (the Mason-Likar Lead System), you must switch **Mod. Lead Placement** to **On** in the monitor. To do this,

- ◆ in the **Setup ECG** menu, select **Mod. LeadPlacement** to toggle between **On** and **Off**.
 - When **Mod. Lead Placement** is set to **On**, 12 Lead ECG Reports will be labelled **12 Lead ECG Report (Mason-Likar)**, and captured 12-lead ECGs will be labelled **Mason-Likar** to the right of the bandwidth annotation at the Information Center.
 - When **Mod. LeadPlacement** is set to **Off**, 12 Lead ECG Reports will be labelled **12 Lead ECG Report**, and captured 12-lead ECGs will not be annotated at the Information Center.

WARNING Do not use ECG analysis interpretation statements and measurements for 12-lead ECGs obtained using the modified (Mason-Likar) limb electrode placement. This may lead to misdiagnosis since the modified (Mason-Likar) limb electrode placement does not look the same as the conventional 12-lead ECG and may mask inferior infarction due to calculated axis, R, P and T wave magnitudes shifts and ST slope.

Do not export 12-lead ECGs obtained using the modified (Mason-Likar) limb electrode placement. Captured 12-Lead ECGs using the modified (Mason-Likar) limb electrode placement exported from the Information Center are not annotated with the Mason-Likar label.

Labelling 12-Lead ECG Reports

To label 12-lead ECG monitor reports and Captured 12-lead ECGs reports:

- ◆ In the **Setup ECG** menu, select **Mod. LeadPlacement** to toggle between **On** and **Off**.

When **Mod LeadPlacement** is set to **On**:

- 12 Lead ECG Reports will be labelled **12 Lead ECG Report (Mason-Likar)**.
- Captured 12-lead ECGs will be labelled Mason-Likar to the right of the bandwidth annotation at the Information Center.

When **Mod. LeadPlacement** is set to **Off**,

- 12 Lead ECG Reports will be labelled **12 Lead ECG Report**.
- Captured 12-lead ECGs will have no annotation next to the bandwidth annotation at the Information Center.

Capture 12-Lead

If the monitor is connected to an Information Center via a wired network, the **Capture 12-Lead** SmartKey may be configured to show on the screen. Selecting this exports 12-Lead ECG information to the Information Center for analysis. For details see the Instructions for Use supplied with the Information Center.

EASI ECG Lead Placement

Using a standard 5-electrode set in EASI lead placement you can monitor up to 12 standard ECG leads simultaneously and continuously at the bedside. EASI provides a monitoring method for trending ST segment changes that can provide an early indication of ischemia. EASI-derived 12-lead ECGs and their measurements are approximations to conventional 12-lead ECGs. As the 12-lead ECG derived with EASI is not exactly identical to the 12-lead conventional ECG obtained from an electrocardiograph, it should not be used for diagnostic interpretations.

Respiratory monitoring is also possible with the EASI placement; respiration is measured between the I and A electrodes.

Place the electrodes as accurately as possible to obtain the best quality EASI measurements.

When EASI lead placement is selected, **EASI** is shown beside the 1mV calibration bar on the ECG wave on the display, and **EASI** is marked on any recorder strips and printouts.

EASI Monitoring During INOP Conditions If one of the derived EASI leads has an INOP condition (for example, **LEAD OFF**), a flat line is displayed. After 10 seconds, the directly acquired EASI AI, AS, or ES lead (depending on which is available) is displayed with the corresponding lead label. This causes an arrhythmia relearn.

EASI Electrode Placement		
1	E (V)	on the lower sternum at the level of the fifth intercostal space
2	A (LL)	on the left midaxillary line at the same level as the E electrode
3	S (LA)	on the upper sternum
4	I (RA)	on the right midaxillary line at the same level as the E electrode
5	N	reference electrode - can be anywhere, usually below the sixth rib on the right hip

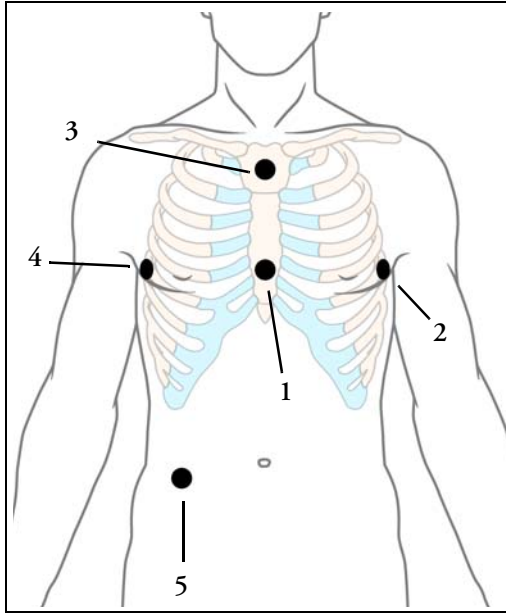

ECG, Arrhythmia, and ST Alarm Overview

The ECG, arrhythmia, and ST alarms available depend on which measurements are switched on, and the arrhythmia option enabled for your monitor.

- Cardiotach alarms are available when HR is on and the active alarm source is ECG
- Basic arrhythmia alarms are available when Arrhythmia is switched on
- Advanced arrhythmia alarms are available when Arrhythmia is switched on and the Advanced Arrhythmia option has been enabled for your monitor
- ST alarms are available when ST analysis is switched on and ST leads are selected for analysis.

Cardiotach Alarms	Alarms with Basic Arrhythmia Option	Alarms with Enhanced Arrhythmia Option	ST Alarms
***Asystole ***Ventricular Fibrillation/Tachycardia ***Extreme Bradycardia ***Extreme Tachycardia **High heart rate **Low heart rate	***Ventricular Tachycardia **Pacer Not Capture **Pacer Not Pacing **Frequent PVCs (PVC > limit/min)	**Supraventricular Tach **Missed Beat **Pause **Irregular HR **Ventricular Rhythm **Run PVCs High **Pair PVCs **R-on-T PVCs **Ventricular bigeminy **Ventricular trigeminy **Nonsustained V-Tach **Multiform PVCs	**ST <Lead> High **ST <Lead> Low

Using ECG Alarms

ECG alarms can be switched on and off and the high and low alarm limits changed just like other measurement alarms, as described in the Alarms section. Special alarm features which apply only to ECG are described here.

Extreme Alarm Limits

The extreme rate alarms, Extreme Tachy and Extreme Brady, generated by the active alarm source, either HR or Pulse, are set in Configuration Mode by adding a set value to the high and low alarm limits. You need to know what value has been configured for your monitor. Changing the high and low alarm limits automatically changes the extreme alarm limits within the allowed range.

- ◆ To see the extreme rate alarms set for your monitor, in the **Setup ECG** menu, see the menu items **ΔExtrTachy** and **ΔExtrBrady**.

ECG Alarms Off Disabled

Be aware that your hospital department may have decided to disable the setting ECG Alarms Off in the monitor's Configuration Mode. In this case, HR alarms cannot be switched off in Monitoring Mode. If you try to switch off the HR alarms, you will see the message **To activate enter Config and enable Alarms Off**.

HR Alarms When Arrhythmia Analysis is Switched Off

When arrhythmia analysis is switched off, only these HR-related alarms will be detected:

- the asystole alarm
- the ventricular fibrillation/ventricular tachycardia alarm
- the extreme tachycardia/extreme bradycardia alarms
- the high heart rate/low heart rate alarms.

HR Alarms When Arrhythmia Analysis is Switched On

WARNING When arrhythmia analysis is on, all yellow alarms connected with ECG are short (one-star). This means that the yellow alarm lamp and the tones are active for a configured number of seconds only, after which the flashing numeric and the alarm message remain for up to three minutes. Alarm reminders are not provided for yellow arrhythmia alarms. Red alarms behave as usual.

ECG Safety Information

CAUTION Interference from instruments near the patient and ESU interference can cause problems with the ECG wave. See the monitor specifications for more information.

-
- WARNING Defibrillation and Electrosurgery:** Do not touch the patient, or table, or instruments, during defibrillation.
After defibrillation, the screen display recovers within 10 seconds if the correct electrodes are used and applied in accordance with the manufacturers instructions.
According to AAMI specifications the peak of the synchronized defibrillator discharge should be delivered within 60 ms of the peak of the R wave. The signal at the ECG output on the IntelliVue patient monitors is delayed by a maximum of 30 ms. Your biomedical engineer should verify that your ECG/Defibrillator combination does not exceed the recommended maximum delay of 60 ms.
When using electrosurgical (ES) equipment, never place ECG electrodes near to the grounding plate of the ES device, as this can cause a lot of interference on the ECG signal.
- General:** When you are connecting the electrodes or the patient cable, make sure that the connectors never come into contact with other conductive parts, or with earth. In particular, make sure that all of the ECG electrodes are attached to the patient, to prevent them from contacting conductive parts or earth.
- During surgery:** Use the appropriate orange electrode ECG safety cable for measuring ECG in the operating room. These cables have extra circuitry to protect the patient from burns during cautery, and they decrease electrical interference. These cables cannot be used for measuring respiration.
- Pacemaker failure:** During complete heart block or pacemaker failure to pace/capture, tall P-waves (greater than 1/5 of the average R-wave height) may be erroneously counted by the monitor, resulting in missed detection of cardiac arrest.
- Patients exhibiting intrinsic rhythm:** When monitoring paced patients who exhibit only intrinsic rhythm, the monitor may erroneously count pace pulses as QRS complexes when the algorithm first encounters them, resulting in missed detection of cardiac arrest.
The risk of missing cardiac arrest may be reduced by monitoring these patients with low heart rate limit at or slightly above the basic/demand pacemaker rate. A low heart rate alarm alerts you when the patient's heart rate drops to a level where pacing is needed. Proper detection and classification of the paced rhythm can then be determined.
- Filtered ECG signal from external instruments:** Instruments such as defibrillators or telemetry units produce a filtered ECG signal. When this signal is used as an input to the bedside monitor, it is filtered again. If this twice-filtered signal is passed to the arrhythmia algorithm, it may cause the algorithm to fail to detect pace pulses, pacemaker non-capture, or asystole, thus compromising paced patient monitoring performance.
- External pacing electrodes:** When a pacemaker with external pacing electrodes is being used on a patient, arrhythmia monitoring is severely compromised due to the high energy level in the pacer pulse. This may result in the arrhythmia algorithm's failure to detect pacemaker noncapture or asystole.
- Fusion beat pacemakers:** Pacemakers that create fusion beats (pace pulse on top of the QRS complex) cannot be detected by the monitor's QRS detector.
- Rate adaptive pacemakers:** Implanted pacemakers which can adapt to the Minute Volume may occasionally react on the Impedance measurement used by patient monitors for the determination of the Resp value and execute pacing with the maximum programmed rate. Switching off the Resp measurement can prevent this.
-

About Arrhythmia Monitoring

Arrhythmia analysis provides information on your patient's condition, including heart rate, PVC rate, rhythm, and ectopics. The monitor uses the user-selected primary and secondary ECG leads for single-lead or multi-lead arrhythmia analysis. During arrhythmia analysis, the monitor continuously

- optimizes ECG signal quality. This is important for arrhythmia analysis. The monitor continuously filters the ECG signal to remove baseline wander, muscle artifact, and signal irregularities. Also, if the Patient Paced status is set to Yes, pace pulses are filtered out to avoid processing them as QRS beats.
- detects beats, for example, QRS complexes, identifying them for further analysis.
- measures signal features such as R-wave height, width, and timing.
- creates beat templates, and classifies and labels beats to aid in rhythm analysis and alarm detection.
- examines the ECG signal for ventricular fibrillation, asystole, and noise.

Arrhythmia Options

Your monitor has either the basic or the enhanced arrhythmia option. Both options provide rhythm and ectopic status messages and beat labelling. The number of rhythms being classified, events being detected, and alarms generated differs according to the option. The alarms available with the different options are listed in the section "ECG, Arrhythmia, and ST Alarm Overview" on page 104, the rhythm and ectopic messages detected are listed in "Arrhythmia Status Messages" on page 110.

Where Can I Find More Information?

See the Application Notes on ST and Arrhythmia supplied on your documentation CD-Rom for detailed information on the arrhythmia algorithm and its clinical application.

Switching Arrhythmia Analysis On and Off

- 1 In the **Setup Arrhythmia** menu, select **Arrhythmia** to toggle between **On** and **Off**.
- 2 Select the **Confirm** pop-up key which appears at the bottom of the screen.

Be aware that when arrhythmia analysis is switched off,

- the message **Arrhythmia OFF** appears beside the ECG wave, if configured to do so
- only the HR-related alarms are detected (the asystole alarm, the ventricular fibrillation/ventricular tachycardia alarm, the extreme tachycardia/extreme bradycardia alarms, the high heart rate/ low heart rate alarms)
- HR High and HR Low alarms behave like normal yellow alarms, no timeout periods are active.

Choosing an ECG Lead for Arrhythmia Monitoring

It is important to select a suitable lead for arrhythmia monitoring.

Guidelines for non-paced patients are:

- QRS should be tall and narrow (recommended amplitude > 0.5 mV)
- R-Wave should be above or below the baseline (but not bi-phasic)
- T-wave should be smaller than 1/3 R-wave height
- the P-wave should be smaller than 1/5 R-wave height.

For paced patients, in addition to the above, the pace pulse should be:

- not wider than the normal QRS
- the QRS complexes should be at least twice the height of pace pulses
- large enough to be detected, with no re-polarization.

To prevent detection of P-waves or baseline noises as QRS complexes, the minimum detection level for QRS complexes is set at 0.15 mV, according to AAMI-EC 13 specifications. Adjusting the ECG wave size on the monitor display (gain adjustment) does not affect the ECG signal which is used for arrhythmia analysis. If the ECG signal is too small, you may get false alarms for pause or asystole.

Aberrantly-Conducted Beats

As P-waves are not analyzed, it is difficult and sometimes impossible for the monitor to distinguish between an aberrantly-conducted supraventricular beat and a ventricular beat. If the aberrant beat resembles a ventricular beat, it is classified as ventricular. You should always select a lead where the aberrantly-conducted beats have an R-wave that is as narrow as possible to minimize incorrect calls. Ventricular beats should look different from these 'normal beats'. Instead of trying to select two leads with a narrow R-wave, it may be easier to just select one lead and use single lead arrhythmia monitoring. Extra vigilance is required by the clinician for this type of patient.

Atrial Fibrillation and Flutter

Since P-waves are not analyzed, it is not possible to discriminate atrial rhythms. If there is constant variance in the R-R interval, the rhythm is classified as Irregular. It is extremely important for accurate analysis of the rhythm to have p-waves with an amplitude of less than 1/5 the height of the R-wave or < 0.15 mV. If the p-waves are larger than this, they may be counted as QRS complexes.

Intermittent Bundle Branch Block

Bundle branch and the other fascicular blocks create a challenge for the arrhythmia algorithm. If the QRS during the block changes considerably from the learned normal, the blocked beat may be incorrectly classified as ventricular, causing false PVC alarms. You should always select a lead where the bundle branch block beats have an R-wave that is as narrow as possible to minimize incorrect calls. Ventricular beats should look different from these 'normal beats'. Instead of trying to select two leads with a narrow R-wave, it may be easier to just select one lead and use single lead arrhythmia monitoring. Extra vigilance is required by the clinician for this type of patient.

Understanding the Arrhythmia Display

Your monitor screen may look slightly different from the illustration.

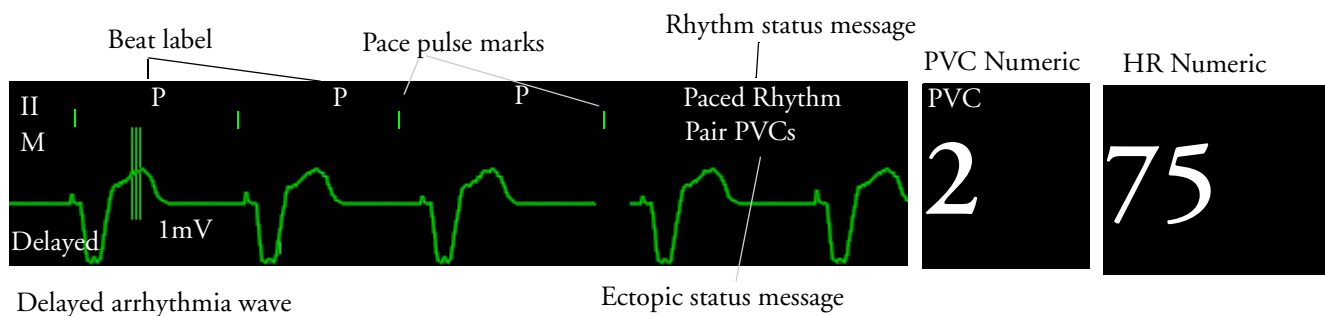

Viewing Arrhythmia Waves

- ◆ To review arrhythmia beat labels, in the **Setup Arrhythmia** menu, select **Annotate Arrhy.**
The wave showing the primary ECG lead will be delayed by six seconds and shown on a grey background. Beat labels will be annotated above the ECG wave and **Delayed** will be written beside it.
- ◆ To return to the normal ECG primary lead display, select **Annotate Arrhy** again.

Arrhythmia Beat Labels

Arrhythmia beat labels tell you how the monitor is classifying beats.

- N** = Normal
- V** = Ventricular Ectopic
- S** = Supra-ventricular Premature
- P** = Paced
- '** = Pacer spike
- L** = Learning patient's ECG
- A** = Artifact (noisy episode)
- ?** = Insufficient information to classify beats
- I** = Inoperative condition (e.g., LEADS OFF)
- M** = Pause or missed beat

Arrhythmia Status Messages

The monitor displays two types of status messages:

- Rhythm Status Messages -- to indicate the patient's rhythm.
- Ectopic Status Messages -- to indicate the presence of ectopic beats.

These status messages are shown on the right hand side of the primary ECG wave. They are updated every second, with the exception of the Sinus and Supraventricular (SV) rhythm messages.

The Sinus and SV rhythm messages are updated based on the current heart rate, taking into account the patient category (adult, pediatric, or neonatal). For the message to change from one rhythm status to another, the HR must be in the new range for five beats.

If you have basic arrhythmia capability, you will get only messages for the alarms provided with this level.

Rhythm Status Messages

The label B or E indicates basic (B) or enhanced (E) arrhythmia capability.

Rhythm Status Message	Description	B or E
ASYSTOLE	No QRS for 4 consecutive seconds in absence of vent fib or chaotic signal	B, E
VENT FIB/TACH	A fibrillatory wave for 4 consecutive seconds	B, E
V-TACH	A dominant rhythm of adjacent Vs and a HR > the V-Tach Heart Rate Limit	B, E
SUST V-TACH	Ventricular tachycardia rhythm for more than 15 seconds	E
VENT RHYTHM	A dominant rhythm of adjacent PVCs and a HR ≤ the V-Tach HR Limit	E
VENT BIGEMINY	A dominant rhythm of N, V, N, V	E
VENT TRIGEMINY	A dominant rhythm of N, N, V, N, N, V	E
PACED RHYTHM	A dominant rhythm of paced beats	B, E
IRREGULAR HR	Consistently irregular rhythm	E
SINUS BRADY SINUS RHYTHM SINUS TACHY	A dominant rhythm of SV beats preceded by P-waves	B, E
SV BRADY SV RHYTHM SV TACHY	A dominant rhythm of SV beats not preceded by P-waves	B, E
UNKNOWN ECG RHYTHM	Rhythm cannot be determined	B, E
LEARNING ECG	Algorithm is learning the ECG beat morphology	B, E
LEARNING RHYTHM	Algorithm is learning the rhythm of the classified beats	B, E
CANNOT ANALYZE ECG	ECG signal is predominantly invalid and therefore cannot be analyzed	B, E

Ectopic Status Messages

The label B or E indicates basic (B) or enhanced (E) arrhythmia capability.

Ectopic Status Message	Explanation	B or E
(No message displayed)	No ectopic activity within the last minute	
RUN PVCs	More than 2 consecutive PVCs within the last minute	E
PAIR PVCs	Pair PVCs within the last minute	E
PACER NOT CAPT	Pause with pace pulse (paced patient only) within the last minute	B, E
PACER NOT PACE	Pause without pace pulse (paced patient only) within the last minute	B, E
PAUSE	No beat detected for 1.75 x average R-R interval for HR <120, or No beat for 1 second with HR >120 (non-paced patient only), or No beat detected for more than the set pause threshold.	E
R-ON-T PVCs	R-ON-T detected within the last minute	E
MULTIFORM PVCs	Multiform PVCs detected within the last minute	E
FREQUENT SVPBs	SVPB count within last minute is greater than 5	E
SVPBs	1-5 SVPBs in the last minute with a sinus rhythm and no Vs	E
SV BEATS	SV count within last minute and rhythm status is PACED	B, E
PACED BEATS	Paced beat count within last minute and rhythm status is NOT PACED	B, E

Arrhythmia Relearning

During a learning phase:

- Alarm timeout periods are cleared
- Stored arrhythmia templates are cleared
- Asystole, Vfib, and HR alarms (when there are enough beats to compute the HR) are active. No other alarms are active.

Initiating Arrhythmia Relearning Manually

- 1 To initiate relearning manually, in the **Setup Arrhythmia** menu, select **Relearn Arrhy.**
 - While the monitor is learning, the delayed arrhythmia wave displays the beat label **L** and the rhythm status message **LEARNING ECG.**
 - Next, the monitor determines the dominant rhythm. The beats are labeled **N**, and the rhythm status message changes to **LEARNING RHYTHM.**
- 2 After relearning is complete, you should check the delayed arrhythmia wave to ensure that the algorithm is labeling the beats correctly.
- 3 If beats are still not classified correctly, check that the ECG is optimized for arrhythmia monitoring. You may need to select a different lead or change the electrodes or electrode positions if there is excessive noise, unstable voltage, low amplitude, or large P- or T-waves.

Automatic Arrhythmia Relearn

Arrhythmia relearning is initiated automatically whenever:

- ECG monitoring is switched on
- The ECG Lead or Lead Label is changed manually, or when fallback occurs
- A **Leads Off** INOP condition (that has been active for > 60 seconds) ends.

If you are monitoring multi-lead arrhythmia and there is a change in one lead only, relearning happens only in the affected lead. During this learning phase, the system will continue monitoring using the other lead. Therefore, the delayed arrhythmia wave is not labeled **L** and there is no **LEARNING ECG** rhythm status message. In addition, alarm timeout periods are maintained, stored arrhythmia templates are maintained for the operative lead, and all alarms switched on are active.

Arrhythmia Relearn and Lead Fallback

Lead fallback triggers an automatic arrhythmia relearn.

WARNING If arrhythmia learning takes place during ventricular rhythm, the ectopics may be incorrectly learned as the normal QRS complex. This may result in missed detection of subsequent events of V-Tach and V-Fib.

For this reason you should:

- take care to initiate arrhythmia relearning only during periods of predominantly normal rhythm and when the ECG signal is relatively noise-free
 - be aware that arrhythmia relearning can happen automatically
 - respond to any INOP messages (for example, if you are prompted to reconnect electrodes)
 - be aware that a disconnected EASI electrode triggers an arrhythmia relearn on all leads
 - always ensure that the arrhythmia algorithm is labeling beats correctly.
-

Arrhythmia Alarms

Arrhythmia alarms can be switched on and off and the settings changed just like other measurement alarms, as described in the Alarms section. Special alarm features which apply only to arrhythmia are described here.

The different alarms detected and generated by the monitor depend on the level of arrhythmia analysis that is enabled. For a complete list of arrhythmia alarms and INOPs, see the Alarms chapter.

The monitor detects arrhythmia alarm conditions by comparing ECG data to a set of pre-defined criteria. An alarm can be triggered by a rate exceeding a threshold (for example, HR >xx), an abnormal rhythm (for example, Ventricular Bigeminy), or an ectopic event (for example, Pair PVCs).

Yellow Arrhythmia Alarms

Yellow arrhythmia alarms are short yellow alarms specific to arrhythmia-related patient conditions. Depending on your monitor and Information Center revision, they may be shown with one or two stars.

WARNING When arrhythmia analysis is on, all yellow alarms connected with ECG are short (one-star). This means that the yellow alarm lamp and the tones are active for a configured number of seconds only, after which the blinking numeric and the alarm message remain for up to three minutes. Red alarms behave as usual.

Arrhythmia Alarms and Latching

When using arrhythmia analysis, **Visual Latching** and **Audible Latching** should be on for red alarms, or at least **Visual Latching** should be on. Because of the transient nature of arrhythmia alarms, many arrhythmia conditions may go unnoticed if alarm latching is off. This setting can only be changed in Configuration Mode.

Switching Individual Arrhythmia Alarms On and Off

Some arrhythmia alarms can be individually switched on or off. They are:

Pacer not capture, Pacer not pace, Non-Sustain VT, Vent Rhythm, Run PVCs, Pair PVCs, R-on-T PVCs, V.Bigeminy, V.Trigeminy, Multif.PVCs, Pause, SVT, Irregular HR, Missed Beat, PVCs/min.

- ◆ To switch individual alarms on or off, in the **Setup Arrhythmia** menu, select the alarm from the list to toggle between **On** and **Off**. The monitor displays the INOP message SOME ECG ALRMS OFF.

Switching All Yellow Arrhythmia Alarms On or Off

All yellow arrhythmia alarms can be switched on and off together. To do this,

- ◆ In the **Setup Arrhythmia** menu, select **All Yellow Off** or **All Yellow On**.

Adjusting the Arrhythmia Alarm Limits

Some arrhythmia alarms have limits which can be individually adjusted. They are:

Vtach HR, Vtach Run, PVCs/min, Vent Rhythm, SVT HR, SVT Run, Asystole Thresh., Pause Threshold.

- 1 To adjust alarm limits, in the **Setup Arrhythmia** menu, select the alarm to be adjusted.
- 2 Select the appropriate setting from the pop-up list.

Arrhythmia Alarm Timeout Periods

Normally, an arrhythmia alarm is announced when an alarm condition is detected. However, there are certain situations that can inhibit the audible and visible indications of the alarm even though the alarm condition was detected. These include:

- if a more serious alarm condition is active in the same chain
- if a timeout period is in effect for a particular alarm
- if a timeout period is in effect for a higher alarm in that chain.

What is a Timeout Period?

Timeout periods are automatically started when a yellow arrhythmia alarm is detected. During this period, the same alarm condition will not generate another alarm. Alarm conditions further down the same arrhythmia alarm chain will also not generate an alarm, but alarms further up the chain will: see “Arrhythmia Alarm Chaining” on page 115).

This setting can only be changed in Configuration Mode.

- ◆ To view the timeout period configured for your monitor, in the **Setup Arrhythmia** menu, see the menu items **TimeOut 1st** and **TimeOut 2nd**.
- ◆ To reset the timeout period, select the **Alarms Off** or **Pause Alarms** permanent key and then reselect it.

Resetting the Timeout Period

Switching alarms off and then on again cancels all visual and audible indicators and resets the timeout periods.

Silencing an alarm cancels all visual and audible indicators, if the alarm condition is no longer present.

How are Yellow Arrhythmia Alarms Indicated?

When a yellow arrhythmia alarm is generated, it triggers visual and audible indicators.

Behavior of Unsilenced Arrhythmia Alarms

Yellow arrhythmia alarms are always set to latch visually for three minutes.

Yellow arrhythmia alarms that have not been silenced behave as explained in this table:

Alarm condition	Example	Configured time out period	Short yellow alarm tone sounds ...	Alarm message displayed ...
Single alarm instance	Non-sustained V-tach	All settings	when alarm condition is initially detected	for 3 minutes (latching time)
Continuous alarm condition	HR LOW	All settings		until the alarm condition stops, plus a maximum of 3 minutes latching time
Same intermittent alarm condition, occurring frequently (more than once per minute)	Pair of PVCs	2 minutes or less	each time the alarm condition is detected, provided that the timeout period has expired and the alarm message has cleared	
		3 minutes or more		

Behavior of Silenced Arrhythmia Alarms

If you silence a yellow arrhythmia alarm and the alarm condition still exists, the visual indicators continue until the condition stops. You will not get a realarm for the same condition or another condition lower down on the same chain until the alarm condition has stopped and reoccurred, and the timeout period has expired.

If you silence a yellow arrhythmia alarm and the alarm condition has stopped, the visual indicators are immediately cleared. Silencing an alarm does not reset its time out period, so you will not get a realarm for the same condition or lower on the chain until the time out expires.

Arrhythmia Alarm Chaining

When arrhythmia analysis is switched on, multiple alarm conditions may be present. Announcing all of the detected alarm conditions would be confusing, and might hide a more serious condition. For this reason, arrhythmia alarms are prioritized in three alarm “chains”: PVC Alarms; Beat Detection Alarms, and Rate Alarms.

Only the highest priority alarm condition in each chain is announced. Lower priority alarms in the same chain will not be announced while an alarm is active or during the configured timeout period. If alarm conditions of equal severity from different chains are detected, the alarm condition that occurred most recently is announced. The exception is Irregular HR, which only occurs if no other alarms are occurring.

See “ECG, Arrhythmia, and ST Alarm Overview” on page 104 for information on which alarms are included in the different arrhythmia options. See “Arrhythmia Alarm Timeout Periods” on page 113 for an explanation of how alarm timeouts work.

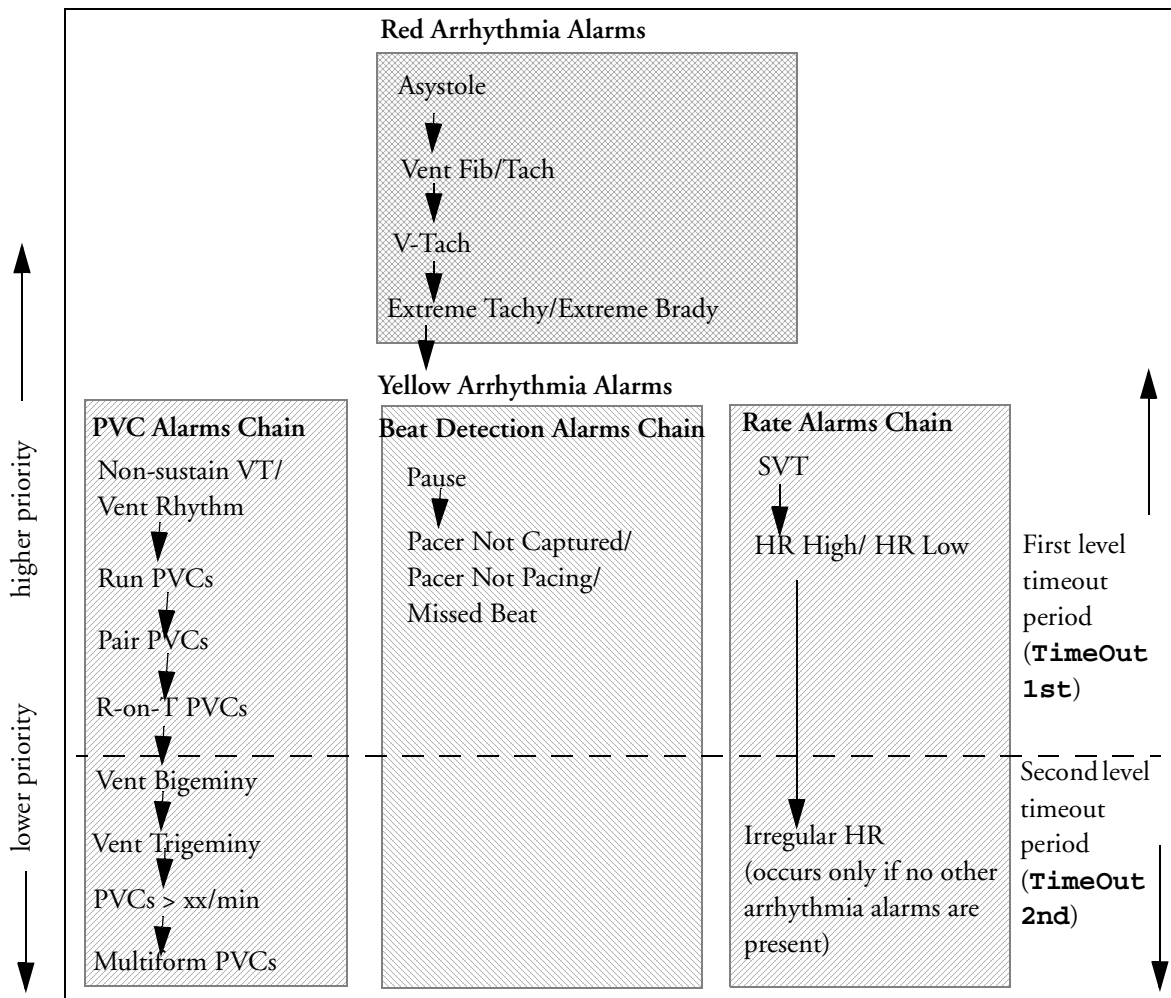

- If there is an active Vent Bigeminy alarm, a PVCs > xx/min will not be triggered because it is lower on the same chain. However, a high HR alarm will become active because it is on a different chain.
- Higher priority alarms supersede previous alarms. For example, if a Vent Trigeminy alarm is active and a Pair PVCs occurs, the Pair alarm will be activated.

Understanding PVC-Related Alarms

PVC-related alarms are detected on the basis of the current ventricular heart rate and the number of consecutive PVCs counted (referred to as PVC Runs). Changing one alarm limit automatically changes linked alarm limits.

Example: This diagram illustrates the conditions under which PVC alarms would be generated if the Vent Rhythm Run limit is set to 12, the V-Tach Run Limit is set to eight, and the V-Tach HR Limit is set to 100.

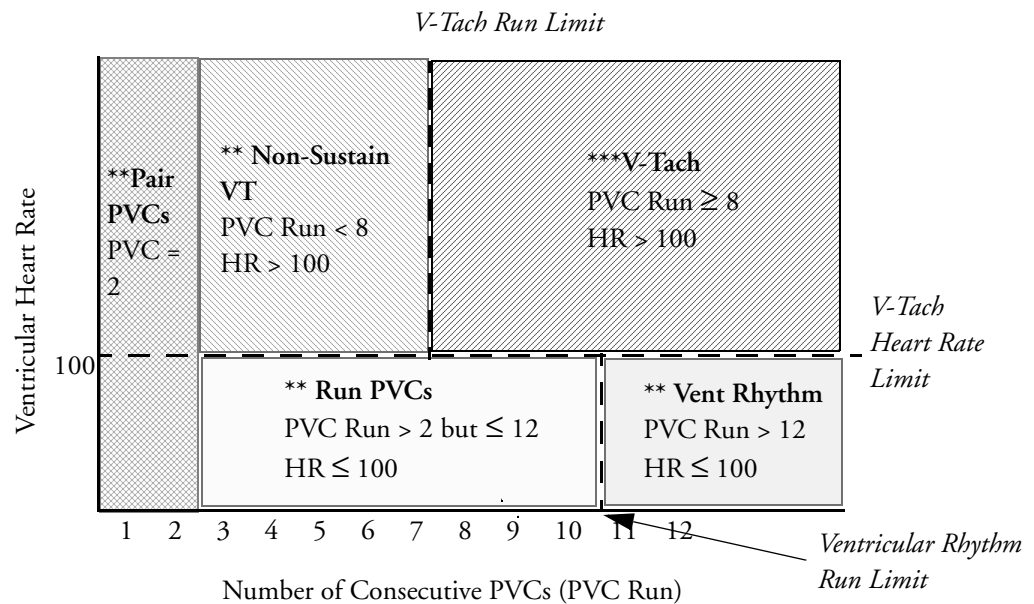

You will see that

- if both the V-Tach Heart Rate Limit and the V-Tach Run Limit are exceeded, a red V-Tach alarm is generated
- if the ventricular heart rate exceeds the V-Tach Heart Rate Limit but not the V-Tach Run Limit, a yellow Non-Sustain VT alarm is generated.

About ST Monitoring

The monitor performs ST segment analysis on normal and atrially paced beats and calculates ST segment elevations and depressions. This information can be displayed in the form of ST numerics and snippets on the monitor.

All available leads can be monitored continuously. The ECG waveform does not need to be displayed on the Screen for ST Segment analysis.

ST segment monitoring is intended for use with adult patients only and is not clinically validated for use with neonatal and pediatric patients. For this reason, the recommended - and default - setting for ST monitoring in neonatal and pediatric modes is **ST Analysis: Off**.

ST analysis is always performed using a dedicated filter which ensures diagnostic quality. If you are monitoring ECG using an ECG filter mode other than Diagnostic, the ST segment of the ECG wave may look different from the ST segment of the ST snippet for the same wave. For diagnostic evaluation of the ST segment, always switch to Diagnostic filter mode or use the ST snippet.

WARNING Some clinical conditions may make it difficult to achieve reliable ST monitoring, for example:

- if you are unable to get a lead that is not noisy
- if arrhythmias such as atrial fib/flutter are present, which may cause an irregular baseline
- if the patient is continuously ventricularly paced
- if the patient has left bundle branch block.

You should consider switching ST monitoring off if these conditions are present.

This monitor provides ST level change information; the clinical significance of the ST level change information should be determined by a physician.

Switching ST On and Off

- ♦ To switch all ST monitoring on or off, in the **Setup ST Analysis** menu, select **ST Analysis** to toggle between **On** and **Off**.

Selecting ST Leads for Analysis

- ♦ To switch ST monitoring for individual leads on or off, in the **Setup ST Analysis** menu, select **Setup ST Leads**. In the pop-up window, the leads in the left column under **Choices** are the leads you can choose from, and the leads in the right-hand column **Selected** are the leads chosen to be displayed. Select the ST leads on the left and use the arrow keys to move the leads from one list to the other, then select **Done** to apply the changes.

Understanding the ST Display

Your monitor screen may be configured to look slightly different from the illustrations.

ST Numerics Up to 12 ST numerics plus the ST index can be displayed on the monitor screen. They can be configured to show beside the measurement numerics, beside the ECG wave, or beside the ST snippet.

A positive ST value indicates ST segment elevation; a negative value indicates depression.

ST numerics are displayed in the order in which you select ST leads for analysis. If there is additional space in the field assigned to ST numerics, the monitor will display extra numerics in the order in which they appear in the **Setup ST Analysis -> Setup ST Leads -> Choices** list. Any ST leads switched on for analysis that do not fit in the assigned numerics field are shown in succession in place of the last ST numeric.

ST Index The ST index numeric (**STindx**) is the sum of the absolute values for the ST leads V2, V5, aVF. Because it is based on absolute values, it is always a positive number. If you haven't selected one of the leads V2, V5, and aVF for ST analysis, the STindx numeric will display a question mark "?".

- ◆ To switch the ST index numeric on or off for display, in the **Setup ST Analysis** menu, select **ST-Index** to toggle between **On** and **Off**.

ST Snippets ST snippets show a one second wave segment for each measured ST lead. The most recent snippet is drawn in the same color as the ECG wave, usually green, superimposed over the stored baseline snippet, drawn in a different color. The comparison shows any deviation in the measurement since the baseline snippet was stored, for example as a result of a procedure carried out on the patient.

The information is updated once per minute.

If you do not see ST snippets on the Screen, select the Screen name in the Monitor Info Line and select a Screen configured to show snippets from the pop-up list of available Screens.

ST Baseline Window The ST Baseline Window shows an ST snippet drawn on a grid. The current ST numeric and the ST numeric stored with the baseline are shown, as well as the difference between these two numerics.

A "?" in front of the difference numeric indicates that the ST measurement points were adjusted since the baseline snippet was stored.

The Baseline Window opens with the ST pop-up keys **Update Baseline, Record ST, Change ST Lead, Adjust ST Points, ST Map** and arrow keys for scrolling through the available leads.

- ◆ To view the **ST Baseline** window, select any snippet on the Screen.

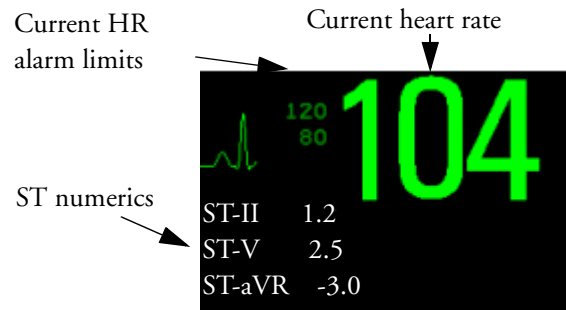

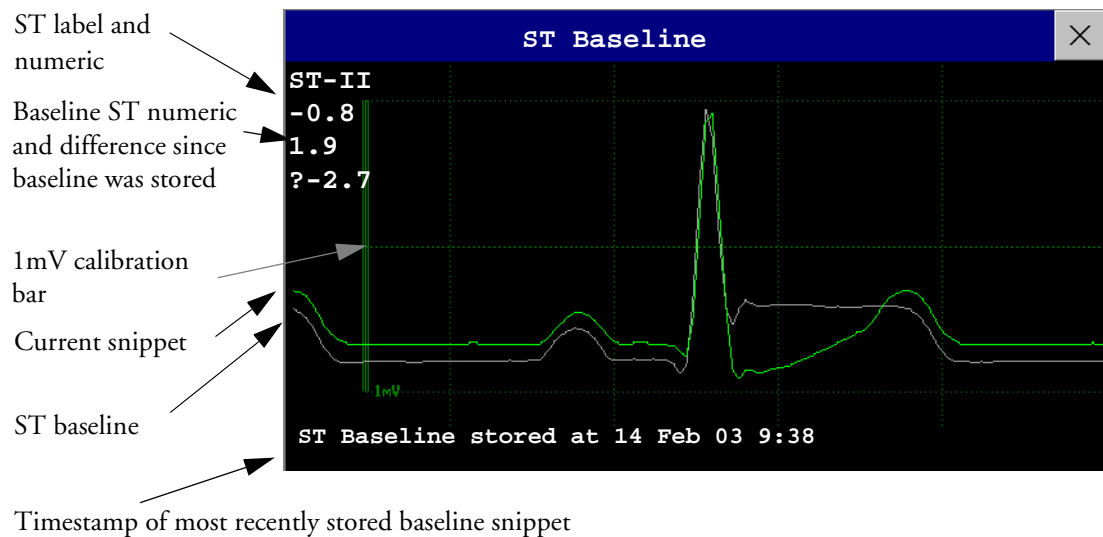

Updating ST Baseline Snippets

ST analysis requires valid samples to measure and store a snippet. ST Snippets and ST values are updated every minute. If there is artifact in the signal, it may take longer for an ST snippet and an ST value to appear.

The first baseline is stored automatically after ST monitoring is started, or when a new patient is admitted. To update ST baselines,

- 1 Select an ST snippet to open the **ST Baseline** window.
- 2 In the **ST Baseline** window, select **Update Baseline** to store all current snippets as baselines. This deletes all previously-stored baselines.

Recording ST Segments

- ◆ To record all currently available ST snippets and baselines, in the **ST Baseline** window, select the pop-up key **Record ST**.

About the ST Measurement Points

The ST value for each beat complex is the vertical difference between the ISO point and the ST point, as shown in the diagram below. The isoelectric (ISO) point provides the baseline, the ST point is at the midpoint of the ST segment. The J point is where the QRS complex changes its slope; as it is a fixed distance away from the ST point, it can be useful to help you position the ST point correctly.

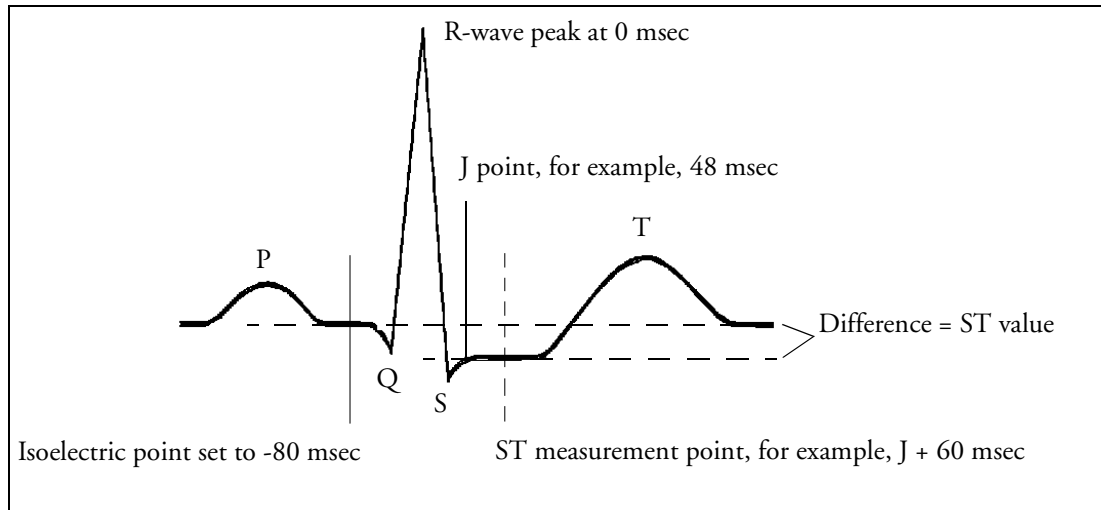

CAUTION The ST measurement points need to be adjusted when you start monitoring, and if the patient's heart rate or ECG morphology changes significantly, as this may affect the size of the QT interval and thus the placement of the ST point. Artifactual ST segment depression or elevation may occur if the isoelectric point or the ST point is incorrectly set.

Always ensure that ST measurement points are appropriate for your patient.

Adjusting ST Measurement Points

Depending on your monitor's configuration, the ST point can be positioned either

- relative to the J-point.
In the **Adjust ST Points** window, the pop-up keys ISO Point, J Point and ST Point are visible and can be adjusted.
or
- directly, by selecting a numeric value for the ST point.
In the **Adjust ST Points** window, you can adjust the ISO and ST point.

The **ST Uses** setting can only be changed in Configuration Mode.

To adjust the ST measurement points,

- 1 In the **Setup ST Analysis** menu, select **Adjust ST Points** to open the **Adjust ST Points** window. Alternatively, you can use the **Adjust ST Points** pop-up key in the **ST Baseline** window.
- 2 Select a suitable ECG lead for ST measurement, with a visible J-point and a visible P wave. Use the up and down arrow keys to scroll through the ST snippets for the other ECG leads.

- Use the **Select Point** pop-up key to scroll through the points and activate the point you need to adjust, then use the left and right arrow keys to move the measurement point. Each point is highlighted while active.

ST label and the ST numeric that would apply using the current points

1mV calibration bar

Cursors for adjusting ST points

Timestamp of most recent ST point adjustment

Highlighted ST point

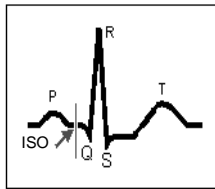
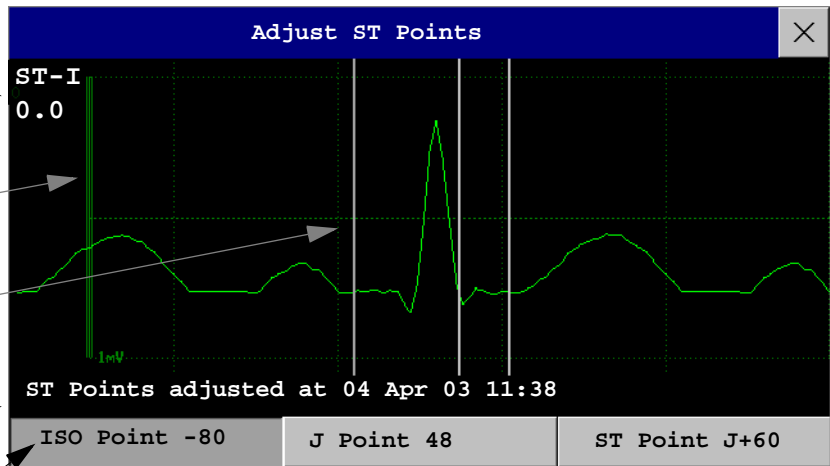

The ISO-point cursor positions the isoelectric point relative to the R-wave peak. The relation is shown beside the ISO-point in milliseconds. Position the ISO-point in the middle of the flattest part of the baseline (between the P and Q waves or in front of the P wave).

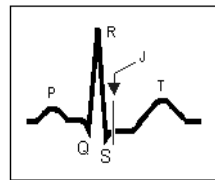

The J-point cursor positions the J-point relative to the R-wave peak. It helps you to correctly position the ST-point. Position the J-point at the end of the QRS complex and the beginning of the ST segment. The J-point cursor is not available if your monitor is configured to let you set the ST point directly.

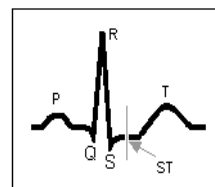

To position the ST-point relative to the J-point: select either **J + 60** or **J + 80**. Select **J Point** and use the arrow keys to move the J-Point and position the ST-point at the midpoint of the ST segment. To position the ST-point directly: select **ST Point** and use the left and right arrow keys to position the ST point at the midpoint of the ST segment.

- Select the **Apply Changes** pop-up key to activate the new ST measurement points and recalculate all ST values.

The most recent ST Points adjustment time is displayed in the **Adjust ST Points** window. This information is cleared when a patient is discharged or when a new Profile is loaded into the monitor.

- 5 To update the ST snippet shown in the **Adjust ST Points** window, select the **Update** pop-up key.

ST Alarms

ST alarms are yellow alarms. Each ST lead has its own alarm limit. ST alarms are triggered when an ST value exceeds its alarm limit for more than one minute. Switching ST alarms off switches off alarms for all ST leads.

If more than one ST measurement is in alarm, the monitor only displays the alarm message of the ST lead which is currently furthest from its set alarm limits.

Single- or Multi-lead ST Alarming

Be aware that if multi-lead ST alarming is switched on, only alarms involving more than one ST lead will be announced.

To choose individual or multi-lead ST alarming,

- ◆ In the **Setup ST Analysis** menu, select **ST Alarm Mode** and select either **Single ST** or **Multi ST**.

Changing ST Alarm Limits

The monitor can detect alarms on each ST lead separately, so you can set high and low ST alarm limits individually for each ST lead. You can also set separate alarm limits for single-lead and multi-lead ST monitoring. Set the high and low alarm limits based on your assessment of the patient's clinical condition, unit protocols, physician orders or medication specified limits. A good guideline is + 1.0 mm or - 1.0 mm from the patients's ST, or follow your hospital protocol.

- 1 In the **Setup ST Analysis** menu, select **ST Alarm Mode** and select **Single ST** or **Multi ST**.
- 2 Select the alarm to be adjusted.
- 3 Select the appropriate setting.

Viewing ST Maps

The monitor can derive a multi-axis portrait (map) from the ST analysis to help you detect changes in ST values. It displays two planes obtained from a multilead ECG in a multi-axis diagram, where each axis represents a lead. The ST value at the J point is given. The position of the axes within the diagram correspond to the placement of the ECG leads. Each ST value is assigned to either a limb lead, or to a chest lead. Every axis shows the polarity of the lead it represents. By joining adjacent ST values, the monitor obtains the ST map. The contour line, and the map shading, is shown in the same color as the ECG parameter.

Current View

In current view, the monitor displays an ST map that corresponds to the current ST values. Three or more leads per plane are necessary to display a map.

The left of the following diagram shows leads I, II, III, aVR, aVL, and aVF on the limb leads. On the right, the V-leads (V1, V2, V3, V4, V5, and V6) are on the chest leads.

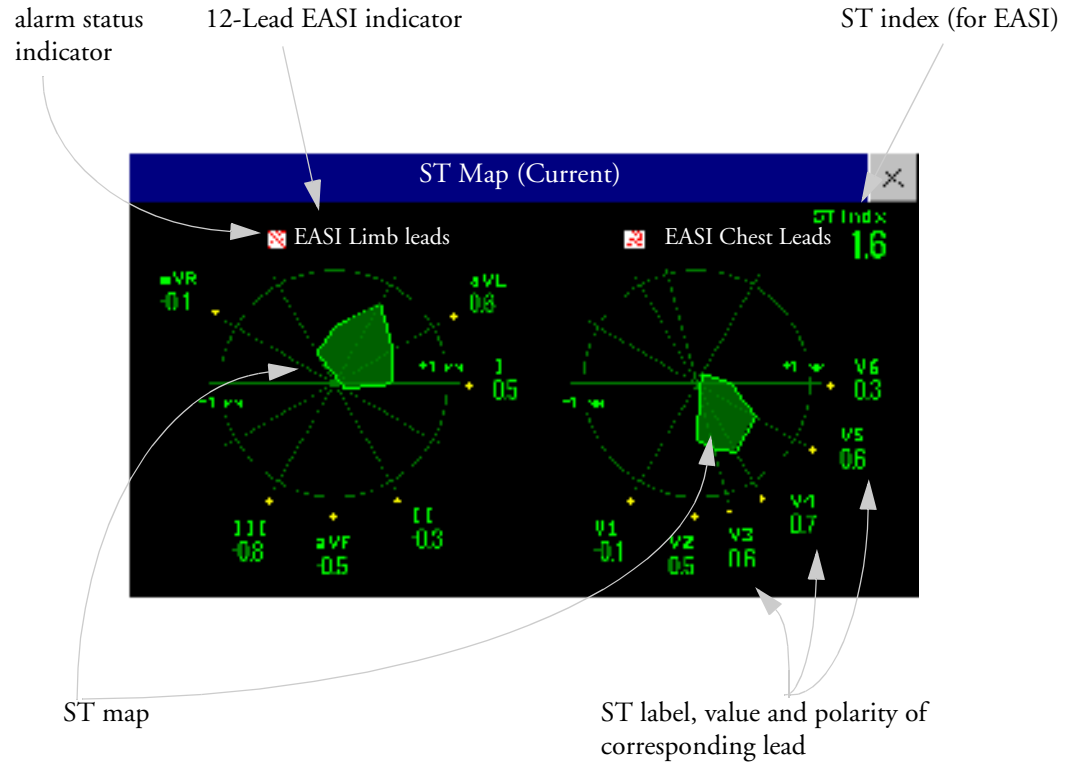

If an ST lead is switched off, its axis is not shown in the map.



If a lead is in INOP (the value is being measured but is invalid or unavailable because, for example, the corresponding ECG electrode is unplugged), the area formed by the remaining ST leads is left open.

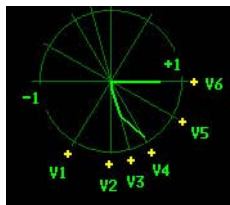

Trend View

In trend view, you can see up to four trended ST maps, and the current ST map, simultaneously. You can configure the time interval between trended samples. The most recent map is shown in the same color as the parameter itself. Past values change from white through dark gray. In the diagram below, the time interval between trends is 12 seconds. The first trended sample is white and is 12 seconds old. The second trended sample corresponds to the ST values 24 seconds ago and so forth. The ST values on the diagrams show the current ST values.

If a lead is turned off, its axis is no longer shown. This has no impact on the presentation of trended values that were recorded while the lead was still on. In the diagram below, lead V4 was switched off 20 seconds ago. The current ST values and the first trended value reflect this change in the lead setup. All other maps are displayed the way in which they were recorded.

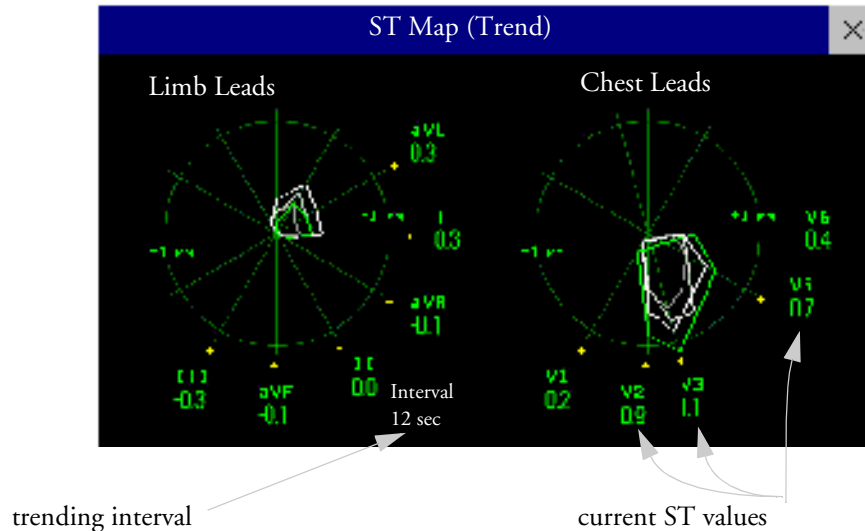

In this diagram, V4 was either temporarily switched off, or in INOP, for around 30 seconds. No data was recorded. Consequently, the affected maps are not closed.

Viewing an ST Map

To display an ST map,

- ◆ In the **Setup ST Analysis** menu, select **ST Map**.

Working in the ST Map Task Window

You may need to activate the ST map task window to see all the data, and to access the pop-up keys. Select the map view on screen to activate its task window. Once you activate it, you can perform the tasks detailed here.

Switching Between ST Map Views

To switch between views,

- ◆ Select **Current View** or **Trend View** to toggle between views.

If your trend view is empty, you need to adjust the priority of this measurement in the trending priority list. See “Trend Priority” on page 227.

Displaying an ST Reference Baseline

You can display an ST reference baseline for the current view, or for the trended view. The baseline is shown in yellow. However, if the ECG color is yellow, the baseline is shown in green. Use this baseline to detect ST changes. The baseline is derived automatically whenever the monitor relearns arrhythmia and also on user request.

- ◆ Select **Show Baseline/Hide Baseline** to toggle between baseline display on and off.

Updating an ST Map Reference Baseline

To update the baseline,

- ◆ In the **Setup ST Analysis** menu, select **ST Baseline -> Update baseline**.

Changing the Scale of the ST Map

To change scale,

- ◆ Select **Size Up** or **Size Down** to alter the size at which monitor displays the map.

Changing the Trending Interval

To determine how frequently the monitor displays a trended sample,

- 1 In Trend view, select **Select Interval**.
- 2 Select the required interval from the menu. The interval ranges between 12 seconds to 30 minutes.

Printing an ST Map Report

To print the most recently viewed (current or trend) window,

- 1 Select **Main Setup -> Reports**.
- 2 Select **ST Map**.
- 3 Press **Print**.

Monitoring Pulse Rate

The pulse numeric counts the arterial pulsations that result from the mechanical activity of the heart in beats per minute (bpm). You can display a pulse from any measured SpO₂ signal (pleth wave) or any arterial pressure (ABP, ART, Ao, BAP, FAP, PAP, UAP, P: see the pressure section for an explanation of the pressure labels). The displayed pulse numeric is labeled and color-coded to match its source wave. If the pulse numeric is not displayed, see the **Setup Pulse** menu to check whether it is switched on.

Entering the Setup Pulse Menu

If a pulse numeric is displayed on the screen, select it to enter the **Setup Pulse (Pulse Source)** menu. If no pulse numeric is visible, in the **Setup SpO₂** menu or an **Setup** arterial pressure menu, select **Pulse (Pulse Source)**.

System Pulse Source

The currently active system pulse source is shown in the setup menus of the pulse source measurements. The pulse rate chosen as system pulse:

- is monitored as system pulse and generates alarms when you select pulse as the active alarm source
- is sent via the network to the Information Center, if available
- is trended in the HighRes Trends and stored in the monitor's databases.

To define which pulse rate is used as system pulse,

- 1 In the **Setup Pulse** menu, select **System Pulse**.
- 2 Select one of the SpO₂ or arterial pressure labels from the pop-up list, or select **Auto**. If you select **Auto**, the monitor automatically chooses a pulse rate to be used as system pulse. It looks through the list from top to bottom and activates the first pulse rate that is switched on and available.

Switching Pulse On and Off

To switch a particular pulse numeric on or off, enter the **Setup Pulse** menu via the measurement setup menu or wave menu of the pulse source. For example, to switch an SpO₂ pulse numeric on or off,

- 1 Enter the **Setup Pulse** menu by selecting the Pulse numeric or by selecting **Pulse** in the **Setup SpO2** menu.
- 2 In the **Setup Pulse** menu, select **Pulse (Pulse source)** to toggle between **On** and **Off**.

To switch the system pulse on or off, in any **Setup Pulse (Pulse Source)** menu, check which measurement is currently selected as pulse source. Enter the **Setup Pulse** menu for this pulse source and then switch off the pulse measurement as described.

Using Pulse Alarms

You can change pulse rate alarm limits in the **Setup Pulse** menu accessed via any Pulse source, or in the **Setup ECG** menu. Changing the alarm limits for a specific Pulse numeric changes the alarm limits for all pulse rate alarms and heart rate alarms.

Pulse alarms are only generated when the active alarm source is set to Pulse and a pulse source is set as system pulse.

Selecting the Active Alarm Source: HR or Pulse?

In most cases the HR and Pulse numerics are identical. In order to avoid simultaneous alarms on HR and Pulse, the monitor uses either HR or Pulse as its active alarm source. To change the alarm source, select **Alarm Source** in the **Setup ECG** or **Setup Pulse** menu, then select either

- **HR:** if you want the HR to be the alarm source for HR/Pulse.
- **Pulse:** If you select Pulse as the active alarm source, the monitor will prompt you to confirm your choice. Be aware that if you select Pulse as the alarm source, all arrhythmia and ECG HR alarms are switched off.
- **Auto:** If the **Alarm Source** is set to **Auto**, the monitor will use the heart rate from the ECG measurement as the alarm source whenever the ECG measurement is switched on and no **ECG LEADS OFF INOP** is active.

The monitor will automatically switch to Pulse as the alarm source if:

- a Pulse source is switched on and available,

and

- the heart rate becomes unavailable and the **ECG LEADS OFF inop** is active.

The monitor then uses the pulse rate from the measurement currently selected as system pulse.

While Pulse is the alarm source, all arrhythmia and ECG HR alarms are switched off. If the HR becomes available again, the monitor automatically uses this as alarm source.

WARNING Selecting Pulse as the active alarm source for HR/Pulse switches off the arrhythmia alarms listed in the section “ECG, Arrhythmia, and ST Alarm Overview” on page 104, and the heart rate alarms. This is indicated by the message **All ECG Alarms Off** (unless this has been configured off for your monitor), and the crossed-out alarm symbol beside the ECG heart rate numeric.

High and low pulse rate and extreme bradycardia and extreme tachycardia alarms from pulse are active.

Alarm Source Selection Disabled

If Alarm Source Selection is disabled, you cannot change the alarm source. If you try to change the source, the monitor displays the message **To activate enter Config and enable AlarmSourceSel**. This setting can only be changed in Configuration Mode.

Changing HR/Pulse Alarm Limits

As Pulse and HR share the same high and low alarm limits, if you change the alarm limit in the **Setup Pulse** menu, the high or low alarm limits for HR in the **Setup ECG** menu change automatically, and vice versa. The only exceptions are caused by a low limit clamp for each measurement: the lowest value for Pulse when derived from SpO₂ is 30 bpm; for HR 15 bpm, and for Pressure 25 bpm.

Extreme Alarm Limits

The extreme rate alarms, Extreme Tachy and Extreme Brady, generated by the active alarm source, either HR or Pulse, are set in Configuration Mode by adding a set value to the high and low alarm limits. You need to know what value has been configured for your monitor. Changing the high and low alarm limits automatically changes the extreme alarm limits within the allowed range.

- ◆ To see the values added to the high and low limit alarms to create the extreme rate alarms for your monitor, in the **Setup ECG** menu, see the menu items **ΔExtrTachy** and **ΔExtrBrady**.

QRS Tone

The active alarm source is also used as a source for the QRS tone. You can change the tone volume in the **Setup SpO₂** and **Setup ECG** menus and the QRS tone modulation in the **Setup SpO₂** menu.

Monitoring Respiration Rate (Resp)

For the respiratory measurement (Resp), the monitor measures the thoracic impedance between two ECG electrodes on the patient's chest. Changes in the impedance due to thoracic movement produce the Resp waveform on the monitor screen. The monitor counts the waveform cycles to calculate the respiration rate (RR).

Lead Placement for Monitoring Resp

Correct patient skin preparation techniques for electrode placement are important for Resp measurement: you will find this information in the chapter on ECG.

The Resp measurement uses the standard ECG cable sets and lead placements. You can use any of the different types of ECG cable sets - 3-lead, 5-lead, or 10-lead, using either standard or EASI™ placement - to measure Resp, as long as you use ICU ECG cables.

The Resp signal is always measured between two of the ECG electrodes. If you are using standard ECG electrode placement, Resp is measured between the RA and LL electrodes. If you are using EASI™ ECG electrode placement, Resp is measured between the I and A electrodes.

Optimizing Lead Placement for Resp

If you want to measure Resp and you are already measuring ECG, you may need to optimize placement of the two electrodes between which Resp will be measured for some patients. Repositioning ECG electrodes from standard positions, especially when you are using EASI™ ECG electrode placement, results in changes in the ECG waveform and may influence ST and arrhythmia interpretation.

Cardiac Overlay

Cardiac activity that affects the Resp waveform is called cardiac overlay. It happens when the Resp electrodes pick up impedance changes caused by the rhythmic blood flow. Correct electrode placement can help to reduce cardiac overlay: avoid the liver area and the ventricles of the heart in the line between the respiratory electrodes. This is particularly important for neonates.

Lateral Chest Expansion



Some patients, especially neonates, expand their chests laterally. In these cases it is best to place the two respiratory electrodes in the right midaxillary and left lateral chest areas at the patient's maximum point of breathing movement to optimize the respiratory wave.

Abdominal Breathing

Some patients with restricted chest movement breathe mainly abdominally. In these cases, you may need to place the left leg electrode on the left abdomen at the point of maximum abdominal expansion to optimize the respiratory wave.

Understanding the Resp Display

The Resp measurement is displayed on the monitor as a continuous wave and a numeric respiration rate. If the detected respiration rate is close to the heart rate, this is indicated by the text **HR = RR** next to the respiration wave if you are in manual monitoring mode. Your monitor screen may look slightly different from the illustration.

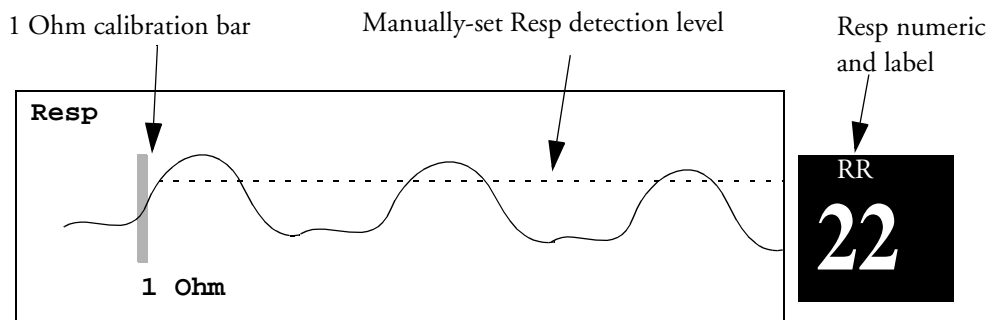

Changing Resp Detection Modes

The Resp detection level can be set either automatically or manually.

- ◆ To change the resp detection mode, in the **Setup Resp** menu, select **Auto/Manual** to toggle between the settings.

Auto Detection Mode

In Auto Detection Mode, the monitor adjusts the detection level automatically, depending on the wave height and the presence of cardiac artifact. Note that in Auto Detection Mode,

- the detection level (a dotted line) is not displayed on the waveform,

- the algorithm expects a heart rate and therefore needs at least 3 electrodes attached to the patient. If you are monitoring respiration with only two electrodes, the detection algorithm becomes less sensitive which may result in reduced breath detection performance.

Use Auto Detection Mode for situations where:

- the respiration rate is not close to the heart rate
- breathing is spontaneous, with or without continuous positive airway pressure (CPAP)
- patients are ventilated, except patients with Intermittent Mandatory Ventilation (IMV).

Manual Detection Mode

In Manual Detection Mode you must set the Resp detection level.

- ◆ In the **Setup Resp** menu, select **Manual Up** or **Manual Down**. Use the dotted detection level line in the Resp waveform to determine when the desired level is reached.

Once set, the detection level will not adapt automatically to different respiration depths. It is important to remember that if the depth of breathing changes, you may need to change the detection level.

Use Manual Detection Mode for situations where:

- the respiration rate and the heart rate are close.
- patients have Intermittent Mandatory Ventilation.
- respiration is weak. Try repositioning the electrodes to improve the signal.

Resp Detection Modes and Cardiac Overlay

In Auto Detection Mode: If you are monitoring Resp and the ECG is switched off, the monitor cannot compare the ECG and Resp rates to detect cardiac overlay. The respiration detection level is automatically set higher to prevent the detection of cardiac overlay as respiration.

In Manual Detection Mode: Cardiac overlay can in certain situations trigger the respiration counter. This may lead to a false indication of a high respiration rate or an undetected apnea condition. If you suspect that cardiac overlay is being registered as breathing activity, raise the detection level above the zone of cardiac overlay. If the Resp wave is so small that raising the detection level is not possible, you may need to optimize the electrode placement as described in the section "Lateral Chest Expansion".

Changing the Size of the Respiration Wave

WARNING When monitoring in Manual Detection Mode, make sure to check the respiration detection level after you have increased or decreased the size of the respiration wave.

- ◆ In the **Setup Resp** menu, select **Size Up** to increase the size of the wave or **Size Down** to decrease it.

Changing the Speed of the Respiration Wave

Resp waveforms are usually viewed at a slower speed than other waveforms. For this reason, the Resp measurement has its own speed control and is not affected by the wave speed settings of the other measurements.

- ◆ Select the Resp wave to enter the **Resp Wave** menu, then select **Change Speed**. Choose the required speed from the pop-up list. This defines the speed at which the wave is drawn across the screen in millimeters per second (mm/s).

Using Resp Alarms

Resp alarms can be switched on and off and the high and low alarm limits can be changed just like other measurement alarms, as described in the Alarms chapter.

Changing the Apnea Alarm Delay

The apnea alarm is a high priority red alarm used to detect apneas. The apnea alarm delay time defines the time period between the point where the monitor cannot detect any respiration activity and the indication of the apnea alarm.

- 1 In the **Setup Resp** menu, select **Apnea Time**.
- 2 Select the appropriate setting.

Resp Safety Information

WARNING **Respiration detection level** If you do not set the detection level for the respiration correctly in manual detection mode, it may not be possible for the monitor to detect apnea. If you set the detection level too low, the monitor is more likely to detect cardiac activity, and to falsely interpret cardiac activity as respiratory activity in the case of apnea.

Apnea The respiration measurement does not recognize obstructive and mixed apneas — it only indicates an alarm when a pre-adjusted time has elapsed since the last detected breath.

The safety and effectiveness of the respiration measurement method in the detection of apnea, particularly the apnea of prematurity and apnea of infancy, has not been established.

Interference If operating under conditions according to the EMC Standard EN 60601-1-2 (Radiated Immunity 3V/m), field strengths above 1V/m may cause erroneous measurements at various frequencies. Therefore it is recommended to avoid the use of electrically radiating equipment in close proximity to the respiration measurement unit.

Resp Accessories To monitor respiration, use only the non-OR ECG accessories listed in the Resp section of the accessories chapter. You cannot measure respiration if you are using an orange OR ECG cable set. This is because of the higher internal impedance of the OR cable set, required for use if electro-surgery is being performed.

Rate adaptive pacemakers: Implanted pacemakers which can adapt to the Minute Volume may occasionally react on the Impedance measurement used by patient monitors for the determination of the Resp value and execute pacing with the maximum programmed rate. Switching off the Resp measurement can prevent this.

Monitoring SpO₂

Philips pulse oximetry uses a motion-tolerant signal processing algorithm, based on Fourier artefact suppression technology (FAST). It provides four measurements:

- Oxygen saturation of arterial blood (SpO₂) - percentage of oxygenated hemoglobin in relation to the sum of oxyhemoglobin and deoxyhemoglobin (functional arterial oxygen saturation).
- Pleth waveform - visual indication of patient's pulse.
- Pulse rate (derived from pleth wave) - detected pulsations per minute.
- Perfusion indicator - numerical value for the pulsatile portion of the measured signal caused by arterial pulsation.

The monitors are also compatible with SpO₂ technologies from other manufacturers. Please refer to the instructions for use provided with these devices for further information.

SpO₂ Sensors

Depending on the purchased SpO₂ option, different sensors and adapter cables can be used. The sensors for the different options are color-coded to match the connectors. See the section on Accessories for a compatibility table.

Familiarize yourself with the instructions for use supplied with your sensor before using it. In particular, check that the sensor being used is appropriate for your patient category and application site.

CAUTION Do not use OxiCliq disposable sensors in a high humidity environment, such as in neonatal incubators or in the presence of fluids, which may contaminate sensor and electrical connections causing unreliable or intermittent measurements. Do not use disposable sensors on patients who have allergic reactions to the adhesive. Always use the MAX-FAST forehead sensor with the foam headband provided by Nellcor.

Applying the Sensor

- 1 Follow the SpO₂ sensor's instructions for use, adhering to all warnings and cautions.
- 2 Remove colored nail polish from the application site.
- 3 Apply the sensor to the patient. The application site should match the sensor size so that the sensor can neither fall off, nor apply excessive pressure. When using the M1195A Infant Finger Sensor,

select a finger or toe with a diameter of between 7 and 8 mm (0.27" and 0.31"). When applying a M1193A neonatal sensor do not overtighten the strap.

- 4 Check that the light emitter and the photodetector are directly opposite each other. All light from the emitter must pass through the patient's tissue.

WARNING Loose Sensor: If a sensor is too loose, it might compromise the optical alignment or fall off. If it is too tight, for example because the application site is too large or becomes too large due to edema, excessive pressure may be applied. This can result in venous congestion distal from the application site, leading to interstitial edema, hypoxemia and tissue malnutrition. Skin irritations or lacerations may occur as a result of the sensor being attached to one location for too long. To avoid skin irritations and lacerations, periodically inspect the sensor application site and change the application site at least every four hours.

Venous Pulsation: Do not apply sensor too tightly as this results in venous pulsation which may severely obstruct circulation and lead to inaccurate measurements.

Ambient Temperature: Never apply an SpO₂ sensor at ambient temperatures from above 37 °C because this can cause severe burns after prolonged application.

Extremities to Avoid: Avoid placing the sensor on extremities with an arterial catheter, or intravascular venous infusion line.

Connecting SpO₂ Cables

- ◆ Connect the sensor cable to the color-coded socket on the measurement device (MMS or module). If you are using a disposable sensor, plug the sensor into the adapter cable and connect this to the measurement device. Connect reusable sensors directly to the measurement device.

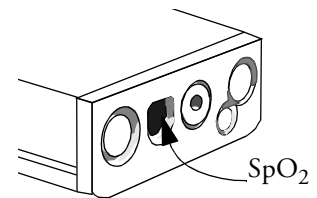

CAUTION Extension cables: Do not use more than one extension cable (M1941A). Do not use an extension cable with Philips reusable sensors or adapter cables with part numbers ending in -L (indicates "long" cable version).

Electrical Interference: Position the sensor cable and connector away from power cables, to avoid electrical interference.

Humidity: For neonatal patients, make sure that all sensor connectors and adapter cable connectors are outside the incubator. The humid atmosphere inside can cause inaccurate measurements.

Measuring SpO₂

- 1 Select the correct patient category setting (adult/pediatric and neonatal), as this is used to optimize the calculation of the SpO₂ and pulse numerics.
- 2 During measurement, ensure that the application site:
 - has a pulsatile flow, ideally with a perfusion indicator value above 1.0.

- has not changed in its thickness (for example, due to edema), causing an improper fit of the sensor.

WARNING Inspect the application site every two to three hours to ensure skin quality and correct optical alignment. If the skin quality changes, move the sensor to another site. Change the application site at least every four hours.

Using an SpO₂ sensor during MR imaging can cause severe burns. Minimize this risk by positioning the cable so that no inductive loops are formed. If the sensor does not appear to be operating properly, remove it immediately from the patient.

CAUTION Injected dyes such as methylene blue, or intravascular dyshemoglobins such as methemoglobin and carboxyhemoglobin may lead to inaccurate measurements.

Interference can be caused by:

- High levels of ambient light. (Hint: cover application site with opaque material.)
 - Electromagnetic interference.
 - Excessive patient movement and vibration.
-

Assessing a Suspicious SpO₂ Reading

Traditionally, pulse rate from SpO₂ was compared with heart rate from ECG to confirm the validity of the SpO₂ reading. With newer algorithms, such as FAST-SpO₂, this is no longer a valid criteria because the correct calculation of SpO₂ is not directly linked to the correct detection of each pulse.

When pulse rate is very low, or strong arrhythmia is present, the SpO₂/Pleth pulse rate may differ from the heart rate calculated from ECG but this does not indicate an inaccurate SpO₂ value.

If you doubt the measured SpO₂, use the pleth wave and perfusion indicator instead to assess the signal quality.

Understanding SpO₂ Alarms

This refers to SpO₂ specific alarms. See the Alarms section for general alarm information. SpO₂ offers high and low limit alarms, and a high priority desat alarm. You cannot set the low alarm limit below the desat alarm limit.

CAUTION If you measure SpO₂ on a limb that has an inflated NBP cuff, a non-pulsatile SpO₂ INOP can occur. If the monitor is configured to suppress this alarm there may be a delay of up to 60 seconds in indicating critical patient status, such as sudden pulse loss or hypoxia.

Alarm Delays

There is a delay between a physiological event at the measurement site and the corresponding alarm at the monitor. This delay has two components:

- The time between the occurrence of the physiological event and when this event is represented by the displayed numerical values. This delay depends on the algorithmic processing and the configured averaging time. The longer the averaging time configured, the longer the time needed until the numerical values reflect the physiological event.
- The time between the displayed numerical values crossing an alarm limit and the alarm indication on the monitor. This delay is the combination of the configured alarm delay time plus the general system delay time (see “Monitor Performance Specifications” on page 342).

Adjusting the Alarm Limits

In the **Setup SpO₂** menu:

- Select **High Limit** then choose the upper alarm limit.
- Select **Low Limit** then choose the lower alarm limit.

WARNING High oxygen levels may predispose a premature infant to retrolental fibroplasia. If this is a consideration do NOT set the high alarm limit to 100%, which is equivalent to switching the alarm off. Transcutaneous pO₂ monitoring is recommended for premature infants receiving supplemental oxygen.

Adjusting the Desat Limit Alarm

The Desat alarm is a high priority (red) alarm notifying you of potentially life threatening drops in oxygen saturation.

- 1 In the **Setup SpO₂** menu, select **Desat Limit**.
- 2 Adjust the limit.

Pleth Wave

The Pleth wave is autoscaled to maximum display size. It decreases only when the signal quality becomes marginal. It is NOT directly proportional to the pulse volume. If you need an indication of change in pulse volume, use the perfusion indicator.

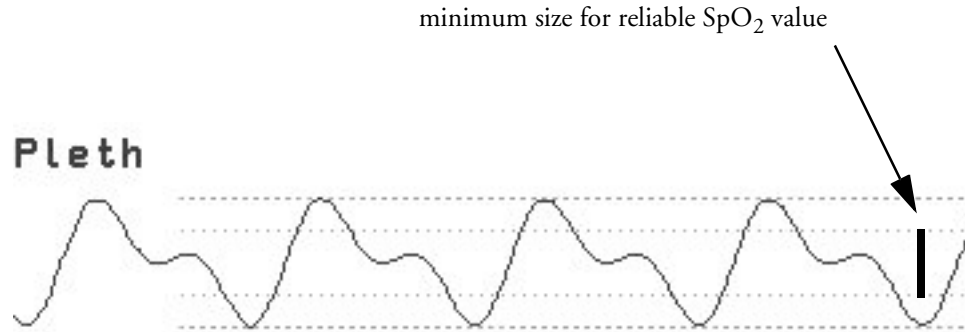

Perfusion (Pleth) Indicator

The perfusion indicator gives a numerical value for the pulsatile portion of the measured signal caused by the pulsating arterial blood flow.

As pulse oximetry is based on the pulsatile nature of the signal, you can also use the perfusion indicator as a quality indicator for the SpO₂ measurement. Above 1 is optimal, between 0.3-1 is acceptable. Below 0.3 is marginal; reposition the sensor or find a better site.

Setting SpO₂/Pleth as Pulse Source

- 1 In the **Setup SpO₂** menu, select **Pulse (SpO₂)** to enter the **Setup Pulse** menu.
- 2 In the **Setup Pulse** menu, select **System Pulse** and select **SpO₂** from the pop-up list.

Setting Up Tone Modulation

If tone modulation is on, the QRS tone pitch lowers when the SpO₂ level drops. Remember, the QRS tone is derived from either heart rate or pulse depending on which is currently selected as the active alarm source.

- ◆ In the **Setup SpO₂** menu, select **Tone Modulation** to toggle between **Yes** (for on) and **No** (for off).

Tone modulation is licensed under US patent US 4,653,498 from Nellcor Puritan Bennett Incorporated, a Tyco Healthcare company.

Setting the QRS Volume

- ◆ In the **Setup SpO₂** menu, select **QRS Volume** and set the appropriate QRS tone volume.

Calculating SpO₂ Difference

When a second SpO₂ measurement is present (either through the SpO₂ module or through VueLink), the monitor displays both SpO₂ values, and calculates the difference between them. The second value is subtracted from the first.

- 1 From the **Main Setup** menu, select **Measurements**.
- 2 From the **ΔSpO₂ Setup** menu, select **First SpO₂**.
- 3 Choose the first measurement source.
- 4 Select **Second SpO₂**.
- 5 Choose the second measurement source.

Monitoring NBP

This monitor uses the oscillometric method for measuring NBP. In adult and pediatric mode, the blood pressure measurements determined with this device comply with the American National Standard for Electronic or Automated Sphygmomanometers (ANSI/AAMI SP10-1992) in relation to mean error and standard deviation, when compared to intra-arterial or auscultatory measurements (depending on the configuration) in a representative patient population. For the auscultatory reference, the fifth Korotkoff sound was used to determine the diastolic pressure.

In neonatal mode, the blood pressure measurements determined with this device comply with the American National Standard for Electronic or Automated Sphygmomanometers (ANSI/AAMI SP10-1992) in relation to mean error and standard deviation, when compared to intra-arterial measurements in a representative patient population.

The NBP measurement is suitable for use in the presence of electrosurgery and during the discharge of a cardiac defibrillator according to IEC 601-2-30/EN 60601-2-30.

A physician must determine the clinical significance of the NBP information.

Introducing the Oscillometric NBP Measurement

Oscillometric devices measure the amplitude of pressure changes in the occluding cuff as the cuff deflates from above systolic pressure. The amplitude suddenly increases as the pulse breaks through the occlusion in the artery. As the cuff pressure decreases further, the pulsations increase in amplitude, reach a maximum (which approximates to the mean pressure), and then diminish.

Studies show that, especially in critical cases (arrhythmia, vasoconstriction, hypertension, shock), oscillometric devices are more accurate and consistent than devices using other noninvasive measuring techniques.

WARNING **Patient Category:** Select the correct patient category setting for your patient. Do not apply the higher adult inflation, overpressure limits and measurement duration to neonatal patients.

Intravenous infusion: Do not use the NBP cuff on a limb with an intravenous infusion or arterial catheter in place. This could cause tissue damage around the catheter when the infusion is slowed or blocked during cuff inflation.

Skin Damage: Do not measure NBP on patients with sickle-cell disease or any condition where skin damage has occurred or is expected.

Unattended measurement: Use clinical judgement to decide whether to perform frequent unattended blood pressure measurements on patients with severe blood clotting disorders because of the risk of hematoma in the limb fitted with the cuff.

CAUTION If you spill liquid onto the equipment or accessories, particularly if there is a chance that it can get inside the tubing or the MMS, contact your service personnel.

Measurement Limitations

Measurements are impossible with heart rate extremes of less than 40 bpm or greater than 300 bpm, or if the patient is on a heart-lung machine.

The measurement may be inaccurate or impossible:

- if a regular arterial pressure pulse is hard to detect
- with cardiac arrhythmias
- with excessive and continuous patient movement such as shivering or convulsions
- with rapid blood pressure changes
- with severe shock or hypothermia that reduces blood flow to the peripheries
- with obesity, where a thick layer of fat surrounding a limb dampens the oscillations coming from the artery
- on an edematous extremity.

Measurement Methods

There are three methods of measuring NBP:

- **Manual** - measurement on demand.
- **Auto** - continually repeated measurements (between one and 120 minute adjustable interval).
- **STAT** - rapid series of measurements over a five minute period, then the monitor returns to the previous mode. Use only on supervised patients.

Reference Method

The NBP measurement reference method can be Auscultatory (manual cuff) or Invasive (intra-arterial). For further information, see the Application Note on NBP supplied on the monitor documentation CD-ROM.

In Adult and Pediatric mode to check the current setting, select **Main Setup** -> **Measurements** -> **NBP**, and check whether the **Reference** setting is set to **Auscultatory** or **Invasive**. This setting can only be changed in Configuration Mode.

In Neonatal mode, to comply with safety standards, invasive is always used as the reference method. This setting cannot be changed and is not visible in any operating mode.

Preparing to Measure NBP

- 1 Connect the cuff to the air tubing.
- 2 Plug the air tubing into the red NBP connector. Avoid compression or restriction of pressure tubes. Air must pass unrestricted through the tubing.

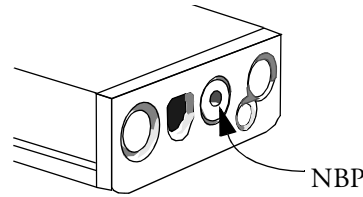

- 3 Make sure that you are using a Philips-approved correct sized cuff and that the bladder inside the cover is not folded or twisted.
A wrong cuff size, and a folded or twisted bladder, can cause inaccurate measurements. The width of the cuff should be in the range from 37% to 47% of the limb circumference. The inflatable part of the cuff should be long enough to encircle at least 80% of the limb.
- 4 Apply the cuff to a limb at the same level as the patient’s heart. If it is not, you must use the measurement correction formula to correct the measurement.
The marking on the cuff must match the artery location. Do not wrap the cuff too tightly around the limb. It may cause discoloration, and ischemia of the extremities. Inspect the application site regularly to ensure skin quality and inspect the extremity of the cuffed limb for normal color, warmth and sensitivity. If the skin quality changes, or if the extremity circulation is being affected, move the cuff to another site or stop the blood pressure measurements immediately. Check more frequently when making automatic or stat measurements.

Correcting the Measurement if Limb is not at Heart Level

To correct the measurement if the limb is not at heart level, to the displayed value

add 0.75mmHg (0.10kPa) for each centimeter higher or	deduct 0.75mmHg (0.10kPa) for each centimeter lower or
add 1.9mmHg (0.25kPa) for each inch higher.	deduct 1.9mmHg (0.25kPa) for each inch lower.

Understanding the NBP Numerics

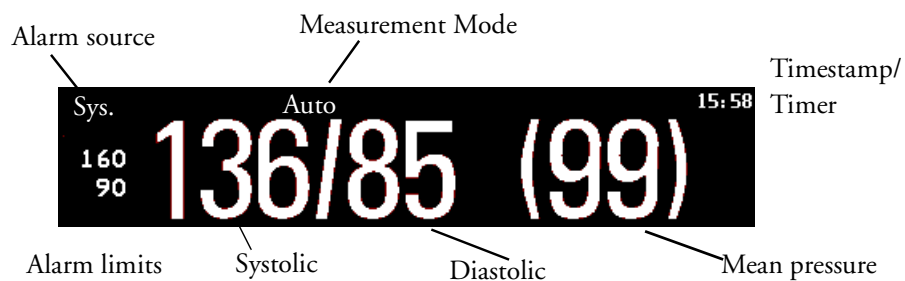

Depending on the NBP numeric size, not all elements may be visible. Your monitor may be configured to display only the systolic and diastolic values.

Alarm Sources if you have parallel alarm sources, the sources are displayed instead of the alarm limits.

NBP Timestamp depending on the configured **NBP Time** setting, the time shown beside the NBP numeric can be:





- **Meas Time**: the time of the most recent NBP measurement, or
- **Next Meas**: the time until the next measurement in an automatic series, displayed with a graphic representation of the remaining time, as shown here.



During measurements the cuff pressure is displayed instead of the units and the repeat time. An early systolic value gives you a preliminary indication of the systolic blood pressure during measurement.

Starting and Stopping Measurements

Use the Setup menu, SmartKeys or the MMS hardkey to start and stop measurements.

Action to be performed	NBP Setup menu	SmartKeys	MMS hardkey
Start/Stop manual measurement Start Auto series Stop current automatic measurement	Start/Stop		Start/Stop
Stop Automatic, Manual or STAT measurement AND series	Stop All		---
Start STAT measurement	NBP STAT		STAT (for MMS without Pressure/Temp measurement)
Stop current STAT measurement and end series	Start/Stop		Start/Stop
	NBP STAT		STAT (for MMS without Pressure/Temp measurement)

CAUTION Use clinical judgement to decide whether to perform repeated series of STAT measurements because of the risk of purpura, ischemia and neuropathy in the limb with the cuff.

Enabling Automatic Mode and Setting Repetition Time

- 1 In the **Setup NBP** menu, select **Auto/Man**.
- 2 Toggle between **Auto/Man**, if necessary, to pick the measurement method.
- 3 If making an automatic measurement, select **Repeat Time** and set the time interval between two measurements.

Choosing the NBP Alarm Source

You can monitor for alarm conditions in systolic, diastolic and mean pressure, either singly or in parallel. Only one alarm is given, with the priority of mean, systolic, diastolic. In the **Setup NBP** menu, select **Alarms from** and choose from:

Menu option	Pressure value monitored
Sys.	systolic
Dia.	diastolic
Mean	mean
Sys&Dia	systolic and diastolic in parallel
Dia&Mean	diastolic and mean in parallel
Sys&Mean	systolic and mean in parallel
S&D&M	all three pressures in parallel

Assisting Venous Puncture

You can use the NBP cuff to cause sub-diastolic pressure. The cuff deflates automatically after a set time (adult/pediatric 170 seconds, neonatal 85 seconds) if you do not deflate it.

- 1 In the **NBP Setup** menu select **VeniPuncture**.
- 2 Puncture vein and draw blood sample.
- 3 Reselect **VeniPuncture** to deflate the cuff.

During measurement, the NBP display shows the inflation pressure of the cuff and the remaining time in venous puncture mode.

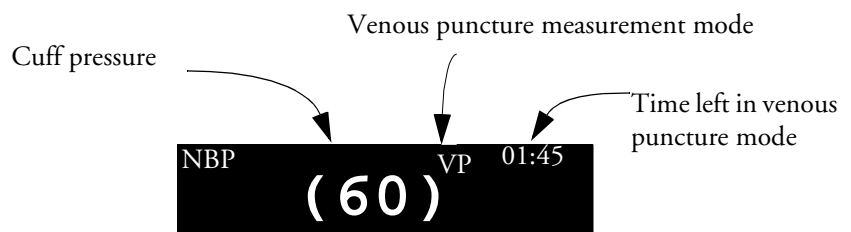

Calibrating NBP

NBP is not user-calibrated. Cuff-pressure transducers must be verified and calibrated, if necessary, at least once every two years by a qualified service professional. See the Service Guide for details.

Monitoring Temperature

You can measure temperature using the Multi-Measurement Server (MMS), one of the measurement server extensions, or the temperature plug-in module. Temp measurement automatically switches on when you connect a probe. You can switch the measurement off manually.

Making a Temp Measurement

- 1 Select the correct type and size of probe for your patient.
- 2 If you are using a disposable probe, connect the probe to the temperature cable.
- 3 Plug the probe or temperature cable into the temperature connector socket.

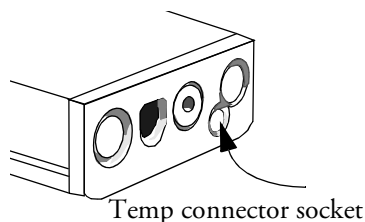

- 4 Apply the probe to the patient. You are advised to use a protective rubber cover on rectal probes.
- 5 Select an appropriate temperature label.
- 6 Check that the alarm settings (on or off, high and low limits) are appropriate for this patient and this type of temperature measurement.

WARNING Make sure you set alarm limits for the correct label. The alarm limits you set are stored for that particular label only. Changing the label may change the alarm limits.

Selecting a Temperature for Monitoring

Tell the monitor which temperature you want to monitor by selecting its temperature label. The label is a unique identifier for each type of temperature. When you choose a label, the monitor uses that label's stored color and alarm settings.

- 1 In the **Setup <Temp>** menu, select **Label**.
- 2 Select the appropriate label from the list.

Temp	non-specific temperature label.	Trect	rectal temperature
Tart	arterial temperature	Tskin	skin temperature
Tcore	core temperature	Tven	venous temperature
Tesoph	esophageal temperature	Tnaso	nasopharyngeal temperature

Extended Temperature Label Set

The following additional labels are available if **Label Set** is set to **Full**. This setting can only be changed in Configuration Mode.

Note that if your monitor is connected to an Information Center, the additional labels in the extended label set may not be correctly displayed. See the Configuration Guide for your monitor for more information.

T1, T2, T3, T4	Non-specific temperature labels
Tamb	ambient temperature
Tcereb	cerebral temperature
Ttymp	tympanic temperature
Tvesic	vesical temperature

Calculating Temp Difference

The monitor can calculate and display the difference between two temperature values by subtracting the second value from the first. The difference is labeled ΔTemp .

- 1 In the **Setup Main** menu, select **Measurements**.
- 2 In the **Setup ΔTemp** menu, select **First Temp**.
- 3 Label the measurement source as appropriate.
- 4 Select **Second Temp**.
- 5 Label the measurement source as appropriate.

Monitoring Invasive Pressure

You can measure pressure using the Multi-Measurement Server (MMS), one of the measurement server extensions or the pressure plug-in module.

Setting up the Pressure Measurement

- 1 Plug in the pressure cable.



MMS



Module

- 2 Prepare the flush solution.
- 3 Flush the system to exhaust all air from the tubing. Ensure that the transducer and stopcocks are free of air bubbles.

WARNING If air bubbles appear in the tubing system, flush the system with the infusion solution again. Air bubbles may lead to a wrong pressure reading.

- 4 Connect the pressure line to the patient catheter.
- 5 If you are using an infusion pressure cuff with the pressure line, attach the pressure cuff to the fluid to be infused. Inflate it according to your standard hospital procedure, then start the infusion.
- 6 Position the transducer so that it is level with the heart, approximately at the level of the midaxillary line.

WARNING If measuring intracranial pressure (ICP) with a sitting patient, level the transducer with the top of the patient's ear. Incorrect leveling may give incorrect values.

Selecting a Pressure for Monitoring

Tell the monitor which pressure you want to monitor by selecting its pressure label. The label is a unique identifier for each type of pressure. When you chose a label, the monitor uses that label's stored color, wave scale and alarm settings.

- 1 In the **Setup <Press>** menu, select **Label**.
- 2 Select the appropriate label from the list.

Label	Description	Label	Description
ABP	Arterial blood pressure	P	Non-specific pressure label
ART	Arterial blood pressure (alternative)	PAP	Pulmonary artery pressure
Ao	Aortic pressure	RAP	Right atrial pressure
CVP	Central venous pressure	UAP	Umbilical arterial pressure
ICP	Intracranial pressure	UVP	Umbilical venous pressure
LAP	Left atrial pressure		

Extended Pressure Label Set

The following additional labels are available if **Label Set** is set to **Full**. This setting can only be changed in Configuration Mode.

Note that if your monitor is connected to an Information Center, the additional labels in the extended label set may not be correctly displayed. See the Configuration Guide for your monitor for more information.

Label	Description
BAP	Brachial arterial pressure
FAP	Femoral arterial pressure
IC1, IC2	Alternative intracranial pressures
P1, P2, P3, P4	Alternative non-specific pressure labels

Zeroing the Pressure Transducer

To avoid inaccurate pressure readings, the monitor requires a valid zero. Zero the transducer in accordance with your hospital policy (at least once per day). You must perform a zero:

- when you use a new transducer or tubing
- every time you reconnect the transducer cable to the monitor
- if you think the monitor's pressure readings are not correct.

Zeroing ICP (or IC1/IC2)

Your hospital guidelines may require you to zero the ICP transducer less frequently than other transducers, due to the need for aseptic conditions. When you zero an ICP transducer, the zero values are automatically stored and you will not be prompted to repeat the zero procedure.

If you want to simultaneously zero all pressures except ICP, disconnect the ICP transducer from the measurement server or module while zeroing. Reconnecting the transducer recalls the stored values.

WARNING If you select the label ICP (or IC1/IC2), the measurement device uses the most recently stored zero. Therefore, make sure you zeroed the transducer correctly in accordance with the transducer manufacturer's instructions and your hospital policy. When you use a transducer that you cannot rezero after placement, ensure that you keep the measuring device with the patient so that you are certain you have the correct zero data for this patient.

Determining a Pressure's Most Recent Zero

The monitor displays the most recent zero on the status line. If this has "timed-out" after you have performed a zero, redisplay the information in the status line by entering the pressure's setup menu.

Zeroing a Pressure Measurement

WARNING Invasive pressure alarms (and pulse alarms, if derived from invasive pressure) are temporarily suppressed until 30 seconds after the transducer finishes zeroing.

- 1 Turn off the stopcock to the patient.
- 2 Vent the transducer to atmospheric pressure, to compensate for the static and atmospheric pressure exerted on the transducer.
- 3 In the setup menu for the pressure, select **Zero <Press>**.
- 4 When you see the message **<Press> zero done at <date and time>** on the status line, (for example, **ABP zero done at 13 Mar 02 23.35**) close the stopcock to atmospheric pressure, and open the stopcock to the patient.

Using the Zero Hardkey

Pressing the Zero hardkey for two seconds on the M1006B Pressure module starts a zero for the pressure currently measured with the module.

Pressing the Zero hardkey for two seconds on the M3001A Multi-Measurement Server zeros the pressure being measured by the measurement server **and** the pressures from any connected measurement extensions.

Zeroing All Pressures Simultaneously

WARNING Before zeroing all pressures, make sure that **all** pressure transducers are vented to atmospheric pressure.

If you are measuring pressures with more than one measuring device, using the **zero** SmartKey to initiate the zeroing calls up a list of all active pressures. Select the pressure you want to zero or select **All Press** to zero all pressures simultaneously.

Troubleshooting the Zero

The status line lists the probable cause of an unsuccessful zero:

Message	Corrective Action
unable to zero - equipment malfunction	The hardware is faulty. Contact your service personnel.
unable to zero - excessive offset	Make sure the transducer is vented to air and try again. If this fails, the hardware may be faulty. Replace the adapter cable and try again. If it fails, replace the transducer and try again. If it still fails, contact your service personnel.
unable to zero - unstable signal	
unable to zero - no transducer	Make sure that the transducer is connected and try again. If this fails, exchange the adapter cable and try again. If this fails, exchange the transducer.
unable to zero - pulsatile pressure	Make sure that the transducer is vented to air, not to the patient, and try again.
unable to zero - timed out	Try pressing the Zero key again. If this fails, replace the transducer and adapter cable and contact your service personnel.
switch <Press> on first	Pressure measurement is switched off. To switch it on, in the Setup Pressure menu, select the pressure's label.

Adjusting the Calibration Factor

Each time you use a reusable transducer, compare the calibration factor written on your transducer with the calibration factor shown on the monitor. To ensure accurate measurement, they must be the same.

- 1 In the **Setup <Press>** menu, select **Cal. Factor**.
If the value here does **not** match that on the transducer, select the corresponding value from the list now in accordance with your hospital's procedure.
- 2 To confirm you want to use the new calibration factor, select the Confirm popup.

Displaying a Mean Pressure Value Only

Use this when you want to see only the mean pressure.

- ◆ In the pressure's setup menu, select **Mean Only**. Toggle between **On** to display mean pressure value only, and **Off** to display all pressure values (systolic, diastolic and mean).

Changing the Pressure Wave Scale

- 1 Select the label of the pressure wave whose scale you want to set to enter the **Setup** menu.
- 2 In the **Setup <Press>** menu, (for example **ABP**) select **Scale**.

- 3 Select a value from the pop-up list:
 - a positive value sets the top gridline. The bottom gridline is set at zero.
 - a negative value sets the bottom gridline. The middle gridline is set at zero.

Optimizing the Waveform

- ◆ In the **Setup <Press>** menu, select **Optimum Scale** to let the monitor select the best minimum and maximum scales for the current wave.

Non-Physiological Artifact Suppression

Some clinical procedures may affect blood pressure, for example, a flush procedure or a blood sample. Your monitor may be configured to suppress these non-physiological artifacts for a specified duration (**Artifact Suppression** is configured to 30, 60, or 90 seconds). During artifact suppression, the monitor shows the INOP message **<Pressure label> ARTIFACT**, and a question mark is shown beside the pressure numerics. Pressure alarms and the **Pulse Non-Pulsatile** INOP are suppressed during the configured period. The CPP high alarm is not suppressed.

Choosing the Pressure Alarm Source

WARNING Make sure you set alarm limits for the correct label. The alarm limits you set are stored for that particular label only. Changing the label may change the alarm limits.

You can monitor for alarm conditions in systolic, diastolic and mean pressure, either singly or in parallel. Only one alarm is given at a time, in this order of priority: mean, systolic, diastolic.

- ◆ In the **Setup <Press>** menu, select **Alarms from** and choose the source.

Menu option	Pressure value monitored
Sys.	systolic
Dia.	diastolic
Mean	mean
Sys&Dia	systolic and diastolic in parallel
Dia&Mean	diastolic and mean in parallel
Sys&Mean	systolic and mean in parallel
Sys&Dia&Mean	all three pressures in parallel

- ◆ Select and set the **High Limit** and **Low Limit** for the pressure(s) you have selected.

Calibrating Reusable Transducer CPJ840J6

Depending on your monitor's configuration, you may be able to perform a calibration in monitoring mode. Perform a mercury calibration when you use a new transducer, and at regular intervals according to your hospital policy. You require:

- standard sphygmomanometer.
- sterile 10cc syringe with heparinised solution.
- 3-way stopcock.
- approximately 25cm of tubing.

Making the Pressure Calibration

WARNING Never perform the invasive pressure calibration while a patient is being monitored.

- 1 Zero the transducer.
- 2 Connect the syringe and manometer.
 - a. Attach the tubing to the manometer.
 - b. Connect the 3-way stopcock to the stopcock that is not connected to the patient catheter when you measure a patient.
 - c. Attach the syringe to one port and the manometer tubing to the other port.
 - d. Open the port to the manometer.

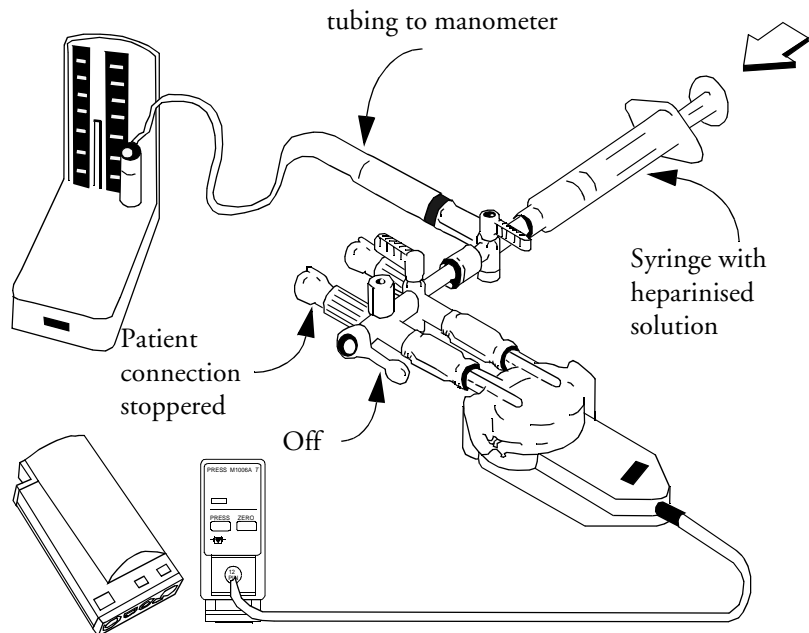

- 3 Move the syringe barrel in and raise the mercury to 200mmHg (30kPa). 200mmHg is the recommended calibration pressure.
- 4 In the **Setup Pressure** menu, select **Cal. Press.**

- 5 Select the calibration pressure from the list, for example 200 mmHg.
- 6 Select **Confirm** to recalculate the calibration factor using the applied pressure.
- 7 When the monitor displays **<Press> calibration done at <date and time>**, remove the manometer tubing, syringe and extra stopcock. We recommend you replace the transducer dome and tubing with sterile ones.
- 8 Label the transducer with the calibration factor shown in the **Cal. Factor** field in the pressure's setup menu.
- 9 Reconnect the patient and start measuring again.

Troubleshooting the Pressure Calibration

The status line lists the probable cause of an unsuccessful calibration.

Message	Corrective Action
unable to calibrate - equipment malfunction	Contact your service department. The pressure hardware is faulty.
unable to calibrate - out of range	Make sure that you have selected the value for Cal. Press that you are applying to the transducer, and repeat the calibration.
unable to calibrate - no transducer	Make sure that the transducer is connected and try again.
unable to calibrate - unstable signal	Make sure there are no disturbances to the transducer, and repeat the calibration.
unable to calibrate - perform zero first	No valid zero. Zero the transducer.

Calculating Cerebral Perfusion

The monitor can calculate the difference between mean arterial pressure and the intracranial pressure. The difference is labeled CPP.

- 1 In the **Main Setup** menu, select **Measurements**.
- 2 In the **Setup CPP** menu, select **ABE, ART, Ao, BAP** or **FAP** as the arterial pressure source.

Calculating Pulse Pressure Variation

Note: The derived measurement Pulse Pressure Variation is not available in the USA.

Pulse Pressure Variation (PPV) is calculated from beat-to-beat arterial pressure values. Pulse pressure is the difference between the systolic and the diastolic pressure values for a single beat. The average variation in pulse pressure is calculated over periods of 32 seconds.

-
- WARNING** • This monitor can calculate PPV from beat-to-beat values of any arterial pulsatile pressure. The circumstances under which the calculation of a PPV value is clinically meaningful, appropriate and reliable must be determined by a physician.

- The clinical value of the derived PPV information must be determined by a physician. According to recent scientific literature, the clinical relevance of PPV information is restricted to sedated patients receiving controlled mechanical ventilation and mainly free from cardiac arrhythmia.

To select an arterial pressure as PPV source:

- 1 In the **Main Setup** menu, select **Measurements**.
- 2 In the **Setup PPV** menu, select **ABP, ART, Ao, BAP, P** or **FAP** as the arterial pressure source.

CAUTION Older measurement servers cannot supply a beat-to-beat arterial pressure value. In this case the monitor shows a **NO PPV FROM <Server> INOP**.

At respiration rates below 8 rpm, PPV calculation may lead to inaccurate values.

Measuring Pulmonary Artery Wedge Pressure

Pulmonary Artery Wedge Pressure (PAWP) values, used to assess cardiac function, are affected by:

- Fluid status
- Myocardial contractility
- Valve and pulmonary circulation integrity

Obtain the measurement by introducing a balloon-tipped pulmonary artery flotation catheter into the pulmonary artery. When the catheter is in one of the smaller pulmonary arteries, the inflated balloon occludes the artery allowing the monitor to record changes in the intrathoracic pressures that occur throughout the respiration cycle. The pulmonary wedge pressure is the left ventricular end diastolic pressure (preload).

The most accurate PAWP values are obtained at the end of the respiration cycle when the intrathoracic pressure is fairly constant. Use the ECG waveform to determine the waveform of the wedge pressure. You can use the respiration waveform as a reference when assessing the PAWP waveform, to ensure constant measurement timing relative to the respiratory cycle. The monitor displays the PAWP value for up to 48 hours or until you admit a new patient.

WARNING The **pressure receptor** in the catheter records pressure changes that occur only in front of the occlusion. Even though the catheter tip is in the pulmonary artery, the receptor records pressure changes transmitted back through the pulmonary circulation from the left side of the heart.

While performing the wedge procedure, the monitor switches off the pressure alarms for pulmonary artery pressure (PAP).

Due to a slight measurement delay, you should not use Microstream (sidestream) CO₂ as a direct reference for determining the end expiratory point in the pressure curve.

To start the Wedge procedure,

- 1 In the **Main Setup** menu, select **Wedge** to display the wedge procedures window.
- 2 Prepare and check the pressure line according to your hospital policy. If the PAP waveform scale is set to **Optimum** prior to the wedge procedure, it is possible that after wedging the catheter, the resulting pressure waveform will fall below the lower scale. In this case, the wedge waveform will

not be displayed or recorded properly. To avoid this, switch out of optimum scale before performing a wedge procedure.

- 3 Use the **Reference Wave 1** and **2** popup keys to select any ECG or respiratory wave as reference waves.
- 4 Select **Wave Speed** if you want to synchronize all displayed waves to your preferred speed.
- 5 Inflate the balloon when the monitor prompts you: **Ready for balloon inflation**. The waveform changes from the PAP to the PAWP wave. The measurement takes approximately 12 seconds. On completion, the monitor stores the PAWP waveform display and prompts you to deflate the balloon. If the monitor cannot detect a wedging waveform you must use **Store Trace** to store the wedge and two reference waves manually.
- 6 Deflate the balloon when the monitor prompts you: **Ready for balloon deflation** and verify that the waveform returns to pulmonary artery shape.
- 7 If you need to start a new measurement, select **Restart Wedge**.

Editing the Wedge

- 1 Select the **Edit Wedge** pop-up key to see the stored waveforms.
- 2 The monitor displays a cursor in the waveform at the PAWP mean value. It also displays any previously stored value and the time it was stored.
- 3 Move the cursors up, down, right and left to set them on the correct wedge position.
- 4 Select **Store Wedge** to store the PAWP value.
- 5 Select **Print Wedge** to print the PAWP waveform and any reference waves or **Record Wedge** to record them. While recording or printing, you cannot perform any more Wedge tasks.

WARNING Prolonged inflation can cause pulmonary hemorrhage, infarction or both. Inflate the balloon for the minimum time necessary to get an accurate measurement.

If the pulmonary artery flotation catheter drifts into the wedge position without inflation of the balloon, the pulmonary artery pressure waveform assumes a wedged appearance. Take appropriate action, in accordance with standard procedures, to correct the situation.

If the PAWP (mean) is greater than the PAP (systolic), deflate the balloon and report the incident in accordance with hospital policy, because the pulmonary artery could be accidentally ruptured, and the wedge value derived will not reflect the patient's hemodynamic state, but will merely reflect the pressure in the catheter or balloon.

Identifying the Pressure Analog Output Connector

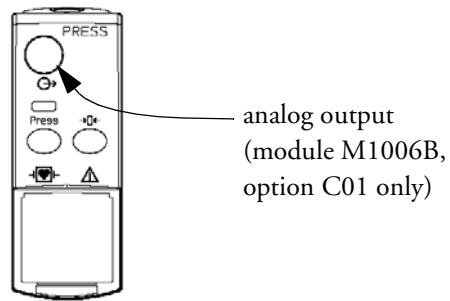

Monitoring Cardiac Output

The Cardiac Output (C.O.) measurement invasively measures cardiac output and other hemodynamic parameters using a technique called thermodilution. This can be used to determine the flow rate of a system by introducing a cold solution into the system and measuring the resulting drop in temperature at a downstream site. The temperature change is displayed as a curve in the C.O. procedure window, and the monitor calculates the C.O. value from this curve. The C.O. value is inversely proportional to the area under the curve. As cardiac output varies continuously, a series of measurements must be carried out to achieve a reliable C.O. average value. Always use the average of multiple thermodilution measurements for therapy decisions.

The measurements can be carried out using the right heart thermodilution method or the PiCCO method (transpulmonary thermodilution).

- The right heart method is available with
 - C.O. module M1012A, standard and option #C10
 - M3012A Hemodynamic Measurement Server Extension, options #C05 and #C10
 - M3014A Capnography Measurement Server Extension, option #C05 and #C10
- The PiCCO method is available with
 - C.O. module M1012A, option #C10
 - M3012A Hemodynamic Measurement Server Extension, option #C10
 - M3014A Capnography Measurement Server Extension, option #C10

The PiCCO method additionally lets you measure Continuous Cardiac Output (CCO) by performing pulse contour analysis on the blood pressure waveform.

Hemodynamic Parameters

This table illustrates the hemodynamic parameters available with each method, whether they are measured continuously, and whether they can be shown on the monitor's resting display or in the HemoCalc Window.

Measured and Calculated Hemodynamic Parameters and Indexes	PiCCO Method (Transpulmonary Thermodilution)			Right Heart Thermodilution		
	Continu ous?	Resting Display	HemoCalc Window	Contin uous?	Resting Display	HemoCalc Window
Blood Temperature (Tblood)	Y	Y	N	Y	Y	N
C.O./C.I.: Cardiac Output	N	Y	Y	N	Y	Y
CCO/CCI: Continuous Cardiac Output	Y	Y	Y (in the C.O. field)	Not available		
SVR/SVRI: Systemic Vascular Resistance	N and Y	Y	Y	N	N	Y
SV/SI: Stroke Volume/SV Index	N and Y	Y	Y	N	N	Y
SVV: Stroke Volume Variation	Y	Y	N	Not available		
*dPmax: Left Ventricular Contractility Index	Y	Y	N	Not available		
CFI: Cardiac Function Index	N	Y	N	Not available		
ITBV/ITBVI: Intrathoracic Blood Volume	N	Y	Y	Not available		
*EVLW/EVLWI: Extravascular Lung Water	N	Y	Y	Not available		
*GEDV/GEDVI: Global End-Diastolic Volume	N	Y	Y	Not available		
PVR/PVRI: Pulmonary Vascular Resistance	Not available			N	N	Y
LCW/LCWI: Left Cardiac Work	N	N	Y	N	N	Y
RCW/RCWI: Right Cardiac Work	Not available			N	N	Y
RVSW/RVSWI: Right Ventricular Stroke Work	Not available			N	N	Y

* currently not available in the U.S.A or in clinical environments under FDA control.

Using the C.O. Procedure Window

The C.O. procedure window displays up to six trials (measurement curves) with the trial number and the C.O. value under the thermomodulation curve. When you open the window, a line of pop-up keys automatically appears to let you carry out C.O.-related tasks. This example shows the procedure window for the transpulmonary (PiCCO) Method. The window may be configured to look slightly different on your monitor.

To open the C.O. procedure window,

- ◆ Select **Cardiac Output** in the **Setup C.O.** or **Setup CCO** menu, or
- ◆ Select the **Cardiac Output** SmartKey on the Screen, if configured, or
- ◆ Press the **START** hardkey on the front of the C.O. plug-in module, if available, or
- ◆ Press a remote start switch, if you are using one.

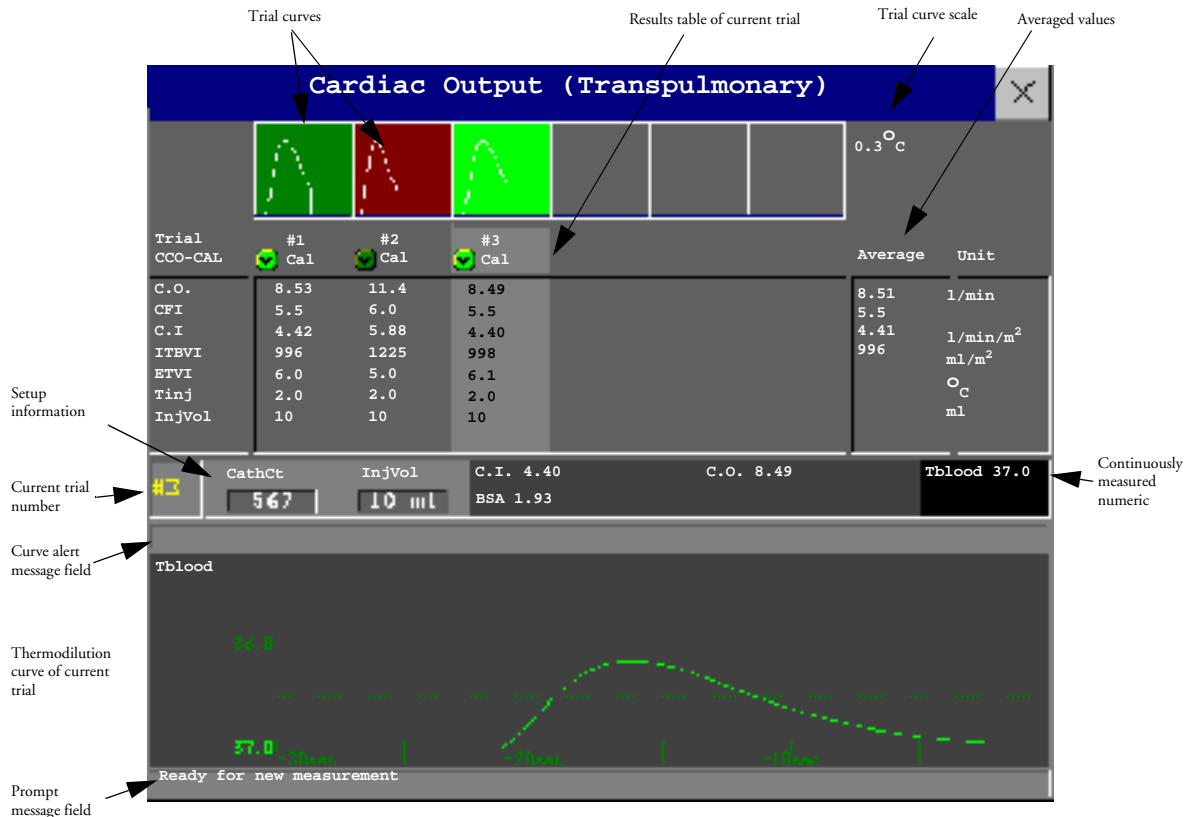

Start C.O.	Stop C.O.	Select Trial	Accept/Reject	Save C.O. & Cal CCO	Print/Record	Table Contents	Hemo Calc	Change Scale	Setup C.O.
------------	-----------	--------------	---------------	---------------------	--------------	----------------	-----------	--------------	------------

- ◆ To change the measurement parameters shown in the results table of the C.O. procedure window, select the **Table Contents** pop-up key and choose from the list of available parameters.
- ◆ To view the currently-used temperature unit, see the “grayed-out” setting **Temperature Unit** in the **Setup C.O.** menu. This setting can only be changed in Configuration Mode.
- ◆ The Cardiac Output screen element may be configured to display permanently on a specially designed Screen. Selecting the screen element opens the cardiac output pop-up keys.

Accessing the Setup C.O. and Setup CCO Menus

C.O. settings can be changed in the **Setup C.O.** menu. To access this menu,

- ◆ press the C.O. hard key on the C.O. module
- ◆ select any of the discontinuous C.O. numerics (for example, C.O., C.I.) on the screen.

CCO/CCI settings can be changed in the **Setup CCO** menu. To access this menu,

- ◆ select any of the continuously measured hemodynamic numerics (CCO, CCI.) on the screen.

Entering the HemoCalc Window

- ◆ From the C.O. procedure window, select the pop-up key **HemoCalc** to open the HemoCalc window.

Measuring C. O. Using the PiCCO Method

The PiCCO method combines transpulmonary thermodilution and pulse contour analysis on the blood pressure waveform. A fluid with a known volume and temperature is injected into the right atrium through a CVP catheter. The injectate bolus mixes with the blood in the heart and the change in blood temperature is measured with a thermistor at the distal end of an arterial catheter placed in one of the bigger systemic arteries, for example, the femoral or the axillary artery.

The PiCCO Method requires a pressure measurement made using either the M1006B Pressure module, or a M3001A MMS, or a measurement server extension M3015A, M3014A, or M3012A. (A VueLink pressure may not be used.) You will also need a conventional central venous (CVP) line and an arterial catheter from Pulsion Medical Systems. You must use the approved catheters and puncture locations.

Measuring Continuous Cardiac Output

Every time C.O. is measured with the PiCCO method, the monitor uses this C.O. value and the result of the pulse contour analysis to calculate a patient-specific calibration factor. The monitor uses this value to compute CCO and the other continuous hemodynamic parameters. CCO values are calculated on a beat-to-beat basis and then averaged over a 12-second time frame. The calculated values are displayed as numerics on the monitor screen.

Measuring Systemic Vascular Resistance

The monitor uses CCO, an arterial pressure, and CVP to calculate a continuous SVR value. If a continuously measured CVP value is not available, the monitor uses a preset, static CVP value to calculate the SVR (you will see the INOP message **SVR SET CVP USED**). If the BSA is available, the monitor uses the CCI to calculate the SVRI.

SVR/SVRI settings can be changed in the **Setup SVR/SVRI** menu. To enter the menu, select -> **Main Setup -> Measurements -> SVR** or **SVRI**.

To display a SVR/SVRI numeric on the Screen, select any numeric, then select **Change Numeric** and select **SVR** or **SVRI** from the list of available numerics.

Setting Up the PiCCO C.O. Measurement

- 1 Set up the arterial line using the arterial catheter (transpulmonary catheter) and the transducer kit from Pulsion Medical Systems. It must be placed in one of the bigger systemic arteries, for example, the femoral or the axillary artery. You must use the approved catheters and puncture locations.
- 2 Set up the central venous line.
- 3 Connect the injectate temperature probe housing to the venous line.
- 4 Plug the C.O. interface cable into the C.O. module or measurement server extension and connect the following devices to the C.O. interface cable:
 - Injectate temperature probe
 - Thermistor connector
 - Remote start switch (if used).

Follow your hospital standards to avoid unintentional extraction of the C.O. catheter. Secure the cable using the mounting clip shipped with each C.O. interface cable. You may also find it helpful to loop the C.O. interface cable, tape the loop, and attach it to the undersheet of the patient's bed using a safety pin.

- 5 If you are measuring CCO, set up the pressure measurement now. The CCO measurement requires a minimally dampened invasive pressure setup. You must ensure that there are no air bubbles in the pressure line or dome and use only specified accessories.
- 6 Check that the correct measurement method is selected.
If a catheter is already connected to the Cardiac Output Interface Cable, the monitor automatically recognizes the method used. If not, in the **Setup C.O.** menu, select **Method** and then select **Transpulmonary**.
- 7 Check that the **Tinj Probe Type** setting in the **Setup C.O.** menu matches the type of injectate temperature probe used. The probe type is usually printed on the plug of the probe.
To change the probe type, in the **Setup C.O.** menu, select **Tinj Probe Type** to call up a list of available probes.
 - **23001**: it is recommended to use this probe with cold injectate
 - **M1646**: this probe can be used with room temperature injectate or with cold injectate.

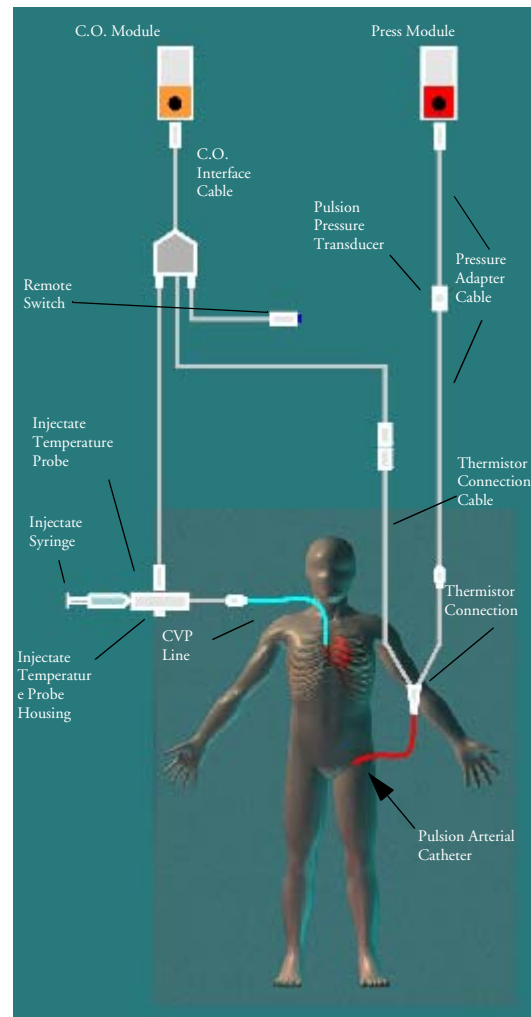

- 8 Check that the correct arterial catheter constant is selected.
If the catheter is recognized by the monitor, the catheter constant is automatically displayed and cannot be changed manually. If it is not recognized, in the C.O. procedure window, select **CathCt** and use the pop-up keypad to enter the correct value. The catheter constant is usually written either on the catheter or on the catheter packaging.
- 9 Make sure that the injectate volume setting matches the injectate volume you will use. To change the volume, in the C.O. procedure window, select **InjVol** and select the correct injectate volume from the pop-up list.
If there is a problem with the volume or temperature you have chosen, the monitor will issue a curve alert message to inform you of this.
- 10 If you are measuring CCO or CCI, check that the correct pressure source is selected in the **Setup CCO** menu. The pressure label under **CCO from** must match the pressure measured with the arterial catheter. To change the pressure source, select **CCO from** to call up a list of available pressure labels and select the correct label.
- 11 If you are measuring CCO or CCI, verify that the correct alarm source is selected in the menu item **Alarms From**. To change the alarm source, select **Alarms From** and choose either **CCO** or **CCI**.

Performing PiCCO C.O. Measurements

Always wait for the monitor to indicate readiness for the next step before proceeding.

If you are measuring CCO, all measurements should be conducted within 15 minutes. Older measurements “expire” for CCO calibration.

- 1 Enter the C.O. procedure window.
- 2 When you see the message **...Ready for new measurement**, start the measurement by selecting the pop-up key **Start C.O.** or pressing the Start hardkey on the C.O. module, or pressing the remote start switch.
- 3 When you hear the ready tone and see the message **...Stable baseline, inject now!**, inject the solution into the CVP catheter.
At the end of the measurement the thermodilution curve, cardiac output, index values, ITBV and EVLW values and any curve alerts are displayed and a message will appear **...Wait before starting new measurement**.
- 4 When you see the **...Ready for new measurement** message, repeat the procedure until you have completed the measurements you want to perform. You can perform a maximum of 6 measurements before editing. If you perform more than 6 measurements without rejecting any, the oldest will automatically be deleted when a 7th curve is stored.

Editing PiCCO C.O. Measurements

It is important to identify and reject erroneous trials, as the monitor uses all the measurement trial values you do not reject to calculate the averaged cardiac output.

- 1 Review the trials. Irregular trials or trials marked with a “?” should be reviewed carefully. Consider the similarity of the values and the shape of the C.O. curve. A normal C.O. curve has one smooth peak and returns to the temperature baseline level after the peak.
- 2 Reject unsatisfactory trials: use the **Select Trial** pop-up key to move between trials, then select the **Accept Reject** pop-up key to accept or reject trials. If you are using a touch screen

you can accept or reject trials directly by tipping on the trial curve. Discard conspicuously different values. The background of rejected trials is red and the background of accepted trials is green. The monitor recalculates the average values after you reject or accept trials.

If all values are different from each other, there may be true hemodynamic instability caused, for example, by severe cardiac arrhythmia.

Saving and Calibrating PiCCO C.O. Measurements

When you have finished editing the trials, you must save the results. This closes the measurement series, sends the average C.O. numeric to be displayed on the main screen, and stores the averaged values in the trends and calculations databases.

Before the monitor can calculate CCO, you must calibrate the measurement. You should also calibrate CCO every eight hours, or if the hemodynamic condition of the patient changes consistently in the same direction over 15 minutes, or if there are large or sudden changes in the patient's condition.

The monitor only uses C.O. measurements from within the last 15 minutes for calibrating CCO.

To save and calibrate,

- ◆ In the C.O. procedure window, select the pop-up key **Save C.O. & Cal CCO** to use the averaged C.O. value to calibrate Continuous Cardiac Output (CCO).

Your monitor may be configured to have two separate pop-up keys, **Save C.O.** and **Cal CCO**, instead of the combined **Save C.O. & Cal CCO**.

WARNING CCO calibration is patient-specific. When the C.O. module or measurement server extension is plugged in after the patient has changed, make sure that the correct CCO calibration is used. When in doubt perform a new CCO calibration first.

CCO Calibration Status Indicators

Each measurement trial is tagged with a calibration status indicator next to its trial number. Reflecting the quality of the pressure signal during the thermodilution measurement, this tag indicates each trial's validity to be used in a CCO calibration.

For a trial to be eligible for calibration, the pressure signal must be continuously available and undisturbed starting 30 seconds before the first C.O. measurement of the series. Do not zero the pressure measurement, change the pressure label, or disturb the pressure signal in any other way during this time.

CAL	A pressure signal for CCO was available during the measurement (valid for calibration)
?CAL	A disturbed pressure signal for CCO was available during the measurement (valid for calibration)
N/A	No adequate pressure signal for CCO was available during the measurement (no valid calibration data)
EXP	This trial is more than 15 minutes older than the most recent trial and has expired for CCO calibration (no valid calibration data)

Measuring C.O. Using the Right Heart Thermodilution Method

In the right heart thermodilution method, a fluid of known volume and temperature is injected into the right atrium through the proximal port of a pulmonary artery (PA) (Swan-Ganz) catheter. The injectate bolus mixes with the blood in the right ventricle and the change in blood temperature is measured with a thermistor at the distal end of the catheter in the pulmonary artery.

Setting up RH C.O. Measurements

- 1 Set up the PA line using a PA catheter.
- 2 Attach the injectate temperature probe housing to the PA line.
- 3 Plug the C.O. interface cable into the C.O. module or measurement server extension and connect the following devices into the C.O. interface cable:
 - injectate temperature probe
 - remote start switch (if used).

Follow your hospital standards to avoid unintentional extraction of the C.O. catheter. Secure the cable using the mounting clip shipped with each C.O. interface cable. You may also find it helpful to loop the C.O. interface cable, tape the loop, and attach it to the undersheet of the patient's bed using a safety pin.

- 4 Plug the thermistor connection cable of the PA catheter into the thermistor connector.
- 5 Connect the injectate temperature probe to the injectate temperature probe housing.
- 6 Check that the correct measurement method is selected.

If a catheter is already connected to the Cardiac Output Interface Cable, the monitor automatically recognizes the method used. If not, in the **Setup C.O.** menu, select **Method** and then select **Right Heart**.

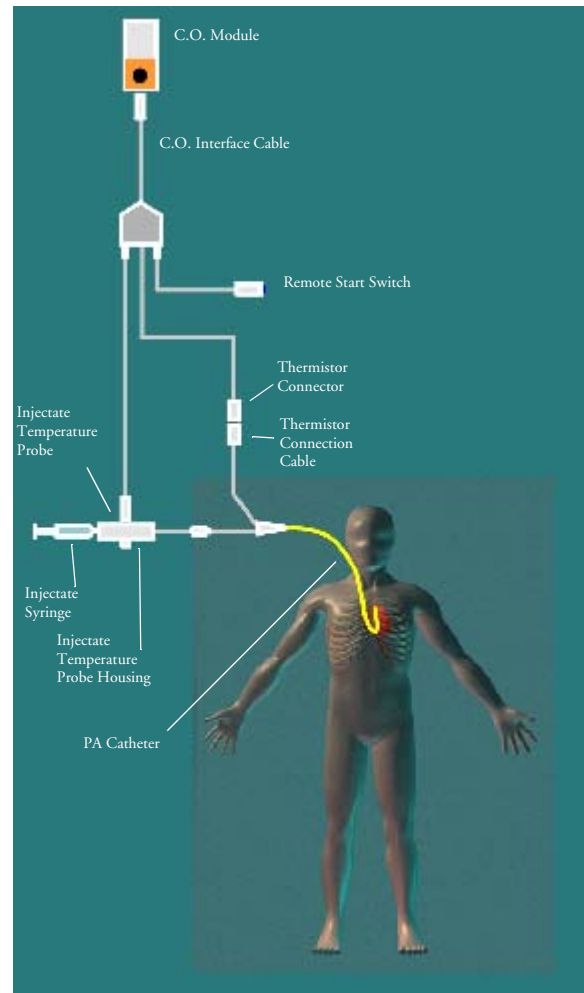

Ice-Bath Setup for RH Thermodilution C.O. Measurements

If you are using the flow-through method illustrated above, the injectate temperature is measured at the time of injection by the temperature probe in the injectate temperature probe housing.

If you are using the ice-bath setup, the injectate temperature probe and the injectate are both placed in an ice-bath and the probe measures the temperature of the contents of the ice bucket.

Setting the Computation Constant

Check that the correct **Computation Constant** is entered in the C.O. procedure window. This can be found in the documentation supplied with the catheter and is based on the injectate volume, injectate temperature and catheter type. To change the value, in the C.O. procedure window, select **Computation Constant** and use the pop-up keypad to enter the correct value.

Performing RH C.O. Measurements

- 1 Enter the C.O. procedure window.
- 2 When you see the message **...Ready for new measurement**, select the pop-up key **Start C.O.**
- 3 When you hear a ready tone and see the message **...Inject now!**, inject the solution into the right atrial port of the Swan-Ganz catheter. The optimal injection rate is 2.5 ml/second.
At the end of the measurement the thermodilution curve, cardiac output, index values and curve alerts (if necessary) are displayed and a message will appear **...Wait before starting new measurement**.
- 4 When you see the **...Ready for new measurement** message, repeat the procedure until you have completed the measurements you want to perform. You can perform a maximum of six measurements before editing. If you perform more than six measurements without rejecting any, the oldest will automatically be deleted when a seventh curve is stored.

Editing and Saving RH C.O. Measurements

It is important to identify and reject erroneous measurements (called “trials”), as the monitor uses all the measurement trial values you do not reject to calculate the averaged cardiac output.

- 1 Review the trials. Irregular trials or trials marked with a “?” should be reviewed carefully. Consider the similarity of the values and the shape of the C.O. curve. A normal C.O. curve has one smooth peak and returns to the temperature baseline level after the peak.
- 2 Reject unsatisfactory trials: use the **Select Trial** pop-up key to move between trials, then select the **Accept Reject** pop-up key to accept or reject trials. If you are using a touch screen you can accept or reject trials directly by tipping on the trial curve. Discard conspicuously different values. The background of rejected trials is red and the background of accepted trials is green. The monitor recalculates the average values after you reject or accept trials.
If all values are different from each other, there may be true hemodynamic instability caused, for example, by severe cardiac arrhythmia.
- 3 Save average C.O. values. To close a measurement series, you must save the average values by selecting the pop-up key **Save C.O.** This sends the average C.O. numeric to be displayed on the main screen, and stores the averaged values in the trends and calculations databases.

Documenting C.O. Measurements

You can document C.O. measurements on the default printer or recorder.

- 1 In the C.O. procedure window, select the pop-up key **Print/Record**.

- 2 From the pop-up list, choose:
 - **Print Results** to print the contents of the C.O. procedure window
 - **Record Results** to record the contents of the C.O. procedure window
 - **Record Trial** to send an individual trial curve to the recorder.

C.O. Injectate Guidelines

The greater the injectate volume and the colder the temperature, the more accurate the measurement. Reduced injectate volume or higher injectate temperature may reduce the specified accuracy.

For adult patients, to ensure the greatest measurement accuracy, use a cold injectate ($< 8^{\circ}\text{C}$) of 10 ml volume, if not contra-indicated by the patient's condition. Your choice of injectate volume should be based on the injectate temperature and the patient's cardiac output.

Guidelines for Right Heart Thermodilution C.O. Injectate

If you are using the right heart thermodilution method, the use of injectate with a temperature less than 8°C lower than the blood temperature may cause incorrect values for the thermodilution.

Guidelines for PiCCO C.O. Injectate

If you are using the PiCCO method, the use of injectate with a temperature less than 12°C lower than the blood temperature may cause incorrect values for the thermodilution and CCO calibration.

Injectate Volume, Patient Weight and ETVI Values (PiCCO Only)

When deciding on an injectate volume and temperature, you must consider your patient's weight and extra-vascular thermal volume index (ETVI).

High ETVI: The dilution of injectate is influenced by extravascular tissue and fluid. The accuracy of the PiCCO method may be reduced in patients with high extra-vascular thermal volume index (ETVI) values. Use the table below as a guide in selecting the correct injectate temperature. As shown in the table, if your patient has an $\text{ETVI} > 10$, you must use cold injectate.

Weight: Use the table below as a guide in choosing an injectate volume appropriate for the patient weight.

Patient Weight	Cold Injectate		Room Temperature Injectate	
	ETVI < 10	ETVI \geq 10	ETVI < 10	ETVI \geq 10
< 3 kg	2 ml	2 ml	3 ml	Use cold injectate
< 10 kg	2 ml	3 ml	3 ml	
< 25 kg	3 ml	5 ml	5 ml	
< 50 kg	5 ml	10 ml	10 ml	
< 100 kg	10 ml	15 ml	15 ml	
\geq 100 kg	15 ml	20 ml	20 ml	

C.O./CCO Curve Alert Messages

After each measurement trial, the monitor analyzes the thermodilution curve. If the curve appears abnormal, a curve alert message appears in the C.O. procedure window. A question mark symbol (“?”) may appear next to the cardiac output numeric if any of these messages appear. The curve alert messages are not error messages and do not necessarily mean that the measured values are invalid.

C.O./CCO Curve Alert Messages	Possible Causes
Tinj off scale	The Tinjectate is out of the range -1°C and 30°C. Cool down or heat up the injectate or change the injectate solution and repeat the measurement.
Noisy Baseline	<p>A blood temperature baseline drift that could not be compensated was detected during the C.O. measurement. Possible causes are:</p> <ul style="list-style-type: none"> - Interference may be caused by a ventilator. - Interference may be caused by an infusion pump: infusions of significant volume through the central line should be paused at least 30 seconds before the first thermodilution measurement in a series and should not recommence until the measurement series is completed. - Do not administer injections through the central line during a measurement series. - Electrical devices in the vicinity can cause interference: check for infusion pumps connected to the central catheter, cables parallel to the thermodilution cable, electrocautery. Make sure all devices are properly grounded. - Wait until measurement results are displayed before moving the patient or catheter. - Close the stopcock to the injectate syringe after the injection. - Do not rinse the catheter during measurement, to avoid temperature fluctuations.
Temperature Baseline Drift	May occur if patient is recovering from open heart surgery, or if patient was cooled down for surgery and is in the process of regaining normal body temperature when the measurement is made.
Small signal, more indicator required	The peak of the transpulmonary thermodilution curve was below 0.1°C. Increase injectate volume and/or lower injectate temperature.
Injectate Temperature too High	The difference between the blood and injectate temperatures is too small. The calculated value for C.O. may not be accurate.
High ETVI, use cold injectate or greater inj. volume	The ETVI value is too high. The accuracy of the transpulmonary thermodilution measurement may be reduced. Increase injectate volume and/or lower injectate temperature following the guidelines given in the section “Guidelines for PiCCO C.O. Injectate” on page 170.
Disturbed Injection	The injection should be performed quickly and with a steady pressure. Shaking, unsteady pressure, or injections that take longer than six seconds may cause this message to appear; you should bear this in mind if you are using a large injectate volume (> 10 ml).

C.O./CCO Curve Alert Messages	Possible Causes
Check Injectate Temperature Probe Type	The recorded Tinj signal is uncharacteristic for the M1646 injectate temperature probe. The probe may be defective or an incorrect probe type may have been used.
Unsteady Baseline	There is a noisy baseline, and thermal baseline drift.
Multiple Peaks	Caused by faulty injection technique.
Abnormal Decay Time	May be caused by low cardiac output. Calculated value for C.O. may not be accurate.
Very Long Curve	The decay time of the curve is longer than 15 seconds.
Very Short Curve	Decay time of the curve is less than 0.5 seconds. If there is a noisy baseline, part of the baseline may have been mistaken for a thermodilution curve. Calculated value for C.O. may not be accurate.
Irregular Curve	Any combination of curve alert messages.
Delayed Injection	Injection is given more than 15 seconds after Start C.O. is selected. Calculated value for C.O. may not be accurate.

If you have followed all of these guidelines, your measurement values should be valid, even if you still see a curve alert message. Ensure that at least three subsequent measurements within the current series do not differ by more than 15%. If the difference exceeds 15%, use your clinical judgement to determine the appropriate intervention.

C.O./CCO Prompt Messages

Prompt messages appear in the C.O. procedure window if a C.O. measurement trial must be terminated.

C.O./CCO Prompt Messages	Possible Causes
Curve Below Baseline, measurement terminated	May be caused by thermal baseline drift. No C.O. value calculated.
Excessive Curve Height, measurement terminated	The curve exceeds the upper limit. This may be caused by an injectate that was too cold. No C.O. value calculated.
Unstable Baseline, injection not recommended	The baseline is unstable. Wait until the baseline is stable before injecting. If this does not occur within a reasonable time, injection is possible but the accuracy of the measured values may be reduced.
Excessive baseline drift, don't inject now	No measurement is possible. Measured values are incorrect.

C.O./CCO Warning Messages

Warning messages contain important information about the C.O. measurement.

C.O./CCO Warning Messages	Possible Causes
Next measurement erases older curve	Six curves are stored, this is the maximum possible. If another measurement is stored, the oldest thermodilution curve will be erased.
Previous C.O. Setup Data replaced	A C.O. module or measurement server extension has been plugged in with different C.O. setup data from the previous data. The new C.O. setup data is read from the new C.O. device, and replaces the current data. The message disappears when the Start C.O. pop-up key is pressed.
Verify the C.O. Setup Data	A new transpulmonary thermodilution catheter has been connected to the C.O. Interface Cable.
Check arterial pressure, CCO cal currently not possible	Poor or invalid pressure signal, for example if pressure was not zeroed.
Verify the Computation Constant	A new catheter has been plugged in, or the computation constant has been changed and Start C.O. has not been selected.
Previous Comp. Constant replaced	A new C.O. module or measurement server extension with a different computation constant from the current one has been connected. The new computation constant is read from the new C.O. device, and replaces the current one. The message disappears when Start C.O. is selected.

C.O./CCO Safety Information

WARNING **Catheter constant:** Make sure that the arterial catheter constant for the measurement is appropriate to the catheter used.

Computation Constant: Make sure that the computation constant for the measurement is appropriate to the injectate volume, injectate temperature and catheter type used.

IABP: Do not perform transpulmonary thermodilution measurements on patients undergoing IABP treatment.

CCO accuracy: Accuracy of the CCO measurement and all the derived values may be influenced by patients with valve diseases or artificial valves.

C.O. and MRI: Do not use the Cardiac Output Interface Cable in Magnetic Resonance Imaging (MRI) Applications.

Aortic graft patients: Do not use an arterial catheter in the arteria femoralis when it is contra indicated, for example, with patients who have an aortic graft.

CAUTION During the cardiac output measurement procedure the blood temperature alarms are inactive. This is indicated by a crossed-out alarm symbol next to the temperature numeric. Making alarms inactive during this procedure prevents false alarms. The alarms are automatically reactivated when you have completed the measurement procedure.

Monitoring Carbon Dioxide

Use the CO₂ measurement to monitor the patient's respiratory status and to control patient ventilation.

There are two methods for measuring carbon dioxide in the patient's airway:

- Mainstream measurement uses a CO₂ sensor attached to an airway adapter directly inserted into the patient's breathing system. This method is available with the M3014A Capnography Extension and the M3016A Mainstream Extension to the M3001A Multi-Measurement Server.
- Sidestream measurement takes a sample of the respiratory gas with a constant sample flow from the patient's airway and analyzes it with a remote CO₂ sensor built into the measurement system. Philips offers the sidestream CO₂ measurement in the M3014A Capnography Extension and the Microstream method of sidestream CO₂ measurement in the M3015A Microstream CO₂ Measurement Extension.

In both cases, the measurement principle is infrared transmission, where the intensity of infrared light passing the respiratory gas is measured with a photo detector. As some of the infrared light is absorbed by the CO₂ molecules, the amount of light passing the gas probe depends on the concentration of the measured CO₂.

When using a wet ventilator circuit, monitor mainstream CO₂ if available, in preference to sidestream CO₂.

The partial pressure is calculated from the gas concentration by multiplying the concentration value with the ambient pressure.

The measurement provides:

- a CO₂ waveform.
- an end tidal CO₂ (etCO₂) value: the CO₂ value measured at the end of the expiration phase.
- an inspired minimum CO₂ (imCO₂): the smallest value measured during inspiration.
- an airway respiration rate (awRR): the number of breaths per minute, calculated from the CO₂ waveform.

Depending on the **Max Hold** setting configured for your monitor, the etCO₂ numeric shows either the highest CO₂ value measured within the configured time period (**Max Hold** set to **10 sec** or **20 sec**) or the etCO₂ numeric shows breath-to-breath value (**Max Hold** set to **Off**).

Refer to your Gas Module Instructions for Use, if you are using a Gas Module to monitor CO₂.

-
- WARNING** **Correlation:** The etCO₂ readings do not always correlate closely with paCO₂, especially in neonatal patients and patients with pulmonary disease, pulmonary embolism or inappropriate ventilation.
- Pharmaceuticals in aerosols:** Do not measure CO₂ in the presence of pharmaceuticals in aerosols.
- Explosion Hazard:** Do not use in the presence of flammable anesthetics, such as a flammable anesthetic mixture with air, oxygen or nitrous oxide. Use of the devices in such an environment may present an explosion hazard.
- Failure of operation:** if the measurement extension or a sensor fails to respond as described, do not use it until the situation has been corrected by qualified personnel.
- Low etCO₂ values:** Leakages in the breathing system or sampling system may cause the displayed etCO₂ values to be significantly too low. Always connect all components securely and check for leaks according to standard clinical procedures. Displacement of the nasal or combined nasal oral cannulas can cause lower than actual etCO₂ readings. Even with combined nasal oral cannulas, the etCO₂ readings may be slightly lower than actual in patients breathing through the mouth only.
-

Using the Capnography Extension (M3014A)

The M3014A Capnography Extension measures partial pressure of carbon dioxide in a patient's expired gas using the mainstream method or the sidestream method. The mainstream CO₂ measurement can be used, with appropriate accessories, with intubated adult, pediatric and neonatal patients. The sidestream CO₂ measurement can be used, with appropriate accessories, with intubated and nonintubated adult, pediatric and infant patients. With intubated patients, a sample of the respiratory gas is drawn from the patient's breathing circuit through an airway adapter and a gas sampling tube. With non-intubated patients, the gas sample is drawn through a nasal or oral-nasal cannula.

-
- WARNING** **Altitude Setting:** The monitor is not equipped with automatic barometric pressure compensation. Before the CO₂ measurement is used for the first time, the altitude must be set to the correct value. An incorrect altitude setting will result in incorrect CO₂ readings. The CO₂ readings will typically deviate 5% for every 1000m difference.
- Electrical Shock Hazard:** Do not open the measurement extension. Contact with exposed electrical components may cause electrical shock. Always turn off and remove power before cleaning the sensor or measurement server. Do not use a damaged sensor or one with exposed electrical contacts. Refer servicing to qualified service personnel.
-

-
- CAUTION** Use the M3014A measurement extension with Philips approved accessories only. Refer to the instructions for use provided with the accessory.
-

Preparing to Measure Mainstream CO₂

You must perform a zero as described in this procedure each time you use a new airway adapter.

- 1 Attach the sensor connector to the CO₂ connector on the measurement extension.
- 2 Wait 2 minutes, allowing the sensor to reach its operating temperature and a stable thermal condition.

- 3 Choose the appropriate airway adapter and connect it to the sensor head. The airway adapter clicks into place when seated correctly.
- 4 To zero the sensor:
 - expose the sensor to room air and keep it away from all sources of CO₂ including the ventilator, the patient's breath and your own.
 - in the setup menu for the CO₂, select **Start Zero Cal.**
 - When you see the message **Zero done at <date and time>** on the status line, the zero calibration is finished and you can begin monitoring.
- 5 Install the airway adapter at the proximal end of the circuit between the elbow and the ventilator Y-section.

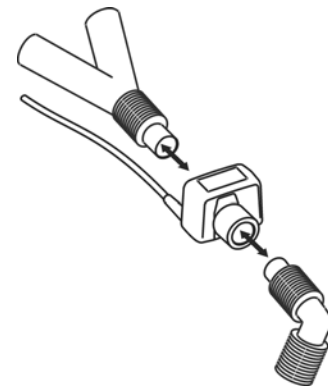
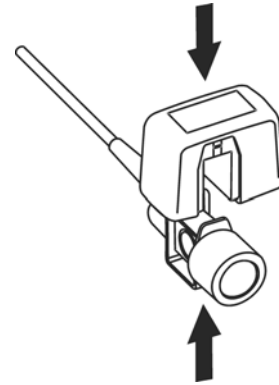

WARNING To prevent stress on the endotracheal tube, support the sensor and airway adapter.

Position sensor cables and tubing carefully to avoid entanglement or potential strangulation. Do not apply excessive tension to any cable.

Replace the airway adapter, if excessive moisture or secretions are observed in the tubing or if the CO₂ waveform changes unexpectedly without a change in patient status.

To avoid infection, use only sterilized, disinfected or disposable airway adapters.

Inspect the airway adapters prior to use. Do not use if airway adapter appears to have been damaged or broken. Observe airway adapter color coding for patient population.

Preparing to Measure Sidestream CO₂

- 1 Plug the sensor cable into the monitor's CO₂ input connector. Allow the sensor two minutes warm up time
- 2 Connect the cannula, airway adapter, or sample line as appropriate, to the sensor. It will click into place when seated correctly.
- 3 To zero the sensor:

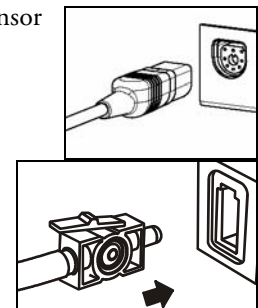

- expose the sensor to room air and keep it away from all sources of CO₂ including the ventilator, the patient's breath and your own.
 - In the setup menu for the CO₂, select **Start Zero Cal.**
 - When you see the message **Zero done at <date and time>** on the status line, the zero calibration is finished and you can begin monitoring.
- 4 *For intubated patients requiring an airway adapter:* Install the airway adapter at the proximal end of the circuit between the elbow and the ventilator Y-section.

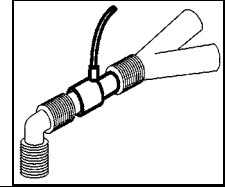

For intubated patients with an integrated airway adapter in the breathing circuit.: Connect the male luer connector on the straight sample line to the female port on the airway adapter.

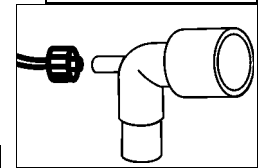

For non-intubated patients: Place the nasal cannula onto the patient.

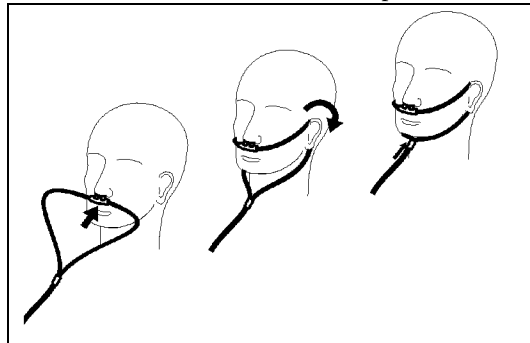

For patients prone to mouth breathing use an oral-nasal cannula. Trim the oral sampling tip if necessary to fit the patient. It should extend down past the teeth and be positioned in the mouth opening. Remove the cannula from the patient if the tip needs to be trimmed.

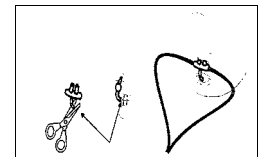

For nasal or oral-nasal cannulas with oxygen delivery, place the cannula on the patient as shown then attach the oxygen supply tubing to the oxygen delivery system and set the prescribed oxygen flow.

WARNING Always connect the airway adapter to the sensor before inserting the airway adapter into the breathing circuit. In reverse, always remove the airway adapter from the breathing circuit before removing the sensor.

CAUTION Always disconnect the cannula, airway adapter or sample line from the sensor when not in use.

Using the Sidestream Sensor Holder

The holder delivered with the sensor can be used to clamp the sensor onto an IV pole or a shelf.

- 1 Push the sensor into the holder until it clicks into position.
- 2 Clamp the holder onto an IV pole, a shelf or another appropriate location.

To remove the sensor from the holder, release the clip and pull the sensor out of the holder.

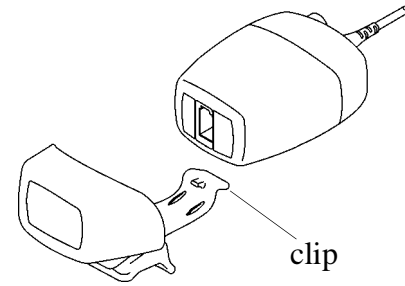

Removing Exhaust Gases from the System

WARNING **Anesthetics:** When using the sidestream CO₂ measurement on patients who are receiving or have recently received anesthetics, connect the outlet to a scavenging system, or to the anesthesia machine/ventilator, to avoid exposing medical staff to anesthetics.

Use an exhaust tube to remove the sample gas to a scavenging system. Attach it to the sidestream sensor at the outlet connector.

Using the Mainstream CO₂ Extension (M3016A)

The M3016A Measurement Server Extension measures partial pressure of carbon dioxide in a patient's expired gas using the mainstream method. When using the appropriate accessories you can use the mainstream CO₂ measurement with ventilated adults, pediatric and neonatal patients.

WARNING **Infra-red radiation:** Do not expose the airway adapter or M1460A transducer to infra-red radiation during use. This may cause incorrect readings.

Preparing to Measure Mainstream CO₂

- 1 Attach the transducer connector to the CO₂ connector on the measurement extension.
- 2 Wait 20 minutes, allowing the transducer to reach its operating temperature and a stable thermal condition.
- 3 Perform an accuracy check and then, if necessary, calibrate the transducer.

Checking Transducer Accuracy

WARNING Check transducer accuracy at least once a week or if you doubt the CO₂ readings.

- 1 In **Setup CO2** menu, select **Cal. Mode** to switch on calibration mode.
- 2 Look at the calibration value displayed in the **Setup CO2** menu next to **Start Cal 1: .** Is it the same as the value on the calstick? If not, calibrate the transducer now.
- 3 Place the transducer on the low cell of the calstick (labelled 0.0 mmHg or "ZERO"). The reading on the screen should be zero within ± 1 mmHg within one minute.

- 4 Place the transducer on the high cell of the calstick. The reading on the screen should be within ± 1 mmHg of the value on the calstick within one minute.
- 5 If both readings are in range, you can leave calibration mode and begin monitoring. If either of the readings is out of range, calibrate the transducer.

Calibrating the Transducer

- 1 Check that the windows on the calstick are clean and clear.
- 2 Place the transducer on one of the calstick cells and select **Start Cal 1**.
- 3 Enter the calibration value printed on the calstick then press **Confirm** to start calibration.
- 4 When the message **CO₂ CAL 1 calibration done - start CAL 2 calibration** appears, put the transducer on the other cell and select **Start Cal 2** then press **Confirm**.
- 5 When you see the message **CO₂ calibration completed. Leave calibration mode.**, calibration is complete.
- 6 Select **Cal Mode** to switch calibration mode off. You cannot monitor in calibration mode.

Attaching and Removing the CO₂ Transducer

- 1 Open the latch and place the transducer onto the airway adapter. Place the airway adapter in the patient's breathing circuit between the endotracheal tube and the Y-piece. You may see the **CO₂ SENSOR WARM UP** message until the transducer reaches operating temperature. Wait until this disappears before starting the measurement.



- 2 To remove the transducer from the airway adapter, open the latch and pull out the airway adapter.



WARNING To prevent stress on the endotracheal tube, support the transducer and airway adapter.
To avoid infection, use only sterilized airway adapters.

Using the Microstream CO₂ Extension (M3015A)

The M3015A Microstream CO₂ Extension measures the partial pressure of carbon dioxide in a patient's expired gas using Microstream technology.

In intubated patients, a sample of the respiratory gas is drawn from the patient's breathing circuit through an airway adapter and a gas sampling tube. In non-intubated patients, the gas sample is drawn through a nasal or oral-nasal cannula.

When using the appropriate accessories, you can use the Microstream CO₂ measurement with adult, pediatric, and neonatal patients.

The M3015A is equipped with an automatic barometric pressure compensation.

Preparing to Measure Microstream CO₂

Use appropriate accessories for:

- the patient type (adult, pediatric or neonatal),
- the ventilation situation (including humidification)
- the duration - short term use, up to 24 hours (typically OR), or long term use (typically ICU).

All accessories are for single patient use only.

Using Microstream Accessories

M3015A can be operated with the special Microstream accessories only. Refer to the instructions for use provided with the accessory.

For intubated patient with non-humidified ventilation, you can use a Microstream FilterLine set. For humidified ventilation, use a FilterLine H Set.

For non-intubated patients, the gas sample is taken through a Nasal FilterLine, or a Smart CapnoLine (which is a combined oral-nasal FilterLine). In parallel to the measurement of the CO₂, oxygen (O₂) may be delivered to the patient to support gas exchange. This is done by using an O₂/CO₂ FilterLine, or a Smart CapnoLine O₂ (a combined oral-nasal O₂/CO₂ FilterLine).

Using the FilterLine and Airway Adapter

- 1 Attach the female Luer connector to the CO₂ inlet connector on the measurement extension by pushing the socket cover down and screwing the connector into place.

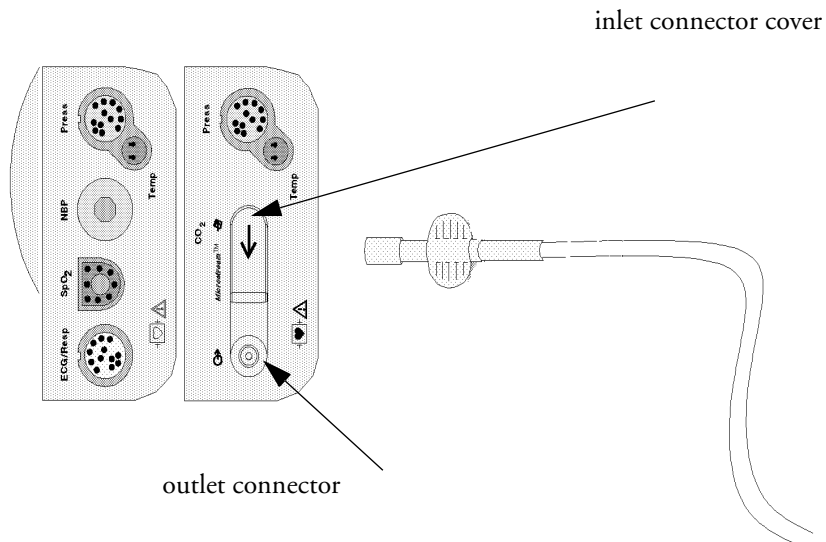

- 2 Check that the FilterLine is not kinked.
- 3 Change the FilterLine if a “CO₂ OCCLUSION” INOP appears on the monitor or if the readings become extremely erratic.

Disconnect the FilterLine during suctioning and nebulizing therapies.

For best results change the FilterLines for non-humidified use (with orange connectors) after 24 hours of continuous use and the FilterLines H, for humidified use, (with yellow connectors) after 72 hours of continuous use.

CO₂ values for non-intubated patients using Microstream accessories will always tend to be lower than for intubated patients. If values appear extremely low, check whether the patient is breathing through the mouth or whether one nostril is blocked

Removing Exhaust Gases from the System

WARNING **Anesthetics:** When using the Microstream CO₂ measurement on patients who are receiving or have recently received anesthetics, connect the outlet to a scavenging system, or to the anesthesia machine/ventilator, to avoid exposing medical staff to anesthetics.

Use an exhaust tube to remove the sample gas to a scavenging system. Attach it to the Measurement Server Extension at the outlet connector.

Suppressing Zero Calibration

To prevent an automatic zero calibration from being started in the next five minutes,

- ◆ in the **Setup CO₂** menu, select **No Zero for 5 Min**, or select the **Suppress CO₂ Zero** SmartKey, if configured.

Selecting **No Zero for 5 Min** or selecting the **Suppress CO₂ Zero** SmartKey again before the timer has timed out resets the timer to five minutes, unless an AutoZero became due during the previous suppression.

Setting up Mainstream and Sidestream CO₂

These tasks are common to all CO₂ measurements except where otherwise noted.

Adjusting the CO₂ Wave Scale

- 1 In the **CO₂ Wave** menu or the **Setup CO₂** menu, select **Scale**.
- 2 Choose a suitable scale range from the pop-up list.

Setting up CO₂ Corrections

Temperature, water vapor in the patient's breath, barometric pressure, and the proportions of O₂, N₂O and Helium in the mixture all influence CO₂ absorption. If values seem inaccurately high or low, check that the monitor is using the appropriate corrections.

Correction	
Altitude (M3014A only)	Altitude is set during installation. The monitor automatically applies an appropriate correction.
O ₂ (M3014A only)	In the Setup CO₂ menu, select Oxygen Corr and select a value between 0% and 100%, the default value is 16%. If the O ₂ correction is not available in the Setup CO₂ menu, the CO ₂ measurement in your Measurement Server Extension does not require O ₂ correction.
Humidity	At installation, the monitor is configured to automatically apply either Body Temperature Pressure Saturated (BTPS) or Standard Temperature Pressure Dry (STPD). To see which, go to the Setup CO₂ menu, and scroll down to look at HumidityCorr .
N ₂ O (M3016A mainstream and M3015A microstream only)	In the Setup CO₂ menu, select N₂O Corr and turn on or off. If N ₂ O is present in the ventilation gas mixture, you must turn this on. If the N ₂ O correction is not available in the Setup CO₂ menu, the CO ₂ measurement in your Measurement Server Extension does not require N ₂ O correction or it is setup with Gas Corr (see below).
Gas (M3014A only)	In the Setup CO₂ menu, select Gas Corr and select Helium, N ₂ O or turn off. If Helium or N ₂ O is present in the ventilation gas mixture, you must make the appropriate selection. If the Gas correction is not available in the Setup CO₂ menu, the CO ₂ measurement in your Measurement Server Extension does not require N ₂ O or Helium correction or the N ₂ O correction is setup with N₂O Corr (see above).

Correction	
Agent (M3014A only)	In the Setup CO₂ menu, select Agent Corr and select the concentration of the anesthetic agent (between 0.0% and 20.0%). If an anesthetic agent is present in the ventilation gas mixture, you must select the appropriate concentration.

Suppressing Sampling (not Mainstream CO₂)

To temporarily stop sampling,

- ◆ in the **Setup CO₂** menu, select **Pump 15Min Off** or use the **CO₂ Pump Off** SmartKey if available.

Selecting **Pump 15Min Off** again before fifteen minutes have passed resets the timer to fifteen minutes.

To re-start the pump,

- ◆ in the **Setup CO₂** menu, select **Pump On**.

Changing CO₂ Alarms

This refers to CO₂ specific alarms. See the Alarms section for general alarm information.

- 1 In the **Setup CO₂** menu, select **etCO₂ High** or **imCO₂ High** and choose the upper alarm limit.
- 2 Select **etCO₂ Low** and choose the lower alarm limit.

Changing the Apnea Alarm Delay

This determines the time limit after which the monitor alarms if the patient stops breathing.

- 1 In the **Setup CO₂** menu, select **awRR**.
- 2 In **Setup awRR** menu, select **Apnea Time**.
- 3 Choose the apnea alarm delay time.

WARNING Safety and effectiveness of the respiration measurement method in the detection of apnea, particularly the apnea of prematurity and apnea of infancy, has not been established.

Prolonged delay: The selected apnea alarm delay may be prolonged by up to 17 seconds, if an apnea occurs during the automatic zero process. This applies to the Microstream (M3015A) measurement only.

Deriving Alarms From awRR

- 1 In the **Setup CO₂** menu, select **awRR**.
- 2 In the **Setup awRR** menu, select **Alarms**.
- 3 Choose **On** to derive alarms from the airway respiration signal or **Off** to disable them.

Changing awRR Alarm Limits

- 1 In the **Setup CO₂** menu, select **awRR**.

- 2 Select **High Limit** to set the upper alarm limit.
Select **Low Limit** to set the lower alarm limit.
- 3 Select the appropriate setting.

Monitoring Airway Flow, Volume and Pressure

The M1014A Spirometry Module is designed to be used in combination with Philips-branded airway flow sensors and combined CO₂/airway flow sensors. It produces a real time wave for flow, volume and pressure of respiratory gases together with numerics for analysis of ventilatory mechanics.

The measurement provides:

- Airway flow, airway volume and airway pressure waveform.
- Numerics for:
 - respiratory rate
 - tidal volume
 - minute volume
 - PEEP (positive end-expiratory pressure)
 - PIP (peak inspiration pressure)
 - dynamic compliance
 - airway resistance
- Numerics for: (only visible in Spirometry Values Window, no alarming, no trending)
 - peak inspiratory flow
 - peak expiratory flow
 - negative inspiratory pressure
 - mean airway pressure
 - plateau pressure numeric
 - I:E ratio

The measurement also provides pressure-volume loops, flow-volume loops and pressure-flow loops. Please see the *Respiratory Loops* chapter for details on loops.

When using combined CO₂/Flow sensors you can also perform mainstream capnography with intubated adult, pediatric and neonatal patients. See the *Measuring CO₂* chapter for details on the CO₂ measurement and the *Accessories* chapter for a list of compatible accessories.

WARNING **Electrical Shock Hazard:** Do not open the module. Contact with exposed electrical components may cause electrical shock. Always turn off and remove power before cleaning the module. Refer servicing to qualified service personnel.

Attaching the Flow Sensor

CAUTION Use the M1014A Spirometry Module with Philips approved accessories only. Refer to the instructions for use provided with the accessory.

- 1 Select the appropriate flow sensor. Make sure that you are using the correct sensor for the respective patient category. Otherwise accuracy may be reduced.

	Pediatric/Adult Flow Sensor (M2785A). Color: clear For intubated patients with endotracheal tube diameters >4 mm. Adds approximately 6.5 cc of deadspace.
	Infant/Neonatal Flow Sensor (M2786A) Color: violet For intubated patients with endotracheal tube diameters ≤ 4 mm. Adds less than 1 cc of deadspace.

You can also use combined CO₂/flow sensors. Note that the M3014A Capnography Extension is required to measure CO₂.

	Pediatric/Adult Combined CO ₂ /Flow Sensor (M2781A). Color: clear For intubated patients with endotracheal tube diameters >5.5 mm. Adds 8 cc of deadspace.
	Pediatric Combined CO ₂ /Flow Sensor (M2783A): Color: green For intubated patients with endotracheal tube diameters of 3.5 - 6 mm. Adds less than 4 cc of deadspace.
	Infant/Neonatal Combined CO ₂ /Flow Sensor (M2782A). Color: violet For intubated patients with endotracheal tube diameters of 2.5 - 4 mm. Adds less than 1 cc of deadspace.

- 2 If you are using a combined CO₂/Flow sensor, connect it to the CO₂ sensor head first. The airway adapter clicks into place when seated correctly.
- 3 Click the connector into place in the flow sensor receptacle on the monitor before connecting to the breathing circuit.
- 4 Install the flow sensor or the combined CO₂/Flow sensor at the proximal end of the breathing circuit between the elbow and the ventilator Y-piece. Make sure that the spirometry sensor is in a horizontal position with its tubing pointing upwards. The correct position is also indicated by an arrow on some of the sensors. (Graphic shows combined CO₂/Flow Sensors).

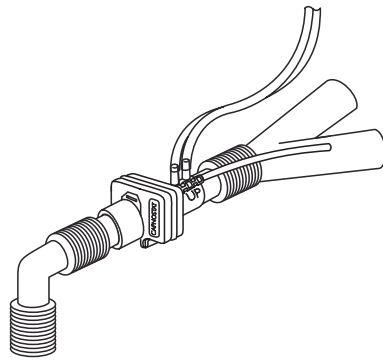

Pediatric/adult sensor

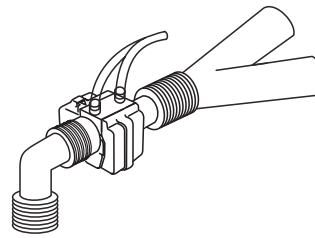

Pediatric sensor

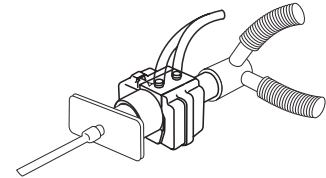

Infant/Neonatal sensor

WARNING To prevent stress on the endotracheal tube, support the sensor and airway adapter.

Position sensor cables and tubing carefully to avoid entanglement or potential strangulation. Do not apply excessive tension to any cable or tubing.

Replace the sensor, if excessive moisture or secretions are observed in the tubing and cannot be removed by a purge cycle.

Reuse poses a patient hazard. Do not disassemble, clean, disinfect or sterilize the sensor.

A system leak may significantly affect readings of flow, volume, pressure and other respiratory mechanics parameters.

Do not leave the sensor in the patient circuit when not connected to the monitor.

- NOTE
- Do NOT place the airway adapter between the endotracheal tube and the elbow (pediatric/adult circuit), as this may allow patient secretions to block adapter windows.
 - The striped tubing of the flow sensor should always be proximal to the patient.
 - Position the airway adapter with the spirometry tubing pointing upwards.
 - To prevent “rain-out” and moisture from draining into the airway adapter, do NOT place the airway adapter in a gravity dependent position.
 - Periodically check the flow sensor and tubing for excessive moisture or secretion build up. Perform a purge cycle if droplets are visible within the sensor or tubing. Repeat if necessary. If purging does not remove the droplets, replace the sensor.
 - For routine performance of airway care, separate the system between the endotracheal tube and the airway adapter (neonatal circuit), or between the endotracheal tube and elbow (pediatric/adult circuit). Lavage and suctioning of the airway can then be performed without fluids and mucous accumulating on the airway adapter windows.
 - Measurement values provided by a ventilator may differ significantly from the values provided by the spirometry module, due to different locations of the flow sensor.
 - Incorrect entry of gas compensation parameters (i.e. temperature, gas composition) may reduce the accuracy of the measured values.

- A volume waveform as displayed below on the left may be an indicator of an air leak:

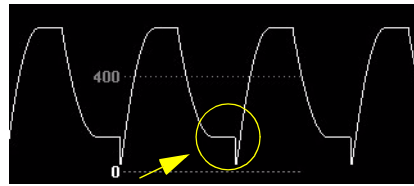

Abnormal waveform due to leak

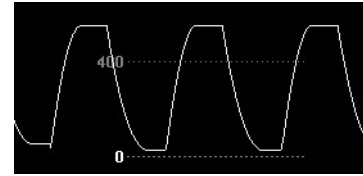

Normal waveform

In general, if MV_{exp} or TV_{exp} are significantly smaller than MV_{in} or TV_{in} , the tubing should be checked for leaks.

Zero Calibration

The zero calibration maintains the accuracy of the spirometry waves and numerics by regularly compensating for drifts within the measurement section. It is performed automatically without user interaction and takes about 2 seconds to complete. The automatic zero calibration is normally carried out every ten minutes. During warm-up or when the ambient pressure changes, this interval may be reduced to two minutes.

During the zero calibration the waveform is flat but the numerics remain on the screen. Typically, a zero calibration is started at the beginning of a respiration cycle, therefore a waveform may begin normally and then immediately become flat for the time of the zero calibration.

Zero Calibration

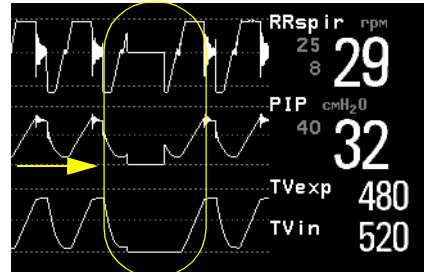

Automatic Purging

A double lumen connecting line (tubing) connects the flow sensors to the patient monitor. The M1014A Spirometry Module includes an automatic and manual purge feature which provides a flush of room air to keep the sensor tubing free from water condensation and patient secretions. This feature is available for the adult, pediatric, and neonatal modes. The purge will begin with the exhalation portion of the ventilator cycle.

- NOTE**
- During the purge cycle the pump will be heard
 - If the purge does not sufficiently clear the flow tubing lines, the flow sensor should be replaced
 - With each purge cycle, a zero calibration is automatically performed

Adult Mode

The system automatically purges the sensor tubing every ten minutes or less, depending on system conditions. In adult mode, the system will purge both sides of the line, one at a time, during each purge cycle. The higher the pressure, the more frequent the purging. This action anticipates increased moisture migration into the sensor tubing due to the increase in circuit pressure.

Neonatal and Pediatric Modes

The automatic purge cycles used in the neonatal or pediatric mode is fixed at every three minutes regardless of circuit pressure. Only one side of the sensor tubing will be purged during each purge cycle.

Unlike the adult purge mode, the neonatal or pediatric purge mode does not use the full force of the internal pump, but rather pressurizes an internal reservoir which is used for the purge. This minimizes the pressure delivered to the ventilator circuit, but does deliver a sufficient pressure to purge the sensor tubing.

Manual Purging

Occasionally, purging may be required in between the automatic purge cycles. The manual purge may be used as often as needed. Check the orientation of the flow sensor if repeated manual purge cycles become necessary.

To manually purge, press the **Purge** button on the module (marked by  on international versions of the module) or select **Purge** in the **Setup Spirometry** window to initiate a combined purge and zero cycle.

Gas Compensation

Temperature and the proportions of individual gases influence the flow measurement. If values seem inaccurately high or low, check that the monitor is using the appropriate gas compensation. Gas compensation can be done using either manually entered gas concentrations or gas concentrations from the gas analyzer.

NOTE If you unintentionally switch the gas compensation to the incorrect setting, the accuracy of the measured flow and volume values may be significantly reduced. The tables below show examples of incorrect gas compensation settings and the resulting inaccuracies:

	N ₂	O ₂	N ₂ O	Agent	Difference between measured and actual values
Actual Gas Composition	60	40			
Gas Compensation Setting		40	60		15%

Table 1 Incorrect Balance Gas Setting (N₂O instead of N₂)

	N ₂	O ₂	N ₂ O	Agent	Difference between measured and actual values
Actual Gas Composition	55	40		5	
Gas Compensation Setting	60	40		0	15%

Table 2 Incorrect Agent Percentage Setting

Setting up Spirometry

The following settings can be accessed through the **Setup Spirometry** menu.

Optimizing Scale Settings

In the **Setup Spirometry** menu, select **Optimize Scales**. The scale settings for all three spirometry waves (AWF, AWP, AWV) will be optimized.

Spirometry Values Window

You can view all spirometry measurement data in the spirometry data window. In the **Setup Spirometry** menu, select **Show All Values**.

Spirometry					
Adult/Pedi Flow Sensor					
RRspir	10 rpm	MVexp	7.2 l/min	PIP	31 cmH ₂ O
I:E 1:	1.9	MVin	7.3 l/min	PEEP	4 cmH ₂ O
COMP	24 ml/cmH ₂ O	TVexp	720 ml	MnAwP	17 cmH ₂ O
Raw	4 cmH ₂ O/l/s	TVin	720 ml	Pplat	30 cmH ₂ O
		PEF	8 l/min	NgInsP	-5 cmH ₂ O
		PIF	12 l/min		

Figure 1 Example for Spirometry Values Window

Alarms and Alarm Limits

Alarms can be derived from PEEP, PIP, MV and RRspir. In the **Setup Spirometry** menu you can set the alarm limits. Please refer to the Alarms chapter of this manual for details on alarm settings.

Changing the Apnea Alarm Delay

This determines the time limit after which the monitor alarms if the patient stops breathing.

- 1 In the **Setup Spirometry** menu, select **RRspir**.
- 2 In **Setup RRspir** menu, select **Apnea Time**.
- 3 Choose the apnea alarm delay time.

WARNING Safety and effectiveness of the respiration measurement method in the detection of apnea, particularly the apnea of prematurity and apnea of infancy, has not been established.

WARNING If an apnea occurs during a zero calibration, the time delay between the start of apnea and the activation of the apnea alarm could be up to 10 seconds plus the configured apnea delay time.

Automatic Alarm Suppression

If the automatic alarm suppression is switched on, all spirometry alarms are suppressed until breathing activity has been detected. This setting must be made in configuration mode.

Choosing Measured AWW Components

- 1 In the **Setup Spirometry** menu, select **AWV**.
- 2 Select **MV** to choose the measured components for Minute Volume (inspiratory and/or expiratory or off).
Select **TV** to choose the measured components for Tidal Volume (inspiratory and/or expiratory or off).

NOTE If MV and TV are set to off, there will be no alarming for these parameters.

Setting the Gas Compensation Mode

- 1 In the **Setup Spirometry** menu, select **Gas Compensation**.
- 2 Select **Mode** to choose the Gas Compensation mode:
 - select **Manual** for manually entered gas concentrations or
 - select **Gas Analyzer** for gas concentrations from the gas analyzer.

NOTE

- Gas concentrations from the gas analyzer are only available for Philips gas analyzers, not for devices connected via the Vuelink module.
- If gas concentrations from the gas analyzer are selected but not all data is available, the missing data is taken from manually entered values. In case of invalid data or no data at all, the INOP message SPIRO GAS COMPENS? is displayed.

Changing the Type of Balance Gas

- 1 In the **Setup Spirometry** menu, select **Gas Compensation**.
- 2 Select **Balance Gas** to change the type of balance gas.
- 3 Select the appropriate setting (N₂ or N₂O).

Changing the Concentration of Inspired O₂ and the Inspired Agents

- 1 In the **Setup Spirometry** menu, select **Gas Compensation**.
- 2 Select **Inspired O₂** to change the concentration of inspired O₂.
Select **Inspired Agent** to change the concentration of the inspired agent(s).

- 3 Select the appropriate setting.

Changing the Temperature of the Inspired Gas

Depending on the type of ventilator environment (e.g. if you are using a Heat Moisture Exchanger) you may want to change the temperature setting of the inspired gas:

- 1 In the **Setup Spirometry** menu, select **Gas Compensation**.
- 2 Select **Inspired Temp** to change the temperature of the inspired gas.
- 3 Select the appropriate temperature setting.

NOTE Changing the temperature setting unintentionally will result in approximately 3% reduced accuracy per 10°C (18°F) temperature setting change.

Monitoring tcGas

The tcGas module measures the partial pressure of the oxygen and carbon dioxide that diffuses through the skin, thereby providing a measure of these gases in the capillary blood.

The monitor's settings for altitude and barometric pressure influence the measurement. The tcpO₂/tcpCO₂ measurement is valid for an infant patient not under gas anesthesia. Anesthetic agents, such as halothane, can cause incorrect or drifting readings.

Transcutaneous measurements cannot replace arterial blood gas monitoring. However, you can use transcutaneous monitoring to reduce the frequency of arterial sampling. The values at tissue level will **not** be the same as those measured arterially because the measurement is transcutaneous. They correlate with (track closely) the arterial values. For example, a drop in transcutaneous values usually indicates a corresponding drop in arterial values.

Transcutaneous values will not always correlate with blood samples taken from the capillary blood of the heel (heelsticks or astrups).

Identifying tcGas Module Components

- 1 press to enter **Setup tcGas** menu
- 2 press to start calibration
- 3 calibration chamber
- 4 transducer connector

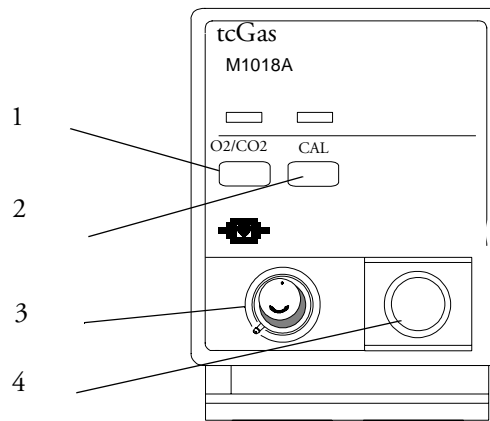

Setting the tcGas Sensor Temperature

- 1 In the **Setup tcGas** menu, select **Transducer Temp**.
- 2 Choose a temperature value appropriate for your patient's age, weight and physical condition in accordance with your hospital policy.
Usually, a higher transducer temperature gives a better correlation and a quicker response time. However, higher temperatures also increase the risk of skin burns. Most physicians prefer a temperature between 42°C (107° F) and 44°C (111° F), and a site time of four hours or less. Usually, the higher the transducer temperature, the less the site time should be. Whenever you change the temperature setting, the monitor forces you to make a new calibration.

Using the tcGas Site Timer

Availability and behavior of the site timer depend on your monitor's configuration.

WARNING Prolonged continuous monitoring may increase the risk of undesirable changes in skin characteristics, such as irritation, reddening, blistering or burns. If the site timer is disabled, the transducer will heat indefinitely while on a patient. Change the site regularly, in accordance with medical procedures in your hospital.

Setting the tcGas Site Timer

The site timer helps reduce the risk of skin burn by ensuring that the transducer is used at one site for no longer than a predefined period. It reminds you when this period expires.

- 1 In the **Setup tcGas** menu, select **Site Time**.
- 2 Choose the time you want the transducer to remain on the measurement site. The optimum time depends on the transducer temperature and your patient's skin sensitivity.

The site timer starts automatically when you remove the calibrated transducer from the calibration chamber. If you return the transducer to the chamber and then remove it again, the site time continues to count down the remaining time; it does not start a new time period. The time remaining before the site timer expires appears in the status line which is visible as long as the **Setup tcGas** menu is open. When the time expires, the monitor sounds a tone and displays a change site INOP. The monitor either switches off the transducer heating or continues monitoring, depending on its configuration. Although you can reuse the transducer for up to two hours after the heating is switched off, without making a new calibration, you are recommended to recalibrate before applying it to a patient. After two hours without heat, you must recalibrate.

During the initial few minutes of use, the monitor eliminates false alarms by temporarily suppressing tcGas alarms. It displays the "STABILIZING" INOP. After you apply the transducer to the skin, the instrument reading slowly assumes a steady value. The reading stabilizes when the measurement site is warm and local hyperemization is complete. This takes 10 to 20 minutes for the tcpO₂ reading and three to seven minutes for tcpCO₂.

Restarting the tcGas SiteTimer

To restart the site timer without recalibration (for example, after the site time has elapsed):

- 1 In the **Setup tcGas** menu, select **Site Time**.
- 2 Enter and confirm your desired time.

Disabling the tcGas Site Timer

Depending on your monitor's configuration, you might be able to disable the site timer. Remember, this means that the transducer heats indefinitely while on a patient.

- 1 In **Setup tcGas** menu, select **Site Timer** and switch this to **Disabled**.
- 2 Select the **Confirm** popup key.

Setting the tcGas Barometric Pressure

Altitude and barometric pressure affect tcGas values. The monitor derives barometric pressure from its altitude setting. If you want to set the true barometric pressure you must do this **before** starting a calibration - changes after calibration do not influence tcGas values. The monitor remembers this pressure setting until you enter a new one.

- 1 In the **Setup tcGas** menu, select **AmbientPress**.
- 2 Enter the current barometric pressure reading indicated by your barometer.
- 3 Select the **Confirm** popup key.

Remembraning the tcGas Transducer

CAUTION The tcGas transducer is thin and flexible. You must treat it with care. Avoid kinking, bending or pulling the cable.

Remembrane the transducer if the electrolyte in your transducer has dried out or:

- if the transducer is new
- if you are using the transducer with a new patient
- if the membranes are damaged (scratched or wrinkled)
- after five days of continued use or 28 days of storage.

- 1 Unscrew the protection cap from the transducer and hook the O-ring remover under both O-rings to remove them.

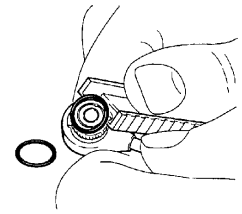

- 2 Remove **both** of the clear plastic membranes using your fingers.

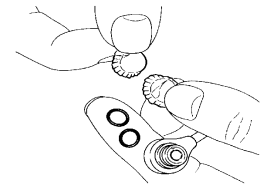

- 3 Clean the transducer head, including the groove and rim, with absorbent paper to remove all old electrolyte (old electrolyte causes incorrect values) and apply approximately two drops of electrolyte solution to the transducer head.

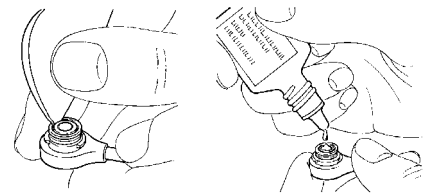

- 4 Press the transducer head downwards into an unused membrane replacer until the replacer retracts as far as it can and you hear a click. Discard used replacer.

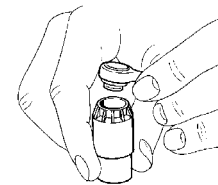

- 5 Remove any surplus electrolyte solution on the outside of the membranes with a soft tissue.
- 6 Make sure that the new membranes are secured by two O-rings on the transducer. If any air bubbles are visible under the membranes, repeat this procedure - air bubbles will cause incorrect readings.
- 7 After 24 hours you can calibrate the transducer. You must remembrane all new and dried out transducers twice before calibration.

New/Dried Out Transducers

Remembrane all new or dried out transducers twice before using. After the first remembraning, unplug the transducer from the module and leave it for 24 hours with the cap on. Remembrane again before calibrating.

Storing tcGas Transducers

If you need to store a sensor for more than 24 hours, protect it for up to 28 days by putting two drops of electrolyte solution into the cap. Screw the cap on the sensor. Remembrane if it dries out or after 28 days.

Calibrating the tcGas Transducer

You can use either a Philips (15210B) or a Radiometer TCC3 calibration unit and a gas cylinder whose pressure indicator is above the 'out-of-gas' zone (black on 15210B, red on TCC3). To maintain accuracy, it is recommended to calibrate the transducer every four hours, even if the monitor does not prompt you to do so. You **MUST** calibrate when:

- you remembrane the transducer
- you change the transducer heat setting
- you doubt the measurement accuracy
- you start a new monitoring period or use a new site
- the monitor displays the "calibration required" INOP message.

- 1 Connect the calibration unit to the inlet on the side of the module's calibration chamber using the recommended gas tubing. Different tubing will cause inaccurate measurements.

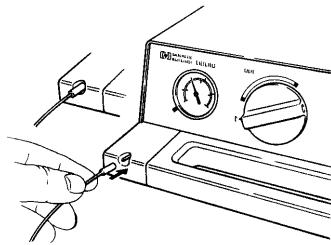

- 2 Plug the transducer cable into the module. Swing the calibration chamber cover open and insert the transducer into the chamber. Close the cover to secure the transducer. Set the transducer temperature at the monitor now.

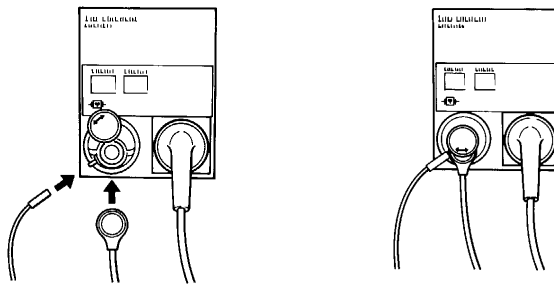

- 3 On the 15210B calibration unit, turn the timer control clockwise as far as you can. On the Radiometer calibration unit, press the button with the green arrow once.

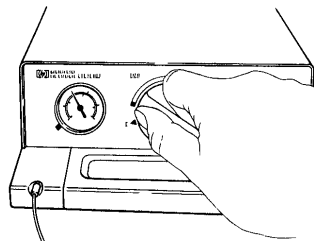

- 4 Press CAL on the module until the light above the key comes on and wait (three - 20 minutes) for the “calibration complete” message to appear on the monitor. Alternatively, in the **Setup tcGas** menu, select **Start Calibration**. To save gas on 15210B, if the timer control dial is not in the start position when the monitor displays the calibration complete message, turn the dial counter-clockwise to the start position. For TCC3, if the green light is still flashing when INOP “tcGas CalRunning” disappears, press the green arrow button again.

Calibration Failure

If calibration fails, the monitor displays “...tcGas transducer or Cal Unit malf” and the CAL FAILED INOP for the measurement.

Troubleshooting tcGas Calibration

Perform each of the following steps, in order, until calibration is successful.

- 1 Check the calibration unit, then recalibrate, remembering to turn on the gas supply on the calibration unit. If the pressure indicator reading is in the out of gas zone, there is insufficient gas in the cylinder. Connect the gas tubing firmly to the calibration unit and to the module’s calibration chamber.
- 2 If Step 1 fails, check whether you need to **activate** the transducer (necessary if the electrolyte has dried out or if you have a new transducer). Remembrane the transducer, removing the old membranes, and cleaning the transducer head thoroughly.
- 3 Calibrate a second time.
- 4 If Step 2 is unsuccessful, calibrate again. This calibration may be required to stabilize the electrochemical system in the transducer.
- 5 Only if the above steps are unsuccessful (you have activated and remembraned the transducer and calibration has still failed twice), replace the transducer.

Applying the tcGas Transducer

- 1 Peel protection film from fixation ring. Using a finger, press the sticky side of the ring on to clean, dry skin. Press around the outside to ensure a good seal. Apply three to five drops of contact fluid in the ring's center. Remove transducer from chamber.

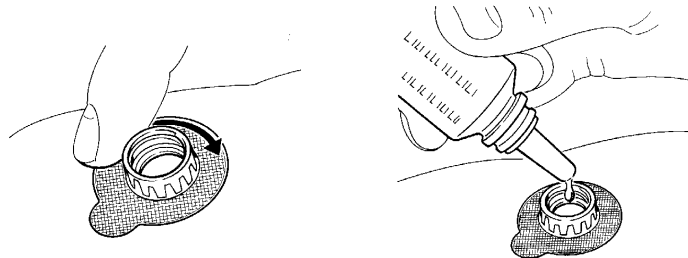

- 2 Align the arrow on the transducer with the tab on the ring and fasten by turning a quarter-turn clockwise. Wait 10-20 minutes for readings to stabilize.

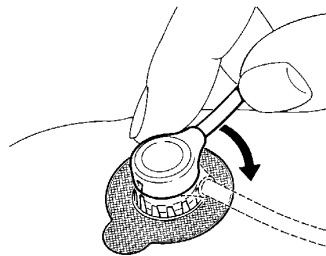

- 3 Apply the transducer as soon as possible after you see the "...calibration complete" message. If you wait longer than 30 minutes, the heat supply to the transducer switches off to prevent the electrolyte from drying out and a new calibration is necessary.

Optimize the measurement by selecting a site with high capillary density and blood flow, thin epidermis and no cardiovascular disorders. Most physicians use the abdomen, chest and back.

WARNING You must either remove the transducer before defibrillating, or remembrane and calibrate the transducer after defibrillating.

CAUTION To avoid transducer damage, remove it from the patient during high frequency surgical procedures.

Selecting the tcGas HeatPowerDisplay Mode

The heat power display gives an indication of the skin's perfusion below the transducer and of the transducer's contact with the skin. If the transducer loses contact, the heat power value drops significantly. When perfusion is poor you need less heat power to maintain the transducer temperature.

- ◆ In the **Setup tcGas** menu, select **HeatPowerDisplay** to toggle between **Relative** and **Absolute**. Choose **Relative** when the skin temperature is stable (the **STABILIZING INOP** disappears). This indicates subsequent changes in the relative heat power (and therefore changes in perfusion or transducer contact) since the last zeroing.

Zeroing the tcGas Relative Heat Power

When you start a calibration, the **HeatPowerDisplay** is set to **Absolute**. When you switch to **Relative**, it automatically zeros. Zero again if you change application site.

Finishing tcGas Monitoring

- ◆ Replace the transducer in the calibration chamber.

When changing the application site after a measuring period, some users leave the fixation rings in position to allow them to quickly move the transducer from site to site. Always unscrew the transducer from the fixation ring before removing the fixation ring from the skin.

TcGas Corrections

Transcutaneous pCO₂ values tend to be higher than arterial values due to the metabolic processes of the skin and the effect of heating on the blood under the transducer. Depending on your monitor's configuration, one or both of these corrections may automatically apply.

Temperature Correction for tcpCO₂

The transducer temperature causes an increase in partial CO₂ pressure. Your monitor may be configured to correct this.

- ◆ In the **Setup tcpGas** menu, look at the menu item **CO₂ Correction**. If correction is enabled, it is set to **On**.

Metabolism Correction for tcpCO₂

CO₂ production in the epidermis increases the CO₂ value. Your monitor may be configured to automatically deduct a metabolism factor (only applies when **CO₂ Correction** is on).

- ◆ In the **Setup tcGas** menu, look at the value shown for the menu item **MetabolismFactor**. This is deducted from the CO₂ value.

Monitoring \bar{SvO}_2

MP60/70/80/90 monitors only The \bar{SvO}_2 module measures the percentage of mixed venous oxygen saturation continuously and invasively using the Hospira, Inc. (formerly Abbott Laboratories) OptiCath family of catheters routed via the right side of the heart into the pulmonary artery. Can be used only with the MP60/MP70/MP80/MP90 monitors.

WARNING Injected dyes, such as methylene blue, or intravascular dyshemoglobin may lead to inaccurate measurements.

Do not monitor oxygen saturation during infusion of I.V. fat emulsion or other turbid substances through the distal lumen of the OptiCath catheter. These liquids might temporarily modify the blood scattering and absorption characteristics at the catheter tip. This interferes with the optical measurement of oxygen saturation. After infusion is complete, you can again monitor oxygen saturation accurately.

During injection of the bolus for thermodilution cardiac output measurements, the \bar{SvO}_2 measurement might be disturbed.

Preparing to Monitor SvO₂

In addition to an SvO₂ module, you need a Hospira OptiCath catheter, and 50131 Optical Module. Use only the Hospira accessories listed in the Accessories section.

- 1 optical module
- 2 balloon inflation stopcock
- 3 Hospira fiber optic catheter
- 4 optical reference
- 5 enter setup/calibration

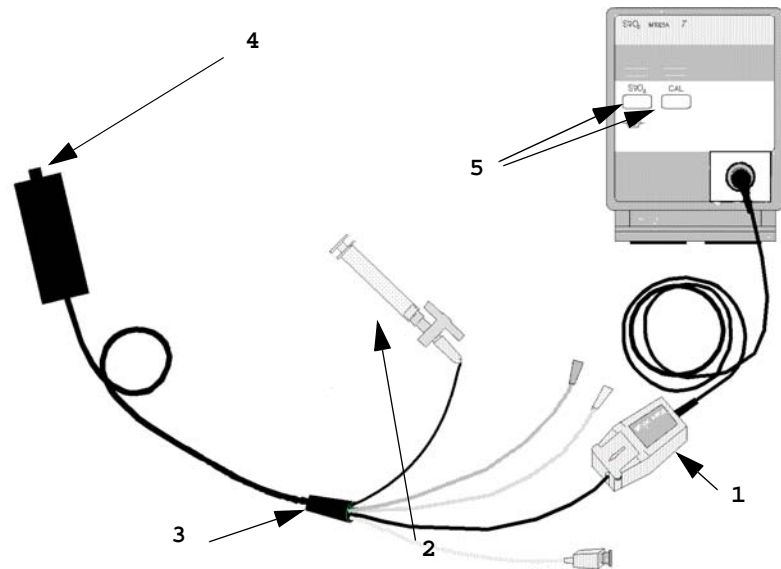

Connect the optical module (Hospira 50131) to the SvO₂ module. Allow the optical module to warm up before you perform a calibration. Although the warm up message disappears from the screen after one minute, Hospira recommends letting the optical module warm up for 15 minutes for best accuracy. Please refer to the instructions for the optical module.

To avoid false alarms during the pre-insertion calibration and insertion of the catheter into the patient, the monitor automatically suspends alarms during the pre-insertion calibration, for up to three minutes after you remove the catheter tip from the optical reference. After light intensity calibration, or after three minutes (whichever comes first), the monitor returns to the alarm state it was in prior to pre-insertion calibration.

Carrying out a Pre-insertion Calibration

WARNING It is strongly recommended to carry out a pre-insertion calibration prior to all insertions. If this is not possible, you must perform an in-vivo calibration after insertion.

Refer to the instructions for use that accompany the catheter. Do not use the catheter if the packaging is damaged. If you have to disconnect the monitor from the patient (for example, when transferring the patient from one location to another), you must disconnect at the SvO₂ module. The catheter should remain in the optical module, otherwise you need to recalibrate.

- 1 Remove outer wrapping from catheter tray to uncover optical connector.
- 2 Place the optical module on the catheter tray in the space provided and open the lid.

- 3 Place the optical connector into the optical module (with the label “TOP” facing upwards) and close the lid.
- 4 In the **Setup SvO2** menu, select **Start Pre-InsCal**. Ensure that the tip of the catheter is still in the optical reference.
- 5 Insert the catheter when you see the message **SvO2 calibration completed - catheter ready for insertion**. If the calibration fails, repeat the calibration before inserting the catheter. If it fails a second time, replace the optical module.

Inserting the Catheter

- 1 Remove the inner cover of the catheter tray.
- 2 Remove the catheter tip from the optical reference. Check the catheter's proper operation (for example: the balloon tip).
- 3 Prepare and insert the catheter in accordance with standard hospital practice.

The SvO₂ catheter is thin and flexible, treat it carefully. Avoid kinking, bending or grasping the catheter with forceps or a hemostat. Damage to the fiber results in low intensity light and sudden decrease in intensity readings. Refer to the documentation provided with the fibre-optic catheter, paying special attention to any precautions, warnings or contraindications.

Secure the optical module directly or in close proximity to the patient, to avoid placing excessive tension on the catheter, which would result in movement of the catheter tip from the optimal position in the patient. Position the optical module to avoid contact with liquids, because fluid entering the catheter-optical module connection may impair light transmission.

If you place the catheter in the patient without performing the pre-insertion calibration, you **must** perform an in-vivo calibration once the catheter is in place.

Performing a Light Intensity Calibration

Perform a light intensity calibration after the catheter is in its proper position. When the catheter is positioned properly, the light intensity indicator must cover at least two small divisions above the midpoint.

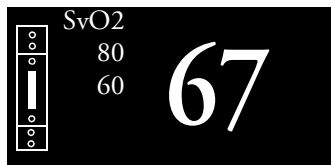

- ◆ In the **Setup SvO2** menu, select **Start Light Cal**.

Calibration is complete after a few seconds. If you doubt existing light intensity readings, recalibrate.

Performing In-Vivo Calibration

Perform an in-vivo calibration:

- if you place the catheter in a patient *without* performing a pre-insertion calibration.
- if the catheter was disconnected from the optical module.
- when the catheter has been in the patient for 24 hours.
- if any significant change in light intensity occurs that the monitor cannot correct automatically.

Setting Up the In-Vivo Calibration

Check for:

- proper positioning of the catheter in the patient.
- relatively stable oxygen saturation in patient.
- that the SvO₂ light intensity indicator covers at least two divisions above the midpoint.

Making the In-Vivo Calibration

- 1 Be prepared to draw a blood sample from the patient.
- 2 In the **Setup SvO2** menu, select **Start In-VivoCal**.
- 3 To clear the distal lumen, draw off and discard at least 2 ml of blood before taking the sample.
- 4 Draw a blood sample from the distal port of the catheter and flush the line according to standard hospital practice.
- 5 Obtain laboratory analysis of the sample using direct measurements.
- 6 Compare the results with the stored calibration value displayed in the **Setup SvO2** menu. If the difference is less, or equal, to 4%, you can skip the next step.
- 7 If there is a difference of more than 4% between the stored value and the laboratory value, select **CalibrationValue** to adjust the stored value. Selecting **Recall PreviousC** recalls the previously stored calibration value.
- 8 Complete the calibration by selecting **Store In-VivoCal** (even if you did not adjust the calibration value). This updates the data stored in the optical module.

Calculating Oxygen Extraction

Oxygen extraction is the difference between the measured SpO₂ and SvO₂ values. If you are monitoring SpO₂ and SvO₂, the monitor can calculate this value and display it as a numeric.

- ◆ To switch oxygen extraction calculation on or off, in the **Setup Sp-vO2** menu, select **Sp-vO2** and toggle between **On** and **Off**.
- ◆ If more than one SpO₂ value is available, you must choose which value is used in the calculation. In the **Setup Sp-vO2** menu, select **SpO2 Source** and select the required source.

If one of the calculation sources becomes unavailable, the monitor displays the INOP **Sp-vO2 CHK SOURCES** for one minute. After this time, the calculation automatically switches off. If the missing source becomes available again, the calculation automatically switches on again.

Monitoring EEG

The Electroencephalograph (EEG) module monitors the patient's cerebral function by measuring the electrical activity of the brain. It provides the monitor with two channels of realtime EEG waves, EEG trend information in the form of Compressed Spectral Arrays (CSA), and up to eight of the following numerics:

Spectral Edge Frequency (SEF): The SEF is the frequency below which a defined percentage of the Total Power lies. The percentage is set in Configuration Mode.

Mean Dominant Frequency (MDF): The MDF is the mean value of the frequency which dominates the measured EEG.

Peak Power Frequency (PPF): The PPF is the frequency with the highest measured amplitude.

Total Power (TP): The TP numeric indicates the power in the measured frequency band.

Percentage of total power in each frequency band:

- **Alpha** waves (8 to 13 Hz)
- **Beta** waves (13 to 30 Hz)
- **Theta** waves (4 to 8 Hz)
- **Delta** waves (0.5 to 4 Hz).

EEG Monitoring Setup

- 1 Plug the trunk cable into the EEG module in the Flexible Module Server.
- 2 Prepare the patient's skin prior to placing the electrodes. Good electrode-to-skin contact is important for a good EEG signal, as the skin is a poor conductor of electricity.
 - Shave hair from sites, if necessary.
 - Wash sites thoroughly with soap and water. We do not recommend using ether or pure alcohol, because this dries the skin and increases the resistance.
 - Use a skin preparation paste to remove skin cells and oil before placing the electrodes.
- 3 Select the desired electrode montage in the **Setup EEG** menu or in the **EEG Impedance/Montage** window.
- 4 Attach the reference electrode first.
- 5 Place the electrodes on the patient's head according to the selected montage. Use electrode gel if you are not using pre-gelled electrodes. Remember to select a site where the signal will not be interfered with by muscle artifacts.
- 6 Connect the electrode connector end to the trunk cable.
- 7 Check the electrode-to-skin impedance in the **EEG Impedance/Montage** window.
- 8 For good signal quality, keep all lead wires together and away from other electric devices and metallic bodies.

Using the EEG Impedance/Montage Window

- ♦ To open the window, in the **Setup EEG** menu, select **Show Montage**, or select the **EEG Montage** SmartKey.

The window may be configured to look slightly different on your monitor.

Electrode locations on the patient's head. The symbols represent the electrode-to-skin impedance.

Wiring and impedance values for the selected montage

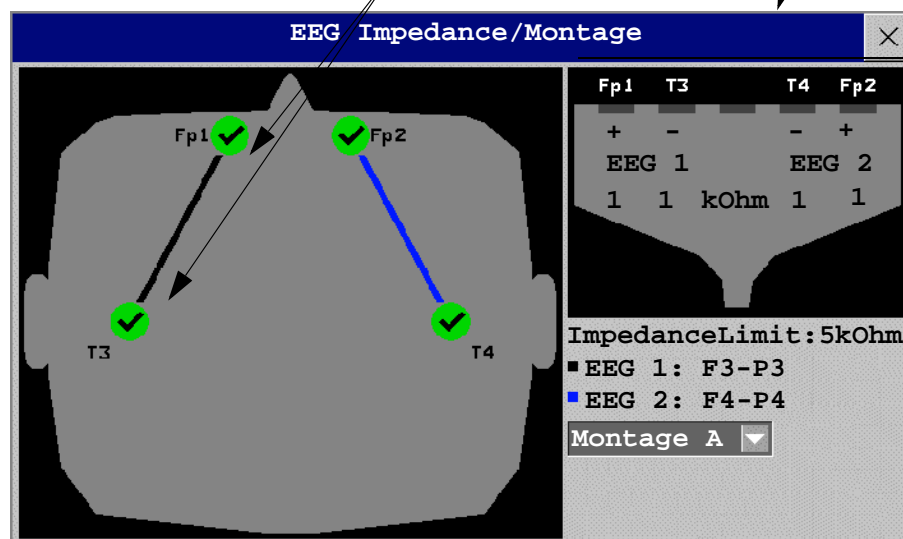

Choosing an EEG Electrode Montage

- 1 To activate one of the five pre-configured electrode montages, select the arrow beside the label in the **EEG Impedance/Montage** window and choose a montage from the list.
- 2 Attach the electrodes as illustrated in the **EEG Impedance/Montage** window.

The five default electrode montage configurations can be modified and renamed in Configuration Mode.

Montage Name	EEG1+	EEG1-	Label1	EEG2+	EEG2-	Label2
Mont.A	Fp1	T3	Fp1-T3	Fp2	T4	Fp2-T4
Mont.B	O1	T3	O1-T3	O2	T4	O2-T4
Mont.C	F3	C3	F3-C3	F4	C4	F4-C4
Mont.D	C3	P3	C3-P3	C4	P4	C4-P4
Mont.E	Fp1	T5	Fp1-T5	Fp2	T6	Fp2-T6

The electrode locations are labeled according to the international 10-20 electrode placement system.

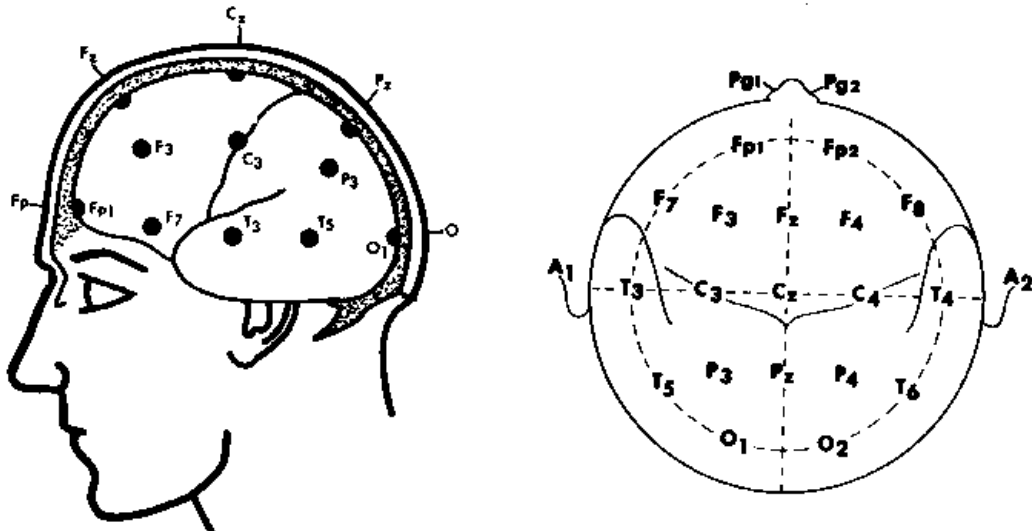

Changing the Impedance Limit

The impedance limit can be set for all electrodes simultaneously in the **Setup EEG** menu, or in the **EEG Impedance/Montage** window using the pop-up keys. If the limit is exceeded during monitoring, an INOP will appear and the graphic impedance indicator will change.

To change the impedance limit, either





- ◆ use the pop-up keys that appear with the **EEG Impedance /Montage** window, or
- ◆ in the **Setup EEG** menu, select **Impedance Limit** to call up a list of selections between 1 and 30 kOhm, then select the required limit from this list.

About Electrode-to-Skin Impedance

Electrode-to-skin impedance is the main quality indicator for the measured EEG signal. During normal EEG monitoring, electrode-to-skin impedance is measured continuously and disconnected electrodes are detected. The impedance value for each single, independent signal electrode is displayed in the **EEG Impedance/Montage** window. If the measured electrode-to skin impedance of one or more electrodes is above the limit, an INOP will be issued.

For impedance measurement at least two electrodes, plus the reference electrode, must be connected.

Impedance Indicators

Electrode/Skin Impedance	Symbol	Color	Displayed Impedance Value	Action
Electrode not connected		red	no value	connect electrode
Noisy signal		gray	60 k Ω (fixed)	check electrode-to-skin connections
Electrode connected, impedance above limit		yellow	measured value (e.g 15 k Ω)	check limit, check electrode-to-skin contact
Electrode connected, impedance at or below limit		green	measured value (e.g. 3 k Ω)	no action necessary

About Compressed Spectral Arrays (CSA)

The continuous EEG signal is sampled periodically and this value is stored in a frame. Each frame is processed using Fast Fourier Transformation (FFT) to provide a frequency spectrum displayed as a compressed spectral array (CSA).

The CSA window provides an overview of the patient’s EEG values over time. It may be configured to look slightly different on your monitor.

- ◆ To view the CSA window permanently embedded on a Screen, select a Screen configured to display the CSA window.
- ◆ To view the **CSA** window over the current Screen, select the **EEG CSA** SmartKey, if configured, or select **Setup EEG** or **Main Setup** then **Show CSA**.

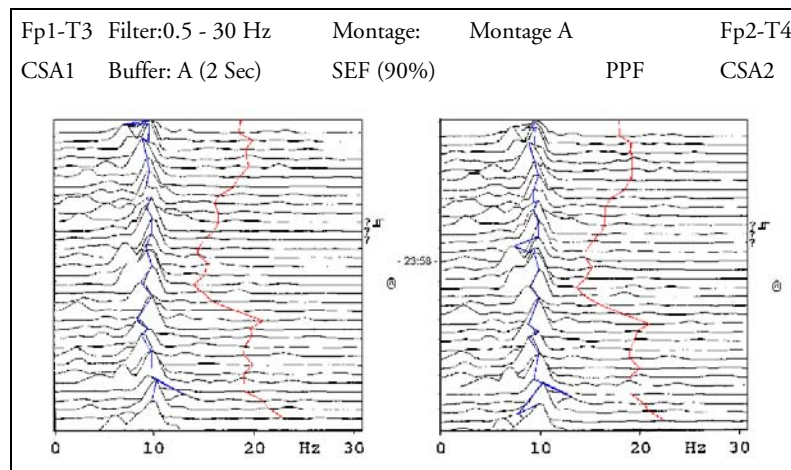

The CSA contains the following information		
Status line	Lead label	for example, Fp1-T3, Fp2-T4
	CSA label	CSA1 or CSA2 according to EEG channel
	Montage label	for example, Montage A
	Filter settings	for example, 1-30 Hz
	Buffer label and time	the buffer and interval between spectral lines on the CSA
	Current SEF Threshold	can only be changed in Configuration Mode
Spectral lines	The energy at each frequency is computed and displayed as a spectral line	
Trendlines	EEG values are sampled at configured time intervals and displayed as color-coded trendlines. Trendlines are available for the three frequency numerics (SEF, PPF, MDF)	
Annotations:	?	INOP marker
	⏏	Filter change marker
	Ⓜ	Montage change marker

Changing CSA Settings

When CSAs are shown embedded on the Main Screen, select the CSA to show the pop-up keys. When the CSA is shown in a window over the current screen, the pop-up keys are always displayed.

Setup CSA	This menu entry lets you
Buffer	choose one of the three pre-configured buffers. A buffer defines the interval between the spectral lines displayed in the CSA.
On/Off SEF/MDF/PPF	switch the trendline of the specific numeric on or off

Changing EEG Settings

Be aware that any changes made to EEG settings apply to both EEG channels.

Switching EEG Numerics On and Off

Each EEG numeric can be individually switched on or off in the **Setup EEG** menu.

- 1 In the **Setup EEG** menu, select the numeric label.
- 2 Select **On/Off** to toggle between the settings.

Changing the Scale of the EEG Waves for Display

This only changes the visual appearance of the wave. It does not affect the signal analyzed by the monitor or printed in reports or recordings.

- 1 In the **Setup EEG** menu, select **Wave Scale** to call up a list of wave scales.
- 2 Select the required scale from this list.

Scaling information is displayed with each EEG wave.

- If **Show Gridlines** is set to **On** in Configuration Mode, gridlines and the current wave scale values are shown with the EEG wave.
- If **Show Gridlines** is set to **Off** in Configuration Mode, the current wave scale is indicated by a size bar beside the EEG wave.

Changing Filter Frequencies

The low and high pass filters screen out undesirable interference from the raw EEG wave display. The current EEG filter frequency settings are shown in the header of the CSA. Changing filter settings affects the EEG wave and all the EEG numerics. Whenever the filter setting is changed, a filter change marker appears next to the spectral lines.

To change the filter settings:

- 1 In the **Setup EEG** menu, select **Low Filter** or **High Filter** to call up a list of available frequencies.
- 2 Select the required frequency from this list.

Changing the Speed of the EEG Wave

The EEG measurement has its own speed control and is not affected by the wave speed settings of the other measurements.

- ◆ In the **Setup EEG** menu, select **Wave Speed**. Choose the required speed from the pop-up list. This defines the speed at which the wave is drawn across the screen in millimeters per second (mm/s).

EEG Reports

The content of EEG Reports is always the same and does not need to be configured.

- ◆ To print an EEG Report, in the **Setup EEG** menu, select **Print Report**.
Alternatively, you can select the CSA and use the **Print Report** pop-up key to start the report.
- ◆ To modify the buffer and trendline settings on the CSA Report, in the **Reports** menu, select **CSA On EEG Rep.**. If you do not change these settings, the monitor will use the default settings SEF Trendlines: On, Buffer: C.

CSA on Report	This menu entry lets you
Buffer	choose one of the three pre-configured buffer times
Trend SEF/MDF/PPF	switch the trendline of the specific numeric on or off

EEG Safety Information

EEG Configuration and Monitor Upgrades The A.2 monitor release (software revision A.20.xx) introduced a new feature that lets you rename EEG montages. It is not possible to clone EEG settings between montages with different names, therefore all EEG settings are reset to factory defaults during any upgrade/downgrade/cloning actions that mix releases/software revisions/configurations before A.2/A.20.xx with subsequent versions. You must check that all EEG settings are correct before resuming monitoring with a monitor that has been upgraded or cloned.

WARNING Do not touch the patient, or table, or instruments during defibrillation.

When connecting electrodes and/or patient cables, ensure that the EEG leads and connectors do not come into contact with other conductive parts or earth.

High-frequency Surgery To reduce the hazard of burns in the high-frequency surgical neutral electrode connection, the EEG electrodes should not be located between the surgical site and the electro-surgical unit return electrode.

EEG and Electrical Interference

CAUTION Interference from a non-grounded instrument near the patient and electrosurgery interference can cause problems with the waveform and the CSA.

Radiated field strengths above 1 V/m and patient signals $\leq 50 \mu\text{V}$ may cause noise on the EEG waves at various frequencies. Therefore, it is recommended to avoid the use of electrical radiating equipment in close proximity to the patient monitor. The noise does not influence the measurement accuracy.

Interference from ECG can be eliminated by adjusting the low filter settings.

Monitoring BIS

Bispectral Index monitoring helps to monitor the level of consciousness of a patient under general anesthesia or sedation in the OR and ICU. The BIS sensor is placed on the patient's forehead to capture electroencephalographic (EEG) signals from which several numerics are derived, including a single BIS value representing the level of consciousness. See the chapter on Specifications for the BIS intended use statement.

The BIS Module or BIS Interface board (for MP20/MP30) provides the monitor with an EEG wave and the following numerics:

Bispectral Index (BIS). The BIS numeric reflects the patient's level of consciousness. It ranges from 100 (fully awake) to 0 (suppression; no electrical brain activity).

Signal Quality Index (SQI). The SQI numeric reflects signal quality and provides information about the reliability of the BIS, SEF, TP, SR, and Bursts numerics during the last minute.

It ranges from 0 to 100%:

SQI < 15%: the numerics cannot be derived

SQI 15% to 50%: the numerics cannot be reliably derived

SQI 50% to 100%: the numerics are reliable.

Electromyographic Activity (EMG). The EMG numeric reflects the electrical power of muscle activity and high frequency artifacts.

EMG < 55 dB: this is an acceptable EMG

EMG ≤ 30 dB: this is an optimal EMG

(note that the minimum possible EMG is approximately 25 dB).

Suppression Ratio (SR). The SR is the percentage of time over the last 63-second period during which the EEG is considered to be in a suppressed state.

Spectral Edge Frequency (SEF). The SEF is the frequency below which 95% of the Total Power is measured.

Total Power (TP). The TP numeric indicates the power in the frequency band 0.5 to 30 Hz. The useful range is 30 - 100 dB.

Bursts (BISx module used with the Extend Sensor only) The Bursts numeric helps you quantify suppression by measuring the number of EEG bursts per minute, where an EEG burst is defined as a period of activity followed and preceded by inactivity (at least 0.5 second).

BIS Monitoring Setup

There are two BIS solutions available for use with the M1034A BIS module: using the DSC and BIS engine or using the BISx.

Monitoring BIS Using the DSC and BIS Engine

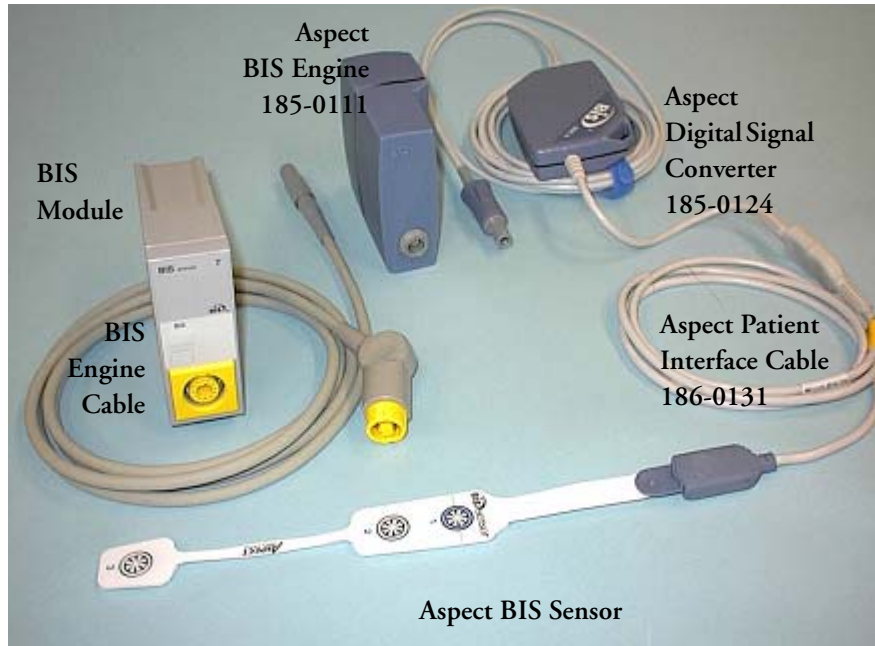

- 1 If you are monitoring BIS with the DSC and BIS engine,
 - a. Connect the BIS engine to the BIS module using the BIS Engine Cable.
 - b. Connect the digital signal converter (DSC) to the digital signal converter port on the front of the BIS Engine. Use the attachment clip to secure the digital signal converter near, but not above the patient's head.
 - c. Attach the patient interface cable (PIC) to the digital signal converter (DSC).
- 2 Attach the BIS sensor to the patient following the instructions supplied with the sensor.

Make sure that the patient's skin is dry. Be aware that a wet sensor or a salt bridge may cause erroneous BIS and impedance values.

A variety of sensors are available for use in the OR and ICU environments: see the chapter on accessories for information.
- 3 Connect the BIS sensor to the patient interface cable.

As soon as a valid sensor is detected, the impedances of all electrodes are measured automatically and the results are shown in the BIS window.

Monitoring BIS using the BISx

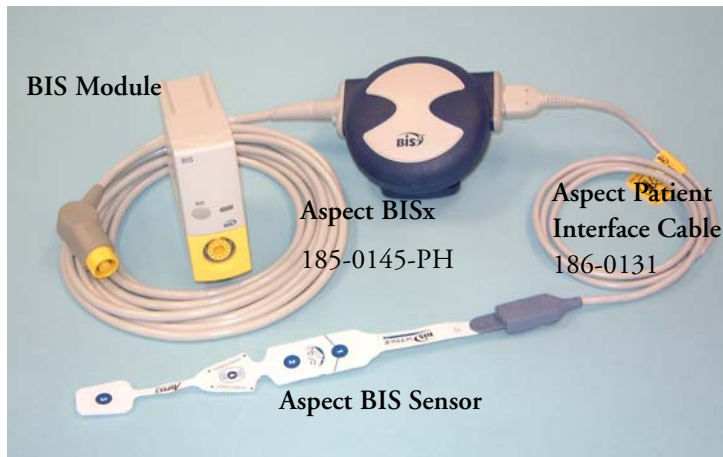

- 1 If you are monitoring BIS using the BISx,
 - a. Connect the BISx device to the BIS module or BIS Interface board connector (MP20/MP30)
 - b. Use the clip on the rear of the BISx device to affix it in a position convenient for your patient, not above the patient's head.
- 2 Attach the BIS sensor/BIS electrodes to the patient following the instructions supplied with the sensor.

Make sure that the patient's skin is dry. Be aware that a wet sensor or a salt bridge may cause erroneous BIS and impedance values.

A variety of sensors are available for use in the OR and ICU environments: see the chapter on accessories for information.

CAUTION Ensure that the BISx does not come into prolonged contact with your patient's skin, as it may generate heat and cause discomfort.

The BISx may remain connected to a patient during defibrillation as long as the sensor is not located between the defibrillator pads.

- 3 With sensors for single-patient use:
 - a. Attach the patient interface cable (PIC) to the BISx device.
 - b. Connect the BIS sensor to the PIC.

With Semi Re-usable Sensors:

- a. Attach the sensor cable to the BISx device.
- b. Snap the sensor cable onto the electrodes.

As soon as a valid sensor is detected, the impedances of all electrodes are measured automatically and the results are shown in the BIS window. The number of uses remaining for the semi-re-usable sensor is shown in the status line when the BIS window is open.

Manufacturer's Information

BISx, the BIS Engine, the DSC, the Patient Interface Cable and the BIS Sensors are manufactured by Aspect Medical Systems.

BIS Continuous Impedance Check

This checks:

- the combined impedance of the signal electrodes plus the reference electrode.
This is done continuously and does not affect the EEG wave. As long as the impedances are within the valid range, there is no notification of this check or its results.
- the impedance of the ground electrode.
This is done every ten minutes and takes approximately 4 seconds. It causes an artifact in the EEG wave, and the message **Ground Check** is shown on the monitor screen during the check. If the ground electrode does not pass this check, another check is started. This continues until the ground electrode passes the check.

If the Continuous Impedance Check interferes with other measurements, it can be switched off. To do this:

- 1 In the **Setup BIS** menu, select **Cont. Imp. Check**.
- 2 Select **On/Off** to toggle between the settings.

CAUTION Switching the continuous impedance check off will disable automatic notification to the user of impedance value changes, which may lead to incorrect BIS values. Therefore, this should only be done if the check interferes with or disturbs other measurements.

When a Semi-reusable Sensor is in use the continuous impedance check **cannot** be switched off. If it is switched off when the sensor is connected, it will automatically be switched on again.

BIS Cyclic Impedance Check

This measures the exact impedance of each individual electrode. It causes a disturbed EEG wave, and the **INOP BIS IMPEDANCE CHCK** is shown on the monitor screen during the check.

Starting a Cyclic Impedance Check

The Cyclic Impedance Check is automatically started when a sensor is connected. To manually start a Cyclic Impedance Check:

- ♦ select **Cyclic Check** in the **BIS Setup** menu to toggle between On and Off, or
- ♦ select **Start Cyclic Check** in the BIS window.

Stopping a Cyclic Impedance Check

The Cyclic Impedance Check stops automatically if the impedances of all electrodes are within the valid range. To manually stop a Cyclic Impedance Check:

- ♦ select **Cyclic Check** in the **BIS Setup menu** to toggle between On and Off, or

- ◆ select **Stop Cyclic Check** in the BIS Impedance Check Window.

If you stop a Cyclic Impedance Check before the ground electrode has passed, a ground electrode impedance check will be started automatically. This cannot be switched off.

BIS Window

- ◆ To open the BIS window, in the **Setup BIS** menu, select **Show Sensor**.

The window may look slightly different on your monitor. The graphic in the BIS Window automatically adapts to show the type of sensor you are using, showing three or four electrodes as required. Each symbol in the graphic represents an electrode and illustrates the most recently-measured impedance status of the electrodes. Although BIS may still be measured when the electrode status is red or yellow, for best performance, all electrodes should be green.

In addition, if the measured electrode-to-skin impedance of any electrode or electrode combination is above the limit, or if disconnected electrodes are detected, an INOP will be issued, either **BIS HIGH IMPEDANCE** or **BIS LEAD OFF**.

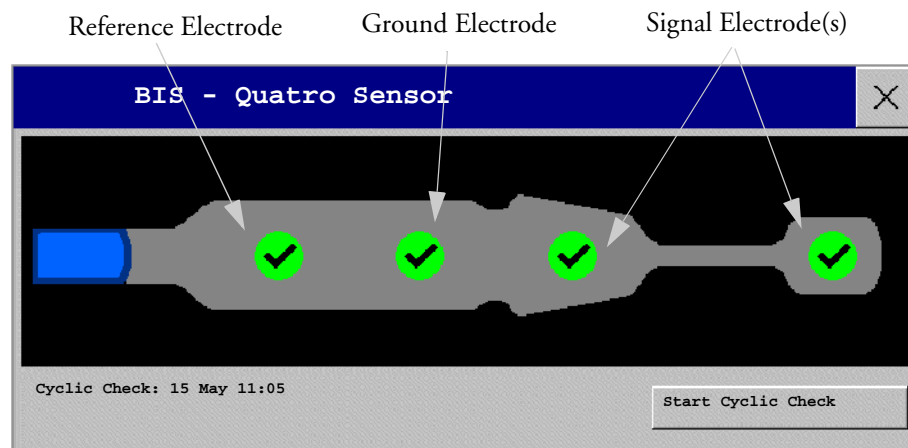

Time of the most recent cyclic check

BIS Impedance Indicators

Electrode-to-Skin Impedance	Symbol	Color	Action
Electrode has no skin contact	✘	red	Reconnect electrode, or check the sensor-to-skin contact. If necessary, clean and dry skin.
Too much signal noise, impedance cannot be measured	?	gray	Check sensor-to-skin contact. Press sensor more firmly to skin. If necessary, clean and dry skin.
Impedance above limit	↑	yellow	Check sensor-to-skin contact. Press sensor more firmly to skin. If necessary, clean and dry skin.
Impedance within valid range	✓	green	No action necessary

Changing the BIS Smoothing Rate

The smoothing rate defines how the monitor averages the BIS value.

- ◆ To change the smoothing rate, in the **Setup BIS** menu, select **BIS Smoothing Rate** then choose either:
 - 15 seconds: this provides increased responsiveness to changes in the patient's state.
 - 30 seconds: this provides a smoother BIS trend with decreased variability and sensitivity to artifacts.

Switching BIS and Individual Numerics On and Off

To switch the BIS measurement on or off:

- ◆ In the **Setup BIS** menu, select **BIS** to toggle between On and Off.

To switch individual numerics provided by the BIS Module on or off:

- ◆ In the **Setup BIS** menu, select **SQI**, **TP**, **SEF**, **SR**, **EMG**, or **BURSTS** to toggle between **On** and **Off**.

Changing the Scale of the EEG Wave

Changing the scale only changes the visual appearance of the wave. It does not affect the signal analyzed by the monitor or printed in reports or recordings.

The scale information shown depends on whether gridlines are switched on or off for display. This setting can only be changed in Configuration Mode.

- 1 In the **Setup BIS** menu, select **Change Scale** to call up a list of wave scales.
- 2 Select the required scale from this list.
 - When gridlines are switched off, you can choose from the available scale values: 50 μV , 100 μV , 200 μV , and 500 μV . Scaling information is displayed as a vertical bar on the EEG wave together with its height equivalent in μV .
 - When gridlines are switched on, scales are defined as a range, either $\pm 25 \mu\text{V}$, $\pm 50 \mu\text{V}$, $\pm 100 \mu\text{V}$, or $\pm 250 \mu\text{V}$. Scaling information is shown in the form of gridlines.

Switching BIS Filters On or Off

The low and high pass filters screen out undesirable interference from the raw EEG wave display. The notch filter removes line frequency interference. Filter settings affect the EEG wave and the SEF and TP values, but they do not affect the BIS, EMG, SR, and SQI values.

The filter settings are set in Configuration Mode. You can switch all the filters on or off together in Monitoring Mode.

- 1 In the **Setup BIS** menu, select **Filters**.
- 2 Select **On/Off** to toggle between all filters On or Off.

BIS Safety Information

For information on the use of BIS in specific monitoring situations and on pharmacological responses to the anesthetic agents Nitrous Oxide (when used as the sole anesthetic agent), Ketamine, and Etomidate, please contact Aspect Medical Systems to request a copy of their publication “A Clinician’s Guide to the Bispectral Index®”.

Considerations for Use Due to limited clinical experience in the following applications, BIS values should be interpreted cautiously in patients with known neurological disorders, those taking psychoactive medications, and in children below the age of 1.

WARNING **Conductive Parts** The conductive parts of sensors and connectors should not contact other conductive parts, including earth.

High-frequency Surgery To reduce the hazard of burns in the high-frequency surgical neutral electrode connection, the BIS sensor should not be located between the surgical site and the electro-surgical unit return electrode.

Defibrillation The BIS sensor must not be located between defibrillator pads when a defibrillator is used on a patient connected to the patient monitor.

Securing Cables To minimize the risk of patient strangulation, the patient interface cable (PIC) must be carefully placed and secured.

CAUTION **Revisions** The system will only function if all component revisions are compatible. Otherwise, an incompatibility INOP is displayed.

If the DSC has an older software revision than the BIS Engine, the DSC will automatically be upgraded by the BIS Engine. Do not disconnect the DSC from the BIS Engine, or disconnect the BIS module from the monitor, or switch the monitor power off within the first ten seconds after connection, as this will disrupt a possible software upgrade and cause damage to the DSC.

The **BIS Interface board** for the MP20/MP30 can only be used with BISx, not with the BIS engine. If the BIS engine is connected to the MP20/MP30 a **BIS ENGINE INCOMPT** INOP will be issued.

Impedance Checks Impedance checks may influence data acquisition of other electroencephalographic devices.

Trends

Trends are patient data collected over time and displayed in graphic or tabular form to give you a picture of how your patient's condition is developing. Trend information is stored in the trends database for continuously-monitored measurements, such as ECG, as well as for aperiodically-measured parameters, such as Cardiac Output.

Viewing Trends

Trend information can be viewed embedded as a screen element on specially-designed Screens, or you can open a trend window over the current Screen.

- ◆ To view trends embedded as a screen element, select the Screen name in the monitor info line to enter the **Change Screen** menu, then select a Screen designed to show an embedded trend window.
- ◆ To open the tabular trends window over the current Screen, select the **Vitals Trend** SmartKey.
- ◆ To open the graphic trends window over the current Screen, select the **Graph Trends** SmartKey.

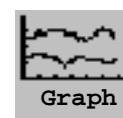

The trend windows open displaying the most recent data and are updated as new data is stored. A timescale along the bottom of the screen shows you where you are in the trends database. The preview column on the right-hand side shows the latest available measurement value. The preview column is updated every five minutes or whenever an NBP or other aperiodic measurement is completed.

A question mark (?) beside a value means that the data may not be reliable, due perhaps to an INOP condition in the measurement.

Your monitor screen may look slightly different to the examples shown here.

Viewing Graphic Trends

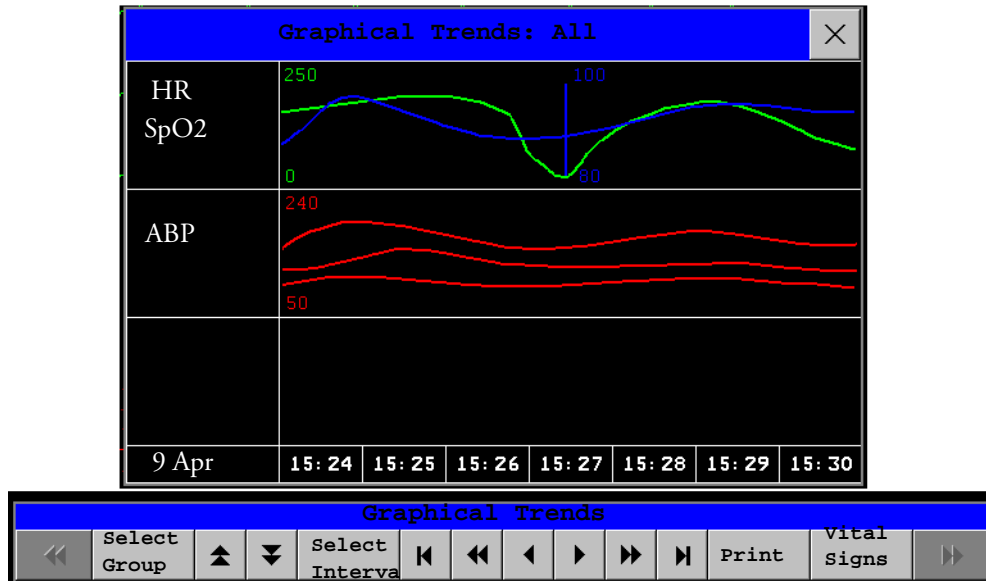

A cursor spanning all measurements in the trend group helps you to navigate through the trends database and shows you your current position in the database. When the cursor is moved across the time line, the values measured at the cursor time are shown in the right hand column.

In graphical trends, aperiodic measurement trends are shown as an asterisk, NBP has a special symbol.

To use the trend cursor to navigate in time through the trends database,

- 1 Select the graphical trend or the arrow pop-up keys to activate the cursor.
- 2 Use the arrow pop-up keys to move the trend cursor backwards and forwards in time, or
- 3 Place the cursor at a specific time by touching the graph.

Viewing Vital Signs Trends

Vital Signs: Standard									X
HR	0	0	80	80	80	80	80	---	---
NBPs	---	---	132	124	125	125	---	---	---
NBPd	---	---	69	74	77	73	---	---	---
NBPm	---	---	83	83	86	81	---	---	---
RR	0	0	20	20	20	20	20	---	---
20 Feb	12:25	12:30	12:35	12:40	12:45	12:50	12:55	(12:55)	

Aperiodic values are shown with a timestamp





The currently-selected column is highlighted. The values can be configured to display in the same colors as the waves and numerics on the realtime display.

Any values available for display before the next scheduled update are shown in the right hand column, with a timestamp in brackets

If more than one value is available for an aperiodic trend for a certain trend period, all measured values are stored in the database and the value closest to the timestamp is shown in the Vital Signs display marked with an arrow.

Trends Pop-Up Keys

When you open the trends window, a selection of pop-up keys appears to let you navigate through the stored trend data and carry out trends-related tasks.

Pop-Up Keys	Selecting this pop-up key lets you....
Select Group	see a pop-up list of trend groups and select a group for viewing.
Select Interval	see a pop-up list of available data resolution settings and select the level of detail shown in the trend view.
Print/Record	print a tabular trends report or make a tabular trend recording of the data in the current window. The report will use the current trend interval settings.
Print	print a graphic trends report of the data in the current window. The report will use the current trend interval settings.
	move the cursor one step to the left or right to navigate through the trends database timeline.
	move the cursor one page to the left or right to navigate through the trends database timeline.
	jump to the beginning or the end of the trends database to see the most recent or oldest trend information stored.
	scroll up and down the screen to see measurement trends that do not fit in the current view.
Vital Signs	open the current trend view in tabular form. The displayed time period and resolution stay the same.
Graph Trends	open the current trend view in graphic form. The displayed time period and resolution stay the same.

Setting Up Trends

Trends are set up in Configuration Mode. You can make temporary changes to trends settings such as trend groups, priorities, or scales in Monitoring Mode. The general settings for all Trends are under **Main Setup -> Trends**.

Settings for a single segment in graphical trends or for the corresponding trend group can be made more easily in that segment menu.

Making Segment Settings

The **Graphical Trends** window is divided into measurement segments, each of which has its own settings.

To enter the segment menu,

- ◆ select the left hand column of the segment, where the measurement label is displayed.

Expanded View

To expand the segment to fill the **Graphical Trends** window,

- ◆ in the **Segment** menu, select **Expand** to have that segment enlarged to fill the window.

In the expanded view, you can also highlight a measurement to make it more easily visible (for example when multiple ST trends are in one segment). To highlight a measurement,

- ◆ in the **Segment** menu, select **Highlight** repeatedly until the highlight is on the required measurement.

To return the segment to its original size,

- ◆ in the **Segment** menu, select **Expand** again.

Trend Scales for Segment Measurements

To change the trend scales for a measurement in the current segment:

- 1 In the segment menu, select the measurement label
- 2 Select **Upper** to change the upper limit of the scale or **Lower** to change the lower limit of the scale.

Optimum Scale

To have the monitor automatically select an optimum scale for viewing, based on current values,

- ◆ in the **Segment** menu, select **Optimum Scale**.

This scale change is temporary. When the graphical trend window is closed the scale reverts back to the setting in **Parameter Scales**.

To switch off automatic optimum scaling,

- ◆ in the **Segment** menu, select **Optimum Scale** again.

Trend Group

To add or remove measurements for this trend group or change the order of the existing measurements:

- 1 In the **Segment** menu, select **Change Group**
- 2 Use the **Add**, **Change**, **Sort Up** and **Sort Down** popup keys to change or re-order the group as required.

No. of Segments

In an embedded graphical trend window, you can select the number of segments to be displayed in the **Segment** menu:

- 1 In the **Segment** menu, select **No. of Segments**
- 2 Select **1, 2, or 3** segments.

Trend Groups

The measurements grouped in trend groups define the trends displayed together in the Vital Signs or Graphics Trends windows and printed in trends reports and recordings. The sequence of the measurements in the group defines the order in which they are displayed. Measurements listed between dotted line separators are displayed overlapping. The trend group **All** contains all available measurements, you cannot change the order or selection of this group.

To change the selection of measurements in a trend group, either use the **Change Group** setting in the **Segment** menu or:

- 1 Select **Main Setup -> Trends -> Trend Groups**
- 2 Select the Trend Group you want to change and use the pop-up keys to **Add, Change, or Delete** the selection of measurements trended.

To temporarily change the order in which the measurements are displayed in a group,

- 1 Select **Main Setup -> Trends -> Trend Groups**
- 2 Select the Trend Group and then the measurement you want to move and use the **Sort Up/Sort Down** pop-up keys.

Trend Interval

The trend interval defines the resolution of trend data shown on the Screen. High-resolution data is especially suited for neonatal applications, where the clinical situation may change very quickly. In adult monitoring, where the patient's status typically changes more gradually, a longer trend may be more informative.

To set the trend resolution, in the Vital Signs or Graphical Trends window,

- ◆ Select the **Select Interval** pop-up key and then select the required interval from the list.

Trend Priority

The monitor stores trend information for all monitored measurements, if configured to do so. If your configuration restricts the number of measurements trended, you must choose which measurements will be included. A priority list is used to select the trended measurements.

To see the measurement priority list for trending,

- 1 In the **Main Setup** menu, select **Trends**.
- 2 Select **Trend Priority**.

To add measurements to the priority list,

- 1 Select the pop-up key **Add** and choose from the pop-up list of available measurements.
- 2 Use the **Sort Up** and **Sort Down** pop-up keys to change the priority order.

Trend Parameter Scales

Parameter scales define how the trend waveform will appear on the screen and in trend reports. Separate scales can be set for adult, pediatric, and neonatal patient trends.

To change the trend parameter scales settings, either use the **Scale** setting in the **Segment** menu or:

- 1 In the **Main Setup** menu, select **Trends**.
- 2 Select **Parameter Scales**.
- 3 Select the measurement or parameter you want to change from the list.
- 4 Select the pop-up key **Change** to call up the **Scale** menu.
- 5 In the **Scale** menu, select the parameter label you want to define settings for. Select **Adult**, **Pedi**, and **Neo** and use the pop-up keypad to enter new upper and lower scale definitions.

Graphical Trend Presentation

Graphical trends and screen trends for measurements with compound values (for example ABP or CO₂) can be viewed in line or band form.

To change the presentation style,

- 1 Select **Main Setup** -> **Trends**
- 2 Select **Global Style** and choose
 - **Line** to display the trends as a continuous line
 - **Band** to fill the area between the trend lines, for example, between the systolic and diastolic pressures, with color.

This sample ABP trend shows the continuously-measured values for the systolic, diastolic and mean pressures displayed in band form.

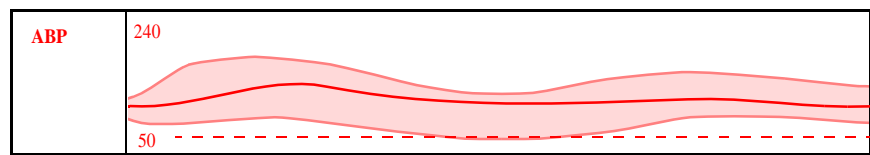

Documenting Trends

To print a Vital Signs or Graphical Trends report,

- ◆ in the **Vital Signs** or **Graph Trends** window, select the pop-up key **Print** to print a report for the trend group currently on the monitor screen.

Reports include the most recent information in the trends database and extend backwards in time according to the selected trend interval and your monitor's configuration. Trends reports can be printed on central or local printers.

To make a Vital Signs recording,

- ◆ in the **Vital Signs** window, select the **Print/Record** pop-up key, then select the **Record Vitals** pop-up key.

Vital Signs recordings print the trend data for the current group and trend period shown in the **Vital Signs** window.

Trends Databases

Depending on the purchased options and the monitor's configuration, the trends databases store information for up to 32 measurements for up to 72 hours.

The values in the trends database are stored as measured by the monitor, they are not averaged values. The trend resolution defines how often a value is stored. In general, if more than one value is available for storage in the trends database, the most recent value is used. Some values in the trends are marked with arrows. This indicates that for this time period, more values were available and the most recent one is shown.

Example database configuration In this example, we see that the monitor stores the most recent data at the highest resolution, older data are stored at a lower resolution.

"4 hours @ 12 second resolution" means that the monitor stores trend data every 12 seconds, for the most recent four hours.

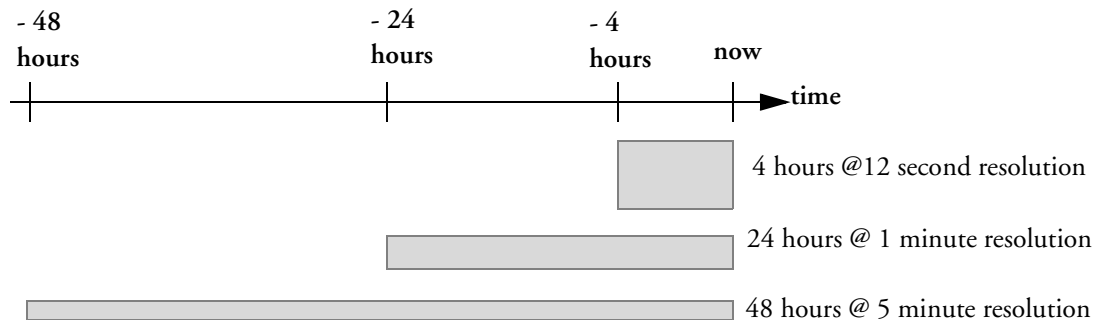

Aperiodic Trends Database

Aperiodic trends do not count toward the maximum number of trends allowed by the trend configuration. Trend data for aperiodic measurements is stored in a separate database and timestamped with the measurement time.

Trending Multiple-Value Measurements

Some measurements generate multiple values, for example invasive pressure measurements can provide systolic, diastolic, and mean values. These values are trended as separate measurements.

Screen Trends

Trends configured to display permanently on special monitor Screens are called screen trends. The selection and number of measurement waves in the Screen Trend segment depends on your monitor configuration. Screen trends are color-coded to match the measurement wave and numerics, and they can be viewed in graphical, tabular, or horizon format.

If you do not see screen trends on the monitor Screen, select a different Screen, one that is configured to show screen trends. Screen trends are only available on specially designed Screens.

Screen Trend information is taken from the Trends database. If you do not see a Screen Trend for a particular measurement on the Screen, check the trend priority list to ensure that this measurement is being trended.

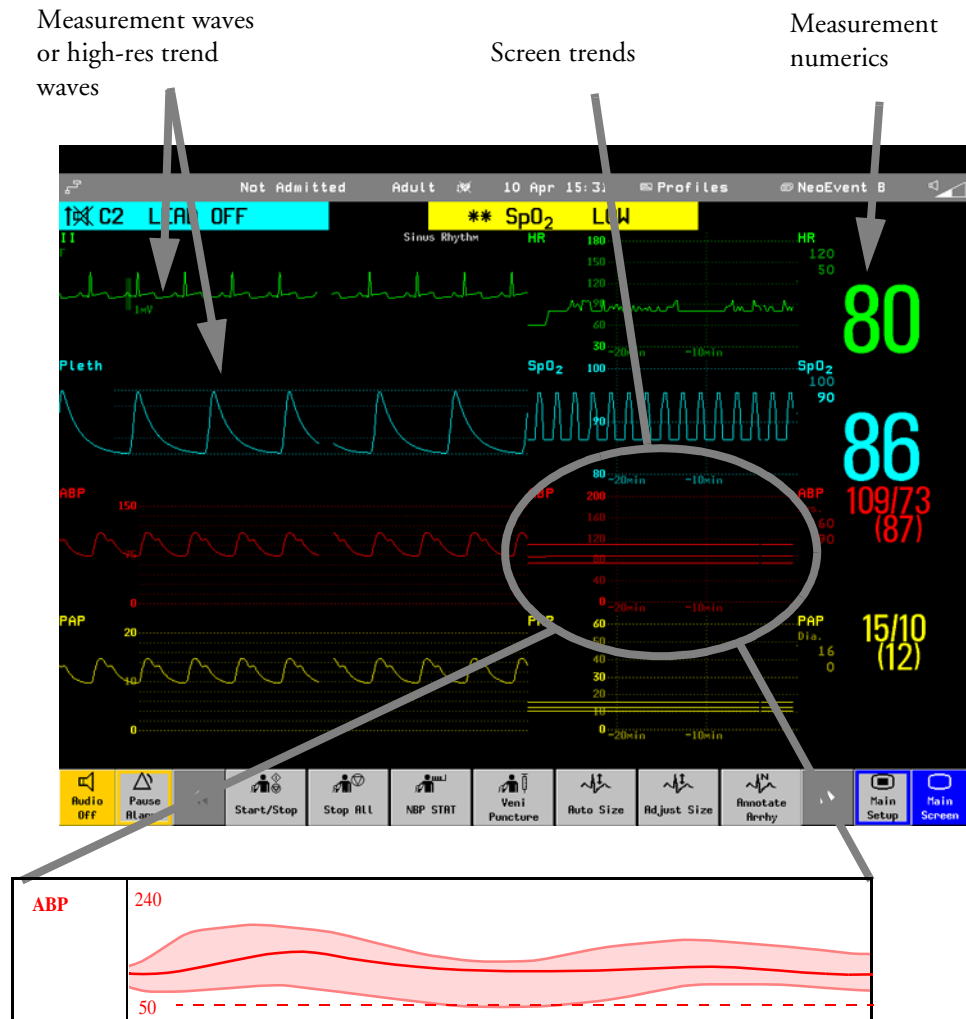

Setting the Screen Trend Time

To set the **ScreenTrend Time** for all graphical and horizon screen trends (“global” trend time),

- 1 Select a screen trend then select **Setup Trend**, or select **Main Setup -> Trends**.
- 2 Select **ScreenTrend Time** and select the required time: 30 minutes, one, two, four, eight, or twelve hours.

This is now the Global screen trend time and defines the period of trend information shown for all screen trends.

To set a different **ScreenTrend Time** for a screen trends or a group of aligned screen trends,

- 1 Select a screen trend
- 2 Select **Change TrendTime**
- 3 Select the required trend time.

Selecting **Global** leaves the trend time set to the global screen trend time.

Changing the Selection of Screen Trends Displayed

- 1 Select the screen trend.
- 2 Select **Change Trend** and select the required trend from the list of available trends.
Select **Blank** to remove the selected trend from the Screen.
If you do not see **Change Trend** in the screen trend menu, the trend is aligned to display with the measurement wave. Changing the wave automatically changes the trend.

To display two or more screen trends overlapping,

- 1 Select the screen trend to open the screen trend menu,
- 2 Select **Change Trend** -> **Add Trend** and select a screen trend from the pop-up list.

Activating the Cursor for Screen Trends

To activate the cursor for Screen Trends:

- 1 Select the screen trend.
- 2 Select **Activate Cursor**

You can now use the arrow keys to move the cursor across the time line. The values measured at the cursor time are shown next to the cursor.

To de-activate the cursor,

- ◆ Select **Main Screen**.

Changing the Screen Trend View

- ◆ To switch between tabular, graphic and horizon views, select the screen trend then select **Change View** and select the required view.

Tabular View

Aperiodic measurements such as NBP, C.O., C.I., and Wedge can be viewed as a screen trend in tabular form. The measured values and their timestamps are shown, with the measurement label.

NBP	15:15	120/80(95)	16:30	120/80(95)
mmHg	15:30	120/80(95)	16:45	120/80(95)
	15:45	120/80(95)	17:00	120/80(95)
	16:00	120/80(95)	17:15	120/80(95)
	16:15	120/80(95)	17:30	120/80(95)

The trend time for tabular screen trends depends on the space available on the Screen. Up to 30 measurements or 12 hours information can be shown.

Horizon View

The horizon view presents trend information superimposed over a defined baseline. This helps you visualize changes in your patient's condition since the baseline was set.

The horizon view is made up of:

- a horizon, drawn in white, as a reference point or baseline to help you visualize changes in your patient's condition. The horizon can be set to represent your patient's current condition, or a target condition.
- a graphical trend, displaying patient data for the set TrendTime (1).
- a trend indicator arrow, indicating how the patient trend has developed in the last ten minutes (2).
- a deviation bar, showing how the currently measured value deviates from the stored baseline (3). The height of the deviation bar is an indication of the extent of the change in your patient's condition relative to the (horizon) baseline.

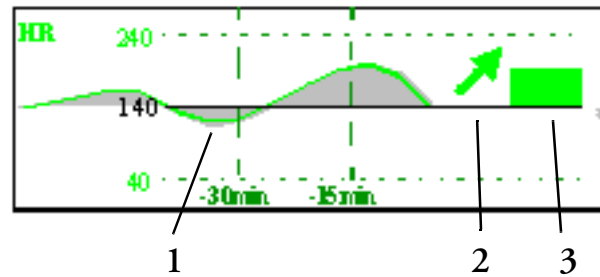

Your monitor may not be configured to show all three elements of the screen trend horizon view.

Setting the Horizon

The horizon is the reference value to which deviations in the measurements are compared.

- 1 To set the baseline, select the horizon trend
- 2 Select
 - **Auto All** to reset the horizon for all horizon screen trends to the currently-measured values
 - **Auto Horizon** to set the horizon for the selected horizon trend to the currently-measured value
 - **Set Horizon** to set the horizon to a specific value from a pop-up list.

Setting the Horizon Trend Scale

The horizon trend scale is defined with respect to the horizon. If your horizon is set to 100 and you select 20 as the horizon scale delta, the upper limit of the horizon scale will be 120 and lower limit 80.

To set the horizon trend scale delta,

- 1 Select the horizon trend.
- 2 Select **Set Scale Delta** and select a value to define the distance between the horizon and the the upper and lower scale limits.

Be aware that changing the horizon trend scale can change the angle of the trend indicator, without the patient's condition having changed.

If a measurement exceeds the outer limits of the scale, the wave will be clipped and you must either reset the horizon or the horizon trend scale to display the values outside the scale limits.

Calculations

Calculations are patient data that is not directly measured but calculated by the monitor when you provide it with the appropriate information.

Your monitor can perform the following hemodynamic, oxygenation, and ventilation calculations.

Hemodynamic	Oxygenation	Ventilation
Cardiac Index (C.I.)	Arterial Oxygen Content (CaO ₂)	Minute Volume (MINVOL)
Stroke Volume (SV)	Venous Oxygen Content (CvO ₂)	Compliance (COMP)
Stroke Index (SI)	Arteriovenous Oxygen Content (avDO ₂)	Dead Space (Vd)
Systemic Vascular Resistance (SVR)	Oxygen Availability Index (O ₂ AVI)	Dead Space/Tidal Volume Ratio (Vd/TV)
Systemic Vascular Resistance Index (SVRI)	Oxygen Consumption (VO ₂)	Alveolar Ventilation (ALVENT)
Pulmonary Vascular Resistance (PVR)	Oxygen Consumption Index (VO ₂ I)	
Pulmonary Vascular Resistance Index (PVRI)	Oxygen Extraction Ratio (O ₂ ER)	
Left Cardiac Work (LCW)	Alveolar-Arterial Oxygen Difference (AaDO ₂)	
Left Cardiac Work Index (LCWI)	Percent Arteriovenous Shunt (Qs/Qt)	
Left Ventricular Stroke Work (LVS _W)		
Left Ventricular Stroke Work Index (LVS _W I)		
Right Cardiac Work (RCW)		
Right Cardiac Work Index (RCWI)		
Right Ventricular Stroke Work (RVS _W)		
Right Ventricular Stroke Work Index (RVS _W I)		
Extra Vascular Lung Water Index (EVLWI)		
Intrathoracic Blood Volume Index (ITBVI)		
Global End Diastolic Volume Index (GEDVI)		

The hemodynamic calculations available depend on the Cardiac Output measurement method being used and the regulatory standards that apply for your hospital: see the C.O. chapter for availability details.

Viewing Calculations

- ◆ Select the **Calculations** SmartKey to open the Calculations window.
- ◆ Select the **Calc Type** field and select the required calculation type for display.



Calculations Windows

This example calculations window shows the hemodynamic calculations window. The ventilation and oxygenation windows are similar.

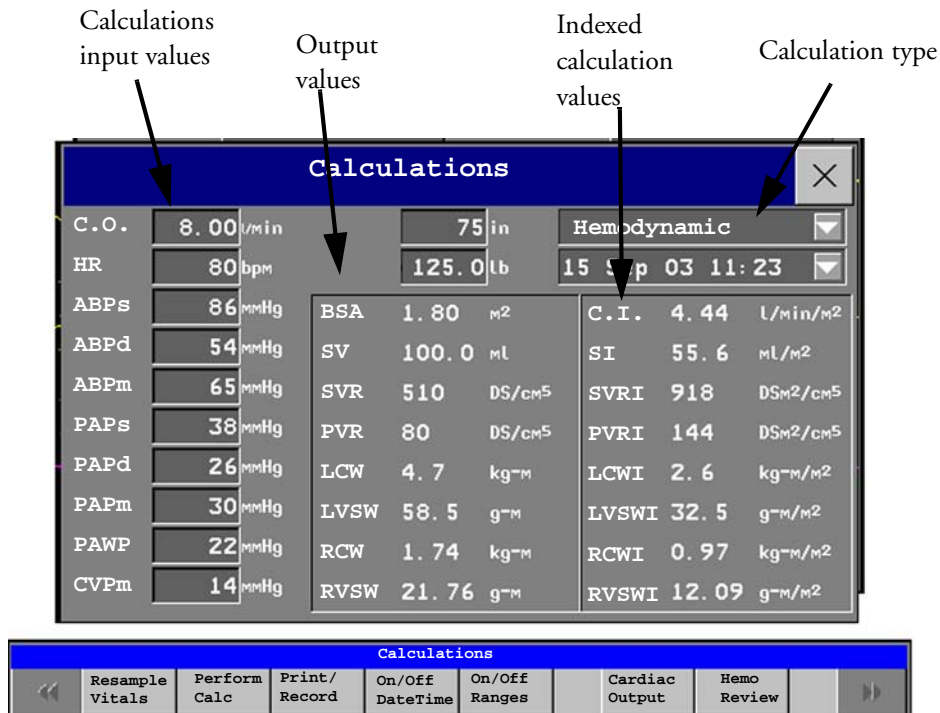

Calculations Pop-Up Keys

Depending on the calculations group you choose, a selection of pop-up keys will appear to let you navigate through the stored events and carry out calculations-related tasks.

Pop-Up Keys	Selecting this pop-up key lets you....
Resample Vitals	tell the monitor to override the values in the calculations database and use the most recent continuously monitored values. Resampling sets the calculation time to the current time, and displays the corresponding values for the previous second.
Perform Calc	perform the displayed calculation using the currently-input values and store the calculation in the calculations database
Print/Record	print or record the displayed calculation.
On/Off DateTime	toggle between showing the date and time or the units for the calculation input values.
On/Off Ranges	toggle between showing the normal ranges or the units for the calculation output values.

Pop-Up Keys	Selecting this pop-up key lets you....
Cardiac Output	access the C.O. procedure window.
Hemo Review	open the hemodynamic calculations review window.
Vent Review	open the ventilation calculations review window.
Oxygen Review	open the oxygenation calculations review window.

Reviewing Calculations

- ◆ To enter the calculations review window, select the **Oxy Review**, **Ventil Review**, or **Hemo Review** pop-up key as required.

The review window lists all the input and output values for each measurement in the calculations group. The timeline in the review window lists the times the calculations were performed.

- ◆ To review individual calculations, select the calculation in the Calculation Review window and then select the **Original Calc** pop-up key.

Performing Calculations

You must check that all input values are appropriate for your patient before performing calculations.

- 1 Select the **Calculations** SmartKey to open the Calculations window.
- 2 Select the **Calc Type** field and select the required calculation type for display.
- 3 Check the calculation time in the **Calc Time** field.

When you enter the calculation window, this field will show either the current time or the time of the most recent available C.O. measurement, depending on your monitor configuration.

- To choose a different calculation time, select the **Calc Time** field. This calls up a list showing the timestamps of calculations performed earlier. Select a time from this list, or select **Select Time** to enter a time of your choice.
 - To enter the current time, select the **Resample Vitals** pop-up key. If you choose the current time, the monitor will resample all the required values that are continuously monitored.
- 4 Enter any values that must be entered or edited manually. Select the value field and then use the pop-up keypad to enter the required values. Select **Enter** to confirm each entered value. Manually-entered values are marked with an asterisk (*).

Entering Values for Calculations

The monitor automatically enters any available values for calculations. For aperiodically-measured values such as C.O., the monitor will re-use the most recent value in the calculation database until a new value becomes available.

- ◆ To enter calculations values manually or edit automatically-entered values, select the value field to open the on-screen keyboard and use this to enter the correct value. Values edited manually are marked with an asterisk symbol (*).

If you enter a value that has more decimal places than allowed for a particular input, the value you enter will be rounded off after you select **Enter**. If you enter a value which cannot be stored, the message **Warning: Value out of range** will appear. Enter a new value.

In hemodynamic calculations, if the systolic and diastolic pressures are manually entered, the mean pressure is calculated and marked with an asterisk. The formula used to estimate the mean pressure is $[\text{systolic} + (\text{diastolic} \times 2)] / 3$.

Automatic Value Substitution

If the monitor cannot find a value required for calculation, it automatically tries to find an equivalent source for this value. For example, if C.O. is required but unavailable, the monitor automatically looks for CCO as a alternative source of C.O. values, or a alternative Pressure label may be used instead of ABP. The label of the value in the **Calculations** window does not change. Substituted values are marked with an asterisk (*).

Automatic Unit Conversion

The monitor needs consistent units for performing calculations. It automatically converts units where necessary before it performs the calculation, for example, pressures sourced in kPa, cmH₂O, or mbar are automatically converted to mmHg, or to cmH₂O for ventilation calculations.

Manual Unit Conversion

If you need to convert units for other purposes you can use the **Unit Conversion** window:

- 1 Select **Main Setup -> Calculations**
- 2 Select **Unit Conversion**.
- 3 Select the field under the unit you know and use the on-screen keypad to enter the known value. The converted value automatically appears in the adjacent field.

Unit Conversion	
Fahrenheit	Celsius
104.00	40.00
Inch	Centimeter
7.48	19.00
Pound	Kilogram
154.32	70.00

BSA Formula

Your monitor provides both the Boyd and Dubois formulas for the calculation of body surface area (BSA). For calculations, the monitor uses the setting defined in the Patient Demographics menu. All calculation results that use BSA are indexed to the selected formula.

- ◆ To check the current setting, select the patient name to enter the Patient Demographics menu. **BSA(B)** indicates that the Boyd formula is used; **BSA(D)** indicates that the Dubois formula is used.

Documenting Calculations

- ◆ To send a Calculations recording to a connected recorder, in the **Calculations** window, select the **Print/Record** pop-up key, then select the **Record Calc** pop-up key.

Calculations recordings print the patient demographic information and the content of the current **Calculations** window on the recorder strip.

- ◆ To print a report for the calculation group currently on the monitor screen, select the pop-up key **Print Calc**. To print the Calculations Review window, select the pop-up key **Print** in the Calculations Review window. All the calculations in the current group will be printed in the report.

Calculation Reports can be printed on central or local printers.

This example report shows the oxygen calculation group. Ventilation and hemodynamic calculation reports are similar.

Patient information

Calculation group

Three columns of calculations input and output values, with times, units and ranges, where appropriate

Bob Jones		123456	
Oxygen Calculations			
Calculation Time 4 Apr 02 12:24			
	Time	Units	
C.O.	3.61	l/min	17.20 ml/dl
PIO2	*0.85		13.24 ml/dl
PaO2	*50	mmHg	4.2-8.0 ml/dl
PACO2	*55	mmHg	950.1350 ml/min
SPO2	*80	%	1.90 ml/min
PO2	*35	mmHg	0.24-0.28
SV02	*53	%	16.15 mmHg
Hb	*15.0	g/dl	3.5 %
PB	*760	mmHg	
Weight	185	cm	
Weight	85.0	kg	
CaO2	16.61		
CvO2	13.03		
Ca-vO2	3.58		
DO2	11.08		
VO2	1.90		
O2ER	0.24		
AaDO2	16.15		
Qs/Qt	1.50		
DO2I	11.08	ml/min/m2	
VO2I	1.90	ml/min/m2	
BSA	2.09	m2	

PHILIPS

General Hospital

Page 1 (last)

High Resolution Trend Waves

High resolution (hi-res) trend waves provide information for fast-changing parameters at a glance. They can help you to recognize trend patterns and to find interrelationships between measurements, by comparing changes in your patient's condition across different hi-res trend waves. This can aid in the early detection of cardiorespiratory and hemodynamic problems.

The amount of data you can show on a screen depends on the display size and resolution: for example, on an eight inch (20 cm) wave trace on your monitor screen, you can view approximately six minutes of hi-res trend wave trace. The hi-res waves are drawn at a speed of 3 cm/minute.

The availability of hi-res trend waves depends on your monitor configuration and on the options purchased for your monitor.

Changing the Hi-Res Trend Waves Displayed

- ◆ To change the selection of hi-res trend waves on the Screen, select the hi-res trend wave and select the required hi-res trend wave from the list of available measurements.

If there are no hi-res trend waves on the Screen, you must change to a Screen with hi-res trend waves.

Hi-Res Trend Wave Scales

High-resolution trend waves are either compressed realtime waves or fast numeric trends.

- Hi-res trend waves from compressed realtime waves include: Resp, CO₂, ABP, PAP, CVP, ICP, AWP, anesthetic agents.
- Hi-res trend waves from fast numeric trends include: btbHR, SpO₂, tcpO₂, tcpCO₂, Pulse, Perf, CPP, BIS, CCO, inO₂, Delta SpO₂.

Hi-res trend waves from waves use the wave scale as their display scale. Changing the wave scale changes the hi-res trend wave scale.

Hi-res trend waves from numerics use a pre-defined display scale dependent on the patient category.

Hi-Res Trend Waves and OxyCRG

OxyCRG is a combination of three hi-res trend waves, btbHR, SpO₂, and Resp, mainly used in neonatal monitoring.

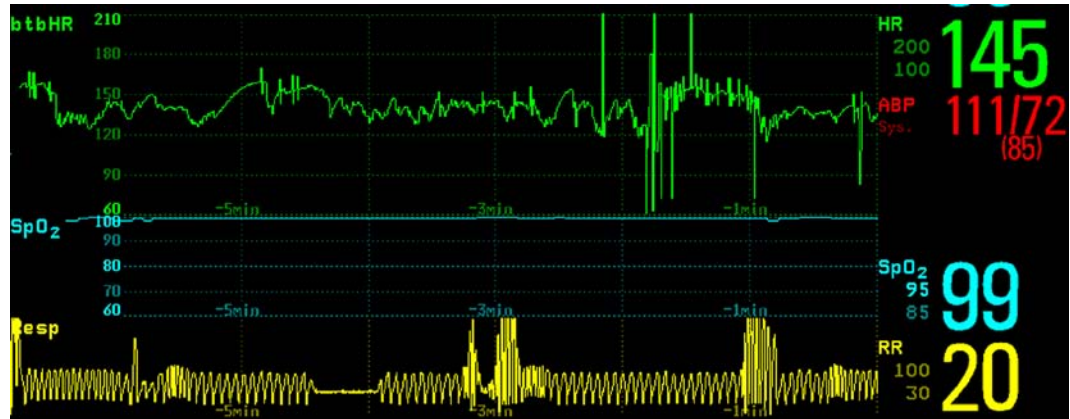

Printing Hi-Res Trend Wave Reports

To print hi-res trend waves on reports, you can choose to print either

- all **VisibleWaves** - prints all waves and hi-res trend waves currently displayed
- **All Waves** - prints realtime waves and hi-res trend waves for all currently-monitored measurements
- **HiRes Waves** - prints hi-res trend waves for the currently-monitored measurements
- **OxyCRG Waves** - prints hi-res trend waves for btbHR, SpO₂, and Resp.

For each hi-res trend wave, six minutes of measurement data will be printed.

See the section on Reports for more information on setting up reports.

Hi-Res Trend Wave Recordings

The selection of waves in hi-res trend wave recordings and the printing speed are defined by the pre-configured HiResTrd recording template. See the section on Recordings for more information.

To start a hi-res trend waves recording,

- 1 select the **Realtime Record** SmartKey, if configured, or select **Main Setup** -> **Recordings**
- 2 select the **Start HiResTrd** pop-up key.

Event Surveillance

Events are electronic records of episodes in your patient's condition. You can trigger them manually, or set them to trigger automatically during pre-defined clinical situations. Depending on the level of event surveillance available on your monitor, the information stored for each event episode can include:

- waveforms for up to four measurements of your choice (depending on episode type, see table on page 243 for more details)
- numeric vital signs for all the measurements monitored
- any alarm conditions active when the event episode was triggered
- any annotations connected with the event.

You can navigate through the event database to view events retrospectively, and you can document events on a recording or report marked with the patient name, bed label, and the data and time.

Levels of Event Surveillance

The appearance of the Events windows and menus and the settings you can select for events depends on the event surveillance option purchased for your monitor: basic event surveillance, advanced event surveillance, or neonatal event review. This table lists the differences between the options.

To determine which level of event surveillance your monitor has, select **Main Setup** -> **Event Surveill.** -> **Setup Events** and select the trigger group to see the available event groups.

- if the only event group listed is NER, your monitor has the Neonatal Event Review option
- if there is one event group and it is not NER, your monitor has the Basic Event Surveillance option
- if you see six event groups, your monitor has the Advanced Event Surveillance option.

Event Functionality	Basic Event Surveillance Option C06	Advanced Event Surveillance Option C07	Neonatal Event Review (NER) Option C04
Event groups	1	5 + NER	NER
Measurements per group	3	4	3
Triggers per measurement	1	2	1
Trigger types	Simple ("at least one")	Combined ("at least two")	Simple ("at least one")
Annotation	no	yes	no

Event Functionality	Basic Event Surveillance Option C06	Advanced Event Surveillance Option C07	Neonatal Event Review (NER) Option C04
Types of event episode	Average trend	Average trend High resolution trend Snapshot events	High Resolution Trend
Event views	Graphic Event Review window, graphic Event Episode window	Summary view, graphic and tabular Event Review window, graphic and tabular Event Episode window	Graphic and tabular Event Review window, graphic and tabular Event Episode window
Database capability	25 events for 24 hours	25 events for 24 hours 25 events for 8 hours 50 events for 8 hours 50 events for 24 hours	25 events for 24 hours 25 events for 8 hours 50 events for 8 hours 50 events for 24 hours
Event Notification	no	yes	no

Event Groups

The event group

- monitors the patient's signals to detect event triggers
- defines which waveforms are recorded in the event data.

In basic event surveillance only one event group can be active at a time, with Advanced Event Surveillance all six groups can be active simultaneously. Active event groups monitor for event triggers.

Event groups are defined in Configuration Mode. In monitoring mode the groups can be adapted to current conditions, for example episode types and threshold levels can be changed .

Event Episodes

When an event occurs, information for a predefined duration is stored. This is the event episode. It includes information from a defined period before the trigger, called the event pre-time. The episode time after the event is called the event post-time. If a further event occurs during the event post-time it changes a single event to a combined event (combi-event).

Manually-triggered event episodes document patient information from the time leading up to the event trigger; they do not have a post-time.

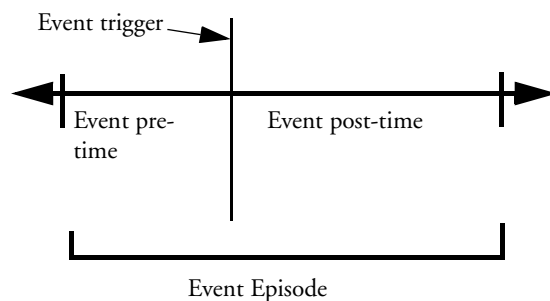



The episode type defines the level of detail captured in an event episode. The higher the data resolution, the shorter the period that the monitor can store in its memory. High-resolution data is suited for neonatal applications, where the clinical situation may change very quickly. In adult monitoring, where the patient's status typically changes more gradually, a longer trend may be more informative.

Event Episode Types	Pre-time	Post-time
Average trend 20 minutes, five samples per minute	2 minutes	18 minutes
	4 minutes	16 minutes
	6 minutes	14 minutes
	8 minutes	12 minutes
	10 minutes	10 minutes
	12 minutes	8 minutes
	14 minutes	6 minutes
	16 minutes	4 minutes
	18 minutes	2 minutes
HiResTrnd Four minutes, four samples per second. Neonatal Event Review (NER) is a type of HiResTrnd	1 minute	3 minutes
	2 minutes	2 minutes
	3 minutes	1 minute
Realtime Wave Snapshot 15 seconds	5 seconds	10 seconds
	10 seconds	5 seconds

Events Pop-Up Keys

Depending on the events view you choose, a selection of the events pop-up keys let you navigate through the stored events and carry out events-related tasks.

Pop-Up Keys	Selecting this pop-up key lets you....
Event Setup	open the Event Surveillance Setup menu.
Show Episode	open the Event Episode window to review the selected event in detail.
Show Review	open the Event Review window.
Review Group	choose a different event group for reviewing in the Event Review window (Advanced Event Surveillance only).
Show Summary	open the Event Summary window.
Manual Event	start a manually-triggered event capture.
	move the cursor left or right to the next event to navigate through the events database. Placing the cursor over an event highlights it and shows the event values for the selected event.

Pop-Up Keys		Selecting this pop-up key lets you....
		jump to the first or last event in the event database.
Vitals View	Graphic View	toggle between a tabular and graphic version of the Event Episode window currently viewed.
Table Review	Graphic Review	toggle between a tabular and graphic version of the Event Review window currently viewed.
Delete Event		delete the currently-selected event from the database. The monitor asks you to confirm this deletion. You cannot retrieve deleted events.
Select Annot.		access the list of available annotations to add a nursing note for the current event episode (Advanced Event Surveillance only).
Print/Record		access the printing and recording pop-up keys to document events.

Event Triggers

You can trigger event capture manually, for example, if you want to record a patient's condition before a procedure. You can also set events to trigger automatically, when the patient's values cross a predefined threshold value, or when a particular measurement or procedure is carried out, for example, when an NBP measurement or a Cardiac Output or Wedge procedure is carried out.

If more than one trigger is available for the measurements in the active event group, the trigger condition may be **AtLeast1Par**, **AtLeast2Par**, **AtLeast3Par**, or **All4Par**. If the trigger is **AtLeast1Par** (this is short for 'at least one measurement parameter'), the monitor starts an event capture if a trigger occurs in any of this event group's measurements. If the trigger is **AtLeast3Par**, the monitor captures events when three or more trigger thresholds from this event group's measurements are violated. With **Enhanced Condition** you can not only select a minimum number of triggers to trigger an event but define which specific measurement triggers these must be. For example, **AtLeast2Par** will cause an event to be captured if a trigger occurs in any two of this event group's measurements - with **Enhanced Condition** you can select that only when triggers are in HR and SpO₂ an event will be captured.

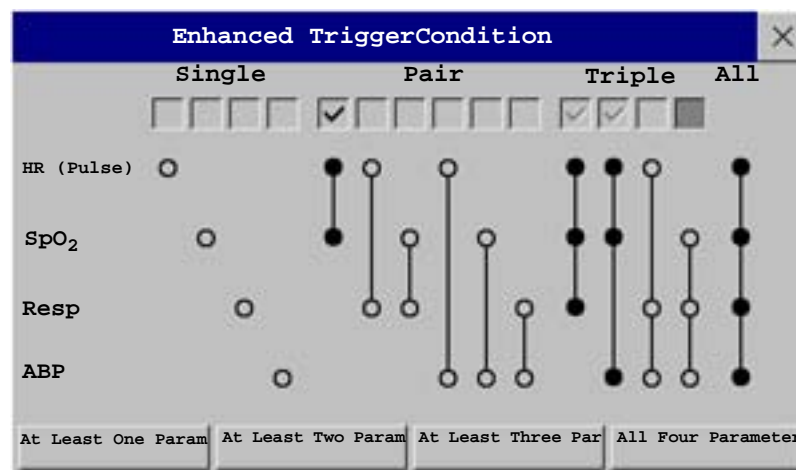

The trigger condition for event groups is set in the monitor's Configuration Mode.

If you use alarm limits as event triggers, the event capture is triggered automatically when your patient's values violate set alarm limits, or when a specified alarm condition, such as apnea, occurs. No events of this kind are triggered if alarms are switched off. Changing alarm limits changes the event trigger definitions.

The asterisk symbols beside the trigger tell you about the alarm triggers:

*** indicates a high priority (red) alarm

** indicates a lower priority (yellow) alarm. This category includes short yellow arrhythmia alarms, which may be configured to be shown as one star alarms (*) on your monitor.

Triggers without asterisk symbols are user-defined triggers.

If you set user-defined threshold triggers, you can define event triggers that are independent of alarm limits. You must set a threshold value and a threshold time for the trigger. If you set the trigger threshold time to 12 seconds, the monitor triggers an event if the threshold is violated for more than 12 seconds.

If you set On Measurement triggers, you can set aperiodic measurements (such as NBP) or procedures (such as Cardiac Output) to trigger an event whenever they start.

If you set user-defined deviation triggers, you can define event triggers that are independent of specific limits and based instead on deviations from the current values. You must set a deviation and a period of time in which the deviation occurs. There are three types of deviation available: **ANY deviation**, **UP deviation** where only changes in a positive direction are detected and **DOWN deviation** where only changes in a negative direction are detected. The deviation can be defined either in relative terms as a percentage, for example 10%, or as an absolute value, such as 10 bpm.

Event Retriggering

If a condition that triggered an event persists and the values remain beyond the trigger threshold, a new event will not be triggered.

For a new event to be triggered by the same condition, the measured values for at least one of the triggers must cross back into the normal range and then recross the trigger threshold.

Event Notification

(Advanced Event Surveillance Only). You can be notified when an event is detected. For each event group you can define a type of notification depending on the severity of the event conditions. The notification can be a status message with a prompt tone or a standard *, **, or *** alarm notification. These event alarms are handled exactly like measurement alarms; they can be silenced and are also suspended when all alarms are suspended. You should only use alarm notification for events which are comparable in severity to standard measurement alarms to avoid potential confusion due to too many alarms. Notification in the form of an alarm is not available when the trigger condition is **At Least One Param**. Selecting **None** switches event notification off.

Setting the type of notification, or switching notification off, is done in Configuration Mode.

Setting Triggers for NER and Basic Event Surveillance

- 1 Select **Main Setup -> Event Surveill.** -> **Setup Events** to enter the **Event Setup** window.

- 2 Select the name of the current episode type to set the episode pre/post time.

- 3 Set the event trigger for each measurement.

Select each trigger name and select, if available, either an alarm trigger, or a

user-defined trigger from the pop-up trigger list. If you select a user-defined trigger, set the required threshold level and delay time.

- 4 Set the trigger status to **Activated** to start event triggering. If the status is **Deactivated** event surveillance is effectively switched off.
- 5 Select **Confirm** to confirm your changes.

Event Setup

Group Name:

Episode Type:

HR (Pulse)

SpO2 % for sec

Resp

Setting Triggers and Notification for Advanced Event Surveillance

- 1 Select the group name to enter the **Event Setup <Group Name>** window.
- 2 Set the trigger status to **Activated**, to have this event group trigger events, or **Deactivated**.

- 3 Set the episode type.

Select the name of the current episode type and select an episode type from the pop-up list. The pre/post episode time for the selected episode type is displayed.

- 4 Set the trigger for each measurement.

Select each trigger

name and select either an alarm trigger or a user-defined trigger from the pop-up trigger list. If you select a user-defined trigger, set the required threshold level and delay time. If a deviation trigger is configured, set the deviation and duration.

- 5 Select **Confirm** to confirm your changes.

Event Setup

Group Name:

Notification Type:

Episode Type:

Trigger Condition:

HR (Pulse)

SpO2 % (dev) within sec

ABP

Resp rpm for sec

Triggering Events Manually

- ◆ To manually trigger an event, select the SmartKey **Manual Event** and (for Advanced Event Surveillance) select the group in which the event will be triggered.

For manually-triggered events, patient information for the time leading up to the trigger moment is stored using the settings of the assigned event group.

The Events Database

The maximum number of events that can be stored in the event database depends on the database configuration and the level of event surveillance used. The event database is set up in the monitor's Configuration Mode. Events are stored in the monitor's event database for the configured lifetime, either 8 hours or 24 hours. Deleted events cannot be retrieved. Events are automatically deleted when:

- their configured lifetime is over
- the storage capacity of the database is exceeded (storing a further event deletes the oldest event in the memory)
- a patient is discharged.

As the event database is cleared when you discharge a patient, you should ensure that you have documented any events you require for the patient records before you confirm the discharge.

Viewing Events

- To see a summary of all the events in every group in the event database, use the **Event Summary** window.
- To review all the events in a particular event group, use the **Event Review** window.
- To review individual event episodes in detail, use the **Event Episode** window.

To start viewing events, either:

- ◆ in the **Main Setup** menu, select **Event Surveillance** and then select the event view you require from the list, or
- ◆ select the **Event Surveillance** SmartKey and then select the event view you require from the list.



Event Counter

Vertical bars mark events in the Event Summary window.

Events: 0

Event Counter

The timeline shows

the position of the stored events in the event database. Selecting this view activates a cursor that lets you navigate across the timeline and select individual events for review in the **Episode Review** window. It also calls up the events pop-up keys.



Event Counter (Graphic)

The event counter counts the total number of events in the database. If more than one event group was set to trigger events within the event history, the event counter also counts the event group totals.

Counting Combi-Events

If one or more events occur during the same Episode Time, the monitor combines them and displays them as distinct events in one event episode, called a combi-event. The first event is the trigger event, and the others are follow-up events. For example, if an apnea event is followed 40 seconds later by a brady event, the brady event is not counted as a single event but as part of the apnea event.





Counting Neonatal Event Review (NER) Events

For neonatal events (NER, formerly “OxyCRG”), apnea events (**A**), bradycardia events (**B**), and combinations of these events are counted and classified by the event counter in the Event Summary. If they are associated with a Desaturation (**D**), this is also marked. Manual events (**M**) are counted separately. In the example below, **A(D):2(1)** indicates that two apnea events occurred and one of them was associated with a desaturation.

16 Stored Events: A(D):2(1) B(D):7(1) AB (D): 1(1) D:6 M:0

Event Summary Window

(Advanced Event Surveillance only). The Event Summary window shows the number of stored events in each event group and the total number of events in the database. Vertical bars mark events on a timeline showing the position of the stored events in the event database. The symbol next to the group name indicates the activation and notification status:

symbol	meaning
	group activated, notification set to ***alarm
	group activated, notification set to **alarm
	group activated, notification set to *alarm
	group activated, notification set to screen prompt
	group is activated, notification is switched off
no symbol	group not activated

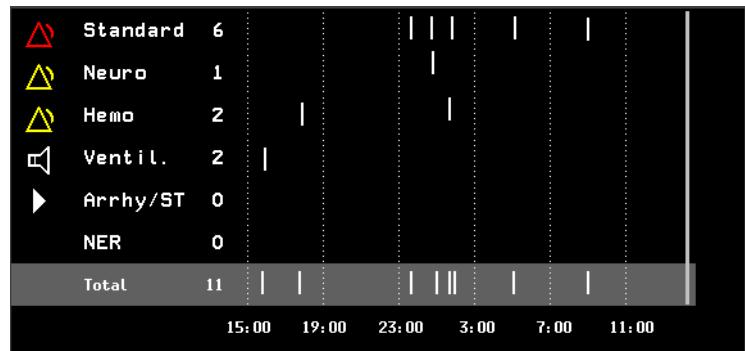

Selecting the **Event Summary** window calls up the events pop-up keys.

Parts of the **Event Summary** window can also be embedded in Screens so that they are always visible, for example the Total row showing the total number of events with the bars on the timeline or the column showing all the groups with the activation and notification status.

Event Review Window

- ◆ To enter the **Event Review** window, select the graphic event summary, if available, or select the events pop-up key **Show Review**.
- ◆ When you open the **Event Review** window, it automatically shows the event group with the most recent event. To view other event groups, select the pop-up key **Review Group** and select the group from the list.

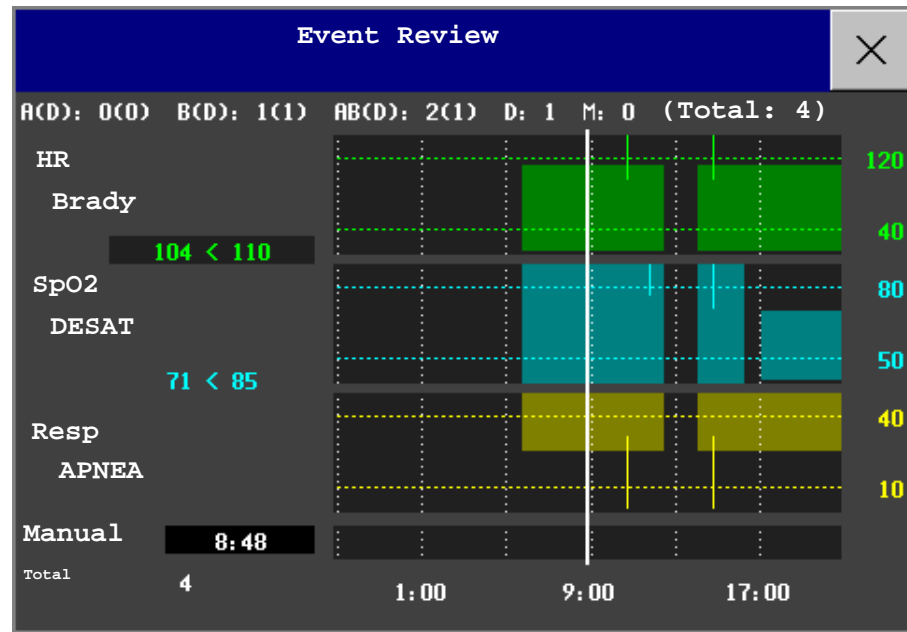

Event bars: Each event bar represents one event. The height indicates the event severity. Bars that extend over more than one channel represent combi-events. Manually-captured events are marked with a bar above the timeline instead of in the measurement channels.

Event values: Event information for the currently-selected event is shown on the left of the review window. The trigger measurement is highlighted.

- If an alarm triggers the event, the monitor shows the alarm conditions that triggered the event.
- If the event trigger was user-defined, instead of an alarm condition the monitor shows for example **SpO2 94<96**, where the second number is the current event trigger threshold and the first number is the maximum deviation from the set limit.

Trigger threshold: The horizontal lines show the trigger thresholds. Gaps in the line indicate that the trigger was inactive for a while, possibly because alarms were switched off or because there was an INOP condition in the group measurements.

Timeline: The timeline at the bottom indicates the period currently stored in the event database.

Event Episode Window

- ♦ To enter the **Event Episode** window, select the pop-up key **Show Episode**.

Depending on the event group settings, the **Event Episode** window shows either 20 minutes of average trend event information, four minutes of high-resolution event information, or 15 seconds of realtime wave information.

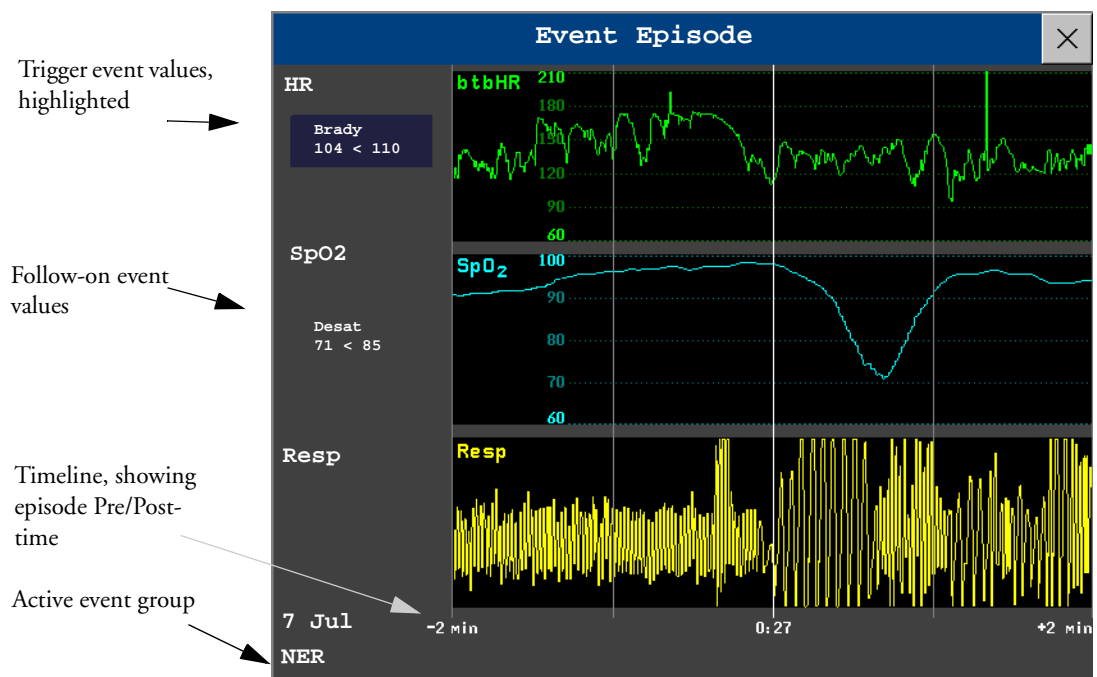

The event values to the left of the measurement channels show the trigger threshold set and the maximum amount by which this limit was exceeded. In this example, **Brady 104<110** tells you that 104 was the lowest HR value measured during the event time and that the low HR trigger threshold was set to 110 when the event was triggered. If the event was manually triggered, the event value boxes display “manual”.

Annotating Events

- 1 To annotate an event, in the Event Episode window, select the pop-up key **Select Annotation**.
- 2 Select the required annotation from the pop-up list of available annotations for the currently active event group.

Up to 20 annotations can be configured to let you add commonly-used clinical notes to event episodes for documentation purposes. To see the complete list of available annotations, in the **Event Setup** menu, select **Event Annotation**.

Documenting Events

You can print a report or make a recording of the events history stored in the database or of individual event episodes.

Documenting Event Review

- 1 In the **Event Review** window, select the pop-up key **Print/Record**. This calls up the event documentation pop-up keys.

- For a graphic **Event Review** recording, select the **Record Graphic** pop-up key.
For a tabular **Event Review** recording, select the **Record Tabular** pop-up key.
To print an Event Report, select the **Print Review** pop-up key.

Documenting an Event Episode

- In the **Event Episode** window, select the pop-up key **Print/Record**. This calls up the event documentation pop-up keys.
- To make an **Event Episode** recording, select the **Record** pop-up key.
To print an **Event Episode**, select the **Print Episode** pop-up key.

Event Recordings

Event recordings can be sent to a locally-connected M1116B recorder module.

Event Review Recordings

Each event review recording strip begins with a summary of the events stored in the event database.

Recording strip annotation is explained in the Recording chapter.

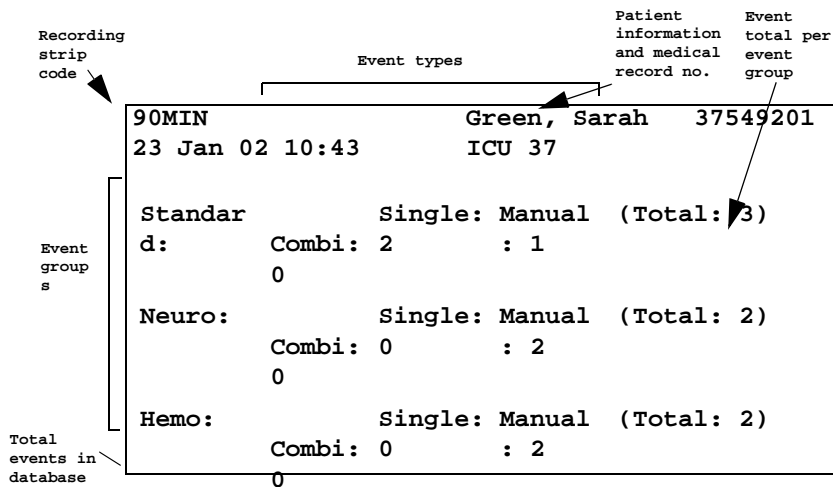

In graphic event review recordings, events are represented by bars, and each event group is printed on a separate channel.

The timeline reflects the period stored in the database, either 24 hours (divided into 4 hour sections) or 8 hours (divided into one-hour sections).

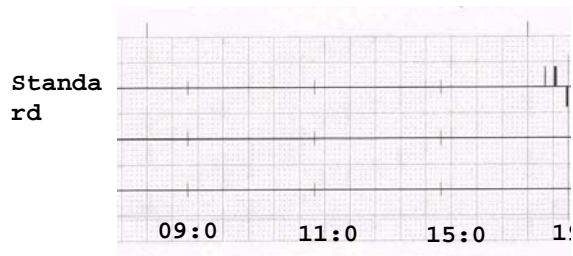

In tabular event review recordings, the events stored in the event database are shown in chronological order, with a number and time-stamp.

#	Time	Group	Parameter 1	Parameter 2	Parameter 3
1	23 Jan 02 07:56	Neuro	Resp	BIS LOW 51<60	ABP
2	23 Jan 02 07:59	Stand ard	HR(Pulse) TACHY 201>180	ST-II	SpO2
3	23 Jan 02	Neuro	Resp HIGH	BIS	ABP

The measurements in the event group are shown in the next columns, marked “Parameter 1, Parameter 2...”, along with the event values measured at the time of the event. For each event, the trigger values are shown.

This section of the recording is A4 or letter size, so that it fits in a patient file.

Event Episode Recordings

Event episode recordings are divided into four sections.

- 1 The first section shows the patient information and the event group of the episode with the event values for the group measurements. The trigger symbol marks the event trigger.
- 2 The second section shows the waveforms recorded during the episode. The trigger moment is marked with a triangle and divides the episode into the pre/post time. Any calibration marks and grid marks on the screen are automatically printed on the recording.

1.

91MIN
Green, Sarah
37549201
23 Jan 02 10:43
ICU 3
Standard:HR (Pulse)

If there are four measurements in the event group being recorded, two waveforms will be recorded in two separate waveform segments.

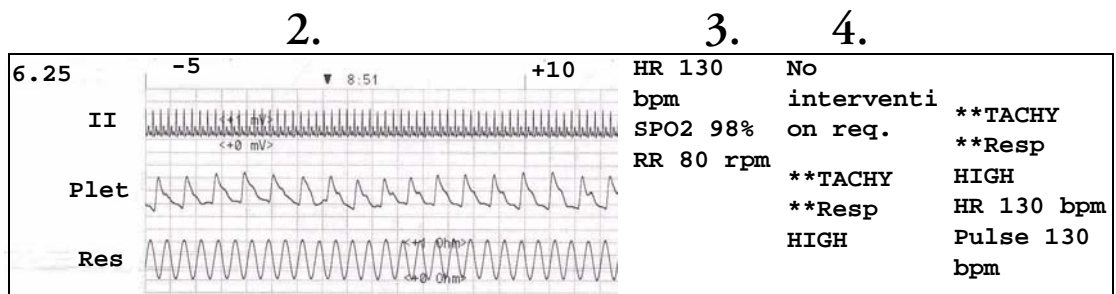

- 3 The third section shows the most important vital signs information, including numerics, active alarms, and any annotations made on the event episode.
- 4 The fourth section shows the numerics for all the currently monitored vital signs and any alarm conditions or INOPs active at the time the event was triggered.

Event Reports

Event reports can be printed on A4 and letter size paper on a printer connected locally or centrally to your monitor.

Event Review Reports

The event review report documents all the events stored in the event database for a selected group.

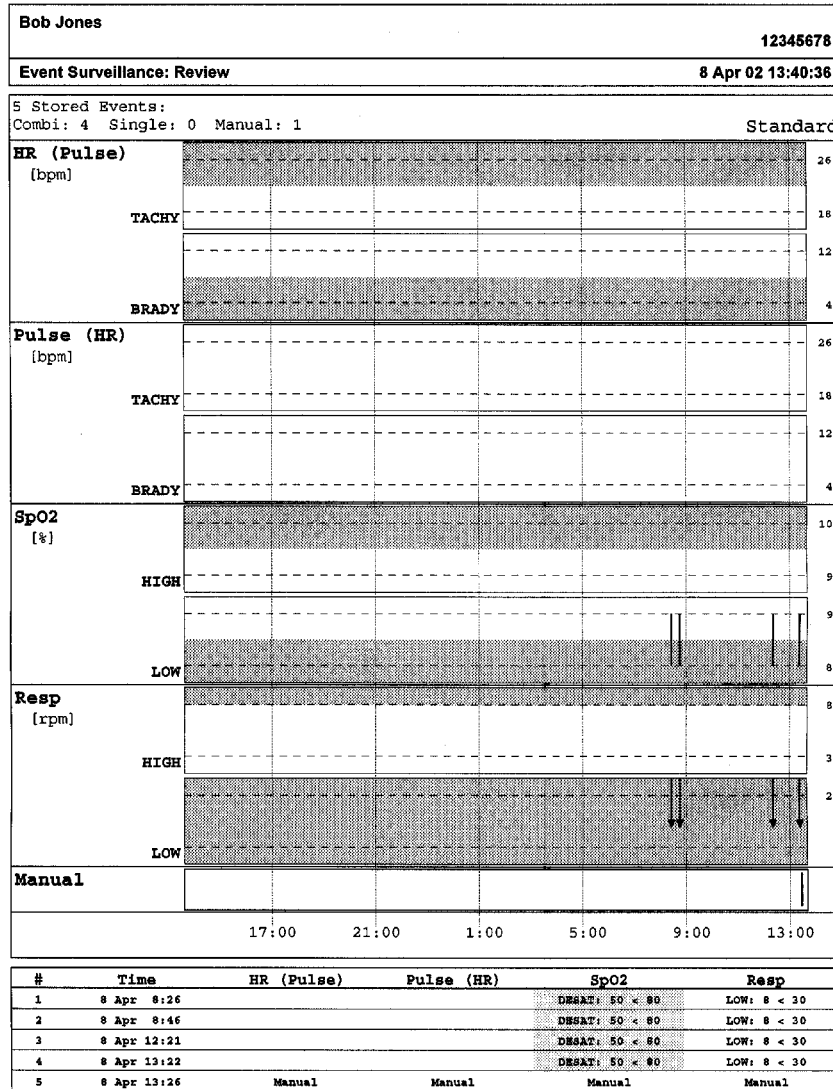

Event Episode Reports

The event episode report documents the patient information from the currently-selected event. See the section on event recordings for an explanation of the report elements.

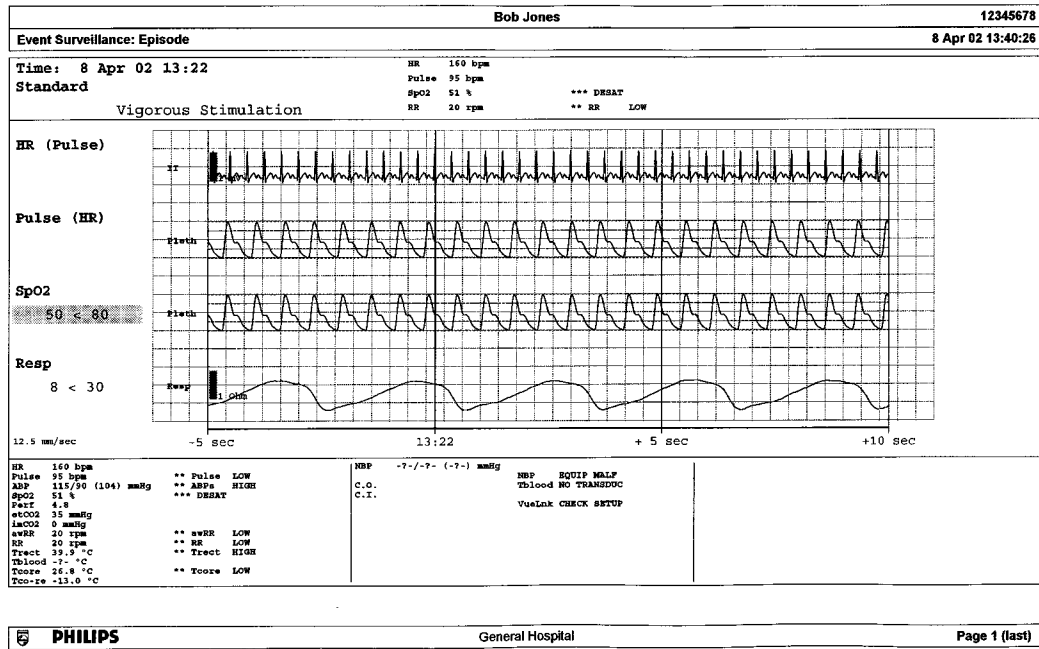

Event Summary Reports

(Advanced Event Surveillance only). The event summary report shows a graphical view and a tabular view of all events in the database for all groups.

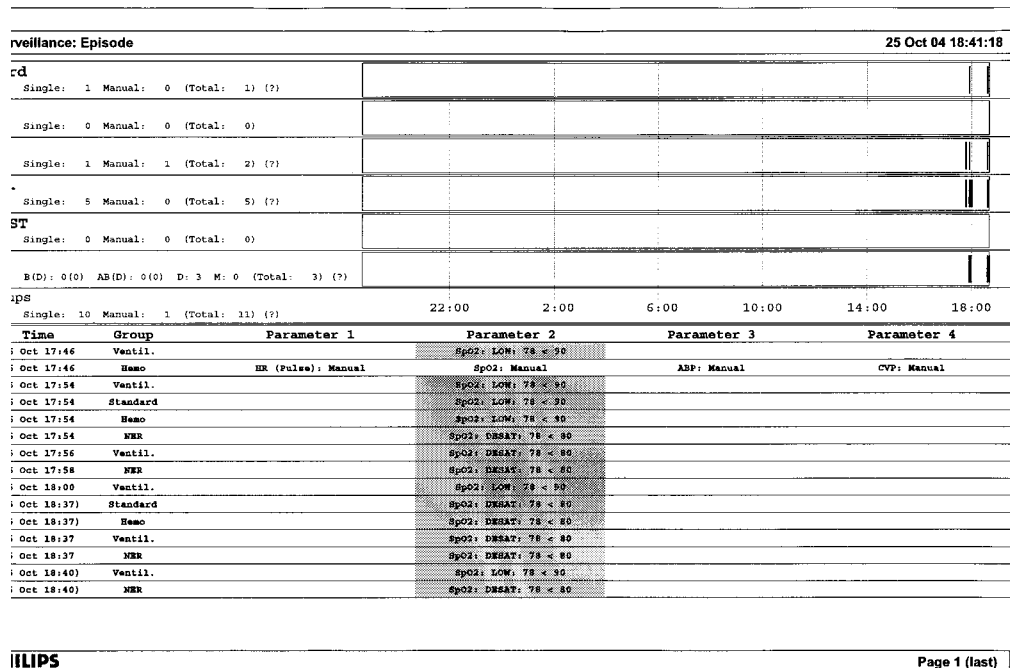

Recording

MP40/MP50/MP60/MP70/MP90 The M1116B plug-in recorder records numerics for all active measurements and up to three waveforms. You can use it for local recording mounted either in the monitor's FMS or in the integrated module slots (MP40/MP50, MP60/MP70).



Continue LED
Flashes if a continuous recording is ongoing

RUN/CONT key
Starts a delayed recording or makes the current recording continuous

STOP key
Stops the current recording

M1116B Plug-in Recorder

MP20/MP30

The integrated recorder records numerics for all active measurements and up to three waveforms.



MP20/MP30 Integrated Recorder

Central Recording For central recording from the bedside, your monitor must be connected via a network to an Information Center. You can use either the M1116B recorder or the standalone M3160A 4-Channel Recorder. Recordings made on the M3160A may look slightly different to those described here. See the documentation supplied with the Information Center for information on the 4-Channel Recorder.

Starting and Stopping Recordings

The recordings pop-up keys let you start and stop recordings. Select the **Recordings** SmartKey to call up the line of pop-up keys. Scroll right or left to see any pop-up keys not displayed.

The selection of pop-up keys available depends on the monitor and recorder model you are using.

Delayed Recordng	RT A Recordng	RT B Recordng	RT C Recordng	Select Waves	HiRes Recordng	All ECG Waves
---------------------	------------------	------------------	------------------	-----------------	-------------------	------------------

Vital Signs	Alarm Limits	ST Segments	Setup Recordng	Stop all Recordng		
----------------	-----------------	----------------	-------------------	----------------------	--	--

Quickstarting Recordings

To quickstart any type of recording using a preconfigured recordings template,

- ◆ Select the **Recordings** SmartKey and then select the pop-up key of the recording type you want to start.

Alternatively, you can

- ◆ Select the **Main Setup** SmartKey, select **Recordings**, then select the recording type.

To quickstart a delayed recording,

- ◆ Select the SmartKey **Delayed Record** to immediately start a delayed recording.

M1116B only ◆ You can also start a delayed recording by pressing the RUN/CONT key on the recorder module.

Extending Recordings

Timed (non-continuous) recordings stop when their runtime is over. Continuous recordings continue until stopped manually or by an INOP condition.

- ◆ To extend an ongoing recording by its runtime, reselect its **Start** pop-up key once.
- ◆ To make an ongoing recording continuous, reselect its **Start** pop-up key twice within 5 seconds.

M1116B only ◆ You can also make an ongoing recording continuous by pressing the RUN/CONT key on the recorder module.

Stopping Recordings

Recordings stop automatically when the preset runtime is over, when the recorder runs out of paper, or when the recorder has an INOP condition.

- ◆ To manually stop a recording, select the **Recordings** SmartKey and then select the pop-up key **Stop all Recording**.

M1116B only ◆ You can also stop a recording by pressing the STOP key on the recorder module.

Recording Without a Template

To record without a preconfigured template, selecting the waves you require,

- 1 Select the **Recordings** SmartKey.
- 2 Select the pop-up key **Select Waves** and use the pop-up keys to choose up to three measurement waves to be printed on the recording. If you want fewer than three waves on the recording, select the waves you want then select the **Continue** pop-up key.
- 3 Select one of the recording speed pop-up keys to set the required recording speed.
- 4 Select the **Start** pop-up key to start the recording.

Select Waves recordings use default values for any recorder settings not defined: runtime is continuous, overlapping is set to non-overlapping.

Overview of Recording Types

This table details settings for local recordings, using either the integrated recorder or the M1116B. For details on recordings made on the central recorder, see your Information Center Instructions for Use.

	Delayed	Alarm	Realtime (RT)	All ECG Waves	HiResTrnd	Procedure or Context
Type of recording	manual	automatic, triggered by defined alarm conditions	manual	manual	manual	manual, use the context window's pop-up keys to start
Local or Central	local and central	local and central	local and central	local only	local only	local only
Information recorded	from the start trigger minus the delay time	from the start trigger minus the delay time	from the start trigger	from the start trigger, in realtime	from the start trigger minus delay time	defined by the context
Number of waves	up to 3	up to 3	up to 3	all ECG waves currently monitored and available	up to 3 high-resolution trends (beat-to-beat) waves	up to 3 waves, or specific to the context, e.g. a C.O. trial curve or a wedge procedure
Speed	50, 25, 12.5, 6.25, 2.5 mm/sec	50, 25, 12.5, 6.25, 2.5 mm/sec	50, 25, 12.5, 6.25, 2.5 mm/sec	25 mm/sec	1, 2, 2.5, 3, 6 cm/min	defined by the context
Runtime	15, 20, 25, or 30 seconds	15, 20, 25, or 30 seconds	15 seconds or continuously	4 seconds per wave	10 minutes, or continuously	defined by the context
Stops	automatically	automatically	automatically if limited, manually if continuous	automatically	automatically if limited, manually if continuous	defined by the context
Delay Time	10, 15 seconds	10, 15 seconds	none	none	6, 5, 4, 3, 2, 1 minutes	defined by the context
Overlap	up to 3 waves	up to 3 waves	up to 3 waves	none	up to 3 waves	defined by the context

All ECG Waves Recordings

An **All ECG Waves** recording shows a 4 second recording of each lead with a calibration bar preceding each ECG lead. All available leads are recorded sequentially in the standardized lead order. The recording is realtime, that is, the information recorded is not simultaneous.

Creating and Changing Recordings Templates

To save you defining recording settings each time you start a recording, you can create templates for commonly-used types of recordings in the **Setup Recording** menu. You can create templates for one delayed recording, one alarm recording, three realtime recordings, and one high resolution recording. **All ECG Waves** recordings do not need to be configured, they always use the same format.

Changing recordings templates changes the settings that will be used each time a recording of this name is triggered.

- 1 Select the **Main Setup** permanent key to call up the Main Setup menu.
- 2 Select the item **Recordings** to enter the **Setup Recordings** menu.

- 3 Select the name of the template you want to create or change. Each recording name is linked to a recording type, delayed, alarm, realtime, and high res trends. Recording names can be changed in the monitor's Configuration Mode.
- 4 Design the template by selecting each menu item and entering the information for the template.
 - **Recorder:** choose which recorder the recording will print to (Local, Central 2-Ch. or Central 4-Ch.).
 - **Channels 1 - 4:** choose which waveform to record in each channel. If the wave assigned to a recording channel in a particular template is not available when a recording is triggered, the channel is left blank on the recording strip. The pop-up list of available (currently monitored) waves differs according to the recording type:
 - Realtime, delayed and alarm recordings: the list shows all the currently available waves.
 - High-resolution recordings: the list shows all the available high-resolution waves
 In addition to the currently available waves, you can choose from several other settings which make an automatic allocation when the recording starts:
 - **Alarm Par** will always record the measurement in alarm in the chosen recorder channel
 - **Primary Lead** will always record the current primary lead in the chosen recorder channel
 - **Secondary Lead** will always record the current secondary lead in the chosen recorder channel
 - **Agent** will always record the currently selected anesthetic agent.
 For high-resolution recordings only the **Agent** setting is available.
 - **Overlap:** define whether the recorded waveforms will be printed overlapping or beside each other.
 - **Speed:** choose the recording print speed.
 - **Delay Time:** Delayed recordings start documenting on the recorder strip from a pre-set time before the recording is started. This interval is called the "Delay Time" and can be set to 10 or 15 seconds. This setting can only be changed in Configuration Mode.
 - **Runtime:** see how long this type of recording is configured to run. This setting can only be changed in Configuration Mode. Continuous recordings run indefinitely.
 - **Central Config** - if available, select this setting to use the recordings settings set for the centrally-connected recorder.

Changing ECG Wave Gain

The **ECG Gain** setting in the **General** menu defines how every recorded ECG wave, irrespective of template or recording type, will appear on the recorder strip. This does not affect the displayed ECG wave, or printed ECG reports. To change the ECG gain setting for recordings,

- 1 In the **Setup Recording** menu select **General**
- 2 Select **ECG Gain**.
- 3 Select the required setting:
 - **Auto:** the wave recording will use the same scale as the ECG wave on the monitor screen
 - **5 mm/mV, 10 mm/mV, 20 mm/mV:** the wave recording will use a scale of 5, 10, or 20 millimeters per millivolt.

Recording Priorities

Manually-started recordings have priority over automatically-started recordings. If an automatically-triggered alarm recording is running, and a realtime or delayed recording is manually started, the alarm recording is stopped and the manually-requested recording is started.

More recent manually-started recordings have priority over older manually-started recordings. If a manually-started recording is running, and another manually-started recording is triggered, then the older recording is stopped and the more recent manually-started recording is started.

Alarm recordings are prioritized according to alarm priority. If an alarm recording triggered by a yellow alarm is running and a new alarm recording is triggered by a red alarm, the yellow alarm recording is stopped and the red alarm recording is started.

Sample Recording Strip

The information printed on the recording strip includes the patient name and MRN, bed number, date and time of recording, recording speed, and recording code. Active alarm and INOP messages as well as numerics for all currently monitored measurements are also printed.

Recording strip annotations are printed at the beginning of the recording strip and updated at regular intervals, every 15 minutes for recordings made at speeds lower than 6.25 mm/s, and every 60 seconds for recordings made at speeds greater or equal to 6.25 mm/s.

This sample recording strip shows a typical initial annotation:

Recording strip code	Recording speed	Measurement numerics
90DIN	25 mm/sec	HR 120 bpm
23 Jan 02 10:43	Bed 3	SPO2 95%
Green, Sarah	37549201	Pulse 120 bpm
		PERF 10.0
*** EXTREME BRADY		ABP 120/70 (91) mmHg
** ABPs HIGH		PAP 28/15 /21) mmHg
** PAPd HIGH		NBP 120/80 (90) mmHg 23 Jan 02
CCO NO CALIBRATION		10:31
SOME ECG ALARMS OFF		C.O.
ABP REDUCE SIZE		C.I.
		CCO -?- 1/min
		CCI
		etCO2 40 mmHg
		imCO2 0 mmHg
		awRR
		RR 15 rpm
		Tnaso 37.0xC
		Tblood 37.0xC
		SV 94 ml
		SI 48 ml/m2

Recording Strip Code

The recording strip code printed in the first line of the initial annotation has up to seven characters, specifying recording type, operating mode, application area, patient category, and delay time, if applicable.

	Code	Meaning
Recording type	90	Realtime
	8A	Delayed
	0B	Alarm
	91	Context (Procedures)
Operating mode	M	Monitoring
	D	Demo
	C	Configuration
	S	Service
Application area	I	ICU
	O	OR
	C	CCU
	N	NICU
Patient category	A	Adult
	P	Pediatric
	N	Neonatal

Recorded Waveforms

A selection of up to three waveforms is recorded, marked with wave labels and wave scale information. Wave scale information can be in the form of a calibration bar, like the 1 mV calibration bar for ECG, or calibration steps before the waveform starts.

Maintaining Recording Strips

Recording ink sometimes fades when covered with transparent tape. Avoid covering any part of a recording that is clinically relevant (annotation or waveforms) when taping a recording strip to a patient record or other patient documentation.

Reloading Paper

M1116B

- 1 Use the latch on the right side of the recorder door to pull the door open.
- 2 Remove the empty core.
- 3 Insert a new roll so that it fits snugly into its housing and the paper end is feeding from the top.
- 4 Pull out some paper and fold along the front edge at a 45° angle. This makes it easier to feed the paper under the roller as shown.
- 5 Feed the paper through and pull some paper out from the top of the roller.
- 6 Close the recorder door.
- 7 To test if paper is loaded correctly, start a recording. If no printing appears, paper may be loaded backwards. Try reloading the paper.



MP20/MP30

- 1 Use the latch on the right side of the recorder door to pull the door open.
- 2 Remove the empty core.
- 3 Insert a new roll and secure it in place on the paper holder. The paper feeds from the bottom of the roll and over the top of the recorder door.
- 4 With at least one inch of paper extending beyond the edge of the door, swing the recorder door up and push it firmly closed.
- 5 To test if paper is loaded correctly, start a recording. If no printing appears, paper may be loaded backwards. Try reloading the paper.

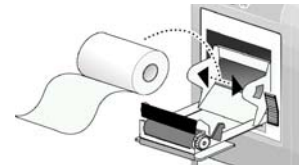

CAUTION When the recorder is disabled (by removal from its slot, door open, or out of paper), any alarm recordings will be sent to the central station recorder, if there is one. If no recorder is available, alarm recordings may be lost during the time the recorder is disabled. The message **no alarm recording available** will be displayed.

Recorder Status Messages

Recorder Status Messages	Explanation
<code><Recording name> running</code>	The named recording is currently running.
<code>No <recorder name> alarm recording available</code>	No alarm recording can be made on the selected recorder. If available, try selecting another recorder. If a local recorder was selected, the monitor will try to reroute the recording. Recordings sent to a central recorder cannot be rerouted. Alarm recordings may be lost.
<code>No alarm recording available</code>	The selected recording cannot be made. Alarm recordings will be lost. Check that the recording has been correctly configured.
<code><Recorder name> out of paper</code>	The named recorder is out of paper.
<code><Recorder name> door open</code>	The door of the specified recorder is open.
<code><Recorder name> not supported</code>	The M1116A recorder is not supported. Connect a M1116B plug-in recorder.

Printing Patient Reports

Starting Reports Printouts

Most patient reports can be printed by selecting **Main Setup - > Reports** (or the **Reports SmartKey**) and then selecting the report name in the top half of the **Reports** menu. Report names are shown only for reports that have been correctly set up.

Data from the time of the print request is printed, even if the print job is delayed in the printer queue.

Report types	Report contents	How to start printing reports
Vital Signs Report	depends on selected trend group, data resolution, and period.	In the Vital Signs window, select Print/Record , then select Print
Graphic Trends Report		In the Graphic Trends window, select Print
Events Reports	Event Episode with up to 5 episodes	In the Events window, select the pop-up key Print/Record , then select the pop-up key Print Review or Print Episode
	Graphic or tabular Event Review	
EEG Report	EEG Waves, numerics, CSAs, montage information and impedance values	In the Setup EEG menu, select Print Report
ECG Reports	Depends on format selected	Select the ECG Report SmartKeys, if configured
ST Map Report	ST data in a transversal and/or horizontal multiaxis diagram,	In the ST Map window, select Print .
Cardiac Output Report	Trial curves and numerics	In the Cardiac Output window, select the pop-up key Print/Record
Wedge Report	Wedge numerics and reference wave	In the Wedge window, select the Print Wedge pop-up key
Calculations Report	Hemodynamic, Oxygenation, or Ventilation Review	In the Calculations windows, select the Print/Record pop-up key
Drug Calculator Report	Titration Table	In the Titration Table window, select the Print Titr.Tbl pop-up key
	Drip Table	In the Drip Table window, select the Print Drip Tbl pop-up key

Report types	Report contents	How to start printing reports
Alarm Limits Report	Graphic and numeric report of all current alarm limits	In the Alarm Limits window, select Print Limits
Realtime Reports, including oxyCRG Reports (Neonatal Event Review)	patient data and numerics, and either: all displayed waves OR all measured waves OR all measured RT waves Or all measured HiRes waves, OR oxyCRG waves (RT waves: ECG Primary lead, Pleth, Resp; HiRes waves: btbHR, HiRes SpO ₂ , HiRes Resp)	Select the Realtime Reports SmartKey, if configured
Loops Report	Individual Loops diagram with timestamp, currently measured numerics	In the Loops window, select Print Loop
Battery Report	Battery serial numbers, information on the currently-measured and potential charge status of the battery or batteries	In the Battery Status window, select Print Status .

Stopping Reports Printouts

- ◆ To stop Reports printing, in the **Reports** menu, select
 - **Stop Report** to stop the current print job
 - **Stop All Reports** to cancel all queued report printouts
 - **Scheduled Rep.** to toggle to **Off** and switch off scheduled reports.

Setting Up Reports

ECG, Vital Signs, Graphic Trends, and Auto Reports settings must be defined in Configuration Mode. As the content of context-linked reports, such as Cardiac Output, Calculations, and Wedge, is defined by the content of the procedure window, these reports do not need to be set up.

The content you define in the individual **Setup Reports** menus will be used in all reports of this type: for example, if you set a print speed of 50 mm/sec in the **ECG Reports** menu, every ECG report will be printed at this speed, irrespective of format.

Setting Up ECG Reports

The settings you choose in the **ECG Reports** menu apply for all ECG reports printed. To set up ECG Reports,

- 1 Select **Main Setup -> Reports -> ECG Reports**. Note the report layout configured for your monitor, either Internat. or Cabrera. This setting is inactive (“grayed-out”) in Monitoring Mode and can only be changed in Configuration Mode.
- 2 Select **ECG Gain** and set the required ECG Gain to define how ECG waves will appear on the ECG report printouts.
- 3 Select **Speed** and select the report print speed.
- 4 Select **Annotation** and toggle to **On** if the printed ECG wave should be annotated with beat labels or not. See the chapter on ECG for a list of beat labels. Pace pulse marks are automatically printed beside the wave for paced patients.

Setting Up Vital Signs and Graphic Trend Reports

The settings you choose in the **Setup Vital Signs Report** and **Graphical Trend Report** menus apply for all Vital Signs and Graphic Trend reports printed.

To set up Vital Signs and Graphic Trend reports,

- 1 Select Main Setup -> Reports -> Vital Signs Rep. or Graph Trend Rep.
- 2 Select Trend Group and select the group you want to print on the report. The groups available depend on your monitor's trend configuration.
- 3 Select Period and select the period of time for which trend data should be printed on the report. If **Automatic Period** is configured to **On**, all trend data for the current patient will be printed, irrespective which trend period is selected.
- 4 Select Interval (Vital Signs Reports only) and select the resolution of the trend data printed on the report,

Setting Up Auto Reports

Auto Reports print automatically when a specified trigger occurs. There are two types of Auto Reports: Scheduled Reports, which print at predefined intervals, and End Case Reports, which print when a patient is discharged using the End Case function. An Auto Report can be both a Scheduled Report and an End Case report.

To set up Auto Reports,

- 1 Select Main Setup -> Reports -> Auto Reports and select the Auto Report you want to set up (A, B, C, or D).
- 2 Select **Report** and assign a report type to the Auto Report.
- 3 Select **End Case Report** and toggle to **On** if you want the selected report to print automatically when you select **End Case** to discharge a patient.
Toggle **End Case Report** to **Off** if the report is a Scheduled Report only.
- 4 Select **Scheduled Rep.** and toggle to **On** if you want the selected report to print at predefined intervals, starting at a predefined time of day. The start time you set applies for every following day. For example, if you set a start time of 07:00 and a repeat time of six hours, the first report will print at 07:00 every day, the next at 13:00 and so on.
 - To set the time of day at which you want the report to print every day: select **Start Hour** and **Start Minute** and select the required time from the pop-up list
 - To set the time interval in minutes between two scheduled reports: select **Rep. Freq. (Hr)** and **Rep. Freq. (Min)** and select the time interval from the pop-up list.
 If you are setting up an end case report, these settings will be inactive (“grayed-out”).
Toggle **Scheduled Rep.** to **Off** if the report is an End Case Report only.
- 5 Repeat the procedure for all Auto Reports you want to set up.

All Auto Reports or Scheduled Reports set to **On** print automatically at the predefined trigger.

Be aware that the monitor's memory for reports is limited. If the memory is full, Auto Reports cannot be printed and the information may be lost.

Setting Up Individual Print Jobs

To adjust the appearance of individual print jobs, in the **Reports** menu,

- 1 Select **Main Setup -> Reports -> Setup Reports** to enter the **Setup Reports** menu.
- 2 Select **Report** and then select the report you want to set up.
- 3 Select **Report Type** and then select the reports template you want the report selected in Step 2 to use. The selection of templates listed depends on the report type selected.

Each template includes patient demographic data, and each Realtime Report also includes alarm and INOP information. In addition, the templates include:

Visible Waves: all waves currently visible, in the order they appear on the screen.

All Waves: all measured waves,

RT Waves: all currently measured realtime waves, according to the monitor's priority list.

HiRes Waves: all measured HiRes waves

OxyCRG Waves: the OxyCRG/Neonatal Event Review waves.

Vital Signs: trend information in tabular form.

Graph Trend: trend information in graphic form.

ECG3X4, ECG6X2, ECG12X1, ECG4X2, ECG8X1, ECG12X1 (2P): ECG reports.

EEG: EEG reports.

Episode: a single patient event episode.

Review: an overview of patient events

Alarm Limits: a list of all currently set alarm limits.

- 4 Select **Report Size** to set choose the paper size to be used for the report: **Unspecified** to use the default size for the template chosen, **Universal, A4, Letter, LrgUniversal, A3, or Ledger**. The list of available sizes depends on the connected printers.
- 5 Select **Orientation** to set the orientation of the report printout: **Unspec.** to use the default size for the template chosen, **Landscape** or **Portrait**.
- 6 Select **Target Device** choose which printer the print job will be sent to: **Unspec.** to use the default printer, or the printer name defined at the Information Center or in the monitor's Configuration Mode (for example, **Local 1**).

Some settings may be inactive ("grayed-out") in this menu for reports that can only be started in a special window.

Checking Printer Settings

The printer settings for your monitor are defined in Configuration Mode. The printer settings **Paper Size, Resolution, Color Support,** and **Duplex Option** for the active printer are visible but inactive ("grayed-out") in the **Setup Printers** menu.

Printer names for locally-connected printers can be defined in Configuration Mode. You can see whether a specified printer is centrally or locally connected in the **Setup Printers** menu under **Port: Local <name>** indicates locally-connected printers, **Remote <name>** indicates centrally-connected printers.

- ◆ To enter the **Setup Printers** menu, in the **Reports** menu, select **Setup Printers**.

Printing a Test Report

A test report can be printed in Configuration mode, refer to the Service Guide for details.

Switching Printers On Or Off for Reports

You can enable or disable printer status to switch individual printers on or off for report printouts.

- 1 In the **Setup Printers** menu, select **Printer** and then select the name of the device you want to switch on or off for Reports printing from the pop-up list.
- 2 Select **Printer Status** to toggle between the settings **Enable** and **Disable**. If you set this to **Disable**, no reports will be printed to the named printer.

If the monitor detects that no printer of a particular type is available, the **Enable/Disable** setting will automatically be set to **Disable** and “grayed out”.

Dashed Lines on Reports

If a section of a wave on a report is drawn with dashed lines, this tells you that a setting that affects the appearance of the wave on the screen was changed while the report was printing.

For example, if you change the wave scale while a report is printing, the wave scale and wave size are changed immediately on the monitor screen and on the report. To indicate that the scale

information printed at the beginning of the report no longer matches the currently used scale, the wave will be printed using dashed lines, starting from the moment the change took place.

Some examples of settings that cause dashed lines in reports if changed during printing are: Filter mode, ECG lead placement, wave scale, measurement unit, paced/non-paced setting, and measurement mode. Note that as ECG waves are drawn with a fixed gain on reports (either 10 mm/mV or 20 mm/mV), changing the ECG wave scale will not cause dashed-line reports.

To avoid dashed lines on reports, wait 15 seconds after changing a setting before you trigger a report.

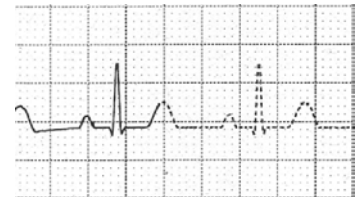

Unavailable Printer: Re-routing Reports

If you send a report to be printed on a printer that is not available, for example, because it has run out of paper, this print job is suspended and stored in the monitor's memory.

If the target device of this print job was set to **Unspecified**, the monitor will periodically try to resend the print job to the first printer listed in the **Setup Printers** menu under **Printer** that is set to **Enabled** and that has paper of the correct size.

To allow the report to print, you must either solve the problem with the target printer, or re-route the print job to another printer with paper of the correct size. To re-route a print job,

- ◆ Enable the new target printer by selecting it in the **Setup Printers** menu and toggling to **Enabled**. As the monitor tries to send the report to the printers in the order they are listed, you must make sure that all the printers above the new target printer are disabled.

If the target device of the print job was set to a specific printer, re-routing is not possible.

Printer Status Messages

Printer Status Message	Possible causes and suggested action
Print job could not be queued	The printer queue is full and the monitor cannot accept another report request. Wait until some more reports have been printed, then try again, OR A report has been triggered that uses a paper size unavailable with the target printer. Try another printer, if available, or change the paper size of the print request.
Cancelling all print jobs	Stop All Reports has been selected in the Report menu, OR The Operating Mode has been changed from Monitoring Mode to Demonstration or Service Mode.
Cancelling N print jobs due to patient discharge	When a patient is discharged, all queued print jobs are cancelled. “N” is the number of print jobs queued.
Printing failed: no report configured	A report has been triggered which has not been correctly set up. Enter the setup menu for the report type to set up the report.
Printer <Printer name> unavailable - job suspended	The chosen device is unavailable. Check that the printer is properly connected and that paper is available. The requested report will start printing when the printer becomes available.
Job on <Printer name> failed	A report cannot be started on the requested printer. Make sure the printer is plugged in, switched on, and has paper loaded. Try another printer, if available. If this problem persists, call your service personnel.

Sample Report Printouts

Each report header contains the patient’s bed label, last name and first name, the patient ID, the date and time, and the name of the report. The report footer contains the hospital label and page number, and the last page contains a note to mark the report end.

The monitor may be configured to leave a space on the top left or right of the report printout to enable you to stick a patient address label on it. This setting is called the Addressograph and it can only be changed in the monitor’s Configuration Mode.

Alarm Limits Report

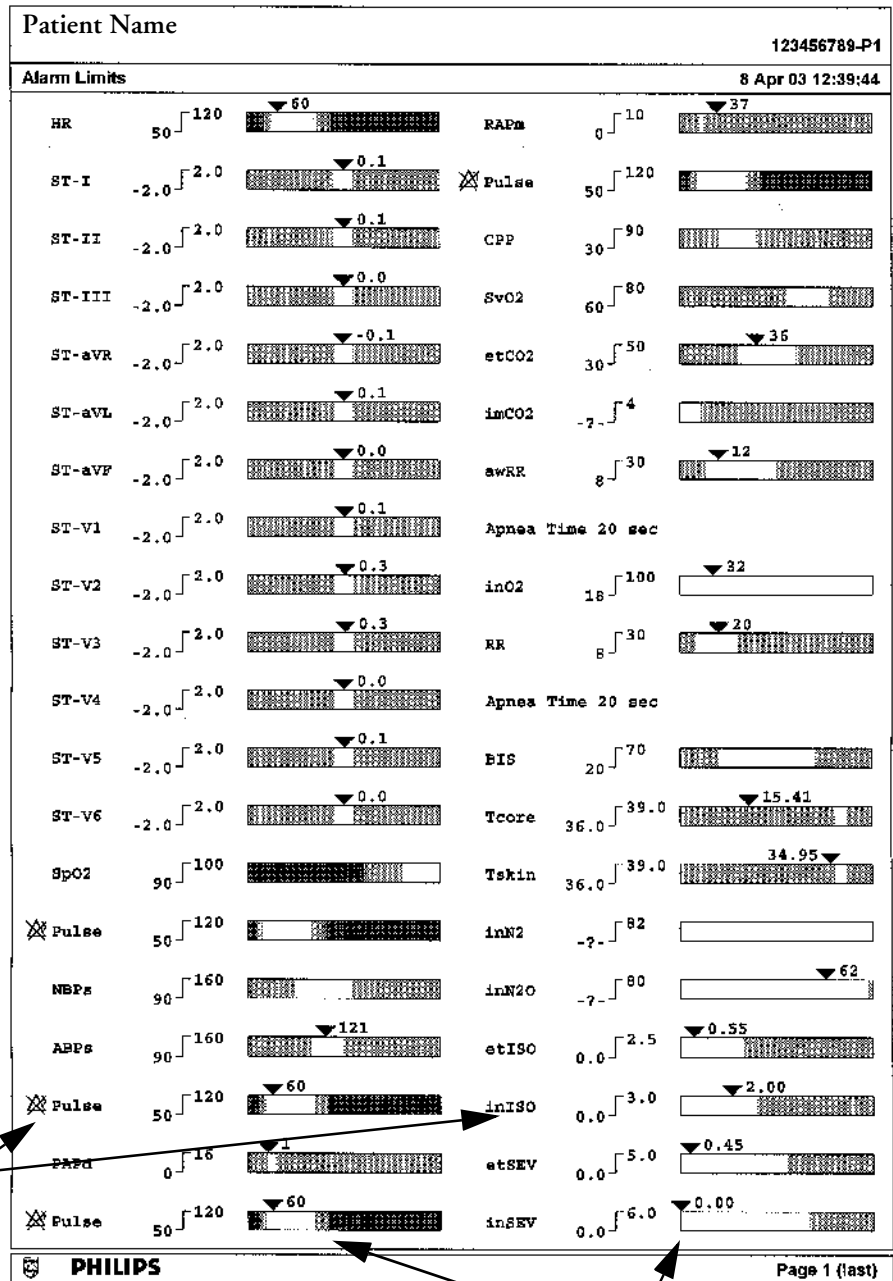

Measurement labels, with alarms off symbol where alarms are switched off

Graphic view of current alarm limits in relation to currently monitored measurement value

Realtime Report

Patient demographic information, time stamp

Active Alarms and INOPs, followed by vital signs

Measurement waves section, including HiRes waves

Bu11	Arnes, Rob	12146878
Realtime Report		30 Apr 03 13:51:23

Patient Cat: Adult	Date Of Birth: 4 Feb 1953	Weight: 77.0 kg
Faced: No	Age: 50 years	BGA: 77.0%
Gender: Male	Height: 177.0 cm	

*** APNEA	SI ICI 0.1 ma	SWER 17 cpm
** DABd HIGH	SI AVR 0.0 mm	STO2 17 %
** etCO2 LOW	SI AVE 0.1 mm	INOP 19 %
** FVCs/min HIGH	SI-aVF -0.1 ma	PR 21 cpm
REG NO TRANSDC	SI-V 0.0 mm	TR 40 mm
Check Settings	SI-VET 0.0 mm	TRD 10 mm
No Central Monit.	SpO2 95 %	STP1 10 Hz
CO2 DEACTIVATED	Pulse 92 bpm	SEP2 10 Hz
DAB REDUCT STAK	Parf 5 %	TRD2 17.0 %
CO2 TRANSDUCER Cal.	NRP	STB20 0 %
	ABP 117/79 (84) mmHg	STB20 0 %
HR 77 bpm	DAD 25/16 (16) mmHg	STACC
PRV 17 /min	SVV (-V-) mmHg	INOP
ST-I 0.0 mm	STB20 14 mmHg	
ST-II 0.0 mm	INOP2 15 mmHg	

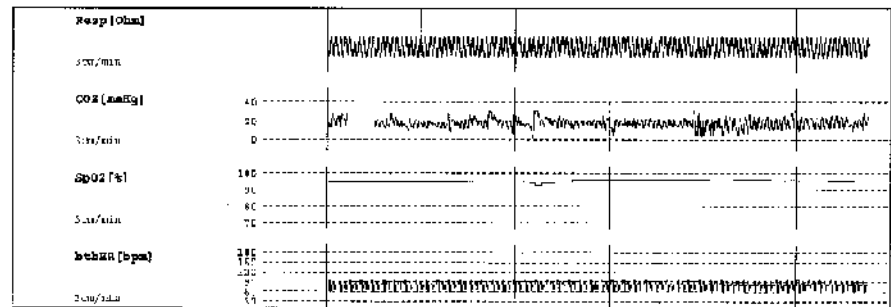
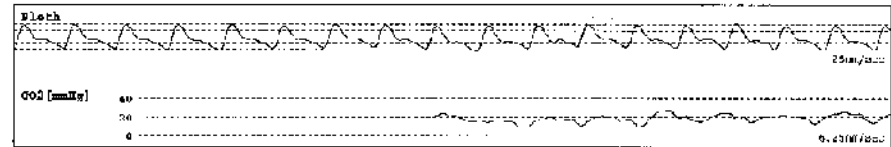

Cardiac Output Report

Patient information

Numbered trial curves

Trial information in tabular form

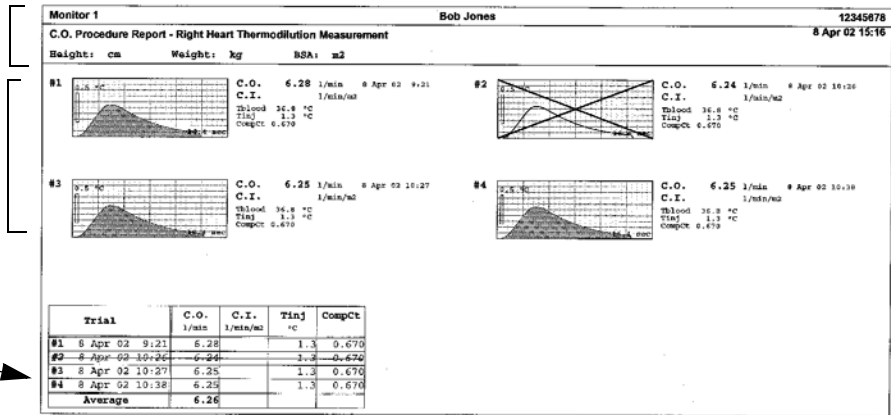

ECG Reports

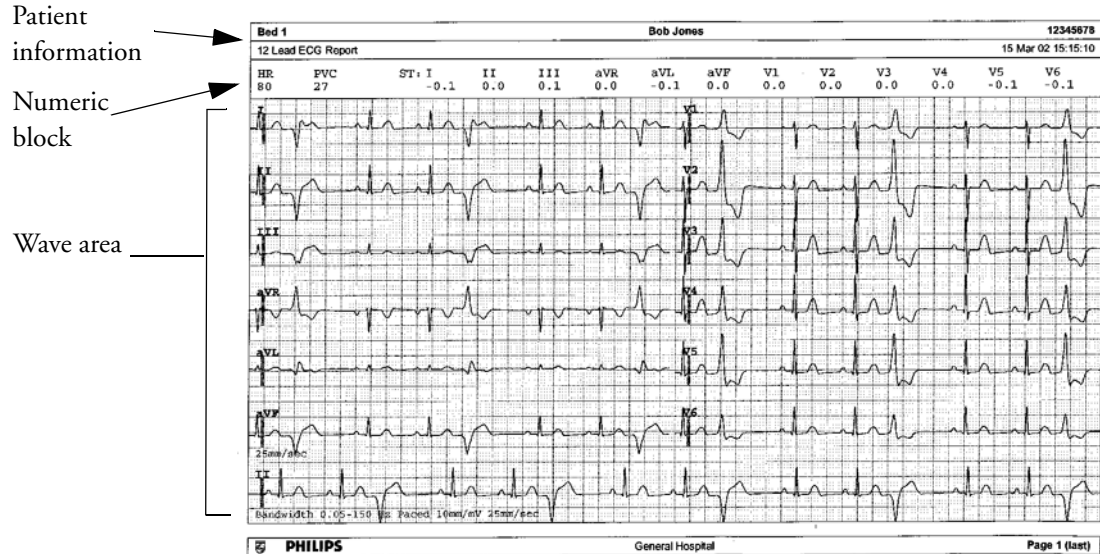

Below the header on ECG Reports, the numeric block shows the current HR, PVC, and ST values. The wave area shows the printed waves for all available ECG leads. A 1 mV calibration bar is printed at the beginning of each wave. With the 3X4, 6X2, and 2X4 formats, a rhythm stripe prints a longer section of the ECG wave from the primary ECG lead for ECG rhythm evaluation. The ECG signal bandwidth, the patient's paced status, the ECG gain, and the print speed are printed at the bottom of the wave area. Pace pulse marks are automatically printed beside the wave for paced patients. Beat labels can be set to print on the rhythm stripe. The 12X1 (2P) format prints the report over two pages.

ECG Report type	Available Formats	Available Paper Sizes
12-Lead ECG	3X4 landscape	A4, letter, A3, ledger
	6X2 landscape	A4, letter, A3, ledger
	12X1 portrait	A4 and letter only
	12X1 landscape	A4, letter, A3, ledger
	12X1 (2P) landscape	A4, letter (2 pages)
Multi-lead ECG	2X4 landscape	A4, letter, A3, ledger
	8X1 portrait	A4 and letter only
	8X1 landscape	A4, letter, A3, ledger

Other Reports

See the sections on Trends and Calculations and the chapter on Event Surveillance for other example reports.

Using the Drug Calculator

Drug mixtures for intravenous (IV) drug infusions combine information on drug dose, rate, amount, volume, concentration, and standardized rate. The Drug Calculator helps you to manage infusions by calculating one of these values at a time.

Term	Definition	Units
Dose	total quantity of drug to be delivered to the patient over time	amount units per time or per kg/time, if the drug is weight-dependent
Rate	volume of the mixture to be delivered to the patient over time	ml/hour
Amount	amount of drug to be added to diluent to make up a mixture	ng, mcg*, mg, g, mUnit, Unit, where g stands for gram
Volume	quantity of mixture of diluent and drug	ml
Concentration	ratio of the amount of drug to the solution volume	amount units per ml
Standardized Rate	1 ml volume of the mixture to be delivered to the patient per hour	ml/hr

*Be aware that your hospital may use either 'µg' or 'mcg' as an abbreviation for microgram. These abbreviations are equivalent.

WARNING Before you administer any drug, always check that the correct calculation units and patient category are selected. Consult your pharmacy if you have questions.

Decisions on the choice and dosage of drugs administered to patients must always be made by the physician in charge. The Drug Calculator performs calculations based on the values input during use, it does not check the plausibility of the calculations performed.

Accessing the Drug Calculator

- ◆ To access the Drug Calculator, select **Main Setup** -> **Calculations** -> **Drug Calculator**, or select the **Drug Calculator** SmartKey, if configured.



Performing Drug Calculations

Using the service Support Tool, a list of drugs can be configured for the monitor containing pre-defined dosage recommendations and unit settings. Selecting the arrow beside the drug name in the Drug Calculator window opens a list of configured drugs. Contact your pharmacist if you have any questions about the drugs in the list.

If **Any Drug** is the only entry in the list of drugs, no drugs have been preconfigured for your monitor. Drug calculations can be performed for non-specific drugs.

You must have a Support Tool to add additional drugs to the Drug Calculator.

About the Rule of Six

If the Rule of Six has been enabled for use with individual drugs in your Drug Calculator, you can use the formula in crisis situations to quickly calculate the amount of a drug needed to yield a target dose for continuous infusion for neonatal or pediatric patients (the drug amount is given in “mg”, the patient weight in “kg”). The Rule of Six can only be used with the dose unit mcg/kg/min.

CAUTION JCAHO recommends disabling the Rule of Six. The configuration is not JCAHO-compliant if Rule of Six is enabled.

The Drug Calculator uses the following formula for Rule of Six calculations, based on the patient’s weight:

- For a target dose of 0.1 mcg/kg/min, the Drug Calculator multiplies 0.6 x patient weight to calculate the amount you need to add to the IV solution to equal a total of 100 ml.
- For a target dose of 1.0 mcg/kg/min, the Drug Calculator multiplies 6.0 x patient weight to calculate the amount you need to add to the IV solution to equal a total of 100 ml.

Performing Calculations for a Non-Specific Drug

If a list of drugs has not been configured for your monitor, you can use the Drug Calculator to calculate drug doses for a single, generic drug called “Any Drug”. Selecting the arrow beside the drug name in the Drug Calculator window shows that are no other drugs configured.

- 1 Enter three of these four values: dose, amount, volume, and rate of the infusion solution.
To enter values, select the correct unit, then select each value field and use the pop-up keypad to enter the correct value.
- 2 If you have chosen a weight-dependent dose unit, you must enter the patient weight now or choose a different unit.

If available, the patient weight from the **Patient Demographic** window is entered automatically in the Drug Calculator window when the Drug Calculator is accessed. To change the patient weight, select the **Weight** key then use the on-screen keypad to enter the correct value. This will not change the patient weight stored in the patient demographic information.

Drug Calculator		
ANY DRUG		
Dose	2	mg/min
Rate	480	ml/hour
Amount	25	mg
Volume	100	ml
Concentr	0.25	mg/ml
1 ml/hr	0.004	mg/min
Weight	150	lb

- When you have entered three values, the Drug Calculator automatically calculates the unknown fourth value and shows it in the highlighted field. Standardized rate and concentration are also calculated.

Performing Calculations for a Specific Drug

- Select the arrow beside **Any Drug**, then select the required drug from the list of drugs.

This opens the **Drug Calculator** window for the selected drug.

- Select the correct patient category for your patient.

If you have a neonatal or pediatric patient, the **Rule of Six** choice may be available. Select if required.

- Enter the patient weight, if necessary.

If available, the patient weight from the **Patient Demographic** window is entered automatically in the Drug Calculator window. To change the patient weight, select the **Weight** key then use the on-screen keypad to enter the correct value. This will not change the patient weight stored in the patient demographic information. Select the weight unit shown to change between **lb** and **kg**.

- When a specific drug is selected, the initial values for **Dose**, **Amount** and **Volume** are the configured Start values for this drug. The **Rate** is then calculated. If other values are required you can calculate any value by entering the remaining three values as described in "Performing Calculations for a Non-Specific Drug".

The column on the right of the Drug Calculator window shows either drug dose or dosage rate, whichever is the calculated value. The current calculated value is shown on a scale with the recommended range in green. If the current calculated value lies outside the recommended range it is shown in red.

If you have changed values in the Drug Calculator and you want to revert to the configured values, select **Reset Values** key at any time.

Drug Calculator			
Patient Category	Lidocaine		
<input checked="" type="radio"/> Adult	Dose	4	mg/min
<input type="radio"/> Pedi	Rate	30	ml/hour
<input type="radio"/> Neo	Amount	2000	mg
	Volume	250	ml
	Concentr.	8	mg/ml
	1 ml/hr	0.133	mg/min
Reset Values	Weight	---	lb

Charting Infusion Progress

The Drip Table shows you at a glance how much of the infusion has been administered to your patient and how much time is left.

- ◆ To see the Drip Table, in the Drug Calculator window, select the **Drip Table** pop-up key.

If the DripTime exceeds 24 hours, the DripTime timestamp shows -- :-- :-- .

Drip Table				
Lidocaine		Amount	Volume	Drip Time
		10.00	16.67	0:03:20
		20.00	33.33	0:06:40
Dose	3 mg/min	30.00	50.00	0:10:00
		40.00	66.67	0:13:20
Rate	300 ml/hour	50.00	83.33	0:16:40
		60.00	100.00	0:20:00
Amount	150 mg	70.00	116.67	0:23:20
		80.00	133.33	0:26:40
Volume	250 ml	90.00	150.00	0:30:00
		100.00	166.67	0:33:20
Weight	--- lb	110.00	183.33	0:36:40
		120.00	200.00	0:40:00
DripTime	0:50:00 hr:min:sec	130.00	216.67	0:43:20
		140.00	233.33	0:46:40
		150.00	250.00	0:50:00

Using the Titration Table

Use the Titration Table to see at a glance what dose your patient would receive of a drug at different infusion rates. By clicking on the title row of the table you can switch between the Dose Increments and Rate Increments view.

Values outside of the recommended range are shown in red.

To see the Titration Table,

- ◆ in the **Drug Calculator** window, select the pop-up key **Titration Table**.

The Titration Table is configured with the service Support Tool.

Titration Table							
Lidocaine				Dose	4	mg/min	
Dose increments				Rate	30	ml/hour	
From a low of				0	mg/min	Amount	2000
To a high of				15	mg/min	Volume	250
In increments of				1	mg/min	Weight	---
Dose	Rate	Dose	Rate	Dose	Rate	Dose	Rate
1	7.5	11	82.5	---	---	---	---
2	15	12	90	---	---	---	---
3	22.5	13	97.5	---	---	---	---
4	30	14	105	---	---	---	---
5	37.5	15	112.5	---	---	---	---
6	45	---	---	---	---	---	---
7	52.5	---	---	---	---	---	---
8	60	---	---	---	---	---	---
9	67.5	---	---	---	---	---	---
10	75	---	---	---	---	---	---

Documenting Drug Calculations

- ◆ In the Drug Calculator window, select the pop-up key **Record DrugCalc** to immediately start a recording of the current drug calculation.
- ◆ In the Titration Table window, select the pop-up key **Print Titr. Tbl** to print a report of the current Titration Table.
- ◆ In the Drip Table window, select the pop-up key **Print Drip Tbl** to print a report of the current Drip Table.

VueLink Modules

A VueLink module transmits information from a connected external device to your monitor. Each module can be connected to up to three external devices, and supports alarms from the external device. Although the external device may transmit more information, the number of waves and numerics you can view simultaneously on your monitor's main screen depends on the module type. Type A modules support one wave and two numerics, type B modules support two waves and six numerics.

Module:	Type	Max Wave	Max numeric	External Devices
Auxiliary	A	1	2	standalone measurement module
Ventilator	B	2	6	ventilators
Gas Analyzer	B	2	6	gas analyzers
Anesthesia Machine	B	2	6	anesthesia machines
Auxiliary Plus	B	2	6	external multi-measurement devices

a module name
b device label
c selection LED
d setup key
e external device cable connector
f setup indicator LED
g module type (A or B)

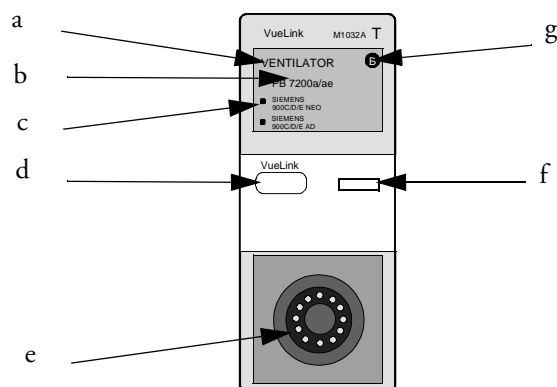

The device labels (b) on the module indicate for which external devices the module is configured. The selection LED (c) shows which device is currently active. The device label text may differ slightly from the labels on the external devices.

See the documentation supplied with the VueLink module for a list of supported devices and accessories, and for configuration information.

Connecting an External Device

- 1 Insert the module into the FMS or integrated module slot.
- 2 Check that the device selection LED (c) lights to show that it has correctly identified the external device. If not, select **Main Setup -> Measurements -> <VueLink Device Name>** to enter the setup menu for the connected device, headed **Setup <VueLink Device Name>**.
- 3 In the device setup menu, select **Device**, select the correct device from the list, and confirm the selection.
- 4 Connect the external device to the module (e) and switch it on.

Once the VueLink device has been correctly connected, you can select the **VueLink SmartKey** and then select the **Setup VueLink** pop-up key to access the **Setup VueLink** menu for the connected device.

CAUTION Selecting the wrong device can cause unpredictable system behavior. Rectify this by switching off the external device when it is safe to do so, and selecting the correct device.

Changing VueLink Waves and Numerics Displayed

To change the waves and numerics from the VueLink module displayed on the Screen,

- 1 Select **Main Setup -> Measurements -> <VueLink Device Name>** to enter the setup menu for the connected device, headed **Setup <VueLink Device Name>**.
- 2 Select the item you want to change, then select the new item from the pop-up list,
or
Select **Show Device Data** to view the device data window.
- 3 Close the setup menu. The monitor takes a few seconds to activate the change.

Viewing the VueLink Device Data Window

To view the VueLink device data window, either

- select the setup hardkey on the VueLink module or the **VueLink SmartKey**, and then select the **<Device Name>** pop-up key, or
- in the **Setup <Device Name>** menu, select **Show Device Data**.

Selecting the device data window opens the setup menu for the connected device.

AUXPLUS2					
AUXILIARY PLUS 2					
VueLink DEND Driver					
Ventilation Mode:		NORMAL		Device Alarms Ignored	
IAPs	100 mHg	IAPd	195.0 mHg	PIP	70 cmHg
IAPd	15 mHg	IAPn	20.0 mHg	PEEP	19.5 cmHg
IAPn	150 mHg	IAPm	55.0 mHg	Pmean	22.0 cmHg
IVs	150 mHg	IVd	100.0 mHg	IV	2.00 liter
IVd	90 mHg	IVn	0.0 mHg	FV	25.30 l/min
IVn	120 mHg	IVm	50.0 mHg	QdR	190 rpm
Tempd	41.2 °C	etCO2	7.00 %	Weight	160.0 kg
Takia	40.5 °C	lCO2	0.5 %	Length	45 cm

Using VueLink Screens

Your monitor may be configured to show VueLink device data permanently on the Screens.

Select the device data window to display the VueLink pop-up keys that let you access the setup menu and carry out VueLink tasks.

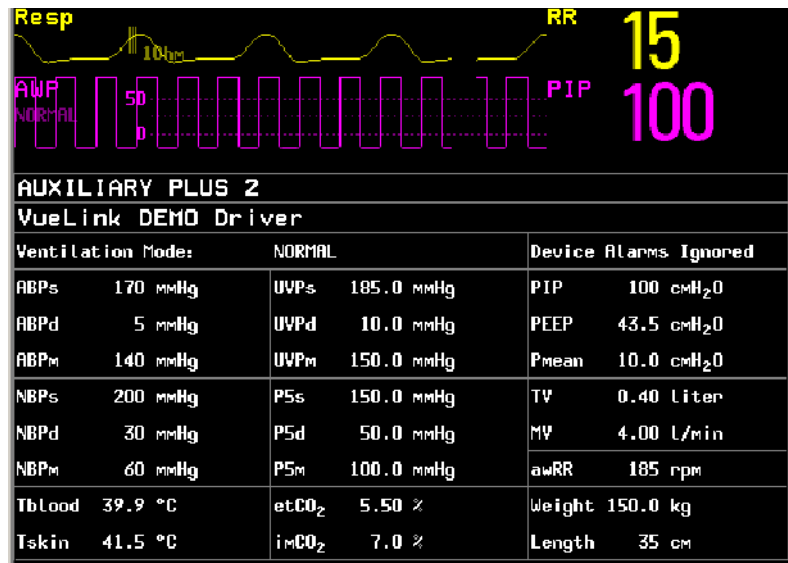

Switching VueLink On and Off

- ◆ To switch VueLink measurements on and off, in the **Setup VueLink** menu, select **Device Interface** to toggle between the settings **On** and **Off**.

Alarms/INOPs From External Devices

The VueLink module itself generates INOPs, but does not generate alarms. If the external device's alarms are on, the module transmits these to the monitor. A message in the VueLink info window tells you either **Device Alarms Ignored** or **Device Alarms Accepted** or **No Alarms Available**. External device alarms status symbols precede some, but not all, measurement labels.

 the monitor is configured to accept external device alarms, but the alarms are switched off at the external device.

! alarms status of this external measurement is unknown

Alarms from external devices are:

- all transmitted to the monitor. For all numerics configured in the **Setup VueLink** menu, an alarm condition is announced at the monitor. For one or more measurements not configured in the **Setup VueLink** menu, an alarm is announced as a text message for the highest priority alarm. Priority is determined at the external device.
- always non-latching on the monitor.
- announced as a flashing numeric while the alarm condition persists.
- announced audibly and visibly at the Information Center.

Language Conflict with External Device Drivers

You should avoid language conflicts between the VueLink module device driver and the monitor. Be aware that if you connect a VueLink module with a different operating language to the monitor, the monitor will show:

- measurement labels in the monitor language
- alarm and INOP texts in the VueLink module device driver language.

Using Timers

With the Timers function you can set timers to notify you when a specific time period has expired.

CAUTION Do not use the timers to schedule critical patient-related tasks.

Viewing Timers

You can view currently active timers in the **Timers** window or directly on the Main Screen (if a timer has been substituted for a numeric).

To open the **Timers** window:

◆ Select the **Timers** SmartKey

or

◆ Select **Main Setup -> Timers**



The maximum number of timers which can be active depends on your monitor model.

For each timer with a defined run time a progress bar is shown with the run time for that timer. Next to the progress bar the elapsed time or the remaining time is shown, depending on whether the timer is counting **Up** or **Down**. On the left, the label of the timer and a symbol indicating the type of expiry notification is shown.

Notification

When any timer expires (except a No Limit timer), the color changes to red and a message appears in the status line on the Main Screen. Be aware that if a timer has been configured to display in red, the color will not change when the timer expires.

Additional notification is also available and can be pre-configured to:

Alarm An INOP alarm indicates the expiry of the timer

Sound A single tone indicates the expiry of the timer

No Sound No additional notification

This additional notification setting is made in the monitor's Configuration Mode and is associated with the timer label. The volume of the tone can also be set in Configuration Mode

Timer Types

There are four types of timer: **Basic**, **Enhanced**, **Cyclic** and **No Limit**. A **Basic** timer has a single, defined run time and progress is shown in the progress bar. An **Enhanced** timer is like a **Basic** timer but the progress bar shows progress beyond the end of the run time. A **Cyclic** timer is like a **Basic** timer but restarts automatically when the run time is expired. A **No Limit** timer has no run time or progress bar and shows the time elapsed since the timer was started.

The type of timer is set in the monitor's Configuration Mode and is associated with the timer label.

Timer Setup Pop-up Keys

When you open the **Timers** window and select a timer, the **Setup** window opens and a selection of pop-up keys appear to let you activate and control the timers.

Pop-Up Keys	Selecting this pop-up key lets you....
Start	start the timer.
Stop	stop the timer, allowing either restarting after a pause (Start key) or clearing (Clear key).
Clear	clear the timer, ending this timer episode.
Timers	return to the timer window showing all active timers

Setting Up Timers

The additional notification setting is made in the monitor's Configuration Mode and is associated with the timer label. The timer type, display color of the timer and whether a window automatically pops up on expiry are also settings made in Configuration Mode for each timer label.

The remaining timer settings can be made in Monitoring Mode. If you change settings when a timer is running it will not be stopped. The timer will continue to count but the new settings will be applied.

To display the Setup window for a timer,

- ◆ in the **Timers** window, select the required timer, or
- ◆ select a timer on the Main Screen then select **Setup Timers**

Timer Label

You can select from a variety of specific labels, for example Tourniquet, Infusion, Documentation or from four non-specific labels Timer A, B, C, D. When you assign a label to a timer, the monitor automatically applies the associated configuration settings to this timer, but the timer continues counting and is not reset.

To select a label, in the **Timers** window:

- 1 Select the required timer to display the **Setup** window.
- 2 Select **Label**.
- 3 Select a specific or non-specific label from the list.

Run Time

The run time can be set between 1 minute and 96 hours. **No Limit** timers have no run time.

To set the run time, in the **Timers** window:

- 1 Select the required timer to display the **Setup** window.
- 2 Select **Run Time**.
- 3 Select a run time from the list.

Timer Counting Direction

Timers can count up or down, showing elapsed time or remaining time. **No Limit** timers automatically count up.

To change the direction, in the **Timers** window:

- 1 Select the required timer to display the **Setup** window.
- 2 Select **Direction** to switch between **Up** and **Down**.

Displaying Timers On The Main Screen

If you want to have a timer displayed on the Main Screen, you can substitute it for a numeric which is not directly associated with a wave. If limited space is available, some elements displayed in the **Timers** window may not be displayed. The minimum information displayed is the label and the elapsed or remaining time.

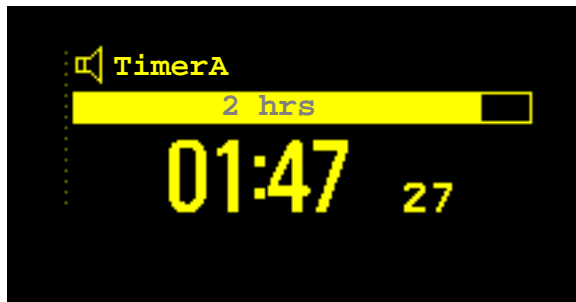

To display a timer on the Main Screen:

- 1 Select the numeric you want to substitute.
- 2 Select **Change Numeric**.
- 3 Select **Any Timer**.
- 4 Select the timer to be displayed.

Main Screen Timer Pop-up Keys

When you select a timer displayed on the Main Screen, additional pop-up keys become available:

Pop-Up Keys	Selecting this pop-up key lets you....
Setup "Label"	enter the setup screen for the currently selected timer.
Change Timer	select a different timer for display.

Displaying A Clock On The Main Screen

In the same way that you can substitute a timer for a numeric, you can also substitute a larger clock display for a numeric.

To display a clock on the Main Screen:

- 1 Select the numeric you want to substitute.
- 2 Select **Change Numeric**.
- 3 Select **Clock**.

Respiratory Loops

Using a VueLink module connected to a ventilator, you can measure and store graphic representations of realtime respiratory loops. Respiratory loops can help you recognize changes in your patient's lung function, and they can also indicate a fault in the airway tubing (for example, if the respiratory loop does not close).

You can measure:

- Pressure-volume loops
- Pressure-flow loops
- Volume-flow loops.

Note that you cannot store loops from different patients and different source devices in the same list as they are patient and device specific. This prevents you from inadvertently comparing information from different patients.

Viewing Loops

In the loops display, the current loop is drawn in white, and up to six stored loops are color-coded to match their timestamps. The currently-used source device is shown in the window title.

To view respiratory loops permanently on your Screen,

- ◆ select the current Screen name to open the **Change Screen** menu, then select a Screen configured to display the loops screen element.

Select the loops screen element to access the loops pop-up keys.

To open the **Loops** window, and its associated pop-up keys,

- ◆ select **Main Setup** -> **Loops**, or select the **Loops SmartKey**, if configured.

In the **Loops** window, in addition to the stored loops, three realtime airway waves and six available numerics from the source device can be shown.

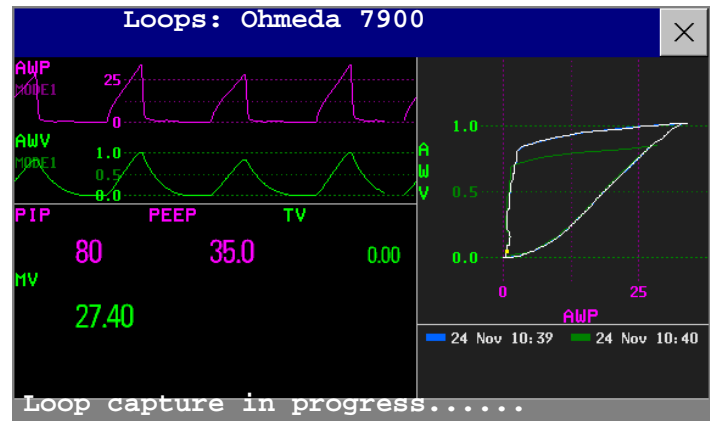

Loops						
Capture Loop	Select Loop		Select Size	Print Loop	Loop Type	Setup Device

Capturing and Deleting Loops

Up to six loops of each kind can be stored for reference.

To capture the current Loop and display it in the **Loops** window,

- ◆ select the **Capture Loop** pop-up key.

The monitor will prompt you to save the loop for reference, either in addition to or in place of previously stored loops.

Status messages at the bottom of the window provide information on the loop capture process.

To delete Loops from the reference list,

- ◆ Select the **Select Loop** pop-up key to view the list of stored loops and delete the loops from the list.

Showing/Hiding Loops

Colored rectangles beside the loops timestamps and color-coded with the loops tell you whether each loop is currently displayed or not:

- A filled-in rectangle marks loops currently shown in the Loops window
- A rectangle outline marks loops not currently shown.



Selecting the timestamp of the currently-displayed loop hides it and shows the next in the list; selecting the timestamp of a currently hidden loop displays it.

Changing Loops Display Size

To change the loops display size, in the **Loops** window, select the pop-up key **Select Size** then select

- **Size x 0.5** to display loops at half the usual size
- **Size x 1** to display loops at the usual size
- **Size x 2** to display loops at twice the usual size

This does not affect the size of loops printed in reports.

Using the Loops Cursor

To view the coordinates for any point on a stored loop,

- 1 Select the pop-up key **Select Loop**.
- 2 Select the required loop from the list of available loops.
- 3 Use the arrow pop-up keys to move the cursor around the loop. The values for both loop axes are shown for every point on the loop.

Select the X at the top of the loop list to exit the cursor.

Changing Loops Type

To change the loop type, in the **Loops** window, select the **Loop Type** pop-up key (only available if the source device delivers three waves), then select

- **Press/Volume** to display Pressure/Volume loops
- **Flow/Volume** to display Volume/Flow loops
- **Press/Flow** to display Pressure/Flow loops.

or, if the source device only delivers two waves,

- 1 In the **Loops** window, select the **Setup Device** pop-up key to enter the **Setup <VueLink Device>** menu.
- 2 Select **Wave 1** and select pressure, flow, or volume waves as required. Repeat for **Wave 2**.

Setting Up Source Device

The source device for the loops is indicated in the **Loops** window title.

- ◆ Select the **Setup Device** pop-up key to view the settings of the current source device.

If the source device is changed, all reference loops from a previous device are cleared from the reference list when the first loop from the new source device is captured. Reconnecting the previous device recalls its reference list.

Documenting Loops

- 1 In the **Loops** window, select the pop-up key **Print Loop**
- 2 From the list of available loops, select an individual loop, or select Print All to print a report of all

For each loop, the report prints

- the currently-displayed loop, with the loop capture timestamp
- up to six realtime numerics provided by the loop source device
- SpO₂, etCO₂, PO₂, and PCO₂ numerics from the patient monitor, if available.

Lastname, Firstname Bed Label
Respiratory Loops Report 10 Jan 13:30

Source Device

Loop Captured at 10 Jan 2004 13:10

TV	550	ml
MV	7.15	l/min
awRR	13	rpm
inO2	100	mmHg
etCO2	38	mmHg
imCO2	0.1	mmHg
SpO2	99	%
SpO2 l	98	%
SpO2 r	99	%

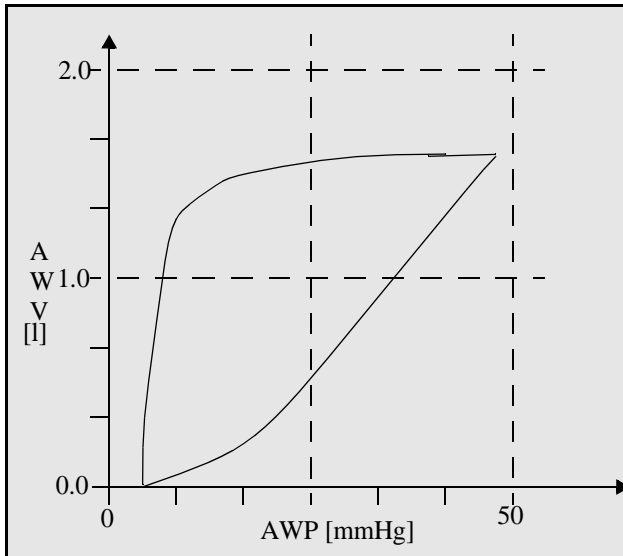

Philips	Hospital Name	Page number
---------	---------------	-------------

Care and Cleaning

Use only the Philips-approved substances and methods listed in this chapter to clean or disinfect your equipment. Warranty does not cover damage caused by using unapproved substances or methods.

Philips makes no claims regarding the efficacy of the listed chemicals or methods as a means for controlling infection. Consult your hospital's Infection Control Officer or Epidemiologist. For comprehensive details on cleaning agents and their efficacy refer to "Guidelines for Prevention of Transmission of Human Immunodeficiency Virus and Hepatitis B Virus to Health Care and Public-Safety Workers" issued by the U.S. Department of Health and Human Services, Public Health Service, Centers for Disease Control, Atlanta, Georgia, February 1989. See also any local policies that apply within your hospital, and country.

General Points

Keep your monitor, modules, Multi-Measurement Server, measurement server extensions, Flexible Module Server, cables and accessories free of dust and dirt. After cleaning and disinfection, check the equipment carefully. Do not use if you see signs of deterioration or damage. If you need to return any equipment to Philips, decontaminate it first.

Observe the following general precautions:

- Always dilute according to the manufacturer's instructions or use lowest possible concentration.
- Do not allow liquid to enter the case.
- Do not immerse any part of the equipment in liquid.
- Do not pour liquid onto the system.
- Never use abrasive material (such as steel wool or silver polish).
- Never use bleach.

WARNING Do not operate any devices when they are wet. If you spill liquid on the equipment, battery, or accessories, contact your service personnel or Philips service engineer.

The general care and cleaning information given here meets the requirements of Aspect Medical Systems for their BIS measurement devices.

Cleaning

Clean with a lint-free cloth, moistened with warm water (40°C/104°F maximum) and soap, a diluted non-caustic detergent, tenside, ammonia- or alcohol-based cleaning agent. Do not use strong solvents such as acetone or trichloroethylene.

Take extra care when cleaning the screen of the monitor because it is more sensitive to rough cleaning methods than the housing. Do not permit any liquid to enter the monitor case and avoid pouring it on the monitor while cleaning. Do not allow water or cleaning solution to enter the connectors of the Multi-Measurement Server, the measurement server extensions and measurement modules. Wipe around, not over, connector sockets.

CAUTION To clean the touch-enabled display, disable the touch operation by switching off the monitor during the cleaning procedure, or by selecting and holding the Main Screen key until the padlock symbol appears on it, indicating that touch operation is disabled. Select and hold again to re-enable touch operation. Unplug a mouse before cleaning it. Switch off the monitor to disable an attached SpeedPoint Device before cleaning the device.

Recommended cleaning agents are:

Tensides (dishwasher detergents)	Edisonite Schnellreiniger [®] , Alconox [®]
Ammonias	Dilution of Ammonia <3%, Window cleaner
Alcohol	Ethanol 70%, Isopropanol 70%, Window cleaner

Disinfecting

CAUTION Solutions: Do not mix disinfecting solutions (such as bleach and ammonia) as hazardous gases may result.

Hospital policy: Disinfect the product as determined by your hospital's policy, to avoid long term damage to the product.

Clean equipment before disinfecting. Recommended disinfecting agents are:

Alcohol based	Ethanol 70%, Isopropanol 70%, Cutasept [®] , Hospisept [®] , Kodan [®] Tinktur forte, Sagrosept [®] , Spitacid [®] , Sterilium fluid [®] (only Ethanol 70% and Isopropanol 70% are tested and qualified)
Aldehyde based	Cidex [®] activated dialdehyde solution, Gigasept (only Cidex is tested and qualified)

Cleaning Monitoring Accessories

To clean, disinfect and sterilize reusable transducers, sensors, cables, leads, and so forth, refer to the instructions delivered with the accessory.

Sterilizing

Sterilization is not recommended for this monitor, related products, accessories or supplies unless otherwise indicated in the Instructions for Use that accompany the accessories and supplies.

Cleaning the Recorder Printhead (M1116B only)

If you run recordings at low speed (1 or 2cm/min) for extended periods, deposits of paper debris may collect on the print head making recordings unevenly fainter in horizontal stripes.

- 1 Remove the recorder.
- 2 Open the recorder door and un-thread the paper from behind the rubber roller.
- 3 Tear off or roll up the excess paper into the roll chamber to get it out of your way.
- 4 Thread the cloth cleaning strip instead of paper around the rubber roller until approximately two inches of the strip come out from the top of the roller.

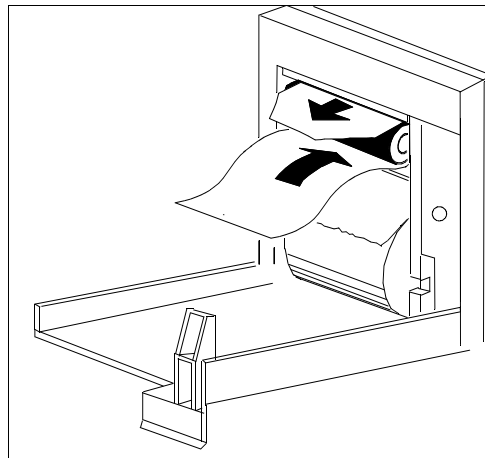

- 5 Close the recorder door, aligning both ends of the strip over the top of the door.
- 6 Holding the top end of the cleaning strip between your thumb and forefinger, pull the strip through and out of the recorder.
- 7 Open the door and ensure that the paper cavity is dust-free. Re-thread the paper and replace the recorder.

Cleaning the Batteries and Battery Compartment

MP20/MP30 Wipe with a lint-free cloth, moistened with warm water (40°C/104°F maximum) and soap. Do not use
MP40/MP50 strong solvents. Do not soak the battery.
Only

Using the Batteries

**IntelliVue
MP20/MP30/
MP40/MP50
only**

MP20/MP30: one OR two Philips M4605A rechargeable Lithium Ion batteries must be inserted into the battery compartment at the rear of the monitor to use the MP20/MP30 monitor with battery power.



Battery compartment

MP40/MP50: two Philips M4605A rechargeable Lithium Ion batteries must be inserted into the battery compartment at the rear of the monitor to use the MP40/MP50 monitor with battery power.



Battery compartment

The MP60/MP70/MP80/MP90 monitors cannot be powered by battery.

You can switch between battery-powered and mains-powered (AC) operation without interrupting monitoring.

The batteries recharge automatically whenever the monitor is connected to mains power.

Battery operation may not be available in all geographies.

Battery Power Indicators

The battery LED and battery status information on the Main Screen, in combination with INOP messages and prompts, help you keep track of the battery power status. The indicators always show the remaining capacity in relation to the battery's actual maximum capacity, which may lessen as the battery ages. You can see the actual capacity in the **Battery Status** window.

When both batteries are empty the monitor switches off automatically.

Battery LED

The battery LED on the front panel of the monitor is indicated by a battery symbol.

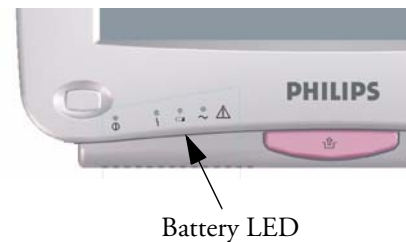

Battery LED Colors	If the monitor is connected to mains power, this means	If the monitor is running on battery power, this means
Green	battery power is > 90%	
Yellow	batteries charging (battery power < 90%)	
Red, flashing		less than 10 minutes power remaining
Red, flashes intermittently	battery malfunction	battery malfunction
Red, flashes once when on/standby switch is pressed		not enough battery power left to power monitor

MP40/50 only If only one battery is inserted during charging, the battery LED is yellow during charging and switches off when the battery is charged.

Battery Status on the Main Screen

Battery status information can be configured to display permanently on all Screens. It shows the status of each of the batteries detected and the combined battery power remaining, with an estimate of the monitoring time this represents.

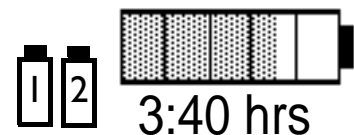















Battery status symbols: These symbols tell you the status of the batteries (see table below) and which battery compartment they are in, either 1 or 2.

Battery power gauge: This shows the remaining battery power in the combined batteries. It is divided into sections, each representing 20% of the total power. If three and a half sections are shaded, as in this example, this indicates that 70% battery power remains. If no batteries are detected, the battery gauge is grayed-out. If no data is available from the batteries, questions marks are shown in the gauge.

Monitoring Time Available: Below the battery power gauge a time is displayed. This is the estimated monitoring time available with the current battery power. Note that this time fluctuates depending on the system load (the display brightness and how many measurements and recordings you carry out), the age of the battery, and the remaining capacity of the battery.

Battery malfunction symbols: If a problem is detected with a battery, these symbols alternate with the symbol indicating the position of the battery affected. They may be accompanied by an INOP message or by a battery status message in the monitor information line providing more details. Symbols indicating critical situations are colored red.

Battery status symbols			Battery malfunction symbols		
			 	 	 
Battery 1 is present	Battery compartments are empty	Battery requires maintenance	Incompatible battery (Battery 1)	Battery malfunction (Battery 1)	Battery 2 is missing, insert battery (MP40/50 only)
					 
battery is empty	battery not charging as the temperature is above or below the specified range			(red) battery temperature too high	Battery 2 has no power left

If both batteries are malfunctioning or incompatible, the monitor will switch off automatically for safety reasons, if it is not connected to AC power.

Battery Status Window

- ◆ To access the **Battery Status** window and its associated pop-up keys, select the battery status information on the Screen, or select **Main Setup -> Battery**.

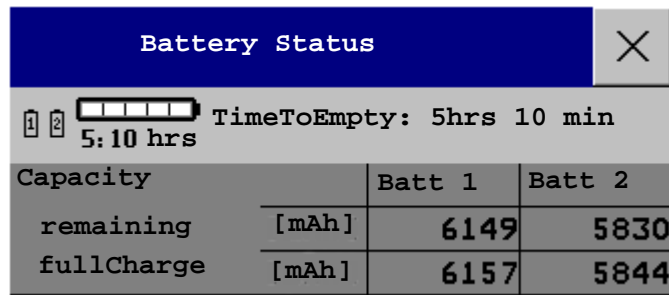

Capacity		Batt 1	Batt 2
remaining	[mAh]	6149	5830
fullCharge	[mAh]	6157	5844

Capacity, Remaining tells you how much power is left in each battery.

Capacity, Full Charge tells you how much power each battery can hold when fully charged.

Time To Empty tells you approximately how long you can continue to use the monitor with these batteries. Note that this time fluctuates depending on the system load (the display brightness and how many measurements and recordings you carry out), the age of the battery, and the remaining capacity of the battery.

Time To Full is shown in place of **Time To Empty** if the monitor is connected to mains power, and tells you how much time is left until the batteries are charged to 90%. When the batteries are charging you can see how much monitoring time the current charging status represents under the battery symbol.

Viewing Individual Battery Status

- ◆ To view information for individual batteries, select the pop-up key **Battery 1** or **Battery 2**.

Recording Battery Status

To print the information in the **Battery Status** window on a connected recorder,

- 1 Select the battery status information on the Screen to open the **Battery Status** window
- 2 Select the **Record Status** pop-up key.

Printing Battery Reports

To print the information in the **Battery Status** window on a connected printer,

- 1 Select the battery status information on the Screen to open the **Battery Status** window
- 2 Select the **Print Status** pop-up key.

Checking Battery Charge

- ◆ To check the charge status of a battery in a monitor, see the battery power gauge on the Screen or select **Main Setup -> Battery** to enter the **Battery Status** window.
- ◆ To check the charge status of a battery that is not connected to a monitor or battery charger, press the black dot marked "PUSH" on the labeled side of the battery. The remaining charge is indicated by four LEDs on the electronic fuel gauge directly above the dot. Each LED represents 25% of

charge. If all LEDs are lit, the battery is fully charged, if only one LED is lit, 25% or less charge is left.

Replacing Batteries



MP40/MP50 You can replace batteries without switching off the monitor, if you replace them one at a time and if the remaining battery has sufficient power. The **Battery Missing INOP** is suppressed for 30 seconds while you exchange each battery.

MP20/MP30 When using the monitor with only one battery, insert the new battery before removing the previous battery, to avoid leaving the monitor without power.

To replace batteries,

- 1 Press the battery compartment latch to open the battery compartment door.
- 2 To replace battery 1, rotate the battery retainer until the battery can be removed.
To replace battery 2, rotate the battery retainer until the battery can be removed.
- 3 Pull gently on the canvas strap to move the battery towards you, then grasp the battery and pull it out fully.
- 4 Slide the new battery into position, making sure that the positive and negative poles are facing in the correct direction, as outlined on the inside of the battery compartment door.
- 5 Repeat with the second battery if required.
- 6 Center the battery retainer and close the battery compartment door.



Optimizing Battery Performance

The performance of rechargeable batteries may deteriorate over time. Maintaining your batteries as recommended here can help to slow down this process.

Display Brightness Setting

- ◆ In the **Main Setup** menu, select **User Interface -> Brightness -> Optimum**. This selects a level of brightness suitable for most monitoring locations that uses less battery power than brighter settings.

Satisfy yourself that this level of brightness is suitable for your monitoring location.

Note that your monitor may be configured to dim or brighten the display brightness automatically when you disconnect from power, to suit the most common transport scenario (“**TransportBrightn**” setting).

Charging Batteries

Batteries can be charged in monitors used to monitor patients. Charging is quicker in unused monitors. Contact your local Philips representative for information on external battery chargers. Use only Lithium Ion battery chargers approved by Philips.

- 1 Insert the batteries into a monitor connected to mains power. The battery LED will light yellow to indicate that charging is in process.
- 2 Charge the battery until it is full, the battery LED is green, and the battery power gauge is fully shaded.

Conditioning Batteries

CAUTION Do not use a monitor being used to monitor patients to condition batteries. The monitor switches off automatically when the batteries are empty.

You must condition a battery when its “battery requires maintenance” symbol shows on the Screen. Do not interrupt the charge or discharge cycle during conditioning. To condition a battery,

- 1 Insert the battery into a monitor connected to mains power.
- 2 Charge the battery until it is completely full. Open the **Battery Status** window and check that the **Batteries fully charged** or **Battery 1 / Battery 2 fully charged** message is displayed.
- 3 Disconnect the monitor from mains power, and let the monitor run until the battery is empty and the monitor switches itself off.
- 4 Reconnect the monitor to mains power and charge the battery until it is full for use or charge to 50% for storage.

Contact your local Philips representative for information on external battery chargers/conditioners. Use only Lithium Ion battery chargers approved by Philips.

Unequally-Charged Batteries

If two batteries in a monitor are unequally charged, the monitor can compensate by causing the fuller battery to discharge faster. For this mechanism to work, the charge state of the two batteries should not differ by more than 50%.

Battery Safety Information

WARNING Use only Philips batteries part number M4605A. Use of a different battery may present a risk of fire or explosion.

Do not open batteries, or dispose of them in fire, or cause them to short circuit. They may ignite, explode, leak or heat up, causing personal injury.

Dispose of used batteries promptly and in an environmentally-responsible manner. Do not dispose of the battery in normal waste containers. Consult your hospital administrator to find out about local arrangements.

CAUTION Do not disassemble, heat above 100°C (212°F) or incinerate the batteries, to avoid the risk of fire and burns. Keep batteries out of the reach of children and in their original package until you are ready to use them.

If battery leakage should occur, use caution in removing the battery. Avoid contact with skin. Clean the battery compartment according to the instructions.

Maintenance and Troubleshooting

WARNING **Schedule:** Failure on the part of the responsible individual hospital or institution employing the use of this equipment to implement a satisfactory maintenance schedule may cause undue equipment failure and possible health hazards.

Contact: If you discover a problem with any of the equipment, contact your service personnel, Philips, or your authorized supplier.

Inspecting the Equipment and Accessories

You should perform a visual inspection before every use, and in accordance with your hospital's policy. With the monitor switched off:

- 1 Examine unit exteriors for cleanliness and general physical condition. Make sure that the housings are not cracked or broken, that everything is present, that there are no spilled liquids and that there are no signs of abuse.
- 2 If the MMS and Server Extensions are mounted on the monitor, make sure that they are locked into place and do not slide out without releasing the locking mechanism.
- 3 Inspect all accessories (cables, transducers, sensors and so forth). If any show signs of damage, do not use.
- 4 Switch the monitor on and make sure the backlight is bright enough. Check that screen is at its full brightness. If the brightness is not adequate, contact your service personnel or your supplier.

Inspecting the Cables and Cords

- 1 Examine all system cables, the power plug and cord for damage. Make sure that the prongs of the plug do not move in the casing. If damaged, replace it with an appropriate Philips power cord.
- 2 Inspect the Measurement Server Link cable and ensure that it makes good connection with the MMS and the FMS. Make sure that there are no breaks in the insulation.
- 3 If the MMS is not mounted directly on the monitor, inspect the cable connecting it to the monitor. Make sure the connectors are properly engaged.

- 4 Inspect the patient cables, leads and their strain reliefs for general condition. Make sure there are no breaks in the insulation. Make sure that the connectors are properly engaged at each end to prevent rotation or other strain.
- 5 Apply the transducer or electrodes to the patient, and with the monitor switched on, flex the patient cables near each end to make sure that there are no intermittent faults.

Maintenance Task and Test Schedule

The following tasks are for Philips-qualified service professionals only. All maintenance tasks and performance tests are documented in detail in the service documentation supplied on the monitor documentation CD.

Ensure that these tasks are carried out as indicated by the monitor's maintenance schedule, or as specified by local laws. Contact a Philips-qualified service provider if your monitor needs a safety or performance test. Clean and disinfect equipment to decontaminate it before testing or maintaining it.

Maintenance and Test Schedule	Frequency
Monitor Tests	
Safety checks. Selected tests on the basis of IEC 60601-1	At least once every two years, or as needed, after any repairs where the power supply is removed or replaced, or if the monitor has been dropped.
Monitor Maintenance	
Check ECG synchronization of the monitor and defibrillator (only if hospital protocol requires use of monitor during defibrillation)	At least once every two years, or as needed.
Replace backlight (integrated displays only)	25,000 - 30,000 hours (about three years) of continuous usage, or as needed.
Measurement Server and Module Tests	
Performance assurance for all measurements not listed below.	At least once every two years, or if you suspect the measurement values are incorrect.
Measurement Server and Module Maintenance	
NBP calibration	At least once every two years, or as specified by local laws.
Microstream CO ₂ calibration and performance test	At least once a year or after 4000 operating hours.
Mainstream and sidestream CO ₂ calibration check (M3014A)	At least once a year, or if you suspect the measurement values are incorrect.
Battery Maintenance	
Battery	See the section on Maintaining Batteries

Troubleshooting

If you suspect a problem with an individual measurement, read the Instructions for Use and doublecheck that you have set up the measurement correctly.

If you suspect an intermittent, system-wide problem call your service personnel. You may be asked for information from the status log. To view the status log,

- 1 In the **Main Setup** menu, select **Revision**.
- 2 Select a pop-up key according to the status log you want to consult, for example, to check the status log for the MMS, select the **M3001A** pop-up key.
- 3 View the status log by selecting the **Stat Log** pop-up key.

Disposing of the Monitor

WARNING To avoid contaminating or infecting personnel, the environment or other equipment, make sure you disinfect and decontaminate the monitor appropriately before disposing of it in accordance with your country's laws for equipment containing electrical and electronic parts. For disposal of parts and accessories such as thermometers, where not otherwise specified, follow local regulations regarding disposal of hospital waste.

You can disassemble the monitor, MMS, FMS and modules as described in the Service Guide.

- There is no metal molded into the plastic case, and there are no metal sprays on the plastic.
- All plastic parts with a weight greater than 10g (0.35 ounces) are marked with the ISO code for identification.
- The sheet metal card cage uses only one kind of steel.
- The screen has a touch resistor laminate.
- You can recycle the paper Instructions for Use.

The battery can be easily removed (see “Replacing Batteries” on page 301), and can be returned, free of charge, to the worldwide-recycling program run by the battery manufacturer (contact your local supplier).

Disposing of Empty Calibration Gas Cylinders

- 1 Empty the cylinder completely by pushing in the pin of the regulator valve or by pulling out the pin of the fill valve using a tire valve stem wrench or a pair of needle nose pliers.
- 2 When the cylinder is empty, either remove the valve stem from the fill (or regulator) hole, or drill a hole in the cylinder.
- 3 Write “Empty” on the cylinder and dispose of it appropriately for scrap metal.

WARNING Ensure that the cylinder is completely empty before trying to remove the valve stem or drill a hole in the cylinder.

Accessories

You can order parts and accessories from Philips supplies at www.medical.philips.com or consult your local Philips representative for details.

WARNING Reuse: Never reuse disposable transducers, sensors, accessories and so forth that are intended for single use, or single patient use only. Reuse may compromise device functionality and system performance and cause a potential hazard.

Philips' approval: Use only Philips-approved accessories.

Packaging: Do not use a sterilized accessory if its packaging is damaged.

ECG/Resp Accessories



This symbol indicates that the cables and accessories are designed to have special protection against electric shocks (particularly regarding allowable leakage currents), and are defibrillator proof.

Trunk Cables

Length	3-Electrode Cable Set		5-Electrode Cable Set		10-Electrode Cable set
	AAMI Part No.	IEC Part No.	AAMI Part No.	IEC Part No.	AAMI/IEC Part No.
0.9m	M1540C	M1550C	M1560C	M1570C	n/a
2.7m	M1500A	M1510A	M1520A	M1530A	M1949A

3-Electrode Cable Sets

Description	Length	AAMI Part No.	IEC Part No.
OR	1.0m	M1601A	M1611A

Description	Length	AAMI Part No.	IEC Part No.
ICU Grabber shielded	1.0m	M1603A	M1613A
ICU snap shielded	1.0m	M1605A	M1615A
ICU Clip non-shielded	0.45m	M1608A	M1618A
ICU Clip non-shielded	0.7m	M1609A	M1619A

5-Electrode Cable Sets

Description	Length	AAMI Part No.	IEC Part No.
OR Grabber shielded	1.0m/1.6m	M1621A	M1631A
ICU Grabber shielded	1.0m/1.6m	M1623A	M1633A
ICU Snap shielded	1.0m/1.6m	M1625A	M1635A
ICU Clip non-shielded	0.7m/1.3m	M1629A	M1639A

10-Electrode Cable Sets

Description	Length	AAMI Part No.	IEC Part No.
OR Grabber - extremities	1.0m/1.6m	M1973A	M1974A
OR Grabber - chest	1.0m	M1979A	M1984A
ICU Extremities	1.0m/1.6m	M1968A (grabber)	M1971A (grabber)
ICU Chest	1.0m	M1976A (grabber)	M1978A (grabber)

3-Electrode One Piece Cables

AAMI 3-Electrode One Piece Cables	Length	AAMI Part No.	IEC 3-electrode One Piece Cables	IEC Part No.
OR Grabber	1.9m	M1970A	OR Grabber	M1980A
ICU Snap	1.9m	M1972A	ICU Grabber	M1981A

5-Electrode One Piece Cables

AAMI 5-electrode One Piece Cables	Length	AAMI Part No.	IEC 5-electrode One Piece Cables	IEC Part No.
OR Grabber	2.5m	M1975A	OR Grabber	M1985A
ICU Snap	2.5m	M1977A	ICU Grabber	M1986A

Set Combiners and Organizers

Set combiners and organizers		Part No.
Set combiner	3-electrode	M1501A
	5-electrode	M1502A
Set organizer	Shielded 3-electrode	M1503A
	Shielded 5-electrode	M1504A
Bedsheet clip		M1509A

NBP Accessories



These cuffs and tubings are designed to have special protection against electric shocks (particularly regarding allowable leakage currents), and are defibrillator proof. You can use them during electrosurgery.

Adult/Pediatric Multi-Patient Comfort Cuffs and Disposable Cuffs

Patient Category	Limb Circumference	Bladder Width	Disposable cuff Part No.	Reusable cuff Part No.	Tubing
Adult (Thigh)	42 to 54 cm	20 cm	M1879A	M1576A	M1598B (1.5m) or M1599B (3m)
Large Adult	34 to 43 cm	16 cm	M1878A	M1575A	
Adult	27 to 35 cm	13 cm	M1877A	M1574A	
Small Adult	20.5 to 28 cm	10.5 cm	M1876A	M1573A	
Pediatric	14 to 21.5 cm	8 cm	M1875A	M1572A	
Infant	10 to 15 cm	5.5 cm	M1874A	M1571A	

Reusable Cuff Kits

Cuff Kits	Part No.
Infant, pediatric, small adult, adult	M1577A
Small adult, adult, large adult, thigh	M1578A
Infant, pediatric, small adult, adult, large adult, thigh	M1579A

Adult/Pediatric Antimicrobial Coated Reusable cuffs

Patient Category (color)	Limb Circumference (cm)	Bladder Width	Part No.	Tubing
Adult Thigh (grey)	45 - 56.5	21.0 cm	M4559A	M1598B (1.5m) or M1599B (3m)
Large Adult X-Long (burgundy)	35.5 - 46.0	17.0 cm	M4558A	
Large Adult (burgundy)	35.5 - 46.0	17.0 cm	M4557A	
Adult X-Long (navy blue)	27.5 - 36.5	13.5 cm	M4556A	
Adult (navy blue)	27.5 - 36.5	13.5 cm	M4555A	
Small Adult (royal blue)	20.5 - 28.5	10.6 cm	M4554A	
Pediatric (green)	13.8 - 21.5	8.0 cm	M4553A	
Infant (orange)	9 - 14.8	5.4 cm	M4552A	

Adult/Pediatric Soft Single Patient Single-Hose Disposable Cuffs

Patient Category	Limb Circumference (cm)	Bladder Width	Part No.	Tubing
Adult (Thigh)	45 - 56.5 cm	20.4 cm	M4579A	M1598B (1.5m) or M1599B (3m)
Large Adult X-Long	35.5 - 46 cm	16.4 cm	M4578A	
Large Adult	35.5 - 46 cm	16.4 cm	M4577A	
Adult X-Long	27.5 - 36.5	13.1 cm	M4576A	
Adult	27.5 - 36.5 cm	13.1 cm	M4575A	
Small Adult	20.5 - 28.5 cm	10.4 cm	M4574A	
Pediatric	15.0 - 21.5 cm	8.0 cm	M4573A	
Infant	9 - 15 cm	5.6 cm	M4572A	

Neonatal/Infant Cuffs (Disposable, non-sterile)

Cuffs	Limb Circumference (cm)	Bladder Width	Part No.	Tubing
Size 1	3.1 to 5.7 cm	2.2 cm	M1866A	M1596B (1.5m) or M1597B (3m)
Size 2	4.3 to 8.0 cm	2.8 cm	M1868A	
Size 3	5.8 to 10.9 cm	3.9 cm	M1870A	
Size 4	7.1 to 13.1 cm	4.7 cm	M1872A	

Invasive Pressure Accessories



These transducers and accessories are designed to have special protection against electric shocks (particularly regarding allowable leakage currents), and are defibrillator proof.

If you are using the M3012A Hemodynamic Measurement Server Extension, and you want to measure temperature and invasive pressure at the same time, we recommend that you use the pressure transducer CPJ840J6, with a round module connector piece, and not a transducer with a square connector. Pressure transducers with square connectors may make it difficult to connect the adjacent Temperature connector at the same time.

Transducer, accessories, sensor kits	Part No
Reusable pressure transducer 5 μ V/.V/mmHg sensitivity	CPJ840J6
Sterile disposable pressure domes for CPJ840J6 (pack of 50)	CPJ84022
Transducer holder for CPJ840J6 (pack of 4)	CPJ84046
IV pole mount for CPJ840J6	CPJ84447
Single channel disposable sensor kit (20) - (EU/EFTA only)	M1567A
Dual channel disposable sensor kit (20) (EU/EFTA only)	M1568A
Transducer holder for M1567/8A (EU/EFTA only)	M2271A
IV pole mount for M1567/8A (EU/EFTA only)	M2272C
Adapter cable for disposable sensor kit 3,0m for M1567/8A	M1634A
Pressure transducer kits	
PiCCO monitoring kit, 30cm pressure line, includes PV4046 injectate temperature sensor housing for M1646A	PV8103
PiCCO monitoring kit, 150cm pressure line, includes PV4046 injectate temperature sensor housing for M1646A	PV8115
PiCCO monitoring kit, 150cm pressure line, includes PV4046 injectate temperature sensor housing for M1646A and central venous pressure line	PV8115CVP
PULSION Pressure Interface Cable for disposable pressure transducer	PMK 206

SpO₂ Accessories

This section lists accessories for use with Philips SpO₂ technology. For accessory lists for other SpO₂ technologies, refer to the instructions for use provided with these devices.

Some Nellcor sensors contain natural rubber latex which may cause allergic reactions. See the Instructions for Use supplied with the sensors for more information. M1901B, M1902B, M1903B and M1904B disposable sensors are not available in USA from Philips. Purchase Nellcor sensors and adapter cables directly from Tyco Healthcare.

Do not use more than one extension cable with any sensors or adapter cables. Do not use an extension cable with Philips reusable sensors or adapter cables with part numbers ending in -L (indicates "Long" version).

All listed sensors operate without risk of exceeding 41°C on the skin if ambient temperature is below 37°C.

The M1020B SpO₂ module with Option A02 may not be available in all countries. Some sensors may not be available in all countries. Always use the MAX-FAST forehead sensor with the foam headband provided by Nellcor.

Make sure that you use only the accessories that are specified for use with this device, otherwise patient injury can result.

Option A01 is the Philips FAST-SpO₂ version; Option A02 is the Nellcor OxiMax-compatible version.

Product Number	Description	Compatible with:		Comments
		Opt. A01	Opt. A02	
Philips reusable sensors.				
M1191A	Adult sensor (2m cable), for patients over 50 kg. Any finger, except thumb.	yes	no	No adapter cable required.
M1191AL	M1191A with longer cable (3 m)	yes	no	
M1192A	Small adult, pediatric sensor (1.5m cable) for patients between 15 kg and 50 kg. Any finger except thumb.	yes	no	
M1193A	Neonatal sensor (1.5m cable) for patients between 1kg and 4 kg. Hand or foot.	yes	no	
M1194A	Ear sensor (1.5m cable) for patients more than 40 kg.	yes	no	
M1195A	Infant sensor (1.5m cable) for patients between 4kg and 15 kg. Any finger except thumb.	yes	no	
M1191T	Adult sensor (0.45m cable), for patients over 50 kg. Any finger, except thumb.	yes	no	Requires M1943 (1 m) or M1943AL (3 m) adapter cable
M1192T	Small adult, pediatric sensor (0.45m cable) for patients between 15 kg and 50 kg. Any finger except thumb.	yes	no	
M1193T	Neonatal sensor (0.9m cable) for patients between 1kg and 4 kg. Hand or foot.	yes	no	

Product Number	Description	Compatible with:		Comments
		Opt. A01	Opt. A02	
M1191ANL	Special Edition (SE) Adult sensor (3m cable), for patients over 50 kg. Any finger, except thumb.	yes	yes	No adapter cable required.
M1192AN	Special Edition (SE) Small adult, pediatric sensor (1.5m cable) for patients between 15 kg and 50 kg. Any finger except thumb.	yes	yes	
M1193AN	Special Edition (SE) Neonatal sensor (1.5m cable) for patients between 1kg and 4 kg. Hand or foot.	yes	yes	
M1194AN	Special Edition (SE) Ear sensor (1.5m cable) for patients more than 40 kg.	yes	yes	No adapter cable required.
M1195AN	Special Edition (SE) Infant sensor (1.5m cable) for patients between 4 kg and 15 kg. Any finger except thumb.	yes	yes	
Philips disposable sensors. Not available in the USA.				
M1904B	Identical to OxiMax MAX-A	yes	yes	Option A01: Use adapter cable M1943A or M1943AL.
M1903B	Identical to OxiMax MAX-P	yes	yes	
M1902B	Identical to OxiMax MAX-I	yes	yes	
M1901B	Identical to OxiMax MAX-N	yes	yes	Option A02: Must use adapter cable M1943NL.
Philips disposable sensors. Available worldwide.				
M1131A	Adult/Pediatric finger sensor, 0.45m cable (patient size >20 kg)	yes	no	Use adapter cable M1943A or M1943AL.
M1132A	Infant finger or toe sensor, 0.9m cable (patient size 3 - 10 kg)	yes	no	Use adapter cable M1943A or M1943AL.
M1133A	Adult/Infant/Neonatal, 0.9m cable Foot or hand for neonates < 3 kg Big toe or thumb for patients between 10kg and 20kg Any finger except thumb for patients > 40kg	yes	no	Use adapter cable M1943A or M1943AL.

Product Number	Description	Compatible with:		Comments
		Opt. A01	Opt. A02	
NELLCOR disposable sensors (must be ordered from Nellcor)				
OxiMax MAX-A	Adult finger sensor (patient size >30 kg)	yes	yes	Option A01: Use adapter cable M1943A or M1943AL.
OxiMax MAX-AL	OxiMax MAX-A with long cable	yes	yes	
OxiMax MAX-P	Pediatric foot/hand sensor (patient size 10-50 kg)	yes	yes	Option A02: Must use adapter cable M1943NL.
OxiMax MAX-I	Infant foot/hand sensor (patient size 3-20 kg)	yes	yes	
OxiMax MAX-N	Adult finger or neonatal foot/hand sensor (patient size >40 kg or <3 kg)	yes	yes	
MAX-FAST	Forehead sensor	no	yes	Must use M1943NL adapter cable.
OxiMax MAX-R	Adult nasal sensor	no	yes	
OxiMax SC-A	Adult softcare sensor	no	yes	
OxiMax SC-NEO	Neonatal softcare sensor	no	yes	
OxiMax SC-PR	Preterm infant softcare sensor	no	yes	
Oxisensor II D-25	Adult sensor (patient size >30kg)	yes	no	Must use M1943A or M1943 AL adapter cable
Oxisensor II D-20	Pediatric sensor (patient size 10-50 kg)	yes	no	
Oxisensor II I-20	Infant sensor (patient size 3-20 kg)	yes	no	
Oxisensor II N-25	Neonatal sensor (patient size <3 kg or >40 kg)	yes	no	
OxiCliq A	See OxiMax MAX-A	yes	yes	Option A01: Use adapter cable M1943A or M1943AL together with OC3 adapter cable. Option A02: Must use adapter cables M1943NL and OC3 adapter cable.
OxiCliq P	See OxiMax MAX-P	yes	yes	
OxiCliq I	See OxiMax MAX-I	yes	yes	
OxiCliq N	See OxiMax MAX-N	yes	yes	

Product Number	Description	Compatible with:		Comments
		Opt. A01	Opt. A02	
Oxiband OXI-A/N	Adult / neonatal sensor	no	yes	Must use M1943NL adapter cable
Oxiband OXI-P/I	Pediatric / infant sensor	no	yes	
Durasensor DS100A	Adult finger clip sensor	no	yes	
Dura-Y D-YS	Y-sensor	no	yes	
Extension / Adapter Cables for Philips and Nellcor Sensors				
M1941A	Extension cable (2 m)	yes	yes	For use with Philips reusable sensors and adapter cables.
M1943A	Adapter cable (1.1 m cable)	yes	no	Adapter cable for Philips/Nellcor disposable sensors.
M1943AL	Adapter cable (3 m cable)	yes	no	
M1943NL	OxiMax adapter cable (3 m cable)	no	yes	Adapter cable for Philips disposable/ Nellcor disposable and reusable sensors.
OC 3	Adapter Cable for OxiCliq sensors	yes	yes	Available from Nellcor only.

Product Number	Description	Compatible with:		Philips Part Number
		Opt. A01	Opt. A02	
MASIMO LNOP[®] reusable sensors. Require AC-1 adapter cable				
LNOP DC-I	Adult Sensor	yes	no	989803140321
LNOP DC-IP	Pediatric Sensor	yes	no	989803140331
LNOP-Y-I	Reusable Multi-Site Sensor	yes	no	n/a
LNOP TC-I	Tip Clip reusable Sensor	yes	no	989803140341
MASIMO LNOP[®] disposable sensors. Require AC-1 adapter cable				
LNOP Adt	Adult Sensor	yes	no	989803140231
LNOP Adtx	Adult Sensor	yes	no	n/a
LNOP Pdt	Pediatric Adhesive Sensor	yes	no	989803140261
LNOP Pdtx	Pediatric Sensor	yes	no	n/a
LNOP INF-L	Neo/Infant Adhesive Sensor	yes	no	989803140311
LNOP NEO-L	Neo Adhesive Sensor	yes	no	989803140291
LNOP NEOPT-L	Neo Pre-Term Sensitive Skin Adhesive Sensors	yes	no	989803140301
Adapter Cable for MASIMO sensors.				
M1020-61101	AC-1 Adapter Cable for Masimo Sensors (8-pin version)	yes	no	451261000771



The Philips M3001A option A01 Multi-Measurement server and the M1020B option A01 SpO₂ Module use Masimo certified pulse oximetry for reduced noise and low perfusion performance with Masimo Sensors under the Masimo NR&LP protocol available from Masimo.

Sensors for use with the Masimo SET[®] SpO₂ Module and orderable from Philips

Sensors	Philps Order No
LNOP Adult Adhesive Sensors (box of 20)	989803140231
Adult Sensor Sample Pack (4 sensors)	989803140241
Neo Sensor Sample Pack (4 sensors)	989803140251
Pediatric Adhesive Sensors (box of 20)	989803140261
LNOP Neonatal Adhesive Sensors (box of 20)	989803140271
Neo Pre-term Sensitive Skin Adhesive Sensors (box of 20)	989803140281
Neo Adhesive Sensors (box of 20)	989803140291
Neo Pre-term Sensitive Skin Adhesive Sensors (box of 20)	989803140301
Neo/Infant Adhesive Sensors (box of 20)	989803140311
DC-I Adult Reusable Sensor	989803140321
DCIP Pediatric Reusable Sensor	989803140331
LNOP TC-I Tip Clip Reusable Sensor	989803140341
Neo Sensitive Replacement Posey Wrap (12)	989803140351
Neo Replacement Tapes (100)	989803140361

Temperature Accessories

Temperature Probes	Part No.	Minimum measurement time for accurate readings
Reusable		
General purpose probe	21075A	90 sec
Small flexible vinyl probe (Infant/Pediatric)	21076A	60 sec
Attachable surface probe	21078A	60 sec
Disposable		
General purpose probe	M1837A	90 sec
Skin probe	21091A	60 sec
Esophageal/Stethoscope Probe (12 French)	21093A	180 sec
Esophageal/Stethoscope Probe (French 18)	21094A	210 sec
Esophageal/Stethoscope Probe (French 24)	21095A	310 sec
Foley Catheter Probe (12 French)	M2255A	180 sec

Temperature Probes	Part No.	Minimum measurement time for accurate readings
Foley Catheter Probe (16 French)	21096A	180 sec
Foley Catheter Probe (18 French)	21097A	180 sec
Adapter cable 1.5m	21082B	
Adapter cable 3.0m	21082A	

Cardiac Output (C.O.) Accessories

See Pressure accessories for PULSION continuous cardiac output accessories.

Description	Part No	
Accessories common to both methods		
Accessories	Set of ice buckets	14455A
	Remote handswitch	15244A
PiCCO inline temperature probe for warmer injectate	Latex free	M1646A
Right Heart Thermodilution		
C. O. Interface Cables	2.7 meter cable (right heart only)	M1642A
	2.4 m + 2.4 m cable	M1643A
Right heart catheter for thermodilution	(from Baxter)	831HF75
Baxter CO-set (only with HP 23001A/B)	contact Baxter for information	
Injectate Probes	2.4m injectate temp. probe (reusable)	23001A
	0.5m injectate temp. probe (reusable)	23001B
	Ice bath temp. probe (right heart only)	23002A
Transpulmonary Thermodilution		
C. O. Interface Cables	2.4 m + 2.4 m cable	M1643A
Injectate Probes	2.4m injectate temp. probe (reusable)	23001A
	0.5m injectate temp. probe (reusable)	23001B
Baxter CO-set (only with HP 23001A/B)	contact Baxter for information	
Pressure Transducer Kits (PULSION)	PV 8003 (30cm pressure line)	
	PV 8010 (100cm pressure line)	
	PV 8015 (150cm pressure line)	
Pressure Interface Cable for disposable pressure transducer	PULSION PMK 206	

Mainstream CO₂ Accessories (for M3014A)

Description	Part No.
CO ₂ Sensor	M2501A
Adult/Pediatric Airway Adapter (reusable)	M2513A
Infant Airway Adapter (reusable)	M2516A
Adult Airway Adapter (single-patient use)	M2533A
Infant Airway Adapter (single-patient use)	M2536A

Sidestream CO₂ Accessories (for M3014A)

Description	Part No.
CO ₂ Sensor	M2741A
Nasal and Oral-Nasal Cannulas	
CO ₂ Nasal Cannula, Adult	M2744A
CO ₂ Nasal Cannula, Pediatric	M2745A
CO ₂ Nasal Cannula, Infant	M2746A
CO ₂ / O ₂ Nasal Cannula, Adult	M2750A
CO ₂ / O ₂ Nasal Cannula, Pediatric	M2751A
CO ₂ Oral-Nasal Cannula, Adult	M2756A
CO ₂ Oral-Nasal Cannula, Pediatric	M2757A
CO ₂ / O ₂ Oral-Nasal Cannula, Adult	M2760A
CO ₂ / O ₂ Oral-Nasal Cannula, Pediatric	M2761A
Airway Adapters	
Airway Adapter Set, ET > 4.0 mm	M2768A
Airway Adapter Set H, ET > 4.0 mm	M2772A
Airway Adapter Set H, ET =< 4.0 mm	M2773A
Straight Sample Lines	
Straight Sample Line	M2776A
Straight Sample Line H	M2777A

Mainstream CO₂ Accessories (for M3016A)

Description	Part No.
CO ₂ Sensor	M1460A
Standard Airway Adapter (reusable)	M1465A
Small Airway Adapter (reusable)	14363A

Microstream CO₂ Accessories

- “FilterLine Set” is a combination of a FilterLine with an Airway Adapter.
- “H” in the accessory name indicates suitability for humidified ventilation and longer usage due to the active removal of humidity from the sample line.
- “Smart CapnoLine” is a combined oral-nasal FilterLine.
- “Smart CapnoLine O₂” is a combined oral-nasal-O₂-CO₂ FilterLine.
- “NIV Line” is a nasal FilterLine suitable for mask ventilation (for example, C-PAP).
- “Single purpose” means CO₂ measurement only, “dual purpose” means CO₂ measurement and O₂ delivery.
- The accessories are supplied in packs of 25.

Microstream accessory selection flowchart						
Is the patient intubated?						
Yes		No				
		Does the patient need oxygen?				
		Yes		No		
Short-term (up to 6 hours)	Long-term (up to 72 hours)	Short term (up to 8 hours)	Long term (up to 24 hours)	Long-term (up to 24 hours)	Short term (up to 8 hours)	Short term (up to 8 hours)
		Oral/Nasal	Nasal	Nasal	Oral/Nasal	Nasal
Key Applications						
Critical Care	OR, EMS, ED	Procedural Sedation, Critical Care, EMS, ED	Critical Care, Sleep Lab, Long-term Pain Management	Critical Care, Sleep Lab	Procedural Sedation, Critical Care, EMS, ED	EMS, ED
Philips part numbers (A = Adult, P= Pediatric, I = Infant, N = Neonate)						
FilterLine Set: A/P: M1920A	FilterLine H Set: A/P: M1921A I/N: M1923A	Smart CapnoLine O ₂ : A: M2522A P: M2520A	CapnoLine HO ₂ : A: M4680A P: M4681A	CapnoLine H: A: M4689A P: M4690A I/N: M4691A	Smart CapnoLine: A: M2526A P: M2524A	NIV Line: A: 4686A P: M4687A

Spirometry Accessories

Description	Part No.
Adult/Pediatric Flow Sensor	M2785A
Neonatal Flow Sensor	M2786A
Adult/Pediatric CO ₂ /Flow Sensor	M2781A
Neonatal CO ₂ /Flow Sensor	M2782A
Pediatric CO ₂ /Flow Sensor	M2783A

tcGas Accessories



This symbol indicates that the specified transducer (but not its membranes) is designed to have special protection against electric shocks (particularly regarding allowable leakage currents), and is defibrillator proof.

Description	Part No.
12x tc Accessory Kit (O-ring remover, absorbent paper, electrolyte solution, replacement membrane)	15209-60010
tc Application Kit (4x25 disposable fixation rings, 4x20ml contact fluid)	15209-60020
Calibration gas - 6 gas bottles	15210-60010
Calibration gas - 6 gas bottles (Europe and Japan only)	15210-64010
Replacement tubing (5 tubes)	M2205A
tcpO ₂ /CO ₂ transducer	M1918A
Calibration unit	15210B
Radiometer TCC3 calibration unit (available from Radiometer)	n/a

EEG Accessories

Description	Part No.
Trunk Cable 2.7m	M2268A
Trunk Cable, 1.0 m	M2269A
Reusable 80-cm-long 5-lead cables with 10mm silver/silverchloride leadwired cup electrodes (Adult)	M1931A
Reusable 80-cm-long 5-lead cables with 6mm silver/silverchloride leadwired cup electrodes (Pediatric/Neonatal)	M1932A
Reusable 80 cm 5-lead cables with clip	M1934A
Disposable EEG electrodes	M1935A
EC2™ Electrode Cream (conductive paste)	M1937A

BIS Accessories

Use only Aspect BIS sensors with the BIS module or BIS Interface board (MP20/MP30). The sensor is a silver/silverchloride electrode array that uses Aspect's patented ZipPrep technology and a proprietary connector. The sensor/electrodes are for single patient use only. Check shelf-life before use.

The patient interface cable (Philips Ordering No. M1034-61630, Aspect Part No. 186-0131) has an estimated lifetime of one year. Do not scrap it when disposing of the BIS sensor.

The sensor cable from the Semi-Reusable Sensor is re-usable but has a maximum number of uses, the electrodes are single patient use only. The monitor displays how many uses remain for the sensor cable.

BIS Sensors

To re-order sensors outside North America, contact your nearest Philips sales office and quote the Philips ordering number. In North America, contact Aspect Medical Systems.

Description	Pieces per pack	Philips Ordering No	Aspect Part No
BIS and BISx - compatible			
BIS Sensor Quatro (formerly Sensor XP)	50	M1997A	186-0106
BIS Sensor Plus	50	M4546A	186-0076
BIS Sensor Pediatric	25	M1998A	186-0110
BIS Sensor Pediatric (4 electrode)	25	989803143581	186-0200
BIS Semi-reusable Sensor (not available in USA, Japan)	100	M4615A	186-0164
BIS Sensor Extend	50	n/a	186-0160

Other BIS Accessories

Order the following parts from your nearest Philips sales office and quote the Philips ordering number

Description	Philips Ordering No
BIS M1034A only	
BIS Engine Cable - Short (0.8 m)	M1034-61610
BIS Engine Cable - Long (2.0 m)	M1034-61620
PIC PLUS Cable	M1034-61630
BIS Universal Clamp Mount	M1180A #C32
BIS FMS Mount (Flexible Module Server)	M1180A #C33
BIS Mount for MP40/MP50	M8003- 64011

SvO₂ Accessories

Contact your local Hospira representative for information on accessories. They are not available from Philips. Part numbers may vary according to country of purchase.

Description	Hospira Part No.	French Size	Length
Optical Module	50131		
Pulmonary artery catheter	50324-05	7.5F	110cm
Pulmonary artery catheter	50355-03	5.5F	75cm
Pulmonary artery catheter	50328-05	8F	110cm
Intravascular catheters	50404-01	4F	40cm
Intravascular catheters	50405-01	4F	25cm
Intravascular catheters	50407-01	5.5F	40cm

Recorder Accessories

Description	Part No.
For M1116B recorder:	
10 rolls of paper	40477A
80 rolls of paper	40477B
For integrated recorder (MP20/MP30):	
10 rolls of paper	M4816A
80 rolls of paper	M4817A

Installation and Specifications

The specifications in this section apply to the MP20, MP30, MP40, MP50, MP60, MP70, MP80 and MP90 patient monitors, unless otherwise stated.

The monitors are not user installable. They must be installed by qualified service personnel.

Intended Use

The monitors are intended to be used for monitoring, recording, and alarming of multiple physiological parameters of adults, pediatrics, and neonates in health care facilities. The devices are to be used by trained health care professionals.

All the monitors are intended for use in health care facilities; the MP20/MP30/MP40/MP50 monitors are additionally intended for use in transport situations within the hospital setting.

The monitors are only for use on one patient at a time. They are not intended for home use. Rx only: U.S. Federal Law restricts this device to sale by or on the order of a physician. Not a therapeutic device.

The transcutaneous gas measurement (tcGas) is restricted to neonatal patients only.

ST segment monitoring is intended for use with adult patients only and is not clinically validated for use with neonatal and pediatric patients.

The ECG measurement is intended to be used for diagnostic recording of rhythm and detailed morphology of complex cardiac complexes (according to AAMI EC 11).

BIS is intended for use under the direct supervision of a licensed health care practitioner or by personnel trained in its proper use. It is intended for use on adult and pediatric patients within a hospital or medical facility providing patient care to monitor the state of the brain by data acquisition of EEG signals. The BIS may be used as an aid in monitoring the effects of certain anesthetic agents. Use of BIS monitoring to help guide anesthetic administration may be associated with the reduction of the incidence of awareness with recall in adults during general anesthesia and sedation.

Indication for Use

The monitor is indicated for use by health care professionals whenever there is a need for monitoring the physiological parameters of patients.

Manufacturer's Information

You can write to **Philips** at this address

Philips Medizin Systeme Boeblingen GmbH
Hewlett-Packard-Str. 2
71034 Boeblingen
Germany

Visit our website at: www.philips.com.

© Copyright 2002 - 2005. Koninklijke Philips Electronics N.V. All Rights Reserved.

BIS Manufacturer's Information

BISx, the BIS engine, the DSC, the Patient Interface Cable and the BIS Sensor are manufactured by Aspect Medical Systems:

Aspect Medical Systems, Inc
141 Needham St
Newton,
MA 02464
USA

1-617-559-7000

Free call:

1-888-BIS_INDEX

1-888-247-4633

Email: bis_info@aspectms.com

Web: www.aspectmedical.com

Address of the EU Authorized Representative:

Aspect Medical Systems International B.V.
Rijnzathe 7d2
3454 PV De Meern
The Netherlands

Phone: +31.30.662.9140

Email: amsint@aspectms.com

Trademark Acknowledgement

PiCCO™ is a trademark of Pulsion Medical Systems AG.

Bispectral Index and BIS are trademarks of Aspect Medical Systems Inc, and are registered in the USA, EU and other countries.

Oxisensor™ II, Oxi-Cliq™, and OxiMax™ are trademarks of Tyco Healthcare Group LP, Nellcor Puritan Bennett Division.

Microstream®, FilterLine®, and Smart CapnoLine® are trademarks or registered trademarks of Oridion Systems Ltd.

























Citrix® and ICA® (Independent Computing Architecture) are registered trademarks of Citrix Systems, Inc.













Masimo®, Masimo SET®, and LNOP are federally registered trademarks of the Masimo Corporation.

Other product and company names mentioned in this book may be trademarks of their respective owners.

Symbols

These symbols appear on the monitor and its associated equipment.

Symbols		
 Refer to accompanying documents	 Protective earth	 RS232 connector RS-232
 Standby	 Equipotential grounding	 2002-06 Identifies year and month of manufacture
 Connection direction indicator	 Alternating current	 Connection direction indicator
 Electrical input indicator (On some older measurement servers and extensions, and modules, this symbol may indicate the gas input.)	 Electrical output indicator (On some older measurement servers and extensions, and modules, this symbol may indicate the gas output.)	 Connector has special protection against electric shocks and is defibrillator proof
 Gas input indicator	 Gas output indicator	 Quick mount release
 FMS Power On Indicator - Ready for operation	 Serial/MIB connector	 Interruption indicator
 Mouse connection indicator	 Keyboard connection indicator	 Printer connection indicator
Parallel Parallel interface indicator for connection to parallel printer	Alarm Nurse call relay connection indicator	DVI Video Digital video device connection indicator for connection to independent display
 Measurement server link connection indicator	 12 Volt DC LAN connection, for connection to wireless device	 LAN connection indicator for connection to a wired network

Symbols		
 <p>Remote Device Philips remote device (SpeedPoint or Alarm Device) connection indicator</p>	 <p>Analog Analog interface indicator for connection to any analog video display</p>	 <p>Digital Digital interface indicator for connection to any digital video display</p>
 <p>Antenna connector</p>	 <p>Battery symbol</p>	 <p>12V 12 Volt DC LAN connection indicator for connection to serial interface</p>
 <p>Non-ionizing radiation symbol</p>	 <p>Data input/output symbol</p>	 <p>12 Volt DC socket</p>
 <p>Locked position</p>	 <p>Unlocked position</p>	 <p>Always use separate collection for waste electrical and electronic equipment (WEEE)</p>

Installation Safety Information

WARNING If multiple instruments are connected to a patient, the sum of the leakage currents may exceed the limits given in IEC/EN60601-1. Consult your service personnel.

Grounding	The monitors or the MP80/MP90 processing unit must be grounded during operation. If a three-wire receptacle is not available, consult the hospital electrician. Never use a three-wire to two-wire adapter.
Equipotential Grounding	If the monitors or MP80/MP90 processing unit are used in internal examinations on the heart or brain, ensure that the room incorporates an equipotential grounding system to which the monitor and MP80/MP90 processing unit have separate connections.
Combining equipment	Combinations of medical equipment with non-medical equipment must comply with IEC 60601-1-1. Never use a multiple portable socket-outlet or extension cord when combining equipment unless the socket outlet is supplied specifically for use with that equipment.
Fusing	The monitors use double pole/neutral fusing.

Connectors

The actual placement of boards and configuration of connections for your monitor depends on how your hardware has been configured. See the symbols table on page 328 to see which symbols are used to mark the connections.

WARNING Connect only medical devices to the ECG output connector socket.

MP20/MP30

MP20/MP30 Left side of monitor

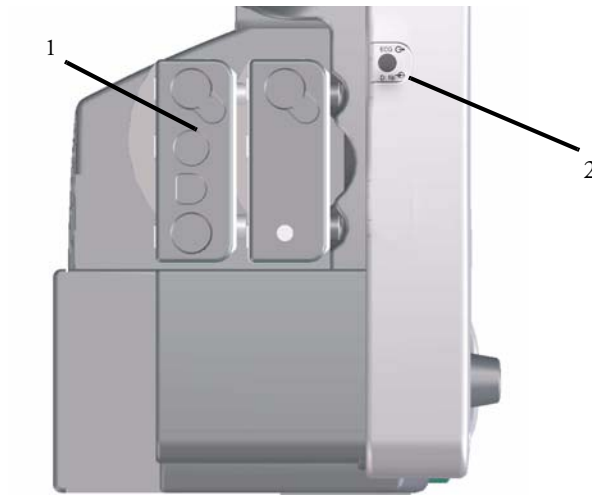

- 1 MMS and one extension
- 2 ECG analog output/marker input connector

MP20/MP30 Rear of monitor

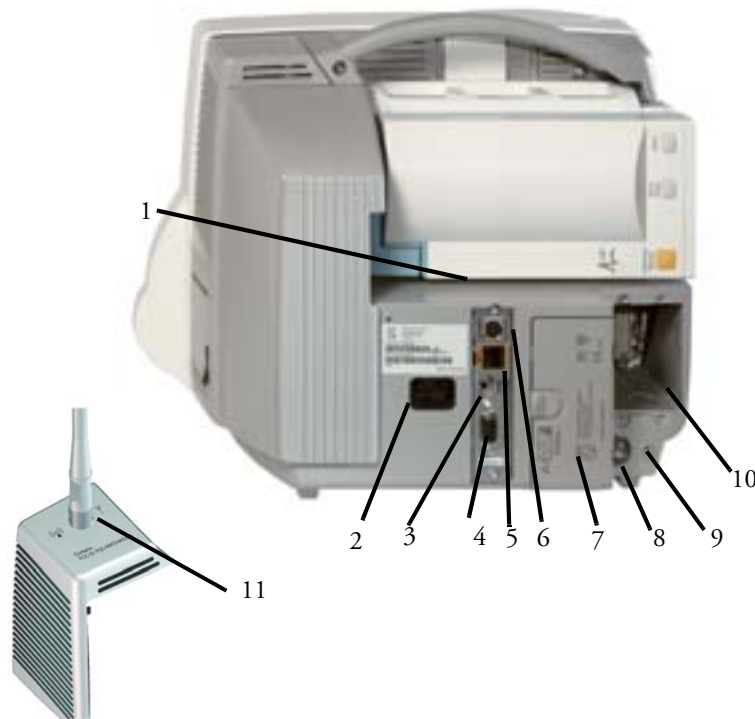

- 1 Measurement Server Link connector
- 2 AC power inlet
- 3 Remote alarm connector
- 4 Analog video out connector
- 5 Wired network connector
- 6 Wireless network connector
- 7 Battery compartment
- 8 Equipotential grounding
- 9 Protective earth
- 10 Space for optional interface boards, e.g. serial/MIB (RS232) connectors, or optional parallel printer connection
- 11 Side cover with antenna for IntelliVue Instrument Telemetry Wireless Network (USA only)

MP40/MP50

MP40/MP50 Rear of monitor

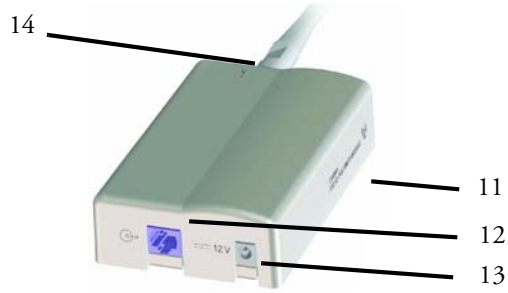
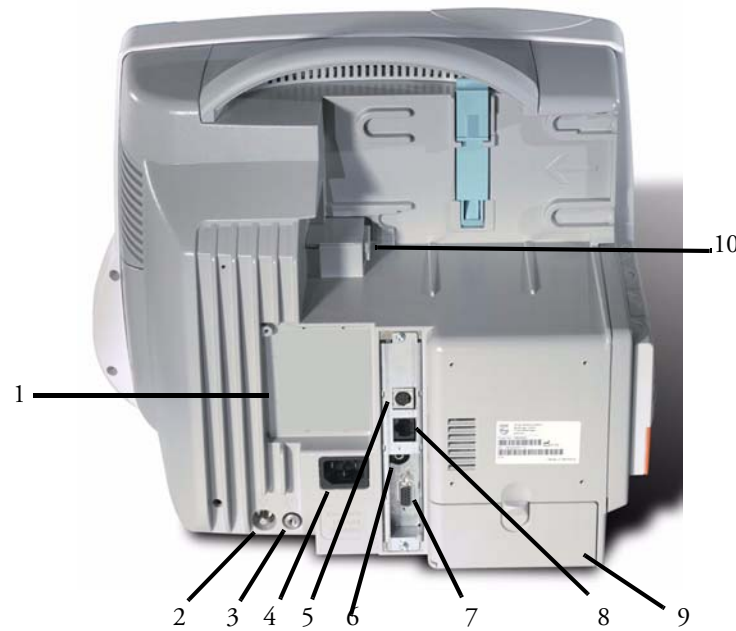

- 1 Space for optional interface boards, e.g. serial/MIB (RS232) connectors, or optional parallel printer connection
- 2 Equipotential grounding
- 3 Protective earth
- 4 AC power inlet
- 5 Wireless network connector for use with wireless LAN or Instrument Telemetry adapter
- 6 Remote alarm connector
- 7 Analog video out connector
- 8 Wired network connector
- 9 Battery compartment
- 10 Measurement Server Link connector
- 11 IntelliVue Instrument Telemetry adapter (USA only)
- 12 Monitor connector (to 5 above)
- 13 12V DC Power Inlet (to 5 above)
- 14 Antenna connector

MP40/MP50 Left side of monitor



- 1 MMS and one extension
- 2 Plug-in module slots
- 3 ECG analog output/marker input connector

MP60/MP70

Right side of monitor (MP60/70)

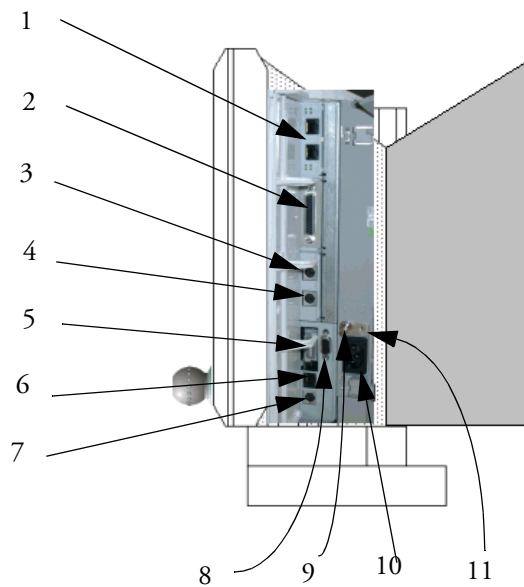

- 1 Serial/MIB (RS232) connectors (optional), type RJ45
- 2 Parallel printer connector
- 3 Keyboard connector
- 4 Mouse/trackball connector
- 5 Main measurement server link (MSL)
- 6 Wired network connector
- 7 Wireless network connector
- 8 Analog video out connector
- 9 Equipotential ground connector
- 10 AC power input
- 11 Protective earth screw hole

Left side of monitor (MP60/70)

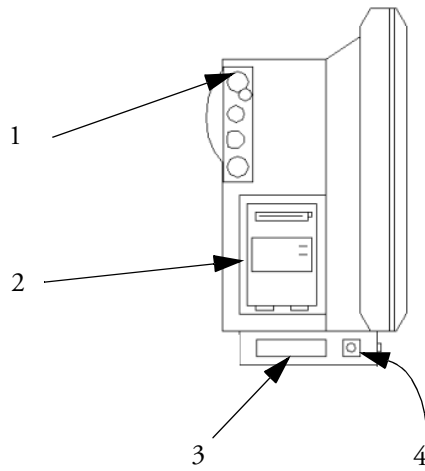

- 1 MMS patient cable connectors
- 2 Slot for integrated recorder module or measurement module
- 3 Additional measurement server link (MSL) cable (alternative or additional to MSL on right of monitor)
- 4 ECG analog output/marker input connector

MP80/MP90

MP80/MP90 (rear of processing unit) - MP80 does not have the top row of connectors

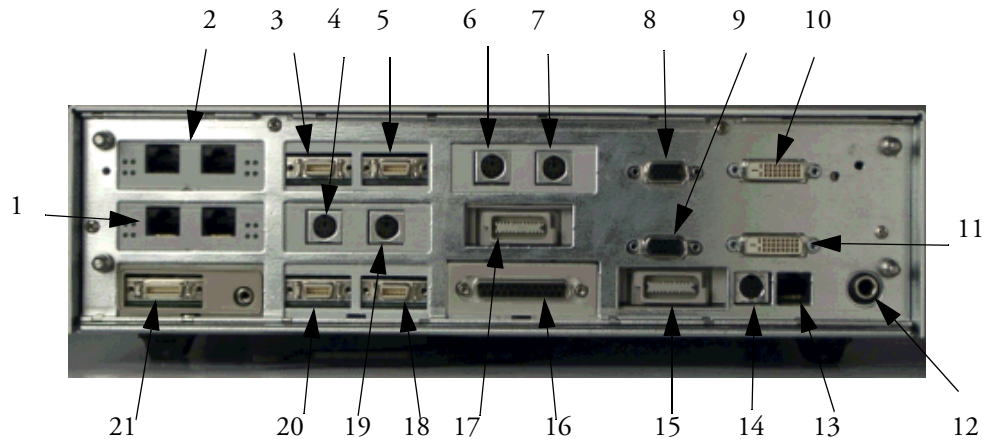

1	Serial/MIB (RS232) connectors, type RJ45	12	ECG analog output/marker input
2	Serial/MIB (RS232) connectors, type RJ45	13	Wired network connector
3	Independent display - remote alarm device connector	14	Wireless network connector
4	Keyboard connector	15	Primary measurement server link
5	Independent display - remote SpeedPoint connector	16	Parallel printer connector
6	Independent display - mouse/trackball connector	17	Additional measurement server link
7	Independent display - keyboard connector	18	Remote SpeedPoint connector
8	Independent display analog video out connector	19	Mouse/trackball connector
9	Primary display - analog video out connector	20	Remote alarm connector
10	Independent display - digital video out connector	21	Flexible nurse call interface
11	Primary display - digital video out connector		

MP80/MP90 (front of processing unit)

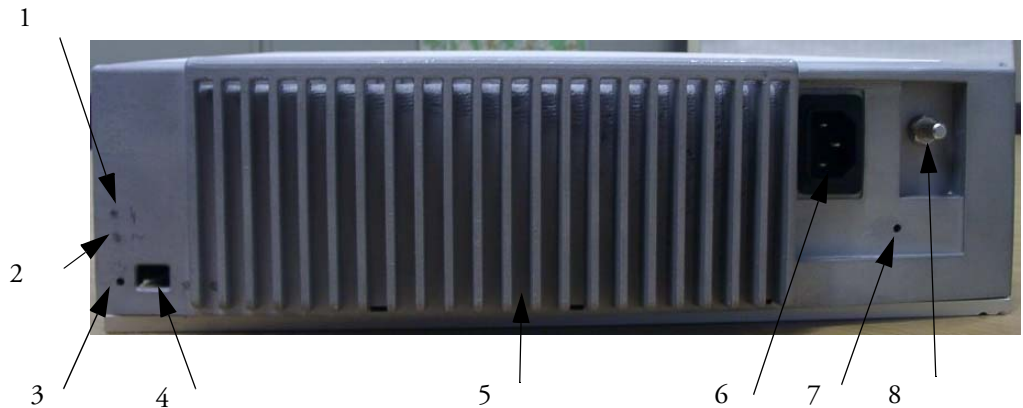

- | | | | |
|---|-----------------|---|-------------------------------|
| 1 | AC Power LED | 5 | Power supply |
| 2 | Error LED | 6 | AC power input |
| 3 | Power on LED | 7 | Protective earth screw hole |
| 4 | Power on switch | 8 | Equipotential grounding point |

802.11 Bedside Adapter (Wireless Network Adapter)

802.11 Bedside Adapter (can be used with all monitors)

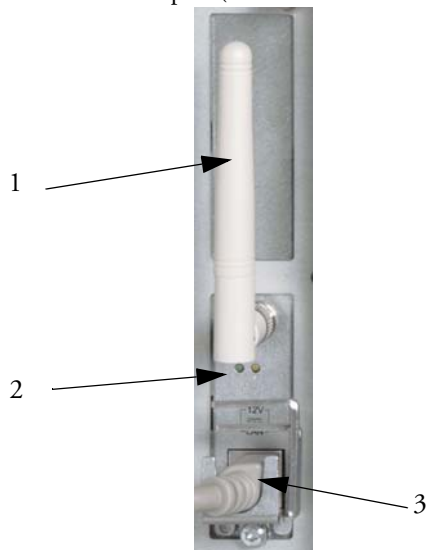

- | | |
|---|--|
| 1 | Antenna |
| 2 | LEDs - green and yellow LEDs light up during startup while selftests are performed. During normal operation the green LED indicates whether Radio is currently on or off; the yellow LED remains off |
| 3 | Combined power/network cable |

Altitude Setting

Altitude affects tcGas and CO₂ measurements. The monitor must be configured at installation to the correct altitude.

Monitor Safety Specifications



The monitors, together with the Multi-Measurement Server (M3001A), and the Flexible Module Server (M8048A), all modules and measurement server extensions, comply with the Medical Device Directive 93/42/EEC.

In addition, the product complies with:

IEC 60601-1:1988 + A1:1991 + A2:1995; EN60601-1:1990 + A1:1993 + A2:1995; UL 60601-1:2003; UL 2601.1:1994; CAN/CSA C22.2#601.1-M90; JIS T 1001-1992; IEC 60601-1-1:2000; EN 60601-1-1:2001; IEC 60601-1-2:2001; EN 60601-1-2:2001.

Classification (according to IEC 60601-1): Class 1, Type CF, Continuous Operation. The BIS measurement uses a Type BF applied part.

The possibility of hazards arising from software errors was minimized in compliance with ISO 14971:2000, EN60601-1-4:1996 + A1:1999 and IEC 60601-1-4:1996 + A1:1999.

This ISM device complies with Canadian ICES-001. Cet appareil ISM est conforme a la norme NMB-001 du Canada.



185-0145-PH Aspect BISx, 185-0111 Aspect BIS Engine and 185-0124 Aspect DSC comply with the requirements of the Council Directive 93/42/EEC of 14 June 1993 (Medical Device Directive).

The MP20/30 including IntelliVue Instrument Telemetry and the MP40/50 with the IntelliVue Instrument Telemetry adapter comply with part 15 of the FCC Rules. Operation is subject to the condition that these devices do not cause harmful interference. Operation of this equipment requires the prior coordination with a frequency coordinator designated by the FCC for the Wireless Medical Telemetry Service.

IntelliVue 802.11 Bedside Adapter (Option J35 Wireless Network Adapter) - FCC and Industry Canada Radio Compliance: This device complies with Part 15 of the FCC Rules and RSS-210 of Industry Canada. Operation is subject to the following two conditions: (1) this device may not cause harmful interference, and (2) this device must accept any interference received, including interference that may cause undesired operation. Any changes or modifications to this equipment not expressly approved by Philips Medical Systems may cause harmful radio frequency interference and void your authority to operate this equipment.

The maximum antenna gain permitted (for devices in the 5250-5350 MHz and 5470-5725 MHz bands) complies with the e.i.r.p. limits as stated in RSS-210.

The maximum antenna gain permitted (for devices in the 5725-5825 MHz band) complies with the e.i.r.p. limits specified for point-to-point operation, as stated in RSS-210.

The device for the band 5150-5350 MHz is only for indoor usage to reduce potential for harmful interference to co-channel mobile satellite systems.

The OEM radio device used in this product is in compliance with the essential requirements and other relevant provisions of Directive 1999/5/EC. This product is intended to be connected to the Publicly Available Interfaces (PAI) and used throughout the EEA.

CAUTION High power radars are allocated as primary users (meaning they have priority) of 5250-5350 MHz and 5650-5850 MHz and these radars could cause interference and /or damage to LE-LAN devices.

IntelliVue 802.11 Bedside Adapter CE compliances:

 This device is compliant to Council Directive 73/23/EEC (Low voltage directive) & 89/336/EEC (EMC directive) & 1999/5/EC (Radio Equipment and Telecommunications Terminal Equipment Directive)

 The radio component contained in this device is compliant to Council Directive 1999/5/EC (Radio Equipment and Telecommunications Terminal Equipment Directive)

WARNING To minimize the risk of causing severe burns during MR imaging, ensure that transducers, sensors and cables are positioned so that no inductive loops are formed. If the measurement does not appear to be operating properly, remove all transducers, sensors and cables immediately from the patient.

Physical Specifications

Product	Max Weight	W x H x D	Comments
MP20/MP30	< 6 kg < 13 lb	< 345 x 275 x 230 mm 13.6 x 11 x 9 in	including M3001A, recorder, and battery, without options
MP40/MP50	< 8.6 kg < 19 lb	< 365 x 330 x 217 mm 14 x 13 x 8.5 in	including M3001A, recorder, and battery, without options
MP60/MP70 (with speedpoint) MP70 (with touchscreen operation)	< 10 kg < 22.05 lb	< 405 x 360 x 170 mm 15.95 x 14.17 x 6.69 in	without handle and speedpoint device, without options
MP80/MP90/D80	< 10 kg < 22.05 lb	342 x 108 x 505 mm 13.47 x 4.25 x 19.88 in	including AC cable, cable cover and feet
M3001A Multi-Measurement Server (MMS)	< 650g < 1.4lb	188 x 96.5 x 51.5 mm 7.4 x 3.8 x 2 in	
M3012A Hemodynamic Measurement Server Extension	< 550 g 1.2 lb	< 190 x 98 x 40 mm < 7.5 x 4 x 1.6 in	
M3014A Measurement Server Extension - Capnography	< 500 g < 0.99 lb	< 190 x 98 x 40 mm < 7.5 x 4 x 1.6 in	
M3015A Measurement Server Extension - Microstream CO ₂	< 550 g < 1.21 lb	< 190 x 98 x 40 mm < 7.5 x 4 x 1.6 in	

Product	Max Weight	W x H x D	Comments
M3016A Measurement Server Extension - Mainstream CO ₂	< 450 g < 0.99 lb	< 190 x 98 x 40 mm < 7.5 x 4 x 1.6 in	
M8048A Flexible Module Server (FMS)	< 3500g < 7.7lb	< 320 x 120 x 35 mm 12.6 x 4.7 x 5.3 in	without plug-in modules
M8045A Docking Station	2700g 5.95lb	250 x 160 x 270 mm 9.8 x 6.3 x 10.6 in	dimensions without lever
M8025A Remote Alarm Device	< 300 g < 0.7 lb	62 x 125 x 63 mm 2.4 x 5 x 2.5 in	
M8026A Remote SpeedPoint	< 400 g < 0.9 lb	103 x 139 x 63 mm 4 x 5.5 x 2.5 in	
M8031A XGA Touchscreen LCD Display	< 4.9 kg < 10.8 lb	408 x 333 x 85 mm 16 x 13.1 x 3.4 in	with mounting bracket
M1006B Invasive Press Module	190 g (6.7 oz) Option #C01: 225 g (7.9 oz)	36 x 99.6 x 97.5 mm 1.4 x 3.9 x 3.8 in	
M1029A Temperature Module	215 g (7.6 oz)	36 x 99.6 x 97.5 mm, 1.4 x 3.9 x 3.8 in	
M1012A Cardiac Output Module	225 g (7.9 oz.)	36 x 99.6 x 97.5 mm 1.4 x 3.9 x 3.8 in	
M1014A Spirometry Module	250 g (8.8 oz.)	36 x 99.6 x 97.5 mm 1.4 x 3.9 x 3.8 in3	
M1018A Transcutaneous Gas Module	350 g (11.3 oz)	72.5 x 99.6 x 97.5 mm, 2.9 x 3.9 x 3.8 in	
M1020B SpO ₂ Module	< 250 g 0.55 lb	36 x 99.6 x 97.5 mm 1.4 x 3.9 x 3.8 in	
M1021A Mixed Venous Oxygen Saturation Module	460 g (13.04 oz)	72.5 x 99.6 x 97.5 mm 2.9 x 3.9 x 3.8 in)	
M1027A Electroencephalograph Module	210 g (7.4 oz)	36 x 99.6 x 97.5 mm 1.4 x 3.9 x 3.8 in	
M1034A BIS Interface Module	215 g 7.6 oz	36 x 99.6 x 97.5 mm 1.4 x 3.9 x 3.8 in	without cables
BISx	450 gr 1 lb	102 x 38 mm 4 x 1.5 in	with PIC Plus Cable (1.22 m, 4 ft) and cable to BIS module
- DSC Digital Signal Converter	130 g (4.6 oz) (without cabling)	66 x 25 x 107 mm 2.6 x 1.0 x 4.25 in	with PIC Plus Cable (1.22 m, 4 ft)
- BIS Engine	170 g (6.0 oz)	43 x 93 x 95 mm 1.7 x 3.7 x 3.8 in	
M1032A Vuelink Module	240 g (8.4 oz)	36 x 99.6 x 97.5 mm 1.4 x 3.9 x 3.8 in	
M1116B Thermal Array Recorder Module	507.5 g 17.9 oz.	73 x 99.6 x 97 mm 2.9 x 3.6 x 3.9 in.	

Environmental Specifications

The monitor may not meet the performance specifications given here if stored or used outside the specified temperature and humidity ranges.

When the monitor and related products have differing environmental specifications, the effective range for the combined products is that range which is common to the specifications for all products.

Monitor MP40, MP50, MP60, MP70, MP80, MP90		
Item	Condition	Range
Temperature Range	Operating	0 to 35 °C (32 to 95 °F)
	Non-operating	-20 to 60 °C (-4 to 140 °F)
	Battery storage	-20 to 50 °C (-4 to 122 °F)
Monitor MP60, MP70 in conjunction with IntelliVue 802.11 Bedside Adapter (option #J35)		
Temperature Range	Operating	0 to 30 °C (32 to 86°F)

Monitor MP20, MP30		
Item	Condition	Range
Temperature Range	Operating	0 to 40 °C (32 to 104°F)
	Operating when charging battery or when equipped with IntelliVue Instrument Telemetry	0 to 35 °C (32 to 95 °F)
	Non-operating	-20 to 60 °C (-4 to 140 °F)
	Battery storage	-20 to 50 °C (-4 to 122 °F)

Monitor MP20, MP30, MP40, MP50, MP60, MP70, MP80, MP90		
Item	Condition	Range
Humidity Range	Operating	20% to 85% Relative Humidity (RH) (non condensing)
	Non-operating	5% to 85% Relative Humidity (RH)
Altitude Range	Operating	-500 m to 3000 m (10000 ft)
	Non-operating	-500 m to 12000 m (40000 ft)

Measurement Server M3001A, Measurement Server Extensions M3016A M3015A, M3014A, M3012A, Measurement Modules, and Flexible Module Server M8048A		
Item	Condition	Range
Temperature Range	Operating	0 to 45 °C (32 to 113 °F)
	Non-operating	-40 to 70 °C (-40 to 158 °F)
Humidity Range	Operating	95% Relative Humidity (RH) max. @ 40 °C (104 °F). M3015A only non-condensing.
	Non-operating	90% Relative Humidity (RH) max. @ 65 °C (150 °F)
Altitude Range	Operating	-500 m to 4600 m (-1600 to 15000 ft)
	Non-operating	-500 m to 15300 m (-1600 to 50000 ft)

D80 Intelligent Display		
Item	Condition	Range
Temperature Range	Operating	0 to 35 °C (32 to 95 °F)
	Non-operating	-20 to 60 °C (-4 to 140 °F)
	Battery storage	-20 to 50 °C (-4 to 122 °F)
Humidity Range	Operating	20% to 85% Relative Humidity (RH) (non condensing)
	Non-operating	5% to 85% Relative Humidity (RH)
Altitude Range	Operating	-500 m to 3000 m (10000 ft)
	Non-operating	-500 m to 12000 m (40000 ft)

Docking Station M8045A		
Item	Condition	Range
Temperature Range	Operating	0 to 40 °C (32 to 100 °F)
	Non-operating	-20 to 60 °C (-4 to 140 °F)
Humidity Range	Operating	20% to 85% Relative Humidity (RH) (non condensing)
	Non-operating	5% to 85% Relative Humidity (RH)
Altitude Range	Operating	-500 m to 3000 m (10000 ft)
	Non-operating	-500 m to 12000 m (40000 ft)

Thermal Array Recorder Module M1116B		
Item	Condition	Range
Temperature Range	Operating	+5 to 45 °C (41 to 113°F)
	Non-operating	-10 to 70 °C (14 to 158 °F)

Thermal Array Recorder Module M1116B		
Item	Condition	Range
Humidity Range	Operating	95% Relative Humidity (RH) max @ 40°C (104°F) (non condensing)
	Non-operating	95% Relative Humidity (RH) max @ 65°C (150°F) (non condensing)
Altitude Range	Operating	up to 3048 m (10000 ft)
	Non-operating	up to 3048 m (10000 ft)

Remote SpeedPoint M8026A		
Item	Condition	Range
Temperature range	Operating	0 ... 55 °C (32 ...130 °F)
	Storage	-20 ... 60 °C (-4 ... 140 °F)
Humidity range	Operating	95 %RH max. at 40 °C (100 °F)
	Storage	85 %RH max. at 50 °C (120 °F)
Altitude range	Operating	-500 ... 4.600 m (-1600 ... 15000 ft)
	Storage	-500 ... 13.100 m (-1600 ... 43000 ft)

Remote Alarm Device M8025A		
Item	Condition	Range
Temperature range	Operating	0 ... 55 °C (32 ...130 °F)
	Storage	-20 ... 60 °C (-4 ... 140 °F)
Humidity range	Operating	95 %RH max. at 40 °C (100 °F)
	Storage	85 %RH max. at 50 °C (120 °F)
Altitude range	Operating	-500 ... 4.600 m (-1600 ... 15000 ft)
	Storage	-500 ... 13.100 m (-1600 ... 43000 ft)

M4605A Battery Specifications

MP20/MP30/MP40/MP50 Only Two batteries are required to operate the MP40/MP50 monitors. The MP20/MP30 monitors can operate with one battery.

M4605A Battery Specifications		
Physical Specifications		
	W x D x H	149 mm (5.866 in) x89 mm (3.504 in) x 19.8 mm (0.78 in)
	Weight	490 g (1.08 lb) per battery
Performance Specifications		
	Nominal Voltage	10.8 Volt
	Rated Capacity at discharge C/5	6000 mAh
	Continuous Discharge Capability	6.5 A
Environmental Specifications		

M4605A Battery Specifications		
	Temperature Range	Discharge 0 to 50 °C (32 to 122 °F) Charge 0 to 45 °C (32 to 113 °F) Storage -20 to 60 °C (-4 to 140 °F)
	Humidity Range	40% to 95% Relative Humidity (RH)
	Battery Type	Smart Battery 10.8V, 6000mAh, Lithium Ion
	Safety	complies with UL 1642 (UL Recognized) and IEC 61960-2:2001
	Electromagnetic Compatibility (EMC)	complies with the requirements for FCC Type B computing Device, and EN 61000-4-2 and EN 61000-3
	Communication Standard	complies with the SMBus specification v1.1

Monitor Performance Specifications

MP20/30, MP40/50, MP60/70/80/90		
Power Specifications	Power consumption	MP60/70/80/90: < 145 W MP20/30, MP40/50: < 100 W
	Line Voltage	100 to 240 V ~
	MP60/MP70/MP80/ MP90 Current	1.6 to 0.7 A
	MP20/MP30/MP40/ MP50 Current	1.8 to 1.0 A
	Frequency	50/60 Hz ~
Battery Specifications MP40/MP50	Operating Time (with 2 new, fully charged batteries)	Basic monitoring configuration: 5 hours (Brightness set to Optimum , MMS connected, NBP measurement every 15 minutes)
		Extended monitoring configuration: 4 hours (Brightness set to Optimum , MMS and measurement server extension connected, NBP every 15 minutes, Recorder, Pressure, Temperature modules connected)
	Charge Time	When monitor is off: 4 hours When monitor is in use: 5 to 12 hours, depending on monitor configuration

MP20/30, MP40/50, MP60/70/80/90		
Battery Specifications MP20/MP30	Operating Time (with 2 new, fully charged batteries)	Basic monitoring configuration: 5 hours (Brightness set to Optimum , MMS connected, NBP measurement every 15 minutes)
		Extended monitoring configuration: 4 hours (Brightness set to Optimum , MMS and measurement server extension connected, NBP every 15 minutes, Recorder, every 15 minutes)
	Operating Time (with 1 new, fully charged battery)	Basic monitoring configuration: 2.5 hours (Brightness set to Optimum , MMS connected, NBP measurement every 15 minutes)
		Extended monitoring configuration: 2 hours (Brightness set to Optimum , MMS and measurement server extension connected, NBP every 15 minutes, Recorder, every 15 minutes)
Charge Time	When monitor is off: 4 hours When monitor is in use: 5 to 12 hours, depending on monitor configuration	
Indicators	Alarms Off	red (crossed-out alarm symbol) LED
	Alarms	red/yellow/cyan LED
	On/Standby	green LED
	AC Power	green LED
	Error	red LED
	Battery LED (MP20/30/40/50 only)	red/yellow/green LED
Sounds	Audible feedback for user input Prompt tone QRS tone, or SpO ₂ modulation tone 4 different alarm sounds Remote tone for alarms on other beds in network Tone for Timer expired	
Trends	Resolution	12, 16, 24 or 32 numerics @ 12 sec, 1 minute, 5 minute resolution
	Information	Multiple choices of number of numerics, resolution and duration depending on trend option and application area. For example: neonatal extended 12 numerics, 24 hours @ 12 secs or 32 numerics 32 hours @ 1 minute intensive care extended: 16 numerics 120 hours @ 5 minutes anesthesia extended 32 numerics 9 hours @ 12 seconds
High-Res Trend Waves	Measurements available	HR, SpO ₂ , Resp, tcpO ₂ , Pulse, Perf, tcpO ₂ , CO ₂ , ABP, PAP, CVP, ICP, CPP, BIS, CCO, AWP, Anesthetic Agents, Delta SpO ₂ , inO ₂
	Resolution	Measurement samples are taken at a resolution of four samples per second
	Update speed	waves are drawn at a speed of 3 cm/minute

MP20/30, MP40/50, MP60/70/80/90		
Events	Information	trigger condition and time, event classification and associated detailed view of episode data
	Episode data	configurable (except MP20/30), either: 4 minutes of high resolution trend or 20 minutes of numerics trend @ 12 sec. resolution or 15 seconds of 4 waves @ 125 samples/sec. (Snapshot) including all current numerics, alarms and inops For MP20/30: 4 minutes of high resolution trend
	Capacity (max)	25 or 50 events for either 8 or 24 hours
Alarm signal	System delay	less than 3 seconds
	Pause duration	1,2,3 minutes or infinite, depending on configuration
	Extended alarm pause	5 or 10 minutes
Review Alarms	Information	all alarms / inops, main alarms on/off, alarm silence and time of occurrence
	Capacity	100 items
Real Time Clock	Range	from: January 1, 1997, 00:00 to: December 31, 2080, 23:59
	Accuracy	< 2 seconds per day (typically)
	Hold Time	infinite if powered by AC; otherwise at least 48 hours (typical: > 72 hours)
Buffered Memory	Hold Time	if powered by AC: infinite without power: at least 48 hours (typical: > 72 hours)
	Contents	Active settings, trends, patient data, realtime reports, events, review alarms

MMS M3001A Performance Specifications		
Trends	Trend Data Buffered Memory	if powered by monitor mains connection via MSL: infinite without power applied: at least 6 hours
	Contents	trend data, patient identification and all active settings

D80 Intelligent Display Performance Specifications		
Power Specifications	Power consumption	< 145 W
	Line Voltage	100 to 240 V ~
	Current	1.6 to 0.7 A
	Frequency	50/60 Hz ~

Docking Station M8045A Performance Specifications		
Power	Line Voltage	100 - 240V
	Frequency	50/60 Hz
	Power Consumption	negligible (for Power On LED)
	Current to attached patient monitor	max. 3.5 A

Monitor Interface Specifications		
Network	Standard	IEEE 802.3 10-Base-T
	Connector	RJ45 (8 pin)
	Isolation	1.5 kV
Parallel Printer Port	Standard	IEEE 1284-I
	Connector	DB-25
	Signals	Level 1 and Level 2 (switchable)
	Isolation	1.5 kV
	Communication Modes	Compatibility (for example Centronics), Nibble, ECP, EPP
Dual PS/2 Inputs	Input Voltage	5V \pm 5%
	Output Current	250mA (comb. max) to connected PS/2 devices
Dual MIB/RS232	Standard	IEEE 1073-3.2-2000
	Connectors	RJ45 (8 pin)
	Mode	Software-controllable BCC (RxD/TxD cross over) or DCC (RxD/TxD straight through)
	Power	5V +/- 5%, 100mA (max.)
	Isolation	1.5kV
MIB-ready/RS-232 Interface (not available in all geographies)	Measurement data exported to external systems:	Numerics, alarms and INOPs, patient demographics, waves (up to 7; maximum number depends on the sample rate of the selected waves).
ECG Output/Marker Input (1/4" stereo phone jack with tip, ring, sleeve)		
General	Connector	1/4" phone each with tip, ring, sleeve
	Isolation	500 V
ECG Output (ring, tip)	Signal Gain	320 to 3200
	Full Scale on Display	3.2V _{pp}
	Gain Error	<20%
	Baseline Offset	<150mV
	Bandwidth	1 to 80Hz
	Output Impedance	ECG Output (ring): <2.2K Ω \pm 20% ECG Output/Marker Input (tip) <2.5k Ω \pm 20%
	Signal delay	\leq 30ms
Marker Input Requirements (tip)	Signal Type	0 to -12V, negative edge pulse
	Pulse Source Impedance	<7k Ω
	Pulse Fall Time	<100 μ s
	Pulse Duration	>4ms
Flexible Nurse Call Relay	Connector	20 pin MDR (Mini D-Ribbon), active open and closed contacts 3.5 mm phone jack, active closed contact only
	Contact	\leq 100 mA, \leq 24 V DC
	Isolation	1.5 kV
	Delay	< (Configured Latency + 0.5 sec)

Monitor Interface Specifications		
Wireless Network Device Interface	Connector	8 pin Mini-DIN
	Signals	RD+/-, TD+/-: IEEE 802.3 10Base-T, PWR, GND 12.5 V \pm 20%, 3.5 W continuous
Remote Application Support	Technology	Citrix® and ICA® (Independent Computing Architecture) client, Tunneling Control Engine (TCE)
	Capabilities	a monitor connected to a Philips Application Server can show a Windows application on the monitor display. The application can be controlled by the monitor user input devices.

Display Specifications		
All displays	Sweep Speeds	6.25, 12.5, 25 and 50 mm/s; additional EEG sweep speeds 15 mm/s, 30 mm/s with \pm 5% accuracy (guaranteed only for integrated displays)
Integrated SVGA Display, MP20/30	Resolution	800 x 600
	Refresh frequency	60 Hz
	Useful screen	211,2 x 158,4 mm
	Pixel size	0.264 x 0.264 mm
Integrated SVGA Display, MP40/50	Resolution	800 x 600
	Refresh frequency	60 Hz
	Useful screen	246 x 184.4 mm
	Pixel size	0.3075 x 0.3075 mm
Integrated XGA Display, MP60/70	Resolution	1024 x 768
	Refresh frequency	60 Hz
	Useful screen	304 x 228 mm (12 x 9 in)
	Pixel size	0.297 x 0.297 mm
External XGA Display (e.g. M8031B),	Resolution	1024 x 768
	Refresh frequency	60 Hz or 75 Hz
	Useful screen	depends on size of display
	Pixel size	depends on size of display
External SXGA Display (e.g. M8033C), MP80, MP90, D80 only	Resolution	1280 x 1024 pixel
	Refresh frequency	60 Hz
	Useful screen	depends on size of display
	Pixel size	depends on size of display
Video Interface MP20/30, MP40/50, MP60/70	Specifications must be the same as the integrated display	
Video Interface SVGA MP20/MP30	Horizontal Frequency	37.9 kHz
	Video Signals	0.7 Vpp @ 75 Ohm, HSYNC/VSYNC Signals TTL
	Connector	15 pin D-SUB
Video Interface SVGA MP40/MP50	Horizontal Frequency	37.5 kHz
	Video Signals	0.7 Vpp @ 75 Ohm, HSYNC/VSYNC Signals TTL
	Connector	15 pin D-SUB

Display Specifications		
Video Interface MP60/ MP70/MP80/MP90 SXGA (MP80, MP90, D80 only), XGA	Horizontal Frequency	48.4 kHz or 60.0 kHz or 64.0 kHz
	Video Signals	0.7 V _{pp} @ 75 Ohm, HSYNC/VSYNC Signals TTL
	DDC	Signals I2C compliant, 5V, 100 mA (max) (M8010 only)
	Connector	15 pin D-SUB
Digital Video MP80, MP90, D80 only	Video Signals	Single Link TMDS
	DDC Signals	I2C compliant
	DDC Power	5V, 100mA (max)
	Connector	DVI

Compatible Devices		
Printers	PCL5 capability required	Examples: HP Laserjet 1200 (monochrome) HP Laserjet 2100 (monochrome) HP DeskJet 2500 C+ (color) Do not use printers that emulate PCL5
Displays (must be approved for medical use)		
MP20/30/40/50/60/70/80/90, D80	M1097A option A02	XGA color 15" LCD touchscreen
	M8031B	XGA color 15" LCD touchscreen
MP80, MP90, D80	M8033B/M8033C	SXGA color 17" LCD touchscreen
Wireless Network	Type	Proxim Range LAN2 7920
	Technology	Frequency Hopping Spread Spectrum (FHSS)
	Frequency Band	2.4 GHz ISM Band
	Weight	300g max.
IntelliVue Instrument Telemetry Wireless Network (USA only, MP20/30/40/50 only)		
Internal WMTS Adapter (MP20/MP30)	Technology	compatible with Philips Cellular Telemetry System (CTS), cellular infrastructure
	Frequency Band	WMTS, 1395-1400 MHz and 1427-1432 MHz
External WMTS Adapter M2638A (MP40/MP50)	Technology	compatible with Philips Cellular Telemetry System (CTS), cellular infrastructure
	Frequency Band	WMTS, 1395-1400 MHz and 1427-1432 MHz
	Weight	350g max.
IntelliVue 802.11 Bedside Adapter (Wireless Network Adapter)		
Internal Wireless Adapter Option J35	Technology	IEEE 802.11a/b/g
	Frequency Band	2.4 GHz and 5 GHz ISM Band

Measurement Specifications

See the Appendix on Default Settings for a list of the settings the monitor is initially shipped with.

ECG/Arrhythmia/ST

Complies with IEC 60601-2-25:1993 + A1:1999 /EN60601-2-25:1995 + A1:1999, IEC 60601-2-27/ EN60601-2-27:1994, IEC 60601-2-51:2003 /EN 60601-2-51:2003 and AAMI EC11/EC13:1991/ 2002.

ECG/Arrhythmia/ST Performance Specifications		
Cardiotach	Range	Adult/pedi: 15 to 300 bpm Neo range: 15 to 350 bpm
	Accuracy	±1% of range
	Resolution	1 bpm
	Sensitivity	≥200 $\mu\text{V}_{\text{peak}}$
PVC Rate	Range	0 to 300 bpm
	Resolution	1 bpm
ST Numeric	Range	-20 to +20 mm
	Accuracy	±0.5 mm or 15%, whichever is greater
	Resolution	0.1 mm
Sinus and SV Rhythm Ranges	Brady	Adult: 15 to 60 bpm Pedi: 15 to 80 bpm Neo: 15 to 90 bpm
	Normal	Adult: 60 to 100 bpm Pedi: 80 to 160 bpm Neo: 90 to 180 bpm
	Tachy	Adult: > 100 bpm Pedi: >160 bpm Neo: >180 bpm
Bandwidth	Diagnostic Mode	Adult: 0.05 to 150Hz Neo/pedi: 0.5 to 150Hz
	Monitoring Mode	Adult: 0.5 to 40Hz Neo/pedi: 0.5 to 55Hz
	Filter Mode	Adult/neo/pedi: 0.5 to 20Hz
Differential Input Impedance		>2M Ω RA-LL leads (Resp) >5M Ω at all other leads (at 10Hz including patient cable)
Common Mode Rejection Ratio		Diagnostic mode: >86 dB (with a 51 k Ω /47 nF imbalance). Filter mode: >106 dB (with a 51 k Ω /47 nF imbalance).
Electrode Offset Potential Tolerance		±500mV
Auxiliary Current (Leads off Detection)		Active electrode: <100 nA Reference electrode: <900 nA
Input Signal Range		±5 mV

ECG/Arrhythmia/ST Alarm Specifications	Range	Adjustment
HR	15 to 300 bpm maximum delay: 10 seconds according to AAMI EC 13-1992 standard	Adult: 1 bpm steps (15 to 40 bpm) 5 bpm steps (40 to 300 bpm) Pedi/Neo: 1 bpm steps (15 to 50 bpm) 5 bpm steps (50 to 300 bpm)
Extreme Tachy	Difference to high limit 0 to 50 bpm	5 bpm steps
	Clamping at 150 to 300 bpm	5 bpm steps
Extreme Brady	Difference to low limit 0 to 50 bpm	5 bpm steps
	Clamping at 15 to 100 bpm	5 bpm steps
Run PVCs	2 PVCs	Not adjustable by user
PVCs Rate	1 to 99 PVCs/minute	1 PVC
Vent Tach HR	20 to 300 bpm	5 bpm
Vent Tach Run	3 to 99 PVCs/minute	1 PVC
Vent Rhythm Run	2 to 99 PVCs/minute	1 PVC
SVT HR	120 to 300 bpm	5 bpm
SVT Run	3 to 99 SV beats	1 SV beat
ST High	-19.8 to +20 mm	0.2 mm
ST Low	-20 to +19.8 mm	0.2 mm

ECG/Arrhythmia/ST Supplemental Information as required by AAMI EC11/13

Respiration Excitation Waveform	Sinusoidal signal, 260 μ A, 39 kHz	
Noise Suppression	RL drive gain 44 dB max., max. voltage 1.8 V _{rms}	
Time to Alarm for Tachycardia	Vent Tachycardia 1 mV _{pp} , 206 bpm	Gain 0.5, Range 6.5 to 8.4 seconds, Average 7.2 seconds
		Gain 1.0 Range 6.1 to 6.9 seconds, Average 6.5 seconds
		Gain 2.0, Range 5.9 to 6.7 seconds, Average 6.3 seconds
	Vent Tachycardia 2 mV _{pp} , 195 bpm	Gain 0.5, Range 5.4 to 6.2 seconds, Average 5.8 seconds
		Gain 1.0, Range 5.7 to 6.5 seconds, Average 6.1 seconds
		Gain 2.0, Range 5.3 to 6.1 seconds, Average 5.7 seconds
Tall T-Wave Rejection Capability	Exceeds ANSI/AAMI EC 13 Sect. 3.1.2.1(c) minimum recommended 1.2 mV T-Wave amplitude	

ECG/Arrhythmia/ST Supplemental Information as required by AAMI EC11/13	
Heart Rate Averaging Method	Three different methods are used: Normally, heart rate is computed by averaging the 12 most recent RR intervals. For runs of PVCs, up to 8 RR intervals are averaged to compute the HR. If each of 3 consecutive RR intervals is greater than 1200 ms (that is, rate less than 50 bpm), then the 4 most recent RR intervals are averaged to compute the HR.
Response Time of Heart Rate Meter to Change in Heart Rate	HR change from 80 to 120 bpm: Range: [6.4 to 7.2 seconds] Average: 6.8 seconds HR change from 80 to 40 bpm: Range: [5.6 to 6.4 sec] Average: 6.0 seconds
Heart Rate Meter Accuracy and Response to Irregular Rhythm	Ventricular bigeminy: 80 bpm Slow alternating ventricular bigeminy: 60 bpm Rapid alternating ventricular bigeminy: 120 bpm Bidirectional systoles: 90 bpm
Accuracy of Input Signal Reproduction	Methods A and D were used to establish overall system error and frequency response.

Respiration

Respiration Performance Specifications		
Respiration Rate	Range	Adult/pedi: 0 to 120 rpm Neo: 0 to 170 rpm
	Accuracy	at 0 to 120 rpm ± 1 rpm at 120 to 170 rpm ± 2 rpm
	Resolution	1 rpm
Bandwidth	0.3 to 2.5Hz (-6dB)	
Noise	Less than 25m Ω (rms) referred to the input	

Respiration Alarm Specifications	Range	Adjustment	Delay
High	Adult/pedi: 10 to 100 rpm Neo: 30 to 150 rpm	under 20 rpm: 1 rpm steps over 20 rpm: 5 rpm steps	max. 14 seconds
Low	Adult/pedi: 0 to 95 rpm Neo: 0 to 145 rpm	under 20 rpm: 1 rpm steps over 20 rpm: 5 rpm steps	for limits from 0 to 20 rpm: max. 4 seconds for limits above 20 rpm: max. 14 seconds
Apnea Alarm	10 to 40 seconds	5 second steps	

SpO₂

Unless otherwise specified, this information is valid for SpO₂ measured using the M3001A measurement server and the M1020B measurement module.

Complies with EN ISO 9919:2005 (except alarm system; alarm system complies with IEC 60601-2-49:2001).

Measurement Validation: The SpO₂ accuracy has been validated in human studies against arterial blood sample reference measured with a CO-oximeter. Pulse oximeter measurements are statistically distributed, only about two-thirds of the measurements can be expected to fall within the specified accuracy compared to CO-oximeter measurements. Display Update Period: Typical: 2 seconds, Maximum: 30 seconds. Max. with NBP INOP suppression on: 60 seconds.

SpO ₂ Performance Specifications		
SpO ₂	Range	0 to 100%
The specified accuracy is the root-mean-square (RMS) difference between the measured values and the reference values	Option #A01 Accuracy	<p>Philips Reusable Sensors: M1191A, M1191AL, M1192A, M1192AN = 2% (70% to 100%) M1193A, M1194A, M1195A, = 3% (70% to 100%) M1191T, M1192T, M1193T (Adult) = 3% (70% to 100%) M1193T (Neonate) = 4% (70% to 100%)</p> <p>Philips Disposable Sensors with M1943A(L): M1132A, M1133A (adult/infant) = 2%</p> <p>M1901B, M1902B, M1903B, M1904B, M1131A, M1133A (neonate) = 3% (70% to 100%)</p> <p>NellcorPB[®] Sensors with M1943A(L): MAX-A, MAX-AL, MAX-P, MAX-I, MAX-N, D-25, D-20, I-20, N-25, OxiCliq A, P, I, N = 3% (70% to 100%)</p> <p>Masimo Sensors[®] with AC-1: LNOP Adt, Adtx,Pdt, Pdtx, INF-L, DC-I, DC-IP, Y-I: 2% (70% to 100%) LNOP NEO-L, NEOPT-L: 3% (70% to 100%) LNOP TC-I: 3.5% (70% to 100%)</p>
	Option #A02 Accuracy	<p>Philips Reusable Sensors M1191ANL, M1192AN = 2% (70% to 100%) M1193AN, M1194AN, M1195AN = 3% (70% to 100%)</p> <p>Philips Disposable Sensors with M1943NL: M1901B (Adult), M1902B, M1903B, M1904B = 2% (70% to 100%) M1901B (Neonate) = 3%</p> <p>NellcorPB[®] Sensors with M1943NL: MAX-FAST, MAX-A, MAX-AL, MAX-P, MAX-I, MAX-N (Adult) = 2% (70 - 100%) SC-A, OxiCliq A, P, I, N (Adult) = 2.5% (70 - 100%) MAX-N (Neonate), Dura-Y D-YS (Infant to Adult), DS-100A, Oxiband OXI-A/N (Adult), OXI-P/I = 3% (70 - 100%) MAX-R, OxiCliq N (Neonate), SC-NEO (Neonate), SC-PR (Neonate), Dura-Y D-YS with D-YSE or D-YSPD clip = 3.5% (70 - 100%) Dura-Y D-YS (Neonate), Oxiband OXI-A/N (Neonate) = 4% (70 - 100%)</p>
	Resolution	1%

SpO ₂ Performance Specifications		
Pulse	Range	30 to 300 bpm
	Accuracy	±2% or 1 bpm, whichever is greater
	Resolution	1 bpm
Sensors	Wavelength range: 500 to 1000 nm Emitted Light Energy: ≤ 15mW Information about the wavelength range can be especially useful to clinicians (for instance, when photodynamic therapy is performed)	
Pulse Oximeter Calibration Range	70 - 100%	

SpO ₂ Alarm Specifications	Range	Adjustment	Delay
SpO ₂	Adult: 50 to 100% Pedi/Neo: 30 to 100%	1% steps	(0, 1, 2, 3,... 30) + 4 seconds
Desat	Adult: 50 to Low alarm limit Pedi/Neo: 30 to Low alarm limit	1% steps	
Pulse	30 to 300 bpm	Adult: 1 bpm steps (30 to 40 bpm) 5 bpm steps (40 to 300 bpm) Pedi/Neo: 1 bpm steps (30 to 50 bpm) 5 bpm steps (50 to 300 bpm)	max. 14 seconds
Tachycardia	Difference to high limit 0 to 50 bpm	5 bpm steps	max. 14 seconds
	Clamping at 150 to 300 bpm	5 bpm steps	
Bradycardia	Difference to low limit 0 to 50 bpm	5 bpm steps	max. 14 seconds
	Clamping at 30 to 100 bpm	5 bpm steps	

NBP

Complies with IEC 60601-2-30:1999/EN60601-2-30:2000.

NBP Performance Specifications		
Measurement Ranges	Systolic	Adult: 30 to 270 mmHg (4 to 36 kPa) Pedi: 30 to 180 mmHg (4 to 24 kPa) Neo: 30 to 130 mmHg (4 to 17 kPa)
	Diastolic	Adult: 10 to 245 mmHg (1.5 to 32 kPa) Pedi: 10 to 150 mmHg (1.5 to 20 kPa) Neo: 10 to 100 mmHg (1.5 to 13 kPa)
	Mean	Adult: 20 to 255 mmHg (2.5 to 34 kPa) Pedi: 20 to 160 mmHg (2.5 to 21 kPa) Neo: 20 to 120 mmHg (2.5 to 16 kPa)
Accuracy	Max. Std. Deviation: 8 mmHg (1.1 kPa) Max. Mean Error: ±5 mmHg (±0.7 kPa)	
Heart Rate Range	40 to 300 bpm	

NBP Performance Specifications		
Measurement Time	Typical at HR > 60bpm Auto/manual: 30 seconds (adult) 25 seconds (neonatal) Stat: 20 seconds Maximum time: 180 seconds (adult/pediatric) 90 seconds (neonates)	
Cuff Inflation Time	Typical for normal adult cuff: Less than 10 seconds Typical for neonatal cuff: Less than 2 seconds	
Initial Cuff Inflation Pressure	Adult: 165 ±15 mmHg Pedi: 130 ±15 mmHg Neo: 100 ±15 mmHg	
Auto Mode Repetition Times	1, 2, 2.5, 3, 5, 10, 15, 20, 30, 45, 60 or 120 minutes	
STAT Mode Cycle Time	5 minutes	
Venipuncture Mode Inflation		
Inflation Pressure	Adult	20 to 120 mmHg (3 to 16 kPa)
	Pediatric	20 to 80 mmHg (3 to 11 kPa)
	Neonatal	20 to 50 mmHg (3 to 7 kPa)
Automatic deflation after	Adult/pediatric	170 seconds
	Neonatal	85 seconds

Measurement Validation: In adult and pediatric mode, the blood pressure measurements determined with this device comply with the American National Standard for Electronic or Automated Sphygmomanometers (ANSI/AAMI SP10 - 1992) in relation to mean error and standard deviation, when compared to intra-arterial or auscultatory measurements (depending on the configuration) in a representative patient population. For the auscultatory reference the 5th Korotkoff sound was used to determine the diastolic pressure.

In neonatal mode, the blood pressure measurements determined with this device comply with the American National Standard for Electronic or Automated Sphygmomanometers (ANSI/AAMI SP10 - 1992 and AAMI/ANSI SP10A -1996) in relation to mean error and standard deviation, when compared to intra-arterial measurements in a representative patient population.

NBP Alarm Specifications	Range	Adjustment
Systolic	Adult: 30 to 270 mmHg (4 to 36 kPa)	10 to 30 mmHg: 2 mmHg (0.5 kPa) > 30 mmHg: 5 mmHg (1 kPa)
	Pedi: 30 to 180 mmHg (4 to 24 kPa)	
	Neo: 30 to 130 mmHg (4 to 17 kPa)	
Diastolic	Adult: 10 to 245 mmHg (1.5 to 32 kPa)	
	Pedi: 10 to 150 mmHg (1.5 to 20 kPa)	
	Neo: 10 to 100 mmHg (1.5 to 13 kPa)	
Mean	Adult: 20 to 255 mmHg (2.5 to 34 kPa)	
	Pedi: 20 to 160 mmHg (2.5 to 21 kPa)	
	Neo: 20 to 120 mmHg (2.5 to 16 kPa)	

NBP Overpressure Settings		
Adult	> 300 mmHg (40 kPa) > 2 sec	not user adjustable
Pedi	> 300 mmHg (40 kPa) > 2 sec	
Neo	> 150 mmHg (20 kPa) > 2 sec	

Invasive Pressure and Pulse

Complies with IEC 60601-2-34:2000/EN60601-2-34:2000.

Invasive Pressure Performance Specifications		
Measurement Range		-40 to 360 mmHg
Pulse Rate	Range	25 to 350 bpm
	Accuracy	±1% Full Range
	Resolution	1 bpm
Input Sensitivity		Sensitivity: 5µV/V/mmHg (37.5µV/V/kPa) Adjustment range: ±10%
Transducer		Load Impedance: 200 to 2000 Ω (resistive) Output Impedance: ≤3000 Ω (resistive)
Frequency Response		dc to 12.5 Hz or 40 Hz
Zero Adjustment	Range:	±200 mmHg (±26 kPa)
	Accuracy	±1 mmHg (±0.1 kPa)
	Drift	Less than 0.1mmHg/°C (0.013 kPa/°C)
Gain Accuracy	Accuracy	±1%
	Drift	Less than 0.05%/°C
	Non linearity and Hysteresis	Error of ≤ 0.4% FS (@CAL 200 mmHg)
Overall Accuracy	(including transducer)	± 4% of reading or ± 4 mmHg (± 0.5 kPa), whichever is greater
Analog Output available only with M1006B #C01 (@ CAL 200 mmHg)	Range	-0.4 V to 3.6 V
	Level	1 V / 100 mmHg
	Accuracy	± 3% full scale
	Offset	± 30 mV
	Resolution	8 Bit (@ 5 V range)
	Signal delay	20 ms
Volume displacement of CPJ840J6		0.1 mm ³ /100 mmHg

Invasive Pressure Alarm Specifications	Range	Adjustment	Delay
Pressure	-40 to 360 mmHg (-5.0 to 48 kPa)	-40 to 30 mmHg 2 mmHg (0.5 kPa) > 30 mmHg 5 mmHg (1 kPa)	max. 12 seconds
Pulse	25 to 300 bpm	Adult: 1 bpm steps (25 to 40 bpm) 5 bpm steps (40 to 300 bpm) Pedi/Neo: 1 bpm steps (25 to 50 bpm) 5 bpm steps (50 to 300 bpm)	
Tachycardia	Difference to high limit 0 to 50 bpm	5 bpm steps	max. 14 seconds
	Clamping at 150 to 300 bpm	5 bpm steps	
Bradycardia	Difference to low limit 0 to 50 bpm	5 bpm steps	max. 14 seconds
	Clamping at 25 to 100 bpm	5 bpm steps	

Temp

Temp Performance Specifications		
Temp	Range	-1 to 45 °C (30 to 113 °F)
	Resolution	0.1 °C (32.2 °F)
	Accuracy	±0.1 °C (±0.2 °F)
Average Time Constant		Less than 10 seconds
Alarms	Range	-1 to 45 °C (30 to 113 °F)
	Adjustment	-1 to 35 °C (30 to 95 °F): 0.5 °C (1.0 °F) steps 35 to 45 °C (95 to 113 °F): 0.1 °C (0.2 °F) steps

Temp Alarm Specifications	Range	Adjustment
Temp High/Low Alarms	-1 to 45 °C (30 to 113 °F)	-1 to 35 °C (30 to 95 °F), 0.5 °C (1.0 °F) steps 35 to 45 °C (95 to 113 °F), 0.1 °C (0.2 °F) steps

CO₂

The CO₂ measurement in M3014A and M3015A complies with EN ISO 21647 (except alarm system; alarm system complies with IEC 60601-2-49:2001)

M3015A Microstream CO₂ Performance Specifications		
CO ₂	Range	0 to 98mmHg (0 to 13 kPa), or 13% CO ₂ , whichever is lower
	Accuracy	Up to 5 minutes during warmup: ±4 mmHg or 12%, whichever is greater After 5 minutes warmup: 0 to 40 mmHg (0 to 5.3 kPa):±2.2 mmHg (±0.3 kPa) Above 40 mmHg (5.3 kPa):±(5.5% + (0.08%/mmHg above 40 mmHg)) of reading These specifications are valid for 21% O ₂ and N ₂ balance, up to 35°C ambient temperature, up to 60 rpm in adult mode and 100 rpm in neonatal mode. Outside of these conditions the accuracy reaches at a minimum ±4 mmHg or ±12% of the reading, whichever is greater.
	Resolution	Numeric: 1.0 mmHg (0.1 kPa) Wave: 0.1 mmHg (0.01 kPa)
	Stability	Included in Accuracy specifications
awRR	Range	0 to 150 rpm
	Accuracy	0 to 40 rpm: ±1 rpm 41 to 70 rpm: ±2 rpm 71 to 100 rpm: ±3 rpm >100 rpm: ±5% of reading
Warm-up Time		20 minutes for full accuracy specification
Rise Time		190 ms for neonatal mode (measured with FilterLine H for neonatal) 240 ms for adult mode (measured with FilterLine H for adult)
Sample Flow Rate		50+15/-7.5 ml/minute
Gas Sampling Delay Time		Typical:2.3 seconds Maximum:3 seconds
Sound Pressure		Acoustic noise: < 45 dBA
Total System Response Time		The total system response time is the sum of the delay time and the rise time.

Microstream CO₂ Humidity Correction Factor

Either BTPS or STPD can be selected as the humidity correction factor for the Microstream CO₂ readings. The formula for the correction calculation is:

$$P_{\text{BTPS}} = (P_{\text{STPD}} \cdot 0.94)$$

M3014A Mainstream CO₂ Performance Specifications		
CO ₂	Range	0 to 150 mmHg (0 to 20.0 kPa)
	Accuracy	after 2 minutes warmup: For values between 0 and 40 mmHg: ±2.0 mmHg (±0.29 kPa) For values from 41 to 70 mmHg: ±5% of reading For values from 71 to 100 mmHg: ±8% of reading The specifications are valid for standard gas mixtures, balance air, fully hydrated at 35°C, P _{abs} = 760 mmHg, flow rate = 2 l/min.
	Resolution	Numeric: 1.0 mmHg (0.1 kPa) Wave: 0.1 mmHg (0.01 kPa)
	Stability: Short term drift Long term drift	±0.8 mmHg over four hours Accuracy specification will be maintained over a 120 hour period
awRR	Range	2 to 150 rpm
	Accuracy	±1 rpm
Warm-up Time		2 minutes with CO ₂ transducer attached for full accuracy specification
Response Time		Less than 60 ms (with adult or infant reusable or disposable adapter)

M3014A Sidestream CO₂ Performance Specifications		
CO ₂	Range	0 to 150 mmHg (0 to 20.0 kPa)
	Accuracy	after 2 minutes warmup: For values between 0 and 40 mmHg: ±2.0 mmHg (±0.29 kPa) For values from 41 to 70 mmHg: ±5% of reading For values from 71 to 100 mmHg: ±8% of reading For values from 101 to 150 mmHg: ±10% of reading At respiration rates above 80 rpm, all ranges are ±12% of actual. The specifications are valid for gas mixtures of CO ₂ , balance N ₂ , dry gas at 760 mmHg within specified operating temperature range.
	Resolution	Numeric: 1.0 mmHg (0.1 kPa) Wave: 0.1 mmHg (0.01 kPa)
	Stability: Short term drift Long term drift	±0.8 mmHg over four hours Accuracy specification will be maintained over a 120 hour period
awRR	Range	2 to 150 rpm
	Accuracy	±1 rpm
Warm-up Time		2 minutes with CO ₂ sensor attached for full accuracy specification
Sample Flow Rate		50±10 ml/minute
Total System Response Time		3 seconds
Operating Temperature		0 to 40 °C (32 to 100 °F)

M3014A Mainstream and Sidestream CO₂ Humidity Correction Factor

Either BTPS or STPD can be selected as the humidity correction factor for the Mainstream CO₂ readings. The formula for the correction calculation is:

$$P_{\text{STPD}} = P_{\text{BTPS}} \cdot \frac{P_{\text{abs}}}{P_{\text{abs}} - P_{\text{H}_2\text{O}}}$$

Where p = partial pressure, P_{abs} = absolute pressure, and $P_{H_2O} = 42 \text{ mmHg @}35^\circ\text{C}$ and 100% RH.

M3016A Mainstream CO ₂ Performance Specifications		
CO ₂	Range	-4 to 150 mmHg (-0.5 to 20.0 kPa)
	Accuracy	after 20 minutes warmup and calibration: For values between 0 and 40 mmHg: $\pm 2.2 \text{ mmHg}$ ($\pm 0.29 \text{ kPa}$) For values between 40 and 76 mmHg: $\pm 5.5\%$ of reading The specifications are valid for 45% O ₂ and N ₂ or N ₂ O balance. Outside these conditions the accuracy reaches at a minimum the requirements of EN864/ISO9918.
	Resolution	Numeric: 1.0 mmHg (0.1 kPa) Wave: 0.1 mmHg (0.01 kPa)
	Stability	$\pm 1.0 \text{ mmHg}$ over a 7 day period
awRR	Range	0 to 150 rpm
	Accuracy	$\pm 2 \text{ rpm}$
Warm-up Time	20 minutes with CO ₂ transducer attached for full accuracy specification	
Response Time	Less than 125 ms (for step from 10% to 90%)	

Mainstream CO₂ Humidity Correction Factor

Either BTPS or STPD can be selected as the humidity correction factor for the Mainstream CO₂ readings. The formula for the correction calculation is:

$$P_{STPD} = P_{BTPS} \cdot \frac{P_{abs}}{P_{abs} - P_{H_2O}}$$

Where p = partial pressure, P_{abs} = absolute pressure, and $P_{H_2O} = 47 \text{ mmHg @}37^\circ\text{C}$ and 100% RH.

CO ₂ Alarm Specifications	Range	Adjustment	Delay
etCO ₂ High	20 to 95 mmHg (2 to 13 kPa)	1 mmHg (0.1 kPa)	M3014A/M3016A: less than 14 seconds M3015A: less than 18 seconds.
etCO ₂ Low	10 to 90 mmHg (1 to 12 kPa)		
imCO ₂ High	2 to 20 mmHg (0.3 to 3.0 kPa)	steps of 1 mmHg (0.1 kPa)	M3014A/M3016A: less than 14 seconds M3015A: less than 18 seconds.
awRR High	Adult/pedi: 10 to 100 rpm Neo: 30 to 150 rpm	under 20 rpm: 1 rpm steps	M3014A/M3016A: less than 14 seconds M3015A: less than 18 seconds. M3015A: settings < 20 rpm: less than 8 seconds > 20 rpm: less than 18 seconds M3014A/M3016A settings < 20 rpm: less than 4 seconds > 20 rpm: less than 14 seconds
awRR Low	Adult/pedi: 0 to 95 rpm Neo: 0 to 145 rpm	over 20 rpm: 5 rpm steps	
Apnea delay	10 to 40 seconds	5 second steps	set apnea delay time + 4 seconds (M3014A/M3016A) or 8 seconds (M3015A)

Interfering Gas and Vapor Effects On CO₂ Measurement Values

The specified deviations for M3014A are valid when the appropriate corrections are switched on and set correctly.

Gas or Vapor	Gas Level (% volume fraction)	M3014A	M3015A
		Additional deviation due to gas interference, measured at 0 - 40 mmHg CO ₂	
Nitrous Oxide	60	±1 mmHg	± 5%
Halothane	4	±1 mmHg	± 5%
Enflurane	5	±1 mmHg	± 5%
Isoflurane	5	±1 mmHg	± 5%
Sevoflurane	5	±1 mmHg	± 5%
Xenon	80	-5 mmHg	± 5%
Helium	50	±1 mmHg	± 5%
Metered dose inhaler propellants	-	not specified for use	
Desflurane	15	+3 mmHg	± 5%
Ethanol	0.1	±1 mmHg	± 5%
Isopropanol	0.1	±1 mmHg	± 5%
Acetone	0.1	±1 mmHg	± 5%
Methane	1.0	±1 mmHg	± 5%

Spirometry

The following specifications apply for 760 mmHg ambient pressure and patient gas: room air at 35°, unless otherwise noted

Spirometry Performance Specifications		
Flow Wave (AWF)	Range	±25 l/min (neonatal) ±100 l/min (pediatric) ±180 l/min (adult)
	Accuracy	±3% or 0.125 l/min (neonatal) 0.25 l/min (pediatric) 0.5 l/min (adult)
	Scales	±10, ±20, ±40, ±60, ±80, ±100, ±120, ±150 l/min
	Scale Default	±20 l/min (neonatal) ±100 l/min (pediatric) ±150 l/min (adult)

Spirometry Performance Specifications		
Volume Wave (AWV)	Range	0 to 100 ml (neonatal) 0 to 400 ml (pediatric) 0 to 3000 ml (adult)
	Accuracy	±5% or ±3 ml (neonatal) ±12 ml (pediatric) ±90 ml (adult), whichever is greater
	Scales	50, 100, 200, 600, 800, 1000, 2000, 3000 ml
	Scale Default	50 ml (neonatal) 200 ml (pediatric) 800 ml (adult)
Pressure Wave (AWP)	Range	-20 to 120 cmH ₂ O
	Accuracy	±2% or ±0.5 cmH ₂ O whichever is greater
	Scales	10, 20, 40, 60, 80, 100, 120 cmH ₂ O
	Scale Default	20 l/min (neonatal) 40 l/min (pediatric) 40 l/min (adult)
Respiration Rate numeric (RR _{spir})	Range	2 to 120 breaths/min
	Resolution	1 breath/min
Inspired Minute Volume numeric (MV _{in})	Range	0.01 to 5 l/min (neonatal) 0.06 to 30 l/min (pediatric) 0.4 to 60l/min (adult)
	Resolution	0.01 l/min (neonatal/pediatric) 0.1 l/min (adult)
Expired Minute Volume numeric (MV _{exp})	Range	0.01 to 5 l/min (neonatal) 0.06 to 30 l/min (pediatric) 0.4 to 60l/min (adult)
	Resolution	0.01 l/min (neonatal/pediatric) 0.1 l/min (adult)
Inspired Volume numeric (TV _{in})	Range	5 to 100 ml (neonatal) 30 to 400 ml (pediatric) 200 to 3000 ml (adult)
	Resolution	1 ml (neonatal/pediatric) 10 ml (adult)
Expired Volume numeric (TV _{exp})	Range	5 to 100 ml (neonatal) 30 to 400 ml (pediatric) 200 to 3000 ml (adult)
	Resolution	1 ml (neonatal/pediatric) 10 ml (adult)
Lung Compliance numeric	Range	0 to 500 ml/cmH ₂ O
	Resolution	1 ml/cmH ₂ O
Airway Resistance numeric	Range	0 to 500 cmH ₂ O/l/s (neonatal) 0 to 250 cmH ₂ O/l/s (pediatric) 0 to 100 cmH ₂ O/l/s (adult)
	Resolution	1 cmH ₂ O/l/s
Peak Inspiratory Pressure numeric (PIP)	Range	0 to +120 cmH ₂ O
	Resolution	1 cmH ₂ O

Spirometry Performance Specifications		
Negative Inspiratory Pressure numeric	Range	-20 to 0 cmH ₂ O
	Resolution	1 cmH ₂ O
Mean Airway Pressure	Range	-20 to +120 cmH ₂ O
	Resolution	1 cmH ₂ O
Plateau Pressure numeric	Range	0 to +120 cmH ₂ O
	Resolution	1 cmH ₂ O
Positive End-Expiratory Pressure numeric (PEEP)	Range	0 to 99 cmH ₂ O
	Resolution	1 cmH ₂ O
Barometric Pressure numeric (PB)	Range	400 to 800 mmHg
	Resolution	1 mmHg
Peak Inspiratory Flow numeric (PIF)	Range	0.1 to 25 l/min (neonatal) 1 to 100 l/min (pediatric) 2 to 180 l/min (adult)
	Resolution	0.1 l/min (neonatal) 1 l/min (pediatric/adult)
Peak Expiratory Flow numeric (PEF)	Range	0.1 to 25 l/min (neonatal) 1 to 100 l/min (pediatric) 2 to 180 l/min (adult)
	Resolution	0.1 l/min (neonatal) 1 l/min (pediatric/adult)
Inspiration to Expiration ratio numeric (I:E)	Range	1: 0.2 ... 9.9
	Resolution	0.1

Cardiac Output / Continuous Cardiac Output

C.O./CCO Performance Specifications		
C.O. (right heart)	Range	0.1 to 20.0 l/min
	Accuracy	Instrument Specification (electrical): + 3% or 0.1 l/min System Specification: + 5%. or 0.2 l/min
	Repeatability	Instrument Specification (electrical): + 2% or 0.1 l/min System Specification: + 3%. or 0.1 l/min
C.O. (transpulmonary)	Range	0.1 to 25.0 l/min
	Accuracy	Instrument Specification (electrical): ± 4% or 0.15 l/min System Specification: ± 5% or 0.2 l/min
	Repeatability	Instrument Specification (electrical): ± 2% or 0.1 l/min System Specification: ± 3% or 0.1 l/min
EVLW not available in USA	Range	10 to 5000 ml
	Standard Deviation	10% or 1 ml/kg

C.O./CCO Performance Specifications		
ITBV	Range	50 to 6000 ml
	Accuracy	± 10% or 30 ml
	Repeatability	± 5% or 20 ml
CCO	Range	0.1 to 25.0 l/min
	Standard Deviation	10% or 0.3 l/min
	Display Update	2 seconds nominal
Blood Temperature	Range	17,0 to 43°C (62,6 to 109,4°F)
Injectate Temperature	Range	-1 to 30°C

C.O./CCO Alarm Specifications	Range	Adjustment	Delay
TBlood	17 to 43°C	Steps of 0.5°C (17 to 35°C) Steps of 0.1°C (35 to 43°C) Steps of 1°F (63 to 95°C) Steps of 0.2°F (95 to 109°C)	10 seconds after the value exceeds the set limit range
CCO	0.1 to 25.0 l/min	0.1 l/min (0.1 to 10.0 l/min) 0.5 l/min (10.0 to 25.0 l/min)	10 seconds after the value exceeds the set limit range

tcGas

Complies with IEC 60601-2-23:1999/EN60601-2-23:2000.

tcGas Performance Specifications		
tcpO ₂	Range	0 to 750 mmHg (0 to 100 kPa)
	Accuracy	0.5% (± 1 digit)
	Resolution	1 mmHg (0.1 kPa)
	Overall Accuracy (incl. transducer)	0 to 160 mmHg ± 5 mmHg 0.0 to 21.3 kPa ± 0.7 kPa >160 mmHg (21.3 kPa) ± 3% of reading
tcpO ₂ Temperature Drift		< 0.1% / °C
tcpO ₂ Test Signal		60 mmHg (8.0 kPa)
tcpO ₂ Drift, including transducer		< 1 mmHg / h @ 10% O ₂
tcpO ₂ response time, including transducer		< 30 s
tcpCO ₂	Range	5 to 200 mmHg (0.7 to 26.7 kPa)
	Accuracy	1.0% (1 ± digit)
	Resolution	1 mmHg (0.1 kPa)
	Overall Accuracy (incl. transducer)	0 to 76 mmHg ± 5 mmHg 0.0 to 10.1 kPa ± 0.7 kPa >76 mmHg (10.1 kPa) ± 10% of reading
tcpCO ₂ Temperature Drift		< 0.1% / °C
tcpCO ₂ Test Signal		40 mmHg (5.3 kPa)
tcpCO ₂ Drift, including transducer		< 1 mmHg / h @ 5% CO ₂

tcGas Performance Specifications	
tcpCO ₂ response time, including transducer	< 50 s
Warm-up Time	< 3 minutes
Site Timer	0.5, 1, 1.5, 2, 2.5, 3, 4, 5, 6, 7, or 8 hours. Change Site alarm when site time is expired and configurable automatic heating switch-off
Transducer Heating	Available Temperatures - 37.0°C, 41.0 to 45°C in steps of 0.5°C

tcGas Alarm Specifications	Range	Adjustment	Alarm Delay
tcpO ₂	10 to 745 mmHg 1.0 to 99.5 kPa	10 to 30 mmHg: 1 mmHg 1.0 to 4.0 kPa: 0.1 kPa 32 to 100 mmHg: 2 mmHg 4.2 to 13 kPa: 0.2 kPa 105 to 745mmHg: 5 mmHg 13.5 to 99.5 kPa: 0.5 kPa	10 seconds after the value exceeds the set limit range.
tcpCO ₂	10 to 195 mmHg 1.0 to 26 kPa	10 to 30 mmHg: 1 mmHg 1.0 to 4.0 kPa: 0.1 kPa 32 to 100 mmHg: 2 mmHg 4.2 to 13 kPa: 0.2 kPa 105 to 195 mmHg: 5 mmHg 13.5 to 26 kPa: 0.5 kPa	

SvO₂

SvO ₂ Performance Specifications		
SvO ₂	Range	10% to 100%
	Accuracy	± 2 % (i.e. ± 2 units), 1 standard deviation over 40 % to 100 % range.
	Resolution	1%
Stability (system)		Drift < 2% over 24 hours
Response Time (10 % to 90%)		5 seconds

SvO ₂ Alarm Specifications	Range	Adjustment	Delay
SvO ₂	10% to 100%	1%	max. 15+4 seconds after value goes beyond the low/high alarm limit settings

EEG

Complies with IEC 60601-2-26:1994/EN60601-2-26:1994.

EEG Performance Specifications		
Leakage Current	$\leq 10 \mu\text{A}$ @ 110V_{ac}	
Input Signal Range	$1 \text{ mV}_{\text{p-p}}$	
Differential Input Impedance	$>15 \text{ M}\Omega$ @ 10 Hz	
Max. DC Input Offset Voltage	$\pm 320 \text{ mV}$	
Input Protection	Against defibrillation (5 kV) and electrosurgery	
Common Mode Rejection	$>105 \text{ dB}$ @ $5 \text{ k}\Omega$ imbalance and 60 Hz	
Noise	$<0.4 \mu\text{VRMS}$ (1 to 30 Hz)	
Electromagnetic Susceptibility	$<10 \mu\text{V}_{\text{p-p}}$ @ 3 V/m, 26-1000 MHz	
Electrode Impedance Measurement	Range	0 to 30 $\text{k}\Omega$
	Accuracy	$\pm 1 \text{ k}\Omega$
Bandwidth	0.5 Hz to 50 Hz (-3 dB)	
Low Filter Cut-Off Frequencies	0.5, 1.0, 2.0, and 5.0 Hz (12 dB/octave)	
High Filter Cut-Off Frequencies	15 Hz (65 dB/octave) 30 Hz (75 dB/octave) 50 Hz (85 dB/octave)	

BIS

BIS Performance Specifications	BIS, BISx M1034A, BIS Interface board for MP20/30
Bispectral Index (BIS) Range	0 - 100
Signal Quality Index (SQI) Range	0 - 100%
EMG Range	0 - 100dB
Suppression Ratio (SR)	0 - 100%
Spectral Edge Frequency (SEF)	0.5 - 30.0Hz
Total Power (TP)	0 - 100 dB
Bursts	(BISx only) 0 - 30/minute
Noise	$<0.3 \mu\text{V RMS}$ ($2.0 \mu\text{V}$ peak-to-peak)
Wave Scale	<i>With gridlines on:</i> $\pm 25 \mu\text{V}$, $\pm 50 \mu\text{V}$, $\pm 100 \mu\text{V}$, $\pm 250 \mu\text{V}$ <i>With gridlines off:</i> $50 \mu\text{V}$, $100 \mu\text{V}$, $200 \mu\text{V}$, $500 \mu\text{V}$
Update Frequency (BIS Numeric)	2048 ms
Bandwidth	0.25 - 100Hz (-3 dB)
High Pass Filters	0.25 Hz, 1 Hz, 2 Hz (-3 dB)
Low Pass Filters	30 Hz, 50 Hz, 70 Hz, 100 Hz (-3 dB)
Notch Filters (for line frequency)	50 Hz, 60 Hz
Impedance Measurement Range	0 to 999 $\text{k}\Omega$

BIS Alarm Specifications	Range	Adjustment	Alarm Delay
BIS High/Low Alarm	0 - 100	1	Max. 2 seconds

Safety and Performance Tests

You must observe any national regulations on the qualification of the testing personnel and suitable measuring and testing facilities. See the maintenance section for a list of required tests. Safety and performance tests, and what to do if the instrument does not meet these specifications are described in the Installation and Service guide.

Electromagnetic Compatibility (EMC) Specifications

Take special precautions regarding electromagnetic compatibility (EMC) when using medical electrical equipment. You must operate your monitoring equipment according to the EMC information provided in this book. Portable and mobile radio frequency (RF) communications equipment can affect medical electrical equipment.

Accessories Compliant with EMC Standards

All accessories listed in the accessories section comply, in combination with the IntelliVue patient monitors, with the requirements of IEC 60601-1-2:2001.

WARNING Using accessories other than those specified may result in increased electromagnetic emission or decreased electromagnetic immunity of the monitoring equipment.

Electromagnetic Emissions

The monitor is suitable for use in the electromagnetic environment specified in the table below. You must ensure that it is used in such an environment

Emissions test	Compliance	Avoiding Electromagnetic Interference
Radio Frequency (RF) emissions	Group 1	The monitor uses RF energy only for its internal function. Therefore, its RF emissions are very low and are not likely to cause any interference in nearby electronic equipment
RF emissions CISPR 11	Class A	The monitor is suitable for use in all establishments other than domestic and those directly connected to the public low-voltage power supply network that supplies buildings used for domestic purposes
Harmonic emissions IEC 61000-3-2	n/a	
Voltage fluctuations IEC 61000-3-3	n/a	

Avoiding Electromagnetic Interference (Resp and BIS)

The respiration (Resp) and BIS measurements are very sensitive measurements that measure very small signals. Technological limitations don't allow higher immunity levels than 1V/m for radiated RF electromagnetic fields and 1Vrms for conducted disturbances induced by RF fields. Electromagnetic fields with field strengths above 1 V/m and conducted disturbances above 1Vrms may cause erroneous measurements. Therefore Philips recommends that you avoid using electrically radiating equipment in the close proximity of these measurements.

WARNING The monitor should not be used next to or stacked with other equipment. If you must stack the monitor, you must check that normal operation is possible in the necessary configuration before you start monitoring patients.

Electromagnetic Immunity

The monitor is suitable for use in the specified electromagnetic environment. The user must ensure that it is used in the appropriate environment as described below.

Immunity test	IEC 60601-1-2 test level	Compliance level	Electromagnetic environment guidance
Electrostatic discharge (ESD) IEC 61000-4-2	± 6 kV contact ± 8 kV air	± 6 kV contact ± 8 kV air	Floors should be wood, concrete, or ceramic tile. If floors are covered with synthetic material, the relative humidity should be at least 30%.
Electrical fast transient/burst IEC 61000-4-4	± 2 kV for power supply lines ± 1 kV for input/output lines	± 2 kV for power supply lines ± 1 kV for input/output lines	Mains power quality should be that of a typical commercial and/or hospital environment
Surge IEC 61000-4-5	± 1 kV differential mode ± 2 kV common mode	± 1 kV differential mode ± 2 kV common mode	Mains power quality should be that of a typical commercial and/or hospital environment
Voltage dips, short interruptions and voltage variations on power supply input lines IEC 61000-4-11	$<5\% U_T$ ($> 95\%$ dip in U_T) for 0.5 cycles $40\% U_T$ (60% dip in U_T) for 5 cycles $70\% U_T$ (30% dip in U_T) for 25 cycles $< 5\% U_T$ ($> 95\%$ dip in U_T) for 5 sec	$<5\% U_T$ ($> 95\%$ dip in U_T) for 0.5 cycles $40\% U_T$ (60% dip in U_T) for 5 cycles $70\% U_T$ (30% dip in U_T) for 25 cycles $< 5\% U_T$ ($> 95\%$ dip in U_T) for 5 sec	Mains power quality should be that of a typical commercial and/or hospital environment. If the user of the monitor requires continued operation during power mains interruptions, it is recommended that the monitor is equipped with an internal battery or is powered from an uninterruptible power supply.
Power frequency (50/60 Hz) magnetic field IEC 61000-4-8	3 A/m	3 A/m	Power frequency magnetic fields should be at levels characteristic of a typical location in a typical commercial and/or hospital environment

In this table, U_T is the a.c. mains voltage prior to application of the test level.

Recommended Separation Distance

WARNING The monitor, equipped with a wireless network interface, intentionally receives RF electromagnetic energy for the purpose of its operation. Therefore, other equipment may cause interference, even if that other equipment complies with CISPR emission requirements.

In the following table, P is the maximum output power rating of the transmitter in watts (W) according to the transmitter manufacturer and d is the recommended separation distance in metres (m). The values given in brackets are for respiration and BIS.

Portable and mobile RF communications equipment should be used no closer to any part of the monitor, including cables, than the recommended separation distance calculated from the equation appropriate for the frequency of the transmitter.

Field strengths from fixed RF transmitters, as determined by an electromagnetic site survey, should be less than the compliance level in each frequency range (over the frequency range 150 kHz to 80 MHz, field strengths should be less than 1 V/m for respiration and BIS and 3 V/m for all other functions).

Interference may occur in the vicinity of equipment marked with this symbol:



Immunity test	IEC 60601-1-2 test level	Compliance level	Electromagnetic environment guidance
Conducted RF IEC 61000-4-6	$3 V_{\text{RMS}}$ 150 kHz to 80 MHz	$3 V_{\text{RMS}}$ ($1 V_{\text{RMS}}$ for respiration and BIS)	Recommended separation distance: $d = 1.2 \cdot \sqrt{P}$: for respiration and BIS: $d = 3.5 \cdot \sqrt{P}$:
Radiated RF IEC 61000-4-3	3 V/m 80 MHz to 2.5 GHz	3 V/m (1 V/m for respiration and BIS)	Recommended separation distance: 80 MHz to 800 MHz $d = 1.2 \cdot \sqrt{P}$ 80 MHz to 800 MHz for respiration and BIS $d = 3.5 \cdot \sqrt{P}$: 800 MHz to 2,5 GHz $d = 2.3 \cdot \sqrt{P}$ 800 MHz to 2,5 GHz for respiration and BIS $d = 7.0 \cdot \sqrt{P}$

Field strengths from fixed transmitters, such as base stations for radio (cellular, cordless) telephones and land mobile radios, amateur radio, AM and FM radio broadcast and TV broadcast cannot be predicted theoretically with accuracy. To assess the electromagnetic environment due to fixed RF transmitters, an electromagnetic site survey should be considered. If the measured field strength in the location in which the monitor is used exceeds the applicable RF compliance level above, the monitor should be observed to verify normal operation. If abnormal performance is observed, additional measures may be necessary, such as reorienting or relocating the monitor.

These guidelines may not apply in all situations. Electromagnetic propagation is affected by absorption and reflection from structures, objects, and people.

Recommended separation distances from portable and mobile RF communication equipment

The monitor is intended for use in an electromagnetic environment in which radiated RF disturbances are controlled. The customer or user of the monitor can help prevent electromagnetic interference by maintaining a minimum distance between portable and mobile RF communications equipment and the monitor as recommended below, according to the maximum output power of the communications equipment.

Frequency of transmitter	150 kHz to 80 MHz	150 kHz to 800 MHz	800 MHz to 2,5 GHz
Equation	$d = 1.2\sqrt{P}$ for respiration and BIS: $d = 3.5\sqrt{P}$	$d = 1.2\sqrt{P}$ for respiration and BIS: $d = 3.5\sqrt{P}$	$d = 2.3\sqrt{P}$ for respiration and BIS: $d = 7.0\sqrt{P}$
Rated max. output power of transmitter (W)	Separation distance (m)	Separation distance (m)	Separation distance (m)
0.01	0.1 (0.4)	0.1 (0.4)	0.2 (0.7)
0.1	0.4 (1.1)	0.4 (1.1)	0.7 (2.2)
1	1.3 (3.5)	1.3 (3.5)	2.3 (7.0)
10	3.8 (11.1)	3.8 (11.1)	7.3 (22.1)
100	12.0 (35.0)	12.0 (35.0)	23.0 (70.0)

Electrosurgery Interference/Defibrillation/Electrostatic Discharge

The equipment returns to the previous operating mode within 10 seconds without loss of any stored data. Measurement accuracy may be temporarily decreased while performing electro-surgery or defibrillation. This does not affect patient or equipment safety. Do not expose the equipment to x-ray or strong magnetic fields (MRI).

Fast Transients/Bursts

The equipment will return to the previous operating mode within 10 seconds without loss of any stored data (M1032 within 30 seconds). If any user interaction is required, the monitor indicates with a technical alarm (INOP).

Restart time

After power interruption, an ECG wave will be shown on the display after 30 seconds maximum.

Default Settings Appendix

This appendix documents the most important default settings of your monitor as it is delivered from the factory. For a comprehensive list and explanation of default settings, see the Configuration Guide supplied with your monitor. The monitor's default settings can be permanently changed in Configuration Mode.

Settings are only entered once per table row if they are the same for all patient categories.

Alarm Default Settings

Alarm Settings	Factory Default H10 / H20 / H40	H30 (deviations from H10/20/40)
Alarm Volume	5	
Alarms Off	3 min.	
Pause Al. 5min	Enabled	
Pause Al. 10min	Enabled	
Auto Alarms Off	Off	
Alarm Off Reminder	Off	
Visual Latching	Red & Yell	Red Only
Audible Latching	Red & Yell	Off
Alarm Reminder	On	
Reminder Time	3 min	
Alarm Sounds	Traditional	
Red Alarm Interval	10 sec	
Yel. Al. Interval	20 sec	
Alarm Low	4	2
Red Alarm Volume	AlarmVol +2	
Yell. Alarm Volume	AlarmVol +0	
Inop Volume	AlarmVol +0	
Auto Increase Vol.	2 Steps	
Increase Vol Delay	20 sec	
Keep Blinking	No	
Relay 1 Sensitiv.	R & Y & I	
Relay 2 Sensitiv.	Red & Yell	
Relay 3 Sensitiv.	Red	
Inop Relay Latency	5 sec	
Yel. Relay Latency	2 sec	
Alarm Text	Standard	
No Centr Mon Min Vol	4	

ECG, Arrhythmia, and ST Default Settings

ECG Settings	Factory defaults H10 / H20 / H40			H30 (deviations from H10/20/40)		
	Adult	Pedi	Neo	Adult	Pedi	Neo
High Limit	120 bpm	160bpm	200 bpm			
Low Limit	50 bpm	75 bpm	100 bpm			
Alarms	On					
Alarm Source	HR			Auto		
ECG	On					
QRS Volume	1					

ECG Settings	Factory defaults H10 / H20 / H40			H30 (deviations from H10/20/40)		
	Adult	Pedi	Neo	Adult	Pedi	Neo
Primary Lead	II					
Secondary Lead	V					
Analysis Mode	Multi-lead					
Lead Placement	Standard					
Mod. Lead Placment	Off					
Filter	Monitor			Filter		
Speed	25mm/s					
Auto Filter	Off					
Default ECG Size	x1					
Color	Green					
Asystole Thresh	4.0 sec		3.0 sec			
Δ ExtrTachy	20 bpm					
Tachy Clamp	200 bpm	220 bpm	240 bpm			
Δ ExtrBrady	20 bpm					
Brady Clamp	40 bpm		50 bpm	40 bpm	60 bpm	80 bpm
ALL ECG IN.	On					
Fallback	On					
Alarms Off	Enabled					
Alarm Source Sel.	Enabled					

Arrhythmia Settings	Factory defaults H10 / H20 / H40			H30 (deviations from H10/20/40)		
	Adult	Pedi	Neo	Adult	Pedi	Neo
Arrhythmia	On		Off	Off		
Pause Threshold	2.0 sec		1.5 sec			
VTach HR	100	120	150			
VTach Run	5					
Vent Rhythm	14					
SVT HR	180	200	210			
SVT Run	5					
PVCs/min	10	5	5			
Non-Sustain	On					
Vent Rhythm	On					
Run PVCs	On					
Pair PVCs	On			Off		
R-On-T PVCs	On			Off		
V. Bigeminy	On			Off		
V. Trigeminy	On			Off		
PVCs/min	On			Off		
Multif. PVCs	On			Off		
Pacer N. Cap	On					
Pacer N. Pac	On					
Pause	On			Off		
Missed Beat	On			Off		
SVT	On					
IrregularHR	On			Off		
TimeOut 1st	3 min					
TimeOut 2nd	10 min					
Arrhy Off Message	Yes					
SOME ECG IN	On			Off		

Lead-independent ST Settings	Factory Adult	Factory Pedi	Factory Neo
ST Alarm Mode	Single ST		
Alarms	On		
ST Analysis	On	Off	
ST-Index	On		
ISO Point	-80 ms		
J Point	48 ms		
ST Point	J+60		

Lead I, II, III, V, aVR, aVL, aVF, V1-6, MCL Settings	Factory Adult	Factory Pedi	Factory Neo
ST(Label)	On	Off	
For Alarm Mode = Single-ST			
ST(Label) High	+2.0 mm		
ST(Label) Low	-2.0 mm		
For Alarm Mode = Multi-ST			
ST(Label) High	+1.0 mm		
ST(Label) Low	-1.0 mm		

Pulse Default Settings

Pulse Settings	Factory defaults H10 / H20 / H40			H30 (deviations from H10/20/40)		
	Adult	Pedi	Neo	Adult	Pedi	Neo
Alarm Source	HR			Auto		
Pulse (Label)	On					
System Pulse	SpO2			Auto		
Alarms Off	Enabled					
Alarm Source Sel.	Enabled					

Pulse Alarm Settings	Factory defaults H10 / H20 / H40			H30 (deviations from H10/20/40)		
	Adult	Pedi	Neo	Adult	Pedi	Neo
Pulse (SpO2)	on					
Pulse Alarms	on					
High Limit	120 bpm	160 bpm	200 bpm			
Low Limit	50 bpm	75 bpm	100 bpm			
Δ Extr Brady	20 bpm					
Brady Clamp	40 bpm	40 bpm	50 bpm			
Δ Extr Tachy	20 bpm					
Tachy Clamp	200 bpm	220 bpm	240 bpm			

Pulse alarms use the settings of the currently selected Pulse alarm source.

Respiration Default Settings

Respiration Settings	Factory defaults H10 / H20 / H40			H30 (deviations from H10/20/40)		
	Adult	Pedi	Neo	Adult	Pedi	Neo
High Limit	30 rpm		100 rpm			
Low Limit	8 rpm		30 rpm			
Apnea Time	20 sec					
Alarms	On					
Resp	On			Off		
Auto/Manual	Auto (Trigger Mode)					
Resp Speed	6.25mm/s					
Color	Yellow			White		

SpO₂ Default Settings

SpO ₂ Settings	Factory Adult	Factory Pedi	Factory Neo
Alarms	On		
QRS Volume	1		
Tone Modulation	Yes		
Tone Mod. Type	Enhanced		
Speed	25mm/s		
Perfusion	On		
Average	10 sec		
NBP Alarm Suppr.	On		
Extd. Auto OnOff	Disabled		
Color	Cyan		

SpO ₂ Alarm Default Settings			
Setting	adult	pediatric	neonatal
Desat Limit	80	80	80
Low Limit	90	90	85
High Limit	100	100	95
Desat delay	20 sec	20 sec	20 sec
High Alarm delay	10 sec	10 sec	10 sec
Low Alarm delay	10 sec	10 sec	10 sec
Parameter Alarms On/Off	on	on	on
Label	SpO ₂	SpO ₂	SpO ₂
Pulse Settings			
Pulse (SpO ₂) On/Off	on	on	on

SpO ₂ Alarm Default Settings			
Setting	adult	pediatric	neonatal
Pulse Alarms On/Off	on	on	on
Pulse High Limit	120 bpm	160bpm	200 bpm
Pulse Low Limit	50 bpm	75 bpm	100 bpm
Δ Extr Brady	20 bpm	20 bpm	20 bpm
Brady Clamp	40 bpm	40 bpm	50 bpm
Δ ExtrTachy	20 bpm	20 bpm	20 bpm
Tachy Clamp	200 bpm	220 bpm	240 bpm

NBP Default Settings

NBP Settings	Factory defaults H10 / H20 / H40			H30 (deviations from H10/20/40)		
	Adult	Pedi	Neo	Adult	Pedi	Neo
Auto/Manual	Auto		Manual			
Alarms from	Sys.					
High Alarm Limit	160/ 90 (110)	120/ 70 (90)	90/ 60 (70)	180/ 90 (110)		
Low Alarm Limit	90/ 50 (60)	70/ 40 (50)	40/ 20 (24)	70/ 50 (65)		
Alarms	On					
NBP	On					
Repetition Time	15 min			3 min		
Unit	mmHg					
Done Tone	Off			On		
Start Time	Synchronized			NotSynchron.		
VP Pressure	60 mmHg	40 mmHg	30 mmHg			
Reference	Auscultatory		Invasive			
Color	Red			Magenta		

Temperature Default Settings

Temp Settings	Factory defaults H10 / H20 / H40			H30 (deviations from H10/20/40)		
	Adult	Pedi	Neo	Adult	Pedi	Neo
Low Limit	36			35		
High Limit	39					
Alarms	On					
Unit	°C					
Range	35...43			30 ... 43		
Color	Green			Light Green		

Invasive Pressure Default Settings

ABP, ART, Ao, BAP, FAP, I, P1, P2, P3, P4, UAP Settings	Factory defaults H10 / H20 / H40			H30 (deviations from H10/20/40)		
	Adult	Pedi	Neo	Adult	Pedi	Neo
Alarms from	Sys.					
High Limit	160/ 90 (110)	120/ 70 (90)	90/ 60 (70)	180/ 90 (110)		
Low Limit	90/ 50 (70)	70/ 40 (50)	55/ 20 (35)	70/ 50 (70)		
Alarms	On					
Scale	150	100	100			
Speed	25mm/s					
Mean Only	No					
Filter	12 Hz					
Mercury Cal.	Yes					
Artifact Suppr.	60 sec					
Unit	mmHg					
Color	Red					

CVP, RAP, LAP, UVP Settings	Factory defaults H10 / H20 / H40			H30 (deviations from H10/20/40)		
	Adult	Pedi	Neo	Adult	Pedi	Neo
Alarms from	Mean					
High Limit	14 / 6 (10)	10 / 2 (4)	10 / 2 (4)			
Low Limit	6 / -4 (0)	2 / -4 (0)	2 / -4 (0)			
Alarms	On					
Scale	30					
Speed	25mm/s					
Mean Only	Yes					
Filter	12 Hz					
Mercury Cal.	Yes					
Artifact Suppr.	60 sec					
Unit	mmHg					
Color	Cyan			Blue		

Invasive Pressure Settings	PAP Settings			ICP, IC1, IC2 Settings		
	Factory Adult	Factory Pedi	Factory Neo	Factory Adult	Factory Pedi	Factory Neo
Alarms from	Dia.			Mean		
High Limit	35 / 16 (20)	60 / 4 (26)	60 / 4 (26)	14 / 6 (10)	10 / 2 (4)	10 / 2 (4)
Low Limit	10 / 0 (0)	24 / -4 (12)	24 / -4 (12)	6 / -4 (0)	2 / -4 (0)	2 / -4 (0)
Alarms	On			On		
Scale	30			30		
Speed	25mm/s			25mm/s		

Invasive Pressure Settings	PAP Settings			ICP, IC1, IC2 Settings		
	Factory Adult	Factory Pedi	Factory Neo	Factory Adult	Factory Pedi	Factory Neo
Mean Only	No			Yes		
Filter	12 Hz			12 Hz		
Mercury Cal.	Yes			Yes		
Artifact Suppr.	60 sec			60 sec		
Unit	mmHg			mmHg		
Color	Yellow			Magenta		

Cardiac Output Default Settings

C.O. Settings	Factory defaults H10 / H20 / H40			H30 (deviations from H10/20/40)		
	Adult	Pedi	Neo	Adult	Pedi	Neo
Auto-Calibration	On					
Tblood High Limit	39.0 °C					
Tblood Low Limit	36.0 °C					
Tblood Alarm On/Off	On					
Temperature Unit	°C					
Color	Green			Yellow		

CCO/CCI Settings	Factory Adult	Factory Pedi	Factory Neo
Settings common to CCO and CCI			
Alarms from	CCO		
CCO from	ABP		
Color	Green		
CCO			
Alarms	On		
CCO High Limit	8.5 l/min	3.7 l/min	1.3 l/min
CCO Low Limit	4.0 l/min	2.6 l/min	0.3 l/min
CCI			
Alarms	On		
CCI High Limit	4.3 l/min/m ²	3.7 l/min/m ²	5.2 l/min/m ²
CCI Low Limit	2.0 l/min/m ²	2.6 l/min/m ²	1.2 l/min/m ²

CO₂ Default Settings

CO ₂ Settings	Factory defaults H10 / H20 / H40			H30 (deviations from H10/20/40)		
	Adult	Pedi	Neo	Adult	Pedi	Neo
etCO ₂ low	30			25		
etCO ₂ high	50			60		
imCO ₂ high	4					
CO ₂ Alarms	on					
Unit	mmHg					
Scale	40 mmHg			50		
ImCO ₂	on			Off		
N ₂ O Corr (only M3015A/ M3016A)	Off					
Oxygen Corr (only M3014A)	16%					
Gas Corr (only M3014A)	Off					
Humidity Corr	BTPS					
Max Hold	Off					
AwRR	On					
AwRR Alarms	On					
AwRR high limit	30		100			
AwRR low limit	8		30			
Apnea time	20 secs					
Color	Yellow			White		

Spirometry Default Settings

Spirometry Settings	Adult	Pedi	Neo
APNEA high limit	20	20	20
MVexp low limit	4.0	2.5	0.4
MVexp high limit	8.0	4.0	0.8
PIP high limit	40	25	20
PEEP low limit	0	0	0
PEEP high limit	25	25	25
RRspir low limit	8	8	30
RRspir high limit	30	30	60
AWF scale	±150 l/min	±100 l/min	±20 l/min
AWV scale	±800 ml	±200 ml	±50 ml
AWP scale	±40 cmH ₂ O	±40 cmH ₂ O	±20 cmH ₂ O

tcGas Default Settings

tcGas Settings	Factory Adult	Factory Pedi	Factory Neo
tcpO ₂ High	80 mmHg		
tcpO ₂ Low	50 mmHg		
tcpO ₂ Alarms	On		
tcpCO ₂ High	50 mmHg		
tcpCO ₂ Low	30 mmHg		
tcpCO ₂ Alarms	On		
Site Time	4.0 hours		
Disable Timer	Not Allowed		
Heat Switch Off (i.e., after Site Timer elapsed)	No		
Transducer Temp.	43.0 °C		
CO ₂ Correction (<i>Severinghaus</i>)	On		
Metabolism Factor	8 mmHg		
TcGas Unit	mmHg		
Temperature Unit	°C		
tcpO ₂ Color	Blue		
tcpCO ₂ Color	Green		

SvO₂ Default Settings

SvO ₂ Settings	Factory Adult	Factory Pedi	Factory Neo
Low Limit	60%		
High Limit	80%		
Alarms	On		
Light Intensity	On		
Color	Yellow		

EEG Default Settings

EEG Settings	Factory Adult	Factory Pedi	Factory Neo
TP, SEF	On		
MDF, PPF, Delta, Theta, Alpha, Beta	Off		
SEF Threshold	90 %		
Numeric Average	8 sec		
Wave Scale	100uV (or +/- 50uV if Show Gridlines is configured to Yes)		
Show Gridlines	No		
Low Filter	0.5 Hz		
High Filter	30 Hz		
Impedance Limit	5 kOhm		
Smoothing CSA	On		
Color	Yellow		

BIS Default Settings

BIS Settings	Factory defaults H10 / H20 / H40			H30 (deviations from H10/20/40)		
	Adult	Pedi	Neo	Adult	Pedi	Neo
SQI	On					
EMG	On					
SR	On					
SEF	Off					
TP	Off					
Bursts	On			Off		
Scale	100uV (or +/- 50uV if Show Gridlines is configured to Yes)					
Show Gridlines	No					
Filters	On					
Low Filter	2 Hz					
High Filter	70 Hz					
Notch Filter	On					
High Alarm Limit	70					
Low Alarm Limit	20					
Alarms	On					
Smoothing Rate	30 sec			15 sec		
Color	Yellow			Magenta		

VueLink Default Settings

Device Alarms	Ignored
Color	Green

#

- 10-lead placement (ECG) 100
- 12-lead placement (ECG) 100
- 3-lead placement (ECG) 98
- 4-channel recorder 258
- 5-lead placement (ECG) 98

A

- AAMI ECG lead labels 97
 - abdominal breathing
 - and Resp electrode placement 132
 - aberrantly conducted beats 108
 - AC power input 332
 - accessories
 - 10-electrode cable sets 310
 - 3-electrode cable sets 309
 - 3-electrode one piece cables 310
 - 5-electrode cable sets 310
 - 5-electrode one piece cables 310
 - Aspect Medical Systems 322
 - C.O. 319
 - CO2 176, 181, 188
 - CO2 (mainstream) 320
 - CO2 (microstream) 321
 - ECG 309
 - EEG 322
 - Hospira Inc. 323
 - NBP
 - adult cuffs 312
 - comfort cuffs 311
 - disposable cuffs 311
 - multi-patient comfort cuff kits 311
 - neonatal/infant cuffs (disposable) 312
 - reusable cuffs 311
 - single-hose disposable cuffs 312
 - Nellcor 313
 - pressure 313
 - Pulsion 313
 - recorder paper 324
 - resp 309
 - set combiners and organizers 311
 - SpO2 313
 - Nellcor adhesive sensors (disposable) 313
 - Philips sensors (disposable) 313
 - Philips sensors (reusable) 313
 - SvO2 323
 - temperature 318
 - trunk cables 309
- active alarms 41
 - address, Philips 326
 - addressograph (printer configuration setting) 272
 - adjusting ST measurement points 120
 - adjusting wave scale (pressure) 154

- adjusting wave size (CO2) 183, 192
- admit
 - editing information 79
 - quick admit 78
- admitting a patient 77
- advanced event surveillance 241
- airway adapter
 - CO2, microstream accessory 182
- alarm latching 51, 52, 113
- alarm limits
 - changing 48
 - checking 46
 - manually adjusting 48
 - narrow 49
 - report 273
 - setting 46
 - ST 122
 - switching auto limits on/off 49
 - using automatic limits 49
 - wide 49
 - window 47
- alarm recording 259
 - choosing recorded measurements 261
- alarm source selection, disabled 129
- alarm status area 14
- alarms
 - acknowledging 44
 - active 41
 - active SpO2 source 141
 - alphabetical listing 53
 - apnea delay 184, 192
 - apnea delay time (Resp) 134
 - arrhythmia 41
 - audible indicators 42
 - awrr limits 184
 - chaining 115
 - CO2 specific 184
 - CO2, apnea delay 184, 192
 - CO2, awRR 184
 - desat, SpO2 140
 - effect on pressure alarms during zero 153
 - extending pause time 46
 - high priority 41
 - INOP 41
 - ISO/IEC standard 9703-2 43
 - limit, SpO2 352
 - NBP source 147
 - patient messages 53
 - pausing 44
 - physiological 53
 - pleth as source 141
 - red 41
 - reminder 44
 - restarting 46
 - reviewing 50
 - reviewing messages 50

- reviewing window 50
 - selftest 52
 - silencing 44
 - SpO2 high and low limits 140
 - SpO2 specific 140
 - ST 122
 - suspended symbol 45
 - SvO2, behavior during measurement 204
 - switching on and off 45
 - temperature 149
 - testing 52
 - tone configuration 42
 - traditional 43
 - visual indicators 42
 - volume, changing 43
 - VueLink and external devices 283
 - yellow 41
- alphabetical listing of alarms 53
 - alternating current symbol 328
 - analog interface symbol 329
 - analog output
 - ECG 329
 - pressure 160
 - analog video out connector 332
 - annotating events 251
 - annotation
 - recording strip 262
 - apnea alarm delay
 - CO2 184, 192
 - apnea alarm delay time (RESP) 134
 - apnea alarms
 - and Resp detection modes 134
 - Application Server 33
 - arrhythmia
 - aberrantly conducted beats 108
 - analysis, how it works 107
 - atrial fibrillation and flutter 108
 - beat labels 109
 - initiating learning 111, 112
 - intermittent bundle branch block 109
 - learning during ventricular rhythm 112
 - levels of analysis 104, 107
 - monitoring non-paced patients 108
 - monitoring paced patients 108
 - options 107
 - relearning 111
 - relearning and lead fallback 112
 - status messages 110
 - switching on/off 108
 - understanding the display 109
 - arrhythmia alarms 41, 112
 - adjusting alarm limits 113
 - all yellow on/off 113
 - chaining 115
 - latching 113
 - multiple 115

- pvc-related alarms 116
 - short yellow 105
 - sinus and SV rhythm ranges 350, 352
 - switching on/off 113
 - timeout periods 113
 - yellow 113
- arrhythmia monitoring
 - and defibrillation 106
- arrhythmia options 104
- arrhythmia relearning
 - with EASI INOP 102
- arterial catheter constant (PiCCO) 166
- arterial pressure source 157, 158
- arterial pulsation 137
- arterial values 195
- artifact suppression (pressure) 155
- Aspect Medical Systems Inc 327
- atrial fibrillation and flutter 108
- audlatching (arrhythmia alarms) 113
- auto alarm limits
 - switching on/off 49
 - using 49
- auto detection mode (Resp) 132
- auto ECG wave gain (recordings) 261
- auto window (care groups) 88
- autofilter 95
- automatic arrhythmia relearn 112
- automatic default setting 26
- automatic NBP
 - repeat time 146
- autosize
 - ECG wave 94
- average trend events 243
- awRR alarm
 - limits 184
- awRR alarms
 - CO2 184

B

- backlight
 - maintenance interval 306
- balloon inflation, wedge measurement 159
- baseline
 - ST map, updating 125
 - ST, updating 119
- basic arrhythmia option 104, 107
- basic event surveillance 241
 - setup 245
- battery
 - and display brightness 302
 - battery compartment location 297, 298
 - battery reports 300
 - battery status recording 300

- battery status window 300
- charge status 301
- conditioning 302
- conserving power 302
- LED 298
- malfunction symbols 298
- power gauge 298
- recharging 298
- replacing 301
- safety information 303
- symbol 329

- battery operation
 - MP20 MP30 297
 - MP40 MP50 297

- beat labels
 - arrhythmia 109

BIS

- BIS engine software revision 221
- cables, securing 221
- Continuous Impedance Check 218
- Cyclic Impedance Check 218
- filters 220
- Ground Check 218
- impedance indicators 219
- monitoring 215
- monitoring setup 216
- numeric 215
- numerics
 - on/off 220
- safety information 221
- smoothing rate
 - changing 220
- updating software 221
- window 219

- Bispectral Index monitoring 215

- blood pressure. See also NBP (non-invasive) or PRESS (invasive)
- Brightness SmartKey 31
- brightness, adjusting 31
- BSA formula (trends) 236
- buffer (EEG) 211
- buffer (EEG) on reports 213
- buffer (EEG) on screen 212
- bursts numeric (BIS) 215

C

- C.I. 162
- C.O. 161
 - accessories 319
 - calibrating measurements (PiCCO) 167
 - curve alert messages 171
 - documenting measurements 169
 - editing measurements (PiCCO) 166
 - editing measurements (RH method) 169
 - flow-through method 168

- hemocalc window 164
- hemodynamic parameters available 162
- injectate guidelines 170
- PiCCO method 164
- Procedure window 163
- prompt messages 172
- results table 163
- right heart thermodilution method 168
- saving measurements (PiCCO) 167
- setup for PiCCO method 165
- setup for RH method 168
- setup menu 164
- temperature unit 163

- C.O. warning messages 173

- C.O./CCO safety information 173

- Calc Type 233

- calculating
 - drug infusions 277
- calculating cerebral perfusion 157
- calculating oxygen extraction 206
- calculating pulse pressure variation 157
- calculating temperature difference 150
- calculations 233
 - pop-up keys 234
- calculations reports 237
- calculations review 235
- calculator 20
- calibrating
 - CO2 transducer 180
 - tcGas transducer 199
- calibrating C.O. measurements 167
- calibration
 - interval, NBP 306
 - NBP 147
 - pressure 156
 - pressure transducer 156
 - SvO2 light intensity 205
 - SvO2 required equipment 203
 - SvO2, in-vivo 206
 - SvO2, pre-insertion 204
- calibration status indicators (C.O) 167

- capnography
 - mainstream 12
 - Microstream 12

- capturing loops 290

- carbon dioxide, see CO2 175, 187

- cardiac output
 - how the measurement works 161
 - report 275

- cardiac overlay
 - and Resp detection modes 133
 - when measuring Resp 131

- cardiotach alarms 104

- care groups
 - alarm notification 88

- other bed window 87
 - pop-up window 88
 - catheter
 - SvO₂, insertion 205
 - catheter constant, setting (PiCCO) 166
 - catheter preparation
 - SvO₂ 204
 - cautions 1
 - CCO
 - calibration status indicators 167
 - choosing the correct pressure source 166
 - how the measurement works 161
 - PiCCO method 164
 - central recorder
 - choosing 261
 - cerebral perfusion 157
 - CFI 162
 - chaining 115
 - change screen menu 22
 - changing ECG lead sets 96
 - changing EEG wave scale 212
 - changing EEG wave speed 213
 - changing Resp detection mode 132
 - changing Resp wave size 133
 - changing Resp wave speed 134
 - changing screen content 22
 - changing screens 22
 - changing wave scale
 - EEG 220
 - channels
 - recorder 261
 - checking battery charge 301
 - checking paced status 92
 - cleaning
 - infection control 293
 - method 294
 - monitoring accessories 294
 - recommended substances 294
 - recorder printhead 295
 - CO₂
 - airway adapter 182
 - alarms, apnea delay 184, 192
 - alarms, awRR 184
 - alarms, specific 184
 - awRR alarm limits 184
 - checking transducer accuracy 179
 - correction, humidity 183
 - correction, N₂O 183
 - corrections 183, 192
 - FilterLine 182
 - mainstream accessories 176, 188
 - measuring mainstream 176, 179
 - measuring microstream 181
 - method, mainstream 175
 - method, microstream 175
 - method, sidestream 175
 - microstream accessories 181
 - microstream extension 181
 - removing exhaust gases 179, 182
 - transducer, calibrating 180
 - transducer, using 180
 - troubleshooting 183, 192
 - wave scale, adjusting 183, 192
 - CO₂ (mainstream).
 - accessories 320
 - CO₂ (microstream).
 - accessories 321
 - code
 - recording 262
 - combi-events 248
 - Compressed Spectral Arrays (CSA) 211
 - computation constant (RH) 169
 - conditioning batteries 302
 - configuration
 - drug calculator 278
 - trends database 229
 - configuration mode 21
 - conflict
 - label 29
 - connecting BIS accessories 216
 - connecting temperature probe 149
 - connection direction indicator symbol 328
 - connection direction symbol 328
 - connector
 - AC power input 332
 - additional MSL 333
 - analog video out 332
 - ECG analog (sync) output 330, 332, 333
 - equipotential ground 332
 - marker input 345
 - MMS patient cable 333
 - mouse 332
 - MSL 332
 - printer 332
 - protective earth 332
 - recorder module 333
 - trackball 332
 - wired network 332
 - wireless network 332
 - connectors 329
 - serial/MIB 330, 331, 332
 - continuous cardiac output 161
 - Continuous Impedance Check (BIS) 218
 - conventional 12-lead ECG 100
 - correcting the NBP measurement 145
 - counting events 247
 - CPAP (RESP) 133
 - CSA (Compressed Spectral Arrays) 211
 - cuff
 - pressure, NBP 146
 - selection, NBP 145
 - current view
 - ST map 122
 - curve alert messages (C.O.) 171
 - Cyclic Impedance Check (BIS) 218
- ## D
-
- damage
 - mechanical 32
 - database
 - events 247
 - database configuration
 - trends 229
 - date, setting 31
 - default profile 26
 - default settings 369
 - defibrillation
 - and arrhythmia monitoring 106
 - and ECG monitoring 106
 - and monitoring BIS 221
 - during EEG monitoring 214
 - synchronization marks 93
 - defibrillator input 345
 - defibrillator proof symbol 328
 - defibrillator synch
 - maintenance interval 306
 - delay time
 - recording 261
 - delayed recording 259
 - deleting events 247
 - demonstration mode 21
 - desat alarm, SpO₂ 140
 - detection modes (Resp) 132
 - device driver
 - language conflict with monitor 284
 - diagnostic (ECG filter setting) 96
 - digital interface symbol 329
 - digital video device connection symbol 328
 - disabling touch operation 15
 - discharging a patient 79
 - disconnect INOPs
 - silencing 44
 - disinfecting
 - infection control 293
 - recommended substances 294
 - display
 - arrhythmia 109
 - ECG 93
 - NBP 145
 - Resp 132
 - ST 118
 - using a second display 23
 - display brightness 302

- display settings 24
 - disposal
 - gas cylinder 307
 - parts and accessories 307
 - documenting events 251
 - dosemeter (drug calculator) 279
 - dPmax 162
 - drip table (drug calculator) 280
 - drug calculator 277
 - DSC (BIS)
 - software revision 221
 - dual SpO2 141
 - dual Temp measurement 150
 - dyshemoglobins
 - intravascular (SpO2) 139
- ## E
-
- early systolic blood pressure, NBP 146
 - EASI
 - activating 96
 - ECG monitoring 102
 - lead placement 102
 - EASI ECG lead labels 97
 - ECG 91
 - accessories 309
 - alarms off (Config Mode) 105
 - changing lead sets 96
 - choosing electrode sites 96
 - conventional 12-lead 100
 - external pacing electrodes 106
 - filter settings 95
 - fusion beat pacemakers 106
 - intrinsic rhythm 106
 - modified 12-lead 100
 - New Lead Setup 96
 - pacemaker failure 106
 - rate adaptive pacemakers 106
 - unfiltered 96
 - wave size 94
 - ECG analog (sync) output 330, 332, 333
 - ECG analog output 329
 - ECG cable
 - for operating room 106
 - ECG cables, connecting 91
 - ECG connector 91
 - ECG display 93
 - ECG electrode colors 97
 - ECG electrode placement
 - during electrosurgery 106
 - ECG gain
 - in recordings 261
 - in reports 268
 - ECG lead labels 97
 - ECG lead placement
 - choosing EASI/Standard 96
 - ECG leads monitored 96
 - ECG output 345
 - ECG report 276
 - lead layout 268
 - ECG safety information 105
 - ECG wave
 - autosize 94
 - calibration bar 94
 - ectopic status messages (arrhythmia monitoring) 111
 - editing C.O. measurements (PiCCO method) 166
 - editing C.O. measurements (RH method) C.O.
 - saving measurements (RH method) 169
 - EEG
 - accessories 322
 - monitor configuration and upgrade 214
 - EEG monitoring 207
 - buffer time 211
 - changing filter frequencies 213
 - changing wave scale 212
 - changing wave speed 213
 - choosing electrode montages 209
 - CSAs 211
 - electrical interference 214
 - electrode-to-skin impedance 210
 - gridlines 212
 - impedance quality indicators 210
 - Impedance/Montage Window 208
 - international 10-20 electrode placement system 209
 - safety information 214
 - setting report buffer time 213
 - setting screen buffer time 212
 - setup 208
 - skin preparation 208
 - switching numerics on and off 212
 - EEG wave
 - changing scale 220
 - electrical input symbol 328
 - electrical interference
 - during EEG monitoring 214
 - electrical output symbol 328
 - electrode montage
 - EEG 209
 - electrode placement (ECG) 91
 - conventional 12-lead 100
 - modified 12-lead 100
 - electrode placement (Resp) 131
 - with abdominal breathing 132
 - with lateral chest expansion 132
 - electrode-to-skin impedance (BIS) 219
 - electrode-to-skin impedance (EEG) 210
 - electromyographic activity numeric (BIS) 215
 - electrosurgery
 - and ECG 106
 - EMC interference
 - Resp 134
 - EMG numeric (BIS) 215
 - EMI filter for ECG 95
 - end case
 - discharging a patient 79
 - report, printing 79
 - end case reports
 - setup 269
 - enhanced arrhythmia option 104, 107
 - entering values
 - calculations 236
 - equipotential ground connector 332
 - equipotential grounding symbol 328
 - event
 - annotation 251
 - combi-events 248
 - counting oxyCRG/NER events 248
 - event counter 247
 - event episode 242
 - event episode recording 253
 - event episode types 243
 - event episode window 250
 - event post-time 242
 - event pre-time 242
 - event retriggering 245
 - event review recording 252
 - event review window 249
 - event summary view 249
 - event time 242
 - event triggers 244
 - event values 251
 - manual event triggers 246
 - recording 251
 - setting up NER 245
 - event database 247
 - event episode reports 270
 - event groups 242
 - event report 254
 - event review reports 270
 - event snapshots 243
 - event surveillance 241
 - options 241
 - events pop-up keys 243
 - EVLW/EVLWI 162
 - exclamation mark symbol 328
 - exhaust gases, removing 179, 182
 - extension cable for SpO2 138
 - external devices
 - alarms and INOPS 283
 - connecting to VueLink 281

connecting via VueLink 282
external pacing electrodes
and ECG monitoring 106
extreme bradycardia alarm 105, 129
extreme rate alarms 105, 129
extreme tachycardia alarm 105, 129

F

fallback (ECG) 97
FAST
Fourier artefact suppression
technology 137
filter (ECG filter setting) 95
filter (ECG) 95
filter frequencies (EEG) 213
FilterLine
CO₂, microstream accessory 182
filters
BIS 220
flexible module server - see FMS 8
flushing invasive pressure accessories 151
FMS
connecting to monitor 8
modules 8
functional arterial oxygen saturation 137
fusion beat pacemakers
and ECG monitoring 106

G

gas cylinder
empty, disposing of 307
gas input symbol 328
gas output symbol 328
GEDV/GEDVI 162
getting started 32
global trend time 230
graphic trend
report 225
graphic trends 224
graphic trends report 228
gridlines (EEG) 212, 220
Ground Check (BIS) 218

H

hardkeys 19
help
INOPS 51
hemodynamic calculations 233
hemodynamic measurement server
extension 13
hemodynamic parameters 162
high filter (EEG) 213

high pass filter (BIS) 220
high resolution recording 259
high-res trend event episodes 243
high-res trend waves
about 239
OxyCRG 239
high-res waves
in reports 240
list of available measurements 343
recordings 240

HiResTrnd
see high-res trend 243
horizon trend
trend time 230
HR = RR (Resp) 132
HR alarms
when arrhythmia off 105
HR alarms off (Config Mode) 105
HR and pulse alarm source selection 129
HR from (heart rate source) 128
humidity correction
CO₂ 183

I

IEC ECG lead labels 97
impedance indicators (BIS) 219
impedance quality indicators 210
IMV (Resp) 133
independent display connection
symbol 328
infection control
cleaning 293
disinfecting 293
sterilizing 293
Information Center
central recording 258
transferring patients 80
injectate guidelines for C.O. 170
injectate volume setting (C.O.) 166
INOPs
from external devices 283
indicators 41
silencing 44
input
defibrillator 345
installation
connectors 329
Instructions for Use
intended audience 1
integrated module slots (MP40 50 60
70) 257
IntelliVue family 1
intermittent bundle branch block 109
intermittent mandatory ventilation

(Resp) 133
interruption symbol 328
intravascular dyshemoglobins (SpO₂) 139
intrinsic rhythm 106
invasive pressure 151
in-vivo calibration, SvO₂ 206
ISO point (ST) 120
ITBV/ITBVI 162

J

J point (ST) 120

K

keyboard connection symbol 328
keys
hardkeys 19
permanent keys 17
pop-up 19
SmartKeys 18

L

label conflict resolution 29
labels
resolving conflict 30
language conflicts with device driver 284
latching
alarms 51
alarms, behavior 52
latching arrhythmia alarms 113
lateral chest expansion (neonates)
monitoring Resp 132
LCW/LCWI 162
lead fallback
and arrhythmia relearning 112
lead fallback (ECG) 97
lead labels (ECG) 97
lead placement
activating EASI/Standard 96
for Resp measurement 131
leads monitored (ECG) 96
Leads Off INOP (ECG) 97
LED
battery status 298
levels of arrhythmia analysis 107
levels of event surveillance 241
line frequency interference (BIS) 220
loops 289
capturing 290
loop size in window 291
loops report 292
source device 291
volume-flow 289
low filter (EEG) 213

- low pass filter (BIS) 220
- LVC1 162
- M**

- M1116B 257
- M3160A recorder 258
- main screen overview 14
- mainstream
 - capnography 12
- mainstream CO2
 - accessories 176, 188
 - measuring 176, 179
- maintenance
 - cables 305
 - cords 305
 - measurements, schedule 306
 - microstream CO2, calibration 306
 - schedule 305
 - visual inspection 305
- major parts and keys
 - MP20 MP30 3
 - MP40 MP50 4
- malfunction symbols
 - battery 298
- manual detection mode (Resp) 133
 - and apnea alarms 134
- manually triggering events 246
- manufacture date symbol 328
- manufacturer's information 326
- map
 - ST 122
- marker input connector 345
- Mason-Likar lead system 100
- max hold setting (CO2) 175
- MDF (mean dominant frequency) 207
- mean dominant frequency (MDF) 207
- mean pressure calculation (trends) 236
- measurement
 - adjusting a wave 27
 - preparation 32
 - setting up 26
 - switching on and off 27
 - wave speed, changing 27
- measurement modules
 - setting up 32
- measurement points, ST 120
- measurement selection window 31
- measurement server
 - ECG connector 91
- measurement server extension
 - M3012A 13
 - M3015A 12
 - M3016A 12
- measurement server link cable 8
 - measurement server link connection symbol 328
 - measurement servers
 - setting up 32
 - measurement settings 24
 - mechanical damage 32
 - merging patient data 84
 - methemoglobin (SpO2) 139
 - MIB connector 330, 331, 332
 - Microstream capnography 12
 - microstream CO2 181
 - accessories 181
 - maintenance, calibration 306
 - measuring 181
 - minimize 34
 - mismatch
 - patient data, resolving 82
 - MMS
 - connecting to FMS 10
 - connecting to monitor 10
 - patient cable connector 333
 - using for patient transfer 81
 - modified 12-lead ECG 100
 - modified screen history 22
 - modifying
 - screens 22
 - module
 - connecting 9
 - reconnecting 9
 - removing 9
 - setup key 9
 - setup menu 9
 - tcGas 195
 - unplugging 9
 - VueLink 281
 - VueLink Type A and Type B 281
 - modules
 - setting up 32
 - monitor
 - inspecting before use 32
 - starting monitoring 33
 - switching on 32
 - monitor (ECG filter setting) 95
 - monitor defaults 369
 - monitor revision
 - how to find 32
 - monitor settings 24
 - changing 31
 - monitoring
 - preparation 32
 - monitoring BIS 215
 - monitoring EEG 207
 - monitoring mode 21
 - mouse
 - using 17
- mouse connection symbol 328
- mouse connector 332
- MP20 2
- MP20 Junior 2
- MP20 MP30
 - major parts and keys 3
 - screen menus 15
- MP30 2
- MP40 4
- MP40 MP50
 - major parts and keys 4
 - screen menus 15
- MP50 4
- MR imaging and the SpO2 transducer 139
- MSL cable 8
- MSL connector 332
- MSL, additional connector 333
- multi-lead ST alarming 122
- multi-measurement server (MMS) 10
- N**

- N2O correction
 - CO2 183
- narrow alarm limits 49
- navigating 14
 - mouse 17
 - permanent keys 17
 - SmartKeys 18
 - trackball 17
- navigation point 17
- NBP
 - adult cuffs 312
 - alarm source 147
 - ANSI/AAMI SP10-1992 143
 - automatic mode, enabling 146
 - calibrating 147
 - calibration interval 306
 - comfort cuff kits 311
 - comfort cuffs 311
 - cuff pressure 146
 - cuff, applying 145
 - cuff, selecting 145
 - cuff, tightness 145
 - disposable cuffs 311
 - how the measurement works 143
 - measurement correction 145
 - measurement limitations 144
 - measurement methods, auto 144
 - measurement methods, manual 144
 - measurement methods, stat 144
 - measurement, starting 146
 - measurement, stopping 146
 - neonatal cuffs (disposable) 312
 - numerics 145

- oscillometric method 143
 - pediatric cuffs 312
 - preparing to measure 144
 - repeat time 145
 - repeat time for automatic 146
 - repetition time, setting 146
 - reusable cuffs 311
 - single-hose disposable cuffs 312
 - site inspection 145
 - time of last measurement 145
 - units 145
 - venous puncture 147
 - neonatal event counting 248
 - neonates
 - Resp electrode placement 132
 - NER setup 245
 - network connection indicator 14
 - network connector, wired 332
 - network connector, wireless 332
 - networked monitoring 33
 - new features 35
 - non-invasive blood pressure. See NBP
 - non-paced patients
 - arrhythmia monitoring 108
 - notch filter (BIS) 220
 - numerics
 - explanation of NBP display 145
 - nurse call 45
 - nurse call relay connection symbol 328
- O**
-
- on screen calculator 20
 - operating 14
 - mouse 17
 - permanent keys 17
 - SmartKeys, using 18
 - trackball 17
 - operating modes 21
 - configuration 21
 - demonstration 21
 - monitoring 21
 - passcode protection 21
 - service 21
 - operating room ECG cable 106
 - orange ECG cable 106
 - organizers 311
 - Oridion Systems Ltd 327
 - Original Calc pop-up key 235
 - oscillometric NBP measurement method 143
 - other bed window 87
 - output
 - ECG 345
 - overlap
 - in recordings 261
 - overlapping screen trends 231
 - oxyCRG 239
 - event counting 248
 - OxyCRG event episodes 243
 - oxygen extraction 206
 - oxygenation calculations 233
- P**
-
- pace pulse rejection (ECG)
 - about 92
 - switching on/off 94
 - paced patients
 - arrhythmia monitoring 108
 - repolarization tails 94
 - safety information 106
 - setting status 106
 - paced status
 - checking 92
 - pacemaker failure 106
 - paper
 - reloading (recorder) 264
 - paper size
 - for reports 270
 - parallel interface symbol 328
 - parallel printer connection symbol 328
 - parameter scales
 - trends 227
 - passcode protection 21
 - patient
 - admit 77
 - category, NBP 143
 - discharge 79
 - end case 79
 - patient alarm messages 53
 - patient demographics window 77
 - patient mismatch 82
 - patient reports
 - contents 272
 - patient trends
 - viewing 223
 - paused alarms 44
 - extending time 46
 - restarting 46
 - PAWP 158
 - peak power frequency (PPF) 207
 - performance specifications
 - pressure 348, 354
 - performance test 365
 - performing calculations 235
 - perfusion indicator 137, 138, 141
 - pf loops 289
 - Philips contact information 326
 - physiological alarms 41
 - PIC cable (BIS)
 - securing 221
 - PiCCO method
 - C.O. 164
 - CCO 164
 - setup 165
 - pleth alarm source 141
 - pleth wave 140
 - pleth waveform 137
 - plug-in recorder 257
 - pop-up keys 19
 - events 243
 - power
 - disconnecting from
 - mains power
 - disconnecting from 33
 - power on symbol 328
 - PPF (peak power frequency) 207
 - PPV 157
 - preparing skin
 - for ECG 91
 - pressure
 - alarms during zero 153
 - arterial source 157, 158
 - calibration pressure 156
 - cerebral perfusion, calculating 157
 - performance specifications 348, 354
 - wave scale 154
 - wave size 154
 - wedge 158
 - wedge, editing 159
 - zeroing the transducer 152
 - pressure accessories 313
 - pressure analog output 160
 - pressure artifact suppression 155
 - pressure of NBP cuff 146
 - pressure transducer
 - calibration 156
 - zeroing 153
 - pressure-flow loops 289
 - pressure-volume loops 289
 - previous screen 22
 - primary lead (ECG)
 - selecting 92
 - print job
 - suspended 271
 - printer
 - disabling 271
 - settings 270
 - status messages 272
 - unavailable 271
 - printer connection symbol 328
 - printer connector 332

- printing
 - C.O. measurements 169
 - calculations reports 237
 - event reports 251
 - ST map reports 125
 - status log 307
 - trends reports 228
 - wedge 159
 - priority list for trends 227
 - probes
 - disposable temperature 149
 - profiles 24
 - default profile 26
 - patient category 25
 - swapping 25
 - swapping setting block 26
 - prompt messages
 - C.O. 172
 - protective earth 332
 - protective earth symbol 328
 - pulse
 - alarms 128
 - system pulse source 127
 - pulse numerics for SpO2 138
 - pulse pressure variation 157
 - Pulsion Medical Systems AG 327
 - pv loops 289
 - PVC-related alarms 116
 - PVR/PVRI 162
- ## Q
-
- QRS tone 129
 - changing volume 31
 - QRS tone pitch, SpO2 141
 - QRS volume, changing 95
 - quick admit 78
 - quick mount release symbol 328
- ## R
-
- radiated field immunity
 - Resp 134
 - rate adaptive pacemakers
 - and ECG monitoring 106
 - ratemeter (drug calculator) 279
 - RCW/RCWI 162
 - realtime recording 259
 - realtime report 274
 - realtime reports
 - content 270
 - reconnecting a module 9
 - recorder 257
 - 4-channel 258
 - cleaning the print head 295
 - paper accessories 324
 - recorder module connector 333
 - recorder status messages 265
 - recording
 - alarm 259
 - annotation 262
 - battery status 300
 - beat-to-beat 259
 - C.O. measurements 169
 - central 258
 - changing recording type 261
 - channels 261
 - choosing recorder 261
 - choosing recording speed 261
 - context 259
 - creating templates 260
 - delayed 259
 - drug calculations 280
 - ECG gain 261
 - extending 259
 - high resolution 259
 - local 257
 - preventing fading ink 263
 - procedure 259
 - realtime 259
 - recording strip 262
 - recording strip code 262
 - reloading paper 264
 - runtime 261
 - setting the runtime 261
 - setup menu 260
 - ST segments 119
 - starting and stopping 258
 - types 259
 - wave overlap 261
 - wave scale 261
 - waveforms recorded 263
 - wedge 159
 - with the plug-in recorder 257
 - recording delay time 261
 - recording events 251
 - reference waves, wedge measurement 158
 - refresh 34
 - rejecting pace pulses 92
 - related products
 - power-on LED 8
 - problem LED 8
 - switching on 8
 - relearning arrhythmia 111
 - reloading recorder paper 264
 - remembrating tCGas transducer 197
 - reminder, alarm 44
 - remote alarm device
 - alarms
 - remote device 7
 - remote applications
 - minimize 34
 - refresh 34
 - using 33
 - window size 34
 - remote SpeedPoint 16
 - removing a module 9
 - replacing batteries 301
 - repolarization tails 94
 - report
 - cardiac output 275
 - event review 254
 - reports
 - alarm limits 273
 - battery reports 300
 - calculations 237
 - choosing paper size 270
 - contents 272
 - drip table 280
 - drug calculator 280
 - ECG 276
 - end case 269
 - loops 292
 - patient trends 228
 - realtime report 274
 - re-routing 271
 - scheduled 269
 - setting up 268
 - ST map 125
 - stopping printouts 268
 - titration table 280
 - trends 225
 - re-routing reports 271
 - resampling vitals 234
 - resolution
 - trends 227
 - resolving patient mismatch 82
 - resp accessories 309
 - Resp alarms
 - apnea alarm delay time 134
 - Resp detection level
 - and apnea detection 134
 - Resp detection modes
 - and cardiac overlay 133
 - changing 132
 - Resp display 132
 - Resp monitoring
 - and cardiac overlay 131
 - Resp safety information 134
 - Resp wave
 - changing size 133
 - changing speed 134
 - respiratory loops
 - source device 291
 - restarting paused alarms 46
 - results table (C.O.) 163

- re-triggering events 245
 - retrolental fibroplasia (SpO₂) 140
 - review
 - calculations 235
 - reviewing alarm messages 50
 - reviewing alarms 50
 - reviewing alarms window 50
 - RH method
 - computation constant 169
 - rhythm status messages (arrhythmia monitoring) 110
 - right heart thermodilution method (C.O.) 168
 - right heart thermodilution setup (C.O.) 168
 - rs-232 interface symbol 328
 - rule of six 278
 - runtime
 - setting recording runtime 261
 - RVSW/RVSWI 162
- ## S
-
- safety
 - maintenance interval 306
 - monitor 336
 - safety information
 - batteries 303
 - BIS 221
 - C.O./CCO 173
 - ECG 105
 - Resp 134
 - safety test 365
 - same patient data merge 84
 - scale
 - ECG wave 94
 - Resp wave 133
 - scales
 - for trends waveforms 227
 - scheduled reports 269
 - screen
 - adjusting brightness 31
 - disabling touch operation 15
 - elements 15
 - using a second display 23
 - screen trend
 - trend time 230
 - screen trends 229
 - screens
 - changing 22
 - changing content 22
 - understanding 22
 - visitor screen 24
 - secondary lead (ECG)
 - selecting 92
 - SEF (spectral edge frequency) 207
 - SEF numeric (BIS) 215
 - on/off 220
 - selecting the primary lead (ECG) 92
 - selecting the secondary lead (ECG) 92
 - selftest
 - alarms 52
 - sensor
 - disposable SpO₂ 137
 - sensor temperature
 - tGas 196
 - serial LAN interface 329
 - serial/MIB connector symbol 328
 - service mode 21
 - set combiners 311
 - setting the arterial catheter constant (PiCCO) 166
 - setting the computation constant (RH) 169
 - setting up
 - trends 225
 - setting up reports 268
 - settings
 - about 26
 - default 369
 - measurement settings 26
 - monitor settings 26
 - screen settings 26
 - settings blocks 24
 - setup key, module 9
 - setup menu, module 9
 - setup menu, MP20 30 40 50 15
 - Setup Recording menu 260
 - short yellow alarms 105
 - signal quality index numeric (BIS) 215
 - signal quality of SpO₂ 139
 - sinus and SV rhythm ranges 350, 352
 - site timer
 - tGas 196
 - skin preparation
 - ECG 91
 - EEG 208
 - SmartKeys 18
 - smoothing rate (BIS) 220
 - snapshots
 - events 243
 - source device
 - loops 291
 - specifications 325
 - arrhythmia 348
 - spectral edge frequency (SEF) 207
 - spectral edge frequency numeric (BIS) 215
 - speed
 - recording 261
 - wave speed, changing 27
 - SpeedPoint 16
 - SpeedPoint, remote 16
 - SpO₂
 - accessories 313
 - active alarm source 141
 - alarms specific to 140
 - arterial pulsation 137
 - assessing suspicious reading 139
 - calculating difference between values 141
 - connecting the cables 138
 - disposable sensors 137
 - dual SpO₂ 141
 - extension cable 138
 - FAST technology 137
 - Nellcor adhesive sensors (disposable) 313
 - perfusion indicator 137, 138, 141
 - Philips sensors (disposable) 313
 - Philips sensors (reusable) 313
 - pleth as alarm source 141
 - pleth wave 140
 - pleth waveform 137
 - pulse numerics 138
 - QRS tone 141
 - signal quality 139
 - site inspection 139
 - site selection 137
 - tone modulation 141
 - SpO₂ desat alarm 140
 - SpO₂ limit alarms 140
 - Sp-vO₂ 206
 - SQI numeric
 - on/off 220
 - SQI numeric (BIS) 215
 - SR numeric (BIS) 215
 - on/off 220
 - ST
 - adjusting alarm limits 122
 - alarms 104, 122
 - baseline, updating 119
 - ensuring diagnostic quality 117
 - filtering 117
 - measurement points, adjusting
 - adjusting 120
 - multi-lead alarms 122
 - numerics in ECG wave 93
 - snippets 118
 - ST display 118
 - ST map
 - baseline, updating 125
 - current view 122
 - report, printing
 - printing
 - ST map report 125
 - scale, changing

- scale
 - ST map 125
- task window 124
- trend view 123
- trending interval, changing 125
- trending priority 124
- ST maps 122
- ST point 120
- standard 10-lead placement 100
- standard 3-lead placement 98
- standard 5-lead placement (ECG) 98
- standardized rate 277
- standby symbol 328
- starting monitoring 33
- status line 14
- status log
 - printing 307
- status messages
 - printer 272
 - recorder 265
- status messages (arrhythmia) 110
 - ectopic 111
 - rhythm 110
- sterilizing
 - infection control 293
- stopping reports printouts 268
- suppression ratio (BIS) 215
- surgical ECG cable 106
- suspended alarm 45
- suspicious SpO2 reading 139
- SV/SI 162
- SvO2
 - accessories 323
 - alarms 204
 - calibration equipment 203
 - catheter insertion 205
 - catheter preparation 204
 - Hospira, accessories 203
 - in-vivo calibration 206
 - light intensity calibration 205
 - measurement principle 203
 - monitoring 204
- SVR/SVRI 162
- switching on
 - monitor 32
- symbols 328
 - battery 298
- synchronization marks (defibrillator) 93
- system pulse 127
- systolic blood pressure, NBP, early 146

T

- tabular trends 224
- Tamb 150

- task window for ST map 124
- Tcereb 150
- tcGas 195
 - sensor temperature 196
 - transducer, calibrating 199
 - transducer, remembraning 197
- tcGas site timer 196
- technical alarms messages
 - see INOPs 59
- temperature 149
 - accessories 318
 - alarm settings 149
 - connecting probe to monitor 149
 - difference, calculating 150
 - dual Temp measurement 150
 - extended label set 150
 - first 150
 - label 149
 - making a measurement 149
 - probe, disposable 149
 - probe, selecting 149
 - second 150
 - tcGas sensor 196
- temperature probe
 - connecting 149
- templates
 - creating for recordings 260
- testing alarms 52
- time, setting 31
- Tinj Probe Type 165
- titration table (drug calculator) 280
- tone configuration, alarm 42
- tone mod (SpO2) 141
- tone modulation 141
- total power (TP) 207
- total power numeric (BIS) 215
- touch tone volume 31
- touchscreen 15
 - disabling 15
- TP (total power) 207
- TP numeric (BIS)
 - on/off 220
- trackball connector 332
- trackball, using 17
- trademarks 327
- transcutaneous gas measurements 195
- transducer
 - CO2, accuracy 179
 - CO2, calibrating 180
 - pressure, zeroing 152
 - tcGas, calibrating 199
 - tcGas, remembraning 197
- transferring centrally-monitored patients 80

- transferring patients with MMS 81
- transport brightness setting 302
- trend time 230
 - global 230
- trend view
 - ST map 123
- trending interval
 - ST map 125
- trends
 - automatic unit conversion 236
 - automatic value substitution 236
 - database configuration 229
 - resolution 227
 - screen trends 229
 - setting parameter scales 227
 - setup 225
 - viewing 223
- trends pop-up keys 225
- trends priority list 227
 - ST map 124
- trigger conditions
 - events 245
- triggers
 - for events 244
- troubleshooting
 - CO2 183, 192
- trunk cables
 - accessories 309
- Tt ymp 150
- Tvesic 150
- Tyco Healthcare Group LP 327

U

- unfiltered ECG signal 96
- unplugging a module 9
- upgrading
 - effect on EEG configuration 214
- user interface settings
 - changing 31

V

- V electrode placement (ECG) 99
- venous puncture 147
- ventilation calculations 233
- viewing arrhythmia waves 109
- viewing trends 223
- visible waves report 270
- visitor screen 24
- vislatching (arrhythmia alarms) 113
- vital signs
 - recording 225
 - report 225
- vital signs report 228

volume
 alarm 43
 touch tone volume 31
volume-flow loops 289
VueLink
 alarm messages 283
 device driver conflicts 284
 language conflicts 284
 module 281
 module options 281
 module setup 282
 visible waves and numerics 281

W

warnings 1
wave
 adjusting 27
 changing speed 27
 scale (CO2) 183, 192
 scale (pressure) 154
 size (CO2) 183, 192
 size (pressure) 154
wave channel speed 28
wave group speed 27
wave scale (EEG)
 changing 220
wave size
 Resp 133
wave size (ECG)
 changing 94
wave speed
 eeg speed
 wave speed
 global speed 27
 respiratory speed 27
wave speed (EEG) 213
wave speed (Resp) 134
wedge
 balloon inflation 159
 editing 159
 printing 159
 pulmonary artery 158
 recording 159
 reference waves 158
what's new 35
wide alarms limits 49
wired network connection symbol 328
wireless device connection symbol 328

Y

yellow arrhythmia alarms 113
yellow arrhythmia alarms on/off 113

Z

zero
 effect on pressure alarms 153
zeroing
 pressure transducer 152

