

Digital Palmcorder® MultiCam™ Camcorder

Panasonic®

Operating Instructions Digital Video Camcorder

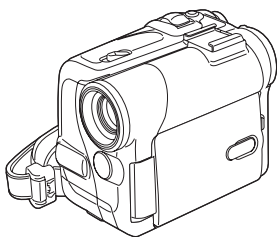

Model No. **PV-GS55**



Before attempting to connect, operate or adjust this product, please read these instructions thoroughly.

Spanish Quick Use Guide is included.

Guía para rápida consulta en español está incluida.

MultiMediaCard™



Mini DV



For USA assistance, please call: 1-800-211-PANA(7262) or, contact us via the web at: <http://www.panasonic.com/contactinfo>

For Canadian assistance, please call: 1-800-561-5505 or visit us at www.panasonic.ca

LSQT0760 B

Things You Should Know

Thank you for choosing Panasonic!

You have purchased one of the most sophisticated and reliable products on the market today. Used properly, we're sure it will bring you and your family years of enjoyment. Please take time to fill in the information on the right.

The serial number is on the tag located on the underside of your Palmcorder. Be sure to **retain this manual** as your convenient Palmcorder information source.

Date of Purchase

Dealer Purchased From

Dealer Address

Dealer Phone No.

Model No.

Serial No.

Safety Precautions

**WARNING: TO PREVENT FIRE OR SHOCK HAZARD,
DO NOT EXPOSE THIS EQUIPMENT TO RAIN OR MOISTURE.**

Your ^{Mini} **IN** Palmcorder is designed to record and play back in Standard Play (SP) mode and Long Play (LP) mode

It is recommended that only cassette tapes that have been tested and inspected for use in Palmcorder with the ^{Mini} **IN** mark be used.



CAUTION
RISK OF ELECTRIC SHOCK
DO NOT OPEN



CAUTION: TO REDUCE THE RISK OF ELECTRIC SHOCK,
DO NOT REMOVE COVER (OR BACK)
NO USER-SERVICEABLE PARTS INSIDE
REFER SERVICING TO QUALIFIED SERVICE PERSONNEL



This symbol warns the user that uninsulated voltage within the unit may have sufficient magnitude to cause electric shock.

Therefore, it is dangerous to make any kind of contact with any inside part of this unit.



This symbol alerts the user that important literature concerning the operation and maintenance of this unit has been included. Therefore, it should be read carefully in order to avoid any problems.

AC Adaptor

- The rating plate is on the underside of the AC Adaptor.

FCC Note: This equipment has been tested and found to comply with the limits for a Class B digital device, pursuant to Part 15 of the FCC Rules. These limits are designed to provide reasonable protection against harmful interference in a residential installation. This equipment generates, uses, and can radiate radio frequency energy and, if not installed and used in accordance with the instructions, may cause harmful interference to radio communications. However, there is no guarantee that interference will not occur in a particular installation. If this equipment does cause harmful interference to radio or television reception, which can be determined by turning the equipment off and on, the user is encouraged to try to correct the interference by one or more of the following measures:

- Reorient or relocate the receiving antenna.
- Increase the separation between the equipment and receiver.
- Connect the equipment into an outlet on a circuit different from that to which the receiver is connected.
- Consult the dealer or an experienced radio/TV technician for help.

FCC Caution: To assure continued compliance, follow the attached installation instructions and use only shielded interface cables with ferrite core when connecting to computer or peripheral devices. Any changes or modifications not expressly approved by the party responsible for compliance could void the user's authority to operate this equipment.

Declaration of Conformity

Trade Name: Panasonic
Model No.: PV-GS55
Responsible party: Matsushita Electric Corporation of America
One Panasonic Way, Secaucus, NJ 07094
Support Contact: Panasonic Consumer Electronics Company
1-800-211-PANA (7262)

This device complies with Part 15 of the FCC Rules. Operation is subject to the following two conditions: (1) This device may not cause harmful interference, and (2) this device must accept any interference received, including interference that may cause undesired operation.

CAUTION: TO PREVENT FIRE OR SHOCK HAZARD AND ANNOYING INTERFERENCE, USE THE RECOMMENDED ACCESSORIES ONLY.

CAUTION: TO PREVENT ELECTRIC SHOCK, MATCH WIDE BLADE OF PLUG TO WIDE SLOT, FULLY INSERT.

CAUTION: DANGER OF EXPLOSION IF BATTERY IS INCORRECTLY REPLACED. REPLACE ONLY WITH THE SAME OR EQUIVALENT TYPE.

- Since this product gets hot during use, operate it in well ventilated place; do not install this equipment in a confined space such as a bookcase or similar unit.

⚠ WARNING

AS WITH ANY SMALL OBJECT, SD CARDS CAN BE SWALLOWED BY YOUNG CHILDREN. DO NOT ALLOW CHILDREN TO HANDLE THE SD CARD.

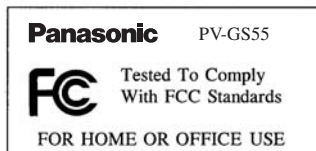

IMPORTANT SAFETY INSTRUCTIONS

- 1) Read these instructions.
- 2) Keep these instructions.
- 3) Heed all warnings.
- 4) Follow all instructions.
- 5) Do not use this apparatus near water.
- 6) Clean only with dry cloth.
- 7) Do not block any ventilation openings. Install in accordance with the manufacturer's instructions.
- 8) Do not install near any heat sources such as radiators, heat registers, stoves, or other apparatus (including amplifiers) that produce heat.
- 9) Do not defeat the safety purpose of the polarized or grounding-type plug. A polarized plug has two blades with one wider than the other. A grounding type plug has two blades and a third grounding prong. The wide blade or the third prong are provided for your safety. If the provided plug does not fit into your outlet, consult an electrician for replacement of the obsolete outlet.
- 10) Protect the power cord from being walked on or pinched particularly at plugs, convenience receptacles, and the point where they exit from the apparatus.
- 11) Only use attachments/accessories specified by the manufacturer.
- 12) Use only with the cart, stand, tripod, bracket, or the table specified by the manufacturer, or sold with the apparatus. When a cart is used, use caution when moving the cart/apparatus combination to avoid injury from tip-over.
- 13) Unplug this apparatus during lightning storms or when it will be left unused for long periods of time.
- 14) Refer all servicing to qualified service personnel. Servicing is required when the apparatus has been damaged in any way, such as when the power-supply cord or plug is damaged, liquid has been spilled or objects have fallen into the apparatus, the apparatus has been exposed to rain or moisture, does not operate normally, or has been dropped.



Precautions

USE & LOCATION

WARNING

- **TO AVOID SHOCK HAZARD ...** Your Palmcorder and power supply should not be exposed to rain or moisture. Do not connect the power supply or operate your Palmcorder if it gets wet. Your Palmcorder has been designed for outdoor use, however it is not designed to sustain direct exposure to water, rain, sleet, snow, sand, dust, or a direct splashing from a pool or even a cup of coffee. This action could permanently damage the internal parts of your Palmcorder. Do not attempt to disassemble this unit. There are no user serviceable parts inside. Unplug your Palmcorder from the power supply before cleaning.

CAUTION

- **DO NOT AIM YOUR PALMCORDER AT THE SUN OR OTHER BRIGHT OBJECTS**
- **DO NOT LEAVE THE PALMCORDER WITH THE EVF AIMED DIRECTLY AT THE SUN AS THIS MAY CAUSE DAMAGE TO THE INTERNAL PARTS OF THE EVF**
- **DO NOT EXPOSE YOUR PALMCORDER TO EXTENDED HIGH TEMPERATURE ...** Such as, in direct sunlight, inside a closed car, next to a heater, etc... This action could permanently damage the internal parts of your Palmcorder.

- **AVOID SUDDEN CHANGES IN TEMPERATURE ...** If the unit is suddenly moved from a cold place to a warm place, moisture may form on the tape and inside the unit.
- **DO NOT LEAVE YOUR PALMCORDER OR THE POWER SUPPLY TURNED ON WHEN NOT IN USE.**
- **STORAGE OF YOUR PALMCORDER ...** Store and handle your Palmcorder in a manner that will not subject it to unnecessary movement (avoid shaking and striking). Your Palmcorder contains a sensitive pick-up device which could be damaged by improper handling or storage.

CARE

- **TO CLEAN YOUR PALMCORDER ...** Do not use strong or abrasive detergents when cleaning your Palmcorder body.
- **TO PROTECT THE LENS ...** Do not touch the surface of the lens with your hand. Use a commercial Palmcorder lens solution and lens paper when cleaning the lens. Improper cleaning can scratch the lens coating.
- **TO PROTECT THE FINISH OF YOUR PALMCORDER ...** Before handling your Palmcorder, make sure your hands and face are free from any chemical products, such as suntan lotion, as it may damage the finish.

Apparatus Claims of U.S. Patent Nos. 4,631,603, 4,577,216, and 4,819,098, licensed for limited viewing.

This product incorporates copyright protection technology that is protected by method claims of certain U.S. patents and other intellectual property rights owned by Macrovision Corporation and other rights owners. Use of this copyright protection technology must be authorized by Macrovision Corporation, and is intended for home and other limited viewing uses only unless otherwise authorized by Macrovision Corporation. Reverse engineering or disassembly is prohibited.

This class B digital apparatus complies with CANADIAN ICES-003.

U.S./CANADA CONSUMERS: ATTENTION:



A lithium ion/polymer battery that is recyclable powers the product you have purchased. Please call 1-800-8-BATTERY for information on how to recycle this battery.

Before opening the CD-ROM package, please read the following.

End User License Agreement (for USB Driver, WebCam Driver and DV STUDIO)

You ("Licensee") are granted a license for the Software defined in this End User Software Agreement ("Agreement") on condition that you agree to the terms and conditions of this Agreement. If Licensee does not agree to the terms and conditions of this Agreement, promptly return the Software to Matsushita Electric Industrial Co., Ltd. ("Matsushita"), its distributors or dealers from which you made the purchase.

Article 1 License

Licensee is granted the right to use the software, including the information recorded or described on the CD-ROM, instruction manuals, and any other media provided to Licensee (collectively "Software"), but all applicable rights to patents, copyrights, trademarks and trade secrets in the Software are not transferred to Licensee.

Article 2 Use by a Third Party

Licensee may not use, copy, modify, transfer or allow any third party, whether free of charge or not, to use, copy or modify the Software, except as expressly provided for in this Agreement.

Article 3 Restrictions on Copying the Software

Licensee may make a single copy of the Software in whole or in part solely for back-up purpose.

Article 4 Computer

Licensee may only use the Software on a single computer at a single location.

Article 5 Reverse Engineering, Decompiling or Disassembly

Licensee may not reverse engineer, decompile, or disassemble the Software, except to the extent either of them is permitted under law or regulation of the country where Licensee resides. Matsushita, or its distributors or dealers will not be responsible for any defects in the Software or damage to Licensee caused by Licensee's reverse engineering, decompiling, or disassembly of the Software.

Article 6 Limitation of Liability

The Software is provided "AS-IS" without warranty of any kind, either expressed or implied, including, but not limited to, warranties of non-infringement, merchantability and/or fitness for a particular purpose. Further, Matsushita does not warrant that the operation of the Software will be uninterrupted or error free. Matsushita or any of its distributors or dealers will not be liable for any damage suffered by Licensee arising from or in connection with Licensee's use of the Software.

Article 7 Export Control

Licensee agrees not to export or re-export to any country the Software in any form without the appropriate export licenses under regulations of the country where Licensee resides, if necessary.

Article 8 Termination of License

The right granted to Licensee hereunder will be automatically terminated if Licensee violates any of the terms and conditions of this Agreement. Upon such automatic termination, Licensee must destroy the Software and related documentation together with all the copies thereof at Licensee's own expense.

Before opening the CD-ROM package, please read the following.

G.726 Audio Decoder End User License Agreement

YOU SHOULD CAREFULLY READ THE FOLLOWING TERMS AND CONDITIONS. THIS IS A LEGAL DOCUMENT WHICH CONSTITUTES YOUR AGREEMENT AS END USER FOR THE USE OF THE SOFTWARE IN THAT PACKAGE. BY INSTALLING THIS SOFTWARE, YOU INDICATE YOUR ACCEPTANCE OF THIS LIMITED USE SOFTWARE LICENSE.

IF YOU DO NOT AGREE TO THE TERMS OF THIS AGREEMENT, PROMPTLY RETURN THE DISK PACKAGE AND THE ACCOMPANYING ITEMS WITH YOUR SALES RECEIPT TO YOUR VENDOR.

LIMITED USE SOFTWARE LICENSE

You, the Licensee, are granted a non-exclusive software license to use the Software and related documentation supplied herein. The terms of this license are as follows:

- 1) You may use the Software on a single computer at a single location.
- 2) As you, the Licensee, own the physical media on which the Software is recorded, the Licensor of the Software retains title and ownership thereof, regardless of the form or media in or on which the original and other copies may exist. This License is not a sale of the original Software or any copy thereof.
- 3) You are required to protect the copyright of the Software. You may NOT distribute or otherwise make the Software or documentation available to any third party without the prior written consent of the Licensor. You may be held legally responsible for any copyright infringement that is caused or encouraged by your failure to abide by the terms of this License.
- 4) You may NOT modify or alter the Software. Any portion of the Software that is merged into or used in conjunction with other software will continue to be the property of the Licensor and will be subject to the terms of this License.
- 5) You are permitted to copy the Software for exclusive use as your working copy. Any such copy must contain the same copyright notice and proprietary marking as the original Software.
- 6) You may not transfer or assign the Software or this License to any other person without the prior written consent of the Licensor. Any authorized transferee of the Software shall be bound by the same terms and conditions of this License and, in such case your license is automatically terminated. In no event may you transfer, assign, rent, sell, or otherwise dispose of the Software on a temporary or permanent basis except as expressly provided herein.
- 7) This License is effective until terminated. This License will terminate automatically without notice from the Licensor if you fail to comply with any provision of this Agreement. Upon termination you will destroy the Software together with all copies and modifications in any form.
- 8) The Software has been tested and the documentation has been reviewed. However, THE LICENSOR MAKES NO WARRANTY OR REPRESENTATION INCLUDING THE IMPLIED WARRANTIES OF MERCHANTABILITY AND FITNESS FOR USE, ALL OF WHICH ARE EXCLUDED. Some states do not allow exclusion of implied warranties so the above disclaimer may not apply to you.
- 9) The Licensor will not be liable or in any way responsible for any incidental or consequential economic or property damage in connection with the Software or its documentation. Some states do not allow the exclusion of incidental or consequential damages so the above exclusion may not apply to you.
- 10) (Notice to U.S. Government End Users) The Software and Documentation are "Commercial Items", as that term is defined at 48 C.F.R. 2.101, consisting of "Commercial Computer Software" and "Commercial Computer Software Documentation", as such terms are used in 48 C.F.R. 12.212 or 48 C.F.R. 227.7202, as applicable. Consistent with 48 C.F.R. 12.212 or 48 C.F.R. 227.7202-1 through 227.7202-4, as applicable, the Commercial Computer Software and Commercial Computer Software Documentation are being licensed to U.S. Government end users (A) only as Commercial Items and (B) with only those rights as are granted to all other end users pursuant to the terms and conditions herein.

Contents

Before Use

Quick Guide.....	10
Standard Accessories.....	12
Controls and Components.....	12
The Remote Controller.....	15
Power Supply.....	16
Charging Time and Available Recording Time.....	16
The One-touch Free Style Grip Belt.....	17
Attaching the Lens Cap.....	17
Attaching the Shoulder Strap.....	17
Inserting a Cassette.....	18
Using a Memory Card.....	18
Turning on the Palmcorder.....	19
Selecting Modes.....	19
Using the Viewfinder/LCD Monitor.....	19
Using the Menu Screen.....	20
List of Menus.....	21
Setting Date and Time.....	24
Internal Lithium Battery Recharge.....	24
LP Mode.....	24
Audio Recording Mode.....	24

Recording Mode

About Recording.....	25
Recording on a Tape.....	25
Recording a Still Picture on a Card (Photoshot).....	26
Recording a Moving Picture on a Card (MPEG4).....	27
Quick Start.....	28
Self-timer Recording.....	28
Zoom In/Out Functions.....	28
Digital Zoom Function.....	29
Image Stabilizer Function.....	29
Fade In/Out Functions.....	30
Backlight Compensation Function.....	30
MagicPix Functions.....	30
Soft Skin Function.....	31
Wind Noise Reduction Function.....	31
Cinema Function.....	31
Recording in Special Situations.....	32
Recording in Natural Colors.....	32
Adjusting White Balance Manually.....	33
Manual Shutter Speed Adjustment.....	34
Manual Iris Adjustment.....	34
Manual Focus Adjustment.....	34
Digital Effect Functions.....	35

Playback Mode

Playing Back a Tape.....	37
Finding a Scene You Want to Play Back.....	37
Slow Motion Playback.....	38
Still Playback/Still Advance Playback.....	38
Index Search Functions.....	39
Playback Zoom Function.....	39
Playback Digital Effect Functions.....	40
Playing Back a Card.....	40
Slide Show.....	41
Creating a Title.....	42
Adding a Title.....	42
Writing Printing Data on a Card.....	43
Protecting the Files on a Card.....	43
Deleting the Files Recorded on a Card.....	43
Formatting a Card.....	44
Enlarging a Movie Picture Size.....	44
Playing Back on Your TV.....	45

Editing Mode

Recording from a Tape onto a Card.....	46
Recording Pictures from a Card onto a Tape.....	46
Audio Dubbing.....	46
Copying on an S-VHS (or a VHS) Cassette.....	47
Recording the Contents of Other Equipment.....	48
Using the DV Cable for Recording.....	48

With a PC

Using the Software with a Computer.....	49
Using USB Driver.....	49
Using as a Web Camera.....	51
Using the DV STUDIO 3.1E-SE.....	53
Using the G.726 Audio Decoder.....	54
Using the ArcSoft Software.....	55
To disconnect USB cable safely.....	57
If you no longer need software or driver (Uninstall).....	58
Notes.....	58

Others

Indications	61
Initializing the Modes	62
Warning/Alarm Indications.....	62
Notes and Hints	63
Cautions for Use	69
Before Requesting Service (Problems and Solutions)	73
Explanation of Terms.....	74
Specifications	76
Palmcorder Accessory System.....	78
Palmcorder Accessory Order Form (For USA Customers)	79
Request for Service Notice (USA Only).....	80
Limited Warranty (For USA Customers).....	81
Customer Services Directory	82
Warranty (For Canadian Customers)	83
Index.....	84
Spanish Quick Use Guide/ Guía española para el uso rápido.....	86

Quick Guide

- 1 Attach the Battery to the AC Adaptor and charge it.

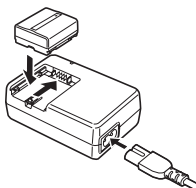

- Before use, fully charge the Battery.
- Since the Battery will not be charged when the DC Cable is connected to the AC Adaptor, disconnect it from the AC Adaptor.
- The [CHARGE] Lamp lights up, and charging starts.
- When the [CHARGE] Lamp goes off, charging is completed.

- 2 Attach the charged Battery to the Palmcorder.

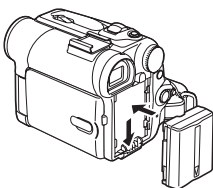

Inserting a Cassette

- 1 Slide the [OPEN/EJECT] Lever ① toward the front and pull down to open the Cassette Compartment Cover.
- 2 Insert a Cassette.

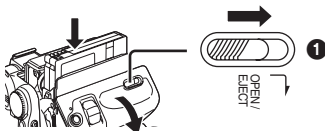

- 3 Close the Cassette Holder by pressing the [PUSH] mark ②.
- 4 Close the Cassette Compartment Cover.

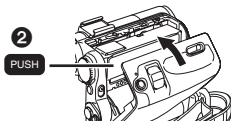

Inserting a Card

- 1 Slide the [OPEN] Lever ① to open the Card Slot Cover ②.
- 2 While holding the Memory Card with its cut corner facing right ③, insert it into the Card Slot ④.
- 3 Close the Card Slot Cover ② securely.

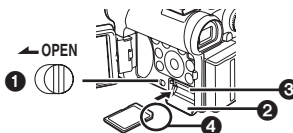

Recording on a Tape

- 1 Set the [OFF/ON] Switch ① to [ON].
 - The [POWER] Lamp ② lights up.

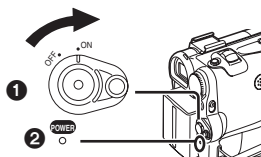

- 2 Set the Mode Dial to Tape Recording Mode.

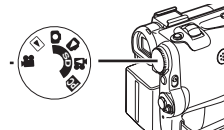

- 3 Press the Recording Start/Stop Button.
 - Recording starts.

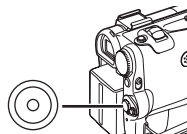

- 4 Press the Recording Start/Stop Button again to pause the recording.

Recording a Still Picture on a Card (Photoshot)

- 1 Set the Mode Dial to Card Recording Mode.

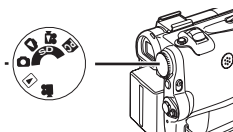

- 2 Press the [PHOTO SHOT] Button.

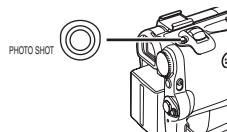

■ Recording a Moving Picture on a Card (MPEG4)

1 Set the Mode Dial to Card Recording Mode.

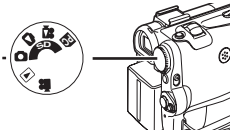

2 Press the Recording Start/Stop Button.

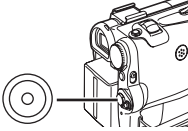

3 Press the Recording Start/Stop Button again to pause the recording.

■ Playing Back a Tape

1 Set the [OFF/ON] Switch ① to [ON].

- The [POWER] Lamp ② lights up.

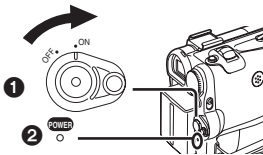

2 Set the Mode Dial to Tape Playback Mode.

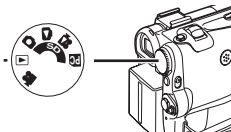

3 Press the [◀◀] Button to rewind the tape.

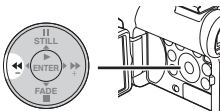

4 Press the [▶] Button to start playback.

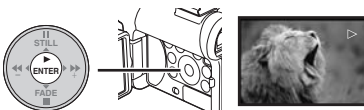

5 Press the [■] Button to stop playback.



■ Playing Back a Card

It plays back files recorded on a Card.

1 Set the Mode Dial to Picture Playback Mode or MPEG4 Playback Mode.

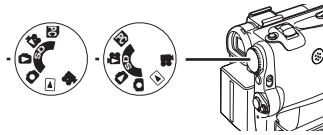

2 Start Playback.

[PICTURE]:

- ▶: Starting the Slide Show
- ▶▶: Playing back the next picture
- ◀◀: Playing back the previous picture
- : Stop the Slide Show
- ||: Pause the Slide Show

[MPEG4]:

- ▶: Playing back the File
- ▶▶: Selecting the next file (When you tap this button during playback, you can search the next file, and when you keep pressing it, cue playback is activated.)
- ◀◀: Selecting the previous file (When you tap this button during playback, you can search the beginning of the file, and when you keep pressing it, review playback is activated.)
- : Stop playing back
- ||: Pause playing back

Before Use

Standard Accessories

Illustrated are accessories supplied with the Palmcorder.

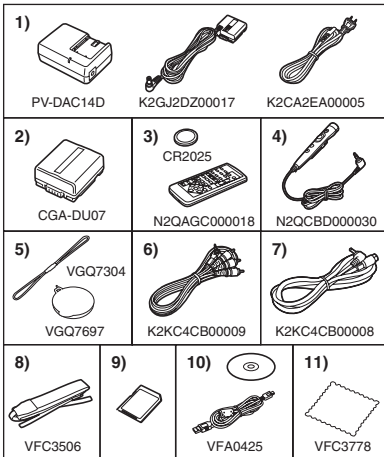

1) AC Adaptor, DC Cable and AC Cable -16-

CAUTION:

This unit will operate on 110/120/220/240 V AC. An AC plug adaptor may be required for voltages other than 120 V AC. Please contact either a local or foreign electrical parts distributor for assistance in selecting an alternate AC plug. We recommend using the accessory power plug adaptor (VJSS0070) in an area which has special AC outlets.

- 2) Battery Pack -16-
- 3) Remote Controller and Button-Type Battery -14-
- 4) Magic Wire Remote Control with Narration Mic -14-
- 5) Lens Cap and Lens Cap Cord -17-
- 6) AV Cable -45-
- 7) S-Video Cable -45-
- 8) Shoulder Strap -17-
- 9) SD Memory Card -18-
- 10) USB Connection Kit (USB Cable and CD-ROM) -49-
- 11) Cleaning Cloth

Controls and Components

■ Palmcorder

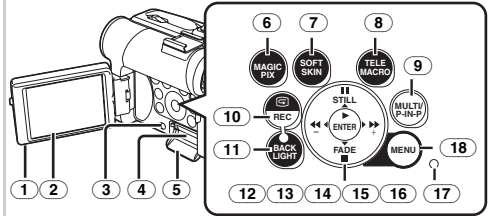

- 1) LCD Monitor Open Knob [OPEN ▼] -19-
- 2) LCD Monitor -19-, -72-

Due to limitations in LCD production technology, there may be some tiny bright or dark spots on the LCD Monitor screen. However, this is not a malfunction and does not affect the recorded picture.

- 3) Card Slot Cover Open Lever [OPEN] -18-
- 4) Card Slot -18-
- 5) Card Slot Cover -18-
- 6) MagicPix Button [MAGICPIX] -30-
- 7) Soft Skin Button [SOFT SKIN] -31-
- 8) Tele Macro Button [TELE MACRO] -28-
- 9) Multi Button [MULTI] -35-
- Picture-in-Picture Button [P-IN-P] -36-
- 10) Recording Check Button [RECORD] -25-
- Recording Button [REC] -48-
- 11) Backlight Button [BACK LIGHT] -30-
- 12) Pause Button [II] -40-
- Still Button [STILL] -26-
- 13) Fast Forward/Cue Button [▶▶] -37-, -40-
- 14) Play Button [▶] -37-, -40-
- Enter Button [ENTER] -20-
- 15) Stop Button [■] -37-, -40-
- Fade Button [FADE] -30-
- 16) Rewind/Review Button [◀◀] -37-, -40-
- 17) Card Access Lamp -18-
- 18) Menu Button [MENU] -20-

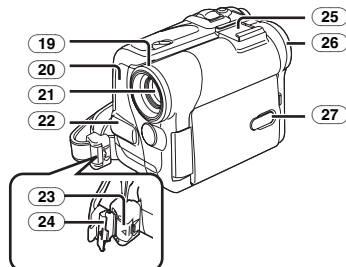

- 19) Lens Hood -72-
- 20) Recording Lamp -25-
- 21) Lens

- 22 **Microphone (built-in, stereo)** -29-, -31-
- 23 **Lock Button** -17-
- 24 **Lock Cover** -17-
- 25 **Accessory Shoe**
- 26 **Eyecup**
- 27 **Power LCD Button [POWER LCD]** -20-
Power LCD Lamp -20-

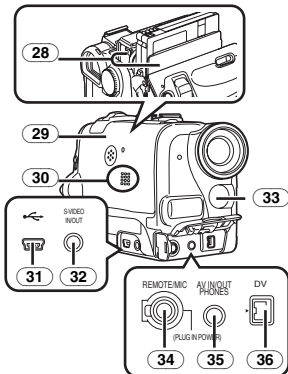

- 28 **Cassette Holder**
- 29 **Cassette Compartment Cover** -18-
- 30 **Speaker** -37-
- 31 **USB Jack** [←] -50-
- 32 **S-Video Input/Output Jack [S-VIDEO IN/OUT]** -45-
- 33 **White Balance Sensor** -33-
Remote Control Sensor -15-
- 34 **Jack for Magic Wire Remote Control with Narration Mic [REMOTE]** -26-
Microphone Jack [MIC]

- When connecting an external microphone or audio equipment to this jack, the built-in microphone does not operate.
- When connecting the Magic Wire Remote Control with Narration Mic to this jack and the [TALK] Button is pressed, the built-in microphone does not operate. -26-
- When connecting the pin plug of the Magic Wire Remote Control with Narration Mic to this jack, plug it in as far as it goes.
- A compatible plug-in powered microphone can be used. Please consult your dealer for more information.
- The microphone may make noises depending on the type used. In this case, we recommend using the battery with the Palmcorder to reduce noises instead of the AC adaptor.

- 35 **Audio-Video Input/Output Jack [AV IN/OUT]** -45-
Headphone Jack [PHONES]

- Connecting an AV Cable to this jack activates the Palmcorder's built-in speaker, but connecting a headphone, etc. deactivates it.

- When connecting the pin plug of the AV Cable to this jack, plug it in as far as it goes.
 - When using headphones, set [AV JACK] of the [AV IN/OUT] or [INITIAL] sub-menu to [OUT/PHONES]. If you set [AV JACK] to [OUT], you may hear noises on the right.
- 36 **DV Terminal [DV]** -48-
 - Connect this to the digital video equipment.

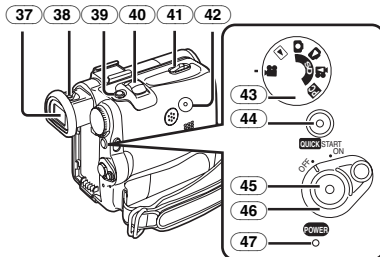

- 37 **Viewfinder** -19-, -72-

Due to limitations in LCD production technology, there may be some tiny bright or dark spots on the Viewfinder screen. However, this is not a malfunction and does not affect the recorded picture.

- 38 **Eyepiece Corrector Knob** -19-
- 39 **Photoshot Button [PHOTO SHOT]** -26-, -46-
- 40 **Zoom Lever [W/T], [-VOL/JOG+]** -28-, -37-
- 41 **Cassette Eject Lever [OPEN/EJECT]** -18-
- 42 **Reset Button [RESET]** -63-
- 43 **Mode Dial** -19-
- 44 **Quick Start Recording Button [QUICK START]** -28-
Quick Start Recording Lamp -28-
- 45 **Recording Start/Stop Button** -25-, -27-
- 46 **Power Switch [OFF/ON]** -19-, -25-, -69-
- 47 **[POWER] Lamp** -19-, -25-, -37-

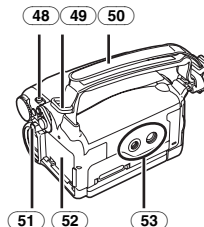

- 48 **Mode Selector Switch [AUTO/MANUAL/FOCUS]** -25-, -32-, -34-
- 49 **Shoulder Strap Holders** -18-
- 50 **Grip Belt (One-touch Free Style Grip Belt)** -17-
- 51 **Battery Eject Button [PUSH BATT]** -16-
- 52 **Battery Holder**
- 53 **Tripod Receptacle**
 - Used for mounting the Palmcorder on an optional tripod.

Remote Controller

Using the wireless Remote Controller that is supplied with the Palmcorder, most of the Palmcorder functions can be operated from a distance.

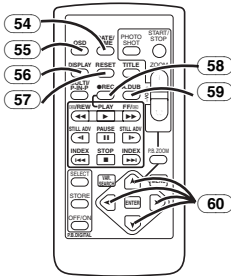

- 54 Date/Time Button [DATE/TIME] -62-
- 55 Indication Output Button [OSD] -45-
- 56 Display Button [DISPLAY] -62-
- 57 Reset Button [RESET] -75-
- 58 Recording Button [●REC] -48-
- 59 Audio Dubbing Button [A.DUB] -46-
- 60 Cursor Buttons for Variable Speed Search Function [▲, ▼] -38-
Direction Buttons for Playback Zoom Function [▲, ◀, ▶, ▼] -40-

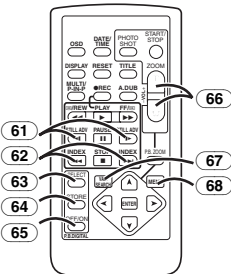

- 61 Slow Motion/Still Advance Buttons [◀1, 1▶] (◀1: reverse, 1▶: forward) -38-
- 62 Index Search Buttons [◀◀, ▶▶] (◀◀: reverse, ▶▶: forward) -39-
- 63 Selection Button [SELECT] -40-
- 64 Store Button [STORE] -40-
- 65 Off/On Button [OFF/ON] -40-
- 66 Zoom/Volume Button [ZOOM/VOL] -28-, -37-, -39-
- 67 Variable Speed Search Button [VAR. SEARCH] -38-
- 68 Menu Button [MENU] -20-

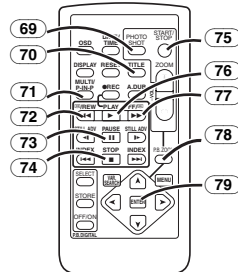

- 69 Photoshot Button [PHOTO SHOT] -26-, -46-
- 70 Title Button [TITLE] -42-
- 71 Multi-Picture/Picture-in-Picture Button [MULTI/P-IN-P] -35-, -41-
- 72 Rewind/Review Button [◀◀] -37-, -40-
- 73 Pause Button [⏸] -38-, -40-
- 74 Stop Button [■] -37-, -40-
- 75 Recording Start/Stop Button [START/STOP] -25-, -27-
- 76 Play Button [▶] -37-, -40-
- 77 Fast-forward/Cue Button [▶▶] -37-, -40-
- 78 Playback Zoom Button [P.B. ZOOM] -39-
- 79 Enter Button [ENTER] -20-

Magic Wire Remote Control with Narration Mic

This controller allows the scene to be shot from various angles, high to low, and is also convenient when a Tripod is used. When the controller is not in use, attach the clip to the Grip Belt for convenience.

This controller makes it easier for left-handed users to use the Palmcorder.

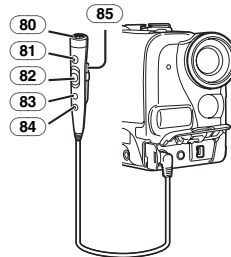

- 80 Microphone [MIC] -26-
- 81 Recording Start/Stop Button [REC]
- 82 Zoom Lever [W/T]
 - Zoom speed changes in 2 stages.
- 83 Photoshot Button [PHOTO SHOT]
- 84 Microphone Switch Button [TALK] -26-
 - When the Magic Wire Remote Control with Narration Mic is connected to [REMOTE] Jack and the [TALK] Button is pressed, the narration microphone is activated and the built-in microphone on the Palmcorder is deactivated.
- 85 Clip

- Insert the plug securely into the [REMOTE] Jack as far as it will go. A loose connection will affect normal operation.

The Remote Controller

■ Inserting a Button-type Battery

Before using the Remote Controller, insert the supplied button-type battery.

- 1 While pressing the Lock Button **1**, pull out the Battery Holder.

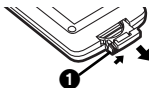

- 2 Insert the button-type battery with the (+) marking facing upwards.



- 3 Insert the Battery Holder into the Remote Controller.

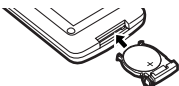

- When the button-type battery is exhausted, replace it with a new CR2025 battery. (A battery is normally expected to last about 1 year. However, it depends on operation frequency.)
- Make sure to match the poles correctly when inserting the battery.

Warning

Danger of explosion if battery is incorrectly replaced.

Replace only with the same or equivalent type recommended by the equipment manufacturer. Discard used batteries according to manufacturer's instructions. Risk of fire, explosion and burns. Do not recharge, disassemble, heat above 212°F (100°C) or incinerate. Keep the Button-Type battery out of the reach of children. Never put Button-Type battery in mouth. If swallowed, call your doctor.

Replace battery with Panasonic PART NO. CR2025 only. Use of another battery may present a risk of fire or explosion. Caution: Battery may explode if mistreated. Dispose of used battery promptly. Keep away from children. Do not recharge, disassemble or dispose of in fire.

■ Using the Remote Controller

- 1 Direct the Remote Controller at the Remote Control Sensor **33** of the Palmcorder and press an appropriate button.

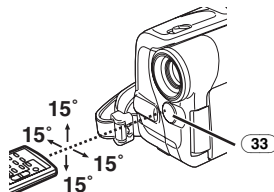

- Distance from the Palmcorder: Within approximately 15 feet (5 meters)
- Angle: Approximately 15° in the vertical and horizontal directions from the central axis
- The above operating ranges are for indoor use. Outdoors or under strong light, the Palmcorder may not operate properly even within the above ranges.
- Within a 3 feet (1 meter) range, you can also use the Remote Controller on the LCD Monitor side of the Palmcorder.

Selecting Remote Controller Modes

When 2 Palmcorders are used simultaneously, they can be operated individually by selecting different Remote Controller Modes.

- If the Remote Controller Mode of the Palmcorder and that of the Remote Controller do not match, [REMOTE] Indication is displayed.

Setup on the Palmcorder:

Set [REMOTE] on the [INITIAL] Sub-Menu to the desired Remote Controller Mode. (-22-)

Setup on the Remote Controller:

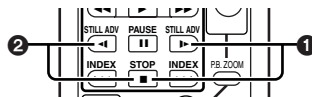

[VCR1]: Press the [▶] Button and [■] Button simultaneously. **1**

[VCR2]: Press the [◀] Button and [■] Button simultaneously. **2**

- When the battery in the Remote Controller is replaced, the mode is automatically reset to [VCR1] Mode.

Power Supply

■ Using the AC Adaptor

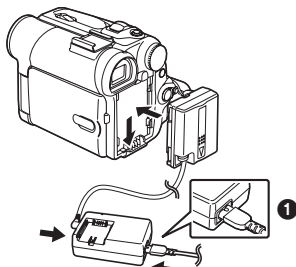

- 1 Connect the DC Cable to the Palmcorder.
- 2 Connect the DC Cable to the AC Adaptor.
- 3 Connect the AC Cable to the AC Adaptor and the AC Jack.

- The AC Cable's outlet plug does not fit entirely into the AC Adaptor jack. A gap will remain as shown ❶.
- Before connecting or disconnecting the power supply, set the [OFF/ON] Switch on the Palmcorder to [OFF] and make sure that [POWER] Lamp is not lit.

■ Using the Battery

Before use, fully charge the Battery.

- We recommend using a Panasonic Battery.
- We cannot guarantee the quality of this Palmcorder when batteries from other companies are used.

- 1 Attach the Battery to the AC Adaptor and charge it.

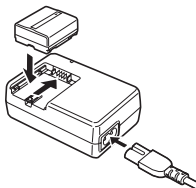

- Since the Battery will not be charged when the DC Cable is connected to the AC Adaptor, disconnect it from the AC Adaptor.
- The [CHARGE] Lamp lights up, and charging starts.
- When the [CHARGE] Lamp goes off, charging is completed.
- When the battery is completely discharged, the [CHARGE] lamp blinks at first, but the battery is charged normally. When the temperature of the battery is too high or low, the [CHARGE] lamp blinks and the charging time becomes longer than usual.

- 2 Attach the charged Battery to the Palmcorder.

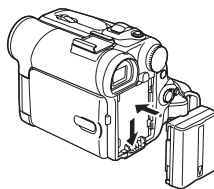

Disconnecting the Power Source

Set the [OFF/ON] Switch (46) to [OFF] and, while pressing the [PUSH BATT] Button (51), slide the Battery or DC Cable upward to disconnect it.

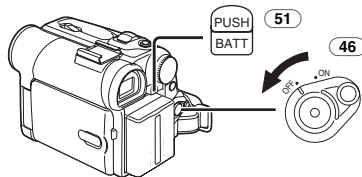

- For other notes concerning this item, see -63-.

Charging Time and Available Recording Time

CGA-DU07	(A)	1h30min.
	(B)	2h15min. (1h50min.)
CGA-DU14	(A)	2h45min.
	(B)	4h30min. (3h40min.)
CGA-DU21	(A)	3h55min.
	(B)	6h45min. (5h30min.)

(A) Charging Time

(B) Maximum Continuous Recording Time

- "1h30min." indicates 1 hour and 30 minutes.
- Battery CGA-DU07 is supplied.
- The times shown in the table are approximate times. The numbers indicate the recording time when the Viewfinder is used. The numbers in parentheses indicate the recording time when the LCD Monitor is used. In actual use, the available recording time may be shorter.
- The times shown in the table are for continuous recording at a temperature of 68°F (25°C) and humidity of 60%. If the Battery is charged at a higher or lower temperature, the charging time may be longer.
- The available recording time becomes shorter if you use both of Viewfinder and LCD Monitor simultaneously when using the 0 Lux MagicPix function or rotating the LCD Monitor forward to record yourself or setting [EVF ON/AUTO] to [ON].

The One-touch Free Style Grip Belt

To Use as a Grip Belt

Adjust the length of the Grip Belt to the size of your hand.

1 Detach the end of the Grip Belt.



2 Adjust the length of the Grip Belt to the size of your hand.



3 Reattach the Grip Belt.

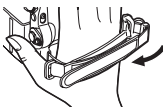

To Use as a Hand Strap

Using the Grip Belt as the hand strap makes it easier to handle and carry a Palmcorder. It is more convenient to use with the Magic Wire Remote Control with Narration Mic.



1 Open the Lock Cover (24) by holding the tabs on both sides (1), press the Lock Button (23) and detach the Grip Belt.

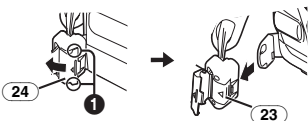

2 Detach the end of the Grip Belt.

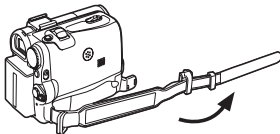

3 Slide (A) in the direction of the arrow and reattach the Grip Belt.

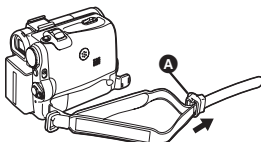

4 Attach the Grip Belt around your wrist.

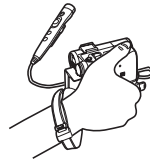

- When returning the Grip Belt to the Grip Belt Attachment, press the Lock Cover (2) to ensure that it is securely locked.

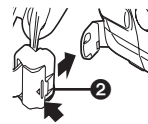

Attaching the Lens Cap

To protect the Lens surface, attach the Lens Cap.

1 Pass one end of the Lens Cap Cord through the attached eye on the Lens Cap. Then pass the other end through the loop made by itself and pull tight.

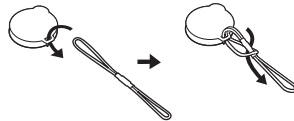

2 Pass the end of the Lens Cap Cord through the hole in the Grip Belt Attachment and the Lens Cap through the Lens Cap Cord.

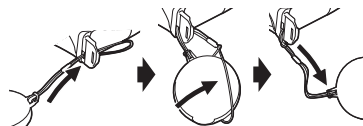

- The removed Lens Cap can be hooked onto the Grip Belt. (It is not possible when using as a hand strap.)
- When you are not recording, be sure to cover the Lens with the Lens Cap for protection.

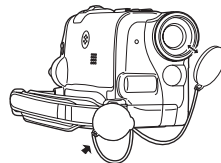

Attaching the Shoulder Strap

We recommend that you attach the Shoulder Strap before going out to avoid dropping the Palmcorder.

- 1 Pull the end of the Shoulder Strap through the Shoulder Strap Holder (49) on the Palmcorder.

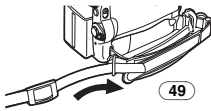

- 2 Fold the end of the Shoulder Strap, run it through the Shoulder Strap Length Adjuster, and pull it.

- Pull it out more than 1 inch (2 cm) ❶ from the Shoulder Strap Length Adjuster so that it cannot slip off.

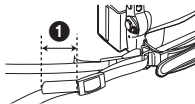

- Attach the other end of the Shoulder Strap to the other Shoulder Strap Holder in the same way.

Inserting a Cassette

- 1 Slide the [OPEN/EJECT] Lever (41) toward the front and pull down to open the Cassette Compartment Cover.

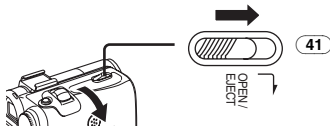

- 2 Insert a Cassette.

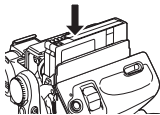

- 3 Close the Cassette Holder by pressing the [PUSH] mark ❶.

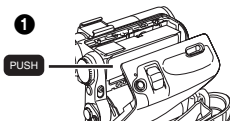

- 4 Close the Cassette Compartment Cover.

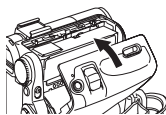

Accidental Erasure Prevention

Opening the accidental erasure prevention slider ❶ on the cassette (by sliding it to the [SAVE] arrow direction) prevents recording. To enable

recording, close the accidental erasure prevention slider (by sliding it to the [REC] arrow direction).

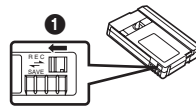

- For other notes concerning this item, see -63-.

Using a Memory Card

A Card can be used to record pictures.

- Use a genuine SD Memory Card or MultiMediaCard manufactured by Panasonic only.

Before inserting or removing a Card, be sure to turn off the Palmcorder.

- Otherwise, the Palmcorder may not function properly or it may cause the loss of recorded data in a Card.

Inserting a Card

- 1 Slide the [OPEN] Lever (3) to open the Card Slot Cover (5).

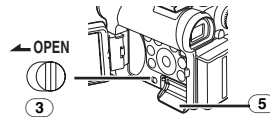

- 2 While holding the Memory Card with its cut corner facing right ❶, insert it into the Card Slot (4).

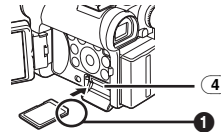

- 3 Close the Card Slot Cover (5) securely.

Removing the Card

Open the Card Slot Cover and press the center of the Card and then pull it straight out.

- After removing the Card, close the Card Slot Cover.
- The Palmcorder may be damaged if the Card is forced out when the Card is fully inserted.

Card Access Lamp (17)

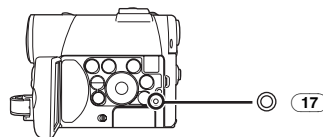

While the Palmcorder is accessing the Card (reading, recording, playback or erasing), the Card Access Lamp lights up.

- While the Card Access Lamp is on, **never** attempt to open the Card Slot Cover, to pull out the Card, to turn off the Palmcorder, or to turn the Mode Dial. Such actions will damage the Card, and recorded data, and cause the Palmcorder to malfunction.

Turning on the Palmcorder

How to Turn on the Power

1 Set the [OFF/ON] Switch (46) to [ON] while pressing the button (1).

- The [POWER] Lamp (47) lights up.

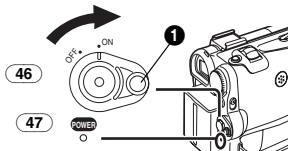

How to Turn off the Power

1 Set the [OFF/ON] Switch (46) to [OFF] while pressing the button (1).

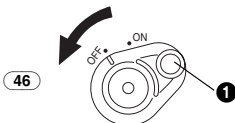

Selecting Modes

You can choose a desired mode by rotating the Mode Dial.

1 Rotate the Mode Dial (43).



:Tape Recording Mode

Use this mode when recording pictures on a tape. Also, you can record still pictures on the card simultaneously during recording on a tape.

:Tape Playback Mode

Use this mode when playing back the recorded scene on a tape.

:Card Recording Mode

Use this mode when recording still picture or moving picture on a card.

:Picture Playback Mode

Use this mode when playing back the recorded still picture on a card.

:MPEG4 Playback Mode

Use this mode when playing back the recorded moving picture on a card.

:PC Mode

Use this mode when you want to connect the Palmcorder to your Personal Computer.

Using the Viewfinder/LCD Monitor

Using the Viewfinder

Before using the Viewfinder, adjust the field of view so that the displays inside the Viewfinder become clear and easy to read.

1 Pull the Viewfinder.

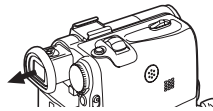

2 Adjust by turning the Eyepiece Corrector Knob (38).

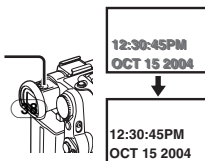

To Use the Viewfinder at the Same Time as the LCD Monitor

Set [LCD/EVF] >> [EVF ON/AUTO] >> [ON].

- The Viewfinder does not turn off even if the LCD Monitor is opened.
- When you turn the Palmcorder off, this setting is cancelled.

Using the LCD Monitor

With the LCD Monitor open, you can also record the picture while watching it.

1 Using your Thumb on the [OPEN▼] Knob (1) and pull the LCD Monitor (2) out in the direction of the arrow.

- The Viewfinder is now deactivated.
- The LCD Monitor can be opened a maximum of 120°. If you open the LCD monitor by 120°, it becomes convenient to operate menus or to play back pictures.

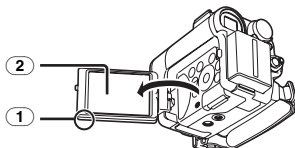

2 Adjust the LCD Monitor angle according to the desired recording angle.

- The LCD Monitor can rotate a maximum of 180° (1) from the vertical position upwards and a maximum of 90° (2) to the downward direction. Forcefully rotating the LCD Monitor beyond these ranges will damage the Palmcorder.

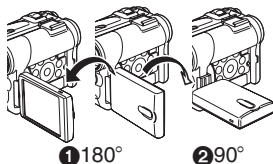

Closing the LCD Monitor

Push the LCD Monitor until it is securely locked.

- Make sure the Card Slot Cover is closed.

Adjusting Brightness and Color Level

When [LCD/EVF SET] on the [LCD/EVF]

Sub-Menu is set to [YES], the following items are displayed.

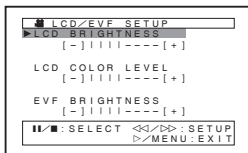

LCD Brightness [LCD BRIGHTNESS]

Adjusts the brightness of the image on the LCD screen.

LCD Color Level [LCD COLOR LEVEL]

Adjusts the color saturation of the image on the LCD screen.

Brightness of the Viewfinder

[EVF BRIGHTNESS]

Adjusts the brightness of the image in the Viewfinder.

To Adjust

Press the [II/III] Button and select the item to be adjusted, and then press the [◀▶] Button to raise or lower the number of vertical bars in the Bar Indication.

- More vertical bars indicates stronger brightness or color saturation.

To Increase the Brightness of the Entire LCD Monitor

Press the [POWER LCD] (27) Button.

When you press [POWER LCD] button, the LCD monitor becomes about twice as bright as usual.

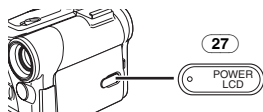

- The [POWER LCD] Lamp (27) lights up.
- When turning the power on while using AC Adaptor, [POWER LCD] function is automatically effective.

To Resume Normal Brightness

Press the [POWER LCD] Button again.

- These adjustments do not affect the recorded images.

• For other notes concerning this item, see -72-.

Using the Menu Screen

To facilitate the selection of a desired function or setup, this Palmcorder displays various function setups on Menus.

- When operating the menu with the Viewfinder, set [LCD/EVF] >> [EVF ON/AUTO] >> [ON] or rotate the LCD monitor by 180°.

1 Press the [MENU] Button (18).

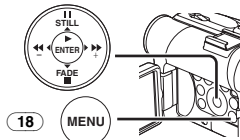

- The Menu corresponding to the Mode selected by using the Mode Dial (43) is displayed.

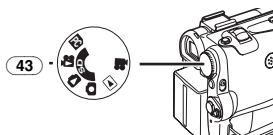

2 Press the [II/III] Button to select a desired Sub-Menu.

- Press the [II/III] Button to display the highlighted item.

3 Press the [▶▶] Button to display the selected Sub-Menu.

4 Press the [II/III] Button to select the item.

5 Press the [▶▶] Button to display the selected item.

6 Press the [II/III] Button to select the desired mode and press [ENTER] Button to determine the setting.

- While a Menu is displayed, you cannot record or play back. Menus can be displayed during playback but not during recording. The above operations can be done using the [MENU] Button, [▲, ◀, ▶, ▼] Buttons and [ENTER] Button on the Remote Controller. (-14-)

To Return the Previous Screen

Press the [◀◀] Button.

To Exit the Menu Screen

Press the [MENU] Button again.

About the Menu Mode Setting

The setting selected on the Menu will be retained even when the Palmcorder is turned off. (The setups of [EFFECT2] (-35-) are not retained.) However, if the Battery or AC Adaptor is disconnected before turning off the Palmcorder, the selected setup may not be retained.

- Menu operation flow is shown in this text by >>.

■ File Selection in the Picture/MPEG4 Playback Mode

A File Selection Operation may be necessary during Menu Operations. In this case, carry out the following procedure.

1 Press the [II/III/◀◀/▶▶] Button and select a file.

- The selected file is marked by a frame.

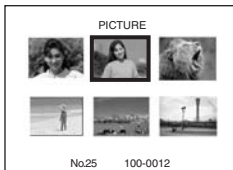

2 Press the [ENTER] Button (14) to confirm the selection of the file.

- After the above File Selection Procedure, carry out the various Menu Operations. (The above procedure will not be repeated in the following instructions.)

List of Menus

The figures of the Menus are for explanation purposes only, and they are different from the actual Menus.

■ [TAPE RECORDING MENU] Tape Recording Menu

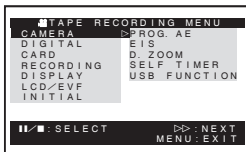

1) [CAMERA]

Camera Setup Sub-Menu

[PROG.AE]

Auto Exposure Mode -32-

[EIS]

Image Stabilizer -29-

[D.ZOOM]

Digital Zoom -29-

[SELF TIMER]

Self-timer Recording -28-

[USB FUNCTION]

USB Functions Mode -49-

- If you press [◀◀] Button, the menu changes back to the previous screen.

2) [DIGITAL]

Digital Setup Sub-Menu

[EFFECT1]

Digital Effects 1 -35-

[EFFECT2]

Digital Effects 2 -35-

[MULTI MODE]

Multi-Picture Mode -35-

[TITLE IN]

Adding a Title -42-

3) [CARD]

Card Setup Sub-Menu

[PICT QUALITY]

Picture Quality -26-

[CREATE TITLE]

Title Creation -42-

4) [RECORDING]

Recording Setup Sub-Menu

[REC SPEED]

Recording Speed Mode -24-

[AUDIO REC]

Audio Recording Mode -24-

[SCENE INDEX]

Scene Index Mode -39-

[WIND CUT]

Wind Noise Reduction -31-

[ZOOM MIC]

Zoom Microphone -29-

[CINEMA]

Cinema-like Format Recording -31-

5) [DISPLAY]

Display Setup Sub-Menu

[DISPLAY]

Display Mode -62-

[DATE/TIME]

Date and Time Indication -62-

[C.DISPLAY]

Counter Display Mode -62-

[C.RESET]

Counter Reset -75-

- It resets the counter to zero. However, it cannot reset the Time Code.

6) [LCD/EVF]

LCD/EVF Setup Sub-Menu

[LCD/EVF SET]

LCD and Viewfinder Adjustment -20-

[SELF REC]

Recording Yourself -27-

[EVF ON/AUTO]

Using the Viewfinder -19-

7) [INITIAL]

Initial Setup Sub-Menu

[BLANK SEARCH]

Blank Search -26-

[DEMO MODE]

Demonstration Mode

- If no operation takes place for approximately 10 minutes after the AC Adaptor is connected to the Palmcorder and the [OFF/ON] Switch is turned to [ON] without inserting a Cassette or a Card, the Palmcorder is automatically set to Demonstration Mode for introducing its functions. If any button is pressed or operated, the Demonstration Mode is cancelled. The Demonstration Mode can be started by setting [DEMO MODE] to [ON] and by exiting the Menu. To terminate the Demonstration Mode, insert a Cassette or set the [DEMO MODE] to [OFF].

[AV JACK]

AV Jack -73-

[REMOTE]

Remote Controller Mode -15-

[REC LAMP]

Recording Lamp -25-

[BEEP SOUND]

Beep Sound -64-

[CLOCK SET]

Date and Time Setting -24-

[INITIAL SET]

Initial Setting Mode -62-

[TAPE PLAYBACK MENU]

Tape Playback Menu

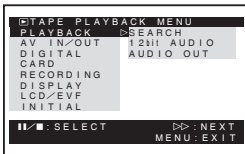
**1) [PLAYBACK]**

Playback Functions Sub-Menu

[SEARCH]

Index Search Mode -39-

[12bit AUDIO]

Audio Selector -46-

[AUDIO OUT]

Audio Output Mode -67-

2) [AV IN/OUT]

Audio-Video Input/Output Setup Sub-Menu

[AV JACK]

AV Jack -46-

[A.DUB INPUT]

Audio Dubbing Input -46-

[DV OUT]

Analog-Digital Conversion Output -69-

3) [DIGITAL]

Playback Digital Setup Sub-Menu

[EFFECT ON]

Digital Effect On/Off -40-

[EFFECT SEL]

Digital Effect Selection -40-

[TITLE IN]

Adding a Title -42-

4) [CARD]

Card Setup Sub-Menu

[PICT QUALITY]

Picture Quality -26-

[MPEG4 MODE]

MPEG4 Picture Quality -27-

[CREATE TITLE]

Title Creation -42-

5) [RECORDING]

Recording Setup Sub-Menu

[REC SPEED]

Recording Speed Mode -24-

[AUDIO REC]

Audio Recording Mode -24-

6) [DISPLAY]

Display Setup Sub-Menu

[DISPLAY]

Display Mode -62-

[DATE/TIME]

Date and Time Indication -62-

[C.DISPLAY]

Counter Display Mode -62-

[C.RESET]

Counter Reset -75-

7) [LCD/EVF]

Adjusting Brightness and Color Level

[LCD/EVF SET]

LCD and Viewfinder Adjustment -20-

[EVF ON/AUTO]

Using the Viewfinder -19-

8) [INITIAL]

Initial Setup Sub-Menu

[BLANK SEARCH]

Blank Search -26-

[REMOTE]

Remote Controller Mode -15-

[REC LAMP]

Recording Lamp -25-

[BEEP SOUND]

Beep Sound -64-

[CARD RECORDING MENU]

Card Recording Menu

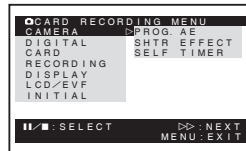
**1) [CAMERA]**

Camera Setup Sub-Menu

[PROG.AE]

Auto Exposure Mode -32-

[SHTR EFFECT]

Shutter Effect -64-

- You can add a sound such as releasing the shutter.

[SELF TIMER]

Self-timer Recording -28-

2) [DIGITAL]

Digital Setup Sub-Menu

[TITLE IN]

Adding a Title -42-

3) [CARD]

Card Setup Sub-Menu

[PICT QUALITY]

Picture Quality -26-

[MPEG4 MODE]

MPEG4 Picture Quality -41-

[CREATE TITLE]

Title Creation -42-

[BURST MODE]

RapidFire Consecutive Photoshot -27-

4) [RECORDING]

Recording Setup Sub-Menu

[WIND CUT]

Wind Noise Reduction -31-

5) [DISPLAY]

Display Setup Sub-Menu

[DISPLAY]

Display Mode -62-

[DATE/TIME]

Date and Time Indication -62-

6) [LCD/EVF]

Adjusting Brightness and Color Level

[LCD/EVF SET]

LCD and Viewfinder Adjustment -20-

[SELF REC]

Recording Yourself -27-

[EVF ON/AUTO]

Using the Viewfinder -19-

7) [INITIAL]

Initial Setup Sub-Menu

[AV JACK]

AV Jack -46-

[REMOTE]

Remote Controller Mode -15-

[REC LAMP]

Recording Lamp -25-

[BEEP SOUND]

Beep Sound -64-

[CLOCK SET]

Date and Time Setting -24-

[INITIAL SET]

Initial Setting Mode -62-

[PICTURE PLAYBACK MENU]

Picture Playback Menu

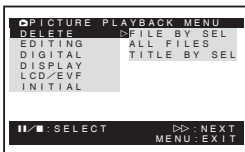

1) [DELETE]

Deleting a File Sub-Menu

[FILE BY SEL]

Selecting and Deleting a File -43-

[ALL FILES]

Deleting All Files -44-

[TITLE BY SEL]

Selecting and Deleting a Title -43-

2) [EDITING]

Editing a File Sub-Menu

[FILE LOCK]

Setting the Lock -43-

[DPOF SET]

Setting DPOF -43-

[CARD FORMAT]

Formatting a Card -44-

3) [DIGITAL]

Playback Digital Setup Sub-Menu

[TITLE IN]

Adding a Title -42-

4) [DISPLAY]

Display Setup Sub-Menu

[DISPLAY]

Display Mode -62-

[DATE/TIME]

Date and Time Indication -62-

[C.DISPLAY]

Counter Display Mode -62-

[C.RESET]

Counter Reset -75-

5) [LCD/EVF]

Adjusting Brightness and Color Level

[LCD/EVF SET]

LCD and Viewfinder Adjustment -20-

[EVF ON/AUTO]

Using the Viewfinder -19-

6) [INITIAL]

Initial Setup Sub-Menu

[AV JACK]

AV Jack -73-

[REMOTE]

Remote Controller Mode -15-

[MPEG4 PLAYBACK MODE]

MPEG4 Playback Menu

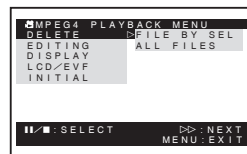

1) [DELETE]

Deleting a File Sub-Menu

[FILE BY SEL]

Selecting and Deleting a File -43-

[ALL FILES]

Deleting All Files -44-

2) [EDITING]

Editing a File Sub-Menu

[FILE LOCK]

Setting the Lock -43-

[CARD FORMAT]

Formatting a Card -44-

3) [DISPLAY]

Display Setup Sub-Menu

[SCREEN]

Screen Setting

[DISPLAY]

Display Mode -62-

[DATE/TIME]

Date and Time Indication -62-

4) [LCD/EVF]

Adjusting Brightness and Color Level

[LCD/EVF SET]

LCD and Viewfinder Adjustment -20-

[EVF ON/AUTO]

Using the Viewfinder -19-

5) [INITIAL]

Initial Setup Sub-Menu

[AV JACK]

AV Jack -73-

[REMOTE]

Remote Controller Mode -15-

Setting Date and Time

Since the internal clock of the Palmcorder has a slight imprecision make sure to check the time before recording.

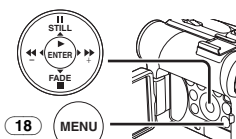
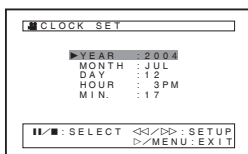
**1 Set [INITIAL] >> [CLOCK SET] >> [YES].****2 Press the [II/III] Button to select [YEAR], [MONTH], [DAY], [HOUR] or [MIN.] and press the [◀▶] Button to set it to the desired value.**

- Year will cycle in the order shown below.
2000, 2001, ..., 2089, 2000, ...

3 Press the [MENU] Button (18) to finish setting the date and time.

- The clock operation starts from [00] second.
- If the built-in battery is weak, the [⚡] Indication flashes. In this case, charge the built-in battery.
- The clock uses the 12-hour system.

Internal Lithium Battery Recharge

The internal lithium battery sustains the operation of the clock. When the [⚡] Indication flashes, the internal lithium battery is near exhaustion.

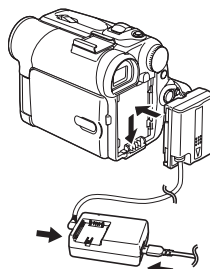
**1 Connect the AC Adaptor to the Palmcorder with the power turned off and then connect to the AC Jack.**

- After charging for 4 hours, the built-in lithium battery can power the clock for approximately 3 months.

LP Mode

A desired recording speed can be selected with [REC SPEED] on the [RECORDING] Sub-Menu. **If LP Mode is selected, the recording time becomes 1.5 times longer than that of SP Mode.**

Although the image quality does not decrease with the LP Mode recording, mosaic-pattern noise may appear on a playback image, or some normal functions may be restricted.

- The contents that are recorded in LP Mode are not completely compatible with other equipment.
- Audio dubbing is not possible with LP Mode. (-46-)

Audio Recording Mode

The sound quality of the recorded sound can be selected with [AUDIO REC] on the [RECORDING] Sub-Menu.

High sound-quality recording is possible with "16 bit 48 kHz 2 track" Mode. With the "12 bit 32 kHz 4 track" Mode, the original sound can be recorded on 2 tracks in stereo, while the other 2 tracks can be used for Audio Dubbing.

Recording Mode

About Recording

When recording pictures on a tape, set the Mode Dial to Tape Recording Mode [].

When recording still pictures or moving pictures on a card, set the Mode Dial to Card Recording Mode [].

When recording with the [AUTO/MANUAL/FOCUS] Switch (48) set to [AUTO], the Palmcorder automatically adjusts the focus and white balance. In some cases, they cannot be adjusted automatically and need to be adjusted manually. (-33-, -34-)

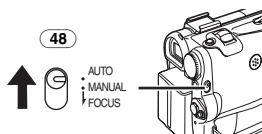

- Before turning on the power, remove the Lens Cap. If the Lens Cap is still attached when the power is turned on, Automatic White Balance Adjustment (-33-) may not function correctly.
- When the Recording Pause Mode continues for more than 5 minutes, the power is turned off automatically for tape protection and power conservation. (If the AC Adaptor is used, the power is turned off only when the tape is inserted in Tape Recording Mode.) When the tape is inserted in Tape Recording Mode and if the Recording Pause Mode continues for more than 5 minutes the power is turned off automatically. To resume recording from this condition, turn off, then turn on the power again.

Recording Lamp

The Recording Lamp (20) lights up during recording and alerts those being recorded that recording is in progress.

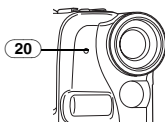

- The Recording Lamp does not light up if the [REC LAMP] on the [INITIAL] Sub-Menu is set to [OFF].

Recording on a Tape

1 Set the [OFF/ON] Switch (46) to [ON].

- The [POWER] Lamp (47) lights up.

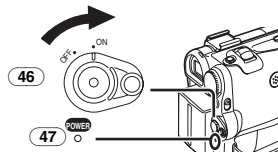

2 Set the Mode Dial (43) to Tape Recording Mode.

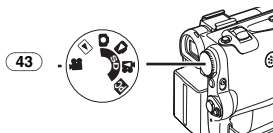

3 Press the Recording Start/Stop Button (45).

- Recording starts.
- After [RECORD] is displayed, it changes to [REC].

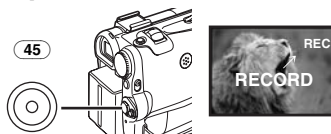

4 Press the Recording Start/Stop Button (45) again to pause the recording.

- The [PAUSE] Indication is displayed.



Recording "Simultaneous Motion/Still Record Mode"

- Even if the Mode Dial is set to Tape Recording Mode and the recording to a tape is in progress, you can also record a still picture on a card by pressing the [PHOTO SHOT] Button.

To Check the Recording

By pressing the [G] Button (10) briefly in the Recording Pause Mode, you can play back the last few seconds of the recorded scene.



- The [CHK] Indication is displayed. After checking, the Palmcorder resumes the Recording Pause Mode.

- For other notes concerning this item, see -64-.

■ Finding the End of Recording (Blank Search Function)

The Blank Search Function aids you in locating the end of the recording on the Cassette quickly.

- 1 Set [TAPE RECORDING MENU] or [TAPE PLAYBACK MENU] >> [INITIAL] >> [BLANK SEARCH] >> [YES]

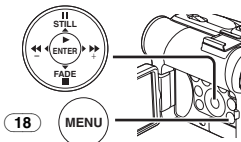

- The [BLANK] Indication appears during the Blank Search.
- Approximately 1 second before the last recorded scene, the Palmcorder switches to the Recording Pause Mode or the Still Playback Mode.
- If there is no blank left on the Cassette, the Palmcorder stops at the end of the tape.

To Cancel Blank Search Before Completion

Press the [■] Button.

■ To Add a Sound while Recording

With the supplied Magic Wire Remote Control with Narration Mic connected to the [REMOTE] Jack (34), you can add a narration while recording is in progress.

While the [TALK] Button (84) is pressed, the [P] Indication is displayed and the sound is recorded from [MIC] (80).

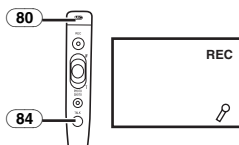

- While the [TALK] Button is pressed, the built-in microphone does not operate.

■ Digital Still Picture

When the [STILL] Button (12) is pressed, images become still pictures. When the button is pressed again, the Digital Still Picture Mode is cancelled.

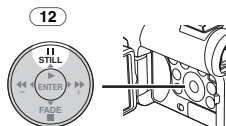

- We recommend that you press the [STILL] Button first at the position where you wish to record the still picture so as to enter the Digital Still Picture Mode and then press the [PHOTO SHOT] Button.

■ Progressive Photoshot

When the [P] Indication is displayed, Progressive Photoshot Function works. You can record still pictures with higher quality by using this function.

- The Progressive Photoshot Function may not be activated depending on the function you use. (-62-)
- To record still pictures with higher quality, we recommend setting to the Card Recording Mode. (To activate the progressive function regardless of the function you use)
- When you record onto the tape and the card simultaneously, the progressive function is not activated.

Recording a Still Picture on a Card (Photoshot)

Still pictures can be recorded on the Memory Card from the Palmcorder.

- 1 Set the Mode Dial (43) to Card Recording Mode.

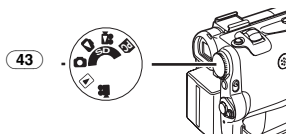

- 2 Press the [PHOTO SHOT] Button (39).

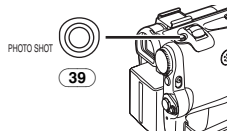

- The [PICTURE] Indication lights up in red.

Selecting the quality of Photoshot images

- 1 Set [CARD RECORDING MENU] >> [CARD] >> [PICT QUALITY] >> a desired image quality.

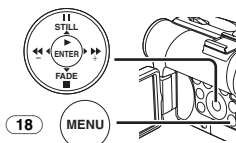

Maximum number of images recordable on the supplied Card (8MB)

- [FINE] (high image quality): approximately 45 pictures
- [NORMAL] (normal image quality): approximately 95 pictures
- [ECONOMY] (low image quality): approximately 190 pictures
- These figures vary depending on the subject being photographed.

■ RapidFire Consecutive Photoshot

The still pictures can be recorded on a Card at regular intervals.

- 1 Set [CARD RECORDING MENU] >> [CARD] >> [BURST MODE] >> [ON].

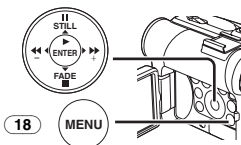

- The [] Indication appears.



- 2 Press the [PHOTO SHOT] Button (39).

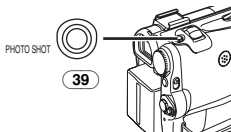

- When [ON] is selected, the still pictures can be recorded in approximately 0.5 second intervals until the [PHOTO SHOT] Button is released or 10 pictures are recorded.

Recording a Moving Picture on a Card (MPEG4)

You can record moving pictures on a Card. The recorded data can also be played back on Windows Media Player (ver.6.4 and later).

- When the Mode Dial (43) is set to Card Recording Mode, you cannot record to the Tape.

- 1 Set the Mode Dial (43) to Card Recording Mode.

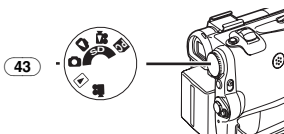

- 2 Press the Recording Start/Stop Button (45).

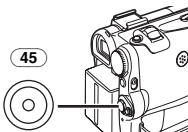

- It takes 1 to 2 seconds to start recording.
- During recording the [MPEG4] Indication is lit in red.

- 3 Press the Recording Start/Stop Button (45) again to pause the recording.

- The maximum continuous recording times are approximately 120 minutes.

The Palmcorder will automatically stop recording when the relevant time listed above has elapsed.

- When Remaining Time Indication becomes [R:0h00m], this Indication flashes in red. Recording will not start.
- The picture size of the moving picture (MPEG4):
[SUPERFINE]: 320×240
[FINE]: 320×240
[NORMAL]: 176×144
[ECONOMY]: 176×144
- When attaching to e-mail, we recommend the file size to be less than 1MB.
[SUPERFINE]: approximately 8 seconds
[FINE]: approximately 15 seconds
[NORMAL]: approximately 20 seconds
[ECONOMY]: approximately 1 minute

Selecting the Quality of MPEG4 Recording images

- 1 Set [CARD RECORDING MENU] >> [CARD] >> [MPEG4 MODE] >> a desired image quality.

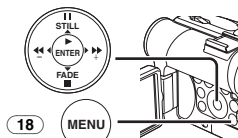

Maximum recording time on the supplied Card (8MB)

- [SUPERFINE]: approximately 1 minute
- [FINE]: approximately 2 minutes
- [NORMAL]: approximately 3 minutes
- [ECONOMY]: approximately 8 minutes

- These figures vary depending on the scene.

- For other notes concerning this item, see -64-.

■ Recording Yourself

By opening the LCD Monitor and rotating it forward (to the lens side), you can let the subject in front of the Palmcorder monitor the shot while recording is in progress.

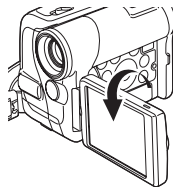

- When the LCD Monitor is opened, the Viewfinder is disabled automatically. However, when the LCD Monitor is rotated forward, the image is also shown in the Viewfinder.

- If you prefer to have the image on the LCD Monitor to look like an image in a mirror, set [SELF REC] on the [LCD/EVF] Sub-Menu to [MIRROR]. Images are recorded normally and no left and right reversal occurs.

Quick Start

By pressing the [QUICK START] Button (44), the Palmcorder will be ready for recording in approximately 1.3 seconds after it is turned on.

1 Press the [QUICK START] Button (44).

- The Quick Start Recording Lamp (44) lights up.

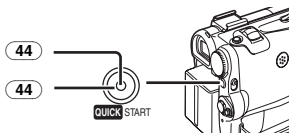

2 Set the [OFF/ON] Switch (46) to [OFF].

- The Quick Start Recording Lamp remains lit.

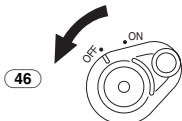

3 Set the [OFF/ON] Switch (46) to [ON].

- The Palmcorder will be ready for recording in approximately 1.3 seconds.

To Cancel the Quick Start

Keep the [QUICK START] Button pressed for approximately 2 seconds and make sure the Quick Start Recording Lamp is not lit.

- For other notes concerning this item, see -64-.

Self-timer Recording

When you set the self-timer, the recording starts automatically after 10 seconds on the Card.

1 Set [TAPE RECORDING MENU] or [CARD RECORDING MENU] >> [CAMERA] >> [SELF TIMER] >> [ON].

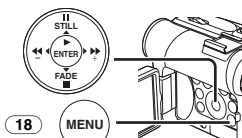

- The [] Indication appears.

2 Press the [PHOTO SHOT] Button (39).

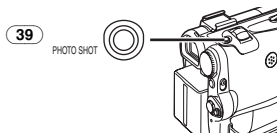

- The Recording Lamp (20) and the [] Indication flash and the recording starts after 10 seconds.
- You can also use the RapidFire Consecutive Photoshot. (-27-)
- For other notes concerning this item, see -65-.

Zoom In/Out Functions

This feature gives special effects to the picture by recording objects close by or with wide-angle shot.

1 For wide-angle shots (zoom out):

Push the [W/T] Lever (40) towards [W].

For close-ups (zoom in):

Push the [W/T] Lever towards [T].

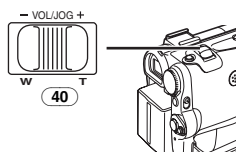

- Zoom Magnification Indication is displayed for a few seconds.



To Take Close-up Shots of Small Subjects

(Macro Close-up Function)

When the zoom magnification is 1x, the Palmcorder can focus on a subject that is as close as approximately 1.6 inches (40 mm) from the Lens. Small subjects like insects can be recorded with this function.

To Use the Tele-Macro Function

With the zoom magnification of 10x, the Palmcorder can bring the subject into focus as close as approximately 7.8 inch (20 cm) from the Lens. Focusing only on the subject and displaying the background out of focus makes the picture more impressive.

1 Press the [TELE MACRO] Button (8).

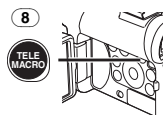

- The zoom magnification is fixed at 10x and the subject can be focused on as close as 7.8 inch (20 cm).

- The [T.MACRO] Indication appears.



- 2 Press the Recording Start/Stop Button (45) or the [PHOTO SHOT] Button (39).

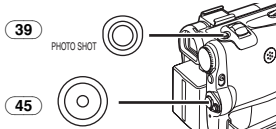

To Cancel the Tele-Macro Function

Press the [TELE MACRO] Button.

To Use the Zoom Microphone Function

Along with the zooming operation, the microphone's directional angle and sensitivity are varied for recording sounds.

- Set [TAPE RECORDING MENU] >> [RECORDING] >> [ZOOM MIC] >> [ON]. (The [Z.MIC] Indication is displayed.)



- For other notes concerning this item, see -65-.

Digital Zoom Function

This function is useful when you want to record close-up shots of subjects located beyond a normal zoom range of 1× to 10× magnification. With the Digital Zoom Function, you can select a magnification from 25× up to 700×.

- 1 Set [TAPE RECORDING MENU] >> [CAMERA] >> [D.ZOOM] >> [25×] or [700×].

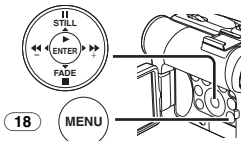

- 25×: Digital zooming to 25×
- 700×: Digital zooming to 700×



- 2 Push the [W/T] Lever (40) towards [W] or towards [T] to zoom in or out.

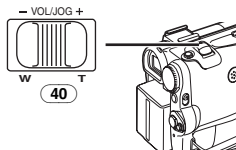

To Cancel the Digital Zoom Function

Set [TAPE RECORDING MENU] >> [CAMERA] >> [D.ZOOM] >> [OFF].

- For other notes concerning this item, see -65-.

Image Stabilizer Function

If the Palmcorder is shaken while recording, the camera shake in the image can be corrected.

- If the Palmcorder shakes too much, the images may not be stabilized.

- 1 Set [TAPE RECORDING MENU] >> [CAMERA] >> [EIS] >> [ON].

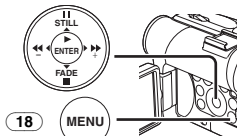

- The [EIS] Indication appears.



- 2 Press the Recording Start/Stop Button (45) or [PHOTO SHOT] Button (39) to start recording.

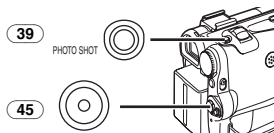

To Cancel Image Stabilizer Function

Set [TAPE RECORDING MENU] >> [CAMERA] >> [EIS] >> [OFF].

- For other notes concerning this item, see -65-.

Fade In/Out Functions

Fade In

Fade In brings out images and sounds gradually from a black screen at the beginning of a scene.



- 1 Keep pressing the [FADE] Button (15) during the Recording Pause Mode.

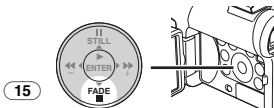

- The image fades out gradually.

- 2 When the image is completely gone, press the Recording Start/Stop Button (45) to start recording.

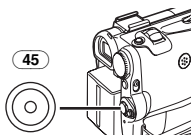

- 3 Release the [FADE] Button (15) about 3 seconds after starting recording.

- The image reappears gradually.

Fade Out

Fade Out causes images and sounds to disappear gradually, leaving a black screen at the end of a scene.



- 1 Keep pressing the [FADE] Button (15) while recording.

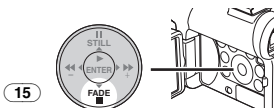

- The image fades out gradually.

- 2 When the image is completely gone, press the Recording Start/Stop Button (45) to stop recording.

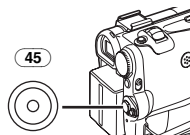

- 3 Release the [FADE] Button (15).

- The still picture cannot fade in or fade out.

Backlight Compensation Function

This prevents the subject from being recorded too darkly when backlit. (Backlight is the light that shines from behind the subject being recorded.)

- 1 Press the [BACK LIGHT] Button (11).



- The [] Indication flashes and then is displayed.
- The entire screen becomes brighter.



To Resume Normal Recording

Press the [BACK LIGHT] Button.

- For other notes concerning this item, see -65-.

MagicPix Functions

MagicPix Function

This function allows you to record color images brightly in a dark place without using the Video Flash.

- 1 Press the [MAGICPIX] Button (6) until the [MAGICPIX] Indication appears.



0 Lux MagicPix Function

Using the LCD Monitor light, a dark scene of almost 0 lux can be recorded.

- 1 Press the [MAGICPIX] Button (6) until the [0LUX MAGICPIX] Indication appears.



- The [REVERSE THE LCD MONITOR] Indication appears.

- 2 Rotate the LCD Monitor forward (to the lens side).

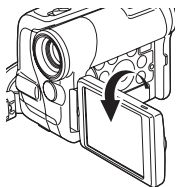

- The screen becomes white and the Viewfinder turns on.
- The available range of the LCD Monitor light is within approximately 3.9 feet (1.2 meter).

To Cancel the MagicPix Functions

Press the [MAGICPIX] Button repeatedly until neither the [MAGICPIX] Indication nor the [0LUX MAGICPIX] Indication appears.

- For other notes concerning this item, see -65-.

Soft Skin Function

This enables you to record skin colors in a softer tone. In order to get the best result, avoid background colors similar to the skin color of the subject. Otherwise, this may result in a softer background lacking in detail.

- 1 Press the [SOFT SKIN] Button (7).



- The [SOFT SKIN] Indication appears.



- To obtain the best effect, we recommend to take a bust shot, so that the upper part from the breast of the subject can be framed in the screen.

To Cancel the Soft Skin Function

Press the [SOFT SKIN] Button.

Wind Noise Reduction Function

This function reduces the sound of wind hitting the microphone when recording.

- 1 Set [TAPE RECORDING MENU] or [CARD RECORDING MENU] >> [RECORDING] >> [WIND CUT] >> [ON].

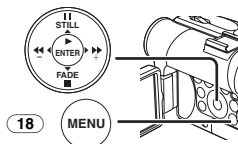

- The [WIND CUT] Indication appears.

**To Cancel the Wind Noise Reduction Function**

Set [TAPE RECORDING MENU] or [CARD RECORDING MENU] >> [RECORDING] >> [WIND CUT] >> [OFF].

- For other notes concerning this item, see -65-.

Cinema Function

This function is for recording a cinema-like image.

- 1 Set [TAPE RECORDING MENU] >> [RECORDING] >> [CINEMA] >> [ON].

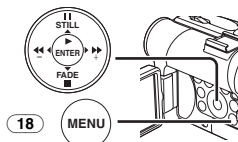

- Black bars appear at the top and bottom of the screen.

**To Cancel the Cinema Mode**

Set [TAPE RECORDING MENU] >> [RECORDING] >> [CINEMA] >> [OFF].

- For other notes concerning this item, see -65-.

Recording in Special Situations

(Program AE)

You can select optimal automatic exposure under specific recording situations.

- 1 Set the [AUTO/MANUAL/FOCUS] Switch (48) to [MANUAL].



- The [MNL] Indication appears.

- 2 Set [TAPE RECORDING MENU] or [CARD RECORDING MENU] >> [CAMERA] >> [PROG.AE] >> a desired mode ([Sports], [Portrait], [Low Light], [Spotlight] or [Surf & Snow]).

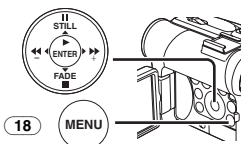

- The Indication of the selected Mode appears.



- 1) [Sports] Sports Mode
 - For recording scenes involving quick movements, such as sports scenes.
- 2) [Portrait] Portrait Mode
 - Use when you want to make people (subjects) stand out from the background.
- 3) [Low Light] Low Light Mode
 - For brightening a dark scene.
- 4) [Spotlight] Spotlight Mode
 - For recording a subject under a spotlight.
- 5) [Surf & Snow] Surf & Snow Mode
 - For recording in glaring surroundings, such as ski slopes, beaches, etc.

To Cancel the Program AE Function

Set the [PROG.AE] on the [CAMERA] Sub-menu to [OFF]. Or, set the [AUTO/MANUAL/FOCUS] Switch to [AUTO].

- For other notes concerning this item, see -66-.

Recording in Natural Colors

(White Balance)

Depending on the scene or light condition, the Automatic White Balance Adjustment Mode may not be able to bring out natural colors. In this case, the white balance can be adjusted manually.

When the Palmcorder is turned on with the Lens Cap on, the Automatic White Balance Adjustment may not function properly. Please turn on the Palmcorder after removing the Lens Cap.

- 1 Set the [AUTO/MANUAL/FOCUS] Switch (48) to [MANUAL].



- The [MNL] Indication appears.

- 2 Press the [ENTER] Button (14).

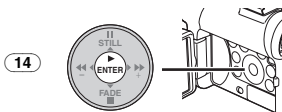

- The [AWB] Indication appears.

- 3 Press the [Right Arrow] Button (13) or [Left Arrow] Button (16) to select a desired White Balance Mode.

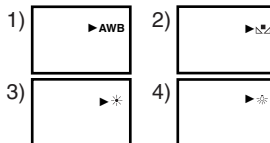

- 1) Automatic White Balance Adjustment [AWB]
- 2) The white balance setting that was previously set manually [Portrait]
- 3) Outdoor Mode [Outdoor]
- 4) Indoor Mode (recording under incandescent lamp) [Indoor]

To Resume Automatic Adjustment

Press the [Right Arrow] Button (13) or [Left Arrow] Button (16) until the [AWB] Indication appears. Or, set the [AUTO/MANUAL/FOCUS] Switch to [AUTO].

Adjusting White Balance Manually

White Balance Adjustment recognizes the color of light and adjust so that the white color will become pure white. The Palmcorder determines the hue of light that comes through the Lens and White Balance Sensor, thereby judging the recording condition, and selects the closest hue setting. This function is called Automatic White Balance Adjustment.

For light outside the functional Auto White Balance Adjustment range, use the Manual White Balance Adjustment Mode.

1 Set the [AUTO/MANUAL/FOCUS] Switch (48) to [MANUAL].

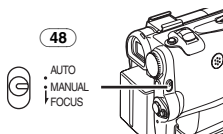

- The [MNL] Indication appears.

2 Press the [ENTER] Button (14).

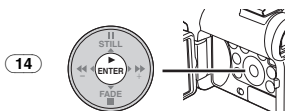

- The [AWB] Indication appears.

3 Press the [▶▶] Button (13) or [◀◀] Button (16) until the [MNL] Indication is displayed.



4 Point the Palmcorder at a full-screen white subject.

5 Keep pressing [ENTER] Button (14) until the [MNL] Indication stops flashing.

To Resume Automatic Adjustment

Press the [▶▶] Button (13) or [◀◀] Button (16) until the [AWB] Indication is displayed. Or, set the [AUTO/MANUAL/FOCUS] Switch to [AUTO].

About White Balance Sensor

The White Balance Sensor (33) determines the nature of the light source during recording.



- Do not cover the White Balance Sensor with your hand during recording because White Balance will not function normally.
- The red light from the Recording Lamp (20) will be reflected off your hand or object, possibly causing the White Balance sensor to operate incorrectly and changing the coloring.

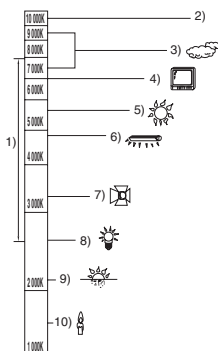

Outside of the effective range of Automatic White Balance Adjustment, the image will become reddish or bluish. Even within the effective range of Automatic White Balance Adjustment, the Automatic White Balance Adjustment may not function properly if there is more than one light source. In this case, adjust the White Balance.

- 1) The effective range of Automatic White Balance Adjustment on this Palmcorder
- 2) Blue sky
- 3) Cloudy sky (rain)
- 4) TV screen
- 5) Sunlight
- 6) White fluorescent lamp
- 7) Halogen light bulb
- 8) Incandescent light bulb
- 9) Sunrise or sunset
- 10) Candlelight

- For other notes concerning this item, see -66-.

Manual Shutter Speed Adjustment

Useful for recording fast-moving subjects.

- 1 Set the [AUTO/MANUAL/FOCUS] Switch (48) to [MANUAL].



- The [MNL] Indication appears.

- 2 Press the [ENTER] Button (14) until the Shutter Speed Indication appears.

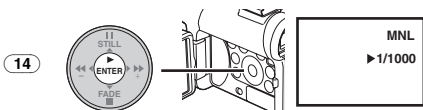

- 3 Press the [▶▶] Button (13) or [◀◀] Button (16) to adjust the shutter speed.

Range of Shutter Speed Adjustment

1/60–1/8000 s in Tape Recording Mode

1/60–1/500 s in Card Recording Mode

The standard shutter speed is 1/60 s.

Selecting a speed closer to [1/8000] causes the shutter speed to be faster.

To Resume Automatic Adjustment

Set the [AUTO/MANUAL/FOCUS] Switch to [AUTO].

- For other notes concerning this item, see -66-.

Manual Iris Adjustment

(F Number)

You can use this function when the screen is too bright or too dark.

- 1 Set the [AUTO/MANUAL/FOCUS] Switch (48) to [MANUAL].



- The [MNL] Indication appears.

- 2 Press the [ENTER] Button (14) until the Iris Indication appears.

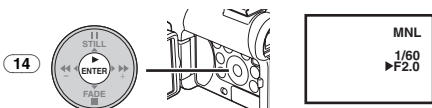

- 3 Press the [▶▶] Button (13) or [◀◀] Button (16) to adjust the iris.

Range of Iris Adjustment

CLOSE (Closed), F16, ..., F2.0,

OP (Opened)+0dB, ..., OP+18dB

When a value closer to [CLOSE] is selected, the image becomes darker.

When a value closer to [OP+18dB] is selected, the image becomes brighter.

The value to which +dB is attached indicates a Gain-up value. If this value is too large, the quality of the image deteriorates.

To Resume Automatic Adjustment

Set the [AUTO/MANUAL/FOCUS] Switch to [AUTO].

- For other notes concerning this item, see -66-.

Manual Focus Adjustment

Focus can be adjusted manually for recording in a situation where auto focus may not function well.

- 1 Set the [AUTO/MANUAL/FOCUS] Switch (48) to [MANUAL].



- The [MNL] Indication appears.

- 2 Slide the [AUTO/MANUAL/FOCUS] Switch (48) to [FOCUS].

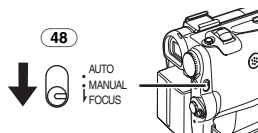

- The [▶MF] Indication (Manual Focus Mode) appears.



- 3 Press the [▶▶] Button (13) or [◀◀] Button (16) to adjust the focus.

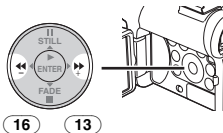

- If you keep pressing the [▶▶] Button or [◀◀] Button, the speed of adjusting will be faster.

To Resume Automatic Adjustment

Set the [AUTO/MANUAL/FOCUS] Switch to [AUTO] or [FOCUS].

Digital Effect Functions

This Palmcorder is equipped with Digital Effect Functions that add special effects to the scene.

Digital Effects 1 [EFFECT1]



- 1) Multi Mode [MULTI]
 - It records an image in black and white.
- 2) Picture-In-Picture Mode [P-IN-P]
 - It records an image with a painting-like effect.
- 3) Wipe Mode [WIPE]
- 4) Mix Mode [MIX]
- 5) Strobe Mode [STROBE]
 - Records images with a stroboscopic effect.
- 6) Trailing Effect Mode [TRAIL]
 - Records images with a trailing effect.
- 7) Mosaic Mode [MOSAIC]
 - Produces a mosaic-like image.
- 8) Mirror Mode [MIRROR]
 - The right half of an image becomes a mirror image of the left half.
- 9) Stretch Mode [STRETCH]
 - The picture is expanded horizontally.
- 10) Slim Mode [SLIM]
 - The picture is expanded vertically.

Digital Effects 2 [EFFECT2]

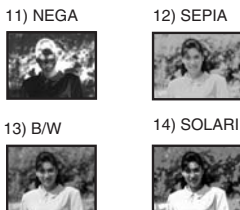

- 11) Negative Mode [NEGA]
 - The colors of the recorded image are inverted as seen in a negative.
- 12) Sepia Mode [SEPIA]
 - It records a scene with a brownish tint, like the color of old pictures.
- 13) Black & White Mode [B/W]

- 14) Solarisation Mode [SOLARI]
 - It records an image in black and white.

To Select a Desired Digital Effect

Set [TAPE RECORDING MENU] >> [DIGITAL] >> [EFFECT1] or [EFFECT2] >> a desired Digital Effect.

To Cancel the Digital Effect

Set [TAPE RECORDING MENU] >> [DIGITAL] >> [EFFECT1] or [EFFECT2] >> [OFF].

- If the Palmcorder is turned off, the [EFFECT2] settings are cancelled.

- For other notes concerning this item, see -66-.

Multi-Picture Mode

Strobe Multi-Picture Mode:



You can capture and record 9 consecutive small still pictures.

Manual Multi-Picture Mode:



You can manually capture and record 9 small still pictures.

- 1 Set [TAPE RECORDING MENU] >> [DIGITAL] >> [EFFECT1] >> [MULTI].

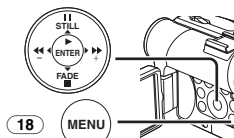

- 2 Set [TAPE RECORDING MENU] >> [DIGITAL] >> [MULTI MODE] >> [STROBE] or [MANUAL].

- 3 Press the [MULTI] Button (9).

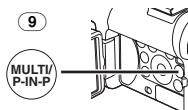

- If [MANUAL] is selected, press the [MULTI] Button at each scene you want to capture.

Deleting All the Captured Multi-Pictures

While 9 multi-pictures are displayed, press the [MULTI] Button.

- If [MANUAL] has been selected, press the [MULTI] Button after 9 pictures are displayed.

To Display the Multi-Pictures Again

Press the [MULTI] Button for 1 second or longer.

To Delete Multi-Pictures One by One

(When pictures were captured in [MANUAL])

When the [MULTI] Button is pressed for 1 second or longer while the still pictures are displayed, the pictures captured last are deleted continuously.

- After still pictures are deleted one by one, they cannot be displayed again.

- For other notes concerning this item, see -66-.

Picture-in-Picture Mode

You can display a sub-screen (still picture) inside the screen.

- 1 Set [TAPE RECORDING MENU] >> [DIGITAL] >> [EFFECT1] >> [P-IN-P].

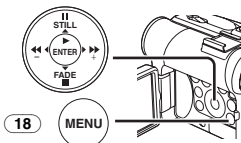

- 2 Aim the Palmcorder at the scene you want to capture and press the [P-IN-P] Button (9) to insert a small still picture.

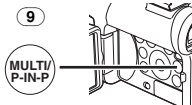

- A small still picture is displayed in a normal picture.
 - If the [P-IN-P] Button is pressed again, the small still picture is cleared.
- For other notes concerning this item, see -66-.

Wipe Mode and Mix Mode**Wipe Mode:**

Like drawing a curtain, the still picture of the last recorded scene gradually changes to the moving image of a new scene.

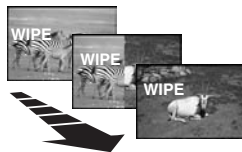
**Mix Mode:**

While the moving image of a new scene fades in, the still image of the last recorded scene gradually fades out.

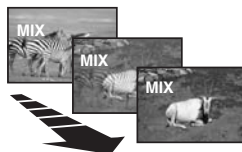

- 1 Set [TAPE RECORDING MENU] >> [DIGITAL] >> [EFFECT1] >> [WIPE] or [MIX].

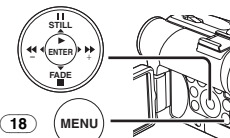

- The [WIPE] or [MIX] Indication appears.
- 2 Press the Recording Start/Stop Button (45) to start recording.

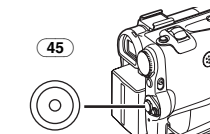

- 3 Press the Recording Start/Stop Button (45) to pause the recording.

- The last scene is stored in memory. The [WIPE] or [MIX] Indication changes to [WIPE] or [MIX].

- 4 Press the Recording Start/Stop Button (45) to restart the recording.

- The last image of the previous scene gradually changes to the new scene.

- For other notes concerning this item, see -66-.

Playback Mode

Playing Back a Tape

The recorded scene can be played back immediately after the recording.

1 Set the [OFF/ON] Switch (46) to [ON].

- The [POWER] Lamp (47) lights up.

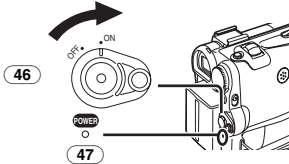

2 Set the Mode Dial (43) to Tape Playback Mode.

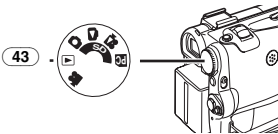

3 Press the [◀◀] Button (16) to rewind the tape.

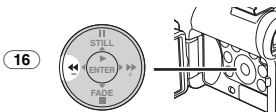

- Rewind the tape to the point where you want to start playback.
- When the tape reaches the beginning, rewinding stops automatically.

4 Press the [▶] Button (14) to start playback.

- The [▶] Indication appears.

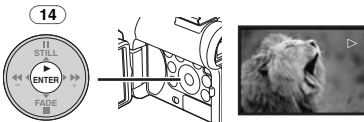

- If a cassette recorded with a copyright protection signal is played back, the picture is distorted by mosaic-like patterns.

To Stop Playback

Press the [■] Button (15).

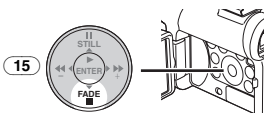

Adjusting the Sound Volume

To adjust the volume, push the [W/T] Lever (40) to display the [VOLUME] Indication. Push the [W/T] Lever towards [T] to increase the volume or push the [W/T] Lever towards [W] to decrease the volume. The [VOLUME] Indication goes off after the adjustment is finished.

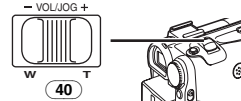

To adjust the volume with the Remote Controller, press the [T] or [W] Button to display the [VOLUME] Indication. Press the [T] Button to increase the volume or press the [W] Button to decrease the volume. The [VOLUME] Indication goes off after the adjustment is finished.



- The sound volume cannot be adjusted using the Remote Controller in Playback Zoom Mode. (-39-)

- For other notes concerning this item, see -67-.

Finding a Scene You Want to Play Back

Cue/Review Playback

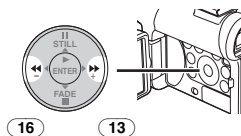

If the [▶▶] Button (13) or [◀◀] Button (16) is pressed during Playback, it turns to Cue Playback (A) or Review Playback (B).

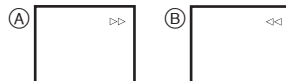

- If the Button is held continuously, it turns to Cue Playback or Review Playback until you release it.

Variable Speed Search Function

The speed of Cue Playback or Review Playback can be varied.

1 During playback, press the [▶] Button (14).

- The [1x▷] Indication appears.

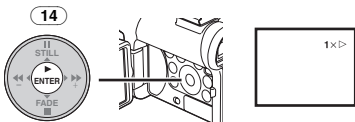

2 Push the [W/T] Lever (40) to select a desired search speed.

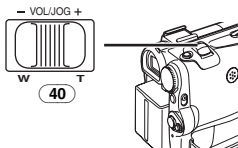

The following 6 playback speeds are available for the Variable Speed Search Function in both the fast-forwarding and rewinding directions:

- 1/5x (slow playback in SP Mode only), 1/3x (slow playback in LP Mode only), 1x, 2x, 5x, 10x and 20x.

- This function works by pressing the [VAR. SEARCH] and cursor buttons ([▲], [▼]) on the Remote Controller. (-14)

To Resume Normal Playback

Press the [▶] Button (14).

- During Cue or Review Playback, fast-moving images may show mosaic-like patterns.
- The sound is muted during search.

Slow Motion Playback

This Palmcorder can play back at a slow speed.

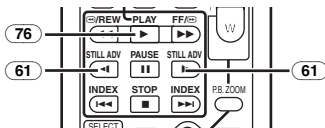

1 Press the [▶] Button (76).
2 Press the [◀] Button or [▶] Button (61) on the Remote Controller.

- The [||▶] or [◀||] Indication appears.



- When the [◀] Button is pressed, Slow Motion Playback proceeds in the reverse direction. When the [▶] Button is pressed, Slow Motion Playback proceeds in the forward direction.

Scenes recorded in the SP Mode are played back at approximately 1/5th of the normal speed. Scenes recorded in the LP Mode are played back at approximately 1/3rd of the normal speed.

To Resume Normal Playback

Press the [▶] Button (76).

- If the Palmcorder is left in the Slow Motion Playback Mode for more than 10 minutes, the Palmcorder switches to the Stop Mode to protect the video heads from excessive wear and tear.

Still Playback/Still Advance Playback

This Palmcorder is capable of still picture playback and frame-advance playback.

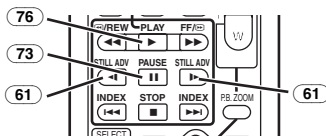

1 Press the [▶] Button (76).
2 Press the [||] Button (73).
3 Press the [◀] Button or [▶] Button (61) on the Remote Controller.

- The playback image stops in the Still Playback Mode.
- With each press of the [◀] Button, still pictures advance in the reverse direction. With each press of the [▶] Button, still pictures advances in the forward direction. If one of the buttons continues to be pressed, still pictures advance continuously 1 frame at a time until the button is released.

To Resume Normal Playback

Press the [▶] Button (76).

Playback with Zoom Lever

By pushing the [W/T] Lever (40) of the Palmcorder in the Still Playback Mode, still pictures can be advanced one frame at a time in the forward or backward direction. If you keep pushing the Lever, still pictures advance continuously.

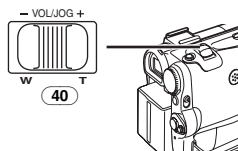

- If the Palmcorder is left in the Still Playback Mode for more than 5 minutes, the Palmcorder switches to the Stop Mode to protect the video heads from excessive wear and tear.

Index Search Functions

To facilitate searching for desired scenes, this Palmcorder automatically records index signals during recording, as explained in the following.

Photoshot Index Signal

These signals are automatically recorded when still pictures on a card are recorded to a tape.

Scene Index Signal

Scene Index Signals are automatically recorded when you start recording after inserting a Cassette.

- If [SCENE INDEX] of [RECORDING] Sub-Menu on the [TAPE RECORDING MENU] is set to [2HOUR], an index signal is recorded when recording is restarted after an elapse of 2 hours or longer. If it is set to [DAY], an index signal is recorded when recording is restarted after the date has changed since the last recording. (While the index signal is being recorded, the [INDEX] Indication flashes for a few seconds.)



- If the Palmcorder is switched from the Tape Playback Mode to Tape Recording Mode or if the date and time is set before the start of recording, the index signal is not recorded.

Photoshot Index Search

- 1 Set [TAPE PLAYBACK MENU] >> [PLAYBACK] >> [SEARCH] >> [PHOTO].

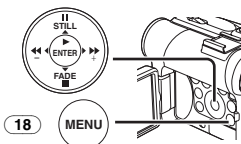

- 2 Press the [▶▶] Button or [◀◀] Button (62) on the Remote Controller.

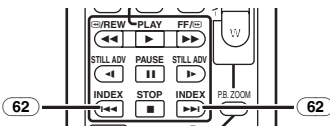

- With each press of the corresponding button, still pictures recorded in Photoshot Mode are searched.

Scene Index Search

- 1 Set [TAPE PLAYBACK MENU] >> [PLAYBACK] >> [SEARCH] >> [SCENE].
- 2 Press the [▶▶] Button or [◀◀] Button (62) on the Remote Controller.

- When the corresponding button is pressed once, the [S 1] Indication appears, and searching for the subsequent scene marked with an index signal starts. Each time the button is pressed after the start of Scene Index Search, the indication changes, from [S 2] to [S 9], and the beginning of the scene corresponding to the selected number will be searched.



- Up to 9 scene numbers can be selected.

Continuous Index Search

If the [▶▶] Button or the [◀◀] Button (62) is pressed for 2 seconds or longer, search can be continued at several-second intervals. (To cancel, press the [▶] Button (76) or the [■] Button (74).)

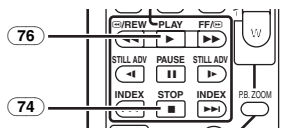

- For other notes concerning this item, see -67-.

Playback Zoom Function

A part of the image can be enlarged up to 10 times during playback.

- 1 During playback, press the [P.B. ZOOM] Button (78) on the Remote Controller.

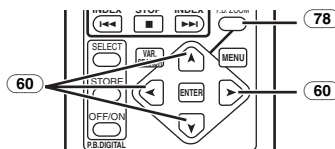

- The center of the image is enlarged to approximately 2 times.



To Change the Zoom Magnification

- 2 Change the magnification by pressing the [W] Button or [T] Button (66) on the Remote Controller.

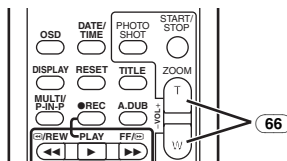

To Change the Enlarging Area of an Image

3 Press the Arrow Button (▲, ◀, ▶, ▼) (60) on the Remote Controller that points to the area you want to enlarge.

To Cancel the Playback Zoom Function

Press the [P.B. ZOOM] Button (78) on the Remote Controller.

• For other notes concerning this item, see -67-.

Playback Digital Effect Functions

During playback, special digital effects can be added to the recorded pictures. The same effects as those of Digital Effects 1 and 2, which are used during recording, are obtained.

1 Press the [▶] Button (76).

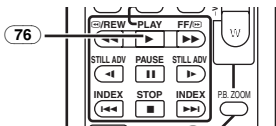

2 Press the [SELECT] Button (63) on the Remote Controller to select a desired digital effect.

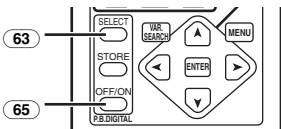

- When the [SELECT] Button is pressed repeatedly, the digital effect selection changes.
- The same setting can be done using [EFFECT SEL] Sub-Menu on the [TAPE PLAYBACK MENU].

To suspend Playback Digital Effect Temporarily

Press the [OFF/ON] Button (65) to suspend or restart the digital effect. When the digital effect is paused temporarily, the selected effect's indication flashes.

To Cancel the Digital Effect

Press the [SELECT] Button (63) on the Remote Controller and clear the digital effect indication.

■ Wipe Mode and Mix Mode

1 Press the [▶] Button (76).

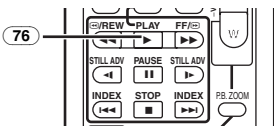

2 Press the [SELECT] Button (63) on the Remote Controller and select [WIPE] or [MIX].

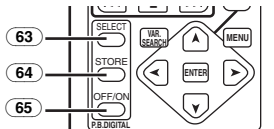

3 Press the [STORE] Button (64) at the moment you want to save as a still picture.

- The [WIPE] or [MIX] Indication appears, and the image is saved.

4 Press the [OFF/ON] Button (65) in the scene in which you want to use the Wipe or Mix effect.

- The scene changes as a result of the Wipe or Mix effect.
- The Wipe Function and Mix Function can only be accessed by using the Remote Controller during playback.
- If the [OFF/ON] Button (65) is pressed while Wipe or Mix is carried out, the effect will stop temporarily at that point. Pressing the [OFF/ON] Button (65) again will bring back the effect.

• For other notes concerning this item, see -67-.

Playing Back a Card

It plays back files recorded on a Card.

1 Set the Mode Dial (43) to Picture Playback Mode or MPEG4 Playback Mode.

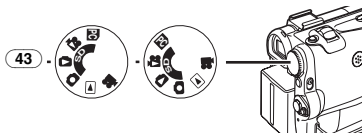

2 Start Playback.

[PICTURE]:

- ▶: Starting the Slide Show
- ▶▶: Playing back the next picture
- ◀◀: Playing back the previous picture
- : Stop the Slide Show
- ||: Pause the Slide Show

[MPEG4]:

- ▶: Playing back the File
- ▶▶: Selecting the next file (When you tap this button during playback, you can search the next file, and when you keep pressing it, cue playback is activated.)
- ◀◀: Selecting the previous file (When you tap this button during playback, you can search the beginning of the file, and when you keep pressing it, review playback is activated.)
- : Stop playing back
- ||: Pause playing back

When you select MPEG4 Playback Mode at Step 1

- File is numbered in hexadecimal.
- When the object is moving fast or zoom operation is performed, picture may appear to be still or mosaic-pattern noise may appear, but this is not a malfunction.
- When you select MPEG4 Playback Mode at step 1, during playback, push the [W/T] lever to display the volume indication until the volume Indication appears and adjust the volume. (-37-)

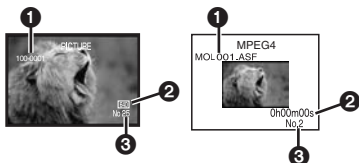

- 1 Folder File Number (When the picture is played back)
File Name (When the MPEG4 data is played back)
- 2 Picture Size (When the picture is played back) (-62-)
Playback time (When MPEG4 data is played back)
- 3 File Number

To Select a Desired File and Playing Back

1 Set the Mode Dial (43) to Picture Playback Mode or MPEG4 Playback Mode.

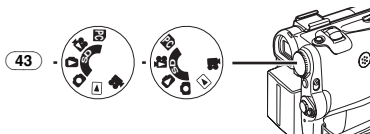

2 Press the [MULTI] Button (9).



- The files recorded on the Card are displayed in Multi-Picture Mode.

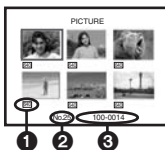

- 1 Picture Size (When Picture Playback Mode is selected at Step 1)
- 2 File Number
- 3 Folder File Number (When Picture Playback Mode is selected at Step 1)
File Name (When MPEG4 Playback Mode is selected at Step 1)

3 Press the [II/III/IIII/IIIIII] Button to select a desired file.

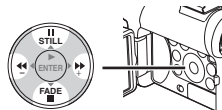

- The selected file is marked with a frame.

4 Press either the [ENTER] Button (14) or the [MULTI] Button (9).

- The selected file is shown on the entire screen.

- For other notes concerning this item, see -67-.

Slide Show

The recorded still pictures in the Card can be played back like a Slide Show.

1 Set the Mode Dial (43) to Picture Playback Mode.

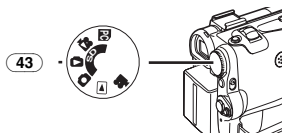

2 Press the [▶] Button (14).

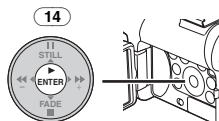

- The [SLIDE▶] Indication is displayed.



- Each of the pictures are played back for several seconds.

To Pause the Slide Show

Press the [IIII] Button.

- The [SLIDEIIII] Indication is displayed.



To Stop the Slide Show

Press the [■] Button.

- For other notes concerning this item, see -68-.

Creating a Title

You can create a title and record on a Card.

1 Recording Mode:

Set the Mode Dial (43) to Tape Recording Mode or Card Recording Mode.

Set the Lens to the image you want to use for creating a title.

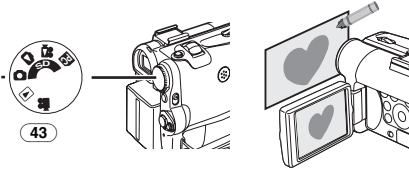

1 Tape Playback Mode:

Search for the image you want to use for creating a title and set the Palmcorder to the Still Playback Mode.

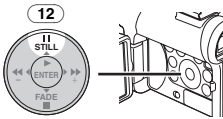

2 Set [CARD] >> [CREATE TITLE] >> [YES].

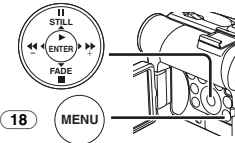

3 Press the [PHOTO SHOT] Button (39).

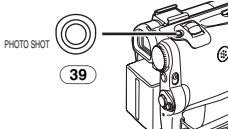

- The title is stored.
- To perform Photoshot again, select [RETURN].

4 Select [LUMINANCE] and press the [ENTER] Button (14), then press the [▶▶] Button (13) or [◀◀] Button (16) to adjust the title contrast and press the [ENTER] Button (14).

5 Press the [▶▶] Button (13) or [◀◀] Button (16) to adjust the color and press the [ENTER] Button (14).



- The dark portion of the image is missing ①, and the colors of the bright portion change in order of black, blue, green, cyan, red, magenta, yellow and white, after which the bright portion of the image is missing ② and

the colors of the dark portion change in the above order.

6 Select [RECORDING] and press the [ENTER] Button (14).

- The title is recorded on the Card.

• For other notes concerning this item, see -68-.

Adding a Title

A title can be added to the picture. It is displayed in Tape/Card Recording Mode and Tape/Picture Playback Mode.

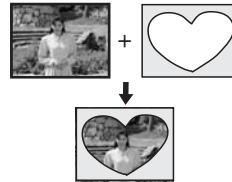

1 Set [DIGITAL] >> [TITLE IN] >> [ON].

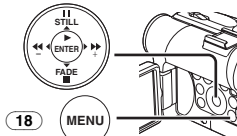

2 Press the [MENU] Button (18).

- The title is displayed.

3 Press the [MULTI] Button (9).

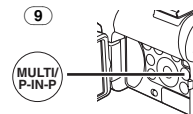

- A list of titles is displayed.

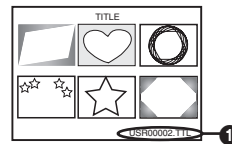

- File Name ①

4 Press the [||/■/◀▶] Button to select a desired title.

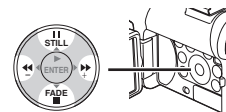

- The selected title is marked with a frame.

5 Press the [ENTER] Button (14) or press the [MULTI] Button (9).

- The selected title is displayed.

- Recording and Photoshot Recording can be made with pictures that have titles.
- A title can be displayed also by pushing [TITLE] Button on the Remote Controller.

To Clear the Title Display

Set [DIGITAL] >> [TITLE IN] >> [OFF].
Or press [TITLE] Button (70) on the Remote Controller.

- For other notes concerning this item, see -68-.

Writing Printing Data on a Card

(DPOF Setting)

DPOF Setting Printing data (DPOF Settings), such as the number of images to be printed, can be written to the Card. "DPOF" means Digital Print Order Format.

1 Set the Mode Dial (43) to Picture Playback Mode.

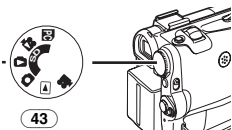

2 Set [PICTURE PLAYBACK MENU] >> [EDITING] >> [DPOF SET] >> [YES] >> [VARIABLE].

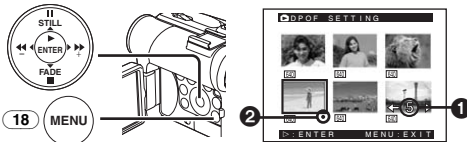

- When all images are not printed, select [ALL 0].

3 Select a desired picture and press the [ENTER] Button (14).

- The selected picture is marked with a frame.
- The number of prints set by DPOF (1) is displayed.

4 Press the [▶▶] Button (13) or [◀◀] Button (16) to select the number of pictures to be printed, and press the [ENTER] Button (14).

- [●] Indication (2) is displayed in the picture set. (-62-)

5 Repeat Steps 3 and 4 and press the [MENU] Button (18) when the setup is completed.

To Verify DPOF Setting

Select [VERIFY] in Step 2. The pictures for which 1 or more print is set in DPOF are played back continuously.

- For other notes concerning this item, see -68-.

Protecting the Files on a Card

(Lock Setting)

Precious files recorded on a Card can be locked to prevent accidental erasure. (Even if files are locked, the files will be deleted if the Card is formatted.)

1 Set [PICTURE/MPEG4 PLAYBACK MENU] >> [EDITING] >> [FILE LOCK] >> [YES].

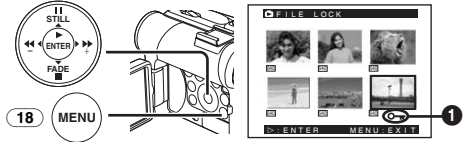

2 Select the file to be locked, and press the [ENTER] Button (14).

- The selected file is locked and the [O-TR] Indication (1) appears. Repeat this procedure to lock 2 or more files.
- Press the [ENTER] Button (14) again to cancel.
- The SD Memory Card has a write protection switch. (-68-)

- For other notes concerning this item, see -68-.

Deleting the Files Recorded on a Card

Using the Palmcorder, you can delete the files recorded on a Card. After the file is deleted, it cannot be restored.

To Select and Delete Files or Titles

1 Set [PICTURE/MPEG4 PLAYBACK MENU] >> [DELETE] >> [FILE BY SEL] >> [YES].

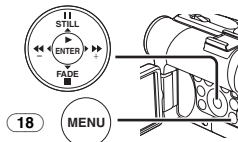

- To erase a title in [PICTURE PLAYBACK MENU], select [TITLE BY SEL].

2 Select the file you wish to delete and press the [ENTER] Button (14).

- The selected picture is marked with a frame.
- To erase 2 files or more, repeat this step.

3 Press the [PHOTO SHOT] Button (39).

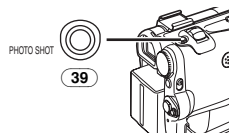

- A verification message appears.

4 Select [YES] and press the [ENTER] Button

14.

- The selected file is deleted from the Card.
- If [NO] is selected, the file selection is cancelled.

To Select and Delete All Files

- 1 Set [PICTURE/MPEG4 PLAYBACK MENU] >> [DELETE] >> [ALL FILES] >> [YES].

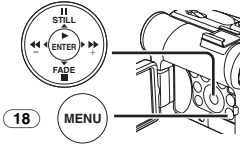

- A verification message appears.
- 2 Select [YES] and press the [ENTER] Button

14.

- All files of Picture/MPEG4 Playback Mode are erased.
- A locked file cannot be erased.
- If there are many files in a card, it takes several minutes for deleting.

Formatting a Card

If a Card becomes unreadable by the Palmcorder, format it for reuse. Formatting erases all the data recorded on a Card.

- 1 Set [PICTURE/MPEG4 PLAYBACK MENU] >> [EDITING] >> [CARD FORMAT] >> [YES].

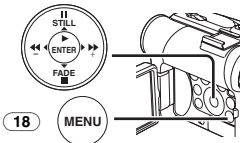

- A confirmation message appears, select [YES] and formatting will be carried out.

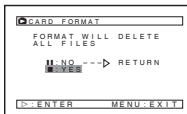

- When the formatting is completed, the screen becomes white.
- It may not be able to use the Card formatted by this Palmcorder on other unit. In this case, format the Card on the unit which will use the Card. Make sure that valuable pictures are stored on PC before proceeding.
- A Card formatted on other equipment (e.g. PC) might be unusable or it might take more time for recording. We recommend that you use this equipment to format the Card.

Enlarging a Movie Picture Size

You can enlarge a Moving Picture to full screen size

- 1 Set [MPEG4 PLAYBACK MENU] >> [DISPLAY] >> [SCREEN] >> [FULL].



Display specifications in playing back MPEG4 moving pictures

[NORMAL] display

- Pictures equal to or smaller than QCIF (176×144) are expanded to twice as large as the original size.
- Pictures larger than QCIF pictures (176×144) are displayed as large as the original size.

[FULL] screen display

- Pictures equal to or larger than QCIF (176×144) are displayed in full screen.
- Pictures smaller than QCIF pictures (176×144) are expanded about 3.6 times as large as the original size.
- When setting to [FULL], pictures may be shown in mosaic-like pattern depending on the file.

To Resume Normal Moving Picture Size

- Set [MPEG4 PLAYBACK MENU] >> [DISPLAY] >> [SCREEN] >> [NORMAL].

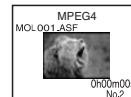

Playing Back on Your TV

By connecting your Palmcorder with your TV, the recorded scenes can be viewed on your TV screen.

- Before connecting them, turn off the power of both the Palmcorder and TV.

1 Connect the [AV IN/OUT] Jack of the Palmcorder and the Video and Audio Input Jacks of the TV.

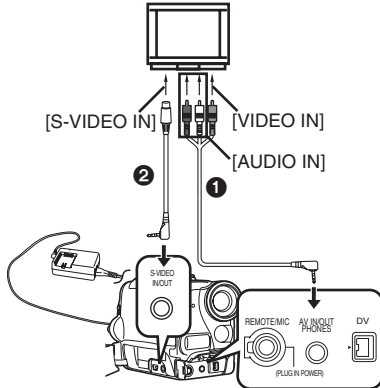

- Connect to the TV with the AV Cable ①. If the TV has an S-Video Jack, connect the S-Video Cable ②, too.
- When plugging the pin plug of the AV cable into the [AV IN/OUT] Jack, plug it in as far as it goes.

To Make the Indications Appear on the TV Screen

Press the [OSD] Button (55) on the Remote Controller.

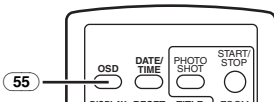

- For other notes concerning this item, see -68-.

Editing Mode

Recording from a Tape onto a Card

Still pictures or moving pictures can be recorded on the Memory Card from scenes that have already been recorded on a cassette.

1 Set the Mode Dial (43) to Tape Playback Mode.

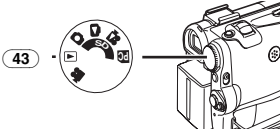

2 Still Picture:

Start playback and set the Palmcorder to Still Playback Mode at the scene you wish to record, and press the [PHOTO SHOT] Button (39).

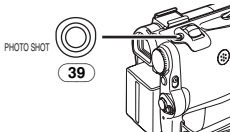

Moving Picture:

Start playback and press the Recording Start/Stop Button (45) at the desired scene.

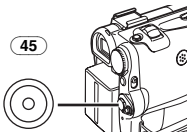

Recording Pictures from a Card onto a Tape

Card Images can be recorded to the Tape.

1 Set the Mode Dial (43) to Picture Playback Mode.

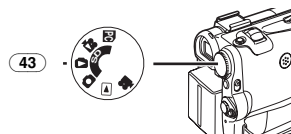

2 Display the first picture.

3 Press the [PHOTO SHOT] Button (39).

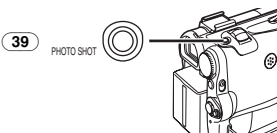

• During the copying, the following Indication appears.



- It takes a few seconds to record a picture to the Tape.
- When recording to tape, select the tape position before recording. The picture will be recorded to the tape position when the [PHOTO SHOT] Button is pressed at Step 3.
- Photoshot index signals are automatically recorded.
- Moving Picture (MPEG4) cannot be recorded from a Card to tape.

• For other notes concerning this item, see -68-.

Audio Dubbing

You can add music or narration to the recorded Cassette.

- If the tape recorded in the [16bit] Mode is dubbed with the Audio Dubbing function, the original sound is erased. (If you wish to preserve the original sound, use the [12bit] Mode when recording.)
- Audio Dubbing cannot be performed on a recording made in LP Mode. (-24-)

1 Set [TAPE PLAYBACK MENU] >> [AV IN/OUT] >> [AV JACK] >> [IN/OUT].

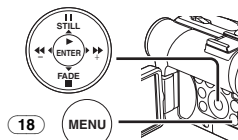

2 Next, select [A.DUB INPUT] >> [MIC] or [AV IN].

- Set to [AV IN] when external device is used, and to [MIC] when an external or built-in microphone is used.

3 Press the [II] Button (73) on the Remote Controller where you want to add new sound.

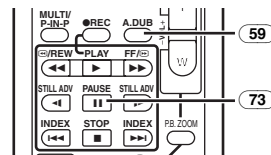

4 Press the [A.DUB] Button (59) on the Remote Controller.

5 To start Audio Dubbing, press the [II] Button (73) on the Remote Controller.

To Cancel Audio Dubbing

Press the [■] Button (73) on the Remote Controller.

The Palmcorder is in the Still Playback Mode again.

To Play Back the Sound Recorded by 12bit Audio Dubbing

Set [TAPE PLAYBACK MENU] >> [PLAYBACK] >> [12bit AUDIO] >> [ST2] or [MIX].

ST1: It plays back only the original sound.

ST2: It plays back only the sound added by Audio Dubbing.

MIX: It plays back both the original sound and the sound added by Audio Dubbing simultaneously.

To Dub Audio While Listening to a Pre-recorded Sound

When pausing the audio dubbing, set the [12bit AUDIO] on the [PLAYBACK] Sub-Menu to [ST2] and you can check the pre-recorded sound.

When a microphone is used for audio dubbing, use headphones to listen to the pre-recorded sound while dubbing the audio. (When using headphones, set [AV JACK] on the [AV IN/OUT] to [OUT/PHONES].) When the line input is used, you can dub audio while listening to the pre-recorded sound from the speaker.

- For other notes concerning this item, see -68-.

Copying on an S-VHS (or a VHS) Cassette**(Dubbing)**

After connecting the Palmcorder and the VCR as illustrated, start the following procedures.

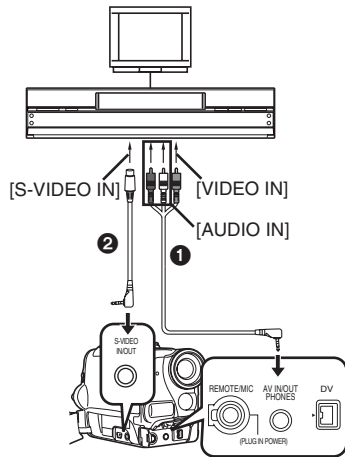

- 1 AV Cable
- 2 S-Video Cable

- Be sure to press the [OSD] Button (-14-) on the Remote Controller prior to copying so that no indications are visible. Otherwise, the displayed tape counter and function indications are also copied.

Palmcorder:

1 Insert the recorded Cassette.

VCR:

2 Insert an unrecorded Cassette with an erasure prevention tab.

- If various setups (such as external input, tape speed, etc.) are required, please refer to the operating instructions of your VCR.

Palmcorder:

3 Press the [▶] Button to start playback.

VCR:

4 Start recording.

5 Press the Pause or Stop Button to stop recording.

Palmcorder:

6 Press the [■] Button to stop playback.

Recording the Contents of Other Equipment

After connecting the Palmcorder and the other equipment as illustrated, start the following procedures.

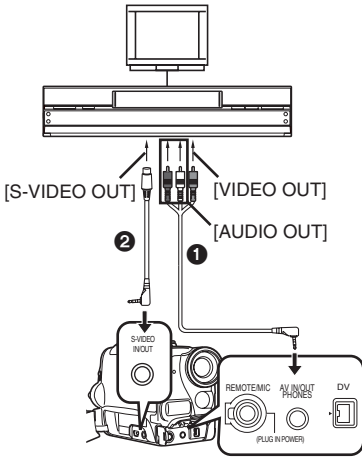

- ① AV Cable
- ② S-Video Cable

Palmcorder:

- 1 Set [TAPE PLAYBACK MENU] >> [AV IN/OUT] >> [AV JACK] >> [IN/OUT].

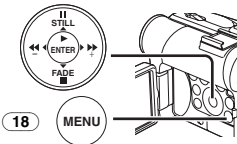

- 2 Insert an unrecorded Cassette.

Other Equipment:

- 3 Insert a recorded Cassette and start playback.

Palmcorder:

- 4 While pressing the [REC] Button (58), press the [PLAY] Button (76).
Or while pressing the [REC] Button (10), press the [BACK LIGHT] Button (11) on the Palmcorder.

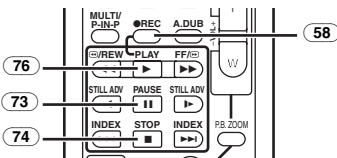

- When recording on a card, press the [PHOTO SHOT] Button or the Recording Start/Stop Button.

- 5 Press the [||] Button (73) or [■] Button (74) to stop recording.

Other Equipment:

- 6 Press the Stop Button to stop playback.

- For other notes concerning this item, see -69-.

Using the DV Cable for Recording

(Digital Dubbing)

By connecting this Palmcorder with other digital video equipment (such as another Palmcorder of the same format/model) that has a DV input/output terminal, and using a 4-pin to 4-pin DV Interface cable PV-DDC9/PV-DDC9-K (optional) ①, high quality images and sounds can be dubbed in the digital mode.

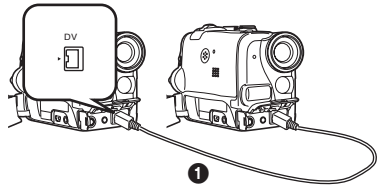

Player/Recorder:

- 1 Insert the Cassette and set to Tape Playback Mode.

Player:

- 2 Press the [▶] Button (76) to start playback.

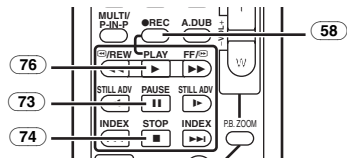

Recorder:

- 3 While pressing the [REC] Button (58), press the [PLAY] Button (76).

Or while pressing the [REC] Button (10), press the [BACK LIGHT] Button (11) on the Palmcorder.

- Recording starts.

To Stop Dubbing

Press the [||] Button (73) or the [■] Button (74).

- For other notes concerning this item, see -69-.

CAUTION:

Unauthorized exchanging and/or copying of copyrighted recordings may be copyright infringement.

With a PC

Using the Software with a Computer

An image stored on the DV Cassette can be transferred to your Personal Computer.

■ Software Installation (Windows)

- 1 Turn on Computer and start up Windows.
- 2 Insert supplied CD-ROM into the CD-ROM drive.

- [Setup Menu] appears.



- 3 Select the software to be installed from [Setup Menu].

• USB Driver -49-:

Software for USB Driver allows you to transfer images directly from the Memory Card into the computer.

• WebCam Driver -51-:

If the Palmcorder is connected to your personal computer, you can send video from the Palmcorder to the other parties via the network.

• DV STUDIO 3.1E-SE -53-:

Using the DV STUDIO 3.1E-SE software allows you to capture stills from video recorded on a tape or still images viewed through the lens of a camera.

• G.726 Audio Decoder -54-:

Software for G.726 Audio Decoder allows you to listen to MPEG4 sound with Windows Media Player.

• ArcSoft Software -55-:

Photolmpression 4.0, PhotoBase 4.0, Panorama Maker 3.0 and PhotoPrinter 4.0 are included.

• Windows Media Update

This update was provided by Microsoft Corporation. Run this update in cases where playback of an MPEG4 moving image file recorded with a Palmcorder is started in Windows Media Player, but ends with an error message after 3 to 4 minutes.

- 4 Follow the instructions on the computer screen until the installation is complete.

- Setup window will disappear when the installation is complete.

Note:

If a window does not appear automatically, click the "Start" Button on your desktop and then click "Run". When the "Run" Box is open, type in "D:\InstMenu.exe" and click "OK". ("D" applies when the CD-ROM drive is drive D.)

Using USB Driver

■ Operating environment

- Despite having the operating environment indicated, it may not be possible to use the program with some types of personal computers.
- A CD-ROM drive is required to install this program.

OS:

IBM PC/AT compatible personal computer with pre-installed;
Microsoft Windows XP Home Edition/
Professional
Microsoft Windows 2000 Professional
Microsoft Windows Me (Millennium Edition)
Microsoft Windows 98 Second Edition

CPU:

Intel Pentium II/Celeron 300 MHz or higher (including compatible CPU)

RAM:

32 MB or more (64 MB or more recommended) (128 MB or more required for Windows XP)

Free hard disk space:

At least 30 MB or more

Ports:

USB Terminal

■ Installing USB Driver

Please install USB Driver first before connecting the Palmcorder to your Personal Computer with the USB Connection Cable.

- 1 Turn on the Personal Computer and start up Windows.
- 2 Insert the supplied CD-ROM into the personal computer's CD-ROM drive.
 - Quit all applications.
 - [Setup Menu] appears.
- 3 Click the [USB Driver].
 - The set up program starts running.
- 4 For Windows 98SE/Me/2000 users, click [Restart] if the [InstallShield] dialog appears.
 - Do not remove the CD-ROM.
- 5 Finish installation by following the on-screen instructions.
 - Click [Next] and proceed with installation.
 - After completing the installation, Click [Finish].
- 6 After the USB Driver is installed, please restart your computer.

- Reboot the computer to finish installing USB driver.
- Installation continues after the computer reboots if you selected additional software.
- A message indicating a conflict between versions may be displayed during the installation. This will not cause a problem. Simply click [Yes] to proceed with the installation.
- Depending on the OS version, illustrations and icon names may vary.

For Windows 2000 Users

The message is displayed during installation. However, testing by the manufacturer has confirmed functionality of this Palmcorder with Windows 2000. Click [Yes] and proceed.

7 Click [OK] when the [Restarting Windows] Dialogue appears.

■ Connecting Computer and Palmcorder

Install USB Driver before connecting.

Never connect the USB Connecting Cable until the USB Driver is installed.

Before making these connections, turn off all devices which are to be connected.

- When using the USB Connection Kit, it is recommended that you use the AC Adaptor as the power supply of the Palmcorder.

■ For Using Built-in SD Drive

By connecting the Palmcorder and Personal Computer with the USB Cable, you can transfer still images saved on a Memory Card directly to your Personal Computer.

For Windows

- 1 Insert the Memory Card into the Palmcorder.**
- 2 Set the Palmcorder to PC Mode.**

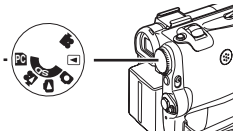

- 3 Connect the Palmcorder to your personal computer with USB Cable.**

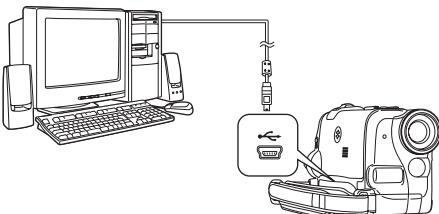

- It enters PC Connecting Mode.

- 4 Open [My Computer] and click [Removable Disk] (For Windows 98SE/Me/2000 users).**

Click [Open folder to view files using Windows Explorer] and then [OK] (For Windows XP users).

- You can view images stored on the Memory Card and also save them to your hard disk.
- Please do not change file or folder names on the Personal Computer. The images on the Memory Card may not be able to be viewed on the Palmcorder.
- After making the connections, turn the connected equipment on.
- Appropriate driver to recognize Palmcorder is automatically installed by Windows Plug and Play when connected for the first time.
- After the USB Driver is installed and USB Connection Cable is connected to the Palmcorder, open [My Computer] or [Windows Explorer] to check that the drive is displayed as a removable disk drive (only when card is inserted into the Palmcorder). It enables you to operate in the same way as a floppy disk drive, and you can use the same drag and drop or copy methods.

For Macintosh

OS:

Mac OS X v 10.1 – X v 10.2

CPU:

PowerPC

RAM:

64 MB or more

- 1 Insert the Memory Card into the Palmcorder.**
- 2 Set the Palmcorder to PC Mode.**

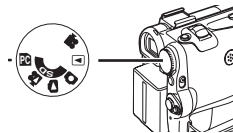

- 3 Connect the Palmcorder to your Macintosh with USB Cable.**

- 4 Double click the "NO_NAME" icon.**

- You can view images stored on the Memory Card and also save them to your hard disk.
- Please do not change file or folder names on the Personal Computer. The images on the Memory Card may not be able to be viewed on the Palmcorder.

Using as a Web Camera

If the Palmcorder is connected to your personal computer, you can send video and sound from the Palmcorder to the other parties via the network.

- Do not connect the USB Cable until the USB Driver or WebCam Driver is installed.

This feature can be used only if both parties are using the same operating system. Please see chart below:

[Send]		[Receive]	[Software]
Windows XP	←OK→	Windows XP	Windows Messenger
Windows XP	←NG→	Windows 98SE/Me/2000	X
Windows 98SE/Me/2000	←OK→	Windows 98SE/Me/2000	MSN Messenger

■ Operating environment

OS:

IBM PC/AT compatible personal computer with preinstalled;

Microsoft Windows XP Home Edition/
Professional

(In this case of Windows XP SP1 or later is needed.)

Microsoft Windows 2000 Professional
Microsoft Windows Me (Millennium Edition)
Microsoft Windows 98 Second Edition

CPU:

Intel Pentium II/Celeron 300 MHz or higher
(including compatible CPU)

RAM:

32 MB or more (64 MB or more recommended)
(128 MB or more required for Windows XP)

Free hard disk space:

At least 250 MB or more

Ports:

USB Terminal

To use the Palmcorder as a Web Camera, the additional minimum requirements must be met.

Graphic display:

High Color (16 bit) or more
Desktop resolution of 800×600 pixels or more

Communication Speed:

56 kbps or faster is recommended

Necessary software:

Windows Messenger 5.0 or later (Windows XP)
MSN Messenger (Windows 98SE/Me/2000)

Other requirements (to send/receive audio):

Sound card
Speaker or headphones and Microphone

To use the Palmcorder as a Web Camera, the following conditions must be met.

- In the case of Windows XP SP1 or later is needed.
- To upgrade Windows XP to SP1, click [Start] >> [All Programs] >> [Windows Update]. (Requires internet connection.)
- You have direct dial-up connection capability to the Internet. Also, you and the other person(s) are in the same Network (LAN).
- Install the Windows Messenger (Windows XP) or MSN Messenger (Windows 98SE/Me/2000). If you have a version older than 5.0, please download the latest version (5.0 or later) from the Microsoft Home Page.
<http://www.microsoft.com/>
<http://www.msn.com/>
(For download and installation instructions, please refer to Help on the Home Page.)
- Install the Windows Messenger or MSN Messenger.
- If the installed version is not the latest, update it by performing the Windows update.
- If you are connected to the Internet through a firewall or a router, proper communication will not be possible.
- The installer is available only in English but can be used on operating systems using other languages.
- When DirectX 9.0 is installed, applications supported by previous versions of DirectX may not run.

■ Installing WebCam Driver

1 Insert the supplied CD-ROM into the personal computer's CD-ROM drive.

- Quit all applications.
- The [Setup] screen appears.

2 Click [WebCam Driver]

- The set up program starts running.

3 You may be required to install DirectX 9.0 depending on the environment of the personal computer. In this case, click [Yes] to install it.

4 Finish installation by following the on-screen instructions.

- Click [Next] and proceed with installation.
- After completing the installation, Click [Finish].

5 Click [OK].

■ Connecting the Palmcorder to Personal Computer (For Using as a Web Camera)

- 1 Install the supplied WebCam Driver.
- 2 Set the Mode Dial to Tape Recording Mode.
- 3 Set [CAMERA] >> [USB FUNCTION] >> [WEB CAMERA].

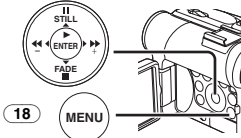

- It enters WEB CAMERA Mode.

4 Connect the Palmcorder to Personal Computer with auxiliary USB Connection Cable.

- When the Palmcorder and personal computer (with Windows 2000) are connected via USB Cable, a message, such as the one below, is displayed. However, testing by the manufacturer has confirmed functionality of this Palmcorder with Windows 2000. Click [Yes] and proceed.



- For Windows 98SE/Me users, “USB Audio Device” is required. Click [Next] and proceed.

For Windows 98SE/Me Users

The following messages may be displayed during the installation depending on the environment of the personal computer. Install the USB Driver as instructed below. Otherwise, it won't be installed correctly.

- 1) The message “The file ‘kstvtune.ax’ on [Unknown] cannot be found...” is displayed.



- Enter “C:\Windows\system” for Windows 98SE.
- Enter “C:\Windows\options\CABS” for Windows Me.
- If the “kstvtune.ax” file is missing in one of the 2 above-mentioned folders, insert the OS CD-ROM and assign the path.

- 2) The message “The file ‘ksclockf.ax’ on [Unknown] cannot be found...” is displayed.

- Enter “C:\Windows\system”.
- If the “ksclockf.ax” file is missing in the above mentioned folder, insert the OS CD-ROM and assign the path.

- You may click [Browse] to look for and assign the path.

5 Start the Windows Messenger or MSN Messenger.

- Click [Start] >> [All Programs (Programs)] >> [Windows Messenger] or [MSN Messenger].
- When you use Windows XP, the other parties via the network have to use the Windows Messenger on Windows XP. When you use other than Windows XP, the other parties via the network have to use the MSN Messenger on the OS other than Windows XP.
- If the Palmcorder is used as a Web Camera, the quality of the video to be exchanged will depend on the Internet connection status.
- If the USB Connection Cable is disconnected from the personal computer, the WEB CAMERA mode is cancelled.
- In the WEB CAMERA mode, video cannot be recorded onto a tape or a card.

■ Setting up the Windows Messenger

When starting the Windows Messenger for the first time, its setup screen is displayed. (However, the screen is not displayed if the Windows Messenger setup has already been done.)

- 1 Click [Click here to sign in].



- 2 After the .NET Passport Wizard is displayed, click [Next].



- Please refer to the instruction manual of your personal computer for how to configure the audio and the microphone.
- To communicate with persons using Windows in other languages, setting up using alphabets or numbers is recommended.

- 3 According to the procedures displayed on the screen, continue the setup.

4 After the setup is completed, sign in and start the Windows Messenger.

- Windows Messenger is activated.



- Please refer to the HELP file of the Windows Messenger for understanding its operation.
- During set up, if [Primary video capture device] selection screen is displayed, [Panasonic DVC Web Camera] is selected.
- Send the sound by using the microphone attached to the Personal Computer.
- If the Palmcorder is used as a Web Camera continuously for two hours, the communication is automatically shut OFF. In this case, restart Windows Messenger and set up the communication again.

■ Setting up the MSN Messenger

When starting the MSN Messenger for the first time, its setup screen is displayed. (However, the screen is not displayed if the MSN Messenger setup has already been done.) For more details, please read the corresponding Help file.

1 Click [Sign In].**2 Type in your Sign-in name and password.**

- If you do not have your Sign-in name and password, click [Get one here]

3 Please carefully read the displayed contents and then proceed.**4 After the setup is completed, sign in and start the MSN Messenger.****5 Click on [Audio Tuning Wizard...] in the [Tools] menu to confirm that equipment is connected correctly.****6 Select the microphone attached to the PC in the [Microphone] menu.****7 Click [Web Camera Settings...] in the [Tools] menu.****8 Confirm the [Panasonic DVC Web Camera Device] is selected.**

- For other information about MSN Messenger, please refer to Help.
- If the Palmcorder is used as a Web Camera continuously for two hours, the communication is automatically shut OFF. In this case, restart MSN Messenger and set up the communication again.
- When access is finished, close MSN Messenger, then turn off the Palmcorder. Finally, disconnect the USB Cable.

Using the DV STUDIO 3.1E-SE**■ Operating environment****OS:**

IBM PC/AT compatible personal computer with pre-installed;
Microsoft Windows XP Home Edition/
Professional
Microsoft Windows Me (Millennium Edition)
Microsoft Windows 98 Second Edition

CPU:

Intel Pentium II/Celeron 300MHz or higher
(including compatible CPU)

Graphic display:

High Color (16 bit) or more
Desktop resolution of 800×600 pixels or more

RAM:

32 MB or more (64 MB or more is recommended)
(128 MB or more are required for Windows XP
(256 MB or more is recommended))

Free hard disk space:

At least 20 MB

Ports:

USB Terminal

Other requirements:

Mouse

- The DV STUDIO 3.1E-SE cannot be operated on Windows 2000.
- When 2 or more USB devices are connected to a personal computer, or when devices are connected through USB hubs or by using extension cables, proper operation is not guaranteed.
- When connected to the keyboard USB terminal, normal function may not be possible.
- This instruction manual describes only the procedures for installation, connection and start-up. Please read the PDF-based instructions for how to use the DV STUDIO 3.1E-SE.

- To view the installed operating instructions, Adobe Acrobat Reader 5.0 or later is required. Please install Adobe Acrobat Reader from the supplied CD-ROM.
- Before using for the first time, select [Readme] from [Start] >> [All programs (Programs)] >> [Panasonic] >> [DV Studio3], and read any supplementary details or updates.

■ Installation of DV STUDIO 3.1E-SE

- 1 Insert the supplied CD-ROM into the personal computer's CD-ROM drive.
- 2 Select the software to be installed from [Setup Menu].



- 3 Click [Next].



- After reading the displayed contents, please carry out the installation according to instructions.

- 4 After the completion of setup, click on [Finish].



- Installation will be completed.
- Sample data is installed concurrently with the DV STUDIO 3.1E-SE software.

■ To start DV STUDIO 3.1E-SE

- 1 Set the Mode Dial to Tape Recording Mode or Tape Playback Mode.

- If you wish to capture data from a tape, set the Palmcorder to Tape Playback Mode and insert the tape.

- 2 Connect the Palmcorder to the Personal Computer with auxiliary USB Connection Cable.

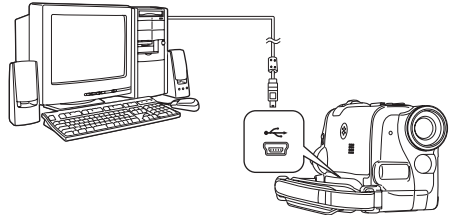

- 3 Select [Start] >> [All Programs (Programs)] >> [Panasonic] >> [DV Studio3] >> [DV Studio3].

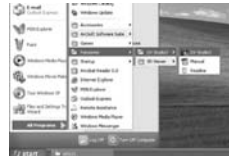

- If a shortcut icon has been created on the desktop during installation, it is also possible to start by double-clicking on the icon.

Using the G.726 Audio Decoder

G.726 Audio Decoder allows you to listen to MPEG4 sound with Windows Media Player. Install it from enclosed CD-ROM.

In order for the G.726 Audio Decoder to be installed, the hard disk must have at least 16 MB of free space. Before proceeding with installation, check out the amount of free space on the hard disk.

■ Operating environment

OS:

IBM PC/AT compatible personal computer with pre-installed;
Microsoft Windows XP Home Edition/
Professional

Microsoft Windows 2000 Professional

Microsoft Windows Me (Millennium Edition)

Microsoft Windows 98 Second Edition

Also, the following software must be correctly installed.

DirectX 6 or later (Runtime)

DirectX Media 6 Runtime

Windows Media Player 6.1 or later

Graphic display:

High Color (16 bit) or more

Desktop resolution of 800×600 pixels or more

RAM:

32 MB or more

Free hard disk space:

At least 16 MB

■ Installing the G.726 Audio Decoder

1 Insert supplied CD-ROM into the CD-ROM drive.

- [Setup Menu] appears.

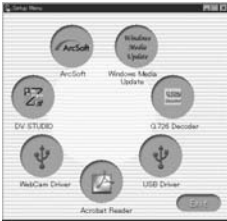

2 Select the software to be installed from [Setup Menu].

- The set up program starts up.
- Quit all Windows applications.

3 Install it by following the instructions on the screen.



- Carefully read the license agreement on the [Software License Agreement] window, and if you agree click [Yes]. Software is not installed if [No] is clicked.

4 Click [Finish] when the [Setup Complete] Dialog Box appears.

- Finish installing the G.726 Audio Decoder by restarting the computer.

Using the ArcSoft Software

There are 4 types of image editing software in the ArcSoft Software package.

1 Panorama Maker 3.0 (Windows, Mac)



- Easy-to-use photo-stitching program seamlessly combines multiple photos into a single panoramic picture.

2 PhotoBase 4.0 (Windows), PhotoBase 2.0 (Mac)



- Create albums of image, video, audio, and other electronic files for easy viewing, retrieval, and management.

3 PhotoImpression 4.0 (Windows, Mac)



- Easy-to-use photo editing program to edit, enhance, retouch or add special effects to any image. Also offers creative solutions for making greeting cards and calendars.

4 PhotoPrinter 4.0 (Windows, Mac)



- Program to layout images in multiple sizes quickly and effortlessly to create a collage or photo album, all on one page.

■ Operating environment

For Windows

OS:

IBM PC/AT compatible personal computer with pre-installed;
Microsoft Windows XP Home Edition/
Professional
Microsoft Windows 2000 Professional
Microsoft Windows Me (Millennium Edition)
Microsoft Windows 98 Second Edition

CPU:

Pentium-based PC or equivalent [1, 3, 4]
Pentium II-based PC or equivalent [2]
(Pentium II 300MHz or higher recommended)

Graphic display:

High Color (16 bit) or more
Desktop resolution of 800×600 pixels or more
*QuickTime and/or VRML viewer needed. [1]

RAM:

64 MB or more (128 MB or more is recommended)

Free hard disk space:

At least 625 MB

Other requirements:

Mouse

For Macintosh

OS:

Mac OS 9 – X

CPU:

PowerPC

Graphic display:

High Color (16 bit) or more
Desktop resolution of 800×600 pixels or more
*QuickTime and/or VRML viewer needed. [1]

RAM:

64 MB or more (128 MB or more is recommended)

Free hard disk space:

At least 300 MB

- This instruction manual describes only the procedures for installation, connection and start-up. Please read the Help messages of your software for how to use the ArcSoft Software Suite.

■ Installation of ArcSoft Software Suite

For Windows

- 1 Insert the supplied CD-ROM into the personal computer's CD-ROM drive.
- 2 Select the software to be installed from [Setup Menu].



- 3 Select the desired language on the [Choose Setup Language] dialogue, and click [OK].

• Installation begins.

- After reading the displayed contents, please carry out the installation according to instructions.
- If a language other than the OS language is selected, the characters may not be presented correctly.

- 4 When the component selection screen is displayed, check the software to be installed and click [Next].

- 5 After the completion of setup, click on [Finish].



- Installation will be completed.

For Macintosh

- 1 Turn on Computer and start up Macintosh.
- 2 Insert supplied CD-ROM into the CD-ROM drive.
- 3 Double click the icon of a CD-ROM that appears.



- 4 Double click [ArcSoft].

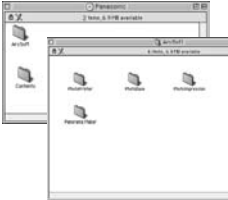

- 5 Double click [Photolmpression] (or [PhotoBase] or [PanoramaMaker] or [PhotoPrinter]).
- 6 Double click [English] or [French].
- 7 Double click [Photolmpression Installer] (or [PhotoBase Installer] or [PanoramaMaker Installer] or [PhotoPrinter Installer]).
- 8 Follow the instructions on the computer screen until the installation is complete.

■ To start software in the ArcSoft Software Suite

- 1 Select [Start] >> [All Programs (Programs)] >> [ArcSoft Software Suite] >> [Panorama Maker 3] (or [PhotoBase 4] or [Photolmpression 4] or [PhotoPrinter 4]).

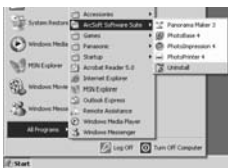

For Information on ArcSoft Software:

TEL: 1-510-440-9901

Web Site: www.arcsoft.com

Refer to Help information about application operations and other Error messages.

To disconnect USB cable safely

If USB cable is disconnected while computer is on, error dialog box may appear. In such a case click [OK] and close the dialog box. By following the steps below you can disconnect the cable safely.

- 1 Double click the  icon in task tray.
 - Hardware disconnect dialog box appears.



- 2 Select [USB Mass Storage Device] and click [Stop].
- 3 Verify [Matshita DVC USB Device] is selected and click [OK].



- You can safely disconnect the cable.

Note on the driver name displayed

The driver name displayed will differ depending on your OS, operating environment and the mode of the Palmcorder.

Windows XP/2000:

(When the Palmcorder is in Tape Recording mode or Tape Playback Mode:)

[Panasonic DVC USB-SERIAL Driver for Win XX (COM X)] (The numeral designation after "Win XX" will differ depending on the OS. The numeral after "COM" will differ depending on the operating environment of your personal computer.)

(When the Palmcorder is in PC Mode:)

[USB Mass Storage Device] or [Panasonic DV DISK Port Driver]

Windows Me:

(When the Palmcorder is in PC Mode:)

[USB Disk]

- Some OS, such as Windows 98SE, may not show the icon indicating that you may safely disconnect in task tray. (OS may be set not to show) Make sure Palmcorder's Card Access Lamp is off and disconnect the cable. Also, with Windows Me, the icon will not be displayed when in Tape Recording Mode or Tape Playback Mode.

CAUTION:

If you disconnect the USB Cable while the Card Access Lamp is on, it may damage the Card data.

Removing the USB connection cable safely for Macintosh

1 Drop the [NO_NAME] icon which appeared when you connected the Palmcorder with the USB connection cable into the recycle bin, then disconnect the USB connection cable.

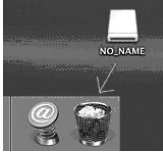

If the above operation is not performed correctly, when data is copied from the Personal Computer to an SD Memory Card, the copied data may be damaged.

Even when the following operations are performed, the same results will occur as when the USB cable is removed (above). Therefore, it is imperative that the above operation is completed before proceeding.

- When SD Memory Card is removed.
- When Palmcorder power is turned OFF.

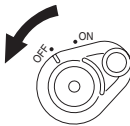

- When Mode Dial (43) is turned to change modes.

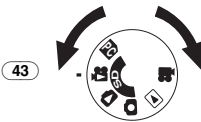

If you no longer need software or driver (Uninstall)

The screens may vary with the type of the OS. (In this manual, explanation is offered with Windows Me screen.)

1 Select [Start] (>> [Settings]) >> [Control Panel], select the software or the driver from [Add/Remove Programs] to uninstall.

- Uninstalling steps may vary depending on the OS. Please refer to the user manual of your OS.

Notes

- Macintosh is a registered trademark of Apple Computer, Inc. ArcSoft, the ArcSoft logo, ArcSoft PhotoImpression 4.0, ArcSoft PhotoBase 4.0, ArcSoft Panorama Maker 3.0 and PhotoPrinter 4.0 are trademarks of ArcSoft, Inc.
- Microsoft®, Windows®, Windows Messenger®, MSN Messenger® and DirectX® are either registered trademarks or trademarks of the Microsoft Corporation in the United States and/or other countries.
- Intel®, Pentium® and Celeron® are the registered trademarks or trademarks of the Intel Corporation.
- All other names, company names, product names, etc. in these instructions are the trademarks or registered trademarks of their respective corporations.
- The names of the products you are using may differ from the names given in the text. Depending on the operating environment and other factors, the contents of the screens used in these instructions may not necessarily match what you will see on your screen.
- Although the screens in these Operating Instructions are shown in English for the sake of example, other languages are supported as well.
- In this Manual, the Panasonic make digital video camera with USB Terminal is referred to as Palmcorder.
- These instructions do not cover the basic operations of the personal computer or define any terms. For this information, refer to the Operating Instructions which accompany your personal computer.
- Do not disconnect USB Connection Cable while the operation light of Palmcorder is on. It may freeze the software or destroy the data in transfer. Please refer to the user manual of Palmcorder.
- We recommend using the AC adaptor as the power source for the Palmcorder when using USB Connection Kit. Data may be lost if the battery power is lost while transferring data.
- If the Palmcorder is used as a Web Camera while virus checking software is running, the Palmcorder's operation may stop midway through. In this case, exit the Windows Messenger or MSN Messenger, reconnect the Palmcorder and restart the Windows Messenger or MSN Messenger.
- G.726 may not recognize Memory Card files not created by Palmcorder.

- Do not delete the folders in Memory Card such as picture folder. Memory card may not be recognized if folders are deleted.
 - When the Palmcorder is switched to the PC Mode while it is connected to the personal computer, "PC ACCESSING" is displayed on the Palmcorder and the operation mode of the Palmcorder cannot be switched. In this case, disconnect the USB Connection Cable. Switch the operation mode of the Palmcorder and reconnect the Cable.
 - If the Palmcorder is connected in the PC Mode, the [Removable Disk] icon representing the Memory Card drive is displayed in [My Computer].
 - When the Tape Recording Mode of the Palmcorder is switched to the PC Mode, a warning message may be displayed. You may simply ignore it.
 - When you are using Windows XP or Windows 2000, you may install or uninstall this software after logging ON by setting the user name to Administrator or to a user name having equivalent authority.
 - If you use Windows 98SE/Me, the message, "File is not found" may be displayed when the Palmcorder is connected for the first time. Enter the following paths to complete the connection: If the message "MTDV98M3.pdr is not found" is displayed, enter "C:\WINDOWS\system\IOSUBSYS". If the message "MTDV98M3.sys is not found" is displayed, enter "C:\WINDOWS\system32\DRIVERS". (The paths will differ depending on the environment of your personal computer.)
 - If you install the USB Driver while the USB Connecting Cable is being connected, or if you do not follow these Operating Instructions, the Palmcorder will not be recognized correctly. In this case, delete the USB Driver from [Device Manager] as described below, uninstall the USB Driver, and re-install it.
- 1** Set the Palmcorder to Tape Recording Mode or Tape Playback Mode, connect it to the personal computer, and delete [Panasonic DVC USB-SERIAL Driver for Win XX (COM X)] (or [Panasonic Serial USB Driver]) from [Device Manager].
The numeral designation after "Win XX" will differ depending on the OS. (Win 98, Win Me, Win 2000, Win XP)

- 2** Set the Palmcorder to PC Mode and delete [Panasonic DVC SD Disk Drive] (or [Panasonic DVC USB Storage]) (Windows 98SE).

■ About the SD Memory Card and MultiMediaCard

SD Memory Card

The SD Memory Card (supplied) is virtually the same size as a MultiMediaCard. It is an external Memory Card that is available in larger capacities. It has a write protect switch to prevent data writing and card formatting, as well as a copyright protection function.

- SD Logo is a trademark.

MultiMediaCard

The MultiMediaCard is a compact, lightweight and removable external Memory Card.

- All other company and product names in the operating instructions are trademarks or registered trademarks of their respective corporations.

■ Files recorded on a SD Memory Card or MultiMediaCard

It may not be possible to play back the files on this Palmcorder recorded on and created by other equipment or vice versa. For this reason, check the compatibility of the equipment in advance.

■ About the compatibility of the card files

Data files recorded on an "SD Memory Card" or a "MultiMediaCard" by this Palmcorder conform with DCF (Design rule for Camera File system) established by JEITA (Japan Electronics and Information Technology Industries Association).

- If you attempt to play back files recorded with this Palmcorder on other equipment or to play back files recorded with other equipment on this Palmcorder, you may not be able to play them back. Please check the compatibility with the other equipment in advance.

■ About the folder structure when using the Memory Card in a personal computer

- When a Card with data recorded on it is inserted into a personal computer, folders will be displayed as in the figure.

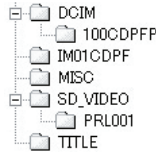
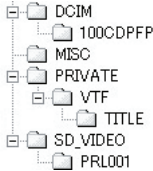

[100CDPFP]: The images (IMGA0001.JPG, etc.) in this folder are recorded in the JPEG format.

[MISC]: Files in which DPOF Data has been set to the image are in this folder.

[TITLE]: This contains the data of the original titles (USR00001.TTL, etc.).

[PRL001]: MPEG4 moving picture is recorded in ASF format (MOL001.ASF etc.). It can be played back with Windows Media Player (ver.6.4 and later). Because of their small size, these files are well suited for transmitting data through telephone lines etc. To play back a moving picture with Windows Media Player, select a file and double click. Necessary software is automatically downloaded and starts playing back. (Internet connection is required). To play back with Mac OS, Windows Media Player for Macintosh is required.















- [DCIM], [IM01CDPF], [PRIVATE], [VTF], [SD_VIDEO], etc. are necessary items in the folder structure. They have nothing to do with actual operations.
- In the Card Mode, the Palmcorder automatically saves file numbers (IMGA0001.JPG, etc.) along with the images. The file numbers are recorded with each image as consecutive numbers.























- When using the software without indication function, indication data, such as date, are not displayed. Depending on the software in use, the date and the time may not be displayed correctly.
- The memory capacity indicated on the SD Card label corresponds to the total card capacity. Some of this capacity is used to protect and manage the copyright data, and not all capacity is available as a conventional memory for a Palmcorder, Personal Computer or others. Capacity that can be used as conventional memory:
8 MB Card: about 6,800,000 bytes















Others

Indications

Various functions and the Palmcorder status are shown on the screen.

- : Remaining Battery Power
- When the battery power becomes low, the Indication changes. When the battery is discharged completely, the  () Indication flashes.
- RO:45: Remaining Tape Time
- Remaining tape time is indicated in minutes. (When it reaches less than 3 minutes, the indication starts flashing.)
- : Tape Recording Mode -25-
- : Tape Playback Mode -37-
- : Card Recording Mode -26-
- : Picture Playback Mode -40-
- : MPEG4 Playback Mode -40-
- : PC Mode -49-
- CINEMA: Cinema Mode -31-
- D.ZOOM: Digital Zoom -29-
- MULTI: Multi Mode -35-
- P-IN-P: P-IN-P Mode -35-
- WIPE: Wipe Mode -35-
- MIX: Mix Mode -35-
- STROBE: Strobe Mode -35-
- TRAIL: Trailing Effect Mode -35-
- MOSAIC: Mosaic Mode -35-
- MIRROR: Mirror Mode -35-
- STRETCH: Stretch Mode -35-
- SLIM: Slim Mode -35-
- NEGA: Negative Mode -35-
- SEPIA: Sepia Mode -35-
- B/W: Black & White Mode -35-
- SOLARI: Solarisation Mode -35-
- (PB) ZOOM: Playback Zoom -39-
- SP: Standard Play Mode (Recording Speed Mode) -24-
- LP: Long Play Mode (Recording Speed Mode) -24-
- INDEX: Index signal recording -39-
- S 1: Search Number -39-
- 5x: Zoom Magnification Indication -28-
- AUTO: Automatic Mode -25-
- MNL: Manual Mode -32-
- EIS: Image Stabilizer -29-
- MIC, AV IN: Audio Dubbing Input Display -46-
- 12 bit, 16 bit: Audio Recording Mode -24-
- MF: Manual Focus -34-
- : Back Light Mode -30-
- : Sports Mode (Program AE) -32-
- : Portrait Mode (Program AE) -32-
- : Low Light Mode (Program AE) -32-
- : Spotlight Mode (Program AE) -32-

- : Surf & Snow Mode (Program AE) -32-
- REC: Recording -25-
- PAUSE: Recording Pause -25-
- : Self-Timer Recording -28-
- : When connecting the Magic Wire Remote Control with Narration Mic to [REMOTE] Jack and the [TALK] Button is pressed, this indication appears. -26-
- : Playback -37-
- : Still Playback -38-
- : Fast-forward/Cue Playback -37-
- : Rewind/Review Playback -37-
- : Slow Motion Playback -38-
- : Still Advance Playback -38-
- : Index Search -39-
- CHK: Recording Check -25-
- A.DUB : Audio Dubbing -46-
- A.DUB : Audio Dubbing Pause -46-
- BLANK: Blank Search -26-
- R : Repeat Playback -67-
- 2x : Variable Speed Search -38-
- 1/500: When you adjust shutter speed manually, this indication appears. -34-
- SLIDE : Slide Show Playback -41-
- SLIDE : Slide Show Playback Pause -41-
- F2.0: When you adjust the F Number manually, this indication appears. -34-
- : White Balance Adjustment Mode -32-
- : Outdoor Mode -32-
- : Indoor Mode (recording under incandescent lamp) -32-
- MAGICPIX: MagicPix Function -30-
- 0LUX MAGICPIX: 0 Lux MagicPix Function -31-
- Z.MIC: Zoom Microphone -29-
- WIND CUT: Wind Noise Reduction -31-
- : Progressive Photoshot Mode -26-
- : Tele Macro -29-
- : Soft Skin Mode -31-
- PICTURE: Picture -40-
- TITLE: Title picture -42-
- MPEG4: Moving Picture (MPEG4) -41-
- 0h00m00s: Recording time of MPEG4
- VOLUME: Volume adjustment -37-
- 3:30:45PM: Date/Time Indication -62-
- N (F, E): Photoshot Picture Quality (during Photoshot recording) [F] means Fine, [N] means Normal and [E] means Economy. -26-
- : MPEG4 Picture Quality -27-

O:	Remaining Number of Photoshot pictures
R:0h00m:	Remaining time of MPEG4
 :	RapidFire Consecutive Photoshot Recording -27-
 :	Lock Setting -43-
● (White):	DPOF Setting completed (set to 1 or more picture) -43-
 :	[640×480] Image size
●	For images not recorded with this Palmcorder, the size display is determined as follows according to the number of horizontal pixels.
 :	640 or more, less than 800 (The size is not displayed at under 640 pixels.)
 :	800 or more, less than 1024
 :	1024 or more, less than 1280
 :	1280 or more, less than 1600
 :	1600 or more, less than 2048
 :	2048 or more
 (Cyan):	Photoshot Mode
 (Red):	While Photoshot recording is activated
 (Green):	While the card is being read
 (Red):	No Card (Still Picture Mode)
 (Cyan):	Moving Picture (MPEG4) Recording Mode
 (Red):	While Moving Picture (MPEG4) recording is activated

■ To Change the Counter Display Mode

By changing [C.DISPLAY] on the [DISPLAY] Sub-Menu, you can change the Counter Display Mode to Tape Counter Indication [COUNTER] (0:00.00), Memory Counter Indication [MEMORY] (M0:00.00), and Time Code Indication [TIMECODE] (0h00m00s00f). (-21-) By repeatedly pressing the [DISPLAY] Button on the Remote Controller, you can change the Counter Display Mode.

■ To Display Date/Time Indication

To display Date/Time Indication, set the appropriate Date/Time in [DATE/TIME] on the [DISPLAY] Sub-Menu. (-21-) You can also press the [DATE/TIME] Button of the Remote Controller repeatedly to display or change the Date/Time Indication.

■ To Change the Display Mode

By changing [DISPLAY] on the [DISPLAY] Sub-Menu, you can change the Display Mode to All Function Display [ALL] and Minimum Display [OFF]. (-21-)

■ Progressive Photoshot

You cannot use the Progressive Photoshot Function in the following cases.

When using Tape Recording Mode

- Digital Effect Modes in [EFFECT1]

- Digital Zoom [D.ZOOM]
 - 1/750 s or faster shutter speed
 - When brightness is insufficient
 - When the MagicPix Function is ON
 - When the Portrait Mode is used
- When using Card Recording Mode**
- When brightness is insufficient
 - When the MagicPix Function is ON

Initializing the Modes

You can change the Menu settings back to the shipping condition.

1 Set [INITIAL] >> [INITIAL SET] >> [YES].

- The initializing takes for a little while.
- After the initializing is completed, the [COMPLETED] Indication appears with beeps.
- Initializing will not erase the clock setting (-24-) that has been adjusted.

Warning/Alarm Indications

If any one of the following indications lights up or flashes, please check the condition of the Palmcorder.

 DEW (DEW DETECT/EJECT TAPE):
Condensation has occurred. -70-

 (CHECK REC TAB):

The accidental erasure prevention switch on the inserted Cassette is open (that is, set to [SAVE]).

You are attempting Audio dubbing or Digital dubbing on a Tape while setting the accidental erasure prevention switch to [SAVE].

 (TAPE NOT INSERTED):

No Cassette in inserted. -18-

 (LOW BATTERY):

The Battery is low. Recharge it. -16-

: The built-in battery is low. -24-

 (NEED HEAD CLEANING):

The video heads are dirty. -71-

 END (TAPE END):

The tape came to end during recording.

REMOTE (CHECK REMOTE MODE):

Wrong Remote Controller Mode has been selected. -15-

UNPLAYABLE TAPE

(OTHER FORMAT):

You are attempting to play back a tape section that has been recorded with a different TV system.

UNABLE TO A.DUB

(LP RECORDED):

Because the original recording was done in LP Mode, audio dubbing cannot be performed.

INCOMPATIBLE TAPE:

This cassette is incompatible.

PUSH THE RESET SWITCH:

Irregular mechanism is detected. Press the [RESET] Button (-I3-). This may solve the problem.

CARD FULL:

Card does not have sufficient memory remaining.
Select Picture/MPEG4 Playback Mode and delete unnecessary files.

NO CARD:

Card is not inserted.

NO DATA:

There is no recorded files in the Card.

UNPLAYABLE CARD:

You are attempting to play back data which is not compatible with this Palmcorder.

CARD ERROR:

The Card is not compatible with this Palmcorder.

COPY INHIBITED:

Because the medium is protected by a copy guard, images cannot be recorded correctly.

INCORRECT OPERATION:

The Recording Start/Stop Button was pressed without connecting the USB cable to the PC in Picture Playback Mode.

CHECK CARD:

You are attempting to record MPEG4 moving pictures recorded in [SUPERFINE] on MultiMediaCard. Use an SD Memory Card.

CANNOT USE USB CHANGE MODE:

The USB cable is connected to the Palmcorder in Card Recording Mode or Picture/MPEG4 Playback Mode.

CANNOT OPERATE:

You are attempting to record pictures on a Card while connecting the USB cable to the Palmcorder in Tape Recording/Playback Mode.

UNABLE TO WRITE**(MULTI RECORDING):**

The [PHOTO SHOT] Button is pressed when you are recording pictures on a Tape while setting the Digital Effect [MULTI] of [EFFECT1].

UNABLE TO WRITE**(MPEG4 RECORDING):**

The [PHOTO SHOT] Button is pressed when you are recording MPEG4 moving pictures.

You are attempting to record on a tape when MPEG4 Recording from external input signals is in progress.

UNABLE TO WRITE:

The Recording Start/Stop Button is pressed when you are recording still pictures on the Card.

CASSETTE DOOR OPEN:

Close the Cassette Compartment Cover before recording.

NO TITLE:

Titles are not recorded.

UNABLE TO INSERT TITLE:

You are attempting to do Title In Function when MPEG4 Recording is in progress or RapidFire Consecutive Photoshot function is set.

UNABLE TO WRITE**(WIDE MODE):**

You are attempting to record pictures of S1 signal (with aspect ratio 16:9) by pressing the [PHOTO SHOT] Button.

FILE LOCKED:

You are attempting to erase protected files.

CARD LOCKED:

The write protection switch on the SD Memory Card is set to [LOCK].

DISCONNECT USB CABLE:

You are attempting to turn the Mode Dial or turn the Palmcorder off in PC Mode while connecting the USB cable to the Palmcorder.

Notes and Hints**■ Concerning the Power Supply**

- When the Palmcorder is used for a long time, the Camera body becomes warm, but this is not a malfunction.
- If the [CHARGE] Lamp does not light up although the Battery is attached to the AC Adaptor, detach the Battery and reattach it.

■ Inserting/Removing the Cassette

- In the case of using a previously recorded Cassette, you can use the Blank Search Function to find the position where you want to continue recording.
- If a new Cassette is inserted, rewind to the beginning of the tape before starting recording.
- When inserting the cassette, make sure it faces in the right direction and then push it in until it stops.
- When the Cassette Holder is in action, do not touch anything except the [PUSH] Button.
- When closing the Cassette Compartment Cover, do not get anything caught in the cover, such as a cable of an optional stereo microphone.

■ Alarm Sounds

When [BEEP SOUND] on the [INITIAL] Sub-Menu on the [TAPE RECORDING MENU] is set to [ON], confirmation/alarm beeps are issued as follows.

1 Beep

- When you start recording
- When you switch the [OFF/ON] Switch from [OFF] to [ON]

2 Beeps

- When you pause recording
- 2 Beeps for 4 times
- If you operate a wrong operation before or during recording.

■ Recording Check

- For Recording Check, the recording speed mode (SP/LP) must be the same as the mode used for the recording. If different, playback images will be distorted.

■ Recording on a Card

- Even if the [SHTR EFFECT] is set to [ON], the Shutter Effect cannot be recorded on the picture.
- Pictures with wide-screen format signals cannot be copied.
- When the color of the screen changes or blurs, adjust the shutter speed manually to 1/60 or 1/100.

■ Photoshot

- The sound cannot be recorded.
- The file format supported by this Palmcorder is JPEG. (Not all the JPEG formatted files will be played back.)
- If [NORMAL] or [ECONOMY] is selected for recording, mosaic-pattern noise may appear on a playback image depending on the image content.

■ RapidFire Consecutive Photoshot

- One more still picture may be recorded after you release the [PHOTO SHOT] Button.
- The RapidFire Consecutive Photoshot and Title Function cannot be used simultaneously.
- When the [SELF TIMER] is set to [ON], the Palmcorder records the maximum number of pictures recordable depending on the [BURST MODE] setting.
- When using a card formatted by other equipment, intervals between pictures may become large.
- If recording or erasing pictures is repeated many times, intervals between pictures may become large. In this case, back up your important data on a PC, and format your card using this Palmcorder.

- Intervals of recording pictures may become large depending on the card. We recommend using Panasonic SD Memory Card.

■ Recording Moving Pictures (MPEG4)

- The following functions are disabled:
 - Self-timer -28-
- The sound is recorded in the monaural that is mixed [L] and [R] of the stereo sound.
- When playing back the MPEG4 moving picture recorded by this Palmcorder with other equipment, black bars may appear at the top and bottom of screen.
- MPEG4 moving pictures recorded in [SUPERFINE] cannot be recorded in the MultiMediaCard.
- If you record wide images as MPEG4 moving pictures when using line input or DV input, the wide images are recorded in lengthwise style.
- MPEG4 moving pictures may not be recorded on a card formatted by other equipment (e.g. PC).

■ Quick Start

- During the Quick Start Standby Mode, a minute amount of electricity is consumed.
- When the Palmcorder is left in the Recording Pause Mode for 5 minutes, it will be turned into the Quick Start Standby Mode. To turn the Palmcorder on again, set the [OFF/ON] Switch to [OFF] and then set it to [ON] again. (The Quick Start Mode will be restored.)
- This Function is not activated in the following cases:
 - A tape and a card is not inserted, while the Tape Recording Mode is set.
 - A Card is not inserted, while the Card Recording Mode is set.
- In the following cases, Quick Start is cancelled during the Quick Start Standby Mode.
 - Operate the mode dial
 - The Battery is replaced
- If the [QUICK START] Button is pressed and held for approximately 2 seconds during the Quick Start Standby Mode, the Lamp will go off and the Palmcorder will completely be turned off.
- If the Palmcorder is not operated for approximately 30 minutes when the Quick Start Recording Lamp lights, the Lamp will go off and the Palmcorder will completely be turned off.
- In the Automatic White Balance Mode, the color may be recorded unnaturally at the beginning of the recording.
- The zoom magnification differs from when it is in the Quick Start Standby Mode and when the recording starts.

Self-timer Recording

- When [BEEP SOUND] on the [INITIAL] Sub-Menu is set to [ON], the beep sound will be emitted along with the Recording Lamp flashing in the Self-timer Standby Mode.
- By operating the [OFF/ON] Switch, Recording Start/Stop Button or Mode Dial, the Self-timer Standby Mode is cancelled.

Zoom In/Out Functions

- When you are zooming on a faraway subject, a sharper focus is achieved if the recording subject is 4 feet (1.2 meters) or further from the Palmcorder.

Tele-Macro Function

- The Tele-Macro Function cannot be started during recording.
- When the [D.ZOOM] is set to [25×] or [700×], the Tele-Macro Function with the magnification greater than 10× is available.
- If a sharper focus cannot be achieved, adjust the focus manually.

In the following cases, the Tele-Macro Function is cancelled.

- The zoom magnification becomes lower than 10×.
- Setting the [OFF/ON] Switch to [OFF].

Zoom Microphone Function

- The Zoom Microphone Function may not work effectively if the surrounding noise is too loud.
- It does not work with an external microphone.

Digital Zoom Functions

- As the magnification of digital zoom increases, the quality of image may deteriorate.
- White balance cannot be set in the digital zoom range.

Image Stabilizer Function

- The Image Stabilizer Function does not operate in a dimly lit place. In this case, the [EIS] Indication flashes.
- Under fluorescent lighting, image brightness may change or colors may not look natural.
- After-images may appear.
- When a tripod is used, it is recommended that you turn the Image Stabilizer off.
- Within the digital zoom range, or when recording with a conversion lens attached, the Image Stabilizer Function may not work effectively.

Backlight Compensation Function

- When setting the Iris manually, the Backlight Compensation Function does not work.
- By operating the [OFF/ON] Switch, the Backlight Compensation Function is cancelled.

MagicPix Functions

- In a bright place, such as outdoors, the recorded picture may become whitish.
- In a dark place, the recorded picture is presented in a time-lapse-like manner.
- Adjust the Focus manually.
- The Progressive Photoshot Function is automatically turned off.
- The RapidFire Consecutive Photoshot Function cannot be used.
- White Balance cannot be set.
- The shutter speed cannot be adjusted.
- The Image Stabilizer, Program AE or Digital Effect Modes in [EFFECT1] cannot be set.
- When recording with the MagicPix Function, it is recommended that you use the tripod.
- The MagicPix Function makes the signal charging time of CCD longer up to 30 times longer than usual, so that the dark scenes that are invisible to the naked eyes can be recorded brightly. For this reason, a bright dots may be seen, but this is not a malfunction.
- The Image Stabilizer Function does not work. In this case, the [EIS] Indication flashes.
- The Soft Skin Function and the Backlight Compensation Function cannot be changed.

Wind Noise Reduction Function

- It does not work with the microphone on the Magic Wire Remote Control with Narration Mic nor an external microphone.
- When it is set to [ON], directivity of microphone is regulated depending on the strength of wind to reduce wind noise.

Cinema Function

- Using the Cinema Mode does not widen the recording angle.
- If you play back tape recorded in Cinema Mode on a wide-screen (16:9) format TV, playback size is automatically adjusted to fit the TV screen format. Please refer to the TV's operating instructions for details.
- When images are displayed on a TV screen, the Date/Time Indication may be erased in some cases.
- Depending on the TV, the picture quality may be deteriorated.
- The Cinema Mode is cancelled when a Title is displayed.
- The Cinema Mode and the Title Creation cannot be used simultaneously.
- Using the Cinema Mode deactivates [MULTI] and [P-IN-P] of [EFFECT1].
- Depending on the software in use, the imported Cinema picture may not be displayed correctly.

■ Program AE

- If any of the Program AE Modes are selected, you cannot adjust the shutter speed (-34-) or iris (-34-).
- Using the MagicPix Function cancels any of the Program AE modes.

Sports Mode

- During normal playback, the image movement may not look smooth.
- Because the color and brightness of the playback image may change, avoid recording under fluorescent light, mercury light or sodium light.
- If you record a subject illuminated with strong light or a highly reflective subject, vertical lines of light may appear.
- If the light is insufficient, the [] Indication flashes.

Sports Mode/Portrait Mode

- If you record a still picture in Progressive Photoshot Mode, the brightness and hue of the recorded still picture may become unstable.
- If this mode is used for indoor recording, playback images may flicker.

Low Light Mode

- Extremely dark scenes may not be able to be made brighter to a satisfactory degree.

Spotlight Mode

- With this mode, recorded images may become extremely dark.
- If the subject is extremely bright, its recorded image may become whitish.

Surf & Snow Mode

- If the subject is extremely bright, its recorded image may turn out to be whitish.

■ White Balance

In the following cases, you cannot change White Balance:

- When you set [EFFECT2] to [SEPIA] or to [B/W].
- When you set the Zoom to 10× or higher
- During Digital Still Picture Mode
- When you display a Menu
- When you use the MagicPix Mode

In the following cases, the [] Indication flashes:

- The flashing indicates that the previously adjusted White Balance setting is still kept. This setting will be kept until White Balance is adjusted again.
- You may not be able to achieve correct White Balance Adjustment manually under weak illumination.

■ Manual Shutter Speed Adjustment

- You may see vertical lines of light in the playback image of a brightly shining subject or highly reflective subject.
- During normal playback, movement in the images may not look smooth.
- Because the color and brightness of the playback image may become unstable, avoid recording under fluorescent light, mercury light or sodium light.
- If you are using MagicPix Mode (-30-) or Programme AE Mode (-32-), you cannot adjust the shutter speed.

■ Manual Iris Adjustment

- Depending on zoom magnification, there are iris values that will not be displayed.
- If you are using MagicPix Mode (-30-) or Program AE Mode (-32-), you cannot adjust the iris.
- If you attempt to adjust the Shutter Speed after setting the Iris, the value set for the Iris will be cancelled.

■ Digital Effect Functions

- If you have set [EFFECT2] to [B/W] or [SEPIA], changing the selected White Balance Mode is not possible. (-32-)
- Setting the Cinema Mode cancels the Picture-in-Picture Mode and the Multi-Picture Mode.
- During the Digital Still Picture Mode, the Digital Effect Functions cannot be set.

In the following cases, using the [EFFECT1] on the [DIGITAL] Sub-Menu is not possible.

- When the MagicPix Mode is set (-30-)

In the following cases, using the Digital Effect Function is not possible.

- Title In

Multi-Picture Mode

- If the [MULTI] Button is pressed while self-recording Mirror Mode (-27-) is used, the still picture is displayed from the upper right corner of the screen, but, in reality, the picture is recorded from the upper left corner as usual.
- The quality of Multi images deteriorates slightly.
- The top and bottom of the Multi pictures will be cut off slightly.

Picture-in-Picture Mode

- If Mode Dial is operated, the smaller picture disappears.
- Titles cannot be inserted into the smaller picture.

Wipe Mode and Mix Mode

If one of the following operations are carried out, stored images will be erased, and Wipe and Mix Functions cannot be used.

- Set another Digital Effect item.

- Operate the [OFF/ON] switch or Mode Dial
- Insert or eject a cassette

■ Playing Back

Repeat Playback

If you continue to press the [▶] Button for 5 seconds or longer, the Palmcorder switches to Repeat Playback Mode, and the [R ▷] Indication appears. (To cancel Repeat Playback Mode, set the [OFF/ON] Switch to [OFF].)

Listening to Playback Sound through Headphones

If you want to use the headphones to listen to the playback sound, set [AV JACK] to [OUT/PHONES] and connect the headphones to the [PHONES] Jack (-13-) on the Palmcorder. In this case, no sound (including warning and shutter sounds) will be reproduced through the built-in speaker of the Palmcorder.

Choosing Sound during Playback

You can select the sound by using the [AUDIO OUT] setting on the [PLAYBACK] Sub-Menu.

STEREO: Stereo Sound (main sound and sub sound)

L: Left channel sound (main sound)

R: Right channel sound (sub sound)

- If you dub a tape recorded at the [12bit] selected as the [AUDIO REC] on the [RECORDING] Sub-Menu, playback sound becomes stereo sound regardless of the [AUDIO OUT] setting if [12bit AUDIO] is set to [MIX].

■ Index Search Functions

- Index Search may not be possible at the beginning of the tape.
- Scene Index Search may not function properly if the interval between 2 scene index signals is less than 1 minute.

■ Playback Zoom Function

- You cannot adjust the sound volume with the Remote Controller in Playback Zoom Mode.
- If you turn off the Palmcorder power or if you operate the Mode Dial, Playback Zoom Mode is automatically cancelled.
- Even if Playback Zoom Functions are being used, images that are output from the DV Terminal (-13-) are not enlarged.
- As you enlarge an image, the quality of the image deteriorates.
- During a Playback Zoom, the Variable Speed Search Function cannot be changed with the Remote Controller.

■ Playback Digital Effect Functions

- Signals of images to which digital effects are added during playback cannot be output from the DV Terminal (-13-).

- You cannot use the Wipe or Mix Function while playing back the non-recorded portion of tape.

■ Playing Back a Card

- If a blank (nothing recorded) Card is played, the screen becomes white.
- If you attempt to play back a file recorded in a different format or if file data is defective, the whole display becomes bluish and the [UNPLAYABLE CARD] Indication may appear as warning.
- When playing back a picture recorded on other equipment, its size and that of this Palmcorder may appear differently.
- When playing back a picture recorded on other equipment, the picture may not be played back or the quality of pictures may be deteriorated.
- When playing back a non standardized file, the Folder File Number may not be displayed.
- In the following cases, black bars may appear, depending on the playback device.
 - When playing back a mega-pixel still-picture with this Palmcorder and recording it onto a tape
 - Changing the picture size to 640×480 pixels with DV STUDIO
- The file format supported by this Palmcorder is ASF. (Not all the ASF formatted files will be played back.)
- When you set [SCREEN] on the [DIGITAL] Sub-Menu to [NORMAL] in playing back MPEG4 moving pictures, they are displayed smaller. This is not a malfunction.
- Moving pictures are kept still during Cue/Review playback. Only the counter number increases or decreases.
- MPEG4 data cannot perform, Slow Motion Playback (forward direction and reverse direction), Still Advance Playback (forward direction and reverse direction) or Playback with Zoom Lever.
- If you try to play back an MPEG4-recorded image for which the [MPEG4 MODE] was set to a mode other than [ECONOMY] on other PANASONIC cameras, this image will not be displayed, and the indication [PLEASE RE-OPERATE AFTER PUSHING RESET BUTTON], etc., may appear. This is not a malfunction.
- For the MPEG4 moving pictures recorded on other equipment, [UNPLAYABLE CARD] Indication may be displayed when they are played back. If the [▶] Button is pressed in this case, [▷] will be displayed for a few seconds and the next image will be displayed.
- The MPEG4 data cannot be output from the DV Terminal.

- When playing back MPEG4 data recorded on other equipment, a part of the playback elapsed time may be indicated as [-] or the date and time display will be different from it when recorded.
- If you attempt to play back a file recorded on other equipment, the [UNPLAYABLE CARD] Indication may appear and the playback may not be possible. Or during playback, the [UNPLAYABLE CARD] Indication may appear, the playback picture may be presented in a time-lapse-like manner, or the picture and the sound may not synchronize.

■ Slide Show

- It may take playback time longer than usual time depending on the picture.

■ Creating a Title

- When setting to MPEG4 Playback Mode, Title Creation Function is not possible.
- Even if the contrast of the Title is adjusted, the portions where there is little difference between light and dark and where the boundary between light and dark is unclear may not appear.
- The Title may not appear well if something small is used for it.
- If titles are created, the number of images that can be recorded on a Card decreases.
- If the number of images that can be recorded on a Card is small, you may not be able to create a title.

■ Adding a Title

- When setting to MPEG4 Playback Mode, Title In Function is not possible.
- The Title In Function and Digital Effects cannot be used simultaneously.
- The Title In Function and RapidFire Consecutive Photoshot cannot be used simultaneously.
- When a title is displayed in Tape Playback Mode, the title is not output from the DV Terminal.
- The Multi-Picture Mode cannot be used once the title is inserted.
- A full-colored title made on other equipment cannot be played back or added to the picture with this Palmcorder.
- A title with size of other than 640×480 pixels cannot be displayed.
- When recording MPEG4 moving pictures is in progress, Title in Function cannot be used.
- When the title is displayed or the Multi screen, the recording and the playback cannot be performed.
- During external input or DV input, you cannot use Title In Function or display titles on the Multi screen. Select the desired titles to display them on the screen before connecting the cable to the Palmcorder.

■ DPOF

- Perform the DPOF Settings with your Palmcorder.
- Verifying the DPOF Settings may take a little time. Wait until the Card Access Lamp goes out.

■ Lock Setting

- The Lock Setting carried out by this Palmcorder is only effective for this Palmcorder.
- The SD Memory Card has a write protection switch on it. If the switch is moved to the [LOCK] side, you cannot write to or format the Card. If it is moved back, you can.
- The MPEG4 data recorded by another Palmcorder may not be able to cancel the lock setting.

■ Playing Back on Your TV

- Depending on your TV, nothing may be shown even if you correctly connect the Palmcorder with your TV. In this case, set [AV JACK] on the [AV IN/OUT] or [INITIAL] Sub-Menu to [OUT].
- If you set [AV JACK] on the [AV IN/OUT] Sub-Menu to [IN/OUT], nothing will be shown on the TV screen except during playback.
- Picture size may be displayed differently when playing back a Cinema picture on a wide-screen TV with Playback Digital Effect.
- We recommend setting the [SCREEN] on the [DISPLAY] Sub-Menu to [NORMAL] when playing back MPEG4 on TV.

■ Recording Pictures from a Card onto a Tape

- When recording the Card Image on a Tape, its size is transformed into 720×480 pixels according to the DV format.
- If you attempt to record a still picture with a large image size on a Tape, there may be a reduction in the quality of the image.
- The MPEG4 data cannot be recorded on a Tape.

■ Audio Dubbing

- The blank section of a tape cannot be dubbed.
- Sounds sent through the DV Terminal cannot be dubbed.
- If a tape has a non-recorded portion when the tape is dubbed, images and sounds may be disturbed when this portion of the tape is played back.
- If you set the tape counter back to 0 at the position where you want to stop Audio Dubbing so as to make it possible to use the Memory Stop Function (-75-), Audio Dubbing is terminated automatically when the tape reaches this position.
- In the case of importing data recorded with Audio Dubbing to a PC using the PC's software, only the original sound (ST1) may be imported, depending on the software.

■ Recording the Contents of Other Equipment

- You cannot record on a tape when MPEG4 recording from external input signals is in progress. You cannot record on a card when recording on a tape from external input signals is in progress.

Recording to a Card

If you set the Mode Dial to Card Recording Mode, you can use the Photoshot function for external input signals.

- Black streaks may appear at the 4 edges of the image.

Analog-Digital Conversion

- When the Palmcorder is connected with other digital video equipment through its DV Terminal, images recorded in analog form from other external equipment can be output to the digital video equipment through the DV Terminal.
- To DV-output analog video signals sent from other equipment, set [DV OUT] on the [AV IN/OUT] Sub-Menu to [ON]. (Normally, keep the [DV OUT] set to [OFF]. If it is set to [ON], the quality of the image may be disturbed.)
- When using AV Cable and DV Cable (optional) at the same time, detach the Grip Belt first for easy connecting.

■ Using the DV Cable for Recording (Digital Dubbing)

- Regardless of the setting, digital dubbing is carried out automatically in the same audio recording mode as that of the playback Cassette.
- The images on the recorded monitor may be disturbed, but it does not affect the recorded images.
- Even if Playback Digital Effects, Playback Zoom, or Playback Title In have been used, these effects are not output from the DV Terminal.
- Even if you use a device equipped with DV Terminals, you may not be able to perform Digital Dubbing in some cases.
- Date or other information to be displayed cannot be displayed if the software of the connected equipment does not support the display function.
- You cannot record on a tape when MPEG4 recording from external input signals is in progress. You cannot record on a card when recording on a tape from external input signals is in progress.

Cautions for Use

■ After Use

- 1 Take out the Cassette. (-18-)
- 2 Set the [OFF/ON] Switch to [OFF].
- 3 Take out the Card. (-18-)
- 4 Detach the power supply and retract the Viewfinder or the LCD Monitor. (-16-, -19-)
- 5 To protect the Lens, attach the supplied Lens Cap.

■ Cautions for Use

When you use your Palmcorder on a rainy or snowy day or on a beach, make sure that no water enters the Palmcorder.

- Water may cause the Palmcorder or Cassette to malfunction. (Irreparable failure may occur.)
- If sea water splashes onto the Palmcorder, wet a soft cloth with tap water, wring it well, and use it to wipe the camera body carefully. Then, wipe it again thoroughly with a soft dry cloth.

Keep the Palmcorder away from magnetized equipment (such as a microwave oven, TV, video game equipment, etc.).

- If you use the Palmcorder on or near a TV, images or sounds may be disturbed due to electromagnetic wave radiation.
- Do not use near a cell phone because doing so may cause noise to adversely affect the picture and sound.
- Recordings on the tape may be damaged, or images may be distorted, by strong magnetic fields created by speakers or large motors.
- Electromagnetic wave radiation generated by a microprocessor may adversely affect the Palmcorder, causing the disturbance of images and sounds.
- If the Palmcorder is affected by magnetically charged equipment and does not function properly, turn off the Palmcorder power and detach the Battery or AC Adaptor and then connect the Battery or AC Adaptor again. Thereafter, turn on the Palmcorder power.

Do not use your Palmcorder near radio transmitters or high-voltage cables.

- If you record pictures near radio transmitters or high-voltage cables, recorded images or sounds may be adversely affected.

Do not use this Palmcorder for surveillance purposes or other business use.

- If you use the Palmcorder for a long period of time, the internal temperature increases and, consequently, this may cause malfunction.
- This Palmcorder is not intended for business use.

When you use your Palmcorder on a beach or similar place, do not let sand or fine dust get into the Palmcorder.

- Sand or dust may damage the Palmcorder or Cassette. (Care should be taken when inserting and removing the Cassette.)

Do not spray insecticides or volatile chemicals onto the Palmcorder.

- If the Palmcorder is sprayed with such chemicals, the camera body may be deformed and the surface finish may peel off.
- Do not keep rubber or plastic products in contact with the Palmcorder for a long period of time.

Do not use benzine, thinner or alcohol for cleaning the Palmcorder.

- The Palmcorder body may be deformed and the surface finish may peel off.
- Before cleaning, detach the Battery or pull out the AC Cable from the AC Jack.
- Wipe the Palmcorder with a soft dry cloth. To remove stubborn stains, wipe with a cloth that is soaked in a detergent diluted with water and afterwards finish wiping with a dry cloth.
- For storing or transporting the Palmcorder, place it in a bag or case lined with soft pads so as to prevent the coating on the camera body from being worn.

After use, be sure to take the Cassette out and detach the Battery from the Palmcorder or pull out the AC Cable from AC Jack.

- If the Cassette is left in the Palmcorder, the tape sags and deteriorates.
- If the Battery is left on the Palmcorder for a long time, the voltage drops excessively, and the Battery will not function even after it is recharged.

■ About AC Adaptor

- If the temperature of the Battery is extremely high or extremely low, the [CHARGE] Lamp may continue flashing, and the Battery may not be charged. After the temperature of the Battery has decreased or increased sufficiently, charging starts automatically. If the [CHARGE] Lamp continues to flash even after the Battery temperature has decreased or increased sufficiently, the Battery or AC Adaptor may be faulty. In this case, please contact a dealer.
- If the Battery is warm, charging takes a longer time than normal.
- If you use the AC Adaptor near a radio, radio reception may be disturbed. Keep the AC Adaptor 3 feet (1 meter) or more away from radio.
- When using the AC Adaptor, it may generate whirring sounds. However, this is normal.

- After use, be sure to pull out the AC Cable from the AC jack. (If they are left connected, a minute amount of current is consumed.)
- Keep the electrodes of the AC Adaptor and Battery always clean.

■ Condensation

If you turn the Palmcorder on when condensation occurs on the head or the tape, Condensation Indication [ DEW] (yellow or red) blinks on the Viewfinder or the LCD monitor and the messages [DEW DETECT] or [EJECT TAPE] (only when the tape is inserted) appear. In this case, follow the procedure below.

Blinking in yellow:

Dew is slightly adhering on the head or the tape.

Blinking in red:

Dew is adhering on the head or the tape.

1 Remove the tape if it is inserted.

- It takes about 20 seconds to open the Cassette Holder. This is not a malfunction.

2 Leave the Palmcorder with the Cassette Compartment Cover closed to cool or warm it to the ambient temperature.

When [DEW] blinks in yellow

- You cannot use the Tape Recording/ Playback Mode. Leave the Palmcorder for about 30 minutes.
- However, you can use the Card Recording Mode or Picture/MPEG4 Playback Mode when the cassette is not inserted.

When [DEW] blinks in red

- The Power Indicator Lamp blinks for about 1 minute and then the Palmcorder automatically turns off. Leave it for about 2 to 3 hours.

3 Turn the Palmcorder on again, set it to the Tape Recording/Playback Mode and then check if the condensation indication disappears.

Especially in cold conditions, dew may be frozen. In this case, it may take more time before the condensation indication disappears.

Watch for Condensation even before the Condensation Indication is displayed.

- The condensation indication may not appear depending on circumstances. When condensation occurs on the lens or the Palmcorder, it also may occur on the head and the tape. Do not open the Cassette Compartment Cover.

When the Lens Is Fogged:

Set the [OFF/ON] Switch to [OFF] and leave the Palmcorder in this condition for about 1 hour. When the lens temperature becomes close to the ambient temperature, the fog disappears naturally.

■ Video Head Clogging and Care

If the heads (the parts that make contact with the tape) are dirty, mosaic-pattern noise may appear on the playback image, or the screen as a whole becomes black. If the heads are extremely dirty, recording performance deteriorates, and, in the worst case, the Palmcorder cannot record at all.

Causes of Dirty Heads

- Large quantity of dust in the air
- High-temperature and high-humidity environment
- Damaged tape
- Long operating hours

Using Mini-DV Format Digital Video Head Cleaner

- 1 Insert the Head Cleaner into the Palmcorder in the same manner as a Video Cassette.
- 2 Press the [▶] Button, and approximately 20 seconds later, press the [■] Button. (Do not rewind the tape.)
- 3 Take out the Head Cleaner. Insert a Video Cassette and start recording. Then, play the tape back to check the recorded image.
- 4 If the image is not still clear, repeat Steps 1 to 3. (Do not use the Head Cleaner for 3 times or more consecutively.)

Notes:

- Do not rewind every time you use the Head Cleaner. Rewind only when the tape reaches the end, and then use it again from the beginning in the same manner as before.
- If the heads become dirty soon after cleaning, the tape may be damaged. In this case, immediately stop using that Cassette.
- Do not clean the heads excessively. (Excessive cleaning may cause excessive wear of the heads. If the heads are worn, images cannot be played back even after the heads are cleaned.)
- If the dirty heads cannot be cleaned with the Head Cleaner, the Palmcorder needs to be cleaned at a service center. Please consult a dealer.
- Video Head Cleaners can be purchased from service centres.
- Head cleaning due to dirty heads is not considered a malfunction of the product. It is not covered by the warranty.

Periodical Check-up

To maintain the highest image quality, we recommend replacement of worn parts, such as heads, etc., after approximately 1000 hours of use. (This, however, depends on operating conditions, such as temperature, humidity, dust, etc.)

■ Optimal Use of the Battery Battery Characteristics

This Battery is a rechargeable lithium ion battery. Its ability to generate power is based upon the chemical reaction that takes place inside it. This reaction is susceptible to the surrounding temperature and humidity, and, if the temperature is too high or too low, the operating time of the Battery becomes shorter. If the Battery is used in an extremely cold environment, the Battery may operate only for about 5 minutes. If the Battery becomes extremely hot, a protective function may operate, and the Battery may become unusable for a while.

Be Sure to Detach the Battery after Use

Be sure to detach the Battery from the Palmcorder. (If it is left attached to the Palmcorder, a minute amount of current is consumed even when the Palmcorder power is off.) If the Battery is left attached to the Palmcorder for a long time, over-discharge takes place. The Battery may become unusable after it is charged.

Disposing of an Unusable Battery

- The Battery has a limited life.
- Do not throw the Battery into fire because it may cause an explosion.

Always Keep the Terminals of the Battery Clean

Prevent the terminals from getting clogged with dirt, dust, or other substances.

If you drop the Battery accidentally, check to see if the Battery body and terminals are deformed. Attaching a deformed Battery to the Palmcorder or AC Adaptor may damage the Palmcorder or AC Adaptor.

■ Cautions for Storage

Before storing the Palmcorder, take the Cassette out and detach the Battery.

Store all the components in a dry place with a relatively stable temperature.

Recommended Temperature: 59°F to 77°F (15°C to 25°C), Recommended Humidity: 40% to 60%

Palmcorder

- Wrap it with a soft cloth to prevent dust from getting into the Camera.
- Do not leave the Palmcorder in places that expose it to high temperature.

Battery

- Extremely high temperatures or low temperatures will shorten the life of the Battery.
- If the Battery is kept in smoky or dusty places, the terminals may rust and cause malfunctions.

- **Do not allow the Battery terminals to come in contact with metal objects (such as necklaces, hairpins, etc.). This can result in a short circuit or heat generation and, if you touch the Battery in this condition, you may be badly burned.**
- Store the Battery in a completely discharged state. To store the Battery for a long period of time, we recommend you charge it once every year and store it again after you completely use up the charged capacity.

Cassette

- Before storing it, rewind the tape to the beginning. If the Cassette is left for more than 6 months with the tape stopped midway, the tape sags (although it depends on the storage condition). Be sure to rewind to the beginning.
- Store the Cassette in its case. Dust, direct sunlight (ultraviolet rays), or humidity may damage the tape. Dust contains hard mineral particles, and dusty Cassettes damage the heads of the Palmcorder and other components. Develop a habit of returning the Cassette back to its case.
- Once every half year, wind the tape to the end and then rewind it to the beginning. If the Cassette is left for 1 year or longer without winding or rewinding, temperature and humidity changes may cause the Cassette to deform due to swelling, shrinking, and so forth. The wound tape may stick to itself.
- Do not place a Cassette near highly magnetic substances or equipment.
- The surface of tape is covered with extremely minute magnetic particles, upon which signals are recorded. Magnetic necklaces, toys, etc., have magnetic force that is stronger than you may normally expect, and they may erase the contents of a recording or may cause noise in images and sounds.

Card

- When the Card is being read, do not remove the Card, turn off the power, or subject it to vibration or impact.
- Do not leave the Card in places where there is high temperature or direct sunlight, or where electromagnetic waves or static electricity are easily generated.
- Do not bend or drop the Card. The Card or the recorded content may be damaged.
- After use, be sure to remove the Card from the Palmcorder.
- After usage, store the supplied SD Memory Card in the enclosed bag.
- Do not touch the terminals on the back of the Card with your fingers. Do not allow dirt, dust or water to enter it.

- Keep the Memory Card out of reach of children to prevent swallowing.

LCD Monitor/Viewfinder/Lens Hood LCD Monitor

- In a place with drastic temperature changes, condensation may form on the LCD Monitor. Wipe it with soft dry cloth.
- If your Palmcorder is extremely cold when you turn its power on, the image on the LCD Monitor is slightly darker than usual at first. However, as the internal temperature increases, it goes back to the normal brightness.

Extremely high precision technology is employed to produce the LCD Monitor screen featuring a total of approximately 123,000 pixels. The result is more than 99.99% effective pixels with a mere 0.01% of the pixels inactive or always lit. However, this is not a malfunction and does not affect the recorded picture.

Viewfinder

- Do not direct the Viewfinder or Lens to the sun. Internal components may be seriously damaged.
- When the Palmcorder is used with a large capacity Battery attached to it, it is not practical to look in the Viewfinder from behind the Battery.

Extremely high precision technology is employed to produce the Viewfinder screen featuring a total of approximately 113,000 pixels. The result is more than 99.99% effective pixels with a mere 0.01% of the pixels inactive or always lit. However, this is not a malfunction and does not affect the recorded picture.

Lens Hood

- Do not attach other conversion lenses in front of the Lens Hood; there is no mount to be used for the attachment.
- When you wish to attach the Tele Conversion Lens (not supplied), Wide Conversion Lens (not supplied), MC Protector (not supplied), or ND Filter (not supplied), first of all, turn the Lens Hood counter-clockwise. If the MC Protector or ND Filter is used, the Lens Hood can be mounted on the filter.
- If you push the [W/T] Lever toward [W] during recording with the filter and conversion lens attached together to the Palmcorder, 4 corners of the image may become dark (vignetting). For details, please refer to the operating instructions of your accessories.

- Be sure to keep the Lens Hood attached to the Palmcorder so as to shut out unnecessary light.

Before Requesting Service (Problems and Solutions)

Power

1: The Palmcorder power cannot be turned on.

- Is the power source connected correctly? (-16-)

2: The Palmcorder power is turned off automatically.

- When the Recording Pause Mode continues for more than 5 minutes, the power is turned off automatically for tape protection and power conservation. (If the AC Adaptor is used, the power is turned off only when the tape is inserted in Tape Recording Mode.) When the tape is inserted in Tape Recording Mode and if the Recording Pause Mode continues for more than 5 minutes the power is turned off automatically. To resume recording from this condition, turn off, then turn on the power again. (-25-, -26-, -27-)

3: The Palmcorder power does not stay on long enough.

- Is the Battery low? Charge the Battery or attach a fully charged Battery. (-16-)
- Has condensation occurred? Wait until the Condensation Indication disappears. (-70-)

Battery

1: Battery runs down quickly.

- Is the Battery fully charged? Charge it with the AC Adaptor. (-16-)
- Are you using the Battery in an extremely cold place? In cold places, the operating time of the Battery becomes shorter. (-71-)
- Has the Battery worn out? If the operating time is still too short even after the Battery is fully charged, the Battery has worn out.

2: The Battery cannot be charged.

- If the DC Cable is connected to the AC Adaptor, charging cannot be performed. Disconnect the DC Cable.

Normal Recording

1: Recording does not start although power is supplied to the Palmcorder and the Cassette is correctly inserted.

- Is the accidental erasure prevention slider on the Cassette open? If it is open (set to [SAVE]), recording cannot be performed. (-18-)
- Is the tape wound to the end? Insert a new Cassette. (-18-)
- Is the Palmcorder power turned on? (-25-)
- Has condensation occurred? Wait until the Condensation Indication disappears. (-70-)

Other Recording

1: Auto Focus Function does not work.

- Is Manual Focus Mode selected? If Auto Focus Mode is selected, focus is automatically adjusted. (-34-)
- There are some recording subjects and recording surroundings for which the Auto Focus Function does not operate correctly. In this case, use the Manual Focus Mode to adjust the focus. (-74-)

Editing

1: Audio dubbing cannot be performed.

- Is the accidental erasure prevention slider on the Cassette open? If it is open (set to [SAVE]), recording cannot be performed. (-18-)
- Are you attempting to edit a tape portion that was recorded in LP Mode? LP Mode does not allow audio dubbing to operate. (-24-)

Indications

1: The Time Code becomes inaccurate.

- The Time Code Indication counter may not be constant in the reverse direction in Slow Motion Playback Mode, but this is not a malfunction.

2: The Remaining Tape Time Indication does not match the actual remaining tape time.

- If scenes of less than 15 seconds are continuously recorded, the remaining tape time cannot be displayed correctly.
- In some cases, the Remaining Tape Time Indication may show remaining tape time that is 2 to 3 minutes shorter than the actual remaining tape time.

Playback (Pictures)

1: Pictures cannot be played back even when the [▶] Button is pressed.

- Is the Mode Dial set to Playback Mode? If not, the playback function cannot be used. (-37-)

2: Mosaic-pattern noise appears on images during Cue, Review or Slow Motion Playback.

- This phenomenon is characteristic of digital video systems. It is not a malfunction.

3: Although the Palmcorder is correctly connected to a TV, playback images cannot be seen.

- Have you selected "Video Input" on the TV? Please read the operating instructions of your TV and select the channel that matches the input sockets used for the connection.
- Depending on your TV, nothing may be shown even if you correctly connect the Palmcorder with your TV. In this case, set [AV JACK] on the [AV IN/OUT] or [INITIAL] Sub-Menu to [OUT].

4: Playback picture is not clear.

- Are the heads of the Palmcorder dirty? If the heads are dirty, playback image cannot be clear. (-71-)

5: Playing back or recording do not function, the screen has frozen or the indication has disappeared.

- Turn the Palmcorder off. If the Palmcorder is not turned off after operating the [OFF/ON] switch, press the [RESET] Button (-13-) first. And detach the Battery or AC Adaptor and then reattach it.

Playback (Sound)**1: Sound is not played back from the built-in speaker of the Palmcorder or the headphones.**

- Is the volume too low? During playback, push the [W/T] Lever to display the [VOLUME] Indication and adjust the volume. (-37-)

2: Different sounds are reproduced at the same time.

- [12bit AUDIO] on the [PLAYBACK] Sub-Menu of the [TAPE PLAYBACK MENU] has been set to [MIX]. As a result, the original sound and sound that was recorded by audio dubbing are played back together. It is possible to reproduce the sounds separately. (-46-)

3: The original sound was erased when audio dubbing was performed.

- If you perform audio dubbing on a recording made in [16bit] Mode, the original sound will be erased. If you wish to preserve the original sound, be sure to select [12bit] Mode at the time of recording.

4: Sounds cannot be played back.

- Although a Cassette with no audio dubbing is being played, is [12bit AUDIO] on the [PLAYBACK] Sub-Menu of the [TAPE PLAYBACK MENU] set to [ST2]? To play back a Cassette with no audio dubbing, [12bit AUDIO] must be set to [ST1]. (-46-)
- Is the Variable Speed Search Function working? Press the [▶] Button to cancel the Variable Speed Search Function. (-38-)

Card**1: Recorded pictures are not clear.**

- Is [PICT QUALITY] on the [CARD] Sub-Menu set to [NORMAL] or [ECONOMY]? If recording is done with it set to [NORMAL] or [ECONOMY], images with fine details may include a mosaic-like pattern. Set [PICT QUALITY] to [FINE]. (-26-)

2: Photoshot Playback images do not look normal.

- The picture may be damaged. In order to prevent the loss of image data, backing up on a

Cassette or a personal computer is recommended. (-46-, -49-)

3: During Playback the [UNPLAYABLE CARD] is displayed.

- The image was either recorded in a different format, or data is damaged.

4: Even if a Card is formatted, it cannot be used.

- Either the Palmcorder or the Card may be damaged. Please consult a dealer.

Others**1: The Magic Wire Remote Control with Narration Mic does not operate correctly.**

- If it is not plugged in tightly, it will not operate correctly.

2: The Palmcorder clatters when shaking it.

- It is a sound of the lens moving, not a malfunction.

3: When the USB Cable is disconnected, an error message will appear on PC.

- To disconnect the USB cable safely, double-click the  icon in the task tray and follow the instructions on the screen. (-57-)

Explanation of Terms**■ Digital Video System**

In a digital video system, images and sounds are converted into digital signals and recorded on a tape. This complete digital recording is capable of recording and playback with minimal image and sound deterioration.

In addition, it automatically records data, such as Time Code and Date/Time, as digital signals.

Compatibility with S-VHS or VHS Cassettes

Because this Palmcorder employs a digital system for recording image and sound data, it is not compatible with conventional S-VHS or VHS video equipment that employs an analog recording system.

The size and shape of the Cassettes are also different.

Compatibility with Output Signals

Because AV signal output from the AV signal output socket is analog (the same as conventional video systems), this Palmcorder can be connected with S-VHS or VHS video or a TV for playback.

■ Focus**Auto Focus Adjustment**

The Auto Focus System automatically moves forward and backward the focusing lens inside the Palmcorder to bring the subject into focus so that the subject can be seen clearly.

However, the Auto Focus System does not function properly for the following subjects or under the following recording conditions.

Please use the Manual Focus Mode instead.

- 1) **Recording a subject whose one end is located closer to the Palmcorder and the other end farther away from it**
 - Because Auto Focus makes adjustments at the center of an image, it may be impossible to focus on a subject that is located in both foreground and background.
- 2) **Recording a subject behind dirty or dusty glass**
 - Because the focus is on the dirty glass, the subject behind the glass will not be focused.
- 3) **Recording a subject in dark surroundings**
 - Because the light information that comes through the lens decreases considerably, the Palmcorder cannot focus correctly.
- 4) **Recording a subject that is surrounded by objects with glossy surfaces or by highly reflective objects**
 - Because the Palmcorder focuses on the objects with glossy surfaces or on highly reflective objects, the subject may become blurry.
- 5) **Recording a fast-moving subject**
 - Because the focus lens-inside moves mechanically, it cannot keep up with the fast-moving subject.
- 6) **Recording a subject with little contrast**
 - Because the Palmcorder achieves focus based upon the vertical lines of an image, a subject with little contrast, such as a white wall, may become blurry.

Time Code

Time Code signals are data that indicate time measured in hours, minutes, seconds, and frames (30 frames per second). If this data is included in a recording, an address is assigned to each image on the tape.

- The Time Code is automatically recorded as a part of the sub-code at each recording.
- When a new (previously unrecorded) Cassette is inserted, the Time Code automatically starts from zero. If a recorded Cassette is inserted, the Time Code picks up from the point where the last scene was recorded. (In this case, when the Cassette is inserted, the zero display [0h00m00s00f] may appear, but the Time Code starts from the previous value.)
- The Time Code cannot be reset to zero.
- Unless the Time Code is continuously recorded from the beginning of a tape, accurate editing may not be possible. To ensure that the Time Code will be recorded with no breaks, we recommend the use of the Blank Search Function (-26-) before recording a new scene.

Memory Stop Function

The Memory Stop Function is useful for the following operations.

Rewinding or fast-forwarding a tape to a desired position

- 1 Set [DISPLAY] >> [C.DISPLAY] >> [MEMORY].
- 2 Reset the Tape Counter to zero at the tape position from which you want to play it back later. (-14-, -21-)
- 3 Start playback or recording.
- 4 After playback or recording has finished: Set the Palmcorder to Tape Playback Mode.
- 5 Rewind the tape.
 - The tape automatically stops approximately at the position where the counter was set to zero.

Stopping editing automatically during audio dubbing

- 1 Set [DISPLAY] >> [C.DISPLAY] >> [MEMORY].
- 2 Reset the Tape Counter to zero at the position where you want to stop editing.
- 3 Play back the still picture where you want to start audio dubbing.
- 4 Start audio dubbing. (-46-)
 - Audio dubbing automatically stops at the position where the counter was set to zero.

Specifications

Digital Video Camera

Information for your safety

Power Source:

DC 7.9/7.2 V

Power Consumption:

Recording

5.0 W

Recording Format:

Mini DV (Consumer-use Digital Video SD Format)

Tape Used:

6.35 mm digital video tape

Recording/Playback Time:

SP: 80 min.; LP: 120 min. (with DVM80)

Video

Recording System:

Digital Component

Television System:

EIA Standard: 525 lines, 60 fields NTSC color signal

Audio

Recording System:

PCM Digital Recording

16 bit (48 kHz/2ch), 12 bit (32 kHz/4ch)

Image Sensor:

1/6-inch CCD Image Sensor

Lens:

Auto Iris, F1.8, Focal Length; 2.3–23 mm, Macro (Full Range AF)

Filter Diameter:

27 mm

Zoom:

10:1 Power Zoom

Monitor:

2.5-inch LCD

Viewfinder:

Color Electronic Viewfinder

Microphone:

Stereo

Speaker:

1 round speaker 20 mm

Standard Illumination:

1,400 lx

Minimum Required Illumination:

1 lx (MagicPix Mode)

Video Output Level:

1.0 Vp-p, 75 ohm

S-Video Output Level:

Y Output: 1.0 Vp-p, 75 ohm

C Output: 0.286 Vp-p, 75 ohm

Audio Output Level (Line):

316 mV, 600 ohm

Video Input Level:

1.0 Vp-p, 75 ohm

S-Video Input Level:

Y Input: 1.0 Vp-p, 75 ohm

C Input: 0.286 Vp-p, 75 ohm

Audio Input Level (Line):

316 mV, 10 kohm or more

Mic Input:

Mic sensitivity –50 dB (0 dB=1 V/Pa, 1 kHz)

(Stereo mini jack)

USB:

Card reader/writer function, USB 2.0 compliant (max. 12 Mbps)

No copyright protection support

Digital Interface:

DV Input/Output Terminal (IEEE1394, 4-pin)

Dimensions:

Approx. 2.48 (W)×3.07 (H)×3.9 (D) inch

Approx. 63 (W)×78 (H)×99 (D) mm

Weight:

Approx. 0.82 lbs. (370 g)

(without Battery and DV cassette)

Operating Temperature:

32°F–104°F (0°C–40°C)

Operating Humidity:

10%–80%

Card Memory Functions

Recording Media:

MultiMediaCard (4 MB/8 MB/16 MB),

SD Memory Card (8 MB/16 MB/32 MB/64 MB/

128 MB/256 MB/512 MB)

Still picture recording file format:

JPEG (Design rule for Camera File system, based on Exif 2.2 standard), DPOF corresponding

Still Image Size:

640×480 pixels (VGA)

Video Compression:

MPEG4

MPEG4 Image Size:

SUPERFINE: 320×240 pixels (QVGA)

FINE: 320×240 pixels (QVGA)

NORMAL: 176×144 pixels (QCIF)

ECONOMY: 176×144 pixels (QCIF)

MPEG4 Transmission rate:

SUPERFINE: approximately 1 Mbps, 15 fps

FINE: approximately 420 kbps, 12 fps

NORMAL: approximately 296 kbps, 12 fps

ECONOMY: approximately 100 kbps, 6 fps

WEB Camera

Compression:

Motion JPEG

Image Size:

320×240 pixels (QVGA)

AC Adaptor

Information for your safety

Power Source:

AC 110–240 V, 50/60 Hz

Power Consumption:

19 W

DC Output:

DC 7.9 V, 1.4 A (Palmcorder Operation)

DC 8.4 V, 0.65 A (Battery Charging)

Dimensions:

2.40 (W)×1.26 (H)×3.58 (D) inch

61 (W)×32 (H)×91 (D) mm

Weight:

Approx. 0.24 lbs. (110 g)

Weight and dimensions are approximate values. Specifications may change without prior notice.

Maximum number of still pictures recordable on an SD Memory Card (optional)

PICTURE QUALITY	FINE	NORMAL	ECONOMY
8MB	45	95	190
16MB	100	200	400
32MB	220	440	880
64MB	440	880	1760
128MB	880	1760	3520
256MB	1760	3520	7040
512MB	3520	7040	14080











- These figures vary depending on the subject being photographed.

Maximum recording time of MPEG4 moving picture on an SD Memory Card (optional)

PICTURE SIZE	320×240 (QVGA)		176×144 (QCIF)	
	SUPERFINE	FINE	NORMAL	ECONOMY
8MB	1min.	2min.	3min.	8min.
16MB	2min.	4min.	8min.	18min.
32MB	4min.	10min.	17min.	37min.
64MB	8min.	20min.	35min.	1h15min.
128MB	17min.	42min.	1h10min.	2h30min.
256MB	35min.	1h25min.	2h20min.	5h.
512MB	1h10min.	2h50min.	4h40min.	10h10min.

- Maximum Continuous Recording Time: Approximately 120 minutes
- "1h10min." indicates 1 hour and 10 minutes.
- The numbers shown in the table are approximations.

Palmcorder Accessory System

Accessory#	Figure	Description
PV-DAC13		AC Adaptor with AC Cable and DC Cable
*CGA-DU07		680mAh/Rechargeable Lithium Ion Battery Pack
*CGA-DU14		1360mAh/Rechargeable Lithium Ion Battery Pack
*CGA-DU21		2040mAh/Rechargeable Lithium Ion Battery Pack
PV-DDC9 (For USA) PV-DDC9-K (For Canada)		DV Interface Cable (i.LINK) (4-pin to 4-pin)
PV-DRC10 (For USA)		IR Remote Control
RP-SD064BPPA RP-SD032BPPA RP-SD016BPPA		64 MB SD Memory Card 32 MB SD Memory Card 16 MB SD Memory Card
BN-SDCAPE/1B (For USA) BN-SDCAPU/1B (For Canada)		USB Reader/Writer for SD Memory Card (compatible with MultiMediaCard)
BN-SDABPE/1B (For USA) BN-SDABPU/1B (For Canada)		SD PCMCIA Adaptor (compatible with MultiMediaCard)
PV-H150 (USA only)		Carrying Case
PV-HB002 (USA only)		Carrying Case

*Please refer to page -16-, concerning the battery charging time and available recording time.

***NOTE: Accessories and/or model numbers may vary by country. Please consult your local dealer.**

Palmcorder Accessory Order Form (For USA Customers)

Please photocopy this form when placing an order.

1. Palmcorder Model # _____

2. Items Ordered

Accessory #	Description	Price Each	Quantity	Total Price
Subtotal				
Your State & Local Sales Tax				
Shipping & Handling				6.95
Total Enclosed				

3. Method of payment (check one)

- Check of Money Order enclosed (NO C.O.D.SHIPMENTS)
- VISA Credit Card # _____
- MasterCard Expiration Date _____
- Discover Customer Signature _____

Make Check or Money Order to: PANASONIC ACCESSORIES

(Please do not send cash)

4. Shipping information (UPS delivery requires complete street address)

Ship To:

Mr.

Mrs.

Ms.

First _____ Last _____

Phone#:

Day () _____

Street Address _____

Night () _____

City _____ State _____ Zip _____

TO OBTAIN ANY OF OUR PALMCORDER ACCESSORIES YOU CAN DO ANY OF
THE FOLLOWING:
VISIT YOUR LOCAL PANASONIC DEALER
OR
CALL PANASONIC'S ACCESSORY ORDER LINE AT 1-800-332-5368
[6 AM-5 PM M-F, 6 AM-10:30 AM SAT, PACIFIC TIME]
OR
MAIL THIS ORDER TO: PANASONIC SERVICES COMPANY ACCESSORY ORDER OFFICE
20421 84th Avenue South Kent, WA. 98032

In CANADA, please contact your local Panasonic dealer for more information on Accessories.

Request for Service Notice (USA Only)

Please photocopy this form when making a request for service notice.

In the unlikely event this product needs service.

Request for Service Notice:

- Please include your **proof of purchase.**
(Failure to do so will delay your repair.)
 - To further speed your repair, please provide an explanation of what wrong with the unit and any symptom it is exhibiting.
-
-
-
-

Mail this completed form and your Proof of Purchase along with your unit to:
Panasonic Services Company
1705 N. Randall Road
Elgin, IL. 60123-7847
Attn: Camcorder Repair

Please write the displayed above Self Diagnostic number here.

Limited Warranty (For USA Customers)

PANASONIC CONSUMER ELECTRONICS
COMPANY, DIVISION OF MATSUSHITA
ELECTRIC CORPORATION OF AMERICA
One Panasonic Way Secaucus, New Jersey 07094

PANASONIC SALES COMPANY, DIVISION OF MATSUSHITA
ELECTRIC OF PUERTO RICO, INC.,
AVE. 65 de Infteria, Km. 9.5 San Gabriel Industrial Park,
Carolina, Puerto Rico 00985

Panasonic/Quasar Video Products Limited Warranty

Limited Warranty Coverage

If your product does not work properly because of a defect in materials or workmanship, Panasonic Consumer Electronics Company or Panasonic Sales Company (collectively referred to as "the warrantor") will, for the length of the period indicated on the chart below, which starts with the date of original purchase ("warranty period"), at its option either (a) repair your product with new or refurbished parts, or (b) replace it with a new or a refurbished product. The decision to repair or replace will be made by the warrantor.

Product	Parts	Labor	Service	Contact Number
Camcorder	One (1) Year (except CCD Image Sensor) CCD Image Sensor - 6 (Six) Months	Ninety (90) Days Ninety (90) Days	Carry-In or Mail-In	1-800-211-PANA(7262)
DVD/VCR Deck, A/V Mixer	One (1) Year	Ninety (90) Days	Carry-In or Mail-In	1-800-211-PANA(7262)
TV/VCR, TV/DVD, TV/DVD/VCR Combination	One (1) Year (except CRT) CRT - Two (2) Years	Ninety (90) Days Ninety (90) Days	Carry-In: 21" CRT and Smaller In-Home or Carry-In: 22" CRT and Larger	1-800-211-PANA(7262)
TV/HDR Combination	One (1) Year (except CRT) CRT - Two (2) Years	Ninety (90) Days Ninety (90) Days	In-Home or Carry-In	1-888-843-9788
Rechargeable Batteries (in exchange for defective item)	Ten (10) Days	Not Applicable	Carry-In or Mail-In	1-800-211-PANA(7262)
Tape (in exchange for defective item)	Five (5) Days	Not Applicable	Carry-In or Mail-In	1-800-211-PANA(7262)
Memory Cards (in exchange for defective item)	Ninety (90) Days	Not Applicable	Carry-In or Mail-In	1-800-211-PANA(7262)

During the "Labor" warranty period there will be no charge for labor. During the "Parts" warranty period, there will be no charge for parts. You must carry-in or mail-in your product or arrange for in-home service, as applicable, during the warranty period. If non-rechargeable batteries are included, they are not warranted. This warranty only applies to products purchased and serviced in the United States or Puerto Rico. This warranty is extended only to the original purchaser of a new product which was not sold "as is". A purchase receipt or other proof of the original purchase date is required for warranty service.

Carry-In, Mail-in or In-Home Service

For Carry-In, Mail-In or In-Home Service (as applicable) in the United States call toll free contact number listed above or visit Panasonic Web Site: <http://www.panasonic.com>

For assistance in Puerto Rico call Panasonic Sales Company (787)-750-4300 or fax (787)-768-2910.

In-Home service, if applicable, requires clear, complete and easy access to the product by the authorized servicer and does not include removal or re-installation of an installed product. It is possible that certain in-home repairs will not be completed in-home, but will require that the product, or parts of the product, be removed for shop diagnosis and/or repair and then returned.

Limited Warranty Limits And Exclusions

This warranty ONLY COVERS failures due to defects in materials or workmanship, and DOES NOT COVER normal wear and tear or cosmetic damage, nor does it cover markings or retained images on the picture tube resulting from viewing fixed images (including, among other things, letterbox pictures on standard 4:3 screen TV's, or non-expanded standard 4:3 pictures on wide screen TV's, or onscreen data in a stationary and fixed location). The warranty ALSO DOES NOT COVER damages which occurred in shipment, or failures which are caused by products not supplied by the warrantor, or failures which result from accidents, misuse, abuse, neglect, mishandling, misapplication, alteration, faulty installation, set-up adjustments, misadjustment of consumer controls, improper maintenance, power line surge, lightning damage, modification, or commercial use (such as in a hotel, office, restaurant, or other business), rental use of the product, service by anyone other than a Factory Servicenter or other Authorized Servicer, or damage that is attributable to acts of God.

THERE ARE NO EXPRESS WARRANTIES EXCEPT AS LISTED UNDER "LIMITED WARRANTY COVERAGE". THE WARRANTOR IS NOT LIABLE FOR INCIDENTAL OR CONSEQUENTIAL DAMAGES RESULTING FROM THE USE OF THIS PRODUCT, OR ARISING OUT OF ANY BREACH OF THIS WARRANTY.

(As examples, this excludes damages for lost time, cost of having someone remove or re-install an installed unit if applicable, or travel to and from the servicer, loss of media or images, data or other memory or recorded content. The items listed are not exclusive, but are for illustration only.)

ALL EXPRESS AND IMPLIED WARRANTIES, INCLUDING THE WARRANTY OF MERCHANTABILITY, ARE LIMITED TO THE PERIOD OF THE LIMITED WARRANTY.

Some states do not allow the exclusion or limitation of incidental or consequential damages, or limitations on how long an implied warranty lasts, so the exclusions may not apply to you. This warranty gives you specific legal rights and you may also have other rights which vary from state to state. If a problem with this product develops during or after the warranty period, you may contact your dealer or Servicenter. If the problem is not handled to your satisfaction, then write to the warrantor's Consumer Affairs Department at the addresses listed for the warrantor.

PARTS AND SERVICE (INCLUDING COST OF AN IN-HOME SERVICE CALL, WHERE APPLICABLE) WHICH ARE NOT COVERED BY THIS LIMITED WARRANTY ARE YOUR RESPONSIBILITY.

Customer Services Directory

Service in Canada: As per Servicenter listed in Canadian warranty information on page -83-.

Obtain Product Information and Operating Assistance; locate your nearest Dealer or Servicenter; purchase Parts and Accessories; or make Customer Service and Literature requests by visiting our Web Site at:

<http://www.panasonic.com/support>

or, contact us via the web at:

<http://www.panasonic.com/contactinfo>

You may also contact us directly at:

1-800-211-PANA (7262),

Monday-Friday 9 am-9 pm; Saturday-Sunday 10 am-7 pm, EST

For hearing or speech impaired TTY users, TTY : 1-877-833-8855

Accessory Purchases

Purchase Parts, Accessories and Instruction Books online for all Panasonic Products by visiting our Web Site at:

<http://www.pasc.panasonic.com>

or, send your request by E-mail to:

npcparts@panasonic.com

You may also contact us directly at:

1-800-332-5368 (Phone) 1-800-237-9080 (Fax Only) (Monday – Friday 9 am to 8 pm, EST.)

Panasonic Services Company

20421 84th Avenue South,

Kent, WA 98032

(We Accept Visa, MasterCard, Discover Card, American Express, and Personal Checks)

For hearing or speech impaired TTY users, TTY : 1-866-605-1277

Product Repairs

Centralized Factory Servicenter

MAIL TO:

Panasonic Services Company

1705 N. Randall Road,

Elgin, IL 60123-7847

Attention: Camcorder Repair

Please carefully pack and ship, prepaid and insured, to the Elgin Centralized Factory Servicenter Customer's in Puerto Rico, please ship or carry in to location below ("Service in Puerto Rico").

Service in Puerto Rico

Matsushita Electric of Puerto Rico, Inc. Panasonic Sales Company

Factory Servicenter:

Ave. 65 de Infantería, Km. 9.5, San Gabriel Industrial Park,

Carolina, Puerto Rico 00985

Phone (787)750-4300, Fax (787)768-2910

As of October 2003

Warranty (For Canadian Customers)**Panasonic Canada Inc.**

5770 Ambler Drive, Mississauga, Ontario L4W 2T3

PANASONIC PRODUCT – LIMITED WARRANTY

Panasonic Canada Inc. warrants this product to be free from defects in material and workmanship and agrees to remedy any such defect for a period as stated below from the date of original purchase.

Camcorder Product – One (1) year, parts and labour**LIMITATIONS AND EXCLUSIONS**

This warranty does not apply to products purchased outside Canada or to any product which has been improperly installed, subjected to usage for which the product was not designed, misused or abused, damaged during shipping, or which has been altered or repaired in any way that affects the reliability or detracts from the performance, nor does it cover any product which is used commercially. Dry cell batteries are also excluded from coverage under this warranty.

This warranty is extended to the original end user purchaser only. A purchase receipt or other proof of date of original purchase is required before warranty service is performed.

THIS EXPRESS, LIMITED WARRANTY IS IN LIEU OF ALL OTHER WARRANTIES, EXPRESS OR IMPLIED, EXCLUDING ANY IMPLIED WARRANTIES OF MERCHANTABILITY OR FITNESS FOR A PARTICULAR PURPOSE.

IN NO EVENT WILL PANASONIC CANADA INC. BE LIABLE FOR ANY SPECIAL, INDIRECT OR CONSEQUENTIAL DAMAGES.

In certain instances, some jurisdictions do not allow the exclusion or limitation of incidental or consequential damages, or the exclusion of implied warranties, so the above limitations and exclusions may not be applicable.

WARRANTY SERVICE

For product operation and information assistance, please contact your Dealer or our Customer Care Centre at:

Telephone #: (905) 624-5505

Fax #: (905) 238-2360

Web: www.panasonic.ca

For product repairs, please contact one of the following:

- Your Dealer who will inform you of an authorized Servicentre nearest you.
- Our Customer Care Centre at (905) 624-5505 or www.panasonic.ca
- A Panasonic Factory Servicentre listed below:

Richmond, British Columbia

Panasonic Canada Inc.

12111 Riverside Way

Richmond, BC

V6W 1K8

Tel: (604) 278-4211

Fax: (604) 278-5627

Calgary, Alberta

Panasonic Canada Inc.

6835-8th St. N. E.

Calgary, AB

T2E 7H7

Tel: (403) 295-3955

Fax: (403) 274-5493

Mississauga, Ontario

Panasonic Canada Inc.

5770 Ambler Dr.

Mississauga, ON

L4W 2T3

Tel: (905) 624-8447

Fax: (905) 238-2418

Lachine, Québec

Panasonic Canada Inc.

3075, rue Louis A. Amos

Lachine, QC

H8T 1C4

Tel: (514) 633-8684

Fax: (514) 633-8020

IF YOU SHIP THE PRODUCT TO A SERVICENTRE

Carefully pack and send prepaid, adequately insured and preferably in the original carton.

Include details of the defect claimed, and proof of date of original purchase.

Index

A		M	
AC Adaptor	16, 70	Macro Close-up	28
ArcSoft	55	Magic Wire Remote Control with Narration Mic	14
Audio Dubbing	46	MagicPix Function	30
Auto Focus	74	Manual Focus	34
B		Memory Card	18
Backlight Compensation	30	Menu Screen	20
Black & White Mode	35	Microphone	29
Blank Search	26	Mirror Mode	35
C		Mix Mode	35
Card Playback	40	Mosaic Mode	35
Charging the Battery	16	Moving Picture (MPEG4) Recording	27
Cinema Mode	31	MPEG4 Playback Mode	40
Condensation	70	Multi-Picture Mode	35
Cue Playback	37	N	
Customer Services Directory	82	Negative Mode	35
D		P	
Date/Time Indication	62	Palmcorder Accessory Order Form	79
Date/Time Setting	24	Photoshot	26
Digital Effects	35	Picture Playback Mode	40
Digital Still Picture	26	Picture-in-Picture Mode	36
Digital Zoom	29	Playback Digital Effects	40
DPOF Setting	43	Playback Zoom	39
Dubbing	47, 48	Playing Back on Your TV	45
DV STUDIO 3.1E-SE	53	Portrait Mode	32
E		Program AE	32
Erasure Prevention Slider	18	Q	
F		Quick Start	28
F Number	34	R	
Fade	30	RapidFire Consecutive Photoshot	27
Formatting	44	Recording Check	25
G		Recording Speed	24
G.726 Audio Decoder	54	Remaining Tape Time	61
I		Remote Controller	14
Image Stabilizer Function	29	Repeat Playback	67
Index Search	39	Request for Service Notice (USA Only)	80
Initializing the Modes	62	Review Playback	37
Iris	34		
L			
LCD Monitor	19, 72		
Limited Warranty (Canada)	83		
Limited Warranty (USA)	81		
Lock Setting	43		
Low Light Mode	32		

■ S	
SD Memory Card	59
Self-Recording	27
Self-timer Recording	28
Sepia Mode	35
Shutter Speed	34
Slide Show	41
Slim Mode	35
Slow Motion Playback	38
Soft Skin Function	31
Solarisation Mode	35
Sound Volume	37
SP/LP Mode	24
Sports Mode	32
Spotlight Mode	32
Still Advance Playback	38
Stretch Mode	35
Strobe Mode	35
Surf & Snow Mode	32
■ T	
Tele-Macro Function	28
Time Code	75
Title	42
Trailing Effect Mode	35
■ U	
USB Connection Kit	49
■ V	
Variable Speed Search	38
Video Head Clogging	71
Viewfinder	19, 72
■ W	
Web Camera	51
White Balance	32
Wind Noise Reduction	31
Wipe Mode	35
■ Z	
Zoom	28
Zoom Microphone	29

Spanish Quick Use Guide/ Guía española para el uso rápido

1 Una la batería al adaptador de CA y cárguela.

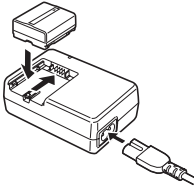

- Antes de usar, cargue completamente la batería.
- Dado que la batería no se cargará cuando el cable de entrada CC está conectado al adaptador de CA, desconéctelo.
- La [CHARGE] lámpara se enciende y comienza la carga.
- Cuando se apaga la luz [CHARGE], termina la carga.

2 Meta la batería cargada en la videocámara.

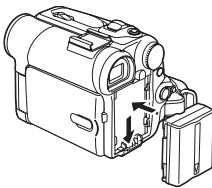

Colocación del cassette

1 Desplace la palanca [OPEN/EJECT] ① hacia delante y tire hacia abajo para abrir el compartimento del cassette.

2 Inserte el cassette.

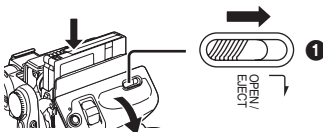

3 Cierre el soporte del cassette presionando la marca [PUSH] ②.

4 Cierre la tapa del compartimento del cassette.

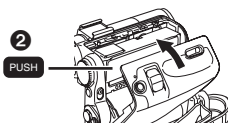

Inserción de la tarjeta

1 Desplace la palanca [OPEN] ① para abrir la tapa del compartimento de tarjeta ②.

2 Manteniendo la tarjeta de memoria con su ángulo cortado mirando a la derecha ④, introdúzcala en su ranura ③.

3 Cierre firmemente la tapa del compartimento de tarjeta ②.

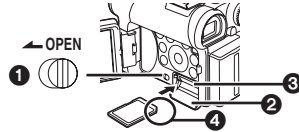

Grabación en una cinta

1 Ponga el interruptor [OFF/ON] ① en [ON].

- La lámpara [POWER] ② se enciende.

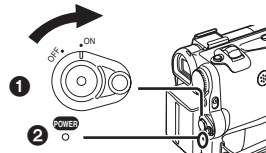

2 Ajuste el disco del modo al de la grabación de cinta.

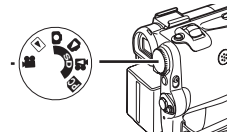

3 Oprima el botón de inicio/parada de la grabación.

- Comienza la grabación.

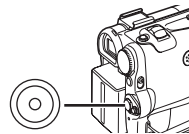

4 Oprima de nuevo el botón de inicio/parada de grabación para detener brevemente la grabación.

Grabación de una imagen fija en una tarjeta (Photoshot)

1 Ajuste en disco del modo al de la grabación.

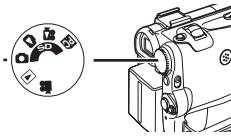

2 Oprima el botón [PHOTO SHOT].

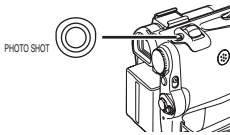

Grabación de una imagen en movimiento en una tarjeta (MPEG4)

1 Ajuste el disco del modo al de la grabación.

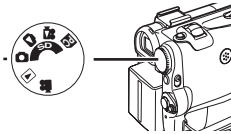

2 Oprima el botón de inicio/parada de grabación.

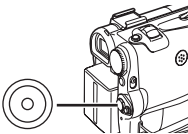

3 Oprima de nuevo el botón de inicio/parada de grabación para detener brevemente la grabación.

Reproducción de una cinta

1 Ponga el interruptor [OFF/ON] ① en [ON].

- La lámpara [POWER] ② se enciende.

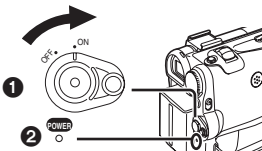

2 Ajuste el disco del modo al de la reproducción de cinta.

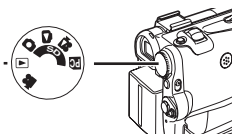

3 Oprima el botón [◀◀] para rebobinar la cinta.

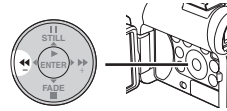

4 Oprima el botón [▶] para comenzar la reproducción.

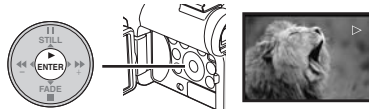

5 Oprima el botón [■] para parar la reproducción.

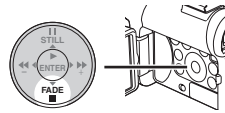

Reproducción de la tarjeta

Reproduce las imágenes grabadas en la tarjeta.

1 Ajuste el disco del modo al de la reproducción de imagen o al de reproducción MPEG4.

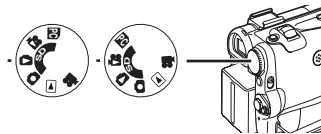

2 Inicio de la reproducción.

[PICTURE]

- ▶: Inicio de la diapositiva
- ▶▶: Reproducción del siguiente archivo
- ◀◀: Reproducción del archivo anterior
- : Parada de la diapositiva
- ||: Diapositiva en pausa

[MPEG4]

- ▶: Reproducción del archivo
- ▶▶: Selección del siguiente archivo (Cuando lo pulsa durante la reproducción, puede buscar el siguiente archivo, mientras que cuando lo mantiene oprimido, se activa la reproducción progresiva)
- ◀◀: Selección del archivo anterior (Cuando lo pulsa durante la reproducción, puede buscar el comienzo del archivo, mientras que cuando lo mantiene oprimido, se activa la reproducción regresiva)
- : Parada de la reproducción
- ||: Reproducción en pausa

**Panasonic Consumer Electronics Company,
Division of Matsushita Electric Corporation of America**

Executive Office:

One Panasonic Way, Secaucus, NJ 07094
(201) 348-7000

Panasonic Company East: 6749 Baymeadow Drive, Glen Burnie, MD 21060

Panasonic Company Central: 1707 North Randall Road, Elgin, IL 60123

Panasonic Company West: 6550 Katella Avenue, Cypress, CA 90630

Division of Matsushita Electric Corporation of America

Panasonic Sales Company (“PSC”)

Division of Matsushita Electric of Puerto Rico, Inc.

San Gabriel Industrial Park, Ave. 65 de Infanteria, Km. 9.5, Carolina, PR 00985

Panasonic Canada Inc.

5770 Ambler Drive, Mississauga, ON, L4W 2T3

