

Register your product and get support at
Registre su producto y obtenga asistencia en

www.philips.com/welcome

BDP2600



EN	User manual	7
ES	Manual del usuario	27

EN: For further assistance, call the customer support service in your country.

- To obtain assistance in the U.S.A., Canada, Puerto Rico, or the U.S. Virgin Islands, contact Philips Customer Care Center at 1-866-309-0866
- To obtain assistance in Mexico, contact Philips Customer Care Center at 01 800 504 62 00

ES: Para obtener mas informacion, llame al servicio de soporte al cliente de su pais.

- Para obtener asistencia en los Estados Unidos, en Canada, Puerto Rico o en las Islas Virgenes de los Estados Unidos, comuniquese con Centro de atencion al cliente de Philips al 1-866-309-0866
- Solo para Mexico CENTRO DE ATENCION A CLIENTES LADA. 01 800 504 62 00 Solo Para Mexico.

For Product recycling information, please visit - www.recycle.philips.com

Para obtener información de productos de reciclaje, por favor visite - www.recycle.philips.com

PHILIPS



- EN Before you operate this Blu-ray disc/ DVD player, read and understand all accompanying instructions.
- ES Antes de utilizar el reproductor de Blu-ray Disc/ DVD, asegúrese de leer y entender todas las instrucciones adjuntas.

Descripción/Description:	REPRODUCTOR DE BLU-RAY Y DVD
Modelo/Model:	BDP2600/F8
Alimentación/Mains:	110-240V ~ 50/60 Hz
Consumo/Consumption:	14W
Importador/Importer:	P&F MEXICANA, S.A. DE C.V.
Domicilio/Street:	Av. La Palma No. 6 Col. San Fernando La Herradura Huixquilucan, Edo. de México.
Localidad y Teléfono/City & Phone:	C.P. 52787 Tel. 52 69 90 00
Exportador/Exporter:	P&F USA INC.
País de Origen/Origin:	CHINA

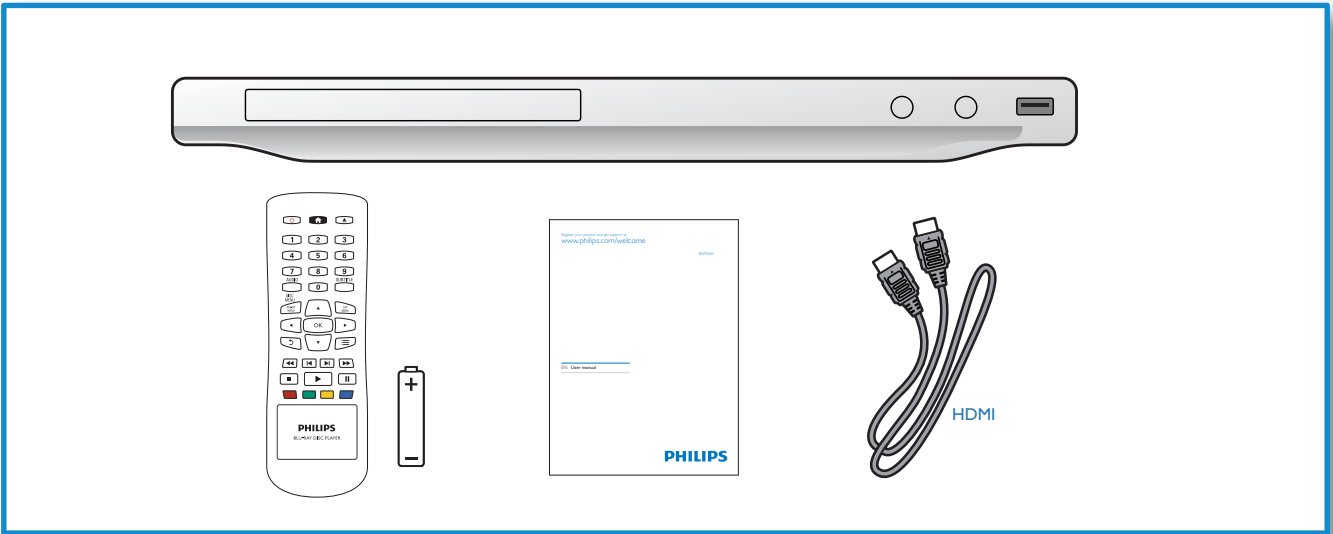

1

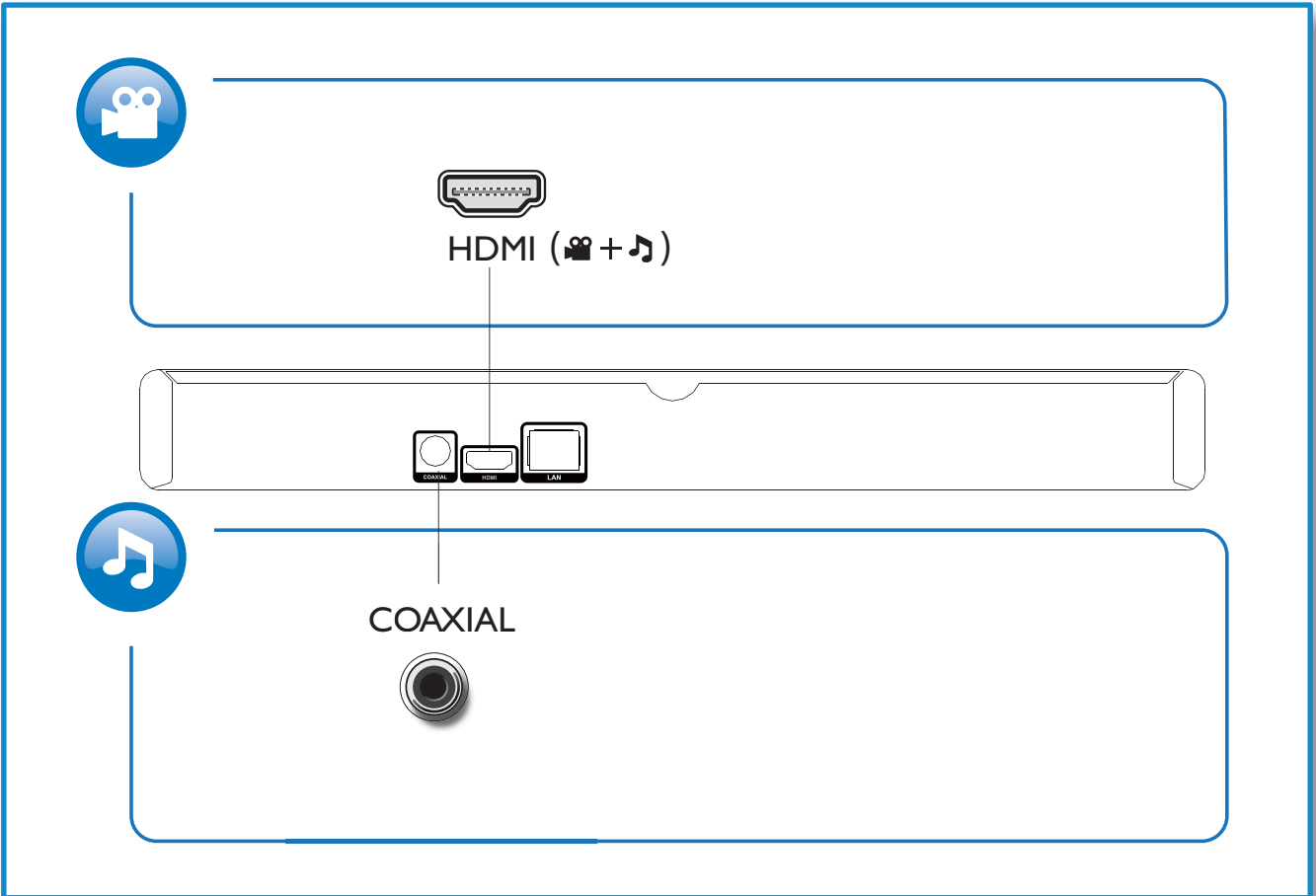

2

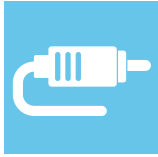

HDMI

HDMI COAXIAL

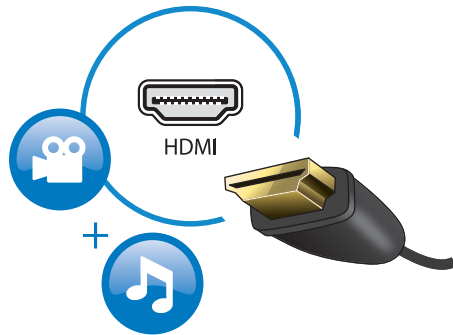

COAXIAL

HDMI COAXIAL

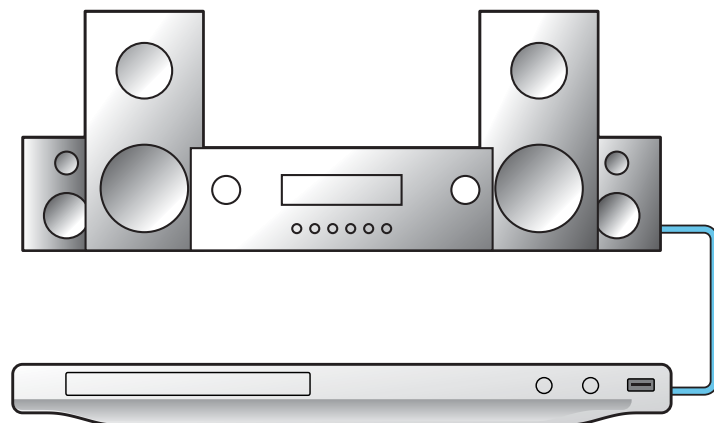

3

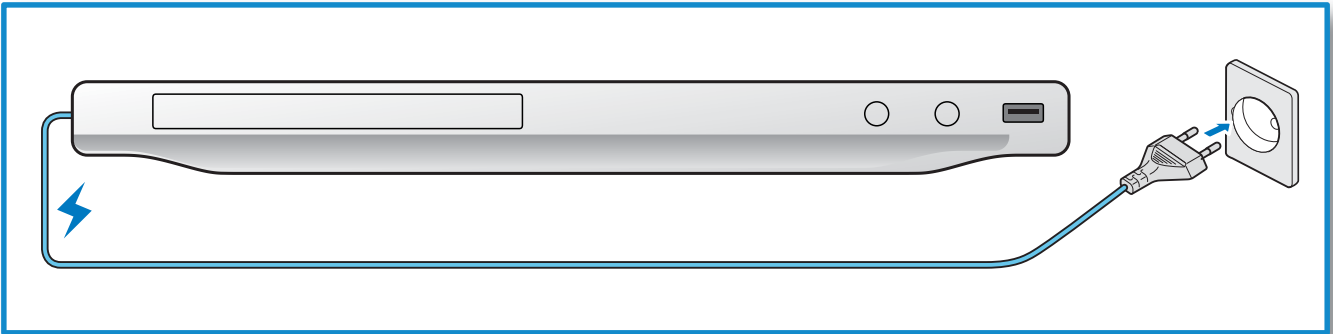

4

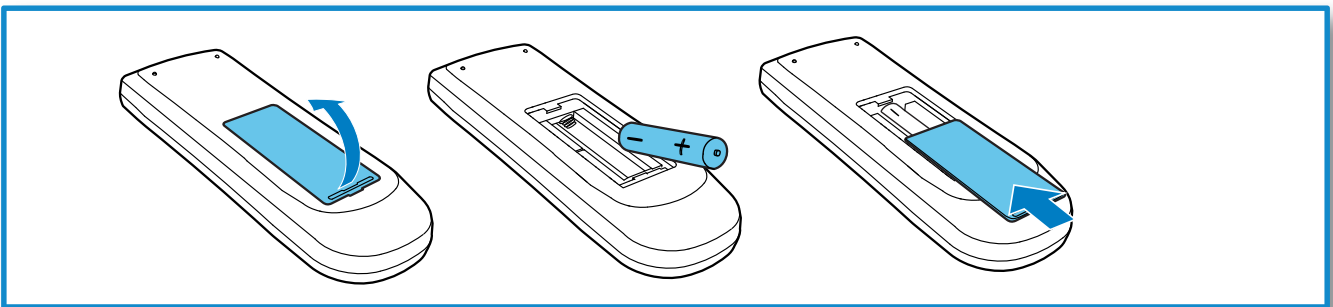

5



6



2

BD
DVD/VCD/CD
DivX Plus HD/MKV
MP3 / JPEG

1



3

4

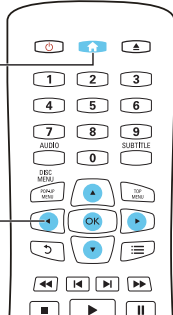

1

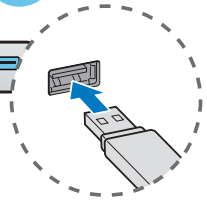

2

3

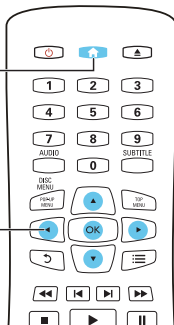

Contenido

1	Conexión y reproducción	2-6
2	Uso del reproductor de Blu-ray / DVD	28
	Controles básicos de reproducción	28
	Opciones de video, audio e imagen	29
	Videos DivX	30
	Reproducción de una secuencia de diapositivas con música	31
	Uso de BonusView en Blu-ray	32
	Acceso a BD-Live en Blu-ray	32
	Instalación de la red	33
	Uso de Philips EasyLink	34
3	Cambio de los ajustes	35
	Imagen	35
	Sound	36
	Red (instalación, estado)	36
	Preferencias (idiomas, control paterno...)	36
	Opciones avanzadas (seguridad de BD-Live, liberación de espacio en la memoria...)	37
4	Actualización de software	38
	Actualización de software a través de Internet	38
	Actualización de software mediante USB	38
5	Especificaciones	39
6	Solución de problemas	41
7	Nota importante sobre seguridad	44
	Garantía	48

2 Uso del reproductor de Blu-ray / DVD

Felicitaciones por su compra y bienvenido a Philips. Para poder beneficiarse por completo de los servicios de asistencia técnica de Philips (por ejemplo, las actualizaciones de software del producto), registre su producto en www.philips.com/welcome.

Controles básicos de reproducción

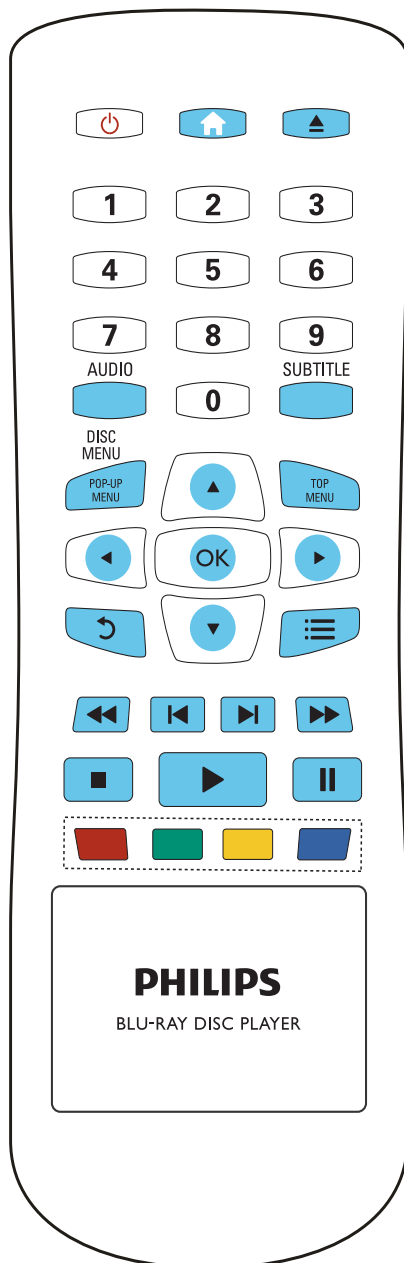

Pulse los siguientes botones para controlar la reproducción.

Botón	Acción
	Accede al menú de inicio.
	Abre o cierra la bandeja de discos.
	Detiene la reproducción.
	Hace una pausa en la reproducción. Pulse varias veces para avanzar lentamente cuadro por cuadro.
	Inicia o reanuda la reproducción.
	Pasa la pista, capítulo o archivo anterior o siguiente.
	Realiza búsquedas rápidas hacia atrás o hacia adelante. Pulse varias veces para incrementar la velocidad de búsqueda. Pulse una vez y, a continuación, pulse para avanzar lentamente.
AUDIO	Selecciona un idioma o canal de audio.
SUBTITLE	Selecciona el idioma de los subtítulos.
DISC MENU / POP-UP MENU	Accede o sale del menú del disco.
TOP MENU	Permite acceder al menú principal de un disco de video.
Botones de color	Selecciona tareas u opciones para los discos Blu-ray.
	Navega a través de los menús. Pulse para girar una imagen a la derecha o a la izquierda durante la secuencia de diapositivas.
OK	Confirma una selección o una entrada.

↶	Regresa al menú de pantalla anterior.
☰	Permite acceder a más opciones durante la reproducción.

Opciones de video, audio e imagen

Hay más opciones disponibles para la reproducción de video o imágenes desde un disco o un dispositivo de almacenamiento USB.

Opciones de video

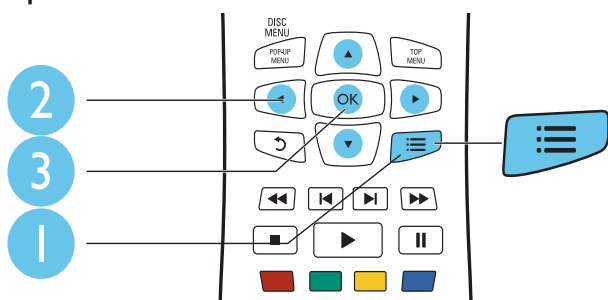

Permite acceder a más opciones durante la reproducción de video.

- **[Idioma de audio]:** selecciona un idioma de audio.
- **[Idioma de subtítulos]:** selecciona el idioma de los subtítulos.
- **[Cambio de subtítulos]:** cambia la posición de los subtítulos en la pantalla. Pulse ▲ ▼ para cambiar la posición de los subtítulos.
- **[Información]:** muestra la información de reproducción.
- **[Conjunto de caracteres]:** selecciona un conjunto de caracteres compatible con los subtítulos de video DivX (sólo para videos DivX).
- **[Búsqueda de tiempo]:** avanza a una hora específica mediante los botones numéricos del control remoto.
- **[2do idioma de audio]:** selecciona el segundo idioma de audio (sólo para discos Blu-ray compatibles con BonusView).
- **[2do idioma subtítulos]:** selecciona el segundo idioma de subtítulos (sólo para discos Blu-ray compatibles con BonusView).
- **[Títulos]:** selecciona un título.
- **[Capítulos]:** selecciona un capítulo.
- **[Lista de ángulos]:** selecciona un ángulo de cámara.
- **[Menús]:** muestra el menú del disco.
- **[Selección PIP]:** muestra la ventana Picture-in-Picture (sólo para discos Blu-ray compatibles con BonusView).
- **[Acercar]:** amplía una imagen de video. Pulse ◀▶ para seleccionar un grado de zoom.
- **[Repetir]:** repite un capítulo o un título.
- **[Repetir A-B]:** marca dos puntos de un capítulo para repetir la reproducción o desactiva el modo de repetición.
- **[Ajustes de imagen]:** selecciona un ajuste de color predefinido.

- Las opciones de video disponibles dependen de la fuente de video.

Opciones de imagen

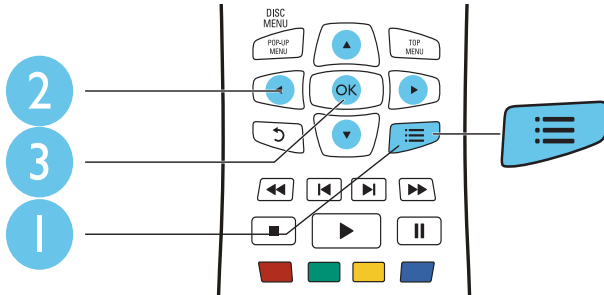

Puede acceder a más opciones durante la secuencia de diapositivas.

- **[Rotar +90]:** gira una imagen 90 grados a la derecha.
- **[Rotar -90]:** gira una imagen 90 grados a la izquierda.
- **[Acercar]:** amplía una imagen. Pulse ◀▶ para seleccionar un grado de zoom.
- **[Información]:** muestra la información de la imagen.
- **[Duración por diapos.]:** configura un intervalo de reproducción para una secuencia de diapositivas.
- **[Animación con diap.]:** selecciona un efecto de transición para una secuencia de diapositivas.
- **[Ajustes de imagen]:** selecciona un ajuste de color predefinido.
- **[Repetir]:** repite una carpeta seleccionada.

Opciones de audio

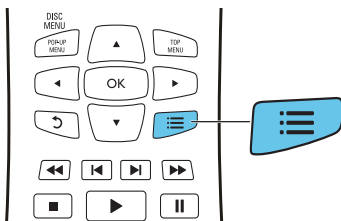

Pulse ≡ varias veces para desplazarse por las siguientes opciones.

- Repite la pista actual.
- Repite todas las pistas del disco o la carpeta.
- Reproduce las pistas de audio en orden aleatorio.
- Desactiva el modo de repetición.

Videos DivX

Puede reproducir videos DivX almacenados en un disco o dispositivo de almacenamiento USB.

código VOD para DivX

- Antes de comprar videos DivX y reproducirlos en este reproductor, registre el reproductor en www.divx.com con el código de DivX VOD.

- Para conocer el código de DivX VOD, pulse  y seleccione **[Configuración]** > **[Avanzada]** > **[Código DivX® VOD]**.

subtítulos DivX

- Pulse **SUBTITLE** para seleccionar el idioma.
- Si los subtítulos no aparecen correctamente, seleccione el conjunto de caracteres compatibles con los subtítulos DivX. Para seleccionar un conjunto de caracteres, pulse  y seleccione **[Conjunto de caracteres]**.

Conjunto de caracteres Idiomas



[Estándar]	Inglés, albanés, danés, holandés, finlandés, francés, gaélico, alemán, italiano, curdo (latín), noruego, portugués, español, sueco y turco
[Europa central]	Albanés, croata, checo, holandés, inglés, alemán, húngaro, irlandés, polaco, rumano, eslovaco, esloveno y serbio
[Cirílico]	Búlgaro, bielorruso, inglés, macedonio, moldavo, ruso, serbio y ucraniano
[Griego]	Griego

Nota

- Para reproducir archivos DivX protegidos por DRM desde un dispositivo de almacenamiento USB, conecte el reproductor a un televisor a través de HDMI.
- Para utilizar los subtítulos, verifique que el archivo de subtítulos tenga el mismo nombre que el archivo de video DivX. Por ejemplo, si el nombre del archivo de video DivX es "movie.avi", guarde el archivo de subtítulos con el nombre "movie.srt" o "movie.sub".
- Este reproductor es compatible con archivos de subtítulos en los siguientes formatos: .srt, .sub, .txt, .ssa, y .smi.

Reproducción de una secuencia de diapositivas con música

Reproduzca música e imágenes de forma simultánea para crear una secuencia de diapositivas con música.

- 1 Reproduzca un archivo de música desde un disco o dispositivo de almacenamiento USB conectado.
- 2 Pulse  y acceda a la carpeta de imágenes.
- 3 Seleccione una imagen del mismo disco o dispositivo USB y pulse **OK** para iniciar la secuencia de diapositivas.
- 4 Pulse  para detener la secuencia de diapositivas.
- 5 Pulse  nuevamente para detener la reproducción de música.

Uso de Bonus View en Blu-ray

Puede ver contenidos especiales (como comentarios) en una ventana pequeña de la pantalla. Esta función sólo se encuentra disponible para los discos Blu-ray compatibles con BonusView (también conocido como Picture-in-Picture).

- 1 Durante la reproducción, pulse **≡**.
↳ Aparecerá el menú de opciones.
- 2 Seleccione **[Selección PIP] > [PIP]** y pulse **OK**.
↳ Las opciones PIP [1]/[2] varían según el contenido del video.
↳ Aparecerá la ventana de video secundaria.
- 3 Seleccione **[2do idioma de audio]** o **[2do idioma subtítulos]** y pulse **OK**.

Acceso a BD-Live en Blu-ray

Acceda a servicios en línea exclusivos, como avances de películas, juegos, tonos de llamada y otros contenidos adicionales.

Esta función sólo se aplica a discos Blu-ray con contenido de BD-Live.

- 1 Prepare la conexión a Internet y configure una red (consulte el capítulo "Instalación de la red").
- 2 Conecte un dispositivo de almacenamiento USB en el reproductor.
 - La unidad USB se usa para guardar el contenido de BD-Live.
 - Si desea borrar los contenidos de BD-Live que descargó anteriormente en el dispositivo USB para liberar espacio en la memoria, pulse **⬆** y seleccione **[Configuración] > [Avanzada] > [Borrar memoria]**.
- 3 Reproduzca un disco con contenido de BD-Live.
- 4 En el menú del disco, seleccione el icono de BD-Live y pulse **OK**.
↳ BD-Live comenzará a cargarse. El tiempo de carga depende del disco y de la conexión a Internet.
- 5 En la interfaz de BD-Live, seleccione la opción a la que desea acceder.

Nota

- Los servicios de BD-Live varían según el país y el disco.
- Al utilizar BD-Live, el proveedor de contenidos accede a los datos del disco y del reproductor.
- Utilice una unidad USB con 1 GB de espacio libre como mínimo para almacenar los archivos descargados.

Instalación de la red

Conecte el reproductor a Internet para acceder a los siguientes servicios:

- **BD-Live:** acceda a funciones adicionales en línea (para discos Blu-ray con contenido de BD-Live)
- **Actualización de software:** actualice el software del reproductor a través de Internet.

1 Conecte este reproductor a Internet con un cable de red (no suministrado).

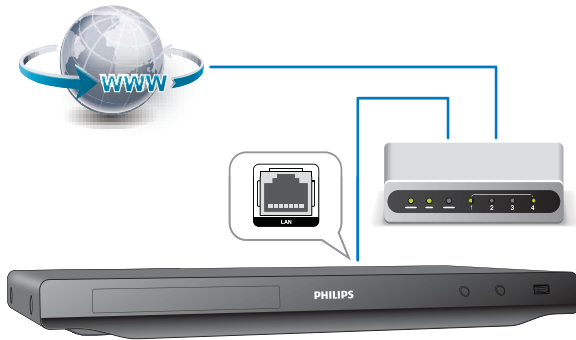

2 Realice la instalación de la red.

- 1) Pulse **⬆**.
- 2) Seleccione **[Configuración]** y pulse **OK**.
- 3) Seleccione **[Red] > [Instalación de red]** y pulse **OK**.
- 4) Siga las instrucciones que aparecen en la pantalla del televisor para completar la instalación.



Precaución

- Antes de conectarse a una red, procure familiarizarse con el router de red y los conceptos relacionados con redes. Si es necesario, lea la información incluida con los componentes de red. Philips no se hace responsable por los datos perdidos o dañados.

Uso de Philips EasyLink

Este reproductor es compatible con Philips EasyLink, que utiliza el protocolo HDMI CEC (Consumer Electronics Control). Puede usar un solo control remoto para controlar los dispositivos compatibles con EasyLink que están conectados mediante HDMI. Philips no garantiza una interoperatividad total con todos los dispositivos HDMI CEC.

- 1** Conecte los dispositivos compatibles con HDMI CEC a través de HDMI y active las funciones HDMI CEC en el televisor y en los demás dispositivos conectados (para obtener más información, consulte el manual del usuario del televisor o de los dispositivos).
- 2** Pulse **⬆**.
- 3** Seleccione **[Configuración]> [EasyLink]**.
- 4** Seleccione **[Encendido]** en las opciones **[EasyLink]**, **[Reproducción con un solo botón]** y **[Modo de espera con un solo botón]**.
↳ La función EasyLink se activará.

Reproducción con un solo botón

Cuando reproduce un disco en el reproductor, el televisor cambia automáticamente a la fuente de entrada de video correcta.

Modo de espera con un solo botón

Cuando un dispositivo conectado (por ejemplo, un televisor) pasa al modo de espera mediante su propio control remoto, el reproductor pasa al modo de espera automáticamente.

3 Cambio de los ajustes

En esta sección encontrará más información sobre cómo cambiar los ajustes del reproductor.

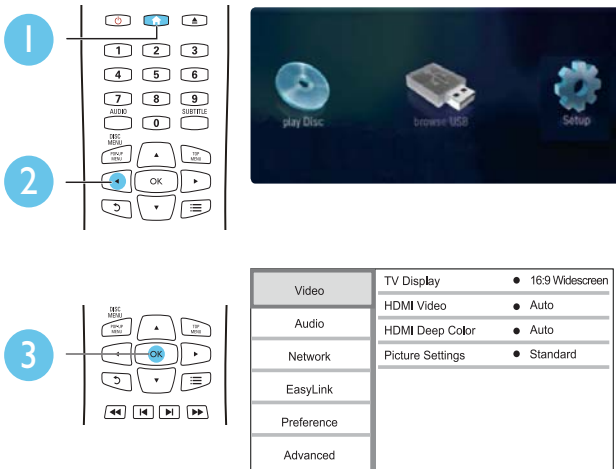

Nota

- No puede modificar las opciones de menú que aparecen deshabilitadas (en gris).
- Para volver al menú anterior, pulse ⏪. Para salir del menú, pulse 🏠.

Imagen

- 1 Pulse 🏠.
- 2 Seleccione **[Configuración]** > **[Video]** para acceder a las opciones de configuración de video.
 - **[Pantalla de TV]**: selecciona un formato de visualización de imágenes que se ajuste a la pantalla del televisor.
 - **[Video HDMI]**: selecciona una resolución de video HDMI.
 - **[HDMI Deep Color]**: reproduce los colores con más sombras y matices si el contenido de video está grabado con Deep Color y el televisor admite esta función.
 - **[Ajustes de imagen]**: selecciona un ajuste de color predefinido.

Nota

- Si modifica el ajuste, verifique que el televisor admita el nuevo ajuste.

Sound

- 1 Pulse .
- 2 Seleccione **[Configuración]** > **[Audio]** para acceder a las opciones de configuración de audio.
 - **[Modo nocturno]**: selecciona un sonido bajo o completamente dinámico. El modo nocturno reduce el volumen de los sonidos altos y aumenta el de los sonidos suaves (por ejemplo, las conversaciones).
 - **[Neo 6]**: activa o desactiva un efecto de sonido envolvente que se convierte a partir del audio de 2 canales.
 - **[Audio HDMI]**: selecciona un formato de audio HDMI cuando el reproductor está conectado a través de HDMI.
 - **[Audio digital]**: selecciona un formato de audio para la salida de sonido cuando el reproductor está conectado a través de un conector digital (coaxial).
 - **[Reducción de resol. PCM]**: ajusta la velocidad de muestreo para la salida de audio PCM cuando el reproductor está conectado a través de un conector digital (coaxial).



Nota

- El modo nocturno sólo está disponible para los DVD con codificación Dolby y los discos Blu-ray.

Red (instalación, estado)

- 1 Pulse .
- 2 Seleccione **[Configuración]** > **[Red]** para acceder a las opciones de configuración de red.
 - **[Instalación de red]**: inicia una instalación mediante cables para hacer funcionar la red.
 - **[Ver los ajustes de red]**: muestra el estado actual de la red.

Preferencias (idiomas, control paterno...)

- 1 Pulse .
- 2 Seleccione **[Configuración]** > **[Preferenc.]** para acceder a las opciones de configuración de preferencias.
 - **[Idioma del menú]**: selecciona un idioma para el menú en pantalla.
 - **[Audio]**: selecciona un idioma de audio para los videos.
 - **[Subtítulos]**: selecciona un idioma para los subtítulos de video.
 - **[Menú del disco]**: selecciona un idioma de menú para un disco de video.
 - **[Control para padres]**: restringe el acceso a los discos grabados con clasificaciones. Introduzca «0000» para acceder a las opciones de restricción. Para reproducir todos los discos, independientemente de su nivel de clasificación, seleccione el nivel «8».
 - **[Protector de pantalla]**: activa o desactiva el modo de protector de pantalla. Si está activado, la pantalla pasará al modo de inactividad después de 10 minutos de inactividad (por ejemplo en modo de pausa o interrupción).

- **[Cambio de subtítulos automático]:** activa o desactiva el desplazamiento de los subtítulos. Si está activada la opción, la posición de los subtítulos cambia automáticamente para ajustarse a la pantalla del televisor (esta característica funciona sólo en algunos televisores Philips).
- **[Cambiar contraseña]:** selecciona o cambia una contraseña para reproducir un disco restringido. Ingrese «0000» si no tiene una contraseña o si la ha olvidado.
- **[Modo de espera automático]:** activa o desactiva el modo de espera automático. Si esta opción está activada, el reproductor pasa al modo de espera después de 30 minutos de inactividad (por ejemplo, en modo de pausa o detención).
- **[VCD PBC]:** muestra u omite el menú de contenido en discos VCD y SVCD.

Nota

- Si el idioma que busca no está disponible entre los idiomas de disco, audio o subtítulos, puede seleccionar **[Otro]** en las opciones de menú e introducir el código de idioma de 4 dígitos que se encuentra en la parte posterior de este manual del usuario.
- Si selecciona un idioma que no está disponible en un disco, el reproductor utilizará el idioma predeterminado del disco.

Opciones avanzadas (seguridad de BD-Live, liberación de espacio en la memoria...)

- 1 Pulse .
- 2 Seleccione **[Configuración]** > **[Avanzada]** para acceder a las opciones de configuración avanzadas.
 - **[Seguridad BD-Live]:** restringe o permite el acceso a BD-Live (sólo para discos BD-Live no comerciales creados por el usuario).
 - **[Actualización de software]:** seleccione esta opción para actualizar el software desde una red o desde un dispositivo de almacenamiento USB.
 - **[Borrar memoria]:** borra la descarga anterior de BD-Live del dispositivo de almacenamiento USB. Se crea automáticamente una carpeta llamada "BUDA" para almacenar los datos descargados de BD-Live.
 - **[Código DivX® VOD]:** muestra el código de registro o el código de anulación de registro DivX® para el reproductor.
 - **[Información de la versión.]:** muestra la versión de software del reproductor.
 - **[Restaurar ajustes predet.]:** restablece los ajustes del reproductor a la configuración predeterminada de fábrica.

Nota

- No puede restringir el acceso a Internet en los discos Blu-ray comerciales.
- Antes de comprar videos DivX y reproducirlos en su reproductor, registre el reproductor en www.divx.com con el código de DivX VOD.
- No es posible restaurar el ajuste del control paterno a los valores predeterminados.

4 Actualización de software

Antes de actualizar el software del reproductor, compruebe la versión actual del software:

- Pulse **⬆** y, a continuación, seleccione **[Configuración] > [Avanzada] > [Información de la versión.]**, y pulse **OK**.

Actualización de software a través de Internet

- 1 Conecte el reproductor a Internet (consulte el capítulo “Instalación de la red”).
- 2 Pulse **⬆** y seleccione **[Configuración]**.
- 3 Seleccione **[Avanzada] > [Actualización de software] > [Red]**.
↳ Si se detecta un soporte de actualización, el sistema le solicitará que inicie la actualización.
- 4 Siga las instrucciones que aparecen en la pantalla del televisor para actualizar el software.
↳ Cuando la actualización finalice, el reproductor se apagará y volverá a encenderse automáticamente.

Actualización de software mediante USB

- 1 Obtenga la versión de software más reciente en www.philips.com/support.
 - Busque su modelo y haga clic en “Software y controladores”.
- 2 Descargue el software en un dispositivo de almacenamiento USB.
 - ① Descomprima el archivo descargado y verifique que la carpeta descomprimida tenga el nombre “UPG_ALL”.
 - ② Coloque la carpeta “UPG_ALL” en el directorio raíz.
- 3 Conecte el dispositivo de almacenamiento USB al conector **🔌** (USB) del reproductor.
- 4 Pulse **⬆** y seleccione **[Configuración]**.
- 5 Seleccione **[Avanzada] > [Actualización de software] > [USB]**.
↳ Si se detecta un soporte de actualización, el sistema le solicitará que inicie la actualización.
- 6 Siga las instrucciones que aparecen en la pantalla del televisor para actualizar el software.
↳ Cuando la actualización finalice, el reproductor se apagará y volverá a encenderse automáticamente.



Precaución

- Para evitar daños en el reproductor, no apague ni desconecte el dispositivo de almacenamiento USB durante la actualización del software.

5 Especificaciones

Nota

- Las especificaciones están sujetas a cambio sin previo aviso.

Código de región

Este reproductor puede reproducir discos con los siguientes códigos de región.

DVD	Blu-ray	Países
 		América Latina

Formatos de reproducción compatibles

- BD-video
- DVD-Video, DVD+R/+RW, DVD-R/-RW, DVD+R/-R DL (doble capa)
- VCD/SVCD
- CD de audio, CD-R/CD-RW, archivos MP3 y JPEG
- DivX (Ultra) / DivX Plus HD, MKV
- unidad de almacenamiento USB

Formatos de archivo

- Video: .avi, .divx, .mp4, .mkv
- Audio: .mp3, .wav
- Imagen: .jpg, .gif, .png

Video

- Sistema de señal: PAL/NTSC
- Salida HDMI: 480p, 576p, 720p, 1080i, 1080p, 1080p/24

Audio

- Salida HDMI
- Salida digital: 0,5 Vp-p (75 ohmios)
 - Coaxial
- Frecuencia de muestreo:
 - MP3: 32 kHz; 44,1 kHz; 48 kHz
- Frecuencia de bits constante:
 - MP3: 112 kbps - 320 kbps

USB

- Compatibilidad: USB (2.0) de alta velocidad
- Estándar compatible: UMS (clase de almacenamiento masivo USB)
- Sistema de archivos: FAT16, FAT32
- Compatible con HDD (disco duro portátil): es posible que se necesite una fuente de alimentación externa.

Unidad principal

- Clasificación de la fuente de alimentación: CA 110 - 240 V~, 50/60 Hz
- Consumo de energía: 14 W
- Consumo de energía en modo de espera: < 1 W
- Dimensiones (An x Al x Pr): 360 x 44 x 210 (mm)
- Peso neto: 1,26 kg

Accesorios incluidos

- Control remoto y una batería
- Cable HDMI
- Manual del usuario
- Adaptador de energía

Especificación de láser

- Tipo de láser (diodo): AlGaInN (BD), AlGaInP (DVD/CD)
- Longitud de onda: 405+7 nm/-7 nm (BD), 655+10 nm/-10 nm (DVD), 790+10/-20 nm (CD)
- Potencia de salida (calificaciones máximas): 1,7mW (BD); 0,19mW (DVD); 0,25mW (CD)

6 Solución de problemas



Advertencia

- Riesgo de shock eléctrico. No extraiga la carcasa del reproductor.

No intente reparar el reproductor usted mismo pues la garantía podría perder validez.

Si detecta algún problema durante el uso de este reproductor, compruebe los siguientes puntos antes de comunicarse con el servicio de reparaciones. Si el problema persiste, registre el reproductor y solicite asistencia en www.philips.com/welcome.

Si se comunica con Philips, le solicitarán el número de serie y de modelo de este reproductor. Estos números figuran en la parte trasera del aparato. Escriba los números aquí:

Número de modelo _____

Número de serie _____

Unidad principal

Los botones del reproductor no funcionan.

- Desconecte el reproductor de la fuente de alimentación durante unos minutos y, a continuación, vuelva a conectarlo.

Imagen

No hay imagen.

- Asegúrese de que el televisor cuente con un conector HDMI y de que este reproductor esté conectado con el televisor por medio de un cable HDMI.
- Asegúrese de que el televisor tenga seleccionada la fuente de entrada adecuada para el reproductor.
- Verifique que el cable HDMI no esté dañado. Si presenta daños, reemplácelo por un cable HDMI nuevo.
- Pulse  en el control remoto y, a continuación, presione "731" (botones numéricos) para recuperar la imagen. Otra alternativa es esperar 10 segundos para la recuperación automática.
- Si el reproductor está conectado a un dispositivo de visualización no autorizado mediante un cable HDMI, es posible que no funcione la salida de las señales de audio y video.

El disco no reproduce videos en alta definición.

- Asegúrese de que el disco contenga video de alta definición.
- Asegúrese de que el televisor admita video de alta definición.

Sound

No hay salida de audio del televisor.

- Asegúrese de que el televisor cuente con un conector HDMI y de que este reproductor esté conectado con el televisor por medio de un cable HDMI.
- Asegúrese de que el televisor tenga seleccionada la fuente de entrada adecuada para el reproductor.

- Si el televisor no es compatible con HDCP, o si sólo es compatible con DVI, es posible que la salida HDMI no emita ningún sonido.

No hay salida de audio secundaria para la función Picture-in-Picture.

- Cuando se selecciona **[Secuencia de bits]** en el menú **[Audio HDMI]** o **[Audio digital]**, se anula el sonido interactivo, como por ejemplo el sonido secundario para la función Picture-in-Picture. Anule la selección de **[Secuencia de bits]**.

Reproducción

No se puede reproducir el disco.

- Limpie el disco.
- Verifique que el disco esté cargado correctamente.
- Asegúrese de que el reproductor sea compatible con el disco. Consulte la sección sobre especificaciones del producto.
- Asegúrese de que el reproductor admita el código de región del DVD o BD.
- En el caso de DVD±RW o DVD±RW, asegúrese de que el disco esté finalizado.

No pueden reproducirse archivos de video DivX.

- Asegúrese de que el archivo de video DivX esté completo.
- Compruebe que la extensión del archivo sea correcta.
- Para reproducir archivos DivX protegidos por DRM desde un dispositivo de almacenamiento USB, conecte el reproductor a un televisor a través de HDMI.

Los subtítulos de DivX no se ven correctamente.

- Compruebe que el archivo de subtítulos tenga exactamente el mismo nombre que el archivo de video DivX.
- Asegúrese de que el nombre del archivo de los subtítulos tenga una extensión compatible con el reproductor (.srt, .sub, .txt, .ssa, .ass o .smi).

No puede leerse el contenido de un dispositivo de almacenamiento USB conectado.

- Asegúrese de que el formato del dispositivo de almacenamiento USB sea compatible con el reproductor.
- Asegúrese de que el sistema de archivos del dispositivo de almacenamiento USB sea compatible con el sistema del reproductor.
- En el caso de un disco duro portátil (HDD), es posible que se necesite una fuente de alimentación externa.

Aparecerá el mensaje “No hay entrada” o “x” en el televisor.

- No puede realizarse la operación.

La función EasyLink no funciona.

- Asegúrese de que el reproductor esté conectado a un televisor Philips con EasyLink y que la opción EasyLink esté activada (consulte la sección “Uso del reproductor de Blu-ray / DVD”> “Uso de Philips EasyLink”).

No se puede acceder a las funciones de BD-Live.

- Asegúrese de que el reproductor esté conectado a la red (consulte “Uso del reproductor de Blu-ray / DVD”> “Instalación de la red”).
- Verifique que se haya realizado la instalación de la red (consulte “Uso del reproductor de Blu-ray / DVD”> “Instalación de la red”).

- Verifique que el disco Blu-ray sea compatible con la función BD-Live.
- Libere espacio en la memoria. Consulte "Cambio de los ajustes" > "Opciones avanzadas (seguridad de BD-Live, liberación de espacio en la memoria...)".

Red

No se encuentra la red inalámbrica o hay interferencias.

- Verifique que la red esté correctamente conectada (consulte la sección "Uso del reproductor de Blu-ray / DVD"> "Instalación de la red").
- Verifique que se haya realizado la instalación de la red (consulte "Uso del reproductor de Blu-ray / DVD"> "Instalación de la red").

7 Nota importante sobre seguridad

Procure leer y comprender todas las instrucciones antes de utilizar este reproductor de Blu-ray / DVD. La garantía no cubre los daños derivados del incumplimiento de las instrucciones.

Seguridad

Riesgo de electrocución o incendio.

- Nunca exponga el producto ni los accesorios a la lluvia ni al agua. Nunca coloque contenedores de líquidos, como jarrones, cerca del producto. Si se derrama algún líquido sobre el producto o en su interior, desconéctelo de la toma de alimentación inmediatamente. Póngase en contacto con el servicio de atención al cliente de Philips para comprobar el dispositivo antes de usarlo.
- No coloque nunca el producto ni los accesorios cerca de llamas u otras fuentes de calor, incluso la luz solar directa.
- No inserte objetos en las ranuras de ventilación ni en las aberturas del producto.
- Si utiliza el enchufe principal u otro conector como dispositivo de desconexión, debe estar en una ubicación accesible.
- Antes de que se produzca una tormenta eléctrica, desconecte el producto de la toma de alimentación.
- Para desconectar el cable de alimentación, tire siempre del enchufe, nunca del cable.

Riesgo de cortocircuito o incendio.

- Antes de conectar el producto a la toma de alimentación, asegúrese de que el voltaje de alimentación se corresponda con el valor impreso en la parte posterior o inferior del producto. Nunca conecte el producto a la toma de alimentación si el voltaje es distinto.

Riesgos de lesiones o daños al producto.

- Radiación láser visible e invisible cuando está abierto. No exponer a los rayos de luz.
- No toque la lente óptica del disco que se encuentra dentro de la bandeja de discos.
- Nunca coloque el producto ni ningún otro objeto sobre cables de alimentación u otros equipos eléctricos.
- Si el producto se transporta a temperaturas inferiores a 5 °C, desembálelo y espere hasta que su temperatura se equipare con la temperatura ambiente antes de conectarlo a la toma de alimentación.

Riesgo de sobrecalentamiento.

- Nunca instale este producto en un espacio reducido. Deje siempre un espacio de 10 cm, como mínimo, alrededor del producto para que se ventile. Asegúrese de que las ranuras de ventilación del producto no estén cubiertas por cortinas u otros objetos.

Riesgo de contaminación.

- No utilice baterías de distintas clases (nuevas y usadas o de carbono y alcalinas, etc.).
- Retire las baterías cuando estén agotadas o cuando no utilice el control remoto durante un período prolongado.
- Las baterías contienen sustancias químicas y deben desecharse de forma adecuada.

Riesgo de deglución de baterías

- El producto / control remoto puede contener una batería tipo botón fácil de tragar.
- Siempre mantenga las baterías lejos del alcance de los niños.



Protección del producto

- No introduzca ningún objeto que no sean discos en la bandeja de discos.
- No introduzca ningún disco deformado o roto en la bandeja de discos.
- Extraiga los discos de la bandeja si sabe que no utilizará el producto durante un período prolongado.
- Utilice únicamente un paño de microfibra para limpiar el producto.

Cuidado del medio ambiente



Este producto ha sido diseñado y fabricado con materiales y componentes de alta calidad que pueden reciclarse y reutilizarse.

Nunca deseche el producto con el resto de la basura doméstica. Infórmese sobre las normas locales sobre la recolección selectiva de baterías y productos eléctricos y electrónicos. La eliminación correcta de este tipo de productos ayuda a evitar consecuencias potencialmente negativas para el medio ambiente y la salud humana.

Este producto contiene baterías que no pueden desecharse con los residuos normales del hogar. Infórmese de la reglamentación local sobre la recolección de baterías por separado. La correcta eliminación de baterías ayuda a evitar posibles consecuencias negativas al medio ambiente y la salud. Visite www.recycle.philips.com para obtener más información sobre los centros de reciclaje de su zona.

Derechos de propiedad intelectual



Este producto ofrece tecnología de protección contra copias protegida por patentes de Estados Unidos y otros derechos de propiedad intelectual de Rovi Corporation. Queda prohibido realizar tareas de ingeniería inversa y desarmar el producto.

Software de código abierto

Por medio del presente, Philips Electronics Hong Kong Ltd. se compromete a entregar una copia completa del código fuente correspondiente a los paquetes de software de código abierto protegidos por derechos de propiedad intelectual utilizados en este producto a los titulares de licencias que así lo soliciten.

Esta oferta es válida dentro de los tres años posteriores a la adquisición del producto para cualquier persona que conozca esta información. Para obtener el código fuente, envíe un mensaje de correo electrónico a la siguiente dirección: open.source@philips.com. Si prefiere no comunicarse por correo electrónico o si no recibe la confirmación de recepción del mensaje dentro de la semana posterior al envío, escriba a "Open Source Team, Philips Intellectual Property & Standards, P.O. Box 220, 5600 AE Eindhoven, The Netherlands". Si no recibe confirmación oportuna de recepción de su carta, envíe un mensaje de correo electrónico a la dirección que se mencionó anteriormente.

Marcas comerciales



'Blu-ray Disc' y el logotipo de 'Blu-ray Disc' son marcas comerciales.



HDMI, el logotipo de HDMI y High-Definition Multimedia Interface son marcas comerciales o marcas comerciales registradas de HDMI Licensing LLC en los Estados Unidos y en otros países.



Fabricado en virtud de una licencia de Dolby Laboratories. Dolby y el símbolo de doble D son marcas comerciales de Dolby Laboratories.



Fabricado con licencia de acuerdo con Los números de patente 5.956.674, 5.974.380, 6.226.616, 6.487.535, 7.212.872, 7.333.929, 7.392.195, 7.272.567 y otros de Estados Unidos y de todo el mundo publicadas y pendientes. DTS-HD, Symbol, DTS-HD y Symbol conjuntamente son marcas comerciales registradas y DTS-HD Master Audio es una marca comercial de DTS, Inc. El producto incluye el software. © DTS, Inc. Todos los derechos reservados.



ACERCA DEL VIDEO DIVX: DivX® es un formato de video digital creado por DivX, Inc. Este dispositivo es un producto DivX Certified® oficial que reproduce videos DivX. Para obtener más información sobre DivX y acceder a las herramientas de software disponibles para convertir archivos al formato de video DivX, visite divx.com.

ACERCA DE DIVX VIDEO-ON-DEMAND: este dispositivo DivX Certified® debe estar registrado para poder reproducir películas DivX Video-on-Demand (VOD). Para obtener el código de registro, consulte la sección DivX VOD en el menú de configuración de su dispositivo. Ingrese en vod.divx.com para obtener más información sobre cómo completar el proceso de registro.

DivX®, DivX Certified®, DivX Plus™ HD y los logotipos relacionados son marcas comerciales registradas de DivX, Inc. y se utilizan en virtud de una licencia.

Certificación DivX Certified® para reproducir videos DivX® y DivX Plus™ HD (H.264/MKV) de hasta 1080p HD con contenido exclusivo.



BONUSVIEW™

«BD LIVE» y «BONUSVIEW» son marcas comerciales de Blu-ray Disc Association.



'DVD Video' es una marca comercial de DVD Format/Logo Licensing Corporation.



Java y el resto de marcas comerciales y logotipos de Java son marcas comerciales o marcas comerciales registradas de Sun Microsystems, Inc. en EE. UU. y/ u otros países.

POLIZA DE GARANTÍA

ESTA POLIZA ES GRATUITA

Este aparato ha sido cuidadosamente diseñado y se ha fabricado con los mejores materiales bajo un estricto control de calidad, garantizando su buen funcionamiento por los periodos establecidos según el aparato (ver lista en la parte inferior) a partir de la entrega del aparato al consumidor.

Esta póliza incluye la reparación o reposición gratuita de cualquier parte o componente que eventualmente fallase y la mano de obra necesaria para su reparación, así como los gastos de transportación razonablemente erogados dentro de nuestros centros de servicio, misma que se hará efectiva en cualquiera de nuestros centros de servicio autorizados en el país.

Si su aparato llegase a requerir de nuestro servicio de garantía, acuda al centro de servicio más cercano a su domicilio, de tener alguna duda por favor llame a nuestro CENTRO DE INFORMACIÓN AL CLIENTE LADA sin costo en toda la república al **01 800 504 62 00** en donde con gusto le indicaremos el centro de servicio autorizado más cercano a su domicilio.

P&F MEXICANA S.A. de C.V. a través de sus centros de servicio autorizados reparará y devolverá a usted su aparato en un plazo no mayor a 20 días hábiles, contados a partir de la fecha de ingreso, impresa en la orden de servicio de cualquiera de nuestros centros de servicio autorizados.

La garantía de esta póliza cubre cualquier desperfecto o daño eventualmente ocasionado por los trabajos de reparación y/o traslado del aparato en el interior de nuestros centros de servicio autorizados.

Esta póliza sólo tendrá validez, si está debidamente requisitada, sellada por la casa vendedora, en caso de extravío de esta póliza, podrá hacer efectiva su garantía con la presentación de su factura de compra.

ESTA POLIZA NO SE HARA EFECTIVA EN LOS SIGUIENTES CASOS:

- Cuando el aparato sea utilizado en condiciones distintas a las normales.
- Cuando el aparato no haya sido operado de acuerdo con el instructivo de uso que se le acompaña.
- Cuando la causa de la falla o mal funcionamiento sea consecuencia de una reparación inadecuada o alteración producida por personas no autorizadas por P&F MEXICANA S.A. de C.V.

PERIODOS DE GARANTÍA

12 MESES.- Televisores con y sin reproductor de video digital DVD, reproductores de discos de video digital DVD, reproductores de disco de video digital BLU-RAY, grabadores reproductores de disco de video digital DVD, sistemas de cine en casa.

PHILIPS

MC - 719 - ARCO

P&F MEXICANA, S.A. de C.V.

Producto Importado Por
P & F MEXICANA, S.A. DE C.V.
Av. La Palma No. 6
Col. San Fernando La Herradura
Huixquilucan Edo. De México C.P. 52787
Tel. 52 69 90 00

Producto Comercializado por:
P&F Mexicana, S.A. de C.V.
Av. La Palma No. 6, Col. San Fernando La Herradura,
Huixquilucan Edo. de México C.P. 52787
Tel: 52 (55) 52 69 90 00

Centro de Información al Cliente
LADA SIN COSTO PARA TODA LA REPÚBLICA
01 800 504 62 00
Horario: Lunes a Domingo las 24 hrs.
e-mail: philipsp@tpmex.com



MODELO _____ No. DE SERIE _____
La presente garantía contará a partir de: DÍA _____ MES _____ AÑO _____

En caso que en su producto presente alguna falla, acuda al centro de servicio más cercano a su domicilio (según listado de talleres anexo) y en caso de tener alguna duda o pregunta por favor llame a nuestro Centro de información al Cliente, en donde con gusto le atenderemos en todo lo relativo a:

- Servicio de sus aparatos Philips
- Información de productos y Talleres Autorizados Philips
- Asesoría en el manejo e instalación de su producto Philips
- Información en donde puede adquirir productos y accesorios Philips

Para hacer efectiva la garantía de su producto, es necesario presentar esta póliza debidamente requisitada o de lo contrario, presentar su factura de compra.

CENTROS DE SERVICIO AUTORIZADOS PHILIPS EN LAS PRINCIPALES CIUDADES

CIUDAD	LADA	TELÉFONO	CORREO ELECTRÓNICO	CIUDAD	LADA	TELÉFONO	CORREO ELECTRÓNICO
ACAPULCO, GRO	744	483-32-96	serproa@yahoo.com.mx	MÉXICO, D. F. ZONA NORTE	55	53711250	matriz@tecdata.com.mx
AGUASCALIENTES, AGS	449	915-51-81	jimsaele@hotmail.com	MÉXICO, D. F. ZONA ORIENTE	55	55 44 16 00	cselectromex@hotmail.com
CAMPECHE, CAMP	981	816 25 75	oreza@hotmail.com	MÉXICO, D. F. ZONA PONIENTE	55	58 12 44 12	serviciotv@prodigy.net.mx
CANCÚN, Q ROO.	998	984 18 74	gammacancun@webtelmex.net.mx	MONTERREY, N.L	818	375-16-17 • 400-54-03	mcesa@prodigy.net.mx
PLAYA DEL CARMEN, Q ROO	984	2 67 27 27 • 745 0678	servicioee@prodigy.net.mx	MORELIA, MICH	443	312-03-17	multiservicios_profesionales_de_zamora@msn.com
CD. JUÁREZ, CHIH	656	618-21-28 • 623-46-20	teleservicio@prodigy.net.mx	NEZHUALCOYOTL EDO. MEX	55	57-33-34-98	servialfa@yahoo.com.mx
CD. OBREGÓN, SON	644	412-41-51 • 416-20-93	mena747@prodigy.net.mx	OAXACA, OAX	951	516-47-37	elfrancistor@prodigy.net.mx
CD. VICTORIA, TAMP	834	315-66-03 • 312-51-93	eeii_smiller@yahoo.com.mx	PUERTO ESCONDIDO, OAX	954	582 03 41	estere_electronica@prodigy.net.mx
CUERNAVACA, MOR	777	313-00-49 • 313-90-92	centroserviciohertz@hotmail.com	ORIZABA, VER	272	724 38 53	barreda_electronics@hotmail.com
LOS MOCHIS, SIN	668	8173099	electronica_morelos@hotmail.com	CORDOBA, VER	271	712-73-22	servicio2@prodigy.net.mx
CUILIACÁN, SIN	667	716-15-10	stereovox@clm.megared.net.mx	POZA RICA, VER	782	824 47 82	sonydigital@prodigy.net.mx
CHIHUAHUA, CHIH	614	415-04-43 • 415-04-43	elecmirador@yahoo.com.mx	VERACRUZ, VER	229	932-78-23 • 932-44-44	antza@ver.megared.net.mx
CHILPANCIÑO, GRO.	747	471 72 73	ingelc_gro@hotmail.com	PUEBLA, PUE	222	248-77-64 • 231-63-77	rascon12@prodigy.net.mx
DURANGO, DGO	618	825-00-05	evsurdgo@yahoo.com	QUERÉTARO, QRO	442	216-10-09	zenersaulphilips@yahoo.com.mx
GUADALAJARA, JAL	33	36-15-72-62 • 36-16-83-27	leecom1@hotmail.com	SALTILLO, COAH	844	439 39 64	electronicaadigital_07@hotmail.com
HERMOSILLO, SON	662	210-54-95 • 210-05-86	manuelw@prodigy.net.mx	SAN LUIS POTOSÍ, S.L.P.	444	815-34-07	centro_servicioslp@prodigy.net.mx
IRAPUATO, GTO	462	626-51-10	tv_gase@hotmail.com	TAMPICO, TAMP	833	214 13 60	electromovie@prodigy.net.mx
LA PAZ, B.C.S	612	122-95-99	cenalfa@prodigy.net.mx	MEXICALI, B.C.N	686	561-98-08 • 561-98-18	bajaelectronics@aol.com
LEÓN, GTO	477	770-26-99	tec ESPECIALIZADOS@hotmail.com	TIJUANA, B.C.N	664	621-22-15	egi_tij@yahoo.com
MAZATLÁN, SIN	669	982-42-21	e_santel@hotmail.com	ENSENADA, B.C.N	646	174 0532	woolrich_r@hotmail.com
MÉRIDA, YUC	999	928-59-05	evia2@prodigy.net.mx	TAPALCÁ, EDO. MEX	722	384 1920	radioyotv@hotmail.com
PACHUCA, HGO	771	714-15-81	zarateelc@hotmail.com	TAPACHUALCHIS	962	62 69998	eaysdi@prodigy.net.mx
TEPIC, NAY	311	212-66-93	spe_tn@hotmail.co	TUXTLA GUTIÉRREZ, CHIS	961	615 0872	sshop_25@hotmail.com
MÉXICO D.F. ZONA ARAGÓN	55	57 94 06 34	philipservicio@hotmail.com	URUAPAN, MICH	452	524-08-38 • 524-37-78	rosaliaq@mich1.telmex.net.mx
MÉXICO, D. F. ZONA SUR	55	58 56 75 24 • 26 38 4532	serviciohg@prodigy.net.mx	VILLAHERMOSA, TAB	993	314-31-36 • 314-61-67	villatec@intraser.net.mx
MÉXICO, D. F. ZONA NORTE	55	53 68 30 21	tissaser@prodigy.net.mx	ZACATECAS, ZAC.	492	922 31 63	sertecmur@hotmail.com

Para mayor referencia de Talleres de Servicio Autorizados en otras ciudades comunicarse al 01 800 504 62 00 (lada sin costo)
Este listado puede sufrir actualizaciones o modificaciones sin previo aviso, para mayor información favor de comunicarse al 01 800 504 62 00

Language Code

Abkhazian	6566	Inupiaq	7375	Pushto	8083
Afar	6565	Irish	7165	Russian	8285
Afrikaans	6570	Íslenska	7383	Quechua	8185
Amharic	6577	Italiano	7384	Raeto-Romance	8277
Arabic	6582	Ivrit	7269	Romanian	8279
Armenian	7289	Japanese	7465	Rundi	8278
Assamese	6583	Javanese	7486	Samoan	8377
Avestan	6569	Kalaallisut	7576	Sango	8371
Aymara	6589	Kannada	7578	Sanskrit	8365
Azerhijani	6590	Kashmiri	7583	Sardinian	8367
Bahasa Melayu	7783	Kazakh	7575	Serbian	8382
Bashkir	6665	Kernewek	7587	Shona	8378
Belarusian	6669	Khmer	7577	Shqip	8381
Bengali	6678	Kinyarwanda	8287	Sindhi	8368
Bihari	6672	Kirghiz	7589	Sinhalese	8373
Bislama	6673	Komi	7586	Slovensky	8373
Bokmål, Norwegian	7866	Korean	7579	Slovenian	8376
Bosanski	6683	Kuanyama; Kwanyama	7574	Somali	8379
Brezhoneg	6682	Kurdish	7585	Sotho; Southern	8384
Bulgarian	6671	Lao	7679	South Ndebele	7882
Burmese	7789	Latina	7665	Sundanese	8385
Castellano, Español	6983	Latvian	7686	Suomi	7073
Catalán	6765	Letzeburgesch;	7666	Swahili	8387
Chamorro	6772	Limburgan; Limburger	7673	Swati	8383
Chechen	6769	Lingala	7678	Svenska	8386
Chewa; Chichewa; Nyanja	7889	Lithuanian	7684	Tagalog	8476
中文	9072	Luxembourgish;	7666	Tahitian	8489
Chuang; Zhuang	9065	Macedonian	7775	Tajik	8471
Church Slavic; Slavonic	6785	Malagasy	7771	Tamil	8465
Chuvash	6786	Magyar	7285	Tatar	8484
Corsican	6779	Malayalam	7776	Telugu	8469
Česky	6783	Maltese	7784	Thai	8472
Dansk	6865	Manx	7186	Tibetan	6679
Deutsch	6869	Maori	7773	Tigrinya	8473
Dzongkha	6890	Marathi	7782	Tonga (Tonga Islands)	8479
English	6978	Marshallese	7772	Tsonga	8483
Esperanto	6979	Moldavian	7779	Tswana	8478
Estonian	6984	Mongolian	7778	Türkçe	8482
Euskara	6985	Nauru	7865	Turkmen	8475
Ελληνικά	6976	Navaho; Navajo	7886	Twi	8487
Faroese	7079	Ndebele, North	7868	Uighur	8571
Français	7082	Ndebele, South	7882	Ukrainian	8575
Frysk	7089	Ndonga	7871	Urdu	8582
Fijian	7074	Nederlands	7876	Uzbek	8590
Gaelic; Scottish Gaelic	7168	Nepali	7869	Vietnamese	8673
Gallegan	7176	Norsk	7879	Volapuk	8679
Georgian	7565	Northern Sami	8369	Walloon	8765
Gikuyu; Kikuyu	7573	North Ndebele	7868	Welsh	6789
Guarani	7178	Norwegian Nynorsk;	7878	Wolof	8779
Gujarati	7185	Occitan; Provençal	7967	Xhosa	8872
Hausa	7265	Old Bulgarian; Old Slavonic	6785	Yiddish	8973
Herero	7290	Oriya	7982	Yoruba	8979
Hindi	7273	Oromo	7977	Zulu	9085
Hiri Motu	7279	Ossetian; Ossetic	7983		
Hrvatski	6779	Pali	8073		
Ido	7379	Panjabi	8065		
Interlingua (International)	7365	Persian	7065		
Interlingue	7365	Polski	8076		
Inuktitut	7385	Português	8084		

License Texts and Acknowledgements for any open source software used in this Philips product

Instructions to obtain source code for this software can be found in the user manual, or in the supplied safety leaflet (if available).

1. U-boot

```
#
# (C) Copyright 2000 - 2008
# Wolfgang Denk, DENX Software Engineering, wd@denx.de.
#
# See file CREDITS for list of people who contributed to this
# project.
#
# This program is free software; you can redistribute it and/or
# modify it under the terms of the GNU General Public License as
# published by the Free Software Foundation; either version 2 of
# the License, or (at your option) any later version.
#
# This program is distributed in the hope that it will be useful,
# but WITHOUT ANY WARRANTY; without even the implied warranty of
# MERCHANTABILITY or FITNESS FOR A PARTICULAR PURPOSE. See the
# GNU General Public License for more details.
#
# You should have received a copy of the GNU General Public License
# along with this program; if not, write to the Free Software
# Foundation, Inc., 59 Temple Place, Suite 330, Boston,
# MA 02111-1307 USA
#
A copy of the GPL is included below at item 2.
```

2. Linux kernel

NOTE! This copyright does *not* cover user programs that use kernel services by normal system calls - this is merely considered normal use of the kernel, and does *not* fall under the heading of "derived work". Also note that the GPL below is copyrighted by the Free Software Foundation, but the instance of code that it refers to (the linux kernel) is copyrighted by me and others who actually wrote it. Also note that the only valid version of the GPL as far as the kernel is concerned is `_this_` particular version of the license (ie v2, not v2.2 or v3.x or whatever), unless explicitly otherwise stated.

Linus Torvalds

GNU GENERAL PUBLIC LICENSE

Version 2, June 1991

Copyright (C) 1989, 1991 Free Software Foundation, Inc.
675 Mass Ave, Cambridge, MA 02139, USA

Everyone is permitted to copy and distribute verbatim copies of this license document, but changing it is not allowed.

Preamble

The licenses for most software are designed to take away your freedom to share and change it. By contrast, the GNU General Public License is intended to guarantee your freedom to share and change free software--to make sure the software is free for all its users. This General Public License applies to most of the Free Software Foundation's software and to any other program whose authors commit to using it. (Some other Free Software Foundation software is covered by the GNU Library General Public License instead.) You can apply it to your programs, too.

When we speak of free software, we are referring to freedom, not price. Our General Public Licenses are designed to make sure that you have the freedom to distribute copies of free software (and charge for this service if you wish), that you receive source code or can get it if you want it, that you can change the software or use pieces of it in new free programs; and that you know you can do these things.

To protect your rights, we need to make restrictions that forbid anyone to deny you these rights or to ask you to surrender the rights. These restrictions translate to certain responsibilities for you if you distribute copies of the software, or if you modify it.

For example, if you distribute copies of such a program, whether gratis or for a fee, you must give the recipients all the rights that you have. You must make sure that they, too, receive or can get the source code. And you must show them these terms so they know their rights.

We protect your rights with two steps: (1) copyright the software, and (2) offer you this license which gives you legal permission to copy, distribute and/or modify the software.

Also, for each author's protection and ours, we want to make certain that everyone understands that there is no warranty for this free software. If the software is modified by someone else and passed on, we want its recipients to know that what they have is not the original, so that any problems introduced by others will not reflect on the original authors' reputations.

Finally, any free program is threatened constantly by software patents. We wish to avoid the danger that redistributors of a free program will individually obtain patent licenses, in effect making the program proprietary. To prevent this, we have made it clear that any patent must be licensed for everyone's free use or not licensed at all.

The precise terms and conditions for copying, distribution and modification follow.

GNU GENERAL PUBLIC LICENSE TERMS AND CONDITIONS FOR COPYING, DISTRIBUTION AND MODIFICATION

0. This License applies to any program or other work which contains a notice placed by the copyright holder saying it may be distributed under the terms of this General Public License. The "Program", below, refers to any such program or work, and a "work based on the Program" means either the Program or any derivative work under copyright law: that is to say, a work containing the Program or a portion of it, either verbatim or with modifications and/or translated into another language. (Hereinafter, translation is included without limitation in the term "modification".) Each licensee is addressed as "you".
Activities other than copying, distribution and modification are not covered by this License; they are outside its scope. The act of running the Program is not restricted, and the output from the Program is covered only if its contents constitute a work based on the Program (independent of having been made by running the Program). Whether that is true depends on what the Program does.
1. You may copy and distribute verbatim copies of the Program's source code as you receive it, in any medium, provided that you conspicuously and appropriately publish on each copy an appropriate copyright notice and disclaimer of warranty; keep intact all the notices that refer to this License and to the absence of any warranty; and give any other recipients of the Program a copy of this License along with the Program.
You may charge a fee for the physical act of transferring a copy, and you may at your option offer warranty protection in exchange for a fee.
2. You may modify your copy or copies of the Program or any portion of it, thus forming a work based on the Program, and copy and distribute such modifications or work under the terms of Section 1 above, provided that you also meet all of these conditions:
 - a) You must cause the modified files to carry prominent notices stating that you changed the files and the date of any change.
 - b) You must cause any work that you distribute or publish, that in whole or in part contains or is derived from the Program or any part thereof, to be licensed as a whole at no charge to all third parties under the terms of this License.
 - c) If the modified program normally reads commands interactively when run, you must cause it, when started running for such interactive use in the most ordinary way, to print or display an announcement including an appropriate copyright notice and a notice that there is no warranty (or else, saying that you provide a warranty) and that users may redistribute the program under these conditions, and telling the user how to view a copy of this License. (Exception: if the Program itself is interactive but does not normally print such an announcement, your work based on the Program is not required to print an announcement.)

These requirements apply to the modified work as a whole. If identifiable sections of that work are not derived from the Program, and can be reasonably considered independent and separate works in themselves, then this License, and its terms, do not apply to those sections when you distribute them as separate works. But when you distribute the same sections as part of a whole which is a work based on the Program, the distribution of the whole must be on the terms of this License, whose permissions for other licensees extend to the entire whole, and thus to each and every part regardless of who wrote it.

Thus, it is not the intent of this section to claim rights or contest your rights to work written entirely by you; rather, the intent is to exercise the right to control the distribution of derivative or collective works based on the Program.

In addition, mere aggregation of another work not based on the Program with the Program (or with a work based on the Program) on a volume of a storage or distribution medium does not bring the other work under the scope of this License.

3. You may copy and distribute the Program (or a work based on it, under Section 2) in object code or executable form under the terms of Sections 1 and 2 above provided that you also do one of the following:
 - a) Accompany it with the complete corresponding machine-readable source code, which must be distributed under the terms of Sections 1 and 2 above on a medium customarily used for software interchange; or,
 - b) Accompany it with a written offer, valid for at least three years, to give any third party, for a charge no more than your cost of physically performing source distribution, a complete machine-readable copy of the corresponding source code, to be distributed under the terms of Sections 1 and 2 above on a medium customarily used for software interchange; or,
 - c) Accompany it with the information you received as to the offer to distribute corresponding source code. (This alternative is allowed only for noncommercial distribution and only if you received the program in object code or executable form with such an offer, in accord with Subsection b above.)

The source code for a work means the preferred form of the work for making modifications to it. For an executable work, complete source code means all the source code for all modules it contains, plus any associated interface definition files, plus the scripts used to control compilation and installation of the executable. However, as a special exception, the source code distributed need not include anything that is normally distributed (in either source or binary form) with the major components (compiler, kernel, and so on) of the operating system on which the executable runs, unless that component itself accompanies the executable.

If distribution of executable or object code is made by offering access to copy from a designated place, then offering equivalent access to copy the source code from the same place counts as distribution of the source code, even though third parties are not compelled to copy the source along with the object code.

4. You may not copy, modify, sublicense, or distribute the Program except as expressly provided under this License. Any attempt otherwise to copy, modify, sublicense or distribute the Program is void, and will automatically terminate your rights under this License. However, parties who have received copies, or rights, from you under this License will not have their licenses terminated so long as such parties remain in full compliance.
5. You are not required to accept this License, since you have not signed it. However, nothing else grants you permission to modify or distribute the Program or its derivative works. These actions are prohibited by law if you do not accept this License. Therefore, by modifying or distributing the Program (or any work based on the Program), you indicate your acceptance of this License to do so, and all its terms and conditions for copying, distributing or modifying the Program or works based on it.
6. Each time you redistribute the Program (or any work based on the Program), the recipient automatically receives a license from the original licensor to copy, distribute or modify the Program subject to these terms and conditions. You may not impose any further restrictions on the recipients' exercise of the rights granted herein. You are not responsible for enforcing compliance by third parties to this License.
7. If, as a consequence of a court judgment or allegation of patent infringement or for any other reason (not limited to patent issues), conditions are imposed on you (whether by court order, agreement or otherwise) that contradict the conditions of this License, they do not excuse you from the conditions of this License. If you cannot distribute so as to satisfy simultaneously your obligations under this License and any other pertinent obligations, then as a consequence you may not distribute the Program at all. For example, if a patent license would not permit royalty-free redistribution of the Program by all those who receive copies directly or indirectly through you, then the only way you could satisfy both it and this License would be to refrain entirely from distribution of the Program.

If any portion of this section is held invalid or unenforceable under any particular circumstance, the balance of the section is intended to apply and the section as a whole is intended to apply in other circumstances.

It is not the purpose of this section to induce you to infringe any patents or other property right claims or to contest validity of any such claims; this section has the sole purpose of protecting the integrity of the free software distribution system, which is implemented by public license practices. Many people have made generous contributions to the wide range of software distributed through that system in reliance on consistent application of that system; it is up to the author/donor to decide if he or she is willing to distribute software through any other system and a licensee cannot impose that choice.

This section is intended to make thoroughly clear what is believed to be a consequence of the rest of this License.

8. If the distribution and/or use of the Program is restricted in certain countries either by patents or by copyrighted interfaces, the original copyright holder who places the Program under this License may add an explicit geographical distribution limitation excluding those countries, so that distribution is permitted only in or among countries not thus excluded. In such case, this License incorporates the limitation as if written in the body of this License.
9. The Free Software Foundation may publish revised and/or new versions of the General Public License from time to time. Such new versions will be similar in spirit to the present version, but may differ in detail to address new problems or concerns.

Each version is given a distinguishing version number. If the Program specifies a version number of this License which applies to it and "any later version", you have the option of following the terms and conditions either of that version or of any later version published by the Free Software Foundation. If the Program does not specify a version number of this License, you may choose any version ever published by the Free Software Foundation.

10. If you wish to incorporate parts of the Program into other free programs whose distribution conditions are different, write to the author to ask for permission. For software which is copyrighted by the Free Software Foundation, write to the Free Software Foundation; we sometimes make exceptions for this. Our decision will be guided by the two goals of preserving the free status of all derivatives of our free software and of promoting the sharing and reuse of software generally.

NO WARRANTY

11. BECAUSE THE PROGRAM IS LICENSED FREE OF CHARGE, THERE IS NO WARRANTY FOR THE PROGRAM, TO THE EXTENT PERMITTED BY APPLICABLE LAW. EXCEPT WHEN OTHERWISE STATED IN WRITING THE COPYRIGHT HOLDERS AND/OR OTHER PARTIES PROVIDE THE PROGRAM "AS IS" WITHOUT WARRANTY OF ANY KIND, EITHER EXPRESSED OR IMPLIED, INCLUDING, BUT NOT LIMITED TO, THE IMPLIED WARRANTIES OF MERCHANTABILITY AND FITNESS FOR A PARTICULAR PURPOSE. THE ENTIRE RISK AS TO THE QUALITY AND PERFORMANCE OF THE PROGRAM IS WITH YOU. SHOULD THE PROGRAM PROVE DEFECTIVE, YOU ASSUME THE COST OF ALL NECESSARY SERVICING, REPAIR OR CORRECTION.
12. IN NO EVENT UNLESS REQUIRED BY APPLICABLE LAW OR AGREED TO IN WRITING WILL ANY COPYRIGHT HOLDER, OR ANY OTHER PARTY WHO MAY MODIFY AND/OR REDISTRIBUTE THE PROGRAM AS PERMITTED ABOVE, BE LIABLE TO YOU FOR DAMAGES, INCLUDING ANY GENERAL, SPECIAL, INCIDENTAL OR CONSEQUENTIAL DAMAGES ARISING OUT OF THE USE OR INABILITY TO USE THE PROGRAM (INCLUDING BUT NOT LIMITED TO LOSS OF DATA OR DATA BEING RENDERED INACCURATE OR LOSSES SUSTAINED BY YOU OR THIRD PARTIES OR A FAILURE OF THE PROGRAM TO OPERATE WITH ANY OTHER PROGRAMS), EVEN IF SUCH HOLDER OR OTHER PARTY HAS BEEN ADVISED OF THE POSSIBILITY OF SUCH DAMAGES.

END OF TERMS AND CONDITIONS

Appendix: How to Apply These Terms to Your New Programs

If you develop a new program, and you want it to be of the greatest possible use to the public, the best way to achieve this is to make it free software which everyone can redistribute and change under these terms.

To do so, attach the following notices to the program. It is safest to attach them to the start of each source file to most effectively convey the exclusion of warranty; and each file should have at least the "copyright" line and a pointer to where the full notice is found.

<one line to give the program's name and a brief idea of what it does.>
Copyright (C) 19yy <name of author>

This program is free software; you can redistribute it and/or modify it under the terms of the GNU General Public License as published by the Free Software Foundation; either version 2 of the License, or (at your option) any later version.

This program is distributed in the hope that it will be useful, but WITHOUT ANY WARRANTY; without even the implied warranty of MERCHANTABILITY or FITNESS FOR A PARTICULAR PURPOSE. See the GNU General Public License for more details.

You should have received a copy of the GNU General Public License along with this program; if not, write to the Free Software Foundation, Inc., 675 Mass Ave, Cambridge, MA 02139, USA.

Also add information on how to contact you by electronic and paper mail.

If the program is interactive, make it output a short notice like this when it starts in an interactive mode:

```
Gnomovision version 69, Copyright (C) 19yy name of author
```

```
Gnomovision comes with ABSOLUTELY NO WARRANTY; for details type `show w`.
```

```
This is free software, and you are welcome to redistribute it under certain conditions; type `show c` for details.
```

The hypothetical commands `show w` and `show c` should show the appropriate parts of the General Public License. Of course, the commands you use may be called something other than `show w` and `show c`; they could even be mouse-clicks or menu items--whatever suits your program.

You should also get your employer (if you work as a programmer) or your school, if any, to sign a "copyright disclaimer" for the program, if necessary. Here is a sample; alter the names:

Yoyodyne, Inc., hereby disclaims all copyright interest in the program `Gnomovision' (which makes passes at compilers) written by James Hacker:

```
<signature of Ty Coon>, 1 April 1989
```

```
Ty Coon, President of Vice
```

This General Public License does not permit incorporating your program into proprietary programs. If your program is a subroutine library, you may consider it more useful to permit linking proprietary applications with the library. If this is what you want to do, use the GNU Library General Public License instead of this License.

3. Busybox, the Linux IR control package, SquashFS and mtd-utils

Busybox, the Linux IR control package, SquashFS and mtd-utils are subject to the GPL, a copy of which is included at item 2.

4. DirectFB, glibc, libusb-compat and libusb

DirectFB, glibc, libusb-compat and libusb are subject to the following license:

GNU LESSER GENERAL PUBLIC LICENSE
Version 2.1, February 1999

Copyright (C) 1991, 1999 Free Software Foundation, Inc.

59 Temple Place, Suite 330, Boston, MA 02111-1307 USA

Everyone is permitted to copy and distribute verbatim copies of this license document, but changing it is not allowed.

[This is the first released version of the Lesser GPL. It also counts as the successor of the GNU Library Public License, version 2; hence the version number 2.1.]

Preamble

The licenses for most software are designed to take away your freedom to share and change it. By contrast, the GNU General Public Licenses are intended to guarantee your freedom to share and change free software--to make sure the software is free for all its users.

This license, the Lesser General Public License, applies to some specially designated software packages--typically libraries--of the Free Software Foundation and other authors who decide to use it. You can use it too, but we suggest you first think carefully about whether this license or the ordinary General Public License is the better strategy to use in any particular case, based on the explanations below.

When we speak of free software, we are referring to freedom of use, not price. Our General Public Licenses are designed to make sure that you have the freedom to distribute copies of free software (and charge for this service if you wish); that you receive source code or can get it if you want it; that you can change the software and use pieces of it in new free programs; and that you are informed that you can do these things.

To protect your rights, we need to make restrictions that forbid distributors to deny you these rights or to ask you to surrender these rights. These restrictions translate to certain responsibilities for you if you distribute copies of the library or if you modify it.

For example, if you distribute copies of the library, whether gratis or for a fee, you must give the recipients all the rights that we gave you. You must make sure that they, too, receive or can get the source code. If you link other code with the library, you must provide complete object files to the recipients, so that they can relink them with the library after making changes to the library and recompiling it. And you must show them these terms so they know their rights.

We protect your rights with a two-step method: (1) we copyright the library, and (2) we offer you this license, which gives you legal permission to copy, distribute and/or modify the library.

To protect each distributor, we want to make it very clear that there is no warranty for the free library. Also, if the library is modified by someone else and passed on, the recipients should know that what they have is not the original version, so that the original author's reputation will not be affected by problems that might be introduced by others.

Finally, software patents pose a constant threat to the existence of any free program. We wish to make sure that a company cannot effectively restrict the users of a free program by obtaining a restrictive license from a patent holder. Therefore, we insist that any patent license obtained for a version of the library must be consistent with the full freedom of use specified in this license.

Most GNU software, including some libraries, is covered by the ordinary GNU General Public License. This license, the GNU Lesser General Public License, applies to certain designated libraries, and is quite different from the ordinary General Public License. We use this license for certain libraries in order to permit linking those libraries into non-free programs.

When a program is linked with a library, whether statically or using a shared library, the combination of the two is legally speaking a combined work, a derivative of the original library. The ordinary General Public License therefore permits such linking only if the entire combination fits its criteria of freedom. The Lesser General Public License permits more lax criteria for linking other code with the library.

We call this license the "Lesser" General Public License because it does Less to protect the user's freedom than the ordinary General Public License. It also provides other free software developers Less of an advantage over competing non-free programs. These disadvantages are the reason we use the ordinary General Public License for many libraries. However, the Lesser license provides advantages in certain special circumstances.

For example, on rare occasions, there may be a special need to encourage the widest possible use of a certain library, so that it becomes a de-facto standard. To achieve this, non-free programs must be allowed to use the library. A more frequent case is that a free library does the same job as widely used non-free libraries. In this case, there is little to gain by limiting the free library to free software only, so we use the Lesser General Public License.

In other cases, permission to use a particular library in non-free programs enables a greater number of people to use a large body of free software. For example, permission to use the GNU C Library in non-free programs enables many more people to use the whole GNU operating system, as well as its variant, the GNU/Linux operating system.

Although the Lesser General Public License is Less protective of the users' freedom, it does ensure that the user of a program that is linked with the Library has the freedom and the wherewithal to run that program using a modified version of the Library.

The precise terms and conditions for copying, distribution and modification follow. Pay close attention to the difference between a "work based on the library" and a "work that uses the library". The former contains code derived from the library, whereas the latter must be combined with the library in order to run.

GNU LESSER GENERAL PUBLIC LICENSE

TERMS AND CONDITIONS FOR COPYING, DISTRIBUTION AND MODIFICATION

0. This License Agreement applies to any software library or other program which contains a notice placed by the copyright holder or other authorized party saying it may be distributed under the terms of this Lesser General Public License (also called "this License").

Each licensee is addressed as "you".

A "library" means a collection of software functions and/or data prepared so as to be conveniently linked with application programs (which use some of those functions and data) to form executables.

The "Library", below, refers to any such software library or work which has been distributed under these terms. A "work based on the Library" means either the Library or any derivative work under copyright law: that is to say, a work containing the Library or a portion of it, either verbatim or with modifications and/or translated straightforwardly into another language. (Hereinafter, translation is included without limitation in the term "modification".)

"Source code" for a work means the preferred form of the work for making modifications to it. For a library, complete source code means all the source code for all modules it contains, plus any associated interface definition files, plus the scripts used to control compilation and installation of the library.

Activities other than copying, distribution and modification are not covered by this License; they are outside its scope. The act of running a program using the Library is not restricted, and output from such a program is covered only if its contents constitute a work based on the Library (independent of the use of the Library in a tool for writing it). Whether that is true depends on what the Library does and what the program that uses the Library does.

1. You may copy and distribute verbatim copies of the Library's complete source code as you receive it, in any medium, provided that you conspicuously and appropriately publish on each copy an appropriate copyright notice and disclaimer of warranty; keep intact all the notices that refer to this License and to the absence of any warranty; and distribute a copy of this License along with the Library.

You may charge a fee for the physical act of transferring a copy, and you may at your option offer warranty protection in exchange for a fee.

2. You may modify your copy or copies of the Library or any portion of it, thus forming a work based on the Library, and copy and distribute such modifications or work under the terms of Section 1 above, provided that you also meet all of these conditions:
 - a) The modified work must itself be a software library.
 - b) You must cause the files modified to carry prominent notices stating that you changed the files and the date of any change.
 - c) You must cause the whole of the work to be licensed at no charge to all third parties under the terms of this License.
 - d) If a facility in the modified Library refers to a function or a table of data to be supplied by an application program that uses the facility, other than as an argument passed when the facility is invoked, then you must make a good faith effort to ensure that, in the event an application does not supply such function or table, the facility still operates, and performs whatever part of its purpose remains meaningful.
(For example, a function in a library to compute square roots has a purpose that is entirely well-defined independent of the application. Therefore, Subsection 2d requires that any application-supplied function or table used by this function must be optional: if the application does not supply it, the square root function must still compute square roots.)

These requirements apply to the modified work as a whole. If identifiable sections of that work are not derived from the Library, and can be reasonably considered independent and separate works in themselves, then this License, and its terms, do not apply to those sections when you distribute them as separate works. But when you distribute the same sections as part of a whole which is a work based on the Library, the distribution of the whole must be on the terms of this License, whose permissions for other licensees extend to the entire whole, and thus to each and every part regardless of who wrote it.

Thus, it is not the intent of this section to claim rights or contest your rights to work written entirely by you; rather, the intent is to exercise the right to control the distribution of derivative or collective works based on the Library.

In addition, mere aggregation of another work not based on the Library with the Library (or with a work based on the Library) on a volume of a storage or distribution medium does not bring the other work under the scope of this License.

3. You may opt to apply the terms of the ordinary GNU General Public License instead of this License to a given copy of the Library. To do this, you must alter all the notices that refer to this License, so that they refer to the ordinary GNU General Public License, version 2, instead of to this License. (If a newer version than version 2 of the ordinary GNU General Public License has appeared, then you can specify that version instead if you wish.) Do not make any other change in these notices.

Once this change is made in a given copy, it is irreversible for that copy, so the ordinary GNU General Public License applies to all subsequent copies and derivative works made from that copy.

This option is useful when you wish to copy part of the code of the Library into a program that is not a library.

4. You may copy and distribute the Library (or a portion or derivative of it, under Section 2) in object code or executable form under the terms of Sections 1 and 2 above provided that you accompany it with the complete corresponding machine-readable source code, which must be distributed under the terms of Sections 1 and 2 above on a medium customarily used for software interchange.

If distribution of object code is made by offering access to copy from a designated place, then offering equivalent access to copy the source code from the same place satisfies the requirement to distribute the source code, even though third parties are not compelled to copy the source along with the object code.

5. A program that contains no derivative of any portion of the Library, but is designed to work with the Library by being compiled or linked with it, is called a "work that uses the Library". Such a work, in isolation, is not a derivative work of the Library, and therefore falls outside the scope of this License.

However, linking a "work that uses the Library" with the Library creates an executable that is a derivative of the Library (because it contains portions of the Library), rather than a "work that uses the library". The executable is therefore covered by this License.

Section 6 states terms for distribution of such executables.

When a "work that uses the Library" uses material from a header file that is part of the Library, the object code for the work may be a derivative work of the Library even though the source code is not.

Whether this is true is especially significant if the work can be linked without the Library, or if the work is itself a library. The threshold for this to be true is not precisely defined by law.

If such an object file uses only numerical parameters, data structure layouts and accessors, and small macros and small inline functions (ten lines or less in length), then the use of the object file is unrestricted, regardless of whether it is legally a derivative work. (Executables containing this object code plus portions of the Library will still fall under Section 6.)

Otherwise, if the work is a derivative of the Library, you may distribute the object code for the work under the terms of Section 6.

Any executables containing that work also fall under Section 6, whether or not they are linked directly with the Library itself.

6. As an exception to the Sections above, you may also combine or link a "work that uses the Library" with the Library to produce a work containing portions of the Library, and distribute that work under terms of your choice, provided that the terms permit modification of the work for the customer's own use and reverse engineering for debugging such modifications.

You must give prominent notice with each copy of the work that the Library is used in it and that the Library and its use are covered by this License. You must supply a copy of this License. If the work during execution displays copyright notices, you must include the copyright notice for the Library among them, as well as a reference directing the user to the copy of this License. Also, you must do one of these things:

- a) Accompany the work with the complete corresponding machine-readable source code for the Library including whatever changes were used in the work (which must be distributed under Sections 1 and 2 above); and, if the work is an executable linked with the Library, with the complete machine-readable "work that uses the Library", as object code and/or source code, so that the user can modify the Library and then relink to produce a modified executable containing the modified Library. (It is understood that the user who changes the contents of definitions files in the Library will not necessarily be able to recompile the application to use the modified definitions.)
- b) Use a suitable shared library mechanism for linking with the Library. A suitable mechanism is one that (1) uses at run time a copy of the library already present on the user's computer system, rather than copying library functions into the executable, and (2) will operate properly with a modified version of the library, if the user installs one, as long as the modified version is interface-compatible with the version that the work was made with.
- c) Accompany the work with a written offer, valid for at least three years, to give the same user the materials specified in Subsection 6a, above, for a charge no more than the cost of performing this distribution.
- d) If distribution of the work is made by offering access to copy from a designated place, offer equivalent access to copy the above specified materials from the same place.
- e) Verify that the user has already received a copy of these materials or that you have already sent this user a copy.

For an executable, the required form of the "work that uses the library" must include any data and utility programs needed for reproducing the executable from it. However, as a special exception, the materials to be distributed need not include anything that is normally distributed (in either source or binary form) with the major components (compiler, kernel, and so on) of the operating system on which the executable runs, unless that component itself accompanies the executable.

It may happen that this requirement contradicts the license restrictions of other proprietary libraries that do not normally accompany the operating system. Such a contradiction means you cannot use both them and the Library together in an executable that you distribute.

7. You may place library facilities that are a work based on the Library side-by-side in a single library together with other library facilities not covered by this License, and distribute such a combined library, provided that the separate distribution of the work based on the Library and of the other library facilities is otherwise permitted, and provided that you do these two things:
 - a) Accompany the combined library with a copy of the same work based on the Library, uncombined with any other library facilities. This must be distributed under the terms of the Sections above.
 - b) Give prominent notice with the combined library of the fact that part of it is a work based on the Library, and explaining where to find the accompanying uncombined form of the same work.

8. You may not copy, modify, sublicense, link with, or distribute the Library except as expressly provided under this License. Any attempt otherwise to copy, modify, sublicense, link with, or distribute the Library is void, and will automatically terminate your rights under this License. However, parties who have received copies, or rights, from you under this License will not have their licenses terminated so long as such parties remain in full compliance.
9. You are not required to accept this License, since you have not signed it. However, nothing else grants you permission to modify or distribute the Library or its derivative works. These actions are prohibited by law if you do not accept this License. Therefore, by modifying or distributing the Library (or any work based on the Library), you indicate your acceptance of this License to do so, and all its terms and conditions for copying, distributing or modifying the Library or works based on it.
10. Each time you redistribute the Library (or any work based on the Library), the recipient automatically receives a license from the original licensor to copy, distribute, link with or modify the Library subject to these terms and conditions. You may not impose any further restrictions on the recipients' exercise of the rights granted herein.

You are not responsible for enforcing compliance by third parties with this License.

11. If, as a consequence of a court judgment or allegation of patent infringement or for any other reason (not limited to patent issues), conditions are imposed on you (whether by court order, agreement or otherwise) that contradict the conditions of this License, they do not excuse you from the conditions of this License. If you cannot distribute so as to satisfy simultaneously your obligations under this License and any other pertinent obligations, then as a consequence you may not distribute the Library at all. For example, if a patent license would not permit royalty-free redistribution of the Library by all those who receive copies directly or indirectly through you, then the only way you could satisfy both it and this License would be to refrain entirely from distribution of the Library.

If any portion of this section is held invalid or unenforceable under any particular circumstance, the balance of the section is intended to apply, and the section as a whole is intended to apply in other circumstances.

It is not the purpose of this section to induce you to infringe any patents or other property right claims or to contest validity of any such claims; this section has the sole purpose of protecting the integrity of the free software distribution system which is implemented by public license practices. Many people have made generous contributions to the wide range of software distributed through that system in reliance on consistent application of that system; it is up to the author/donor to decide if he or she is willing to distribute software through any other system and a licensee cannot impose that choice.

This section is intended to make thoroughly clear what is believed to be a consequence of the rest of this License.

12. If the distribution and/or use of the Library is restricted in certain countries either by patents or by copyrighted interfaces, the original copyright holder who places the Library under this License may add an explicit geographical distribution limitation excluding those countries, so that distribution is permitted only in or among countries not thus excluded. In such case, this License incorporates the limitation as if written in the body of this License.
13. The Free Software Foundation may publish revised and/or new versions of the Lesser General Public License from time to time. Such new versions will be similar in spirit to the present version, but may differ in detail to address new problems or concerns.

Each version is given a distinguishing version number. If the Library specifies a version number of this License which applies to it and "any later version", you have the option of following the terms and conditions either of that version or of any later version published by the Free Software Foundation. If the Library does not specify a license version number, you may choose any version ever published by the Free Software Foundation.

14. If you wish to incorporate parts of the Library into other free programs whose distribution conditions are incompatible with these, write to the author to ask for permission. For software which is copyrighted by the Free Software Foundation, write to the Free Software Foundation; we sometimes make exceptions for this. Our decision will be guided by the two goals of preserving the free status of all derivatives of our free software and of promoting the sharing and reuse of software generally.

NO WARRANTY

15. BECAUSE THE LIBRARY IS LICENSED FREE OF CHARGE, THERE IS NO WARRANTY FOR THE LIBRARY, TO THE EXTENT PERMITTED BY APPLICABLE LAW. EXCEPT WHEN OTHERWISE STATED IN WRITING THE COPYRIGHT HOLDERS AND/OR OTHER PARTIES PROVIDE THE LIBRARY "AS IS" WITHOUT WARRANTY OF ANY KIND, EITHER EXPRESSED OR IMPLIED, INCLUDING, BUT NOT LIMITED TO, THE IMPLIED WARRANTIES OF MERCHANTABILITY AND FITNESS FOR A PARTICULAR PURPOSE. THE ENTIRE RISK AS TO THE QUALITY AND PERFORMANCE OF THE LIBRARY IS WITH

YOU. SHOULD THE LIBRARY PROVE DEFECTIVE, YOU ASSUME THE COST OF ALL NECESSARY SERVICING, REPAIR OR CORRECTION.

16. IN NO EVENT UNLESS REQUIRED BY APPLICABLE LAW OR AGREED TO IN WRITING WILL ANY COPYRIGHT HOLDER, OR ANY OTHER PARTY WHO MAY MODIFY AND/OR REDISTRIBUTE THE LIBRARY AS PERMITTED ABOVE, BE LIABLE TO YOU FOR DAMAGES, INCLUDING ANY GENERAL, SPECIAL, INCIDENTAL OR CONSEQUENTIAL DAMAGES ARISING OUT OF THE USE OR INABILITY TO USE THE LIBRARY (INCLUDING BUT NOT LIMITED TO LOSS OF DATA OR DATA BEING RENDERED INACCURATE OR LOSSES SUSTAINED BY YOU OR THIRD PARTIES OR A FAILURE OF THE LIBRARY TO OPERATE WITH ANY OTHER SOFTWARE), EVEN IF SUCH HOLDER OR OTHER PARTY HAS BEEN ADVISED OF THE POSSIBILITY OF SUCH DAMAGES.

END OF TERMS AND CONDITIONS

How to Apply These Terms to Your New Libraries

If you develop a new library, and you want it to be of the greatest possible use to the public, we recommend making it free software that everyone can redistribute and change. You can do so by permitting redistribution under these terms (or, alternatively, under the terms of the ordinary General Public License).

To apply these terms, attach the following notices to the library. It is safest to attach them to the start of each source file to most effectively convey the exclusion of warranty; and each file should have at least the "copyright" line and a pointer to where the full notice is found.

<one line to give the library's name and a brief idea of what it does.>

Copyright (C) <year> <name of author>

This library is free software; you can redistribute it and/or modify it under the terms of the GNU Lesser General Public License as published by the Free Software Foundation; either version 2.1 of the License, or (at your option) any later version.

This library is distributed in the hope that it will be useful, but WITHOUT ANY WARRANTY; without even the implied warranty of MERCHANTABILITY or FITNESS FOR A PARTICULAR PURPOSE. See the GNU Lesser General Public License for more details.

You should have received a copy of the GNU Lesser General Public License along with this library; if not, write to the Free Software Foundation, Inc., 59 Temple Place, Suite 330, Boston, MA 02111-1307 USA

Also add information on how to contact you by electronic and paper mail.

You should also get your employer (if you work as a programmer) or your school, if any, to sign a "copyright disclaimer" for the library, if necessary. Here is a sample; alter the names:

Yoyodyne, Inc., hereby disclaims all copyright interest in the library 'Frob' (a library for tweaking knobs) written by James Random Hacker.

<signature of Ty Coon>, 1 April 1990

Ty Coon, President of Vice

That's all there is to it!

5. IJG: JPEG software decoder

The authors make NO WARRANTY or representation, either express or implied, with respect to this software, its quality, accuracy, merchantability, or fitness for a particular purpose. This software is provided "AS IS", and you, its user, assume the entire risk as to its quality and accuracy.

This software is copyright (C) 1991-1998, Thomas G. Lane.

All Rights Reserved except as specified below.

Permission is hereby granted to use, copy, modify, and distribute this software (or portions thereof) for any purpose, without fee, subject to these conditions:

- (1) If any part of the source code for this software is distributed, then this README file must be included, with this copyright and no-warranty notice unaltered; and any additions, deletions, or changes to the original files must be clearly indicated in accompanying documentation.
- (2) If only executable code is distributed, then the accompanying documentation must state that "this software is based in part on the work of the Independent JPEG Group".
- (3) Permission for use of this software is granted only if the user accepts full responsibility for any undesirable consequences; the authors accept NO LIABILITY for damages of any kind.

6. WPA Supplicant

Copyright (c) 2003-2009, Jouni Malinen <j@w1.fi> and contributors
All Rights Reserved.

Redistribution and use in source and binary forms, with or without modification, are permitted provided that the following conditions are met:

1. Redistributions of source code must retain the above copyright notice, this list of conditions and the following disclaimer.
2. Redistributions in binary form must reproduce the above copyright notice, this list of conditions and the following disclaimer in the documentation and/or other materials provided with the distribution.
3. Neither the name(s) of the above-listed copyright holder(s) nor the names of its contributors may be used to endorse or promote products derived from this software without specific prior written permission.

THIS SOFTWARE IS PROVIDED BY THE COPYRIGHT HOLDERS AND CONTRIBUTORS "AS IS" AND ANY EXPRESS OR IMPLIED WARRANTIES, INCLUDING, BUT NOT LIMITED TO, THE IMPLIED WARRANTIES OF MERCHANTABILITY AND FITNESS FOR A PARTICULAR PURPOSE ARE DISCLAIMED. IN NO EVENT SHALL THE COPYRIGHT OWNER OR CONTRIBUTORS BE LIABLE FOR ANY DIRECT, INDIRECT, INCIDENTAL, SPECIAL, EXEMPLARY, OR CONSEQUENTIAL DAMAGES (INCLUDING, BUT NOT LIMITED TO, PROCUREMENT OF SUBSTITUTE GOODS OR SERVICES; LOSS OF USE, DATA, OR PROFITS; OR BUSINESS INTERRUPTION) HOWEVER CAUSED AND ON ANY THEORY OF LIABILITY, WHETHER IN CONTRACT, STRICT LIABILITY, OR TORT (INCLUDING NEGLIGENCE OR OTHERWISE) ARISING IN ANY WAY OUT OF THE USE OF THIS SOFTWARE, EVEN IF ADVISED OF THE POSSIBILITY OF SUCH DAMAGE.

7. Unicode Bidirectional Algorithm

For the general privacy policy governing access to this site, see the Unicode Privacy Policy. For trademark usage, see the Unicode Consortium® Trademarks and Logo Policy.

Notice to End User: Terms of Use

Carefully read the following legal agreement ("Agreement"). Use or copying of the software and/or codes provided with this agreement (The "Software") constitutes your acceptance of these terms

Unicode Copyright.

Copyright © 1991-2009 Unicode, Inc. All rights reserved.

Certain documents and files on this website contain a legend indicating that "Modification is permitted." Any person is hereby authorized, without fee, to modify such documents and files to create derivative works conforming to the Unicode® Standard, subject to Terms and Conditions herein.

Any person is hereby authorized, without fee, to view, use, reproduce, and distribute all documents and files solely for informational purposes in the creation of products supporting the Unicode Standard, subject to the Terms and Conditions herein.

Further specifications of rights and restrictions pertaining to the use of the particular set of data files known as the "Unicode Character Database" can be found in Exhibit 1.

Each version of the Unicode Standard has further specifications of rights and restrictions of use. For the book editions, these are found on the back of the title page. For the online edition, certain files (such as the PDF files for book chapters and code charts) carry specific restrictions. All other files are covered under these general Terms of Use. To request a permission to reproduce any part of the Unicode Standard, please contact the Unicode Consortium.

No license is granted to "mirror" the Unicode website where a fee is charged for access to the "mirror" site.

Modification is not permitted with respect to this document. All copies of this document must be verbatim.

Restricted Rights Legend. Any technical data or software which is licensed to the United States of America, its agencies and/or instrumentalities under this Agreement is commercial technical data or commercial computer software developed exclusively at private expense as defined in FAR 2.101, or DFARS 252.227-7014 (June 1995), as applicable. For technical data, use, duplication, or disclosure by the Government is subject to restrictions as set forth in DFARS 202.227-7015 Technical Data, Commercial and Items (Nov 1995) and this Agreement. For Software, in accordance with FAR 12-212 or DFARS 227-7202, as applicable, use, duplication or disclosure by the Government is subject to the restrictions set forth in this Agreement.

Warranties and Disclaimers.

This publication and/or website may include technical or typographical errors or other inaccuracies. Changes are periodically added to the information herein; these changes will be incorporated in new editions of

the publication and/or website. Unicode may make improvements and/or changes in the product(s) and/or program(s) described in this publication and/or website at any time.

If this file has been purchased on magnetic or optical media from Unicode, Inc. the sole and exclusive remedy for any claim will be exchange of the defective media within ninety (90) days of original purchase.

EXCEPT AS PROVIDED IN SECTION C.2, THIS PUBLICATION AND/OR SOFTWARE IS PROVIDED "AS IS" WITHOUT WARRANTY OF ANY KIND EITHER EXPRESS, IMPLIED, OR STATUTORY, INCLUDING, BUT NOT LIMITED TO, ANY WARRANTIES OF MERCHANTABILITY, FITNESS FOR A PARTICULAR PURPOSE, OR NON-INFRINGEMENT. UNICODE AND ITS LICENSORS ASSUME NO RESPONSIBILITY FOR ERRORS OR OMISSIONS IN THIS PUBLICATION AND/OR SOFTWARE OR OTHER DOCUMENTS WHICH ARE REFERENCED BY OR LINKED TO THIS PUBLICATION OR THE UNICODE WEBSITE.

Waiver of Damages. In no event shall Unicode or its licensors be liable for any special, incidental, indirect or consequential damages of any kind, or any damages whatsoever, whether or not Unicode was advised of the possibility of the damage, including, without limitation, those resulting from the following: loss of use, data or profits, in connection with the use, modification or distribution of this information or its derivatives.

Trademarks.

Unicode and the Unicode logo are registered trademarks of Unicode, Inc.

This site contains product names and corporate names of other companies. All product names and company names and logos mentioned herein are the trademarks or registered trademarks of their respective owners. Other products and corporate names mentioned herein which are trademarks of a third party are used only for explanation and for the owners' benefit and with no intent to infringe.

Use of third party products or information referred to herein is at the user's risk.

Miscellaneous.

Jurisdiction and Venue. This server is operated from a location in the State of California, United States of America. Unicode makes no representation that the materials are appropriate for use in other locations. If you access this server from other locations, you are responsible for compliance with local laws. This Agreement, all use of this site and any claims and damages resulting from use of this site are governed solely by the laws of the State of California without regard to any principles which would apply the laws of a different jurisdiction. The user agrees that any disputes regarding this site shall be resolved solely in the courts located in Santa Clara County, California. The user agrees said courts have personal jurisdiction and agree to waive any right to transfer the dispute to any other forum.

Modification by Unicode Unicode shall have the right to modify this Agreement at any time by posting it to this site. The user may not assign any part of this Agreement without Unicode's prior written consent.

Taxes. The user agrees to pay any taxes arising from access to this website or use of the information herein, except for those based on Unicode's net income.

Severability. If any provision of this Agreement is declared invalid or unenforceable, the remaining provisions of this Agreement shall remain in effect.

Entire Agreement. This Agreement constitutes the entire agreement between the parties.

EXHIBIT 1

UNICODE, INC. LICENSE AGREEMENT - DATA FILES AND SOFTWARE

Unicode Data Files include all data files under the directories <http://www.unicode.org/Public/>, <http://www.unicode.org/reports/>, and <http://www.unicode.org/cldr/data/>. Unicode Software includes any source code published in the Unicode Standard or under the directories <http://www.unicode.org/Public/>, <http://www.unicode.org/reports/>, and <http://www.unicode.org/cldr/data/>.

NOTICE TO USER: Carefully read the following legal agreement. BY DOWNLOADING, INSTALLING, COPYING OR OTHERWISE USING UNICODE INC.'S DATA FILES ("DATA FILES"), AND/OR SOFTWARE ("SOFTWARE"), YOU UNEQUIVOCALLY ACCEPT, AND AGREE TO BE BOUND BY, ALL OF THE TERMS AND CONDITIONS OF THIS AGREEMENT. IF YOU DO NOT AGREE, DO NOT DOWNLOAD, INSTALL, COPY, DISTRIBUTE OR USE THE DATA FILES OR SOFTWARE.

COPYRIGHT AND PERMISSION NOTICE

Copyright © 1991-2009 Unicode, Inc. All rights reserved. Distributed under the Terms of Use in <http://www.unicode.org/copyright.html>.

Permission is hereby granted, free of charge, to any person obtaining a copy of the Unicode data files and any associated documentation (the "Data Files") or Unicode software and any associated documentation (the "Software") to deal in the Data Files or Software without restriction, including without limitation the rights to use, copy, modify, merge, publish, distribute, and/or sell copies of the Data Files or Software, and to permit persons to whom the Data Files or Software are furnished to do so, provided that (a) the above copyright notice(s) and this permission notice appear with all copies of the Data Files or Software, (b) both the above

copyright notice(s) and this permission notice appear in associated documentation, and (c) there is clear notice in each modified Data File or in the Software as well as in the documentation associated with the Data File(s) or Software that the data or software has been modified.

THE DATA FILES AND SOFTWARE ARE PROVIDED "AS IS", WITHOUT WARRANTY OF ANY KIND, EXPRESS OR IMPLIED, INCLUDING BUT NOT LIMITED TO THE WARRANTIES OF MERCHANTABILITY, FITNESS FOR A PARTICULAR PURPOSE AND NONINFRINGEMENT OF THIRD PARTY RIGHTS. IN NO EVENT SHALL THE COPYRIGHT HOLDER OR HOLDERS INCLUDED IN THIS NOTICE BE LIABLE FOR ANY CLAIM, OR ANY SPECIAL INDIRECT OR CONSEQUENTIAL DAMAGES, OR ANY DAMAGES WHATSOEVER RESULTING FROM LOSS OF USE, DATA OR PROFITS, WHETHER IN AN ACTION OF CONTRACT, NEGLIGENCE OR OTHER TORTIOUS ACTION, ARISING OUT OF OR IN CONNECTION WITH THE USE OR PERFORMANCE OF THE DATA FILES OR SOFTWARE.

Except as contained in this notice, the name of a copyright holder shall not be used in advertising or otherwise to promote the sale, use or other dealings in these Data Files or Software without prior written authorization of the copyright holder.

Unicode and the Unicode logo are trademarks of Unicode, Inc., and may be registered in some jurisdictions. All other trademarks and registered trademarks mentioned herein are the property of their respective owners.

8. OpenSSL.

Open SSL is an Open Source toolkit implementing the Secure Sockets Layer (SSL v2/v3) and Transport Layer Security (TLS v1) protocols as well as a full-strength general purpose cryptography library.

See <http://www.openssl.org/> and in particular <http://www.openssl.org/source/license.html>.

The license conditions are copied below.

The OpenSSL toolkit stays under a dual license, i.e. both the conditions of the OpenSSL License and the original SSLeay license apply to the toolkit.

See below for the actual license texts. Actually both licenses are BSD-style

Open Source licenses. In case of any license issues related to OpenSSL, please contact openssl-core@openssl.org.

OpenSSL License

/* =====
* Copyright (c) 1998-2008 The OpenSSL Project. All rights reserved.
*
* Redistribution and use in source and binary forms, with or without
* modification, are permitted provided that the following conditions
* are met:
*
* 1. Redistributions of source code must retain the above copyright
* notice, this list of conditions and the following disclaimer.
*
* 2. Redistributions in binary form must reproduce the above copyright
* notice, this list of conditions and the following disclaimer in
* the documentation and/or other materials provided with the
* distribution.
*
* 3. All advertising materials mentioning features or use of this
* software must display the following acknowledgment:
* "This product includes software developed by the OpenSSL Project
* for use in the OpenSSL Toolkit. (<http://www.openssl.org/>)"
*
* 4. The names "OpenSSL Toolkit" and "OpenSSL Project" must not be used to
* endorse or promote products derived from this software without
* prior written permission. For written permission, please contact
* openssl-core@openssl.org.
*
* 5. Products derived from this software may not be called "OpenSSL"

```

* nor may "OpenSSL" appear in their names without prior written
* permission of the OpenSSL Project.
*
* 6. Redistributions of any form whatsoever must retain the following
* acknowledgment:
* "This product includes software developed by the OpenSSL Project
* for use in the OpenSSL Toolkit (http://www.openssl.org/)"
*
* THIS SOFTWARE IS PROVIDED BY THE OpenSSL PROJECT "AS IS" AND ANY
* EXPRESSED OR IMPLIED WARRANTIES, INCLUDING, BUT NOT LIMITED TO, THE
* IMPLIED WARRANTIES OF MERCHANTABILITY AND FITNESS FOR A PARTICULAR
* PURPOSE ARE DISCLAIMED. IN NO EVENT SHALL THE OpenSSL PROJECT OR
* ITS CONTRIBUTORS BE LIABLE FOR ANY DIRECT, INDIRECT, INCIDENTAL,
* SPECIAL, EXEMPLARY, OR CONSEQUENTIAL DAMAGES (INCLUDING, BUT
* NOT LIMITED TO, PROCUREMENT OF SUBSTITUTE GOODS OR SERVICES;
* LOSS OF USE, DATA, OR PROFITS; OR BUSINESS INTERRUPTION)
* HOWEVER CAUSED AND ON ANY THEORY OF LIABILITY, WHETHER IN
* CONTRACT, STRICT LIABILITY, OR TORT (INCLUDING NEGLIGENCE OR
* OTHERWISE) ARISING IN ANY WAY OUT OF THE USE OF THIS SOFTWARE,
* EVEN IF ADVISED OF THE POSSIBILITY OF SUCH DAMAGE.
* =====
*
* This product includes cryptographic software written by Eric Young
* (eay@cryptsoft.com). This product includes software written by Tim
* Hudson (tjh@cryptsoft.com).
*
*/

```

Original SSLeay License

```

/* Copyright (C) 1995-1998 Eric Young (eay@cryptsoft.com)
* All rights reserved.
*
* This package is an SSL implementation written
* by Eric Young (eay@cryptsoft.com).
* The implementation was written so as to conform with Netscapes SSL.
*
* This library is free for commercial and non-commercial use as long as
* the following conditions are aheared to. The following conditions
* apply to all code found in this distribution, be it the RC4, RSA,
* lhash, DES, etc., code; not just the SSL code. The SSL documentation
* included with this distribution is covered by the same copyright terms
* except that the holder is Tim Hudson (tjh@cryptsoft.com).
*
* Copyright remains Eric Young's, and as such any Copyright notices in
* the code are not to be removed.
* If this package is used in a product, Eric Young should be given attribution
* as the author of the parts of the library used.
* This can be in the form of a textual message at program startup or
* in documentation (online or textual) provided with the package.
*
* Redistribution and use in source and binary forms, with or without
* modification, are permitted provided that the following conditions
* are met:
* 1. Redistributions of source code must retain the copyright
* notice, this list of conditions and the following disclaimer.
* 2. Redistributions in binary form must reproduce the above copyright
* notice, this list of conditions and the following disclaimer in the
* documentation and/or other materials provided with the distribution.
* 3. All advertising materials mentioning features or use of this software
* must display the following acknowledgement:

```

```

* "This product includes cryptographic software written by
* Eric Young (eay@cryptsoft.com)"
* The word 'cryptographic' can be left out if the rouines from the library
* being used are not cryptographic related :-).
* 4. If you include any Windows specific code (or a derivative thereof) from
* the apps directory (application code) you must include an acknowledgement:
* "This product includes software written by Tim Hudson (tjh@cryptsoft.com)"
*
* THIS SOFTWARE IS PROVIDED BY ERIC YOUNG "AS IS" AND ANY EXPRESS OR
* IMPLIED WARRANTIES, INCLUDING, BUT NOT LIMITED TO, THE IMPLIED
* WARRANTIES OF MERCHANTABILITY AND FITNESS FOR A PARTICULAR
* PURPOSE ARE DISCLAIMED. IN NO EVENT SHALL THE AUTHOR OR
* CONTRIBUTORS BE LIABLE FOR ANY DIRECT, INDIRECT, INCIDENTAL,
* SPECIAL, EXEMPLARY, OR CONSEQUENTIAL DAMAGES (INCLUDING, BUT
* NOT LIMITED TO, PROCUREMENT OF SUBSTITUTE GOODS OR SERVICES; LOSS
* OF USE, DATA, OR PROFITS; OR BUSINESS INTERRUPTION) HOWEVER
* CAUSED AND ON ANY THEORY OF LIABILITY, WHETHER IN CONTRACT,
* STRICT LIABILITY, OR TORT (INCLUDING NEGLIGENCE OR OTHERWISE)
* ARISING IN ANY WAY OUT OF THE USE OF THIS SOFTWARE, EVEN IF ADVISED
* OF THE POSSIBILITY OF SUCH DAMAGE.
*
* The licence and distribution terms for any publically available version or
* derivative of this code cannot be changed. i.e. this code cannot simply be
* copied and put under another distribution licence
* [including the GNU Public Licence.]
*/

```

9. Zlib general purpose compression library

See <http://www.zlib.net/>, and in particular http://www.zlib.net/zlib_license.html.

```

/* zlib.h -- interface of the 'zlib' general purpose compression library version 1.2.3, July 18th, 2005

```

```

Copyright (C) 1995-2005 Jean-loup Gailly and Mark Adler

```

This software is provided 'as-is', without any express or implied warranty. In no event will the authors be held liable for any damages arising from the use of this software.

Permission is granted to anyone to use this software for any purpose, including commercial applications, and to alter it and redistribute it freely, subject to the following restrictions:

1. The origin of this software must not be misrepresented; you must not claim that you wrote the original software. If you use this software in a product, an acknowledgment in the product documentation would be appreciated but is not required.
2. Altered source versions must be plainly marked as such, and must not be misrepresented as being the original software.
3. This notice may not be removed or altered from any source distribution.

```

Jean-loup Gailly jloup@gzip.org
Mark Adler madler@alumni.caltech.edu

```

```

*/

```

10. cURL

COPYRIGHT AND PERMISSION NOTICE

Copyright (c) 1996 - 2010, Daniel Stenberg, <daniel@haxx.se>.

All rights reserved.

Permission to use, copy, modify, and distribute this software for any purpose with or without fee is hereby granted, provided that the above copyright notice and this permission notice appear in all copies.

THE SOFTWARE IS PROVIDED "AS IS", WITHOUT WARRANTY OF ANY KIND, EXPRESS OR IMPLIED, INCLUDING BUT NOT LIMITED TO THE WARRANTIES OF MERCHANTABILITY, FITNESS FOR A PARTICULAR PURPOSE AND NONINFRINGEMENT OF THIRD PARTY RIGHTS. IN NO EVENT SHALL THE AUTHORS OR COPYRIGHT HOLDERS BE LIABLE FOR ANY CLAIM, DAMAGES OR OTHER

LIABILITY, WHETHER IN AN ACTION OF CONTRACT, TORT OR OTHERWISE, ARISING FROM, OUT OF OR IN CONNECTION WITH THE SOFTWARE OR THE USE OR OTHER DEALINGS IN THE SOFTWARE.

Except as contained in this notice, the name of a copyright holder shall not be used in advertising or otherwise to promote the sale, use or other dealings in this Software without prior written authorization of the copyright holder.

11. Freetype, a Free, High-Quality, and Portable Font Engine

The software is based in part of the work of the FreeType Team.

See <http://freetype.sourceforge.net/>, and in particular <http://freetype.sourceforge.net/FTL.TXT>.

Portions of the relevant license conditions are copied below.

The FreeType Project LICENSE

2006-Jan-27

Copyright 1996-2002, 2006 by David Turner, Robert Wilhelm, and Werner Lemberg

...

1. No Warranty

THE FREETYPE PROJECT IS PROVIDED 'AS IS' WITHOUT WARRANTY OF ANY KIND, EITHER EXPRESS OR IMPLIED, INCLUDING, BUT NOT LIMITED TO, WARRANTIES OF MERCHANTABILITY AND FITNESS FOR A PARTICULAR PURPOSE. IN NO EVENT WILL ANY OF THE AUTHORS OR COPYRIGHT HOLDERS BE LIABLE FOR ANY DAMAGES CAUSED BY THE USE OR THE INABILITY TO USE, OF THE FREETYPE PROJECT.

2. Redistribution

This license grants a worldwide, royalty-free, perpetual and irrevocable right and license to use, execute, perform, compile, display, copy, create derivative works of, distribute and sublicense the FreeType Project (in both source and object code forms) and derivative works thereof for any purpose; and to authorize others to exercise some or all of the rights granted herein, subject to the following conditions:

...

- o Redistribution in binary form must provide a disclaimer that states that the software is based in part of the work of the FreeType Team, in the distribution documentation. We also encourage you to put an URL to the FreeType web page in your documentation, though this isn't mandatory.

...

12. International Components for Unicode

COPYRIGHT AND PERMISSION NOTICE

Copyright (c) 1995-2009 International Business Machines Corporation and others

All rights reserved.

Permission is hereby granted, free of charge, to any person obtaining a copy of this software and associated documentation files (the "Software"), to deal in the Software without restriction, including without limitation the rights to use, copy, modify, merge, publish, distribute, and/or sell copies of the Software, and to permit persons to whom the Software is furnished to do so, provided that the above copyright notice(s) and this permission notice appear in all copies of the Software and that both the above copyright notice(s) and this permission notice appear in supporting documentation.

THE SOFTWARE IS PROVIDED "AS IS", WITHOUT WARRANTY OF ANY KIND, EXPRESS OR IMPLIED, INCLUDING BUT NOT LIMITED TO THE WARRANTIES OF MERCHANTABILITY, FITNESS FOR A PARTICULAR PURPOSE AND NONINFRINGEMENT OF THIRD PARTY RIGHTS. IN NO EVENT SHALL THE COPYRIGHT HOLDER OR HOLDERS INCLUDED IN THIS NOTICE BE LIABLE FOR ANY CLAIM, OR ANY SPECIAL INDIRECT OR CONSEQUENTIAL DAMAGES, OR ANY DAMAGES WHATSOEVER RESULTING FROM LOSS OF USE, DATA OR PROFITS, WHETHER IN AN ACTION OF CONTRACT, NEGLIGENCE OR OTHER TORTIOUS ACTION, ARISING OUT OF OR IN CONNECTION WITH THE USE OR PERFORMANCE OF THIS SOFTWARE.

Except as contained in this notice, the name of a copyright holder shall not be used in advertising or otherwise to promote the sale, use or other dealings in this Software without prior written authorization of the copyright holder.

13. Expat

Copyright (c) 1998, 1999, 2000 Thai Open Source Software Center Ltd and Clark Cooper

Copyright (c) 2001, 2002, 2003, 2004, 2005, 2006 Expat maintainers.

Permission is hereby granted, free of charge, to any person obtaining a copy of this software and associated documentation files (the "Software"), to deal in the Software without restriction, including without limitation the rights to use, copy, modify, merge, publish, distribute, sublicense, and/or sell copies of the Software, and to permit persons to whom the Software is furnished to do so, subject to the following conditions:

The above copyright notice and this permission notice shall be included in all copies or substantial portions of the Software.

THE SOFTWARE IS PROVIDED "AS IS", WITHOUT WARRANTY OF ANY KIND, EXPRESS OR IMPLIED, INCLUDING BUT NOT LIMITED TO THE WARRANTIES OF MERCHANTABILITY, FITNESS FOR A PARTICULAR PURPOSE AND NONINFRINGEMENT.

IN NO EVENT SHALL THE AUTHORS OR COPYRIGHT HOLDERS BE LIABLE FOR ANY CLAIM, DAMAGES OR OTHER LIABILITY, WHETHER IN AN ACTION OF CONTRACT, TORT OR OTHERWISE, ARISING FROM, OUT OF OR IN CONNECTION WITH THE SOFTWARE OR THE USE OR OTHER DEALINGS IN THE SOFTWARE.

14. DNS Resolver

The DNS resolver code, taken from BIND 4.9.5, is copyrighted both by UC Berkeley and by Digital Equipment Corporation. The DEC portions are under the following license:

Portions Copyright (C) 1993 by Digital Equipment Corporation.

Permission to use, copy, modify, and distribute this software for any purpose with or without fee is hereby granted, provided that the above copyright notice and this permission notice appear in all copies, and that the name of Digital Equipment Corporation not be used in advertising or publicity pertaining to distribution of the document or software without specific, written prior permission.

THE SOFTWARE IS PROVIDED "AS IS" AND DIGITAL EQUIPMENT CORP. DISCLAIMS ALL WARRANTIES WITH REGARD TO THIS SOFTWARE, INCLUDING ALL IMPLIED WARRANTIES OF MERCHANTABILITY AND FITNESS. IN NO EVENT SHALL DIGITAL EQUIPMENT CORPORATION BE LIABLE FOR ANY SPECIAL, DIRECT, INDIRECT, OR CONSEQUENTIAL DAMAGES OR ANY DAMAGES WHATSOEVER RESULTING FROM LOSS OF USE, DATA OR PROFITS, WHETHER IN AN ACTION OF CONTRACT, NEGLIGENCE OR OTHER TORTIOUS ACTION, ARISING OUT OF OR IN CONNECTION WITH THE USE OR PERFORMANCE OF THIS SOFTWARE.

15. getnameinfo, getaddrinfo

The files inet/getnameinfo.c and sysdeps/posix/getaddrinfo.c are copyright (C) by Craig Metz and are distributed under the following license:

```
/* The Inner Net License, Version 2.00
```

The author(s) grant permission for redistribution and use in source and binary forms, with or without modification, of the software and documentation provided that the following conditions are met:

0. If you receive a version of the software that is specifically labelled as not being for redistribution (check the version message and/or README), you are not permitted to redistribute that version of the software in any way or form.
 1. All terms of the all other applicable copyrights and licenses must be followed.
 2. Redistributions of source code must retain the authors' copyright notice(s), this list of conditions, and the following disclaimer.
 3. Redistributions in binary form must reproduce the authors' copyright notice(s), this list of conditions, and the following disclaimer in the documentation and/or other materials provided with the distribution.
 4. [The copyright holder has authorized the removal of this clause.]
 5. Neither the name(s) of the author(s) nor the names of its contributors may be used to endorse or promote products derived from this software without specific prior written permission.

THIS SOFTWARE IS PROVIDED BY ITS AUTHORS AND CONTRIBUTORS "AS IS" AND ANY EXPRESS OR IMPLIED WARRANTIES, INCLUDING, BUT NOT LIMITED TO, THE IMPLIED WARRANTIES OF MERCHANTABILITY AND FITNESS FOR A PARTICULAR PURPOSE ARE DISCLAIMED. IN NO EVENT SHALL THE AUTHORS OR CONTRIBUTORS BE LIABLE FOR ANY DIRECT, INDIRECT, INCIDENTAL,

SPECIAL, EXEMPLARY, OR CONSEQUENTIAL DAMAGES (INCLUDING, BUT NOT LIMITED TO, PROCUREMENT OF SUBSTITUTE GOODS OR SERVICES; LOSS OF USE, DATA, OR PROFITS; OR BUSINESS INTERRUPTION) HOWEVER CAUSED AND ON ANY THEORY OF LIABILITY, WHETHER IN CONTRACT, STRICT LIABILITY, OR TORT (INCLUDING NEGLIGENCE OR OTHERWISE) ARISING IN ANY WAY OUT OF THE USE OF THIS SOFTWARE, EVEN IF ADVISED OF THE POSSIBILITY OF SUCH DAMAGE.

If these license terms cause you a real problem, contact the author: */

16. libpng

This copy of the libpng notices is provided for your convenience. In case of any discrepancy between this copy and the notices in the file png.h that is included in the libpng distribution, the latter shall prevail.

COPYRIGHT NOTICE, DISCLAIMER, and LICENSE:

If you modify libpng you may insert additional notices immediately following this sentence.

This code is released under the libpng license.

libpng versions 1.2.6, August 15, 2004, through 1.2.41, December 3, 2009, are Copyright (c) 2004, 2006-2009 Glenn Randers-Pehrson, and are distributed according to the same disclaimer and license as libpng-1.2.5 with the following individual added to the list of Contributing Authors

Cosmin Truta

libpng versions 1.0.7, July 1, 2000, through 1.2.5 - October 3, 2002, are

Copyright (c) 2000-2002 Glenn Randers-Pehrson, and are distributed according to the same disclaimer and license as libpng-1.0.6 with the following individuals added to the list of Contributing Authors

Simon-Pierre Cadieux

Eric S. Raymond

Gilles Vollant

and with the following additions to the disclaimer:

There is no warranty against interference with your enjoyment of the library or against infringement. There is no warranty that our efforts or the library will fulfill any of your particular purposes or needs. This library is provided with all faults, and the entire risk of satisfactory quality, performance, accuracy, and effort is with the user.

libpng versions 0.97, January 1998, through 1.0.6, March 20, 2000, are Copyright (c) 1998, 1999 Glenn Randers-Pehrson, and are distributed according to the same disclaimer and license as libpng-0.96, with the following individuals added to the list of Contributing Authors:

Tom Lane

Glenn Randers-Pehrson

Willem van Schaik

libpng versions 0.89, June 1996, through 0.96, May 1997, are Copyright (c) 1996, 1997 Andreas Dilger

Distributed according to the same disclaimer and license as libpng-0.88, with the following individuals added to the list of Contributing Authors:

John Bowler

Kevin Bracey

Sam Bushell

Magnus Holmgren

Greg Roelofs

Tom Tanner

libpng versions 0.5, May 1995, through 0.88, January 1996, are Copyright (c) 1995, 1996 Guy Eric Schalnat, Group 42, Inc.

For the purposes of this copyright and license, "Contributing Authors" is defined as the following set of individuals:

Andreas Dilger

Dave Martindale

Guy Eric Schalnat
Paul Schmidt
Tim Wegner

The PNG Reference Library is supplied "AS IS". The Contributing Authors and Group 42, Inc. disclaim all warranties, expressed or implied, including, without limitation, the warranties of merchantability and of fitness for any purpose. The Contributing Authors and Group 42, Inc. assume no liability for direct, indirect, incidental, special, exemplary, or consequential damages, which may result from the use of the PNG Reference Library, even if advised of the possibility of such damage.

Permission is hereby granted to use, copy, modify, and distribute this source code, or portions hereof, for any purpose, without fee, subject to the following restrictions:

1. The origin of this source code must not be misrepresented.
2. Altered versions must be plainly marked as such and must not be misrepresented as being the original source.
3. This Copyright notice may not be removed or altered from any source or altered source distribution.

The Contributing Authors and Group 42, Inc. specifically permit, without fee, and encourage the use of this source code as a component to supporting the PNG file format in commercial products. If you use this source code in a product, acknowledgment is not required but would be appreciated.

A "png_get_copyright" function is available, for convenient use in "about" boxes and the like:

```
printf("%s",png_get_copyright(NULL));
```

Also, the PNG logo (in PNG format, of course) is supplied in the files "pngbar.png" and "pngbar.jpg (88x31) and "pngnow.png" (98x31).

Libpng is OSI Certified Open Source Software. OSI Certified Open Source is a certification mark of the Open Source Initiative.

Glenn Randers-Pehrson

glennrp at users.sourceforge.net

December 3, 2009

17. SQLite

All of the deliverable code in SQLite has been dedicated to the HYPERLINK "http://en.wikipedia.org/wiki/Public_Domain" public domain by the authors. All code authors, and representatives of the companies they work for, have signed affidavits dedicating their contributions to the public domain and originals of those signed affidavits are stored in a firesafe at the main offices of HYPERLINK "<http://www.hwaci.com>" Hwaci. Anyone is free to copy, modify, publish, use, compile, sell, or distribute the original SQLite code, either in source code form or as a compiled binary, for any purpose, commercial or non-commercial, and by any means.

The previous paragraph applies to the deliverable code in SQLite - those parts of the SQLite library that you actually bundle and ship with a larger application. Portions of the documentation and some code used as part of the build process might fall under other licenses. The details here are unclear. We do not worry about the licensing of the documentation and build code so much because none of these things are part of the core deliverable SQLite library.

All of the deliverable code in SQLite has been written from scratch. No code has been taken from other projects or from the open internet. Every line of code can be traced back to its original author, and all of those authors have public domain dedications on file. So the SQLite code base is clean and is uncontaminated with licensed code from other projects.

NOTIFICACIÓN

CONTRATO DE LICENCIA PARA EL USUARIO FINAL DEL SOFTWARE

EL PRESENTE CONTRATO DE LICENCIA PARA EL USUARIO FINAL DEL SOFTWARE (EL "CONTRATO") CONSTITUYE UN ACUERDO LEGAL Y VINCULANTE QUE SE CELEBRA ENTRE USTED (PERSONA FÍSICA O MORAL) Y PHILIPS CONSUMER LIFESTYLE B.V., UNA SOCIEDAD DE RESPONSABILIDAD LIMITADA NEERLANDESA CON DOMICILIO SOCIAL EN HIGH TECH CAMPUS 37, 5656 AE EINDHOVEN, PAÍSES BAJOS, Y SUS EMPRESAS SUBSIDIARIAS (EN ADELANTE, INDIVIDUAL Y COLECTIVAMENTE "PHILIPS"). ESTE CONTRATO LE OTORGA EL DERECHO A UTILIZAR DETERMINADO SOFTWARE (EL "SOFTWARE"), INCLUYENDO LA DOCUMENTACIÓN DEL USUARIO EN FORMATO ELECTRÓNICO QUE SE LE HAYA PODIDO ENTREGAR POR SEPARADO O JUNTO CON UN PRODUCTO PHILIPS (EL "DISPOSITIVO") O CON UNA PC. AL DESCARGAR, INSTALAR O UTILIZAR DE ALGUNA OTRA FORMA EL SOFTWARE, USTED ACEPTA Y CONVIENE EN OBLIGARSE CON RESPECTO A TODOS LOS TÉRMINOS Y CONDICIONES DEL PRESENTE CONTRATO. EN CASO DE NO ESTAR DE ACUERDO CON ESTOS TÉRMINOS Y CONDICIONES, NO DESCARGUE, INSTALE NI UTILICE DE OTRA MANERA EL SOFTWARE. SI USTED HA ADQUIRIDO EL SOFTWARE EN UN SOPORTE TANGIBLE, POR EJEMPLO EN CD, SIN HABER TENIDO LA OPORTUNIDAD DE CONSULTAR ESTA LICENCIA, Y NO ACEPTA ESTOS TÉRMINOS, PUEDE RECIBIR LA DEVOLUCIÓN TOTAL DEL MONTO PAGADO, EN SU CASO, POR EL SOFTWARE, SIEMPRE Y CUANDO DEVUELVA EL SOFTWARE SIN HABERLO USADO, ACOMPAÑADO DEL COMPROBANTE DE PAGO, DENTRO DE LOS 30 DÍAS DE LA FECHA DE COMPRA.

- 1. Otorgamiento de la licencia.** El presente Contrato le otorga una licencia no exclusiva, intransferible y no sub-licenciable para instalar y utilizar, en el Dispositivo o en una PC (según corresponda), una (1) copia de la versión especificada del Software en formato de código objeto, tal y como se establece en la documentación del usuario y exclusivamente para su uso personal. El Software se considera "en uso" al cargarlo en la memoria temporal o permanente (es decir, la RAM, el disco duro, etc.) de la PC o del Dispositivo.
- 2. Propiedad El Software es objeto de una licencia y no de una venta para usted.** Este Contrato sólo le concede el derecho a utilizar el Software, pero usted no adquiere ningún derecho, expreso o implícito, sobre el Software, salvo los que se señalan en el presente Contrato. Philips y sus licenciantes conservan todos los derechos, titularidad e intereses relacionados con el Software, incluidas todas las patentes, derechos de autor, secretos comerciales y cualesquiera otros derechos de propiedad intelectual incorporados en el mismo. El Software está protegido por las leyes sobre derechos de autor, disposiciones de tratados internacionales y otras leyes de propiedad intelectual. Por lo tanto, salvo lo dispuesto de manera expresa en este documento, usted no podrá copiar el Software sin previa autorización por escrito de Philips, excepto, que usted puede realizar una (1) copia de respaldo del Software para su uso personal. No podrá copiar ningún material impreso incluido con el Software, ni imprimir más de una (1) copia de la documentación para el usuario proporcionada en formato electrónico, sin embargo, podrá hacer una (1) copia de respaldo de dicha documentación para su uso personal.
- 3. Restricciones de la licencia.** Salvo lo dispuesto en contrario en este documento, usted no podrá alquilar, rentar, sub-licenciar, vender, ceder, prestar o transferir de manera alguna el Software. No podrá, ni permitirá a terceros, revertir la ingeniería, descompilar ni desensamblar el Software, excepto en la medida en que la legislación aplicable prohíba la anterior restricción de forma expresa. Usted no podrá retirar ni destruir ninguna identificación del producto, ni avisos sobre derechos de autor ni ningún otro aviso o restricción de propiedad que tenga el Software. Todos los avisos sobre derechos de propiedad, marcas comerciales, derechos de autor y derechos restringidos deberán ser reproducidos en la copia de respaldo personal del Software. No podrá modificar ni adaptar el Software, fusionar el Software en otro programa ni crear trabajos derivados basados en el Software.
- 4. Renuncia de responsabilidad** EL SOFTWARE ESTÁ DESTINADO PARA AYUDARLO EN LA TRANSFERENCIA DE MATERIALES DE LOS CUALES USTED POSEA LOS DERECHOS DE AUTOR O HAYA OBTENIDO DEL

PROPIETARIO DE ÉSTOS LA AUTORIZACIÓN PARA DESCARGAR Y TRANSFERIR. A MENOS QUE USTED POSEA LOS DERECHOS DE AUTOR O HAYA SIDO AUTORIZADO POR EL PROPIETARIO DE ÉSTOS A DESCARGAR Y TRANSFERIR, PODRÍA ESTAR INFRINGIENDO LA LEY DE DERECHOS DE AUTOR, POR LO QUE ESTARÍA SUJETO A PAGAR DAÑOS Y PERJUICIOS Y OTROS RESARCIMIENTOS. SI TIENE DUDAS EN LO QUE RESPECTA A SUS DERECHOS, DEBERÁ CONSULTAR A SU ASESOR LEGAL. USTED ASUME PLENA RESPONSABILIDAD POR EL USO LEGAL Y RESPONSABLE DEL SOFTWARE

5. **Renuncia de responsabilidad de terceros y limitaciones relativas al software WM-DRM:** WM-DRM: Los proveedores de contenido utilizan la tecnología de administración de derechos digitales de Windows Media ("WM-DRM") para proteger la integridad de su contenido ("Contenido Seguro"), de forma que no se produzcan apropiaciones ilícitas de la propiedad intelectual, incluidos los derechos de autor, sobre dicho contenido. Algunas partes de este Software y otras aplicaciones de terceros ("Software WM-DRM") utilizan software WM-DRM para transferir o reproducir Contenido Seguro. Si la seguridad del Software WM-DRM se ve comprometida, los propietarios del Contenido Seguro ("Propietarios del Contenido Seguro") podrán solicitar a Microsoft la revocación del derecho del Software WM-DRM para copiar, visualizar, transferir y/o reproducir el Contenido Seguro. La referida revocación no modifica la capacidad del Software WM-DRM para reproducir contenido no protegido. Cada vez que descargue de Internet una licencia de Contenido Seguro, se le enviará a su computadora una lista del Software WM-DRM revocado. Junto con dicha licencia, Microsoft también podrá descargar listas de revocación en su computadora en nombre de los Propietarios del Contenido Seguro. Los Propietarios del Contenido Seguro también pueden solicitarle que actualice algunos de los componentes WM-DRM distribuidos con este Software ("Actualizaciones de WM-DRM") antes de acceder a su contenido. En el momento en que usted intente reproducir el Contenido Seguro, el Software WM-DRM construido por Microsoft le notificará sobre la necesidad de realizar una Actualización de WM-DRM y, a continuación, le solicitará su consentimiento antes de descargar dicha actualización. Puede que el Software WM-DRM utilizado por terceros siga el mismo proceso. Si rechaza la actualización, usted no podrá acceder al Contenido Seguro que requiere la Actualización de WM-DRM; sin embargo, seguirá teniendo acceso al contenido no protegido y a la parte del Contenido Seguro que no requiera actualización.
6. **Software de código abierto.** a) Este software puede contener componentes que están sujetos a condiciones de código abierto, tal como se estipula en la documentación que acompaña al Dispositivo. En consecuencia, el presente Contrato no se aplica a este software. b) Sus derechos de licencia en virtud del presente Contrato no incluyen ningún derecho ni licencia de uso, distribución o creación de trabajos derivados del Software de ninguna forma en que el Software quede sujeto a Condiciones de Código Abierto. Se entiende por "Condiciones de Código Abierto" los términos de cualquier licencia que, de manera directa o indirecta: 1) cree o pretenda crear para Philips obligaciones relacionadas con el Software y/o con cualquier trabajo derivado de éste; o bien 2) otorgue o pretenda otorgar a cualquier tercero cualquier derecho o inmunidad que afecte la propiedad intelectual o los derechos de propiedad de Philips sobre el Software o cualquier trabajo derivado de éste.
7. **Terminación.** Este Contrato surtirá efectos desde la instalación o al primer uso del Software y se dará por terminado i) a discreción de Philips si usted no cumple con cualquiera de las condiciones de este Contrato; o bien ii) al destruirse todas las copias del Software y de los materiales relacionados proporcionados a usted por Philips en virtud del presente. Sus obligaciones y los derechos de Philips no desaparecerán al terminarse este Contrato.
8. **Actualizaciones.** Philips podrá, de forma unilateral, ofrecer actualizaciones del Software mediante disponibles para su carga en una página Web, o por cualquier otro medio o método. Dichas actualizaciones podrán ofrecerse conforme a los términos de este Contrato, o bien la provisión de dichas actualizaciones podrá estar sujeta a la aceptación de otro contrato por su parte.
9. **Servicios de Asistencia.** Philips no está obligado a prestar asistencia técnica u otro soporte ("Servicios de Asistencia") para el Software. En el caso de que Philips le prestara dichos Servicios de Asistencia, éstos se registrarán por términos independientes acordados entre usted y Philips.
10. **Garantía limitada del Software.** Philips proporciona el Software 'tal como está', sin ninguna garantía, salvo la de que el Software funcionará sustancialmente de acuerdo con la documentación que se acompaña con el mismo durante un período de un año después de la primera descarga, instalación o uso del Software, lo que ocurra primero. Toda la responsabilidad de Philips y el único resarcimiento al que usted tendrá derecho en caso de incumplimiento de esta garantía será, a discreción de Philips, i) la devolución del precio que usted haya pagado por el Software (si corresponde), o bien b) la reparación o reemplazo del Software que no cumpla con la garantía establecida en este documento, y que deberá devolverse a Philips junto con una copia de su recibo. Esta garantía limitada será nula si

la falla de funcionamiento del Software se debe a cualquier accidente, abuso, uso indebido o aplicación errónea. Cualquier Software que se proporcione en reemplazo del anterior dispondrá de una garantía por el tiempo restante del período de garantía original o por treinta (30) días, el tiempo que sea mayor. Esta garantía limitada no se aplicará a su situación si el Software le ha sido proporcionado de forma gratuita y únicamente para fines de evaluación.

- 11. EXCLUSIÓN DE OTRAS GARANTÍAS.** SALVO LO ESTABLECIDO ANTERIORMENTE, PHILIPS Y SUS LICENCIANTES NO GARANTIZAN QUE EL SOFTWARE FUNCIONARÁ SIN ERRORES O DE FORMA ININTERRUMPIDA, O QUE CUBRIRÁ SUS NECESIDADES. USTED ASUME TODAS LAS RESPONSABILIDADES DERIVADAS DE LA ELECCIÓN DEL SOFTWARE PARA OBTENER LOS RESULTADOS DESEADOS, ASÍ COMO DE SU INSTALACIÓN, USO Y LOS RESULTADOS OBTENIDOS DEL SOFTWARE. DENTRO DE LOS LÍMITES MÁXIMOS PERMITIDOS POR LA LEY APLICABLE, PHILIPS Y SUS LICENCIANTES RENUNCIAN A CUALQUIER GARANTÍA Y CONDICIÓN, EXPRESA O TÁCITA, INCLUIDAS, DE MANERA ENUNCIATIVA MÁS NO LIMITATIVA, LAS GARANTÍAS IMPLÍCITAS DE COMERCIABILIDAD, APTITUD PARA UN FIN ESPECÍFICO Y PRECISIÓN O INTEGRIDAD DE RESULTADOS CON RELACIÓN AL SOFTWARE Y AL MATERIAL QUE LO ACOMPAÑA. NO HAY NINGUNA GARANTÍA CONTRA EL INCUMPLIMIENTO. PHILIPS NO GARANTIZA QUE USTED PODRÁ DESCARGAR, COPIAR, ALMACENAR, VISUALIZAR, TRANSFERIR Y/O REPRODUCIR CONTENIDO SEGURO.
- 12. LIMITACIÓN DE RESPONSABILIDAD.** BAJO NINGUNA CIRCUNSTANCIA NI PHILIPS NI SUS LICENCIANTES ASUMIRÁN RESPONSABILIDAD ALGUNA POR NINGÚN TIPO DE DAÑOS MEDIATOS, ESPECIALES, INDIRECTOS, INCIDENTALS O PUNITIVOS, INCLUIDOS, DE MANERA ENUNCIATIVA MAS NO LIMITATIVA, DAÑOS POR PÉRDIDA DE UTILIDADES O INGRESOS, INTERRUPCIÓN DE LA ACTIVIDAD COMERCIAL, PÉRDIDA DE INFORMACIÓN COMERCIAL, PÉRDIDA DE DATOS, PÉRDIDA DE USO U OTRO TIPO DE PÉRDIDA PECUNIARIA, INCLUSO EN EL CASO DE QUE PHILIPS O SUS LICENCIANTES HUBIERAN SIDO INFORMADOS SOBRE LA POSIBILIDAD DE TALES DAÑOS. EN NINGÚN CASO, LA RESPONSABILIDAD TOTAL DE PHILIPS O DE SUS LICENCIANTES POR LOS DAÑOS QUE PUDIERAN DERIVARSE DEL PRESENTE CONTRATO EXCEDERÁ EL MONTO QUE RESULTE MAYOR ENTRE EL PRECIO PAGADO POR EL SOFTWARE O CINCO LIBRAS ESTERLINAS (5.00).
- 13. Marcas comerciales.** Algunos de los nombres de producto y de Philips que se utilizan en este Contrato, en el Software y en la documentación del usuario impresa pueden ser marcas comerciales de Philips, de sus licenciantes o de terceros. Usted no está autorizado a utilizar ninguna de dichas marcas comerciales.
- 14. Administración de exportaciones.** Usted conviene en no exportar o reexportar, de manera directa o indirecta, el Software a ningún país en el que se requiera licencia de exportación u otra aprobación expedida por el gobierno de Estados Unidos en virtud de la Ley de Administración de Exportaciones de Estados Unidos (United States Export Administration Act) o de cualquier ley o norma similar estadounidense, salvo que se haya obtenido dicha licencia o aprobación de exportación con anterioridad. Al descargar o instalar el Software, usted conviene en registrarse por esta disposición sobre Exportaciones.
- 15. Ley aplicable.** Este Contrato se rige por las leyes de su país de residencia, no obstante lo que puedan disponer sus normas para conflictos de leyes. Cualquier controversia entre usted y Philips en relación con este Contrato quedará sujeta a la jurisdicción no exclusiva de los tribunales de su país de residencia.
- 16. Acuerdo completo.** El presente Contrato constituye el acuerdo completo entre usted y Philips, y sustituye y deja sin efecto cualquier otra declaración, compromiso, notificación o anuncio realizados con anterioridad en relación con el Software y la documentación del usuario. Si cualquier parte del presente Contrato se considerara no válida, el resto del Contrato seguirá en vigor y surtiendo pleno efecto. Este Contrato no afecta los derechos expresamente reconocidos por ley a cualquiera de las partes que actúe con carácter de consumidor.

EULA-Mexican-Spanish
January 2011

P&F USA, Inc.
PO Box 430 Daleville, IN 47334-0430

P&F Mexicana, S.A. de C.V.
Av. La Palma No. 6, Col. San Fernando La Herradura,
Huixquilucan Edo. de México C.P. 52787



REPRODUCTOR DE BLU-RAY Y DVD

Blu-ray y DVD	ENERGIA
BDP2600/F8	110V – 220V ~ 50/60 Hz 14W

IMPORTADOR:

P & F MEXICANA. S.A. DE C.V.

Av. La Palma No. 6, Col. San Fernando La Herradura

C.P.52787 Huixquilucan Edo. De México Tel. 52 69 90 00

**LEA CUIDADOSAMENTE ESTE INSTRUCTIVO
ANTES DE USAR SU APARATO.**

