

Register your product and get support at
www.philips.com/welcome

BDP7500 MK II
(BDP7500S2/BDP7500B2)



EN	User manual	3
MS-MY	Manual pengguna	29
ZH-HK	使用手冊	57

PHILIPS

Daftar kandungan

1	Penting	28
	Notis keselamatan penting	28
	Notis tanda dagangan	28

2	Produk anda	30
	Sorotan penting ciri	30
	Media boleh main	30
	Gambaran keseluruhan produk	30

3	Sambungkan	32
	Sambungkan kabel video/audio	32
	Halakan audio ke peranti lain	33
	Sambungkan peranti USB	34
	Sambungkan rangkaian	34
	Sambungkan kuasa	35

4	Mulakan	35
	Sediakan kawalan jauh	35
	Cari input TV	35
	Gunakan menu Laman utama	35
	Navigasi menu	35
	Pilih bahasa paparan menu	36
	Sediakan rangkaian	36
	Gunakan Pautan Mudah Philips	37

5	Main	38
	Mainkan cakera	38
	Main dari peranti USB	38
	Mainkan video	38
	Mainkan foto	41
	Mainkan muzik	42
	Semak imbas PC	42
	Semak Imbas Net TV	43

6	Laraskan tetapan	44
	Persediaan video	44
	Persediaan audio	45
	Persediaan rangkaian	46
	Persediaan EasyLink	47
	Persediaan keutamaan	47
	Persediaan lanjutan	48

7	Maklumat tambahan	49
	Kemas kinikan perisian	49
	Penjagaan	50
	Spesifikasi	50

8	Menyelesaikan masalah	51
----------	------------------------------	----

1 Penting

Notis keselamatan penting



Amaran

- Risiko pemanasan melampau! Jangan pasang produk dalam ruang yang terhad. Sentiasa tinggalkan ruang sekurang-kurangnya 4 inci di sekeliling produk untuk pengalihan udara. Pastikan langsir atau objek lain tidak menutup slot pengalihan udara pada produk tersebut.
- Jangan sekali-kali letakkan produk, kawalan jauh atau bateri berhampiran dengan api terbuka atau sumber haba yang lain, termasuk cahaya matahari langsung.
- Hanya gunakan produk ini di dalam bangunan. Jauhkan produk ini daripada air, kelembapan dan objek yang berisi cecair.
- Jangan letak produk ini di atas kelengkapan elektrik yang lain.
- Jauhkan diri anda daripada produk ini semasa ribut kilat.
- Apabila plag sesaluruksa atau pengganding perkakas digunakan sebagai peranti putus sambungan, peranti putus sambungan tersebut akan tetap sedia beroperasi.
- Sinaran laser boleh nampak dan tak nampak apabila dibuka. Elakkan pendedahan kepada pancaran.

Amaran kesihatan pada tontonan 3D

- Jika anda atau keluarga anda mempunyai sejarah mengalami epilepsi atau sawan fotosensitif, jumpalah doktor sebelum mendedahkan diri anda kepada sumber cahaya berkelip, jujukan imej deras atau tontonan 3D.
- Untuk mengelakkan ketidakeselesaan seperti pening, sakit kepala atau disorientasi, kami mengesyorkan agar anda tidak menonton 3D dalam tempoh masa yang panjang. Jika anda mengalami sebarang ketidakeselesaan, hentikan menonton 3D dan jangan dengan serta merta melakukan perkara yang mungkin berbahaya (seperti memandu kereta) sehingga gejala telah hilang. Jika gejala berterusan, jangan teruskan menonton 3D tanpa merujuk kepada doktor terlebih dahulu.
- Ibu bapa hendaklah mengawasi anak mereka ketika menonton 3D dan memastikan mereka tidak mengalami ketidakeselesaan seperti yang disebutkan di atas. Menonton 3D tidak disyorkan bagi kanak-kanak di bawah umur 6 tahun kerana sistem penglihatan mereka masih belum lagi berkembang dengan sempurna.

**CLASS 1
LASER PRODUCT**

Pembuangan produk dan bateri lama

Produk anda direka bentuk dan dilahirkan dengan menggunakan bahan dan komponen berkualiti tinggi, yang boleh dikitar semula dan digunakan semula.



Jangan buang produk anda dengan buangan isi rumah yang lain. Sila ambil tahu tentang peraturan tempatan mengenai pengumpulan berasingan produk elektrik dan elektronik dan bateri. Pembuangan produk ini dengan cara yang betul akan membantu mencegah kemungkinan akibat negatif terhadap alam sekitar dan kesihatan manusia. Produk anda mengandungi bateri, yang tidak boleh dibuang bersama buangan isi rumah yang biasa. Sila ambil tahu tentang peraturan tempatan mengenai pengumpulan berasingan bateri. Cara membuang bateri yang betul akan membantu mencegah kemungkinan akibat negatif terhadap alam sekitar dan kesihatan manusia. Sila lawati www.recycle.philips.com untuk maklumat tambahan mengenai pusat kitaran semula di kawasan anda.

Notis hak cipta



**Be responsible
Respect copyrights**

Produk ini mengandungi teknologi perlindungan hak cipta yang dilindungi oleh paten A.S. dan hak harta intelek lain Rovi Corporation. Kejuruteraan undur dan penyahhimpunan adalah dilarang.

Perisian sumber terbuka

Philips Electronics Singapore Ltd dengan ini menawarkan untuk menghantar, apabila diminta, salinan kod sumber lengkap yang sepadan dengan pakej perisian sumber terbuka berhak cipta yang digunakan dalam produk ini, yang baginya tawaran seumpama ini diminta oleh lesen masing-masing. Tawaran ini sah sehingga tiga tahun selepas pembelian produk kepada sesiapa yang menerima maklumat ini. Untuk mendapatkan kod sumber, sila hubungi open.source@philips.com. Jika anda lebih suka untuk tidak menggunakan e-mel atau jika anda tidak menerima pengesahan penerimaan dalam masa seminggu selepas menulis ke alamat e-mel ini, sila hantar surat kepada "Open Source Team, Philips Intellectual Property & Standards, P.O. Box 220, 5600 AE Eindhoven, The Netherlands." Jika anda tidak menerima pengesahan penerimaan surat anda pada masa yang sepatutnya, sila hantar e-mel ke alamat e-mel di atas.

Notis tanda dagangan



'Blu-ray', 'Blu-ray Disc', logo 'Blu-ray Disc', 'Blu-ray 3D' dan logo 'Blu-ray 3D' adalah tanda dagangan Blu-ray Disc Association.



HDMI, dan logo HDMI dan High-Definition Multimedia Interface adalah tanda niaga atau tanda niaga berdaftar HDMI licensing LLC.



DLNA®, logo DLNA dan DLNA CERTIFIED® adalah tanda dagangan, tanda perkhidmatan, atau tanda perakuan Digital Living Network Alliance.



Dikilangkan di bawah lesen daripada Dolby Laboratories. Dolby dan simbol D berganda adalah tanda dagangan Dolby Laboratories.



Dikilangkan di bawah lesen Paten A.S. # Paten: 5,451,942; 5,956,674; 5,974,380; 5,978,762; 6,226,616; 6,487,535; 7,212,872; 7,333,929; 7,392,195; 7,272,567 & paten A.S. dan seluruh dunia yang telah dikeluarkan & yang masih menunggu kelulusan. DTS dan Simbolnya adalah tanda dagangan berdaftar, & DTS-HD, DTS-HD Master Audio, dan logo DTS adalah tanda dagangan DTS, Inc. Produk adalah termasuk perisian. © DTS, Inc. Semua Hak Terpelihara.



TENTANG DIVX PLUS™ HD:
DivX® adalah format video digital yang dicipta oleh DivX, Inc. Ini adalah peranti DivX Certified® rasmi yang memainkan video DivX, termasuk video DivX Plus™ HD (H.264/MKV) sehingga 1080p dan kandungan premium. Lawati www.divx.com untuk mendapatkan maklumat lanjut dan alat perisian untuk menukar fail anda menjadi video DivX.

MENGENAI DIVX VIDEO-ON-DEMAND: Peranti DivX Certified® ini mestilah didaftarkan sebelum dapat memainkan kandungan DivX Video-on-Demand (VOD). Untuk menjana kod pendaftaran, cari bahagian DivX VOD dalam menu persediaan peranti. Pergi ke vod.divx.com dengan kod ini untuk melengkapkan proses pendaftaran dan untuk mendapatkan maklumat lanjut mengenai VOD DivX. DivX®, DivX Certified®, DivX Plus™ HD dan logo yang berkaitan adalah tanda dagangan berdaftar DivX, Inc. dan digunakan di bawah lesen.



'BD LIVE' dan 'BONUSVIEW' adalah tanda dagangan Persatuan Blu-ray Disc.

AVCHD™ 'AVCHD' dan logo 'AVCHD' adalah tanda dagangan Matsushita Electric Industrial Co., Ltd dan Sony Corporation.

x.v.Colour 'x.v.Colour' adalah tanda dagangan Sony Corporation.



Logo USB-IF adalah tanda dagangan Universal Serial Bus Implementers Forum, Inc.



'DVD Video' adalah tanda dagangan DVD Format/Logo Licensing Corporation.



Java dan semua tanda dagangan serta logo Java yang lain adalah tanda dagangan atau tanda dagangan berdaftar Sun Microsystems, Inc. di Amerika Syarikat dan/atau negara lain.



Windows Media dan logo Windows adalah tanda dagangan atau tanda dagangan berdaftar Microsoft Corporation di Amerika Syarikat dan/atau negara lain.

2 Produk anda

Tahniah atas pembelian anda dan selamat menggunakan Philips! Untuk mendapat faedah sepenuhnya daripada sokongan yang ditawarkan oleh Philips (seperti peningkatan perisian produk), daftarkan produk anda di www.philips.com/welcome.

Jika anda menghubungi Philips, anda akan diminta untuk memberikan model dan nombor siri produk anda. Nombor model dan nombor siri terletak pada bahagian belakang produk anda. Tulis nombor tersebut di sini:

No. Model _____

No. Siri _____

Sorotan penting ciri

Agar produk ini sentiasa berprestasi optimum, anda disyorkan agar mengemas kini perisian produk ini dengan tetap.

Mainan cakera 3D Blu-ray

Pemain ini dapat memainkan cakera 3D Blu-ray dan ia menyediakan pengalaman HD 3D penuh di rumah. Sambungkan pemain anda kepada TV patuh 3D menggunakan kabel HDMI, dan pakai kaca mata 3D yang disertakan bersama TV untuk menikmati keterujaan alam 3D.

Net TV

Net TV membawakan kepada anda berbagai maklumat dan hiburan dalam talian pada TV anda yang bersambung dengan produk ini. Dengan Net TV anda dapat menikmati antara laman web terbaik yang disesuaikan untuk muat pada TV anda.

DLNA

Hanya sambungkan produk ini kepada rangkaian rumah anda melalui bicu LAN, atau tanpa wayar dengan penyesuai Wi-Fi USB Philips yang opsyenal. Anda boleh strimkan video dan gambar anda kepada produk ini dan menontonnya terus pada TV anda.

DivX Plus HD

Produk ini adalah peranti Diperakui DivX Plus HD. Ia memainkan semua video DivX termasuk fail video DivX Plus HD (video H.264 dengan sambungan fail .mkv dan audio AAC) sehingga 1080p dan kandungan Hollywood premium.

Hiburan Definisi Tinggi

Tonton cakera kandungan definisi tinggi dengan HDTV (Televisyen Definisi Tinggi). Sambungkannya melalui kabel HDMI berkelajuan tinggi (1.3 atau kategori 2). Anda boleh menikmati kualiti gambar yang hebat sehingga 1080p resolusi dengan kadar bingkai sebanyak 24 bingkai satu saat dengan output imbas progresif.

Bunyi surround saluran 7.1 fideliti tinggi

Produk ini menyokong audio definisi tinggi seperti Dolby TrueHD dan DTS-HD Master Audio.

BD-Live

Sambungkan produk ini kepada tapak web studio filem melalui pangkalan LAN atau Wi-Fi luaran untuk mengakses pelbagai kandungan terkini (seperti pratonton dimuat semula dan ciri khas yang eksklusif).



Media boleh main

Produk ini boleh memainkan

- BD-Video, BD-R/RE2.0, BD 3D
- DVD, DVD-Video, DVD+R/+RW, DVD-R/-RW, DVD+R/-R DL (Dual Layer)
- CD Video/SVCD
- CD audio, CD-R/CD-RW, media MP3, media WMA, fail JPEG
- Media DivX (Ultra)/DivX Plus HD, media MKV
- Pemacu flash USB

Kod rantau

Anda boleh memainkan cakera yang mempunyai kod rantau berikut.

Kod kawasan	Negara		
DVD	Blu-ray		
			Asia Pasifik, Taiwan, Korea

Gambaran keseluruhan produk

Unit utama

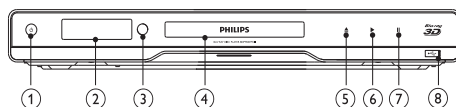

- ① 
 - Hidupkan produk ini atau bertukar ke mod siap sedia.
- ② **Panel paparan**
- ③ **Sensor IR**
 - Mengesan isyarat daripada kawalan jauh. Setiap kali halakan kawalan jauh ke arah sensor IR.
- ④ **Kompartmen cakera**

- 5 ▲
 - Buka atau tutup petak cakera.
- 6 ►
 - Mula atau sambung semula main
- 7 ||
 - Jedakan main.
- 8 ↔ bicu
 - Sambungkan pemacu flash USB.

Kawalan jauh

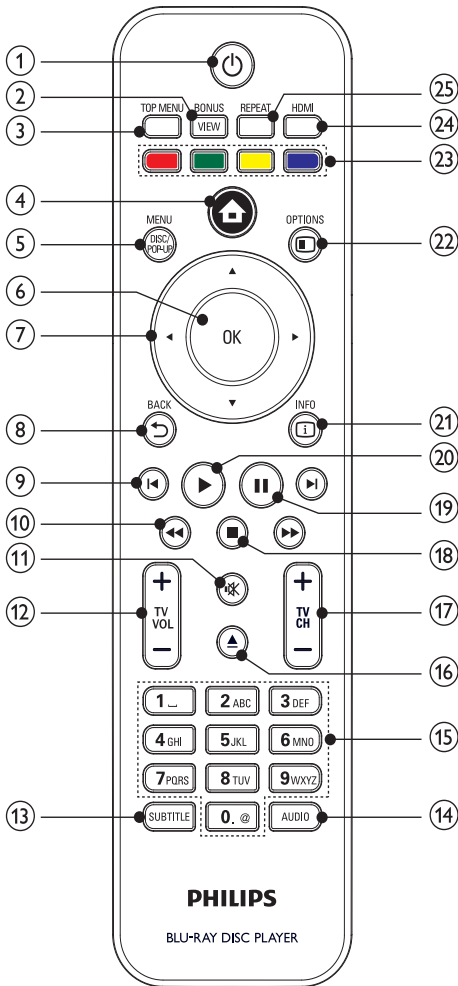

- 1 ⏻
 - Hidupkan produk ini atau bertukar ke mod siap sedia.
 - Apabila EasyLink didayakan, tekan dan tahan selama sekurang-kurangnya tiga saat untuk mengalihkan semua peranti yang mematuhi HDMI CEC yang bersambung ke siap sedia.
- 2 **BONUSVIEW**
 - Hidupkan atau matikan video kedua dalam tetingkap skrin kecil semasa memainkan (boleh digunakan hanya pada cakera Blu-ray yang menyokong BONUSVIEW atau ciri Gambar-Dalam-Gambar).
- 3 **TOP MENU**
 - **BD**: Paparkan menu atas.
 - **DVD**: Paparkan menu tajuk.
- 4 🏠
 - Akses menu utama produk ini.
- 5 **DISC MENU / POP-UP MENU**
 - **BD**: Akses atau keluar daripada menu pop timbul.
 - **DVD**: Akses atau keluar daripada menu cakera.
- 6 OK
 - Sahkan entri atau pemilihan.
- 7 ▲▼▶◀
 - Navigasi menerusi menu.
- 8 ↶ BACK
 - Kembali ke menu paparan sebelumnya.
- 9 ◀ / ▶
 - Melangkaui ke tajuk, bab atau trek sebelum atau seterusnya.
- 10 ◀◀ / ▶▶
 - Cari ke belakang atau ke hadapan.
- 11 🗣️
 - Bisukan bunyi TV (hanya berkaitan dengan TV jenama Philips yang tertentu).
- 12 **TV VOL +/-**
 - Laraskan kelantangan TV (hanya berkaitan dengan TV jenama Philips yang tertentu).
- 13 **SUBTITLE**
 - Pilih bahasa sari kata pada cakera.
- 14 **AUDIO**
 - Pilih bahasa atau saluran audio pada cakera.
- 15 **Butang abjad angka**
 - Pilih item untuk dimainkan.
 - Masukkan nilai.
 - Masukkan huruf melalui masukan gaya SMS.

- 16 ▲
 - Buka atau tutup petak cakera.
- 17 TV CH +/-
 - Pilih saluran TV (hanya berkaitan dengan TV jenama Philips yang tertentu).
- 18 ■
 - Hentikan main.
- 19 ||
 - Jedakan main.
 - Gerakan gambar yang dijeda satu langkah ke hadapan.
- 20 ►
 - Mula atau sambung semula main
- 21 ⓘ INFO
 - Paparkan status semasa atau maklumat cakera.
- 22 ☰ OPTIONS
 - Akses pilihan untuk aktiviti atau pemilihan semasa.
- 23 Butang berwarna
 - **BD:** Pilih tugas atau opsiyen.
- 24 HDMI
 - Memilih resolusi video bagi output HDMI.
- 25 REPEAT
 - Pilih main ulang atau main kocok.

3 Sambungkan

Lakukan sambungan berikut untuk menggunakan produk ini.

Sambungan asas:

- Video
- Audio
- Kuasa

Sambungan pilihan:

- Halakan audio ke peranti lain
 - Penerima/penguat AV yang patuh HDMI
 - Penerima/penguat AV berbilang saluran
 - Penerima/penguat AV digital
 - Sistem stereo analog
- Pemacu flash USB
- Rangkaian Berwayar/Tanpa Wayar

☰ Catatan

- Rujuk pada plat jenis pada bahagian belakang produk untuk pengenalpastian dan perkadaran pembekalan.
- Sebelum anda membuat atau menukar sebarang sambungan, pastikan semua peranti telah diputuskan sambungan daripada alur keluar kuasa.

Sambungkan kabel video/audio

Pilih sambungan video terbaik yang boleh disokong oleh TV.

- **Pilihan 1:** Sambungkan ke bicu HDMI (untuk TV akur HDMI, DVI atau HDCP).
- **Pilihan 2:** Sambungkan ke bicu video komponen (bagi TV biasa atau TV Imbas Progresif).
- **Pilihan 3:** Sambungkan ke bicu video komposit (bagi TV biasa).

Pilihan 1: Sambungkan ke bicu HDMI

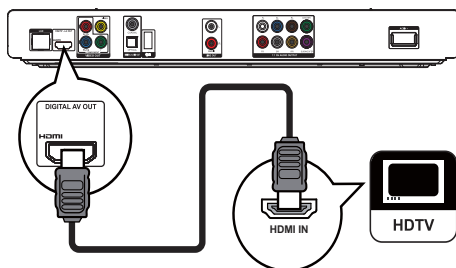

- 1 Sambungkan kabel HDMI (dibekalkan) kepada:
 - bicu **HDMI** pada produk ini.
 - bicu input HDMI pada TV.

Petua

- Jika TV mempunyai hanya penyambung DVI, sambungkan melalui penyesuai HDMI/DVI. Sambungkan kabel audio untuk output bunyi.
- Jika terdapat skrin kosong pada penyambungan HDMI, pada unit kawalan jauh, tekan  dan kemudian tekan "731" (butang angka) untuk memulihkan paparan gambar.
- Jika produk ini menyambung kepada TV yang serasi dengan 1080p atau 1080p/24Hz, Philips mengesyorkan kabel kategori 2 HDMI, yang juga dikenali sebagai kabel HDMI Halaju Tinggi, untuk output video dan audio yang optimum.
- Untuk memainkan balik imej video digital bagi video BD atau video DVD melalui sambungan HDMI, kedua-dua produk dan peranti paparan ini (atau penerima/amplifier AV) perlu menyokong sistem perlindungan hak cipta disebut HDCP (sistem perlindungan kandungan digital lebar jalur tinggi).
- Sambungan jenis ini menyediakan kualiti gambar yang paling baik.

Pilihan 2: Sambungkan ke bicu video komponen

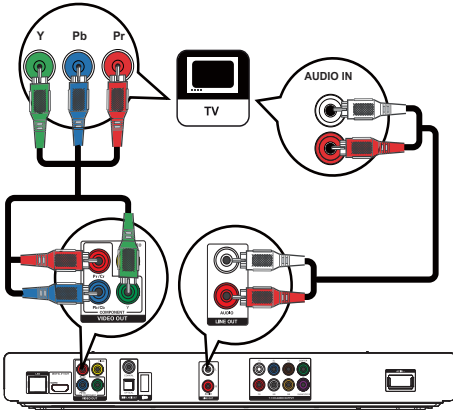

- 1 Sambungkan kabel video komponen (tidak dibekalkan) kepada:
 - bicu **Y Pb/Cb Pr/Cr** pada produk ini.
 - bicu input **VIDEO KOMPONEN** pada TV.
- 2 Sambungkan kabel audio kepada:
 - bicu **LINE OUT/AUDIO -L/R** pada produk ini.
 - bicu input **AUDIO** pada TV.

Petua

- Bicu input video komponen pada TV mungkin dilabelkan sebagai Y Pb Pr atau YUV.

Pilihan 3: Sambungkan ke bicu video komposit

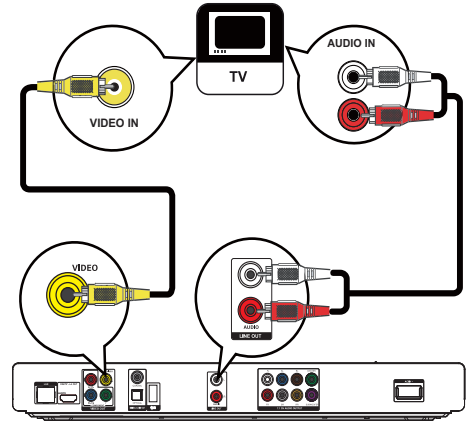

- 1 Sambungkan kabel video komposit ke:
 - bicu **VIDEO** pada produk ini.
 - bicu input **VIDEO** pada TV.
- 2 Sambungkan kabel audio kepada:
 - bicu **LINE OUT/AUDIO -L/R** pada produk ini.
 - bicu input **AUDIO** pada TV.

Petua

- Bicu input video pada TV mungkin dilabelkan sebagai A/V IN, VIDEO IN, COMPOSITE atau BASEBAND.

Halakan audio ke peranti lain

Anda boleh mengalakan audio daripada produk ini kepada peranti lain.

Sambung kepada penerima/penguat AV yang patuh HDMI

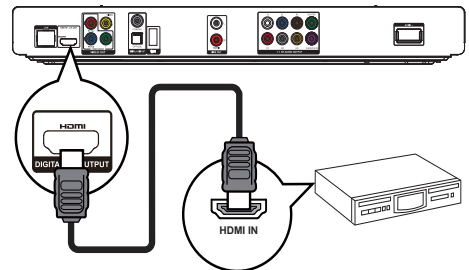

- 1 Sambungkan kabel HDMI (dibekalkan) kepada:
 - bicu **HDMI** pada produk ini.
 - bicu input bicu HDMI pada peranti.

Petua

- Sambungan HDMI menyediakan kualiti audio terbaik.

Sambung kepada penerima/penguat AV berbilang saluran

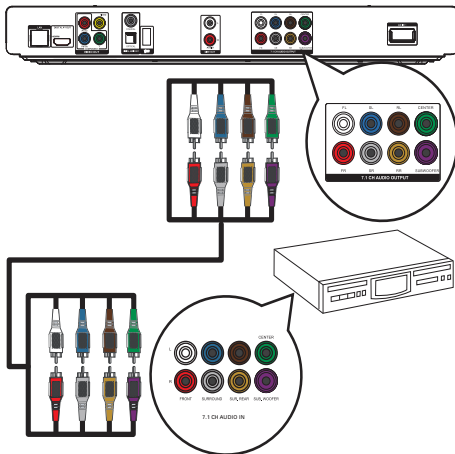

- 1 Sambungkan kabel audio saluran 7.1 (tidak dibekalkan) kepada:
 - bicu **7.1 CH AUDIO OUTPUT** pada produk ini.
 - bicu input **AUDIO** yang sepadan pada peranti.

Petua

- Untuk menyambungkan penerima/penguat AV 5.1 saluran, sambungkan bicu audio saluran 7.1 kecuali bicu **SL/SR**.
- Anda boleh mengoptimumkan output pembesar suara (lihat "Laraskan tetapan" > [Audio] > [Persediaan Pembesar Suara]).

Sambung kepada penguat/penerima AV digital

Sambungkan ke bicu sepaksi

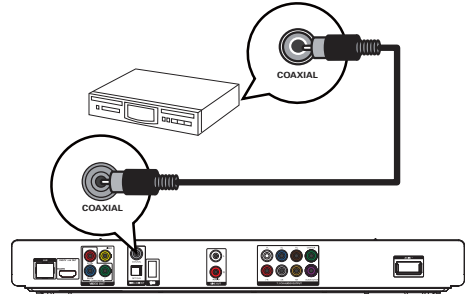

- 1 Sambungkan kabel sepaksi (tidak dibekalkan) ke:
 - bicu **COAXIAL** pada produk ini.
 - bicu input **SEPAKSI/DIGITAL** pada peranti.

Sambungkan ke bicu optik

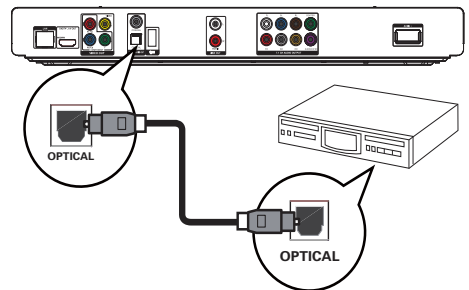

- 1 Sambungkan kabel optik (tidak dibekalkan) kepada:
 - bicu **OPTICAL** pada produk ini.
 - bicu input **OPTIK/DIGITAL** pada peranti.

Sambungkan sistem stereo analog

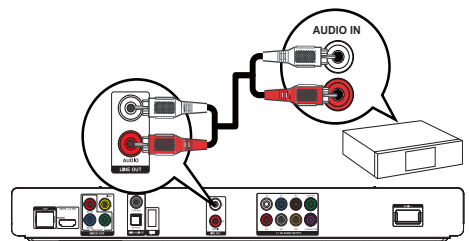



- 1 Sambungkan kabel audio kepada:
 - bicu **LINE OUT/AUDIO -L/R** pada produk ini.
 - bicu input **AUDIO** pada peranti.

Sambungkan peranti USB

- 1 Sambung peranti USB kepada bicu  (USB) pada panel hadapan produk ini.

Catatan

- Tekan  dan pilih [Semak Imbas USB] dalam menu untuk mengakses kandungan dan memainkan fail.
- Sambung peranti USB hanya kepada bicu  pada panel hadapan produk ini.
- Philips tidak menjamin keserasian dengan semua peranti USB.

Sambungkan rangkaian

Dengan sambungan berwayar atau wayarles (lihat "Bermula" > "Sediakan rangkaian"), anda boleh menyambung produk ini ke:

- Internet (untuk kemas kini perisian/BD Live/perkhidmatan Net TV).
- atau rangkaian rumah (untuk mengakses fail media daripada pelayan media DLNA, seperti PC).

Catatan

- Akses Internet kepada tapak web Philips untuk kemas kini perisian mungkin tidak dibenarkan, bergantung kepada penghala yang anda gunakan atau dasar Pembekal Perkhidmatan Internet. Hubungi Pembekal Perkhidmatan Internet anda untuk mendapatkan maklumat lanjut.

Sambungkan kuasa

! Awas

- Risiko kerosakan produk! Pastikan voltan bekalan kuasa sepadan dengan voltan yang dicetak pada bahagian belakang unit.
- Sebelum menyambungkan kord kuasa AC, pastikan anda telah melengkapkan semua sambungan lain.

Catatan

- Plat jenis terletak pada bahagian belakang produk.

- 1 Sambungkan kabel kuasa AC ke:
 - produk ini.
 - soket dinding.

↳ Produk ini sedia untuk disediakan untuk penggunaan.

4 Mulakan

! Awas

- Penggunaan kawalan atau pelarasan atau prestasi prosedur selain daripada yang terdapat di sini boleh menyebabkan dedahan sinaran yang berbahaya atau pengendalian lain yang tidak selamat.

Sentiasa ikuti arahan dalam bab ini mengikut urutan.

Sediakan kawalan jauh

- 1 Tekan dan tolak petak bateri untuk meluncurkannya hingga terbuka (lihat "1" dalam ilustrasi).
- 2 Masukkan dua bateri AAA dengan kutub (+/-) yang betul sebagaimana yang ditunjukkan.
- 3 Tolak dan luncurkan petak bateri ke belakang (lihat "3" dalam ilustrasi).

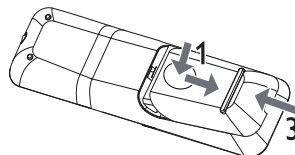

Catatan

- Jika anda tidak akan menggunakan kawalan jauh dalam tempoh masa yang panjang, keluarkan bateri.
- Jangan campurkan bateri (lama dan baru atau karbon dan alkali, dll).
- Bateri mengandungi bahan kimia, maka, ia harus dilupuskan dengan betul.

Cari input TV

- 1 Tekan  untuk menghidupkan produk ini.
- 2 Hidupkan TV dan tukar kepada input video (rujuk manual pengguna TV mengenai cara untuk memilih input A/V).

Gunakan menu Laman utama

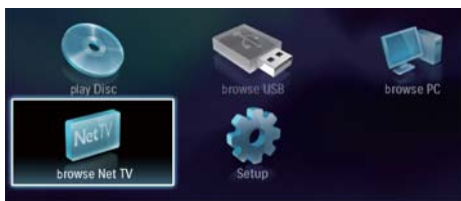

- 1 Tekan untuk memaparkan menu laman utama.
 - Untuk mula memainkan cakera, pilih **[mainkan cakera]**.
 - Untuk melihat kandungan USB, pilih **[Semak Imbas USB]**.
 - Untuk mengakses menu persediaan, pilih **[Persediaan]**.
 - Untuk mengakses fail media daripada pelayan media rangkaian rumah DLNA (seperti PC), pilih **[Layari PC]**.
 - Untuk mengakses perkhidmatan Net TV di Internet, pilih **[Layari Net TV]**.

Navigasi menu

- 1 When a menu is displayed, press the buttons on the remote control to navigate.

Butang	Tindakan
▲▼	Gerak ke atas atau bawah.
◀▶	Gerak ke kiri atau kanan.
OK	Sahkan pemilihan.
	Masukkan angka/huruf/teks.

Pilih bahasa paparan menu

Catatan

- Jika produk ini disambungkan ke TV yang mematuhi HDMI CEC, langkau tetapan ini. Ia dialih secara automatik ke bahasa menu OSD yang sama seperti tetapan TV anda (jika bahasa yang ditetapkan pada TV disokong oleh produk ini).

- 1 Dalam menu Laman utama, pilih **[Persediaan]** dan tekan **OK**.
- 2 Pilih **[Keutamaan]**, kemudian tekan .
- 3 Pilih **[Bahasa menu]**, kemudian tekan .

Video	Menu Language	English
Audio	Audio	Français
	Subtitle	Deutsch
Network	Disc Menu	Italiano
EasyLink	Parental Control	Español
	Screen Saver	Nederlands
Preference	Auto Subtitle Shift	Svenska
Advanced	Change Password	Português

- Pilihan bahasa mungkin berbeza dari rantaу berbeza.
- 4 Tekan untuk memilih bahasa, kemudian tekan **OK**.

Sediakan rangkaian

Anda boleh menyambungkan produk ini ke Internet (untuk kemas kini perisian/BD Live/perkhidmatan Net TV), atau ke rangkaian rumah (untuk mengakses fail media daripada pelayan media DLNA, seperti PC).

Untuk mengakses fail media daripada komputer anda, anda hendaklah memastikan bahawa:

- perisian pelayan media (seperti Windows Media Player 11) dipasang pada komputer anda;
- dan perisian pelayan media dikonfigurasi untuk mendayakan perkongsian media (Lihat dokumentasi “Bantuan” daripada perisian pelayan media).

Sediakan rangkaian berwayar

Catatan

- Pastikan bahawa kabel rangkaian disambung dengan betul.

- 1 Sambung kabel rangkaian (tidak dibekalkan) ke:
 - bicu LAN pada produk ini.
 - bicu LAN pada penghala dengan sambungan Internet.
- 2 Untuk mengakses fail media daripada komputer anda, sambung komputer kepada penghala.
- 3 Hidupkan produk ini, komputer dan penghala.

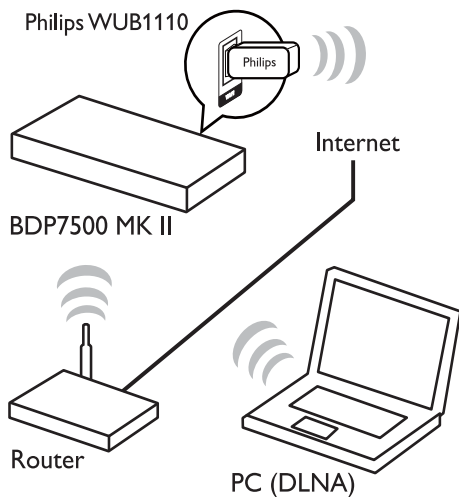
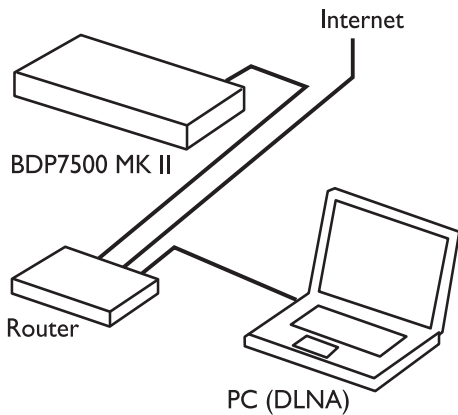

Petua

- Rangkaian berwayar menjamin prestasi terbaik bagi penghantaran data antara peranti.



Petua

- Prestasi wayarles berbeza-beza disebabkan oleh sambungan lebar jalur, lalu lintas pada sambungan, dan beberapa kesan persekitaran, seperti dikelilingi oleh panel logam atau konkrit berat, gangguan radio dan jarak liputan.

Sediakan rangkaian wayarles



Catatan

- Untuk sambungan tanpa wayar, anda perlu menggunakan penyesuai opsyenal Wi-Fi USB Philips (yang dinamakan WUB1110).
- Penyesuai Wi-Fi USB (WUB1110) tidak disertakan. Untuk membeli penyesuai ini, lawati shop.philips.com. Jika kedai dalam talian Philips tidak tersedia di negara anda, sila hubungi perkhidmatan pelanggan Philips. Untuk butiran hubungan, pergi ke www.philips.com/support.

- 1 Sambung penyesuai Wi-Fi USB Philips (yang dinamakan WUB1110, dijual berasingan) kepada bicu **Wi-Fi** pada bahagian belakang produk ini.
- 2 Untuk mengakses fail media daripada komputer anda, sambungkan komputer kepada penghalu.
- 3 Hidupkan produk ini, komputer dan penghalu.

Pasang sambungan rangkaian

Pada kali pertama anda menyambungkan rangkaian, pasang sambungan rangkaian.

- 1 Sediakan rangkaian berwayar atau wayarles.
- 2 Tekan untuk memaparkan menu laman utama.
- 3 Pilih **[Persediaan]** dan tekan **OK**.
- 4 Pilih **[Rangkaian]**, kemudian tekan .
- 5 Pilih **[Pemasangan Rangkaian]**, kemudian tekan **OK**.

Video	Network Installation ●
	View Network Settings ●
Audio	View Wireless Settings ●
	Net TV User Location ●
Network	Clear Net TV Memory ●
EasyLink	
Preference	
Advanced	

- 6 Ikut arahan pada skrin untuk melengkapkan pemasangan rangkaian.
- ↳ Selepas selesainya pemasangan rangkaian, anda boleh mengakses perkhidmatan: semak imbas Net TV, semak imbas PC, BD-Live, kemas kinian perisian.

Petua

- Anda dapat memeriksa status sambungan berwayar atau wayarles produk ini (lihat "Laraskan tetapan" > "Persediaan rangkaian" > **[Lihat Tetapan Rangkaian]** atau **[Lihat Tetapan Wayarles]**).

Gunakan Pautan Mudah Philips

Produk anda menyokong PautanMudah Philips, yang menggunakan protokol HDMI CEC (Kawalan Elektronik Pengguna). Anda boleh menggunakan satu kawalan jauh tunggal untuk mengawal peranti yang mematuhi PautanMudah yang disambungkan melalui penyambung HDMI.

Catatan

- Untuk mendayakan ciri PautanMudah, anda mesti menghidupkan operasi HDMI CEC pada TV dan pada peranti lain yang disambungkan pada TV. Rujuk kepada manual TV/peranti untuk butiran.

Mainan satu sentuhan

- 1 Tekan  (siap sedia) untuk menghidupkan produk ini.
- ↳ TV (jika ia menyokong mainan satu sentuhan) akan hidup dan bertukar kepada saluran video masuk yang betul secara automatik.
 - ↳ Jika cakera dimuat dalam produk ini, mainan cakera bermula secara automatik.

Siap sedia satu sentuhan

- 1 Tekan dan tahan  (siap sedia) selama lebih daripada 3 saat.
- ↳ Semua peranti yang disambungkan (jika peranti menyokong siap sedia satu sentuhan) bertukar ke siap sedia secara automatik.

Catatan



- Philips tidak menjamin kesalingfungsian dengan peranti HDMI CEC yang lain.

5 Main

Mainkan cakera

Awas

- Jangan letakkan sebarang objek selain daripada cakera ke dalam petak cakera.

- 1 Tekan  untuk membuka petak cakera.
- 2 Masukkan cakera dengan labelnya menghadap ke atas.
- 3 Tekan  untuk menutup petak cakera dan memulakan mainan cakera.
 - Untuk melihat mainan cakera, hidupkan TV pada input video.
 - Untuk menghentikan mainan cakera, tekan .

Catatan



- Semak format cakera/fail yang disokong (lihat "Produk anda" > "Media Boleh Main").
- Jika menu masukan kata laluan dipaparkan, masukkan kata laluan sebelum anda dapat memainkan cakera yang dikunci atau disekat (lihat "Laraskan tetapan" > "Persediaan Keutamaan" > **[Kawalan Ibubapa]**).
- Jika anda menjedakan atau menghentikan cakera, gambar skrin muncul setelah 10 minit tiada aktiviti. Untuk menyahaktifkan gambar skrin, tekan sebarang butang.
- Setelah anda menjeda atau menghentikan cakera dan tiada butang ditekan dalam masa 30 minit, produk ini akan bertukar ke mod siap sedia secara automatik.

Main dari peranti USB

Mainkan atau lihat fail media pada peranti USB berikut:

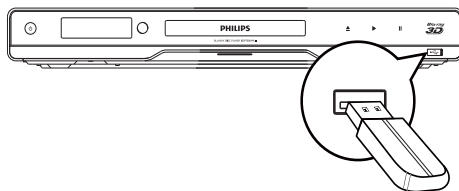
- pemacu denyar
- pembaca kad memori
- HDD (Produk ini hanya dapat mengesan pemacu cakera keras mudah alih dengan arus puncak kuasa USB yang tidak lebih daripada 500mA.)



- 1 Sambung peranti USB kepada bicu  (USB) pada panel hadapan produk ini.
- 2 Tekan , dan pilih **[Semak Imbas USB]**, kemudian tekan **OK**.
 - ↳ Menu kandungan dipaparkan.

- 3 Pilih fail untuk dimainkan, kemudian tekan OK.
- ↳ Mainan bermula (lihat "Mainkan video", "Mainkan foto", "Mainkan muzik" untuk butiran).
 - Untuk menghentikan mainan, tekan ■ atau keluarkan peranti USB.

Catatan

- Philips tidak menjamin keserasian dengan semua peranti USB.
- Tidak semua kamera digital disokong. Kamera digital yang memerlukan pemasangan program PC adalah tidak disokong.
- Format data NTFS (Sistem Fail Teknologi Baru) tidak disokong.

Mainkan video

Kawal mainan video

- 1 Mainkan tajuk.
- 2 Gunakan kawalan jauh untuk mengawal mainan.

Butang Tindakan

	Jedakan main. <ul style="list-style-type: none"> • Tekan berulang kali untuk main perlahan ke hadapan bingkai demi bingkai.
▶	Mula atau sambung semula main.
■	Hentikan main.
◀▶	Langkau ke tajuk atau bab sebelumnya/ seterusnya.
◀▶▶▶	Cari ke hadapan cepat atau ke belakang cepat. Tekan berulang kali untuk menukar kelajuan carian. <ul style="list-style-type: none"> • Tekan sekali , dan kemudian tekan berulang kali ◀▶▶▶ untuk memainkan perlahan ke belakang atau ke hadapan.

Catatan

- Bagi cakera BD dengan aplikasi Java, ketersediaan fungsi sambung main bergantung kepada cakera tertentu.

Tukar mainan video

- 1 Mainkan tajuk.
- 2 Gunakan kawalan jauh untuk menukar mainan.

Butang	Tindakan
AUDIO	Terus pilih bahasa atau saluran audio pada cakera.
SUBTITLE	Terus pilih bahasa sari kata pada cakera.
REPEAT	Terus pilih/matikan mod ulang atau kocok. <ul style="list-style-type: none"> • Ulang pilihan mungkin berbeza dari jenis cakera. • Untuk VCD, main berulang hanya boleh dibuat apabila mod PBC dimatikan.
☰ OPTIONS	Akses tindakan di atas atau lebih banyak pilihan.
ℹ INFO	Paparkan status semasa atau maklumat cakera.
BONUSVIEW	Hidupkan atau matikan video kedua dalam tettingkap skrin kecil semasa mainan (boleh digunakan hanya pada video BD yang menyokong BONUSVIEW atau ciri Gambar-Dalam-Gambar).

Catatan

- Sesetengah operasi mungkin tidak berfungsi dengan sesetengah cakera. Lihat maklumat yang dibekalkan bersama cakera untuk mendapatkan butiran.

Menu paparan

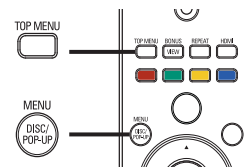

Cakera video BD

- **TOP MENU** menghentikan mainan video dan menunjukkan menu cakera. Ciri ini bergantung kepada cakera.
- **POP-UP MENU** mengakses menu cakera video BD tanpa mengganggu mainan cakera.

Cakera video DVD

- **TOP MENU** memaparkan menu asas bagi cakera.
- **DISC MENU** memaparkan maklumat cakera dan memandu anda melalui fungsi yang tersedia dalam cakera.

Cakera VCD/SVCD/DivX:

- **DISC MENU** memaparkan kandungan cakera.



Petua

- Jika tetapan PBC dimatikan, VCD/SVCD melangkaui menu dan mula bermain daripada tajuk pertama. Untuk memaparkan menu sebelum dimainkan, hidupkan tetapan PBC (lihat bab 'Laraskan tetapan' - [Keutamaan] > [VCD PBC]).

Pilih tajuk/bab

- 1 Semasa mainan, tekan **⏸** **OPTIONS**.
↳ Menu pilihan mainan dipaparkan.
- 2 Pilih [**Tajuk**] atau [**Bab**] dalam menu, kemudian, tekan **OK**.
- 3 Pilih tajuk atau nombor bab, kemudian tekan **OK**.

Langkau mainan ke masa tertentu

- 1 Semasa mainan, tekan **⏸** **OPTIONS**.
↳ Menu pilihan mainan dipaparkan.
- 2 Pilih [**Carian Masa**] dalam menu, kemudian tekan **OK**.
- 3 Tekan **butang Navigasi** (**▲▼**) untuk menukar masa untuk melangkaui, kemudian, tekan **OK**.

Zum masuk/keluar

- 1 Semasa mainan, tekan **⏸** **OPTIONS**.
↳ Menu pilihan mainan dipaparkan.
- 2 Pilih [**Zum**] dalam menu, kemudian tekan **OK**.
- 3 Tekan **butang Navigasi** (**◀▶**) untuk memilih faktor zum, kemudian tekan **OK**.
- 4 Tekan **butang Navigasi** untuk menavigasi dalam gambar yang dizum.
 - Untuk membatalkan mod zum, tekan **↩** **BACK** atau **OK** untuk memaparkan bar faktor zum, kemudian tekan **butang Navigasi** (**◀▶**) sehingga faktor zum [x1] dipilih.

Ulangkan mainan untuk bahagian tertentu

- 1 Semasa mainan, tekan **⏸** **OPTIONS**.
↳ Menu pilihan mainan dipaparkan.
- 2 Pilih [**Ulang A-B**] dalam menu, kemudian tekan **OK** untuk menetapkan titik mula.

- 3 Majukan mainan video, kemudian tekan **OK** untuk menetapkan titik akhir.
↳ Mainan ulangan bermula.
 - Untuk membatalkan mod main ulang, tekan **⏸** **OPTIONS**, dan pilih [**Ulang A-B**] kemudian tekan **OK**.



Catatan

- Bahagian yang bertanda untuk mainan ulangan hanya boleh dilakukan di dalam trek/tajuk.

Lihat mainan video daripada sudut kamera yang berlainan

- 1 Semasa mainan, tekan **⏸** **OPTIONS**.
↳ Menu pilihan mainan dipaparkan.
- 2 Pilih [**Senarai Sudut**] dalam menu, kemudian tekan **▶**.
- 3 Pilih pilihan sudut, kemudian tekan **OK**.
↳ Mainan perubahan kepada sudut yang dipilih.



Catatan

- Diguna pakai hanya pada cakera yang mengandungi pemandangan berbilang sudut.

Alih secara manual paparan sari kata

Anda boleh melaraskan secara manual kedudukan sari kata pada skrin TV.

- 1 Semasa mainan, tekan **⏸** **OPTIONS**.
↳ Menu pilihan mainan dipaparkan.
- 2 Pilih [**Anjak Sari Kata**] dalam menu, kemudian tekan **▶**.
- 3 Tekan **butang Navigasi** (**▲▼**) untuk mengalihkan sari kata, kemudian tekan **OK**.



Petua

- Alihan sari kata tidak disokong untuk video DivX dengan sari kata luaran.

Mainkan video BD

Video Blu-ray mempunyai kemampuan lebih besar dan menyokong ciri seperti video definisi tinggi, bunyi surround berbilang saluran, menu interaktif dan sebagainya.

- 1 Masukkan cakera video BD.
- 2 Tekan **▶**, pilih [**mainkan cakera**] kemudian tekan **OK**.

- 3 Mainan bermula secara automatik atau pilih pilihan mainan dalam menu dan tekan **OK**.
 - Semasa mainan, anda boleh menekan **TOP MENU** untuk memaparkan maklumat, ciri atau kandungan tambahan yang disimpan dalam cakera.
 - Sewaktu mainkan, anda boleh menekan **POP-UP MENU** untuk memaparkan menu cakera tanpa mengganggu mainan cakera.

Nikmati video 3D Blu-ray

Pemain ini dapat memainkan video 3D Blu-ray.

- 1 Pastikan bahawa TV patuh 3D dan HDMI, dan sambungkan TV kepada pemain ini melalui kabel HDMI.
- 2 Hidupkan output 3D Blu-ray (lihat "Laraskan tetapan" > [Video] > [Video Blu-ray 3D]).
- 3 Pakai cermin mata 3D yang serasi dengan TV untuk menonton.

Nikmati BONUSVIEW

(Boleh digunakan hanya pada cakera yang serasi dengan BONUSVIEW atau ciri Gambar-dalam-Gambar.

Anda boleh serta-merta melihat kandungan tambahan (seperti komentar) dalam tettingkap skrin kecil.

- 1 Tekan **BONUSVIEW** untuk menghidupkan tettingkap video kedua.
- 2 Tekan **OPTION**.
 - ↳ Menu pilihan mainan dipaparkan.
- 3 Pilih [**Bahasa Audio ke-2**] atau [**Bahasa Audio ke-2**] dalam menu, kemudian tekan **▶**.
- 4 Pilih bahasa untuk dimainkan, kemudian tekan **OK**.

Nikmati BD-LIVE

(boleh digunakan hanya pada cakera yang menyedai kandungan bonus BD-Live.)

Kandungan tambahan (seperti gazet filem, sari kata dll.) boleh dimuat turun kepada simpanan tempatan produk ini atau peranti penyimpanan USB yang bersambung. Data video khas mungkin dimainkan sementara ia dimuat turunkan.

Apabila cakera yang menyokong BD-Live dimainkan, ID produk atau cakera boleh dihantar kepada pembekal kandungan melalui internet. Perkhidmatan dan fungsi yang disediakan berbeza antara satu cakera dengan yang lain.

Mainkan video DivX®

Video DivX adalah format media digital yang mengekalkan kualiti yang tinggi walaupun pada kadar pemampatan yang tinggi.

- 1 Masukkan cakera atau peranti USB yang mengandungi video DivX.
- 2 Tekan **▶**, pilih [**mainkan cakera**] atau [**Semak Imbas USB**], kemudian tekan **OK**.
 - ↳ Menu kandungan dipaparkan.
- 3 Pilih folder video, kemudian tekan **OK**.
- 4 Pilih tajuk untuk dimainkan, kemudian tekan **OK**.
- 5 Gunakan kawalan jauh untuk mengawal mainan.

Butang	Tindakan
AUDIO	Pilih bahasa atau saluran audio.
SUBTITLE	Pilih bahasa sari kata.
■	Hentikan main.

Catatan

- Anda hanya boleh memainkan video DivX yang disewa atau dibeli dengan kod pendaftaran DivX produk ini (lihat 'Laraskan Tetapan' - [**Lanjutan**] > [**Kod VOD DivX®**]).
- Anda boleh memainkan fail video DivX sehingga 4GB.
- Produk ini boleh memaparkan sehingga 45 aksara dalam sari kata.

Mainkan foto

Mainkan foto sebagai pertunjukan slaid

Anda boleh memainkan foto JPEG (fail dengan lanjutan .jpeg atau .jpg).

- 1 Masukkan cakera atau peranti USB yang mengandungi foto JPEG.
- 2 Tekan **▶**, pilih [**mainkan cakera**] atau [**Semak Imbas USB**], kemudian tekan **OK**.
 - ↳ Menu kandungan dipaparkan.
- 3 Pilih folder foto, kemudian tekan **OK** untuk masuk.
 - Untuk memilih foto, tekan **butang Navigasi**.
 - Untuk membesarkan foto yang dipilih dan memulakan tayangan slaid, tekan **OK**.
- 4 Tekan **▶** untuk memulakan mainan tayangan slaid.



Catatan

- Masa yang lebih lama mungkin akan diambil untuk memaparkan kandungan cakera pada TV jika bilangan lagu/foto yang banyak dikumpulkan dalam satu cakera.
- Produk ini hanya boleh memaparkan gambar kamera digital berformat JPEG-EXIF, yang biasanya digunakan oleh kebanyakan kamera digital. Ia tidak boleh memaparkan Motion JPEG atau gambar dalam format selain daripada JPEG, atau klip bunyi yang dikaitkan dengan gambar.
- Folder/fail yang melebihi had disokong oleh produk ini tidak boleh dipaparkan atau dimainkan.

Kawal mainan foto

- 1 Mainkan pertunjukan slaid foto.
 - Tekan **OPTIONS** untuk mengakses pilihan mainan, pilih pilihan, kemudian tekan **OK**.
 - Semasa tayangan slaid dimainkan, anda juga boleh menekan **▲▼** untuk memutar foto secara mendatar/menegak.
 - Jika tayangan slaid berhenti, tekan **▶** untuk meneruskan mainan.

Tetapkan selang tayangan slaid dan animasi

- 1 Semasa mainan, tekan **OPTIONS**.
↳ Menu pilihan mainan dipaparkan.
- 2 Pilih [**Tempoh setiap slaid**] dalam menu, kemudian tekan **OK**.
- 3 Pilih tempoh, kemudian tekan **OK**.
- 4 Pilih [**Animasi Slaid**] dalam menu, kemudian tekan **OK**.
- 5 Pilih jenis kesan animasi, kemudian tekan **OK**.

Mainkan pertunjukan slaid muzikal

Buat pertunjukan slaid muzikal untuk memainkan fail muzik MP3/WMA dan fail foto JPEG dengan serentak.



Catatan

- Untuk membuat tayangan slaid muzikal, anda mesti menyimpan fail MP3/WMA dan JPEG pada cakera atau peranti USB yang sama.

- 1 Mainkan muzik MP3/WMA.
- 2 Tekan **BACK** untuk kembali ke menu utama.

- 3 Navigasi untuk memasukkan folder foto, kemudian tekan **OK** untuk mula memainkan tayangan slaid.
 - ↳ Tayangan slaid bermula dan berterusan sehingga penghujung folder foto.
 - ↳ Audio terus bermain sehingga akhir cakera.
 - Untuk menghentikan mainan tayangan slaid, tekan **■**.
 - Untuk menghentikan mainan muzik, tekan **■** sekali lagi.

Mainkan muzik

Kawal trek

- 1 Mainkan trek.
- 2 Gunakan kawalan jauh untuk mengawal mainan.

Butang	Tindakan
	Jedakan main.
	Mula atau sambung semula main
	Hentikan main.
	Langkau ke trek sebelumnya/ seterusnya.
	Pilih item untuk dimainkan.
	Cari ke hadapan cepat atau ke belakang cepat. Tekan berulang kali untuk menukar kelajuan carian.
REPEAT	Pilih atau matikan mod ulang atau shuffle.

Mainkan muzik MP3/WMA

MP3/WMA adalah sejenis fail audio termampat (fail dengan sambungan .mp3 dan .wma).

- 1 Masukkan cakera atau peranti USB yang mengandungi muzik MP3/WMA.
- 2 Tekan , pilih [**mainkan cakera**] atau [**Semak Imbas USB**], kemudian tekan **OK**.
↳ Menu kandungan dipaparkan.
- 3 Pilih folder muzik, kemudian tekan **OK**.
- 4 Pilih fail untuk dimainkan, kemudian tekan **OK**.
 - Untuk kembali ke menu utama, tekan **BACK**.



Catatan

- Bagi CD yang dirakam dalam berbilang sesi, hanya sesi pertama dimainkan.
- Untuk fail WMA yang dilindungi oleh Pengurusan Hak Digital (DRM), ia tidak boleh dimainkan pada produk ini.
- Pemain ini tidak menyokong format audio MP3PRO.
- Jika sebarang aksara khas terdapat di dalam nama trek MP3 (ID3) atau nama album, ia mungkin tidak dipaparkan dengan betul pada skrin kerana aksara ini tidak disokong.
- Folder/fail yang melebihi had disokong oleh produk ini tidak boleh dipaparkan atau dimainkan.

Semak imbas PC

Dengan rangkaian rumah, anda boleh memainkan video /muzik /foto yang distrimkan daripada pelayan media DLNA (seperti PC) kepada TV anda melalui produk diperakui DLNA ini.



Catatan

- Untuk menyemak imbas PC, pastikan bahawa perisian pelayan media DLNA (seperti Windows Media Player 11) dipasang pada PC.

- 1 Sediakan rangkaian rumah (lihat "Bermula" > "Sediakan rangkaian").
 - Pastikan bahawa anda telah menyelesaikan pemasangan rangkaian.
- 2 Pada komputer anda, dalam perisian pelayan media DLNA, anda hendaklah menetapkan:
 - ① Kongsi media saya dengan produk ini (lihat maklumat "Bantuan" dalam perisian pelayan media).
 - ② Kongsi fail atau tambah fail kepada pustaka (lihat maklumat "Bantuan" dalam perisian pelayan media).
- 3 Tekan untuk memaparkan menu laman utama.
- 4 Pilih **[Layari PC]**, kemudian tekan **OK**.
 - ↳ Produk ini secara automatik mengimbas, dan memaparkan senarai bagi peranti rangkaian yang tersedia.
- 5 Pilih komputer anda daripada senarai, dan tekan **OK**.
- 6 Pilih fail media daripada pelayan media DLNA (komputer anda).
- 7 Tekan **OK** untuk memulakan mainan.
 - Anda boleh mengawal mainan dengan ciri mainan (lihat "Mainkan video", "Mainkan foto", "Mainkan muzik" untuk butiran).



Catatan

- Fail media mungkin tidak dimainkan dengan betul, atau fungsi mainan mungkin terhad.
- Semasa fail dimainkan, suatu bingkai imej mungkin hilang atau bunyi mungkin terlangkau, bergantung kepada prestasi pelayan media dan persekitaran rangkaian.

Semak Imbas Net TV

Sambung produk ini kepada Internet untuk mengakses perkhidmatan Net TV dalam talian, seperti filem, gambar, maklumat hiburan muzik. Anda dapat menikmati Net TV pada TV anda yang bersambung dengan produk ini.



Catatan

- Oleh kerana Net TV adalah sistem dalam talian, ia boleh diubah suai sepanjang masa untuk memenuhi fungsinya dengan lebih baik.
- Beberapa perkhidmatan Net TV dapat ditambah, diubah atau dihentikan selepas tempoh masa tertentu.
- Pada Net TV, anda tidak boleh memuat turun dan menyimpan fail, mahupun memasang pasang masuk.

- 1 Sediakan rangkaian (lihat "Bermula" > "Sediakan rangkaian").
 - Pastikan bahawa anda telah menyelesaikan pemasangan rangkaian.
- 2 Tekan untuk memaparkan menu laman utama.
- 3 Pilih **[Layari Net TV]**, kemudian tekan **OK**.
 - ↳ Produk ini mula menyambung kepada Net TV dan membuka halaman permulaan.
 - ↳ **Pada penggunaan kali pertama**, ikuti arahan pada skrin untuk melengkapkan pendaftaran, kemudian hidupkan kawalan ibu bapa untuk mengunci/membuka kunci perkhidmatan yang ditawarkan pada halaman Net TV.

Butang	Tindakan
	Pilih perkhidmatan, atau item pada halaman Internet.
OK	Sahkan pemilihan.
BACK	Kembali ke halaman sebelumnya, atau padam teks input.
OPTIONS	Akses tindakan yang berkaitan dengan aktiviti semasa.
	Masukkan angka/huruf (seperti alamat e-mel dan kod untuk mengunci/membuka kunci).

Halaman permulaan Net TV

Tunjukkan perkhidmatan kegemaran anda dan beberapa perkhidmatan yang disyorkan.

Halaman Semak imbas semua



Anda dapat melihat semua perkhidmatan Net TV mengikut kategori. Perkhidmatan kegemaran ditandakan sebagai ikon bintang.

Semak imbas negara lain

Pada halaman Semak imbas semua, anda boleh menukar negara Net TV. Negara lain mungkin mempunyai perkhidmatan berlainan.





Tandakan kegemaran

Anda boleh menandakan sehingga 12 perkhidmatan. Hanya perkhidmatan Net TV yang dapat ditandakan sebagai kegemaran. Laman web iklan dan Internet terbuka tidak dapat ditandai.

- 1) Pilih ikon bagi perkhidmatan.
 - 2) Tekan  **OPTIONS** untuk memilih Tandakan kegemaran, kemudian tekan **OK**.
 - Untuk membuang tanda kegemaran, tekan  **OPTIONS** untuk memilih tindakan membuang tanda lalu tekan **OK**.
-

Laman web Internet terbuka

Dengan Net TV anda dapat menyambung kepada Internet terbuka. Anda boleh melayari mana-mana laman web. Jangan lupa bahawa kebanyakan laman web tidak disesuaikan untuk dilihat pada skrin TV.

- 1) Pada halaman Semak imbas semua, pilih Semak imbas Internet, kemudian tekan **OK**.
 - 2) Pada papan kekunci atas skrin, pilih aksara lalu tekan **OK**. Ulangi Langkah 2 untuk memasukkan alamat web.
 - Untuk memadam teks input, tekan  **BACK**.
 - Untuk menavigasi ke pautan yang tersedia pada halaman internet terbuka, tekan     pada alat kawalan jauh, dan tekan **OK** untuk membuka pautan.
-





Catatan

- Koninklijke Philips Electronics N.V. tidak menanggung sebarang tanggungjawab terhadap kualiti kandungan yang dibekalkan oleh pembekal perkhidmatan kandungan.

Kawalan ibu bapa

Anda boleh mengunci perkhidmatan Net TV dan kategori perkhidmatan. Apabila perkhidmatan berkunci, anda perlu memasukkan kod untuk membuka perkhidmatan atau kategori tersebut.

- 1) Hidupkan Kawalan ibu bapa:
 - a. Pada halaman permulaan Net TV, tekan  **OPTIONS**, pilih Dayakan kawalan ibu bapa lalu tekan **OK**.
 - b. Menggunakan pad kekunci pada alat kawalan jauh, masukkan kod 4 digit sebagai kod mengunci/membuka kunci.
 - c. Masukkan kod yang sama untuk mengesahkan.
 - 2) Pada halaman permulaan Net TV atau halaman Semak imbas semua, pilih perkhidmatan atau kategori.
 - 3) Tekan  **OPTIONS**, pilih Kunci perkhidmatan, kemudian tekan **OK**.
 - ↳ Simbol kunci muncul pada bahagian atas ikon perkhidmatan.
 - Untuk membuka kunci perkhidmatan atau kategori, pilih perkhidmatan kemudian tekan  **OPTIONS** lalu pilih Buka kunci.
-



Catatan

- Hanya perkhidmatan pada halaman Net TV sahaja yang boleh dikunci. Laman web iklan dan Internet terbuka tidak dapat dikunci.
- Perkhidmatan dikunci mengikut negara. Kategori dikunci bagi semua negara.
- Apabila anda telah mendaftar untuk Net TV dan anda mematikan kawalan ibu bapa dalam menu Opsyen, semua kunci akan diingati dan tersedia semula apabila anda menghidupkan semula Kawalan ibu bapa.

Kosongkan sejarah

Kosongkan kod Kawalan ibu bapa, kata laluan, kuki dan sejarah.

- 1) Tekan  untuk memaparkan menu laman utama.
 - 2) Pilih **[Persediaan] > [Rangkaian] > [Kosongkan Memori Net TV]**.
-



Catatan



- Jika anda mengosongkan ingatan Net TV dengan mengosongkan sejarah, anda perlu membuat semula pendaftaran penggunaan pertama apabila anda menyambung kepada Net TV sekali lagi. Jika anda telah pun mendaftar sebelumnya, anda dapat mengembalikan perkhidmatan kegemaran anda dan kunci anda yang dahulu.

6 Laraskan tetapan



Catatan

- Jika pilihan persediaan dikelabukan, ia bermaksud tetapan tidak boleh ditukar pada keadaan semasa.

Persediaan video

- 1 Tekan .
- 2 Pilih **[Persediaan]**, kemudian tekan **OK**.
- 3 Pilih **[Video]**, kemudian tekan .

Video	TV Display	● 16:9 Widescreen
Audio	HDMI Video	● Auto
	HDMI Deep Color	● Auto
Network	Component Video	● 480i/576i
EasyLink	Picture Settings	● Standard
Preference		
Advanced		

- 4 Buat pilihan, kemudian tekan **OK**.
- 5 Pilih tetapan, kemudian tekan **OK**.
 - Untuk kembali ke menu sebelumnya, tekan  **BACK**.
 - Untuk keluar dari menu, tekan .

[Papar TV]

Pilih format paparan:



4:3 Letter Box (LB)



4:3 Pan Scan (PS)



16:9 (Wide Screen)



16:9

- **[Format Peti Surat 4:3]** – Untuk skrin TV 4:3: paparan skrin lebar dengan bar hitam di bahagian atas dan bawah skrin.
- **[Format Gerak Imbas 4:3]** – Untuk skrin TV 4:3: paparan ketinggian penuh dengan tepi yang dipotong.
- **[16:9 Skrin Lebar]** – Untuk TV skrin lebar: papar gambar pada nisbah 16:9.

- **[16:9]** – Untuk skrin TV 16:9: paparkan gambar pada nisbah 4:3 bagi cakera dengan nisbah 4:3, dengan bar hitam di sebelah kiri dan kanan skrin.

Catatan

- Jika **[Format Gerak Imbas 4:3]** yang anda telah pilih tidak disokong oleh cakera, skrin memaparkan dalam format **[Format Peti Surat 4:3]**.

[Video HDMI]

Pilih resolusi output video HDMI yang serasi dengan kemampuan paparan TV anda.

- **[Auto]** - Kesan dan pilih resolusi video yang paling disokong secara automatik.
- **[Asal]** - Tetapkan resolusi video asal.
- **[480i/576i], [480p/576p], [720p], [1080i], [1080p], [1080p/24Hz]** - Pilih tetapan resolusi video yang paling disokong oleh TV. Lihat manual TV untuk mendapatkan butiran.

Catatan

- Jika resolusi video yang dipilih tidak disokong pada TV anda dan skrin kosong muncul, untuk memulihkan paparan gambar, tunggu selama 10 saat, atau pada unit kawalan jauh tekan  dan kemudian tekan "731" (butang angka).

[HDMI Deep Color]

Ciri ini tersedia hanya apabila peranti paparan disambungkan dengan kabel HDMI, dan apabila ia menyokong ciri warna pekat.

- **[Auto]** - Menikmati imej terang dalam lebih daripada satu bilion warna pada TV yang didayakan dengan Warna Pekat.
- **[Hidup]** - Menikmati imej terang dalam lebih daripada satu bilion warna pada TV yang didayakan dengan Warna Pekat. Mengoutput warna 12 bit yang mengurangkan kesan posterisasi.
- **[Mati]** - Output standard warna 8 bit.

[Video Komponen]

Memilih resolusi output video komponen yang serasi dengan kemampuan paparan TV.

- **[480i/576i], [480p/576p], [720p], [1080i]** - Pilih tetapan resolusi video yang paling baik disokong oleh TV. Lihat manual TV untuk mendapatkan butiran.

Catatan

- Jika tetapan tidak serasi dengan TV, skrin kosong muncul. Tunggu selama 10 saat untuk pemulihan automatik.
- DVD yang dilindungi salin hanya boleh mengoutput resolusi 480p/576p atau 480i/576i.

[Tetapan Gambar]

Memilih set pratentu bagi tetapan warna gambar.



- **[Standard]** – Tetapan warna asal.
- **[Terang]** – Tetapan warna terang.
- **[Dingin]** - Tetapan warna lembut.
- **[Tindakan]** – Tetapan warna jelas. Ia meningkatkan butiran di kawasan gelap. Sempurna untuk filem aksi.
- **[Animasi]** – Tetapan warna kontras. Sempurna untuk gambar animasi.

[Video Blu-ray 3D]



Tetapkan kepada output 2D atau 3D apabila memainkan cakera 3D Blu-ray.

- **[Auto]** - Dayakan output 3D jika cakera 3D Blu-ray dimuatkan dan TV patuh 3D dan HDMI, dan TV disambung melalui kabel HDMI. Jika tidak, hanya output 2D akan dikeluarkan.
- **[Mati]** - Matikan output 3D untuk mendayakan output 2D.

Persediaan audio

- 1 Tekan .
- 2 Pilih **[Persediaan]**, kemudian tekan **OK**.
- 3 Pilih **[Audio]**, kemudian tekan .

Video	Night Mode	● Off
	Neo 6	● Off
Audio	HDMI Audio	● Auto
Network	Digital Audio	● Auto
EasyLink	PCM Downsampling	● On
Preference	Speaker Setup	●
Advanced		

- 4 Buat pilihan, kemudian tekan **OK**.
- 5 Pilih tetapan, kemudian tekan **OK**.
 - Untuk kembali ke menu sebelumnya, tekan  **BACK**.
 - Untuk keluar daripada menu, tekan .

[Mod Malam]

Tingkatkan tahap bunyi lembut seperti dialog agar mudah untuk didengar pada kelantangan rendah, sambil pada masa yang sama mengurangkan tahap bunyi yang lantang.

- **[Auto]** - Kesan dan pilih tahap bunyi terbaik pada kelantangan rendah. Digunakan pada trek dengan audio Dolby TrueHD sahaja.
- **[Hidup]** – Untuk tontonan senyap pada waktu malam.

- **[Mati]** – Untuk bunyi surround dengan julat dinamik lengkap.

Catatan

- Digunakan hanya pada video DVD atau video BD yang mempunyai pengkodan Dolby.

[Neo 6]

Pasca pemprosesan oleh DTS untuk menjana kesan bunyi surround daripada audio 2 saluran.

- **[Panggung wayang]** – Dayakan pasca pemprosesan Neo 6 kepada mod pawagam.
- **[Muzik]** - Dayakan pasca pemprosesan Neo 6 kepada mod muzik.
- **[Mati]** – Nyahdayakan pasca pemprosesan Neo 6.

[Audio HDMI]

Memilih output audio HDMI apabila anda menyambungkan produk ini dan peranti TV/audio dengan kabel HDMI.

- **[Strim Bit]**– Pilih pengalaman audio HD asal yang terbaik (hanya melalui penerima serasi audio HD).
- **[Auto]**- Mengesan dan memilih resolusi audio yang paling disokong secara automatik.

[Audio Digital]

Memilih format audio bagi output bunyi daripada bicu DIGITAL OUT(sepaksi /optik).

- **[Auto]**- Mengesan dan memilih resolusi audio yang paling disokong secara automatik.
- **[PCM]** - Peranti audio tidak menyokong format berbilang saluran. Audio dicampur turun menjadi bunyi dua saluran.
- **[Strim Bit]** - Memilih audio asal supaya mengalami audio Dolby atau DTS (Kesan bunyi istimewa video BD dinyahdayakan).

Catatan

- Pastikan format audio disokong oleh cakera dan peranti audio yang bersambung (amplifier/penerima).
- Apabila **[Strim Bit]** dipilih, audio interaktif seperti bunyi butang dibisukan.

[Pensampelturunan PCM]

Menetapkan kadar pensampelan bagi output audio PCM daripada bicu DIGITAL OUT (sepaksi/optik).

- **[Hidup]** - Audio PCM akan disampelkan turun pada 48kHz.
- **[Mati]** - Bagi BD atau DVD yang dirakam dalam LPCM tanpa perlindungan hak cipta, isyarat audio dua saluran sehingga 96 kHz dioutputkan sebagai isyarat LPCM dengan tiada penukaran.

[Persediaan Pembesar Suara]

Optimumkan output surround untuk sistem pembesar suara yang disambungkan.

- **[Persediaan Pembesar Suara]** - Aktifkan nada ujian bagi pembesar suara dan subwufer.
- **[Jarak Pembesar Suara]** - Tetapkan masa tunda bagi pembesar suara dan subwufer sekiranya ia diletakkan lebih dekat dengan kedudukan pendengaran, supaya output bunyi daripada semua pembesar suara tiba di kedudukan pendengaran pada masa yang sama.
- **[Kelantangan Pembesar Suara]** - Tetapkan tahap kelantangan pembesar suara dan subwufer untuk mendapatkanimbangan audio yang ideal.
- **[Saiz Pembesar Suara]**
 - Tetapkan saiz pembesar suara bagi pembesar suara dan subwufer.
 - Pilih saiz **[Besar]** untuk pembesar suara yang boleh mengeluarkan isyarat frekuensi rendah di bawah 120 Hz.
 - Pilih **[Mati]** jika tiada pembesar suara disambungkan.
 - Jika pembesar suara hadapan ditetapkan pada **[Kecil]**, tetapan subwufer ialah **[Hidup]** dan tidak boleh ditukar.
 - Jika subwufer ditetapkan pada **[Mati]**, tetapan pembesar suara hadapan ialah **[Besar]** dan tidak boleh ditukar.



Petua

- Nada ujian dipancarkan daripada pembesar suara semasa melaraskan tahap kelantangan.
- Benarkan tetapan 1ms bagi setiap jarak 30cm antara pembesar suara dan kedudukan pendengaran.

Persediaan rangkaian

- 1 Tekan .
- 2 Pilih **[Persediaan]**, kemudian tekan **OK**.
- 3 Pilih **[Rangkaian]**, kemudian tekan .

Video	Network Installation ●
Audio	View Network Settings ●
Network	View Wireless Settings ●
EasyLink	Net TV User Location ●
Preference	Clear Net TV Memory ●
Advanced	

- 4 Buat pilihan, kemudian tekan **OK**.
- 5 Pilih tetapan, kemudian tekan **OK**.
 - Untuk kembali ke menu sebelumnya, tekan **BACK**.
 - Untuk keluar daripada menu, tekan .

[Pemasangan Rangkaian]

Pasang sambungan rangkaian.

[Lihat Tetapan Rangkaian]

Paparkan maklumat status rangkaian semasa.

[Lihat Tetapan Wayarles]

Paparkan maklumat status Wi-Fi semasa.

[Lokasi Pengguna Net TV]

Pilih lokasi pelayan Philips yang menyediakan perkhidmatan Net TV.

[Kosongkan Memori Net TV]

Kosongkan kuki, sejarah, data yang anda masukkan untuk Net TV yang disimpan dalam ruang cache penyemak imbas web.

Persediaan EasyLink

- 1 Tekan .
- 2 Pilih **[Persediaan]**, kemudian tekan **OK**.
- 3 Pilih **[EasyLink]**, kemudian tekan .

Video	EasyLink ● On
Audio	One Touch Play ● On
Network	One Touch Standby ● On
EasyLink	
Preference	
Advanced	

- 4 Buat pilihan, kemudian tekan **OK**.
- 5 Pilih tetapan, kemudian tekan **OK**.
 - Untuk kembali ke menu sebelumnya, tekan **BACK**.
 - Untuk keluar daripada menu, tekan .

[EasyLink]

Produk ini menyokong EasyLink Philips yang menggunakan protokol HDMI CEC (Kawalan Elektronik Pengguna). Anda boleh menggunakan alat kawalan jauh tunggal untuk mengawal semua peranti patuh EasyLink yang disambungkan melalui penyambung HDMI.

- **[Hidup]** - Hidupkan ciri EasyLink.
- **[Mati]** - Nyahdayakan ciri EasyLink.

[Main Satu Sentuhan]

Apabila anda menekan  (siap sedia) untuk menghidupkan produk ini, TV (jika TV menyokong mainan satu sentuhan) secara automatik akan dihidupkan dan beralih kepada saluran video masuk. Mainan cakera bermula jika terdapat cakera dalam produk ini.

- **[Hidup]** - Menghidupkan ciri mainan satu sentuhan.
- **[Mati]** - Menyahdayakan ciri mainan satu sentuhan.

[Siap Sedia Satu Sentuhan]

Apabila anda tekan dan tahan  (siap sedia), semua peranti HDMI CEC yang bersambung (jika peranti menyokong siap sedia satu sentuhan) beralih kepada mod siap sedia dengan serentak.



- **[Hidup]** - Menghidupkan ciri mainan satu sentuhan.
- **[Mati]** - Menyahdayakan ciri mainan satu sentuhan.





Catatan

- Anda mesti menghidupkan operasi HDMI CEC pada TV/peranti anda sebelum anda boleh menikmati kawalan Pautan Mudah. Lihat manual TV/peranti untuk mendapatkan butiran.
- Philips tidak menjamin 100% kesalingfungsian dengan semua peranti yang mematuhi HDMI CEC.

Persediaan keutamaan

- 1 Tekan .
- 2 Pilih **[Persediaan]**, kemudian tekan **OK**.
- 3 Pilih **[Keutamaan]**, kemudian tekan .

Video	Menu Language	● English
Audio	Audio	● English
	Subtitle	● Off
Network	Disc Menu	● English
EasyLink	Parental Control	● Off
	Screen Saver	● On
Preference	Auto Subtitle Shift	● On
	Change Password	●
Advanced		

- 4 Buat pilihan, kemudian tekan **OK**.
- 5 Pilih tetapan, kemudian tekan **OK**.
 - Untuk kembali ke menu sebelumnya, tekan  **BACK**.
 - Untuk keluar daripada menu, tekan .

[Bahasa menu]

Pilih bahasa menu pada-skrin.



Catatan

- Jika produk ini disambungkan pada TV yang mematuhi HDMI CEC menggunakan kabel HDMI, ia bertukar ke bahasa paparan menu yang sama seperti tetapan TV anda (jika bahasa yang ditetapkan pada TV tidak disokong oleh produk ini).

[Audio]

Pilih bahasa audio untuk mainan cakera.

[Sari Kata]

Pilih bahasa sari kata untuk mainan cakera.

[Menu Cakera]

Pilih bahasa untuk menu cakera.



Catatan

- Jika bahasa yang telah anda tetapkan tidak tersedia pada cakera, cakera menggunakan bahasa lainnya sendiri.
- Untuk sesetengah cakera, bahasa sari kata/audio hanya boleh ditukar daripada menu cakera.

[Kawalan Ibubapa]

Hadkan akses kepada cakera yang tidak sesuai untuk anak-anak anda. Cakera jenis ini mesti dirakam bersama pengedaran.

Untuk akses, masukkan kata laluan terakhir yang anda tetapkan atau '0000'.



Catatan

- Cakera yang nilai pengedarannya melebihi tahap yang anda tetapkan dalam **[Kawalan Ibubapa]** memerlukan kata laluan untuk dimainkan.
- Pengedaran adalah bergantung kepada negara. Untuk membenarkan semua cakera untuk dimainkan, pilih **'8'** untuk video DVD dan Video BD.
- Sesetengah cakera mempunyai kadar yang tercetak padanya tetapi tidak dirakam bersama kadar. Fungsi ini tidak memberi kesan pada cakera sedemikian.

[Penyelamat Skrin]

Hidupkan atau matikan mod gambar skrin. Ia membantu melindungi skrin TV daripada mengalami kerosakan disebabkan oleh pendedahan berlebihan kepada imej statik buat tempoh masa yang terlalu lama.

- **[Hidup]** - Tetapkan gambar skrin aktif selepas 10 minit bagi tiada aktiviti (contohnya, dalam mod jeda atau berhenti)
- **[Mati]** - Nyahdayakan mod gambar skrin.

[Anjak Sari Kata Automatik]

Hidupkan atau matikan alihan automatik sari kata.

- **[Hidup]** - Kedudukan sari kata pada skrin TV dilaraskan secara automatik.

- **[Mati]** - Nyahdayakan alihan automatik sari kata.

[Tukar Kata Laluan]

Tetapkan atau tukar kata laluan.

- 1) Tekan butang Angka untuk memasukkan kata laluan atau kata laluan anda yang terakhir ditetapkan. Jika anda terlupa kata laluan anda, masukkan '0000', kemudian tekan **OK**.
- 2) Masukkan kata laluan baru.
- 3) Masukkan kata laluan yang sama sekali lagi.
- 4) Berpindah ke **[Sahkan]** dalam menu dan tekan **OK**.

[Panel Paparan]

Memilih tahap kecerahan bagi paparan panel hadapan.

- **[Normal]** - Kecerahan biasa.
- **[Malap]** - Untuk menyuramkan paparan.

[Auto Siap Sedia]

Hidupkan atau matikan mod siap sedia. Ia adalah ciri penjimatan tenaga.



- **[Hidup]** – Bertukar ke siap sedia selepas 30 minit tiada aktiviti (contohnya, dalam mod jeda atau berhenti).
- **[Mati]** - Menyahdayakan mod siap sedia.

[VCD PBC]

Menghidupkan atau mematikan menu kandungan VCD/SVCD dengan ciri PBC (kawalan main balik).



- **[Hidup]** - Memaparkan menu indeks apabila anda memuatkan cakera untuk dimainkan.
- **[Mati]** - Melangkau menu dan memulakan mainan daripada tajuk pertama.

Persediaan lanjutan

- 1 Tekan .
- 2 Pilih **[Persediaan]**, kemudian tekan **OK**.
- 3 Pilih **[Lanjutan]**, kemudian tekan .

Video	BD Live Security	● Off
	Software Update	●
Audio	Clear Memory	●
Network	Local Storage	● Internal
EasyLink	DivX® VOD Code	●
Preference	Version Info.	●
Advanced	Restore Default Settings	●

- 4 Buat pilihan, kemudian tekan **OK**.

- 5 Pilih tetapan, kemudian tekan **OK**.
 - Untuk kembali ke menu sebelumnya, tekan  **BACK**.
 - Untuk keluar dari menu, tekan .

[Keselamatan BD-Live]

Anda boleh menghadkan akses internet untuk kandungan bonus BD-Live yang disediakan untuk cakera Blu-ray tertentu.

- **[Hidup]** - Akses Internet dilarang bagi semua kandungan BD-Live.
- **[Mati]** - Akses Internet dibenarkan bagi semua kandungan BD-Live.

[Kemas Kini Perisian]

Kemas kini perisian produk ini (jika versi lebih baru tersedia di tapak web Philips) untuk meningkatkan prestasi produk ini.

- **[USB]** - Kemas kini perisian daripada peranti USB yang disambung kepada produk ini.
- **[Network]** - Kemas kini perisian daripada internet.

Catatan

- Untuk kemas kini perisian yang terperinci, lihat "Maklumat tambahan" > "Kemas kini perisian".

[Kosongkan memori]

Padamkan data BD-Live yang dimuat turun pada memori dalaman pemain ini atau pemacu denyar USB yang tersambung.

Pada peranti denyar USB yang tersambung, folder bernama "BUDA" diwujudkan secara automatik untuk menyimpan data BD-Live yang dimuat turun.

[Kosongkan Storan Tempatan]

Pilih lokasi tempat menyimpan data BD-Live yang dimuat turun.

- **[Dalaman]** - Simpan muat turun pada memori dalaman pemain ini.
- **[Luaran]** - Simpan muat turun pada pemacu denyar USB yang bersambung.

[Kod VOD DivX®]

Dapatkan kod pendaftaran DivX® atau kod pembatalan pendaftaran.

Petua

- Masukkan kod pendaftaran DivX produk ini apabila anda menyewa atau membeli video daripada www.divx.com/vod. Video DivX yang disewa atau dibeli melalui perkhidmatan DivX® VOD (Video Atas Permintaan) boleh dimainkan hanya pada peranti yang didaftarkan.

[Maklumat Versi]

Paparkan versi perisian dan alamat MAC produk ini.



- Maklumat ini diperlukan untuk anda menyemak jika versi perisian terkini disediakan pada tapak web Philips supaya anda boleh memuat turun dan memasang pada produk ini.

[Kembalikan tetapan lalai]

Tetapkan semula semua tetapan produk ini ke tetapan kilang, kecuali untuk tetapan [Kawalan Ibubapa].

7 Maklumat tambahan

Kemas kinikan perisian

Untuk kemas kinian perisian untuk meningkatkan prestasi, semak versi perisian semasa bagi produk ini untuk membandingkan dengan perisian terkini (jika ada) di tapak web Philips.

- 1 Tekan .
- 2 Pilih [Persediaan], kemudian tekan OK.
- 3 Pilih [Lanjutan] > [Maklumat Versi], kemudian tekan OK.

Kemas kini perisian melalui rangkaian

- 1 Sediakan sambungan internet (lihat "Bermula" > "Sediakan rangkaian").
- 2 Dalam menu Utama, pilih [Persediaan] > [Lanjutan] > [Kemas Kini Perisian] > [Network].
 - ↳ Anda digesa untuk memulakan proses naik taraf jika naik taraf media dikesan.
- 3 Ikut arahan pada skrin TV untuk mengesahkan operasi kemas kinian.
 - ↳ Sebaik sahaja kemas kinian perisian selesai, produk ini dimatikan kepada siap sedia secara automatik.

Kemas kinikan perisian melalui USB

- 1 Pergi ke www.philips.com/support untuk melihat jika versi perisian terkini disediakan untuk produk ini.
- 2 Muat turun perisian pada pemacu denyar USB:
 - ① Buka zip fail yang dimuat turun, dan pastikan folder yang dinyahzip diberi nama "UPG".
 - ② Letakkan folder "UPG" di dalam direktori induk.
- 3 Masukkan pemacu denyar USB pada bicu  (USB) pada panel hadapan produk ini.
- 4 Dalam menu Utama, pilih [Persediaan] > [Lanjutan] > [Kemas Kini Perisian] > [USB].
- 5 Ikut arahan pada skrin TV untuk mengesahkan operasi kemas kinian.
 - ↳ Sebaik sahaja kemas kinian perisian selesai, produk ini dimatikan kepada siap sedia secara automatik.



Catatan

- Jangan matikan kuasa atau mencabut pemacu denyar USB semasa kemas kinian perisian dalam perkembangan untuk mengelakkan kemungkinan kerosakan produk ini.

Penjagaan



Awas

- Jangan gunakan pelarut seperti benzena, pencair, pembersih komersil atau semburan anti statik yang dimaksudkan untuk cakera.

Bersihkan cakera

Lap cakera dengan kain pembersih mikrogentian dari tengah ke tepi, menggunakan pergerakan lurus.

Spesifikasi



Catatan

- Spesifikasi boleh ditukar tanpa notis.

Video

- Sistem isyarat: PAL / NTSC
- Output video komposit: 1 Vp-p (75 ohm)
- Output video komponen: 480/576i, 480/576p, 720p, 1080i
 - Y: 1 Vp-p (75 ohm)
 - Pb: 0.7 V-pp (75 ohm)
 - Pr: 0.7 V-pp (75 ohm)
- Output HDMI 480p, 576p, 720p, 1080i, 1080p, 1080p24

Audio

- Output analog 2 Saluran
 - Audio Hadapan L + R : 2 Vrms (> 1 kohm)
 - Nisbah isyarat-hingar: > 120 dB
 - Julat Dinamik (1kHz): >100 dB
 - Jumlah herotan harmonik: <90 dB
- Output analog Saluran 7.1
 - Audio Hadapan L + R : 2 Vrms (> 1 kohm)
 - Audio Surround L + R : 2 Vrms (> 1 kohm)
 - Audio Tengah : 2 Vrms (> 1 kohm)
 - Audio Subwufer : 1.15 Vrms (> 1 kohm)
 - Audio Belakang L + R : 2 Vrms (> 1 kohm)
- Output digital: 0.5 Vp-p (75 ohm)
 - Optik, Sepaksi
- Output HDMI

USB

- Keserasian: USB Kelajuan tinggi (2.0)
- Sokongan kelas: UMS (Kelas Penyimpanan Massa USB)

Unit utama

- Pengedaran bekalan kuasa: 110~240V ~AC, 50/60 Hz
- Penggunaan kuasa: 22 W
- Penggunaan kuasa dalam mod siap sedia: < 0.25 W
- Dimensi (l x t x k): 435 x 55.7 x 245 (mm)
- Berat Bersih: 2.4 kg

Aksesori yang dibekalkan

- Kawalan jauh dan bateri
- Kabel HDMI
- Kabel Audio/Video
- Kabel kuasa
- Panduan permulaan pantas
- Manual pengguna

Aksesori pilihan

- Penyesuai wayarles Wi-Fi USB Philips (yang dinamakan WUB1110, dijual berasingan)
 - Sambungan multimedia: Wi-Fi 802.11b/g/n
 - Kesambungan: Sambungan belakang (USB)
 - Suhu sekeliling: 5 darjah C hingga 40 darjah C.
 - Dimensi dogle (L x T x D): 28.4 x 82 x 13.4 mm

Spesifikasi Laser

- Jenis Laser:
 - Diod Laser BD: AlGaInN
 - Diod Laser DVD: AlGaInP
 - Diod Laser CD: AlGaInP
- Panjang gelombang:
 - BD: 405 +5nm/-5nm
 - DVD: 655 +10nm/-10nm
 - CD: 790 +10nm/-20nm
- Kuasa output:
 - BD: Maks. pengedaran: 20mW
 - DVD: Maks. pengedaran: 6mW
 - CD: Maks. pengedaran: 7mW

8 Menyelesaikan masalah



Amaran

- Risiko kejutan elektrik. Jangan keluarkan sarung produk ini.

Supaya jaminan tetap sah, jangan cuba baiki sistem ini sendiri.

Jika anda mempunyai masalah menggunakan produk ini, periksa perkara yang berikut sebelum anda memohon perkhidmatan. Jika anda masih mempunyai masalah, daftar produk anda dan dapatkan sokongan di www.philips.com/welcome.

Unit utama

Tiada tindakan kepada kawalan jauh.

- Sambungkan produk ini ke alur keluar kuasa.
- Arahkan kawalan jauh pada sensor IR yang terletak pada panel hadapan produk ini.
- Masukkan bateri dengan betul.
- Masukkan bateri baru dalam kawalan jauh.

Gambar

Tiada gambar.

- Lihat manual TV untuk mendapatkan pemilihan input video yang betul. Tukar saluran TV sehingga anda dapat melihat skrin Philips.

Tiada gambar pada sambungan HDMI.

- Jika produk ini disambungkan ke peranti paparan yang tidak disahkan dengan kabel HDMI, isyarat audio/video mungkin tidak dioutputkan.
- Periksa sama ada kabel HDMI rosak. Gantikan kabel HDMI yang baru.
- Pada unit kawalan jauh, tekan  dan kemudian tekan "731" (butang angka) untuk memulihkan paparan gambar.

Tiada isyarat video definisi tinggi pada TV.

- Pastikan cakera mengandungi video definisi tinggi.
- Pastikan sokongan TV mengandungi video definisi tinggi.

Kesan 3D Blu-ray tidak kelihatan pada TV.

- Pilihan 3D pada pemain ini dimatikan. Dayakan output 3D (lihat 'Laraskan tetapan' > "Persediaan video" > [Video Blu-ray 3D]).
- Pastikan bahawa tajuk cakera yang dimainkan patuh 3D Blu-ray.
- Pastikan bahawa TV patuh 3D dan HDMI, dan TV ditetapkan kepada mod 3D (rujuk kepada manual pengguna TV).

- Pastikan bahawa kaca mata 3D diaktifkan (rujuk kepada manual pengguna TV).

Bunyi

Tiada output audio daripada TV.

- Pastikan kabel audio disambungkan kepada input audio TV.
- Tugaskan input audio TV kepada input video yang sepadan. Lihat manual pengguna TV untuk mendapatkan butiran.

Tiada output audio daripada pembesar suara peranti audio (teater rumah/amplifier/penerima).

- Pastikan kabel audio disambungkan kepada input audio pada peranti audio.
- Hidupkan peranti audio kepada sumber input audionya yang betul.

Tiada audio saluran 7.1 daripada pembesar suara sistem audio.

- Pastikan cakera mengandungi audio saluran 7.1.
- Pastikan peranti audio menyokong audio saluran 7.1.
- Pastikan format audio disokong oleh cakera dan peranti audio yang bersambung (amplifier/penerima).

Tiada bunyi pada sambungan HDMI.

- Anda mungkin tidak mendengar sebarang bunyi daripada output HDMI jika peranti yang bersambung tidak mematuhi HDCP atau hanya serasi DVI.

Tiada output audio kedua untuk ciri Gambar-dalam-Gambar.

- Apabila [Strim Bit] di bawah [Audio HDMI] atau menu [Audio Digital] dipilih, bunyi interaktif seperti bunyi kedua untuk ciri Gambar-dalam-Gambar dibisukan. Nyahpilih [Strim Bit].

Main

Cakera tidak boleh dimainkan.

- Pastikan cakera dimuat dengan betul.
- Pastikan produk ini menyokong cakera. Lihat "Produk anda" > "Media Boleh Main".
- Pastikan produk ini menyokong kod rantau DVD atau BD.
- Untuk DVD±RW or DVD±R, pastikan cakera dimuktamadkan.
- Bersihkan cakera.

Fail data (JPEG, MP3, WMA) tidak boleh dimainkan atau dibaca.

- Pastikan fail data telah dicatat dalam format UDF, ISO9660 atau JOLIET.
- Pastikan cakera tidak mengandungi lebih daripada 9,999 fail bagi DVD, dan 999 fail bagi CD.

- Pastikan lanjutan fail JPEG ialah .jpg, .JPG, .jpeg atau .JPEG.
- Pastikan lanjutan fail MP3/WMA adalah .mp3 atau .MP3, dan .wma atau .WMA untuk tetingkap Media™ Audio.

Fail video DivX tidak boleh dimainkan.

- Pastikan fail video DivX lengkap.
- Pastikan lanjutan nama fail betul.

Kandungan pemacu denyar USB tidak boleh dibaca.

- Format pemacu denyar USB tidak serasi dengan produk ini.
- Saiz maksimum memori yang disokong ialah 160GB.

Tanda 'Tiada entri' atau 'x' muncul pada TV.

- Operasi tidak boleh dijalankan.

Ciri EasyLink tidak berfungsi.

- Pastikan produk ini disambungkan kepada TV EasyLink berjenama Philips dan [EasyLink] dalam menu ditetapkan kepada [Hidup].

Tidak dapat mengakses ciri BD-Live.

- Semak sambungan rangkaian atau pastikan bahawa rangkaian telah disediakan.
- Kosongkan simpanan tempatan, memori dalaman (jika ada) atau USB.
- Pastikan cakera BD menyokong ciri BD Live.

Rangkaian

Rangkaian wayarles tidak didapati atau terherot.

- Ketuhar gelombang mikro, telefon Dect atau peranti wayarles yang lain di kejiranan anda mungkin akan mengganggu rangkaian wayarles.
- Pastikan tembok api dalam rangkaian anda membenarkan akses kepada sambungan wayarles produk ini.
- Jika rangkaian wayarles tidak berfungsi dengan betul di rumah anda, cuba sambungan rangkaian berwayar (lihat "Bermula" > "Sediakan rangkaian").

Net TV tidak berfungsi.

- Periksa sambungan penghala (rujuk manual pengguna bagi penghala).

Semak imbas PC berfungsi dengan perlahan.

- Rujuk manual pengguna penghala wayarles anda untuk mendapatkan maklumat mengenai julat dalam bangunan, kadar pemindahan dan faktor lain berkenaan kualiti isyarat.
- Anda memerlukan sambungan berkelajuan tinggi bagi penghala anda.

NOTICE

SOFTWARE END USER LICENSE AGREEMENT

THIS SOFTWARE END USER LICENSE AGREEMENT ("THIS AGREEMENT") IS A LEGAL AND BINDING AGREEMENT BETWEEN YOU (EITHER AN INDIVIDUAL OR ENTITY) AND PHILIPS CONSUMER LIFESTYLE B.V. A DUTCH LIMITED LIABILITY COMPANY, WITH ITS PRINCIPAL OFFICE AT HIGH TECH CAMPUS 37, 5656 AE EINDHOVEN, THE NETHERLANDS AND ITS SUBSIDIARY COMPANIES (INDIVIDUALLY AND COLLECTIVELY "PHILIPS"). THIS AGREEMENT GIVES YOU THE RIGHT TO USE CERTAIN SOFTWARE (THE "SOFTWARE") INCLUDING USER DOCUMENTATION IN ELECTRONIC FORM WHICH MAY HAVE BEEN PROVIDED SEPARATELY OR TOGETHER WITH A PHILIPS PRODUCT (THE "DEVICE") OR A PC. BY DOWNLOADING, INSTALLING OR OTHERWISE USING THE SOFTWARE, YOU ACCEPT AND AGREE TO BE BOUND BY ALL OF THE TERMS AND CONDITIONS OF THIS AGREEMENT. IF YOU DO NOT AGREE TO THESE TERMS AND CONDITIONS, DO NOT DOWNLOAD, INSTALL OR OTHERWISE USE THE SOFTWARE. IF YOU ACQUIRED THE SOFTWARE IN TANGIBLE MEDIA E.G. CD WITHOUT THE OPPORTUNITY TO REVIEW THIS LICENSE AND DO NOT ACCEPT THESE TERMS, YOU MAY RECEIVE A FULL REFUND OF THE AMOUNT, IF ANY, THAT YOU PAID FOR THE SOFTWARE IF YOU RETURN THE SOFTWARE UNUSED WITH PROOF OF PAYMENT WITHIN 30 DAYS FROM THE DATE OF PURCHASE.

- 1. Grant of License.** This Agreement grants you a non-exclusive, nontransferable, non-sub licensable license to install and use, on the Device or a PC, as applicable, one (1) copy of the specified version of the Software in object code format as set out in the user documentation solely for your personal use. The Software is "in use" when it is loaded into the temporary or permanent memory (i.e. RAM, hard disk, etc.) of the PC or the Device.
- 2. Ownership.** The Software is licensed and not sold to you. This Agreement grants you only the right to use the Software, but you do not acquire any rights, express or implied, in the Software other than those specified in this Agreement. Philips and its licensors retain all right, title, and interest in and to the Software, including all patents, copyrights, trade secrets, and other intellectual property rights incorporated therein. The Software is protected by copyright laws, international treaty provisions, and other intellectual property laws. Therefore, other than as expressly set forth herein, you may not copy the Software without prior written authorization of Philips, except that you may make one (1) copy of the Software for your back-up purposes only. You may not copy any printed materials accompanying the Software, nor print more than one (1) copy of any user documentation provided in electronic form, except that you may make one (1) copy of such printed materials for your back-up purposes only.
- 3. License Restrictions.** Except as provided otherwise herein, you shall not rent, lease, sublicense, sell, assign, loan, or otherwise transfer the Software. You shall not, and you shall not permit any third party, to reverse engineer, decompile, or disassemble the Software, except to the extent that applicable law expressly prohibits the foregoing restriction. You may not remove or destroy any product identification, copyright notices, or other proprietary markings or restrictions from the Software. All titles, trademarks, and copyright and restricted rights notices shall be reproduced on your back up copy of the Software. You may not modify or adapt the Software, merge the Software into another program or create derivative works based upon the Software.
- 4. Termination of certain functionality.** The Software may contain components of certain licensed software including software licensed from Microsoft Corporation ("Microsoft") which implements Microsoft's digital rights management technology for Windows Media. Content providers are using the digital rights management technology for Windows Media ("WM-DRM") to protect the integrity of their content ("Secure Content") so that their intellectual property, including copyright, in such content is not misappropriated. Your Device may also use WM-DRM software to transfer or play Secure Content ("WM-DRM Software"). If the security of such WM-DRM Software is compromised, Microsoft may revoke (either on its own or upon the request of the owners of Secure Content ("Secure Content Owners")) the WM-DRM Software's right to acquire new licenses to copy, store, transfer, display and/or play Secure Content. Revocation does not alter the WM-DRM Software's ability to play unprotected content. A list of revoked WM-DRM Software is sent to your PC and/or your Device whenever you download a license for Secure Content. Microsoft may, in conjunction with such license, also download revocation lists onto your Device on behalf of Secure Content Owners, which may disable your Device's ability to copy, store, display, transfer, and/or play Secure Content. Secure Content Owners may also require you to upgrade some of the WM-DRM components distributed with this Software ("WM-DRM Upgrades") before accessing their content. When you attempt to play Secure Content, WM-DRM Software built by Microsoft will notify you that a WM-DRM Upgrade is required and then ask for your consent before the WM-DRM Upgrade is downloaded. WM-DRM Software built by Philips may do the same. If you decline

the upgrade, you will not be able to access Secure Content that requires the WM-DRM Upgrade; however, you will still be able to access unprotected content and Secure Content that does not require the upgrade. WM-DRM features that access the Internet, such as acquiring new licenses and/or performing a required WM-DRM Upgrade, can be switched off. When these features are switched off, you will still be able to play Secure Content if you have a valid license for such content already stored on your Device. However, you will not be able to use certain of the WM-DRM Software features that require Internet access such as the ability to download content that requires the WM-DRM Upgrade. All title and intellectual property rights in and to the Secure Content is the property of the respective Secure Content owners and may be protected by applicable copyright or other intellectual property laws and treaties. This Agreement grants you no rights to use such Secure Content. **To summarize, if the Software contains Microsoft WM-DRM components – Secure Content you desire to download, copy, store, display, transfer, and/or play is protected by the Microsoft WM-DRM components of the Software. Microsoft, Secure Content Owners, or Secure Content distributors may deny you access, or restrict your access, to Secure Content even after you have paid for, and/or obtained, it. Neither your consent nor the consent or approval of Philips is necessary for any of them to deny, withhold or otherwise restrict your access to Secure Content. Philips does not guaranty that you will be able to download, copy, store, display, transfer, and/or play Secure Content.**

5. **Open Source Software.** (a) This software may contain components that are subject to open-source terms, as stated in the documentation accompanying the Device. This Agreement does not apply to this software as such. (b) Your license rights under this Agreement do not include any right or license to use, distribute or create derivative works of the Software in any manner that would subject the Software to Open Source Terms. "Open Source Terms" means the terms of any license that directly or indirectly (1) create, or purport to create, obligations for Philips with respect to the Software and/or derivative works thereof; or (2) grant, or purport to grant, to any third party any rights or immunities under intellectual property or proprietary rights in the Software or derivative works thereof.
6. **Termination.** This Agreement shall be effective upon installation or first use of the Software and shall terminate (i) at the discretion of Philips, due to your failure to comply with any term of this Agreement; or (ii) upon destruction of all copies of the Software and related materials provided to you by Philips hereunder. Philips's rights and your obligations shall survive the termination of this Agreement.
7. **Upgrades.** Philips may, at its sole option, make upgrades to the Software available by general posting on a website or by any other means or methods. Such upgrades may be made available pursuant to the terms of this Agreement or the release of such upgrades to you may be subject to your acceptance of another agreement.
8. **Support Services.** Philips is not obligated to provide technical or other support ("Support Services") for the Software. If Philips does provide you with Support Services, these will be governed by separate terms to be agreed between you and Philips.
9. **Limited Software Warranty.** Philips provides the Software 'as is' and without any warranty except that the Software will perform substantially in accordance with the documentation accompanying the Software for a period of one year after your first download, installation or use of the Software, whichever occurs first. Philips' entire liability and your exclusive remedy for breach of this warranty shall be, at Philips' option, either (i) return of the price paid by you for the Software (if any); or (b) repair or replacement of the Software that does not meet the warranty set forth herein and that is returned to Philips with a copy of your receipt. This limited warranty shall be void if failure of the Software has resulted from any accident, abuse, misuse or wrongful application. Any replacement Software will be warranted for the remainder of the original warranty period or thirty (30) days, whichever is longer. This limited warranty shall not apply to you if the Software was provided to you free of charge on an evaluation only basis.
10. **NO OTHER WARRANTIES.** EXCEPT AS SET FORTH ABOVE, PHILIPS AND ITS LICENSORS DO NOT WARRANT THAT THE SOFTWARE WILL OPERATE ERROR FREE OR UNINTERRUPTED, OR WILL MEET YOUR REQUIREMENTS. YOU ASSUME ALL RESPONSIBILITIES FOR SELECTION OF THE SOFTWARE TO ACHIEVE YOUR INTENDED RESULTS, AND FOR THE INSTALLATION OF, USE OF, AND RESULTS OBTAINED FROM THE SOFTWARE. TO THE MAXIMUM EXTENT PERMITTED BY APPLICABLE LAW, PHILIPS AND ITS LICENSORS DISCLAIM ALL WARRANTIES AND CONDITIONS, WHETHER EXPRESS OR IMPLIED, INCLUDING BUT NOT LIMITED TO THE IMPLIED WARRANTIES OF MERCHANTABILITY, FITNESS FOR A PARTICULAR PURPOSE, AND ACCURACY OR COMPLETENESS OF RESULTS WITH RESPECT TO THE SOFTWARE AND THE ACCOMPANYING MATERIALS. THERE IS NO WARRANTY AGAINST INFRINGEMENT. PHILIPS DOES NOT WARRANT THAT YOU WILL BE ABLE TO DOWNLOAD, COPY, STORE, DISPLAY, TRANSFER, AND/OR PLAY SECURE CONTENT.

- 11. LIMITATION OF LIABILITY.** UNDER NO CIRCUMSTANCES WILL PHILIPS OR ITS LICENSORS BE LIABLE FOR ANY CONSEQUENTIAL, SPECIAL, INDIRECT, INCIDENTAL OR PUNITIVE DAMAGES WHATSOEVER, INCLUDING, WITHOUT LIMITATION, DAMAGES FOR LOSS OF PROFITS OR REVENUES, BUSINESS INTERRUPTION, LOSS OF BUSINESS INFORMATION, LOSS OF DATA, LOSS OF USE OR OTHER PECUNIARY LOSS, EVEN IF PHILIPS OR ITS LICENSORS HAVE BEEN ADVISED OF THE POSSIBILITY OF SUCH DAMAGES. IN NO EVENT SHALL PHILIPS' OR ITS LICENSORS' AGGREGATE LIABILITY FOR DAMAGES ARISING OUT OF THIS AGREEMENT EXCEED THE GREATER OF THE PRICE ACTUALLY PAID BY YOU FOR THE SOFTWARE OR FIVE POUNDS STERLING (5.00).
- 12. Trademarks.** Certain of the product and Philips names used in this Agreement, the Software, and the printed user documentation may constitute trademarks of the Philips, its licensors or other third parties. You are not authorized to use any such trademarks.
- 13. Export Administration.** You agree that you will not directly or indirectly, export or re-export the Software to any country for which the United States Export Administration Act, or any similar United States law or regulation requires an export license or other U.S. Government approval, unless the appropriate export license or approval has first been obtained. By downloading or installing the Software you agree to abide by this Export provision.
- 14. Governing law.** This Agreement is governed by the laws of your country of residence, without reference to its conflict of laws principles. Any dispute between you and Philips regarding this Agreement shall be subject to the non-exclusive jurisdiction of the courts of your country of residence.
- 15. General.** This Agreement contains the entire agreement between you and Philips and supersedes any prior representation, undertaking or other communication or advertising with respect to the Software and user documentation. If any part of this Agreement is held invalid, the remainder of this Agreement will continue in full force and effect. This Agreement shall not prejudice the statutory rights of any party dealing as a consumer.

License Texts and Acknowledgements for any open source software used in this Philips product

Instructions to obtain source code for this software can be found in the user manual.

1. U-boot

```
#
# (C) Copyright 2000 - 2008
# Wolfgang Denk, DENX Software Engineering, wd@denx.de.
#
# See file CREDITS for list of people who contributed to this
# project.
#
# This program is free software; you can redistribute it and/or
# modify it under the terms of the GNU General Public License as
# published by the Free Software Foundation; either version 2 of
# the License, or (at your option) any later version.
#
# This program is distributed in the hope that it will be useful,
# but WITHOUT ANY WARRANTY; without even the implied warranty of
# MERCHANTABILITY or FITNESS FOR A PARTICULAR PURPOSE. See the
# GNU General Public License for more details.
#
# You should have received a copy of the GNU General Public License
# along with this program; if not, write to the Free Software
# Foundation, Inc., 59 Temple Place, Suite 330, Boston,
# MA 02111-1307 USA
#
A copy of the GPL is included below at item 2.
```

2. Linux kernel

NOTE! This copyright does **not** cover user programs that use kernel services by normal system calls - this is merely considered normal use of the kernel, and does **not** fall under the heading of "derived work". Also note that the GPL below is copyrighted by the Free Software Foundation, but the instance of code that it refers to (the linux kernel) is copyrighted by me and others who actually wrote it. Also note that the only valid version of the GPL as far as the kernel is concerned is `_this_` particular version of the license (ie v2, not v2.2 or v3.x or whatever), unless explicitly otherwise stated.

Linus Torvalds

GNU GENERAL PUBLIC LICENSE
Version 2, June 1991

Copyright (C) 1989, 1991 Free Software Foundation, Inc.
675 Mass Ave, Cambridge, MA 02139, USA

Everyone is permitted to copy and distribute verbatim copies of this license document, but changing it is not allowed.

Preamble

The licenses for most software are designed to take away your freedom to share and change it. By contrast, the GNU General Public License is intended to guarantee your freedom to share and change free software--to make sure the software is free for all its users. This General Public License applies to most of the Free Software Foundation's software and to any other program whose authors commit to using it. (Some other Free Software Foundation software is covered by the GNU Library General Public License instead.) You can apply it to your programs, too.

When we speak of free software, we are referring to freedom, not price. Our General Public Licenses are designed to make sure that you have the freedom to distribute copies of free software (and charge for this service if you wish), that you receive source code or can get it if you want it, that you can change the software or use pieces of it in new free programs; and that you know you can do these things.

To protect your rights, we need to make restrictions that forbid anyone to deny you these rights or to ask you to surrender the rights. These restrictions translate to certain responsibilities for you if you distribute copies of the software, or if you modify it.

For example, if you distribute copies of such a program, whether gratis or for a fee, you must give the recipients all the rights that you have. You must make sure that they, too, receive or can get the source code. And you must show them these terms so they know their rights.

We protect your rights with two steps: (1) copyright the software, and (2) offer you this license which gives you legal permission to copy, distribute and/or modify the software.

Also, for each author's protection and ours, we want to make certain that everyone understands that there is no warranty for this free software. If the software is modified by someone else and passed on, we want its recipients to know that what they have is not the original, so that any problems introduced by others will not reflect on the original authors' reputations.

Finally, any free program is threatened constantly by software patents. We wish to avoid the danger that redistributors of a free program will individually obtain patent licenses, in effect making the program proprietary. To prevent this, we have made it clear that any patent must be licensed for everyone's free use or not licensed at all.

The precise terms and conditions for copying, distribution and modification follow.

GNU GENERAL PUBLIC LICENSE TERMS AND CONDITIONS FOR COPYING, DISTRIBUTION AND MODIFICATION

0. This License applies to any program or other work which contains a notice placed by the copyright holder saying it may be distributed under the terms of this General Public License. The "Program", below, refers to any such program or work, and a "work based on the Program" means either the Program or any derivative work under copyright law: that is to say, a work containing the Program or a portion of it, either verbatim or with modifications and/or translated into another language. (Hereinafter, translation is included without limitation in the term "modification".) Each licensee is addressed as "you".
Activities other than copying, distribution and modification are not covered by this License; they are outside its scope. The act of running the Program is not restricted, and the output from the Program is covered only if its contents constitute a work based on the Program (independent of having been made by running the Program). Whether that is true depends on what the Program does.
1. You may copy and distribute verbatim copies of the Program's source code as you receive it, in any medium, provided that you conspicuously and appropriately publish on each copy an appropriate copyright notice and disclaimer of warranty; keep intact all the notices that refer to this License and to the absence of any warranty; and give any other recipients of the Program a copy of this License along with the Program.
You may charge a fee for the physical act of transferring a copy, and you may at your option offer warranty protection in exchange for a fee.
2. You may modify your copy or copies of the Program or any portion of it, thus forming a work based on the Program, and copy and distribute such modifications or work under the terms of Section 1 above, provided that you also meet all of these conditions:
 - a) You must cause the modified files to carry prominent notices stating that you changed the files and the date of any change.
 - b) You must cause any work that you distribute or publish, that in whole or in part contains or is derived from the Program or any part thereof, to be licensed as a whole at no charge to all third parties under the terms of this License.
 - c) If the modified program normally reads commands interactively when run, you must cause it, when started running for such interactive use in the most ordinary way, to print or display an announcement including an appropriate copyright notice and a notice that there is no warranty (or else, saying that you provide a warranty) and that users may redistribute the program under these conditions, and telling the user how to view a copy of this License. (Exception: if the Program itself is interactive but does not normally print such an announcement, your work based on the Program is not required to print an announcement.)

These requirements apply to the modified work as a whole. If identifiable sections of that work are not derived from the Program, and can be reasonably considered independent and separate works in themselves, then this License, and its terms, do not apply to those sections when you distribute them as separate works. But when you distribute the same sections as part of a whole which is a work based on the Program, the distribution of the whole must be on the terms of this License, whose permissions for other licensees extend to the entire whole, and thus to each and every part regardless of who wrote it.

Thus, it is not the intent of this section to claim rights or contest your rights to work written entirely by you; rather, the intent is to exercise the right to control the distribution of derivative or collective works based on the Program.

In addition, mere aggregation of another work not based on the Program with the Program (or with a work based on the Program) on a volume of a storage or distribution medium does not bring the other work under the scope of this License.

3. You may copy and distribute the Program (or a work based on it, under Section 2) in object code or executable form under the terms of Sections 1 and 2 above provided that you also do one of the following:
 - a) Accompany it with the complete corresponding machine-readable source code, which must be distributed under the terms of Sections 1 and 2 above on a medium customarily used for software interchange; or,
 - b) Accompany it with a written offer, valid for at least three years, to give any third party, for a charge no more than your cost of physically performing source distribution, a complete machine-readable copy of the corresponding source code, to be distributed under the terms of Sections 1 and 2 above on a medium customarily used for software interchange; or,
 - c) Accompany it with the information you received as to the offer to distribute corresponding source code. (This alternative is allowed only for noncommercial distribution and only if you received the program in object code or executable form with such an offer, in accord with Subsection b above.)

The source code for a work means the preferred form of the work for making modifications to it. For an executable work, complete source code means all the source code for all modules it contains, plus any associated interface definition files, plus the scripts used to control compilation and installation of the executable. However, as a special exception, the source code distributed need not include anything that is normally distributed (in either source or binary form) with the major components (compiler, kernel, and so on) of the operating system on which the executable runs, unless that component itself accompanies the executable.

If distribution of executable or object code is made by offering access to copy from a designated place, then offering equivalent access to copy the source code from the same place counts as distribution of the source code, even though third parties are not compelled to copy the source along with the object code.

4. You may not copy, modify, sublicense, or distribute the Program except as expressly provided under this License. Any attempt otherwise to copy, modify, sublicense or distribute the Program is void, and will automatically terminate your rights under this License. However, parties who have received copies, or rights, from you under this License will not have their licenses terminated so long as such parties remain in full compliance.
5. You are not required to accept this License, since you have not signed it. However, nothing else grants you permission to modify or distribute the Program or its derivative works. These actions are prohibited by law if you do not accept this License. Therefore, by modifying or distributing the Program (or any work based on the Program), you indicate your acceptance of this License to do so, and all its terms and conditions for copying, distributing or modifying the Program or works based on it.
6. Each time you redistribute the Program (or any work based on the Program), the recipient automatically receives a license from the original licensor to copy, distribute or modify the Program subject to these terms and conditions. You may not impose any further restrictions on the recipients' exercise of the rights granted herein. You are not responsible for enforcing compliance by third parties to this License.
7. If, as a consequence of a court judgment or allegation of patent infringement or for any other reason (not limited to patent issues), conditions are imposed on you (whether by court order, agreement or otherwise) that contradict the conditions of this License, they do not excuse you from the conditions of this License. If you cannot distribute so as to satisfy simultaneously your obligations under this License and any other pertinent obligations, then as a consequence you may not distribute the Program at all. For example, if a patent license would not permit royalty-free redistribution of the Program by all those who receive copies directly or indirectly through you, then the only way you could satisfy both it and this License would be to refrain entirely from distribution of the Program.

If any portion of this section is held invalid or unenforceable under any particular circumstance, the balance of the section is intended to apply and the section as a whole is intended to apply in other circumstances.

It is not the purpose of this section to induce you to infringe any patents or other property right claims or to contest validity of any such claims; this section has the sole purpose of protecting the integrity of the free software distribution system, which is implemented by public license practices. Many people have made generous contributions to the wide range of software distributed through that system in reliance on consistent application of that system; it is up to the author/donor to decide if he or she is willing to distribute software through any other system and a licensee cannot impose that choice.

This section is intended to make thoroughly clear what is believed to be a consequence of the rest of this License.

8. If the distribution and/or use of the Program is restricted in certain countries either by patents or by copyrighted interfaces, the original copyright holder who places the Program under this License may add an explicit geographical distribution limitation excluding those countries, so that distribution is permitted only in or among countries not thus excluded. In such case, this License incorporates the limitation as if written in the body of this License.
9. The Free Software Foundation may publish revised and/or new versions of the General Public License from time to time. Such new versions will be similar in spirit to the present version, but may differ in detail to address new problems or concerns.

Each version is given a distinguishing version number. If the Program specifies a version number of this License which applies to it and "any later version", you have the option of following the terms and conditions either of that version or of any later version published by the Free Software Foundation. If the Program does not specify a version number of this License, you may choose any version ever published by the Free Software Foundation.

10. If you wish to incorporate parts of the Program into other free programs whose distribution conditions are different, write to the author to ask for permission. For software which is copyrighted by the Free Software Foundation, write to the Free Software Foundation; we sometimes make exceptions for this. Our decision will be guided by the two goals of preserving the free status of all derivatives of our free software and of promoting the sharing and reuse of software generally.

NO WARRANTY

11. BECAUSE THE PROGRAM IS LICENSED FREE OF CHARGE, THERE IS NO WARRANTY FOR THE PROGRAM, TO THE EXTENT PERMITTED BY APPLICABLE LAW. EXCEPT WHEN OTHERWISE STATED IN WRITING THE COPYRIGHT HOLDERS AND/OR OTHER PARTIES PROVIDE THE PROGRAM "AS IS" WITHOUT WARRANTY OF ANY KIND, EITHER EXPRESSED OR IMPLIED, INCLUDING, BUT NOT LIMITED TO, THE IMPLIED WARRANTIES OF MERCHANTABILITY AND FITNESS FOR A PARTICULAR PURPOSE. THE ENTIRE RISK AS TO THE QUALITY AND PERFORMANCE OF THE PROGRAM IS WITH YOU. SHOULD THE PROGRAM PROVE DEFECTIVE, YOU ASSUME THE COST OF ALL NECESSARY SERVICING, REPAIR OR CORRECTION.
12. IN NO EVENT UNLESS REQUIRED BY APPLICABLE LAW OR AGREED TO IN WRITING WILL ANY COPYRIGHT HOLDER, OR ANY OTHER PARTY WHO MAY MODIFY AND/OR REDISTRIBUTE THE PROGRAM AS PERMITTED ABOVE, BE LIABLE TO YOU FOR DAMAGES, INCLUDING ANY GENERAL, SPECIAL, INCIDENTAL OR CONSEQUENTIAL DAMAGES ARISING OUT OF THE USE OR INABILITY TO USE THE PROGRAM (INCLUDING BUT NOT LIMITED TO LOSS OF DATA OR DATA BEING RENDERED INACCURATE OR LOSSES SUSTAINED BY YOU OR THIRD PARTIES OR A FAILURE OF THE PROGRAM TO OPERATE WITH ANY OTHER PROGRAMS), EVEN IF SUCH HOLDER OR OTHER PARTY HAS BEEN ADVISED OF THE POSSIBILITY OF SUCH DAMAGES.

END OF TERMS AND CONDITIONS

Appendix: How to Apply These Terms to Your New Programs

If you develop a new program, and you want it to be of the greatest possible use to the public, the best way to achieve this is to make it free software which everyone can redistribute and change under these terms.

To do so, attach the following notices to the program. It is safest to attach them to the start of each source file to most effectively convey the exclusion of warranty; and each file should have at least the "copyright" line and a pointer to where the full notice is found.

<one line to give the program's name and a brief idea of what it does.>
Copyright (C) 19yy <name of author>

This program is free software; you can redistribute it and/or modify it under the terms of the GNU General Public License as published by the Free Software Foundation; either version 2 of the License, or (at your option) any later version.

This program is distributed in the hope that it will be useful, but WITHOUT ANY WARRANTY; without even the implied warranty of MERCHANTABILITY or FITNESS FOR A PARTICULAR PURPOSE. See the GNU General Public License for more details.

You should have received a copy of the GNU General Public License along with this program; if not, write to the Free Software Foundation, Inc., 675 Mass Ave, Cambridge, MA 02139, USA.

Also add information on how to contact you by electronic and paper mail.

If the program is interactive, make it output a short notice like this when it starts in an interactive mode:

```
Gnomovision version 69, Copyright (C) 19yy name of author
```

```
Gnomovision comes with ABSOLUTELY NO WARRANTY; for details type `show w`.
```

```
This is free software, and you are welcome to redistribute it under certain conditions; type `show c` for details.
```

The hypothetical commands `show w` and `show c` should show the appropriate parts of the General Public License. Of course, the commands you use may be called something other than `show w` and `show c`; they could even be mouse-clicks or menu items--whatever suits your program.

You should also get your employer (if you work as a programmer) or your school, if any, to sign a "copyright disclaimer" for the program, if necessary. Here is a sample; alter the names:

Yoyodyne, Inc., hereby disclaims all copyright interest in the program `Gnomovision' (which makes passes at compilers) written by James Hacker.

```
<signature of Ty Coon>, 1 April 1989
```

```
Ty Coon, President of Vice
```

This General Public License does not permit incorporating your program into proprietary programs. If your program is a subroutine library, you may consider it more useful to permit linking proprietary applications with the library. If this is what you want to do, use the GNU Library General Public License instead of this License.

3. Busybox, the Linux IR control package and SquashFS

Busybox, the Linux IR control package and SquashFS are subject to the GPL, a copy of which is included at item 2.

4. DirectFB, glibc, libusb-compat, libusb and mtd-utils

DirectFB glibc, libmtp and libusb are subject to the following license:

GNU LESSER GENERAL PUBLIC LICENSE
Version 2.1, February 1999

Copyright (C) 1991, 1999 Free Software Foundation, Inc.
59 Temple Place, Suite 330, Boston, MA 02111-1307 USA

Everyone is permitted to copy and distribute verbatim copies of this license document, but changing it is not allowed.

[This is the first released version of the Lesser GPL. It also counts as the successor of the GNU Library Public License, version 2, hence the version number 2.1.]

Preamble

The licenses for most software are designed to take away your freedom to share and change it. By contrast, the GNU General Public Licenses are intended to guarantee your freedom to share and change free software--to make sure the software is free for all its users.

This license, the Lesser General Public License, applies to some specially designated software packages--typically libraries--of the Free Software Foundation and other authors who decide to use it. You can use it too, but we suggest you first think carefully about whether this license or the ordinary General Public License is the better strategy to use in any particular case, based on the explanations below.

When we speak of free software, we are referring to freedom of use, not price. Our General Public Licenses are designed to make sure that you have the freedom to distribute copies of free software (and charge for this service if you wish); that you receive source code or can get it if you want it; that you can change the software and use pieces of it in new free programs; and that you are informed that you can do these things.

To protect your rights, we need to make restrictions that forbid distributors to deny you these rights or to ask you to surrender these rights. These restrictions translate to certain responsibilities for you if you distribute copies of the library or if you modify it.

For example, if you distribute copies of the library, whether gratis or for a fee, you must give the recipients all the rights that we gave you. You must make sure that they, too, receive or can get the source code. If you link other code with the library, you must provide complete object files to the recipients, so that they can relink them with the library after making changes to the library and recompiling it. And you must show them these terms so they know their rights.

We protect your rights with a two-step method: (1) we copyright the library, and (2) we offer you this license, which gives you legal permission to copy, distribute and/or modify the library.

To protect each distributor, we want to make it very clear that there is no warranty for the free library. Also, if the library is modified by someone else and passed on, the recipients should know that what they have is not the original version, so that the original author's reputation will not be affected by problems that might be introduced by others.

Finally, software patents pose a constant threat to the existence of any free program. We wish to make sure that a company cannot effectively restrict the users of a free program by obtaining a restrictive license from a patent holder. Therefore, we insist that any patent license obtained for a version of the library must be consistent with the full freedom of use specified in this license.

Most GNU software, including some libraries, is covered by the ordinary GNU General Public License. This license, the GNU Lesser General Public License, applies to certain designated libraries, and is quite different from the ordinary General Public License. We use this license for certain libraries in order to permit linking those libraries into non-free programs.

When a program is linked with a library, whether statically or using a shared library, the combination of the two is legally speaking a combined work, a derivative of the original library. The ordinary General Public License therefore permits such linking only if the entire combination fits its criteria of freedom. The Lesser General Public License permits more lax criteria for linking other code with the library.

We call this license the "Lesser" General Public License because it does Less to protect the user's freedom than the ordinary General Public License. It also provides other free software developers Less of an advantage over competing non-free programs. These disadvantages are the reason we use the ordinary General Public License for many libraries. However, the Lesser license provides advantages in certain special circumstances.

For example, on rare occasions, there may be a special need to encourage the widest possible use of a certain library, so that it becomes a de-facto standard. To achieve this, non-free programs must be allowed to use the library. A more frequent case is that a free library does the same job as widely used non-free libraries. In this case, there is little to gain by limiting the free library to free software only, so we use the Lesser General Public License.

In other cases, permission to use a particular library in non-free programs enables a greater number of people to use a large body of free software. For example, permission to use the GNU C Library in non-free programs enables many more people to use the whole GNU operating system, as well as its variant, the GNU/Linux operating system.

Although the Lesser General Public License is Less protective of the users' freedom, it does ensure that the user of a program that is linked with the Library has the freedom and the wherewithal to run that program using a modified version of the Library.

The precise terms and conditions for copying, distribution and modification follow. Pay close attention to the difference between a "work based on the library" and a "work that uses the library". The former contains code derived from the library, whereas the latter must be combined with the library in order to run.

GNU LESSER GENERAL PUBLIC LICENSE

TERMS AND CONDITIONS FOR COPYING, DISTRIBUTION AND MODIFICATION

0. This License Agreement applies to any software library or other program which contains a notice placed by the copyright holder or other authorized party saying it may be distributed under the terms of this Lesser General Public License (also called "this License").

Each licensee is addressed as "you".

A "library" means a collection of software functions and/or data prepared so as to be conveniently linked with application programs (which use some of those functions and data) to form executables.

The "Library", below, refers to any such software library or work which has been distributed under these terms. A "work based on the Library" means either the Library or any derivative work under copyright law: that is to say, a work containing the Library or a portion of it, either verbatim or with modifications and/or translated straightforwardly into another language. (Hereinafter, translation is included without limitation in the term "modification".)

"Source code" for a work means the preferred form of the work for making modifications to it. For a library, complete source code means all the source code for all modules it contains, plus any associated interface definition files, plus the scripts used to control compilation and installation of the library.

Activities other than copying, distribution and modification are not covered by this License; they are outside its scope. The act of running a program using the Library is not restricted, and output from such a program is covered only if its contents constitute a work based on the Library (independent of the use of the Library in a tool for writing it). Whether that is true depends on what the Library does and what the program that uses the Library does.

1. You may copy and distribute verbatim copies of the Library's complete source code as you receive it, in any medium, provided that you conspicuously and appropriately publish on each copy an appropriate copyright notice and disclaimer of warranty; keep intact all the notices that refer to this License and to the absence of any warranty; and distribute a copy of this License along with the Library.

You may charge a fee for the physical act of transferring a copy, and you may at your option offer warranty protection in exchange for a fee.

2. You may modify your copy or copies of the Library or any portion of it, thus forming a work based on the Library, and copy and distribute such modifications or work under the terms of Section 1 above, provided that you also meet all of these conditions:
 - a) The modified work must itself be a software library.
 - b) You must cause the files modified to carry prominent notices stating that you changed the files and the date of any change.
 - c) You must cause the whole of the work to be licensed at no charge to all third parties under the terms of this License.
 - d) If a facility in the modified Library refers to a function or a table of data to be supplied by an application program that uses the facility, other than as an argument passed when the facility is invoked, then you must make a good faith effort to ensure that, in the event an application does not supply such function or table, the facility still operates, and performs whatever part of its purpose remains meaningful.
(For example, a function in a library to compute square roots has a purpose that is entirely well-defined independent of the application. Therefore, Subsection 2d requires that any application-supplied function or table used by this function must be optional: if the application does not supply it, the square root function must still compute square roots.)

These requirements apply to the modified work as a whole. If identifiable sections of that work are not derived from the Library, and can be reasonably considered independent and separate works in themselves, then this License, and its terms, do not apply to those sections when you distribute them as separate works. But when you distribute the same sections as part of a whole which is a work based on the Library, the distribution of the whole must be on the terms of this License, whose permissions for other licensees extend to the entire whole, and thus to each and every part regardless of who wrote it.

Thus, it is not the intent of this section to claim rights or contest your rights to work written entirely by you; rather, the intent is to exercise the right to control the distribution of derivative or collective works based on the Library.

In addition, mere aggregation of another work not based on the Library with the Library (or with a work based on the Library) on a volume of a storage or distribution medium does not bring the other work under the scope of this License.

3. You may opt to apply the terms of the ordinary GNU General Public License instead of this License to a given copy of the Library. To do this, you must alter all the notices that refer to this License, so that they refer to the ordinary GNU General Public License, version 2, instead of to this License. (If a newer version than version 2 of the ordinary GNU General Public License has appeared, then you can specify that version instead if you wish.) Do not make any other change in these notices.

Once this change is made in a given copy, it is irreversible for that copy, so the ordinary GNU General Public License applies to all subsequent copies and derivative works made from that copy.

This option is useful when you wish to copy part of the code of the Library into a program that is not a library.

4. You may copy and distribute the Library (or a portion or derivative of it, under Section 2) in object code or executable form under the terms of Sections 1 and 2 above provided that you accompany it with the complete corresponding machine-readable source code, which must be distributed under the terms of Sections 1 and 2 above on a medium customarily used for software interchange.

If distribution of object code is made by offering access to copy from a designated place, then offering equivalent access to copy the source code from the same place satisfies the requirement to distribute the source code, even though third parties are not compelled to copy the source along with the object code.

5. A program that contains no derivative of any portion of the Library, but is designed to work with the Library by being compiled or linked with it, is called a "work that uses the Library". Such a work, in isolation, is not a derivative work of the Library, and therefore falls outside the scope of this License.

However, linking a "work that uses the Library" with the Library creates an executable that is a derivative of the Library (because it contains portions of the Library), rather than a "work that uses the library". The executable is therefore covered by this License.

Section 6 states terms for distribution of such executables.

When a “work that uses the Library” uses material from a header file that is part of the Library, the object code for the work may be a derivative work of the Library even though the source code is not.

Whether this is true is especially significant if the work can be linked without the Library, or if the work is itself a library. The threshold for this to be true is not precisely defined by law.

If such an object file uses only numerical parameters, data structure layouts and accessors, and small macros and small inline functions (ten lines or less in length), then the use of the object file is unrestricted, regardless of whether it is legally a derivative work. (Executables containing this object code plus portions of the Library will still fall under Section 6.)

Otherwise, if the work is a derivative of the Library, you may distribute the object code for the work under the terms of Section 6.

Any executables containing that work also fall under Section 6, whether or not they are linked directly with the Library itself.

6. As an exception to the Sections above, you may also combine or link a “work that uses the Library” with the Library to produce a work containing portions of the Library, and distribute that work under terms of your choice, provided that the terms permit modification of the work for the customer's own use and reverse engineering for debugging such modifications.

You must give prominent notice with each copy of the work that the Library is used in it and that the Library and its use are covered by this License. You must supply a copy of this License. If the work during execution displays copyright notices, you must include the copyright notice for the Library among them, as well as a reference directing the user to the copy of this License. Also, you must do one of these things:

- a) Accompany the work with the complete corresponding machine-readable source code for the Library including whatever changes were used in the work (which must be distributed under Sections 1 and 2 above); and, if the work is an executable linked with the Library, with the complete machine-readable “work that uses the Library”, as object code and/or source code, so that the user can modify the Library and then relink to produce a modified executable containing the modified Library. (It is understood that the user who changes the contents of definitions files in the Library will not necessarily be able to recompile the application to use the modified definitions.)
- b) Use a suitable shared library mechanism for linking with the Library. A suitable mechanism is one that (1) uses at run time a copy of the library already present on the user's computer system, rather than copying library functions into the executable, and (2) will operate properly with a modified version of the library, if the user installs one, as long as the modified version is interface-compatible with the version that the work was made with.
- c) Accompany the work with a written offer, valid for at least three years, to give the same user the materials specified in Subsection 6a, above, for a charge no more than the cost of performing this distribution.
- d) If distribution of the work is made by offering access to copy from a designated place, offer equivalent access to copy the above specified materials from the same place.
- e) Verify that the user has already received a copy of these materials or that you have already sent this user a copy.

For an executable, the required form of the “work that uses the library” must include any data and utility programs needed for reproducing the executable from it. However, as a special exception, the materials to be distributed need not include anything that is normally distributed (in either source or binary form) with the major components (compiler, kernel, and so on) of the operating system on which the executable runs, unless that component itself accompanies the executable.

It may happen that this requirement contradicts the license restrictions of other proprietary libraries that do not normally accompany the operating system. Such a contradiction means you cannot use both them and the Library together in an executable that you distribute.

7. You may place library facilities that are a work based on the Library side-by-side in a single library together with other library facilities not covered by this License, and distribute such a combined library, provided that the separate distribution of the work based on the Library and of the other library facilities is otherwise permitted, and provided that you do these two things:
 - a) Accompany the combined library with a copy of the same work based on the Library, uncombined with any other library facilities. This must be distributed under the terms of the Sections above.
 - b) Give prominent notice with the combined library of the fact that part of it is a work based on the Library, and explaining where to find the accompanying uncombined form of the same work.

8. You may not copy, modify, sublicense, link with, or distribute the Library except as expressly provided under this License. Any attempt otherwise to copy, modify, sublicense, link with, or distribute the Library is void, and will automatically terminate your rights under this License. However, parties who have received copies, or rights, from you under this License will not have their licenses terminated so long as such parties remain in full compliance.
9. You are not required to accept this License, since you have not signed it. However, nothing else grants you permission to modify or distribute the Library or its derivative works. These actions are prohibited by law if you do not accept this License. Therefore, by modifying or distributing the Library (or any work based on the Library), you indicate your acceptance of this License to do so, and all its terms and conditions for copying, distributing or modifying the Library or works based on it.
10. Each time you redistribute the Library (or any work based on the Library), the recipient automatically receives a license from the original licensor to copy, distribute, link with or modify the Library subject to these terms and conditions. You may not impose any further restrictions on the recipients' exercise of the rights granted herein.

You are not responsible for enforcing compliance by third parties with this License.

11. If, as a consequence of a court judgment or allegation of patent infringement or for any other reason (not limited to patent issues), conditions are imposed on you (whether by court order, agreement or otherwise) that contradict the conditions of this License, they do not excuse you from the conditions of this License. If you cannot distribute so as to satisfy simultaneously your obligations under this License and any other pertinent obligations, then as a consequence you may not distribute the Library at all. For example, if a patent license would not permit royalty-free redistribution of the Library by all those who receive copies directly or indirectly through you, then the only way you could satisfy both it and this License would be to refrain entirely from distribution of the Library.

If any portion of this section is held invalid or unenforceable under any particular circumstance, the balance of the section is intended to apply, and the section as a whole is intended to apply in other circumstances.

It is not the purpose of this section to induce you to infringe any patents or other property right claims or to contest validity of any such claims; this section has the sole purpose of protecting the integrity of the free software distribution system which is implemented by public license practices. Many people have made generous contributions to the wide range of software distributed through that system in reliance on consistent application of that system; it is up to the author/donor to decide if he or she is willing to distribute software through any other system and a licensee cannot impose that choice.

This section is intended to make thoroughly clear what is believed to be a consequence of the rest of this License.

12. If the distribution and/or use of the Library is restricted in certain countries either by patents or by copyrighted interfaces, the original copyright holder who places the Library under this License may add an explicit geographical distribution limitation excluding those countries, so that distribution is permitted only in or among countries not thus excluded. In such case, this License incorporates the limitation as if written in the body of this License.
13. The Free Software Foundation may publish revised and/or new versions of the Lesser General Public License from time to time. Such new versions will be similar in spirit to the present version, but may differ in detail to address new problems or concerns.

Each version is given a distinguishing version number. If the Library specifies a version number of this License which applies to it and "any later version", you have the option of following the terms and conditions either of that version or of any later version published by the Free Software Foundation. If the Library does not specify a license version number, you may choose any version ever published by the Free Software Foundation.

14. If you wish to incorporate parts of the Library into other free programs whose distribution conditions are incompatible with these, write to the author to ask for permission. For software which is copyrighted by the Free Software Foundation, write to the Free Software Foundation; we sometimes make exceptions for this. Our decision will be guided by the two goals of preserving the free status of all derivatives of our free software and of promoting the sharing and reuse of software generally.

NO WARRANTY

15. BECAUSE THE LIBRARY IS LICENSED FREE OF CHARGE, THERE IS NO WARRANTY FOR THE LIBRARY, TO THE EXTENT PERMITTED BY APPLICABLE LAW. EXCEPT WHEN OTHERWISE STATED IN WRITING THE COPYRIGHT HOLDERS AND/OR OTHER PARTIES PROVIDE THE LIBRARY "AS IS" WITHOUT WARRANTY OF ANY KIND, EITHER EXPRESSED OR IMPLIED, INCLUDING, BUT NOT LIMITED TO, THE IMPLIED WARRANTIES OF MERCHANTABILITY AND FITNESS FOR A PARTICULAR PURPOSE. THE ENTIRE RISK AS TO THE QUALITY AND PERFORMANCE OF THE LIBRARY IS WITH

YOU. SHOULD THE LIBRARY PROVE DEFECTIVE, YOU ASSUME THE COST OF ALL NECESSARY SERVICING, REPAIR OR CORRECTION.

16. IN NO EVENT UNLESS REQUIRED BY APPLICABLE LAW OR AGREED TO IN WRITING WILL ANY COPYRIGHT HOLDER, OR ANY OTHER PARTY WHO MAY MODIFY AND/OR REDISTRIBUTE THE LIBRARY AS PERMITTED ABOVE, BE LIABLE TO YOU FOR DAMAGES, INCLUDING ANY GENERAL, SPECIAL, INCIDENTAL OR CONSEQUENTIAL DAMAGES ARISING OUT OF THE USE OR INABILITY TO USE THE LIBRARY (INCLUDING BUT NOT LIMITED TO LOSS OF DATA OR DATA BEING RENDERED INACCURATE OR LOSSES SUSTAINED BY YOU OR THIRD PARTIES OR A FAILURE OF THE LIBRARY TO OPERATE WITH ANY OTHER SOFTWARE), EVEN IF SUCH HOLDER OR OTHER PARTY HAS BEEN ADVISED OF THE POSSIBILITY OF SUCH DAMAGES.

END OF TERMS AND CONDITIONS

How to Apply These Terms to Your New Libraries

If you develop a new library, and you want it to be of the greatest possible use to the public, we recommend making it free software that everyone can redistribute and change. You can do so by permitting redistribution under these terms (or, alternatively, under the terms of the ordinary General Public License).

To apply these terms, attach the following notices to the library. It is safest to attach them to the start of each source file to most effectively convey the exclusion of warranty; and each file should have at least the "copyright" line and a pointer to where the full notice is found.

<one line to give the library's name and a brief idea of what it does.>

Copyright (C) <year> <name of author>

This library is free software; you can redistribute it and/or modify it under the terms of the GNU Lesser General Public License as published by the Free Software Foundation; either version 2.1 of the License, or (at your option) any later version.

This library is distributed in the hope that it will be useful, but WITHOUT ANY WARRANTY; without even the implied warranty of MERCHANTABILITY or FITNESS FOR A PARTICULAR PURPOSE. See the GNU Lesser General Public License for more details.

You should have received a copy of the GNU Lesser General Public License along with this library; if not, write to the Free Software Foundation, Inc., 59 Temple Place, Suite 330, Boston, MA 02111-1307 USA

Also add information on how to contact you by electronic and paper mail.

You should also get your employer (if you work as a programmer) or your school, if any, to sign a "copyright disclaimer" for the library, if necessary. Here is a sample; alter the names:

Yoyodyne, Inc., hereby disclaims all copyright interest in the library 'Frob' (a library for tweaking knobs) written by James Random Hacker.

<signature of Ty Coon>, 1 April 1990

Ty Coon, President of Vice

That's all there is to it!

5. IJG: JPEG software decoder

The authors make NO WARRANTY or representation, either express or implied, with respect to this software, its quality, accuracy, merchantability, or fitness for a particular purpose. This software is provided "AS IS", and you, its user, assume the entire risk as to its quality and accuracy.

This software is copyright (C) 1991-1998, Thomas G. Lane.

All Rights Reserved except as specified below.

Permission is hereby granted to use, copy, modify, and distribute this software (or portions thereof) for any purpose, without fee, subject to these conditions:

- (1) If any part of the source code for this software is distributed, then this README file must be included, with this copyright and no-warranty notice unaltered; and any additions, deletions, or changes to the original files must be clearly indicated in accompanying documentation.
- (2) If only executable code is distributed, then the accompanying documentation must state that "this software is based in part on the work of the Independent JPEG Group".
- (3) Permission for use of this software is granted only if the user accepts full responsibility for any undesirable consequences; the authors accept NO LIABILITY for damages of any kind.

6. WPA Supplicant

Copyright (c) 2003-2009, Jouni Malinen <j@w1.fi> and contributors
All Rights Reserved.

Redistribution and use in source and binary forms, with or without modification, are permitted provided that the following conditions are met:

1. Redistributions of source code must retain the above copyright notice, this list of conditions and the following disclaimer.
2. Redistributions in binary form must reproduce the above copyright notice, this list of conditions and the following disclaimer in the documentation and/or other materials provided with the distribution.
3. Neither the name(s) of the above-listed copyright holder(s) nor the names of its contributors may be used to endorse or promote products derived from this software without specific prior written permission.

THIS SOFTWARE IS PROVIDED BY THE COPYRIGHT HOLDERS AND CONTRIBUTORS "AS IS" AND ANY EXPRESS OR IMPLIED WARRANTIES, INCLUDING, BUT NOT LIMITED TO, THE IMPLIED WARRANTIES OF MERCHANTABILITY AND FITNESS FOR A PARTICULAR PURPOSE ARE DISCLAIMED. IN NO EVENT SHALL THE COPYRIGHT OWNER OR CONTRIBUTORS BE LIABLE FOR ANY DIRECT, INDIRECT, INCIDENTAL, SPECIAL, EXEMPLARY, OR CONSEQUENTIAL DAMAGES (INCLUDING, BUT NOT LIMITED TO, PROCUREMENT OF SUBSTITUTE GOODS OR SERVICES; LOSS OF USE, DATA, OR PROFITS; OR BUSINESS INTERRUPTION) HOWEVER CAUSED AND ON ANY THEORY OF LIABILITY, WHETHER IN CONTRACT, STRICT LIABILITY, OR TORT (INCLUDING NEGLIGENCE OR OTHERWISE) ARISING IN ANY WAY OUT OF THE USE OF THIS SOFTWARE, EVEN IF ADVISED OF THE POSSIBILITY OF SUCH DAMAGE.

7. Unicode Bidirectional Algorithm

For the general privacy policy governing access to this site, see the Unicode Privacy Policy. For trademark usage, see the Unicode Consortium® Trademarks and Logo Policy.

Notice to End User: Terms of Use

Carefully read the following legal agreement ("Agreement"). Use or copying of the software and/or codes provided with this agreement (The "Software") constitutes your acceptance of these terms

Unicode Copyright.

Copyright © 1991-2009 Unicode, Inc. All rights reserved.

Certain documents and files on this website contain a legend indicating that "Modification is permitted." Any person is hereby authorized, without fee, to modify such documents and files to create derivative works conforming to the Unicode® Standard, subject to Terms and Conditions herein.

Any person is hereby authorized, without fee, to view, use, reproduce, and distribute all documents and files solely for informational purposes in the creation of products supporting the Unicode Standard, subject to the Terms and Conditions herein.

Further specifications of rights and restrictions pertaining to the use of the particular set of data files known as the "Unicode Character Database" can be found in Exhibit 1.

Each version of the Unicode Standard has further specifications of rights and restrictions of use. For the book editions, these are found on the back of the title page. For the online edition, certain files (such as the PDF files for book chapters and code charts) carry specific restrictions. All other files are covered under these general Terms of Use. To request a permission to reproduce any part of the Unicode Standard, please contact the Unicode Consortium.

No license is granted to "mirror" the Unicode website where a fee is charged for access to the "mirror" site.

Modification is not permitted with respect to this document. All copies of this document must be verbatim.

Restricted Rights Legend. Any technical data or software which is licensed to the United States of America, its agencies and/or instrumentalities under this Agreement is commercial technical data or commercial computer software developed exclusively at private expense as defined in FAR 2.101, or DFARS 252.227-7014 (June 1995), as applicable. For technical data, use, duplication, or disclosure by the Government is subject to restrictions as set forth in DFARS 202.227-7015 Technical Data, Commercial and Items (Nov 1995) and this Agreement. For Software, in accordance with FAR 12-212 or DFARS 227-7202, as applicable, use, duplication or disclosure by the Government is subject to the restrictions set forth in this Agreement.

Warranties and Disclaimers.

This publication and/or website may include technical or typographical errors or other inaccuracies. Changes are periodically added to the information herein; these changes will be incorporated in new editions of

the publication and/or website. Unicode may make improvements and/or changes in the product(s) and/or program(s) described in this publication and/or website at any time.

If this file has been purchased on magnetic or optical media from Unicode, Inc. the sole and exclusive remedy for any claim will be exchange of the defective media within ninety (90) days of original purchase.

EXCEPT AS PROVIDED IN SECTION C.2, THIS PUBLICATION AND/OR SOFTWARE IS PROVIDED "AS IS" WITHOUT WARRANTY OF ANY KIND EITHER EXPRESS, IMPLIED, OR STATUTORY, INCLUDING, BUT NOT LIMITED TO, ANY WARRANTIES OF MERCHANTABILITY, FITNESS FOR A PARTICULAR PURPOSE, OR NON-INFRINGEMENT. UNICODE AND ITS LICENSORS ASSUME NO RESPONSIBILITY FOR ERRORS OR OMISSIONS IN THIS PUBLICATION AND/OR SOFTWARE OR OTHER DOCUMENTS WHICH ARE REFERENCED BY OR LINKED TO THIS PUBLICATION OR THE UNICODE WEBSITE.

Waiver of Damages. In no event shall Unicode or its licensors be liable for any special, incidental, indirect or consequential damages of any kind, or any damages whatsoever, whether or not Unicode was advised of the possibility of the damage, including, without limitation, those resulting from the following: loss of use, data or profits, in connection with the use, modification or distribution of this information or its derivatives.

Trademarks.

Unicode and the Unicode logo are registered trademarks of Unicode, Inc.

This site contains product names and corporate names of other companies. All product names and company names and logos mentioned herein are the trademarks or registered trademarks of their respective owners. Other products and corporate names mentioned herein which are trademarks of a third party are used only for explanation and for the owners' benefit and with no intent to infringe.

Use of third party products or information referred to herein is at the user's risk.

Miscellaneous.

Jurisdiction and Venue. This server is operated from a location in the State of California, United States of America. Unicode makes no representation that the materials are appropriate for use in other locations. If you access this server from other locations, you are responsible for compliance with local laws. This Agreement, all use of this site and any claims and damages resulting from use of this site are governed solely by the laws of the State of California without regard to any principles which would apply the laws of a different jurisdiction. The user agrees that any disputes regarding this site shall be resolved solely in the courts located in Santa Clara County, California. The user agrees said courts have personal jurisdiction and agree to waive any right to transfer the dispute to any other forum.

Modification by Unicode Unicode shall have the right to modify this Agreement at any time by posting it to this site. The user may not assign any part of this Agreement without Unicode's prior written consent.

Taxes. The user agrees to pay any taxes arising from access to this website or use of the information herein, except for those based on Unicode's net income.

Severability. If any provision of this Agreement is declared invalid or unenforceable, the remaining provisions of this Agreement shall remain in effect.

Entire Agreement. This Agreement constitutes the entire agreement between the parties.

EXHIBIT 1

UNICODE, INC. LICENSE AGREEMENT - DATA FILES AND SOFTWARE

Unicode Data Files include all data files under the directories <http://www.unicode.org/Public/>, <http://www.unicode.org/reports/>, and <http://www.unicode.org/cldr/data/>. Unicode Software includes any source code published in the Unicode Standard or under the directories <http://www.unicode.org/Public/>, <http://www.unicode.org/reports/>, and <http://www.unicode.org/cldr/data/>.

NOTICE TO USER: Carefully read the following legal agreement. BY DOWNLOADING, INSTALLING, COPYING OR OTHERWISE USING UNICODE INC.'S DATA FILES ("DATA FILES"), AND/OR SOFTWARE ("SOFTWARE"), YOU UNEQUIVOCALLY ACCEPT, AND AGREE TO BE BOUND BY, ALL OF THE TERMS AND CONDITIONS OF THIS AGREEMENT. IF YOU DO NOT AGREE, DO NOT DOWNLOAD, INSTALL, COPY, DISTRIBUTE OR USE THE DATA FILES OR SOFTWARE.

COPYRIGHT AND PERMISSION NOTICE

Copyright © 1991-2009 Unicode, Inc. All rights reserved. Distributed under the Terms of Use in <http://www.unicode.org/copyright.html>.

Permission is hereby granted, free of charge, to any person obtaining a copy of the Unicode data files and any associated documentation (the "Data Files") or Unicode software and any associated documentation (the "Software") to deal in the Data Files or Software without restriction, including without limitation the rights to use, copy, modify, merge, publish, distribute, and/or sell copies of the Data Files or Software, and to permit persons to whom the Data Files or Software are furnished to do so, provided that (a) the above copyright notice(s) and this permission notice appear with all copies of the Data Files or Software, (b) both the above

copyright notice(s) and this permission notice appear in associated documentation, and (c) there is clear notice in each modified Data File or in the Software as well as in the documentation associated with the Data File(s) or Software that the data or software has been modified.

THE DATA FILES AND SOFTWARE ARE PROVIDED "AS IS", WITHOUT WARRANTY OF ANY KIND, EXPRESS OR IMPLIED, INCLUDING BUT NOT LIMITED TO THE WARRANTIES OF MERCHANTABILITY, FITNESS FOR A PARTICULAR PURPOSE AND NONINFRINGEMENT OF THIRD PARTY RIGHTS. IN NO EVENT SHALL THE COPYRIGHT HOLDER OR HOLDERS INCLUDED IN THIS NOTICE BE LIABLE FOR ANY CLAIM, OR ANY SPECIAL INDIRECT OR CONSEQUENTIAL DAMAGES, OR ANY DAMAGES WHATSOEVER RESULTING FROM LOSS OF USE, DATA OR PROFITS, WHETHER IN AN ACTION OF CONTRACT, NEGLIGENCE OR OTHER TORTIOUS ACTION, ARISING OUT OF OR IN CONNECTION WITH THE USE OR PERFORMANCE OF THE DATA FILES OR SOFTWARE.

Except as contained in this notice, the name of a copyright holder shall not be used in advertising or otherwise to promote the sale, use or other dealings in these Data Files or Software without prior written authorization of the copyright holder.

Unicode and the Unicode logo are trademarks of Unicode, Inc., and may be registered in some jurisdictions. All other trademarks and registered trademarks mentioned herein are the property of their respective owners.

8. OpenSSL.

Open SSL is an Open Source toolkit implementing the Secure Sockets Layer (SSL v2/v3) and Transport Layer Security (TLS v1) protocols as well as a full-strength general purpose cryptography library.

See <http://www.openssl.org/> and in particular <http://www.openssl.org/source/license.html>.

The license conditions are copied below.

The OpenSSL toolkit stays under a dual license, i.e. both the conditions of the OpenSSL License and the original SSLeay license apply to the toolkit.

See below for the actual license texts. Actually both licenses are BSD-style

Open Source licenses. In case of any license issues related to OpenSSL, please contact openssl-core@openssl.org.

OpenSSL License

/* =====
* Copyright (c) 1998-2008 The OpenSSL Project. All rights reserved.
*
* Redistribution and use in source and binary forms, with or without
* modification, are permitted provided that the following conditions
* are met:
*
* 1. Redistributions of source code must retain the above copyright
* notice, this list of conditions and the following disclaimer.
*
* 2. Redistributions in binary form must reproduce the above copyright
* notice, this list of conditions and the following disclaimer in
* the documentation and/or other materials provided with the
* distribution.
*
* 3. All advertising materials mentioning features or use of this
* software must display the following acknowledgment:
* "This product includes software developed by the OpenSSL Project
* for use in the OpenSSL Toolkit. (<http://www.openssl.org/>)"
*
* 4. The names "OpenSSL Toolkit" and "OpenSSL Project" must not be used to
* endorse or promote products derived from this software without
* prior written permission. For written permission, please contact
* openssl-core@openssl.org.
*
* 5. Products derived from this software may not be called "OpenSSL"

```

* nor may "OpenSSL" appear in their names without prior written
* permission of the OpenSSL Project.
*
* 6. Redistributions of any form whatsoever must retain the following
* acknowledgment:
* "This product includes software developed by the OpenSSL Project
* for use in the OpenSSL Toolkit (http://www.openssl.org/)"
*
* THIS SOFTWARE IS PROVIDED BY THE OpenSSL PROJECT "AS IS" AND ANY
* EXPRESSED OR IMPLIED WARRANTIES, INCLUDING, BUT NOT LIMITED TO, THE
* IMPLIED WARRANTIES OF MERCHANTABILITY AND FITNESS FOR A PARTICULAR
* PURPOSE ARE DISCLAIMED. IN NO EVENT SHALL THE OpenSSL PROJECT OR
* ITS CONTRIBUTORS BE LIABLE FOR ANY DIRECT, INDIRECT, INCIDENTAL,
* SPECIAL, EXEMPLARY, OR CONSEQUENTIAL DAMAGES (INCLUDING, BUT
* NOT LIMITED TO, PROCUREMENT OF SUBSTITUTE GOODS OR SERVICES;
* LOSS OF USE, DATA, OR PROFITS; OR BUSINESS INTERRUPTION)
* HOWEVER CAUSED AND ON ANY THEORY OF LIABILITY, WHETHER IN
* CONTRACT, STRICT LIABILITY, OR TORT (INCLUDING NEGLIGENCE OR
* OTHERWISE) ARISING IN ANY WAY OUT OF THE USE OF THIS SOFTWARE,
* EVEN IF ADVISED OF THE POSSIBILITY OF SUCH DAMAGE.
* =====
*
* This product includes cryptographic software written by Eric Young
* (eay@cryptsoft.com). This product includes software written by Tim
* Hudson (tjh@cryptsoft.com).
*
*/

```

Original SSLeay License

```

/* Copyright (C) 1995-1998 Eric Young (eay@cryptsoft.com)
* All rights reserved.
*
* This package is an SSL implementation written
* by Eric Young (eay@cryptsoft.com).
* The implementation was written so as to conform with Netscapes SSL.
*
* This library is free for commercial and non-commercial use as long as
* the following conditions are aheared to. The following conditions
* apply to all code found in this distribution, be it the RC4, RSA,
* lhash, DES, etc., code; not just the SSL code. The SSL documentation
* included with this distribution is covered by the same copyright terms
* except that the holder is Tim Hudson (tjh@cryptsoft.com).
*
* Copyright remains Eric Young's, and as such any Copyright notices in
* the code are not to be removed.
* If this package is used in a product, Eric Young should be given attribution
* as the author of the parts of the library used.
* This can be in the form of a textual message at program startup or
* in documentation (online or textual) provided with the package.
*
* Redistribution and use in source and binary forms, with or without
* modification, are permitted provided that the following conditions
* are met:
* 1. Redistributions of source code must retain the copyright
* notice, this list of conditions and the following disclaimer.
* 2. Redistributions in binary form must reproduce the above copyright
* notice, this list of conditions and the following disclaimer in the
* documentation and/or other materials provided with the distribution.
* 3. All advertising materials mentioning features or use of this software
* must display the following acknowledgement:

```

```

* "This product includes cryptographic software written by
* Eric Young (eay@cryptsoft.com)"
* The word 'cryptographic' can be left out if the rouines from the library
* being used are not cryptographic related :-).
* 4. If you include any Windows specific code (or a derivative thereof) from
* the apps directory (application code) you must include an acknowledgement:
* "This product includes software written by Tim Hudson (tjh@cryptsoft.com)"
*
* THIS SOFTWARE IS PROVIDED BY ERIC YOUNG "AS IS" AND ANY EXPRESS OR
* IMPLIED WARRANTIES, INCLUDING, BUT NOT LIMITED TO, THE IMPLIED
* WARRANTIES OF MERCHANTABILITY AND FITNESS FOR A PARTICULAR
* PURPOSE ARE DISCLAIMED. IN NO EVENT SHALL THE AUTHOR OR
* CONTRIBUTORS BE LIABLE FOR ANY DIRECT, INDIRECT, INCIDENTAL,
* SPECIAL, EXEMPLARY, OR CONSEQUENTIAL DAMAGES (INCLUDING, BUT
* NOT LIMITED TO, PROCUREMENT OF SUBSTITUTE GOODS OR SERVICES; LOSS
* OF USE, DATA, OR PROFITS; OR BUSINESS INTERRUPTION) HOWEVER
* CAUSED AND ON ANY THEORY OF LIABILITY, WHETHER IN CONTRACT,
* STRICT LIABILITY, OR TORT (INCLUDING NEGLIGENCE OR OTHERWISE)
* ARISING IN ANY WAY OUT OF THE USE OF THIS SOFTWARE, EVEN IF ADVISED
* OF THE POSSIBILITY OF SUCH DAMAGE.
*
* The licence and distribution terms for any publically available version or
* derivative of this code cannot be changed. i.e. this code cannot simply be
* copied and put under another distribution licence
* [including the GNU Public Licence.]
*/

```

9. Zlib general purpose compression library

See <http://www.zlib.net/>, and in particular http://www.zlib.net/zlib_license.html.

```

/* zlib.h -- interface of the 'zlib' general purpose compression library version 1.2.3, July 18th, 2005

```

```

Copyright (C) 1995-2005 Jean-loup Gailly and Mark Adler

```

This software is provided 'as-is', without any express or implied warranty. In no event will the authors be held liable for any damages arising from the use of this software.

Permission is granted to anyone to use this software for any purpose, including commercial applications, and to alter it and redistribute it freely, subject to the following restrictions:

1. The origin of this software must not be misrepresented; you must not claim that you wrote the original software. If you use this software in a product, an acknowledgment in the product documentation would be appreciated but is not required.
2. Altered source versions must be plainly marked as such, and must not be misrepresented as being the original software.
3. This notice may not be removed or altered from any source distribution.

```

Jean-loup Gailly jloup@gzip.org
Mark Adler madler@alumni.caltech.edu

```

```

*/

```

10. cURL

COPYRIGHT AND PERMISSION NOTICE

Copyright (c) 1996 - 2009, Daniel Stenberg, <daniel@haxx.se>.

All rights reserved.

Permission to use, copy, modify, and distribute this software for any purpose with or without fee is hereby granted, provided that the above copyright notice and this permission notice appear in all copies.

THE SOFTWARE IS PROVIDED "AS IS", WITHOUT WARRANTY OF ANY KIND, EXPRESS OR IMPLIED, INCLUDING BUT NOT LIMITED TO THE WARRANTIES OF MERCHANTABILITY, FITNESS FOR A PARTICULAR PURPOSE AND NONINFRINGEMENT OF THIRD PARTY RIGHTS. IN NO EVENT SHALL THE AUTHORS OR COPYRIGHT HOLDERS BE LIABLE FOR ANY CLAIM, DAMAGES OR OTHER

LIABILITY, WHETHER IN AN ACTION OF CONTRACT, TORT OR OTHERWISE, ARISING FROM, OUT OF OR IN CONNECTION WITH THE SOFTWARE OR THE USE OR OTHER DEALINGS IN THE SOFTWARE.

Except as contained in this notice, the name of a copyright holder shall not be used in advertising or otherwise to promote the sale, use or other dealings in this Software without prior written authorization of the copyright holder.

11. Freetype, a Free, High-Quality, and Portable Font Engine

The software is based in part of the work of the FreeType Team.

See <http://freetype.sourceforge.net/>, and in particular <http://freetype.sourceforge.net/FTL.TXT>.

Portions of the relevant license conditions are copied below.

The FreeType Project LICENSE

2006-Jan-27

Copyright 1996-2002, 2006 by David Turner, Robert Wilhelm, and Werner Lemberg

...

1. No Warranty

THE FREETYPE PROJECT IS PROVIDED 'AS IS' WITHOUT WARRANTY OF ANY KIND, EITHER EXPRESS OR IMPLIED, INCLUDING, BUT NOT LIMITED TO, WARRANTIES OF MERCHANTABILITY AND FITNESS FOR A PARTICULAR PURPOSE. IN NO EVENT WILL ANY OF THE AUTHORS OR COPYRIGHT HOLDERS BE LIABLE FOR ANY DAMAGES CAUSED BY THE USE OR THE INABILITY TO USE, OF THE FREETYPE PROJECT.

2. Redistribution

This license grants a worldwide, royalty-free, perpetual and irrevocable right and license to use, execute, perform, compile, display, copy, create derivative works of, distribute and sublicense the FreeType Project (in both source and object code forms) and derivative works thereof for any purpose; and to authorize others to exercise some or all of the rights granted herein, subject to the following conditions:

...

- o Redistribution in binary form must provide a disclaimer that states that the software is based in part of the work of the FreeType Team, in the distribution documentation. We also encourage you to put an URL to the FreeType web page in your documentation, though this isn't mandatory.

...

12. International Components for Unicode

COPYRIGHT AND PERMISSION NOTICE

Copyright (c) 1995-2009 International Business Machines Corporation and others

All rights reserved.

Permission is hereby granted, free of charge, to any person obtaining a copy of this software and associated documentation files (the "Software"), to deal in the Software without restriction, including without limitation the rights to use, copy, modify, merge, publish, distribute, and/or sell copies of the Software, and to permit persons to whom the Software is furnished to do so, provided that the above copyright notice(s) and this permission notice appear in all copies of the Software and that both the above copyright notice(s) and this permission notice appear in supporting documentation.

THE SOFTWARE IS PROVIDED "AS IS", WITHOUT WARRANTY OF ANY KIND, EXPRESS OR IMPLIED, INCLUDING BUT NOT LIMITED TO THE WARRANTIES OF MERCHANTABILITY, FITNESS FOR A PARTICULAR PURPOSE AND NONINFRINGEMENT OF THIRD PARTY RIGHTS. IN NO EVENT SHALL THE COPYRIGHT HOLDER OR HOLDERS INCLUDED IN THIS NOTICE BE LIABLE FOR ANY CLAIM, OR ANY SPECIAL INDIRECT OR CONSEQUENTIAL DAMAGES, OR ANY DAMAGES WHATSOEVER RESULTING FROM LOSS OF USE, DATA OR PROFITS, WHETHER IN AN ACTION OF CONTRACT, NEGLIGENCE OR OTHER TORTIOUS ACTION, ARISING OUT OF OR IN CONNECTION WITH THE USE OR PERFORMANCE OF THIS SOFTWARE.

Except as contained in this notice, the name of a copyright holder shall not be used in advertising or otherwise to promote the sale, use or other dealings in this Software without prior written authorization of the copyright holder.

13. Expat

Copyright (c) 1998, 1999, 2000 Thai Open Source Software Center Ltd and Clark Cooper

Copyright (c) 2001, 2002, 2003, 2004, 2005, 2006 Expat maintainers.

Permission is hereby granted, free of charge, to any person obtaining a copy of this software and associated documentation files (the "Software"), to deal in the Software without restriction, including without limitation the rights to use, copy, modify, merge, publish, distribute, sublicense, and/or sell copies of the Software, and to permit persons to whom the Software is furnished to do so, subject to the following conditions:

The above copyright notice and this permission notice shall be included in all copies or substantial portions of the Software.

THE SOFTWARE IS PROVIDED "AS IS", WITHOUT WARRANTY OF ANY KIND, EXPRESS OR IMPLIED, INCLUDING BUT NOT LIMITED TO THE WARRANTIES OF MERCHANTABILITY, FITNESS FOR A PARTICULAR PURPOSE AND NONINFRINGEMENT.

IN NO EVENT SHALL THE AUTHORS OR COPYRIGHT HOLDERS BE LIABLE FOR ANY CLAIM, DAMAGES OR OTHER LIABILITY, WHETHER IN AN ACTION OF CONTRACT, TORT OR OTHERWISE, ARISING FROM, OUT OF OR IN CONNECTION WITH THE SOFTWARE OR THE USE OR OTHER DEALINGS IN THE SOFTWARE.

14. DNS Resolver

The DNS resolver code, taken from BIND 4.9.5, is copyrighted both by UC Berkeley and by Digital Equipment Corporation. The DEC portions are under the following license:

Portions Copyright (C) 1993 by Digital Equipment Corporation.

Permission to use, copy, modify, and distribute this software for any purpose with or without fee is hereby granted, provided that the above copyright notice and this permission notice appear in all copies, and that the name of Digital Equipment Corporation not be used in advertising or publicity pertaining to distribution of the document or software without specific, written prior permission.

THE SOFTWARE IS PROVIDED "AS IS" AND DIGITAL EQUIPMENT CORP. DISCLAIMS ALL WARRANTIES WITH REGARD TO THIS SOFTWARE, INCLUDING ALL IMPLIED WARRANTIES OF MERCHANTABILITY AND FITNESS. IN NO EVENT SHALL DIGITAL EQUIPMENT CORPORATION BE LIABLE FOR ANY SPECIAL, DIRECT, INDIRECT, OR CONSEQUENTIAL DAMAGES OR ANY DAMAGES WHATSOEVER RESULTING FROM LOSS OF USE, DATA OR PROFITS, WHETHER IN AN ACTION OF CONTRACT, NEGLIGENCE OR OTHER TORTIOUS ACTION, ARISING OUT OF OR IN CONNECTION WITH THE USE OR PERFORMANCE OF THIS SOFTWARE.

15. getnameinfo, getaddrinfo

The files `inet/getnameinfo.c` and `sysdeps/posix/getaddrinfo.c` are copyright (C) by Craig Metz and are distributed under the following license:

```
/* The Inner Net License, Version 2.00
```

The author(s) grant permission for redistribution and use in source and binary forms, with or without modification, of the software and documentation provided that the following conditions are met:

0. If you receive a version of the software that is specifically labelled as not being for redistribution (check the version message and/or README), you are not permitted to redistribute that version of the software in any way or form.
 1. All terms of the all other applicable copyrights and licenses must be followed.
 2. Redistributions of source code must retain the authors' copyright notice(s), this list of conditions, and the following disclaimer.
 3. Redistributions in binary form must reproduce the authors' copyright notice(s), this list of conditions, and the following disclaimer in the documentation and/or other materials provided with the distribution.
 4. [The copyright holder has authorized the removal of this clause.]
 5. Neither the name(s) of the author(s) nor the names of its contributors may be used to endorse or promote products derived from this software without specific prior written permission.

THIS SOFTWARE IS PROVIDED BY ITS AUTHORS AND CONTRIBUTORS "AS IS" AND ANY EXPRESS OR IMPLIED WARRANTIES, INCLUDING, BUT NOT LIMITED TO, THE IMPLIED WARRANTIES OF MERCHANTABILITY AND FITNESS FOR A PARTICULAR PURPOSE ARE DISCLAIMED. IN NO EVENT SHALL THE AUTHORS OR CONTRIBUTORS BE LIABLE FOR ANY DIRECT, INDIRECT, INCIDENTAL,

SPECIAL, EXEMPLARY, OR CONSEQUENTIAL DAMAGES (INCLUDING, BUT NOT LIMITED TO, PROCUREMENT OF SUBSTITUTE GOODS OR SERVICES; LOSS OF USE, DATA, OR PROFITS; OR BUSINESS INTERRUPTION) HOWEVER CAUSED AND ON ANY THEORY OF LIABILITY, WHETHER IN CONTRACT, STRICT LIABILITY, OR TORT (INCLUDING NEGLIGENCE OR OTHERWISE) ARISING IN ANY WAY OUT OF THE USE OF THIS SOFTWARE, EVEN IF ADVISED OF THE POSSIBILITY OF SUCH DAMAGE.

If these license terms cause you a real problem, contact the author: */

16. libpng

This copy of the libpng notices is provided for your convenience. In case of any discrepancy between this copy and the notices in the file png.h that is included in the libpng distribution, the latter shall prevail.

COPYRIGHT NOTICE, DISCLAIMER, and LICENSE:

If you modify libpng you may insert additional notices immediately following this sentence.

This code is released under the libpng license.

libpng versions 1.2.6, August 15, 2004, through 1.2.41, December 3, 2009, are Copyright (c) 2004, 2006-2009 Glenn Randers-Pehrson, and are distributed according to the same disclaimer and license as libpng-1.2.5 with the following individual added to the list of Contributing Authors

Cosmin Truta

libpng versions 1.0.7, July 1, 2000, through 1.2.5 - October 3, 2002, are

Copyright (c) 2000-2002 Glenn Randers-Pehrson, and are distributed according to the same disclaimer and license as libpng-1.0.6 with the following individuals added to the list of Contributing Authors

Simon-Pierre Cadieux

Eric S. Raymond

Gilles Vollant

and with the following additions to the disclaimer:

There is no warranty against interference with your enjoyment of the library or against infringement. There is no warranty that our efforts or the library will fulfill any of your particular purposes or needs. This library is provided with all faults, and the entire risk of satisfactory quality, performance, accuracy, and effort is with the user.

libpng versions 0.97, January 1998, through 1.0.6, March 20, 2000, are Copyright (c) 1998, 1999 Glenn Randers-Pehrson, and are distributed according to the same disclaimer and license as libpng-0.96, with the following individuals added to the list of Contributing Authors:

Tom Lane

Glenn Randers-Pehrson

Willem van Schaik

libpng versions 0.89, June 1996, through 0.96, May 1997, are Copyright (c) 1996, 1997 Andreas Dilger

Distributed according to the same disclaimer and license as libpng-0.88, with the following individuals added to the list of Contributing Authors:

John Bowler

Kevin Bracey

Sam Bushell

Magnus Holmgren

Greg Roelofs

Tom Tanner

libpng versions 0.5, May 1995, through 0.88, January 1996, are Copyright (c) 1995, 1996 Guy Eric Schalnat, Group 42, Inc.

For the purposes of this copyright and license, "Contributing Authors" is defined as the following set of individuals:

Andreas Dilger

Dave Martindale

Guy Eric Schalnatz
Paul Schmidt
Tim Wegner

The PNG Reference Library is supplied "AS IS". The Contributing Authors and Group 42, Inc. disclaim all warranties, expressed or implied, including, without limitation, the warranties of merchantability and of fitness for any purpose. The Contributing Authors and Group 42, Inc. assume no liability for direct, indirect, incidental, special, exemplary, or consequential damages, which may result from the use of the PNG Reference Library, even if advised of the possibility of such damage.

Permission is hereby granted to use, copy, modify, and distribute this source code, or portions hereof, for any purpose, without fee, subject to the following restrictions:

1. The origin of this source code must not be misrepresented.
2. Altered versions must be plainly marked as such and must not be misrepresented as being the original source.
3. This Copyright notice may not be removed or altered from any source or altered source distribution.

The Contributing Authors and Group 42, Inc. specifically permit, without fee, and encourage the use of this source code as a component to supporting the PNG file format in commercial products. If you use this source code in a product, acknowledgment is not required but would be appreciated.

A "png_get_copyright" function is available, for convenient use in "about" boxes and the like:

```
printf("%s",png_get_copyright(NULL));
```

Also, the PNG logo (in PNG format, of course) is supplied in the files "pngbar.png" and "pngbar.jpg (88x31) and "pngnow.png" (98x31).

Libpng is OSI Certified Open Source Software. OSI Certified Open Source is a certification mark of the Open Source Initiative.

Glenn Randers-Pehrson

glennrp at users.sourceforge.net

December 3, 2009

17. SQLite

All of the deliverable code in SQLite has been dedicated to the HYPERLINK "http://en.wikipedia.org/wiki/Public_Domain" public domain by the authors. All code authors, and representatives of the companies they work for, have signed affidavits dedicating their contributions to the public domain and originals of those signed affidavits are stored in a firesafe at the main offices of HYPERLINK "<http://www.hwaci.com>" Hwaci. Anyone is free to copy, modify, publish, use, compile, sell, or distribute the original SQLite code, either in source code form or as a compiled binary, for any purpose, commercial or non-commercial, and by any means.

The previous paragraph applies to the deliverable code in SQLite - those parts of the SQLite library that you actually bundle and ship with a larger application. Portions of the documentation and some code used as part of the build process might fall under other licenses. The details here are unclear. We do not worry about the licensing of the documentation and build code so much because none of these things are part of the core deliverable SQLite library.

All of the deliverable code in SQLite has been written from scratch. No code has been taken from other projects or from the open internet. Every line of code can be traced back to its original author, and all of those authors have public domain dedications on file. So the SQLite code base is clean and is uncontaminated with licensed code from other projects.

