



**Mexico**

**NOM-135** 

Es necesario que lea cuidadosamente su instructivo de manejo.

	<b>PRECAUCIÓN - ADVERTENCIA</b>	
	No abrir, riesgo de choque eléctrico	
	<b>ATENCIÓN</b>	
	Verifique que el voltaje de alimentación sea el requerido para su aparato	
Para evitar el riesgo de choque eléctrico, no quite la tapa. En caso de requerir servicio, dirijase al personal calificado.		

Descripción: **Tocadiscos de MP3-CD portatil**  
Modelo: **EXP 201/01/16**  
**EXP 203/01/16**  
Alimentación: **110-127/220-240 V; ~50-60 Hz**  
Consumo: **8 W (AY3160)**  
Importador: **Philips Mexicana, S.A. de C.V.**  
Domicilio: **Norte 45, # 669, Col. Industrial Vallejo**  
Localidad y Telefono: **C.P. 02300 México D.F.,**  
**Tel. 57284200**  
Exportador: **Philips Electronics HK, Ltd.**  
País de Origen: **China**  
Nº de Serie: \_\_\_\_\_

**LEA CUIDADOSAMENTE ESTE INSTRUCTIVO  
ANTES DE USAR SU APARATO.**

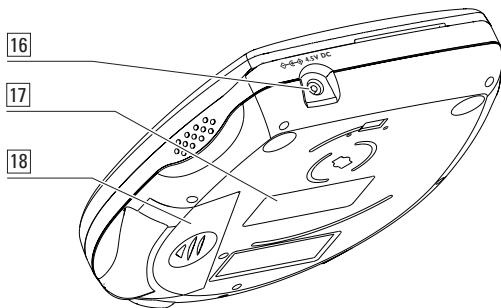
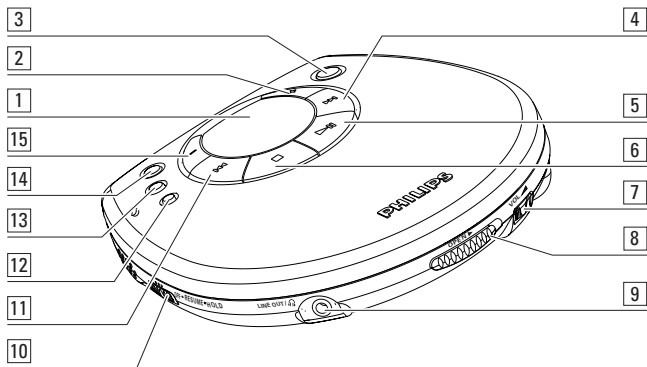

## **CAUTION**

**Use of controls or adjustments or performance of procedures other than herein may result in hazardous radiation exposure.**

## **ATTENTION**

**L'utilisation des commandes ou réglages ou le non-respect des procédures ci-incluses peuvent se traduire par une exposition dangereuse à l'irradiation.**

## **ATENCIÓN**

**El uso de mandos o ajustes o la ejecución de métodos que no sean los aquí descritos puede ocasionar peligro de exposición a radiación.**

## **中文**

**Use of controls or adjustments or performance of procedures other than herein may result in hazardous radiation exposure.**

**English**

Controls/Quick start .....	6-7	In-car connection .....	12
Power supply/Line out .....	8-9	Features .....	13-17
Headphones .....	10	CD play .....	18-19
General information .....	11	MP3-CD playback .....	20-23
		Troubleshooting .....	24-25

English

**Français**

Commandes .....	26	Raccordement en voiture .....	32
Mise en service rapide .....	27	Fonctions spéciales .....	33-37
Alimentation électrique/Line out .....	28-29	Lecture CD .....	38-39
Ecouteurs .....	30	Lecture d'un CD MP3 .....	40-43
Informations générales .....	31	Pannes et remèdes .....	44-45

Français

**Español**

Controles/Descripción rápida .....	46-47	Conexión para el automóvil .....	52
Suministro eléctrico .....	48-49	Características .....	53-67
Auriculares .....	50	Reproducción de CD .....	58-59
Información general .....	51	Reproducción de CD MP3 .....	60-63
		Localización de averías .....	64-65

Español

## 中文

Controls/Quick start .....	66-67	In-car connection .....	72
Power supply/Line out .....	68-69	Features .....	73-77
Headphones .....	70	CD play .....	78-79
General information .....	71	MP3-CD playback .....	80-83
		Troubleshooting .....	74-85

中文

**Guarantees**

Philips product warranty for <b>Australia</b> .....	86-87	Guarantee and service for <b>New Zealand</b> .....	88
		Certificado de Garantia <b>Brasil</b> .....	89
		Ploiza de Garantia <b>México</b> .....	90-91

# CONTROLS, refer to the illustration on page 3

- 1 .....display
- 2 + ..... **MP3** : searches to the next album/ fast searches next titles
- 3 ESP ..... **ELECTRONIC SKIP PROTECTION** ensures continuous playback regardless of vibrations and shocks
- 4 ►► ..... **CD Audio** : searches within a track/ fast searches to the next track  
**MP3** : fast searches next titles/ searches to the next album
- 5 ►|| ..... switches the set on, starts and pause CD play
- 6 ■ ..... stops CD play, erases a program and switches the set off
- 7 VOL ▲ ..... adjusts the volume
- 8 OPEN ..... opens the CD lid
- 9 LINE OUT /  ..... 3.5mm line out socket to connect the set to an audio input of an additional audio equipment and 3.5 mm headphone
- 10 OFF ..... switches RESUME and HOLD off  
RESUME ..... **CD Audio** : stores and continues playback from the last position played  
**MP3** : stores and continues playback from the last title played
- HOLD** ..... **locks all buttons**
- 11 ◀◀ ..... **CD Audio** : searches within a track/ fast searches to a previous track  
**MP3** : fast searches previous titles/ searches to a previous album
- 12 PROGRAM ..... programs tracks and reviews the program
- 13 MODE ..... selects the different playing possibilities e.g.: **SHUFFLE**, **SHUFFLE REPEAT ALL**, **REPEAT** and **REPEAT ALL**
- 14 DBB ..... **DYNAMIC BASS BOOST** switches the bass enhancement on/off. This button also switches the acoustic feedback (the beep) on/off when pressed for more than 2 seconds
- 15 - ..... **MP3** : searches to a previous album/ fast searches previous titles
- 16 4.5V DC ..... socket for external power supply
- 17 ..... model serial number plate
- 18 ..... battery compartment

# QUICK START

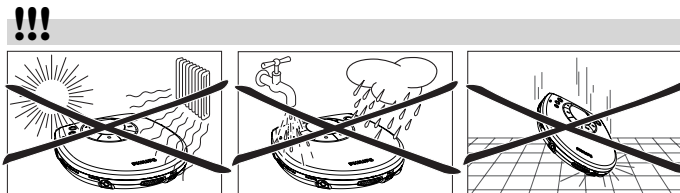
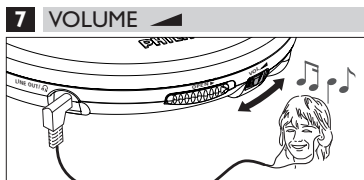
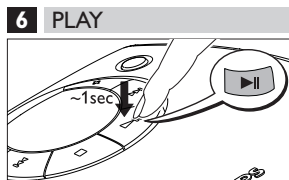
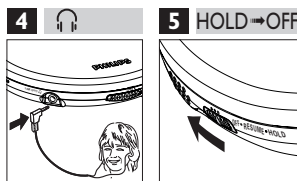
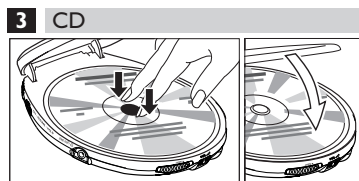
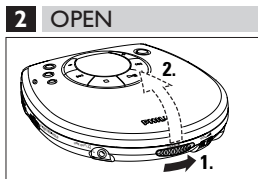
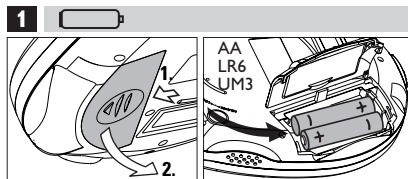

*This set complies with the radio interference requirements of the European Community.*

# POWER SUPPLY

## Batteries (not included)

With this set you can use :

- alkaline batteries (type **LR6, UM3** or **AA**)

### Inserting batteries

- 1 Open the battery compartment and insert 2 alkaline batteries.

*Notes: – Old and new or different types of batteries should not be used in combination.  
– Remove batteries if they are empty or if the set will not be used for a long time.*

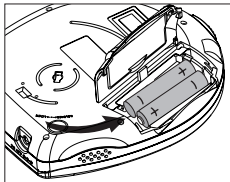

**Batteries contain chemical substances, so they should be disposed of properly.**

### Battery indication

- The battery symbol on the display is divided into 3 segments which indicate the approximate power capacity of the batteries. Full battery capacity is shown by three segments.

### Indication of empty batteries

- Replace the batteries or connect the power adapter as soon as  flashes and **と ㊦ と と** is displayed.



*Notes: The average playing time of batteries under normal conditions.*

Battery type	ESP on	ESP off
MP3 Normal	3 hours	N/A
MP3 Alkaline	10 hours	N/A



# POWER SUPPLY/LINE OUT

## Mains adapter (supplied or optionally available)

Only use the AY 3160 mains adapter (4.5 V/400mA direct current, positive pole to the center pin). Any other product may damage the set.

- 1 Make sure the local voltage corresponds to the adapter's voltage.
- 2 Connect the mains adapter to the 4.5V DC socket of the player and to the wall socket.

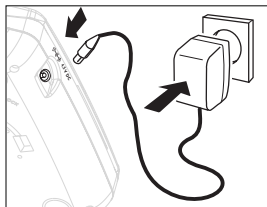

*Note: Always disconnect the adapter when you are not using it.*

## Line out

You can connect the CD player to an additional audio equipment, E.g. amplifier, radio cassette recorder, etc., with a LINE IN socket.

- 1 Turn down the volume on the additional audio equipment.
- 2 Connect an audio signal cable (not supplied,) to the LINE OUT /  socket of the CD player and the CD IN, AUX IN or LINE IN socket of the additional audio equipment.
- 3 To adjust the sound and volume, use the controls on the connected audio equipment and on the CD player.

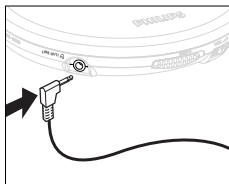

# HEADPHONES AND SOUND OPTIONS

## Headphones (HE 545)

### Connecting the headphones

- Connect the supplied headphones to LINE OUT / .

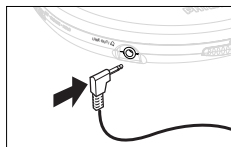

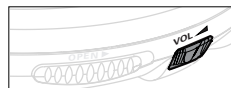

## Volume and sound adjustment

- Adjust the volume by using VOL .



## DBB - Dynamic bass boost and Audible (beep) feedback

- Press the **DBB** button once or more to select your DBB option.
  - The display shows the various DBB options: *dbb 1* and , or *dbb 2* and .
  - If deactivated, no DBB indications are shown.
- Press the **DBB** button for more than 2 seconds to select your beep option on/off.
  - The display shows *beep* or *beep*.
  - If selected, the beep is heard when buttons on the set are pressed, the set is in pause mode, or battery power is low.



### Use your head when using headphones

- **Hearing safety:** Do not play your headset at a high volume as extended play at high volume will damage your hearing.
- **Traffic safety:** Do not use while driving. It may create a traffic hazard and it's illegal in many areas. Even if your headset is an open-air type designed to let you hear outside sounds, don't turn up the volume so high that you can't hear what's around you.

# GENERAL INFORMATION

## MP3-CD player and CD handling

- Do not touch the lens (A) of the CD player.
- Do not expose the set, batteries or CDs to humidity, rain, sand or excessive heat (caused by heating equipment or direct sunlight).
- You can clean the CD player with a soft, slightly dampened lint-free cloth. Do not use any cleaning agents as they may have a corrosive effect.
- To clean the CD, wipe it in a straight line from the center toward the edge using a soft, lint-free cloth. A cleaning agent may damage the disc! Never write on a CD or attach a sticker to it.
- The lens may cloud over when the set is moved suddenly from cold to warm surroundings. Playing a CD is not possible then. Leave the CD player in a warm environment until the moisture evaporates.
- Active mobile phones in the vicinity may cause interference to your CD player.
- Avoid dropping the set as this may cause damage.

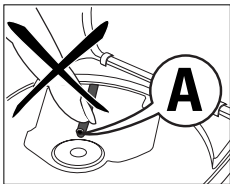



## Environmental information

- All redundant packing material has been omitted. We have done our utmost to make the packaging easily separable into 2 materials: cardboard and polyethylene.
- Your set consists of materials which can be recycled if disassembled by a specialized company. Please observe the local regulations regarding the disposal of packing materials, dead batteries and old equipment.

# IN-CAR CONNECTION

## In-car use (connections supplied or optionally available)

Only use the AY 3545 car voltage converter (**4.5 V, DC, positive pole to the center pin**) and the AY 3501 car cassette adapter. Any other product may damage the set.

- Put the CD player on a horizontal, vibration-free and stable surface. Make sure it is a safe place, where the player is not a danger or obstacle to the driver and passengers.
  - Insert the voltage converter into the cigarette lighter socket. If necessary, clean the cigarette lighter socket to obtain a good electrical contact. (**only for a 12 V car battery, negative grounding**).
  - Connect the DC plug of the voltage converter to the 4.5V DC socket of the CD player.
  - Turn down the volume and connect the cassette adapter plug to the LINE OUT /  of the CD player.
  - Carefully insert the cassette adapter into the car radio's cassette compartment.
  - Make sure the cord does not hinder your driving.
  - Start the CD player, set VOL  to position 8 and adjust the sound with the car radio controls.
- Always remove the voltage converter from the cigarette lighter socket when the CD player is not in use.

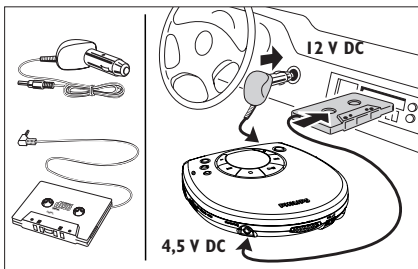

*Notes: – Avoid excessive heat from the car heating or from direct sunlight (e.g. in a parked car in the summer).*

*– If your car radio has a LINE IN socket, use the LINE IN socket for the car radio connection instead of the cassette adapter. Connect the signal lead to this LINE IN socket and the LINE OUT /  socket of the CD player.*

## Selecting a track / title and searching (CD and MP3)

### Selecting a track / title during playback

- Briefly press **◀◀** or **▶▶** once or several times to skip to the current, previous or subsequent track /title start.
  - ▶ Playback continues with the selected track /title and its number is displayed.

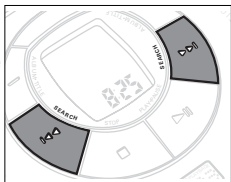

### Searching for a passage during playback

- Keep **◀◀** or **▶▶** pressed to find a particular passage in a backward or forward direction.
  - ▶ Searching starts and playback continues at a low volume. After 2 seconds the search speeds up.
- Release the button when you reach the desired passage.
  - ▶ Normal playback continues.

*Notes: – During SHUFFLE, SHUFFLE REPEAT ALL, REPEAT, REPEAT ALL or while playing a program searching is possible only within the track.  
 -- Sound is muted during MP3 search.*

## MP3 quick search (on MP3-CDs only)

### Selecting an album during playback

- Toggle **-** or **+** to find your album.  
 the first title of the current, previous or subsequent album.
  - ▶ The first title of the selected album is played.



### Searching an MP3 title during playback

- Keep **+** or **-** pressed to search a title in forward or backward direction.
  - ▶ Searching starts at high speed through all the titles, album by album.

# FEATURES

## Programming track/title numbers

You can select up to 32 titles and store them in the memory in a desired sequence. You can store any track/titles more than once.

- 1 While playback is stopped, select a track/title with **◀◀** or **▶▶**.
- 2 Press **PROGRAM** to store the track/titles.
  - **PROGRAM** lights up, the track/titles number programmed and **P** with the total number of stored track/titles are displayed.
- 3 Select and store all desired tracks in this way.
- 4 Press **▶||** to start playback of your selected track/titles.
  - **PROGRAM** is shown and playback starts.
  - You can review the program by pressing **PROGRAM** for more than 2 seconds.
    - The display shows all stored track/titles in sequence.



*Note:* – If you try to store more than 32 track/titles, **FULL** is displayed.

## Erasing the program

- 1 If necessary, press **■** to stop playback.
- 2 Press **■** to erase the program.
  - **⏮** is displayed once, **PROGRAM** goes off and the program is erased.

*Notes:* The program will also be erased if you

- interrupt the power supply,
- open the CD lid, or
- the set is switched off automatically.



## Storing the last position played – RESUME

You can store the last position played. When restarting, playback continues from where you have stopped, according to CD Audio or MP3 playback.

- 1 Switch the slider to RESUME during playback to activate RESUME.

→ **RESUME** is shown.

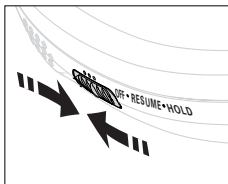

- 2 Press **■** whenever you want to stop playback.

- 3 Press **▶||** whenever you want to resume playback.

→ **RESUME** is shown and playback continues from where you have stopped (CD Audio), or from the last title played (MP3).

- To deactivate RESUME, switch the slider to OFF.

→ **RESUME** goes off.



## Locking all buttons – HOLD

You can lock the buttons of the set. When a key is pressed, no action will be executed then.

- 1 Switch the slider to HOLD to activate HOLD.

→ All buttons are locked. **HOLD** is displayed by pressing any key. If the set is switched off, **HOLD** is displayed only by pressing **▶||**.

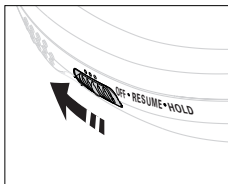

- 2 To deactivate HOLD, switch the slider to OFF.

*Note: When you deactivate HOLD by switching the slider to RESUME and restart, playback continues from where you have stopped (CD Audio), or from the last title played (MP3).*



# FEATURES

## ESP

With a conventional portable CD player, you might have experienced that the music stopped e.g. when jogging. The **ELECTRONIC SKIP PROTECTION** protects against loss of sound caused by vibrations and shocks.

**However, it does not protect the set against any damage caused by dropping!**



When switching on your player, the ESP function is displayed and automatically activated.

- Toggle the **ESP** button to select ESP on/off.
  - **ESP** disappears from the display: ESP deactivated.
  - **OOPS** appears briefly: playback also starts to skip indicating you have exceeded the maximum ESP time, during ESP activation.



**Note:** In MP3-CD mode, the **ESP** feature is automatically activated and you cannot deactivate the ESP setting.



## Selecting different playing options – MODE

During CD or MP3 playback, you can change play options. You can also combine the options with programmed tracks or titles.

- 1 During playback, toggle **MODE** to select your option:  
 → Playback starts in the chosen mode after blinking stops.

### MP3:

**REPEAT** : repeats all titles within the current album.

**REPEAT ALL** : repeats all titles from all albums.

**SHUFFLE** : plays titles in random order within a current album

**REPEAT ALL SHUFFLE** : plays all titles in random order.

### CD Audio:

**REPEAT** : repeats the current track.

**REPEAT ALL** : repeats all CD tracks.

**SHUFFLE** : plays tracks in random order.

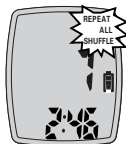
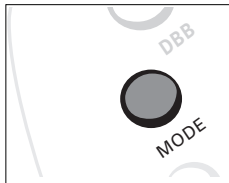

- 2 To return to normal playback, press **MODE** repeatedly until the mode option indication disappears.

# CD PLAY

## Playing a CD

This CD player can play all kinds of **Audio Discs** such as MP3 CD-ROMs, CD Recordables and CD Rewritables. Do not try to play a CDi, CDV, DVD or VCD.

- 1 Push the OPEN ► slider.  
→ The lid opens.
- 2 Insert an audio CD, printed side up, by pressing gently on the CD center so that it fits onto the hub. Close the lid by pressing it down on the left side.
- 3 Toggle ►|| to switch on the set, start playback or pause.  
→ The current track number and the elapsed playing time are displayed.  
→ When on pause mode, the playback time flashes.
- 4 Press ■ to stop playback.  
→ The total number of tracks and the total playing time of the CD are displayed.
- 5 Press ■ again to switch off the set.
- 6 To remove the CD, hold it by its edge and press the hub gently while lifting the CD.

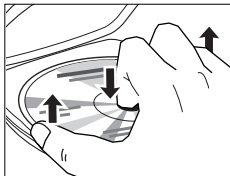
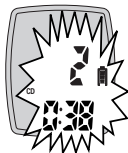
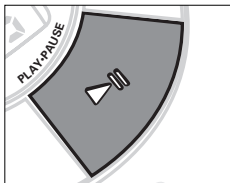
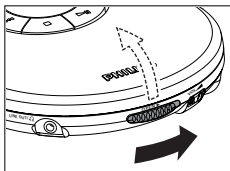

## Playback information

- If a CD Rewritable (CD Recordable) is not recorded properly, *RF d 150* is displayed.  
For CD Audio, use **FINALIZE** on your CD recorder to complete the recording.

**Note :** It is possible to play multi-session MP3 tracks without finalizing/closing a CD. However, the session needs to be finalized or closed.

- If you play CD Audio tracks on a CD Rewritable disc, it takes 10–25 seconds for sound reproduction to start after you have pressed **▶ II**. MP3 track recordings take 15-30 seconds for sound reproduction to start.
- Playback will stop if you open the CD lid.
- While the CD is reading, *RF d* flashes.
- In the stop position, if there is no activity for 20 seconds the set will clear the display, and if there is no activity after another 5 seconds, the set will switch off automatically to save energy. Any settings like program and playing modes will be cancelled.

# MP3-CD PLAYBACK

## IMPORTANT SPECIFICATIONS

### Supported formats

This set supports:

- Use ISO 9660 disc format when burning the CD-ROM.
- Disc format: ISO9660, Joliet, Multisession
- MP3 music file formats
- MP3 bit rate (data rate): 32–320 kbps and variable bit rate.

## General Information

### MP3

The music compression technology MP3 (MPEG Audio Layer 3) reduces the original digital audio data by a factor up to 10 without losing significant sound quality. This allows you to record up to 10 hours of CD-like quality music on a single CD-ROM.

### How to get MP3 music

- Either download legal MP3 music from the internet to your computer hard disk or insert your audio CD into your computer's CD-ROM drive and compress the music into MP3 format with any MP3 encoder software.
- **To achieve a good sound quality a bit rate of 128 kbps is recommended for MP3 files.**

### When burning the MP3-CD

- Make sure that the file names of the MP3 files end with **.mp3**
- Some MP3-encoders assign numbers to tracks automatically.

# MP3-CD PLAYBACK

## How to organize the MP3 files

The set can play up to 400 tracks on one MP3-CD.

- In order to find them easily, you can organize them in folders ("albums"), e.g. the album VERDI in CLASSIC has the album name CLASSICMOZARTVERDI (e.g. corresponding to Expanium **ALBUM** number 3).



The albums in the illustration will be played in the following way:

Expanium Album Display	PC Pathway Display
1	CLASSIC
2	CLASSICMOZART
3	CLASSICMOZARTVERDI
4	POPLBLUR
5	REGGAE

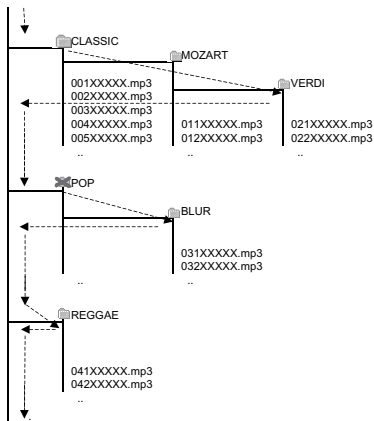

### Notes:

→ Arrow pathway shows the sequence of MP3 album and title playback.

✗ In POP, there are no MP3 files. POP is therefore skipped.

Visit the **EXPANIUM** homepage

<http://www.expanium.philips.com>

## General information on Writing Formats

There are 3 formats used to record data on a disc:

### 1 DAO (Disc At Once)

All data to be recorded must be prepared and written onto a disc from start to finish in one recording (**single session**) and will be 'closed' or finalized. You will not be able to add further data onto your CD.

### 2 Multisession

Data is recorded at different times (**multisession**), where you can delete, copy, move and rename files. However, by default most CD-ROM drives will only access the last session of a CD-ROM disc. You should therefore use information or file pointers about the last session where the old files were located, and about the new files imported from the hard disk, in order to link all sessions and avoid any loss of titles and album arrangement.

### 3 Packet or Package Writing

Packet Writing format divides tracks into smaller pieces of data during recording. Depending on the available spaces on the disc, this means a single CD track recording will be broken up into perhaps 10 fragments of music!

#### IMPORTANT!

- **THIS SET CANNOT READ** recordings created on the following: **DirectCD, Packet Writing, Package Writing and UDF.**
- **Do not attempt to combine CD audio and MP3 tracks within a CD-R(W) or CD-ROM, as the set will only be able to playback your CD audio tracks from mixed CD formats.**

# MP3-CD PLAYBACK

## To play MP3-CDs

- 1 Insert a MP3 CD-ROM with the label side up.  
Push the CD centre lightly to set it in position.  
In the stop position, the display shows the total number of albums (maximum 40), and titles (maximum 400).
- 2 Press ►|| to start playback.  
The display shows **MP3** and **ESP**, the current album and title numbers and the elapsed playing time.
- 3 Press ■ to stop playback.  
Playback stops and the display shows the total number of titles and total number of albums.



# TROUBLESHOOTING

## WARNING

***Under no circumstances should you try to repair the set yourself as this will invalidate the guarantee.***

If a fault occurs, first check the points listed, before taking the set for repair.

If you are unable to solve a problem by following these hints, consult your dealer or service centre.

Symptom	Check point	Treatment
<b>Power cannot be turned on</b>	<b>Batteries</b>	
	Are the batteries inserted correctly?	Insert batteries in correctly.
	Are the batteries dead?	Replace batteries.
	<b>Power adapter</b>	
	Loose connection?	Connect the adapter securely
	Is the power adapter connected properly?	Connect the power adapter properly.
	<b>In-car use</b>	
	Cigarette lighter is not powered when ignition is off?	Switch on ignition or insert batteries.
Is the cigarette lighter power on?	Switch on ignition or insert batteries.	
<b>HOLD, OOPS or no disc indication and Playback is impossible or stops</b>	Is the disc cover closed properly?	Close the disc cover tightly.
	Is the set in the HOLD mode?	Deactivate HOLD
	Is there condensation on the lens?	Wait until the lens has cleared.
	Is the CD inserted properly?	Place the CD with the label side up.
	Is the CD scratched or damaged?	Use another CD.



# TROUBLESHOOTING

Symptom	Check point	Treatment
<i>nF d 15C</i> <b>indication</b>	Is the CD-RW (CD-R) not recorded properly?	Use FINALIZE on the CD recorder to complete the recording.
<b>Playback does not start from first track</b>	Is the RESUME or PROGRAM function activated?	Switch off the RESUME function or clear the PROGRAM.
<b>No sound or poor sound quality</b>	Are connection plugs inserted properly?	Check all connections.
	Is the volume set too low?	Adjust the volume.
	Is the headphone plug dirty?	Clean the headphone plug.
	Is the set located near strong magnetic fields?	Move the set away from strong magnetized fields.
<b>In-car use</b>		
	Is the cassette adapter inserted properly?	Insert the cassette adapter correctly.
	Is the temperature inside car too high/low?	Let the set recover to room temperature.
	Is the cigarette lighter socket dirty?	Clean the cigarette lighter socket.
	Is the car cassette using auto-reverse?	Change the auto reverse direction.

***The model and serial number plate is located on the bottom of the set.***

# AUSTRALIA

## Philips product warranty for Australia only

Warranty conditions valid for Colour Television, Video Cassette Recorders, CD Recordable, DVD Players, Audio Systems, and Portable Audio.

The benefits given to the purchaser by this warranty are in addition to all other rights and remedies which the purchaser has in respect of the product under the Trade Practices Act or other Commonwealth or State Law.

Philips Consumer Electronics warrants its products to the purchaser as follows and subject to the stated conditions.

### 12 months free service

#### Conditions of warranty

1. All claims for warranty service should be made to your nearest Philips Authorised Service Centre. Reasonable evidence of date of purchase must be provided.
2. This warranty extends only to defects occurring under normal use of the product when operated in accordance with the instructions.
3. Home service within the normal service area of our Philips Authorised Service Centres will be provided for television receivers with screen size 48cm and above. All other products are to be brought or sent to your nearest Philips Authorised Service Centre.
4. This warranty does not cover:
  - a) Mileage or traveling time, pickup

or delivery, cost of insurance.

- b) Service costs arising from failure to correctly adjust the controls of the product or to observe the instructions, or inspections that reveal that the product is in normal working order.
- c) Product failures caused by misuse, neglect, normal wear and tear, accidental breakage, transit damage, inexperienced repairs or modification by unauthorised persons, lightning strikes, vermin infestation or liquid spillage.
- d) Cleaning of video or audio heads.
- e) Inadequate receiving antennae.
- f) Replacement of worn or used batteries, styli or other consumables.

The conditions contained in this warranty card replace and override the provisions of the World-Wide Guarantee for Products sold in Australia.

## **Philips Service Branches**

To contact your nearest Philips Authorised Service Centre call **1300 36 1392** from anywhere in Australia.

**Sydney**

**Adelaide**

**Newcastle**

**Hobart**

**Perth**

**Wollongong**

**Melbourne**

**Canberra**

**Brisbane**

Service is provided through 350 accredited service dealers throughout Australia. To find out about your nearest centre, call **1300 36 1392**.

Please record the following information for your records and keep in a safe place.

Model No:.....

Serial No:.....

***Please retain your purchase receipt which is required to claim service under warranty.***

Philips Consumer Electronics Australia Limited  
ACN 008 445 743, 3 Figtree Drive  
Homebush NSW 2140

Version 4, 03/99, FPCP-03

# NEW ZEALAND

## Guarantee and Service for New Zealand

Thank-you for purchasing this quality Philips product.

Philips New Zealand Ltd guarantees this product against defective components and faulty workmanship for a period of 12 months. Any defect in materials or workmanship occurring within 12 months from the date of purchase subject to the following conditions will be rectified free of charge by the retailer from whom this product was purchased.

### Conditions

1. The product must have been purchased in New Zealand. As proof of purchase, retain the original sales docket indicating the date of purchase.
2. The guarantee applies only to faults caused by defective components, or faulty workmanship on the part of the manufacturer.
3. The guarantee does not cover failures caused by misuse, neglect, normal wear and tear, accidental breakage, use on the incorrect voltage, use contrary to operating instructions, or unauthorised modification to the product or repair by an unauthorised technician.
4. Reasonable evidence (in the form of a sales docket) must be supplied to indicate that the product was purchased no more than 12 months prior to the date of your claim.
5. In the event of a failure, Philips shall be under no liability for any injury, or any loss or damage caused to property or products other than the product under guarantee.

This guarantee does not prejudice your rights under common law and statute, and is in addition to the normal responsibilities of the retailer and Philips.

### How to claim

Should your Philips product fail within the guarantee period, please return it to the retailer from whom it was purchased. In most cases the retailer will be able to satisfactorily repair or replace the product.

However, should the retailer not be able to conclude the matter satisfactorily, or if you have other difficulties claiming under this guarantee, please contact

### The Guarantee Controller

**Philips New Zealand Ltd.**

✉ P.O. Box 41.021

**Auckland**

☎ (09) 84 94 160

fax ☎ (09) 84 97 858

# CERTIFICADO DE GARANTIA PARA O BRASIL

## (Os dados deste manual estão sujeitos a alterações.)

Este aparelho é garantido pela PHILIPS DA AMAZÔNIA INDÚSTRIA ELETRÔNICA LTDA, por um período superior ao estabelecido por lei, porém, para que a garantia tenha validade, é imprescindível que, além deste certificado, seja apresentada a nota fiscal de compra do produto.

- 1) A PHILIPS DA AMAZÔNIA INDÚSTRIA ELETRÔNICA LTDA, assegura ao proprietário consumidor deste aparelho a garantia de 365 dias (90 dias legal mais 275 dias adicional) **CONTADOS A PARTIR DA DATA DE ENTREGA DO PRODUTO, CONFORME EXPRESSO NA NOTA FISCAL DE COMPRA**, que passa a fazer parte deste certificado.
- 2) Esta garantia perderá sua validade se:
  - A) O defeito apresentado for ocasionado por uso indevido ou em desacordo com o seu manual de instruções.
  - B) O produto for alterado, violado ou consertado por pessoa não autorizada pela Philips.
  - C) O produto for ligado a fonte de energia (rede elétrica, pilhas, bateria, etc.) de características diferentes das recomendadas no manual de instruções e/ou no produto.
  - D) O número de série que identifica o produto estiver de alguma forma adulterado ou rasurado.
- 3) Estão excluídos desta garantia defeitos decorrentes do descumprimento do manual de instruções do produto, de casos fortuitos ou de força maior, bem como aqueles causados por agentes da natureza e acidentes.
- 4) Excluem-se igualmente desta garantia defeitos decorrentes do uso dos produtos em serviços não doméstico/residencial regular ou em desacordo
- 5) Nos municípios onde não exista oficina autorizada de serviço Philips, as despesas de transporte do aparelho e/ou do técnico autorizado, correm por conta do Sr. consumidor requerente do serviço.
- 6) Este produto tem **GARANTIA INTERNACIONAL**. O serviço técnico (durante ou após a garantia) é disponível em todos os países onde este produto é oficialmente distribuído pela Philips. Nos países onde a Philips não distribui este produto, o serviço técnico da Philips local poderá prestar tal serviço, contudo poderá ocorrer algum atraso no prazo de atendimento se a devida peça de reposição e o manual técnico não forem prontamente disponíveis.
- 7) A garantia não será válida se o produto necessitar de modificações ou adaptações para habilitá-lo a operar em qualquer outro país que não aquele para o qual foi designado, fabricado, aprovado e/ou autorizado, ou ter sofrido qualquer dano decorrente deste tipo de modificação.

PHILIPS DA AMAZÔNIA  
INDÚSTRIA ELETRÔNICA LTDA.

Dentro do Brasil, para informações adicionais sobre o produto ou para eventual necessidade de utilização da rede de oficinas autorizadas, ligue para o Centro de Informações ao Consumidor ou escreva para Av. Engenheiro Luis Carlos Berrini, 1400 14 andar – CEP 04571-000 Brooklin Novo – São Paulo - SP ou envie um e-mail para: [cic@philips.com.br](mailto:cic@philips.com.br).

CENTRO DE INFORMAÇÕES AO CONSUMIDOR  
GRANDE SÃO PAULO = 3191.0091  
DEMAIS LOCALIDADES = 0800.123123

Horário de atendimento: de segunda à sexta-feira, das 08:00 às 20:00 h,  
aos sábados das 08:00 às 13:00 h.

Para atendimento fora do Brasil, contate a Philips local ou a:

Philips Consumer Service

Beukenlaan 2

5651 CD Eindhoven

The Netherlands



# POLIZA DE GARANTÍA

## ESTA POLIZA ES GRATUITA

Este aparato ha sido cuidadosamente diseñado y se ha fabricado con los mejores materiales bajo un estricto control de calidad, garantizando su buen funcionamiento por los periodos establecidos según el aparato (ver lista en la parte inferior) **a partir de la entrega del aparato al consumidor. Esta póliza incluye la reparación o reposición gratuita de cualquier parte o componente que eventualmente fallase y la mano de obra necesaria para su reparación**, misma que se hará efectiva en cualquiera de nuestros centros de servicio autorizados en el país.

Si su aparato llegase a requerir de nuestro servicio de garantía, acuda al centro de servicio más cercano a su domicilio, de tener alguna duda por favor llame a nuestra CENTRAL DE SERVICIO al tel.: 57 28 42 52, y en el interior del país LADA sin costo al 01 800 506 92 00 en donde con gusto le indicaremos el centro de servicio autorizado más cercano a su domicilio.

PHILIPS MEXICANA S.A. de C.V. a través de sus centros de servicio autorizados **reparará y devolverá a usted su aparato en un plazo no mayor a 20 días hábiles**, contados a partir de la fecha de ingreso, impresa en la orden de servicio de cualquiera de nuestros centros de servicio autorizados.

**La garantía de esta póliza cubre cualquier desperfecto o daño eventualmente ocasionado por los trabajos de reparación y/o traslado del aparato en el interior de nuestros centros de servicio autorizados.**

**Esta póliza sólo tendrá validez, si está debidamente requisitada, sellada y firmada por la casa vendedora**, en caso de extravío de esta póliza, podrá hacer efectiva su garantía con la presentación de su factura de compra.

### ESTA POLIZA NO SE HARÁ EFECTIVA EN LOS SIGUIENTES CASOS:

- Cuando el aparato sea utilizado en condiciones anormales y los daños o desperfectos que manifestase sean causados por mal trato, descuido o mal uso.
- Cuando el aparato no haya sido operado de acuerdo a su instructivo de uso, en donde se señalan las condiciones normales de operación, los valores nominales y las tolerancias de las tensiones (voltaje), frecuencia (ciclaje) de alimentación eléctrica y las características que deben reunir las instalaciones auxiliares.
- Cuando la causa de la falla o mal funcionamiento sea consecuencia de una reparación inadecuada o alteración producida por personas no autorizadas por PHILIPS MEXICANA S.A. de C.V.
- Cuando los datos de esta póliza hayan sido alterados o modificados.
- Por fenómenos naturales no imputables a la empresa tales como: temblores, inundaciones, incendios, descargas eléctricas, rayos, etc.

### PERIODOS DE GARANTÍA

**36 MESES.** – Monitores para computadora.

**12 MESES.** – Televisores, videocassetteras, video reproductores DVD, grabador reproductor de disco compacto, video proyectores (excepto la lámpara), cámaras de video, decodificadores de señal (IRD), televisor para hotel, sistemas de observación, televisores de proyección, teléfonos celulares, pagers, equipos modulares, sintonificadores, facsimil, LNB, antena de recepción de satélite, DVD ROM, CDR ROM y CDRW ROM para computadora.

**6 MESES.** – Radiograbadoras con y sin reproductor de disco compacto, reproductor de cassette portátil, reproductor de disco compacto portátil, radio relojes, radios A.M./F.M., auto esteros y teléfonos inalámbricos.

**3 MESES.** – Accesorios, controles remotos, bocinas, cinta para fax y cámara de videoconferencia.



# PHILIPS

# Philips Mexicana, S.A. de C.V.

Producto importado por:

Philips Mexicana, S.A. de C.V.  
Norte 45 No. 669 Col. Ind. Vallejo,  
Del. Atzacapotzalco C.P. 02300  
Tels. 57 28 42 00 y 57 29 48 00

Centro de Información al Consumidor:

Norte 45 No. 669 Col. Ind. Vallejo  
Del. Atzacapotzalco C.P. 02300  
Tel. 53 68 77 88 Lada 01 800 504 62 00

MODELO \_\_\_\_\_

N° DE SERIE \_\_\_\_\_

La presente garantía contará a partir de: **DIA** \_\_\_\_\_ **MES** \_\_\_\_\_ **AÑO** \_\_\_\_\_

En caso que en su producto se produzca alguna falla, acuda al centro de servicio más cercano a su domicilio (según listado de talleres), de tener alguna duda, por favor llame a nuestra CENTRAL DE SERVICIO, en donde con gusto le atenderemos.

Así mismo, cuando requiera refacciones y partes originales para su producto, acuda a los centros de servicio. Para hacer efectiva la garantía de su producto, es necesario que presente usted esta póliza debidamente requisitada o de lo contrario presentar su factura de compra.

## CENTROS DE SERVICIO

Ciudad	EDO	Calle y N°	Colonia	C. P.	Nombre Comercial	Lada	Telefono	Fax	
Acapulco	GRO	Av. Revolucion N° 28	M. Aleman	39300	Servicio Electronico Profesional	74	83 32 96	--	S
Cd. Juarez	CHIH.	Rancho el Becero 3011	Pradera Dorada	32610	Teleservicio Dominguez	16	18 21 28	18 21 28	S
Cd. Reynosa	TAMPS	Tiburcio Garza N° 401	Rodriguez	88699	Teleservicio Pepe	89	22 59 86	--	S
Chihuahua	CHIH.	Trasviña y Retes N° 3503-A	San Felipe	31240	Zener Electronica	14	14 01 16	26 50 41	S
Colima	COL	Francisco I. Madero N° 426	Centro	28000	TV Antenas de Colima	331	403 01	403 01	S
Culiacan	SIN.	Venustiano Carranza N° 140-A Nte.	Centro	80090	Estereo Voz	67	16 15 10	--	S
Guadalajara	JAL	Av. Vallarta N° 2250	Ladron de Guevara	44600	Leecom S.A. de C.V.	3	516 18 88 616 01 26	615 72 62	SR
Leon	GTO	Hernandez Alvarez N° 726	San Juan de Dios	37480	Tecnicos Especializados	47	70 26 99	15 58 64	S
Merida	YUC	Calle 70 N° 443 X 49 Depto. 8	Centro	97000	Servicentro	99	28 54 28	23 39 97	S
Mexicali	B.C.N.	Calz. Cuauhtemoc N° 866-2	Cuauhtemoc Nte.	21200	Baja Electronic's	619	67 49 16	67 49 16	S
Mexico	D.F.	Calz. Vallejo N° 1045-03 Esq Poniente 124	Industrial Nueva Vallejo	2300	Chyr S.A. de C.V.	5	567 22 56 567 96 32	567 96 32	SR
Mexico	D.F.	Calz. Vallejo N° 904 Loc. 5	Industrial Vallejo	2300	Tecnologia y Servicio S.A. de C. V.	5	587 57 99	587 57 99	S
Mexico	D.F.	Pilares N° 519 Local C-3	Del Valle	03100	Cocesionario Pilares	5	605 42 15 605 42 76	605 43 46	SR
Monterrey	N.L.	Juan Mendez N° 825 Nte.	Centro	64000	Monterrey Centro Electronico S.A.	8	375 16 17	374 85 42	SR
Morelia	MICH.	Lago de Patzcuaro N° 500-A	Ventura Puente	58020	Multiserv. Prof. de Zamora	43	12 03 17	--	S
Oaxaca	OAX	Huazares N° 207	Centro	68000	El Francisor S. de R.L. de C.V.	951	647 37	--	S
Pachuca	HGO	Pza. de las Americas Lote 28 Nucleo D	Valle de Sn Javier	42086	Frazare Electronica	77	14 15 81	--	S
Puebla	PUE	Av. 10 Poniente N° 2902-B	San Alejandro	72090	Selcom	22	48 77 64	48 77 64	SR
Queretaro	QRO	Bolivia 32	Lomas de Queretaro	76190	Electronica Zener	421	610 09	--	S
San Luis Potosi	S.L.P.	Fuente De La Glorietta N° 147	Balcones del Valle	78320	Servicios Electronicos	481	534 07	--	S
Tampico	TAMPS	Laredo N° 105	Mainero	89060	Concesionario Philips Tampico	12	12 36 04	--	SR
Tijuana	B.C.N.	Calle 1a. N° 1540-3	Centro	22000	Sistemas Instalabricos de Comunicacion	66	85 95 58	85 95 58	S
Toluca	EDO MEX	Calle Toluca N° 505	Sanchez	50040	Concesionario Philips Toluca	72	14 83 09	17 03 21	S
Torreón	COAH	Mariano Lopez Ortiz N° 1126 Nte.	Centro	27000	Electronica Jomar	17	22 00 05	--	S
Tuxtla Gutierrez	CHIS	10 Nte. Ote 153-A	Centro	29000	KC-Video	96	18 19 08	--	S
Veracruz	VER	Guerrero N° 1877 Entre Cortes y Canal	Centro	91700	Antza Comunicaciones	29	32 78 23 32 44 44	32 78 23	S
Villahermosa	TAB	Sanchez Marmol N° 206	Centro	86000	Tecnicentro	93	14 31 36	--	S

**NOTA: Los Centros que tengan (S) solo proporcionan Servicio y los que tengan (SR) venden refacciones y proporcionan Servicio.**





