

Magnetic Direct Drives and Air Bearing Technology

PRECISION ENGINEERING AND MOTION CONTROL EXPERTISE

PIMag® Core Technologies

MAGNETIC DIRECT DRIVE TECHNOLOGY

Drive technology and regulation know-how as well as an expertise in bearings and encoders allow for a broad range of motors for system integration. Proprietary developments also include high-resolution force sensors for manufacturing and test equipment.

Voice coil drives

- High dynamics for fast scanning and positioning
- OEM actuators, linear scanners, Hexapods
- Optional force sensors

Ironless linear motors

- High acceleration and velocity
- Linear stages, planar scanners, PIMag® 6D positioning system
- Torque motors for rotation stages

Drive technology beyond standard

- Highest accelerations up to 60 g with resonance motor
- Highest force density for single phase linear motors with reluctance motor and cylindrical Halbach arrays
- High force density and low weight with linear Halbach arrays

Guiding systems

- Flexure guidings provide frictionless motion over short strokes
- Ball and roller bearings from the leading suppliers
- Active magnetic guidings align flatness during motion
- PIGlide air bearings for frictionless motion and optimum straightness and flatness

**FORCE
REGULATION**

**NANOMETER
PRECISION**

**UP TO 60G
ACCELERATION**

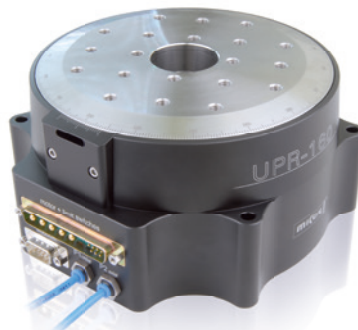
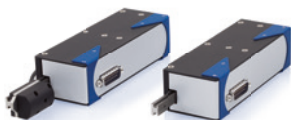

PIMag[®] Electronics and Software

PRECISION MOTION CONTROL

The flexible PIMag[®] controller design allows to pursue different goals while the focus is always on high-precision positioning systems. Sinusoidal commutated control with low-noise power amplifiers provides for smoothest operation. Controller configurations include single or dual axis controllers and modular multi-axis devices with housing. Digital controller solutions for 1- and 3-phase motors up to 48VDC are available. Communication interfaces meet industrial standards.

Sensor technology

- Nanometrology position sensors
 - Absolute measuring, capacitive single and dual plate sensors
 - PIOne optical incremental encoder with picometer resolution
 - Incremental sensors (1 V_{pp}) with adjustable interpolation (up to 65536fold)
 - Absolute encoders (BISS)
- High resolution proprietary force sensor measures and records applied forces at highest resolution (1 mN, open-loop)

Regulation of position, velocity and force

- Dynamic: Peak current up to 15 A_{rms}, continuous current up to 5 A_{rms}, up to 150 kHz current regulation loop
- Fast step and settle
- Constant scanning velocity
- Allows on-the-fly switch from position control mode to force control mode

Software interfaces

- Graphic easy-to-use user interface for rapid start-up and optimization of parameters
- One command set for all PI motor technologies
- Drivers for fast integration into third party software, various supported languages like C, C++, VB, Python, LabVIEW[™], Matlab[®], etc.

AIR BEARINGS

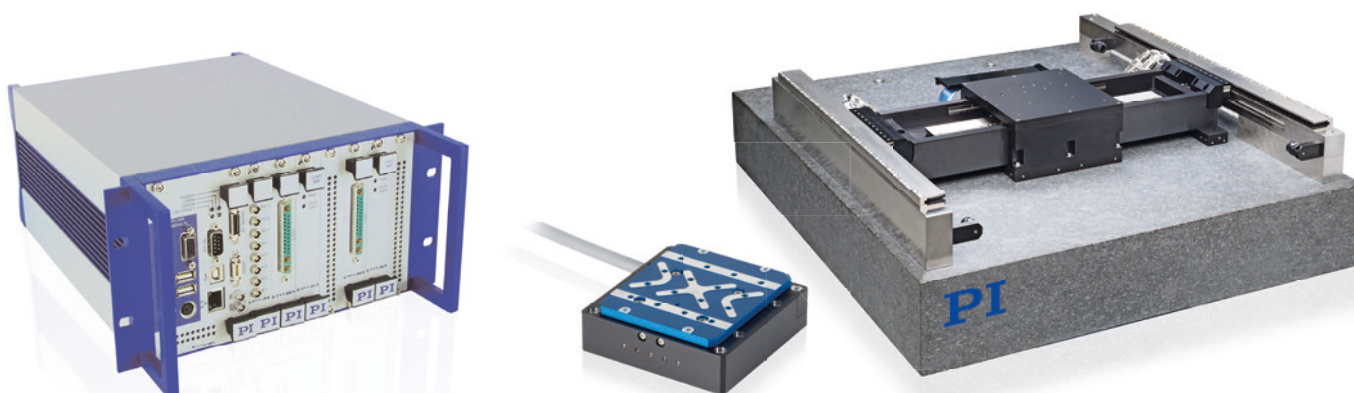

PIMag[®] Stages

THE STEP AHEAD WITH THE FULL RANGE OF PI TECHNOLOGIES

All core technologies available in-house allows PI to design and manufacture excellent products. Optimum performance is achieved by extensive simulations of relevant components, from the magnetic field for the motor layout, the FEM simulations of stages, to the regulation loop. Keeping the number of parts low secures high reliability of the system.

Flexible axis configurations

- Single-axis linear and rotary stages
- Multi-axis solutions in different accuracy classes, like planar scanners, tip-tilt mirrors and XY-stages
- Parallel kinematics for up to six axes, as for Hexapods and PIMag[®] 6D magnetic levitation technology

Standard products & customized solutions

- Standard range of high-resolution single-axis scanning stages: linear motor stages for various strokes and torque motor rotation stages
- Application-specific solutions: vertical axes for assembly and automation with force control, 2-axis testing systems in XZ, or air-bearing gantry systems
- High-end solutions adapted to detailed customer specifications in automation, semiconductor, medical or other markets. Examples are multi-axis combinations of linear and rotary axes, most compact devices providing maximum force, low-energy-consumption solutions, and actuators that optionally include force sensors for high-volume production observing low cost targets

SYSTEM
SOLUTIONS



CONSTANT
VELOCITY

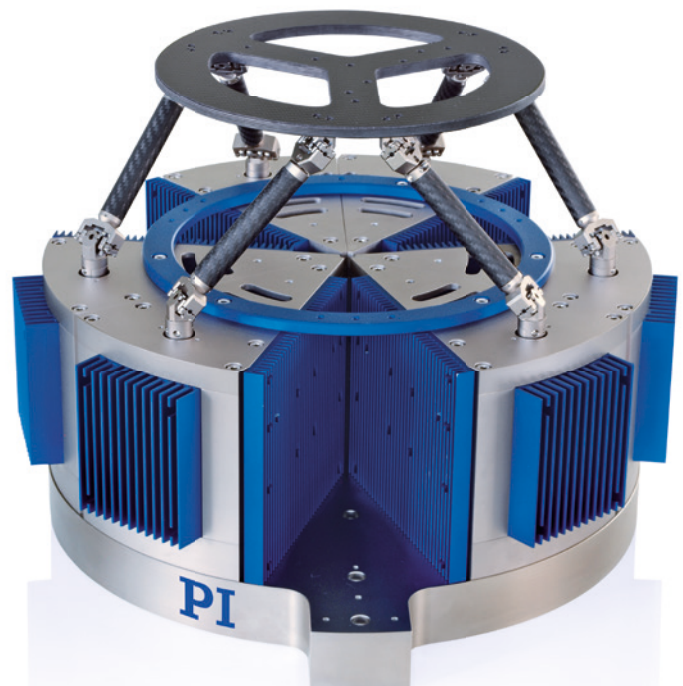
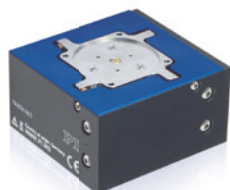

Force Detection and Control

FORCE-SENSITIVE TEST AND MANUFACTURING EQUIPMENT

The force control allows operation of PIMag[®] drives and stages with a defined holding or feed force. The force and position sensors can be read and the values processed simultaneously. In addition to pure force control, subordinate position and velocity control is also an option. The C-413 motion controllers enable external force sensors to be read via analog inputs.

PI offers V-27x-series PIMag[®] actuators with a force sensor. The working principle of the sensor is based on an optical linear encoder detecting the deflection of a flexure design.

Customer advantages

- High dynamic movement to workpiece surface allows the highest productivity
- On-the-fly switching between position and force mode with high-precision force regulation down to 1 mN
- Reliable and repeatable results due to magnetic direct drive solution
- Auto zero function for holding current

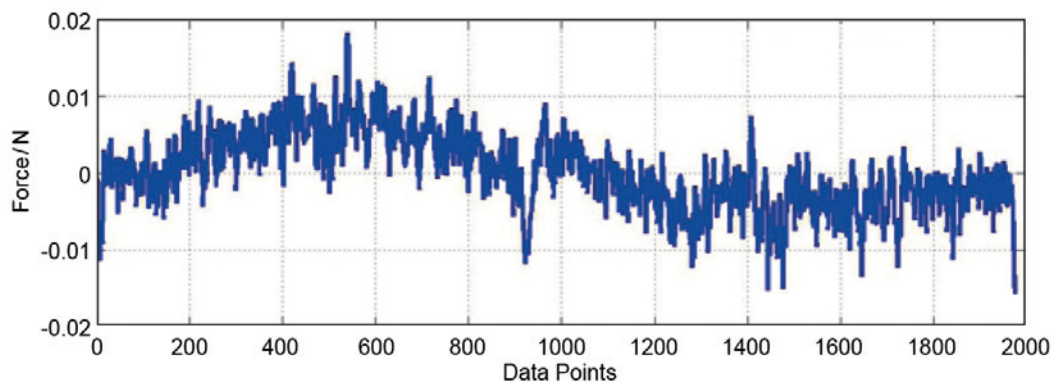
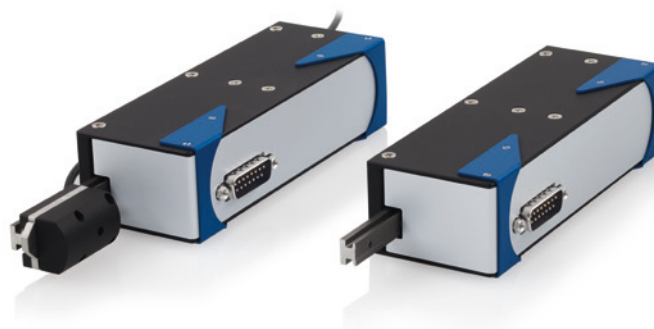

Unique in Technology for Precision Positioning

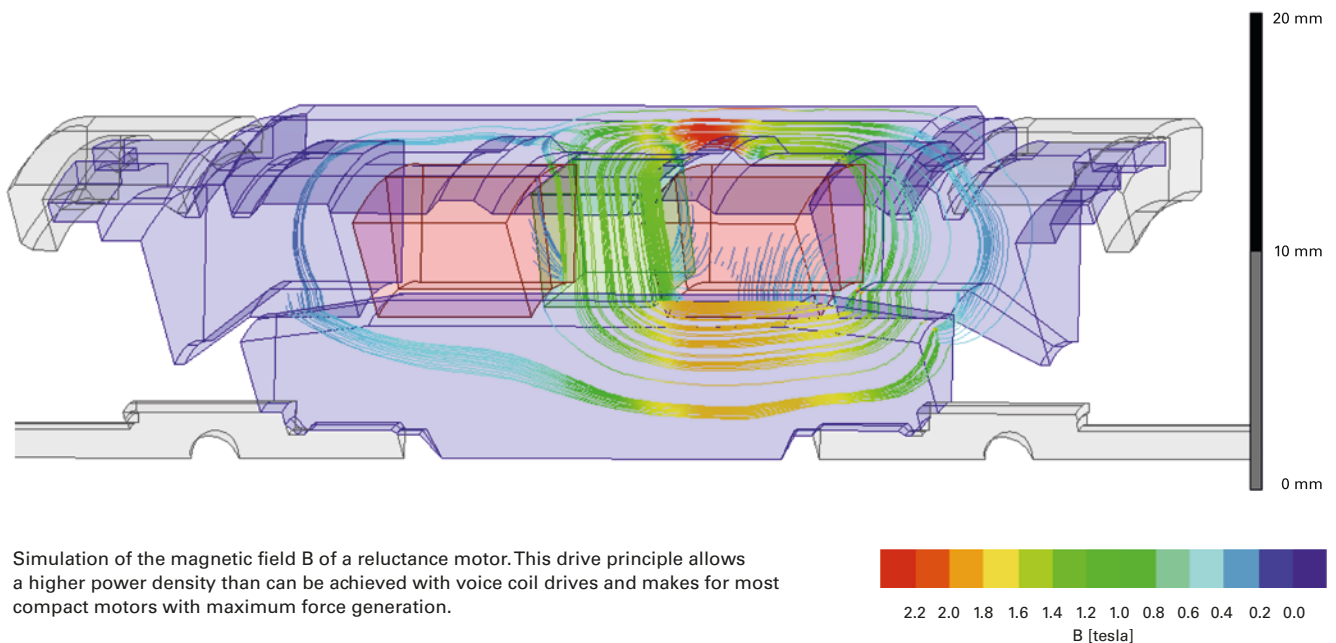

PIMag® Magnetic Direct Drives supplement PI's broad portfolio of innovative solutions for dynamic motion and positioning tasks. PIMag® technology is developed fully in-house as a basis for application and customer specific needs. This includes drives, force and position sensors as well as guidings for single-, multi-axis and customized solutions. The proprietary development of motion controllers, regulation concepts and their software complete the package and enable PI to provide a new approach to precision automation. PI produces all key components in-house, to guarantee highest quality and optimal customer orientation.

Customers benefit from PI in many ways:

- Six R&D and manufacturing sites around the world in touch with the local markets
- Present in all key technology regions worldwide: 15 facilities around the globe for sales, service, repair and system qualification
- Sales engineers and application experts ensure close contact for customized developments from the initial consultation to the delivery
- Over 40 years of experience in precision motion and positioning technology
- Company in private ownership with continuous and constant growth

PIglide

THE STEP AHEAD WITH AIR BEARING TECHNOLOGY

Frictionless high-precision positioning

A direct-drive motor and high-resolution encoder can position a moving carriage supported by an air bearing to within nanometers in a linear application or within tenths of arc-seconds in rotational applications. The lack of friction and mechanical contact means there is minimal hysteresis or reversal error, making it highly repeatable and ideal for many inspection and manufacturing operations. Stiction is virtually eliminated, improving resolution capabilities, position repeatability can be obtained within a few fundamental encoder counts. Similar precision can be obtained by piezo flexure guided stages, however over much smaller travel ranges.

Velocity stability and scanning

The lack of mechanical bearing elements means there is nothing to get in the way of smooth, controlled velocity (stability to better than 0.01 %). Experiments and processes like inertial sensor testing, tomography, wafer scanning, and surface profiling require continuous motion at a tightly controlled speeds are best served by air bearing systems.

High guiding accuracy

Linear air bearing stages have incredibly straight and flat travels, measured in the 100's or 10's of nanometers and subarc-second pitch, roll, and yaw errors. Rotary stages have tilt (wobble) errors less than 1 arc-second. Additionally, the angular performance of an air bearing is remarkably repeatable. This guarantees optimal part quality and measurement reliability for applications such as optics inspection, semiconductor inspection, and medical device manufacturing.

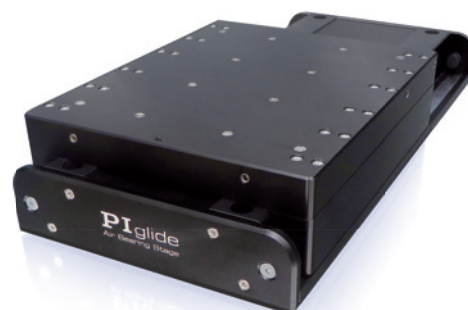

Linear Stages



V-52x
High-Dynamic PIMag® Linear Stage
Voice Coil Direct Drive with Direct Position Measurement



A-110
PIglide LC Linear Air Bearing Stage
High Performance Affordable Nanopositioning System



V-551
PIMag® Precision Linear Stage
High Velocity and Precision Due to Magnetic Direct Drive



LMS-180
Precision Linear Stage
High Dynamic Due to Magnetic Direct Drive, Excellent Travel Accuracy



LMS-270
Precision Linear Stage
High Dynamic Due to Magnetic Direct Drive, High Stability

Linear Actuators



V-900KPIC
PIMag® VC Vertical Linear Actuator
Compact with Integrated Position Sensor



V-273
PIMag® Voice Coil Linear Actuator
Cost-Effective with High Dynamics



V-275
PIMag® Voice Coil Linear Actuator
High Dynamics with Optional Force Control



V-277
PIMag® High-Load Linear Actuator
Voice Coil Drive for High Velocity

Multi-Axis Positioning Systems



MCS
Metrology XY Stage
Excellent Travel Accuracy and Stability



L-731
Metrology XY Stage
 High Travel Accuracy and Stability



A-311
PIGlide IS: Planar XY Air Bearing Stage
 Ultra Performance, Compact XY Nanopositioning Systems

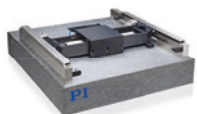

A-322
PIGlide HS Air Bearing Stage
 XY Positioning System with 1 nm Resolution



PIMag® 6D
Magnetic Levitation
 Friction-free with Nanometer Precision

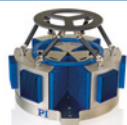

H-860KMAG
High-Dynamics Hexapod
 Magnetic Direct Drive for High Velocity

Rotation Stages



UPR-100/UPR-120 AIR
Ultra Precision Rotation Stage
 High Dynamic Due to Magnetic Direct Drive, High Stability



UPR-120
Ultra Precision Rotation Stage
 Excellent Stability and Travel Accuracy

Motion Controllers



C-891
PIMag® Motion Controller
 For Linear Motors with Average Power Consumption



C-413
PIMag® Motion Controller
 Control of Force, Position and Velocity

High-Dynamic PIMag® Linear Stage

VOICE COIL DIRECT DRIVE WITH DIRECT POSITION MEASUREMENT

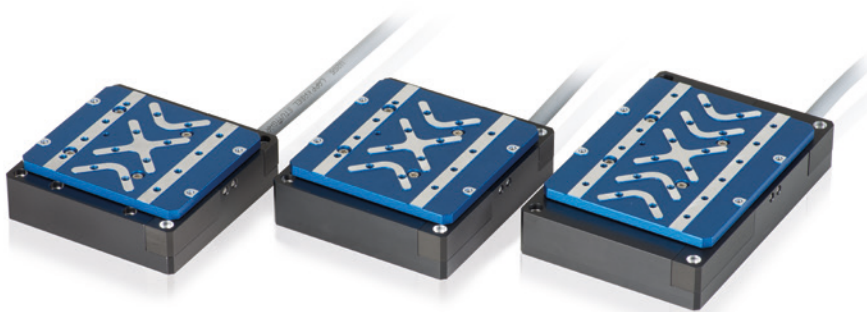

V-522/V-524/V-528

- Fast scanning and positioning
- Travel ranges 5 mm, 10 mm, 20 mm
- Scanning frequencies to tens of Hz
- Max. velocity 250 mm/s
- Crossed roller bearings for highest precision

Reference-class linear stage

Linear positioning stages with magnetic direct drives largely dispense with mechanical components in the drivetrain and the drive force acts directly on the motion platform. Together with precision bearings, a high travel accuracy and longer lifetime is achieved. The linear positioning stages are particularly suitable for scanning applications

PIMag® voice coil

Voice coil drives consist of 2 essential components: A permanent magnet and a coil, which is located in the air gap of the magnetic field. When current flows through the coil, it moves in the magnetic field of the permanent magnet. The direction of motion depends on the polarity. Thanks to their low weight and friction-free drive principle, voice coil drives are particularly suitable for applications, which require high dynamics and high velocities at limited travel ranges. High scan frequencies and precision positioning are also possible with these drives, because they are free of the effects of hysteresis

Crossed roller bearings

With crossed roller bearings, the point contact of the balls in ball bearings is replaced by a line contact of the hardened rollers. Consequently, they are considerably stiffer and need less preload, which reduces friction and allows smoother running. Crossed roller bearings are also distinguished by high guiding accuracy and load capacity. Forced guiding of the rolling body cages prevents the roller bearings from creeping

Direct position measurement with incremental encoder

Noncontact optical encoders measure the actual position directly at the motion platform with the greatest accuracy so that nonlinearity, mechanical play or elastic deformation have no influence on position measuring

Fields of application

Industry and research. Metrology, photonics and precision scanning in semiconductor or flat panel display manufacturing

Pliglide LC Linear Air Bearing Stage

HIGH PERFORMANCE AFFORDABLE NANOPositionING SYSTEM



A-110 Series

- Ideal for scanning or high-resolution positioning
- Cleanroom compatible
- Customizable
- Table size 160 mm x 200 mm
- Travel lengths to 400 mm
- 10 kg max payload
- Non-contact fully preloaded air bearings
- Ironless cog-free linear motor
- Integral optical linear encoder
- Resolutions to 1 nm
- Velocity to 1 m/sec
- Acceleration to 3 g

Overview

The Pliglide LC series of stages are linear servo motor driven with magnetically preloaded air bearings and an integral optical linear encoder. The combination of these non-contact components results in a frictionless motion platform that offers the highest performance, quality and life. These stages are ideally suited for many high precision applications, such as metrology, photonics alignment, semiconductor, flat panel display and preci-

sion scanning applications. The non-contact design also makes these stages perfect for cleanroom applications

Accessories and Options

- Multiple encoder options
- Air preparation kits
- Single or multi-axis motion controllers and servo drives
- XY stacks and custom configurations
- Granite bases and vibration isolation systems

	A-110.050	A-110.100	A-110.200	A-110.300	A-110.400
Travel	50 mm	100 mm	200 mm	300 mm	400 mm
Drive system	Brushless ironless linear servo motor, 3-phase				
Feedback system	Non-contact optical linear encoder with travel limits and home index				
Motor bus voltage	48 VDC nominal, 60 VDC max				
Motor force constant	4.2 N/A		12.3 N/A		
Continuous force	9.2 N		39 N		
Peak force	25 N		85 N		
Motor back EMF (phase-to-phase)	4.2 V/m/sec		10.1 V/m/sec		
Motor resistance (phase-to-phase)	8.2 ohms		3.6 ohms		
Motor inductance (phase-to-phase)	2.7 mH		1.24 mH		
Maximum velocity ⁽¹⁾	0.5 m/sec		1 m/sec		
Maximum acceleration ⁽¹⁾ (unloaded)	1 g		3 g		
Maximum payload ⁽²⁾	10 kg				
Accuracy ⁽³⁾ (uncompensated)	±1.0 µm	±1.5 µm	±2.0 µm	±3.0 µm	±4.0 µm
Accuracy ⁽³⁾ (with error compensation)	±1.0 µm			±1.5 µm	
Repeatability ⁽⁴⁾	±0.5 µm				
Encoder resolution ⁽⁴⁾	up to 1 nm				
Straightness & flatness ⁽⁵⁾	< ± 10 nm / 10 mm				
	< 2 µm TIR		< 3 µm TIR	< 4 µm TIR	< 5 µm TIR
Pitch & yaw TIR ⁽⁵⁾	< 2 arc-sec	< 4 arc-sec	< 6 arc-sec	< 8 arc-sec	< 10 arc-sec
Stage mass	6.3 g	7.5 kg	11 kg	12 kg	14 kg
Moving mass	2.5 kg		2.6 kg		
Cabling	Internal, non-moving		External, moving loop		
Operating pressure ⁽⁶⁾	65 (±5) psi (450 ±35 kPa)				
Air consumption	< 1.0 SCFM (28 SLPM)				
Air quality	Clean (filtered to 1.0 µm or better) - ISO 8573-1 class 1 Oil-free -ISO 8573-1 class 1 Dry (-15 °C dew point) - ISO 8573-1 class 3				
Construction	Hardcoat aluminum SS Fasteners				

- Maximum velocity and acceleration based on unloaded stage capability, may be limited by payload, controller, or drive performance.
- Assumes payload CG is centered no more than 50mm above the stage table. Stage is only designed for horizontal operation.
- Improved accuracy can be obtained with controller-based error compensation. Specs listed are for encoder options A & C. Accuracy values assume short-term time duration and do not consider the long-term effects of thermal drift on the stage.
- Encoder resolution depends on encoder option chosen and interpolation used if sine encoders are chosen. Resolution will impact repeatability specification.
- Dependent on the flatness of the surface to which the stage is mounted.
- To protect stage from damage, an under-pressure air sensor tied to the controller E-stop input is recommended.
Further information and technical drawing on www.pi.ws.

Model	Travel	Encoder ⁽¹⁾	Motor Wiring
A-110	050 = 50 mm	A = 20 µm grating pitch incremental, sine (1 V _{pp}) output	1 = Standard motor, 48 VDC buss
	100 = 100 mm	B = 1 nm resolution absolute, BiSS-C serial output	
	200 = 200 mm	C = 50 nm resolution incremental, A-quad-B (TTL) output	
	300 = 300 mm		
	400 = 400 mm		

1. Alternate TTL encoder resolutions are available on request.

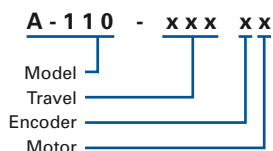

Ordering Example

Part# A-110.300A1 is a

Model: A-110 (PIglide LC linear motorized air bearing stage)

Travel: 300 mm

Encoder: A (20 µm/line sine output, 1 V_{pp})

Motor Wiring: 1 (48 VDC)

PIMag[®] Precision Linear Stage

HIGH VELOCITY DUE TO MAGNETIC DIRECT DRIVE, NANOMETER RESOLUTION



V-551

- Travel ranges to 230 mm
- Velocity up to 0.5 m/s
- Incremental encoder with < 2 nm resolution, absolute-measuring
- 200 N peak force
- Compact design with 160 mm width

Reference-class linear stage

High travel accuracy due to precision linear guiding rails with crossed rollers. No cage creep due to forced guidance (anti creep). Smooth-running precision linear guiding, especially suitable for scanning applications with constant velocity. No moving cables. Travel range can be adjusted mechanically due to adjustable hard stops

PIMag[®] magnetic direct drive

Ironless magnetic direct drive for high velocity and acceleration. High position resolution by sine-commuted control with PI motion controller. Modularly configurable push/pull force

Absolute-measuring encoder

Position measurement with integrated incremental encoder. Absolute position measurement, no referencing during switch-on required, therefore increased efficiency and additional safety during operation. BiSS interface, analog signal transmission (sin/cos, 1 V_{pp}). Down to < 2 nm position resolution when operating with PI motion controller

Fields of application

Industry and research. Metrology, photonics, medical and precision scanning in semiconductor or flat panel display manufacturing

	V-551.2B	V-551.4B	V-551.7B	Unit
Motion and positioning				
Travel	50	130	230	mm
Integrated sensor	Incremental encoder, absolute-measuring, BiSS	Incremental encoder, absolute-measuring, BiSS	Incremental encoder, absolute-measuring, BiSS	
Sensor resolution*	< 2	< 2	< 2	nm
Min. incremental motion	0.01	0.01	0.01	µm
Unidirectional repeatability	0.02	0.02	0.02	µm
Bidirectional repeatability	±0.05	±0.05	±0.05	µm
Pitch / yaw	±50	±50	±25	µrad
Straightness / flatness per 100 mm	±1	±1	±1	µm
Velocity	0.5	0.5	0.5	m/s
Mechanical Properties				
Max. load, horizontal	15	15	15	kg
Max. load, lateral	12	12	12	kg
Moved mass	2.2	2.7	4.9	kg
Overall mass	4.2	5.5	9.7	kg
Linear guiding	Crossed roller guide, anti creep	Crossed roller guide, anti creep	Crossed roller guide, anti creep	
Drive Properties				
Motor Type	Ironless PIMag® linear motor	Ironless PIMag® linear motor	Ironless PIMag® linear motor	
Intermediate circuit voltage	300	300	300	VDC
Peak force	200	200	200	B
Nominal force	58	58	58	N
Peak current, effective	10	10	10	A
Nominal current, effective	2.9	2.9	2.9	A
Force constant, effective	19.9	19.9	19.9	N/A
Resistance per phase	2.8	2.8	2.8	Ω
Inductivity per phase	0.9	0.9	0.9	mH
Back EMF phase-phase	16	16	16	Vs/m
Reference point and limit switches	Hall effect	Hall effect	Hall effect	
Miscellaneous				
Operating temperature range	10 to 50	10 to 50	10 to 50	°C
Humidity	20 – 90 % rel., not condensing	20 – 90 % rel., not condensing	20 – 90 % rel., not condensing	
Material	Al (black anodized)	Al (black anodized)	Al (black anodized)	
Recommended controller	C-891	C-891	C-891	

* With C-891 controller. Optional down to 0.03 nm with incremental encoder. Ask about custom designs! Further information on www.pi.ws.

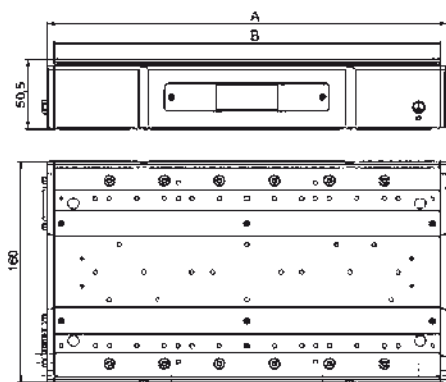

	V-551.2B	V-551.4B	V-551.7B
A	170	220	450
B	160	260	440



V-551, dimensions in mm

Precision Linear Stage

HIGH DYNAMICS DUE TO MAGNETIC DIRECT DRIVE, EXCELLENT TRAVEL ACCURACY

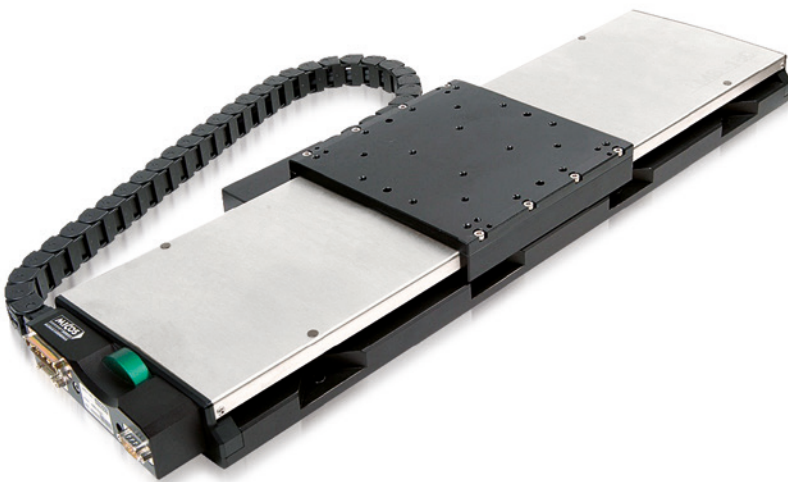

LMS-180

- Travel range up to 508 mm (20")
- Velocity to 500 mm/s
- Incremental encoder with 15 nm resolution
- 450 N peak force

Reference-class linear stage

High travel accuracy with recirculating ball bearings. Inductive limit switches. High position resolution due to incremental encoder with analog signal transmission (sin/cos, 1 V_{pp}) Multi-axis combinations with the directly driven rotation stages of the UPR series. Versions with DC servo or stepper motors are available with the same footprint

Magnetic direct drive

Ironless magnetic direct drive for high velocity and acceleration. High position resolution

Fields of application

Industry and research. Metrology, precision scanning in semiconductor or flat panel display manufacturing.

	68509111	68509121	68509131	68509141	68509151	Unit	Tolerance
Motion and Positioning							
Active axes	X	X	X	X	X		
Travel range	155	205	305	408	508	mm	
Integrated sensor	Incremental encoder	Incremental encoder	Incremental encoder	Incremental encoder	Incremental encoder		
Sensor resolution*	15	15	15	15	15	nm	
Minimum incremental motion	0.04	0.04	0.04	0.04	0.04	nm	typ.
Unidirectional repeatability	0.05	0.05	0.05	0.05	0.05	µm	typ.
Bidirectional repeatability	±0.1	±0.1	±0.1	±0.1	±0.1	µm	typ.
Pitch	±40	±50	±60	±70	±80	µrad	typ.
Yaw	±50	±50	±50	±50	±50	µrad	typ.
Straightness	±2	±3	±5	±5	±6	µm	typ.
Flatness	±2	±3	±5	±5	±6	µm	typ.
Velocity	500	500	500	500	500	mm/s	max.
Mechanical Properties							
Load capacity in z	250					N	max.
Load capacity in y	250					N	max.
Moved mass	0.9	0.9	0.9	0.9	0.9	kg	
Overall mass	10.2	10.4	11.5	12.8	14.2	kg	
Linear guiding	Recirculating ball bearings	Recirculating ball bearings	Recirculating ball bearings	Recirculating ball bearings	Recirculating ball bearings		
Drive Properties							
Drive type	Linear motor, ironless	Linear motor, ironless	Linear motor, ironless	Linear motor, ironless	Linear motor, ironless		
Intermediate circuit voltage	48	48	48	48	48	VDC	max.
Peak force	300	300	300	300	300	N	typ.
Nominal force	65	65	65	65	65	N	typ.
Peak current, effective	15	15	15	15	15	A	typ.
Nominal current, effective	3.2	3.2	3.2	3.2	3.2	A	typ.
Force constant, effective	19.9	19.9	19.9	19.9	19.9	N/A	typ.
Resistance per phase	1.8	1.8	1.8	1.8	1.8		typ.
Inductivity per phase	0.6	0.6	0.6	0.6	0.6	mH	typ.
Back EMF phasephase	16	16	16	16	16	Vs/m	max.
Limit switches	Inductive	Inductive	Inductive	Inductive	Inductive		
Miscellaneous							
Operating temperature range	10 to 50	10 to 50	10 to 50	10 to 50	10 to 50	°C	
Humidity	20 – 90 % rel., not condensing	20 – 90 % rel., not condensing	20 – 90 % rel., not condensing	20 – 90 % rel., not condensing	20 – 90 % rel., not condensing		
Material	Aluminum (black anodized)	Aluminum (black anodized)	Aluminum (black anodized)	Aluminum (black anodized)	Aluminum (black anodized)		
Recommended controller	SMC Hydra, C-891, ACS SPii +EC and other industrial solutions	SMC Hydra, C-891, ACS SPii +EC and other industrial solutions	SMC Hydra, C-891, ACS SPii +EC and other industrial solutions	SMC Hydra, C-891, ACS SPii +EC and other industrial solutions	SMC Hydra, C-891, ACS SPii +EC and other industrial solutions		

* With SMC Hydra controller.
Further information and technical drawing on www.pi.ws.

Precision Linear Stage

HIGH DYNAMICS DUE TO MAGNETIC DIRECT DRIVE, HIGH STABILITY



LMS-270

- Travel ranges to 1016 mm (40")
- Velocity to 800 mm/s
- Incremental encoder with 15 nm resolution
- 480 N peak force

Reference-class linear stage

High travel accuracy with recirculating ball bearings. Inductive limit switches. High position resolution due to incremental encoder with analog signal transmission (sin/cos, $1 V_{pp}$). Multi-axis combinations with the directly driven rotation stages of the UPR series. Versions with DC servo motors or stepper motors are available with the same footprint

Magnetic direct drive

Ironless magnetic direct drive for high velocity and acceleration. High position resolution

Fields of application

Industry and research. Metrology, precision scanning in semiconductor or flat panel display manufacturing

Preliminary Data	LMS-270KSHO	LMS-270KMED	LMS-270KLON	LMS-270KMAX	Unit	Tolerance
Motion and Positioning						
Active axes	X	X	X	X		
Travel range	305	508	815	1016	mm	
Integrated sensor	Incremental encoder	Incremental encoder	Incremental encoder	Incremental encoder		
Sensor resolution*	15	15	15	15	nm	
Minimum incremental motion	0.05	0.05	0.05	0.05	µm	typ.
Unidirectional repeatability	0.075	0.075	0.075	0.075	µm	typ.
Bidirectional repeatability	±0.15	±0.15	±0.15	±0.15	µm	typ.
Pitch	±40	±80	±100	±120	µrad	typ.
Yaw	±20	±30	±40	±50	µrad	typ.
Straightness	±3	±4	±7	±10	µm	typ.
Flatness	±3	±4	±7	±10	µm	typ.
Velocity	800	800	800	800	m/s	max.
Mechanical Properties						
Load capacity in z	500	500	500	500	N	max.
Load capacity in y	500	500	500	500	N	max.
Moved mass	1.3	1.3	1.3	1.3	kg	
Overall mass	35	40	51	61	kg	
Linear guiding	Recirculating ball bearings	Recirculating ball bearings	Recirculating ball bearings	Recirculating ball bearings		
Drive Properties						
Drive type	Linear motor, ironless	Linear motor, ironless	Linear motor, ironless	Linear motor, ironless		
Intermediate circuit voltage	48	48	48	48	VDC	max.
Peak force	480	480	480	480	N	typ.
Nominal force	100	100	100	100	N	typ.
Peak current, effective	17.5	17.5	17.5	17.5	A	typ.
Nominal current, effective	3.7	3.7	3.7	3.7	A	typ.
Force constant, effective	27.5	27.5	27.5	27.5	N/A	typ.
Resistance per phase	1.28	1.28	1.28	1.28		typ.
Inductivity per phase	1	1	1	1	mH	typ.
Back EMF phasephase	22.5	22.5	22.5	22.5	Vs/m	max.
Miscellaneous						
Operating temperature range	10 to 50				°C	
Humidity	20 – 90 % rel., not condensing	20 – 90 % rel., not condensing	20 – 90 % rel., not condensing	20 – 90 % rel., not condensing		
Material	Aluminum (black anodized)	Aluminum (black anodized)	Aluminum (black anodized)	Aluminum (black anodized)		
Recommended controller	SMC Hydra, ACS SPii +EC and other industrial solutions	SMC Hydra, ACS SPii +EC and other industrial solutions	SMC Hydra, ACS SPii +EC and other industrial solutions	SMC Hydra, ACS SPii +EC and other industrial solutions		

* With SMC Hydra controller.
Further information and technical drawing on www.pi.ws.

PIMag® VC Vertical Linear Actuator

COMPACT WITH INTEGRATED POSITION SENSOR



V-900KPIC

- Travel range 1.5 mm
- High scanning frequencies, fast step-and-settle
- Integrated linear encoder, 0.1 μm resolution
- Wear-free flexure guiding for long lifetime
- Compact design

OEM linear actuator

PIMag® voice coil magnetic drive, high velocity and high dynamics. Low wear and high lifetime. Integrated linear encoder for reliable position control and repeatable accuracy. 10 kHz servo update rate. Optional force sensor for applying defined forces. Easy integration by coupling the guided load to the moving runner

PIMag® C-413 digital motion controller for position and force control

2 channels (position control) or 1 channel (simultaneous

position and force control). Controlled output current up to 1.5 A at 24 V, 150 kHz. USB interface for sending commands, digital I/Os, SPI interface. Plug&Play: ID chip for reading stage parameters. Available as OEM board or bench-top device. PIMikroMove user software, compatible with PI General Command Set (GCS)

Fields of application

OEM drives in automation. For fast handling tasks and precision positioning in the micrometer range, micromanipulation

Preliminary Data	V-900KPIC	Unit	Tolerance
Active axes	Z		
Motion and positioning			
Travel range	1.5	mm	
Integrated sensor	Optical linear encoder		
Servo update rate	10*	kHz	
Open-loop resolution	10*	nm	typ.
Closed-loop resolution	100	nm	typ.
Closed-loop linearity error	±1	%	typ.
Repeatability	±500	nm	typ.
Straightness of travel	±5	µm	±5
Maximum velocity, open-loop	250	mm/s	
Velocity, closed-loop	45	mm/s	
Mechanical properties			
Moved mass	10	g	typ.
Average push/pull force	0.5	N	nominal
Maximum push/pull force	0.8	N	max.
Force constant	4	N/A	typ.
Drive properties			
Motor type	PIMag® voice coil drive		
Magnet material	NdFeB (N38SH)		
Coil resistance	8.8	Ω	typ.
Coil inductance	0.8	mH	typ.
Average continuous current	120**	mA	max.
Peak current (max. 3 s)	200	mA	
Miscellaneous			
Operating temperature range	10 to 45	°C	
Material	Aluminum		
Mass	40	g	±5 %
Cable length	0.2	m	
Motor/sensor connection	Molex 12-pin		
Lifetime	> 10 ⁸	cycles	min.
Recommended controller	C-413 (plug adapter required)		

* With C-413 controller.

** Allowable average value for continuous operation, not to be exceeded.
Further information on www.pi.ws.

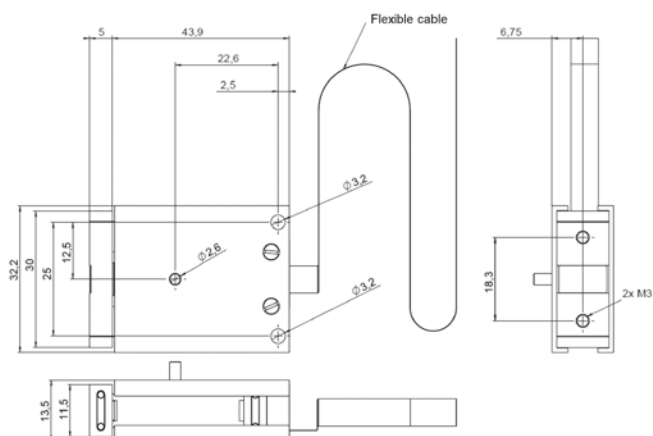

V-900KPIC, dimensions in mm

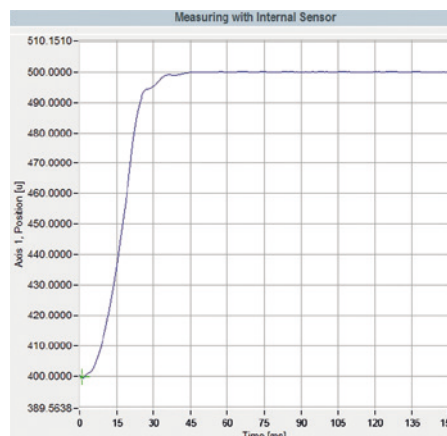

The settling time for a 100 µm step is approx. 50 ms.

PIMag[®] Voice Coil Linear Actuator

COST-EFFECTIVE WITH HIGH DYNAMICS



V-273

- Travel ranges to 20 mm
- Velocity to 250 mm/s
- Integrated linear encoder, 0.01 μm resolution
- Optional force sensor with 1 mN resolution
- Optional: Weight force compensation
- Maximum force 10 N
- Resolution 0.01 μm (open-loop)
- Long Lifetime; > 10 million cycles
- C-413 motion controller for simultaneous position and force control

OEM linear actuator

PIMag[®] Voice coil magnetic drive, high velocity and high dynamics. Low wear and high lifetime. Integrated linear encoder for reliable position control and repeatable accuracy. Position sensor resolution: 0.01 μm . Optional force sensor for applying defined forces. Force sensor resolution: 1 mN. Easy integration by coupling the guided load to the moving runner

Fields of application

OEM drives in automation. For fast handling tasks and precision positioning in the micrometer range, micro-manipulation

	V-273.440 / V-273.441	Unit	Tolerance
Active axes	Z		
Motion and positioning			
Travel	20	mm	
Integrated sensor	Optical linear encoder		
Sensor resolution	10*	nm	max.
Min. incremental motion	100	nm	typ.
Linearity error, closed-loop	1	%	typ.
Repeatability	±0.5	µm	typ.
Velocity	200	mm/s	max.
Force sensor resolution (optional)	1	mN	max.
Smallest force step (optional)	5	mN	typ.
Mechanical properties			
Bearing / guiding	Recirculating ball bearing		
Straightness of travel	±20	µm	±5 %
Moved mass without load	100 (230 with force sensor)	g	typ.
Drive properties			
Motor type	PIMag® voice coil drive, moving coil		
Coil resistance	16	Ω	typ., at 20 °C
Coil inductance	6	mH	typ., at 20 °C
Time constant	0.375	ms	
Mutual inductance	8	Vs/m	
Force constant	8	N/A	typ.
Motor constant	2	N/W ^{1/2}	
Current constant	0.125	A/N	typ.
Average continuous current	375**	mA	max.
Peak current (max. 3 s)	800	mA	
Average push / pull force	3	N	nominal
Power dissipation with 100 % duty cycle	2.25	W	
Maximum push / pull force	10	N	max.
Power dissipation with 10 % duty cycle	0.02	W	
Miscellaneous			
Operating temperature range	10 to 60	°C	
Material	Aluminum		
Mass	660 (790 with force sensor)	g	±5 %
Cable length	1	m	
Motor / sensor connection	Sub-D 15 (m) with force sensor: 2 x Sub-D 15 (m)		
Lifetime	> 10 ⁷	cycles	min.
Recommended controller	C-413.2x		

* With C-413 controller.

** Allowable average value for continuous operation, not to be exceeded.
Further information on www.pi.ws.

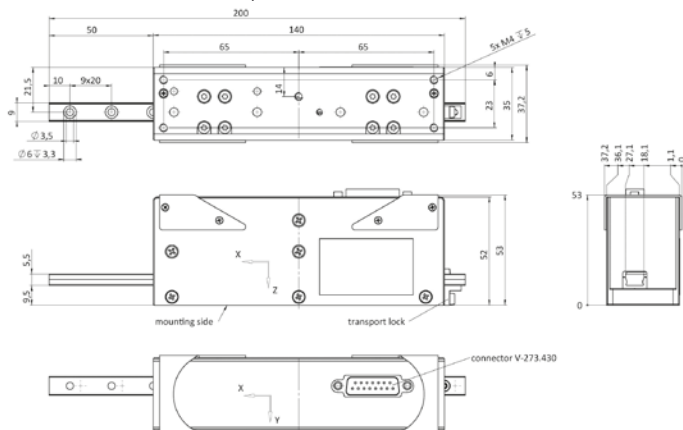

V-273.440, dimensions in mm

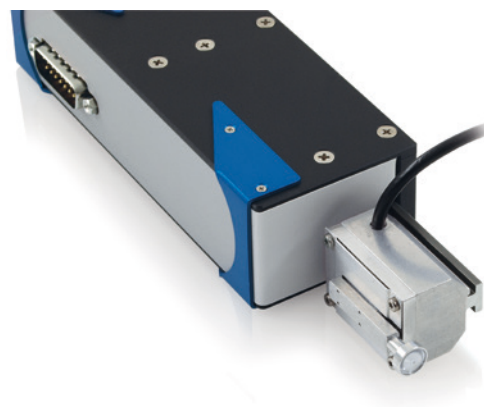

Optional force sensor on V-273

PIMag[®] Voice Coil Linear Actuator

HIGH DYNAMICS, WITH OPTIONAL FORCE CONTROL



V-275

- Push force up to 10 N
- Velocity to 600 mm/s
- Integrated linear encoder, 0.01 μm resolution
- Weight force compensation
- Optional force sensor with 1 mN resolution

OEM Linear Actuator

PIMag[®] voice coil linear drive, high velocity and high dynamics. Low wear and high lifetime. Integrated linear encoder for reliable position control and repeatable accuracy. Position sensor resolution: 0.01 μm . Optional force sensor for applying defined forces. Force sensor resolution: 1 mN. Easy integration by coupling the guided load to the moving runner

Fields of application

OEM drives in automation. For fast handling tasks and precision positioning in the micrometer range, micromanipulation. Testing of force-sensitive switches and surfaces

	V-275.430/V-275.431	Unit	Tolerance
Active axes	Z		
Motion and positioning			
Travel	10	mm	
Integrated sensor	Optical linear encoder		
Sensor resolution	10*	nm	max.
Min. incremental motion	100	nm	typ.
Linearity error, closed-loop	1	%	typ.
Repeatability	±0.5	µm	typ.
Velocity	600	mm/s	max.
Force sensor resolution (optional)	1	mN	max.
Smallest force step (optional)	5	mN	typ.
Mechanical properties			
Bearing / guiding	Linear recirculating ball bearings		
Straightness of travel	±5	µm	±5 %
Moved mass without load	150	g	typ.
Drive properties			
Motor type	PIMag® voice coil drive, moving coil		
Coil resistance	5.7	Ω	typ., at 20 °C
Coil inductance	3.75	mH	typ., at 1 kHz, at 20 °C
Time constant	0.65	ms	
Mutual inductance	10	Vs/m	
Force constant	10	N/A	typ.
Motor constant	3.5	N/W ^{1/2}	
Current constant	0.1	A/N	typ.
Average continuous current	700**	mA	max.
Peak current (max. 3 s)	1500	mA	
Average push / pull force	7	N	nominal
Power dissipation with 100 % duty cycle	4	W	
Maximum push / pull force	15	N	max.
Power dissipation with 10 % duty cycle	0.04	W	
Miscellaneous			
Operating temperature range	10 to 60	°C	
Material	Aluminum		
Mass	800	g	±5 %
Cable length	3	m	
Motor / sensor connection	Sub-D 26 (m), with force sensor Sub-D 9 (m)		
Lifetime	> 10 ⁷	cycles	min.
Recommended controller	C-413.1x		

* With C-413 controller.

** Allowable average value for continuous operation, not to be exceeded.
Further information on www.pi.ws.

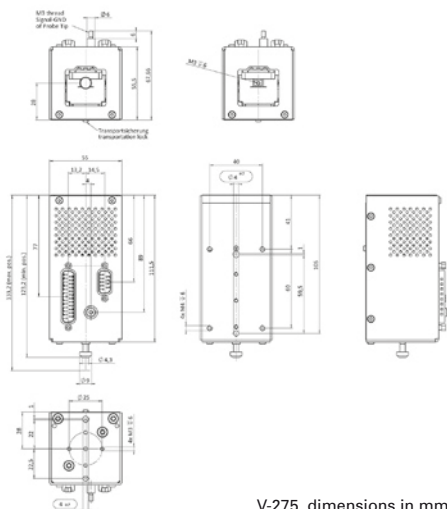

V-275, dimensions in mm

PIMag® High-Load Linear Actuator

VOICE COIL DRIVE FOR HIGH VELOCITY



V-277

- Force up to 20 N
- Velocity up to 750 mm/s
- Integrated linear encoder, 0.01 μm resolution
- Optional force sensor with 1 mN resolution
- Optional: Weight force compensation

OEM Linear Actuator

PIMag® voice coil linear drive, high velocity and high dynamics. Low wear and high lifetime. Integrated linear encoder for reliable position control and repeatable accuracy. Position sensor resolution: 0.01 μm . Optional force sensor for applying defined forces. Force sensor resolution: 1 mN. Easy integration by coupling the guided load to the moving runner

Fields of application

OEM drives in automation. For fast handling tasks and precision positioning in the micrometer range, micromanipulation. Testing of force-sensitive switches and surfaces

	V-277	Unit	Tolerance
Active axes	Z		
Motion and positioning			
Travel	15	mm	
Integrated sensor	Optical linear encoder		
Sensor resolution	10*	nm	max.
Min. incremental motion	100	nm	typ.
Linearity error, closed-loop	1	%	typ.
Repeatability	±0.5	µm	typ.
Velocity	750	mm/s	max.
Force sensor resolution (optional)	1	mN	max.
Force resolution, closed-loop	5	mN	typ.
Mechanical properties			
Bearing/guiding	Linear recirculating ball bearings		
Straightness of travel	±5	µm	±5 %
Moved mass without load	190	g	typ.
Drive properties			
Motor type	PIMag® voice coil drive, moving coil		
Coil resistance	6.3	Ω	typ., at 20 °C
Coil inductance	2.70	mH	typ., at 1 kHz, at 20 °C
Time constant	0.43	ms	typ.
Mutual inductance	14	Vs/m	
Force constant	13.5	N/A	typ.
Motor constant	5.6	N/W ^{1/2}	
Current constant	0.072	A/N	typ.
Average continuous current	800**	mA	max.
Peak current (max. 3 s)	1500	mA	
Average push/pull force	10	N	nominal
Power dissipation with 100 % duty cycle	4	W	
Maximum push/pull force	20	N	max.
Miscellaneous			
Operating temperature range	10 to 60	°C	
Material	Aluminum		
Mass	1850	g	±5 %
Cable length	3	m	
Motor/sensor connection	Sub-D 26 (m), with force sensor Sub-D 9 (m)		
Lifetime	> 10 ⁷	cycles	min.
Recommended controller	C-413		

* With C-413 controller.

** Allowable average value for continuous operation, not to be exceeded.
Further information on www.pi.ws.

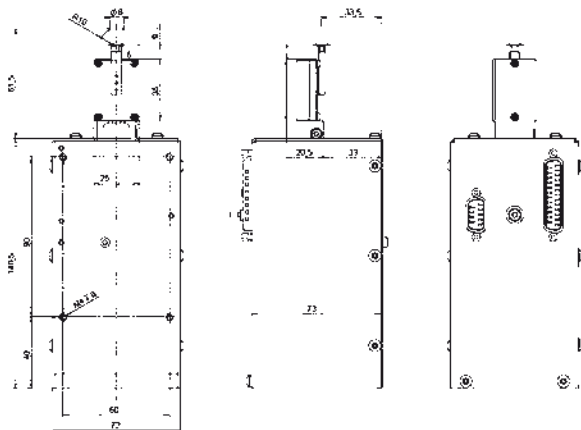

V-277, dimensions in mm

Metrology XY Stages

EXCELLENT TRAVEL ACCURACY AND STABILITY



L-731/MCS

- Travel ranges to 205 mm x 205 mm (8")
- Unidirectional repeatability to 0.2 μm
- Velocity to 240 mm/s
- High-resolution incremental encoder
- Optional with DC motor or stepper motor

Reference-class XY stage

High travel accuracy. L-731: crossed roller guides, no cage creep due to forced guidance (anti-creep). MCS: recirculating ball bearings. Smoothrunning precision linear guiding. Compact dimensions. Optical limit and reference point switches. High position resolution due to incremental encoder with analog signal transmission (sin/cos, 1 V_{pp})
MCS: large aperture 155 mm x 155 mm
Versions with DC servo and stepper motors on request.
Other travel ranges on request.

Magnetic direct drives

Ironless magnetic direct drive for high velocity and acceleration. High position resolution

Fields of application

Industry and research. Metrology, inspection, industrial microscopy



MCS

Preliminary Data	L-731KLM	6304942230 MCS	Unit	Tolerance
Motion and Positioning				
Active axes	X, Y	X, Y		
Travel range	205 x 205	102 x 102	mm	
Integrated sensor	Incremental encoder	Incremental encoder		
Sensor resolution*	10	2	nm	
Minimum incremental motion	0.02	0.01	nm	typ.
Unidirectional repeatability	0.2	0.05	µm	typ.
Bidirectional repeatability	±0.1	±0.1	µm	typ.
Pitch	±40	±40	µrad	typ.
Yaw	±40	±20	µrad	typ.
Straightness	±1.5	±2	µm	typ.
Flatness	±1.5	±2	µm	typ.
Velocity	100	240	mm/s	max.
Mechanical Properties				
Max. load, horizontal	50	100	N	max.
Moved mass	14	14	kg	
Overall mass	20	22	kg	
Linear guiding	Crossed roller bearing with anti-creep system	Recirculating ball bearings		
Drive Properties				
Drive type	Linear motor, ironless	Linear motor, ironless		
Intermediate circuit voltage	48	48	VDC	max.
Peak force	100	300	N	typ.
Nominal force	29	65	N	typ.
Peak current, effective	5	15	A	typ.
Nominal current, effective	1.1	3.2	A	typ.
Force constant, effective	19.9	19.9	N/A	typ.
Resistance per phase	5.5	1.8		typ.
Inductivity per phase	1.8	0.6	mH	typ.
Back EMF phase-phase	16	16	Vs/m	max.
Magnetic periods	30	30	mm	
Reference point switch	Optical	Encoder index		
Limit switches	Optical	Optical		
Miscellaneous				
Operating temperature range	10 to 50	10 to 50	°C	
Dimensions	310 x 310 x 80	380 x 380 x 80; Free aperture 155 x 155	mm	
Humidity	20 – 90% rel., not condensing	20 – 90% rel., not condensing		
Material	Aluminum, (black anodized)	Aluminum, (black anodized)		
Recommended controller	SMC Hydra, ACS SPii +EC and other industrial solutions	SMC Hydra, ACS SPii +EC and other industrial solutions		

Further information and technical drawing on www.pi.ws.

PIglide IS: Planar XY Air Bearing Stage

ULTRA PERFORMANCE, COMPACT XY NANOPOSITIONING SYSTEMS

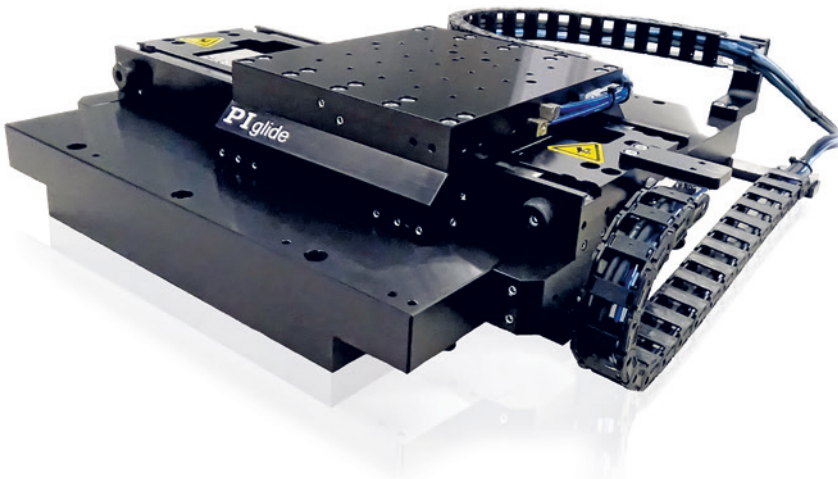

A-311

- Ideal for scanning or high-resolution positioning
- Clean room compatible
- Customizable
- Travel lengths to 200 mm x 200 mm
- Load to 15 kg max
- Non-contact fully preloaded air bearings
- Low profile design
- Resolution to 1 nm
- Velocity to 1m/sec
- Acceleration to 1 g

Overview

The PIglide IS planar XY air-bearing stage is a low profile, high precision alternative to stacked XY stages. The fully preloaded air bearing puck floats in both X and Y directions on a common base, providing smooth, frictionless motion. Ideal for inspection, laser marking, microscopy, scanning, and other precision motion applications. The efficient, compact design saves space in tight machine designs. Ironless linear motors provide smooth motion with no cogging or attractive forces. Optical linear encoders provide position feedback information down to 1 nm, depending on interpolation.

The PIglide IS can be coupled with a variety of industry-leading digital controls and drives that offer advanced algorithms to improve dynamic performance and error compensation and a wide suite of software development tools.

Accessories and Options

- Air preparation kits
- Multi-axis motion controller and servo drives
- Machine bases
- Vibration isolation systems
- Additional accessories and customizations available

Model A-311.BA1	X- Axis (Lower Axis)	Y- Axis (Upper Axis)
Travel range	150 mm	150 mm
Drive system	Brushless linear servo motor, 3-phase	
Feedback system	Non-contact optical linear encoder	
Motor bus voltage	Up to 80 VDC (48 VDC nominal)	
Maximum Velocity ⁽¹⁾	Up to 1 m/sec	
Motor force constant	12.3 N/A	
Motor back EMF	10.1 V/m/sec	
Motor resistance (@25 °C, phase-to-phase)	2 ohms	
Maximum acceleration ⁽¹⁾	Up to 1 g	
Maximum payload ⁽²⁾	15 kg	
Accuracy ⁽³⁾	±0.5 µm	
Repeatability	±0.5 µm	
Encoder resolution ⁽⁴⁾	Up to 1.0 nm	
Flatness ⁽⁵⁾	< 0.1 µm/25 mm, 1 µm TIR overall	
Straightness	< 0.1 µm/25 mm, 1 µm TIR overall	< 0.1 µm/25 mm, 1 µm TIR overall
Roll/pitch	1 arc-sec TIR	
Yaw	2 arc-sec TIR	
XY orthogonality	5 arc-sec	
Stage mass	20 kg	
Moving mass	5 kg	2.5 kg
Operating pressure ⁽⁶⁾	65 (±5) psi (450 ±35 kPa)	
Air consumption	< 2.0 SCFM (56 SLPM)	
Air quality	Clean (filtered to 1.0 µm or better) and oil-free Dry (-15 °C dew point)	
Construction	Hardcoat aluminum with SS fasteners	

¹ Maximum velocity and acceleration based on stage capability, may be limited by controller or drive performance.

² Assumes payload CG is centered no more than 50 mm above the stage table.

³ Can be improved using controller-based error compensation.

⁴ Encoder resolution depends on options chosen and interpolation used.

⁵ Dependent on the machine base and isolation system to which the stage is mounted.

⁶ To protect stage from damage, an under-pressure air sensor tied to the controller E-stop input is recommended.

Further information on www.pi.ws.

Model	Travel (X-Axis x Y-Axis)	Encoder ⁽¹⁾	Motor Wiring
A-311	A = 100 mm x 100 mm	A = 20 µm/line incremental, sine (1 V _{pp}) output	1 = Standard motor option, 48 VDC
	B = 150 mm x 150 mm	B = 1 nm resolution absolute, BiSS-C serial output	
	C = 200 mm x 200 mm	C = 50 nm resolution incremental, A-quad-B (TTL) output	

1. Alternate TTL encoder resolutions are available on request.

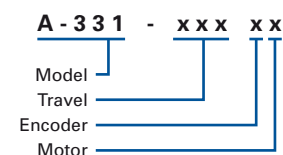

Ordering Example

Part# **A-331.BA1** is a

Model: A-331 (Pliglide IS planar motorized air bearing stage)

Travel: B (150 mm x 150 mm)

Encoder: A (20 µm/line sine output, 1 V_{pp})

Motor Wiring: 1 (48 VDC)

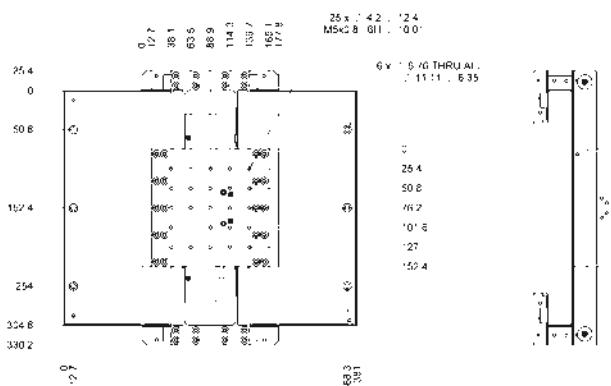
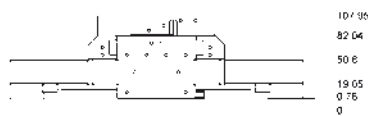

Model A-311.Bxx, in mm

PIglide HS: Planar Air Bearing Stage

ULTRA PERFORMANCE XY NANO POSITIONING SYSTEM

A-322 Series

- Ideal for scanning or high-resolution positioning
- Clean room compatible
- Customizable
- Travel lengths to 500 mm x 1000 mm
- Load to 15 kg max
- Non-contact fully preloaded air bearings
- Resolution to 1 nm
- Velocity to 1 m/sec
- Acceleration to 1 g
- Straightness/Flatness to 0.25 μm
- Active yaw control and error compensation
- Dynamic mapping achieves near „laser“ performance
- Active error compensation algorithms for straightness

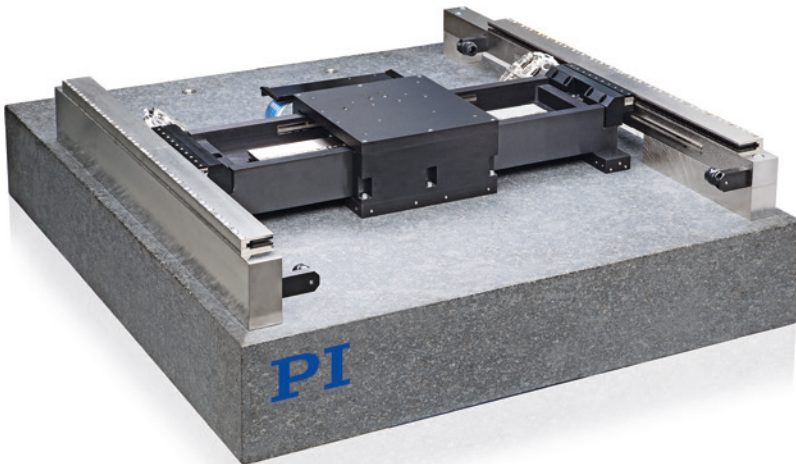

Overview

The PIglide HS planar air-bearing stage has been designed to maximize throughput while providing the ultimate level of precision. This stage is ideal for wafer inspection and scribing applications, as well as other ultra-precision motion applications such as flat panel inspection.

Flexural coupling of the cross beam to the lower axis provides yaw-compliance without sacrificing system stiffness. The gantry axis cross beam incorporates dual linear motors and dual linear encoders. Ironless linear motors provide smooth motion and no cogging or attractive forces. Both incremental and absolute encoder options are available. The PIglide HS incorporates three high-ac-

curacy linear encoders, one for the bridge axis and two for the gantry axis.

The PIglide HS can be coupled with a variety of industry-leading digital controls and drives that offer advanced algorithms to improve dynamic performance and error compensation and a wide suite of software development tools.

Accessories and Options

- Air preparation kits
- Multi-axis motion controller and servo drives
- Machine bases
- Vibration isolation systems
- Additional accessories and customizations available on request

Model A-322.BB1	X-Axis (Cross Axis)	Y-Axis (Lower Axis)
Travel (limit to limit)	350 mm	500 mm
Drive system	Brushless linear servo motor, 3-phase	
Feedback system	Non-contact optical linear encoder	
Motor bus voltage	Up to 80 VDC (48 VDC nominal)	
Maximum velocity ⁽¹⁾	Up to 1 m/sec	
Maximum acceleration ⁽¹⁾	Up to 1 g	
Maximum payload ⁽²⁾	15 kg	
Accuracy ⁽³⁾	±1.0 µm	
Repeatability	±50 nm	
Servo stability ⁽⁵⁾	±10 nm	±15 nm
Velocity stability ⁽⁵⁾	< 0.06 % @ 80 mm/sec	< 0.1 % @ 80 mm/sec
Encoder resolution ⁽⁴⁾	Up to 1.0 nm	
Flatness	< 0.1 µm/25 mm 2.0 µm TIR overall	< 0.1 µm/25 mm 4.0 µm TIR overall
Straightness ⁽³⁾	< 0.1 µm/25 mm 1.0 µm TIR overall	< 0.1 µm/25 mm 1.0 µm TIR overall
Pitch	4 arc-sec TIR	6 arc-sec TIR
Yaw ⁽³⁾	0.6 arc-sec TIR	0.4 arc-sec TIR
XY orthogonality	±2 arc-sec	
Step and settle ⁽¹⁾	10 mm step, settle to ±0.1 µm within 150 msec 20 mm step, settle to ±0.1 µm within 190 msec 50 mm step, settle to ±0.1 µm within 262 msec	
Stage mass	705 kg	
Moving mass	13 kg	39 kg
Operating pressure ⁽⁶⁾	65 (±5) psi (450 ±35 kPa)	
Air consumption	< 2.0 SCFM (56 SLPM)	
Air quality	Clean (filtered to 1.0µm or better) and oil-free / dry (-15 °C dew point)	
Construction	Hardcoat aluminum with SS fasteners / granite base ⁽⁷⁾	

¹ Maximum velocity and acceleration based on stage capability, may be limited by controller or drive performance.

² Assumes payload CG is centered no more than 50 mm above the table.

³ Values shown obtained using controller-based error compensation.

⁴ Encoder resolution depends on options chosen and interpolation used.

⁵ Dependent on the machine base and isolation system to which the stage is mounted.

⁶ To protect stage from damage, an under-pressure air sensor tied to the controller E-stop input is recommended.

⁷ Other materials are available, please contact a PI Sales Engineer for more information.

Further information on www.pi.ws.

Model	Travel (X-Axis x Y-Axis)	Encoder ⁽¹⁾	Motor Wiring
A-322	A = 350 mm x 350 mm	A = 20 µm/line incremental, sine (1 V _{pp}) output	1 = Standard motor option, 48 VDC
	B = 350 mm x 500 mm	B = 1 nm resolution absolute, BiSS-C serial output	
	C = 500 mm x 500 mm	C = 50 nm resolution incremental, A-quad-B (TTL) output	
	D = 500 mm x 1000 mm		

1. Alternate TTL encoder resolutions are available on request.

A - 322 - x x x x x



Ordering Example

Part# **A-322.BB1** is a

Model: A-322 (PIglide HS planar motorized air bearing stage)

Travel: B (350 mm x 500 mm)

Encoder: B (1 nm absolute BiSS)

Motor Wiring: 1 (48 VDC)

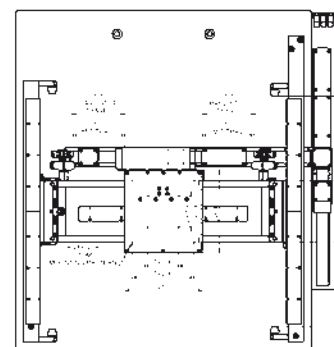
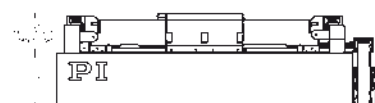

Model A-322.Bxx, in mm

PIMag® 6D Magnetic Levitation

FRICION-FREE WITH NANOMETER PRECISION

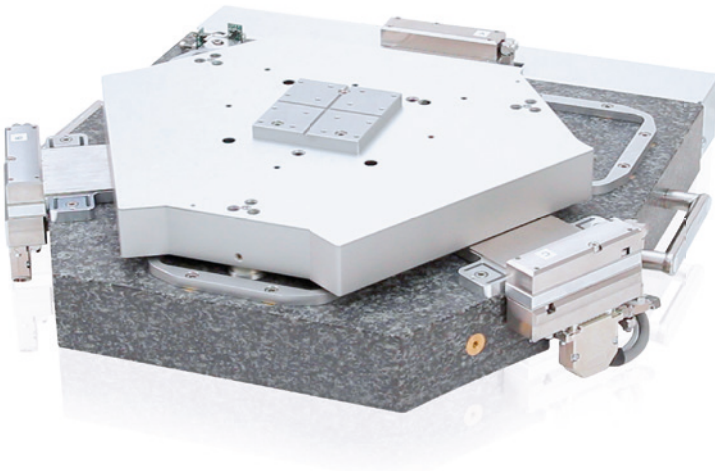

- Six degrees of freedom
- 100 x 100 mm² planar travel range
- Stroke in Z ± 50 μ m for crosstalk compensation
- 10 nm resolution
- Resonance frequency of approx. 500 Hz for control, high dynamics

Air-bearing solutions and magnetic linear motors currently represent the state of the art in inspection and manufacturing systems in the semiconductor industry

However, with increasing requirements for achieving nanometer precision or for applications in vacuum or nitrogen atmosphere, such systems soon reach their limits.

Characteristics of the PIMag® 6D

The PIMag® 6D is an electromagnetic positioning system, where the passive platform levitates on a magnetic field which guides this actively. In this way, objects can be moved linearly or rotationally on a plane with a previously unattained guiding accuracy

The major advantage of this concept is the absence of any mechanical contact in the drivetrain or the guides; consequently, there is no friction. As there is no friction, there is no wear which could contaminate the work space. Fur-

thermore, neither air nor grease are needed for lubrication, making magnetic-field based systems perfectly suitable for applications in vacuum or nitrogen atmosphere

Operating principle: six planar coils and Halbach arrays

The PIMag® 6D positioning system was developed in cooperation with the Institute for Microelectronic and Mechatronic Systems and the Department of Mechatronics at the University Ilmenau. Owing to its simple design, it offers several unique features, as compared to the known approaches:

The platform levitates on a magnetic field generated by only six planar coils in the stator, with the magnetic field being actively controlled using a 6D sensor. The platform itself is passive, so it does not need any electrical supply lines. This provides more freedom of movement as there are no cables in motion to prevent the platform from moving quickly and accurately over an extensive surface area

	PIMag® 6D	Unit	Tolerance
Active axes	X, Y, Z, θ_x , θ_y , θ_z		
Motion and positioning			
Travel range X, Y	100	mm	
Travel range Z	0.05	Mm	
Design resolution	10	nm	
Repeatability	< 10	nm	typ.
Max. velocity	100	mm/s	
Max. acceleration	2	g	
Mechanical properties			
Load	5	N	max.

Further information on www.pi.ws.

The Halbach arrangement of the magnets in the passive platform makes it possible to increase the load carrying capacity, to minimize the energy required by the active coils in the stator for carrying the platform, and to reduce thermal load.

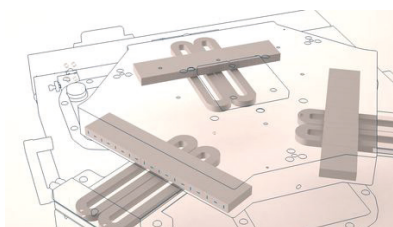

Simple structure: the platform levitates on a magnetic field generated by only six planar coils in the stator.

The Halbach arrays consist of permanent magnet segments with the magnetization directions tilted against each other by 90° in the direction of the array's longitudinal axis. This makes the field lines move closer together on one side, thus increasing the magnetic flow density. On the opposite side, the field lines are less dense than in the undisturbed magnet. Consequently, the magnetic field is already attenuated at a short distance and is therefore very weak.

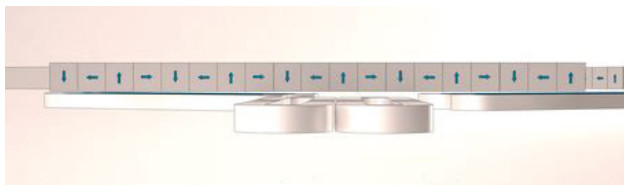

In order to ensure thermal stability in the working space, the drive coils in the stator are surrounded by a flat, sandwich-type cooling system, allowing for efficient heat dissipation. During system operation, the increase in temperature on the upper side of the coil is therefore less than 1 K.

6D measuring system integrated in the stator

The high-resolution measuring system for six degrees of freedom, integrated in the stator, is the key element of positioning control.

The compact sensor head of the PIMag® 6D consists of optical and capacitive sensor elements and captures the position of the platform in all six levels of freedom.

The incremental optical 2D sensor has a resolution of 10 nm and is able to detect rotations about the vertical axis by up to ±0.25°. The platform also does not require an electrical supply line for the measuring system.

If the system moves on a circular path with a radius of 1 μm the maximum deviation from the ideal line is only a few nanometers.

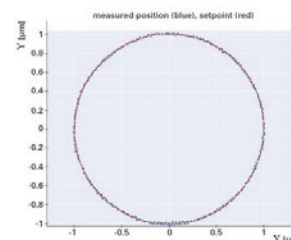

High-Dynamics Hexapod

MAGNETIC DIRECT DRIVE FOR HIGH VELOCITY

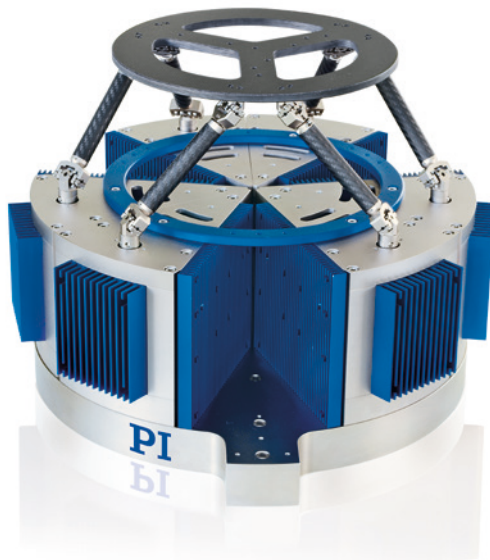

H-860KMAG

- Dynamics to 25 Hz over 0.1° travel range
- Integrated wave generator
- Developed for test stations for image stabilization
- Low moved mass
- Velocity > 250 mm/s
- Freely programmable, virtual pivot point

Reference-class 6-axis positioning system

Parallel-kinematic design for six degrees of freedom making it significantly more compact and stiffer than serialkinematic systems, no moved cables. Precise running of predefined motion profiles with high path accuracy: Sine curves and freely definable trajectories. Digital I/O interfaces for trigger signal emission

Powerful digital controller, open software architecture

User-defined, stable pivot point, software-selectable. Positions commanded in Cartesian coordinates. Macro programming. Open source LabVIEW driver set. Work space simulation software. Virtual hexapod machine software. Optional: Collision avoidance software (external obstacles)

PIMag® voice coil magnetic drive for high velocity and high dynamics

Noncontact magnetic drive principle, no frictional or

rolling parts for guiding and joints. Zero-backlash positioning, no mechanical noise in the drivetrain. Silent. Low wear and high lifetime. Integrated linear encoder for reliable position control and repeatable accuracy. Fast and precise direction reversal through low moved mass and lightweight design (highly stiff, milled carbon parts)

Fields of application

Research and industry, test systems, e.g. for image stabilization in cameras and mobile devices. Equipment for camera test systems and image stabilization software, certification according to CIPA planned. Oscillation simulation, eye tracking, simulation of human and artificial motion

Ultraprecision Rotation Stage

HIGH DYNAMICS DUE TO MAGNETIC DRIVE, HIGH STABILITY



UPR-100

- Unlimited travel range
- Velocity to 360°/s
- Incremental angle measuring system with 0.00002° resolution
- Clear aperture with 20 mm diameter

Reference-class rotation stage

High travel accuracy. High position resolution due to incremental encoder with analog signal transmission (sin/cos, 1 V_{pp})

Magnetic direct drive

Ironless magnetic direct drive (torque motor) for high velocity and acceleration. High position resolution

Fields of application

Industry and research. Metrology, semiconductor manufacturing and testing, synchrotron applications

	680591111	Unit	Tolerance
Motion and Positioning			
Active axes	θ_z		
Travel range	> 360	°	
Integrated Sensor	Incremental angle measuring system		
Sensor resolution*	0.00002	°	
Minimum incremental motion	0.00008	°	typ.
Unidirectional repeatability	0.00008	°	typ.
Bidirectional repeatability	±0.0001	°	typ.
Flatness	±2.5	µm	typ.
Eccentricity	±2.5	µm	typ.
Wobble	±15	µrad	typ.
Velocity	360	°/s	max.
Mechanical Properties			
Max. load, axial	20	N	max.
Max. load, radial	15	N	max.
Moved mass	0.4	kg	
Overall mass	1.2	kg	
Drive Properties			
Drive type	Torque motor, ironless		
Intermediate circuit voltage	48	VDC	max.
Peak torque	0.5	Nm	typ.
Nominal torque	0.16	Nm	typ.
Nominal current, effective	1.2	A	typ.
Torque constant, effective	0.13	Nm/A	typ.
Resistance per phase	6.6		typ.
Inductivity per phase	0.7	mH	typ.
Back EMF phase-phase	0.67	Vs/rad	max.
Reference point switch	Encoder index		
Miscellaneous			
Operating temperature range	10 to 50	°C	
Humidity	20 – 90 % rel., not condensing		
Material	Aluminum, (black anodized)		
Recommended controller	SMC Hydra, C-891, ACS SPii +EC and other industrial solutions		

Ask about custom designs!
 Further information and technical drawing on www.pi.ws.

Ultraprecision Rotation Stage

EXCELLENT STABILITY AND TRAVEL ACCURACY



UPR-120/ UPR-120 AIR

- Unlimited travel range
- Velocity to 360°/s
- Incremental angle measuring system with 0.00002° resolution
- Clear aperture with 35 mm diameter
- Optional: Air bearings for optimized flatness

Reference-class rotation stage

High travel accuracy. High position resolution due to incremental encoder with analog signal transmission (sin/cos, 1 V_{pp})

Magnetic direct drive

Ironless magnetic direct drive (torque motor) for high velocity and acceleration. High position resolution

Fields of application

Industry and research. Metrology, semiconductor manufacturing and testing, synchrotron applications

	6808911130 UPR-120	68624911130 UPR-120 AIR	Unit	Tolerance
Motion and Positioning				
Active axes	θ_z	θ_z		
Travel range	> 360	> 360	°	
Integrated sensor	Incremental angle measuring system	Incremental angle measuring system		
Sensor resolution*	0.00002	0.00002	°	
Min. incremental motion	0.00008	0.00004	°	typ.
Unidirectional repeatability	0.00008	0.00005	°	typ.
Bidirectional repeatability	±0.0001	±0.00008	°	typ.
Flatness	±1	±0.05	µm	typ.
Eccentricity	±3	±0.1	µm	typ.
Wobble	±25	±1.25	µrad	typ.
Velocity	360	360	°/s	max.
Mechanical Properties				
Max. load, axial	100	100	N	max.
Max. load, radial	50	50	N	max.
Moved mass	0.8	1.1	kg	
Overall mass	6	6.5	kg	
Drive Properties				
Drive type	Torque motor, ironless			
Intermediate circuit voltage	48		VDC	max.
Peak torque	2.08	2.08	Nm	typ.
Nominal torque	0.76	0.76	Nm	typ.
Nominal current, effective	7.7	7.7	A	typ.
Torque constant, effective	0.26	0.26	Nm/A	typ.
Resistance per phase	2.2	2.2		typ.
Inductivity per phase	1.17	1.17	mH	typ.
Back EMF phase-phase	0.18	0.18	Vs/rad	max.
Limit switches	optical	optical		
Miscellaneous				
Operating temperature range	10 to 50		°C	
Humidity	20 – 90 % rel., not condensing			
Material	Aluminum, (black anodized)			
Recommended controller	SMC Hydra, C-891, ACS SPii +EC and other industrial solutions			

* With SMC Hydra controller.

Further information and technical drawing on www.pi.ws.

ACS Industrial Controller Series

MOTION CONTROL SOLUTIONS FOR OEMS

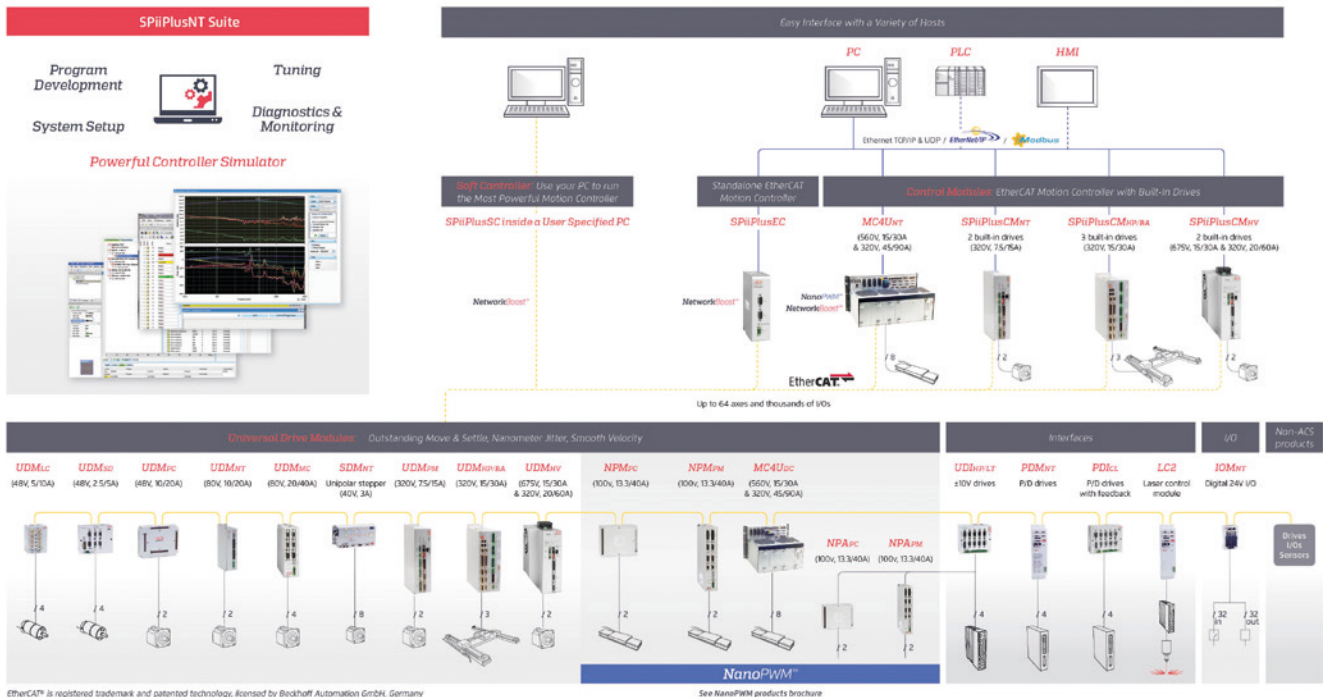

- Modular hardware design, easy to tailor
- EtherCAT®-based communications
- Open architecture for third party EtherCAT® drivers
- Support of multiple drive concepts

ACS is a preferred supplier of PI for professional industrial motion control. ACS' powerful platform consists of an EtherCAT® Controller MPU (MotionProcessor Unit) and one Servo Processor at each EtherCAT® node. The MPU can manage systems with up to 64 fully synchronized axes, executing all high level tasks, such as communication, real time ACSPL+ and PLC programs, diagnostics, I/O control and profile generation. The floating point processor at each node executes the real time control algorithms for up to four axes, always at a sampling and update rate of 20 kHz for each and every axis.

Fast settling, low jitter, fine velocity

The servo performance of an axis can be defined and measured by three main parameters: settling time, jitter (stand-still when motor is under servo) and constant velocity. With our advanced software tools including a four-channel soft-scope, these three parameters are easily monitored and analyzed.

Minimum settling time

Axis settling time has a direct impact on total machine throughput. With our 20 kHz high-rate servo control loops,

advanced control algorithms and professional analysis and adjustment tools, the settling time of an axis can be reduced to a minimum. Depending on specific application characteristics, a settling time of a few milliseconds is possible. By defining axis stabilization and duration windows, settling time can easily be monitored.

Minimal jitter

Standstill jitter is a critical factor in many high-end applications like wafer inspection or precision inspection systems. Using the 20 kHz servo rate, Sin-Cos encoder multiplier and advanced control algorithms, jitter can be reduced down to ± 1 feedback count. This low jitter can eliminate the need for mechanical brakes to hold the axis during standstill.

Fine constant velocity

Constant velocity is also a critical factor in scanning applications. With our advanced algorithms, including special torque ripple compensation (cogging), constant axis velocity can be significantly improved to less than 1 % of the specified velocity. Our products include a dedicated tool to accurately monitor the constant axis velocity.

Gantry control-accurate and flexible

For highly accurate gantry positioning tables, where two motors (each with its own feedback) are used to control an axis, ACS Motion Control has developed unique and powerful algorithms that provide an unprecedented levels of position accuracy, speed stability, and settling time.

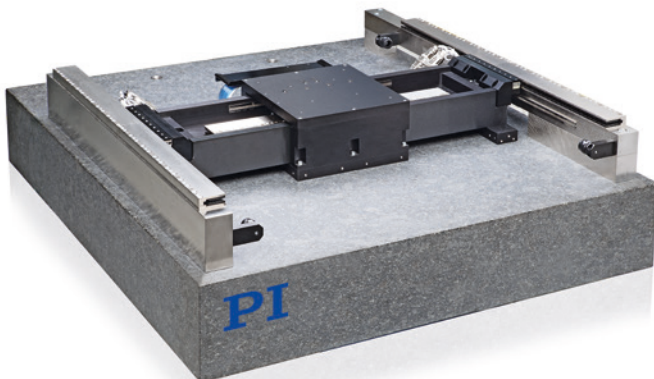

A-322 Pglide HS Air Bearing Stage with active error compensation

Gantry algorithm key features

- MIMO Control with decoupled loops
 - Loop controlling the longitudinal direction
 - Loop controlling the rotational (yaw) direction
- Automatic force/encoder scheduling as a function of the cross axis position
- Dynamic compensation for the yaw angles
- Suitable for both „stiff“ and „flexible“ gantries

Advantages

- Higher bandwidth
- Better stability
- Minimal crosstalk
- Easy tuning
- Reliable operation

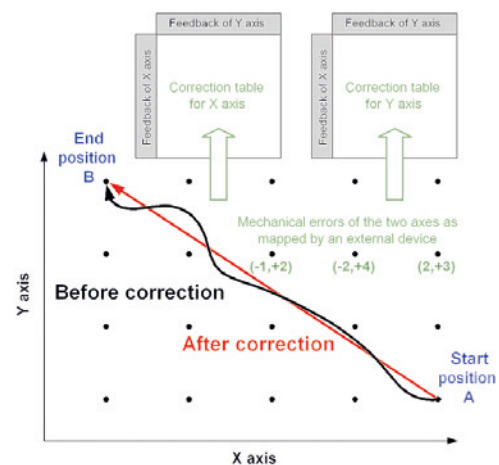

PIMag® Motion Controller

FOR LINEAR MOTORS WITH AVERAGE POWER CONSUMPTION



C-891

- Maximum average current consumption 3 A
- 20 kHz control bandwidth
- USB interface for sending commands and for configuration
- Digital inputs and outputs
- Optional analog input

Digital motion controller for PIMag® linear motors

1 motor channel, 1 sensor channel. For three-phase linear motors, maximum current consumption 3A (rms) per phase. Sine-commuted operation, field-oriented current control. Automatic detection of the motor phase. PID controller for position and velocity. 20 kHz servo update rate

Encoder inputs

Differential signal transmission for digital (A/B) or analog (sin/cos) encoder signals. BiSS interface support for absolute encoders. TTL signal inputs for limit and reference point switches

Extensive functionality

Data recorder: Recording of operating data such as motor

current, velocity, position or position error. Wave generator: Saves and outputs periodical motion profiles. ID chip support: Identifies the connected stages and simplifies configuration and exchangeability. Supports direction-sensing reference point switches. Extensive software support, for example for LabVIEW, dynamic libraries for Windows and Linux

Interfaces

USB 2.0, RS-232 commanding. Digital inputs and outputs for automation. Analog input for direct control of the motor current

Preliminary Data	C-891.120200	Unit
Function	PIMag® motion controller for 3-phase linear motors, sine-commuted, field-oriented current control	
Motor channels	1	
Sensor channels	1	
Motion and control		
Servo characteristics	PID controller for position and velocity, parameter change on-the-fly	
Servo frequency	20	kHz
Profile generator	Trapezoidal velocity profile, setting of maximum velocity and acceleration	
Encoder input	Analog signals (sin/cos) or digital signals (A/B differential TTL or BiSS interface)	
Reference point switch	TTL	
Electrical properties		
Max. output voltage	24	V
Max. output current	3	A _{rms}
Interfaces and operation		
Communication interfaces	USB, RS-232	
Motor connector	HD Sub-D 26-pin (w)	
Sensor connection	Sub-D 15-pin (m)	
I/O port	4 x digital input 4 x digital output Via HD Sub-D 15-pin (w) Optional analog input, -10 to 10 V	
Command set	PI General Command Set (GCS)	
User software	PIMikroMove	
Software drivers	LabVIEW driver, dynamic libraries for Windows and Linux	
Supported functions	Point-to-point motion, data recorder with 16,000 values and 8 recorder channels, movement, automatic motor phase detection, ID chip detection	
Safety features	Axis stop by hardware switch, overload protection of motor driver, overtemp protection of motor, overcurrent protection of the system	
Miscellaneous		
Operating voltage	24 V, external power supply included in scope of delivery	
Max. current consumption	4.5	A
Operating temperature range	5 to 40	°C
Max. mass	1.0	kg
Dimensions	190 x 83 x 110 (206 x 83 x 112 including rubber feet and supply voltage connector)	mm

Ask about custom designs!
Further information on www.pi.ws.

PIMag[®] Motion Controller

CONTROL OF FORCE, POSITION AND VELOCITY



C-413

- 1 or 2 motor channels
- Up to 4 sensor channels for 2 force and 2 position sensors each
- Depending on version, TCP/IP or USB interface for configuration and sending commands
- Depending on version, real-time SPI interface for sending commands
- Optional analog inputs and outputs
- Auto zero function for holding current
- ID chip support
- Extensive software support

Digital motion controller for PIMag[®] voice coil drives

C-413.1: 1 motor channel, 2 sensor channels, for the V-275 and V-275 linear actuators. C-413.2: 2 motor channels, 4 sensor channels. PID controller for force, position, velocity. Servo update rate selectable between 5 to 10 kHz

Force control

The force control allows operation of PIMag[®] drives and stages with a defined holding or feed force. The force and position sensors can be read simultaneously and the values processed. In addition to pure force control, subordinate position and velocity control is also an option. PI offers PIMag[®] actuators with a force sensor. The C-413.20A/.2GA models enable external force sensors to be read via analog inputs

Extensive functionality

Data recorder: recording of operating data such as motor

current, velocity, position or position error. Wave generator: Saves and outputs periodical motion profiles. Auto-zero function defines the holding current, at which the drive outputs a force of 0 N in open-loop operation, e.g., for compensating the weight force. ID chip support: Identifies the connected stages and simplifies configuration and exchangeability. Supports direction-sensing reference point switches. Extensive software support, for example for LabVIEW, dynamic libraries for Windows and Linux

Interfaces

Depending on the version, commanding via TCP/IP, USB 2.0, SPI. Digital inputs and outputs for automation. Optional analog inputs and outputs, e.g. for sensors, for sending commands or for position feedback

Preliminary Data	C-413.1G	C-413.20/C-413.20A C-413.2G/C-413.2GA	Unit
Function	PIMag® Motion controller for voice coil drives, 1 channel, cased device	PIMag® Motion controller for voice coil drives, 2 channelsC-413.20/.20A: OEM boardC-413.2G/.2GA: cased device	
Motor channels	1	2	
Sensor channels	2	4	
Motion and control			
Servo characteristics	PID controller for force, position and velocity; parameter change on-the-fly	PID controller for force, position and velocity; parameter change on-the-fly	
Servo cycle time	100 µs to 200 µs, selectable in 4 steps	100 µs to 200 µs, selectable in 4 steps	
Profile generator	Trapezoidal velocity profile, setting of maximum velocity and acceleration	Trapezoidal velocity profile, setting of maximum velocity and acceleration	
Encoder input	SPI sensor interface	SPI sensor interface	
Reference point switches	4 × TTL, direction-sensing	4 × TTL, direction-sensing	
Electrical properties			
Max. output voltage	24	24	V
Max. output current	±1.5	±1.5	A, regulated
Interface and operation			
Communication interfaces	TCP/IP	USB 2.0, real time SPI	
Motor / sensor connection	Sub-D 9-pin (f) for motor, Sub-D 25-pin (f) for sensor	Sub-D 15-pin (f), combined for motor and sensor	
I/O port	2 × analog outputs, -10 to 10 V, 17 bit, 1 kHz 4 × digital input, 24 V 6 × digital output, 24 V	2 × analog inputs, -10 to 10 V, 16 bit, 1 kHz (only C-413.20A and C-413.2GA) 2 × analog outputs, -10 to 10 V, 17 bit, 1 kHz (only C-413.20A and C-413.2GA) 6 × digital outputs (open collector, voltage range 5 V to 24 V, 33 kΩ internal pull-up to 5 V) 4 × digital input (5 V TTL level, to 24 V max. input voltage, 10 kΩ input resistance)	
Command set	PI General Command Set (GCS)	PI General Command Set (GCS)	
User software	PIMikroMove	PIMikroMove	
Software drivers	LabVIEW driver, dynamic libraries for Windows and Linux	LabVIEW driver, dynamic libraries for Windows and Linux	
Supported functions	Point-to-point motion, data recorder, wave generator, auto zero, ID chip detection	Point-to-point motion, data recorder, wave generator, auto zero, ID chip detection	
Miscellaneous			
Operating voltage	External power supply 24 V, included in scope of delivery	External power supply 24 V, included in scope of delivery	
Max. operating current	2	2	A
Operating temperature range	5 to 50	5 to 50	°C
Max. mass	0.3	0.3	kg
Dimensions	210 × 28 × 105	189 × 28 × 105 (C-413.2G/.2GA) 160 × 18 × 100 (C-413.20/.20A)	mm

Further information on www.pi.ws.

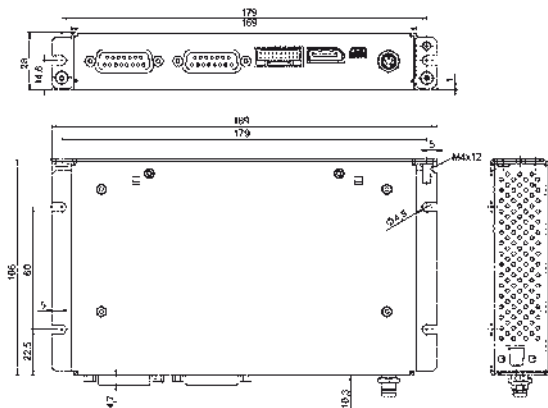

C-413 with case, dimensions in mm

Motorized Positioning Systems with Rotating Electric Motors and Drive Screw

Large selection of positioning stages for different levels of accuracy and different loads or sizes

- Variable travel ranges to 1 m
- Large number of motorization variants: Stepper motors, DC servo motors, brushless DC motors (BLDC)
- Optional efficient ActiveDrive drive concept for high performance

High-precision components

- Excellent long-term stability thanks to high-stiffness bases
- Preloaded precision leadscrews or zero-backlash ball screws for high velocity and number of cycles
- Optionally direct position measurement with linear encoder

PRECISION STAGES

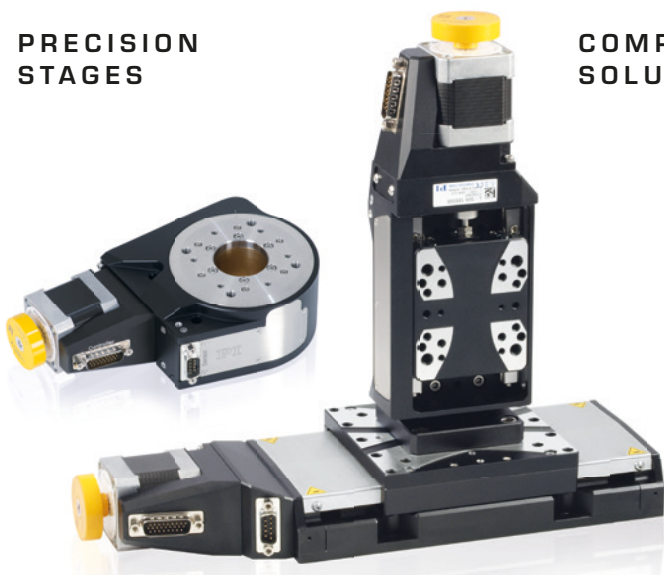

COMPACT SOLUTIONS

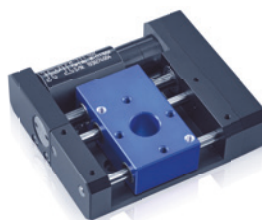

Variety of versions

- Customized designs and modifications
- Vacuum versions to 10^{-9} hPa
- Multi-axis combinations and parallel-kinematic Hexapods

Motion controllers

- Single- and multi-axis controllers for DC and stepper motors
- PI MotionMaster multi-axis controller system for all drive types
- User-friendly PIMikroMove user software
- Data recorder as well as extensive software support for example, for LabVIEW, dynamic libraries for Windows or Linux, macro programming
- Digital interfaces such as RS-232, USB or Ethernet (depending on model)

MULTI-AXIS SOLUTIONS AND APPLICATION-SPECIFIC DESIGNS

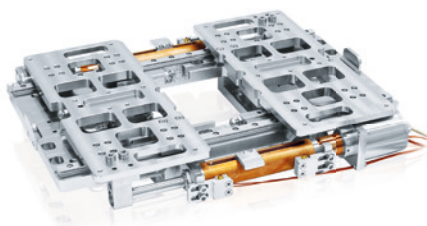

Technology

THE BROADEST AND DEEPEST PORTFOLIO

The technological scope of the PI Group is unique worldwide. PI develops, manufactures and qualifies all its core technologies itself. Thus PI is independent of components available on the market and offers individual solutions that go beyond the state of the art. Through its high measure of flexibility, PI plays a pioneering role in precision positioning and enables PI customers to benefit from distinct competitive advantages.

Core technologies

- Piezo components, actuators and motors
- Magnetic drives
- Air bearing technology

- Guiding systems
- Nanometrology sensors
- Electronic amplifiers
- Digital controllers
- Software

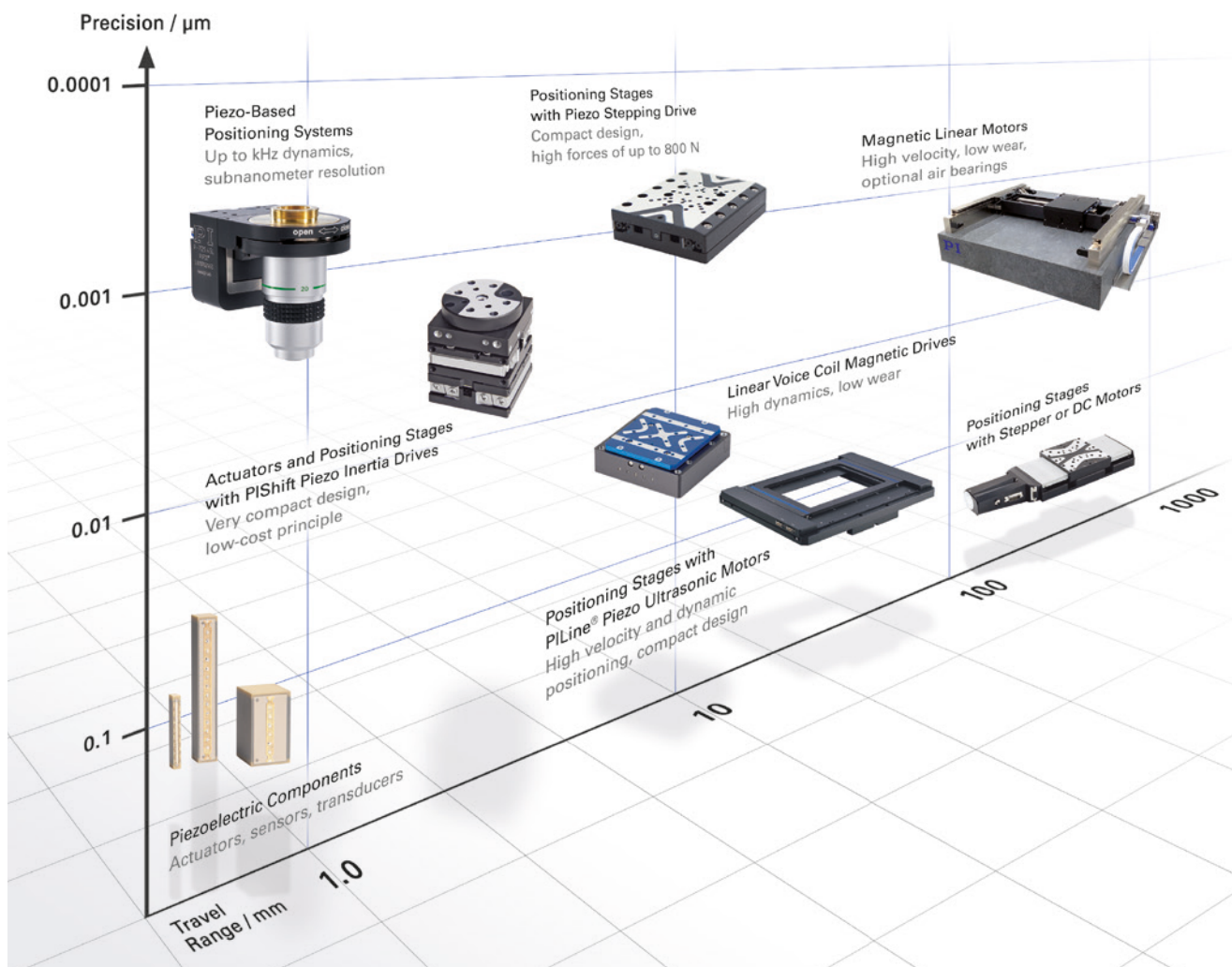

Philosophy

GROWTH AND ADVANCES IN TECHNOLOGY

The aim of the PI Group is to expand its pioneering role on the world market through advanced positioning solutions. The broad spectrum of technology and the high vertical range of manufacturing available at PI are the basis for further growth and expansion. Novel drive concepts, products and system solutions have led to a continuous growth in market shares and a healthy company development in the past years.

PI compact

- Four production sites in Germany, six in total worldwide
- More than 860 employees worldwide
- 15 subsidiaries in key markets
- Privately run company
- Over 40 years of experience in piezo technology

Production Management

MANUFACTURING PRECISION EFFICIENTLY





Headquarters

GERMANY

Physik Instrumente (PI) GmbH & Co. KG

Auf der Roemerstrasse 1
76228 Karlsruhe
Phone +49 721 4846-0
Fax +49 721 4846-1019
info@pi.ws
www.pi.ws

PI miCos GmbH

Freiburger Strasse 30
Eschbach
Phone +49 7634 5057-0
Fax +49 7634 5057-99
info@pimicos.com
www.pi.ws

PI Ceramic GmbH

Lindenstrasse
Lederhose
Phone +49 36604 882-0
Fax +49 36604 882-4109
info@piceramic.com
www.piceramic.com



© Physik Instrumente (PI) GmbH & Co. KG

All contents, including texts, graphics, data etc., as well as their layout, are subject to copyright and other protective laws. Any copying, modification or redistribution in whole or in parts is subject to a written permission of PI.

Although the information in this document has been compiled with the greatest care, errors cannot be ruled out completely. Therefore, we cannot guarantee for the information being complete, correct and up to date. Illustrations may differ from the original and are not binding. PI reserves the right to supplement or change the information provided without prior notice.

Subsidiaries

USA (East) & CANADA

PI (Physik Instrumente) L.P.
Auburn, MA 01501
www.pi-usa.us

USA (San Francisco Bay Area Office)

PI (Physik Instrumente) L.P.
Sausalito, CA 94965
www.pi-usa.us

ITALY

Physik Instrumente (PI) S. r. l.
Bresso
www.pionline.it

FRANCE FRANCE

PI France SAS
Aix-en-Provence
www.pi.ws

JAPAN

PI Japan Co., Ltd.
Tokyo
www.pi-japan.jp

CHINA

Physik Instrumente
(PI Shanghai) Co., Ltd.
Shanghai
www.pi-china.cn

SOUTHEAST ASIA

PI (Physik Instrumente)
Singapore LLP
Singapore
www.pi-singapore.sg
For ID / MY / PH / SG / TH / VNM

KOREA

PI Korea Ltd.
Seoul
www.pikorea.co.kr

USA (West) & MEXIKO

PI (Physik Instrumente) L.P.
Irvine, CA 92620
www.pi-usa.us

UK & IRELAND

PI (Physik Instrumente) Ltd.
Cranfield, Bedford
www.physikinstrumente.co.uk

NETHERLANDS

PI Benelux B.V.
Sint-Oedenrode
www.pi.ws

SPAIN

Micos Iberia S.L.
Vilanova i la Geltrú
www.pimicos.es

PI Japan Co., Ltd.
Osaka
www.pi-japan.jp

Physik Instrumente
(PI Shanghai) Co., Ltd.
Peking
www.pi-china.cn

TAIWAN

Physik Instrumente (PI)
Taiwan Ltd.
Taipeh
www.pi-taiwan.com.tw