

# DTXPRO-10U DIGITAL TRANSMITTER

DIGITAL MODULATOR, TRANSMITTER, AND REMOTE CONTROL



## OPERATING AND SERVICE MANUAL

**DRAFT**

JUNE 14, 2011



**PINEAPPLE TECHNOLOGY, INC.**

4231 Pacific Street, Suite 27, Rocklin, CA 95677

[www.ptibroadcast.com](http://www.ptibroadcast.com)



## TABLE OF CONTENTS

<b>SECTION I – SAFETY NOTICES</b> .....	4
<b>SECTION II – DTXPRO-10U INTRODUCTION</b> .....	4
<b>SECTION III –DTXPRO-10U TECHNICAL SPECIFICATIONS</b> .....	6
<b>SECTION IV DTXPRO-10U BLOCK DIAGRAM</b>	
A. BLOCK DIAGRAM.....	10
B. BILL OF MATERIALS.....	11
<b>SECTION V – DXDPRO-10U MANUAL</b>	
<b>V.1 – DXDPRO-10U INTRODUCTION</b> .....	12
<b>V.2 – DXDPRO-10U TECHNICAL SPECIFICATIONS</b> .....	14
<b>V.3 – DXDPRO-10U APPLICATIONS AND INSTALATION</b>	
A. APPLICATIONS.....	18
B. TRANSMITTER INSTALATION.....	18
C. DIGITAL UPGRADE NOTES.....	19
D. 8 VDC OPERATIONS.....	19
E. GPS RECEIVER ACTIVATION.....	19
<b>V.4 DXDPRO-10U FRONT PANEL CONTROL AND MONITORING</b>	
A. OVERVIEW.....	22
B. TRANSMITTER PERFORMANCE MONITORING .....	22
C. ALARM SIGNALS.....	22
D. POWER LEVEL ADJUSTMENT AND ALC.....	22



## TABLE OF CONTENTS

### V.5 – DXDPRO-10U ETHERNET WEB PAGE CONTROL AND MONITORING

A. LOCAL PC INTERNAL MODEM SETTINGS FOR FIXED IP.....	24
B. ETHERNET WEB PAGE SETUP.....	28
C. IP ADDRESS CONFIGURATION.....	28
D. WEB SERVICE OPERATION.....	30

### V.6 – DXDPRO-10U ADAPTIVE PRE-CORRECTOR WEB SERVICE OPERATION

A. INTRODUCTION.....	43
B. ELECTRICAL INTERFACE.....	43
C. OPERATION OF ADAPTIVE PRE-CORRECTOR.....	46
D. ECHO CANCELLING AND ADAPTIVE PRE-CORRECTION.....	56
E. APPENDIX-A – CLIPPER OPERATION.....	57

V.7 - DXDPRO-10U BLOCK DIAGRAM.....	61
-------------------------------------	----

SECTION VI DTXPRO-10U INSTALLATION PROCEDURE.....	63
---	----

SECTION VII – DTXPRO-10U SERVICE REQUIREMENTS.....	69
--	----

SECTION VIII – DTXPRO-10U WARRANY.....	68
--	----

# SECTION I

## SAFETY NOTICES



## I ---SAFETY NOTICES

### **\*\* READ THIS SECTION BEFORE INSTALLATION \*\***

SEVERE ELECTRICAL SHOCK OR BURNS MAY OCCUR IF THIS EQUIPMENT IS USED IMPROPERLY.

---

NEVER WORK ON THIS EQUIPMENT ALONE. ALWAYS HAVE ANOTHER PERSON PRESENT WHILE WORKING ON ELECTRICAL CIRCUITS OR MOVING EQUIPMENT. COMMUNICATIONS TO EMERGENCY SERVICES SHOULD BE AVAILABLE AT ALL TIMES.

---

BEFORE CONNECTING THIS EQUIPMENT TO ANY AC ELECTRICAL SOURCE READ THE SECTION ON INSTALLATION. ALL ELECTRICAL WIRING FOR THIS EQUIPMENT MUST BE PERFORMED BY QUALIFIED ELECTRICIANS. ALL WIRING MUST BE COMPLIANT WITH LOCAL ELECTRICAL CODES.

---

POWER AMPLIFIERS AND SUPPLIES ARE HEAVY. TO INSTALL THIS EQUIPMENT IN RACKS USE TWO (2) PERSONS TO AVOID POSSIBLE INJURIES.

---

NEVER OPEN THE CABINET ENCLOSURE OR UNPLUG CABLES OR WIRES WHILE THIS EQUIPMENT IS OPERATING.

---

***ALL SERVICE WORK MUST BE PERFORMED BY QUALIFIED TECHNICIANS ONLY. IF ONE IS NOT AVAILABLE LOCALLY, CONTACT PINEAPPLE TECHNOLOGY, INC. FOR A LIST IN YOUR AREA.***

# **SECTION II**

## **DTXPRO-10U INTRODUCTION**



## I. DTXPRO-10U INTRODUCTION

The DTXPRO-10U transmitter is an integrated transmission system. Included in a 19 inch 13 RU rack is a modulator, power amplifier, mask filter, and standard accessories. The DTXPRO-10U is tested to FCC specifications. The modulator used in this assembly is the DXDPRO-10U. The DXDPRO-10U is a wide-band UHF modulator with adaptive linear and non-linear correction controllable via an Ethernet IP connection. Many additional features are included in this basic modulator such as transmitter remote control and status monitoring, GPS receiver, ASI or SMPTE 310M, and fault notification via email.

The DXDPRO-10U is an all-channel modulator with adaptive linear and nonlinear correction controllable via an Ethernet IP connection. The DR100PRO-U provides power amplification to achieve the desired power output level to comply with FCC license requirements. LDMOS 50 volt device technology is used throughout the HPA section for state-of-the-art performance. This unit is wired to operate off 48V DC or 110V AC. The 48V DC is automatically switched on in case the AC mains fail. This feature is activated only if a 48 VDC auxiliary power source is available.

An FCC compliant stringent mask filter is supplied and is built into the rack. Additional components are included to sample forward and reflected power as well as samples for the adaptive linear and non-linear corrector. The system transmitter is protected using an isolator between the mask filter and the HPA. Any failures in the filters or antenna will be detected by the onboard protection circuits. This transmitter includes a low pass filter for additional harmonic suppression in the GPS bands.

Pineapple Technology, Inc. warrants the DTXPRO-10U for two (2) years from ship date. An extended warranty is available for an additional five (5) years. Contact PTI sales for details.

# **SECTION III**

# **TECHNICAL SPECIFICATIONS**





### III. TECHNICAL SPECIFICATIONS

#### ELECTRICAL SPECIFICATIONS

PRIMARY POWER.....	(AC) 110/220 50/60 Cycles Universal Power (DC) 48 VDC Nominal 44-52 VDC Operating Range
ELECTRICAL STANDARDS.....	8VSB ATSC Transmission ATSC: A/53, A54, A64, SMPTE-310M DVB-ASI: EN50083-9, ETSI TR 101 819 MPEG-TS ISO/IEC 13818-1
SIGNAL PERFORMANCE.....	IMD Shoulders and MER/SNR Upper Typical -55db (FCC STDR) Lower Typical -55dB (FCC STDR) MER/SNR Typical -37Db
CREST FACTOR LIMITING .....	2-12.5db Adjustable
OPERATING FREQUENCY.....	*470-810 MHz
OUTPUT POWER LEVEL.....	10 Watts Average Digital Power into 50ohm Load
INPUT TRANSPORT STREAM.....	ASI OR SMPTE-310M
WEB PAGE VIA ETHERNET.....	Remote Controled Features Are Included
(REMOTE OR LOCAL).....	Linear And Non-Linear Adaptive Correction Transport Stream Selection Output Level Adjustment Mute/Un-Mute Control Three (3) Level Password Protection Up To 12 Alarm Signals Up To 12 Analog Monitoring Ports ALC And Power Set Features.
PROTECTION CIRCUITS.....	High Reflected Power Over Temperature Protection

*\*Frequency range limited by external equipment i.e. filters and isolators. This can be modified and/or adjusted if it becomes necessary to change channels*

**THE INFORMATION PROVIDED HEREIN IS PINEAPPLE TECHNOLOGY INCORPORATED PROPRIETARY INFORMATION AND CANNOT BE COPIED OR DISTRIBUTED WITHOUT PRIOR AUTHORIZATION**



III. TECHNICAL SPECIFICATIONS (Continued)

**ELECTRICAL SPECIFICATIONS** (Continued)

REMOTE MONITORING..... Output Power Level  
 Reflected Power Level  
 DC Supply Voltage  
 DC Current  
 AC Main Voltage  
 Heat Sink Temperature  
 Ambient Temperature

ALARMS..... Over Temp  
 Low Supply Voltage  
 High Reflected Power  
 Low Output Power  
 Intruder  
 AC Main Power  
 PA1 Current Low  
 PA2 Current Low  
 PA3 Current Low  
 PA4 Current Low  
 PA5 Current Low

REMOTE MONITORING..... Output Power Level  
 Reflected Power Level  
 DC Supply Voltage  
 DC Current  
 AC Main Voltage  
 Heat Sink Temperature  
 Ambient Temperature

**MECHANICAL SPECIFICATIONS**

Size..... Height 25 inches (635 mm)  
 Width 21 inches (534mm)  
 Depth 24.5 inches (623mm)  
 Weight <85 lbs. (36.3Kg)

Construction..... Steel Construction With Black PC Finish

# **SECTION IV**

# **DTXPRO-10U BLOCK DIAGRAM AND BILL OF MATERIALS**



**IV. DTXPRO-10U BLOCK DIAGRAM**

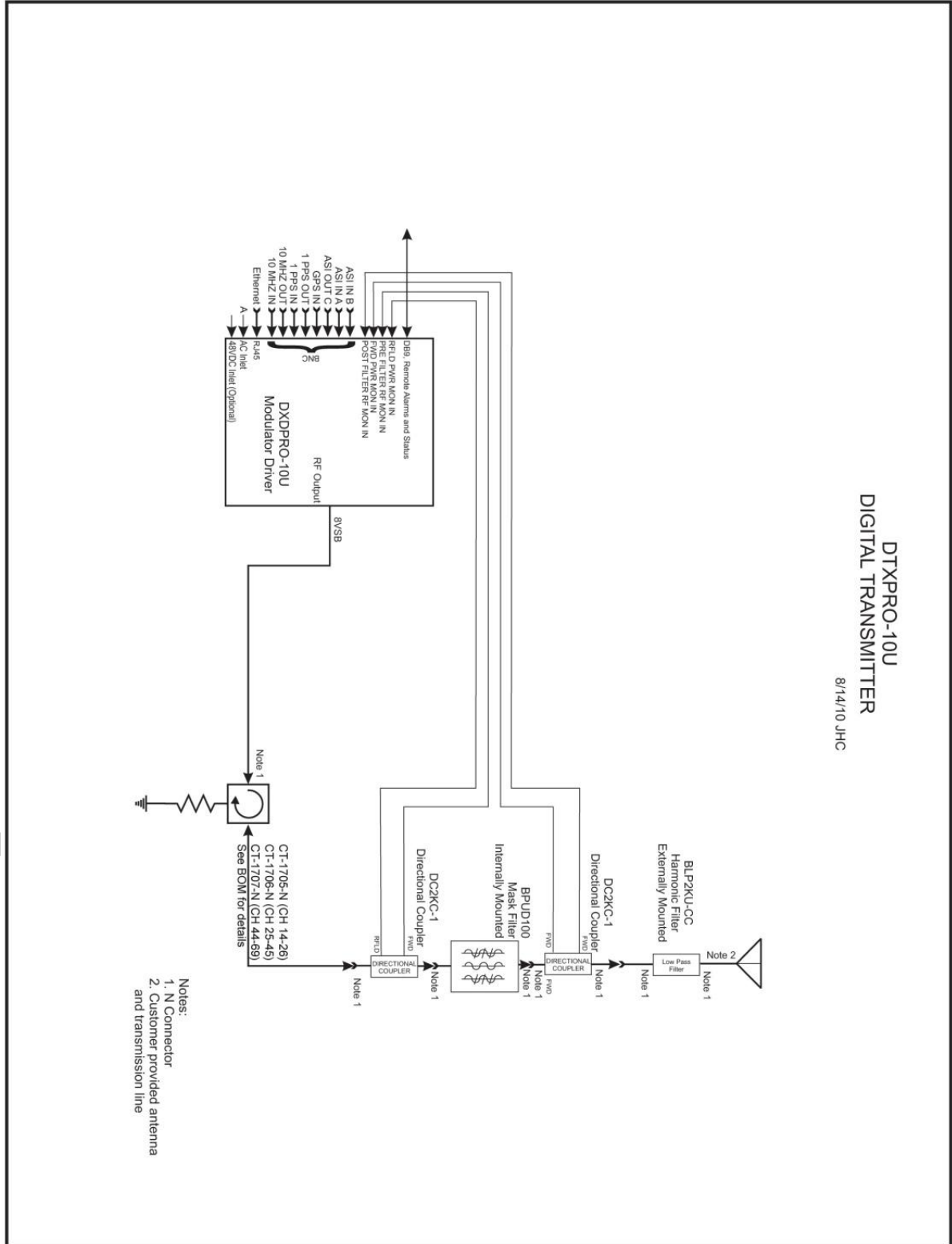



#### IV. DTXPRO-10U BILL OF MATERIALS

DXDPRO-10U - MODULATOR, DIGITAL, UHF, ADAPTIVE, 10W RMS.....	1	ea
DC2KC-1 - DC, 2KW RMS, UHF, N M/F.....	2	ea
BPUD100 - FILTER, UHF, 100W RMS, TYPE N FEMALE.....	1	ea
BLP2KU-CC – HARMONIC FILTER .....	1	ea
The following part is dependent upon the channel selected:.....	1	ea
CT-1705-N ISO 100 W N CONN UHF 470-548 MHz (Channels 14-26)		
CT-1706-N ISO 100W N CONN UHF 542-656 MHz (Channels 25-45)		
CT-1707-N ISO 100W TYPE N 650-806 MHz (Channels 44-69)		

DRAFT

# **SECTION V**

# **DXDPRO-10U MODULATOR MANUAL**



## V.1. DXDPRO-10U INTRODUCTION

Pineapple Technology Inc. (PTI) is proud to introduce the DXDPRO and DTXPRO line of modulators and transmitters. This is the most advanced line of transmission products available on the market for low power television (LPTV), mobile/hand held (M/H), translators, and media flow.

The product introduced by Pineapple Technology Inc. covers the following key areas of advanced telecommunications technology:

1. Adaptive modulator technology
2. Multimode modulation options on a common platform
3. High power amplifiers (HPA) utilizing state-of-the-art 48 volt LDMOS devices

These products are designed to be modular and field serviceable. In most cases it is possible to diagnose problems via an Ethernet connection. This minimizes service time and reduces down time. PTI's field support plan calls for stocking complete and tested modulator assemblies for quick delivery to the site. PTI maintains a 24/7 hot line for field support with access to engineering and technician support as needed.

# **SECTION V.2**

# **DXDPRO-10U TECHNICAL SPECIFICATIONS**





## V.2 DXDPRO-10U TECHNICAL SPECIFICATIONS

### ELECTRICAL SPECIFICATIONS

PRIMARY POWER.....	(AC) 110/220 50/60 Cycles Universal Power (DC) 48 VDC Nominal 44-52 VDC Operating Range
ELECTRICAL STANDARDS.....	8vsb ATSC Transmission ATSC: A/53, A54, A64, SMPTE-310M DVB-ASI: EN50083-9, ETSI TR 101 819 MPEG-TS ISO/IEC 13818-1
SIGNAL PERFORMANCE.....	MD Shoulders and MER/SNR Upper Typical -55db (FCC STDR) Lower Typical -55dB (FCC STDR) MER/SNR TYPICAL -37Db
CREST FACTOR LIMITING .....	2-12.5db Adjustable
OPERATING FREQUENCY.....	30 – 1000 MHz Any Channel
OUTPUT POWER LEVEL.....	0 dBm into 50ohm Load
INPUT TRANSPORT STREAM.....	ASI OR SMPTE-310M
WEB PAGE VIA ETHERNET.....	Remote Controlled Features Are Included
(REMOTE OR LOCAL).....	Linear And Non-Linear Adaptive Correction Transport Stream Selection Output Level Adjustment Mute/Un-Mute Control Three (3) Level Password Protection Up To 12 Alarm Signals Up To 12 Analog Monitoring Ports ALC And Power Set Features.
PROTECTION CIRCUITS.....	High Reflected Power Over Temperature Protection



**V.2. DXDPRO-10U TECHNICAL SPECIFICATIONS (Continued)**

**ELECTRICAL SPECIFICATIONS** (Continued)

REMOTE MONITORING..... Output Power Level  
 Reflected Power Level  
 DC Supply Voltage  
 DC Current  
 AC Main Voltage  
 Heat Sink Temperature  
 Ambient Temperature

ALARMS..... Over Temp  
 Low Supply Voltage  
 High Reflected Power  
 Low Output Power  
 Intruder  
 AC Main Power  
 PA1 Current Low  
 PA2 Current Low  
 PA3 Current Low  
 PA4 Current Low  
 PA5 Current Low

REMOTE MONITORING..... Output Power Level  
 Reflected Power Level  
 DC Supply Voltage  
 DC Current  
 AC Main Voltage  
 Heat Sink Temperature  
 Ambient Temperature

**MECHANICAL SPECIFICATIONS**

Size..... Height 1.65 in (41.91) mm  
 Width 17.25 in (438.1) mm  
 Depth 17 in (431.8) mm  
 Weight <8 lbs. (3.63) kg

Construction..... All With Gold Alodine Finish

# **SECTION V.3**

# **DXDPRO-10U APPLICATIONS AND INSTALATION**



## V.3 DXDPRO-10U APPLICATIONS AND INSTALLATION

### A. APPLICATIONS

The DXDPRO Modulator line was developed to process ASI or SMPTE-310M transport streams and convert them into an ATSC Compliant signal for Television Broadcast transmission. Additional broadcast formats are available i.e. H/M, xxx, and others.

Models available in this family of products include:

- a. **DXDPRO-MB** - This is the “BASE MODEL”. This modulator can be used on all channels for UHF, VHF High Band, or VHF Low Band TV Channels between 45 and 900 MHz.
- b. **DXDPRO-MBR** - Built in receiver for Translator/Transposers with 0 dBm output on any channel between 45 and 900 MHz.
- c. **DXDPRO-10U** - Transmitter modulator for UHF TV with 10 W average digital power output. Excellent for high power transmitter.
- d. **DXDPRO-10UR** - Built in receiver for Translator/Transposer with 10 W average digital power output on UHF TV Channels.
- e. **DXDPRO-10VH** - Transmitter modulator for VHF High Band TV Transmitter with 10 W average digital power output. Excellent for high power transmitters.
- f. **DXDPRO-10VHR** - Built in receiver for Translator/Transposers with 10 W average digital power output on all VHF High Band TV Channels.

### B. TRANSMITTER INSTALLATION



The modulator is enclosed in a convenient one (1) RU 19 inch package. This allows installation into most standard rack. Do not use the front panel to hold up the modulator in the rack. **RACK SUPPORT RAILS MUST BE USED.** All cable connections are located on the rear of the chassis. Several cable types are used to make necessary connections. Please review the following list;

1. SMA 50 ohm connectors with RG 223 cable should be used for linear and non-linear connections between the modulator and the directional couplers located before and after the mask filter. A similar set of cables should be used to connect the forward and reflected power sample for the Modulators power meter.
2. Type N 50 ohm connector with RG 223 or RG 8 cable can be used for the RF Output
3. DB15 cable for alarm input
4. DB9 cable for analog and control functions
5. AC Inlet (filtered) type
6. Molex 3 p connector of 48 VDC Auxiliary input
7. RJ-45 Ethernet connection
8. GPS 1pps or 10 MHz BNC 75 ohm connections
9. ASI OR SMPTE-310M BNC 75 ohm connections

**THE INFORMATION PROVIDED HEREIN IS PINEAPPLE TECHNOLOGY INCORPORATED PROPRIETARY INFORMATION AND CANNOT BE COPIED OR DISTRIBUTED WITHOUT PRIOR AUTHORIZATION**



## V.3 DXDPRO-10U APPLICATIONS AND INSTALLATION

### C. DIGITAL UPGRADE NOTES

The DXDPRO-10U is suitable for upgrading analog transmitters to digital service. Special attention must be given to every detail of the conversion to insure that the desired objective is met and that it is compliant with FCC requirements. The equipment used to make a conversion is expensive and can be costly. The following needs to be considered when making a conversion to digital from analog;

1. Replace the modulator with a good quality digital modulator with adaptive linear and non-linear correction
2. Check the drive level required to achieve the desired output power level from the transmitter. A driver may be required after the modulator
3. The output band pass filter will have to be replaced with a MASK FILTER. Consider using a Mask Filter that is rated at 1.25 times the desired output power level.
4. Digital transmitters and mask filters need to be correctable by the modulator. This will require the addition of dual directional couplers before and after the mask filter to provide correction signals.
5. IMPORTANT: Modification of FCC approved equipment requires special test and test equipment. A qualified Broadcast engineer should be employed to do this work.

### D. 48 VDC OPERATIONS

The DXDPRO-10U Modulator is designed to be used with an external 48 VDC supply similar to those found at TELECOM SITES. If the Modulator is used with standard AC supplied power sources the DC backup can be automatically switched with internal circuits. The battery charge level can be monitored on the front panel or on the web page. The operating range is from 42 to 52 VDC.

### E. GPS RECEIVER ACTIVATION



GPS Receiver  
Input  
Connection



## V.3 DXDPRO-10U APPLICATIONS AND INSTALLATION

### E. GPS RECEIVER ACTIVATION (Continued)

The GPS receiver can be activated by using the Web Page by following these steps:

1. Connect an antenna.
2. Open the web page main menu and select the GPS Icon and pull it down to the lower level of the web page. A new section on GPS appears.

GPS	Reference	Output Signal
GPS Alarms: Ok	Reference Alarms: Passive	Mute reasons
SNR of Visible Sats: 51.5	-Int. 10MHz Loss: Ok	Active alarms
Visible Satellites: 10	-Ext. 10MHz Loss: Passive	Passive alarms
Tracked Satellites: 10	-Ext. 10MHz Ref Holdover: Ok	TS Primary Sync Loss
Status: LOCKED	-Ext. 1PPS Loss: Passive	TS Secondary Sync Loss
Unit State: Normal	-Ext. 1PPS Ref Holdover: Ok	Alarm Input 3
Active Antenna: <input checked="" type="checkbox"/>	GPS Alarms: Ok	Ext. 1PPS Loss
Antenna Voltage: 5V	-Unlocked: Ok	Ext. 10MHz Loss
Time: 02/09/2010 16:59:4	-Holdover: Ok	
Longitude: 121 12 55 W	Reference Source: Auto	
Latitude: 38 48 19 N	Actual source: GPS	
Altitude: 99.9 m	Source @ 10MHz: 50 Ohm, High	
Cable Delay: 0 ns	10 MHz Impedance: 50 Ohm, High	
GPS Holdover Time: 3600 sec	10 MHz Holdover Time: 3600 sec, Forever	
	Source @ 1 PPS: [ ]	

GPS Setup Window

3. Select the antenna voltage for the receiving antenna. Options are 5 vdc, 3.2 vdc, or none.
4. Check the "ATIVATE ANTENNA"
5. Go to the reference window and select "AUTO" AS REFERENCE SOURCE.



The modulator is now locked to GPS source and will remain there until changed. If for some reason the GPS signal is lost, the internal clock is automatically selected and the system continues to operate without interruption.

DRAFT

# **SECTION V.4**

# **DXDPRO-10U FRONT PANEL CONTROL AND MONITORING**





## V.4 DXDPRO-10U FRONT PANEL CONTROL AND MONITORING

### A. OVERVIEW

The front panel of the DXDPRO-10U modulator has three important functions for transmitter monitoring and control. Standard on all modulator is an LCD display, display selector switch, ALC and Power Level adjustments, and alarm display. These areas are show below:

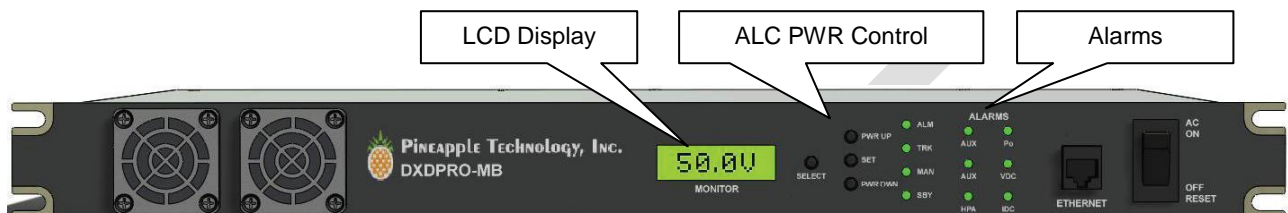

### B. TRANSMITTER PERFORMANCE MONITORING

The LCD display will display most all key analog inputs to the modulator as shown below;

1. Transmitter output power in percent (%). 100% being the license TPO.
2. Antenna reflected power in percent (%). Calibrated to 20% maximum before fault.
3. DC 48 VOLTAGE internal or external supply.
4. DC current draw internal and/or external transmitter.
5. Heat sink temperature in degrees Celsius.
6. Internal temperature
7. External temperature

### C. ALARM SIGNALS

Key alarms are set according to the addendum attached to this manual and/or listed under the LED on the front panel.

### D. POWER LEVEL ADJUSTMENT AND ALC

The selections are made using the LCD display selector switch shown above. The display changes each time the switch is enabled.

The ALC/Power Level control panel has three control switches. The switches shown are:

1. Power UP
2. SET
3. Power DWN

The LED to the right of the switches indicates the ALC operating status.

# **SECTION V.5**

## **DXDPRO-10U ETHERNET WEB PAGE CONTROL AND MONITORING**



## V.5 DXDPRO-10U ETHERNET WEB PAGE CONTROL AND MONITORING

### A. LOCAL PC INTERNAL MODEM SETTINGS FOR A FIXED IP

To view the ProTelevision web page used to control operation of the modulator you must set your PC internal modem for a fixed IP. The following instructions will explain this process.

1. For **Windows 7** click “**Start**” then “**Control Panel**”.
  - a. When the Control Panel window opens click “**Network and Internet**”.
  - b. When the Network and Internet windows opens click “**Network and Sharing Center**” (Fig 1)

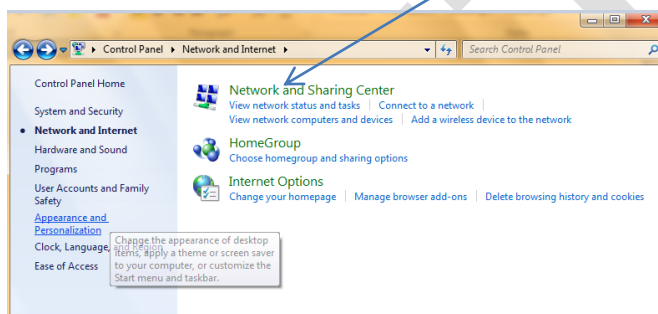

Fig 1

- c. When the Network and Sharing Center opens click on “**Change adapter settings**” (Fig 2)

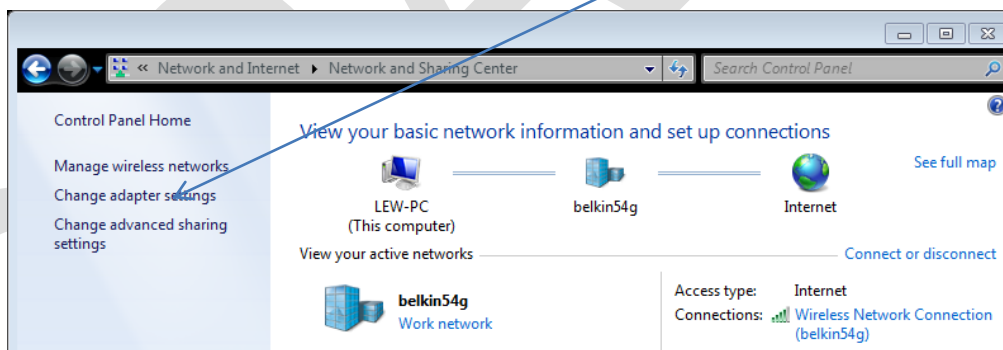

Fig 2

- d. When the Change adapter settings opens click on “**Local Area Connection**” and click on “**Properties**” from the pop up menu. (Fig 3)

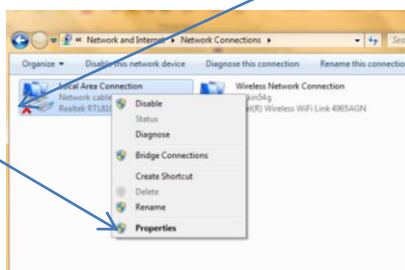

Fig 3



## V.5 DXDPRO-10U ETHERNET WEB PAGE CONTROL AND MONITORING

### A. LOCAL PC INTERNAL MODEM SETTINGS FOR A FIXED IP

- e. When the properties window opens click on “**Internet Protocol Version 4 (TCP/IPv4)**” to bring it in focus then click the “**Properties**” button. (Fig 4)

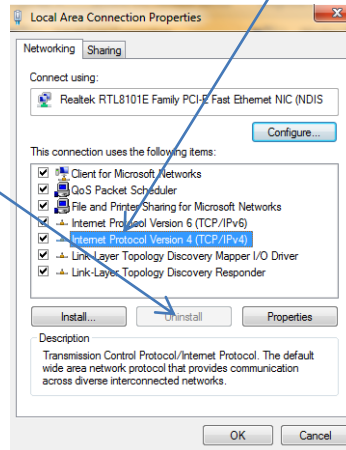

Fig 4

- f. When the Properties window opens click the “**Use the following IP address**” and fill in the “**IP address**”, “**Subnet mask**” and “**Default gateway**” as shown and click “**OK**”. Fig 5

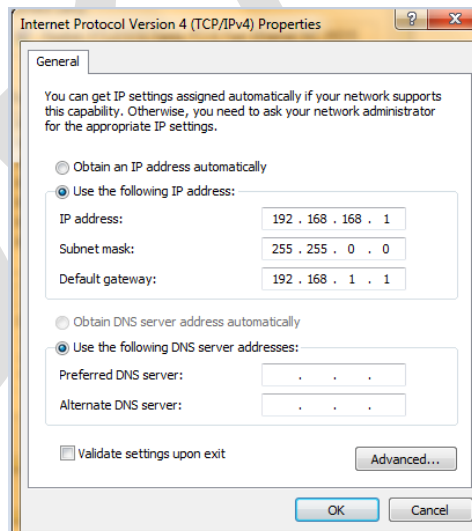

Fig 5

- g. Click “**OK**” to close the Local Area Connection Properties window. Close any remaining windows that are open.



## V.5 DXDPRO-10U ETHERNET WEB PAGE CONTROL AND MONITORING

### A. LOCAL PC INTERNAL MODEM SETTINGS FOR A FIXED IP

2. For **Windows Vista** click “Start” then “**Control Panel**”.

- When the Control Panel window opens click “**Network and Internet**”.
- When the Network and Internet windows opens click “**Network and Sharing Center**” (Fig 6)

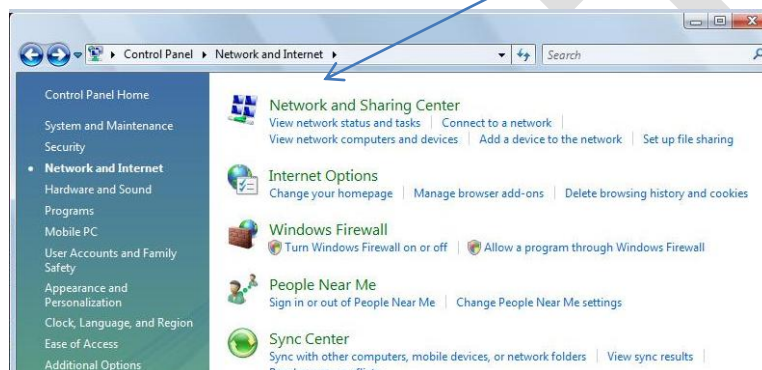

Fig 6

c. When the window opens click on “**Manage Network Connections**” (Fig 7)

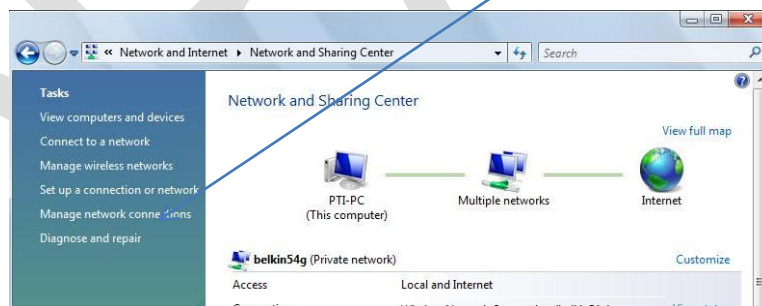

Fig 7

d. Follow steps “e” through “g” above.

3. For **Windows XP** click “**Start**” then “**Control Panel**”.

- When the Control Panel window opens, click “**Network Connections**”.



## V.5 DXDPRO-10U ETHERNET WEB PAGE CONTROL AND MONITORING

### A. LOCAL PC INTERNAL MODEM SETTINGS FOR A FIXED IP

- b. When the window opens right click "**Local Area Connection**" and select "**Properties**" from the pop-up menu. (Fig 8)



Fig 8

- c. When the Properties window opens click "**Internet Protocol (TCP/IP)**" to bring it into focus and then select "**Properties**" (Fig 9)

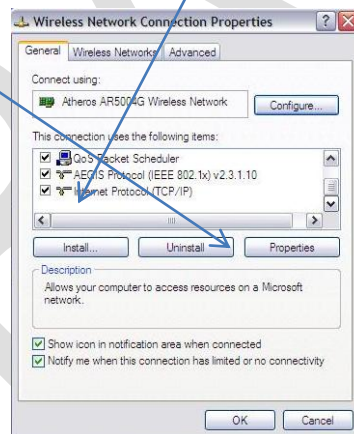

Fig 9

- d. Follow steps "f" and "g" above.
4. You are now ready to open the ProTelevision web page in your browser.
  5. Connect your cable from the Ethernet port on your computer to the Ethernet port on the back of the modulator.
  6. Open Internet Explorer or Mozilla Firefox and enter IP address 192.168.168.168 in the address field.
  7. Enter the provided User name and Password. You are now ready to control the modulator.

**THE INFORMATION PROVIDED HEREIN IS PINEAPPLE TECHNOLOGY INCORPORATED PROPRIETARY INFORMATION AND CANNOT BE COPIED OR DISTRIBUTED WITHOUT PRIOR AUTHORIZATION**



## **V.5 DXDPRO-10U ETHERNET WEB PAGE CONTROL AND MONITORING**

### **B. ETHERNET WEB PAGE SETUP**

#### **General Introduction**

The web service control interface allows monitoring of status as well as configuration of the operational parameters of the device subject to the log-in status for the user (observer, operator or administrator). The user interface (web browser display) applies a user friendly concept where the general navigation between individual sub menus is based on a block oriented representation of the controlled device. The specific control for a certain function is therefore easily accessed by 'dragging' the functional block of interest into the configuration section of the display.

The web service interface is equally useful for controlling the PT2000 Terrestrial Gateway product in a configuration with a direct connection (Ethernet patch cable) between the PT2000 Terrestrial Gateway product and the PC as well as in the typical operational environment where multiple products are accessible from the PC across a shared network.

#### **Document structure and scope**

This instruction manual is divided into three main sections:

- Electrical interface and IP address configuration;
- Operation principle for the Web service interface; and,
- Software update over Ethernet.

The present document describes the operation from a generic viewpoint and it does therefore not address in detail functions or settings applicable to a specific member of the Terrestrial Gateway product family.

### **C. IP ADDRESS CONFIGURATION**

IP address settings for the PT2000 Terrestrial Gateway product can be carried out in several different ways:

- a) Hardware preset to default status
- b) Configuration over Ethernet (the current address setting must be known and that the PC used for the configuration must be configured with a compatible address)

#### **1. IP Address Preset**

- IP address : 192.168.168.168
- Network Mask: 255.255.0.0



## **V.5 . DXDPRO-10U ETHERNET WEB PAGE CONTROL AND MONITORING (Continued)**

### **C. IP ADDRESS CONFIGURATION (Continued)**

#### **2. IP Configuration Over Ethernet (Terminal)**

The PT2000 Terrestrial Gateway product can be configured for either static or dynamic IP address operation. The factory default setting for the unit is:

- Address management: DHCP = OFF (static IP address)
- Default IP: 192.168.168.168
- Default Mask: 255.255.0.0
- Default gateway: 192.168.1.1

Provided that the current IP setting for the unit is known (IP address and network mask) it is possible to carry out further query of IP settings by connecting a PC to the Ethernet port. (The PC must, of course, be configured with IP settings that are compatible with the address space currently set for the PT2000 Terrestrial Gateway product).

#### **3. IP configuration over Ethernet (Web Service)**

The factory default setting for the unit is:

- Address management: DHCP = OFF (static IP address)
- Default IP: 192.168.168.168
- Default Mask: 255.255.0.0
- Default gateway: 192.168.1.1

Provided that the current IP setting for the unit is known (IP address and network mask), it is possible to carry out further query of IP settings by connecting a PC to one of the three RJ45 management ports of the PT2000 Terrestrial Gateway product (the PC must of course be configured with IP settings that are compatible with the address space currently set for the PT2000).





**V.5 . DXDPRO-10U ETHERNET WEB PAGE CONTROL AND MONITORING (Continued)**

**D. WEB SERVICE OPERATION**

The PT2000 Terrestrial Gateway product is fully controllable over ethernet by means of the web service function (web browser control). The PT2000 web service is designed for use with **Internet Explorer V7** and **Mozilla Firefox V2** so it is strongly recommended to use one of these two browser types for the operation. The PT2000 Terrestrial Gateway unit must be configured in advance for the same address space as the PC used for the control and the PC must be connected to one of the TCP/IP management either directly or over a network.

**Preparation Of The Web Browser**

The status pages provided by the PT2000 web service are updated in the web server whenever the operational status of the device changes. However, changes to operational status, occurrence of alarm messages, etc, may be masked if the web browser is configured for use of locally cached web pages. To ensure that the web browser always displays the latest status from the PT2000 web service and not displays outdated cached information it must be configured specifically to check for newer versions of a web page on every visit to the page. For Microsoft Internet Explorer 7 this is done as follows:

- a) Select 'Internet options' from the 'Tools' menu.
- b) Select 'Browsing history' → 'Settings' from the "General' tab page.
- c) Make sure 'Every time I visit the page' is ticked.

**1. Login To The Web Service**

Connection to the web service function is established simply by entering in the Web browsers address field the IP address assigned to the specific PT2000 Terrestrial Gateway unit. A login window will appear in order to authenticate the user's access to the web service. Login can be made at three different levels:

User classification	Default User name	Default Password	Remarks
Administrator	<i>admin</i>	(no password)	Unrestricted access to all configurable parameters including IP management and SW/FW upload
Operator	<i>oper</i>	(no password)	Access to all configurable parameters related to the PT2000 Terrestrial Gateway function excluding configuration of IP parameters and excluding SW/FW upload
Observer	<i>observer</i>	(no password)	Only access to status displays and observation of current status in the configuration pages (no parameter modification is allowed – 'submit' button disabled.)



**V.5 . DXDPRO-10U ETHERNET WEB PAGE CONTROL AND MONITORING (Continued)**

**D. WEB SERVICE OPERATION**

**1. Login To The Web Service**

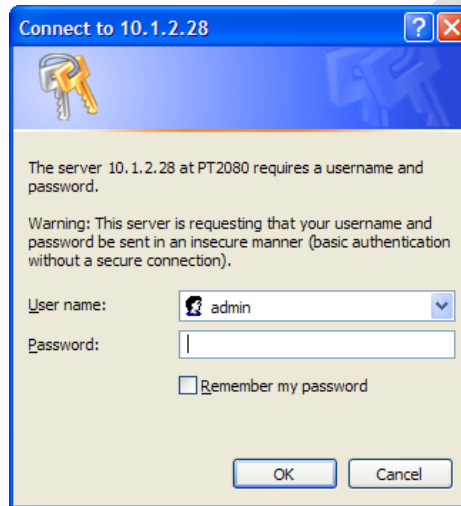

**Figure 0-1 Login window (administrator status / default password)**

**2. Web Service Main Page**

Connection to the web service function is established simply by entering in the Web browsers address field the IP address of the PT2000 Terrestrial Gateway unit. As soon as the connection has been opened the primary control and status page will appear. The page is divided into an upper section and a lower section.

The upper section provides a graphic representation of the block schematic of the device. The block schematic provides general status information about the device and serves as navigation tool for accessing specific status and configuration menus.

The lower section provides space for simultaneous display of three control and status panels for specific functional areas of the unit. The control panels are easily adapted to the current activity by dragging-and-dropping the required functional block from the upper section of the screen to the lower section of the screen (See next page - Section D.- Web Service Operation -- Part 3 - Control Panel Configuration for details).

In case an alarm condition exists for one of the functional elements shown in the upper section of the screen, the particular element will be shown in red color. Functional elements that are in the normal operational status will be shown in green color. Functional blocks that are not used in the current configuration are shown in grey color.



## V.5 . DXDPRO-10U ETHERNET WEB PAGE CONTROL AND MONITORING (Continued)

### D. WEB SERVICE OPERATION

#### 2. PT 2000 Web Service Main Page



#### 3. Web Service - Operation Principle

##### Control panel configuration

The control panel (lower section of the screen) is easily adapted to the current activity by dragging-and-dropping the required functional block from the upper section of the screen to the lower section of the screen. Control panels for three functional blocks can be open simultaneously in the lower section.

The 'Functional Blocks' in the upper section of the screen can be subdivided into three types:

- **Main function block:** a main function block holds the top level control and status parameters for a specific function. These blocks are identified by the blue label 'attached' above the block (white text on blue background). In the below example screen print main functional blocks exist for the sub-functions Reception, Input, Mode, Pre-Correction, Output and Reference.
- **Specific function block:** a specific function block holds control and status functions for a specific function within a 'Main function block'. In the below example screen print it can for example be noted that the Reception main block contains specific functional blocks for the tuner and the channel filter functions. Likewise, it can be seen that the mode block contains specific functional blocks for the HP Coder, LP Coder, OFDM and SFN functions.

**THE INFORMATION PROVIDED HEREIN IS PINEAPPLE TECHNOLOGY INCORPORATED PROPRIETARY INFORMATION AND CANNOT BE COPIED OR DISTRIBUTED WITHOUT PRIOR AUTHORIZATION**



**V.5 . DXDPRO-10U ETHERNET WEB PAGE CONTROL AND MONITORING (Continued)**

**D. WEB SERVICE OPERATION**

**3. Web Service - Operation Principle**

**Control panel configuration**

- **Interface points:** The various interface points in and out of the unit presented in the upper section of the block are themselves mini functional blocks and similar to the main and specific functional blocks these points can be dragged-and-dropped to the lower section of the screen whenever it's desired to check or set parameters related to the specific point. In the below screen print it can for example be noted that individual connection points exist for the RF, IF, GPS, 10MHz, 1PPS, MONITOR, IF (out) and RF (out).





## V.5. DXDPRO-10U ETHERNET WEB PAGE CONTROL AND MONITORING (Continued)

### D. WEB SERVICE OPERATION

#### 3. Web Service - Operation Principle

##### Parameter Control for Main Function Block

To access the control panel for a main function block (for example the 'Reference' block) proceed as follows:

1. Place the cursor over the blue label of the block of interest (for example the 'Reference' block).
2. Press the left mouse button
3. While keeping the left mouse button pressed drag the block to the lower section of the screen
4. When the block has been dragged to the lower section release the left mouse button. The control panel that is associated with the block will now open in place of the panel over which the block was dropped. The block may freely be dropped in any of the three panels (left, centre or right) in accordance with the preferences.

The screenshot displays the Terrestrial Gateway PT2000 web interface. At the top, it shows system information: Terrestrial Gateway PT2000, TS-ID:0, NET-ID:0, CELL-ID:0, and PINEAPPLE TELEVISION TECHNOLOGIES. The main area features a block diagram with sections for RECEPTION, INPUT, MONITOR, MODE, PRE-CORRECTION, and OUTPUT. A 'REFERENCE' block is highlighted in blue. Below the diagram are three control panels: 'Switching', 'HP Coderate', and 'Constellation'. Three callout boxes with numbered instructions are overlaid on the interface:

- 1.** Place the cursor over the blue label.
- 2.** Press the left mouse key
- 3.** While keeping the left mouse key pressed drag the block to the lower section of the screen



## V.5 . DXDPRO-10U ETHERNET WEB PAGE CONTROL AND MONITORING (Continued)

### D. WEB SERVICE OPERATION

#### 3. Web Service - Operation Principle

##### Parameter Control for Main Function Block



##### Parameter control for Specific Function Block

To access the control panel for a specific function block (for example the 'Tuner' block) proceed as follows:

1. Place the cursor over the block of interest (for example the 'Tuner' block).
2. Press the left mouse button
3. While keeping the left mouse button pressed drag the block to the lower section of the screen
4. When the block has been dragged to the lower section release the left mouse button. The control panel that is associated with the block will now open in place of the panel over which the block was dropped. The block may freely be dropped in any of the three panels (left, center or right) in accordance with the preferences.



**V.5 . DXDPRO-10U ETHERNET WEB PAGE CONTROL AND MONITORING (Continued)**

**D. WEB SERVICE OPERATION**

**3. Web Service - Operation Principle**

**Parameter control for Specific Function Block**

The screenshot displays the DTXPRO-10U web interface with a block diagram at the top and control panels below. The diagram shows a signal flow from RECEPTION (RF input) through INPUT (Tuner, Ch. Filter), MONITOR (Switching), MODE (HP Codor, OFDM), PRE-CORRECTION (Linear, Clipping, Non-Linear), and OUTPUT (RF Output). Below the diagram are control panels for Reference, Tuner, and OFDM Mode.

**1.** Place the cursor over the block

**2.** Press the left mouse key

**3.** While keeping the left mouse key pressed drag the block to the lower section of the screen

**4.** When the block is placed in the desired panel (left, centre or right), release the left mouse key. The new control panel will now automatically open

THE INFORMATION PROVIDED HEREIN IS PINEAPPLE TECHNOLOGY INCORPORATED PROPRIETARY INFORMATION AND CANNOT BE COPIED OR DISTRIBUTED WITHOUT PRIOR AUTHORIZATION



## V.5 . DXDPRO-10U ETHERNET WEB PAGE CONTROL AND MONITORING (Continued)

### D. WEB SERVICE OPERATION

#### 3. Web Service - Operation Principle

##### Parameter Control For Interface Point

To access the control panel for a specific Interface point (for example the 'RF' input) proceed as follows:

1. Place the cursor over the interface point of interest (for example the 'RF' input).
2. Press the left mouse button
3. While keeping the left mouse button pressed drag the 'Interface point' to the lower section of the screen

When the 'Interface point' has been dragged to the lower section release the left mouse button. The control panel that is associated with the connection point will now open in place of the panel over which the Interface point was dropped. The Interface point may freely be dropped in any of the three panels (left, centre or right) in accordance with the preferences.







**V.5 DXDPRO-10U. ETHERNET WEB PAGE CONTROL AND MONITORING (Continued)**

**D. WEB SERVICE OPERATION**

**3. Web Service - Operation Principle  
Parameter Control For Interface Point**

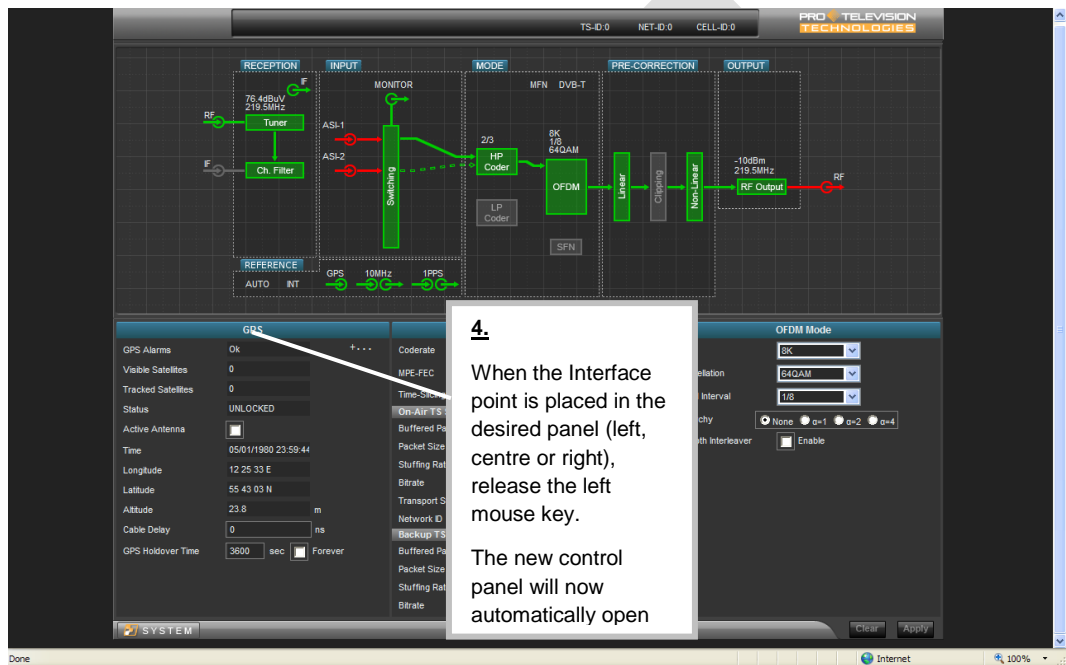

**Access To System Parameters**

A number of system oriented parameters can be accessed by left-clicking the [System] button located in the lower-left corner of the web page. To access a specific system (for example saving or loading a device preset) proceed as follows:

1. Left click the [System] button. A menu including the various choices will now open up above the [system] button.
2. From the menu select the required function (for example 'Preset' management) by left-clicking the point in the menu.
3. The corresponding control panel will now open up in the lower section of the screen in place of the three regular control panels.
4. When the setting of interest has been verified/changed as required the 'system' control panel is closed again by left clicking the [X] in the top-right corner of the panel.

**THE INFORMATION PROVIDED HEREIN IS PINEAPPLE TECHNOLOGY INCORPORATED PROPRIETARY INFORMATION AND CANNOT BE COPIED OR DISTRIBUTED WITHOUT PRIOR AUTHORIZATION**



**V.5 . DXDPRO-10U ETHERNET WEB PAGE CONTROL AND MONITORING (Continued)**

**D. WEB SERVICE OPERATION**

**3. Web Service - Operation Principle**

**Access To System Parameters**

**1:**  
Left-click the [SYSTEM] button to open the system configuration menu.

**2:**  
From the system menu select the required sub menu (for example 'Preset') by left-clicking the menu

**3:**  
When the parameter of interest in the system menu has been verified or set as required click the [x] to close the system menu and revert to the normal three-panel display

The screenshot displays the DTXPRO-10U web interface. At the top, it shows 'TS-D:0 NET-D:0 CELL-D:0' and the 'PRO TELEVISION TECHNOLOGIES' logo. The main area is a block diagram of the system's signal flow, divided into sections: RECEPTION (76.4dBuV 219.5MHz, Tuner, Ch. Filter), INPUT (AS1-1, AS1-2, Switching), MONITOR, MODE (MFN, DVB-T, HP Coder, LP Coder, OFDM, SFN), PRE-CORRECTION (Linear, Clipping, Non-Linear), and OUTPUT (-10dBm 219.5MHz, RF Output). Below the diagram are control panels for GPS, HP Coder, and OFDM Mode. A 'SYSTEM' menu is open on the left, listing options like ALARM CONTROL, EVENTLOG, ADMIN, SNMP, LAN, NETWORK, DEVLOCATE, TIME/DATE, MAINTENANCE, SCHEDULE, SW UPGRADE, PRESET, SERVICE LED, SYSTEM, RESTORE, USERS, OPTIONS, ABOUT, and REBOOT. The 'Preset' dialog box is open at the bottom, showing 'Preset activation' (Preset 4, Activate), 'Save current configuration as preset' (Preset 5, Save), and 'Upload file from PC to preset' (Preset 4, Upload). A close button (X) is visible in the top right of the dialog box.

**THE INFORMATION PROVIDED HEREIN IS PINEAPPLE TECHNOLOGY INCORPORATED PROPRIETARY INFORMATION AND CANNOT BE COPIED OR DISTRIBUTED WITHOUT PRIOR AUTHORIZATION**



**V.5 DXDPRO-10U. ETHERNET WEB PAGE CONTROL AND MONITORING (Continued)**

**D. WEB SERVICE OPERATION**

**3. Web Service - Operation Principle**

**Setting Of A Parameter Value**

To change the setting of a specific user parameter, proceed as follows:

1. If not already available for modification move the functional block in which the parameter resides to the control panel in the lower section of the screen as described above.
2. Place the cursor over the location in the control panel where the parameter of interest resides and click the left mouse button to set the point in focus. Depending on the type of input set the new value as required. The input can be 'alpha-numeric for input by keyboard' or based on a drop-down list holding the valid choices or based on a tick-box or radio-button system. Notice that some fields are status displays only (read only) and that it consequently isn't possible to access these fields for parameter change.
3. When the new value has been specified the border of the field in question will be presented in a light blue color to indicate that a new value has been specified but not yet implemented/confirmed.
4. To implement/confirm the new value move the cursor to the [Apply] button and click the left mouse button to confirm the entry.
5. When the new value has implemented/confirmed the light blue border around the parameter input field will return to the normal black color.

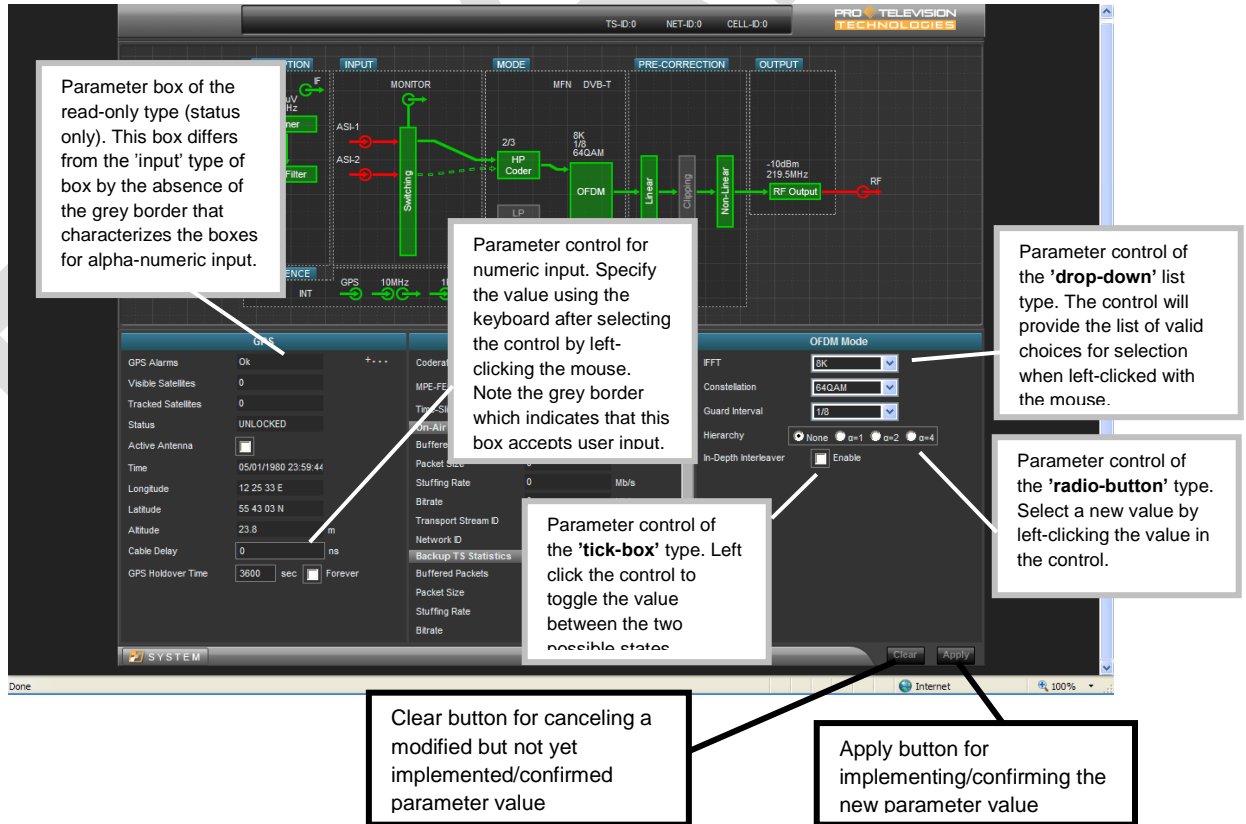

**THE INFORMATION PROVIDED HEREIN IS PINEAPPLE TECHNOLOGY INCORPORATED PROPRIETARY INFORMATION AND CANNOT BE COPIED OR DISTRIBUTED WITHOUT PRIOR AUTHORIZATION**



## V.5 . DXDPRO-10U ETHERNET WEB PAGE CONTROL AND MONITORING (Continued)

### D. WEB SERVICE OPERATION

#### 3. Web Service - Operation Principle

##### SW/FW update

SW/FW update of the PT2000 Terrestrial Gateway product is carried out over the ethernet interface. The update is based on a so called 'tarball' file that contains the SW/FW images that define the specific product version (for example a DVB-T/H modulator, an ATSC modulator or a MediaFLO modulator). The typical size of the 'tarball' is about 16Mb.

The update procedure is as follows:

1. Download the 'tarball' file from the FTP site to a directory on your local network or to the PC that you are using explicitly for managing the PT2000 Terrestrial Gateway unit or insert the CDROM that contains the tarball into a CDROM drive on this PC.
2. Connect to the Web service interface of the PT2000 Terrestrial Gateway product as described in Section D, Web Service Operation--1. Login to the Web Server, page 31.
3. In the lower left corner of the Web service graphical user interface you will find the [System] button. Click this button to open the system menu.
4. In the system menu select the function [SW Upgrade]. See Section D, Web Service Operation— Subsection 3- Web Service - Operation Principle - Access to System Parameters, on page 39, for further details about access to the system menu.
5. In the *Maintenance* section of the *System* menu select *Software Upgrade*
6. Select [*Browse*] and navigate to the location of the downloaded 'tarball' file
7. Select the file '*tarball.tgz*' and click [Upload]
8. The loading of the new SW/FW should now start automatically. The progress can be monitored from the Web service interface. A number of steps including uploading, unpacking and verifying and deleting files will pass automatically (the processing time is several minutes).
9. When the loading of new SW/FW is completed the unit will automatically reboot. After the reboot the new SW/FW version is active.
10. The active SW/FW version can be verified after the reboot via the [About] function in the [System] menu.

# **SECTION V.6**

## **DXDPRO-10U ADAPTIVE PRE-CORRECTOR WEB SERVICE OPERATION**



## V.6. DXDPRO-10U ADAPTIVE PRE-CORRECTOR WEB SERVICE OPERATION

### A. INTRODUCTION

This section describes the web browser based operation of the **Adaptive pre-corrector** for the PT2000 Terrestrial Gateway unit. For an introduction to IP address configuration, log-in procedure and general operation principle for the web service<sup>1</sup> control interface for the DXDPRO product family please refer to the separate publication *DXDPRO Modulator and Repeater Products Web service Interface Instruction Manual* available from Pineapple Technology, Inc..

The web service control interface allows monitoring of status as well as configuration of the operational parameters of the adaptive pre-corrector device subject to the log-in status for the user (observer, operator or administrator). The user interface (web browser display) applies a user friendly concept where the general navigation between individual sub menus is based on a block oriented representation of the controlled device. The specific control for a certain function is therefore easily accessed by 'dragging' the functional block of interest into the configuration section of the display.

The web service interface is equally useful for controlling any of the PT2000 Terrestrial Gateway products in a configuration with a direct connection (Ethernet patch cable) between the PT2000 Terrestrial Gateway unit and the PC as well as in the typical operational environment where multiple products are accessible from the PC across a shared network.

### SECTION STRUCTURE AND SCOPE

This section is divided into three main chapters:

- a. Electrical interface for the adaptive pre-corrector
- b. Operation principle for adaptive pre-corrector
- c. Application of the adaptive pre-corrector in combination with Echo Canceller option

### B. ELECTRICAL INTERFACE

#### 1. General information

The adaptive pre-corrector's electrical interface consists of two **SMA** type coaxial connectors:

- Sense input 1: Non-linear sense port
- Sense input 2: Linear sense port



**V.6 DXDPRO-10U ADAPTIVE PRE-CORRECTOR WEB SERVICE OPERATION (Continued)**

**B. ELECTRICAL INTERFACE**

The required signal level for both inputs is **0dBm +/-10dB**. The impedance is **50 ohm**.

**Location of sense inputs (stand alone 1RU/19" rack mount chassis):**

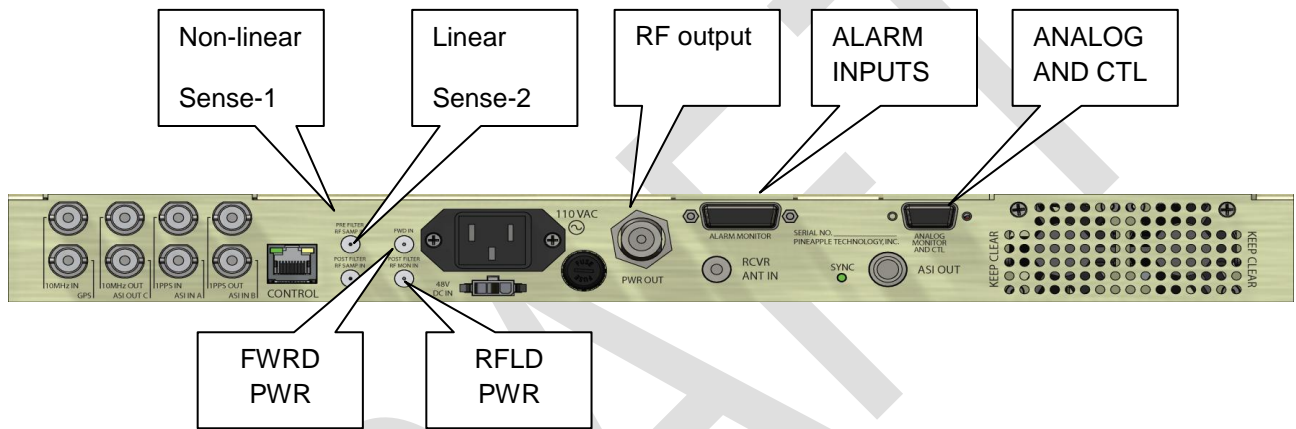

**Location of sense inputs (OEM board version):**

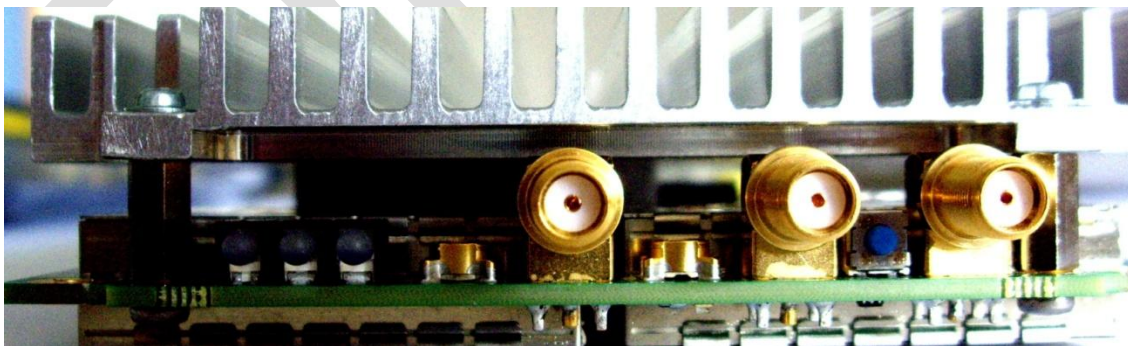

**THE INFORMATION PROVIDED HEREIN IS PINEAPPLE TECHNOLOGY INCORPORATED PROPRIETARY INFORMATION AND CANNOT BE COPIED OR DISTRIBUTED WITHOUT PRIOR AUTHORIZATION**



## V.6 DXDPRO-10U ADAPTIVE PRE-CORRECTOR WEB SERVICE OPERATION (Continued)

### B. ELECTRICAL INTERFACE

#### 2. Interface to the Transmitter

The non-linear sense input must be connected to a suitable coupler/tap-off at a point right after the power amplifier before any band limiting filter. The linear sense input must be connected to a suitable coupler/tap-off point after the channel filter. Notice further that the bandwidth between the RF output of PT2160 and the input of the power amplifier must be at least 20MHz wide to ensure effective non-linear pre-correction of the amplifiers non-linearity.

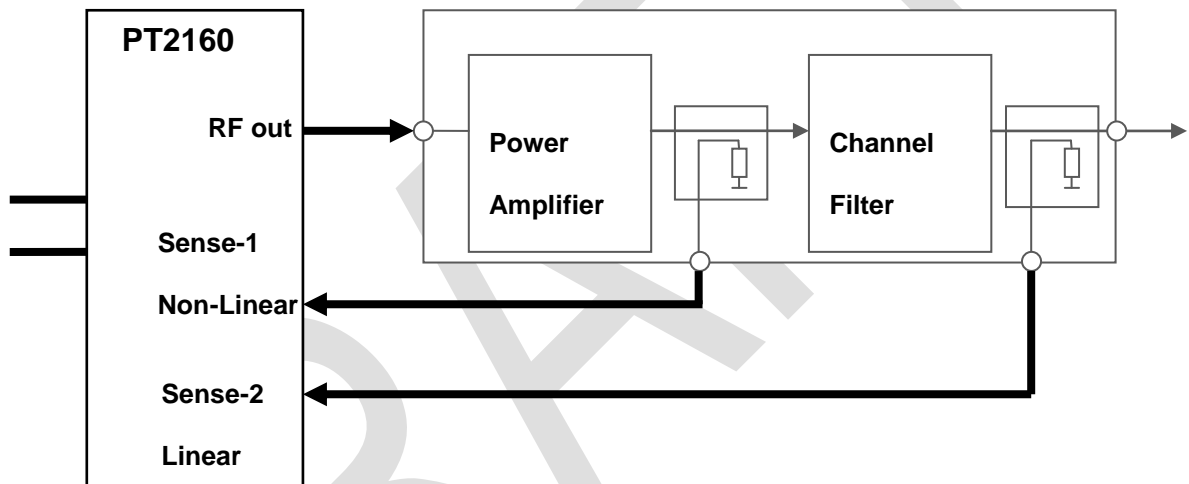

### C. OPERATION OF ADAPTIVE PRE-CORRECTOR

#### 1. Connection and Verification of Signal Levels

The RF output and the sense inputs of the PT2000 Terrestrial Gateway unit must be connected as described in above in Sub-section 2 - Interface to the Transmitter. The graphical illustration of the two sense inputs in the web service block schematic will appear in green color if the level is within the valid range for the respective input. If the level is marginal relative to the required max/min limits the input will be shown in yellow color. If the level is outside the valid range the input is shown in red color. For optimal result the corrector should only be operated with input levels in the 'green' state. Performance with 'yellow' input state is not guaranteed. The adaptive pre-corrector is not usable when the level is in the 'red' state.





**V.6 DXDPRO-10U ADAPTIVE PRE-CORRECTOR WEB SERVICE OPERATION (Continued)**

**C. OPERATION OF ADAPTIVE PRE-CORRECTOR**

**1. Connection and Verification of Signal Levels (Continued)**

Valid sense input for linear and non-linear pre-corrector:

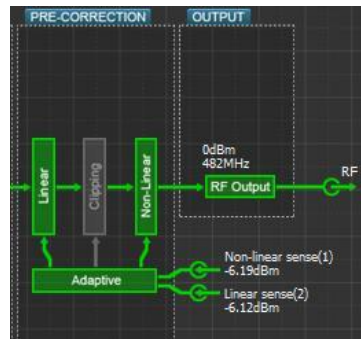

Marginal sense input for linear and non-linear pre-corrector (yellow warning):

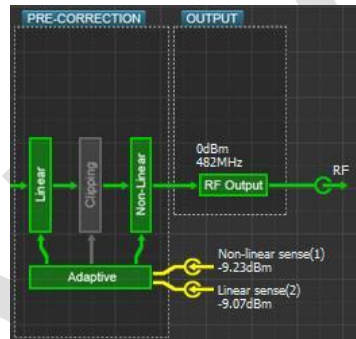

Invalid sense input for linear pre-corrector. Valid sense input for non-linear corrector.

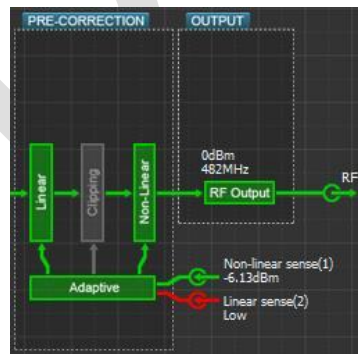



## V.6 DXDPRO-10U ADAPTIVE PRE-CORRECTOR WEB SERVICE OPERATION (Continued)

### C. OPERATION OF ADAPTIVE PRE-CORRECTOR

#### 2. Preparation of Web Service Interface

To enable web service control of the non-linear and linear adaptive pre-corrector, proceed as follows:

- Drag the linear pre-corrector block to the configuration panel
- Drag the non linear pre-corrector block to the configuration panel
- Drag the adaptive pre-corrector block to the configuration panel (this panel provides status info only and it is therefore as such not strictly required for operation of the adaptive system)
- Drag the three control blocks into the configuration panel one-by-one:

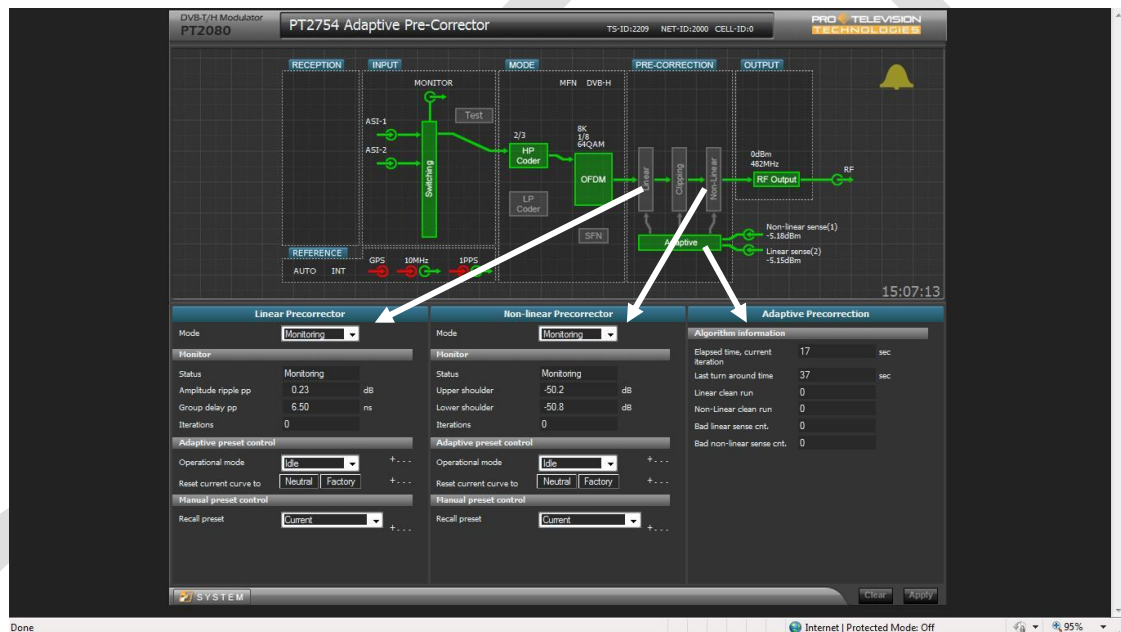

Depending on the current operational mode for the pre-corrector system the linear and non-linear blocks may appear in grey or in green. When the pre-corrector function is disabled the respective block (linear and/or non-linear) is shown in grey. When the pre-corrector function is enabled the respective block (linear and/or non-linear) is shown in green color. When the active pre-corrector mode is 'adaptive' a green arrow will connect the adaptive function block and the respective pre-corrector block. When the adaptive pre-corrector mode is 'static' (manual correction mode) the connection between the adaptive function block and the respective pre-corrector block is grayed out.



**V.6 DXDPRO-10U ADAPTIVE PRE-CORRECTOR WEB SERVICE OPERATION (Continued)**

**C. OPERATION OF ADAPTIVE PRE-CORRECTOR**

**2. Preparation of Web Service Interface (Continued)**

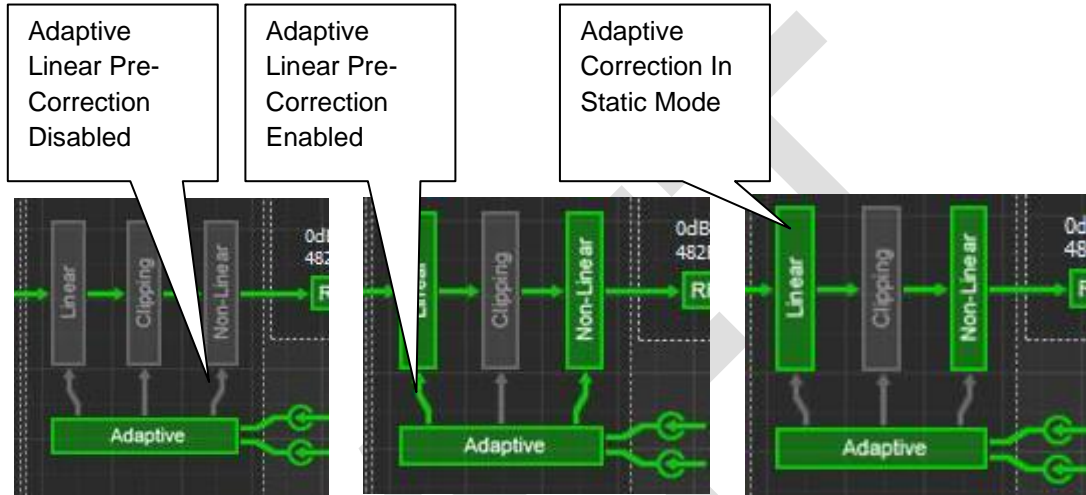

**3. Linear Pre-Corrector Configuration**

**Linear Pre-Corrector Mode Selection**

The linear pre-corrector system can operate in three different modes. The required mode is selected by opening the operational mode 'drop-down' list (1).

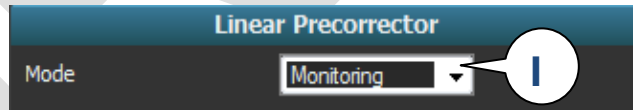

The available modes are:

- **Monitoring:** No pre-correction is applied to the RF output (the corrector characteristic is neutral). The amplitude ripple and the group delay performance is measured and displayed provided that a valid feedback is applied to the RF sense input 2.
- **Static:** The currently loaded manual linear pre-corrector characteristic is applied to the RF output. The manual pre-corrector characteristics must be generated and uploaded by means of the PC software package IMD Buster McTwo. The curve format used by the manual pre-corrector system is incompatible with the curves used and generated by the adaptive system.
- **Adaptive:** The current adaptive linear pre-corrector characteristic is applied and maintained according to the adaptive pre-corrector mode selected (see below for details).



## V.6 DXDPRO-10U ADAPTIVE PRE-CORRECTOR WEB SERVICE OPERATION (Continued)

### C. OPERATION OF ADAPTIVE PRE-CORRECTOR

#### 3. LINEAR PRE-CORRECTOR CONFIGURATION

##### Linear Pre-Corrector Monitor Panel

The linear pre-corrector monitor panel provided information about the instantaneous performance and operation mode.

Monitor		
Status	Auto applying	
Amplitude ripple pp	0.08	dB
Group delay pp	14.18	ns
Iterations	79	

- **Status:** The status field shows the operational status for the linear pre-corrector system. The possible states are:
  - **Monitoring:** indicates that the adaptive linear mode is disabled and that either the 'Static' or 'Monitoring' mode (refer to 3.3.1 above) is selected.
  - **Initializing <nn%>:** Indicates the progress of the initial data collection by adaptive linear mode.
  - **Auto applying:** Indicates that correction results of the adaptive linear process are being applied to the RF output characteristic
  - **Not running:** Adaptive linear operation is suspended by the controller system while adaptive linear mode is selected.
  - **Amplitude ripple pp:** Read-out of the measured amplitude ripple for the signal applied to the linear sense port. Displays the result of the last completed iteration by adaptive mode. Displays the instantaneous performance by 'Static' and 'Monitoring' mode.
  - **Group delay pp:** Read-out of the measured group delay ripple for the signal applied to the linear sense port. Displays the result of the last completed iteration by adaptive mode. Displays the instantaneous performance by 'Static' and 'Monitoring' mode.
  - **Iterations:** Displays the number of adaptive linear pre-corrector iterations completed since reset of corrector characteristic or reboot of the unit.



## V.6 DXDPRO-10U ADAPTIVE PRE-CORRECTOR WEB SERVICE OPERATION (Continued)

### C. OPERATION OF ADAPTIVE PRE-CORRECTOR

#### 3. LINEAR PRE-CORRECTOR CONFIGURATION

##### Adaptive Linear Pre-Corrector Mode Selection

The adaptive linear corrector can operate in four different modes. The required mode is selected by opening the operational mode 'drop-down' list (II).

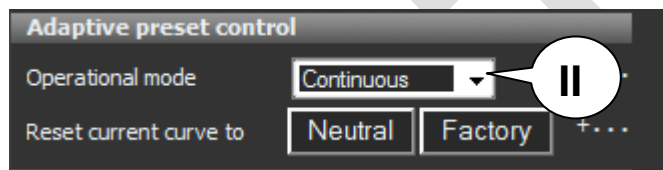

The available modes are:

- **Idle:** The current adaptive pre-corrector characteristic is applied to the RF output. The pre-corrector algorithm is stopped. Changes in transmitter characteristic will not be tracked by the pre-corrector.
- **Continuous:** The instantaneous adaptive pre-corrector characteristic is applied to the RF output. The pre-corrector algorithm runs continuously.
- **Run to target:** The instantaneous adaptive pre-corrector characteristic is applied to the RF output. The pre-corrector algorithm will run until the set threshold value is obtained for the upper respectively the lower RE spectrum shoulder.
- **Auto run:** The instantaneous adaptive pre-corrector characteristic is applied to the RF output. The pre-corrector algorithm will run until the set threshold value is obtained for the upper respectively the lower RE spectrum shoulder. The adaptive pre-corrector algorithm will be automatically restarted in case the upper and/or lower shoulder performance subsequently drops below the set threshold.

##### Adaptive Linear Pre-Corrector Threshold Settings

The threshold values for the adaptive pre-corrector system's 'Run to target' and 'Auto run' modes are accessed and set by expanding the 'Auto-run and run-to-target threshold settings' control (III). Notice that the respective parameter values must be 'enabled' by ticking the associated enable field in order for the parameter to have any effect on the pre-corrector algorithm.



**V.6 DXDPRO-10U ADAPTIVE PRE-CORRECTOR WEB SERVICE OPERATION (Continued)**

**C. OPERATION OF ADAPTIVE PRE-CORRECTOR**

**3. LINEAR PRE-CORRECTOR CONFIGURATION**

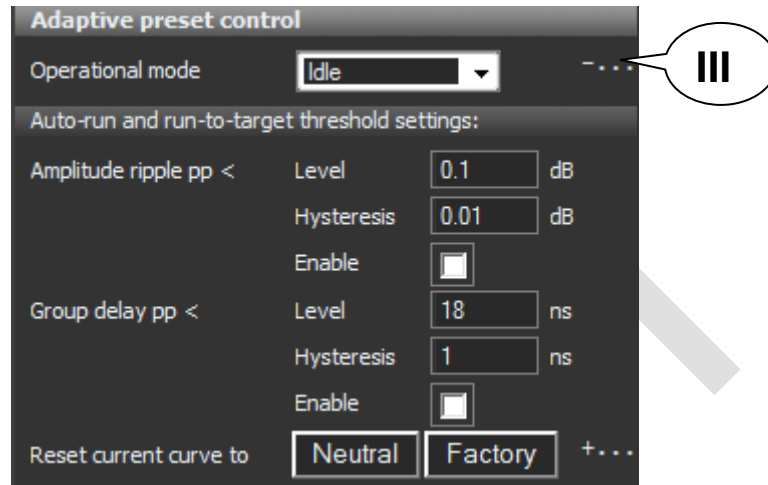

**Adaptive Linear Pre-Corrector Reset Functions**

The adaptive linear pre-corrector control panel includes two controls for resetting the corrector characteristic (IV).

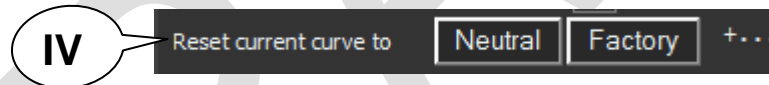

There is a choice of two possible reset functions:

- **Neutral:** The linear adaptive pre-corrector is instantly set to neutral characteristic when this control is operated. It is recommended to start the first adaptive alignment of a new amplifier from the neutral state.
- **Factory:** This reset function is intended for future use. The idea is that the transmitter manufacturer is allowed to save an adaptively derived curve characteristic and later retrieve this specific characteristic by activating the 'factory' reset.



## V.6 DXDPRO-10U ADAPTIVE PRE-CORRECTOR WEB SERVICE OPERATION (Continued)

### C. OPERATION OF ADAPTIVE PRE-CORRECTOR

#### 4. NON-LINEAR PRE-CORRECTOR CONFIGURATION

##### Non-Linear Pre-Corrector Mode Selection

The non-linear pre-corrector system can operate in three different modes. The required mode is selected by opening the operational mode 'drop-down' list (I).

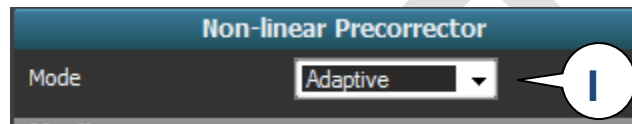

The available modes are:

- **Monitoring:** No non-linear pre-correction is applied to the RF output (the corrector characteristic is neutral). The shoulder performance is measured and displayed provided that a valid feedback is applied to the RF sense input 1.
- **Static:** The currently loaded manual non-linear pre-corrector characteristic is applied to the RF output. The manual pre-corrector characteristics must be generated and uploaded by means of the PC software package IMD Buster McTwo. The curve format used by the manual pre-corrector system is incompatible with the curves used and generated by the adaptive system.
- **Adaptive:** The current adaptive non-linear pre-corrector characteristic is applied and maintained according to the adaptive pre-corrector mode selected (see below for details).

##### Non-Linear Pre-Corrector Monitor Panel

The non-linear pre-corrector monitor panel provided information about the instantaneous performance and operation mode.

Monitor		
Status	Monitoring	
Upper shoulder	-50.4	dB
Lower shoulder	-50.2	dB
Iterations	82	



## V.6 DXDPRO-10U ADAPTIVE PRE-CORRECTOR WEB SERVICE OPERATION (Continued)

### C. OPERATION OF ADAPTIVE PRE-CORRECTOR

#### 4. NON-LINEAR PRE-CORRECTOR CONFIGURATION

- **Status:** The status field shows the operational status for the non-linear pre-corrector system. The possible states are:
  - **Monitoring:** indicates that the adaptive mode is disabled and that either the 'Static' or 'Monitoring' mode (refer to 3.4.1 above) is selected.
  - **Initializing <nn%>:** Indicates the progress of the initial data collection by adaptive non-linear mode.
  - **Auto applying:** Indicates that correction results of the adaptive non-linear process are being applied to the RF output characteristic
  - **Not running:** Adaptive operation is suspended by the controller system while adaptive mode is selected.
- **Upper shoulder:** Read-out of the measured upper shoulder level for the signal applied to the non-linear sense port. Displays the result of the last completed iteration by adaptive mode. Displays the instantaneous performance by 'Static' and 'Monitoring' mode.
- **Lower shoulder:** Read-out of the measured lower shoulder level for the signal applied to the non-linear sense port. Displays the result of the last completed iteration by adaptive mode. Displays the instantaneous performance by 'Static' and 'Monitoring' mode.
- **Iterations:** Displays the number of adaptive non-linear pre-corrector iterations completed since reset of corrector characteristic or reboot of the unit.

#### Adaptive Non-Linear Pre-Corrector Mode Selection

The adaptive Non-Linear corrector can operate in four different modes. The required mode is selected by opening the operational mode 'drop-down' list (II).

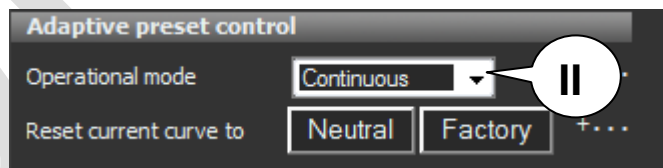

The available modes are:

- **Idle:** The current adaptive pre-corrector characteristic is applied to the RF output. The pre-corrector algorithm is stopped. Changes in transmitter characteristic will not be tracked by the adaptive non-linear pre-corrector.
- **Continuous:** The instantaneous adaptive non-linear pre-corrector characteristic is applied to the RF output. The pre-corrector algorithm runs continuously.
- **Run to target:** The instantaneous adaptive non-linear pre-corrector characteristic is applied to the RF output. The pre-corrector algorithm will run until the set threshold value is obtained for the upper respectively the lower RE spectrum shoulder.





**V.6 DXDPRO-10U ADAPTIVE PRE-CORRECTOR WEB SERVICE OPERATION (Continued)**

**C. OPERATION OF ADAPTIVE PRE-CORRECTOR**

**4. NON-LINEAR PRE-CORRECTOR CONFIGURATION**

- **Auto run:** The instantaneous adaptive non-linear pre-corrector characteristic is applied to the RF output. The pre-corrector algorithm will run until the set threshold value is obtained for the upper respectively the lower RF spectrum shoulder. The adaptive pre-corrector algorithm will be automatically restarted in case the upper and/or lower shoulder performance subsequently drops below the set threshold.

**Adaptive Non-Linear Pre-Corrector Threshold Settings**

The threshold values for the adaptive non-linear pre-corrector system's 'Run to target' and 'Auto run' modes are accessed and set by expanding the 'Auto-run and run-to-target threshold settings' control (III). Notice that the respective parameter values must be 'enabled' by ticking the associated enable field in order for the parameter to have any effect on the pre-corrector algorithm.

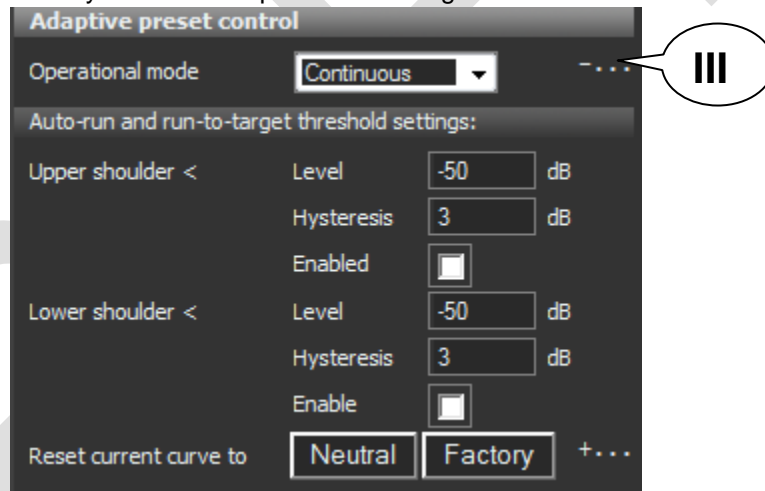

**Adaptive Non-Linear Pre-Corrector Reset Functions**

The adaptive non-linear pre-corrector control panel includes two controls for resetting the corrector characteristic (IV).

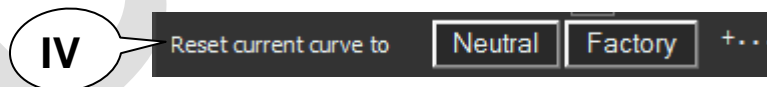

There is a choice of two possible reset functions:

- **Neutral:** The non-linear adaptive pre-corrector is instantly set to neutral characteristic when this control is operated. It is recommended to start the first adaptive alignment of a new amplifier from the neutral state.
- **Factory:** This reset function is intended for future use. The idea is that the transmitter manufacturer is allowed to save an adaptively derived curve characteristic and later retrieve this specific characteristic by activating the 'factory' reset.

**THE INFORMATION PROVIDED HEREIN IS PINEAPPLE TECHNOLOGY INCORPORATED PROPRIETARY INFORMATION AND CANNOT BE COPIED OR DISTRIBUTED WITHOUT PRIOR AUTHORIZATION**



**V.6 DXDPRO-10U ADAPTIVE PRE-CORRECTOR WEB SERVICE OPERATION (Continued)**

**C. OPERATION OF ADAPTIVE PRE-CORRECTOR**

**5. ADAPTIVE PRE-CORRECTOR STATISTICS**

The 'Adaptive' pre-corrector block provides various statistics concerning the adaptive process when dragged to and expanded in the lower half of the web service page.

Adaptive Precorrection		
Algorithm information		
Elapsed time, current iteration	15	sec
Last turn around time	37	sec
Linear clean run	0	
Non-Linear clean run	0	
Bad linear sense cnt.	0	
Bad non-linear sense cnt.	0	

- **Elapsed time, Current iteration:** Displays the time elapsed for the ongoing iteration (data collection and analysis) for the adaptive process. The elapsed time may accumulate continuously in the event that the sense input is invalidated and thereby preventing successful data collection and analysis.
- **Last turn-around time:** Displays the recorded time consumption for the last completed iteration (data collection/analysis/curve implementation). The iteration time may typically vary from less than 10 seconds up to about one minute depending on the signal characteristic and the type of adaptive correction running. The shortest iteration time is noted when only the non-linear adaptive pre-corrector is running. The iteration time is increased when the adaptive linear pre-corrector process is running.
- **Linear clean run:** Accumulated count of the number of times the adaptive system has discarded the collected linear data set and initiated a new collection of data. Under normal conditions this counter is '0'.
- **Linear bad sense count:** Accumulated count of the number of times the data collection from the linear sense port has failed for reasons other than level out of range (typically due to application of an invalid type of spectrum on the sense port). Under normal conditions this counter is '0'.
- **Non-Linear clean run:** Accumulated count of the number of times the adaptive system has discarded the collected non-linear data set and initiated a new collection of data. Under normal conditions this counter is '0'.
- **Non-Linear bad sense count:** Accumulated count of the number of times the data collection from the non-linear sense port has failed for reasons other than level out of range (typically due to application of an invalid type of spectrum on the sense port). Under normal conditions this counter is '0'.



## V.6 DXDPRO-10U ADAPTIVE PRE-CORRECTOR WEB SERVICE OPERATION (Continued)

### D. ECHO CANCELLING AND ADAPTIVE PRE-CORRECTION

**NOTICE: THIS FEATURE IS NOT INCLUDED IN THE DXDPRO LINE PRODUCTS. THIS IS AVAILABLE AND THE CUSTOMER SHOULD REQUEST A QUOTATION FOR PRICE AND AVAILABILITY.**

The adaptive pre-corrector option works very well in combination with the echo canceller option by ISO-channel repeater mode with the DTXPRO-10U digital repeater unit from Pineapple Technology, Inc. However, the echo canceller's ability to work effectively with high positive loop gains is dependent on already completed linearization of the amplifier non-linearity by the adaptive pre-corrector system. Therefore, when setting in operation a system that involves the adaptive pre-corrector as well as the echo canceller in an ISO-channel scenario it is recommended to follow one of the following two methods:

#### **Off-Line Linearization**

The ISO-channel repeater should initially be put in operation in a configuration where feedback between output and input is non-existent. This can be done either by feeding:

- a) The input with the actual RF feed off-air while feeding the power output from the ISO-repeater into a dummy load instead of feeding it to the transmitting antenna or
- b) A locally generated RF feed into the unit from a test transmitter which is not affected by the output of the ISO-channel repeater.

In this configuration the adaptive non-linear pre-corrector should be run until a shoulder performance of about 40dB or better is obtained from the power amplifier. After this initial linearization of the power amplifier the ISO-repeater can be put in operation with 'live' input and output.

#### **Gradual Loop Gain Ramp-Up**

The ISO-channel repeater may alternatively be put in operation by starting at a low 'max loop gain' setting for the echo canceller (for example 0dB or lower) and for each step allowing the adaptive non-linear pre-corrector to maximize the power amplifier performance to a shoulder level of about 40dB or better before increasing the permitted loop gain by a few dB.



## V.6 DXDPRO-10U ADAPTIVE PRE-CORRECTOR WEB SERVICE OPERATION (Continued)

### E. APPENDIX-A CLIPPER OPERATION

#### 1. GENERAL INFORMATION

The clipper function included with the Terrestrial Gateway product allows a controlled limitation of the output signals peak-to-average-power-ratio (PAPR).

When the clipper is disabled the output from the Terrestrial Gateway product will exhibit a PAPR equivalent to the inherent PAPR for the modulation format when the unit is configured/operated as a modulator. When the unit is configured as repeater or transposer the PAPR of the processed signal may be limited by headroom constraints in equipment prior to the repeater or transposer input. In the latter scenario the PAPR measured on the RF output may therefore be lower than the inherent PAPR for the modulation format in question even when the clipper is off.

Although the highest power peaks for multicarrier COFDM formats like DVB-T and MediaFLO reach a level about 15dB over the signals average RMS power the high peaks have limited energy content. The peaks are therefore not of immediate danger to the safe operation of a power amplifier following the modulator output even in the normal case where the average power setting for the amplifier is not backed off with the full PAPR relative to the peak power rating for the amplifier. The highest peaks are simply clipped by the power amplifier. However, a performance improvement and an extension of amplifier lifetime may be obtained if the peaks are limited to a point just below the amplifiers clip point by the clipper function of the Terrestrial Gateway product. When the clipping is done by the Terrestrial Gateway the following characteristics are obtained:

- a) The potential short time effect on the amplifier characteristic after a power peak is eliminated; the clipping in the Terrestrial Gateway is an instant process with no subsequent effect on the signal processing characteristic.
- b) The unavoidable noise that results from the clipping may, when the clipping takes place in the DXDPRO modulator, be distributed as preferred by use of the 'soft clipper' function (see below). When the clipping occurs in the amplifier the noise resulting from the clipping will be distributed evenly below, within and above the used channel. When using the clipper function of the Terrestrial Gateway the noise may be displaced from the upper and lower sideband of the channel to minimize disturbance of adjacent channels.
- c) By clipping the signal in the Terrestrial Gateway product any possible degradation of amplifier life time by repeated peak power stress is minimized.

#### 2. OPERATION OF THE CLIPPER FUNCTION

##### Level Definition

The point of clipping relative to average power level for the signal processed can be set by dragging the clipper block to the configuration panel. The Clipper level control can be set in the range from 12dB to 2dB. This setting refers to the baseband processing which is equivalent to a range from 15dB to 5dB for the actual RF output (the addition to the signal of a single CW carrier, the local oscillator used in the up-conversion process, corresponds to an increase of the PAPR by 3dB).



## V.6 DXDPRO-10U ADAPTIVE PRE-CORRECTOR WEB SERVICE OPERATION (Continued)

### E. APPENDIX-A CLIPPER OPERATION

#### 3. OPERATION OF THE CLIPPER FUNCTION

For practical reason the clipper function is considered 'active' whenever the clip point is set to a value lower than 12dB irrespective of the actual PAPR format for the modulation standard in use. When set to the 'active' state the clipper is shown in green color in the block schematic. When the clipper is inactive it is shown in grey.

Clipper in the inactive 'off' state (12dB):

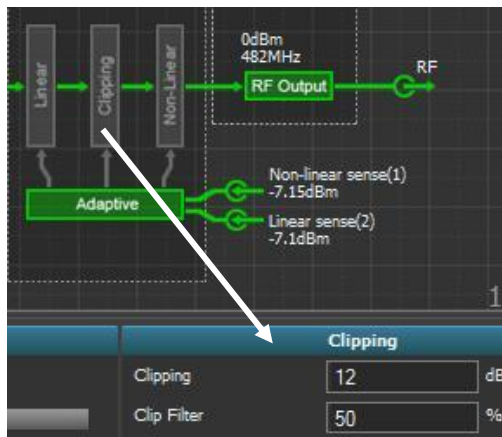

Clipper active (PAPR setting 8dB):

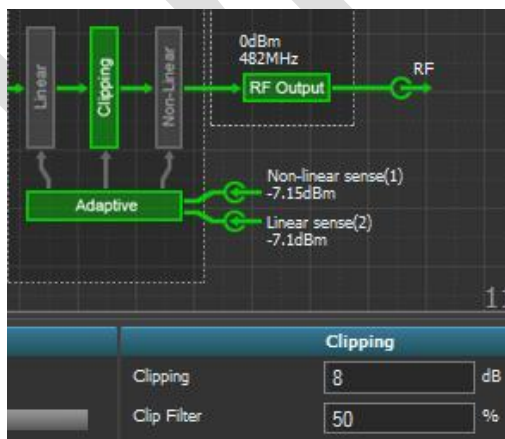



**V.6 DXDPRO-10U ADAPTIVE PRE-CORRECTOR WEB SERVICE OPERATION (Continued)**

**E. APPENDIX-A CLIPPER OPERATION**

**3. OPERATION OF THE CLIPPER FUNCTION**

**Identification of Optimal Clipper Setting**

The optimal clipper setting can be identified by monitoring the output of the power amplifier using a spectrum analyzer. The steps are as follows:

- a) Ensure that the clipper initially is set to 12dB
- b) Ensure that the clip filter is initially set to 0%.
- c) Configure the spectrum analyzer for zero-span operation with the view focused on either the upper or lower shoulder of the signal. A resolution of 0.1dB to 0.5dB per division is recommended. Maintaining the original level in the form of a second trace on the analyzer (clear-write → View) is recommended for easy identification of change in the shoulder level.
- d) Now, gradually increase the level of clipping applied by the Terrestrial Gateway product (12→11,5→11→10,5→10.....etc). When an increase of the shoulder level observed on the spectrum analyzer is just noticed it shows that the clipping applied by the Terrestrial Gateway is now limiting the peaks to a point fractionally below the clip point of the amplifier itself. Although the point will be individual from amplifier to amplifier and dependent on the actual average power level and peak power rating of the amplifier the point is typically found around of a clipper setting between 8 to 6 dB.

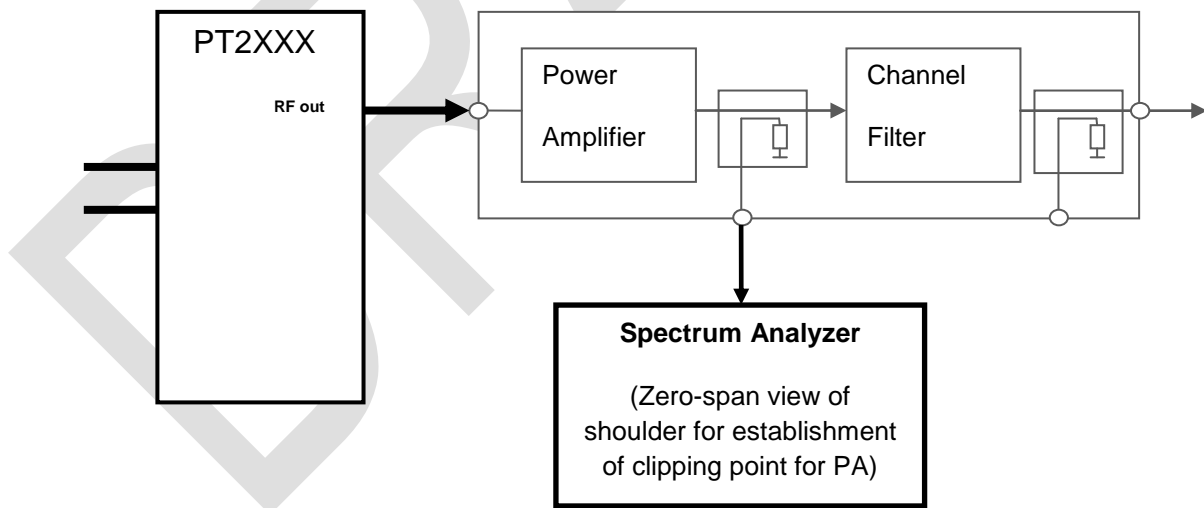

**Selection of Clipper Softness (Clip Filter)**

The clip filter setting may be varied according to preferences between 0% and 100%. The 100% setting provides for maximum suppression of the clipper noise from the sidebands (lower and upper adjacent channel) while the tradeoff is a reduction of the in-band MER performance.

# SECTION V.7

## DXDPRO-10U BLOCK DIAGRAM





# **SECTION VI**

# **DTXPRO-10U INSTALLATION PROCEDURES**



## VI. DTXPRO-10U INSTALLATION PROCEDURES

To ensure long and reliable trouble-free service from the DTXPRO-10U transmitter, the following steps for installation are recommended:

1. **MECHANICAL INSTALLATION:** The DTXPRO-10U was designed to be installed in a building protected from the weather. The building should have a hard-surface floor such as concrete with a moisture barrier. This barrier could be pressure-treated wood sub flooring which could be anchored to the concrete and to the transmitter to make the installation earthquake resistant. Allow a minimum of three feet around the transmitter cabinet for service access.. Provisions for air inlet and exhaust from the room must allow air flow with minimal obstruction. In the event that the room temperature exceeds 35° Celsius (95° F), cooling air must be provided so that the room temperature will not exceed 35 degrees Celsius under worse case conditions.

Notice: This equipment is **HEAVY** and must be handled by professional movers with proper equipment. Any damage caused by the installers is not covered under warranty. Check to ensure the installing crews have proper insurance coverage.

2. **GROUNDING:** Transmitter grounding is **VERY IMPORTANT** and must be done correctly for safety and operational reasons. The single point grounding technique can be effective to protect multiple pieces of equipment installed inside an equipment rack cabinet. Treat the rack the same as you would a building, a copper bus bar has been mounted inside the cabinet to act as both an entrance panel and reference ground for all conductors entering and leaving the rack. It is recommended the customer install an AC surge protector at this point in shunt to ground, and install a series impedance between the panel and the equipment. The chassis of each piece of equipment has been bonded to this buss bar with a single copper braid or strap. Redundant ground connections by means of the AC cable and the shields of audio cables should be avoided when possible. Finally, connect the rack's access panel to the building reference ground using a heavy gauge wire such as #2 AWG stranded copper or solid copper buss one (1) inch wide by 1/8 inch thick for connections. The bonding between the transmitter and the ground rods must be good quality and protected from corrosion. The ground wires should run over the floor and be connected to the ground rods located outside the building. The wire should not go thru the concrete floor but over and around it.
3. **AC WIRING:** AC voltage for the transmitter is normally 110 VAC. Connections to the AC Main should be made as follows:

- RED and BLACK wires are connected to the 110 VAC.
- WHITE wire is connected to NEUTRAL.
- GREEN wire is connected to SAFETY GROUND.

NOTICE: All wiring of this type must be done by a QUALIFIED ELECTRICIAN and must conform to LOCAL and NATIONAL wiring CODES.

Consult with your electrician to ensure that the proper breaker size is selected for the main circuit.



## VI. DTXPRO-10U INSTALLATION PROCEDURE (Continued)

- 4. ANTENNA CONNECTION:** The transmitter is equipped with a type N connector located at the rear of the rack. The RF ATSC Compliant Mask Filter and output Directional Coupler(s) are provided with the transmitter and are to be located and mounted at the customer discretion. Pineapple Technology recommends the filter be securely mounted above the transmitter cabinet but not in a position that could inhibit air circulation from the top of the cabinet. The directional coupler is usually mounted on the output of the mask filter convenient for connection to the station antenna transmission line. Two cables have been provided for connection between the output directional coupler monitor ports and the DXDPRO-10U Modulator. Conditions vary from site to site so some engineering may be required to ensure that the antenna is receiving the correct amount of power to comply with FCC licenses and to ensure safety from lightning, etc.

DRAFT

# **SECTION VII**

# **DTXPRO-10U SERVICE REQUIREMENTS**



## VII. DTXPRO-10U SERVICE REQUIREMENTS

Routine maintenance of the DTXPRO-10U consists of cleaning or replacing the air inlet filter. In normal operating environments this should be done once a month or more often in dusty environments. Cleaning should be done with a light detergent. Rinse and dry the filter carefully before installing. Any detergent residue could damage components in the modulator. For this reason, the first option should be to replace the filter with a new one (**PTI Part Number 990202**)

The following data should be recorded in the station log. This information should be compared to previous test recordings to insure normal operations.

1. DC SUPPLY VOLTAGE
2. DC CURRENT
3. OUTPUT POWER PERCENT (%)
4. REFLECTED POWER PERCENT (%)
5. HEAT SINK TEMPERATURE IN DEGREES CELCIUS

Under normal operating conditions is the performance of the adaptive linear and non- linear correction performance should be checked. This can be done remotely if the unit is connected via Ethernet or on each visit to the site. Adaptive linear correction is normally placed in the idle mode once the correction is complete. If so, the corrector can be placed in AUTO RUN for a while to optimize the correction and then returned to the idle mode.

# **SECTION VIII**

## **DTXPRO-10U WARRANTY**

THE INFORMATION PROVIDED HEREIN IS PINEAPPLE TECHNOLOGY INCORPORATED PROPRIETARY INFORMATION AND CANNOT BE COPIED OR DISTRIBUTED WITHOUT PRIOR AUTHORIZATION



### VIII. DTXPRO-10U WARRANTY

The WARRANTY provided by Pineapple Technology, Inc., on this transmitter is detailed below. It should be noted that some of the equipment sub-systems have warranty coverage by the original manufacture that differs from the standard warranty provided by PTI Warranty details on equipment falling into this category may be found in the Manufacturers instruction manual provided with the transmitter. In all cases, replacement units of this equipment are normally in stock at PTI for quick turn service support to our customers during the PTI Standard Warranty period.

#### STANDARD WARRANTY

Seller warrants that each product sold by it is free of defects in materials and workmanship. Seller's obligation under said warranty continues for a period of one (1) year from date of shipment. Repairs or replacement of defective parts shall be the sole and exclusive remedy under warranty, at Seller's option, provided that Seller may, as an alternative, elect to refund an equitable portion of the purchase price of the product. THIS WARRANTY IS EXPRESSLY IN LIEU OF AND EXCLUDES ALL OTHER EXPRESS OR IMPLIED WARRANTIES, INCLUDING BUT NOT LIMITED TO WARRANTIES OF FITNESS FOR A PARTICULAR PURPOSE, USE, OR APPLICATION, AND ALL OTHER OBLIGATIONS OR LIABILITIES ON THE PART OF THE SELLER, UNLESS SUCH OTHER WARRANTIES OBLIGATIONS OR LIABILITIES ARE EXPRESSLY AGREED TO IN WRITING BY SELLER.

#### WARRANTY REPLACEMENT AND REPAIRS

All claims under warranty must be made promptly after occurrence of circumstances giving rise to thereto and must be received within the applicable warranty period by seller or its authorized representatives. Such claims must be documented on a PTI\* Field Failure Report with a full description of the circumstances giving rise to the claim. Before any products are returned for repair and/or adjustment, written authorization from Seller or its authorized representative for the return and instructions as to how and where these products should be shipped must be obtained. This is to include a Return Authorization (RA) number provided by the Seller or its authorized representative, this must accompany ALL returns. Any product returned to the Seller for the examination shall be sent prepaid via the means of transportation indicated as acceptable by Seller. Seller reserves the right to reject any warranty claim not promptly reported and any claim on any item that has been altered, i.e. circuit modifications, components removed, or has been shipped by non acceptable means of transportation . When a product has been returned for examination and inspection, or for any other reason, customer shall be responsible for all damage resulting from improper packaging or handling, and for loss in transit, notwithstanding any defect or nonconformity in the product. In all cases the Seller has sole responsibility for determining the cause and nature of the failure, and the Seller's determination with regard thereto shall be final. If it is found that Seller's product has been returned without cause and is still serviceable, customer will be notified and the product returned at customer's expense. In addition, a charge for testing and examination may, in Seller's sole discretion, be made on products so returned.

- *A Field Failure Report is included at the end of this manual - Additional Field Failure Reports can be obtained by calling Pineapple Technology, Inc. at (916) 652-1116 or you may download one from our website at [www.ptibroadcast.com](http://www.ptibroadcast.com) in the Warranty section.*

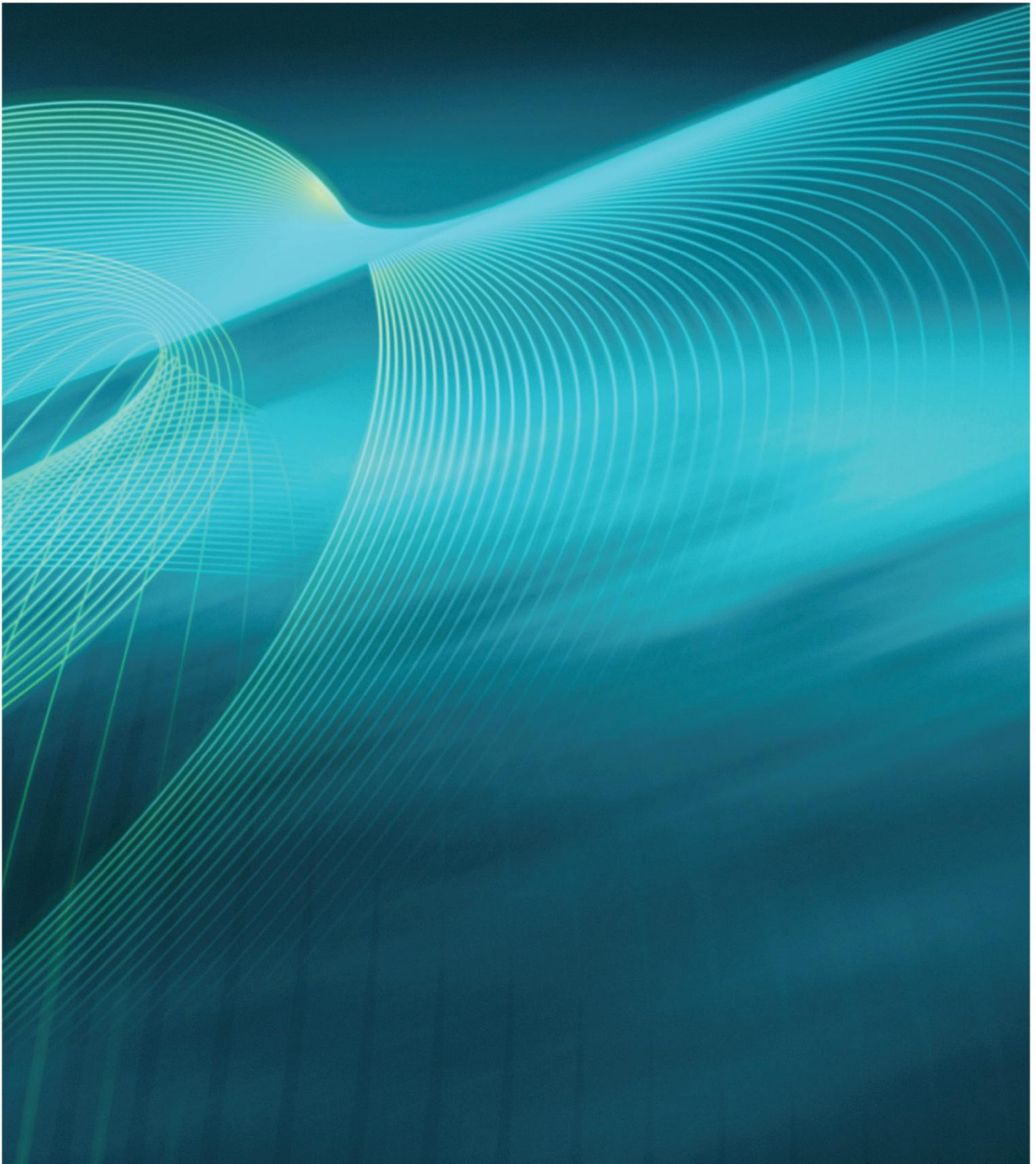

**PINEAPPLE TECHNOLOGY, INC.**

Web site: [www.ptibroadcast.com](http://www.ptibroadcast.com)

4231 Pacific Street, Suite 27, Rocklin, CA 95677

(916) 652-1116 . Fax: (916) 652-1161  
U.S. Toll-free (888) 888-8229

ASSEMBLED IN U.S.A. Some products include foreign components.  
Information contained herein is subject to change without notice.  
© 2010 Pineapple Technology, Inc. All Rights Reserved.