

Operation Manual

CD RECEIVER

DEH-P7000BT



English

Thank you for buying this Pioneer product.

Please read through these operating instructions so you will know how to operate your model properly. *After you have finished reading the instructions, keep this manual in a safe place for future reference.*

01 Before You Start

- Information to User **5**
- For Canadian model **5**
- About this unit **5**
- After-sales service for Pioneer products **8**
- Visit our website **8**
- In case of trouble **8**
- Protecting your unit from theft **8**
 - Removing the front panel **8**
 - Attaching the front panel **9**
- Resetting the microprocessor **9**
- Use and care of the remote control **9**
 - Installing the battery **9**
 - Using the remote control **10**

02 Operating this unit

- What's What **11**
 - Head unit **11**
 - Remote control **12**
 - Display indication **13**
- Basic Operations **14**
 - Power ON/OFF **14**
 - Selecting a source **14**
 - Adjusting the volume **14**
- Tuner **15**
 - Basic Operations **15**
 - Storing and recalling broadcast frequencies **15**
 - Introduction to advanced operations **15**
 - Storing the strongest broadcast frequencies **15**
 - Tuning in strong signals **16**
- Built-in CD Player **16**
 - Basic Operations **16**
 - Selecting a track directly **17**
 - Displaying text information on disc **17**
 - Selecting tracks from the track title list **18**
 - Selecting files from the file name list **18**
 - Introduction to advanced operations **18**

- Selecting a repeat play range **18**
- Playing tracks in random order **19**
- Scanning folders and tracks **19**
- Pausing playback **19**
- Using Sound Retriever **19**
- Using disc title functions **19**
- Playing songs on USB portable audio player/
USB memory **21**
 - Basic Operations **21**
 - Selecting an audio file directly in the current folder **21**
 - Selecting files from the file name list **21**
 - Displaying text information of an audio file **21**
 - Introduction to advanced operations **21**
- Playing songs on iPod **22**
 - Basic Operations **22**
 - Browsing for a song **22**
 - Displaying text information on iPod **23**
 - Introduction to advanced operations **23**
 - Playing songs in a random order (shuffle) **24**
 - Playing all songs in a random order (shuffle all) **24**
 - Selecting songs from album list of currently playing artist **24**
 - Operating this unit's iPod function from your iPod **24**
 - Changing audiobook speed **25**
- Bluetooth Audio **25**
 - Connecting a Bluetooth audio player **25**
 - Disconnecting a Bluetooth audio player **26**
 - Basic Operations **27**
 - Introduction to advanced operations **27**
 - Playing songs on a Bluetooth audio player **27**

- Stopping playback **27**
- Connecting to a Bluetooth audio player automatically **27**
- Displaying BD (Bluetooth Device) address **28**
- Bluetooth Telephone **28**
 - Setting up for hands-free phoning **28**
 - Introduction of connection and registration **29**
 - Connecting and disconnecting a cellular phone **29**
 - Making a phone call **32**
 - Taking a phone call **33**
 - Using the phone number list **33**
 - Using the call history **34**
 - Using the phone book **34**
 - Using preset numbers **36**
 - Introduction to advanced operations **37**
 - Downloading phone books from your cellular phone **38**
 - Transferring entries to the phone book **39**
 - Setting the automatic connection **39**
 - Setting automatic answering **39**
 - Echo canceling and noise reduction **39**
 - Switching the ring tone **40**
 - Making a call by entering phone number **40**
 - Clearing memory **40**
 - Changing the phone book display order **40**
 - Selecting menu language **41**
- 03 Audio Adjustments**
 - Introduction of audio adjustments **42**
 - Using balance adjustment **42**
 - Using the equalizer **42**
 - Recalling equalizer curves **42**
 - Adjusting equalizer curves **43**
 - Fine-adjusting equalizer curve **43**
 - Adjusting loudness **43**
 - Using subwoofer output **44**
 - Adjusting subwoofer settings **44**
 - Using the high pass filter **44**
 - Boosting the bass **45**
 - Adjusting source levels **45**
- 04 Initial Settings**
 - Adjusting initial settings **46**
 - Setting the date **46**
 - Setting the clock **46**
 - Switching the warning tone **46**
 - Switching the auxiliary setting **47**
 - Setting the rear output and subwoofer controller **47**
 - Switching the sound muting/attenuation **47**
 - Setting the internal power amplifier **48**
 - Switching the ever scroll **48**
 - Activating the BT AUDIO source **48**
 - Entering PIN code for Bluetooth wireless connection **48**
 - Editing device name **49**
 - Displaying system version for repair **49**
 - Resetting the Bluetooth wireless technology module **49**
 - Updating the software about Bluetooth connection **50**
- 05 Other Functions**
 - Using the AUX source **51**
 - About AUX1 and AUX2 **51**
 - AUX1 source: **51**
 - AUX2 source: **51**
 - Selecting AUX as the source **51**
 - Setting the AUX title **51**
 - Using the external unit **51**
 - Selecting the external unit as the source **51**
 - Basic operation **52**
 - Advanced operations **52**
 - Turning the clock display on or off **52**
 - Switching the display indication and button illumination **52**
 - Using the PGM button **52**

06 Available accessories

Playing songs on iPod 54

- Basic operation 54
- Displaying text information on iPod 54
- Browsing for a song 54
- Introduction to advanced operations 54
- Playing songs in a random order (shuffle) 55

XM tuner 55

- Listening to XM Satellite Radio 55
- Selecting an XM channel directly 55
- Switching the XM display 55
- Storing and recalling broadcast stations 55
- Switching the XM channel select mode 56
- Displaying the Radio ID 56

SIRIUS Satellite Radio tuner 56

- Listening to SIRIUS Satellite Radio 56
- Selecting a SIRIUS channel directly 57
- Switching the SIRIUS display 57
- Storing and recalling broadcast stations 57
- Introduction of advanced operations 57
- Selecting the SIRIUS channel select mode 58
- Using the Game Alert function 58
- Displaying the Radio ID 59
- Using Instant Replay function 59

HD Radio tuner 60

- Basic Operations 60
- Storing and recalling broadcast frequencies 60
- Switching the display 60
- Introduction to advanced operations 61
- Switching the seek mode 61
- Switching the reception mode 61

Multi-CD Player 61

- Basic Operations 61
- Using CD TEXT functions 62
- Selecting a track directly 62
- Introduction to advanced operations 62
- Using compression and bass emphasis 63
- Using ITS playlists 63
- Using disc title functions 64

DVD Player 65

- Basic Operations 65
- Selecting a disc 65
- Selecting a folder 65
- Introduction to advanced operations 65

TV tuner 67

- Basic Operations 67
- Storing and recalling broadcast stations 67
- Storing the strongest broadcast stations sequentially 68

Additional Information

Troubleshooting 69

Error messages 69

Handling guideline of discs and player 71

Dual Discs 71

Compressed audio compatibility 71

Compressed audio files on the disc 72

- Example of a hierarchy 72

USB audio player/USB memory 72

- USB audio player/USB memory compatibility 72
- Handling guideline and supplemental information 73

iPod 74

- About handling the iPod 74
- About iPod settings 74

Bluetooth profiles 74

Specifications 75

Before You Start

Information to User

FCC ID: AJDK016
 MODEL NO.: DEH-P7000BT
 IC: 775E-K016

This device complies with Part 15 of FCC Rules and RSS-Gen of IC Rules. Operation is subject to the following two conditions: (1) this device may not cause interference, and (2) this device must accept any interference, including interference that may cause undesired operation of this device.

MADE IN THAILAND

This equipment has been tested and found to comply with the limits for a class B digital device, pursuant to Part 15 of the FCC Rules. These limits are designed to provide reasonable protection against harmful interference in a residential installation.

This equipment generates, uses and can radiate radio frequency energy and, if not installed and used in accordance with the instructions, may cause harmful interference to radio communications. However, there is no guarantee that interference will not occur in a particular installation.

If this equipment does cause harmful interference to radio or television reception, which can be determined by turning the equipment off and on, the user is encouraged to try to correct the interference by one or more of the following measures:

- Reorient or relocate the receiving antenna.
- Increase the separation between the equipment and receiver.
- Connect the equipment into an outlet on a circuit different from that to which the receiver is connected.
- Consult the dealer or an experienced radio/TV technician for help.

Alteration or modifications carried out without appropriate authorization may invalidate the user's right to operate the equipment.

- This transmitter must not be co-located or operated in conjunction with any other antenna or transmitter.
- This equipment complies with FCC/IC radiation exposure limits set forth for uncontrolled equipment and meets the FCC/IC radio frequency (RF) Exposure Guidelines in Supplement C to OET65 and RSS-102 of the IC radio frequency (RF) exposure rules. This equipment has very low levels of RF energy that it is deemed to comply without testing of specific absorption ratio (SAR). ▣

For Canadian model

Operation is subject to the following two conditions:

(1) This device may not cause harmful interference, and (2) this device must accept any interference received, including interference that may cause undesired operation.

This Class B digital apparatus complies with Canadian ICES-003.



About this unit

The tuner frequencies on this unit are allocated for use in North America. Use in other areas may result in poor reception.

Before You Start

WARNING

Handling the cord on this product or cords associated with accessories sold with the product may expose you to chemicals listed on proposition 65 known to the State of California and other governmental entities to cause cancer and birth defects or other reproductive harm. **Wash hands after handling.**

**CAUTION:
USE OF CONTROL OR ADJUSTMENT OR
PERFORMANCE OF PROCEDURES
OTHER THAN THOSE SPECIFIED HEREIN
MAY RESULT IN HAZARDOUS RADIATION
EXPOSURE.**

**CAUTION:
THE USE OF OPTICAL INSTRUMENTS
WITH THIS PRODUCT WILL INCREASE
EYE HAZARD.**

CAUTION

- Do not allow this unit to come into contact with liquids. Electrical shock could result. Also, damage to this unit, smoke, and overheating could result from contact with liquids.
- Keep this manual handy as a reference for operating procedures and precautions.
- Always keep the volume low enough so that you can hear sounds from outside the vehicle.
- Protect this unit from moisture.
- If the battery is disconnected or discharged, the preset memory will be erased and must be reprogrammed.

Important (Serial number)

The serial number is located on the bottom of this unit. For your own security and convenience, be sure to record this number on the enclosed warranty card.

About WMA



The Windows Media™ logo printed on the box indicates that this unit can play back WMA data.

Windows Media and the Windows logo are trademarks or registered trademarks of Microsoft Corporation in the United States and/or other countries.

- This unit may not operate correctly depending on the application used to encode WMA files.

About MP3

Supply of this product only conveys a license for private, non-commercial use and does not convey a license nor imply any right to use this product in any commercial (i.e. revenue-generating) real time broadcasting (terrestrial, satellite, cable and/or any other media), broadcasting/streaming via internet, intranets and/or other networks or in other electronic content distribution systems, such as pay-audio or audio-on-demand applications. An independent license for such use is required. For details, please visit <http://www.mp3licensing.com>.

About AAC

This unit plays back AAC files encoded by iTunes®.

iTunes is a trademark of Apple Inc., registered in the U.S. and other countries.

Portable audio player compatibility

- Inquire at the manufacturer about your USB portable audio player/USB memory. This unit corresponds to the following.
 - USB MSC (Mass Storage Class) compliant portable audio player and memory
 - WMA, MP3, AAC and WAV file playback

Before You Start

For details about the compatibility, refer to *USB audio player/USB memory compatibility* on page 72.

iPod® compatibility

This unit can control and listen to songs on an iPod.

- This unit supports only the following iPods. Supported iPod software versions are shown below. Older versions of iPod software may not be supported.
 - iPod nano first generation (software version 1.3.1)
 - iPod nano second generation (software version 1.2.1)
 - iPod nano third generation (software version 1.0.2)
 - iPod fifth generation (software version 1.2.1)
 - iPod classic (software version 1.0.2)
 - iPod touch (software version 1.1.1)
- Operations may vary depending on the software version of iPod.
- When using an iPod, iPod Dock Connector to USB Cable is required.
- Pioneer CD-IU50 interface cable is also available. For details, consult your dealer.
- This unit can control previous generations iPod models with a Pioneer iPod adapter (e.g. CD-IB100II). For details concerning operation with the iPod adapter, refer to *Playing songs on iPod* on page 54.
- iPod is a trademark of Apple Inc., registered in the U.S. and other countries.

About Bluetooth



Bluetooth is a short-range wireless radio connectivity technology that is developed as a cable replacement for mobile phones, hand-

held PCs and other devices. Bluetooth operates in 2.4 GHz frequency range and transmits voice and data at speeds up to 1 megabit per second. Bluetooth was launched by a special interest group (SIG) that comprises of Ericsson Inc., Intel Corp., Nokia Corp., Toshiba and IBM in 1998, and it is currently developed by nearly 2 000 companies worldwide.

- The Bluetooth word mark and logos are owned by the Bluetooth SIG, Inc. and any use of such marks by Pioneer Corporation is under license. Other trademarks and trade names are those of their respective owners.

About the SAT RADIO READY mark



The SAT RADIO READY mark indicates that the Satellite Radio Tuner for Pioneer (i.e., XM tuner and Sirius satellite tuner which are sold separately) can be controlled by this unit. Please inquire to your dealer or nearest authorized Pioneer service station regarding the satellite radio tuner that can be connected to this unit. For satellite radio tuner operation, please refer to the satellite radio tuner owner's manual.

- The system will use direct satellite-to-receiver broadcasting technology to provide listeners in their cars and at home with crystal-clear sound seamlessly from coast to coast. Satellite radio will create and package over 100 channels of digital-quality music, news, sports, talk and children's programming.
- "SAT Radio", the SAT Radio logo and all related marks are trademarks of Sirius Satellite Radio inc., and XM Satellite Radio Inc.

About HD Radio

- The HD Radio Ready logo is a proprietary trademark of iBiquity Digital Corp.

CAUTION

- Pioneer accepts no responsibility for data lost on the USB portable audio player/USB memory even if that data is lost while using this unit.
- Pioneer accepts no responsibility for data lost on the iPod even if that data is lost while using this unit. 

After-sales service for Pioneer products

Please contact the dealer or distributor from where you purchased this unit for after-sales service (including warranty conditions) or any other information. In case the necessary information is not available, please contact the companies listed below:

Please do not ship your unit to the companies at the addresses listed below for repair without advance contact.

U.S.A.

Pioneer Electronics (USA) Inc.
CUSTOMER SUPPORT DIVISION
P.O. Box 1760
Long Beach, CA 90801-1760
800-421-1404

CANADA

Pioneer Electronics of Canada, Inc.
CUSTOMER SATISFACTION DEPARTMENT
300 Allstate Parkway
Markham, Ontario L3R 0P2
1-877-283-5901
905-479-4411

For warranty information please see the Limited Warranty sheet included with this unit. 

Visit our website

Visit us at the following site:

<http://www.pioneerelectronics.com>

- 1 Register your product. We will keep the details of your purchase on file to help you refer to this information in the event of an insurance claim such as loss or theft.
- 2 Receive updates on the latest products and technologies.
- 3 Download owner's manuals, order product catalogues, research new products, and much more. 

In case of trouble

Should this product fail to operate properly, contact your dealer or nearest authorized Pioneer Service Station. 

Protecting your unit from theft

The front panel can be detached to deter theft.

- If the front panel is not detached from the head unit within five seconds of turning off the ignition, a warning tone sounds.
- You can turn off the warning tone. See *Switching the warning tone* on page 46.



Important

- Handle gently when removing or attaching the front panel.
- Avoid subjecting the front panel to excessive shock.
- Keep the front panel out of direct sunlight and high temperatures.

Removing the front panel

- 1 **Press OPEN to open the front panel.**
- 2 **Grip the left side of the front panel and pull it gently outward.**

Take care not to grip it too tightly or to drop the front panel and protect it from contact with water or other fluids to prevent permanent damage.

Before You Start

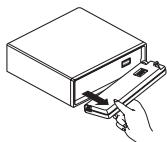

- Put the front panel into the provided protective case for safe keeping.

Attaching the front panel

- Reattach the front panel by holding it upright to the unit and clipping it securely into the mounting hooks.

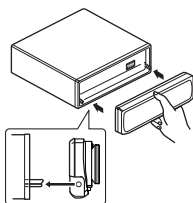

Resetting the microprocessor

The microprocessor must be reset under the following conditions:

- Prior to using this unit for the first time after installation
- If the unit fails to operate properly
- When strange or incorrect messages appear on the display

- Press RESET with a pen tip or other pointed instrument.

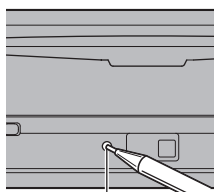

RESET button



Use and care of the remote control

Installing the battery

Slide the tray on the back of the remote control out and insert the battery with the plus (+) and minus (-) poles aligned properly.

- When using for the first time, pull out the film protruding from the tray.

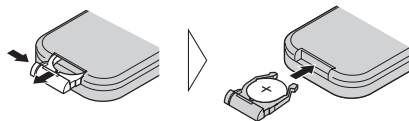

WARNING

Keep the battery out of the reach of children. Should the battery be swallowed, consult a doctor immediately.

CAUTION

- Use one **CR2025 (3 V)** lithium battery.
- Remove the battery if the remote control is not used for a month or longer.
- There is a danger of explosion if the battery is incorrectly replaced. Replace only with the same or equivalent type.
- Do not handle the battery with metallic tools.
- Do not store the battery with metallic objects.

Before You Start

- If the battery leaks, wipe the remote control completely clean and install a new battery.
- When disposing of used batteries, comply with governmental regulations or environmental public institutions' rules that apply in your country/area.
- "Perchlorate Material – special handling may apply.
See www.dtsc.ca.gov/hazardouswaste/perchlorate. (Applicable to California, U.S.A.)"

Using the remote control

Point the remote control in the direction of the front panel to operate.

- The remote control may not function properly in direct sunlight.



Important

- Do not store the remote control in high temperatures or direct sunlight.
- Do not let the remote control fall onto the floor, where it may become jammed under the brake or accelerator pedal. 

Operating this unit

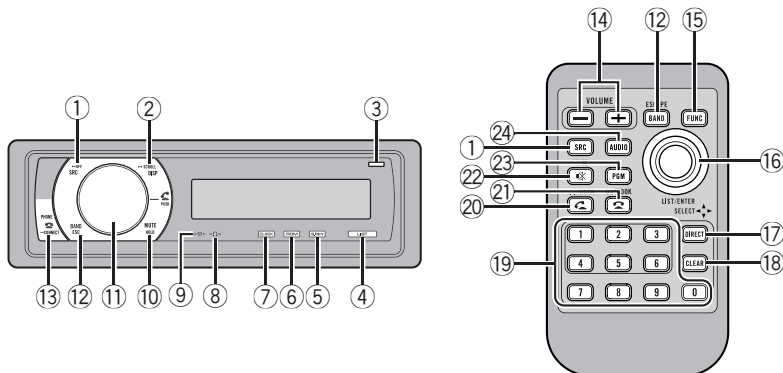

What's What

Head unit

① SRC/OFF button

This unit is turned on by selecting a source. Press to cycle through all the available sources.

② DISP/SCROLL button

Press to select different displays.

③ OPEN button

Press to open the front panel.

④ LIST button

Press to display the disc title list, track title list, folder list, file list, preset channel list or phone number list depending on the source.

⑤ S.Rtrv/SAT MODE button

Press to switch Sound Retriever settings. When XM tuner or SIRIUS tuner is selected as the source, press to change the channel select mode. When SIRIUS tuner is selected as the source, press and hold to perform the Instant Replay mode.

⑥ RDM/∞/iPod button

Press to turn random function on or off while using CD or USB.

While using an iPod, press to shuffle all tracks.

Press and hold to switch the control mode while using an iPod.

If using the iPod with an interface adapter (CD-IB100II), press to switch the shuffle function.

⑦ CLOCK/DISP OFF button

Press to change to the clock display.

Press and hold to turn the display indication and button illumination off or on.

⑧ "BT" indicator

Lights up when your Bluetooth audio player is connected via Bluetooth wireless technology.

- While connecting, this indicator flashes.

⑨ "C" indicator

Lights up when your cellular phone is connected via Bluetooth wireless technology.

- While connecting, this indicator flashes.
- While phone connection is not completed, this indicator flashes.

Operating this unit



1

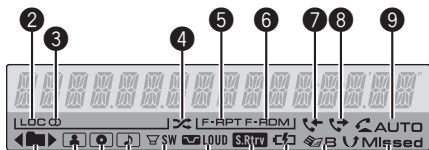

10

11

12

13

14

15

16

17

18

19

10 MUTE/HOLD button

Press to turn off the sound. To turn on the sound, press again.

While talking on the phone, press to put the call on hold.

11 MULTI-CONTROL

Move to perform manual seek tuning, fast forward, reverse and track search controls. Also used for controlling functions.

Turn to increase or decrease the volume.

12 BAND/ESC button

Press to select among three FM bands and one AM band.

Press to return to the ordinary display when operating the menu.

13 PHONE/CONNECT button

Press to select the phone as the source.

While operating a phone source, press to end a call, reject an incoming call or cancel making a call.

Press and hold to perform Bluetooth connection.

Remote control

Operation is the same as when using the buttons on the head unit.

14 VOLUME buttons

Press to increase or decrease the volume.

15 FUNCTION button

Press to select functions.

16 Thumb pad

Move to perform manual seek tuning, fast forward, reverse and track search controls. Also used for controlling functions.

Functions are the same as

MULTI-CONTROL except for volume control.

17 DIRECT button

Press to directly select the desired track.

18 CLEAR button

Press to cancel the input number when **0** to **9** are used.

19 0 to 9 buttons

Press to directly select the desired track, preset tuning or disc. Buttons **1** to **6** can operate the preset tuning for the tuner or disc number search for the multi-CD player.

20 (off hook) button

Press to start talking on the phone while operating a phone source.

21 (on hook) button

While operating the phone source, press to end a call or reject an incoming call.

22 (mute) button

Press to turn off the sound. To turn on the sound, press again.

23 PGM button

Press to operate the preprogrammed functions for each source. (Refer to *Using the PGM button* on page 52.)

24 AUDIO button

Press to select an audio function.

Operating this unit

Display indication

1 Main display section

Displays band, frequency, elapsed playback time and other settings.

- Tuner
Band and frequency are displayed.
- Built-in CD player, USB, iPod
Elapsed playback time and literal information are displayed.

2 LOC indicator

Appears when local seek tuning is on.

3 (stereo) indicator

Appears when the selected frequency is being broadcast in stereo.

4 (shuffle) indicator

Appears when shuffle function is on while iPod source is being selected.

5 F-RPT indicator

Appears when folder repeat is on.
When repeat function is on, only **RPT** is displayed.

6 F-RDM indicator

Appears when folder random is on.
When random function is on, only **RDM** is displayed.

7 (received call) indicator

Appears when received call list is displayed while telephone source is being selected.

8 (dialled call) indicator

Appears when dialled call list is displayed while telephone source is being selected.

9 **AUTO (auto answer) indicator**

Shows when the automatic answering function is on (for more details, refer to *Setting automatic answering* on page 39).

10 (folder) indicator

Appears when operating list function.
When an upper tier folder or menu exists, ◀ appears.

When a lower tier folder or menu exists, ▶ appears.

11 (artist) indicator

Appears when the disc (track) artist name is displayed on the main display section.

Appears when artist search refinement on the iPod browsing function is in use.

12 (disc) indicator

Appears when the disc (album) name is displayed on the main display section.

Appears when album search refinement on the iPod browsing function is in use.

13 (song) indicator

Appears when the track (song) name is displayed on the main display section.

Appears when song search refinement on the iPod browsing function is in use.

14 **SW (subwoofer) indicator**

Appears when subwoofer is on.

15 (loudness) indicator

Appears when loudness is on.

16 **S.Rtrv (Sound Retriever) indicator**

Appears when Sound Retriever function is on.

17 (iPod connection) indicator

Appears when the iPod connection is recognized while USB source is being selected.

18 **B (phone book) indicator**

Appears when phone book list is displayed while telephone source is being selected.

19 **Missed (missed call) indicator**

Appears when there are missed call log.
Appears when missed call list is displayed while telephone source is being selected. ◻

Basic Operations

Power ON/OFF

Turning the unit on

- Press **SRC** to turn the unit on.

Turning the unit off

- Press **OFF** and hold until the unit turns off.

Selecting a source

You can select a source you want to listen to. To switch to the built-in CD player, load a disc in the unit (refer to page 16).

- Press **SRC** repeatedly to switch between the following sources.
XM tuner—Sirius tuner—HD Radio—Tuner—Television—DVD player/Multi-DVD player—Built-in CD player—Multi-CD player—iPod—USB—External unit 1—External unit 2—AUX1—AUX2—BT Audio—BT Telephone



Notes

- In the following cases, the sound source will not change.
 - When no unit corresponding to the selected source is connected.
 - When there is no disc or magazine in the player.
 - When the iPod is not connected to this unit.
 - When AUX (auxiliary input) is set to off (refer to page 47).
 - When the BT audio source is set to off (refer to *Activating the BT AUDIO source* on page 48).
- If the HD Radio tuner is connected to this unit, tuner source is skipped.
- AUX1 is set to on by default. Turn off the AUX1 when not in use (refer to *Switching the auxiliary setting* on page 47).

- Charging the portable audio player using car's DC power source while connecting it to AUX input may generate noise. In this case, stop charging.
- External unit refers to a Pioneer product (such as ones available in the future) that, although incompatible as a source, enables control of basic functions with this unit. Two external units can be controlled with this unit. When two external units are connected, the external unit is automatically allocated to external unit 1 or external unit 2 by this unit.
- When this unit's blue/white lead is connected to the vehicle's auto-antenna relay control terminal, the vehicle's antenna extends when this unit's source is turned on. To retract the antenna, turn the source off.

Adjusting the volume

- Use **MULTI-CONTROL** to adjust the sound level.

Operating this unit

Tuner

Basic Operations

- **Select a band**

Press **BAND/ESC**.

- Band can be selected from among **FM1**, **FM2**, **FM3** or **AM**.

- **Manual tuning (step by step)**

Push **MULTI-CONTROL** left or right.

- **Seek tuning**

Push and hold **MULTI-CONTROL** left or right, and then release.

- You can cancel seek tuning by pushing **MULTI-CONTROL** left or right.
- While pushing and holding **MULTI-CONTROL** left or right, you can skip stations. Seek tuning starts as soon as you release **MULTI-CONTROL**.

Storing and recalling broadcast frequencies

You can easily store up to six broadcast frequencies for later recall.

- Six stations for each band can be stored in memory.

1 Press **LIST**.

Preset screen is displayed.

2 Use **MULTI-CONTROL** to store the selected frequency in memory.

Turn to change the preset number. Press and hold to store.

3 Use **MULTI-CONTROL** to select the desired station.

Turn to change the station. Press to select.

- You can also change the station by pushing **MULTI-CONTROL** up or down.
- To return to the ordinary display, press **BAND/ESC** or **LIST**.
- If you do not operate the list within about 30 seconds, the display automatically returns to the ordinary display.

Using the remote control

- When you find a frequency that you want to store in memory, press one of preset tuning buttons **1** to **6** and hold until the preset number stops flashing.

The number you have pressed will flash in the preset number indicator and then remain lit.

The selected radio station frequency has been stored in memory.

The next time you press the same preset tuning button the radio station frequency is recalled from memory.

- You can also recall radio station frequencies assigned to preset tuning numbers by pushing **MULTI-CONTROL** up or down during the frequency display.

Introduction to advanced operations

1 Press **MULTI-CONTROL to display the main menu.**

2 Use **MULTI-CONTROL to select **FUNCTION**.**

Turn to change the menu option. Press to select.

The function menu is displayed.

3 Turn **MULTI-CONTROL to select the function.**

BSM (best stations memory)—**LOCAL** (local seek tuning)



Notes

- You can also select the function by pressing **FUNCTION** on the remote control.
- To return to the ordinary display, press **BAND/ESC**.

Storing the strongest broadcast frequencies

BSM (best stations memory) lets you automatically store the six strongest broadcast frequencies.

Operating this unit

1 Display the function menu.

Refer to *Introduction to advanced operations* on the previous page.

2 Use MULTI-CONTROL to select BSM in the function menu.

3 Press MULTI-CONTROL to turn BSM on.

The six strongest broadcast frequencies are stored in the order of their signal strength.

- To cancel, press **MULTI-CONTROL** again.

Tuning in strong signals

Local seek tuning lets you tune in only those radio stations with sufficiently strong signals for good reception.

1 Display the function menu.

Refer to *Introduction to advanced operations* on the previous page.

2 Use MULTI-CONTROL to select LOCAL in the function menu.

3 Press MULTI-CONTROL to turn local seek tuning on.

- To turn local seek tuning off, press **MULTI-CONTROL** again.

4 Push MULTI-CONTROL left or right to set the sensitivity.

FM: **LEVEL 1—LEVEL 2—LEVEL 3—LEVEL 4**

AM: **LEVEL 1—LEVEL 2**

The **LEVEL 4** setting allows reception of only the strongest stations, while lower settings let you receive progressively weaker stations. 

Built-in CD Player

Basic Operations

● Open the front panel

Press **OPEN**.

Disc loading slot appears.

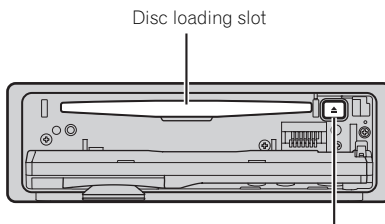

▲ (eject) button

▪ When loading a disc, face the label side of a disc up.

- To avoid a malfunction, make sure that no metal objects come into contact with the terminals when the front panel is open.

● Eject a disc

Press ▲ (eject).

● Select a folder

Push **MULTI-CONTROL** up or down.

- You cannot select a folder that does not have a compressed audio file recorded in it.

● Select a track

Push **MULTI-CONTROL** left or right.

● Fast forward or reverse

Push and hold **MULTI-CONTROL** left or right.

- When playing compressed audio, there is no sound on fast forward or reverse.

● Return to root folder

Press and hold **BAND/ESC**.

- If folder 01 (ROOT) contains no files, playback commences with folder 02.

● Switch between compressed audio and CD-DA

Press **BAND/ESC**.

- This operation is available only when playing CD-EXTRA or MIXED-MODE CDs.

Operating this unit

- If you have switched between compressed audio and CD-DA, playback starts at the first track on the disc.

Notes

- The built-in CD player can play back audio CD and compressed audio recorded on a CD-ROM. (Refer to page 72 for files that can be played back.)
- Read the precautions for discs and player on page 71.
- A disc has already been inserted, press **SRC** to select the built-in CD player.
- There is sometimes a delay between starting up disc playback and the sound being issued. When being read, **FORMAT READ** is displayed.
- If an error message is displayed, refer to *Error messages* on page 69.
- Playback is carried out in order of file number. Folders are skipped if they contain no files. (If folder 01 (ROOT) contains no files, playback commences with folder 02.)

Selecting a track directly

When using the remote control, you can select a track directly by entering the desired track number.

- When audio files are being played back, you can select track in the current folder.

1 Press **DIRECT**.

Track number input display appears.

2 Press **0 to 9** to enter the desired track number.

- You can cancel the input number by pressing **CLEAR**.

3 Press **DIRECT**.

The track for the entered number will play.

- After entering the number input mode, if you do not perform an operation within about eight seconds, the mode is automatically canceled.

Displaying text information on disc

- Press **DISP** to select the desired text information.

For title entered **CD**

Play time—disc title

For **CD TEXT** discs

Play time—disc title—disc artist name—track title—track artist name

For **WMA/MP3/AAC**

Play time—folder name—file name—track title—artist name—album title—comment—bit rate

For **WAV**

Play time—folder name—file name—sampling frequency

Notes

- You can scroll to the left of the title by pressing and holding **DISP**.
- Audio CD that contains certain information such as text and/or number is CD TEXT.
- If specific information is not recorded on a disc, title or name is not displayed.
- Depending on the version of iTunes® used to write MP3 files onto a disc, comment information may not be correctly displayed.
- Depending on the version of Windows Media Player used to encode WMA files, album names and other text information may not be correctly displayed.
- When playing back VBR (variable bit rate)-recorded WMA files, the average bit rate value is displayed.
- When playing back VBR (variable bit rate)-recorded MP3 files, **VBR** is displayed instead of bit rate value.
- The sampling frequency shown in the display may be abbreviated.
- When Ever Scroll is set to ON at the initial setting, text information scrolls continuously in the display. Refer to *Switching the ever scroll* on page 48.

Selecting tracks from the track title list

Track title list lets you see the list of track titles on a CD TEXT disc and select one of them to play back.

1 Press LIST to switch to the track title list mode.

2 Use MULTI-CONTROL to select the desired track title.

Turn to change the track title. Press to play.

- You can also change the track title by pushing **MULTI-CONTROL** up or down.
- You can also play the track by pushing **MULTI-CONTROL** right.
- To return to the ordinary display, press **BAND/ESC** or **LIST**.
- If you do not operate the list within about 30 seconds, the display automatically returns to the ordinary display.

Selecting files from the file name list

File name list lets you see the list of file names (or folder names) and select one of them to playback.

1 Press LIST to switch to the file name list mode.

Names of files and folders appear in the display.

2 Use MULTI-CONTROL to select the desired file name (or folder name).

Turn to change the name of file or folder.

- when a file is selected, press to play.
- when a folder is selected, press to see a list of files (or folders) in the selected folder.
- when a folder is selected, press and hold to play a song in the selected folder.
- You can also play the file by pushing **MULTI-CONTROL** right.
- You can also play a song in the selected folder by pushing and holding **MULTI-CONTROL** right.

- To return to the previous list (the folder one level higher), push **MULTI-CONTROL** left.
- To return to the ordinary display, press **BAND/ESC** or **LIST**.
- If you do not operate the list within about 30 seconds, the display automatically returns to the ordinary display.

Introduction to advanced operations

1 Press MULTI-CONTROL to display the main menu.

2 Use MULTI-CONTROL to select FUNCTION.

Turn to change the menu option. Press to select.

The function menu is displayed.

3 Turn MULTI-CONTROL to select the function.

REPEAT (repeat play)—**RANDOM** (random play)—**SCAN** (scan play)—**PAUSE** (pause)—**S. RTRV** (sound retriever)—**TITLE INPUT** (disc title input)



Notes

- You can also select the function by pressing **FUNCTION** on the remote control.
- To return to the ordinary display, press **BAND/ESC**.
- If you do not operate functions except for **TITLE INPUT** within about 30 seconds, the display automatically returns to the ordinary display.
- When playing a compressed audio disc or CD TEXT disc, you cannot switch to disc title input display.

Selecting a repeat play range

1 Display the function menu.

Refer to *Introduction to advanced operations* on this page.

Operating this unit

2 Use MULTI-CONTROL to select REPEAT in the function menu.

3 Press MULTI-CONTROL to select the desired setting.

- **DISC** – Repeat all tracks
- **TRACK** – Repeat the current track
- **FOLDER** – Repeat the current folder
- If you select another folder during repeat play, the repeat play range changes to disc repeat.
- Performing track search or fast forward/reverse during **TRACK** (track repeat) changes the repeat play range to disc/folder.
- When **FOLDER** (folder repeat) is selected, it is not possible to play back a subfolder of that folder.

Playing tracks in random order

Tracks in a selected repeat range are played in random order.

● **Press RDM to turn random play on.**

Tracks play in a random order.

- To turn random play off, press **RDM** again.



Note

You can also turn this function on or off in the menu that appears by using **MULTI-CONTROL**.

Scanning folders and tracks

Scan play searches the song within the selected repeat range.

1 Display the function menu.

Refer to *Introduction to advanced operations* on the previous page.

2 Use MULTI-CONTROL to select SCAN in the function menu.

3 Press MULTI-CONTROL to turn scan play on.

The first 10 seconds of each track is played.

4 When you find the desired track press MULTI-CONTROL to turn scan play off.

- If the display has automatically returned to the playback display, select **SCAN** again by using **MULTI-CONTROL**.
- After scanning of a disc (folder) is finished, normal playback of the tracks begins.

Pausing playback

1 Display the function menu.

Refer to *Introduction to advanced operations* on the previous page.

2 Use MULTI-CONTROL to select PAUSE in the function menu.

3 Press MULTI-CONTROL to turn pause on.

Playback of the current track pauses.

- To turn pause off, press **MULTI-CONTROL** again.

Using Sound Retriever

Sound Retriever function automatically enhances compressed audio and restores rich sound.

● **Press S.Rtrv repeatedly to select the desired setting.**

OFF (off)—**1**—**2**

- **2** is more effective than **1**.



Note

You can also perform this operation in the menu that appears by using **MULTI-CONTROL**.

Using disc title functions

You can input CD titles and display the title.

The next time you insert a CD for which you have entered a title, the title of that CD is displayed.

Operating this unit

Entering disc titles

Use the disc title input feature to store up to 48 CD titles in the unit. Each title can be up to 10 characters long.

1 Display the function menu.

Refer to *Introduction to advanced operations* on page 18.

2 Play the CD that you want to enter a title for.

3 Use **MULTI-CONTROL** to select **TITLE INPUT** in the function menu.

4 Press **MULTI-CONTROL** to display the title input mode.

5 Push **MULTI-CONTROL** up or down to select a letter of the alphabet.

6 Press **DISP** to select the desired character type.

Press **DISP** repeatedly to switch between the following character types:
Alphabet—Numbers

7 Push **MULTI-CONTROL** left or right to move the cursor to the previous or next character position.

8 Move the cursor to the last position by pushing **MULTI-CONTROL** right after entering the title.

When you push **MULTI-CONTROL** right one more time, the entered title is stored in memory.

9 Press **BAND/ESC** to return to the playback display.



Notes

- Titles remain in memory, even after the disc is removed from the unit, and are recalled when the disc is reinserted.
- After data for 48 discs are stored in the memory, data for a new disc overwrites the oldest one.

- If you connect a multi-CD player, you can input disc titles for up to 100 discs.
- When a multi-CD player that does not support disc title functions is connected, you cannot enter disc titles in this unit.

Operating this unit

Playing songs on USB portable audio player/USB memory

For details about the supported device, refer to *Portable audio player compatibility* on page 6.

Basic Operations

- **Select a folder**

Push **MULTI-CONTROL** up or down.

- **Fast forward or reverse**

Push and hold **MULTI-CONTROL** left or right.

- **Select a track**

Push **MULTI-CONTROL** left or right.

- **Return to root folder**

Press and hold **BAND/ESC**.



Notes

- Optimum performance of this unit may not be obtained depending on the connected USB portable audio player/USB memory.
- If folder 01 (ROOT) contains no files, playback commences with folder 02.
- When the USB portable audio player having battery charging function is connected to this unit and the ignition switch is set to ACC or ON, the battery is charged.
- You can disconnect the USB portable audio player/USB memory anytime you want to finish listening to it.
- If USB portable audio player/USB memory is connected to this unit, the source is changed to USB automatically. If you do not use an USB device, disconnect it from this unit. Depending on the connected USB device, turning on the ignition switch while USB device is connected to this unit may change the source automatically.

Selecting an audio file directly in the current folder

The operation is the same as that of the built-in CD player.

Refer to *Selecting a track directly* on page 17.

Selecting files from the file name list

The operation is the same as that of the built-in CD player. (Refer to *Selecting files from the file name list* on page 18.)

Displaying text information of an audio file

The operation is the same as that of the built-in CD player.

Refer to *Displaying text information on disc* on page 17.



Notes

- If the characters recorded on the audio file are not compatible with the head unit, those characters are not displayed.
- If specific information is not recorded on an audio file, title or name is not displayed.
- The text information of some audio files may not be correctly displayed.
- You can scroll the text information to the left by pressing and holding **DISP**.
- When Ever Scroll is set to ON at the initial setting, text information scrolls continuously in the display. Refer to *Switching the ever scroll* on page 48.

Introduction to advanced operations

1 Press **MULTI-CONTROL** to display the main menu.

2 Use **MULTI-CONTROL** to select **FUNCTION**.

Turn to change the menu option. Press to select.

The function menu is displayed.

3 Turn **MULTI-CONTROL** to select the function.

REPEAT (repeat play)—**RANDOM** (random play)—**SCAN** (scan play)—**PAUSE** (pause)—

S. RTRV (sound retriever)

Function and operation

REPEAT, RANDOM, SCAN, PAUSE and **S. RTRV** operations are basically the same as that of the built-in CD player.

Function name	Operation
REPEAT	Refer to <i>Selecting a repeat play range</i> on page 18. However, the repeat play ranges you can select are different from that of the built-in CD player. The repeat play ranges of the USB portable audio player/USB memory are: <ul style="list-style-type: none"> • TRACK – Repeat just the current file • FOLDER – Repeat the current folder • ALL – Repeat all files
RANDOM	Refer to <i>Playing tracks in random order</i> on page 19.
SCAN	Refer to <i>Scanning folders and tracks</i> on page 19.
PAUSE	Refer to <i>Pausing playback</i> on page 19.
S. RTRV	Refer to <i>Using Sound Retriever</i> on page 19.



Notes

- You can also select the function by pressing **FUNCTION** on the remote control.
- To return to the ordinary display, press **BAND/ESC**.
- If you select another folder during repeat play, the repeat play range changes to **ALL**.
- If you perform track search or fast forward/reverse during **TRACK**, the repeat play range changes to **FOLDER**.
- When **FOLDER** is selected, it is not possible to play back a subfolder of that folder.
- After file or folder scanning is finished, normal playback of the files begins again. 

Playing songs on iPod

For details about the supported iPod, refer to iPod® compatibility on page 7.

Basic Operations

- **Fast forward or reverse**
Push and hold **MULTI-CONTROL** left or right.
- **Select a track (chapter)**
Push **MULTI-CONTROL** left or right.



Notes

- When using an iPod, iPod Dock Connector to USB Cable is required.
- Read the precautions for iPod on page 74.
- While iPod is connected to this unit, **PIONEER** (or ✓ (check mark)) is displayed on the iPod.
- If an error message is displayed, refer to *Error messages* on page 69.
- When the ignition switch is set to ACC or ON, the iPod's battery is charged while the iPod is connected to this unit.
- While the iPod is connected to this unit, the iPod cannot be turned on or off.
- Before connecting the dock connector of this unit to the iPod, disconnect the headphones from the iPod.
- The iPod is turned off about two minutes after the ignition switch is set to OFF.

Browsing for a song

Searching songs by category

Operations to control an iPod with this unit is designed to be as close to the iPod as possible to make operation and song search easy.

- Depending on the number of files in the iPod, there may be a delay when displaying a list.
- If the characters recorded on the iPod are not compatible with this unit, those characters are not displayed.

1 Press LIST.

Operating this unit

2 Use MULTI-CONTROL to select a category.

Turn to change the category; press to select.

PLAYLISTS (playlists)—**ARTISTS** (artists)—**ALBUMS** (albums)—**SONGS** (songs)—**PODCASTS** (podcasts)—**GENRES** (genres)—**COMPOSERS** (composers)—**AUDIOBOOKS** (audiobooks)

List for the selected category is displayed.

- You can start playback throughout the selected category by pressing and holding **MULTI-CONTROL**. You can also perform this operation by pushing and holding **MULTI-CONTROL** right.
- You can also change the category by pushing **MULTI-CONTROL** up or down.
- You can also select the category by pushing **MULTI-CONTROL** right.
- To return to the previous category, push **MULTI-CONTROL** left.

3 Repeat step 2 to find a song you want to listen to.

- To return to the top tier of categories, push and hold **MULTI-CONTROL** left.
- If you do not operate the list within about 30 seconds, the display automatically returns to the ordinary display.

Searching songs by alphabet

1 Press LIST.

2 Use MULTI-CONTROL to select a category.

Turn to change the category. Press to select.

3 Press LIST to switch to alphabet search mode.

4 Turn MULTI-CONTROL to select a desired alphabet.

5 Press MULTI-CONTROL to display the alphabetical list.

Displaying text information on iPod

● Press DISP to select the desired text information.

Play time—song title—artist name—album title

- If the characters recorded on the iPod are not compatible with this unit, those characters are not displayed.



Notes

- You can scroll the text information to the left by pressing and holding **DISP**.
- When Ever Scroll is set to ON at the initial setting, text information scrolls continuously in the display. Refer to *Switching the ever scroll* on page 48.

Introduction to advanced operations

1 Press MULTI-CONTROL to display the main menu.

2 Use MULTI-CONTROL to select FUNCTION.

Turn to change the menu option. Press to select.

The function menu is displayed.

3 Turn MULTI-CONTROL to select the function.

REPEAT (repeat play)—**SHUFFLE** (shuffle)—**SHUFFLE ALL** (shuffle all)—**LINK SEARCH** (link search)—**CONTROL** (control mode)—**PAUSE** (pause)—**AUDIOBOOKS** (audiobook speed)—**S. RTRV** (sound retriever)

Function and operation

REPEAT, **PAUSE** and **S. RTRV** operations are basically the same as that of the built-in CD player.

Function name	Operation
REPEAT	Refer to <i>Selecting a repeat play range</i> on page 18. However, the repeat play ranges you can select are different from that of the built-in CD player. The repeat play ranges of the iPod are: <ul style="list-style-type: none"> • ONE – Repeat the current song • ALL – Repeat all songs in the selected list
PAUSE	Refer to <i>Pausing playback</i> on page 19.
S. RTRV	Refer to <i>Using Sound Retriever</i> on page 19.



Notes

- You can also select the function by pressing **FUNCTION** on the remote control.
- To return to the ordinary display, press **BAND/ESC**.
- If you do not operate functions within about 30 seconds, the display automatically returns to the ordinary display.
- When **CONTROL** is on, only **CONTROL** and **S. RTRV** can be operated.

Playing songs in a random order (shuffle)

1 Display the function menu.

Refer to *Introduction to advanced operations* on the previous page.

2 Use **MULTI-CONTROL** to select **SHUFFLE** in the function menu.

3 Press **MULTI-CONTROL** to select the desired setting.

- **SONGS** – Play back songs in the selected list in random order.
- **ALBUMS** – Play back songs from a randomly selected album in order.
- **OFF** – Cancel random play.

Playing all songs in a random order (shuffle all)

● Press **⌘** to turn shuffle all on.

All songs on the iPod play randomly.

- To turn shuffle all off, set **SHUFFLE** in the **FUNCTION** menu to off.



Note

You can also turn this function on in the menu that appears by using **MULTI-CONTROL**.

Selecting songs from album list of currently playing artist

Album list of the currently selected artist is displayed. You can select an album or song from the artist name.

- Depending on the number of files in the iPod, there may be a delay when displaying a list.

1 Press and hold **LIST** to turn link search on.

Searches albums of the artist and displays the list.

2 Use **MULTI-CONTROL** to select an album or song from the list.

For more details about the selecting operation, refer to step 2 of *Browsing for a song* on page 22.



Notes

- If link search is aborted, **NOT FOUND** is displayed.
- You can also turn this function on in the menu that appears by using **MULTI-CONTROL**.

Operating this unit's iPod function from your iPod

This function cannot be operated with the following iPod models.

— iPod nano first generation (software version 1.3.1)

Operating this unit

— *iPod fifth generation (software version 1.2.1)*

This unit's iPod function can be operated from your iPod. Sound can be heard from car's speaker, and operation can be conducted from your iPod.

- While this function is in use, even if the ignition key is turned off, iPod is not turned off. To turn off power, operate the iPod.

1 Press iPod and hold to switch the control mode.

- Each pressing and holding **iPod** switches the control mode.
- While using this function, play time and titles are not displayed on this unit.
- Even if this function is performed, track up/down can be operated from this unit.
- While using this function, browse function cannot be operated from this unit.

2 Operate the connected iPod to select a song and play.



Note

You can also turn this function on or off in the menu that appears by using **MULTI-CONTROL**.

Changing audiobook speed

While listening to an audiobook on iPod, playback speed can be changed.

1 Display the function menu.

Refer to *Introduction to advanced operations* on page 23.

2 Use **MULTI-CONTROL** to select **AUDIOBOOKS** in the function menu.

3 Press **MULTI-CONTROL** to select the desired setting.

- **FASTER** – Playback faster than normal speed
- **SLOWER** – Playback slower than normal speed
- **NORMAL** – Playback in normal speed

Bluetooth Audio



Important

- Depending on the Bluetooth audio player connected to this unit, the operations available with this unit are limited to the following two levels:
 - Lower level: Only playing back songs on your audio player is possible.
 - Higher level: Playing back, pausing, selecting songs, etc., are possible (all the operations illustrated in this manual).
- Since there are a number of Bluetooth audio players available on the market, operations with your Bluetooth audio player using this unit vary extensively. Refer to the instruction manual that came with your Bluetooth audio player as well as this manual while operating your player on this unit.
- Information about songs (e.g. the elapsed playing time, song title, song index, etc.) cannot be displayed on this unit.
- While you are listening to songs on your Bluetooth audio player, refrain from using on your cellular phone as much as possible. If you use your cellular phone, the signal from your cellular phone may cause noise on the song playback.
- When you are talking on a cellular phone connected to this unit via Bluetooth wireless technology, song playback from your Bluetooth audio player connected to this unit is muted.
- Even if you are listening to a song on your Bluetooth audio player and you switch to another source, song playback continues.

Connecting a Bluetooth audio player

- Before you can use audio players you may need to enter the PIN code into this unit. If your player requires a PIN code to establish a connection, look for the code on the player or in its accompanying documentation. Refer to *Entering PIN code for Bluetooth wireless connection* on page 48.

Using a Bluetooth audio player to initiate a connection

1 Press MULTI-CONTROL to display the main menu.

2 Use MULTI-CONTROL to select CONNECTION.

Turn to change the menu option. Press to select.

- You can also select this menu by pressing and holding **PHONE**//**CONNECT** on the ordinary display.

3 Turn MULTI-CONTROL to select BT AUDIO DEVICE.

- If there is previous connection log in this unit, you can select the Bluetooth device from

PAIRED DEVICE.

Refer to *Connecting a paired Bluetooth audio player*.

4 Use MULTI-CONTROL to select a group.

Push **MULTI-CONTROL** up or down to select a group.

NOKIA (Nokia)—**STANDARD** (standard)

- Normally select **STANDARD**. If the device of Nokia is not paired to this unit, select **NOKIA**.
- Push **MULTI-CONTROL** left or right to display a group name or an ID.

5 Press MULTI-CONTROL to open the connection.

READY will be displayed.

- This unit is now on standby for connection from Bluetooth audio player.
- Push **MULTI-CONTROL** left or right to display the device name, BD address and PIN code of this unit.

6 Use your Bluetooth audio player to establish connection.

PIN code is set to **0000** as the default. You can change this code in the initial setting. Refer to *Entering PIN code for Bluetooth wireless connection* on page 48.

While connecting, **CONNECTING** is displayed. If the connection is established, **CONNECTED** is displayed.

Connecting a paired Bluetooth audio player

1 Press MULTI-CONTROL to display the main menu.

2 Use MULTI-CONTROL to select CONNECTION.

Turn to change the menu option. Press to select.

3 Turn MULTI-CONTROL to select PAIRED DEVICE.

Paired device name will be displayed.

- Push **MULTI-CONTROL** left or right to switch the device name, BD address, group name and group ID.

4 Press MULTI-CONTROL to establish connection.

- While connecting, **CONNECTING** flashes. If the connection is established, **CONNECTED** is displayed.
- If the connection fails, **ERROR** is displayed. In this case, try again from the beginning.

Disconnecting a Bluetooth audio player

This function can be operated only when the Bluetooth wireless connection is being established.

1 Press MULTI-CONTROL to display the main menu.

2 Use MULTI-CONTROL to select CONNECTION.

Turn to change the menu option. Press to select.

3 Turn MULTI-CONTROL to select DISCONNECT AUDIO.

4 Press MULTI-CONTROL to disconnect the Bluetooth wireless connection.

Operating this unit

Basic Operations

● Fast forward or reverse

Push and hold **MULTI-CONTROL** left or right.

● Select a track

Push **MULTI-CONTROL** left or right.



Note

Even though your audio player does not contain a Bluetooth module, you can still control it from this unit via Bluetooth wireless technology. To control your audio player using this unit, connect a product featuring Bluetooth wireless technology (available on the market) to your audio player.

Introduction to advanced operations

1 Press MULTI-CONTROL to display the main menu.

2 Use MULTI-CONTROL to select FUNCTION.

Turn to change the menu option. Press to select.

The function menu is displayed.

3 Turn MULTI-CONTROL to select the function.

PLAY (play)—**STOP** (stop)—**PAUSE** (pause)—**AUTO CONNECT** (automatic connection setting)—**DEVICE INFO** (device information)

Function and operation

PAUSE is the same as that of the built-in CD player.

Function name	Operation
PAUSE	Refer to <i>Pausing playback</i> on page 19.



Notes

- You can also select the function by pressing **FUNCTION** on the remote control.
- To return to the ordinary display, press **BAND/ESC**.

- If a Bluetooth audio player is not connected to this unit yet, **AUTO CONNECT** and **DEVICE INFO** appear in the function menu and other functions are not available.
- If a Bluetooth audio player is connected via A2DP (Advanced Audio Distribution Profile), only **AUTO CONNECT** and **DEVICE INFO** appear in the function menu.
- If you do not operate functions within about 30 seconds, the display automatically returns to the ordinary display.

Playing songs on a Bluetooth audio player

1 Display the function menu.

Refer to *Introduction to advanced operations* on this page.

2 Use MULTI-CONTROL to select PLAY in the function menu.

3 Press MULTI-CONTROL to start playback.

Stopping playback

1 Display the function menu.

Refer to *Introduction to advanced operations* on this page.

2 Use MULTI-CONTROL to select STOP in the function menu.

3 Press MULTI-CONTROL to stop the playback.

Connecting to a Bluetooth audio player automatically

- Initially, this function is set to on.

1 Display the function menu.

Refer to *Introduction to advanced operations* on this page.

2 Use MULTI-CONTROL to select AUTO CONNECT in the function menu.

Operating this unit

3 Press **MULTI-CONTROL** to turn automatic connection on.

If your Bluetooth audio player is ready for Bluetooth wireless connection, connection to this unit is automatically established.

- To turn automatic connection off, press **MULTI-CONTROL** again.

Displaying BD (Bluetooth Device) address

This unit displays the BD address of this unit.

1 Display the function menu.

Refer to *Introduction to advanced operations* on the previous page.

2 Use **MULTI-CONTROL** to select **DEVICE INFO** in the function menu.

3 Push **MULTI-CONTROL** left to switch to the BD address.

12-digit hexadecimal string is displayed.

- Pushing **MULTI-CONTROL** right returns to the device name. 

Bluetooth Telephone



Important

- Since this unit is on standby to connect with your cellular phone via Bluetooth wireless technology, using this unit without running the engine can result in battery drainage.
- Advanced operations that require your attention such as dialing numbers on the monitor, using phone book, etc., are prohibited while you are driving. When you need to use these advanced operations, stop your vehicle in a safe place.

Setting up for hands-free phoning

Before you can use the hands-free phoning function you must set up the unit for use with your cellular phone. This entails establishing a Bluetooth wireless connection between this unit and your phone, pairing your phone with this unit, and adjusting the volume level.

1 Connection

For detailed instructions on connecting your phone to this unit via Bluetooth wireless technology, refer to *Connecting and disconnecting a cellular phone* on the next page.

2 Pairing

Pairing is usually performed automatically during the connection operation. You only need to perform this operation manually when your phone is connected temporarily for any reason.

We recommend you pair the phone to this unit to make best use of the technology.

To pair your temporarily connected phone, refer to *Pairing a connected cellular phone* on page 31.

3 Volume adjustment

Adjust the earpiece volume on your cellular phone for comfort. When adjusted, the volume level is recorded in this unit as the default setting.

- Caller's voice volume and ring volume may vary depending on the type of cellular phone.

Operating this unit

- If the difference between the ring volume and caller's voice volume is big, overall volume level may become unstable.
- Before disconnecting the cellular phone from this unit, make sure to adjust the volume to a proper level. If the volume is muted (zero level) on your cellular phone, the volume level of your cellular phone remains muted even after the cellular phone is disconnected.

Notes

- The equalizer curve for the phone source is fixed.
- When selecting the phone source, you can only operate **FADER** (balance adjustment) in the audio menu.
- When selecting the phone source, the fader value is set to **FADER:F15** as an initial setting.

Introduction of connection and registration

1 Press MULTI-CONTROL to display the main menu.

2 Use MULTI-CONTROL to select CONNECTION.

The connection menu is displayed. Turn to change the menu option. Press to select.

- You can also select this menu by pressing and holding **PHONE/☎/CONNECT** on the ordinary display.

3 Turn MULTI-CONTROL to select the function.

PAIRED PHONE (paired phone)—**BT HANDS FREE** (new phone)—**SET PHONE** (phone registration)—**DISCONNECT PHONE** (disconnect phone)—**DELETE PHONE** (delete phone)

If the phone is not connected and not paired

The following function can be operated.

- **BT HANDS FREE** (new phone)

If the phone is not connected but paired

The following functions can be operated.

- **PAIRED PHONE** (pair phone manually)

- **BT HANDS FREE** (new phone)
- **DELETE PHONE** (delete phone)

If the phone is connected but not paired

The following functions can be operated.

- **SET PHONE** (phone registration)
- **DISCONNECT PHONE** (disconnect phone)
- **DELETE PHONE** (delete phone)

If the phone is connected and paired

The following functions can be operated.

- **DISCONNECT PHONE** (disconnect phone)
- **DELETE PHONE** (delete phone)

Notes

- The device name is set to **PIONEER FLAP BT** as default. You can change the device name in the initial setting. Refer to *Editing device name* on page 49.
- PIN code is set to **0000** as the default. You can change this code in the initial setting. Refer to *Entering PIN code for Bluetooth wireless connection* on page 48.

Connecting and disconnecting a cellular phone

Using a cellular phone to initiate a connection

1 Display the connection menu.

Refer to *Introduction of connection and registration* on this page.

2 Use MULTI-CONTROL to select BT HANDS FREE.

3 Use MULTI-CONTROL to select a group.

Push **MULTI-CONTROL** up or down to select a group.

NOKIA (Nokia)—**STANDARD** (standard)

- Normally select **STANDARD**. If the device of Nokia is not paired to this unit, select **NOKIA**.
- Push **MULTI-CONTROL** left or right to display a group name or an ID.

4 Press MULTI-CONTROL to switch to PAIRE FROM PHONE.

Push **MULTI-CONTROL** up or down to switch **PAIRE FROM PHONE** and **SEARCH DEVICE**.

Operating this unit

5 Select PAIRE FROM PHONE and then press MULTI-CONTROL to ready for pairing. **READY** will be displayed.

6 Use your cellular phone to establish connection.

PIN code is set to **0000** as the default. You can change this code in the initial setting. Refer to *Entering PIN code for Bluetooth wireless connection* on page 48.

While connecting, **CONNECTING** is displayed. If the connection is established, **COMPLETED** is displayed.

After connected, this unit automatically changes to **PH. BOOK DL** (phone book download confirmation) display.

- If the connection fails, **ERROR** is displayed. In this case, check the cellular phone and try again.
- If three cellular phones have already been paired, the pairing assignment selection display will appear. Select one assignment to pair the new phone. The newly paired phone overwrites the previously paired phone. The assignment selection operation is the same as Step 3 to 4 of *Pairing a connected cellular phone* on the next page except for the operation below.

- Switching the BD address and device name

7 Use MULTI-CONTROL to decide to download the phone book from your cellular phone or not.

Push **MULTI-CONTROL** left or right to select **NO** (No) or **YES** (Yes).

Press **MULTI-CONTROL** to decide.

When you select **YES**, this unit changes to **PH BOOK DOWNLOAD** and the download operation automatically begins. After completing, **DATA DOWNLOADED** is displayed.

According to the circumstances, this unit changes to **PH BOOK TRANSFER**. In this case, refer to step 4 on *Transferring entries to the phone book* on page 39.

- When you select **NO**, the display reverts to normal.

Using this unit to initiate a connection

1 Display the connection menu.

Refer to *Introduction of connection and registration* on the previous page.

2 Use MULTI-CONTROL to select BT HANDS FREE.

3 Use MULTI-CONTROL to select a group.

Push **MULTI-CONTROL** up or down to select a group.

NOKIA (Nokia)—**STANDARD** (standard)

- Normally select **STANDARD**. If the device of Nokia is not paired to this unit, select **NOKIA**.
- Push **MULTI-CONTROL** left or right to display a group name or an ID.

4 Press MULTI-CONTROL to switch to PAIRE FROM PHONE.

Push **MULTI-CONTROL** up or down to switch **PAIRE FROM PHONE** and **SEARCH DEVICE**.

5 Select SEARCH DEVICE and then press MULTI-CONTROL to start searching.

While searching, **SEARCHING** is displayed.

- If this unit fails to find any available cellular phones, **NOT FOUND** is displayed.

6 Use MULTI-CONTROL to select a device.

Push **MULTI-CONTROL** up or down to select a device name you want to connect.

Press **MULTI-CONTROL** to select a device name.

- Push **MULTI-CONTROL** left or right to switch the BD address and device name.

7 Use your cellular phone to establish connection.

PIN code is set to **0000** as the default. You can change this code in the initial setting. Refer to *Entering PIN code for Bluetooth wireless connection* on page 48.

While connecting, **CONNECTING** is displayed. If the connection is established, **COMPLETED** is displayed.

After connected, this unit automatically changes to **PH. BOOK DL** (phone book download confirmation) display.

Operating this unit

- If the connection fails, **ERROR** is displayed. In this case, check the cellular phone and try again.
- If three cellular phones have already been paired, the pairing assignment selection display will appear. Select one assignment to pair the new phone. The newly paired phone overwrites the previously paired phone. The assignment selection operation is the same as Step 3 to 4 of *Pairing a connected cellular phone* on this page except for the operation below.

- Switching the BD address and device name

8 Use MULTI-CONTROL to decide to download the phone book from your cellular phone or not.

Push **MULTI-CONTROL** left or right to select **NO** (No) or **YES** (Yes).

Press **MULTI-CONTROL** to decide.

When you select **YES**, this unit changes to **PH BOOK DOWNLOAD** and the download operation automatically begins. After completing, **DATA DOWNLOADED** is displayed.

According to the circumstances, this unit changes to **PH BOOK TRANSFER**. In this case, refer to step 4 on *Transferring entries to the phone book* on page 39.

- When you select **NO**, the display reverts to normal.

Connecting a paired cellular phone

1 Display the connection menu.

Refer to *Introduction of connection and registration* on page 29.

2 Turn MULTI-CONTROL to select PAIRED PHONE.

- Push **MULTI-CONTROL** up or down to select a desired phone.
- Push **MULTI-CONTROL** left or right to switch the device name, BD address, group name and group ID.

3 Press MULTI-CONTROL to start connection.

While connecting, **CONNECTING** is displayed. If the connection is established, **CONNECTED** is displayed.

After connected, this unit automatically changes to **PH. BOOK DL** (phone book download confirmation) display.

- If the connection fails, **ERROR** is displayed. In this case, check the cellular phone and try again.

4 Use MULTI-CONTROL to decide to download the phone book from your cellular phone or not.

Push **MULTI-CONTROL** left or right to select **NO** (No) or **YES** (Yes).

Press **MULTI-CONTROL** to decide.

When you select **YES**, this unit changes to **PH BOOK DOWNLOAD** and the download operation automatically begins. After completing, **DATA DOWNLOADED** is displayed.

- When you select **NO**, the display reverts to normal.

Disconnecting a cellular phone

1 Display the connection menu.

Refer to *Introduction of connection and registration* on page 29.

2 Use MULTI-CONTROL to select DISCONNECT PHONE.

3 Press MULTI-CONTROL to disconnect a cellular phone from this unit.

After disconnection is completed, **DISCONNECTED** is displayed.

Pairing a connected cellular phone

Pairing is usually performed automatically during the connection operation. You only need to perform this operation manually when your phone is connected temporarily for any reason. We recommend you pair the phone to this unit to make best use of the technology.

1 Display the connection menu.

Refer to *Introduction of connection and registration* on page 29.

2 Use MULTI-CONTROL to select SET PHONE.

Operating this unit

3 Push MULTI-CONTROL up or down to select a pairing assignment.

1 (user phone 1)—2 (user phone 2)—3 (user phone 3)

- Push **MULTI-CONTROL** left or right to switch the BD address and device name.
- If a phone is already assigned to the user phone number, the new phone will overwrite the old one.
- As you select each assignment, you can see whether or not a phone is already paired. If the assignment is empty, **NO DATA** is displayed.

4 Press MULTI-CONTROL to pair the currently connected phone.

When pairing is completed, **COMPLETED** is displayed.

- If the pairing fails, **REGISTER ERROR** is displayed. In this case, return to step 1 and try again.

Deleting a registered phone

1 Display the connection menu.

Refer to *Introduction of connection and registration* on page 29.

2 Use MULTI-CONTROL to select DELETE PHONE.

3 Push MULTI-CONTROL up or down to select a pairing assignment.

1 (user phone 1)—2 (user phone 2)—3 (user phone 3)

- Push **MULTI-CONTROL** left to display the BD address of the selected device.
- If the assignment is empty, **NO DATA** is displayed and operation is not possible.

4 Push MULTI-CONTROL right to select DELETE YES.

DELETE YES is displayed. Deleting phone is now on standby.

5 Press MULTI-CONTROL to delete the phone.

After the phone is deleted, **DELETED** is displayed.

Making a phone call

Dial a number

The most basic way to make a call is to simply dial the number.

Refer to *Making a call by entering phone number* on page 40 for detailed instructions.

Calling a number in the Phone Book or the Call History

Refer to *Calling a number in the phone book* on page 34 and *Using the call history* on page 34 for detailed instructions.

Preset number

Numbers that you dial frequently can be assigned to presets for quick recall.

Refer to *Using preset numbers* on page 36 for how to assign a number to a preset.

Voice recognition

If your cellular phone features voice recognition technology, you can make a call by voice commands.

- Operation varies depending on the type of cellular phone. Refer to the instruction manual that came with your cellular phone for detailed instructions.
- This function can be operated only when the connection is established with HFP (Hands Free Profile).

1 Press BAND/ESC and hold until VOICE DIAL appears in the display.

When **VOICE DIAL ON** is displayed, voice recognition function is ready.

- If your cellular phone does not feature voice recognition function, **NO VOICE DIAL** appears in the display and operation is not possible.

2 Pronounce the name of your contact.

Operating this unit

Taking a phone call

Answering or rejecting an incoming call

● Answering an incoming call

When a call comes in, press

MULTI-CONTROL.

- You can also take a phone call by pressing **OFF HOOK** on the remote control.

● End a call

Press .

- You can also end the call by pressing **ON HOOK** on the remote control.

● Rejecting an incoming call

When a call comes in, press .

- You can also reject an incoming call by pressing **ON HOOK** on the remote control.

● Put the call on hold

Press **MUTE** while talking on the phone.

- You can also perform the same operation by pressing  on the remote control.

Notes

- Pressing **MULTI-CONTROL** while talking on the phone changes into **ECHO CANCEL** of **FUNCTION**. For details on **ECHO CANCEL**, refer to *Echo canceling and noise reduction* on page 39.
- The estimated call time appears in the display (this may differ slightly from the actual call time).

Operating a call waiting

● Answering a call waiting

When a call comes in, press

MULTI-CONTROL.

- You can also answer a call waiting by pressing **OFF HOOK** on the remote control.

● End all calls

Press .

- You can also end all calls by pressing **ON HOOK** on the remote control.

● Switch between callers on hold

Press **MULTI-CONTROL.**

- You can also switch between callers on hold by pressing **OFF HOOK** on the remote control.

● Rejecting call waiting

Press .

- You can also reject call waiting by pressing **ON HOOK** on the remote control.

Note

To end the call, both you and your caller need to hang up the phone.

Using the phone number list

Important

Be sure to park your vehicle and apply the parking brake when operating the list.

● Press **LIST** to display the list.

Press **LIST** repeatedly to switch between the following lists:

RECENT CALLS (call history)—**ABC SEARCH** (phone book)—**DIAL PRESET** (preset number list)

- For more details about the call history, refer to *Using the call history* on the next page.
- For more details about the Phone Book list, refer to *Using the phone book* on the next page.
- For more details about the preset number list, refer to *Using preset numbers* on page 36.

- If no phone numbers are stored in the selected list, **NO DATA** is displayed.

Using the call history

The 20 most recent calls dialed, received, and missed are stored in the call history. You can browse the call history and call numbers from it.

1 Press LIST to display RECENT CALLS (call history list).

Refer to *Using the phone number list* on the previous page.

2 Turn MULTI-CONTROL to select a phone number.

Turning **MULTI-CONTROL** to change the phone numbers stored in the list.

- If the phone number is already in the phone book, the corresponding name is displayed. In this case, press and hold **DISP** to scroll the name.
- You can also change the phone number by pushing **MULTI-CONTROL** up or down.

3 Push MULTI-CONTROL right to display the detailed list.

Name, phone number and date are displayed in the detailed list.

- If the number is already in the Phone Book then the name is also displayed.
- Turning **MULTI-CONTROL** switches to the previous or next phone number displayed in the detailed list.
- If you do not operate anything within about 30 seconds, the list display is canceled automatically.

4 Press MULTI-CONTROL to make a call.

- While in the phone number list, press and hold **MULTI-CONTROL** to add or delete **+** to the phone number.

5 To end the call, press .

Using the phone book

Before using the phone book, you need to set up the phone book. To set up the phone book, refer to *Downloading phone books from your cellular phone* on page 38 and refer to *Transferring entries to the phone book* on page 39.

Calling a number in the phone book

After finding the number you want to call in the phone book, you can select the entry and make the call.

1 Press LIST to display ABC SEARCH (phone book).

Refer to *Using the phone number list* on the previous page.

2 Turn MULTI-CONTROL to select the first letter of the name you are looking for.

- You can also perform the same operation by pushing **MULTI-CONTROL** up or down.

3 Press MULTI-CONTROL to display entries.

The display shows the first Phone Book entry starting with that letter (e.g. "Ben", "Brian" and "Burt" when "B" is selected).

4 Turn MULTI-CONTROL to select a phone book entry you want to call.

- You can also perform the same operation by pushing **MULTI-CONTROL** up or down.
- You can scroll literal information by pressing and holding **DISP**.

5 Press MULTI-CONTROL to display the phone number list of the selected entry.

- You can also display the phone number list of the selected entry by pushing **MULTI-CONTROL** right.
- You can scroll literal information by pressing and holding **DISP**.
- If several phone numbers are included in an entry, select one by turning **MULTI-CONTROL**.
- If you want to go back and select another entry, push **MULTI-CONTROL** left.

6 Press MULTI-CONTROL to make a call.

7 To end the call, press .

Operating this unit

Editing phone numbers

You can edit the phone numbers of phone book entries.

1 Display the phone number list of your desired phone book entry.

See step 1 to 5 on *Calling a number in the phone book* on the previous page for how to do this.

2 Press and hold MULTI-CONTROL to display the edit screen.

3 Turn MULTI-CONTROL to display EDIT NUMBER (number edit screen).

Turning **MULTI-CONTROL** switches input screens in the following order:

EDIT NUMBER (number edit screen)—**EDIT GENRE** (genre edit screen)—**CLR MEMO** (clear memory screen)

4 Push MULTI-CONTROL left or right to move the cursor to the number you want to change.

5 Push MULTI-CONTROL up or down to change numbers.

Repeat these steps until you have finished changing the number.

- Press and hold **MULTI-CONTROL** to add or delete **+** to the phone number.

6 Press MULTI-CONTROL to store the new number.

After the number is stored, the display reverts to the detailed list.

Assign genres to phone numbers

If there are a lot of entries in the Phone Book it can be useful to assign them to specific genres (categories) for easier searching. There are four preset genres that you can assign entries to: **HOME**, **MOBILE**, **OFFICE** and **OTHERS**.

1 Display the phone number list of your desired phone book entry.

See step 1 to 5 on *Calling a number in the phone book* on the previous page for how to do this.

2 Press and hold MULTI-CONTROL to display the edit screen.

3 Turn MULTI-CONTROL to display EDIT GENRE (genre edit screen).

Turning **MULTI-CONTROL** switches input screens in the following order:

EDIT NUMBER (number edit screen)—**EDIT GENRE** (genre edit screen)—**CLR MEMO** (clear memory screen)

4 Push MULTI-CONTROL up or down to select a genre.

Each time **MULTI-CONTROL** is pushed up or down, the genres are switched in the following order:

HOME (home)—**MOBILE** (mobile)—**OFFICE** (office)—**OTHERS** (other)

5 Press MULTI-CONTROL to assign a genre to the phone number.

The selected genre is assigned to the phone number, and the display reverts to the detailed list.

Clearing a phone book entry

1 Display the phone number list of your desired phone book entry.

See step 1 to 5 on *Calling a number in the phone book* on the previous page for how to do this.

2 Press and hold MULTI-CONTROL to display the edit screen.

3 Turn MULTI-CONTROL to display CLR MEMO (clear memory screen).

Turning **MULTI-CONTROL** switches input screens in the following order:

EDIT NUMBER (number edit screen)—**EDIT GENRE** (genre edit screen)—**CLR MEMO** (clear memory screen)

4 Push MULTI-CONTROL right to show a confirmation display.

CLEAR MEMORY YES is displayed.

- If you do not want to clear the memory that you have selected, push **MULTI-CONTROL** left. The display reverts to normal.

Operating this unit

5 Press **MULTI-CONTROL** to delete the **Phone Book** entry.

The Phone Book entry is deleted and **CLEARED** is displayed. The display returns to Phone Book entry list.

Using preset numbers

Numbers that you dial frequently can be assigned to presets for quick recall.

Assigning preset numbers

1 Press **LIST** to display **DIAL PRESET (preset number list)**.

Refer to *Using the phone number list* on page 33.

2 Turn **MULTI-CONTROL** to switch preset numbers.

You can select preset number from **1** to **10**.

- Press and hold **DISP** to scroll the phone number.
- If the phone number is already in the phone book, the corresponding name is displayed. In this case, press and hold **DISP** to scroll the name.
- You can also change the phone number by pushing **MULTI-CONTROL** up or down.

3 Press **MULTI-CONTROL** to select a preset number that you want to assign a phone number to.

4 Press and hold **MULTI-CONTROL** to display **MEMORY**.

Push **MULTI-CONTROL** up or down to switch **MEMORY** (memory) and **DELETE** (delete).

- If a phone number is already stored in the selected preset number, the new phone number will overwrite the old one.
- For details on deleting, refer to *Deleting preset numbers* on this page.

5 Select **MEMORY** and then press **MULTI-CONTROL** to display the phone book.

6 Turn **MULTI-CONTROL** to select the first letter of the name you are looking for.

- You can also perform the same operation by pushing **MULTI-CONTROL** up or down.

7 Press **MULTI-CONTROL** to display entries.

The display shows the first three Phone Book entries starting with that letter (e.g. "Ben", "Brian" and "Burt" when "B" is selected).

8 Turn **MULTI-CONTROL** to select a phone book entry you want to store in the preset list.

- You can also perform the same operation by pushing **MULTI-CONTROL** up or down.
- You can scroll literal information by pressing and holding **DISP**.

9 Press **MULTI-CONTROL** to display the phone number list of the selected entry.

- You can also display the phone number list of the selected entry by pushing **MULTI-CONTROL** right.
- If several phone numbers are included in an entry, select one by turning **MULTI-CONTROL**.
- You can scroll literal information by pressing and holding **DISP**.
- If you want to go back and select another entry, push **MULTI-CONTROL** left.

10 Press **MULTI-CONTROL** to store the phone number in the preset list.

Deleting preset numbers

1 Press **LIST** to display **DIAL PRESET (preset number list)**.

Refer to *Using the phone number list* on page 33.

2 Turn **MULTI-CONTROL** to switch preset numbers.

- Press and hold **DISP** to scroll the phone number.
- If the phone number is already in the phone book, the corresponding name is displayed. In this case, press and hold **DISP** to scroll the name.
- You can also change the preset phone number by pushing **MULTI-CONTROL** up or down.

Operating this unit

3 Press MULTI-CONTROL to select a preset phone number that you want to delete.

4 Press and hold MULTI-CONTROL to display MEMORY.

Push **MULTI-CONTROL** up or down to switch **MEMORY** (memory) and **DELETE** (delete).

- About assigning , *Assigning preset numbers* on the previous page.

5 Select DELETE and then press MULTI-CONTROL to delete the preset phone number.

Calling a number in the preset list

After finding the number you want to call in the preset list, you can select the entry and make a call.

1 Press LIST to display DIAL PRESET (preset number list).

Refer to *Using the phone number list* on page 33.

2 Turn MULTI-CONTROL to select the phone number.

- Press and hold **DISP** to scroll the phone number.
- If the phone number is already in the phone book, the corresponding name is displayed. In this case, press and hold **DISP** to scroll the name.
- You can also change the phone number by pushing **MULTI-CONTROL** up or down.

3 Press MULTI-CONTROL to make a call.

4 To end the call, press .

Assigning preset numbers by using MULTI-CONTROL

1 Push MULTI-CONTROL up or down to switch preset numbers.

2 Perform from step 4 to 10 of *Assigning preset numbers* on the previous page.

Assigning preset numbers by using remote control

1 Press thumb pad to display RECENT CALLS (call history list).

2 Push thumb pad up or down to select a phone number.

3 Press a number from 0 to 9 and hold to preset in memory.

Preset number 10 is assigned to **0**.

Calling number in the preset list by using MULTI-CONTROL

1 Push MULTI-CONTROL up or down to switch preset numbers.

2 Press MULTI-CONTROL to make a call.

3 To end the call, press .

Calling number in the preset list by using remote control

1 Push thumb pad up or down to select a preset phone number.

- Pressing a number from **0** to **9** also recalls the preset phone number.

2 Press thumb pad to make a call.

- Pressing **OFF HOOK** can also make a call.

3 To end the call, press ON HOOK.

Introduction to advanced operations

1 Press MULTI-CONTROL to display the main menu.

2 Use MULTI-CONTROL to select FUNCTION.

The function menu is displayed.

Turn to change the menu option. Press to select.

Operating this unit

3 Turn MULTI-CONTROL to select the function.

PH BOOK DOWNLOAD (phone book download)—**PH BOOK TRANSFER** (phone book transfer)—**AUTO CONNECT** (automatic connection setting)—**AUTO ANSWER** (automatic answer setting)—**ECHO CANCEL** (echo cancel)—**RING TONE** (ring tone select)—**NUMBER DIAL** (call by entering number)—**CLR MEMO** (clear memory)—**PH. B. NAME VIEW** (phone book name view)—**MENU** (menu language)—**DEVICE INFO** (device information)

If not connected yet

The following functions cannot be operated.

- **PH BOOK DOWNLOAD** (phone book download)
- **ECHO CANCEL** (echo cancel)
- **NUMBER DIAL** (call by entering number)
- **CLR MEMO** (clear memory)
- **PH. B. NAME VIEW** (phone book name view)

If connected but not paired yet

The following functions cannot be operated.

- **PH BOOK DOWNLOAD** (phone book download)
- **ECHO CANCEL** (echo cancel)
- **CLR MEMO** (clear memory)
- **PH. B. NAME VIEW** (phone book name view)



Notes

- You can also select the function by pressing **FUNCTION** on the remote control.
- To return to the playback display, press **BAND/ESC**.
- **DEVICE INFO** is the same as that of the Bluetooth audio. (Refer to *Displaying BD (Bluetooth Device) address* on page 28.)
- If cellular phone is connected to this unit via Bluetooth wireless technology with HFP (Hands-Free Profile), PBAP (Phone Book Access Profile) and SPP (Serial Port Profile), **PH BOOK DOWNLOAD** can be operated.
- If you do not operate functions other than **PH BOOK DOWNLOAD**, **PH BOOK TRANSFER**, and **NUMBER DIAL**

within about 30 seconds, the display automatically returns to the ordinary display.

Downloading phone books from your cellular phone

Phone books in your cellular phone can be downloaded and stored in this unit.

- Depending on the cellular phone, you cannot use this function.
- 400 entries for each user (max. 3 users) can be stored in the phone book. Each independent entry can hold three phone numbers and genres.

1 Display the function menu.

Refer to *Introduction to advanced operations* on the previous page.

2 Use MULTI-CONTROL to select PH BOOK DOWNLOAD.

3 Press MULTI-CONTROL to enter in the phone book download standby mode.

Phone book downloading starts automatically. When phone book download is completed, **DATA DOWNLOADED** is displayed.

- The display indicates how many entries have been transferred and the total number to be transferred.
- If the ID and the password are requested, refer to *Entering the ID and the password* on this page.

Entering the ID and the password

If the ID and the password are requested, read the following instructions to enter the ID and the password.

- Up to 20 characters can be entered for the ID and up to 16 characters can be entered for the password.

1 Press DISP to switch between alphabet and numbers.

Press **DISP** repeatedly to switch between the following character types:

Alphabet—Numbers and symbols

2 Push MULTI-CONTROL up or down to select a letter.

Operating this unit

3 Push MULTI-CONTROL left or right to move the cursor to the previous or next character position.

4 Press MULTI-CONTROL to determine the ID and the password.

5 After entering the ID and password, use your cellular phone to continue the procedure.

Transferring entries to the phone book

Phone books in your cellular phone can be transferred to this unit by using your cellular phone.

- 400 entries for each user (max. 3 users) can be stored in the phone book. Each independent entry can hold three phone numbers and genres.

1 Display the function menu.

Refer to *Introduction to advanced operations* on page 37.

2 Use MULTI-CONTROL to select PH BOOK TRANSFER.

3 Press MULTI-CONTROL to enter the phone book transfer standby mode.

4 Use the cellular phone to perform phone book transfer.

Perform phone book transfer using the cellular phone. For detailed instructions, refer to the instruction manual that came with your cellular phone.

When phone book transfer is completed,

DATA TRANSFERRED is displayed.

- The display indicates how many entries have been transferred and the total number to be transferred.

Setting the automatic connection

It is possible to set the automatic connection between your cellular phone and this unit. If this function is set to on, connection between your cellular phone and this unit will take

place automatically as soon as the two devices are less than a few meters apart.

- With some cellular phones, it may not be possible to perform the automatic connection.

1 Display the function menu.

Refer to *Introduction to advanced operations* on page 37.

2 Use MULTI-CONTROL to select AUTO CONNECT.

3 Press MULTI-CONTROL to turn automatic connection on.

- To turn automatic connection off, press **MULTI-CONTROL** again.



Note

Automatic connection is performed in the registration number order.

Setting automatic answering

1 Display the function menu.

Refer to *Introduction to advanced operations* on page 37.

2 Use MULTI-CONTROL to select AUTO ANSWER.

3 Press MULTI-CONTROL to turn automatic answering on.

- To turn automatic answering function off, press **MULTI-CONTROL** again.

Echo canceling and noise reduction

1 Display the function menu.

Refer to *Introduction to advanced operations* on page 37.

2 Use MULTI-CONTROL to select ECHO CANCEL.

3 Push MULTI-CONTROL left or right to select the desired setting.

OFF (off)—LOW—MID—HIGH

- This function can be performed even while talking on the phone. In this case, press **MULTI-CONTROL** to switch to **ECHO CANCEL**.

Switching the ring tone

1 Display the function menu.

Refer to *Introduction to advanced operations* on page 37.

2 Use MULTI-CONTROL to select RING TONE in the function menu.

3 Push MULTI-CONTROL left or right to select the desired setting.

OFF (off)—1—2—3

Making a call by entering phone number



Important

Be sure to park your vehicle and apply the parking brake when performing this operation.

1 Display the function menu.

Refer to *Introduction to advanced operations* on page 37.

2 Use MULTI-CONTROL to select NUMBER DIAL.

- You can also press **DIRECT** on the remote control to enter in this menu from the standby display.

3 Push MULTI-CONTROL up or down to select a number.

- You can also perform the same operation by pressing **0** to **9** on the remote control.

4 Push MULTI-CONTROL left or right to move the cursor to the previous or next position.

- Up to 24 digits can be entered.

5 When you finish entering the number, press MULTI-CONTROL.

Call confirmation appears.

- You can also perform the same operation by pressing thumb pad on the remote control.

6 Press MULTI-CONTROL again to make a call.

- You can also perform the same operation by pressing  on the remote control.

7 To end the call, press .

- You can also perform the same operation by pressing  on the remote control.

Clearing memory

1 Display the function menu.

Refer to *Introduction to advanced operations* on page 37.

2 Use MULTI-CONTROL to select CLR MEMO.

3 Push MULTI-CONTROL up or down to select an item.

PH BOOK (phone book)—**ALL** (delete all memory)—**PRESET** (preset phone numbers)—**RECENT** (call history)

- If you want to clear the entire Phone Book, call history list and preset phone number, select **ALL**.

4 Push MULTI-CONTROL right to determine the item that you want to delete from this unit.

CLEAR MEMORY YES is displayed. Clearing memory is now on standby.

- If you do not want to clear the memory that you have selected, push **MULTI-CONTROL** left. The display reverts to normal.

5 Press MULTI-CONTROL to clear the memory.

CLEARED is displayed and data on the selected item is cleared from this unit's memory.

Changing the phone book display order

1 Display the function menu.

Refer to *Introduction to advanced operations* on page 37.

2 Use MULTI-CONTROL to select PH. B. NAME VIEW.

INVERT NAMES YES is displayed.

3 Press MULTI-CONTROL to change the name view order.

INVERTED is displayed.

Operating this unit

Pressing **MULTI-CONTROL** repeatedly changes the name view order between first and last name.

Selecting menu language

Menu language related to Bluetooth audio/telephone can be changed.

- Some characters may not be displayed properly.

1 Display the function menu.

Refer to *Introduction to advanced operations* on page 37.

2 Use **MULTI-CONTROL** to select **MENU**.

3 Press **MULTI-CONTROL** to select the language.

ENGLISH (English)—**ESPAÑOL** (Spanish)

Introduction of audio adjustments

1 Press MULTI-CONTROL to display the main menu.

2 Use MULTI-CONTROL to select AUDIO.
Turn to change the menu option. Press to select.
The audio menu is displayed.

3 Turn MULTI-CONTROL to select the audio function.

Turn **MULTI-CONTROL** to switch between the audio functions in the following order.

FADER (balance adjustment)—**P. EQ** (equalizer recall)—**EQ** (equalizer adjustment)—**EQ** (equalizer fine adjustment)—**LOUDNESS** (loudness)—**SUB W1** (subwoofer on/off setting)—**SUB W2** (subwoofer setting)—**HPF** (high pass filter)—**BASS BOOST** (bass boost)—**SLA** (source level adjustment)

- You can select the **SUB W2** only when subwoofer output is turned on in **SUB W1**.
- When selecting FM as the source, you cannot switch to **SLA**.
- You can also select the audio function by pressing **AUDIO** on the remote control.
- To return to the display of each source, press **BAND/ESC**.
- If you do not operate functions within about 30 seconds, the display automatically returns to the ordinary display. 

Using balance adjustment

You can change the fader/balance setting so that it can provide the ideal listening environment in all occupied seats.

1 Display the audio menu.

Refer to *Introduction of audio adjustments* on this page.

2 Use MULTI-CONTROL to select FADER.

- If the balance setting has been previously adjusted, **BALANCE** will be displayed.

3 Push MULTI-CONTROL up or down to adjust front/rear speaker balance.

Each time **MULTI-CONTROL** is pushed up or down, the front/rear speaker balance moves towards the front or rear.

FADER :F15 to **FADER :R15** is displayed as the front/rear speaker balance moves from front to rear.

- **FADER:F/R 0** is the proper setting when only two speakers are used.
- When the rear output setting is **SUB W**, you cannot adjust front/rear speaker balance. Refer to *Setting the rear output and subwoofer controller* on page 47.

4 Push MULTI-CONTROL left or right to adjust left/right speaker balance.

Each time **MULTI-CONTROL** is pushed left or right, the left/right speaker balance moves towards the left or right.

BALANCE :L15 to **BALANCE :R15** is displayed as the left/right speaker balance moves from left to right. 

Using the equalizer

The equalizer lets you adjust the equalization to match the car's interior acoustic characteristics as desired.

Recalling equalizer curves

There are six stored equalizer curves which you can easily recall at any time. Here is a list of the equalizer curves.

Display	Equalizer curve
POWERFUL	Powerful
NATURAL	Natural
VOCAL	Vocal
CUSTOM	Custom
FLAT	Flat
SUPER BASS	Super bass

Audio Adjustments

- **CUSTOM** is an adjusted equalizer curve that you create. If you make adjustments to an equalizer curve, the equalizer curve setting is memorized in **CUSTOM**.
- When **FLAT** is selected, no supplement or correction is made to the sound. This is useful to check the effect of the equalizer curves by switching alternatively between **FLAT** and a set equalizer curve.

1 Use MULTI-CONTROL to select P. EQ.

POWERFUL appears in the display.

If the equalizer curve has been previously selected, the curve of that previously selected will be displayed instead of **POWERFUL**.

2 Push MULTI-CONTROL left or right to select an equalizer curve.

Each time **MULTI-CONTROL** is pushed left or right, equalizer curves are selected in the following order:

POWERFUL—NATURAL—VOCAL—CUSTOM—FLAT—SUPER BASS

Adjusting equalizer curves

The factory supplied equalizer curves can be adjusted to a fine degree (nuance control).

1 Recall the equalizer curve you want to adjust.

See *Recalling equalizer curves* on the previous page.

2 Push MULTI-CONTROL left or right to select the equalizer band to adjust.

EQ-LOW (low)—**EQ-MID** (mid)—**EQ-HI** (high)

3 Push MULTI-CONTROL up or down to adjust the equalizer curve.

+6 to **-6** is displayed as the equalizer curve is increased or decreased.

Fine-adjusting equalizer curve

You can adjust the center frequency and the Q factor (curve characteristics) of each currently selected curve band (**EQ-LOW/EQ-MID/EQ-HI**).

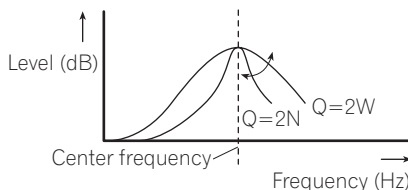

1 Use MULTI-CONTROL to select EQ.

2 Push MULTI-CONTROL left or right to select a desired frequency.

Low: **40HZ—80HZ—100HZ—160HZ**

Mid: **200HZ—500HZ—1KHZ—2KHZ**

High: **3KHZ—8KHZ—10KHZ—12KHZ**

3 Push MULTI-CONTROL up or down to select the desired Q factor.

Q factor

2N—1N—1W—2W

Adjusting loudness

Loudness compensates for deficiencies in the low- and high-sound ranges at low volume.

1 Display the audio menu.

Refer to *Introduction of audio adjustments* on the previous page.

2 Use MULTI-CONTROL to select LOUDNESS.

3 Press MULTI-CONTROL to turn loudness on.

Loudness level (e.g., **MID**) appears in the display.

- To turn loudness off, press **MULTI-CONTROL** again.

Audio Adjustments

4 Push MULTI-CONTROL left or right to select a desired level.

Each time **MULTI-CONTROL** is pushed left or right, level is selected in the following order:

LOW (low)—**MID** (mid)—**HIGH** (high)

Using subwoofer output

This unit is equipped with a subwoofer output which can be turned on or off.

Also, phase can be selected between normal and reverse.

1 Display the audio menu.

Refer to *Introduction of audio adjustments* on page 42.

2 Use MULTI-CONTROL to select SUB W1.

3 Press MULTI-CONTROL to turn subwoofer output on.

NORMAL appears in the display. Subwoofer output is now on.

- To turn subwoofer output off, press **MULTI-CONTROL** again.

4 Push MULTI-CONTROL left or right to select the phase of subwoofer output.

Push **MULTI-CONTROL** left to select reverse phase and **REV** appears in the display. Push **MULTI-CONTROL** right to select normal phase and **NORMAL** appears in the display.

Adjusting subwoofer settings

When the subwoofer output is on, you can adjust the cut-off frequency and the output level of the subwoofer.

- When the subwoofer output is on, you can select **SUB W2**.

1 Display the audio menu.

Refer to *Introduction of audio adjustments* on page 42.

2 Use MULTI-CONTROL to select SUB W2.

3 Push MULTI-CONTROL left or right to select cut-off frequency.

Each time **MULTI-CONTROL** is pushed left or right, cut-off frequencies are selected in the following order:

50—63—80—100—125

4 Push MULTI-CONTROL up or down to adjust the output level of the subwoofer.

Each time **MULTI-CONTROL** is pushed up or down, subwoofer level increases or decreases.

+6 to -24 is displayed as the level is increased or decreased.

Using the high pass filter

When you do not want low sounds from the subwoofer output frequency range to play from the front or rear speakers, turn on the HPF (high pass filter). Only frequencies higher than those in the selected range are output from the front or rear speakers.

1 Display the audio menu.

Refer to *Introduction of audio adjustments* on page 42.

2 Use MULTI-CONTROL to select HPF.

3 Press MULTI-CONTROL to turn high pass filter on.

80HZ appears in the display. High pass filter is now on.

- If the high pass filter has been previously adjusted, the frequency of that previously selected will be displayed instead of **80HZ**.
- To turn high pass filter off, press **MULTI-CONTROL** again.

4 Push MULTI-CONTROL left or right to select cut-off frequency.

Each time **MULTI-CONTROL** is pushed left or right, cut-off frequencies are selected in the following order:

50HZ—63HZ—80HZ—100HZ—125HZ

Audio Adjustments

Boosting the bass

Bass boost function boosts the bass level of sound.

1 Display the audio menu.

Refer to *Introduction of audio adjustments* on page 42.

2 Use MULTI-CONTROL to select BASS BOOST.

3 Push MULTI-CONTROL up or down to select a desired level.

0 to +6 is displayed as the level is increased or decreased. 

- External unit 1 and external unit 2 are set to the same source level adjustment volume automatically. 

Adjusting source levels

Source level adjustment (SLA) lets you adjust the volume level of each source to prevent radical changes in volume when switching between sources.

- Settings are based on the FM volume level, which remains unchanged.

1 Compare the FM volume level with the level of the source you wish to adjust.

2 Display the audio menu.

Refer to *Introduction of audio adjustments* on page 42.

3 Use MULTI-CONTROL to select SLA.

4 Push MULTI-CONTROL up or down to adjust the source volume.

Each time MULTI-CONTROL is pushed up or down, source volume increases or decreases. +4 to -4 is displayed as the source volume is increased or decreased.



Notes

- The AM volume level can also be adjusted with source level adjustments.
- The built-in CD player and the multi-CD player are set to the same source level adjustment volume automatically.

Adjusting initial settings

1 Press SRC and hold until the unit turns off.

2 Press MULTI-CONTROL and hold until the initial setting menu appears in the display.

3 Turn MULTI-CONTROL to select one of the initial settings.

CLNDR (calendar)—**CLOCK** (clock)—

WARNING (warning tone)—**AUX1** (auxiliary input 1)—**AUX2** (auxiliary input 2)—**REAR SP** (rear output and subwoofer controller)—**TEL** (telephone muting/attenuation)—

BUILT-IN AMP (power amp setting)—

EVERSCROLL (ever scroll)—**BT AUDIO** (Blue-

tooth audio)—**PIN CODE INPUT** (pin code

input)—**EDIT DEVICE NAME** (device name

edit)—**BT INFO** (Bluetooth version informa-

tion)—**BT RESET:MEMORY** (Bluetooth reset)

—**SOFTWARE UPDATE** (software update)

- You can also select the function by pressing **FUNCTION** on the remote control.

- To cancel initial settings, press **BAND/ESC**. 

Setting the date

The calendar display adjusted in this mode appears when the telephone source is selected or sources and the feature demo are off.

1 Display the initial setting menu.

Refer to *Adjusting initial settings* on this page.

2 Use MULTI-CONTROL to select CLNDR. CLNDR appears in the display.

3 Push MULTI-CONTROL left or right to select the segment of the calendar display you wish to set.

Day—Month—Year

As you select segments of the calendar display the segment selected will blink.

4 Push MULTI-CONTROL up or down to set the date.

Pushing **MULTI-CONTROL** up will increase the selected day, month or year. Pushing **MULTI-CONTROL** down will decrease the selected day, month or year. 

Setting the clock

Use these instructions to set the clock.

1 Display the initial setting menu.

Refer to *Adjusting initial settings* on this page.

2 Use MULTI-CONTROL to select CLOCK.

3 Push MULTI-CONTROL left or right to select the segment of the clock display you wish to set.

Hour—Minute

As you select segments of the clock display, the selected segment blinks.

4 Push MULTI-CONTROL up or down to put a clock right.



Note

You can match the clock to a time signal by pressing **MULTI-CONTROL**.

- If **00** to **29**, the minutes are rounded down. (e.g., **10:18** becomes **10:00**.)
- If **30** to **59**, the minutes are rounded up. (e.g., **10:36** becomes **11:00**.) 

Switching the warning tone

If the front panel is not detached from the head unit within four seconds of turning off the ignition, a warning tone sounds. You can turn off the warning tone.

1 Display the initial setting menu.

Refer to *Adjusting initial settings* on this page.

2 Use MULTI-CONTROL to select WARNING.

Initial Settings

3 Press MULTI-CONTROL to turn warning tone on.

- To turn warning tone off, press **MULTI-CONTROL** again. 

Switching the auxiliary setting

Auxiliary devices connected to this unit can be activated individually. Set each AUX source to ON when using. For more information about connecting or using auxiliary devices, refer to *Using the AUX source* on page 51.

1 Display the initial setting menu.

Refer to *Adjusting initial settings* on the previous page.

2 Use MULTI-CONTROL to select AUX1/ AUX2.

3 Press MULTI-CONTROL to turn AUX1/ AUX2 on.

- To turn AUX off, press **MULTI-CONTROL** again. 

Setting the rear output and subwoofer controller

This unit's rear output (rear speaker leads output) can be used for full-range speaker (**FULL**) or subwoofer (**SUB W**) connection. If you switch the rear output setting to **SUB W**, you can connect a rear speaker lead directly to a subwoofer without using an auxiliary amp. Initially, the unit is set for rear full-range speaker connection (**FULL**).

1 Display the initial setting menu.

Refer to *Adjusting initial settings* on the previous page.

2 Use MULTI-CONTROL to select REAR SP.

3 Press MULTI-CONTROL to switch the rear output setting.

Pressing **MULTI-CONTROL** will switch between **FULL** (full-range speaker) and **SUB W** (subwoofer) and that status will be displayed.

- When no subwoofer is connected to the rear output, select **FULL** (full-range speaker).
- When a subwoofer is connected to the rear output, select **SUB W** (subwoofer).

Notes

- Even if you change this setting, there is no output unless you turn the subwoofer output on (refer to *Using subwoofer output* on page 44).
- If you change this setting, subwoofer output in the audio menu return to the factory settings. 

Switching the sound muting/attenuation

Sound from this system is muted or attenuated automatically when the signal from the equipment with mute function is received.

- The sound is muted or attenuated, **MUTE** or **ATT ON** are displayed and no audio adjustment is possible.
- Sound from this system returns to normal when the muting or attenuation is canceled.

1 Display the initial setting menu.

Refer to *Adjusting initial settings* on the previous page.

2 Use MULTI-CONTROL to select TEL.

3 Press MULTI-CONTROL to switch the telephone muting/attenuation.

Pressing **MULTI-CONTROL** will switch between **ATT** (attenuation) and **MUTE** (muting) and that status will be displayed. 

Setting the internal power amplifier

This unit features high power amplifier. However, in particular system, external amplifiers are used instead of internal amplifier. If you use external amplifiers in order to establish a multi-amp system, and don't use internal amplifier, it is recommended to turn off the internal amplifier. Turning off internal amplifier reduces the noise that comes from the behavior of internal amplifier.

- For this function, verify the topic *Adjusting initial settings* before initiating the operation.

- 1 Display the initial setting menu.**
- 2 Use MULTI-CONTROL to select BUILT-IN AMP.**
- 3 Press MULTI-CONTROL to turn the internal power amplifier on.**
 - To turn the internal power amplifier off, press **MULTI-CONTROL** again. 

Switching the ever scroll

When Ever Scroll is set to ON, recorded text information scrolls continuously in the display. Set to OFF if you prefer the information to scroll just once.

- 1 Display the initial setting menu.**
Refer to *Adjusting initial settings* on page 46.
- 2 Use MULTI-CONTROL to select EVERSCROLL.**
- 3 Press MULTI-CONTROL to turn the ever scroll on.**
 - To turn the Ever Scroll off, press **MULTI-CONTROL** again. 

Activating the BT AUDIO source

You need to activate the **BT AUDIO** source in order to use a Bluetooth audio player.

- 1 Display the initial setting menu.**
Refer to *Adjusting initial settings* on page 46.
- 2 Use MULTI-CONTROL to select BT AUDIO.**
- 3 Press MULTI-CONTROL to turn the BT AUDIO source on.**
 - To turn the **BT AUDIO** source off, press **MULTI-CONTROL** again. 

Entering PIN code for Bluetooth wireless connection

To connect your cellular phone to this unit via Bluetooth wireless technology, you need to enter PIN code on your phone to verify the connection. The default code is **0000**, but you can change this in this function.

- With some Bluetooth audio players, you may be required to enter the Bluetooth audio player PIN code in advance to set this unit for a connection.
- 1 Display the initial setting menu.**
Refer to *Adjusting initial settings* on page 46.
 - 2 Use MULTI-CONTROL to select PIN CODE INPUT.**
 - 3 Push MULTI-CONTROL up or down to select a number.**
 - 4 Push MULTI-CONTROL left or right to move the cursor to the previous or next position.**
 - 5 After inputting PIN code (up to 16 digits), press MULTI-CONTROL.**
PIN code can be stored in memory.
When you press **MULTI-CONTROL** again on the same display, the PIN code you entered is stored in this unit.

Initial Settings

- Pushing **MULTI-CONTROL** right in the confirmation display returns you to the PIN code input display, and you can change the PIN code. 

Editing device name

You can edit the device name.

The device name is set to **PIONEER FLAP BT** as default.

1 Display the initial setting menu.

Refer to *Adjusting initial settings* on page 46.

2 Use **MULTI-CONTROL** to select **EDIT DEVICE NAME**.

3 Press **DISP** to select the desired character type.

Press **DISP** repeatedly to switch between the following character types:

Alphabet—Numbers

4 Push **MULTI-CONTROL** up or down to select a letter of the alphabet.

5 Push **MULTI-CONTROL** left or right to move the cursor to the previous or next character position.

6 Move the cursor to the last position by pushing **MULTI-CONTROL** right after entering the device name.

Push **MULTI-CONTROL** right again to store the device name in memory temporarily.

- Pressing **MULTI-CONTROL** can also store the device name in memory temporarily. In this method, cursor doesn't need to be the last position.
- If an invalid character has been entered, subsequent characters are not displayed.
- If an invalid character has been entered in the beginning, device name cannot be stored in memory. 

Displaying system version for repair

Should this unit fails to operate properly and you consult your dealer for repair, you may be asked to indicate the system versions of this unit and of Bluetooth module. You can display the versions and confirm them.

1 Display the initial setting menu.

Refer to *Adjusting initial settings* on page 46.

2 Use **MULTI-CONTROL** to select **BT INFO**.

The system (microprocessor) version of this unit is displayed.

3 Push **MULTI-CONTROL** left to switch to the version of the Bluetooth module of this unit.

- Pushing **MULTI-CONTROL** right returns to the system version of this unit. 

Resetting the Bluetooth wireless technology module

Bluetooth telephone and Bluetooth Audio data can be deleted. To protect personal information, we recommend deleting this data before transferring the unit to other persons. The following settings will be deleted.

- phone book entries on the Bluetooth telephone
- preset numbers on the Bluetooth telephone
- registration assignment of Bluetooth telephone
- call history of Bluetooth telephone
- history of the most recently connected Bluetooth audio

1 Display the initial setting menu.

Refer to *Adjusting initial settings* on page 46.

2 Use **MULTI-CONTROL** to select **BT RESET:MEMORY**.

Initial Settings

3 Push MULTI-CONTROL right to show a confirmation display.

BT RESET:YES is displayed. Clearing memory is now on standby.

- If you do not want to reset phone memory, press **BAND/ESC**.

4 Press MULTI-CONTROL to clear the memory.

Updating the software about Bluetooth connection

This function is used to update this unit with the latest software. For about software and updating, refer to our website.

1 Display the initial setting menu.

Refer to *Adjusting initial settings* on page 46.

2 Use MULTI-CONTROL to select SOFTWARE UPDATE.

3 Push MULTI-CONTROL up or down to select a appropriate group.

4 Press MULTI-CONTROL to display the data transfer mode.

- To finish the updating, follow the on-screen instructions. 

Other Functions

Using the AUX source

Up to two auxiliary devices such as VCR or portable devices (sold separately) can be connected to this unit. When connected, auxiliary devices are automatically read as AUX sources and assigned to **AUX1** or **AUX2**. The relationship between **AUX1** and **AUX2** sources is explained below.

About AUX1 and AUX2

There are two methods to connect auxiliary devices to this unit.

AUX1 source:

When connecting auxiliary device using a stereo mini plug cable

- **Insert the stereo mini plug into the input jack on this unit.**

For more details, refer to the installation manual.

This auxiliary device is automatically set to **AUX1**.

AUX2 source:

When connecting auxiliary device using an IP-BUS-RCA Interconnector (sold separately)

- **Use an IP-BUS-RCA Interconnector such as the CD-RB20/CD-RB10 (sold separately) to connect this unit to auxiliary device featuring RCA output.**

For more details, refer to the IP-BUS-RCA Interconnector owner's manual.

This auxiliary device is automatically set to **AUX2**.

- You can only make this type of connection if the auxiliary device has RCA outputs.

Selecting AUX as the source

- **Press SRC to select AUX as the source.**
 - If the auxiliary setting is not turned on, **AUX** cannot be selected. For more details, see *Switching the auxiliary setting* on page 47.

Setting the AUX title

The title displayed for the **AUX1** or **AUX2** source can be changed.

- 1 After you have selected AUX as the source, use MULTI-CONTROL and select FUNCTION to display TITLE INPUT.**

- 2 Enter a title in the same way as the built-in CD player.**

For details concerning operation, refer to *Entering disc titles* on page 20. ▣

Using the external unit

External unit refers to a Pioneer product (such as ones available in the future) that, although incompatible as a source, enables control of basic functions with this unit. Two external units can be controlled with this unit. When two external units are connected, the external unit is automatically allocated to external unit 1 or external unit 2 by this unit.

Basic operations of the external unit are explained below. Allocated functions are different depending on the connected external unit. For details concerning functions, refer to external unit's owner's manual.

Selecting the external unit as the source

- **Press SRC to select EXTERNAL as the source.**

Basic operation

Functions allocated to the following operations are different depending on the connected external unit. For details concerning functions, refer to the connected external unit's owner's manual.

- Press **BAND/ESC**.
- Press and hold **BAND/ESC**.
- Push **MULTI-CONTROL** left or right.
- Push and hold **MULTI-CONTROL** left or right.
- Push **MULTI-CONTROL** up or down.

Advanced operations

1 Press **MULTI-CONTROL** to display the main menu.

2 Use **MULTI-CONTROL** to select **FUNCTION**.

Turn to change the menu option. Press to select.

3 Turn **MULTI-CONTROL** to select the function.

FUNC1 (function 1)—**FUNC2** (function 2)—
FUNC3 (function 3)—**FUNC4** (function 4)—
AUTO/MANUAL (auto/manual)



Note

To return to the ordinary display, press **BAND/ESC**. 

Turning the clock display on or off

You can turn the clock display on or off.

- Even when the sources and the feature demo are off, the clock display appears on the display.

- Press **CLOCK** to turn the clock display on or off.

Each press of **CLOCK** turns the clock display on or off.

- The clock display disappears temporarily when you perform other operations, but the clock display appears again after 25 seconds. 

Switching the display indication and button illumination

Display indication and button illumination can be switched on or off.

- Press and hold **DISP OFF**.

Pressing and holding **DISP OFF** switches the display indication and button illumination on or off.

- While the display indication is turned off, **CLOCK/DISP OFF** button lights up.
- Even if the display indication is turned off, operation can be conducted. If operation is conducted while the display indication is off, display will light up for a few seconds and then turn off again. 

Using the PGM button

You can operate the preprogrammed functions for each source by using **PGM** on the remote control.

The remote control CD-R510 is sold separately.

- Press **PGM** to turn pause on when selecting the following sources:

- **COMPACT DISC** – Built-in CD player
- **USB** – USB portable audio player/USB memory
- **IPOD** – iPod
- **MULTI CD** – Multi-CD player
- **BT AUDIO** – Bluetooth audio player
- **DVD** – DVD player/multi-DVD player

- To turn pause off, press **PGM** again.

Other Functions

- **Press PGM and hold to turn BSM on when selecting tuner or HD Radio as the source.**

Press **PGM** and hold until the BSM turns on.

- To cancel the storage process, press **PGM** again.

- **Press PGM and hold to turn BSSM on when selecting television as the source.**

Press **PGM** and hold until the BSSM turns on.

- To cancel the storage process, press **PGM** again.

- **Press PGM to turn FUNC1 (function 1) on when selecting external unit as the source.**

- To turn **FUNC1** (function 1), press **PGM** again.
- Function allocated **FUNC1** (function 1) is different depending on the connected external unit. 

Playing songs on iPod

Basic operation

You can use this unit to control an interface adapter for iPod, which is sold separately.

- **Fast forward or reverse**

Push and hold **MULTI-CONTROL** left or right.

- **Select a track**

Push **MULTI-CONTROL** left or right.



Notes

- Read the precautions for iPod on page 74.
- While iPod is connected to this unit, **PIONEER** (or ✓ (check mark)) is displayed on the iPod.
- If an error message is displayed, refer to *Error messages* on page 69.
- When the ignition switch is set to ACC or ON, the iPod's battery is charged while the iPod is connected to this unit.
- While the iPod is connected to this unit, the iPod cannot be turned on or off.
- Before connecting the dock connector of this unit to the iPod, disconnect the headphones from the iPod.
- The iPod is turned off about two minutes after the ignition switch is set to OFF.

Displaying text information on iPod

The operation is the same as that of the iPod connected to USB interface of this unit. (Refer to *Displaying text information on iPod* on page 23.)

Browsing for a song

The operation is the same as that of the iPod connected to USB interface of this unit. (Refer to *Browsing for a song* on page 22.)

However, the selectable categories are slightly different. Selectable categories are

PLAYLISTS (playlists)—**ARTISTS** (artists)—**ALBUMS** (albums)—**SONGS** (songs)—**GENRES** (genres)

Introduction to advanced operations

1 Press MULTI-CONTROL to display the main menu.

2 Use MULTI-CONTROL to select FUNCTION.

Turn to change the menu option. Press to select.

The function menu is displayed.

3 Turn MULTI-CONTROL to select the function.

REPEAT (repeat play)—**SHUFFLE** (shuffle)—**PAUSE** (pause)

Function and operation

REPEAT and **PAUSE** operations are basically the same as that of the built-in CD player.

Function name	Operation
REPEAT	Refer to <i>Selecting a repeat play range</i> on page 18. However, the repeat play ranges you can select are different from that of the built-in CD player. The repeat play ranges of the iPod are: <ul style="list-style-type: none"> • ONE – Repeat the current song • ALL – Repeat all songs in the selected list
PAUSE	Refer to <i>Pausing playback</i> on page 19.



Notes

- You can also select the function by pressing **FUNCTION** on the remote control.
- To return to the ordinary display, press **BAND/ESC**.
- If you do not operate functions within about 30 seconds, the display automatically returns to the ordinary display.

Available accessories

Playing songs in a random order (shuffle)

- **Press \times repeatedly to select the desired setting.**
 - **SONGS** – Play back songs in the selected list in random order.
 - **ALBUMS** – Play back songs from a randomly selected album in order.
 - **OFF** – Cancel random play.
- To turn shuffle off, press \times again.



Note

You can also perform this operation in the menu that appears by using **MULTI-CONTROL**.

XM tuner

Listening to XM Satellite Radio

You can use this unit to control an XM satellite digital tuner (GEX-P920XM), which is sold separately.

For details concerning operation, refer to the XM tuner's operation manuals. This section provides information on XM operations with this unit which differs from that described in the XM tuner's operation manual.

- With this unit, you can operate two additional functions: XM channel direct selection and preset channel list.

● **Select an XM band.**

Press **BAND/ESC**.

- Band can be selected from **XM1**, **XM2** or **XM3**.

● **Select a channel.**

Push **MULTI-CONTROL** left or right.

- If you push and hold **MULTI-CONTROL** left or right, you can increase or decrease channel number continuously.
- You can also perform tuning from a desired channel category. (Refer to *Selecting a channel in the channel category* on the next page.)

Selecting an XM channel directly

When using the remote control, you can select the XM channel directly by entering the desired channel number.

1 **Press DIRECT.**

Channel number input display appears.

2 **Press 0 to 9 to enter the desired channel number.**

- You can cancel the input number by pressing **CLEAR**.

3 **Press DIRECT.**

The XM channel of entered number is selected.

- After entering the number input mode, if you do not perform an operation within about eight seconds, the mode is automatically canceled.

Switching the XM display

● **Press DISP to switch the XM display.**

- You can scroll the text information to the left by pressing and holding **DISP**.

Storing and recalling broadcast stations

You can easily store up to six broadcast stations for later recall.

- Six stations for each band can be stored in memory.

1 **Press LIST.**

Preset screen is displayed.

2 **Use MULTI-CONTROL to store the selected station in memory.**

Turn to change the preset number. Press and hold to store.

The XM preset number you have selected will flash and then remain lit. The selected station has been stored in memory.

3 **Use MULTI-CONTROL to select the desired station.**

Turn to change the station; press to select.

- You can also change the station by pushing **MULTI-CONTROL** up or down.
- If you do not operate the list within about 30 seconds, the display is automatically returned to the ordinary display.

Using the remote control

- **When you find a station that you want to store in memory, press one of preset tuning buttons 1 to 6 and hold until the XM preset number stops flashing.**

The number you have pressed will flash in the XM preset number indicator and then remain lit. The selected station has been stored in memory.

The next time you press the same preset tuning button the station is recalled from memory.

- You can also recall stations assigned to preset tuning numbers by pushing **MULTI-CONTROL** up or down.

Switching the XM channel select mode

You have two methods for selecting a channel: by number and by category. When selecting by number, channels in any category can be selected. Select by category to narrow your search down to only channels in a particular category.

- **Press SAT MODE repeatedly to select the desired channel select setting.**
CH NUMBER (channel number select setting)
—**CATEGORY** (channel category select setting)

Note

You can also perform this operation in the menu that appears by using **MULTI-CONTROL**.

Selecting a channel in the channel category

- 1 **Select the channel select settings to CATEGORY.**

Refer to *Switching the XM channel select mode* on this page.

- 2 **Push MULTI-CONTROL up or down to select the desired channel category.**

- 3 **Push MULTI-CONTROL left or right to select the desired channel in the selected channel category.**

Displaying the Radio ID

Channel number select setting

- 1 **Select the channel select settings to CH NUMBER.**

Refer to *Switching the XM channel select mode* on this page.

- 2 **Push MULTI-CONTROL left or right to select RADIO ID.**

- If you select another channel, display of the ID code is canceled.
- Display of the ID code repeats displaying **RADIO ID** and the ID code one after the other. 

SIRIUS Satellite Radio tuner

Listening to SIRIUS Satellite Radio

You can use this unit to control a SIRIUS Satellite Radio tuner, which is sold separately.

When the SIRIUS tuner is used together with this unit, some operations differ slightly from those described in the SIRIUS operation manual. This manual provides information on these points. For all other information on using the SIRIUS tuner, please refer to the SIRIUS operation manual.

- **Select a SIRIUS band.**

Press **BAND/ESC**.

- Band can be selected from **SR1**, **SR2** or **SR3**.

Available accessories

● Select a channel.

Push **MULTI-CONTROL** left or right.

- If you push and hold **MULTI-CONTROL** left or right, you can increase or decrease channel number continuously.
- You can also perform tuning from a desired channel category. (Refer to *Selecting a channel in the channel category* on the next page.)



Note

It may take a few seconds before you can hear anything while this unit acquires and processes the satellite signal when you change the source to SIRIUS tuner or select a channel.

Selecting a SIRIUS channel directly

When using the remote control, you can select the SIRIUS channel directly by entering the desired channel number.

1 Press **DIRECT**.

Channel number input display appears.

2 Press **0 to 9** to enter the desired channel number.

- You can cancel the input number by pressing **CLEAR**.

3 Press **DIRECT**.

The SIRIUS channel of entered number is selected.

- After entering the number input mode, if you do not perform an operation within about eight seconds, the mode is automatically canceled.

Switching the SIRIUS display

● Press **DISP** to switch the SIRIUS display.

Each press of **DISP** changes the SIRIUS display in the following order:
 Play time—Channel number—Channel name—Category name—Artist name—Song title/program title—Composer name

- Play time is displayed during the Instant Replay mode. Refer to *Using Instant Replay function* on page 59.

- Play time display indicates the time inverted from the live broadcast. Play time is displayed in negative number.

Storing and recalling broadcast stations

You can easily store up to six broadcast stations for later recall.

- Six stations for each band can be stored in memory.

● When you find a station that you want to store in memory press one of preset tuning buttons **1 to 6** and hold until the SIRIUS preset number stops flashing.

The number you have pressed will flash in the SIRIUS preset number indicator and then remain lit. The selected station has been stored in memory.

The next time you press the same preset tuning button the station is recalled from memory.

- You can also recall stations assigned to preset tuning numbers by pushing **MULTI-CONTROL** up or down.

Introduction of advanced operations

1 Press **MULTI-CONTROL** to display the main menu.

2 Use **MULTI-CONTROL** to select **FUNCTION**.

The function selection menu is displayed. Turn to change the menu option. Press to select.

3 Turn **MULTI-CONTROL** to select the function.

MODE (channel select mode setting)—**GAME ALERT** (game alert setting)—**TEAM SETTING** (team setting)—**GAME INFO** (game info)—**PAUSE** (pause)

**Notes**

- You can also select the function by pressing **FUNCTION** on the remote control.
- To return to the ordinary display, press **BAND/ESC**.
- If you do not operate functions within about 30 seconds, the display is automatically returned to the ordinary display.
- During the Instant Replay mode, you can select **PAUSE** (pause). Refer to *Using Instant Replay function* on the next page.
- **PAUSE** is the same as that of the built-in CD player. (Refer to *Pausing playback* on page 19.)

Selecting the SIRIUS channel select mode

You have two methods for selecting a channel: by number and by category. When selecting by number, channels in any category can be selected. Select by category to narrow your search down to only channels in a particular category.

- **Press SAT MODE repeatedly to select the desired channel select setting.**
CH NUMBER (channel number select setting)
—**CATEGORY** (channel category select setting)

**Note**

You can also perform this operation in the menu that appears by using **MULTI-CONTROL**.

Selecting a channel in the channel category

1 Select the channel select settings to CATEGORY.

Refer to *Selecting the SIRIUS channel select mode* on this page.

2 Push MULTI-CONTROL up or down to select the desired channel category.

3 Push MULTI-CONTROL left or right to select the desired channel in the selected channel category.

Using the Game Alert function

Only when SIR-PNR2/SIR-PNR2C is connected to this unit, you can operate this function.

This system can alert you when games involving your favorite teams are about to start. To use this function you need in advance to set up a game alert for the teams.

Selecting teams for Game Alert

1 Display the function selection menu.

Refer to *Introduction of advanced operations* on the previous page.

2 Use MULTI-CONTROL to select TEAM SETTING in the function menu.

3 Push MULTI-CONTROL left or right to select a desired league.

League names are switched in the display.

4 Push MULTI-CONTROL up or down to select a desired team.

Teams in the selected category are switched in the display.

5 Press MULTI-CONTROL to store the selected team in memory.

The game alert function will start on that team.

- To turn the Game Alert off of the selected team, press **MULTI-CONTROL** again.
- When you have already made 12 team selections, **FULL** is displayed and additional team selection is not possible. In this case, first delete the team selection and then try again.

6 Repeat these steps for selecting other teams.

Up to 12 teams can be selected.

Available accessories

Switching the Game Alert on or off

Once you made team selections, you need to turn the Game Alert function on.

- The Game Alert function is on at the default setting.

1 Display the function selection menu.

Refer to *Introduction of advanced operations* on page 57.

2 Use MULTI-CONTROL to select GAME ALERT in the function menu.

3 Press MULTI-CONTROL to turn the Game Alert on.

The Game Alert function is now on.

- To turn the Game Alert function off, press MULTI-CONTROL again.

When the game of the selected team starts

When a game of the selected team is about to start (or is currently playing) on a different station, **GAME ALERT** is displayed. Press and hold **MULTI-CONTROL** to switch to that station, and you can listen to that game.

- If you do not operate the function within about 10 seconds, the display is automatically returned.

Displaying game information

If games of your selected teams are currently playing, you can display information of the games and tune to the broadcast channel. You can display information of the games while enjoying the sound from currently tuning station. You can also tune to the broadcast channel when you wish to.

1 Display the function selection menu.

Refer to *Introduction of advanced operations* on page 57.

2 Use MULTI-CONTROL to select GAME INFO in the function menu.

The game information of your selected team is displayed.

3 Push MULTI-CONTROL up or down to select a game.

The game is displayed, followed by more detailed game information.

- Game score will be updated automatically.

4 Press MULTI-CONTROL to switch to that station to listen to the game.



Notes

- If you have not made any team selections, **NOT SET** is displayed.
- When games involving your favorite teams are not currently playing, **NO GAME** is displayed.

Displaying the Radio ID

If you select **CH 000**, the ID code is displayed.

- Push MULTI-CONTROL left or right to select **CH 000**.



Note

To select **CH 000**, set the channel select setting to **CH NUMBER**. About the channel select setting, refer to *Selecting the SIRIUS channel select mode* on the previous page.

Using Instant Replay function

Following functions can be operated during the Instant Replay mode.

- To use this function, Pioneer SIRIUS bus interface (e.g. CD-SB10) is required.
- To use this function, SIRIUS plug-and-play unit with Instant Replay Function is required.
- For details, refer to SIRIUS plug-and-play unit's manuals.

● Performing the Instant Replay mode

When SIRIUS tuner is selected as the source, press and hold **SAT MODE**.

- In the following conditions, tuner exits from the Instant Replay mode.
 - When **BAND/ESC** is pressed
 - When another source is selected

- **Select a track**

Push **MULTI-CONTROL** left or right.

- **Fast forward or reverse**

Push and hold **MULTI-CONTROL** left or right for about one second and release. 

HD Radio tuner

Basic Operations

You can use this unit to control an HD Radio tuner (GEX-P10HD), which is sold separately. For details concerning operation, refer to the HD Radio's operation manual.

- **Select a band**

Press **BAND/ESC**.

- Band can be selected from among **FM1**, **FM2**, **FM3** or **AM**.

- **Manual tuning (step by step)**

Push **MULTI-CONTROL** left or right.

- **Seek tuning**

Push and hold **MULTI-CONTROL** left or right, and then release.

- You can cancel seek tuning by pushing **MULTI-CONTROL** left or right.

Storing and recalling broadcast frequencies

You can easily store up to six broadcast frequencies for later recall.

- Six stations for each band can be stored in memory.

1 Press **LIST**.

Preset screen is displayed.

2 Use **MULTI-CONTROL** to store the selected frequency in memory.

Turn to change the preset number. Press and hold to store.

3 Use **MULTI-CONTROL** to select the desired station.

Turn to change the station. Press to select.

- You can also change the station by pushing **MULTI-CONTROL** up or down.

- To return to the ordinary display, press **BAND/ESC** or **LIST**.

- If you do not operate the list within about 30 seconds, the display automatically returns to the ordinary display.

Using the remote control

- **When you find a frequency that you want to store in memory, press one of preset tuning buttons 1 to 6 and hold until the preset number stops flashing.**

The number you have pressed will flash in the preset number indicator and then remain lit. The selected radio station frequency has been stored in memory.

The next time you press the same preset tuning button the radio station frequency is recalled from memory.

- You can also recall radio station frequencies assigned to preset tuning numbers by pushing **MULTI-CONTROL** up or down during the frequency display.

Switching the display

Desired information can be displayed.

- **Press **DISP**.**

Press **DISP** repeatedly to switch between the following settings:

Frequency or station name—song title—artist name—program type

- Only when the tuner has been tuned in to an HD Radio broadcasting, display can be changed.
- When the tuner has been tuned in to an HD Radio broadcasting, default display is changed into station name instead of frequency.

Available accessories

Introduction to advanced operations

1 Press **MULTI-CONTROL** to display the main menu.

2 Use **MULTI-CONTROL** to select **FUNCTION**.

Turn to change the menu option. Press to select.

The function menu is displayed.

3 Turn **MULTI-CONTROL** to select the function.

BSM (best stations memory)—**LOCAL** (local seek tuning)—**SEEK MODE** (seek mode)—**BLENDING** (reception mode)

Function and operation

BSM and **LOCAL** operations are basically the same as that of the tuner.

Function name	Operation
BSM	Refer to <i>Storing the strongest broadcast frequencies</i> on page 15.
LOCAL	Refer to <i>Tuning in strong signals</i> on page 16.

Notes

- You can also select the function by pressing **FUNCTION** on the remote control.
- To return to the playback display, press **BAND/ESC**.

Switching the seek mode

There are two method of seek tuning settings, one is **HD** (Digital broadcasting stations seek) and the other is **ALL** (normal seek).

1 Display the function menu.

Refer to *Introduction to advanced operations* on this page.

2 Use **MULTI-CONTROL** to select **SEEK MODE** in the function menu.

3 Press **MULTI-CONTROL** to select your favorite setting.

ALL—HD

Switching the reception mode

If a digital broadcast reception condition gets poor, this unit automatically switches to the analog broadcast of the same frequency level. If this function is set to on, the tuner switches between digital broadcast and analog broadcast automatically. If this function is off, reception will be conducted within an analog broadcast.

1 Display the function menu.

Refer to *Introduction to advanced operations* on this page.

2 Use **MULTI-CONTROL** to select **BLENDING** in the function menu.

3 Press **MULTI-CONTROL** to select your favorite setting.

ON—OFF 

Multi-CD Player

Basic Operations

You can use this unit to control a multi-CD player, which is sold separately.

- Only functions described in this manual are supported by 50-disc multi-CD players.
- This unit is not designed to operate disc title list functions with a 50-disc multi-CD player. For information about the disc title list functions, refer to *Selecting discs from the disc title list* on page 65.

● Select a disc

Push **MULTI-CONTROL** up or down.

- You can also select a disc by using **1** to **6** buttons on the remote control.
 - For discs 1 to 6, press the corresponding button number.

Available accessories

- For discs 7 to 12, press and hold the corresponding numbers, such as **1** for disc 7, until the disc number appears in the display.

● Fast forward or reverse

Push and hold **MULTI-CONTROL** left or right.

● Select a track

Push **MULTI-CONTROL** left or right.

Notes

- When multi-CD player completes preparatory operations, **READY** is displayed.
- If an error message is displayed, refer to the multi-CD player owner's manual.
- If there are no discs in the multi-CD player magazine, **NO DISC** is displayed.

Using CD TEXT functions

You can use these functions only with a CD TEXT compatible multi-CD player.

The operation is the same as that of the built-in CD player.

Refer to *Displaying text information on disc* on page 17.

Selecting a track directly

The operation is the same as that of the built-in CD player.

Refer to *Selecting a track directly* on page 17.

Introduction to advanced operations

*You can only use **COMP/DBE** (compression and DBE) with a multi-CD player that supports them.*

1 Press **MULTI-CONTROL** to display the main menu.

2 Use **MULTI-CONTROL** to select **FUNCTION**.

Turn to change the menu option. Press to select.

The function menu is displayed.

3 Turn **MULTI-CONTROL** to select the function.

REPEAT (repeat play)—**RANDOM** (random play)—**SCAN** (scan play)—**PAUSE** (pause)—**COMP/DBE** (compression and DBE)—

ITS PLAY (ITS play)—**ITS MEMORY** (ITS programming)—**TITLE INPUT** (disc title input)

- If you do not operate functions other than **ITS MEMORY** and **TITLE INPUT** within about 30 seconds, the display automatically returns to the ordinary display.

- When playing a CD TEXT disc on a CD TEXT compatible multi-CD player, you cannot switch to **TITLE INPUT**. The disc title is already recorded on the CD TEXT disc.

Function and operation

REPEAT, RANDOM, SCAN, PAUSE,

COMP/DBE and **TITLE INPUT** operations are basically the same as that of the built-in CD player.

Function name	Operation
REPEAT	Refer to <i>Selecting a repeat play range</i> on page 18. However, the repeat play ranges you can select are different from that of the built-in CD player. The repeat play ranges of the multi-CD player are: <ul style="list-style-type: none"> • MCD – Repeat all discs in the multi-CD player • TRACK – Repeat just the current track • DISC – Repeat the current disc
RANDOM	Refer to <i>Playing tracks in random order</i> on page 19.
SCAN	Refer to <i>Scanning folders and tracks</i> on page 19.

Available accessories

PAUSE	Refer to <i>Pausing playback</i> on page 19.
TITLE INPUT	Refer to <i>Entering disc titles</i> on page 20.

Notes

- You can also select the function by pressing **FUNCTION** on the remote control.
- To return to the playback display, press **BAND/ESC**.
- If you select other discs during repeat play, the repeat play range changes to **MCD**.
- If you perform track search or fast forward/reverse during **TRACK**, the repeat play range changes to **DISC**.
- After track or disc scanning is finished, normal playback of the tracks begins again.

Using compression and bass emphasis

You can only use these functions with a multi-CD player that supports them.

COMP (compression) and DBE (dynamic bass emphasis) functions lets you adjust the sound playback quality of the multi-CD player.

1 Display the function menu.

Refer to *Introduction to advanced operations* on the previous page.

2 Use MULTI-CONTROL to select COMP/DBE in the function menu.

- If the multi-CD player does not support COMP/DBE, **NO COMP** is displayed when you attempt to select it.

3 Press MULTI-CONTROL to select your favorite setting.

OFF—COMP 1—COMP 2—OFF—DBE 1—DBE 2

Using ITS playlists

ITS (instant track selection) lets you make a playlist of favorite tracks from the multi-CD

player magazine. After you have added your favorite tracks to the playlist, you can turn on ITS play and play just those selections.

You can use ITS to enter and play back up to 99 tracks per disc from up to 100 discs (with the disc titles). (With multi-CD players sold before the CDX-P1250 and CDX-P650, up to 24 tracks can be stored in the playlist.)

Creating a playlist with ITS programming

1 Play a CD that you want to program.

Push **MULTI-CONTROL** up or down to select the CD.

2 Display the function menu.

Refer to *Introduction to advanced operations* on the previous page.

3 Use MULTI-CONTROL to select ITS MEMORY in the function menu.

4 Select the desired track by pushing MULTI-CONTROL left or right.

5 Push MULTI-CONTROL up to store the currently playing track in the playlist.

MEMORY COMPLETE is displayed and the currently playing selection is added to your playlist.

6 Press BAND/ESC to return to the playback display.

Note

After data for 100 discs is stored in memory, data for a new disc will overwrite the oldest one.

Playback from your ITS playlist

ITS play lets you listen to the tracks that you have entered into your ITS playlist. When you turn on ITS play, tracks from your ITS playlist in the multi-CD player begin to play.

1 Select the repeat range.

Refer to *Playing tracks in random order* on page 19.

Available accessories

2 Display the function menu.

Refer to *Introduction to advanced operations* on page 62.

3 Use MULTI-CONTROL to select ITS PLAY in the function menu.

4 Press MULTI-CONTROL to turn ITS play on.

ITS PLAY: ON appears in the display. Playback begins of those tracks from your playlist within the previously selected **MCD** or **DISC** ranges.

- If no tracks in the current range are programmed for ITS play, then **ITS PLAY: EMPTY** is displayed.
- To turn ITS play off, press **MULTI-CONTROL** again.

Erasing a track from your ITS playlist

You can delete a track from your ITS playlist if ITS play is on.

If ITS play is already on, skip to step 2. If ITS play is off, use **MULTI-CONTROL**.

1 Play the CD with the track you want to delete from your ITS playlist, and turn ITS play on.

Refer to *Playback from your ITS playlist* on the previous page.

2 Display the function menu.

Refer to *Introduction to advanced operations* on page 62.

3 Use MULTI-CONTROL to select ITS MEMORY in the function menu.

4 Select the desired track by pushing MULTI-CONTROL left or right.

5 Push MULTI-CONTROL down to erase the track from your ITS playlist.

The currently playing selection is erased from your ITS playlist and playback of the next track begins.

6 Press BAND/ESC to return to the playback display.

Erasing a CD from your ITS playlist

You can delete all tracks of a CD from your ITS playlist if ITS play is off.

1 Play the CD that you want to delete.

Push **MULTI-CONTROL** up or down to select the CD.

2 Display the function menu.

Refer to *Introduction to advanced operations* on page 62.

3 Use MULTI-CONTROL to select ITS MEMORY in the function menu.

4 Push MULTI-CONTROL down to erase all tracks on the currently playing CD from your ITS playlist.

All tracks on the currently playing CD are deleted from your playlist and **MEMORY DELETED** is displayed.

5 Press BAND/ESC to return to the playback display.

Using disc title functions

You can input CD titles and display the titles. Then, you can easily search for and play a desired disc.

Entering disc titles

Use the disc title input feature to store up to 100 CD titles (with ITS playlist) into the multi-CD player. Each title can be up to 10 characters long.

For details concerning operation, refer to *Entering disc titles* on page 20.

- Titles remain in the memory even after the disc is removed from the magazine, and are recalled when the disc is reinserted.
- After data for 100 discs is stored in memory, data for a new disc will overwrite the oldest one.

Available accessories

Displaying disc titles

You can display the text information of any disc that has the disc title entered.

The operation is the same as that of the built-in CD player.

Refer to *Displaying text information on disc* on page 17.

Selecting discs from the disc title list

Disc title list lets you see the list of disc titles entered in the multi-CD player and select one of them to play back.

1 Press LIST to switch to the disc title list mode during the playback display.

2 Use MULTI-CONTROL to select the desired disc title.

Turn to change the disc title. Press to play.

- You can also change the disc title by pushing **MULTI-CONTROL** up or down.

- When playing CD TEXT disc, push

MULTI-CONTROL right to see a list of the tracks in the selected disc. Push **MULTI-CONTROL** left to return to the disc list.

- If no title is entered for a disc, **NO DISC TITLE** is displayed.

- **NO DISC** is displayed next to the disc number when there is no disc in the magazine.

- If you do not operate the list within about 30 seconds, the display automatically returns to the ordinary display. 

DVD Player

Basic Operations

You can use this unit to control a DVD player or multi-DVD player, which is sold separately.

For details concerning operation, refer to the DVD player's or multi-DVD player's operation manual. This section provides information on DVD operations with this unit which differs from that described in the DVD player's or multi-DVD player's operation manual.

- **Select a chapter/track**

Push **MULTI-CONTROL** left or right.

- **Fast forward or reverse**

Push and hold **MULTI-CONTROL** left or right.

- When playing compressed audio, there is no sound on fast forward or reverse.

- **To skip back or forward to another chapter/track, push MULTI-CONTROL left or right.**

Selecting a disc

- You can operate this function only when a multi-DVD player is connected to this unit.

- **Press any of 1 to 6 on the remote control to select the desired disc.**

Selecting a folder

- You can operate this function only when a DVD player compatible with compressed audio playback is connected to this unit.

- **Push MULTI-CONTROL up or down to select a folder.**

Introduction to advanced operations

1 Press MULTI-CONTROL to display the main menu.

2 Use MULTI-CONTROL to select FUNCTION.

The function menu is displayed.
Turn to change the menu option. Press to select.

3 Turn MULTI-CONTROL to select the function.

During DVD video or Video CD playback

REPEAT (repeat play)—**PAUSE** (pause)

During CD playback

REPEAT (repeat play)—**RANDOM** (random play)—**SCAN** (scan play)—**PAUSE** (pause)—**ITS PLAY** (ITS play)—**ITS MEMO** (ITS input)—**TITLE INPUT** (disc title input)

During compressed audio playback

REPEAT (repeat play)—**RANDOM** (random play)—**SCAN** (scan play)—**PAUSE** (pause)

- To return to the playback display, press

BAND/ESC.

- If you do not operate functions except for **ITS MEMO** and **TITLE INPUT** within about 30 seconds, the display is automatically returned to the ordinary display.

Function and operation

REPEAT, **RANDOM**, **SCAN**, **PAUSE** and **TITLE INPUT** operations are basically the same as that of the built-in CD player.

Also, **ITS PLAY** and **ITS MEMO** operations are basically the same as that the multi-CD player.

Function name	Operation
REPEAT	Refer to <i>Selecting a repeat play range</i> on page 18. But the repeat play range that you can select is vary depending on the type of disc or system. The repeat play ranges of the DVD player/multi-DVD player are as below: During PBC playback of Video CDs, this function cannot be operated.
RANDOM	Refer to <i>Playing tracks in random order</i> on page 19.
SCAN	Refer to <i>Scanning folders and tracks</i> on page 19.
PAUSE	Refer to <i>Pausing playback</i> on page 19.
ITS PLAY	Refer to <i>Using ITS playlists</i> on page 63.
ITS MEMO	Refer to <i>Using ITS playlists</i> on page 63.
TITLE INPUT	Refer to <i>Entering disc titles</i> on page 20.

- **DISC** – Repeat the current disc
- **FOLDER** – Repeat the current folder
- **TITLE** – Repeat just the current title
- **CHAP** – Repeat just the current chapter
- **TRACK** – Repeat the current track



Notes

- You can also select the function by pressing **FUNCTION** on the remote control.
- To return to the playback display, press **BAND/ESC.**
- If you select other discs during repeat play, the repeat play range changes to **DISC.**
- When playing back Video CD or CD, if you perform track search or fast forward/reverse during **TRACK**, the repeat play range changes to **DISC.**

Available accessories

- When playing back compressed audio, if you select another folder during repeat play, the repeat play range changes to **DISC**.
- When playing back compressed audio, if you perform track search or fast forward/reverse during **TRACK**, the repeat play range changes to **FOLDER**.
- Multi-DVD player that has ITS functions and disc title functions can also be connected to this unit. In this case, **ITS PLAY, ITS MEMO** and disc title input can be controlled.
- The ITS function of a DVD player differs slightly from ITS playback with a multi-CD player. With multi-DVD player, ITS playback applies only to the CD playing. For details, refer to *Using ITS playlists* on page 63. 

TV tuner

Basic Operations

You can use this unit to control a TV tuner, which is sold separately.

For details concerning operation, refer to the TV tuner's operation manual. This section provides information on TV operations with this unit, which differs from that described in the TV tuner's operation manual.

● Select a band

Press **BAND/ESC**.

● Select a channel (step by step)

Push **MULTI-CONTROL** left or right.

● Seek tuning

Push and hold **MULTI-CONTROL** left or right, and then release.

Notes

- Band can be selected from **TV-1** or **TV-2**.
- You can cancel seek tuning by pushing **MULTI-CONTROL** left or right.
- While pushing and holding **MULTI-CONTROL** left or right, you can skip stations. Seek tuning starts as soon as you release **MULTI-CONTROL**.

Storing and recalling broadcast stations

You can easily store up to 12 broadcast stations for later recall.

- 12 stations for each band can be stored in memory.

1 Press LIST.

Preset screen is displayed.

2 Use MULTI-CONTROL to store the selected station in memory.

Turn to change the preset number. Press and hold to store.

3 Use MULTI-CONTROL to select the desired station.

Turn to change the station. Press to select.

- You can also change the station by pushing **MULTI-CONTROL** up or down.
- If you do not operate the list within about 30 seconds, the display automatically returns to the ordinary display.

Using the remote control

You can also store and recall stations assigned to preset tuning numbers **P 1** to **P 6** by using the remote control.

- **When you find a station that you want to store in memory, press one of preset tuning buttons 1 to 6 and hold until the preset number stops flashing.**

The number you have pressed will flash in the preset number indicator and then remain lit. The selected station has been stored in memory.

The next time you press the same preset tuning button the station is recalled from memory.

- You can also recall stations assigned to preset tuning numbers by pushing **MULTI-CONTROL** up or down during the channel display.

Storing the strongest broadcast stations sequentially

1 Press **MULTI-CONTROL** to display the main menu.

2 Use **MULTI-CONTROL** and select **FUNCTION** to display **BSSM**.

3 Press **MULTI-CONTROL** to turn **BSSM** on.

SEARCH begins to flash. While **SEARCH** is flashing, the 12 strongest broadcast stations are stored in order from the lowest channel up. When finished, the preset channel list appears.

- To cancel the storage process, press **MULTI-CONTROL** again.

4 Use **MULTI-CONTROL** to select the desired station.

Turn to change the station. Press to select.

- You can also change the station by pushing **MULTI-CONTROL** up or down.
- You can also select the function by pressing **FUNCTION** on the remote control.
- To return to the ordinary display, press **BAND/ESC**.
- If you do not operate the list within about 30 seconds, the display automatically returns to the ordinary display. 

Additional Information

Troubleshooting

Bluetooth audio/telephone

Symptom	Cause	Action
The audio of the Bluetooth audio source is not played back.	A Bluetooth-connected cellular phone is currently in a phone call.	The audio will be played back when the call is completed.
	A Bluetooth-connected cellular phone is currently in operation.	Do not operate the cellular phone at this time.
	A call was made with a Bluetooth-connected cellular phone and then immediately terminated. As a result, communication between this unit and the cellular phone was not terminated properly.	Reconnect the Bluetooth connection between this unit and the cellular phone.



Error messages

When you contact your dealer or your nearest Pioneer Service Center, be sure to have the error message recorded.

Built-in CD Player

Message	Cause	Action
ERROR-11, 12, 17, 30	Dirty disc	Clean disc.
ERROR-11, 12, 17, 30	Scratched disc	Replace disc.
ERROR-10, 11, 12, 15, 17, 30, A0	Electrical or mechanical	Turn the ignition switch OFF and back ON, or switch to a different source, then back to the CD player.
ERROR-15	The inserted disc does not contain any data	Replace disc.

ERROR-22, 23	The CD format cannot be played back	Replace disc.
NO AUDIO	The inserted disc does not contain any files that can be played back	Replace disc.
TRK SKIPPED	The inserted disc contains WMA files that are protected by DRM	Replace disc.
PROTECT	All the files on the inserted disc are secured by DRM	Replace disc.

USB audio player/USB memory

Message	Cause	Action
NO AUDIO	No songs	Transfer the audio files to the USB portable audio player/USB memory and connect.
	USB memory with security enabled is connected	Follow the USB memory instructions to disable the security.
	No songs	Transfer the songs to iPod.
TRK SKIPPED	The connected USB portable audio player/USB memory contains WMA files that are protected by Windows Media DRM 9/10	Play an audio file not protected by Windows Media DRM 9/10.
PROTECT	All the files on the connected USB portable audio player/USB memory are protected by Windows Media DRM 9/10	Transfer audio files not protected by Windows Media DRM 9/10 to the USB portable audio player/USB memory and connect.
N/A USB	The USB device connected to is not supported by this unit.	Connect a USB portable audio player or USB memory that is USB Mass Storage Class compliant.

Additional Information

CHECK USB	The USB connector or USB cable is short-circuited.	Confirm that the USB connector or USB cable is not caught in something or damaged.
	The connected USB portable audio player/USB memory consumes more than 500 mA (maximum allowable current).	Disconnect the USB portable audio player/USB memory and do not use it. Turn the ignition switch to OFF, then to ACC or ON and then connect the compliant USB portable audio player/USB memory.
ERROR-19	Communication failure	Perform one of the following operations. -Turn the ignition switch OFF and back ON. -Disconnect the USB portable audio player/USB memory. -Change to a different source. Then, return to the USB portable audio player/USB memory.
ERROR-23	USB device is not formatted with FAT16 or FAT32	USB device should be formatted with FAT16 or FAT32.

iPod

Message	Cause	Action
ERROR-19	Communication failure	Disconnect the cable from iPod. Once iPod main menu is displayed, connect the cable again. Reset the iPod.
	iPod failure	Disconnect the cable from iPod. Once iPod main menu is displayed, connect the cable again. Reset the iPod.

N/A USB	Old version of iPod	Update the iPod version.
	iPod failure	Reset the iPod.
ERROR-16	Old version of iPod	Update the iPod version.
	iPod failure	Disconnect the cable from iPod. Once iPod main menu is displayed, connect the cable again. Reset the iPod.
CHECK USB	iPod is not charged but operates correctly	Check if the connection cable for iPod shorted out (e.g., not caught in metal objects). After checking, turn the ignition switch OFF and back ON or disconnect the iPod and connect again.
NO SONGS	No songs	Transfer the songs to iPod.
STOP	No songs in the current list	Select a list that contains the songs.

Bluetooth audio/telephone

Message	Cause	Action
ERROR-10	Built-in Bluetooth unit encountered an error	Turn the ignition OFF and ON.
ERROR-80	Built-in FLASH ROM encountered an error	Turn the ignition OFF and ON.



Additional Information

Handling guideline of discs and player

- Use only discs featuring either of following two logos.



- Use only conventional, fully circular discs. Do not use shaped discs.



- Use 12-cm or 8-cm CD. Do not use an adapter when playing 8-cm CDs.
- Do not insert anything other than a CD into the CD loading slot.
- Do not use cracked, chipped, warped, or otherwise damaged discs as they may damage the player.
- Unfinalized CD-R/CD-RW disc playback is not possible.
- Do not touch the recorded surface of the discs.
- Store discs in their cases when not in use.
- Avoid leaving discs in excessively hot environments including under direct sunlight.
- Do not attach labels, write on or apply chemicals to the surface of the discs.
- To clean a CD, wipe the disc with a soft cloth outward from the center.
- Condensation may temporarily impair the player's performance. Leave it to adjust to the warmer temperature for about one hour. Also, wipe any dump discs with a soft cloth.
- Playback of discs may not be possible because of disc characteristics, disc format, recorded application, playback environment, storage conditions, and so on.
- Text information may not be correctly displayed depending on the recorded environment.

- Road shocks may interrupt disc playback.
- Read the precautions for discs before using them.

Dual Discs

- Dual Discs are two-sided discs that have a recordable CD for audio on one side and a recordable DVD for video on the other.
- Since the CD side of Dual Discs is not physically compatible with the general CD standard, it may not be possible to play the CD side with this unit.
- Frequent loading and ejecting of a Dual Disc may result in scratches on the disc. Serious scratches can lead to playback problems on this unit. In some cases, a Dual Disc may become stuck in the disc loading slot and will not eject. To prevent this, we recommend you refrain from using Dual Disc with this unit.
- Please refer to the information from the disc manufacturer for more detailed information about Dual Discs.

Compressed audio compatibility

WMA

- Compatible format: WMA encoded by Windows Media Player
- Bit rate: 48 kbps to 320 kbps (CBR), 48 kbps to 384 kbps (VBR)
- Sampling frequency: 32 kHz to 48 kHz
- Windows Media Audio 9 Professional, Lossless, Voice: No

MP3

- Bit rate: 8 kbps to 320 kbps
- Sampling frequency: 16 kHz to 48 kHz (32, 44.1, 48 kHz for emphasis)
- Compatible ID3 tag version: 1.0, 1.1, 2.2, 2.3, 2.4 (ID3 tag Version 2.x is given priority than Version 1.x.)
- M3u playlist: No

Additional Information

- MP3i (MP3 interactive), mp3 PRO: No

AAC

- Compatible format: AAC encoded by iTunes®
- Sampling frequency: 11.025 kHz to 48 kHz
- Transmission rate: 16 kbps to 320 kbps
- AAC file bought on the iTunes Store (.m4p file extension): No
- Apple Lossless: No

WAV

- Compatible format: Linear PCM (LPCM), MS ADPCM
- Quantization bits: 8 and 16 (LPCM), 4 (MS ADPCM)
- Sampling frequency: 16 kHz to 48 kHz (LPCM), 22.05 kHz to 44.1 kHz (MS ADPCM)

Compressed audio files on the disc

- Depending on the version of Windows Media Player used to encode WMA files, album names and other text information may not be correctly displayed.
- There may be a slight delay when starting playback of WMA/AAC files encoded with image data.
- ISO 9660 Level 1 and 2 compliant. Romeo and Joliet file systems are both compatible with this player.
- Multi-session playback is possible.
- Compressed audio files are not compatible with packet write data transfer.
- Only 64 characters from the beginning can be displayed as a file name (including the extension such as .wma, .mp3, .m4a or .wav) or a folder name.
- Folder selection sequence or other operation may be altered depending on the encoding or writing software.
- Regardless of the length of blank section between the songs of original recording,

compressed audio discs play with a short pause between songs.

- File extensions such as .wma, .mp3, .m4a or .wav must be used properly.

Example of a hierarchy

 Folder

 Compressed audio file

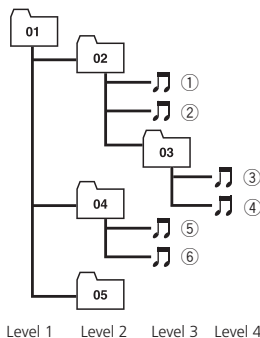

Level 1 Level 2 Level 3 Level 4

- This unit assigns folder numbers. The user cannot assign folder numbers.
- Folder hierarchy is allowed up to eight tiers. However, a practical hierarchy of folder is less than two tiers.
- Up to 99 folders on a disc can be played back.

USB audio player/USB memory

USB audio player/USB memory compatibility

- USB version: 2.0, 1.1 and 1.0
- USB data transfer rate: full speed
- USB Class: MSC (Mass Storage Class) device
- Protocol: bulk
- Minimum amount of memory: 250 MB
- Maximum amount of memory: 250 GB
- File system: FAT32 and FAT16
- Supply current: 500 mA

Additional Information

Notes

- Partitioned USB memory is not compatible with this unit.
- Depending on the kind of USB portable audio player/USB memory you use, this unit may not recognize the USB audio player/USB memory or audio files may not be played back properly.
- This unit can play back files in the USB portable audio player/USB memory that is USB Mass Storage Class. However, copyright protected files that are stored in above-mentioned USB devices cannot be played back. (If the iPod is connected to this unit, file playback condition depends on the iPod specifications.)
- You cannot connect a USB portable audio player/USB memory to this unit via a USB hub.

Handling guideline and supplemental information

- Do not leave the USB portable audio player/USB memory in direct sunlight for extended amounts of time. Extended exposure to direct sunlight can result in USB portable audio player/USB memory malfunction due to the resulting high temperature.
- Do not leave the USB portable audio player/USB memory in high temperature.
- Firmly secure the USB portable audio player/USB memory when driving. Do not let the USB portable audio player/USB memory fall onto the floor, where it may become jammed under the brake or accelerator pedal.
- There may be a slight delay when starting playback of audio files encoded with image data.
- Depending on the USB devices connected to this unit, it may generate noise in the radio.
- Only 32 characters from the beginning can be displayed as a file name (including the extension) or a folder name when USB por-

table audio player/USB memory is selected as a source.

- The text information of some audio files may not be correctly displayed.
- File extensions must be used properly.
- Up to 15 000 files on a USB portable audio player/USB memory can be played back.
- Up to 500 folders on a USB portable audio player/USB memory can be played back.
- Up to eight tiers directory on a USB portable audio player/USB memory can be played back.
- There may be a slight delay when starting playback of audio files on a USB portable audio player/USB memory with numerous folder hierarchies.
- Do not connect anything other than the USB portable audio player/USB memory.
- Operations may vary depending on the kind of USB audio player and a USB memory.

The sequence of audio files on USB memory

For USB portable audio players, the sequence is different from that of USB memory and depends on the player.

Example of a hierarchy

📁: Folder

🎵: Compressed audio file

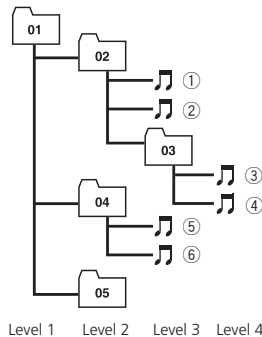

Additional Information

- 01 to 05 represent assigned folder numbers. ① to ⑥ represent the playback sequence. The user cannot assign folder numbers and specify the playback sequence with this unit.
- Playback sequence of the audio file is the same as recorded sequence in the USB device.
- To specify the playback sequence, the following method is recommended.
 - 1 Create the file name including numbers that specify the playback sequence (e.g., 001xxx.mp3 and 099yyy.mp3).
 - 2 Put those files into a folder.
 - 3 Record the folder containing files into the USB device.

However, depending on the system environment, you cannot specify the file playback sequence.

iPod

About handling the iPod

- Do not leave the iPod in direct sunlight for extended amounts of time. Extended exposure to direct sunlight can result in iPod malfunction due to the resulting high temperature.
- Do not leave the iPod in a high temperature.
- Connect directly the dock connector cable to the iPod so that this unit works properly.
- Firmly secure the iPod when driving. Do not let the iPod fall onto the floor, where it may become jammed under the brake or accelerator pedal.
- For details, refer to the iPod's manuals.

About iPod settings

- You cannot operate the iPod Equalizer on Pioneer products. We recommend that you set the iPod Equalizer to off, before connecting to this unit.

- You cannot set Repeat to off on the iPod when using this unit. Even if you set Repeat to off on the iPod, Repeat is automatically changed to All when connecting the iPod to this unit.

Bluetooth profiles

- In order to use Bluetooth wireless technology, devices must be able to interpret certain profiles. This unit is compatible with the following profiles.
 - A2DP (Advanced Audio Distribution Profile)
 - AVRCP (Audio/Video Remote Control Profile)
 - GAP (Generic Access Profile)
 - SDP (Service Discovery Protocol)
 - OPP (Object Push Profile)
 - HFP (Hands Free Profile)
 - PBAP (Phone Book Access Profile)
 - SPP (Serial Port Profile)

Additional Information

Specifications

General

Power source	14.4 V DC (10.8 V to 15.1 V allowable)
Grounding system	Negative type
Max. current consumption	10.0 A
Dimensions (W × H × D):	
DIN	
Chassis	178 mm × 50 mm × 162 mm (7 in. × 2 in. × 6-1/2 in.)
Nose	188 mm × 58 mm × 15 mm (7-3/8 in. × 2-1/4 in. × 5/8 in.)
D	
Chassis	178 mm × 50 mm × 162 mm (7 in. × 2 in. × 6-1/2 in.)
Nose	170 mm × 46 mm × 15 mm (6-3/4 in. × 1-3/4 in. × 5/8 in.)
Weight	1.3 kg (2.9 lbs)

Audio

Maximum power output	50 W × 4 50 W × 2/4 Ω + 70 W × 1/2 Ω (for subwoofer)
Continuous power output	22 W × 4 (50 Hz to 15 000 Hz, 5% THD, 4 Ω load, both channels driven)
Load impedance	4 Ω to 8 Ω × 4 4 Ω to 8 Ω × 2 + 2 Ω × 1
Preout max output level	4.0 V
Equalizer (3-Band Parametric Equalizer):	
Low	
Frequency	40/80/100/160 Hz
Q Factor	0.35/0.59/0.95/1.15 (+6 dB when boosted)
Gain	±12 dB
Mid	
Frequency	200/500/1k/2k Hz
Q Factor	0.35/0.59/0.95/1.15 (+6 dB when boosted)
Gain	±12 dB
High	
Frequency	3.15k/8k/10k/12.5k Hz
Q Factor	0.35/0.59/0.95/1.15 (+6 dB when boosted)
Gain	±12 dB
HPF:	
Frequency	50/63/80/100/125 Hz
Slope	-12 dB/oct
Subwoofer (mono):	
Frequency	50/63/80/100/125 Hz

Slope	-18 dB/oct
Gain	+6 dB to -24 dB
Phase	Normal/Reverse
Bass boost:	
Gain	+12 dB to 0 dB

CD player

System	Compact disc audio system
Usable discs	Compact disc
Signal-to-noise ratio	94 dB (1 kHz) (IEC-A network)
Number of channels	2 (stereo)
MP3 decoding format	MPEG-1 & 2 Audio Layer 3
WMA decoding format	Ver. 7, 7.1, 8, 9, 10, 11 (2ch audio) (Windows Media Player)
AAC decoding format	MPEG-4 AAC (iTunes® encoded only) (.m4a) (Ver. 7.2 and earlier)
WAV signal format	Linear PCM & MS ADPCM (Non-compressed)

USB

Specification	USB 2.0 full speed
Supply current	500 mA
Maximum amount of memory	250 GB
File system	FAT16, FAT32
MP3 decoding format	MPEG-1 & 2 Audio Layer 3
WMA decoding format	Ver. 7, 7.1, 8, 9, 10, 11 (2ch audio) (Windows Media Player)
AAC decoding format	MPEG-4 AAC (iTunes® encoded only) (.m4a) (Ver. 7.2 and earlier)
WAV signal format	Linear PCM & MS ADPCM (Non-compressed)

FM tuner

Frequency range	87.9 MHz to 107.9 MHz
Usable sensitivity	8 dBf (0.7 μV/75 Ω, mono, S/N: 30 dB)
Signal-to-noise ratio	75 dB (IEC-A network)

AM tuner

Frequency range	530 kHz to 1 710 kHz (10 kHz)
Usable sensitivity	18 μV (S/N: 20 dB)
Signal-to-noise ratio	65 dB (IEC-A network)

Bluetooth

Version	Bluetooth 2.0 certified
---------------	-------------------------

Additional Information

CEA2006 Specifications



Power output 14 W RMS × 4 Channels (4 Ω and $\leq 1\%$ THD+N)
S/N ratio 91 dBA (reference: 1 W into 4 Ω)

Note

Specifications and the design are subject to modifications without notice due to improvements.



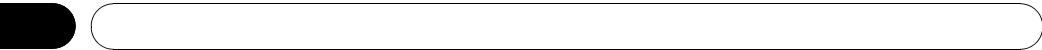



*Register your product at
Enregistrez votre produit au
Registre su producto en*

<http://www.pioneerelectronics.com>

*See "Visit our website" page
Voir la page "Visitez notre site Web"
Consulte la página sobre "Visite nuestro sitio Web"*

PIONEER CORPORATION

4-1, MEGURO 1-CHOME, MEGURO-KU
TOKYO 153-8654, JAPAN

PIONEER ELECTRONICS (USA) INC.

P.O. Box 1540, Long Beach, California 90801-1540, U.S.A.
TEL: (800) 421-1404

PIONEER EUROPE NV

Haven 1087, Keetberglaan 1, B-9120 Melsele, Belgium
TEL: (0) 3/570.05.11

PIONEER ELECTRONICS ASIACENTRE PTE. LTD.

253 Alexandra Road, #04-01, Singapore 159936
TEL: 65-6472-7555

PIONEER ELECTRONICS AUSTRALIA PTY. LTD.

178-184 Boundary Road, Braeside, Victoria 3195, Australia
TEL: (03) 9586-6300

PIONEER ELECTRONICS OF CANADA, INC.

300 Allstate Parkway, Markham, Ontario L3R 0P2, Canada
TEL: 1-877-283-5901
TEL: 905-479-4411

PIONEER ELECTRONICS DE MEXICO, S.A. de C.V.

Bldv.Manuel Avila Camacho 138 10 piso
Col.Lomas de Chapultepec, Mexico, D.F. 11000
TEL: 55-9178-4270

先鋒股份有限公司

總公司：台北市中山北路二段44號13樓
電話：(02) 2521-3588

先鋒電子（香港）有限公司

香港九龍尖沙咀海港城世界商業中心
9樓901-6室
電話：(0852) 2848-6488

Published by Pioneer Corporation.
Copyright © 2007 by Pioneer Corporation.
All rights reserved.