

Operation Manual

FLASH MEMORY MULTIMEDIA AV NAVIGATION
RECEIVER

AVIC-X910BT AVIC-X710BT

Notice to all users:

This software requires that the navigation system is properly connected to your vehicle's parking brake and depending on your vehicle, additional installation may be required. For more information, please contact your Authorized Pioneer Electronics retailer or call us at (800) 421-1404.

 **Radio**
READY

SUPER  **TUNER III** **D**

English

Thank you for buying this Pioneer product.

Please read through these operating instructions so you will know how to operate your model properly. *After you have finished reading the instructions, keep this manual in a safe place for future reference.*



Important

The screens shown in the examples may differ from actual screens.
Actual screens may be changed without notice for performance and function improvements.

01 Introduction

- Information to User **9**
- License Agreement **10**
 - PIONEER AVIC-X910BT, AVIC-X710BT - for U.S.A. **10**
 - PIONEER AVIC-X910BT, AVIC-X710BT - for Canada **12**
 - Terms and Conditions for the Tele Atlas Data **14**
 - Licenses **16**
- About the database **19**
 - About the Data for the Map Database **19**
 - Copyright Notices for North American data **20**
- Important Safety Information **20**
 - "GOOG-411" service **22**
 - Speed limit indication **22**
- Additional Safety Information **22**
 - Parking brake interlock **22**
 - When using a display connected to REAR MONITOR OUTPUT **23**
 - To avoid battery exhaustion **23**
 - Rear view camera **23**
- Notes Before Using the System **23**
 - Failure to operate **23**
 - Visit Our Web site **24**
- Manual overview **24**
 - How to use this manual **24**
 - Terminology **24**
 - Definitions of terminology **24**

- Notice regarding video viewing **25**
- Notice regarding DVD-Video viewing **25**
- Notice regarding MP3 file usage **25**
- iPod compatibility **25**
- Map coverage **26**
- Protecting the LCD panel and screen **26**
- Notes on internal memory **26**
 - Before removing the vehicle battery **26**
 - Data subject to erasure **26**
 - Resetting the microprocessor **26**

02 Basic operation

- Checking part names and functions **28**
- Inserting and ejecting a disc **29**
 - Inserting a disc **29**
 - Ejecting a disc **29**
- Inserting and ejecting an SD memory card **29**
 - Inserting an SD memory card **30**
 - Ejecting an SD memory card **30**
- Plugging and unplugging a USB storage device **30**
 - Plugging in a USB storage device **30**
 - Unplugging a USB storage device **30**
- Connecting and disconnecting an iPod **31**
 - Connecting your iPod **31**
 - Disconnecting your iPod **31**
- Flow from startup to termination **31**
 - On first-time startup **31**
- Regular startup **32**
- How to use the navigation menu screens **34**
 - Screen switching overview **34**
 - What you can do on each menu **35**
 - Displaying the rear view camera image **35**
- How to use the map **36**
 - How to read the map screen **36**
 - Switching the map mode **38**

- Changing the scale of the map **38**
 - Scrolling the map to the position you want to see **39**
 - Changing the tilt and rotation angle of the map **39**
 - The basic flow of creating your route **40**
 - Operating list screens (e.g. city list) **40**
 - Operating the on-screen keyboard **41**
- 03 Searching for and selecting a location**
- Searching for a location by address **42**
 - Searching for the vicinity Points of Interest (POI) **44**
 - Searching for POIs around the cursor **44**
 - Searching for a nearby POI **45**
 - Searching for POIs along the current route **45**
 - Searching for POIs around the destination **45**
 - Searching for POIs around the address **45**
 - Using “Saved Criteria” **46**
 - Searching for POIs by using the data on external storage devices (USB, SD) **48**
 - Searching for a location by coordinates **49**
 - Selecting a location you searched for recently **50**
 - Deleting an entry in “History” **50**
 - Selecting a location stored in “Favorites” **50**
 - Deleting an entry in “Favorites” **51**
 - Setting up a route to your home **51**
 - Setting a route by recalling a saved route **51**
 - Searching for a location by scrolling the map **52**
- 04 After the location is decided (Map Confirmation Screen)**
- What you can do with the “Map Confirmation Screen” **54**
 - Route... **54**
 - Save as... **55**
 - Setting the location as a new destination **55**
 - Setting the location as a waypoint **55**
 - Replacing the location as the new final destination **55**
 - Setting the location as the start point **55**
 - Viewing information about a specified location **56**
 - Placing a map pin on the location **56**
 - Removing a map pin **57**
 - Registering the location as a customized POI **57**
 - Storing the location in “Favorites” **58**
 - Deleting an entry in “Favorites” **58**
- 05 Checking the current route**
- Checking the current route conditions **59**
 - Playing simulated travel at high speed **60**
 - Checking the entire route overview on the map **60**
 - Checking the current itinerary **60**
- 06 Editing waypoints and the destination**
- Editing waypoints **62**
 - Adding a waypoint **62**
 - Sorting waypoints **62**
 - Deleting a waypoint **62**
 - Storing the current route **62**
 - Deleting the entry in “Saved Routes” **63**
 - Deleting the current route **63**
- 07 Browsing information on MSN Direct**
- Activating the service **64**
 - Checking your product key **64**
 - Subscribing to the MSN Direct service **65**

- Activating the MSN Direct function **65**
 - Browsing gas prices **65**
 - Browsing movie times **66**
 - Searching for a theater by selecting a movie title **66**
 - Searching for a movie title by selecting a theater **67**
 - Browsing weather information **68**
 - Checking the local weather information **68**
 - Checking worldwide weather conditions **68**
 - Using traffic information **68**
 - Viewing the traffic event **68**
 - Viewing the traffic flow **69**
 - Setting the traffic information **70**
 - Browsing news headlines **71**
 - Browsing local events **71**
 - Browsing stock quotes **72**
 - Selecting stock symbols **72**
 - Viewing the detailed stock quotes **72**
- 08 Using hands-free phoning**
- Hands-free phoning overview **73**
 - Preparing communication devices **73**
 - Displaying the Phone Menu **73**
 - Registering your cellular phone **73**
 - Searching for nearby phones **74**
 - Searching for a specified phone **74**
 - Pairing from your cellular phone **75**
 - Connecting a registered cellular phone **76**
 - Disconnecting a cellular phone **76**
 - Deleting a registered phone **76**
 - Receiving a phone call **77**
 - Answering an incoming call **77**
 - Rejecting an incoming call **77**
 - Making a phone call **77**
 - Direct dialing **78**
 - Dialing from the history **78**
 - Calling a number in the “Contacts” screen **79**
 - Dialing a phone number of the POI **79**
 - Making a call home easily **79**
 - Dialing GOOG-411 **80**
 - Announcing incoming short mails **80**
 - Transferring the phone book **80**
 - Clearing memory **81**
 - Setting the phone **82**
 - Setting the phone volume **82**
 - Stopping Bluetooth wave transmission **82**
 - Answering a call automatically **82**
 - Setting the automatic rejection function **83**
 - Echo canceling and noise reduction **83**
 - Setting automatic connection **83**
 - Editing the device name **83**
 - Notes for hands-free phoning **84**
 - Updating the Bluetooth wireless technology software **85**
- 09 Playing audio CDs**
- Reading the screen **86**
 - Using the touch panel keys **86**
 - Selecting a track from the list **87**
 - Using the “Function” menu **87**
- 10 Playing music files on ROM**
- Reading the screen **88**
 - Using the touch panel keys **88**
 - Selecting a track from the list **89**
 - Browsing embedded text information **89**
 - Using the “Function” menu **90**
- 11 Playing a DVD-Video**
- Reading the screen **91**
 - Using the touch panel keys **91**

- Resuming playback (Bookmark) **93**
 - Searching for a specific scene and starting playback from a specified time **93**
 - Direct number search **93**
 - Operating the DVD menu **93**
 - Frame-by-frame playback **94**
 - Slow motion playback **94**
 - Using the “Function” menu **94**
- 12 Playing a DVD-VR disc**
- Reading the screen **96**
 - Using the touch panel keys **96**
 - Searching for a specific scene and starting playback from a specified time **97**
 - Switch the playback mode **98**
 - Using the short-time skip function **98**
 - Playing by selecting from the title list **98**
 - Frame-by-frame playback **98**
 - Slow motion playback **98**
 - Using the “Function” menu **99**
- 13 Playing a DivX video**
- Reading the screen **100**
 - Using the touch panel keys **100**
 - Frame-by-frame playback **101**
 - Slow motion playback **101**
 - Searching for a specific scene and starting playback from a specified time **101**
 - Using the “Function” menu **102**
- 14 DVD-Video, DVD-VR, DivX setup**
- Displaying DVD Setup menu **103**
 - Setting the top-priority languages **103**
 - Setting the angle icon display **103**
 - Setting the aspect ratio **104**
 - Setting the parental lock **104**
- Setting the code number and level **104**
 - Displaying your DivX VOD registration code **105**
 - Setting “Auto Play” **105**
 - Setting the subtitle file for DivX **105**
 - Language code chart for DVDs **106**
- 15 Playing music files (from USB or SD)**
- Starting procedure **107**
 - Reading the screen **107**
 - Using the touch panel keys (Music) **108**
 - Selecting a track from the list **109**
 - Browsing embedded text information **109**
 - Using the “Function” menu **109**
- 16 Playing video files (from USB or SD)**
- Starting procedure **111**
 - Reading the screen **111**
 - Using the touch panel keys (Video) **112**
 - Searching for a specific scene and starting playback from a specified time **112**
 - Using the “Function” menu **113**
- 17 Using an iPod (iPod)**
- Starting procedure **114**
 - Reading the screen **114**
 - Using the touch panel keys (Music) **115**
 - Browsing for a song **115**
 - Starting the video playback **116**
 - Using the touch panel keys (Video) **117**
 - Browsing for a video **117**
 - Using the “Function” menu **118**
- 18 Using the radio (FM)**
- Reading the screen **120**
 - Using the touch panel keys **120**

- Switching between the detailed information display and the preset list display **121**
- Storing and recalling broadcast frequencies **121**

Using the "Function" menu **121**

- Storing the strongest broadcast frequencies **121**
- Tuning in strong signals **122**

19 Using the HD Radio (Digital Radio)

Reading the screen **123**

Using the touch panel keys **123**

- Switching between the detailed information display and the preset list display **124**
- Storing and recalling broadcast frequencies **124**

Switching the display **124**

Using the "Function" menu **124**

- Storing the strongest broadcast frequencies **125**
- Switching the seek mode **125**
- Tuning in strong signals **125**
- Switching the reception mode **125**

20 Using the radio (AM)

Reading the screen **126**

Using the touch panel keys **126**

- Switching between the detailed information display and the preset list display **126**
- Storing and recalling broadcast frequencies **127**

Using the "Function" menu **127**

- Storing the strongest broadcast frequencies **127**
- Tuning in strong signals **127**

21 Using the XM tuner

Reading the screen **129**

Using the touch panel keys **130**

- Selecting an XM channel directly **130**
- Displaying the Radio ID **131**
- Storing and recalling broadcast stations **131**
- Selecting a channel from the list **131**
- Using "My Mix" function **132**
- Using the direct traffic announcement function **132**

Using the "Function" menu **133**

- Setting the memorized songs **133**

22 Using the SIRIUS tuner

Reading the screen **134**

Using the touch panel keys **134**

- Selecting a SIRIUS channel directly **135**
- Display the Radio ID **135**
- Storing and recalling broadcast stations **136**
- Using "My Mix" function **136**
- Using the direct traffic announcement function **136**
- Using the "Instant Replay" function **137**

Using the "Function" menu **137**

- Setting the memorized songs **138**
- Using the Game Alert function **138**
- Displaying Game Information **139**

23 Using AV input

Using AV1 **140**

Using AV2 **140**

Using the touch panel keys **140**

24 Using the external unit (EXT1, EXT2)

Reading the screen **141**

Using the touch panel keys **141**

25 Customizing preferences

The options in the “Navi Settings”

- menu **143**
 - Basic operations in the “Navi Settings” menu **143**
 - GPS & Time Settings **143**
 - Time Settings **144**
 - POI Settings **145**
 - 3D Settings **145**
 - Map Settings **145**
 - Displayed Info **146**
 - Smart Zoom **146**
 - Overview Mode **147**
 - Manage Track Logs **147**
 - Route **147**
 - Warnings **148**
 - Regional Settings **149**
 - Set Home **149**
 - Demo Mode **149**
 - Sound settings **149**
 - About **150**
 - POI display settings **150**
 - Creating new categories **151**
 - Editing your customized POI **152**
 - Recording your travel history **152**
 - Setting your home position **154**

Options on the “System Settings” menu **154**

- Displaying the “System Settings” menu **154**
- Selecting the language **155**
- Changing the splash screen **155**
- Setting the rear view camera **156**
- Adjusting the response positions of the touch panel (touch panel calibration) **157**
- Adjusting the screen brightness **157**
- Setting the illumination color **157**
- Checking the version information **158**
- Restore Factory Settings **158**

- Turning off the screen **159**
- The “AV Sound Settings” menu options **159**
- Displaying the “AV Sound Settings” menu **159**
 - Using balance adjustment **159**
 - Using the equalizer **160**
 - Adjusting loudness **161**
 - Using subwoofer output **162**
 - Using the high pass filter **162**
 - Adjusting source levels **162**
 - Enhancing bass (Bass Booster) **163**

Options on the “AV System Settings”

- menu **163**
 - Displaying the “AV System Settings” menu **163**
 - Setting video input 1 (AV1) **163**
 - Setting video input 2 (AV2) **163**
 - Switching the auto antenna setting **164**
 - Changing the wide screen mode **164**
 - Switching the sound muting/attenuation **164**
 - Setting the rear output **165**
 - Acquiring/Cataloging iPod music information **165**

26 Operating Your Navigation System with Voice

To Ensure Safe Driving **167**

Basics of Voice Operation **167**

- Flow of voice operation **167**
- Starting voice operation **168**

Operating iPod by voice **168**

Calling the entry on “Contacts” **168**

Available Basic Voice Commands **169**

- Basic commands **169**
- Voice operation for the iPod **169**
- Voice operation for AV source (other than iPod) **170**

- Voice commands related to hands-free phoning **171**

Tips for Voice Operation **172**

27 Other functions

Setting the anti-theft function **173**

- Setting the password **173**
- Entering the password **173**
- Deleting the password **173**
- Forgotten passwords **173**

Returning the navigation system to the default or factory settings **174**

- Setting items to be deleted **175**

Appendix

Troubleshooting **177**

Messages and how to react to them **182**

Messages for audio functions **183**

Positioning technology **186**

- Positioning by GPS **186**
- Positioning by “Dead Reckoning” **186**
- How do GPS and “Dead Reckoning” work together? **186**

Handling large errors **187**

- When positioning by GPS is impossible **187**
- Conditions likely to cause noticeable positioning errors **188**

Route setting information **189**

- Route search specifications **189**

Handling and care of discs **191**

- Built-in drive and care **191**
- Ambient conditions for playing a disc **191**

Playable discs **192**

- DVD-Video and CD **192**
- AVCHD recorded discs **192**
- Playing DualDisc **192**
- Dolby Digital **192**
- DTS sound **192**

Detailed information for playable media **193**

- Compatibility **193**
- Media compatibility chart **196**

Bluetooth **200**

About the SAT RADIO READY Logo **200**

HD Radio Technology **200**

SD and SDHC logo **201**

WMA **201**

DivX **201**

AAC **201**

Detailed information regarding connectable

iPods **201**

- iPod **202**
- iPhone **202**
- iTunes **202**

Using the LCD screen correctly **202**

- Handling the LCD screen **202**
- Liquid crystal display (LCD) screen **203**
- Maintaining the LCD screen **203**
- LED (light-emitting diode) backlight **203**

Display information **204**

- Destination Menu **204**
- Phone Menu **204**
- Settings Menu **205**
- Shortcut menu **207**
- DVD Setup **208**

Glossary **209**

Specifications **212**

Introduction

Information to User

This device complies with part 15 of the FCC Rules. Operation is subject to the following two conditions:

(1) This device may not cause harmful interference, and (2) this device must accept any interference received, including interference that may cause undesired operation.

Alteration or modifications carried out without appropriate authorization may invalidate the user's right to operate the equipment.

FCC ID : AJDK020
 MODEL NO. : AVIC-X910BT
 IC : 775E-K020
 FCC ID : AJDK020
 MODEL NO. : AVIC-X710BT
 IC : 775E-K020

This device complies with Part 15 of FCC Rules and RSS-Gen of IC Rules. Operation is subject to the following two conditions: (1) this device may not cause interference, and (2) this device must accept any interference, including interference that may cause undesired operation of this device.

MADE IN CHINA

For Canadian model

This Class B digital apparatus complies with Canadian ICES-003.

This transmitter must not be co-located or operated in conjunction with any other antenna or transmitter.

This equipment complies with FCC radiation exposure limits set forth for uncontrolled equipment and meets the FCC radio frequency (RF) Exposure Guidelines in Supplement C to OET65. This equipment has very low levels of RF energy that it deemed to comply without maximum permissive exposure evaluation (MPE). But it is desirable that it should be installed and operated with at least 20cm and more between the radiator and person's body (excluding extremities: hands, wrists, feet and ankles).

CAUTION:
 USE OF CONTROL OR ADJUSTMENT OR PERFORMANCE OF PROCEDURES OTHER THAN THOSE SPECIFIED HEREIN MAY RESULT IN HAZARDOUS RADIATION EXPOSURE.
CAUTION:
 THE USE OF OPTICAL INSTRUMENTS WITH THIS PRODUCT WILL INCREASE EYE HAZARD.

WARNING

Handling the cord on this product or cords associated with accessories sold with the product will expose you to chemicals listed on proposition 65 known to the State of California and other governmental entities to cause cancer and birth defect or other reproductive harm. ***Wash hands after handling.*** 

License Agreement

PIONEER AVIC-X910BT, AVIC-X710BT- for U.S.A.

THIS IS A LEGAL AGREEMENT BETWEEN YOU, AS THE END USER, AND PIONEER ELECTRONICS (USA) INC. ("PIONEER"). PLEASE READ THE TERMS AND CONDITIONS OF THIS AGREEMENT CAREFULLY BEFORE USING THE SOFTWARE INSTALLED ON THE PIONEER PRODUCTS. BY USING THE SOFTWARE INSTALLED ON THE PIONEER PRODUCTS, YOU AGREE TO BE BOUND BY THE TERMS OF THIS AGREEMENT. THE SOFTWARE INCLUDES A DATABASE LICENSED BY THIRD PARTY SUPPLIER(S) ("SUPPLIERS"), AND YOUR USE OF THE DATABASE IS COVERED BY THE SUPPLIERS' SEPARATE TERMS, WHICH ARE ATTACHED TO THIS AGREEMENT (Refer to page 14). IF YOU DO NOT AGREE WITH ALL OF THESE TERMS, PLEASE RETURN THE PIONEER PRODUCTS (INCLUDING THE SOFTWARE, AND ANY WRITTEN MATERIALS) WITHIN FIVE (5) DAYS OF RECEIPT OF THE PRODUCTS, TO THE AUTHORIZED PIONEER DEALER FROM WHICH YOU PURCHASED THEM. USE OF THE SOFTWARE SHALL BE DEEMED TO BE YOUR CONSENT TO THE LICENSE AGREEMENT.

1 GRANT OF LICENSE

Pioneer grants to you a non-transferable, non exclusive license to use the software installed on the Pioneer products (the "Software") and the related documentation solely for your own personal use or for internal use by your business, only on such Pioneer products. You shall not copy, reverse engineer, translate, port, modify or make derivative works of the Software. You shall not loan, rent, disclose, publish, sell, assign, lease, sublicense, market or otherwise transfer the Software or use it in any manner not expressly authorized by this agreement. You shall not derive or attempt to derive the source code or structure of all or any portion of the Software by reverse engi-

neering, disassembly, decompilation, or any other means. You shall not use the Software to operate a service bureau or for any other use involving the processing of data for other persons or entities.

Pioneer and its licensor(s) shall retain all copyright, trade secret, patent and other proprietary ownership rights in the Software. The Software is copyrighted and may not be copied, even if modified or merged with other products. You shall not alter or remove any copyright notice or proprietary legend contained in or on the Software.

You may transfer all of your license rights in the Software, the related documentation and a copy of this License Agreement to another party, provided that the party reads and agrees to accept the terms and conditions of this License Agreement.

2 DISCLAIMER OF WARRANTY

The Software and related documentation are provided to you "AS IS". PIONEER AND ITS LICENSOR(S) (for the purpose of provisions 2 and 3, Pioneer and its licensor(s) shall be collectively referred to as "Pioneer") MAKES AND YOU RECEIVE NO WARRANTY FOR THE SOFTWARE, WHETHER EXPRESS OR IMPLIED, AND ALL WARRANTIES OF MERCHANTABILITY AND FITNESS FOR ANY PARTICULAR PURPOSE FOR THE SOFTWARE ARE EXPRESSLY EXCLUDED. SOME STATES DO NOT ALLOW EXCLUSION OF IMPLIED WARRANTIES, SO THE ABOVE EXCLUSION MAY NOT APPLY TO YOU. The Software is complex and may contain some nonconformities, defects or errors. Pioneer does not warrant that the Software will meet your needs or expectations, that operation of the Software will be error free or uninterrupted, or that all non-conformities can or will be corrected. Furthermore, Pioneer does not make any representations or warranties regarding the use or results of the use of the Software in terms of its accuracy, reliability or otherwise.

Introduction

3 LIMITATION OF LIABILITY

IN NO EVENT SHALL PIONEER BE LIABLE FOR ANY DAMAGES, CLAIM OR LOSS INCURRED BY YOU (INCLUDING, WITHOUT LIMITATION, COMPENSATORY, INCIDENTAL, INDIRECT, SPECIAL, CONSEQUENTIAL, OR EXEMPLARY DAMAGES, LOST PROFITS, LOST INCOME, LOST SALES OR BUSINESS, EXPENDITURES, INVESTMENTS, OR COMMITMENTS IN CONNECTION WITH ANY BUSINESS, LOSS OF ANY GOODWILL, OR DAMAGES) RESULTING FROM THE USE OF OR INABILITY TO USE THE SOFTWARE, EVEN IF PIONEER HAS BEEN INFORMED OF, KNEW OF, OR SHOULD HAVE KNOWN OF THE LIKELIHOOD OF SUCH DAMAGES. THIS LIMITATION APPLIES TO ANY AND ALL CAUSES OF ACTION INDIVIDUALLY OR IN THE AGGREGATE, INCLUDING WITHOUT LIMITATION BREACH OF CONTRACT, BREACH OF WARRANTY, NEGLIGENCE, STRICT LIABILITY, MISREPRESENTATION, AND OTHER TORTS. IF PIONEER'S WARRANTY DISCLAIMER OR LIMITATION OF LIABILITY SET FORTH IN THIS AGREEMENT SHALL OR FOR ANY REASON WHATSOEVER BE HELD UNENFORCEABLE OR INAPPLICABLE, YOU AGREE THAT PIONEER'S LIABILITY SHALL NOT EXCEED FIFTY PERCENT (50%) OF THE PRICE PAID BY YOU FOR THE ENCLOSED PIONEER PRODUCT.

Some states do not allow the exclusion or limitation of incidental or consequential damages, so the above limitation or exclusion may not apply to you. This warranty disclaimer and limitation of liability shall not be applicable to the extent that they are prohibited by any applicable federal, state or local law which provides that such a disclaimer or limitation cannot be waived or preempted.

4 EXPORT LAW ASSURANCES

You agree and certify that neither the Software nor any other technical data received from Pioneer, nor the direct product thereof, will be exported outside the United States except as authorized and as permitted by the laws and

regulations of the United States. If the Software has been rightfully obtained by you outside of the United States, you agree that you will not re-export the Software nor any other technical data received from Pioneer, nor the direct product thereof, except as permitted by the laws and regulations of the United States and the laws and regulations of the jurisdiction in which you obtained the Software.

5 TERMINATION

This Agreement is effective until terminated. You may terminate it at any time by destroying the Software. The Agreement also will terminate if you do not comply with any terms or conditions of this Agreement. Upon such termination, you agree to destroy the Software.

6 U.S. GOVERNMENT END USERS

If the Software is being acquired by or on behalf of the United States government or any other entity seeking or applying rights similar to those customarily claimed by the United States government, the Data is licensed with "Limited Rights". Utilization of the Software is subject to the restrictions specified in the "Rights in Technical Data" clause at DFARS 252.227-7013, or the equivalent clause for non-defense agencies. Pioneer Electronics (USA) Inc., 2265 East 220th Street, Long Beach, CA 90810.

7 MISCELLANEOUS

This is the entire Agreement between Pioneer and you regarding its subject matter. No change in this Agreement shall be effective unless agreed to in writing by Pioneer. Pioneer retailers do not have the authority to change this Agreement. This Agreement shall be governed by and construed in accordance with the internal laws of the State of California. If any provision of this Agreement is declared invalid or unenforceable, the remaining provisions of this Agreement shall remain in full force and effect.

PIONEER AVIC-X910BT, AVIC-X710BT - for Canada

THIS IS A LEGAL AGREEMENT BETWEEN YOU, AS THE END USER, AND PIONEER ELECTRONICS OF CANADA, INC. ("PIONEER"). PLEASE READ THE TERMS AND CONDITIONS OF THIS AGREEMENT CAREFULLY BEFORE USING THE SOFTWARE INSTALLED ON THE PIONEER PRODUCTS. BY USING THE SOFTWARE INSTALLED ON THE PIONEER PRODUCTS, YOU AGREE TO BE BOUND BY THE TERMS OF THIS AGREEMENT. THE SOFTWARE INCLUDES A DATABASE LICENSED BY THIRD PARTY SUPPLIER(S) ("SUPPLIERS"), AND YOUR USE OF THE DATABASE IS COVERED BY THE SUPPLIERS' SEPARATE TERMS, WHICH ARE ATTACHED TO THIS AGREEMENT (Refer to page 14). IF YOU DO NOT AGREE WITH ALL OF THESE TERMS, PLEASE RETURN THE PIONEER PRODUCTS (INCLUDING THE SOFTWARE, AND ANY WRITTEN MATERIALS) WITHIN FIVE (5) DAYS OF RECEIPT OF THE PRODUCTS, TO THE AUTHORIZED PIONEER DEALER FROM WHICH YOU PURCHASED THEM. USE OF THE SOFTWARE SHALL BE DEEMED TO BE YOUR CONSENT TO THE LICENSE AGREEMENT.

1 GRANT OF LICENSE

Pioneer grants to you a non-transferable, non-exclusive license to use the software installed on the Pioneer products (the "Software") and the related documentation solely for your own personal use or for internal use by your business, only on such Pioneer products. You shall not copy, reverse engineer, translate, port, modify or make derivative works of the Software. You shall not loan, rent, disclose, publish, sell, assign, lease, sublicense, market or otherwise transfer the Software or use it in any manner not expressly authorized by this agreement. You shall not derive, or attempt to derive, the source code or structure of all or any portion of the Software by reverse engineering, disassembly, decompilation, or any

other means. You shall not use the Software to operate a service bureau or for any other use involving the processing of data for other persons or entities.

Pioneer and its licensor(s) shall retain all copyright, trade secret, patent and other proprietary ownership rights in the Software. The Software is copyrighted and may not be copied, even if modified or merged with other products. You shall not alter or remove any copyright notice or proprietary legend contained in or on the Software.

You may transfer all of your license rights in the Software, the related documentation and a copy of this License Agreement to another party, provided that the party reads and agrees to accept the terms and conditions of this License Agreement.

2 DISCLAIMER OF WARRANTY

The Software and related documentation are provided to you "AS IS". PIONEER AND ITS LICENSOR(S) (for the purpose of provisions 2 and 3, Pioneer and its licensor(s) shall be collectively referred to as "Pioneer") MAKES AND YOU RECEIVE NO WARRANTY FOR THE SOFTWARE, WHETHER EXPRESS OR IMPLIED, AND ALL WARRANTIES OF MERCHANTABILITY AND FITNESS FOR ANY PARTICULAR PURPOSE FOR THE SOFTWARE ARE EXPRESSLY EXCLUDED. SOME STATES DO NOT ALLOW EXCLUSION OF IMPLIED WARRANTIES, SO THE ABOVE EXCLUSION MAY NOT APPLY TO YOU. The Software is complex and may contain some nonconformities, defects or errors. Pioneer does not warrant that the Software will meet your needs or expectations, that operation of the Software will be error free or uninterrupted, or that all non-conformities can or will be corrected. Furthermore, Pioneer does not make any representations or warranties regarding the use or results of the use of the Software in terms of its accuracy, reliability or otherwise.

Introduction

3 LIMITATION OF LIABILITY

IN NO EVENT SHALL PIONEER BE LIABLE FOR ANY DAMAGES, CLAIM OR LOSS INCURRED BY YOU (INCLUDING, WITHOUT LIMITATION, COMPENSATORY, INCIDENTAL, INDIRECT, SPECIAL, CONSEQUENTIAL, OR EXEMPLARY DAMAGES, LOST PROFITS, LOST SALES OR BUSINESS, EXPENDITURES, INVESTMENTS, OR COMMITMENTS IN CONNECTION WITH ANY BUSINESS, LOSS OF ANY GOODWILL, OR DAMAGES) RESULTING FROM THE USE OF OR INABILITY TO USE THE SOFTWARE, EVEN IF PIONEER HAS BEEN INFORMED OF, KNEW OF, OR SHOULD HAVE KNOWN OF THE LIKELIHOOD OF SUCH DAMAGES. THIS LIMITATION APPLIES TO ALL CAUSES OF ACTION IN THE AGGREGATE, INCLUDING WITHOUT LIMITATION BREACH OF CONTRACT, BREACH OF WARRANTY, NEGLIGENCE, STRICT LIABILITY, MISREPRESENTATION, AND OTHER TORTS. IF PIONEER'S WARRANTY DISCLAIMER OR LIMITATION OF LIABILITY SET FORTH IN THIS AGREEMENT SHALL OR FOR ANY REASON WHATSOEVER BE HELD UNENFORCEABLE OR INAPPLICABLE, YOU AGREE THAT PIONEER'S LIABILITY SHALL NOT EXCEED FIFTY PERCENT (50%) OF THE PRICE PAID BY YOU FOR THE ENCLOSED PIONEER PRODUCT.

Some states do not allow the exclusion or limitation of incidental or consequential damages, so the above limitation or exclusion may not apply to you. This warranty disclaimer and limitation of liability shall not be applicable to the extent that they are prohibited by any applicable federal, state or local law which provides that such a disclaimer or limitation cannot be waived or preempted.

4 EXPORT LAW ASSURANCES

You agree and certify that neither the Software nor any other technical data received from Pioneer, nor the direct product thereof, will be exported outside Canada except as authorized and as permitted by the laws and regulations of Canada. If the Software has been rightfully

obtained by you outside of Canada, you agree that you will not re-export the Software nor any other technical data received from Pioneer, nor the direct product thereof, except as permitted by the laws and regulations of Canada and the laws and regulations of the jurisdiction in which you obtained the Software.

5 TERMINATION

This Agreement is effective until terminated. You may terminate it at any time by destroying the Software. The Agreement also will terminate if you do not comply with any terms or conditions of this Agreement. Upon such termination, you agree to destroy the Software.

6 MISCELLANEOUS

This is the entire Agreement between Pioneer and you regarding its subject matter. No change in this Agreement shall be effective unless agreed to in writing by Pioneer. Pioneer retailers do not have the authority to change this Agreement. This Agreement shall be governed by and construed in accordance with the internal laws of the Province of Ontario and the federal laws of Canada applicable therein. If any provision of this Agreement is declared invalid or unenforceable, the remaining provisions of this Agreement shall remain in full force and effect.

Terms and Conditions for the Tele Atlas Data

THIS IS A LEGAL AGREEMENT (THE "AGREEMENT") BETWEEN YOU, THE END USER, AND TELE ATLAS NORTH AMERICA, INC. ("Tele Atlas"). BY USING YOUR COPY OF THE TELE ATLAS DATA, YOU AGREE TO THE TERMS AND CONDITIONS OF THIS AGREEMENT.

1 Grant of License.

Tele Atlas grants you a non-transferable, non-exclusive license to use the map data and business points of interest information (the "POIs"), (together, the "Data") contained on these discs, solely for personal, non-commercial use and not to operate a service bureau or for any other use involving the processing of data of other persons or entities. You may make one (1) copy of the Data for archival or backup purposes only but you may not otherwise copy, reproduce, modify, make derivative works, derive the structure of or reverse engineer the Data. The Data contains confidential and proprietary information and materials, and may contain trade secrets, so you agree to hold the Data in confidence and in trust and not to disclose the Data or any portions in any form, including by renting, leasing, publishing, leasing, sublicensing or transferring the Data to any third party. You are prohibited from removing or obscuring any copyright, trademark notice or restrictive legend.

2 Ownership.

The Data is copyrighted by Tele Atlas and its licensors and they retain all ownership rights in the Data. You agree not to alter, remove, obliterate, or obscure any copyright notice or proprietary legend contained in or on the Data.

3 Warranty Disclaimer.

THE DATA IS PROVIDED ON AN "AS IS" AND "WITH ALL FAULTS BASIS" AND TELE ATLAS AND ITS SUPPLIERS EXPRESSLY DISCLAIM ALL WARRANTIES, EXPRESS OR IMPLIED, INCLUDING BUT NOT LIMITED TO, THE IMPLIED WARRANTIES OF NON-INFRINGEMENT, MER-

CHANTABILITY, SATISFACTORY QUALITY, ACCURACY, TITLE AND FITNESS FOR A PARTICULAR PURPOSE. NO ORAL OR WRITTEN ADVICE OR INFORMATION PROVIDED BY TELE ATLAS OR ANY OF ITS AGENTS, EMPLOYEES OR THIRD PARTY PROVIDERS SHALL CREATE A WARRANTY, AND YOU ARE NOT ENTITLED TO RELY ON ANY SUCH ADVICE OR INFORMATION. THIS DISCLAIMER OF WARRANTIES IS AN ESSENTIAL CONDITION OF THE AGREEMENT.

4 Limitation of Liability.

TELE ATLAS SHALL NOT BE LIABLE TO YOU FOR ANY INCIDENTAL, CONSEQUENTIAL, SPECIAL, INDIRECT OR EXEMPLARY DAMAGES ARISING OUT OF THIS AGREEMENT, INCLUDING LOST PROFITS OR COSTS OF COVER, LOSS OF USE OR BUSINESS INTERRUPTION OR THE LIKE, REGARDLESS OF WHETHER YOU WERE ADVISED OF THE POSSIBILITY OF SUCH DAMAGES. NOTWITHSTANDING ANYTHING TO THE CONTRARY CONTAINED HEREIN, TELE ATLAS SHALL HAVE NO MONETARY LIABILITY TO YOU FOR ANY CAUSE (REGARDLESS OF THE FORM OF ACTION) UNDER OR RELATING TO THIS AGREEMENT.

5 Termination.

This Agreement will terminate immediately and automatically, without notice, if you breach any term of this Agreement. You agree that in the event of termination of the Agreement, you shall return the Data (including all documentation and all copies) to Tele Atlas and its suppliers.

Introduction

6 Indemnity.

You agree to indemnify, defend and hold Tele Atlas, its Licensors, and its Suppliers (including their respective licensors, suppliers, assignees, subsidiaries, affiliated companies, and the respective officers, directors, employees, shareholders, agents and representatives) free and harmless from and against any liability, loss, injury (including injuries resulting in death), demand, action, cost, expense, or claim of any kind or character, including but not limited to attorney's fees, arising out of or in connection with any use or possession by you of the Data.

7 U.S. Government Rights.

If you are an agency, department, or other entity of the United States Government, or funded in whole or in part by the United States Government, then use, duplication, reproduction, release, modification, disclosure or transfer of this commercial product and accompanying documentation, is restricted in accordance with the LIMITED or RESTRICTED rights as described in DFARS 252.227-7014(a) (1) (JUN 1995) (DOD commercial computer software definition), DFARS 227.7202-1 (DOD policy on commercial computer software), FAR 52.227-19 (JUN 1987) (commercial computer software clause for civilian agencies), DFARS 252.227-7015 (NOV 1995) (DOD technical data – commercial items clause); FAR 52.227-14 Alternates I, II, and III (JUN 1987) (civilian agency technical data and noncommercial computer software clause); and/or FAR 12.211 and FAR 12.212 (commercial item acquisitions), as applicable. In case of conflict between any of the FAR and DFARS provisions listed herein and this License, the construction that provides greater limitations on the Government's rights shall control. Contractor/manufacturer is Tele Atlas North America, Inc., 11 Lafayette Street, Lebanon, NH 03766-1445. Phone: 603.643. 0330. The Data is ©1984-2009 by Tele Atlas. ALL RIGHTS RESERVED. For purpose of any public disclosure provision under any federal, state or local law,

it is agreed that the Data is a trade secret and a proprietary commercial product and not subject to disclosure.

If you are an agency, department, or other entity of any State government, the United States Government or any other public entity or funded in whole or in part by the United States Government, then you hereby agree to protect the Data from public disclosure and to consider the Data exempt from any statute, law, regulation, or code, including any Sunshine Act, Public Records Act, Freedom of Information Act, or equivalent, which permits public access and/or reproduction or use of the Data. In the event that such exemption is challenged under any such laws, this Agreement shall be considered breached and any and all right to retain any copies or to use of the Data shall be terminated and considered immediately null and void. Any copies of the Data held by you shall immediately be destroyed. If any court of competent jurisdiction considers this clause void and unenforceable, in whole or in part, for any reason, this Agreement shall be considered terminated and null and void, in its entirety, and any and all copies of the Data shall immediately be destroyed.

8 Additional Provisions with respect to POI Data only.

- a No Creation of Mailing Lists.
You are prohibited from using the POIs (i) to create mailing lists or (ii) for other such similar uses.
- b Compliance.
You will use the POIs in compliance with all applicable federal, state and local laws, rules and regulations.
- c Indemnification.
You shall indemnify and hold infoUSA, Inc. harmless against all third party claims or liability which are based in whole or in part of the users failure to comply with such laws, rules and regulations or which result from the use of the POIs through you.
- d Warranty.

In addition to the Warranties contained in the Agreement, YOU UNDERSTAND THAT THE POIS ARE LICENSED ON AN "AS IS" BASIS WITHOUT GUARANTEE, AND THERE ARE NO OTHER WARRANTIES MADE WHETHER, EXPRESS OR IMPLIED, INCLUDING WITHOUT LIMITATION, ANY EXPRESS OR IMPLIED WARRANTIES OF MERCHANTABILITY OR FITNESS FOR A PARTICULAR PURPOSE.

e *POIs Segregation.*

You are prohibited from combining or merging the POIs with any other POI data. The POIs shall be maintained in such a way that they are separately identifiable from all other POI data at all times.

9 *Agreement in English.*

The parties hereto confirm that they have requested that this Agreement and all attachments and related documents be drafted in English.

Les parties ont exigé que le présent contrat et tous les documents attachés soient rédigés en Anglais.

10 *Miscellaneous.*

This is the exclusive and complete Agreement between Tele Atlas and you regarding its subject matter. Nothing in this Agreement shall create a joint venture, partnership or principal-agent relationship between Tele Atlas and you. The internal laws of California shall govern this Agreement and you consent to the jurisdiction of the Northern District of California or the State of California for the County of Santa Clara. Sections 2 – 10 shall survive the expiration or termination of this Agreement. This Agreement may be amended, altered, or modified only by Tele Atlas. You may not assign any part of this Agreement without Tele Atlas' prior written consent. You acknowledge and understand that the Data may be subject to restrictions on exportation and agree to comply with any applicable export laws. In the event that any provision or part of a provision of this Agreement is determined to be invalid, illegal,

or unenforceable, such provision or part thereof shall be stricken from this Agreement and the remainder of this Agreement shall be valid, legal, and enforceable to the maximum extent possible. Any notice under this Agreement shall be delivered by courier to Tele Atlas North America, Inc., Attention Contracts Department, 11 Lafayette Street, Lebanon, NH 03766 USA. The covenants and obligations undertaken by you herein are intended for the direct benefit of Tele Atlas and may be enforced by Tele Atlas directly against you.

Licenses

7-Zip

7-Zip

License for use and distribution
7-Zip Copyright (C) 1999-2007 Igor Pavlov.
Licenses for files are:

- 1 7z.dll: GNU LGPL + unRAR restriction
- 2 All other files: GNU LGPL

The GNU LGPL + unRAR restriction means that you must follow both GNU LGPL rules and unRAR restriction rules.

You can use 7-Zip on any computer, including a computer in a commercial organization. You don't need to register or pay for 7-Zip.

GNU LGPL information

This library is free software; you can redistribute it and/or modify it under the terms of the GNU Lesser General Public License as published by the Free Software Foundation; either version 2.1 of the License, or (at your option) any later version.

This library is distributed in the hope that it will be useful, but WITHOUT ANY WARRANTY; without even the implied warranty of MERCHANTABILITY or FITNESS FOR A PARTICULAR PURPOSE. See the GNU Lesser General Public License for more details.

Introduction

You should have received a copy of the GNU Lesser General Public License along with this library; if not, write to the Free Software Foundation, Inc., 59 Temple Place, Suite 330, Boston, MA 02111-1307 USA

unRAR restriction

The decompression engine for RAR archives was developed using source code of unRAR program.

All copyrights to original unRAR code are owned by Alexander Roshal.

The license for original unRAR code has the following restriction:

The unRAR sources cannot be used to re-create the RAR compression algorithm, which is proprietary. Distribution of modified unRAR sources in separate form or as a part of other software is permitted, provided that it is clearly stated in the documentation and source comments that the code may not be used to develop a RAR (WinRAR) compatible archiver.

GNU LESSER GENERAL PUBLIC LICENSE

GNU LESSER GENERAL PUBLIC LICENSE

Version 3, 29 June 2007

Copyright (C) 2007 Free Software Foundation, Inc. <<http://fsf.org/>>

Everyone is permitted to copy and distribute verbatim copies of this license document, but changing it is not allowed.

This version of the GNU Lesser General Public License incorporates the terms and conditions of version 3 of the GNU General Public License, supplemented by the additional permissions listed below.

0 Additional Definitions

As used herein, “this License” refers to version 3 of the GNU Lesser General Public License, and the “GNU GPL” refers to version 3 of the GNU General Public License.

“The Library” refers to a covered work governed by this License, other than an Application or a Combined Work as defined below.

An “Application” is any work that makes use of an interface provided by the Library, but which is not otherwise based on the Library.

Defining a subclass of a class defined by the Library is deemed a mode of using an interface provided by the Library.

A “Combined Work” is a work produced by combining or linking an Application with the Library. The particular version of the Library with which the Combined Work was made is also called the “Linked Version”.

The “Minimal Corresponding Source” for a Combined Work means the Corresponding Source for the Combined Work, excluding any source code for portions of the Combined Work that, considered in isolation, are based on the Application, and not on the Linked Version.

The “Corresponding Application Code” for a Combined Work means the object code and/or source code for the Application, including any data and utility programs needed for reproducing the Combined Work from the Application, but excluding the System Libraries of the Combined Work.

1 Exception to Section 3 of the GNU GPL.

You may convey a covered work under sections 3 and 4 of this License without being bound by section 3 of the GNU GPL.

2 Conveying Modified Versions.

If you modify a copy of the Library, and, in your modifications, a facility refers to a function or data to be supplied by an Application that uses the facility (other than as an argument passed when the facility is invoked), then you may convey a copy of the modified version:

- a under this License, provided that you make a good faith effort to ensure that, in the event an Application does not supply the function or data, the facility still operates, and performs whatever part of its purpose remains meaningful, or
- b under the GNU GPL, with none of the additional permissions of this License applicable to that copy.

3 Object Code Incorporating Material from Library Header Files.

The object code form of an Application may incorporate material from a header file that is part of the Library. You may convey such object code under terms of your choice, provided that, if the incorporated material is not limited to numerical parameters, data structure layouts and accessors, or small macros, inline functions and templates (ten or fewer lines in length), you do both of the following:

- a Give prominent notice with each copy of the object code that the Library is used in it and that the Library and its use are covered by this License.
- b Accompany the object code with a copy of the GNU GPL and this license document.

4 Combined Works.

You may convey a Combined Work under terms of your choice that, taken together, effectively do not restrict modification of the portions of the Library contained in the Combined Work and reverse engineering for debugging such modifications, if you also do each of the following:

- a Give prominent notice with each copy of the Combined Work that the Library is used in it and that the Library and its use are covered by this License.
- b Accompany the Combined Work with a copy of the GNU GPL and this license document.
- c For a Combined Work that displays copyright notices during execution, include the copyright notice for the Library among these notices, as well as a reference directing the user to the copies of the GNU GPL and this license document.
- d Do one of the following:
 - 1 Convey the Minimal Corresponding Source under the terms of this License, and the Corresponding Application Code in a form suitable for, and under terms that permit, the user to recombine or relink the Application with a modified version of the Linked Version to produce

a modified Combined Work, in the manner specified by section 6 of the GNU GPL for conveying Corresponding Source.

- 2 Use a suitable shared library mechanism for linking with the Library. A suitable mechanism is one that (a) uses at run time a copy of the Library already present on the user's computer system, and (b) will operate properly with a modified version of the Library that is interface-compatible with the Linked Version.
- e Provide Installation Information, but only if you would otherwise be required to provide such information under section 6 of the GNU GPL, and only to the extent that such information is necessary to install and execute a modified version of the Combined Work produced by recombining or relinking the Application with a modified version of the Linked Version. (If you use option 4d0, the Installation Information must accompany the Minimal Corresponding Source and Corresponding Application Code. If you use option 4d1, you must provide the Installation Information in the manner specified by section 6 of the GNU GPL for conveying Corresponding Source.)

5 Combined Libraries.

You may place library facilities that are a work based on the Library side by side in a single library together with other library facilities that are not Applications and are not covered by this License, and convey such a combined library under terms of your choice, if you do both of the following:

- a Accompany the combined library with a copy of the same work based on the Library, uncombined with any other library facilities, conveyed under the terms of this License.
- b Give prominent notice with the combined library that part of it is a work based on the Library, and explaining where to find the accompanying uncombined form of the same work.

Introduction

6 Revised Versions of the GNU Lesser General Public License.

The Free Software Foundation may publish revised and/or new versions of the GNU Lesser General Public License from time to time.

Such new versions will be similar in spirit to the present version, but may differ in detail to address new problems or concerns.

Each version is given a distinguishing version number. If the Library as you received it specifies that a certain numbered version of the GNU Lesser General Public License “or any later version” applies to it, you have the option of following the terms and conditions either of that published version or of any later version published by the Free Software Foundation. If the Library as you received it does not specify a version number of the GNU Lesser General Public License, you may choose any version of the GNU Lesser General Public License ever published by the Free Software Foundation. If the Library as you received it specifies that a proxy can decide whether future versions of the GNU Lesser General Public License shall apply, that proxy’s public statement of acceptance of any version is permanent authorization for you to choose that version for the Library.

7-Zip Source Notice

The software program used in this product contains 7-Zip library. 7-Zip contains the software granted permission for the usage under the terms of the GNU Lesser General Public License. A copy of appropriate source code is available at customer necessary expense for the distribution.

Please contact our Customer Support Center to obtain a copy. For more information on the GNU Lesser General Public License, visit the GNU’s website at <http://www.gnu.org>. ■

About the database

About the Data for the Map Database

- Modifications related to roads, streets/highways, terrain, construction and other things before/during the development period may not be reflected in this database. Inevitably, those modifications after that period are not reflected in this database.
- For more details about the map coverage of this navigation system, refer to the information on our website.
- It is strictly prohibited to reproduce and use any part or the whole of this map in any form without permission from the copyright owner.
- If the local traffic regulations or conditions deviate from this data, follow the local traffic regulations (such as signs, indications, etc.) and conditions (such as construction, weather, etc.).
- The traffic regulation data used in the map database applies only to standard sized passenger vehicles. Note that regulations for larger vehicles, motorbikes, and other non-standard vehicles are not included in the database.

Copyright Notices for North American data

1) Tele Atlas® MultiNet® North America data. As of the Effective Date, the copyright notice for Tele Atlas® MultiNet® North America is: NOTICE

© 1984 – 2009 Tele Atlas. All rights reserved. This material is proprietary and the subject of copyright protection and other intellectual property rights owned or licensed to Tele Atlas. Tele Atlas is an authorized distributor of selected Statistics Canada computer files under Agreement number 6776. The product includes information copied with permission from Canadian authorities, including © Canada Post Corporation and GeoBase®, All rights reserved. The product is sourced in part from Geography Division, Statistics Canada, 2006 Road Network File (RNF), 92-500-XWE/XWF. The incorporation of data sources from Statistics Canada within this product shall not be construed as constituting an endorsement by Statistics Canada of such product. The use of this material is subject to the terms of a License Agreement. You will be held liable for any unauthorized copying or disclosure of this material.

2) As of the Effective Date, the copyright notice for all third-party brand icons (the “Brand Icons”) are located in the operator’s manual included in the Licensed Products.

3) As of the Effective Date, the copyright notice with logo for infoUSA, Inc. is:

Data by

 Copyright ©2009
 All Rights Reserved

Powered by NNG 

Important Safety Information

WARNING

- Do not attempt to install or service your navigation system by yourself. Installation or servicing of the navigation system by persons without training and experience in electronic equipment and automotive accessories may be dangerous and could expose you to the risk of electric shock or other hazards.
- If liquid or foreign matter should get inside this navigation system, park your vehicle to safe place and turn the ignition switch off (ACC OFF) immediately and consult your dealer or the nearest authorized Pioneer Service Station. Do not use the navigation system in this condition because doing so may result in a fire, electric shock, or other failure.
- If you notice smoke, a strange noise or odor from the navigation system, or any other abnormal signs on the LCD screen, turn off the power immediately and consult your dealer or the nearest authorized Pioneer Service Station. Using this navigation system in this condition may result in permanent damage to the system.
- Do not disassemble or modify this navigation system, as there are high-voltage components inside which may cause an electric shock. Be sure to consult your dealer or the nearest authorized Pioneer Service Station for internal inspection, adjustments or repairs.
- Do not allow this product to come into contact with liquids. Electrical shock could result. Also, damage to the product, smoke, and overheating could result from contact with liquids.

Introduction

CAUTION

- When a route is calculated, the route and voice guidance for the route are automatically set. Also, for day or time traffic regulations, only information about traffic regulations applicable at the time when the route was calculated is shown. One-way streets and street closures may not be taken into consideration. For example, if a street is open during the morning only, but you arrive later, it would be against the traffic regulations so you cannot drive along the set route. When driving, please follow the actual traffic signs. Also, the system may not know some traffic regulations.

Before using your navigation system, be sure to read and fully understand the following safety information:

- ❑ Read the entire manual before operating this navigation system.
- ❑ The navigation features of your navigation system (and rear view camera option if purchased) are intended solely as an aid to you in the operation of your vehicle. It is not a substitute for your attentiveness, judgment, and care when driving.
- ❑ Do not operate this navigation system (or the rear view camera option if purchased) if doing so will divert your attention in any way from the safe operation of your vehicle. Always observe safe driving rules and follow all existing traffic regulations. If you experience difficulty in operating the system or reading the display, park your vehicle in a safe location and apply the parking brake before making the necessary adjustments.
- ❑ Never allow others to use the system unless they have read and understood the operating instructions.
- ❑ Never use this navigation system to route to hospitals, police stations or similar facilities in an emergency. Stop using any functions relating to the hands-free phone and please call 911.
- ❑ Route and guidance information displayed by this equipment is for reference purposes only. It may not accurately reflect the latest permissible routes, road conditions, one way streets, road closures, or traffic restrictions.
- ❑ Traffic restrictions and advisories currently in force should always take precedence over guidance given by the navigation system. Always obey current traffic restrictions, even if the navigation system provides contrary advice.
- ❑ Failure to set correct information about the local time may result in the navigation system providing improper routing and guidance instructions.
- ❑ Never set the volume of your navigation system so high that you cannot hear outside traffic and emergency vehicles.
- ❑ To promote safety, certain functions are disabled unless the vehicle is stopped and/or the parking brake is applied.
- ❑ The data encoded in the built-in memory is the intellectual property of the provider, and the provider is responsible for such content.
- ❑ Keep this manual handy as a reference for operating procedures and safety information.
- ❑ Pay close attention to all warnings in this manual and follow the instructions carefully.
- ❑ Do not install this navigation system where it may (i) obstruct the driver's vision, (ii) impair the performance of any of the vehicle's operating systems or safety features, including air bags or hazard lamp buttons or (iii) impair the driver's ability to safely operate the vehicle.
- ❑ Please remember to fasten your seat belt at all times while operating your vehicle. If you are ever in an accident, your injuries can be considerably more severe if your seat belt is not properly buckled.
- ❑ Never use headphones while driving.

“GOOG-411” service

- ❑ Pioneer does not bear responsibility for the accuracy of the information.
- ❑ Pioneer does not bear responsibility for changes to information services provided by related companies, such as cancellation of services or changing to pay-services. Also, we do not accept return of the product for this reason.

Speed limit indication

The speed limit is based on the map database. The speed limit in the database may not match the actual speed limit of the current road. This is not a definite value. Be sure to drive according to the actual speed limit. 

Additional Safety Information

Parking brake interlock

Certain functions (such as viewing of DVD-Video and certain touch key operations) offered by this navigation system could be dangerous and/or unlawful if used while driving. To prevent such functions from being used while the vehicle is in motion, there is an interlock system that senses when the parking brake is set and when the vehicle is moving. If you attempt to use the functions described above while driving, they will become disabled until you stop the vehicle in a safe place, and apply the parking brake. Please keep the brake pedal pushed down before releasing the parking brake.



WARNING

- **LIGHT GREEN LEAD AT POWER CONNECTOR IS DESIGNED TO DETECT PARKED STATUS AND MUST BE CONNECTED TO THE POWER SUPPLY SIDE OF THE PARKING BRAKE SWITCH. IMPROPER CONNECTION OR USE OF THIS LEAD MAY VIOLATE APPLICABLE LAW AND MAY RESULT IN SERIOUS INJURY OR DAMAGE.**
- To avoid the risk of damage and injury and the potential violation of applicable laws, the navigation system is not for use with a “Video image” that is visible to the driver.
- In some countries or states the viewing of “Video image” on a display inside a vehicle even by persons other than the driver may be illegal. Where such regulations apply, they must be obeyed.
- When applying the parking brake in order to view “Video image” or to enable other functions offered by the navigation system, park your vehicle in a safe place, and keep the brake pedal pushed down before releasing the parking brake if the vehicle is parked on a hill or otherwise might move when releasing the parking brake.



CAUTION

Accuracy/performance of interlock may be impacted by such factors as GPS signal detection and driving habits or conditions of the place where the vehicle is parked.

When you attempt to watch “Video image” while driving, the warning “**Viewing of front seat video source while driving is strictly prohibited.**” will appear on the screen. To watch “Video image” on this display, stop the vehicle in a safe place and apply the parking brake. Please keep the brake pedal pushed down before releasing the parking brake.

Introduction

When using a display connected to REAR MONITOR OUTPUT

The video output terminal (**REAR MONITOR OUTPUT**) is for connection of a display to enable passengers in the rear seats to watch video images.

WARNING

NEVER install the Rear Display in a location that enables the driver to watch video images while driving.

- This cautionary statements apply to AVIC-X910BT.

To avoid battery exhaustion

Be sure to run the vehicle engine while using this product. Using this product without running the engine can drain the battery.

WARNING

Do not use with vehicles that do not feature an ACC position.

Rear view camera

With an optional rear view camera, you are able to use the navigation system as an aid to keep an eye on trailers, or backing into a tight parking spot.

WARNING

- SCREEN IMAGE MAY APPEAR REVERSED.
- USE INPUT ONLY FOR REVERSE OR MIRROR IMAGE REAR VIEW CAMERA. OTHER USE MAY RESULT IN INJURY OR DAMAGE.

CAUTION

- For safety reasons, the rear view camera function is not available until the navigation system boots up completely.
- The rear view mode is to use the navigation system as an aid to keep an eye on the trailers,

or while backing up. Do not use this function for entertainment purposes. 

Notes Before Using the System

Important (Serial Number:)

The serial number of this device is located on the bottom of this product. For your own security and convenience, be sure to record this number on the enclosed warranty card.

Failure to operate

Should the navigation system fail to operate properly, contact your dealer or nearest authorized Pioneer Service Station.

After-sales service for Pioneer products

Please contact the dealer or distributor from which you purchased the product for after-sales service (including warranty conditions) or any other information. In case the necessary information is not available, please contact the companies listed below.

Please do not ship your product to the companies at the addresses listed below for repair without making advance contact.

- **U.S.A**

Pioneer Electronics (USA) Inc.
CUSTOMER SUPPORT DIVISION
P.O. Box 1760 Long Beach, CA 90801-1760
800-421-1404

- **CANADA**

Pioneer Electronics of Canada, Inc.
CUSTOMER SATISFACTION DEPARTMENT
300 Allstate Parkway Markham, Ontario
L3R 0P2
1-877-283-5901
905-479-4411

For warranty information, please see the Limited Warranty sheet included with your product.

Visit Our Web site

Visit us at the following site:

<http://www.pioneerelectronics.com>

In Canada

<http://www.pioneerelectronics.ca>

- 1 Register your product. We will keep the details of your purchase on file to help you refer to this information in the event of an insurance claim such as loss or theft.
- 2 Receive updates on the latest products and technologies.
- 3 Download owner's manuals, order product catalogues, research new products, and much more.
- 4 Receive notices of software upgrades and software updates.

Manual overview

How to use this manual

Finding the operation procedure for what you want to do

When you have decided what you want to do, you can find the page you need from the "Contents".

Finding the operation procedure from a menu name

If you want to check the meaning of an item displayed on the screen, you will find the necessary page from the "Display information" at the end of the manual.

Glossary

Use the glossary to find the meanings of terms.

Terminology

Before moving on, take a few minutes to read the following information about the conventions used in this manual. Familiarity with these conventions will help you greatly as you learn how to use your new equipment.

- Buttons on your navigation system are described in **ALL CAPITAL, BOLD** lettering; e.g.) **MENU** button, **MAP** button.
- Items in different menus, screen titles, and functional components are described in **bold** with double quotation marks " "; e.g.) "Destination Menu" screen or "AV Source" screen
- Touch panel keys that are available on the screen are described in **bold** in brackets []: e.g.) **[Destination]**, **[Settings]**.
- Extra information, alternatives and other notes are presented in the following format: e.g.)
 - If the home location has not been stored yet, set the location first.
- References are indicated like this: e.g.)
 - For details, refer to *Setting your home position* on page 154.

Definitions of terminology

"Front Display" and "Rear Display"

In this manual, the screen that is attached to the body of this navigation unit will be referred to as the "Front Display". Any additional optional screen that is purchased for use in conjunction with this navigation unit will be referred to as the "Rear Display".

"Video image"

"Video image" in this manual indicates moving images of DVD-Video, DivX®, iPod, and any equipment that is connected to this system with an RCA cable, such as general-purpose AV equipment.

Introduction

“External storage device (USB, SD)”

The SD memory card, SDHC memory card and USB memory device are collectively referred to as the “external storage device (USB, SD)”. If it indicates the USB memory only, it is referred to as the “USB storage device”. □

Notice regarding video viewing

Remember that use of this system for commercial or public viewing purposes may constitute an infringement on the author’s rights as protected by the Copyright Law. □

Notice regarding DVD-Video viewing

This product incorporates copyright protection technology that is protected by method claims of certain U.S. patents and other intellectual property rights owned by Macrovision Corporation and other rights owners. Use of this copyright protection technology must be authorized by Macrovision Corporation, and is intended for home and other limited viewing uses only unless otherwise authorized by Macrovision Corporation. Reverse engineering or disassembly is prohibited. □

Notice regarding MP3 file usage

Supply of this navigation system conveys only a license for private, non-commercial use and does not convey a license nor imply any right to use this product in any commercial (i.e. revenue-generating), real time broadcasting (terrestrial, satellite, cable and/or any other media), broadcasting/streaming via internet, intranets and/or other networks or in other electronic content distribution systems, such as pay-audio or audio-on-demand applications. An independent license for such use is required. For details, please visit <http://www.mp3licensing.com>. □

iPod compatibility

This product supports only the following iPod models and iPod software versions. Others may not work correctly.

- iPod nano first generation; Ver. 1.3.1
 - iPod nano second generation; Ver. 1.3.1
 - iPod nano third generation; Ver. 1.1.3
 - iPod nano fourth generation; Ver. 1.0.3
 - iPod fifth generation; Ver. 1.3
 - iPod classic; Ver. 2.0
 - iPod touch first generation; Ver. 2.2
 - iPod touch second generation; Ver. 2.2
 - iPhone; Ver. 2.2
 - iPhone 3G; Ver. 2.2
- In this manual, iPod and iPhone will be referred to as iPod.
- When you use this navigation system with a Pioneer USB interface cable for iPod (CD-IU230V) (sold separately), you can control an iPod compatible with this navigation system.
- To obtain maximum performance, we recommend that you use the latest software for the iPod.
- Operation methods may vary depending on the iPod models and the software version of iPod.

- ❑ For more details about iPod compatibility with this navigation system, refer to the information on our website. 

Map coverage

For more details about the map coverage of this navigation system, refer to the information on our website. 

Protecting the LCD panel and screen

- ❑ Do not allow direct sunlight to fall on the LCD screen when this product is not being used. Extended exposure to direct sunlight can result in LCD screen malfunction due to the resulting high temperatures.
- ❑ When using a cellular phone, keep the antenna of the cellular phone away from the LCD screen to prevent disruption of the video in the form of spots, colored stripes, etc.
- ❑ To protect the LCD screen from damage, be sure to touch the touch panel keys with your finger and gently touch the screen. 

Notes on internal memory

Before removing the vehicle battery

If the battery is disconnected or discharged, the memory will be erased and must be reprogrammed.

- ❑ Some data remains. Read *Returning the navigation system to the default or factory settings* before you operate this function.
 - For more detailed information about the items which would be erased, refer to *Returning the navigation system to the default or factory settings* on page 174.

Data subject to erasure

The information is erased by pressing the **RESET** button or disconnecting the yellow lead from the battery (or removing the battery itself). However, some items remain.

- ❑ Some data remains. Read *Returning the navigation system to the default or factory settings* before you operate this function.
 - For more detailed information about the items which would be erased, refer to *Returning the navigation system to the default or factory settings* on page 174.

Resetting the microprocessor

CAUTION

Pressing the **RESET** button clears the settings for the AV source without clearing all the navigation function items. Please refer to the related section before clearing.

- For more detailed information about the items which would be erased, refer to *Returning the navigation system to the default or factory settings* on page 174.

The microprocessor must be reset under the following conditions:

- Prior to using this product for the first time after installation.
- If the product fails to operate properly.
- If there appear to be problems with the operation of the system.
- When changing the combination of equipment.
- When adding/removing additional products that connect to the navigation system.
- If your vehicle position is shown on the map with a significant positioning error.

1 Turn the ignition switch OFF.

Introduction

- 2 Press the RESET button with a pen tip or other pointed implement.

RESET button

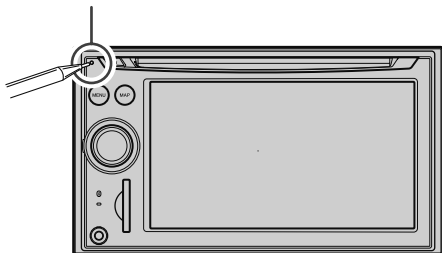

- If you have connected other equipment to this navigation system with IP-BUS, be sure to reset that equipment too.

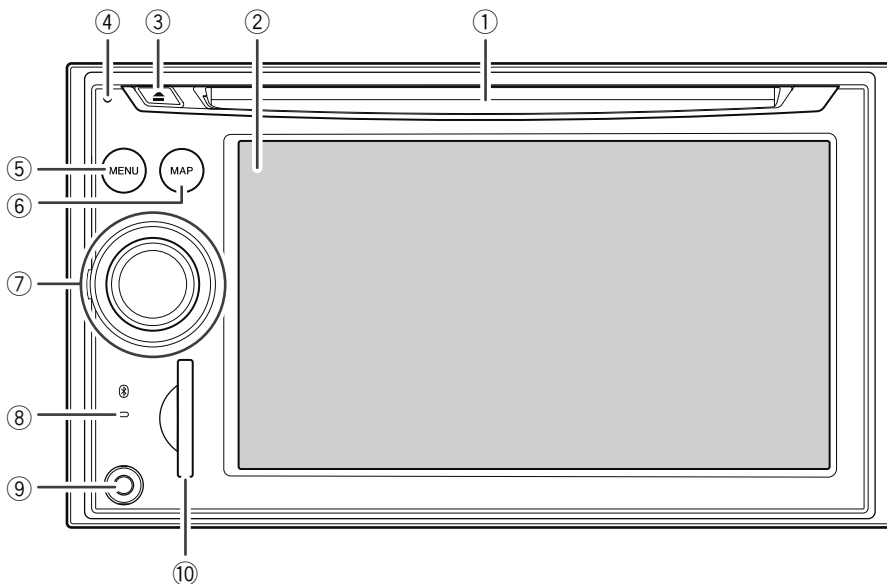

Checking part names and functions

This chapter gives information about the names of the parts and the main features using the buttons.

① Disc loading slot

Insert a disc to play.

➔ For details concerning operations, refer to *Inserting and ejecting a disc* on the next page.

② LCD screen

③ EJECT button

④ RESET button

➔ For details concerning operations, refer to *Resetting the microprocessor* on page 26.

⑤ MENU button

Press the **MENU** button to display the “**Top Menu**”.

Press and hold the button when the “**Top Menu**” is displayed. The “**Screen Calibration**” screen appears.

➔ For details concerning operations, refer to *Adjusting the response positions of the touch panel (touch panel calibration)* on page 157.

⑥ MAP button

Press to view the map screen.

Press and hold to display the “**Picture Adjustment**” screen.

➔ For details concerning operations, refer to *Adjusting the screen brightness* on page 157.

⑦ MULTI-CONTROL

Rotating;

Adjusts the AV (Audio and Video) source volume.

Moving upward or downward once;

Changes the map scale one step at a time.

Basic operation

Keep moving upward or downward;

Changes the map scale continuously.

- This operation is available only while the map screen is displayed.

Moving MULTI-CONTROL to the left or right;

Allows you to change the frequency one step at a time; operates track search controls.

Keep moving MULTI-CONTROL to the left or right;

Allows you to perform manual seek tuning, fast forward or reverse.

Pressing the center of MULTI-CONTROL;

Enables you to start the voice operation when "English" is selected in "Program language:". (When a language other than "English" is selected, pressing the center allows you to hear the previous route guidance.)

- When your phone is paired to the navigation system, press the center of the multicontrol to answer an incoming call or end the phone call.

Keep pressing the center of MULTI-CONTROL;

Mutes the AV (Audio and Video) source. To cancel the muting, press and hold it again.

⑧ Bluetooth connection status indicator

Lights up when your phone is paired to the navigation system by Bluetooth wireless technology.

⑨ "AV2" input jack

This is the "AV2" input terminal. Use the CD-RM10 (sold separately) to connect the external video component.

- To connect your iPod by using USB interface cable for iPod (CD-IU230V), use "AV1" input (RCA) on the back of the unit.

⑩ SD card slot

- ➔ For more detailed information, refer to *Inserting and ejecting an SD memory card* on this page.

Inserting and ejecting a disc

Inserting a disc

- Insert a disc into the disc loading slot.

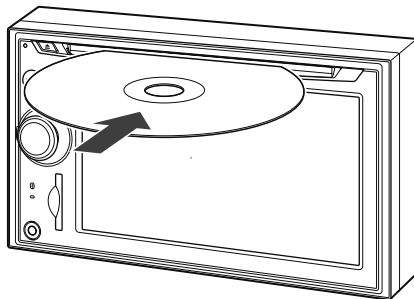

- Do not insert anything other than a disc into the disc loading slot.

Ejecting a disc

- Press the EJECT button.

The disc is ejected.

Inserting and ejecting an SD memory card

⚠ CAUTION

- Keep the dummy SD card out of the reach of small children to prevent them from accidentally swallowing it.
- To prevent data loss and damage to the storage device, never remove it from this navigation system while data is being transferred.
- If data loss or corruption occurs on the storage device for any reason, it is usually not possible to recover the data. Pioneer accepts no liability for damages, costs or expenses arising from data loss or corruption.

Inserting an SD memory card

- Insert an SD memory card into the SD card slot.

Insert it with the contact surface facing to the left and press the card until it clicks and completely locks.

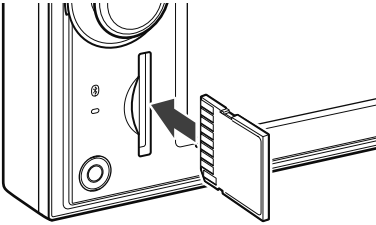

- This system is not compatible with Multi Media Card (MMC).
- Compatibility with all SD memory cards is not guaranteed.
- This unit may not achieve optimum performance with some SD memory cards.
- Do not insert anything other than SD memory cards or dummy SD cards into the SD card slot.

Ejecting an SD memory card

- 1 Press the SD memory card until it clicks.

The SD memory card is ejected.

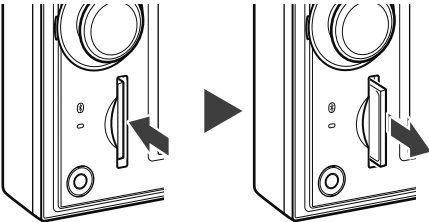

- 2 Pull out the SD memory card.

- Insert the dummy SD card to keep the SD card slot free of dust when the SD memory card is not inserted. □

Plugging and unplugging a USB storage device

! CAUTION

- To prevent data loss and damage to the storage device, never remove it from this navigation system while data is being transferred.
- If data loss or corruption occurs on the storage device for any reason, it is usually not possible to recover the data. Pioneer accepts no liability for damages, costs or expenses arising from data loss or corruption.
- Never remove the USB storage device immediately after plugging it. It may cause that the navigation system cannot recognize the external storage device (USB, SD).

Plugging in a USB storage device

- Plug a USB storage device into the USB connector.

USB connector

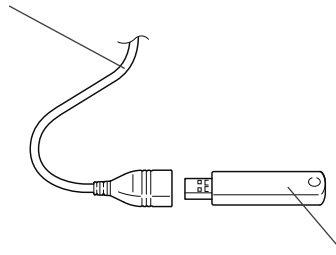

USB storage device

- Compatibility with all USB storage device is not guaranteed.
This navigation system may not achieve optimum performance with some USB storage devices.
- Connection via USB hub is not possible.

Unplugging a USB storage device

- Pull out the USB storage device after checking that no data is being accessed. □

Basic operation

Connecting and disconnecting an iPod

⚠ CAUTION

- To prevent data loss and damage to the storage device, never remove it from this navigation system while data is being transferred.
- If data loss or corruption occurs on the storage device for any reason, it is usually not possible to recover the data. Pioneer accepts no liability for damages, costs or expenses arising from data loss or corruption.

Connecting your iPod

Using the USB interface cable for iPod enables you to connect your iPod to the navigation system.

- ❑ A USB interface cable for iPod (CD-IU230V) (sold separately) is required for connection.

1 Pull out the USB storage device after checking that no data is being accessed.

To AV input on the back of the navigation system

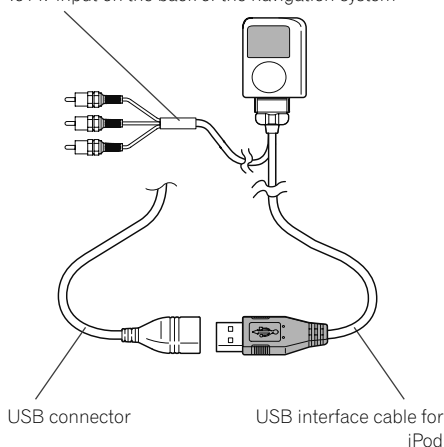

- ❑ For more details about iPod compatibility with this navigation system, refer to the information on our website.
- ❑ Connection via USB hub is not possible.

2 Connect your iPod.

Disconnecting your iPod

- Pull out the USB interface cable for iPod after checking that no data is being accessed. ❑

Flow from startup to termination

⚠ CAUTION

For safety reasons, the rear view camera function is not available until the navigation system boots up completely.

1 Start the engine to boot up the system.

After a short pause, the navigation splash screen comes on for a few seconds.

2 Turn off the vehicle engine to terminate the system.

The navigation system is also turned off.

On first-time startup

When you use the navigation system for the first time, select the language that you want to use.

1 Start the engine to boot up the system.

After a short pause, the navigation splash screen comes on for a few seconds.

2 Touch the language that you want to use on the screen.



3 Touch the language that you want to use for the voice guidance.



The navigation system will now restart.

4 Touch [Destination] to display Destination menu.



The disclaimer appears. Read the disclaimer carefully, checking its details, and then touch [OK] if you agree to the conditions.

The "Destination Menu" appears.

- When the system boots up, the vehicle's antenna may extend or turn on depending on the setting. To retract the antenna, turn the ignition switch off.
- ➔ For details, refer to *Switching the auto antenna setting* on page 164.

Regular startup

CAUTION

For safety reasons, the rear view camera function is not available until the navigation system boots up completely.

● Start the engine to boot up the system.

After a short pause, the navigation splash screen comes on for a few seconds.

- The screen shown will differ depending on the previous conditions.
- If the navigation screen was shown previously, the disclaimer appears. Read the disclaimer carefully, checking its details, and then touch [OK] if you agree to the conditions.
- If other screens were shown previously, the disclaimer screen will be skipped.
- If the anti-theft function is activated, you must enter your password. After unlocking the navigation system, the "Top Menu" appears. If you enter the navigation screen first, the disclaimer screen will appear. Read the disclaimer carefully, checking its details, and then touch [OK] if you agree to the conditions.

Basic operation

How to use the navigation menu screens

Screen switching overview

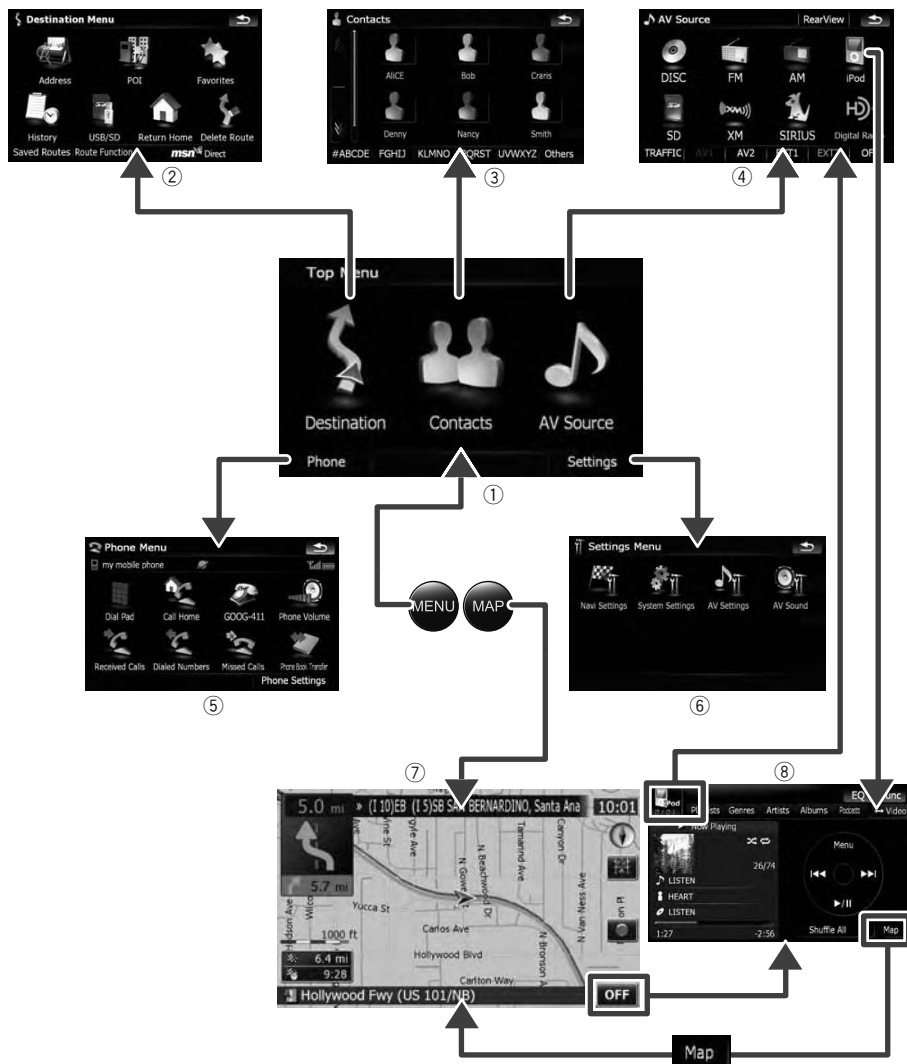

Basic operation

What you can do on each menu

① Top Menu

Press the **MENU** button to display the “**Top Menu**”.

This is the starting menu to access the desired screens and operate the various functions.

② Destination Menu

You can search for your destination on this menu. You can also check or cancel your set route from this menu.

[MSN Direct] is available for AVIC-X910BT only.

③ Contacts screen

You can access the list of contacts to call up an entry.

➔ For details, refer to *Using hands-free phoning*.

④ AV Source menu

You can access the screen for selecting the audio and visual source to play.

⑤ Phone Menu

You can access the screen that is related to hands-free phoning to see call histories and change the settings on the Bluetooth wireless technology connection.

⑥ Settings Menu

You can access the screen to customize settings.

⑦ Map screen

Press the **MAP** button to display the navigation map screen.

⑧ AV operation screen

This is the screen that normally appears when you play the AV source. Touching the icon on the top left corner displays the “**AV Source**” menu.

To return to the previous screen, touch



➔ For details, refer to *Setting the rear view camera* on page 156.

1 Press the MENU button to display the “Top Menu”, and then touch [Settings].

2 Touch [System Settings] and then touch [Back Camera].

3 Touch [On] next to “Camera” to activate the camera setting.

4 Press the MENU button to display the “Top Menu” and then touch [AV Source].

5 Touch [RearView] on the “AV Source” menu.



Displaying the rear view camera image

[RearView] can be displayed the full-screen rear view camera image. **[RearView]** is useful if you want to monitor an attached trailer, etc.

How to use the map

Most of the information provided by your navigation system can be seen on the map. You need to become familiar with how information appears on the map.

How to read the map screen

This example shows an example of a 2D map screen.

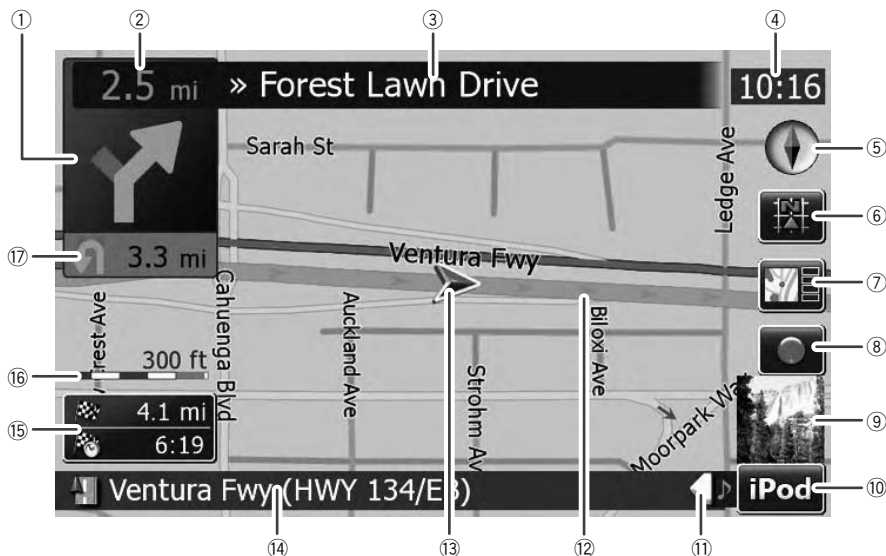

Information with the mark (*) appears only when the route is set.

Depending on the conditions and settings, some items may not be displayed.

① Next direction of travel*

When you approach a guidance point, this appears in green. Touching this item enables you to hear the previous guidance again.

For more information about the direction symbol, refer to *Supplemental information about directions* on page 190.

② Distance to the guidance point*

Shows the distance to the next guidance point.

③ Name of the street to be used (or next guidance point)*

④ Current time

⑤ Compass

The red arrow indicates north.

⑥ Map mode selector

➔ For details, refer to *Switching the map mode* on page 38.

⑦ Shortcut to the “Map Confirmation Screen”

Touching this shortcut enables the screen to switch to the “Map Confirmation Screen” directly with the current position or the cursor position centered.

➔ For details, refer to *What you can do with the “Map Confirmation Screen”* on page 54.

⑧ Stop key for the dummy run

Basic operation

This key will be displayed while you activate the dummy run (“**Fly over**” or “**Demo Mode**”). Touch the key to cancel the dummy run.

- For details, refer to **Demo Mode** on page 149.
- For details, refer to *Playing simulated travel at high speed* on page 60.

⑨ Album artwork on iPod

If you connect your iPod to this navigation system, the artwork for the album that is playing appears.

⑩ Shortcut to the AV operation screen

The **AV Source** currently selected is shown. Touching the indicator displays the AV operation screen of the current source directly.

⑪ Extension tab for the AV information bar

Touching this tab opens the AV information bar and enables you to briefly view the current status on the AV source. Touching it again retracts the bar.

⑫ Current route*

The route currently set is highlighted in bright color on the map. If a waypoint is set on the route, the route after the next waypoint is highlighted in another color.

⑬ Current position

Indicates the current location of your vehicle. The apex of the triangular mark indicates your orientation and the display moves automatically as you drive.

- The apex of the triangular mark is the proper current position.

⑭ Street name (or city name) that your vehicle is traveling along

⑮ Multi-Info window

Shows the value on the items selected on “**Displayed Info**”. Touching this area allows you to display the “**Route Information**” screen.

- For details, refer to **Displayed Info** on page 146.
- For details, refer to *Checking the current route conditions* on page 59.
- This item is not shown when “**Full Screen Map**” is set to “**On**”.

- For details, refer to **Map Settings** on page 145.
- The estimated time of arrival is an ideal value that the navigation system computes internally as the route is calculated. The estimated time of arrival should be read just as a reference value, and does not guarantee arrival at the time indicated.

⑯ Map scale

The scale of the map is indicated by distance.

⑰ Second Maneuver Arrow*

Shows the turning direction after next and the distance to there.

- This item is not shown when “**Full Screen Map**” is set to “**On**”.
- For details, refer to **Map Settings** on page 145.

Meaning of guidance flags



: Destination

The checkered flag indicates your destination.



: Waypoint

The yellow flags indicate your waypoints.



: Start point

The bright green flag indicates your start point.

Signpost and recommended lane

Signposts will appear together with the recommended lane where multi-lane roads exist when you are driving on your route. The highlighted lane indicates the recommended lane.



Basic operation

- This information is based on the map database. Thus, the information may differ from actual conditions. Use it as just a directional reference for your driving.

Note regarding the route highlighted in purple

- A route highlighted in purple on the map indicates that your route includes a road not matching your preference on the following settings in **“Route”**; **“Unpaved Roads”**, **“Highways”**, **“Ferries”**, **“U-turns”**, **“Permit Needed”**, **“Toll Roads”**.

For your safety, please review and obey all local traffic rules along the highlighted route.

Switching the map mode

There are a number of map displays. Touching the map mode selector allows you to change the map display.



Map mode selector

2D map screen (Heading up mode)

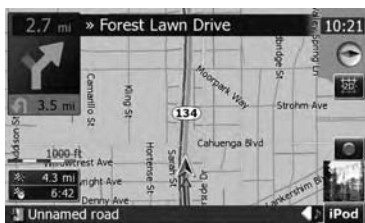

The map display always shows the vehicle's direction as proceeding toward the top of the screen.

When “Heading up” mode is selected,  is displayed.

2D map screen (North up mode)



The map display always has north at the top of the screen.

When “North up” mode is selected,  is displayed.

3D map screen



When the 3D map screen is selected,  is displayed.

1 Press the MAP button to display the navigation map screen.

2 Touch the map mode selector to switch the map display.

Each touch of the map mode selector changes the map display as follows:

2D map screen (Heading up mode) — 2D map screen (North up mode) — 3D map screen

Changing the scale of the map

1 Press the MAP button to display the navigation map screen.

Basic operation

2 Move MULTI-CONTROL down or up to zoom in or out.

Moving **MULTI-CONTROL** upward or downward once allows you to change the map scale one step at a time. Holding **MULTI-CONTROL** while moving it up or down allows you to change the scale sequentially.



- Zooming out will reduce the size of the icon and further zooming out will hide it. However, the pin-shaped icon is not resized and keeps displayed.
- Further zooming out hides the lines of traffic information.

Scrolling the map to the position you want to see

1 Press the MAP button to display the navigation map screen.

2 Switch to the 2D map screen.

- ➔ For details, refer to *Switching the map mode* on the previous page.

3 Touch the map briefly.

Briefly touching the position on the map that you want to see positions the cursor there.



Cursor

Positioning the cursor to the desired location results in a brief informational overview about the location being displayed at the bottom of screen, with street name and other information for this location being shown. (The information shown varies depending on the position.)

4 Touch and drag the map in the desired direction to scroll.

Dragging the map scrolls it. The scrolling increment depends on your dragging length.

- Pressing the **MAP** button returns the map to the current position.

Changing the tilt and rotation angle of the map

On the 3D map screen, briefly touching the map shows the tilt controls and rotation angle.

1 Press the MAP button to display the navigation map screen.

2 Switch to the 3D map screen.

- ➔ For details, refer to *Switching the map mode* on the previous page.

3 Touch anywhere on the map briefly to show the tilt controls and rotation angle.



Controls for tilt and rotation angle

□ Touching  hides the tilt controls and rotation angle.

4 Touch the controls to adjust the tilt and rotation angle. □

The basic flow of creating your route

- 1 Park your vehicle in a safe place, and apply the parking brake.
- ↓
- 2 Display the "Destination Menu".
- ↓
- 3 Select the method of searching for your destination.
- ↓
- 4 Enter information about the destination and narrow down candidates to one.
- ↓
- 5 Touch [Go Here Now] on the "Map Confirmation Screen".
- ↓
- 6 The navigation system calculates the route to your destination, and then shows the route on the map.
- ↓
- 7 After releasing the parking brake, drive in accordance with navigation guidance.

Operating list screens (e.g. city list)

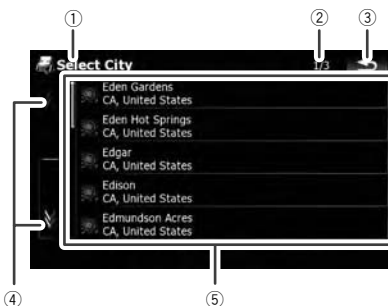

- 1 **Screen title**
The screen title appears.

Basic operation

② Current page/total pages



Returns the previous screen.



Touching or on the scroll bar scrolls through the list and allows you to view the remaining items.

⑤ Listed items

Touching an item on the list allows you to narrow down the options and proceed to the next operation.

Operating the on-screen keyboard

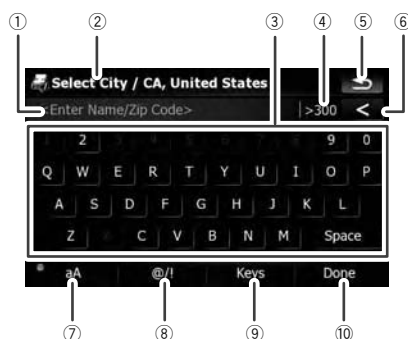

① Text box

Displays the characters that are entered. If there is no text in the box, an informative guide with text appears.

② Screen title

The screen title appears.

③ Keyboard

Touch the keys to enter the characters.

④ Number of possible choices



Returns the previous screen.



Deletes the input text one letter at a time, beginning at the end of the text. Continuing to touch the button deletes all of the text.

⑦ Caps lock control

Switches the keyboard between lowercase letters and uppercase letters.

Each touch of [aA] changes the setting as follows:

— enables you to capitalize the first letter of a word.

— enables you to enter letters in lower-case. (When a space is entered, it switches automatically.)

— enables you to enter letters with capitals (caps) lock.

⑧ [!@]

Displays the key to enter special characters, such as [!].

The appearance of this key and typeable characters change according to the current keyboard layout.

⑨ [Keys]

Switches the on-screen keyboard layout.

⑩ [Done]

Confirms the entry and allows you to proceed to the next step.

! CAUTION

For safety reasons, these route-setting functions are not available while your vehicle is in motion. To enable these functions, you must stop in a safe place and put on the parking brake before setting your route.

- Some information regarding traffic regulations depends on the time when the route calculation is performed. Thus, the information may not correspond with a certain traffic regulation when your vehicle actually passes through the location in question. Also, the information on the traffic regulations provided will be for a passenger vehicle, and not for a truck or other delivery vehicles. Always follow the actual traffic regulations when driving.

Searching for a location by address

The most frequently used function is [Address], in which the address is specified and the destination is searched.

- 1 Touch [Destination] on the "Top Menu".



- 2 Touch [Address].



- 3 Touch the key next to "Country:" to display the country list.



- 4 Touch one of the items on the list to set the country as search area.



The screen returns to the previous screen.

Searching for and selecting a location

5 Touch the key next to “State:” and touch the desired state, province, or territory on the list.



The screen returns to the previous screen.

6 Touch the key next to “City:” to enter the city name.



7 Enter the city name or Zip code.



- When the options are narrowed down to six or less, those are automatically listed.
- If you want to list the options matching to the current information entered, touch **[Done]**.
- Touching **[History]** displays the list of cities that you selected before.

8 Touch the desired city name.



- When a city is already set, touching **[City Center]** allows you to select the representative location of the city and proceed to the “Map Confirmation Screen”.

9 Enter the street name and touch the desired one from the list.

- When a street is already set, touching **[Street Center]** allows you to select the representative point of the street and proceed to the “Map Confirmation Screen”.
- When a street is already set, touching **[Intersection]** allows you to search for an intersection. After entering the second street name and selecting the desired intersection, the “Map Confirmation Screen” appears. This is useful when you don’t know the house number or cannot input the house number of the selected street.

10 Enter the house number and then touch **[Done]**.

- If the house number you have entered is not found, a message appears. In that case, a house number near entered one is selected after touching **[OK]**.

11 Touch one of the options at the bottom of the “Map Confirmation Screen” to select the next operation.



Touch **[Route...]** then **[Go Here Now]** to set your selected position as your destination and calculate the route up that point.

- ➔ For details of other operations on the “Map Confirmation Screen”, refer to *What you can do with the “Map Confirmation Screen”* on page 54.

If only one option is appropriate for your entry, the screen will jump to the “Map Confirmation Screen” directly and the process of entering the street name or house number will be skipped. If you do not want that location, touch **[↶]** to retry with another address. **[□]**

Searching for the vicinity Points of Interest (POI)

Information about various facilities (Points Of Interest - POI), such as gas stations, parking lots or restaurants, is available. You can search for a POI by selecting the category (or entering the POI Name).

Searching for POIs around the cursor

1 Touch **[Destination]** on the “Top Menu”, and then touch **[POI]**.

2 Touch **[Around Cursor]**.



3 Drag the map to move the cursor to the desired position and touch **[OK]**.



The number of nearby POIs will appear at the bottom of the screen.

4 Touch the category you want.



If there are more detailed categories within the selected category, repeat this step as many times as necessary.

Touch **[Search]** to search for a POI by entering the POI name in the selected category.

Touching **[All]** lists all POIs that are included in the categories currently displayed.

Searching for and selecting a location

5 Touch the POI you want.



- Touching the **[Name]** tab sorts the options in the list in alphabetical order.
- Touching the **[Distance]** tab sorts the options in the list in order by distance.
- ☐ Icons are helpful for quickly telling the category of facilities with the same name.

6 Touch one of the options at the bottom of the “Map Confirmation Screen” to select the next operation.

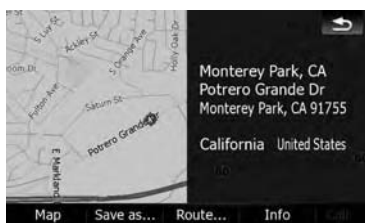

Touch **[Route...]** then **[Go Here Now]** to set your selected position as your destination and calculate the route up that point.

- ➔ For details of other operations on the “Map Confirmation Screen”, refer to *What you can do with the “Map Confirmation Screen”* on page 54.
- ☐ Searching for a spot and touching **[Info]** on the “Map Confirmation Screen” also allows you to search for nearby POIs around the cursor.
- ➔ For details, refer to *Viewing information about a specified location* on page 56.

Searching for a nearby POI

1 Touch **[Destination]** on the “Top Menu”, and then touch **[POI]**.

2 Touch **[Around Current GPS Location]**.

The list of POI categories appears.

- ➔ For the subsequent operations, refer to *Searching for POIs around the cursor* on the previous page.

Searching for POIs along the current route

- ☐ This function is available when the route is set.

1 Touch **[Destination]** on the “Top Menu”, and then touch **[POI]**.

2 Touch **[Along Route]**.

The list of POI categories appears.

- ➔ For the subsequent operations, refer to *Searching for POIs around the cursor* on the previous page.

Searching for POIs around the destination

- ☐ This function is available when the route is set.

1 Touch **[Destination]** on the “Top Menu”, and then touch **[POI]**.

2 Touch **[Around Destination]**.

The list of POI categories appears.

- ➔ For the subsequent operations, refer to *Searching for POIs around the cursor* on the previous page.

Searching for POIs around the address

1 Touch **[Destination]** on the “Top Menu”, and then touch **[POI]**.

2 Touch **[Around entered address]**.

3 Enter the address you want.

- For details, refer to *Searching for a location by address* on page 42.

4 Touch the category you want.

- For the subsequent operations, refer to *Searching for POIs around the cursor* on page 44.

4 Touch the search method that you want to put into memory.**Using “Saved Criteria”****Storing your selection sequence**

You can store the selected search method and one of the categories as a shortcut to recall it later. It allows you to search for a POI in the same way as you did before. You can also delete the shortcuts.

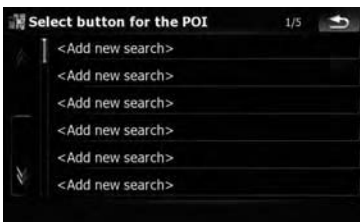
1 Touch [Destination] on the “Top Menu”, and then touch [POI].**2 Touch [Register Search Criteria].****3 Touch one of the items on the list.**

- Selecting an item that has already been stored allows you to overwrite it.

The list of POI categories appears.

5 Touch the category that you want to put into memory.

If there are more detailed categories within the selected category, select the desired category from the list repeatedly until your desired category appears.



Your selection sequence is shown on the top of the screen.

6 Recheck the sequence and touch [Save Criteria] to put it into memory.

Searching for and selecting a location

- Touching [**Save Criteria**] without selecting a category allows you to store only your selected search method including all categories.
- If there aren't any more detailed categories, a blank list appears. In that case, touching [**Save Criteria**] allows you to store it as the currently selected category. Check the current sequence at the top of the screen.

7 Enter the name and then touch [**Done**] to complete the entry.



The storing process is complete and the shortcut is available on "**Saved Criteria**".

Searching for POIs by using the memorized sequence

You can search for POIs with using the pre-stored shortcut.

- 1 Touch [**Destination**] on the "Top Menu", and then touch [**POI**].
- 2 Touch [**Saved Criteria**].
- 3 Touch one of the items on the list.



4 Touch the POI you want.



5 Touch one of the options at the bottom of the "Map Confirmation Screen" to select the next operation.

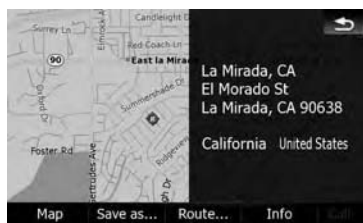

Touch [**Route...**] then [**Go Here Now**] to set your selected position as your destination and calculate the route up that point.

- For details of other operations on the "Map Confirmation Screen", refer to *What you can do with the "Map Confirmation Screen"* on page 54.

Deleting memorized sequence

- 1 Touch [**Destination**] on the "Top Menu", and then touch [**POI**].
- 2 Touch [**Saved Criteria**].

3 Touch [Delete] on the right of the item that you want to delete.



4 Touch the folder you want on the list.



5 Touch one of the items on the list.



Searching for POIs by using the data on external storage devices (USB, SD)

Creating a customized POI is possible by using the utility program “AVIC FEEDS” which is available separately, on your PC. (“AVIC FEEDS” will be available on our website.) Storing the customized POI properly and connecting the external storage device (USB, SD) enables the system to use the data for searches.

1 Connect the USB device or insert the SD card.

2 Touch [Destination] on the “Top Menu”, and then touch [USB/SD].

3 Touch the storage that you want to load from.



6 Touch one of the options at the bottom of the “Map Confirmation Screen” to select the next operation.

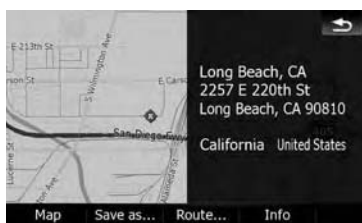

Touch [Route...] then [Go Here Now] to set your selected position as your destination and calculate the route up that point.

- For details of other operations on the “Map Confirmation Screen”, refer to *What you can do with the “Map Confirmation Screen”* on page 54. ▣

Searching for and selecting a location

Searching for a location by coordinates

Entering a latitude and longitude pinpoints the location.

- 1 Touch [Destination] on the "Top Menu", and then touch [Route Function].



- 2 Touch [Coordinate].



- 3 Touch either the latitude key or the longitude key, whichever you want to enter.

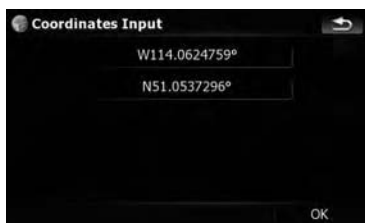

The values on the latitude key or longitude key shows the coordinates on the cursor just before entering this screen.

- 4 Touch **<** to delete the current value and enter the desired coordinate.



- Touching [N/S] or [E/W] changes the hemisphere.

- 5 Touch [Done].

The screen returns to the previous screen. Touch the other key that you have not entered yet, enter the latitude or longitude and then touch [Done] to finish the entry.

- 6 Touch [OK].



The "Map Confirmation Screen" appears.

- 7 Touch one of the options at the bottom of the "Map Confirmation Screen" to select the next operation.

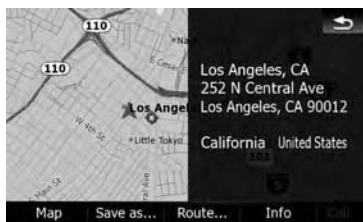

Touch **[Route...]** then **[Go Here Now]** to set your selected position as your destination and calculate the route up that point.

- For details of other operations on the “Map Confirmation Screen”, refer to *What you can do with the “Map Confirmation Screen”* on page 54. 

Selecting a location you searched for recently

The places that you have searched for in the past are automatically stored in “History”. Selecting an item from the list provides an easy way to specify the position.

- “History” can store up to 32 locations. If the entries reach the maximum, the new entry overwrites the oldest one.

1 Touch [Destination] on the “Top Menu”, and then touch [History].

2 Touch the entry you want.



3 Touch one of the options at the bottom of the “Map Confirmation Screen” to select the next operation.

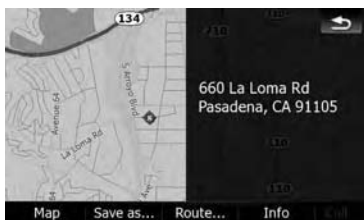

Touch **[Route...]** then **[Go Here Now]** to set your selected position as your destination and calculate the route up that point.

- For details of other operations on the “Map Confirmation Screen”, refer to *What you can do with the “Map Confirmation Screen”* on page 54.

Deleting an entry in “History”

Items in “History” can be deleted. All entries in “History” can also be deleted at once.

1 Touch [Destination] on the “Top Menu”, and then touch [History].

2 Touch [Delete] on the right of the item that you want to delete.

3 Touch [Yes].

A message will appear asking you to confirm the deletion.

- Touching **[Clear History]** allows you to delete all the entries.
- Because deleted data cannot be restored, take extra care not to mistakenly delete items. 

Selecting a location stored in “Favorites”

Storing locations you visit frequently saves time and effort.

Selecting an item from the list provides an easy way to specify the position.

- “Favorites” can store up to 30 locations.

1 Touch [Destination] on the “Top Menu”, and then touch [Favorites].

Searching for and selecting a location

2 Touch the entry you want.



3 Touch one of the options at the bottom of the “Map Confirmation Screen” to select the next operation.

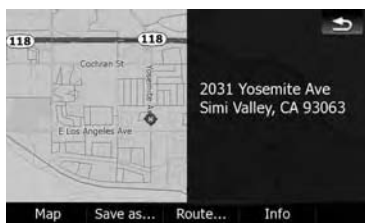

Touch **[Route...]** then **[Go Here Now]** to set your selected position as your destination and calculate the route up that point.

- For details of other operations on the “Map Confirmation Screen”, refer to *What you can do with the “Map Confirmation Screen”* on page 54.

Deleting an entry in “Favorites”

All entries in “Favorites” can be deleted at once.

1 Touch **[Destination]** on the “Top Menu”, and then touch **[Favorites]**.

2 Touch **[Clear All]**.

A message will appear asking you to confirm the deletion.

3 Touch **[Yes]**.

- ❑ Because deleted data cannot be restored, take extra care not to mistakenly delete items. ❑

Setting up a route to your home

If your home location is stored, the route home can be calculated by touching a single key.

● Touch **[Destination]** on the “Top Menu”, and then touch **[Return Home]**.

When the route is not set, route calculation starts immediately.

When a route has already been set, a message will appear asking you to cancel it. Touch **[Yes]** to start the route calculation.

- ❑ If the home location has not been stored yet, set the location first.
 - For details, refer to *Setting your home position* on page 154. ❑

Setting a route by recalling a saved route

Saving a route enables you to recall the same route. Selecting a saved item from a list is an easy way to set a saved route. Selecting an item from the list provides an easy way to specify the position.

- If there are no entries on the list, save a route first.
 - For details concerning other operations, refer to *Storing the current route* on page 62.

1 Touch **[Destination]** on the “Top Menu”, and then touch **[Saved Routes]**.

2 Touch the entry you want.



If no route has been set yet, the saved route is recalled and the guidance will start immediately. 

Searching for a location by scrolling the map

Specifying a location after scrolling the map enables you to set the position as an operable target in the “Map Confirmation Screen”.

1 Press the MAP button to display the navigation map screen.

2 Touch and drag the screen to scroll the map to the position you want.

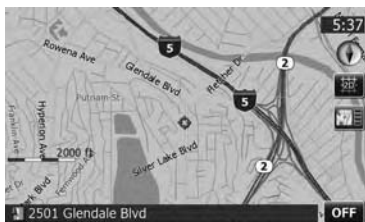
3 Touch  to display the “Map Confirmation Screen”.

The “Map Confirmation Screen” appears.

4 Touch one of the options at the bottom of the “Map Confirmation Screen” to select the next operation.

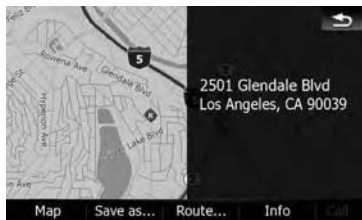

Touch **[Route...]** then **[Go Here Now]** to set your selected position as your destination and calculate the route up that point.

- ➔ For details of other operations on the “Map Confirmation Screen”, refer to *What you can do with the “Map Confirmation Screen”* on page 54. 

Searching for and selecting a location

Searching for and selecting a location

What you can do with the “Map Confirmation Screen”

Under most conditions after searching for a location, the “Map Confirmation Screen” appears, so you can select the next operation. The options shown below are available on this screen:

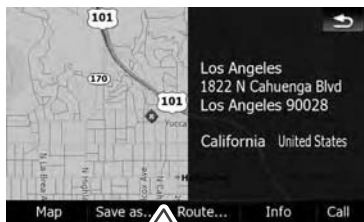

Map

Shows a full-screen 2D map centered on the cursor position.

Save as...

Places a map pin, and saves the position.

- For more details of the operation, refer to **Save as...** on the next page.

Route...

Sets the destination, waypoints, and starting point positions.

- For more details of the operation, refer to **Route...** on this page.

Info

Shows detailed information about the location of the cursor position.

- For more details of the operation, refer to *Viewing information about a specified location* on page 56.

Call

Enables you to call the POI that has a telephone number. (Pairing with cellular phone featuring Bluetooth wireless technology is required.)

- For more details of the operation, refer to *Dialing a phone number of the POI* on page 79. ■

Route...

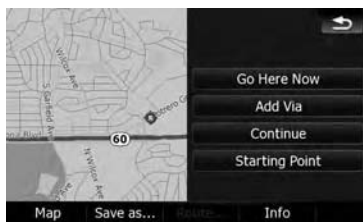

Go Here Now

Calculates the new route by setting the cursor position as the new destination.

- For more details of the operation, refer to *Setting the location as a new destination* on the next page.

Add Via

Recalculates the route by adding the cursor position as a waypoint.

- For more details of the operation, refer to *Setting the location as a waypoint* on the next page.

Continue

Recalculates the route by setting the cursor position as the new destination. The previous destination becomes a waypoint.

After the location is decided (Map Confirmation Screen)

- For more details of the operation, refer to *Replacing the location as the new final destination* on this page.

Starting Point

Sets the location as a starting point.

- For more details of the operation, refer to *Setting the location as the start point* on this page.

Save as...

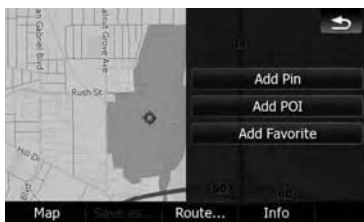

Add Pin

Puts a map pin at the cursor position as a mark up.

- For details, refer to *Placing a map pin on the location* on the next page.

Add POI

Stores the cursor position as a POI.

- For details, refer to *Registering the location as a customized POI* on page 57.

Add Favorite

Stores the cursor position as one of the "Favorites".

- For details, refer to *Storing the location in "Favorites"* on page 58.

Setting the location as a new destination

- 1 Touch [Route...] on the "Map Confirmation Screen".

2 Touch [Go Here Now].

When the route is not set, route calculation starts immediately.

When a route has already been set, a message will appear asking you to cancel it. Touch [Yes] to start the route calculation.

- When the cursor overlaps with a destination that has already been set, touch [Remove Dest.] to cancel the current route or recalculate the route by setting one of the remaining waypoints as the destination.

Setting the location as a waypoint

- 1 Touch [Route...] on the "Map Confirmation Screen".

2 Touch [Add Via].

- When the cursor overlaps a waypoint already set, touch [Remove Via] to delete the waypoint and recalculate the route.

Replacing the location as the new final destination

- 1 Touch [Route...] on the "Map Confirmation Screen".

2 Touch [Continue].

- Recalculates the route by setting the cursor position as the new destination. The previous destination becomes a waypoint.

Setting the location as the start point

When there is no route, only the starting point can be set. Otherwise, the new route from the starting point to the current destination will be recalculated.

- 1 Touch [Route...] on the "Map Confirmation Screen".

2 Touch [Starting Point].

- When the cursor overlaps with a starting point already set, it changes to **[Remove Start]**. All waypoints already set are deleted.

Viewing information about a specified location

Locating the cursor to your desired position enables you to view detailed information about the location by using the “Map Confirmation Screen”.

1 Press the **MAP** button to display the navigation map screen.

2 Touch and drag the screen to scroll the map to the position you want.



3 Touch **[Info]** to display the “Map Confirmation Screen”.

The “Map Confirmation Screen” appears.

4 Touch **[Info]** at the bottom of the “Map Confirmation Screen”.

The “Point Info” screen appears.

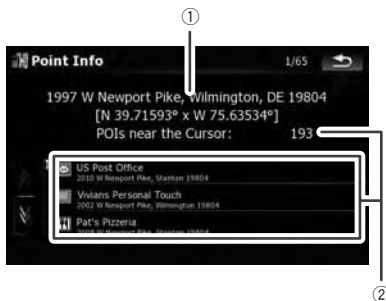

- ① The address and coordinates
- ② Information about a nearby POI
 - Up to 300 nearby POIs will be listed.

5 Touch **[Touch]** or **[Touch]** to scroll the nearby POI list and then touch the desired POI.

Touching one of the listed POIs enables you to view more detailed information about the POI.

6 Touch **[OK]**.

If you touch **[OK]**, the “Map Confirmation Screen” appears with a focus on the selected POI.

Placing a map pin on the location

The pin-shaped icons called “map pins” can be used just like markers. Placing the colored pins on the map makes the position stand out and helps you to find the position easily later.



After the location is decided (Map Confirmation Screen)

1 Search for a location or position the cursor on the desired area by scrolling the map and displaying the “Map Confirmation Screen”.

2 Touch [Save as...] on the “Map Confirmation Screen”.

3 Touch [Add Pin].

The pin icon is placed on the map and the screen returns to the map screen.

- The color of the pin icon is assigned automatically within predefined colors when you set it up.

Removing a map pin

When the cursor overlaps a map pin that has already been set, you can remove the map pin.

1 Locate the cursor at the pin icon and display the “Map Confirmation Screen”.

2 Touch [Save as...] on the “Map Confirmation Screen”.

3 Touch [Remove Pins].

The pin icon is removed and the screen returns to the map screen.

Registering the location as a customized POI

If a new business has opened, it may not be found in the database. Registering the location as a new POI allows you to use the item just like a preinstalled POI.

1 Search for a location or position the cursor on the desired area by scrolling the map and displaying the “Map Confirmation Screen”.

2 Touch [Save as...] on the “Map Confirmation Screen”.

3 Touch [Add POI].

The list of POI categories appears.

4 Touch the desired category to which the location is to be assigned.



If there are more detailed categories within the selected category, repeat this step as many times as necessary.

5 Touch [Add here] when the desired category list appears to add the item to it.

If there aren't any more detailed categories, the blank list appears. In such case, touching [Add here] allows you to add the item and register it as an item belonging to the category that you selected on the previous screen.

- Touching [Add here] without selecting any category is invalid.

6 Enter the name and then touch [Done] to complete the entry.



The registration is now complete and the item is available as a customized POI.

- You can edit the stored POI later in “POI Settings”.
- ➔ For more details of the operation, refer to *Editing your customized POI* on page 152.

Storing the location in “Favorites”

Storing your favorite locations as “**Favorites**” provides you with the opportunity to save the time and effort of re-entering this information. Stored items can be made available on “**Favorites**” later.

- ➔ For more details of the operation, refer to *Selecting a location stored in “Favorites”* on page 50.
- “**Favorites**” can store up to 30 locations.

- 1 Search for a location or position the cursor on the desired area by scrolling the map and displaying the “Map Confirmation Screen”.
- 2 Touch [Save as...] on the “Map Confirmation Screen”.
- 3 Touch [Add Favorite].
- 4 Touch the entry you want.



Selecting an item that has already been stored allows you to overwrite it.

- 5 Enter the name and then touch [Done] to complete the entry.

Storage is complete and the item is available as a preset entry on “**Favorites**”.

- 1 Touch [Destination] on the “Top Menu”, and then touch [Favorites].

- 2 Touch [Clear All].

A message will appear asking you to confirm the deletion.

- 3 Touch [Yes].

- Because deleted data cannot be restored, take extra care not to mistakenly delete items.

Deleting an entry in “Favorites”

All entries in “**Favorites**” can be deleted at once.

Checking the current route

Checking the current route conditions

The “**Route Information**” screen provides you with various detailed information about the current route.

This is an example showing a route with two waypoints.

- ❑ This function is available only when the route is set and your vehicle position is on the route.
- ❑ You can also display the “**Route Information**” screen by touching “**Multi-Info window**” on the map screen.
 - ➔ For details, refer to **Multi-Info window** on page 37.

1 Touch [Destination] on the “Top Menu”, and then touch [Route Function].

2 Touch [Route info].

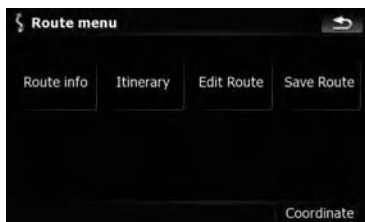

The “**Route Information**” screen appears.

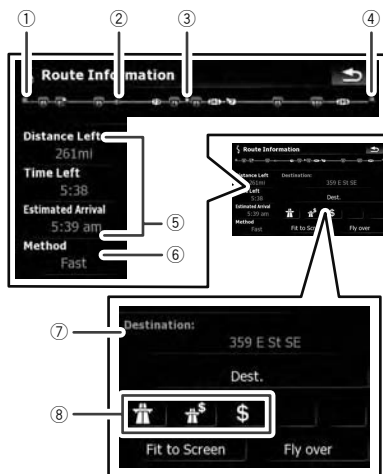

- ① Starting point
- ② Current position
- ③ Waypoint
- ④ Destination
- ⑤ Time and distance up to the point currently shown
- ⑥ “**Method:**” is the route calculation method that is currently set
 - ➔ For details, refer to **Route** on page 147.
- ⑦ Point currently shown and information regarding the point
- ⑧ The route conditions up to the point currently shown

Touching the icon enables you to check the details. If there are five or more icons, touch  to show the next four icons.

Checking the current route

- 3 Touch [Dest.] to switch to the first waypoint screen.

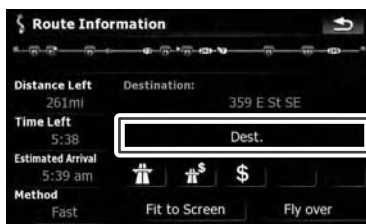

The “Route Information (to via)” screen appears.

- 4 Touch [Via] to switch to the second waypoint screen.

The “Route Information (to via)” screen for next waypoint appears.

- 5 Touch [Via] to return to the screen for whole route.

The “Route Information” screen appears.

- If three or more waypoints are set, each touch of [Via] shows the screen for the next waypoint.

Playing simulated travel at high speed

This function allows you to play the simulated navigation function at high speed without voice guidance. This function is useful if you want to browse how the current route will be navigated.

- 1 Touch [Destination] on the “Top Menu”, and then touch [Route Function].

- 2 Touch [Route info].

The “Route Information” screen appears.

- 3 Touch [Fly over].

The simulation will start.

- If you want to stop the simulation, touch  on the map.

Checking the entire route overview on the map

You can check the entire outline of the current route.

- 1 Touch [Destination] on the “Top Menu”, and then touch [Route Function].

- 2 Touch [Route info].

The “Route Information” screen appears.

- 3 Touch [Fit to Screen].

A 2D map screen will appear with the current overall route fitted onto the screen. 

Checking the current itinerary

You can check the route details.

- This function is available only when the route is set and your vehicle position is on the route.

- 1 Touch [Destination] on the “Top Menu”, and then touch [Route Function].

- 2 Touch [Itinerary].

- 3 Touch  or  to scroll the list.

Scroll the list as necessary.



- ① Turning direction
- ② Driving distance
- ③ Names of the streets you are driving through

- 4 Touch [Mode].

Each touch of [Mode] changes the list mode.

Checking the current route

Alternative options:

- **Detailed Instructions**
All turning points, passed streets and other information is shown.
 - **Instructions**
All turning points (where voice guidance is given) are shown.
 - **Road List**
Displays the turning points in the most simplified form (duplicated route names are merged into one).
- When a long distance route is calculated, your navigation system may not be able to list all roads. (In this case, the remaining roads will be shown in the list as you drive on.)

Editing waypoints

You can edit waypoints (locations you want to visit on the way to your destination) and recalculate the route so that it passes through these locations.

Adding a waypoint

1 Search for a location.

- ➔ For more details, refer to the descriptions from page 42 to page 52.

2 Touch [Route...] on the "Map Confirmation Screen".

3 Touch [Add Via].

- ➔ For more details of the operation, refer to *Sorting waypoints* on this page.
- ☐ When you set waypoints in the route to your destination, the route up to the next waypoint will appear in light green. The rest of the route will appear in light blue.

Sorting waypoints

You can sort waypoints and recalculate the route.

1 Touch [Destination] on the "Top Menu", and then touch [Route Function].

2 Touch [Edit Route].

The "Edit Route" screen appears.

3 Touch [↑] or [↓] to move the waypoint or destination.

Put them in the desired order.

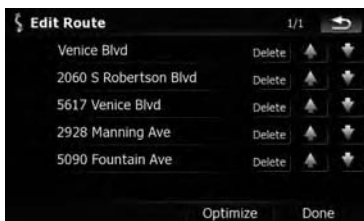

Touching [Optimize] sorts the waypoints automatically so that the route will compromise the least time and distance.

4 Touch [Done].

The route is recalculated and the map of the current position appears.

Deleting a waypoint

You can delete waypoints from the route and then recalculate the route. (You can delete waypoints successively.)

1 Touch [Destination] on the "Top Menu", and then touch [Route Function].

2 Touch [Edit Route].

The "Edit Route" screen appears.

3 Touch [Delete] on the right of the waypoint that you want to delete.

The waypoint will be deleted from the list.

4 Touch [Done].

The route is recalculated and the map of the current position appears. ☐

Storing the current route

Storing the current route allows you to recall and set the stored route.

- ☐ This function is available only when the route is set and your vehicle position is on the route.

1 Touch [Destination] on the "Top Menu", and then touch [Route Function].

2 Touch [Save Route].

Editing waypoints and the destination

- 3 Enter the name and then touch [Done] to complete the entry.



The previous screen appears.

- Saved route can be recalled later.
- ➔ For details, refer to *Setting a route by recalling a saved route* on page 51.

Deleting the entry in “Saved Routes”

- 1 Touch [Destination] on the “Top Menu”, and then touch [Saved Routes].
- 2 Touch [Delete] on the right of the item that you want to delete.
 - Because deleted data cannot be restored, take extra care not to mistakenly delete items.

Deleting the current route

If you no longer need to travel to your destination, follow the steps below to delete the current route and cancel the route guidance.

- 1 Touch [Destination] on the “Top Menu”, and then touch [Delete Route].
A message confirming the cancellation of the current route appears.
- 2 Touch [Yes].

If you have an active subscription to MSN Direct service, you can check and browse various information on your navigation system, such as gas prices, movie times, weather conditions and traffic information. The information will be updated periodically. — This function is available for AVIC-X910BT only.

Notice about MSN Direct™

Pioneer is not responsible for the accuracy of the MSN Direct content. The MSN Direct content may not be current or available at times, and is subject to change without notice. To receive MSN Direct content, you must subscribe to the MSN Direct service, and you must be within the MSN Direct coverage area. Coverage may also be affected by the availability and relative strength of FM transmissions, as well as reception limitations of Microsoft's Direct-Band network.

Please visit

<http://www.msndirect.com/pioneer>
or current coverage area maps, subscription details, and other important information about MSN Direct.

Activating the service

You have to activate MSN Direct first.

- ❑ A web-connected computer is required for the online subscription.
- ❑ If you have difficulty for the online subscription, please call toll-free 1-866-658-7032.

General flow chart:

- 1 Check your product key.
You have to know your product key for the subscription.
(Refer to *Checking your product key* on this page.)
↓
- 2 Make an online subscription to MSN Direct service using your PC.
(Refer to *Subscribing to the MSN Direct service* on the next page.)
↓
- 3 Activate the MSN Direct service on this product.
(Refer to *Activating the MSN Direct function* on the next page.)
↓
- 4 Activation is complete.

Checking your product key

The product key that you can find here is used in the online subscription.

1 Touch [Destination] on the "Top Menu", and then touch [MSN Direct].

The "MSN Direct" screen appears.

2 Touch [Status].

3 Write your product key down in the following box;

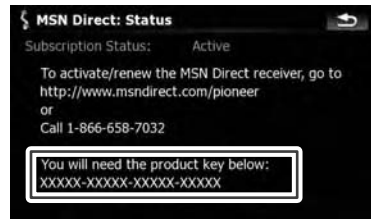

Browsing information on MSN Direct

Subscribing to the MSN Direct service

Within two days of completing the subscription, execute *Activating the MSN Direct function*.

1 Access the following URL and read the description.

http://www.msndirect.com/pioneer

2 Be sure to check the coverage area and other availabilities of MSN Direct on the web page.

3 Go to the page for activation and enter your product key.

4 Follow the directions on the web page to complete the subscription.

Activating the MSN Direct function

After the online subscription, complete the activation so that the navigation system can receive the information.

This operation must be performed under the following conditions

- You are currently in the coverage area of MSN Direct.
- The signal strength (📶) on "MSN Direct" screen is not weak.

1 Boot-up your navigation system.

2 Touch [Destination] on the "Top Menu", and then touch [MSN Direct].

The "MSN Direct" screen appears.

Check the signal strength. If the signal is weak, move to another location where a stronger signal can be received.

3 Touch [Status].

4 Wait until the activation status changes to "Active".

It may take approximately 20 or 30 minutes to complete the activation.

After activation is complete, the information will be available on each menu. □

Browsing gas prices

Recent gas prices of nearby gas stations are displayed in a list.

Although the MSN Direct service regularly updates gas price information, the information provided may not necessarily correspond to actual gas prices. Please refer to *Notice about MSN Direct™* on the previous page.

It may take up to 24 hours for all the data to become available under the following conditions:

- When you use MSN Direct for the first time.
- When you have not performed this function previously around the current area.
- After the navigation system has been turned off for a few days.

1 Touch [Destination] on the "Top Menu", and then touch [MSN Direct].

The "MSN Direct" screen appears.

2 Touch [Gas Prices].



3 Touch the desired tab to change the sort order.

Name	Price	Distance
Mobil	n/a	9.2mi
Circle K	\$3.89 (today)	9.2mi
Valero	\$4.11 (today)	9.3mi
Chevron	\$3.95 (today)	9.3mi
76	\$3.93 (today)	9.4mi

Available options;

Browsing information on MSN Direct

- **[Distance]** (default):
Sorts the items in the list in order by distance from the vehicle position.
- **[Name]**:
Sorts the items in the list alphabetically.
- **[Price]**:
Sorts the items in the list by price.

4 Touch on the item that you want to view in detail.



Name	Price	Distance
Mobil	n/a	9.2mi
Circle K	\$3.89 (today)	9.2mi
Valero	\$4.11 (yesterday)	9.3mi
Chevron	\$3.95 (today)	9.3mi
76	\$3.93 (today)	9.4mi

- ① The names of gas stations and their locations
- ② Gas prices
The information in () shows how current the information is.
- ③ Distance from the current position

5 Touch one of the options at the bottom of the "Map Confirmation Screen" to select the next operation.

- ➔ For details of other operations on the "Map Confirmation Screen", refer to *What you can do with the "Map Confirmation Screen"* on page 54. 

Browsing movie times

Nearby theaters can be displayed on a list. Switching the screen allows you to see the movie title now showing.

Although the MSN Direct service regularly updates movie information, the information provided may not necessarily correspond to actual movie information. Please refer to *Notice about MSN Direct™* on page 64.

It may take up to 6 hours for all the data to become available under the following conditions:

- When you use MSN Direct for the first time.
- When you have not performed this function previously around the current area.
- After the navigation system has been turned off for a few days.

Searching for a theater by selecting a movie title

1 Touch [Destination] on the "Top Menu", and then touch [MSN Direct].

2 Touch [Movie Times].

3 Touch [All Movie Titles].

The movie titles now showing are displayed.

4 Touch the desired movie title.

The theaters that are currently showing the selected movie are displayed.



Movie Title	Rating
10,000 B.C.	(PG-13)
21	(PG-13)
88 Minutes	(R)
Alvin and the Chipmunks	(PG)
Baby Mama	(PG-13)
Before the Rains	(PG-13)

All Movie Theaters

Browsing information on MSN Direct

5 Touch the desired tab to change the sort order.

Name	Distance
Silver Super Saver Cinema 8 - Norwalk	13.6mi
Redondo Beach Cinema 3	14.1mi
Picture Show @ Main Place	29mi
Starplex Cinemas - Woodbridge Dollar Mo	36mi
Cinemark Movies 12 - Lancaster	45mi

Available options;

- **[Distance]** (default):
Sorts the items in the list in order by distance from the vehicle position.
- **[Name]**:
Sorts the items in the list alphabetically.

6 Touch on the item that you want to view in detail.

Name	Distance
Silver Super Saver Cinema 8 - Norwalk	13.6mi
Redondo Beach Cinema 3	14.1mi
Picture Show @ Main Place	29mi
Starplex Cinemas - Woodbridge Dollar Mo	36mi
Cinemark Movies 12 - Lancaster	45mi

- ① The names of theaters and their locations
- ② Distance from the current position

7 Touch one of the options at the bottom of the “Map Confirmation Screen” to select the next operation.

- ☞ For details of other operations on the “Map Confirmation Screen”, refer to *What you can do with the “Map Confirmation Screen”* on page 54.

Searching for a movie title by selecting a theater

1 Touch [Destination] on the “Top Menu”, and then touch [MSN Direct].

2 Touch [Movie Times].

The nearby theaters are displayed.

3 Touch the desired tab to change the sort order.

Name	Distance
Silver Super Saver Cinema 8 - Norwalk	13.6mi
Old Town Music Hall	13.6mi
Pacific Sherman Oaks 5	13.7mi
Santa Fe Springs Plaza 3	13.7mi
AMC Norwalk 20	13.8mi

Available options;

- **[Distance]** (default):
Sorts the items in the list in order by distance from the vehicle position.
- **[Name]**:
Sorts the items in the list alphabetically.

4 Touch the desired theater.

The movie titles currently shown on the selected theater are displayed.

5 Touch on the item that you want to view in detail.

6 Touch one of the options at the bottom of the “Map Confirmation Screen” to select the next operation.

- ☞ For details of other operations on the “Map Confirmation Screen”, refer to *What you can do with the “Map Confirmation Screen”* on page 54. ■

Browsing weather information

Local weather information can be displayed on a list. Switching the screen allows you to see worldwide weather conditions.

Although the MSN Direct service regularly updates weather information, the information provided may not necessarily correspond to actual weather conditions. Please refer to *Notice about MSN Direct™* on page 64.

Checking the local weather information

1 Touch [Destination] on the “Top Menu”, and then touch [MSN Direct].

2 Touch [Weather].

The local weather information is displayed. The area name, distance and direction from current position are displayed on the list. The items on the list are sorted by distance.

3 Touch the desired area.

Detailed information is displayed.



Touching [**Forecast**] displays the weather forecasts for these three days.

Checking worldwide weather conditions

1 Touch [Destination] on the “Top Menu”, and then touch [MSN Direct].

2 Touch [Weather].

The local weather information is displayed.

3 Touch [Worldwide].

Worldwide weather conditions are displayed. The area name, distance and direction from current position are displayed on the list. The list is sorted alphabetically by the area name.

4 Touch the desired area.

Detailed information is displayed.

Using traffic information

You can view current traffic conditions and information. When the navigation system receives updated traffic information, it will overlay the traffic information on your map and also display detailed text information when available.

In the default setting, the navigation system takes into account traffic information and tries to avoid traffic congestions and suggest better routes. Also, when you are traveling along a route and the system finds another better route for avoiding the traffic congestion, the current route will be recalculated automatically.

The term “traffic congestion” in this section indicates the following types of traffic conditions:

- Stop-and-go traffic
- Stopped traffic
- Closed/blocked roads

Viewing the traffic event

Traffic Information is displayed on a screen in the form of a list. This allows you to check how many traffic incidents have occurred, their location and their distance from your current position.

Browsing information on MSN Direct

Although the MSN Direct service regularly updates traffic information, the information provided may not necessarily correspond to actual traffic conditions. Please refer to *Notice about MSN Direct™* on page 64.

1 Touch [Destination] on the “Top Menu”, and then touch [MSN Direct].

2 Touch [Traffic].

A list with traffic information that has been received is shown. The list is sorted by distance from your current position. Places (street names) where incidents have occurred are displayed on the list.



- ① Event-related icon
- ② Street or location and direction
- ③ Distance to the location and event
- ④ Switching to traffic flow list
 - ➔ For more details concerning the operation, refer to *Viewing the traffic flow* on this page.
- ⑤ Touch to change the settings of traffic information.
 - ➔ For more details concerning the operation, refer to *Setting the traffic information* on the next page.

3 Touch the item you want to check its position on the map.

The traffic event information displayed on the map is as follows.



Traffic event icon and line

- 🚗 with yellow line: Heavy traffic
- 🚗 with red line: Traffic jam
- 🚧 with black line: Closed/blocked roads
- 🚫 etc.: Accidents, constructions, etc.

Viewing the traffic flow

Traffic Information is displayed on a screen in the form of a list. This allows you to check how many traffic incidents have occurred, their location and their distance from your current position.

Although the MSN Direct service regularly updates traffic information, the information provided may not necessarily correspond to actual traffic conditions. Please refer to *Notice about MSN Direct™* on page 64.

1 Touch [Destination] on the “Top Menu”, and then touch [MSN Direct].

2 Touch [Traffic].

3 Touch [Traffic Flow].

A list with traffic event information that has been received is shown. Places (street names) where incidents have occurred are displayed on the list.

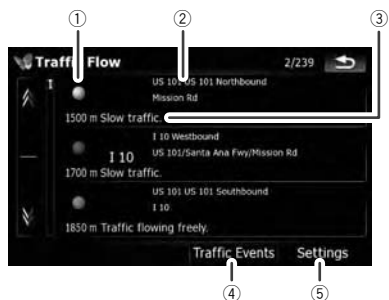

- ① Flow-related icon
- ② Street or location and direction
- ③ Distance to the location and event
- ④ Switching to traffic event list
 - ➔ For more details concerning the operation, refer to *Viewing the traffic event* on page 68.
- ⑤ Touch to change the settings of traffic information.
 - ➔ For more details concerning the operation, refer to *Setting the traffic information* on this page.

4 Touch the item you want to check its position on the map.

The traffic event information displayed on the map is as follows.



Traffic flow icon and line

- **Red:** average speed in this area is slower than 15mph (24 km/h)
- **Yellow:** average speed in this area is between 15 mph to 45mph (24 km/h to 72 km/h)

- **Green:** average speed in this area is faster than 45 mph (72 km/h) (An icon without a line will be displayed)

Setting the traffic information

Preferred functions related to traffic information can be set.

1 Touch [Destination] on the “Top Menu”, and then touch [MSN Direct].

2 Touch [Traffic] and then touch [Settings].

The “Traffic Settings” screen appears.

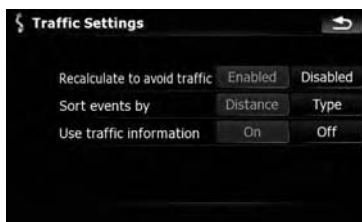

Available options;

- “**Recalculate route avoiding traffic**”
 - [Enabled]: Calculates the new route with the traffic congestion taken into account when rerouting.
 - [Disabled]: Calculates the new route without taking traffic jam into account when rerouting.
- “**Sort events by**”
 - [Distance]: Sorts the traffic event items in the list by distance.
 - [Type]: Sorts the traffic event items in the list by event type.
- “**Use traffic information**”
 - [On]: Calculates the route with the traffic congestion taken into account in the initial calculation.
 - [Off]:

Browsing information on MSN Direct

Calculates the route without taking traffic jam into account in the initial calculation. 

Browsing news headlines

Recent news headlines are displayed in a list.

Although the MSN Direct service regularly updates news headlines, the information provided may not necessarily correspond to current news headlines. Please refer to *Notice about MSN Direct™* on page 64.

- 1 Touch **[Destination]** on the “**Top Menu**”, and then touch **[MSN Direct]**.
- 2 Touch **[News Headlines]**.
- 3 Touch the desired news headline.



Further details about the news are displayed.

- 4 Touch  or  to scroll the list.

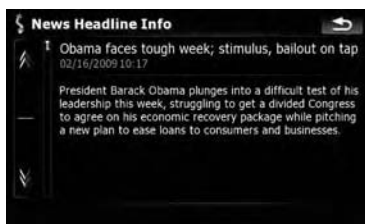

Browsing local events

The nearby events to be held in the next few days are displayed on a list, and you can see the detail event information.

Although the MSN Direct service regularly updates local event information, the information provided may not necessarily correspond to actual local event conditions. Please refer to *Notice about MSN Direct™* on page 64.

- 1 Touch **[Destination]** on the “**Top Menu**”, and then touch **[MSN Direct]**.
- 2 Touch **[Local Events]**.
The recent local events are displayed in a list.
- 3 Touch the desired event to display detailed information of the event.

Name	Time	Distance
Javier Vergara Quartet	02/17/2009	7.2 mi.
Club Dublin's	02/18/2009	6.1 mi.
Pro Blues Jam	02/18/2009	13.1 mi.
Steel Rod	02/18/2009	15.9 mi.
All-Star Pro Jam	02/18/2009	14.6 mi.

Available options;

- **[Name]:**
Sorts the items in the list alphabetically.
- **[Distance]:**
Sorts the items in the list in order by distance from the vehicle position.
- **[Time]:**
Sorts the items in the list in order by the time when the event is opened.

- 4 Touch [Select] to display there with the map.

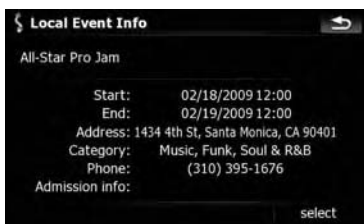

The “Map Confirmation Screen” appears.

- 5 Touch one of the options at the bottom of the “Map Confirmation Screen” to select the next operation.

- ➔ For details of other operations on the “Map Confirmation Screen”, refer to *What you can do with the “Map Confirmation Screen”* on page 54.

Browsing stock quotes

Recent stock quotes are displayed in a list.

Although the stock quote displayed onscreen is updated about 40 minutes (approx.), these prices are not realtime values.

It may take up to 20 minutes for all the data to become available under the following conditions:

- When you use MSN Direct for the first time.
 - When you have not performed this function previously around the current area.
 - After the navigation system has been turned off for a few days.
- ➔ Please refer to *Notice about MSN Direct™* on page 64.

Selecting stock symbols

- 1 Touch [Destination] on the “Top Menu”, and then touch [MSN Direct].

- 2 Touch [Stock Quotes].

- The blank list appears when no symbols are selected.

- 3 Touch [Select].

The list of stock symbols is displayed.

- 4 Touch the stock symbol that you want to add.

When you touch the symbol, a check mark appears indicating that it is selected.



- To cancel the selection, remove the check mark by touching the item again.
- Arrow in the left of each item indicates the stock price movement. If there is no stock price movements than previous close, “—” is displayed.

Viewing the detailed stock quotes

- 1 Touch [Destination] on the “Top Menu”, and then touch [MSN Direct].

- 2 Touch [Stock Quotes].

- 3 Touch the desired stock quote.



Detailed stock quote information is displayed.

Using hands-free phoning

Hands-free phoning overview

⚠ CAUTION

For your safety, avoid talking on the phone as much as possible while driving.

If your cellular phone features Bluetooth® technology, this navigation system can be connected to your cellular phone wirelessly. Using this hands-free function, you can operate the navigation system to make or receive phone calls. You can also transfer the phone book data stored in your cellular phone to the navigation system. This section describes how to set up a Bluetooth connection and how to operate a cellular phone featuring Bluetooth technology on the navigation system.

For more information about the connectivity with the cellular phone featuring Bluetooth wireless technology, refer to the information on our website.



Preparing communication devices

This navigation system has a built-in function to use cellular phones featuring Bluetooth wireless technology.

While your cellular phone featuring Bluetooth wireless technology is connected, the Bluetooth connection status indicator lights.

- ➔ For details, refer to *Notes for hands-free phoning* on page 84.
- ☐ When the navigation system is turned off, the Bluetooth connection is also disconnected. When the system restarts, the system automatically attempts to reconnect the previously-connected cellular phone. Even when the connection is severed for some reason, the system automatically reconnects the specified cellular phone (except when the connection is severed due to cellular phone operation). ☐

Displaying the Phone Menu

Use the “**Phone Menu**” if you connect the cellular phone to the navigation system for utilization.

1 Press the MENU button to display the “Top Menu”.

2 Touch [Phone].



- ① : Network name of the cellular phone company
- ② : Reception status of the cellular phone
- ③ : Battery status of the cellular phone
- ④ : Name of connected cellular phone ☐

Registering your cellular phone

You need to register your cellular phone featuring Bluetooth wireless technology when you connect it for the first time. A total of three phones can be registered. Three registration methods are available:

- Searching for nearby phones
- Searching for a specified phone
- Pairing from your cellular phone
- ☐ The default device name displayed on the cellular phone is “**Pioneer Navi**”. The PIN code is “**1111**”.

Searching for nearby phones

The system searches for available cellular phones near the navigation system, displays them in a list, and registers them for connection.

1 Activate the Bluetooth wireless technology on your cellular phone.

For some cellular phones, no specific action is necessary to activate Bluetooth wireless technology. For details, refer to the instruction manual of your cellular phone.

2 Touch [Phone Settings] on the “Phone Menu”.

- For details, refer to *Displaying the Phone Menu* on the previous page.

3 Touch [Connection].

4 Touch [Add Device], and then [Search devices].

The system searches for cellular phones featuring Bluetooth technology that are waiting for the connection and displays them in the list if the device has found.

- Up to 10 cellular phones will be listed in the order that the cellular phone is found.

5 Wait until your cellular phone appears in the list.

- If you cannot find the cellular phone you want to connect, check that the cellular phone is waiting for the Bluetooth wireless technology connection.

6 Touch the cellular phone name you want to register.

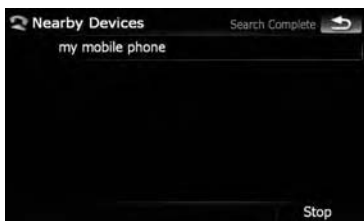

A message prompting you to enter a PIN code appears.

7 Enter the PIN code “1111” using the cellular phone.



When a connection is successfully established, a connection complete message appears, the screen returns to the “Phone Settings” menu by touching [OK].

Searching for a specified phone

If you cannot connect your phone using [Search devices] and [Pair from the mobile phone], try this method if your phone is found in the list.

1 Activate the Bluetooth wireless technology on your cellular phone.

For some cellular phones, no specific action is necessary to activate Bluetooth wireless technology. For details, refer to the instruction manual of your cellular phone.

2 Touch [Phone Settings] on the “Phone Menu”.

- For details, refer to *Displaying the Phone Menu* on the previous page.

3 Touch [Connection].

4 Touch [Add Device], and then [Select specific devices].

Using hands-free phoning

5 Touch the model name of the cellular phone to be connected.

The system searches for cellular phones featuring Bluetooth technology that are waiting for the connection and displays them in the list if the device has found.

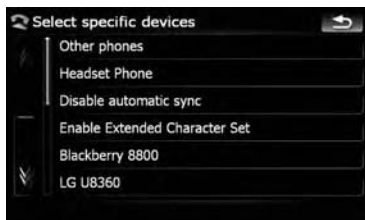

- If you cannot find the desired model name on the list, touch **[Other phones]** to search the cellular phones available nearby.

6 Select the cellular phone you want to register from the list.

A message prompting you to enter a PIN code appears.

7 Enter the PIN code "1111" using the cellular phone.



When a connection is successfully established, a connection complete message appears, the screen returns to the **"Phone Settings"** menu by touching **[OK]**.

Pairing from your cellular phone

You can register the cellular phone by setting the navigation system to standby mode and requesting connection from the cellular phone.

1 Activate the Bluetooth wireless technology on your cellular phone.

For some cellular phones, no specific action is necessary to activate Bluetooth wireless technology. For details, refer to the instruction manual of your cellular phone.

2 Touch [Phone Settings] on the "Phone Menu".

- ☞ For details, refer to *Displaying the Phone Menu* on page 73.

3 Touch [Connection].

4 Touch [Add Device], and then [Pair from the mobile phone].

The navigation system waits for a Bluetooth wireless technology connection.



5 Register the navigation system on your cellular phone.

If your cellular phone asks you to enter a password, enter the PIN code (password) of the navigation system.

After the registration is completed, the following screen appears.



- If registration fails repeat the procedure from the beginning. □

Connecting a registered cellular phone

The navigation system automatically connects the cellular phone selected as the target of connection. However, connect the cellular phone manually in the following cases:

- Two or more cellular phones are registered, and you want to manually select the cellular phone to be used.
- You want to reconnect a disconnected cellular phone.
- Connection cannot be established automatically for some reason.

If you start connection manually, carry out the following procedure. You can also connect the phone by having the navigation system detect it automatically.

➤ For details, refer to *Setting automatic connection* on page 83.

1 Activate the Bluetooth wireless technology on your cellular phone.

For some cellular phones, no specific action is necessary to activate Bluetooth wireless technology. For details, refer to the instruction manual of your cellular phone.

2 Touch [Phone Settings] on the "Phone Menu".

➤ For details, refer to *Displaying the Phone Menu* on page 73.

3 Touch [Connection].

4 Touch the name of the cellular phone that you want to connect.

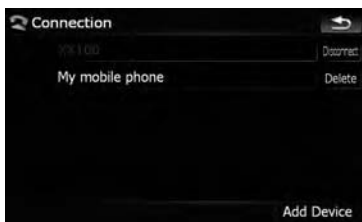

Connection starts.

When a connection is successfully established, a connection complete message appears, the screen returns to the "Phone Settings" menu by touching [OK].

- ❑ To cancel the connection to your cellular phone, touch [Cancel].
- ❑ If connection fails, check to see whether your cellular phone is waiting for a connection and then retry.

Disconnecting a cellular phone

1 Touch [Phone Settings] on the "Phone Menu".

➤ For details, refer to *Displaying the Phone Menu* on page 73.

2 Touch [Connection].

3 Touch [Disconnect] next to the cellular phone name.

Deleting a registered phone

If you no longer need to use a registered phone with the navigation system, you can delete it from the registration assignment to free this spot up for another phone.

- ❑ If a registered phone is deleted, all the phone book entries and call history lists that correspond to the phone will be also cleared.

1 Touch [Phone Settings] on the "Phone Menu".

➤ For details, refer to *Displaying the Phone Menu* on page 73.

2 Touch [Connection].

3 Touch [Delete] next to the cellular phone name.

The registration is canceled. ❑

Using hands-free phoning

Receiving a phone call

You can perform hands-free answering by using the navigation system.

Answering an incoming call

The system informs you that it is receiving a call by displaying a message and producing a ring sound.

If **[Auto Answer Preference]** is set to **[Off]**, answer the call manually. Answering is available if any screen is displayed, such as the map screen or the setting screen.

- You can set this navigation system to automatically answer incoming calls.
 - ➔ For details, refer to *Answering a call automatically* on page 82.

1 When a call comes in, the answering operation menu appears on the bottom of the screen.

2 To answer an incoming call, touch .



When there is an incoming call, you can reject it by touching .

- You can adjust volume when you are talking. To adjust volume, touch **[Vol -]** and **[Vol +]** displayed on the screen (like below) when you are talking.

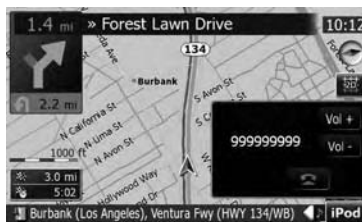

3 Touch  to end the call.

The call ends.

- When there is an incoming call, pressing **MULTI-CONTROL** answers the call. During the call, pressing **MULTI-CONTROL** gets you off the phone.
- If the voice on the other end of the call is too quiet to hear, you can adjust the volume of the received voice.
 - ➔ For more details about **"Phone Volume"**, refer to *Setting the phone volume* on page 82.
- You may hear a noise when you hang up the phone.

Rejecting an incoming call

You can reject an incoming call.

- ➔ For details, refer to *Setting the automatic rejection function* on page 83.

● When a call comes in, touch .

The call is rejected.

- The rejected call is recorded in the missed call history list.
- ➔ For details, refer to *Dialing from the history* on the next page. .

Making a phone call

You can make a phone call in many different ways.

Direct dialing

1 Touch [Dial Pad] on the “Phone Menu”.

- ➔ For details, refer to *Displaying the Phone Menu* on page 73.

The direct dial screen appears.

2 Touch the number keys to enter the phone number.

The phone number that was input is displayed.

Input number



< :

The input number is deleted a digit at a time from the end of the number. Continuing to press this deletes all of the digits.

↶ :

Return to the previous screen.

3 Touch to make a call.

- To cancel the call after the system starts dialing, touch .

4 Touch to end the call.

Dialing from the history

The most recent calls made (dialed), received and missed are stored in the call history list. You can browse the call history list and call numbers from it.

Making a phone call using the dialed number history

The dialed number history saves 30 calls per registered cellular phone. If the entries exceed 30, the oldest one will be deleted.

1 Touch [Dialed Numbers] on the “Phone Menu”.

- ➔ For details, refer to *Displaying the Phone Menu* on page 73.

2 If you touch an entry on the list, dialing starts.

- If you touch [Detail], you can check the details of the party before making a phone call.
- To cancel the call after the system starts dialing, touch .

3 Touch to end the call.

Making a phone call using the received call history

The received call history saves 30 calls per registered cellular phone. If the number of calls exceeds 30, the oldest entry will be deleted.

1 Touch [Received Calls] on the “Phone Menu”.

- ➔ For details, refer to *Displaying the Phone Menu* on page 73.

2 If you touch an entry on the list, dialing starts.

- If you touch [Detail], you can check the details of the party before making a phone call.
- To cancel the call after the system starts dialing, touch .

3 Touch to end the call.

Making a phone call using missed call history

The missed call history saves 20 calls per registered cellular phone. If the number of calls exceeds 20, the oldest entry will be deleted.

1 Touch [Missed Calls] on the “Phone Menu”.

- ➔ For details, refer to *Displaying the Phone Menu* on page 73.

Using hands-free phoning

2 If you touch an entry on the list, dialing starts.

- If you touch **[Detail]**, you can check the details of the party before making a phone call.
- To cancel the call after the system starts dialing, touch .

3 Touch to end the call.

Calling a number in the "Contacts" screen

After finding the entry you want to call in the "Contacts" screen, you can select the number and make the call.

1 Press the MENU button to display the "Top Menu".

2 Touch **[Contacts]**.

The "Contacts" screen appears.

3 Switch the page of the list to display the desired entry.

If you touch an alphabet tab, you can jump to the first page of the contacts whose names start with that letter.



 or .

Shows the next or previous page.

Alphabet tabs

Makes the screen jump to the beginning of the page including the entry whose names start with any of selected alphabets.

Touching **[#ABCDE]** also displays the page including the entry whose names start with primary symbols or numbers.

Touching **[Others]** displays the page including entries that are not assigned to any of the other tabs.

4 Touch the desired entry on the list to make a call.

5 Touch to end the call.

Dialing a phone number of the POI

You can make a call to the POI that has a telephone number.

1 To display the "Map Confirmation Screen", search for a locations or moves the cursor and touch .

2 Touch **[Info]** and select the POI that has a telephone number.

3 Touch **[Call]** to make a call.

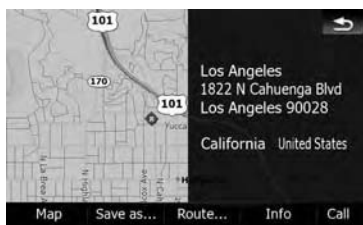

To cancel the call after the system starts dialing, touch .

4 Touch to end the call.

Making a call home easily

You can call home without taking the time to enter the phone number if the phone number has been registered.

● Touch **[Call Home]** on the "Phone Menu".

Dialing home starts.

- For details, refer to *Displaying the Phone Menu* on page 73.

- ❑ If you have not registered your home number, a message appears. Touch **[Yes]** to start registration.
 - ➔ For more details about "**Set Home**", refer to *Setting your home position* on page 154.

Dialing GOOG-411



CAUTION

Local and/or long distance charges for making a phone call may apply.

You can dial GOOG-411 to dial the free business listing service of Google™ with one touch.

1 Touch [GOOG-411] on the "Phone Menu".

- ➔ For details, refer to *Displaying the Phone Menu* on page 73.

Dialing GOOG-411 starts.

2 You can now use the GOOG-411 phone service.

For details about GOOG-411 service and availability, contact Google™. ■

Announcing incoming short mails

While the cellular phone and the navigation system are connected, the following notice is displayed when you get a new SMS message. "**New mail from:** (sender's name)" is displayed and the notice disappears after eight seconds.



- ❑ Touch anywhere on the screen to clear the announcement message.
- ❑ If the voice language with TTS is currently used, the audible message can be output.
 - ➔ For details, refer to *Selecting the language* on page 155. ■

Transferring the phone book

You can transfer the numbers in a registered user phone's address book into the phone book.

- ❑ With some cellular phones, it may not be possible to transfer the entire phone book at once. In this case, transfer addresses one at a time from your phone book using your cellular phone.
- ❑ The maximum 400 entries can be transferred per cellular phone. If the entries exceed 400, the extra entries will not be transferred. If more than one number is registered for one person, such as work place and home, each number is counted separately.
- ❑ Each entry can hold up to 3 phone numbers.

Using hands-free phoning

- ❑ Depending on the cellular phone that is connected to this navigation system via Bluetooth technology, this navigation system may not be able to display the phone book correctly. (Some characters may be garbled.)
- ❑ If the phone book in the cellular phone contains image data, the phone book may not be correctly transferred.

1 Connect the cellular phone that has the phone book to transfer.

- For details, refer to *Connecting a registered cellular phone* on page 76.

2 Touch [Phone Book Transfer] on the "Phone Menu".

The confirmation messages appear.

3 Check the messages and touch [OK].

- ❑ If there is a phone book already transferred, a message asking whether you can accept the data replacement appears.

4 Check that the following screen is displayed, and operate your cellular phone to transfer the phone book entries.



Transfer starts. It may take time depending on how many entries will be transferred.

- ❑ You can send the phone book entries repeatedly before touching [OK]. If your cellular phone supports one-by-one transfer only, send all the entries that you want to transfer before touching [OK].
- ❑ If your phone has a capability for automatic transfer of phone book, this screen is skipped and transfer will start.

- ❑ The transferred data can not be edited on the navigation system.

5 When the completion message appears, check the message and touch [OK]. Transfer ends. [OK]

Clearing memory

You can clear the memory of each item that corresponds to the connected cellular phone: phone book, dialed/received/missed call history list and preset dials.

1 Touch [Phone Settings] on the "Phone Menu".

- For details, refer to *Displaying the Phone Menu* on page 73.

2 Touch [Clear Memory].

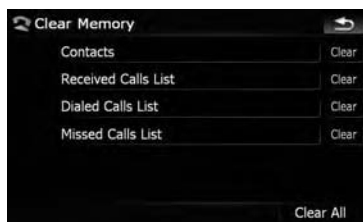

On this screen, you can select the following items:

Contacts:

You can clear the registered phone book.

Received Calls List:

You can clear the received call history list.

Dialed Calls List:

You can clear the dialed call history list.

Missed Calls List:

You can clear the missed call history list.

- ❑ Touching [Clear] displays the confirmation message for clearing the memory.
- ❑ Touching [Clear All] clears all the data that correspond to the connected cellular phone.

3 Touch [OK].

Data on the selected item is cleared from this navigation system's memory.

- ❑ If you do not want to clear memory that you have selected, touch [Cancel]. ❑

Setting the phone

Setting the phone volume

The volume level for hands-free phoning can be adjusted.

1 Touch [Phone Volume] on the "Phone Menu".

- ➔ For details, refer to *Displaying the Phone Menu* on page 73.

2 Adjust volume to touch the sliders of [Phone Ringtone] and [Phone Voice].

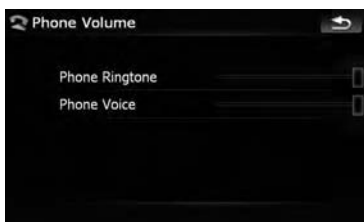

[Phone Ringtone]:

This setting controls the incoming ring tone volume.

[Phone Voice]:

This setting controls the incoming voice volume.

- ❑ Phone volume varies depending on the incoming caller's phone, volume setting and other conditions.
- ➔ For details concerning operations, refer to *Answering an incoming call* on page 77.

Stopping Bluetooth wave transmission

You can stop transmission of electric waves by turning off the Bluetooth function. If you do not use the Bluetooth wireless technology, we recommend selecting [Off].

1 Touch [Phone Settings] on the "Phone Menu".

- ➔ For details, refer to *Displaying the Phone Menu* on page 73.

2 Touch [Off] next to "Bluetooth On/Off".

Touching [Bluetooth On/Off] switching between [On] and [Off].

Answering a call automatically

The navigation system automatically answers incoming calls to the cellular phone, so you can answer a call while driving without taking your hands off the steering wheel.

1 Touch [Phone Settings] on the "Phone Menu".

- ➔ For details, refer to *Displaying the Phone Menu* on page 73.

2 Touch the key next to [Auto Answer Preference].

Auto Answer Preference selection appears.

3 Touch the desired option.

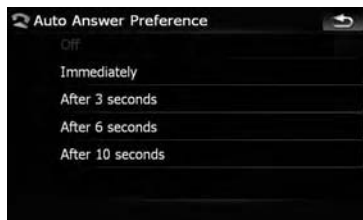

[Off]: No automatic response. Respond manually

[Immediately]: Answers immediately

[After 3 seconds]: Answers after three seconds

Using hands-free phoning

[After 6 seconds]: Answers after six seconds

[After 10 seconds]: Answers after ten seconds

Setting the automatic rejection function

If this function is on, the navigation system automatically rejects all incoming calls.

1 Touch [Phone Settings] on the “Phone Menu”.

- For details, refer to *Displaying the Phone Menu* on page 73.

2 Touch the key next to “Refuse All Calls”.

Touching the key activates or deactivates the function.

- ☐ If both “Refuse All Calls” and “Auto Answer Preference” are set to [On], “Refuse All Calls” is prioritized and all incoming calls are automatically rejected.

Echo canceling and noise reduction

When you are operating hands-free phoning in the vehicle, you may hear an undesirable echo. This function reduces the echo and noise while you are using hands-free phoning, and maintains a certain sound quality.

1 Touch [Phone Settings] on the “Phone Menu”.

- For details, refer to *Displaying the Phone Menu* on page 73.

2 Touch [Echo Cancel].

Touching [Echo Cancel] switches between [On] and [Off].

Setting automatic connection

When automatic connection is active, the navigation system will automatically establish a connection with a registered phone when it comes into range. Using this feature avoids all

of the processes for establishing a connection.

- ☐ With some cellular phones, it may not be possible to perform automatic connection.

1 Touch [Phone Settings] on the “Phone Menu”.

- For details, refer to *Displaying the Phone Menu* on page 73.

2 Touch [Auto Connect].

Touching [Auto Connect] switches between [On] and [Off].

- ☐ Automatic connection is performed in the registration number order.
- ☐ Some cellular phones do not support automatic connection.

Editing the device name

You can change the device name to be displayed on your cellular phone. (Default is [Pioneer Navi].)

1 Touch [Phone Settings] on the “Phone Menu”.

- For details, refer to *Displaying the Phone Menu* on page 73.

2 Touch [Edit Name].

The keyboard to enter the name appears.

3 Touch to delete the current name, and enter the new name by using the keyboard.



4 Touch [Done].

The name is changed.

- Up to 30 characters can be entered for a device name. □

Notes for hands-free phoning

General notes

- Connection to all cellular phones featuring Bluetooth wireless technology is not guaranteed.
- The line-of-sight distance between this navigation system and your cellular phone must be 10 meters or less when sending and receiving voice and data via Bluetooth technology. However, the actual transmission distance may be shorter than the estimated distance, depending on the usage environment.
- With some cellular phones, the speakers of the system may not produce a ring sound.
- If private mode is selected on the cellular phone, hands-free phoning may be disabled.
- The cellular phone used must be compatible with the profile of this navigation system.
- When using Bluetooth wireless technology, this navigation system may not be able to operate all of the functions on the cellular phone.



Registration and connection

- Cellular phone operations vary depending on the type of cellular phone. Refer to the instruction manual that came with your cellular phone for detailed instructions.
- With cellular phones, phone book transfer may not work even though your phone is paired with the navigation system. In that case, disconnect your phone, perform pairing again from your phone to the navigation system, and then perform the phone book transfer.

Making and receiving calls

- You may hear a noise in the following situations:

- When you answer the phone by using the button on the phone.
- When the person on the other end of line hangs up the phone.

- If the person on the other end of the phone call cannot hear the conversation due to an echo, decrease the volume level for hands-free phoning. This may reduce the echo.
- With some cellular phones, even if you press the accept button on the cellular phone when a call comes in, hands-free phoning may not be performed.
- The registered name appears if the phone number of the received call is already registered in the phone book. When one phone number is registered under different names, the name that comes first alphabetically is displayed.
- If the phone number of the received call is not registered in the phone book, the phone number of the received call appears.
- During incoming and outgoing calls or talking on a phone, you can only do the following operations:
 - Touching , , [Vol +], and [Vol -].
 - Press the **MAP** button.
 - Scrolling the map and changing the map scale.

The received call history and the dialed number history

- Calls made or editing performed only on your cellular phone will not be reflected to the dialed number history or phone book in the navigation system.
- You cannot make a call to the entry of an unknown user (no phone number) in the received call history.
- History data will be recorded into the navigation system only when your cellular phone is pairing with the navigation system.

Phone book transfers

- If there are more than 400 phone book entries on your cellular phone, all entries may not be able to be downloaded completely.

Using hands-free phoning

- With some cellular phones, it may not be possible to transfer all items in the phone book at one time. In this case, transfer items one by one from your cellular phone.
- Depending on the cellular phone, this navigation system may not display the phone book correctly. (Some characters may be garbled, or first name and last name may be in reverse order.)
- If the phone book in the cellular phone contains image data, the phone book may not be transferred correctly. (Image data cannot be transferred from the cellular phone.)
- Depending on the cellular phone, phone book transfer may not be available.



3 Touch [Software Update].

Update starts.

Updating the Bluetooth wireless technology software

Update files will be available for download in the future. You will be able to download the latest update from an appropriate website to your PC.

- Before you download the files and install the update, read through the instructions on the website. Follow the instructions on the website for steps until **[Software Update]** becomes active.
- Registered phones that are listed on **[Connection]** are cleared by the software update.

1 Touch [Phone Settings] on the "Phone Menu".

- ➔ For details, refer to *Displaying the Phone Menu* on page 73.

2 Touch [Bluetooth Software Update].

The current version is displayed.

Playing audio CDs

You can play a normal music CD using the built-in drive of the navigation system. This section describes how.

1 Insert the disc you want to play into disc-loading slot.

Playback starts from the first track of the CD.

2 Touch [DISC] on the “AV Source” menu to display the “CD” screen.

- ➔ For details concerning operations, refer to *Screen switching overview* on page 34.

3 Use the touch panel keys on the screen to control the disc.

Reading the screen



- Source icon**
Shows which source has been selected.
- Track number indicator**
Shows the number of the track currently playing.
- Scan/Random/Repeat indicator**
The marks shown below indicate the current playback status.
 - : Scan
 - : Random
 - and repeat range:** Displays the current repeat range
- Play time indicator**
Shows the elapsed playing time within the current track.

Using the touch panel keys

Touch panel keys



- Recall equalizer curves**
➔ For details, refer to *Recalling equalizer curves* on page 160.
- Display the “Function” menu**
➔ For details, refer to *Using the “Function” menu* on the next page.
- Switch the media file type played**
➔ For details, refer to *Switch the media file type played* on page 88.
- Skip the track forward or backward**
Touching skips to the start of the next track. Touching once skips to the start of the current track. Touching it again will skip to the previous track.
Fast reverse or forward
Touch and hold or to fast rewind or fast forward.
 - Fast reverse is canceled when it reaches the beginning of the first track on the disc.
 - Moving **MULTI-CONTROL** left or right enables you to perform the equivalent operations.
- Playback and Pause**
Touching switches between “playback” and “pause”.
- Shuffle All**
All of the songs in the disc can be played at random by touching only one key.
 - [Shuffle All]** is not available for AVIC-X710BT.
 - To cancel random play, switch **[Random]** to **[Off]** on the “Function” menu.
- Display the map screen**



Playing audio CDs

Selecting a track from the list

The list lets you see the list of track titles, file names or folder names on a disc and select one of them to play.

- 1 Touch **[List]**.
- 2 Touch the track you want to play.



The track currently playing is highlighted. Touching  or  switches the selection to the next or previous page in the list.

- The “-” mark is displayed if there is no corresponding information.

- 3 To return to the previous screen, touch **[Detail]**. 

Using the “Function” menu

- 1 Touch **[DISC]** on the “AV Source” menu to display the “CD” screen.

- ➔ For details concerning operations, refer to *Screen switching overview* on page 34.

- 2 Touch **[Func]**.

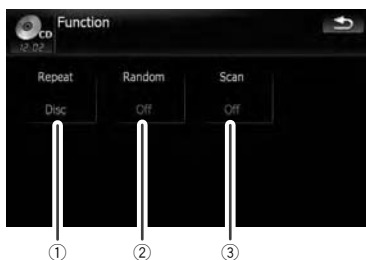

- ① Repeating play

Each touch of **[Repeat]** changes the setting as follows:

- **Disc** — Repeats the current disc
 - **Track** — Repeats just the current track
 - If you perform track search or fast forward/rewind, repeat play is automatically canceled.
- ② **Play tracks in a random order**
Touching **[Random]** switches between **[On]** and **[Off]**.
 - ③ **Scan tracks of a CD**
Touching **[Scan]** switches between **[On]** and **[Off]**. Scan play lets you hear the first 10 seconds of each track on the CD. When you find the track you want, touch **[Scan]** to turn scan play off.
 - After scanning is finished, normal playback of the tracks will begin again. 

Playing music files on ROM

You can play a disc that contains compressed audio files using the built-in drive of the navigation system. This section describes these operations.

- In the following description, the MP3, WMA, AAC, WAV files are collectively referred to as “Compressed audio file”.
- AVIC-X910BT cannot play WAV files.

1 Insert the disc you want to play into disc-loading slot.

Playback starts from the first file of the ROM.

2 Touch [DISC] on the “AV Source” menu to display the “ROM” screen.

- ⇒ For details concerning operations, refer to *Screen switching overview* on page 34.

3 Use this ROM screen to play the disc.

- ⇒ For details, refer to *Using the touch panel keys* on this page.

Reading the screen

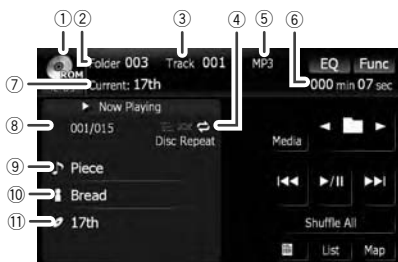

① Source icon

Shows which source has been selected.

② Folder number indicator

Shows the folder number currently playing.

③ Track indicator

Shows the track number currently playing.

④ Scan/Random/Repeat indicator

The marks shown below indicate the current playback status.

 : Scan

 : Random

 and repeat range: Displays the current repeat range

⑤ File type indicator

Shows the type of audio file currently playing.

⑥ Play time indicator

Shows the elapsed playing time within the current track.

⑦ Folder name indicator

Shows the folder name currently playing.

⑧ Song number indicator

Shows the number of the song playing in the selected list.

⑨ Song title indicator

Shows the title of the current song.

⑩ Artist name indicator

Shows the artist name for the current song.

⑪ Album title indicator

Shows the title of the album for the current song. 

Using the touch panel keys



① Switch the media file type played

When playing a disc containing a mixture of various media file types, you can switch between media files types to play.

Touch [Media] repeatedly to switch between the following media file types:

CD (audio data (CD-DA)) — **ROM** (compressed audio file) — **DivX** (DivX video files)

- This touch panel key appears only when playing a disc containing a mixture of various media file types.

② Recall equalizer curves

Playing music files on ROM

- ➔ For details, refer to *Recalling equalizer curves* on page 160.
- ③ **Display the “Function” menu**
 - ➔ For details, refer to *Using the “Function” menu* on the next page.
- ④ **Select the previous or next folder**
 - Touching these keys enables you to select the previous or next folder and playback the first track on the folder. You cannot select a folder that does not have a compressed audio file.
- ⑤ **Skip the track forward or backward**

Touching [▶▶] skips to the start of the next track. Touching [◀◀] once skips to the start of the current track. Touching it again will skip to the previous track.

Fast reverse or forward

Touch and hold [◀◀] or [▶▶] to fast rewind or fast forward.

- Fast rewind stops when it reaches the beginning of the first file on the repeat range.
- In the case of compressed audio files, there is no sound on fast rewind or forward.
- Moving **MULTI-CONTROL** left or right enables you to perform the equivalent operations.
- ⑥ **Playback and Pause**

Touching [▶/||] switches between “playback” and “pause”.
- ⑦ **Shuffle All**

All of the songs in the disc can be played at random by touching only one key.

 - If the disc contains a mixture of various media file types, all tracks within the current part (“CD” or “ROM”) are played randomly.
 - [Shuffle All] is not available for AVIC-X710BT.
 - To cancel random play, switch [Random] to [Off] on the “Function” menu.
- ⑧ **Display the map screen**

Selecting a track from the list

The list lets you see the list of track titles or folder names on a disc. Touch a folder on the list to view its contents. You can play a track on the list by touching it.

- 1 Touch [List].
- 2 Touch the folder that you want to view.

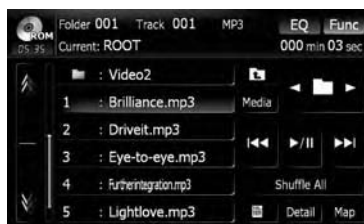

The track currently playing is highlighted. Touching [◀] or [▶] switches the selection to the next or previous page in the list. Touching [⏪] displays the content of the upper folder (parent folder). If the uppermost folder is listed, [⏪] cannot be used.

- If the selected folder does not contain any playable track, the track list is not displayed.

3 Touch the track you want to play.

- To cancel the list screen, touch [Detail].

Browsing embedded text information

Text information recorded in a compressed audio file disc can be displayed.

● Touch [Info].

The next piece of information is displayed.

- **Album Title :** (album title)
- **Track Title :** (track title)
- **Folder Title :** (folder title)
- **File Name :** (file name)
- **Artist Name :** (artist name)

If no information has been recorded for the item, none can be displayed.

- ❑ If you operate no functions for about 30 seconds, the display automatically returns to the ordinary display. ■

Using the “Function” menu

1 Touch [DISC] on the “AV Source” menu to display the “ROM” screen.

- ➔ For details concerning operations, refer to *Screen switching overview* on page 34.

2 Touch [Func].

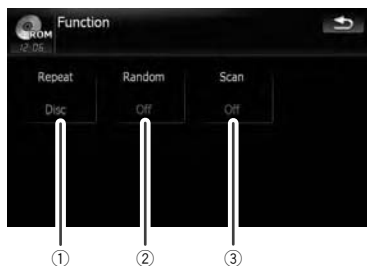

① Repeating play

Each touch of **[Repeat]** changes the setting as follows:

- **Disc** — Repeats all compressed audio files
- **Track** — Repeats just the current track
- **Folder** — Repeats the current folder
- ❑ If you select another folder during repeat play, the repeat play range changes to **[Disc]**.
- ❑ If you perform fast scan/rewind during **[Track]**, the repeat play range changes to **[Folder]**.
- ❑ When **[Folder]** is selected, it is not possible to play back a subfolder of that folder.
- ❑ When playing discs with compressed audio files and audio data (CD-DA), repeat play is performed within the currently playing data session even if **[Disc]** is selected.

② Play tracks in a random order

Touching **[Random]** switches between **[On]** and **[Off]**. When using **ROM**, the tracks in the current repeat play range are randomly played.

- ❑ If you turn **[Random]** to **[On]** when the repeat play range is set to **[Track]**, the repeat play range changes to **[Folder]** automatically.

③ Scan folders and tracks

Scan play lets you hear the first 10 seconds of each track. Scan play is performed in the current repeat play range.

Touching **[Scan]** switches between **[On]** and **[Off]**. When you find the track you want, touch **[Scan]** to turn scan play off.

- ❑ After completion of track or folder scanning, normal playback of the tracks will begin again.
- ❑ If you turn **[Scan]** to **[On]** when the repeat play range is set to **[Track]**, the repeat play range changes to **[Folder]** automatically.
- ❑ If you turn **[Scan]** to **[On]** while the repeat play range is set to **[Disc]**, scan play is performed for only the first tracks of each folder. ■

Playing a DVD-Video

You can play a DVD-Video using the built-in drive of the navigation system. This section describes operations for playing a DVD-Video.

❑ AVIC-X710BT cannot play DVDs.

Reading the screen

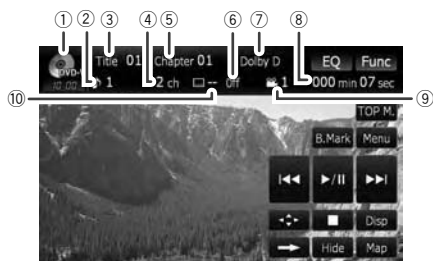

- ① **Source icon**
Shows which source has been selected.
- ② **Audio track indicator**
Shows the audio track number and audio language currently selected.
- ③ **Title number indicator**
Shows the title number currently playing.
- ④ **Audio channel indicator**
Shows the current audio channel type, such as "Mch" (Multi-channel).
- ⑤ **Chapter number indicator**
Shows the chapter currently playing.
- ⑥ **Subtitle language indicator**
Shows the subtitle language currently selected.
- ⑦ **Digital sound format indicator**
Shows which digital sound format (surround sound format) has been selected.
- ⑧ **Play time indicator**
Shows the elapsed playing time within the current title.
- ⑨ **Viewing angle indicator**
Shows what viewing angle has been selected.
- ⑩ **Subtitle number indicator**
Shows the subtitle number currently selected.

Using the touch panel keys

Playback screen (page1)

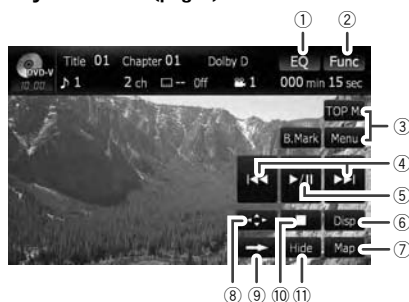

Playback screen (page2)

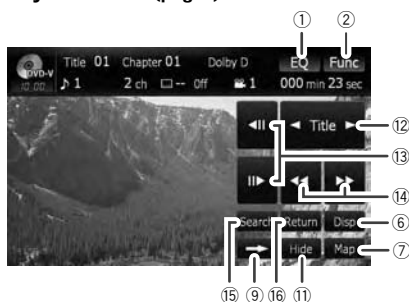

Playback screen (page3)

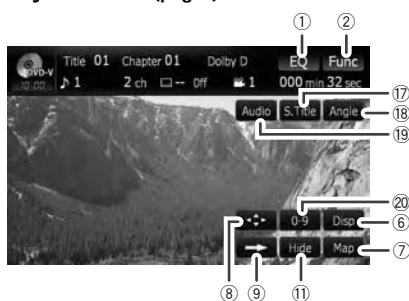

❑ With some discs, the icon  may be displayed, meaning that the operation is not valid.

- ① **Recall equalizer curves**
➡ For details, refer to *Recalling equalizer curves* on page 160.
- ② **Display the "Function" menu**

Playing a DVD-Video

- For details, refer to *Using the “Function” menu* on page 94.
- ③ **Display the DVD menu**
You can display the menu by touching [Menu] or [TOP M.] while a disc is playing. Touching either of these keys again lets you start playback from the location selected from the menu. For details, refer to the instructions provided with the disc.
- ④ **Skip forward or backward**
Touching [▶▶] skips to the start of the next chapter. Touching [◀◀] once skips to the start of the current chapter. Touching it again will skip to the previous chapter.
 Moving **MULTI-CONTROL** left or right enables you to perform the equivalent operations.
- ⑤ **Playback and Pause**
Touching [▶/II] switches between “playback” and “pause”.
- ⑥ **Switch the display**
Touching [Disp] changes the indication on the information plate as follows:
Disc information display — Repeat range and L/R select display
- ⑦ **Display the map screen**
- ⑧ **Display the DVD menu keypad**
➤ For details, refer to *Using DVD menu by touch panel keys* on page 94.
- ⑨ **Switch next page of touch panel keys**
- ⑩ **Stop playback**
- ⑪ **Hide the touch panel keys**
Touching [Hide] hides the touch panel keys. Touch anywhere on the LCD screen to display the touch panel keys again.
- ⑫ **Skip the title forward or backward**
Touching [▶] skips to the start of the next title. Touching [◀] skips to the start of the previous title.
- ⑬ **Frame-by-frame playback (or slow-motion playback)**
➤ For details, refer to *Frame-by-frame playback* on page 94.
➤ For details, refer to *Slow motion playback* on page 94.
- ⑭ **Fast reverse or forward**
Touch [◀◀] or [▶▶] to perform fast reverse or forward.
If you touch and hold [◀◀] or [▶▶] for five seconds, fast reverse/fast forward continues even if you release either of these keys. To resume playback at a desired point, touch [▶/II], [◀◀] or [▶▶].
- ⑮ **Searching for a desired scene and starting playback from a specified time**
 For details, refer to *Searching for a specific scene and starting playback from a specified time* on the next page.
- ⑯ **Perform an operation (such as resuming) that is stored on the disc**
When using a DVD that has a point recorded that indicates where to return to, the DVD returns to the specified point and begins playback from that point.
- ⑰ **Change the subtitle (Multi-subtitle)**
Each touch of [S.Title] switches between the subtitle languages.
- ⑱ **Change the viewing angle (Multi-angle)**
Each touch of [Angle] switches between viewing angles.
 During playback of a scene shot from multiple angles, the angle icon  is displayed. Turn the angle icon display on or off using the “DVD Setup” menu.
➤ For details, refer to *Setting the angle icon display* on page 103.
- ⑲ **Change audio language and audio systems (Multi-audio)**
Each touch of [Audio] switches between audio languages and audio systems.
 DTS audio cannot be output, so select an audio setting other than DTS.
 Display indications such as **MPEG-A** and **Mch** indicate the audio system recorded on the DVD. Depending on the setting, playback may not use the same audio system as that indicated.
- ⑳ **Entering the numerical commands**
➤ For details, refer to *Direct number search* on the next page.

Playing a DVD-Video

Resuming playback (Bookmark)

The Bookmark function lets you resume playback from a selected scene the next time the disc is loaded.

Touching [B.Mark]:

You can bookmark one point for each of up to five discs. If you try to memorize another point for the same disc, the oldest bookmark will be overwritten by the newest one.

- To clear the bookmark on a disc, touch and hold [B.Mark] during playback.

Press and hold down the EJECT button:

You can also bookmark a point for one disc by pressing and holding down the **EJECT** button. The next time you load the same disc, playback will resume from the bookmarked point. When you newly bookmark a point with this method, any previously bookmarked point(s) will be overwritten.

- For playback, the point bookmarked with this method is given priority over the point bookmarked by using [B.Mark].

Searching for a specific scene and starting playback from a specified time

You can search for the scene you want by specifying a title or a chapter, and the time.

- Chapter search and time search are not possible when disc playback has been stopped.

- 1 Touch [Search] and then touch [Title] (title), [Chapter] (chapter), [Time] (time).



- 2 Touch the keys to input the target number or time and then touch [Enter].



For titles, chapters

- To select 3, touch [3] and [Enter] in order.
- To select 10, touch [1] and [0] and [Enter] in order.

For time (time search)

- To select 5 minutes 03 seconds, touch [5], [0], [3] and [Enter] in order.
- To select 71 minutes 00 seconds, touch [7], [1], [0], [0] and [Enter] in order.
- To cancel the input numbers, touch [Clear].

Direct number search

You can use this function when you need to enter a numerical command during DVD playback.

- 1 Touch [0-9].
- 2 Touch [0] to [9] to input the desired number.
- 3 While the input number is displayed, touch [Enter].

Operating the DVD menu

You can operate the DVD menu by touching the menu item on the screen directly.

- This function may not work properly with some DVD disc content. In that case, use touch panel keys to operate the DVD menu.

- 1 Touch the screen to display the touch panel keys.
- 2 Touch [TOP M.] or [Menu] to display touch panel keys to operate the DVD menu.

3 Touch the desired menu item.

Using DVD menu by touch panel keys

If items on the DVD menu appear at the bottom of the screen, the touch panel keys may overlay them. If so, select an item using those touch panel keys.

1 Touch [▲], [▼], [◀] or [▶] to select the desired menu item.



- ❑ If the touch panel keys for DVD menu selection disappear, touching anywhere on the screen, then touching  displays them again.

2 Touch [Enter].

Playback starts from the selected menu item. The way to display the menu differs depending on the disc.

Frame-by-frame playback

This lets you move ahead one frame at a time during playback.

● Touch [⏮] during playback.

Each time you touch [⏮], you move ahead one frame.

To return to normal playback, touch [▶/⏮].

- ❑ With some discs, images may be unclear during frame-by-frame playback.

Slow motion playback

This lets you slow down playback speed.

1 Touch and hold [⏮] until is displayed during playback.

The icon  is displayed, and forward slow motion playback begins.

- ❑ To return to normal playback, touch [▶/⏮].

2 Touch [◀⏮] or [⏮▶] to adjust playback speed during slow motion playback.

Each time you touch [◀⏮] or [⏮▶] it changes the speed in four steps in the following order:

1/16 ↔ 1/8 ↔ 1/4 ↔ 1/2

- ❑ There is no sound during slow motion playback.
- ❑ With some discs, images may be unclear during slow motion playback.
- ❑ Reversed slow motion playback is not possible. 

Using the “Function” menu

1 Touch [DISC] on the “AV Source” menu to display the “DVD-V” screen.

- For details concerning operations, refer to *Screen switching overview* on page 34.

2 Touch the screen to display the touch panel keys.

3 Touch [Func].

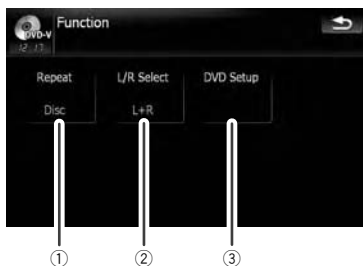

① Repeating play

Each touch of [Repeat] changes the setting as follows:

- **Title** — Repeats just the current title
- **Chapter** — Repeats just the current chapter
- **Disc** — Plays throughout the current disc

- ❑ If you perform chapter (title) search, fast forward/rewind or slow motion playback, the repeat play range changes to [Disc].

② Selecting audio output

Playing a DVD-Video

When playing DVDs recorded with LPCM audio, you can switch the audio output. Touch **[L/R Select]** repeatedly until the desired audio output appears in the display. Each touch of **[L/R Select]** changes the settings as follows:

- **L+R** — Left and right
 - **L** — Left
 - **R** — Right
 - **Mix** — Mixing left and right
- This function is not available when disc playback has been stopped.

③ DVD setup adjustments

- ➔ For details, refer to *Displaying DVD Setup menu* on page 103.

Playing a DVD-VR disc

You can play a DVD-VR (DVD Video Recording Format) disc using the built-in drive of the navigation system. This section describes operations for DVD-VR discs.

❑ AVIC-X710BT cannot play DVD-VR discs.

Reading the screen

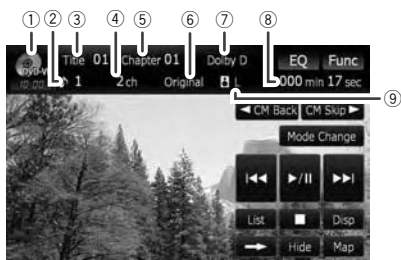

- ① **Source icon**
Shows which source has been selected.
- ② **Audio track indicator**
Shows the audio track number currently selected.
- ③ **Title number indicator**
Shows the title number currently playing.
- ④ **Audio channel indicator**
Shows the current audio channel type, such as "Mch" (Multi-channel).
- ⑤ **Chapter number indicator**
Shows the chapter currently playing.
- ⑥ **Play mode indicator**
Shows the current play mode.
➔ For details, refer to **Switch the playback mode** on page 98.
- ⑦ **Digital sound format indicator**
Shows which digital sound format (surround sound format) has been selected.
- ⑧ **Play time indicator**
Shows the elapsed playing time within the current title.
- ⑨ **Mixing condition indicator**
Shows the current mixing condition. ❑

Using the touch panel keys

Playback screen (page1)

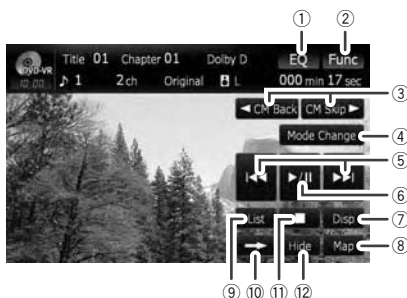

Playback screen (page2)

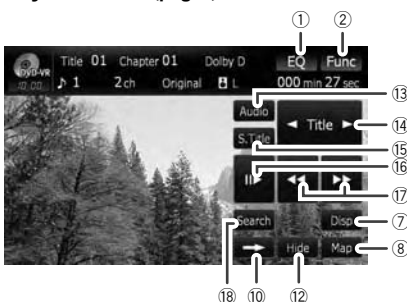

- ❑ With some discs, the icon Ⓞ may be displayed, meaning that the operation is not valid.

- ① **Recall equalizer curves**
➔ For details, refer to *Recalling equalizer curves* on page 160.
- ② **Display the "Function" menu**
➔ For details, refer to *Using the "Function" menu* on page 99.
- ③ **◀ CM Back/CM Skip ▶**
➔ For details, refer to *Using the short-time skip function* on page 98.
- ④ **Switch the playback mode**
➔ For details, refer to *Switch the playback mode* on page 98.
- ⑤ **Skip forward or backward**
Touching [▶▶] skips to the start of the next chapter. Touching [◀◀] once skips to the start of the current chapter. Touching it again will skip to the previous chapter.

Playing a DVD-VR disc

- ❑ Moving **MULTI-CONTROL** left or right enables you to perform the equivalent operations.
- ⑥ **Playback and Pause**
Touching [▶/II] switches between “playback” and “pause”.
- ⑦ **Switch the display**
Touching [Disp] changes the information as follows:
Disc information display — Repeat range display
- ⑧ **Display the map screen**
- ⑨ **Display the title list**
Displays the title list recorded on the disc.
- ⑩ **Switch next page of touch panel keys**
- ⑪ **Stop playback**
- ⑫ **Hide the touch panel keys**
Touching [Hide] hides the touch panel keys. Touch anywhere on the LCD screen to display the touch panel keys again.
- ⑬ **Change audio tracks (Multi-audio)**
Each touch of [Audio] switches between audio tracks.
❑ Display indications such as **MPEG-A** and **Mch** indicate the audio system recorded on the DVD. Depending on the setting, playback may not use the same audio system as that indicated.
- ⑭ **Skip the title forward or backward**
Touching [▶] skips to the start of the next title. Touching [◀] skips to the start of the previous title.
- ⑮ **Change the subtitle (Multi-subtitle)**
Each touch of [S.Title] switches between the subtitle languages.
- ⑯ **Frame-by-frame playback (or slow-motion playback)**
➔ For details, refer to *Frame-by-frame playback* on the next page.
➔ For details, refer to *Slow motion playback* on the next page.
- ⑰ **Fast reverse or forward**
Touch [◀◀] or [▶▶] to perform fast reverse or forward.
If you touch and hold [◀◀] or [▶▶] for five seconds, fast reverse/fast forward continues even if you release either of these keys. To resume playback at a desired point, touch [▶/II], [◀◀] or [▶▶].

⑱ Searching for a desired scene and starting playback from a specified time

- ➔ For details, refer to *Searching for a specific scene and starting playback from a specified time* on this page.

Searching for a specific scene and starting playback from a specified time

You can search for the scene you want by specifying a title or a chapter, and the time.

- ❑ Chapter search and time search are not possible when disc playback has been stopped.

1 Touch [Search] and then touch [Title] (title), [Chapter] (chapter), [Time] (time).



2 Touch the keys to input the target number or time and then touch [Enter].



For titles, chapters

- To select 3, touch [3] and [Enter] in order.
- To select 10, touch [1] and [0] and [Enter] in order.

For time (time search)

- To select 5 minutes 03 seconds, touch [5], [0], [3] and [Enter] in order.

Playing a DVD-VR disc

- To select 71 minutes 00 seconds, touch [7], [1], [0], [0] and [Enter] in order.
- To cancel the input numbers, touch [Clear].

Switch the playback mode

You have two methods for playing DVD-VR discs: **Original** (original) and **Playlist** (playlist).

- Titles created with DVD recorders are called original. Those based on original, re-arranged titles are called playlist. Playlists are created on DVD-R/-RW discs.

● Touch [Mode Change] to switch the play mode.

If the play mode is changed, playback starts from the beginning of the selected play mode.

Using the short-time skip function

This function enables you to skip over your specified interval on the video playback. This is useful to skip commercials on your recorded DVD-VR disc.

- **To skip progressively backward or forward, touch [◀ CM Back] or [CM Skip ▶].** Each touch of [◀ CM Back] or [CM Skip ▶] changes steps in the following order:

◀ CM Back

5 sec. — 15 sec. — 30 sec. — 1 min. — 2 min. — 3 min. — 0 sec.

CM Skip ▶

30 sec. — 1 min. — 1.5 min. — 2 min. — 3 min. — 5 min. — 10 min. — 0 sec.

Playing by selecting from the title list

You can select and play the title you want from the list.

1 Touch [List] on the playback screen.

2 Touch the title to play from the list.

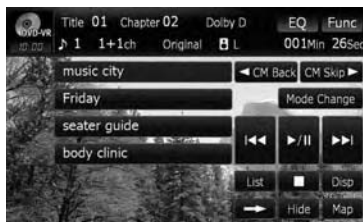

- Touching [◀] or [▶] switches the selection to the next or previous page in the list.

3 To return to the previous screen, touch [List].

Frame-by-frame playback

This lets you move ahead one frame at a time during playback.

● Touch [II▶] during playback.

Each time you touch [II▶], you move ahead one frame.

To return to normal playback, touch [▶/II].

- With some discs, images may be unclear during frame-by-frame playback.

Slow motion playback

This lets you slow down playback speed.

1 Touch and hold [II▶] until [▶] is displayed during playback.

The icon [▶] is displayed, and forward slow motion playback begins.

- To return to normal playback, touch [▶] or [◀◀], etc.

2 Touch [II▶] to adjust playback speed during slow motion playback.

Each touch of [II▶] changes the speed in four steps as below:

1/16 → 1/8 → 1/4 → 1/2

- There is no sound during slow motion playback.
- With some discs, images may be unclear during slow motion playback.
- Reversed slow motion playback is not possible. [■]

Playing a DVD-VR disc

Using the “Function” menu

1 Touch [DISC] on the “AV Source” menu to display the “DVD-VR” screen.

- ➔ For details concerning operations, refer to *Screen switching overview* on page 34.

2 Touch the screen to display the touch panel keys.

3 Touch [Func].

Function menu

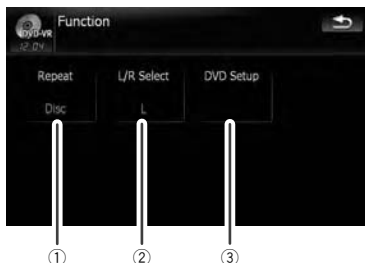

① Repeating play

Each touch of [Repeat] changes the setting as follows:

- **Title** — Repeats just the current title
 - **Chapter** — Repeats just the current chapter
 - **Disc** — Plays throughout the current disc
- ☐ If you perform chapter (title) search, fast forward/rewind or slow motion playback, the repeat play range changes to [Disc].

② Selecting audio output

When playing DVDs recorded with LPCM audio, you can switch the audio output. Touch [L/R Select] repeatedly until the desired audio output appears in the display.

- **L+R** — Left and right
- **L** — Left
- **R** — Right
- **Mix** — Mixing left and right

☐ This function is not available when disc playback has been stopped.

③ DVD setup adjustments

- ➔ For details, refer to *Displaying DVD Setup menu* on page 103. ☐

Playing a DivX video

You can play a DivX disc using the built-in drive of the navigation system. This section describes that operations.

❑ AVIC-X710BT cannot play DivX files.

Reading the screen

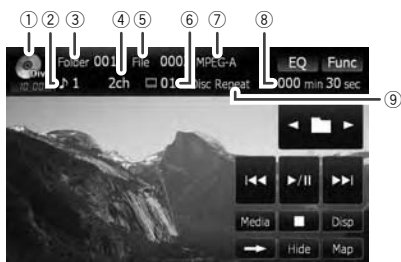

- ① **Source icon**
Shows which source has been selected.
- ② **Audio track indicator**
Shows the audio track number currently selected.
- ③ **Folder number indicator**
Shows the folder number currently playing.
- ④ **Audio channel indicator**
Shows the current audio channel type, such as "Mch" (Multi-channel).
- ⑤ **File number indicator**
Shows the file number currently playing.
- ⑥ **Subtitle number indicator**
Shows the subtitle number currently selected.
- ⑦ **Digital sound format indicator**
Shows the digital sound format (surround sound format) currently selected.
- ⑧ **Play time indicator**
Shows the elapsed playing time of the current file.
- ⑨ **Repeat range indicator**
Shows which repeat range has been selected. ❑

Using the touch panel keys

Playback screen (page1)

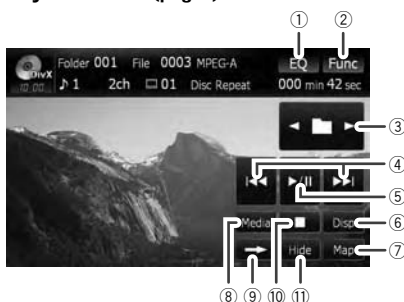

Playback screen (page2)

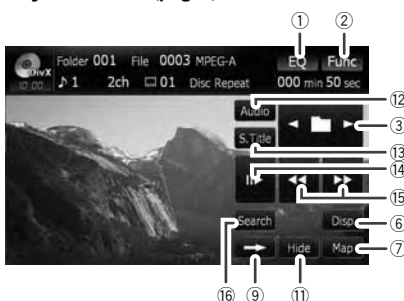

- ❑ With some discs, the icon Ⓞ may be displayed, meaning that the operation is not valid.
- ① **Recall equalizer curves**
➡ For details, refer to *Recalling equalizer curves* on page 160.
- ② **Display the "Function" menu**
➡ For details, refer to *Using the "Function" menu* on page 102.
- ③ **Select the previous or next folder**
Touching [◀] or [▶] to select the desired folder.
- ④ **Skip forward or backward**
Touching [▶▶] skips to the start of the next file. Touching [◀◀] once skips to the start of the current file. Touching again will skip to the previous file.
❑ Moving **MULTI-CONTROL** left or right enables you to perform the equivalent operations.
- ⑤ **Playback and Pause**
Touching [▶/⏸] switches between "playback" and "pause".

Playing a DivX video

⑥ Switch the information

Touching [Disp] changes the content of the information panel as follows:

Disc information display — Current folder display — File name display

⑦ Display the map screen

⑧ Switch the media file type played

When playing a disc containing a mixture of various media file types, you can switch between media files types to play.

Touch [Media] repeatedly to switch between the following media file types:

CD (audio data (CD-DA)) — **ROM** (compressed audio file) — **DivX** (DivX video files)

This touch panel key appears only when playing a disc containing a mixture of various media file types.

⑨ Switch next page of touch panel keys

⑩ Stop playback

⑪ Hide the touch panel keys

Touching [Hide] hides the touch panel keys. Touch anywhere on the LCD screen to display the touch panel keys again.

⑫ Change audio tracks (Multi-audio)

Each touch of [Audio] switches between audio tracks.

⑬ Change the subtitle (Multi-subtitle)

Each touch of [S.Title] switches between the subtitle languages.

⑭ Frame-by-frame playback (or slow-motion playback)

➤ For details, refer to *Frame-by-frame playback* on this page.

➤ For details, refer to *Slow motion playback* on this page.

⑮ Fast reverse or forward

Touch [◀◀] or [▶▶] to perform fast reverse or forward.

If you touch and hold [◀◀] or [▶▶] for five seconds, fast reverse/fast forward continues even if you release either of these keys. To resume playback at a desired point, touch [▶/II], [◀◀] or [▶▶].

⑯ Searching for a desired scene and starting playback from a specified time

➤ For details, refer to *Searching for a specific scene and starting playback from a specified time* on this page.

Frame-by-frame playback

This lets you move ahead one frame at a time during playback.

● Touch [II▶] during playback.

Each time you touch [II▶], you move ahead one frame.

To return to normal playback, touch [▶/II].

With some discs, images may be unclear during frame-by-frame playback.

Slow motion playback

This lets you slow down playback speed.

● Touch and hold [II▶] until III▶ is displayed during playback.

The icon III▶ is displayed, and forward slow motion playback begins.

To return to normal playback, touch [▶▶] or [◀◀], etc.

There is no sound during slow motion playback.

With some discs, images may be unclear during slow motion playback.

Reversed slow motion playback is not possible.

Searching for a specific scene and starting playback from a specified time

You can search for a desired scene by specifying a folder or a file, and the time.

Time search are not possible when disc playback has been stopped.

1 Touch [Search] and then touch [Folder] (folder), [File] (file), [Time] (time).



2 Touch the keys to input the target number or time and then touch [Enter].



For folders, files

- To select 3, touch [3] and [Enter] in order.
- To select 10, touch [1] and [0] and [Enter] in order.

For time (time search)

- To select 5 minutes 03 seconds, touch [5], [0], [3] and [Enter] in order.
 - To select 71 minutes 00 seconds, touch [7], [1], [0], [0] and [Enter] in order.
- To cancel the input numbers, touch [Clear].

Each touch of [Repeat] changes the setting as follows:

- **File** — Repeat just the current file
 - **Folder** — Repeat just the current folder
 - **Disc** — Plays throughout the current disc
- If you select another folder during repeat play, the repeat play range changes to [Disc].
- If you perform fast forward/rewind during [File], the repeat play range changes to [Folder].
- When [Folder] is selected, it is not possible to play back a subfolder of that folder.
- When playing discs with compressed audio files and audio data (CD-DA), repeat play is performed within DivX videos even if [Disc] is selected.
- ② **DVD setup adjustments**
- For details, refer to *Displaying DVD Setup menu* on the next page.

Using the “Function” menu

1 Touch [DISC] on the “AV Source” menu to display the “DivX” screen.

- For details concerning operations, refer to *Screen switching overview* on page 34.

2 Touch the screen to display the touch panel keys.

3 Touch [Func].

Function menu



① Repeating play

DVD-Video, DVD-VR, DivX setup

Configure the DVD-Video/DVD-VR/DivX player.

Displaying DVD Setup menu

1 Play the disc that contains DVD-Video, DVD-VR or DivX.

2 Touch [DISC] on the "AV Source" menu to display the normal playback screen.

- For details concerning operations, refer to *Screen switching overview* on page 34.

3 Touch [Func].

The "Function" menu appears.

4 Touch [DVD Setup].



5 Touch the desired function.



Setting the top-priority languages

You can assign the top-priority language to the top-priority subtitle, audio and menu in initial playback. If the selected language is recorded on the disc, subtitles, audio and menu are displayed or output in that language.

1 Touch [DVD Setup] on the "Function" menu.

- For details, refer to *Displaying DVD Setup menu* on this page.

2 Touch [Language].

You can select the language preference of the subtitle, audio, and menus.

3 Touch the key next to [Subtitle Language], [Audio Language] or [Menu Language].

Each language menu is displayed and the currently set language is selected.

4 Touch the desired language.

When you select [Others], a language code input display is shown. Input the four digit code of the desired language then touch [Enter].

- Refer to *Language code chart for DVDs* on page 106.
- If the selected language is not recorded on the disc, the default language specified on the disc is output and displayed.
- You can also switch the subtitle and audio language by touching [S.Title] or [Audio] during playback.
- Even if you use [S.Title] or [Audio] to switch the subtitle or audio language, this does not affect the settings here. 

Setting the angle icon display

You can set the angle icon  to display in scenes where the angle can be switched.

1 Touch [DVD Setup] on the "Function" menu.

- For details, refer to *Displaying DVD Setup menu* on this page.

2 Touch [Multi Angle].

Touching [Multi Angle] switches between [On] and [Off]. 

Setting the aspect ratio

There are two kinds of displays. A wide screen display has a width-to-height ratio (TV aspect) of 16:9, while a regular display has a TV aspect of 4:3. If you use a regular rear display with a TV aspect of 4:3, you can set the aspect ratio suitable for your rear display. (We recommend use of this function only when you want to fit it to the rear display.)

- When using a regular display, select either “**Letter Box**” or “**Panscan**”. Selecting “**16:09**” may result in an unnatural picture.

1 Touch [DVD Setup] on the “Function” menu.

- For details, refer to *Displaying DVD Setup menu* on the previous page.

2 Touch [TV Aspect].

Each touch of [TV Aspect] changes the setting as follows:

- **16:09** — Wide screen picture (16:9) is displayed as it is (initial setting)
- **Letter Box** — The picture is in the shape of a letter box with black bands at the top and bottom of the screen
- **Panscan** — The picture is cut short at the right and left of the screen
- When playing discs that do not have a panscan system, the disc is played back with [Letter Box] even if you select [Panscan] setting. Confirm whether the disc package bears the **16:9 LB** mark.
- Some discs do not enable changing of the TV aspect. For details, refer to the disc’s instructions.

Setting the parental lock

Some DVD-Video discs let you use parental lock to set restrictions so that children cannot watch violent or adult-oriented scenes. You can set the parental lock level in steps as desired.

- When you set a parental lock level and then play a disc featuring parental lock, code number input indications may be displayed. In this case, playback will begin when the correct code number is input.

Setting the code number and level

When you first use this function, register your code number. If you do not register a code number, parental lock will not operate.

1 Touch [DVD Setup] on the “Function” menu.

- For details, refer to *Displaying DVD Setup menu* on the previous page.

2 Touch [Parental].

3 Touch the key next to “Parental”.

4 Touch [0] to [9] to input a four digit code number.

5 While the input number is displayed, touch [Enter].

The code number is registered, and you can now set the level.

6 Touch any of [1] to [8] to select the desired level.

The parental lock level is set.

- **Level 8** — Playback of the entire disc is possible (initial setting)
- **Level 7 to Level 2** — Playback of discs for children and non-adult oriented discs is possible
- **Level 1** — Only playback of discs for children is possible
- If you want to change the parental level already set, enter the registered code number and then select the parental level.
- We recommend that you keep a record of your code number in case you forget it.
- The parental lock level is recorded on the disc. You can confirm it by looking at the disc package, the included literature or the disc itself. You cannot use parental lock with discs that do not feature a recorded parental lock level.
- With some discs, parental lock operates to skip certain scenes only, after which normal playback resumes. For details, refer to the disc’s instructions.
- If you forget the registered code number, touch [Clear] 10 times on the number input screen. The registered code number is canceled, letting you register a new one.

DVD-Video, DVD-VR, DivX setup

Displaying your DivX VOD registration code

In order to play DivX VOD (video on demand) content on this navigation system, you first need to register the unit with your DivX VOD content provider. You do this by generating a DivX VOD registration code, which you submit to your provider.

1 Touch [DVD Setup] on the "Function" menu.

- ➔ For details, refer to *Displaying DVD Setup menu* on page 103.

2 Touch [DivX VOD].

Your 8-digit registration code is displayed.

- Make a note of the code as you will need it when you register with a DivX VOD provider.

Setting "Auto Play"

When a DVD disc with DVD menu is inserted, this unit will cancel the DVD menu automatically and start playback from the first chapter of the first title.

- This function is available for DVD-Video.
- Some DVDs may not operate properly. If this function is not fully operable, turn this function off and start playback.

1 Touch [DVD Setup] on the "Function" menu.

- ➔ For details, refer to *Displaying DVD Setup menu* on page 103.

2 Touch [Auto Play].

Touching [Auto Play] switches this setting between [On] and [Off].

- When [Auto Play] is [On], repeat play cannot be used.

Setting the subtitle file for DivX

You can select whether to display DivX external subtitles or not.

- If no DivX external subtitle files exist, the original DivX subtitles are displayed even when [Custom] is selected.

1 Touch [DVD Setup] on the "Function" menu.

- ➔ For details, refer to *Displaying DVD Setup menu* on page 103.

2 Touch [Subtitle File].

Touching [Subtitle File] switches this setting between [Original] and [Custom].

- Up to 42 characters can be displayed on one line. If more than 42 characters are set, the line breaks and the characters are displayed on the next line.
- Up to 126 characters can be displayed on one screen. If more than 126 characters are set, the excess characters will not be displayed.
- The DivX subtitles will be displayed even when the subtitle file setting is on if no corresponding subtitle files exist.
- Up to three lines can be displayed at once.

Language code chart for DVDs

Language (code), input code	Language (code), input code	Language (code), input code
Japanese (ja), 1001	Guarani (gn), 0714	Pashto, Pushto (ps), 1619
English (en), 0514	Gujarati (gu), 0721	Quechua (qu), 1721
French (fr), 0618	Hausa (ha), 0801	Rhaeto-Romance (rm), 1813
Spanish (es), 0519	Hindi (hi), 0809	Kirundi (rn), 1814
German (de), 0405	Croatian (hr), 0818	Rumanian (ro), 1815
Italian (it), 0920	Hungarian (hu), 0821	Kinyarwanda (rw), 1823
Chinese (zh), 2608	Armenian (hy), 0825	Sanskrit (sa), 1901
Dutch (nl), 1412	Interlingua (ia), 0901	Sindhi (sd), 1904
Portuguese (pt), 1620	Interlingue (ie), 0905	Sango (sg), 1907
Swedish (sv), 1922	Inupiak (ik), 0911	Serbo-Croatian (sh), 1908
Russian (ru), 1821	Indonesian (in), 0914	Shinghalese (si), 1909
Korean (ko), 1115	Icelandic (is), 0919	Slovak (sk), 1911
Greek (el), 0512	Hebrew (iw), 0923	Slovenian (sl), 1912
Afar (aa), 0101	Yiddish (ji), 1009	Samoaian (sm), 1913
Abkhazian (ab), 0102	Javanese (jw), 1023	Shona (sn), 1914
Afrikaans (af), 0106	Georgian (ka), 1101	Somali (so), 1915
Amharic (am), 0113	Kazakh (kk), 1111	Albanian (sq), 1917
Arabic (ar), 0118	Greenlandic (kl), 1112	Serbian (sr), 1918
Assamese (as), 0119	Cambodian (km), 1113	Siswati (ss), 1919
Aymara (ay), 0125	Kannada (kn), 1114	Sesotho (st), 1920
Azerbaijani (az), 0126	Kashmiri (ks), 1119	Sundanese (su), 1921
Bashkir (ba), 0201	Kurdish (ku), 1121	Swahili (sw), 1923
Belorussian (be), 0205	Kirghiz (ky), 1125	Tamil (ta), 2001
Bulgarian (bg), 0207	Latin (la), 1201	Telugu (te), 2005
Bihari (bh), 0208	Lingala (ln), 1214	Tajik (tg), 2007
Bislama (bi), 0209	Laotian (lo), 1215	Thai (th), 2008
Bengali, Bangla (bn), 0214	Lithuanian (lt), 1220	Tigrinya (ti), 2009
Tibetan (bo), 0215	Latvian, Lettish (lv), 1222	Turkmen (tk), 2011
Breton (br), 0218	Malagasy (mg), 1307	Tagalog (tl), 2012
Catalan (ca), 0301	Maori (mi), 1309	Setswana (tn), 2014
Corsican (co), 0315	Macedonian (mk), 1311	Tongan (to), 2015
Czech (cs), 0319	Malayalam (ml), 1312	Turkish (tr), 2018
Welsh (cy), 0325	Mongolian (mn), 1314	Tsonga (ts), 2019
Danish (da), 0401	Moldavian (mo), 1315	Tatar (tt), 2020
Bhutani (dz), 0426	Marathi (mr), 1318	Twi (tw), 2023
Esperanto (eo), 0515	Malay (ms), 1319	Ukrainian (uk), 2111
Estonian (et), 0520	Maltese (mt), 1320	Urdu (ur), 2118
Basque (eu), 0521	Burmese (my), 1325	Uzbek (uz), 2126
Persian (fa), 0601	Nauru (na), 1401	Vietnamese (vi), 2209
Finnish (fi), 0609	Nepali (ne), 1405	Volapük (vo), 2215
Fiji (fj), 0610	Norwegian (no), 1415	Wolof (wo), 2315
Faroese (fo), 0615	Occitan (oc), 1503	Xhosa (xh), 2408
Frisian (fy), 0625	Oromo (om), 1513	Yoruba (yo), 2515
Irish (ga), 0701	Oriya (or), 1518	Zulu (zu), 2621
Scottish Gaelic (gd), 0704	Panjabi (pa), 1601	
Galician (gl), 0712	Polish (pl), 1612	



Playing music files (from USB or SD)

You can play the compressed audio files stored in the external storage device (USB, SD).

- In the following description, the SD memory card and USB memory device are collectively referred to as the “external storage device (USB, SD)”. If it indicates the USB memory device only, it is referred to as the “USB storage device”.
- When “**SD**” or “**USB**” is selected as the AV source, the AV sounds, the navigation guidance and beep sounds are mixed and the volume can be adjusted simultaneously.

Important Notice regarding Volume of Navigation Voice Guidance when Playing Audio Files from USB or SD

If music files stored on an external storage device (USB, SD) are played when the system guides the route (i.e., a destination has been selected and the system is routing you to a destination), the volume of the navigation guidance voice will be the same as the volume of the music files being played, even if a different volume level has been selected on “**Master**” or “**Voice**” or “**Dynamic Volume**” in the “**Sound settings**” menu.

Starting procedure

- **Insert the SD memory card into the SD card slot or plug the USB storage device into the USB connector.**

The source changes and then playback will start if there is a playable file on the external storage device.

- ➔ For details, refer to *Plugging in a USB storage device* on page 30.
- ➔ For details, refer to *Inserting and ejecting an SD memory card* on page 29.
- If the external storage device is already set, touch [USB] or [SD] on the “**AV Source**” menu.
- ➔ For details concerning operations, refer to *Screen switching overview* on page 34.

- Playback is performed in order of folder number. Folders are skipped if they contain no playable files. (If there are no playable files in folder 001 (root folder), playback starts from folder 002.) □

Reading the screen

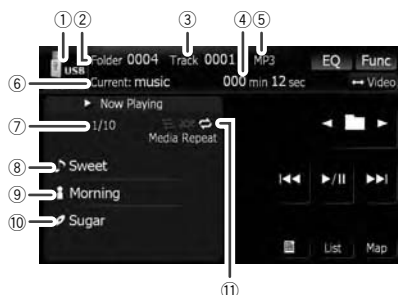

- This unit may not achieve optimum performance with some external storage devices.
- You can playback the files on a USB storage device compliant with Mass Storage Class. For details about the USB Class, refer to the manual supplied with USB storage device.

- ① **Source icon**
Shows which source has been selected.
- ② **Folder number indicator**
- ③ **Track number indicator**
- ④ **Play time indicator**
Shows the elapsed playing time within the current track.
- ⑤ **File type indicator**
Shows the type of audio file currently playing.
- ⑥ **Current folder name indicator**
Shows the folder name currently playing.
- ⑦ **Current file number and total number of files**
Shows the file number currently played and the total number of playable audio files.
- ⑧ **Track title indicator***
Shows the title of the track currently playing (when available).
- ⑨ **Artist name indicator***

Shows the artist name currently playing (when available).

⑩ **Album title indicator***

Shows the title of the album for the current track (when available).

⑪ **Playback condition indicator**

The marks shown below appears and indicates the current playback condition.

 Scan play

 Random play

 Repeat play

Indicator	Meaning
Media Repeat	All audio files in the current external storage device (USB, SD) are played repeatedly. This is the default condition.
Folder Repeat	The current folder is played repeatedly.
Track Repeat	The current file is played repeatedly.
Media Random	All audio files in the current external storage device (USB, SD) are played in random order.
Folder Random	All audio files in the current folder are played in random order.
Media Scan	The beginning of each audio file is played for about 10 seconds.
Folder Scan	The beginning of each track in the current folder is played for about 10 seconds.

➡ For more information, refer to *Using the “Function” menu* on the next page.

- The information marked with an asterisk (*) is displayed only when the information has been encoded on the compressed audio files. If specific information has not been encoded on the files, “—” is displayed instead. □

Using the touch panel keys (Music)

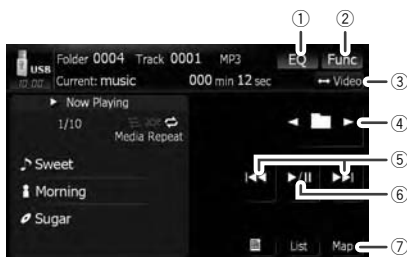

① **Recall equalizer curves**

➡ For details, refer to *Recalling equalizer curves* on page 160.

② **Display the “Function” menu**

➡ For details, refer to *Using the “Function” menu* on the next page.

③ **Switch the operation screen**

Touching this key switches between the screen to operate music files and the screen to operate video files. This touch panel key is available only when there are both audio and video files in the external storage device (USB, SD).

④ **Select the previous or next folder**

Touching [◀] or [▶] play the first playable file on the previous or next folder. The folders that there is no playable files are skipped.

⑤ **Skip forward or backward**

Touching [▶▶] skips to the start of the next file. Touching [◀◀] once skips to the start of the current file. Touching again will skip to the previous file.

Fast reverse or forward

Touch and hold [◀◀] or [▶▶] to fast rewind or fast forward.

□ There is no sound on fast reverse or forward.

□ Moving **MULTI-CONTROL** left or right enables you to perform the equivalent operations.

⑥ **Playback and Pause**

Touching [▶/||] switches between playback and pause.

⑦ **Display the map screen**

Playing music files (from USB or SD)

Selecting a track from the list

The list lets you see the list of track titles or folder names on an external storage device (USB, SD). Touch a folder on the list to view its contents. Touch a track on the list to play that track.

- 1 Touch [List].
- 2 Touch the folder that you want to view.



The track currently playing is highlighted. Touching or switches the selection to the next or previous page in the list. Touching displays the content of the upper folder (parent folder). If the uppermost folder is listed, cannot be used.

- If the selected folder does not contain any playable track, the track list is not displayed.

- 3 Touch the track you want to play.

- To cancel the list screen, touch [Detail].

Browsing embedded text information

Text information recorded in a compressed audio file can be displayed.

- Touch .

The next piece of information is displayed.

- **Album Title** : (album title)
- **Track Title** : (track title)
- **Folder Title** : (folder title)
- **File Name** : (file name)
- **Artist Name** : (artist name)

- If the information has not been recorded on files, nothing may be displayed.
- For WAV files, only the information marked with (*) can be displayed.
- If the characters recorded on the compressed audio file are not compatible with this navigation system, those characters may turn into garbled characters.

Using the “Function” menu

- 1 Touch [USB] or [SD] on the “AV Source” menu to display the “USB” or “SD” screen.

- For details concerning operations, refer to *Screen switching overview* on page 34.

- 2 Touch [Func].

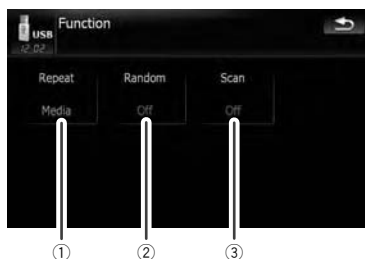

- ① Repeating play

Each touch of [Repeat] changes the setting as follows:

- **Media** — Repeat all compressed audio files in the selected external storage device (USB, SD)
- **Track** — Repeat just the current track
- **Folder** — Repeat the current folder
- If you skip the file forward or backward when the repeat play range in “Track”, the repeat play range changes to “Folder”.

- ② Play tracks in a random order

Random play lets you playback tracks in random order within the current repeat range.

Touching [Random] switches between “On” and “Off”.

- ❑ If you turn [**Random**] to “**On**” while the repeat play range is set to “**Track**”, the repeat play range changes to “**Folder**” automatically.

③ **Scan folders and tracks**

Scan play lets you hear the first 10 seconds of each track. Scan play is performed in the current repeat play range.

Touching [**Scan**] switches between “**On**” and “**Off**”. When you find the track you want, touch [**Scan**] to turn scan play off.

- ❑ After all tracks or folders scanning are finished, normal playback will begin again.
- ❑ If you turn [**Scan**] to “**On**” while the repeat play range is set to “**Track**”, the repeat play range changes to “**Folder**” automatically.

Playing video files (from USB or SD)

You can play the video files stored in the external storage device (USB, SD).

- ❑ In the following description, the SD memory card and USB memory device are collectively referred to as the “external storage device (USB, SD)”. If it indicates the USB memory device only, it is referred to as the “USB storage device”.
- ❑ When “SD” or “USB” is selected as the AV source, the AV sounds, the navigation guidance and beep sounds are mixed and the volume can be adjusted simultaneously.

Important Notice regarding Volume of Navigation Voice Guidance when Playing Audio Files from USB or SD

If music files stored on an external storage device (USB, SD) are played when the system guides the route (i.e., a destination has been selected and the system is routing you to a destination), the volume of the navigation guidance voice will be the same as the volume of the music files being played, even if a different volume level has been selected on “Master” or “Voice” or “Dynamic Volume” in the “Sound settings” menu.

Starting procedure

- **Insert the SD memory card into the SD card slot or plug the USB storage device into the USB connector.**

The source changes and then playback will start if there is a playable file on the external storage device.

- ➡ For details, refer to *Plugging in a USB storage device* on page 30.
- ➡ For details, refer to *Inserting and ejecting an SD memory card* on page 29.
- ❑ If the external storage device is already set, touch [USB] or [SD] on the “AV Source” menu.
- ❑ Playback is performed in order of folder number. Folders are skipped if they contain no playable files. (If there are no play-

able files in folder 001 (root folder), playback starts from folder 002.)

Reading the screen



- ❑ This unit may not achieve optimum performance with some external storage devices.
- ❑ You can playback the files on a USB storage device compliant with Mass Storage Class. For details about the USB Class, refer to the manual supplied with USB storage device.

- ① **Source icon**
Shows which source has been selected.
- ② **Folder number indicator**
- ③ **File number indicator**
- ④ **Play time indicator**
Shows the elapsed playing time within the current track.
- ⑤ **File type indicator**
Shows the type of audio file currently playing.
- ⑥ **Current folder name indicator**
Shows the folder name currently playing.

Using the touch panel keys (Video)

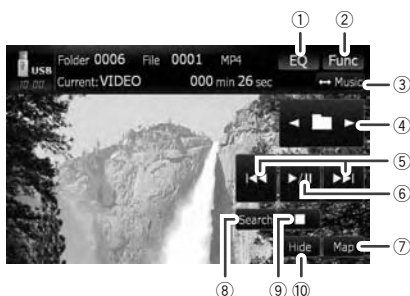

- ① **Recall equalizer curves**
 ➤ For details, refer to *Recalling equalizer curves* on page 160.
- ② **Display the “Function” menu**
 ➤ For details, refer to *Using the “Function” menu* on the next page.
- ③ **Switch the operation screen**
 Touching this key switches between the screen to operate music files and the screen to operate video files. This touch panel key is available only when there are both audio and video files in the external storage device (USB, SD).
- ④ **Select the previous or next folder**
 Touching [◀] or [▶] play the first playable file on the previous or next folder. The folders that there is no playable files are skipped.
- ⑤ **Skip forward or backward**
 Touching [▶▶] skips to the start of the next file. Touching [◀◀] once skips to the start of the current file. Touching again will skip to the previous file.
Fast reverse or forward
 Touch and hold [◀◀] or [▶▶] to fast rewind or fast forward.
 - ❑ There is no sound on fast reverse or forward.
 - ❑ Moving **MULTI-CONTROL** left or right enables you to perform the equivalent operations.
- ⑥ **Playback and Pause**

Touching [▶/⏸] switches between playback and pause.

- ⑦ **Display the map screen**
- ⑧ **Searching for a desired scene and starting playback from a specified time**
 ➤ For details, refer to *Searching for a specific scene and starting playback from a specified time* on this page.
- ⑨ **Stop playback**
- ⑩ **Hide the touch panel keys**
 Touching [Hide] hides the touch panel keys. Touch anywhere on the LCD screen to display the touch panel keys again.

Searching for a specific scene and starting playback from a specified time

You can search for a desired scene by specifying a folder number, file number or the time.

- 1 Touch [Search] and then touch [Folder], [File] or [Time].



- 2 Touch the keys to input the target number or time and then touch [Enter].



Playing video files (from USB or SD)

For folders, files

- To select 3, touch **[3]** and **[Enter]** in order.
- To select 10, touch **[1]** and **[0]** and **[Enter]** in order.

For time (time search)

- To select 5 minutes 03 seconds, touch **[5]**, **[0]**, **[3]** and **[Enter]** in order.
- To select 71 minutes 00 seconds, touch **[7]**, **[1]**, **[0]**, **[0]** and **[Enter]** in order.
- ☐ To clear the input numbers, touch **[Clear]**. 

the repeat play range changes to "Folder". 

Using the "Function" menu

1 Touch **[USB]** or **[SD]** on the "AV Source" menu to display the "USB" or "SD" screen.

- ➔ For details concerning operations, refer to *Screen switching overview* on page 34.

2 Touch the screen to display the touch panel keys.

3 Touch **[Func]**.

- ☐ If the touch panel keys are not shown, touch anywhere on the screen to display them.

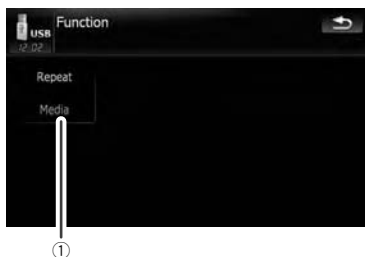

① Repeating play

Each touch of **[Repeat]** changes the setting as follows:

- **Media** — Repeat all video files in the selected external storage device (USB, SD)
- **File** — Repeat just the current file
- **Folder** — Repeat the current folder
- ☐ If you skip the file forward or backward when the repeat play range in "Track",

Using the USB interface cable for iPod enables you to connect your iPod to the navigation system.

- ❑ A USB interface cable for iPod (CD-IU230V) (sold separately) is required for connection.

Starting procedure

● Connect your iPod.

The source changes and then playback will start.

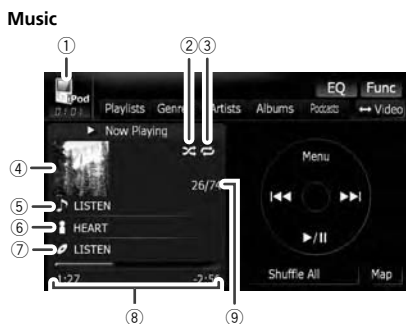

- For details, refer to *Connecting your iPod* on page 31.
- ❑ If the iPod is already connected, touch [iPod] on the "AV Source" menu.
- For details concerning operations, refer to *Screen switching overview* on page 34.
- ❑ No sound or video output if iPod is selected as AV source, check the setting in "AV1 Input" on the "AV System Settings" menu.
- For details, refer to *Setting video input 1 (AV1)* on page 163. ❑

Reading the screen



Video



- ① **Source icon**
Shows which source has been selected.
- ② **Shuffle play indicator**
Appears when shuffle play is activated.
- ③ **Repeat play indicator**
Appears when repeat play is activated.
: All-tracks repeat
: One-track repeat
- ④ **Album artwork**
Album art of the current song is displayed if it is available.
- ⑤ **Song title (episode) indicator**
Shows the title of the current song. When a podcast is played, the episode is displayed.
- ⑥ **Artist name (podcast title) indicator**
Shows the artist name currently playing. When a podcast is played, the podcast title is displayed.
- ⑦ **Album title (release date) indicator**
Shows the title of the album for the song. When a podcast is played, the release date is displayed.
- ⑧ **Play time indicator**
Shows the elapsed playing time within the current song.
- ⑨ **Song number indicator**
Shows the number of the song currently playing and total number of songs in the selected list.
- ⑩ **Chapter number indicator**
Shows the current chapter number and total number of chapters when the video with chapters played.

Using an iPod (iPod)

- ❑ If characters recorded on the iPod are not compatible with this navigation system, they may turn into garbled characters. ❑

Using the touch panel keys (Music)

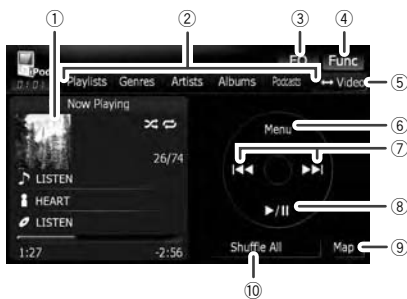

- ① **Album artwork**
Touch the key to enlarge the album artwork. If you touch again, the artwork returns to its normal size.
- ② **Category tabs**
Shows the list to narrow down the songs. If you want to use the list of “Audiobooks”, “Composers” or “Songs”, touch [Menu] to display the lists.
- ③ **Recall equalizer curves**
➔ For details, refer to *Recalling equalizer curves* on page 160.
- ④ **Display the “Function” menu**
➔ For details, refer to *Using the “Function” menu* on page 118.
- ⑤ **Switch the operation screen**
Touching this key switches between the screen to operate music files and the screen to operate video files. After you touch the key, the top category menu appears to let you select the item for playback.
❑ This touch panel key is available only when there are both audio and video file in your iPod.
- ⑥ **Display the top category menu**
Touching the key displays the top category before you use the category tabs. If you select

the song using the category tabs to play, touching the key displays the previous list.

- ⑦ **Skip back or forward to another song**
Touching [▶▶] skips to the start of the next song. Touching [◀◀] once skips to the start of the current song. Touching again will skip to the previous song. When the track with chapters played, chapter can be skipped back and forward.

Fast reverse or forward

Touch and hold [◀◀] or [▶▶] to fast rewind or fast forward.

- ❑ Moving **MULTI-CONTROL** left or right enables you to perform the equivalent operations.

- ⑧ **Playback and Pause**
Touching [▶/||] switches between playback and pause.
- ⑨ **Display the map screen**
- ⑩ **Shuffle All**

All songs (except for the track in “Audiobooks” and “Podcasts”) in your iPod can be played randomly.

- ❑ To cancel the random play, switch [Shuffle] on the “Function” menu to the “Off”.

Browsing for a song

Touch an item on list to search for a song and play it on your iPod.

Narrowing down listed songs

1 Touch your desired category tab to display the song or track list.

- **Playlists** (playlists)
- **Genres** (genres)
- **Artists** (artists)
- **Albums** (albums)
- **Podcasts** (podcasts)

The search screen is displayed.



Search control

2 Touching **[A]** or **[B]** switches the selection to the next or previous page in the list.

3 Touch the item that you want to refine.

Refine the item until the track title is displayed on the list.

- ❑ Touching **[All]** on the list includes all options in the current list. For example, if you touch **[All]** after touching **[Artists]**, you can proceed to the next screen with all artists in the list selected.
- ❑ After you select **Artists, Albums, or Genres**, go on to touch one of the list to start playing the first songs in the selected list and display the next options.

4 On the song (or episode) list, touch the track you want to play.

- ❑ After you select the track using this function, touching **[Menu]** displays the list previously selected.

Searching for applicable items alphabetically

Using the search control displays the page which includes the first applicable option.

- ❑ This function is available for the alphabetical list only.

1 Touch your desired category tab to display the list.

2 Touch the item that you want to refine.

3 Touch **[<]** or **[>]** to select the character.

- ❑ "THE" or "The" and space at the beginning of the artist name will be ignored and the next character will be taken into account for searching.

4 Touch the character key to display the page which includes applicable options.

5 On the song (or episode) list, touch the track you want to play. 

Starting the video playback

This navigation system can play video if an iPod with video capabilities is connected.

1 Touch **[Video]**.

2 Touch one of the categories in that contains the video you want to play.

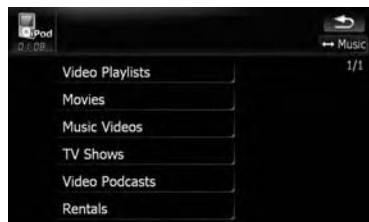

Video playback will start.

Using an iPod (iPod)

3 Touch your desired item on the list to narrow down them until the video list appears.

- ➔ For details concerning operations, refer to *Browsing for a video* on this page.

4 On the video list, touch the video you want to play.

5 Touch the screen to display the touch panel keys.

- ➔ For more details of the operation, refer to *Using the touch panel keys (Video)* on this page. 

Using the touch panel keys (Video)

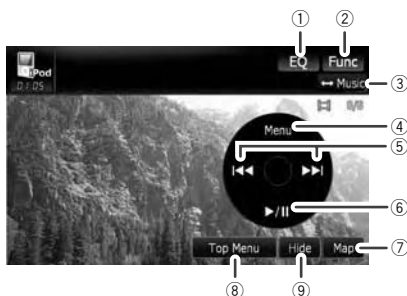

① Recall equalizer curves

- ➔ For details, refer to *Recalling equalizer curves* on page 160.

② Display the "Function" menu

- ➔ For details, refer to *Using the "Function" menu* on the next page.

③ Switch the operation screen

Touching this key switches between the screen to operate music files and the screen to operate video files. After you touch the key, the top category menu appears to let you select the item for playback.

- This touch panel key is available only when there are both audio and video file in your iPod.

④ Display the previous selected list

If you select the video from the list to play after touching **Top Menu**, touching the key displays the previous list. (If you touch **Top Menu** again but do not select a video, this key is disabled until you select a video with the list next time.)

⑤ Skip back or forward to another song

Touching [▶▶] skips to the start of the next video. Touching [◀◀] once skips to the start of the current video. Touching again will skip to the previous video. When the video with chapters played, chapter can be skipped back and forward.

Fast reverse or forward

Touch and hold [◀◀] or [▶▶] to fast rewind or fast forward.

- Moving **MULTI-CONTROL** left or right enables you to perform the equivalent operations.

⑥ Playback and Pause

Touching [▶/||] switches between playback and pause.

⑦ Display the map screen

⑧ Display the top category menu for video

Touching the key displays the top category for video playback.

⑨ Hide the touch panel keys

Touching [Hide] hides the touch panel keys. Touch anywhere on the LCD screen to display the touch panel keys again.

Browsing for a video

Touching the item on list allows you to search for a video and play it in your iPod.

Narrowing down a video with the list

- 1 Touch the category you want.

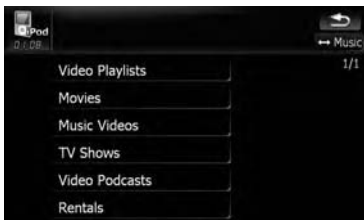

- 2 Touching or switches the selection to the next or previous page in the list.
- 3 Touch the item that you want to refine. Refine the item until the track title is displayed on the list.
- 4 On the video list, touch the video you want to play.

- After you select the video using this function, touching **[Menu]** displays the list previously selected.

Searching for applicable items alphabetically

Using the search control displays the page which includes the first applicable option.

- This function is available for the alphabetical list only.



Search control

- 1 Touch the category you want.
- 2 Touch the item that you want to refine.

- 3 Touch **[◀]** or **[▶]** to select the character.

- "THE" or "The" and space at the beginning of the artist name will be ignored and the next character will be taken into account for searching.

- 4 Touch the character key to display the page which includes applicable options.

- 5 On the video list, touch the video you want to play.

Using the "Function" menu

- 1 Touch **[iPod]** on the "AV Source" menu to display the control screen for "iPod".

- For details concerning operations, refer to *Screen switching overview* on page 34.

- 2 Touch **[Func.]**.

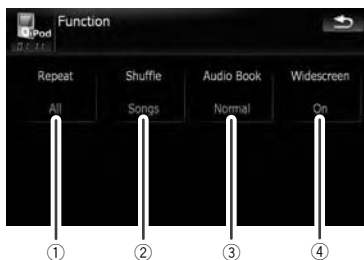

- ① **Setting repeat play**

There are two repeat play types for playback.

Each touch of **[Repeat]** changes the setting as follows:

- **One** — Repeats just the current track
- **All** — Repeats all tracks in the selected list

- ② **Setting the shuffle play for music**

This function shuffles songs or albums and plays them in random order.

Each touch of **[Shuffle]** changes the setting as follows:

- **Off** — Does not shuffle.
- **Songs** — Plays back songs in random order within the selected list

Using an iPod (iPod)

- **Albums** — Selects an album randomly, and then plays back all songs in that album in order

③ **Setting the audiobook play speed**

While listening to an audiobook on iPod, playback speed can be changed.

Each touch of [**Audio Book**] changes the setting as follows:

- **Normal** — Playback in normal speed
- **Slower** — Playback slower than normal speed
- **Faster** — Playback faster than normal speed

④ **Playback video in wide screen mode**

If the video is compatible with wide screen format, set [**Widescreen**] to [**On**] in order to view the video image in the wide screen.

Each touch of [**Widescreen**] changes the setting as follows:

- **On** — Outputs the wide-screen video from iPod
- **Off** — Outputs the normal-sized video from iPod
- Display size is changed after you change "**Widescreen**" setting and select the video to play.
- This setting is available only during the video operation.

Using the radio (FM)

You can listen to the radio by using the navigation system. This section describes operations for radio (FM).

- **Touch [FM] on the “AV Source” menu to display the “FM” screen.**

- ➔ For details concerning operations, refer to *Screen switching overview* on page 34.

Reading the screen

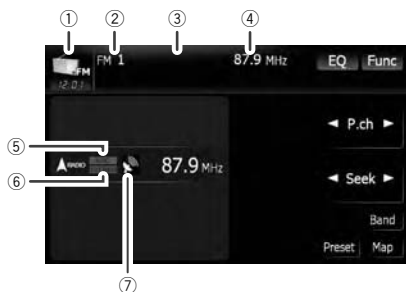

- ① **Source icon**
Shows which source has been selected.
- ② **Band indicator**
Shows which band the radio is tuned to: FM1 to FM3.
- ③ **Preset number indicator**
Shows what preset item has been selected.
- ④ **Frequency indicator**
- ⑤ **LOCAL indicator**
Shows when local seek tuning is on.
- ⑥ **STEREO indicator**
Shows that the frequency selected is being broadcast in stereo.
- ⑦ **Signal level indicator**

Using the touch panel keys



- ① **Recall equalizer curves**
➔ For details, refer to *Recalling equalizer curves* on page 160.
- ② **Display the “Function” menu**
➔ For details, refer to *Using the “Function” menu* on the next page.
- ③ **Select a preset channel**
[◀] or [▶] can be used to switch preset channels.
- ④ **Perform manual tuning**
To tune manually, touch [◀] or [▶] briefly. The frequencies move up or down one step at a time.
Perform seek tuning
To perform seek tuning, touch and hold [◀] or [▶] for about one second and release. The tuner will scan the frequencies until a broadcast strong enough for good reception is found.
 - You can cancel seek tuning by touching either [◀] or [▶] briefly.
 - If you touch and hold [◀] or [▶], you can skip broadcasting frequencies. Seek tuning will start as soon as you release the keys.
 - Moving **MULTI-CONTROL** left or right enables you to perform the equivalent operations.
- ⑤ **Select an FM band**
Touch [Band] repeatedly until the desired FM band is displayed, **FM1**, **FM2** or **FM3**.
 - This function is convenient for preparing different preset lists for each band.
- ⑥ **Display the map screen**

Using the radio (FM)

Switching between the detailed information display and the preset list display

You can switch the left side of the basic screen according to your preference.



- **Touch [Preset] (or [Detail]).**

Each touch of [Preset] (or [Detail]) changes the detailed information display or preset list display.

Storing and recalling broadcast frequencies

With a touch of any of the preset tuning keys ([P1] to [P6]), you can easily store up to six broadcast frequencies for later recall (also with the touch of a key).

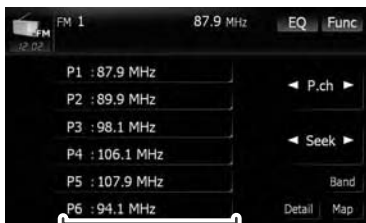

Preset tuning keys

- 1 **When you find a frequency that you want to store in memory, touch and hold a preset tuning key [P1] to [P6] until the preset number (e.g., P.ch 1) stops flashing.**

The selected radio station has been stored in memory.

- Up to 18 FM stations, 6 for each of the three FM bands, and 6 AM stations can be stored in memory.

- 2 **The next time you touch the same preset tuning key [P1] to [P6], the radio station frequencies are recalled from memory.**

- You can also use [◀] and [▶] to recall radio stations assigned to preset tuning keys [P1] to [P6].

Using the “Function” menu

- 1 **Touch [FM] on the “AV Source” menu to display the “FM” screen.**

- ☞ For details concerning operations, refer to *Screen switching overview* on page 34.

- 2 **Touch [Func].**

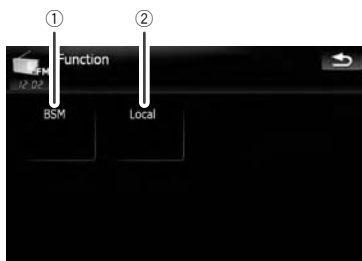

- ① **Storing the strongest broadcast frequencies**

- ☞ For details, refer to this page.

- ② **Tuning in strong signals**

- ☞ For details, refer to the next page.

Storing the strongest broadcast frequencies

“BSM” (best stations memory) lets you automatically store the six strongest broadcast frequencies under the preset tuning keys [P1] to [P6] and, once stored there, you can tune in to these frequencies with the touch of a key.

- 1 **Touch [BSM].**

2 Touch [Start] to start “BSM”.

BSM begins to flash. While **BSM** is flashing, the six strongest broadcast frequencies will be stored under the preset tuning keys [P1] to [P6] in order of their signal strength. When this is complete, **BSM** stops flashing.

- ❑ To cancel the storage process, touch [Stop].
- ❑ Storing broadcast frequencies with **BSM** may replace broadcast frequencies you have already saved by using [P1] to [P6].

Tuning in strong signals

Local seek tuning allows you to tune in only those radio stations with sufficiently strong signals for good reception.

1 Touch [Local].

2 Touch [On] to turn local seek tuning on.

To turn local seek tuning off, touch [Off].

3 Touch [◀Prev] or [Next▶] to set the sensitivity.

There are four levels of sensitivity for FM.

Level: 1 — 2 — 3 — 4

- ❑ The level “4” setting allows reception of only the strongest stations, while lower settings let you receive weaker stations. ▣

Using the HD Radio (Digital Radio)

You can listen to the radio by using the navigation system. This section describes operations for HD Radio™.

- For details concerning operation, refer to the HD Radio tuner's operation manual.

- **Touch [Digital Radio] on the "AV Source" menu to display the "Digital Radio" screen.**

- ➔ For details concerning operations, refer to *Screen switching overview* on page 34.

Reading the screen

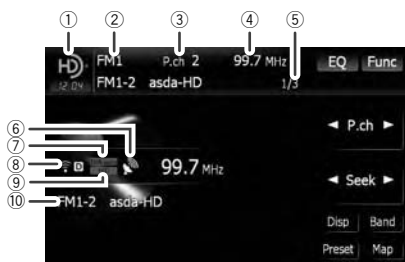

- ① **Source icon**
Shows which source has been selected.
- ② **Band indicator**
Shows which band the radio is tuned to: FM1, FM2, FM3 or AM.
- ③ **Preset number indicator**
Shows what preset item has been selected.
- ④ **Frequency indicator**
- ⑤ **Multicasting indicator**
Shows the number of multicast channels in the current frequency.
- ⑥ **Signal level indicator**
- ⑦ **Blending mode indicator**
➔ For details, refer to **Switching the reception mode** on page 125.
- ⑧ **Signal type indicator**
Shows the type of signal currently being received. If a digital broadcasting is received, "D" appears. Otherwise, "A" appears.
- ⑨ **Seek type indicator**
➔ For details, refer to **Switching the seek mode** on page 125.

- ⑩ **Detailed information**

- ➔ For details, refer to *Switching the display* on the next page. □

Using the touch panel keys



- ① **Recall equalizer curves**
➔ For details, refer to *Recalling equalizer curves* on page 160.
- ② **Display the "Function" menu**
➔ For details, refer to *Using the "Function" menu* on the next page.
- ③ **Select a preset channel**
[◀] or [▶] can be used to switch preset channels.
- ④ **Perform manual tuning**
To tune manually, touch [◀] or [▶] briefly. The frequencies move up or down one step at a time.
Perform seek tuning
To perform seek tuning, touch and hold [◀] or [▶] for about one second and release. The tuner will scan the frequencies until a broadcast strong enough for good reception is found.
□ You can cancel seek tuning by touching either [◀] or [▶] briefly.
□ If you touch and hold [◀] or [▶], you can skip broadcasting frequencies. Seek tuning will start as soon as you release the keys.
- ⑤ **Select a band**
Touch [Band] repeatedly until the desired band is displayed: **FM1, FM2, FM3 or AM**.
□ This function is convenient for preparing different preset lists for each band.
- ⑥ **Display the map screen**

Switching between the detailed information display and the preset list display

You can switch the left side of the basic screen according to your preference.

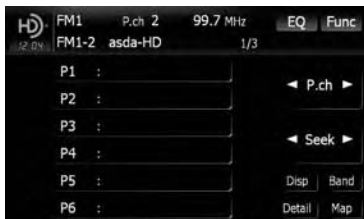

● Touch [List] (or [Detail]).

Each touch of [List] (or [Detail]) changes the detailed information display or preset list display.

Storing and recalling broadcast frequencies

With a touch of any of the preset tuning keys ([P1] to [P6]), you can easily store up to six broadcast frequencies for later recall (also with the touch of a key).



Preset tuning keys

1 When you find a frequency that you want to store in memory, touch and hold a preset tuning key [P1] to [P6] until the preset number (e.g., P.ch 1) stops flashing.

The selected radio station has been stored in memory.

2 The next time you touch the same preset tuning key [P1] to [P6], the radio station frequencies are recalled from memory.

- You can also use [◀] and [▶] to recall radio stations assigned to preset tuning keys [P1] to [P6]. □

Switching the display

Desired information can be displayed.

● Touch [Disp].

Touch [Disp] repeatedly to switch between the following settings:

Call sign or frequency — Artist name — Song title — Program type

- Only when the tuner has been tuned in to an HD Radio broadcasting, display can be changed.
- When the tuner has been tuned in to an HD Radio broadcasting, default display is changed into station name instead of frequency. □

Using the “Function” menu

1 Touch [Digital Radio] on the “AV Source” menu to display the “Digital Radio” screen.

- ➔ For details concerning operations, refer to *Screen switching overview* on page 34.

2 Touch [Func].

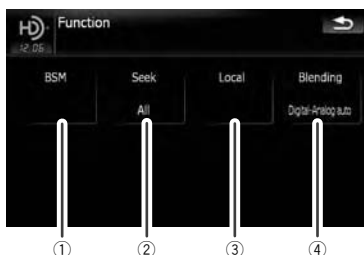

① Storing the strongest broadcast frequencies

- ➔ For details, refer to the next page.

Using the HD Radio (Digital Radio)

② Switching the seek mode

➔ For details, refer to this page.

③ Tuning in strong signals

➔ For details, refer to this page.

④ Switching the reception mode

➔ For details, refer to this page.

Storing the strongest broadcast frequencies

"**BSM**" (best stations memory) lets you automatically store the six strongest broadcast frequencies under the preset tuning keys [**P1**] to [**P6**] and, once stored there, you can tune in to these frequencies with the touch of a key.

● Touch [**Start**] to turn **BSM** on.

BSM begins to flash. While **BSM** is flashing, the six strongest broadcast frequencies will be stored under the preset tuning keys [**P1**] to [**P6**] in order of their signal strength. When this is complete, **BSM** stops flashing.

- To cancel the storage process, touch [**Stop**].
- Storing broadcast frequencies with **BSM** may replace broadcast frequencies you have already saved by using [**P1**] to [**P6**].

Switching the seek mode

You can select the method of seek tuning.

● Touch [**Seek**] to select the desired setting.

- [**All**]:
Seeks stations from both analog and digital broadcasting.
- [**HD**]:
Seeks from digital broadcasting only.
- If you select "**HD**" on this setting while [**Blending**] is set to "**Analog**", the setting on [**Blending**] turns to "**Digital-Analog auto**" automatically.

Tuning in strong signals

Local seek tuning allows you to tune in only those radio stations with sufficiently strong signals for good reception.

1 Touch [**On**] to turn local seek tuning on. To turn local seek tuning off, touch [**Off**].

2 Touch [**◀Prev**] or [**Next▶**] to set the sensitivity.

There are four levels of sensitivity for FM and two levels for AM:

FM: **1 — 2 — 3 — 4**

AM: **1 — 2**

- The FM "**4**" (AM "**2**") setting allows reception of only the strongest stations, while lower settings let you receive weaker stations.

Switching the reception mode

If a digital broadcast reception condition gets poor, the tuner automatically switches to the analog broadcast of the same frequency level in default. If you want to prevent a frequent automatic switching, switch this setting to [**Analog**].

● Touch [**Blending**] to switch the reception mode.

- [**Analog**]:
Receives analog broadcasting only.
- [**Digital-Analog auto**]:
Automatically switches to the analog broadcast of the same frequency level as the digital broadcast.
- If you select "**Analog**" on this setting while [**Seek**] is set to "**HD**", the setting on [**Seek**] turns to "**All**" automatically.

Using the radio (AM)

You can listen to the radio using this navigation system. This section describes operations for radio (AM).

● Touch [AM] on the “AV Source” menu to display the “AM” screen.

- ➔ For details concerning operations, refer to *Screen switching overview* on page 34.

Reading the screen

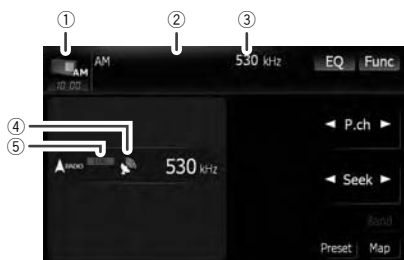

- Source icon**
Shows which source has been selected.
- Preset number indicator**
Shows what preset item has been selected.
- Frequency indicator**
- Signal level indicator**
- LOCAL indicator**
Shows when local seek tuning is on.

Using the touch panel keys



- Recall equalizer curves**
➔ For details, refer to *Recalling equalizer curves* on page 160.
- Display the “Function” menu**

- ➔ For details, refer to *Using the “Function” menu* on the next page.

③ Select a preset channel

◀ or ▶ can be used to switch presets.

④ Perform manual tuning

To tune manually, touch [◀] or [▶] briefly. The frequencies move up or down one step at a time.

Perform seek tuning

To perform seek tuning, touch and hold [◀] or [▶] for about one second and release. The tuner will scan the frequencies until a broadcast strong enough for good reception is found.

- You can cancel seek tuning by touching either [◀] or [▶] briefly.
- If you touch and hold [◀] or [▶], you can skip broadcasting frequencies. Seek tuning will start as soon as you release the keys.
- Moving **MULTI-CONTROL** left or right enables you to perform the equivalent operations.

⑤ Display the map screen

Switching between the detailed information display and the preset list display

You can switch the left side of the basic screen according to your preference.



● Touch [Preset] (or [Detail]).

Each touch of [Preset] (or [Detail]) changes the detailed information display or preset list display.

Using the radio (AM)

Storing and recalling broadcast frequencies

With a touch of any of the preset tuning keys ([P1] to [P6]), you can easily store up to six broadcast frequencies for later recall (also with the touch of a key).



Preset tuning keys

1 When you find a frequency that you want to store in memory, touch and hold a preset tuning key [P1] to [P6] until the preset number (e.g., P.ch 1) stops flashing.

The selected radio station has been stored in memory.

2 The next time you touch the same preset tuning key [P1] to [P6], the radio station frequencies are recalled from memory.

- ☐ You can also use [◀] and [▶] to recall radio stations assigned to preset tuning keys [P1] to [P6].

Using the “Function” menu

1 Touch [AM] on the “AV Source” menu to display the “AM” screen.

- ➡ For details concerning operations, refer to *Screen switching overview* on page 34.

2 Touch [Func].

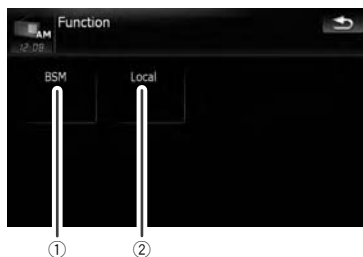

① Storing the strongest broadcast frequencies

- ➡ For details, refer to this page.

② Tuning in strong signals

- ➡ For details, refer to this page.

Storing the strongest broadcast frequencies

“BSM” (best stations memory) lets you automatically store the six strongest broadcast frequencies under the preset tuning keys [P1] to [P6] and, once stored there, you can tune in to these frequencies with the touch of a key.

● Touch [Start] to turn BSM on.

BSM begins to flash. While BSM is flashing, the six strongest broadcast frequencies will be stored under the preset tuning keys [P1] to [P6] in order of their signal strength. When this is complete, BSM stops flashing.

- ☐ To cancel the storage process, touch [Stop].
- ☐ Storing broadcast frequencies with BSM may replace broadcast frequencies you have already saved by using [P1] to [P6].

Tuning in strong signals

Local seek tuning allows you to tune in only those radio stations with sufficiently strong signals for good reception.

1 Touch [On] to turn local seek tuning on.

To turn local seek tuning off, touch [Off].

2 Touch [◀Prev] or [Next▶] to set the sensitivity.

There are two levels of sensitivity for AM.

Level: **1** — **2**

- The level "2" setting allows reception of only the strongest stations, while lower settings let you receive weaker stations. ▣

Using the XM tuner

You can use the navigation system to control an XM satellite digital tuner, which is sold separately.

For details concerning operation, refer to the XM tuner's operation manuals. This section provides information on XM operations with the navigation system which differs from that described in the XM tuner's operation manual.

The following XM satellite digital tuner units cannot be connected:
GEX-P900XM, GEX-P910XM

Reading the screen

ALL CH MODE



CATEGORY MODE



About the logo for channel name

Only the logo data that is contained in the navigation system can be displayed for each channel. The logo of a newly established channel that is not contained cannot be displayed. When no logo may be displayed, the following substitute icon is displayed.

Substitute icon



- ❑ The icon of each broadcast station is contained in the hard disk drive based on the data provided by XM Satellite Radio as of December 2008.
- ❑ Any changes made by XM Satellite Radio in the lineup or icon of the broadcast station in the future may not be supported by the navigation system, and may cause the unit to display incorrect icons.

- ① **Source icon**
Shows which source has been selected.
- ② **XM band indicator**
Shows the XM band that has been selected.
- ③ **Preset number indicator**
Shows what preset item has been selected.
- ④ **XM channel number indicator**
Shows the XM channel number the tuner is currently tuned to.
- ⑤ **XM channel category**
Shows the category of broadcast channel.
- ⑥ **XM channel select mode indicator**
Shows what channel select mode has been selected. You can select a channel from all channels in **ALL CH MODE**, and select a channel from selected category in **CATEGORY MODE**.
- ⑦ **XM station name logo**
 - ❑ The message "ON THE AIR" disappears if the navigation system cannot receive XM tuner reception for some reason.
- ⑧ **XM station name indicator**
Shows the XM broadcast station name the tuner is currently tuned in.
- ⑨ **Detail information**

Shows the detailed information of the broadcast channel currently being received. 

Using the touch panel keys

● Touch [XM] on the “AV Source” menu to display the “XM” screen.

- ➔ For details concerning operations, refer to *Screen switching overview* on page 34.

ALL CH MODE

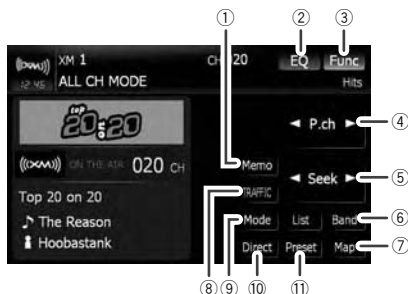

CATEGORY MODE

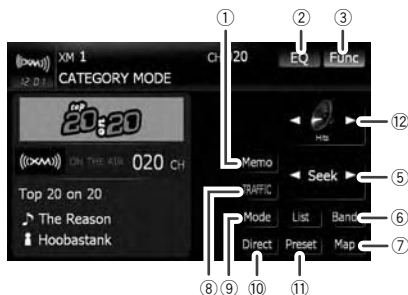

- ① **Memorize the current song**
➔ For details, refer to *Memorizing the song* on page 132.
- ② **Recall equalizer curves**
➔ For details, refer to *Recalling equalizer curves* on page 160.
- ③ **Display the “Function” menu**
➔ For details, refer to *Using the “Function” menu* on page 133.
- ④ **Recalling channels from the preset**
Touch to recall the preset channel.
- ⑤ **Perform manual tuning**

The channels move up or down one at a time.

- If you keep touching [◀] or [▶] you can skip the broadcasting channels.

- ⑥ **Select an XM band**
Touch [Band] repeatedly until the desired XM band is displayed: **XM 1**, **XM 2** or **XM 3**. This is useful for switching the preset item.
- ⑦ **Display the map screen**
- ⑧ **Preset key for receiving the traffic audio service**

- ➔ For details, refer to *Using the direct traffic announcement function* on page 132.

- ⑨ **Switching the XM channel select mode**
You can switch the mode between the two methods for selecting and listing the channel.

ALL CH MODE :

You can select a channel from all channels when you operate this function.

CATEGORY MODE:

You can select a channel within a selected category that you operate this function.

- ⑩ **Selecting an XM channel directly**
➔ For details, refer to *Selecting an XM channel directly* on this page.
- ⑪ **Switching to the list display**
You can select the desired channel from the list display.
➔ For details, refer to *Selecting a channel from the list* on the next page.
- ⑫ **Switching the channel category**
Touch [◀] or [▶] to select the desired category.

Selecting an XM channel directly

You can select an XM channel directly by entering the desired channel number.

- 1 Touch [Direct].
- 2 Touch [0] to [9] to input the desired channel number.
To cancel the input numbers, touch [Clear].

Using the XM tuner

3 While the input number is displayed, touch [Enter].

The XM channel that was entered is selected.

4 Touch .

You return to the previous display.

Displaying the Radio ID

If you select CH: 000, the Radio ID is displayed.

1 Touch [Direct].

2 Input [000] and then touch [Enter].

If you select another channel, display of the Radio ID is canceled.

Storing and recalling broadcast stations

With a touch of any of the preset tuning keys ([P1] to [P6]), you can easily store up to six broadcast channels for later recall (also with the touch of a key).

1 Select the channel that you want to store in memory.

2 Touch [Preset] to display the preset list.

3 Keep touching a preset tuning key [P1] to [P6].

The selected station has been stored in memory.

The next time you touch the same preset tuning key [P1] to [P6] the station is recalled from memory.

- Up to 18 stations, 6 for each of three XM bands can be stored in memory.
- You can also touch [◀] or [▶] to recall stations assigned to preset tuning keys [P1] to [P6] in the detailed information display during the "ALL CH MODE".

Selecting a channel from the list

The list content can be switched so you can search for the track you want to listen to not only by the channel name but also by the artist name or song title.

- The channel list shows all channels during **ALL CH MODE**, and the channels included in the selected category during **CATEGORY MODE**. To switch the channel mode, touch [Mode].

1 Touch [List].



XM channel list appears in the display.

Each touch of [List] changes the screen as follows:

Detail information display or Preset list display — CH name list (Channel name) — **Song title list** (Song title) — **Artist name list** (Artist name)

2 Touch the desired channel that you want to listen to.



Touch  or  to switch to the next page or previous page.

- During **CATEGORY MODE**, touch [◀] or [▶] to switch to another category.
- When the list switching operation is started from the detailed information display, the preset list appears in the end of the list section.

Using “My Mix” function

“My Mix” function memorizes the song title and artist name of the song currently being received. When the song that matches the memorized song title and artist name is being broadcast on a station other than the one you are listening to, you will be alerted, and you can switch the station to listen to that song.

- ❑ A track itself is NOT downloaded. ONLY the song title and the artist name are memorized.

Memorizing the song

The song title and artist name of the song you are listening to can be memorized to “My Mix”.

● Touch [Memo].

The song title and artist name of current song you are listening to are memorized, and a confirmation message appears.

- ❑ The song title and artist name of up to 12 songs can be memorized. Trying to save more than 12 songs will result in older ones being overwritten.
- ❑ You cannot memorize the song title or the artist name when “-----” is displayed on the title information.
- ❑ This function is invalid for the channel “000”.
- ❑ The memorized title may not be displayed correctly depending on the conditions.
- ❑ You can customize the setting for the memorized songs later.
 - ➔ For more details concerning the operation, refer to **Setting the memorized songs** on the next page.

When the memorized song is broadcast

A beep sounds, and a message is displayed. Touch [Yes] to switch to that station and listen to that track.

- ❑ If the memorized song is not checked or when [Off] is selected on [Alert] on “MEMO Edit” screen, no alert will be provided.

➔ Refer to **Setting the memorized songs** on the next page.

- ❑ Notification may not be provided depending on the status of the Navigation System.
- ❑ If there is even a slight difference between the memorized title and the title of the song being broadcast, no notification will be provided even though they are the same song.

Using the direct traffic announcement function

You can listen to the memorized “Instant Traffic & Weather” channel by directly calling it up with [TRAFFIC]. (Only one station can be memorized.)

Memorizing an “Instant Traffic & Weather” channel

1 Tune into “Instant Traffic & Weather” channel.

2 Touch and hold [TRAFFIC] for two seconds or more.

That “Instant Traffic & Weather” channel will be memorized.

- ❑ Even if you use the SiriusConnect universal tuner together, only one station can be memorized. The station memorized afterward will overwrite the existing one.

Tuning in to the memorized channel

● Touch [TRAFFIC].

- ❑ You can also perform this operation by touching [TRAFFIC] on the “AV Source” menu.
- ❑ You can even call up a “Instant Traffic & Weather” channel from a source other than the XM source.
- ❑ To cancel the announcement, touch [TRFC Off] on the screen. ■

Using the XM tuner

Using the “Function” menu

1 Touch [XM] on the “AV Source” menu to display the “XM” screen.

- For details concerning operations, refer to *Screen switching overview* on page 34.

2 Touch [Func].



①

① **Setting the memorized songs**

Setting the memorized songs

Selecting the songs to alert

The list of song titles memorized for the MyMix Function (MyMix list) is displayed. You can change the notification setting when the song is broadcast again. You can enable or disable notification for each song.

1 Touch [Memo].

2 Touch the song title that you want to exclude from the notification list.

The check mark is removed, and the song title is excluded from the notification list.

Changing the alert setting

You can enable or disable alerts for all items at the same time. This function is useful when you want to turn alerts off temporarily without changing each memorized song.

1 Touch [Memo].

2 Touch [Alert On] or [Alert Off].

Touch to toggle the selection.

Deleting the memorized songs

You can delete each one of the memorized songs from the song title list.

1 Touch [Memo].

2 Touch and hold the song you want to delete.

- To delete all songs that are memorized, touch [Delete All].

3 Touch [Yes].

Using the SIRIUS tuner

You can use the navigation system to control a Pioneer Sirius satellite digital tuner, which is sold separately.

For details concerning operation, refer to the SIRIUS tuner's operation manuals. This section provides information on SIRIUS operations with navigation system which differs from that described in the SIRIUS tuner's operation manual.

❑ When you use the SiriusConnect universal tuner (sold separately) with this navigation system, Pioneer SIRIUS BUS INTERFACE is required. For details concerning operation, refer to the owner's manual of Pioneer SIRIUS BUS INTERFACE and SiriusConnect universal tuner.

Reading the screen

All Ch Mode



Category Mode



- ① **Source icon**
Shows which source has been selected.
- ② **SIRIUS band indicator**
Shows the SIRIUS band that has been selected.
- ③ **Preset number indicator**

Shows what preset item has been selected.

- ④ **SIRIUS channel number indicator**
Shows the SIRIUS channel number that the tuner is tuned to.
- ⑤ **SIRIUS channel select mode indicator**
Shows what channel select mode has been selected. You can select a channel from all channels in **All Ch Mode**, and select a channel from the selected category in **Category Mode**.
 - For details, refer to **Switch the SIRIUS channel select mode** on the next page.
- ⑥ **SIRIUS station name logo**
 - ❑ The message "ON THE AIR" disappears if the navigation system cannot receive SIRIUS tuner reception for some reason.
- ⑦ **Variable information area**
Shows various information about the broadcast channel currently being received.
 - For more details about the displayed information, refer to **Switch the SIRIUS display** on the next page. ❑

Using the touch panel keys

- Touch [SIRIUS] on the "AV Source" menu to display the "SIRIUS" screen.
 - For details concerning operations, refer to **Screen switching overview** on page 34.

All Ch Mode

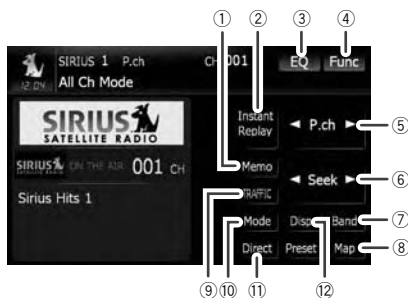

Using the SIRIUS tuner

Category Mode

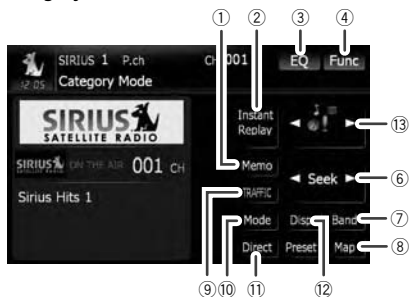

- ① **Memorize the current song**
 - ➔ For details, refer to *Memorizing the song* on the next page.
- ② **Switch the SIRIUS Instant replay mode**
 - ➔ For details, refer to *Using the “Instant Replay” function* on page 137.
- ③ **Recall equalizer curves**
 - ➔ For details, refer to *Recalling equalizer curves* on page 160.
- ④ **Display the “Function” menu**
 - ➔ For details, refer to *Using the “Function” menu* on page 137.
- ⑤ **Recalling channels from the preset**
Touch to recall the preset channel.
Storing broadcast stations
You can register the channel currently being broadcast to the preset list.
- ⑥ **Perform manual tuning**
The channels move up or down one at a time.
 - If you keep touching [◀] or [▶] you can skip the broadcasting channels.
- ⑦ **Select a SIRIUS band**
Touch [Band] repeatedly until the desired SIRIUS band is displayed, **SIRIUS 1**, **SIRIUS 2**, or **SIRIUS 3**. This is useful for switching the preset.
- ⑧ **Display the map screen**
- ⑨ **Preset key for receiving the traffic audio service**
 - ➔ For details, refer to *Using the direct traffic announcement function* on the next page.

⑩ Switch the SIRIUS channel select mode

You can switch the mode between the two methods for selecting and listing the channel.

All Ch Mode:

You can select a channel from all channels when you operate this function.

Category Mode:

You can select a channel within a selected category that you operate this function.

⑪ Select a SIRIUS channel directly

➔ For details, refer to *Selecting a SIRIUS channel directly* on this page.

⑫ Switch the SIRIUS display

Each touch of [Disp] changes the display information.

Channel number — Channel name — Channel category — Artist name/feature — Song/program title — Composer

⑬ Switch the channel category

Touch [◀] or [▶] to select the desired category.

Selecting a SIRIUS channel directly

You can select a SIRIUS channel directly by entering the desired channel number.

1 Touch [Direct].

2 Touch [0] to [9] to input the desired channel number.

To cancel the input numbers, touch [Clear].

3 While the input number is displayed, touch [Enter].

The SIRIUS channel that was entered selected.

4 Touch [Back].

You return to the previous display.

Display the Radio ID

If you select CH: 000, the Radio ID is displayed.

1 Touch [Direct].**2 Input [000] and then touch [Enter].**

If you select another channel, display of the Radio ID is canceled.

Storing and recalling broadcast stations

With a touch of any of the preset tuning keys [P1] to [P6], you can easily store up to six broadcast stations for later recall (also with the touch of a key).

1 Select the channel that you want to store in memory.**2 Touch [Preset] to display the preset list.****3 Keep touching a preset tuning key [P1] to [P6].**

The selected station has been stored in memory.

The next time you touch the same preset tuning key [P1] to [P6] the station is recalled from memory.

- Up to 18 stations, 6 for each of three SIRIUS bands can be stored in memory.
- You can also touch [◀] or [▶] to recall stations assigned to preset tuning keys [P1] to [P6] in the detailed information display during "All Ch Mode".

Using "My Mix" function

The MyMix function memorizes the song title and artist name of the song currently being received. When a track that matches the memorized song title and artist name is being broadcast on a station other than the one you are listening to, you will be alerted, and you can switch the station to listen to that song.

- The track itself is NOT downloaded; only the song title and the artist name are memorized.

Memorizing the song

The song title and artist name of the song you are listening to can be memorized.

● Touch [Memo].

The song title and artist name of the song you are listening to are memorized, and a confirmation message appears.

- Up to 10 song titles and artist names can be memorized.
- You cannot memorize the song title or the artist name when "-----" is displayed on the title information.
- You cannot memorize the song title or the artist name of channel "000".
- The memorized title may not be displayed correctly.

When the memorized song is broadcast

A beep sounds, and a message is displayed. Touch [Yes] to switch to that station and listen to that track.

- If the alert for the song is "Off" or [Alert Off] is selected, no notification will be provided even when that song is broadcast.
 - ➔ For details, refer to **Setting the memorized songs** on page 138.
- Notification may not be provided depending on the situation of the Navigation System.
 - ➔ For details, refer to *Selecting the songs to alert* on page 138.
- If there is even a slight difference between the memorized title and the title of the track being broadcast, no notification will be provided even though they are the same song.

Using the direct traffic announcement function

You can listen to a memorized traffic channel by directly calling it up with the [TRAFFIC] (Only one station can be memorized).

Using the SIRIUS tuner

Memorizing an traffic channel

1 Tune in to a traffic channel.

2 Touch and hold [TRAFFIC] for two seconds or more.

The traffic channel will be memorized.

- ❑ Even if you use this with the XM satellite radio tuner, only one station can be memorized. The station memorized afterward will overwrite the existing one.
- ❑ The channels 000 can not be memorized.

Tuning in to the memorized channel

● Touch [TRAFFIC].

- ❑ You can also perform this operation by touching [TRAFFIC] on the “AV Source” menu.
- ❑ To cancel a traffic announcement, touch [TRFC Off].

Using the “Instant Replay” function

The “Instant Replay” function allows you to replay the stored broadcast on the SIRIUS tuner (if the tuner capable for this function). As soon as you tune to a channel, the SIRIUS tuner automatically begins storing the broadcast. It can store approximately up to 44 minutes previous (depending on the selected channel and the memory capacity of connected tuner).

1 Touch [Instant Replay] on the SIRIUS screen to activate the “Instant Replay” mode.

2 Touch keys for “Instant Replay”.

[◀◀]	Return to the start of the current song or program. Touching again will skip back to the previous song or program.
[◀◀] and hold	Fast reverses.
[▶▶]	Forwards play to the next song or program

[▶▶] and hold	Fast-forwards.
---------------	----------------

[▶/]	Touching [▶/] switches between playback and pause.
--------	--

- ❑ During “Instant Replay” mode, each touch of [Disp] changes the display information as follows:
Time position — Channel number — Channel name — Channel category — Artist name/feature — Song/program title — Composer
- ❑ You cannot replay the broadcast prior to the beginning of stored data. ◻

Using the “Function” menu

1 Touch [SIRIUS] on the “AV Source” menu to display the “SIRIUS” screen.

- For details concerning operations, refer to *Screen switching overview* on page 34.

2 Touch [Func].

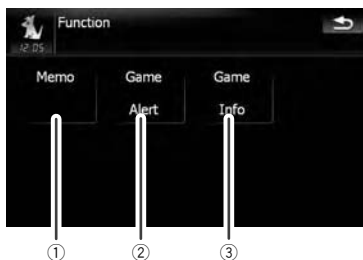

① Setting the memorized songs

- For details, refer to the next page.

② Using the Game Alert function

- For details, refer to the next page.

③ Displaying Game Information

- For details, refer to page 139.

Setting the memorized songs

Selecting the songs to alert

Display the song title list memorized for the MyMix Function (MyMix list). You can change the setting of the notification when the song is broadcast again. You can enable or disable notification for each song.

- 1 Touch **[Memo]**.
- 2 Touch **[◀ Prev]** or **[Next ▶]** to select the desired song.



- 3 Touch **[On/Off]** to turn the setting on.

When the alert for the song is activated, **[ON]** appears at the beginning of the selected title.

- Touch **[On/Off]** again to turn the setting off.

Changing the alert setting

You can enable or disable alerts for all items at the same time. This function is useful when you want to turn alerts off temporarily without changing each memorized song.

- 1 Touch **[Memo]**.
- 2 Touch **[Alert On]** or **[Alert Off]**.
 - Touch to toggle the selection.

Deleting the memorized songs

You can delete each one of the memorized tracks from the song title list.

- 1 Touch **[Memo]**.
- 2 Touch **[◀ Prev]** or **[Next ▶]** to select the song title that you want to delete.

- 3 Touch **[Delete]** when the song you want to delete is displayed.

A message will appear asking you to confirm the deletion.

- 4 Touch **[Yes]**.

Using the Game Alert function

Selecting teams for Game Alert

This navigation system can alert you when games involving your favorite sports teams are about to start. To use this function you need to store the teams you want to follow in advance.



- 1 Touch **[Game Alert]**.
- 2 Touch **[◀ Prev]** or **[Next ▶]** to select the league.
- 3 Touch **[◀ Prev]** or **[Next ▶]** to select the team.

- 4 Touch **[On/Off]**.

The team displayed as **[ON]** is the alert target.

- When the selected team is excluded from the alert target, the team is displayed as **[OFF]**. Up to 12 teams can be selected. When you have already made 12 team selections, "FULL" is displayed and additional team selection is not possible. In this case, first delete the team selection and then try again.

Using the SIRIUS tuner

5 Touch [Alert On].



Changing the alert setting

You can enable or disable the alert for selected items. This function is useful when to want to turn the alert off temporarily without changing the setting of each selected team.

1 Touch [Game Alert].

2 Touch [Alert On] or [Alert Off].

- Touch to toggle the selection.

When a game involving one of your teams is broadcast

A message is displayed. Touch [Jump] to switch the station, and you can view the game information. If you touch [Stay], the channel does not switch.

- Alerts may not be provided depending on the status of the navigation system.

Displaying Game Information

An alert will be displayed when a game with the team you selected is about to start (or is currently under way). You can also display game information and changes to the broadcast channel.

- The Game Information function is available when [Alert] is [On] in "Game Alert".

1 Touch [Game Info].

2 Touch [Prev] or [Next] to view the game score information which is registered.

- The game score will be updated automatically.
- Touch [Tune To] to switch to the channel that broadcasts the displayed game.
- If you have not made any team selections, "Not Set" is displayed.
- When no games involving your favorite teams are currently being played "NO GAME" is displayed.

You can display “video image” output by **AV1 Input** or **AV2 Input** to the screen of the navigation system. For details of the connection method, refer to “Installation Manual”.

! CAUTION

For safety reasons, video images cannot be viewed while your vehicle is in motion. To view video images, you must stop in a safe place and apply the parking brake.

Using AV1

You can display “video image” output by the equipment connected to “**AV1 Input**”.

1 Touch [AV1 Input] on the “AV System Settings” menu.

- ➔ For details, refer to *Setting video input 1 (AV1)* on page 163.

2 Touch [AV1] on the “AV Source” menu.

The image is displayed on the screen.

- ➔ For details concerning operations, refer to *Screen switching overview* on page 34.

Using AV2

You can display “video image” output by the equipment connected to “**AV2 Input**”.

1 Touch [AV2 Input] on the “AV System Settings” menu.

- ➔ For details, refer to *Setting video input 2 (AV2)* on page 163.

2 Touch [AV2] on the “AV Source” menu.

The image is displayed on the screen.

- ➔ For details concerning operations, refer to *Screen switching overview* on page 34.

Using the touch panel keys

- Touch the screen to display the touch panel keys.



① Recall equalizer curves

- ➔ For details, refer to *Recalling equalizer curves* on page 160.

② Hide the touch panel keys

- Touching [**Hide**] hides the touch panel keys. Touch anywhere on the LCD screen to display the touch panel keys again.

③ Display the map screen

Using the external unit (EXT1, EXT2)

The term “external unit” refers to future Pioneer devices that are not currently planned for, or to devices that allow control of basic functions although they are not fully controlled by the navigation system. Two external units can be controlled by this navigation system. When two external units are connected, the navigation system allocates them as external unit 1 or external unit 2.

For details of the connection method, refer to “Installation Manual”.

For details concerning operation, refer to the external unit’s operation manual. This section provides information on external unit operations with the navigation system that differ from those described in the external unit’s operation manual.

- ❑ Operation varies depending on the external unit connected. (In some cases, the external unit may not respond.)

Reading the screen



- ① **Source icon**
Shows which source has been selected.
- ② **External unit indicator**
Displays the information that is sent by connected external units.
- ③ **Auto/Manual mode indicator**
Shows the current mode.

Using the touch panel keys

- **Touch [EXT1] or [EXT2] on the “AV Source” menu to select the external unit.**
 - For details concerning operations, refer to *Screen switching overview* on page 34.

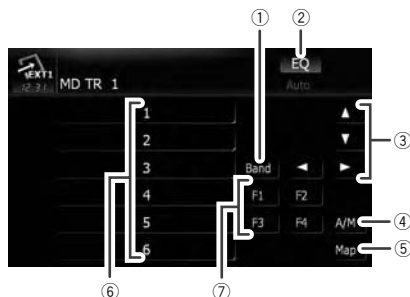

- ① **Send a band command**
Touch to send a band command to the external unit.
 - ❑ Operation varies depending on the external unit connected. (In some cases, the external unit may not respond.)
- ② **Recall equalizer curves**
 - For details, refer to *Recalling equalizer curves* on page 160.
- ③ **Send an [▲], [▼], [◀], or [▶] command**
Touch to operate the external unit.
 - ❑ Operation varies depending on the external unit connected. (In some cases, some functions may not be used until you touch and hold the key.)
- ④ **Switching between automatic and manual function**
You can turn automatic and manual function on or off.
You can switch between **Auto** and **Manual** functions of the external unit connected. Initially, this function is set to **Auto**.
 - ❑ Operating commands set for **Auto** and **Manual** operations vary depending on the external unit connected.
- ⑤ **Display the map screen**
- ⑥ **Send a 1 key to 6 key command**

Using the external unit (EXT1, EXT2)

The external unit can be operated by transmitting the operating commands set to **1** key — **6** key.

- ❑ Operation varies depending on the external unit connected. (In some cases, some functions may not be used until you touch and hold the key.)

⑦ Use F1 — F4 to operate the external unit

The external unit can be operated by transmitting the operating commands set to **F1** — **F4**.

- ❑ The operating commands set to **F1** — **F4** vary depending on the external unit.
- ❑ Some functions may not be used until you touch and hold the key. ▣

Customizing preferences

The options in the “Navi Settings” menu

Basic operations in the “Navi Settings” menu

Preferences related to the navigation functions can be set.

A method for changing the volume setting for the navigation guidance and beep is described here, along with an operational example.

1 Press the MENU button to display the “Top Menu”, and then touch [Settings].

2 Touch [Navi Settings].



The “Navi Settings” menu appears.

3 Touch [Sound settings].



The “Sound settings” menu appears.

4 Use the tool assigned to the desired option to change the settings.

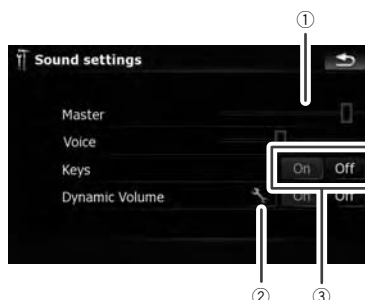

① Slider

Change the value by touching the desired point on the bar or dragging the slider to the desired point.

② Detailed setup key

Displays the screen for setting the preferences in detail.

③ On-off control

Touching [On] or [Off] enables activation or deactivation of this function.

5 Touch [Return] to return to the “Navi Settings” menu.

GPS & Time Settings

Indicates the connection status of the GPS antenna, its reception sensitivity, and from how many satellites the signal is being received from.

● Touch [GPS & Time Settings] on the “Navi Settings” menu.

The “GPS Status” screen appears.

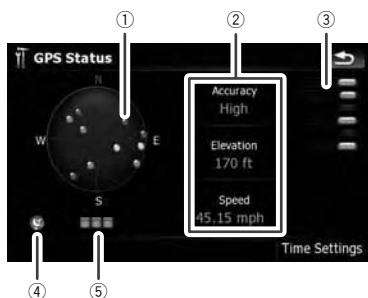

- ① Positions of the GPS constellation being received by the navigation system

Color	Signal communication	Used in positioning
Green	Yes	Yes
Gray	Yes	No
Red	No	No

- ② Shows the current comprehensive accuracy, altitude and speed.
 ③ Shows each satellite's signal strength.
 ④ Shows the connection status or reception condition of GPS antenna.

Color	Condition
Green	3D reception (Normal positional accuracy)
Yellow	2D reception (lower positional accuracy)
Red	Connected and no reception
Black with x	No connection

- ⑤ Shows the GPS reception status. A blinking green lamp indicates whether positioning is works normally. If the lamp lights up in another color, there is a problem related with GPS reception. In such case, check whether the connection and installation are correct.

Time Settings

Use the "Time Settings" screen to set the time manually.

- 1 Touch [GPS & Time Settings] on the "Navi Settings" menu.

The "GPS Status" screen appears.

- 2 Touch [Time Settings].

The "Time Settings" screen appears.



Available options;

- "Auto Correction"

Synchronizes the internal clock of this navigation system with the accurate time transmitted from GPS (GMT). Changing this preference allows you to set the time manually.

CAUTION

Turning "Auto Correction" to "Off" disables the automatic change to the appropriate time zone. Note that the proper route may not be calculated if the time you set does not match the time zone of the area that your route passes through.

[On]:

Corrects the current time by changing the time zone automatically according to this system's whereabouts.

[Off]:

Corrects the current time according to the settings on "Time Zone" and "Time".

- "Time Zone"

Enables you to set the time zone manually. Touch the key to show the list and then touch the current time zone.

Customizing preferences

- **"Time"**
Enables you to adjust the time difference by one hour. Touch ▲ or ▼ to adjust it.
 "Time Zone" and **"Time"** are activated only when **[Off]** is selected.

POI Settings

1 Touch [Map Visual] on the "Navi Settings" menu.

The **"Map Visual Settings"** screen appears.

2 Touch [POI Settings].

The **"POI Settings"** screen appears.

- ➔ For more details of the operation, refer to *POI display settings* on page 150.

3D Settings

The 3D map screen settings can be customized.

1 Touch [Map Visual] on the "Navi Settings" menu.

The **"Map Visual Settings"** screen appears.

2 Touch [3D Settings].

The **"3D Visual Settings"** screen appears.

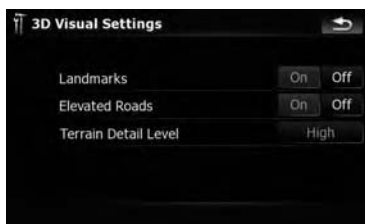

Available options;

- **"Landmarks"**
You can select whether to draw or refrain from drawing graphical 3D landmarks on the map.
- **"Elevated Roads"**
You can select whether to draw or refrain from drawing elevated roads, interchanges, and bridges on the map.
- **"Terrain Detail Level"**

[High], **[Medium]**, **[Low]**:

Draws the terrain (e.g. mountain chains) on the map with the selected detail level.

[Off]:

Does not draw the terrain on the map.

Map Settings

The general settings related with a map screen can be customized.

1 Touch [Map Visual] on the "Navi Settings" menu.

The **"Map Visual Settings"** screen appears.

2 Touch [Map Settings].

The **"Map Settings"** screen appears.

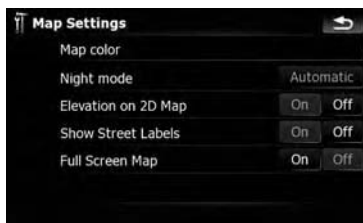

Available options;

- **[Map color]**
Enables you to define the map color for daytime and nighttime use. Touch this key to show the next screen.
"Daylight color profile:"
The daytime map color can be set. Touch the key and select the desired profile from the list.
"Night color profile:"
The nighttime map color can be set. Touch the key and select the desired profile from the list.
- **"Night mode"**
Changes the settings for the nighttime map.
[Automatic]:
Switches the map color defined under **"Map color"** automatically between daytime and nighttime.

[Night]:

Always displays the map in the color defined on "**Night color profile**".

[Day]:

Always displays the map in the color defined on "**Daylight color profile**".

- "**Elevation on 2D Map**"
You can select whether to draw or refrain from drawing the terrain with a realistic landscape on the map, such as a green space, water place, undulating surface.
- "**Show Street Labels**"
Shows or hides street names and city names.
- "**Full Screen Map**"
Shows/hides the "**Multi-Info window**" and "Second manoeuvre arrow".

Displayed Info

Allows you to select what options you want to display on each part of the "**Multi-Info window**".

- The estimated time of arrival is an ideal value that the navigation system computes internally as the route is calculated. The estimated time of arrival should be read just as a reference value, and does not guarantee arrival at the time indicated.

A method for changing the value of **Top field**: is described here along with an operational example.



1 Touch [Map Visual] on the "Navi Settings" menu.

The "**Map Visual Settings**" screen appears.

2 Touch [Displayed Info].

The "**Displayed Info**" screen appears.

3 Touch the key on the right of "Top field:" to display the options.



4 Touch your desired option.



Smart Zoom

Enables the navigation system to zoom in automatically when you approach a guidance point and zoom out after you pass through it. You can setup the behavior while "**Smart Zoom**" is activated.

- When no route is set, the navigation system will simply zoom in or out depending on your speed.

1 Touch [Map Visual] on the "Navi Settings" menu.

The "**Map Visual Settings**" screen appears.

2 Touch [On] or [Off] to activate or deactivate "Smart Zoom".

Touching  allows you to enter the detailed setting screen only when [On] has been selected.

Customizing preferences

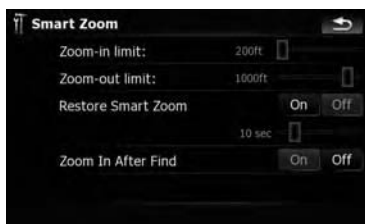

Available options;

- **"Zoom-in limit:"**
Allows you to set the limit for zoom-in behavior.
- **"Zoom-out limit:"**
Allows you to set the limit for zoom-out behavior.
- **"Restore Smart Zoom"**
Allows you to set whether **"Smart Zoom"** is to be reactivated after changing the map scale, tilt, or rotation.
Also, enables you to set how soon **"Smart Zoom"** interval will be reactivated after completion of the operations described previously.
- **"Zoom In After Find"**
Shows the **"Map Confirmation Screen"** with the preset map scale after you have searched for a position using one of the methods on the **"Destination Menu"**.

Overview Mode

Enables the navigation system to zoom out automatically up to the selected map scale when the next guidance point is distant.

1 Touch [Map Visual] on the "Navi Settings" menu.

The **"Map Visual Settings"** screen appears.

2 Touch [On] or [Off] to activate or deactivate "Overview Mode".

Touching  allows you to enter the detailed setting screen only when [On] has been selected.

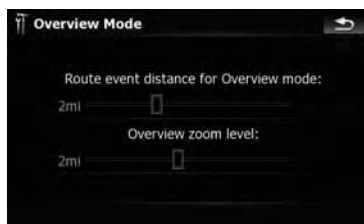

Available options;

- **"Route event distance for Overview mode:"**
Allows you to set a distance to activate **"Overview Mode"**. The map starts zooming out when the distance to the next guidance point is further than the distance set here.
- **"Overview zoom level:"**
Allows you to set the map scale for zoom-out behavior in **"Overview Mode"**.

Manage Track Logs

- For more details of the operation, refer to *Recording your travel history* on page 152.

Route

The settings related to route calculation can be customized.

- **Touch [Route] on the "Navi Settings" menu.**

The **"Route Settings"** screen appears.



Available options;

- **"Method:"**

Determines which condition takes priority for route calculation.

[Fast]:

Calculates a route with the shortest travel time to your destination as a priority.

[Short]:

Calculates a route with the shortest distance to your destination as a priority.

[Easy]:

Calculates a route to your destination with the fewest turning points possible as a priority.

[Economical]:

Calculates a route on the basis of least fuel consumption.

- **"U-turn penalty:"**

Allows you to limit the distance increase for U-turns.

- **"Unpaved Roads"**

[On]:

Calculates a route which does not avoid unpaved roads.

[Off]:

Calculates a route which avoids unpaved roads as far as possible.

- **"Highways"**

[On]:

Calculates a route which does not avoid freeways.

[Off]:

Calculates a route which avoids freeways as far as possible.

- **"Ferries"**

[On]:

Calculates a route which does not avoid ferries.

[Off]:

Calculates a route which avoids ferries as far as possible.

- **"U-turns"**

[On]:

Calculates a route which does not avoid U-turns.

[Off]:

Calculates a route which avoids U-turns as far as possible.

Turning back on a divided highway is not considered a U-turn.

- **"Permit Needed"**

[On]:

Calculates the route without taking into account roads and areas where permission is needed for entry.

[Off]:

Calculates the route taking into account the roads and areas where permission is needed for entry.

- **"Toll Roads"**

[On]:

Calculates a route which does not avoid toll roads and areas.

[Off]:

Calculates a route which avoids toll roads and areas as far as possible.

Warnings

The settings related to warnings can be customized.

- **Touch [Warnings] on the "Navi Settings" menu.**

The **"Warning settings"** screen appears.



Available options;

- **"Warn When Speeding"**

Sets whether or not to enable the excessive speed warnings for when you exceed the speed limit.



Customizing preferences

The speed limit is based on the map database. The speed limit in the database may not match the actual speed limit of the current road. This is not a definite value. Be sure to drive according to the actual speed limit.

- **"Speeding Tolerance"**
Sets the tolerance for the speed limit with a percentage.

Regional Settings

The display format for the distance unit, latitude and longitude, and other settings related to time and date can be customized.

- **Touch [Regional Settings] on the "Navi Settings" menu.**

The **"Regional Settings"** screen appears.

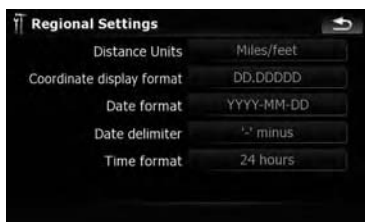

Available options;

- **"Distance Units"**
Controls the unit of distance and speed shown.
- **"Coordinate display format"**
Controls the format of latitude and longitude shown.
- **"Date format"**
Controls the date display format.
- **"Date delimiter"**
Controls the delimiter format used for date display.
- **"Time format"**
Controls the time display format.

Set Home

- For more details of the operation, refer to *Setting your home position* on page 154.

Demo Mode

This is a demonstration function for retail stores. After a route is set, touching this key starts the simulation of route guidance.

- 1 **Touch [Demo Mode] on the "Navi Settings" menu.**

- 2 **The demonstration guidance will begin.**

- ☐ If you want to run the simulation at faster speed, touch **[Fly over]** on the **"Route Information"** screen.
- For more details of the operation, refer to *Playing simulated travel at high speed* on page 60.

Sound settings

All settings here are effective only for the navigation guidance and beep.

- **Touch [Sound settings] on the "Navi Settings" menu.**

The **"Sound settings"** menu appears.



Available options;

- **"Master"**
Controls the master volume of both the navigation guidance and beep.
- **"Voice"**
Controls the volume of the navigation guidance.

- **"Keys"**
[On]: Sounds a beep.
[Off]: Does not sound a beep.
- **"Dynamic Volume"**
Increases and decreases the master volume of the navigation guidance and beep automatically according to the current speed. This function is very helpful when you are driving at high speed and there is too much noise to hear the guidance instructions and beep.
Touching  allows you to enter the detailed setting screen only when [On] has been selected.
"Minimum speed:"
Enables the navigation system to automatically start turning the volume up as the current speed reaches the value set here.
"Maximum speed:"
Enables the navigation system to automatically maximize the volume when the current speed reaches the value set here.

Important Notice regarding Volume of Navigation Voice Guidance when Playing Audio Files from USB or SD

If music files stored on an external storage device (USB, SD) are played when the system guides the route (i.e., a destination has been selected and the system is routing you to a destination), the volume of the navigation guidance voice will be the same as the volume of the music files being played, even if a different volume level has been selected on **"Master"** or **"Voice"** or **"Dynamic Volume"** in the **"Sound settings"** menu.

About

Enables you to check the copyright and other information about the map database.

1 Touch [About].

Copyright information of the database is displayed.

2 Touch [Maps].

Touching **[Maps]** allows you to view the information regarding the map database in detail. After that, touching the desired item on the list allows you to view more detailed information about the selected map database.

POI display settings

You can display or hide the POI (points of interest) icons on the map. To avoid the screen becoming crowded with POI icons, all the icons have been made invisible as a default setting. You can set the conditions for each category here and also create new categories.

- If the custom POI is found on an external storage device (USB, SD), the navigation system will show a POI list which includes them.

1 Touch [Map Visual] on the "Navi Settings" menu.

The **"Map Visual Settings"** screen appears.

2 Touch [POI Settings].

3 Touch the desired category that you want to display.



If there are more detailed categories within the selected category, repeat this step as many times as necessary.

If there aren't anymore detailed categories, a blank list appears. In this case, you can only create the new category by touching **[New Group]**.

4 Touch [Edit] on the right of the desired sub-category to set the appearance.

Customizing preferences

5 Touch the desired key to customize it.



Available options;

- **"POI Icon Visibility Distance"**
Touch this key to show options. Touch one of them to set the desired visibility. When **"Satellite"** is selected, the POI icons will appear even though they are far away from your current position. When **"Close"** is selected, only the nearest POI icons will appear. Selecting **"Off"** hides the POI icons of this category.
- **"Same Visibility in Subgroups"**
[On]:
Also applies this visibility to all sub-categories belonging to this category.
[Off]:
Does not apply this visibility to all sub-categories belonging to this category.
- **"Icon:"**
Touch this key to show options. Touch one of them to set the desired icon.
- **[Remove]:**
Touch this key to delete the selected category.
 - [Remove]** is available only for POI categories that are created on this navigation system.

Creating new categories

If your customized POI does not match any of the pre-installed categories, create a new category and edit your customized POI so that it can belong to this newly-created category.

- If the custom POI is found on an external storage device (USB, SD), the navigation

system will show a POI list which includes them.

1 Touch [Map Visual] on the "Navi Settings" menu.

The **"Map Visual Settings"** screen appears.

2 Touch [POI Settings].

3 Touch the desired category.



If there are more detailed categories within the selected category, repeat this step as many times as necessary.

If there aren't any more detailed categories, a blank list appears. In this case, touching **[New Group]** allows you to create a new category.

4 Touch [New Group] at the screen where you want to create a new category.

5 Enter the category name and touch [Done] to complete the entry.



Editing your customized POI

If you have already stored the customized POI, you can edit its POI properties.

- ❑ If the custom POI is found on an external storage device (USB, SD), the navigation system will show a POI list which includes them.

1 Touch [Map Visual] on the “Navi Settings” menu.

The “Map Visual Settings” screen appears.

2 Touch [POI Settings].

3 Touch the category you want to edit.

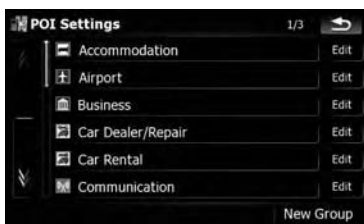

If there are more detailed categories within the selected category, repeat this step until the desired POI appears.

4 Touch the POI you want.

The “Edit POI” screen appears.

5 Touch the desired key to customize it.



Available options;

- **“Group:”**
The category that the item currently selected belongs to can be changed. Touching the key shows the options available.

Touch one of them to set the desired category.

- **“POI Name:”**
Touching the key displays the screen for entering a new POI name. Enter the name and then touch **[Done]** to complete the entry.
- **“Icon:”**
Touch this key to show options. Touch one of them to set the desired icon.
- **[Remove]:**
Touching the key allows you to delete the selected POI.
 - ❑ **[Remove]** is available only for POIs that are created on this navigation system.
 - ❑ The POI address is not editable.

Recording your travel history

Activating the track logger enables you to record your driving history (called “track log” below). You can review the travel history later and replay the travel for your reference.

Activating track logger temporarily

One-time activation is useful if you want to create a log only for that trip.

1 Touch [Map Visual] on the “Navi Settings” menu.

The “Map Visual Settings” screen appears.

2 Touch [Manage Track Logs].

A list of track logs already recorded appears. A blank list appears if you have not recorded it yet.

Customizing preferences

- 3 Touch **[Record]** to activate the track logger.

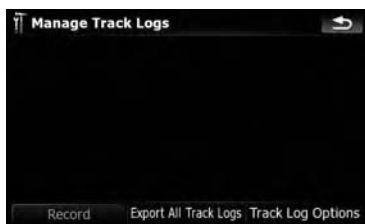

The key then changes to **[Stop Recording]**. Touching **[Stop Recording]** allows you to deactivate the track logger. Touching **[Export all track logs]** exports all track logs currently stored to the external storage device (USB or SD) at once. In addition, if you export track logs to the external storage devices, you can check the track logs using **[AVIC FEEDS]**.

- ❑ If there is not enough space in the built-in memory, the oldest track log will be overwritten by the new one.
- ❑ If you want to permanently activate the track logger whenever the GPS signal is available, switch **"Enable Auto-saving"** to **"On"**.
 - ➔ For details, refer to *Setting track logger options* on this page.

Browsing and replaying the track log

- 1 Touch **[Map Visual]** on the **"Navi Settings"** menu.

The **"Map Visual Settings"** screen appears.

- 2 Touch **[Manage Track Logs]**.

A list of track logs already recorded appears. Touching  enables you to replay the track log with **"Fly over"**.

- 3 Touch the desired track log on the list. More details about the track log appears.

- 4 Touch the desired key to operate it.



Available options;

- **[Rename]:** Touch this key to display the screen for entering a new name for the track log. Enter the name and then touch **[Done]** to complete the entry.
- **[Export]:** Touch this key to export the currently selected track log to the external storage device (USB or SD).
- **[Delete]:** Touch this key to delete the track log.
- **[Delete all]:** Touching this key deletes all track logs.
- **The key next to "Color on the map":** Touching this key displays the screen for changing the color used for the route highlighting of the track log. Touch the desired color on the color list. The color of track logs is assigned automatically within predefined colors when this setting is established.

Setting track logger options

- 1 Touch **[Map Visual]** on the **"Navi Settings"** menu.

The **"Map Visual Settings"** screen appears.

- 2 Touch **[Manage Track Logs]**.

- 3 Touch **[Track Log Options]**.

4 Touch the desired key to operate it.

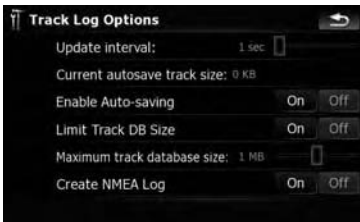

Available options;

- **"Update interval:"**
Sets how often the system updates the log.
- **"Current autosave track size:"**
Sets a size limit on automatic logging. This setting will be effective only when **"Enable Auto-saving"** is **"On"**.
- **"Enable Auto-saving"**
Sets whether or not automatic logging is activated.
- **"Limit Track DB Size"**
Limits the total data size for logging.
- **"Maximum track database size:"**
Sets a size limit on logging. This parameter is only adjustable when **"Limit Track DB Size"** is **"On"**.
- **"Create NMEA Log"**
Creates the log files in the SD memory card. When this setting is **"On"**, the system outputs the log files with NMEA-0183 format onto the SD memory card.

Setting your home position

Registering your home position saves time and effort. Also, routes to home positions can be calculated easily with a single touch of the key from the **"Destination Menu"**. The registered home position can also be modified later.

1 Touch [Set Home] on the **"Navi Settings"** menu.

2 Touch the key next to **"Address:"**.

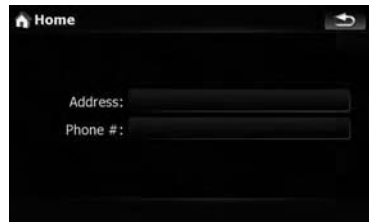

3 Perform one of the search methods and locate the cursor on your desired position.



4 Touch [OK].

5 Touch the key next to **"Phone #"**.

6 Enter your home phone number, then touch [Done].

Options on the **"System Settings"** menu

Displaying the **"System Settings"** menu

1 Press the MENU button to display the **"Top Menu"**, and then touch [Settings].

2 Touch [System Settings].

The **"System Settings"** menu appears.

Customizing preferences

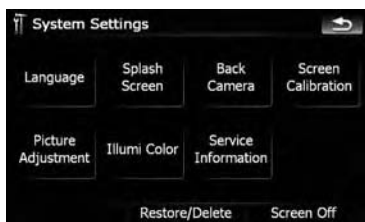

Selecting the language

You can set the languages used on the program and voice guidance. Each language can be set separately.

- ❑ If you use voice operation, select **[English]** in **[Program language:]** of **"Language"**. If you select other languages, voice operation will not be available.
 - ➔ For details, refer to *Basics of Voice Operation* on page 167.

1 Touch **[Language]** on the **"System Settings"** menu.

- ➔ For details, refer to *Displaying the "System Settings" menu* on the previous page.

2 Touch the key next to **"Voice language:"**.

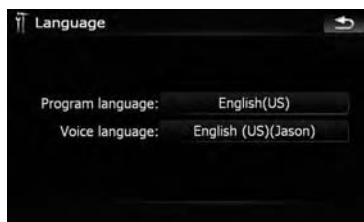

The language list is displayed.

3 Touch the desired language.

After the language is selected, the screen returns to the previous screen.

- ❑ **[TTS Setup]** is not used normally. This key will be used in the future when the system needs a replacement of current TTS files.

4 Touch the key next to **"Program language:"**.

5 Touch the desired language.

If you change **[Program language:]**, a message prompting you to reboot appears. Touch **[OK]** to reboot the system.

Changing the splash screen

You can change the splash screen that appears when the navigation system starts. Copy your chosen image to the external storage device (USB, SD), and select the image to import.

- ❑ Splash screen images should be used within the following formats;
 - BMP or JPEG files
 - Allowable horizontal and vertical size are 2592 pixels x 1944 pixels or smaller
 - Allowable data size is 15 MB or smaller
- ❑ Proper compatibility with allowable files is not guaranteed.

- ❑ Imported original images will be stored in the built-in memory, but the ability to save these images cannot be guaranteed completely. If your original image data is deleted, insert the external storage device (USB, SD) again and re-import the original image.

1 Create a folder named “Pictures” on the top-most directory of the external storage device (USB, SD) and store the picture files in this folder.

2 Insert the SD memory card into the SD card slot or plug the USB storage device into the USB connector.

3 Touch [Splash Screen] on the “System Settings” menu.

- ➔ For details, refer to *Displaying the “System Settings” menu* on page 154.

The navigation system checks the external storage device (USB, SD). If an appropriate file is found, the file list will be displayed.

- ❑ If there is no “Pictures” folder or loadable file, a message appears.
- ❑ You can switch the list by touching [Import from SD] and [Import from USB].

4 Touch the image to use as the splash screen from the list.

The image is displayed on the screen.

5 Touch [OK].

The image is set as the splash screen, and the system returns to the “System Settings” menu.

Setting the rear view camera

The following two functions are available. The rear view camera feature requires a separately sold rear view camera (e.g. ND-BC2). (For details, consult your dealer.)

Rear view camera

The navigation system features a function that automatically switches to the full-screen rear

view camera image installed on your vehicle. When the shift lever is in the REVERSE (R) position, the screen automatically switches to full-screen rear view camera.

Camera for “RearView”

[RearView] can display the full-screen rear view camera image any time without relation to the shift lever position after touching [RearView] on the “AV Source” menu. [RearView] is useful if you want to monitor an attached trailer, etc.

CAUTION

Pioneer recommends the use of a camera which outputs mirror reversed images, otherwise the screen image may appear reversed.

- ❑ Immediately verify whether the display changes to a rear view camera image when the shift lever is moved to REVERSE (R) from another position.
- ❑ When the whole screen changes to a rear view camera image during normal driving, switch to another setting.
- ❑ Initially, this function is set to “On”.

1 Touch [Back Camera] on the “System Settings” menu.

- ➔ For details, refer to *Displaying the “System Settings” menu* on page 154.

The “Camera Input” screen appears.

2 Touch [On] next to “Camera” to activate the camera setting.

- ❑ You can only switch to “RearView” if this setting is [On].

3 Touch [Battery] or [GND] next to “Polarity” to select the appropriate polarity setting.

- **Battery** — When the polarity of the connected lead is positive while the shift lever is in the REVERSE (R) position
- **GND** — When the polarity of the connected lead is negative while the shift lever is in the REVERSE (R) position

Customizing preferences

Adjusting the response positions of the touch panel (touch panel calibration)

If you feel that the touch panel keys on the screen deviate from the actual positions that respond to your touch, adjust the response positions of the touch panel screen.

- ❑ Do not use a sharp pointed tool such as a ballpoint pen or a mechanical pen, which could damage the screen.

1 Touch [Screen Calibration] on the “System Settings” menu.

A message confirming whether to start the calibration appears.

- ❑ You can also start calibration by pressing and holding the **MENU** button on the “Top Menu”.

2 Touch [OK].



3 Touch and hold the target that point to the center and corners of the LCD screen.

The target indicates the order.

4 Touch anywhere on the screen.

The adjusted position data will be saved.

- ❑ Do not turn off the engine while saving the adjusted position data.

5 Touch [OK].

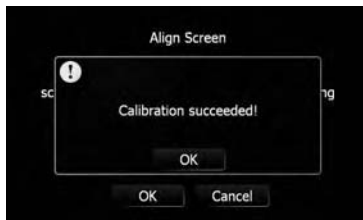

Adjusting the screen brightness

1 Touch [Picture Adjustment] on the “System Settings” menu.

- For details, refer to *Displaying the “System Settings” menu* on page 154.

2 Touch [+] or [-] to adjust the brightness.

Each time you touch [+] or [-] increases or decreases the level. **10** to **00** is displayed as the level is increased or decreased.

3 Touch to return to the previous screen.

- ❑ You can also start adjustment by pressing and holding the **MAP** button.

Setting the illumination color

The illumination color can be selected from 11 different colors. Furthermore, the illumination color can be switched between these 11 colors in order.

Selecting the color from the preset colors

1 Touch [Illumi Color] on the “System Settings” menu.

- For details, refer to *Displaying the “System Settings” menu* on page 154.

2 Touch the color you want.

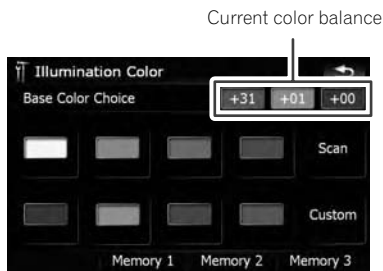

Available options;

- Colored keys — Selects the desired preset color
- **Memory 1/Memory 2/Memory 3** — Colors registered in the memory
 - For details, refer to *Creating a user-defined color and storing it to memory* on this page.
- **Scan** — Shifts between the eight default colors in sequence gradually.

Creating a user-defined color and storing it to memory

You can create a user-defined color and set it as the illumination color.

1 Touch [Illumi Color] on the “System Settings” menu.

- For details, refer to *Displaying the “System Settings” menu* on page 154.

2 Touch [Custom].

- ☐ If [Scan] is set, [Custom] cannot be selected.

3 Touch [+] or [-] to adjust the values for Red, Green and Blue to create a favorite color.

Watch the illumination of hardware keys while adjusting the color.

Each time you touch [+] or [-] increases or decreases the value of the selected item. +31 to +00 is displayed as the value is increased or decreased.

- ☐ An entry cannot be stored with all of the values set to “+00”.

4 Touch [Memory 1], [Memory 2] or [Memory 3] to store the illumination color.

5 Touch [Return] to return to the previous screen.

Checking the version information

1 Touch [Service Information] on the “System Settings” menu.

- For details, refer to *Displaying the “System Settings” menu* on page 154.

2 Check the version information.

Restore Factory Settings

Resets various settings registered to the navigation system and restores them to the default or factory settings.

- ☐ Some data remains. Read *Returning the navigation system to the default or factory settings* before you operate this function.
 - For more detailed information about the items which would be erased, refer to *Returning the navigation system to the default or factory settings* on page 174.

Customizing preferences

- 1 Touch [Restore/Delete] on the “System Settings” menu.



- 2 Touch [Restore Factory Settings] or [Delete user information].

- Because deleted data cannot be restored, take extra care not to mistakenly delete items.

- 3 Touch [OK].

The navigation system will now restart.

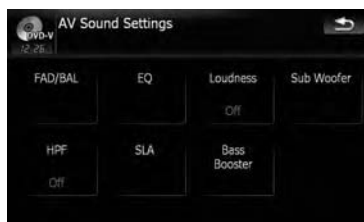

- You cannot make adjustments when the AV source is “OFF”.
- You cannot select [SLA] when the FM tuner is selected as the AV source.

Turning off the screen

By turning off the backlight of the LCD screen, you can turn off the screen display without turning off the voice guidance.

- Touch [Screen Off] on the “System Settings” menu.

- ☞ For details, refer to *Displaying the “System Settings” menu* on page 154.

The screen is turned off.

- Touch anywhere on the screen to turn it back on.

The “AV Sound Settings” menu options

Displaying the “AV Sound Settings” menu

- 1 Press the MENU button to display the “Top Menu”, and then touch [Settings].

- 2 Touch [AV Sound].

The “AV Sound Settings” menu appears.

Using balance adjustment

You can select a fader/balance setting that provides an ideal listening environment in all occupied seats.

- 1 Touch [FAD/BAL] on the “AV Sound Settings” menu.

- ☞ For details, refer to *Displaying the “AV Sound Settings” menu* on this page.

When [Sub W] is selected in [Rear SP], [Balance] will be displayed instead of [FAD/BAL] and front/rear speaker balance cannot be adjusted.

- ☞ Refer to *Setting the rear output* on page 165.

- 2 Touch [▲] or [▼] to adjust front/rear speaker balance.

Each time you touch [▲] or [▼], the front/rear speaker balance moves towards the front or the rear.

“**Front:15**” to “**Rear:15**” is displayed as the front/rear speaker balance moves from front to rear.

Setting “**Front:**” and “**Rear:**” to “**0**” is correct when using a two speaker system.

3 Touch [◀] or [▶] to adjust left/right speaker balance.

Each time you touch [◀] or [▶], the left/right speaker balance moves towards the left or the right.

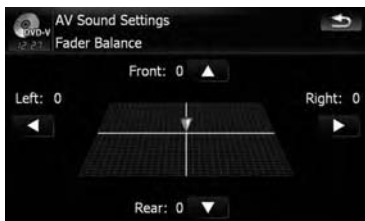

Left:15 to **Right:15** is displayed as the left/right speaker balance moves from left to right.

Using the equalizer

The equalizer lets you adjust equalization to match vehicle interior acoustic characteristics as desired.

Recalling equalizer curves

There are seven stored equalizer curves that you can easily recall at any time. Here is a list of the equalizer curves:

Equalizer curve

S.Bass

S.Bass is a curve in which only low-pitched sound is boosted.

Powerful

Powerful is a curve in which low-pitched and high-pitched sounds are boosted.

Natural

Natural is a curve in which low-pitched and high-pitched sounds are slightly boosted.

Vocal

Vocal is a curve in which the midrange, which is the human vocal range, is boosted.

Flat

Flat is a flat curve in which nothing is boosted.

Custom1

Custom1 is an adjusted equalizer curve that you create. A separate custom curve can be created for each source.

Custom2

Custom2 is an adjusted equalizer curve that you create. If you select this curve, the effect is reflected all AV source.

1 Touch [EQ] on the “AV Sound Settings” menu.

- For details, refer to *Displaying the “AV Sound Settings” menu* on the previous page.

2 Touch the equalizer you want.

- ☐ You can also sequentially select the desired equalizer curve by touching [EQ] on the AV operation screen of each source.

Adjusting the equalizer curves

You can adjust the currently selected equalizer curve setting as desired. Adjustments can be made with a 3-band parametric equalizer.

The difference between “Custom1” and “Custom2”

- A separate **Custom1** curve can be created for each source. If you make adjustments when a curve **S.Bass**, **Powerful**, **Natural**, **Vocal**, **Flat**, or **Custom1** is selected, the equalizer curve settings will be memorized in **Custom1**.
- A **Custom2** curve can be created common to all sources. If you make adjustments when **Custom2** curve is selected, the **Custom2** curve will be updated.
- The adjusted **Custom1** curve is memorized for each of the source selected, but one curve is shared for the following sources.
 - **CD**, **ROM**, **DVD-V**, **DVD-VR**, **DivX** (for AVIC-X910BT)

Customizing preferences

- **CD, ROM** (for AVIC-X710BT)
- **XM** and **SIRIUS**
- **AV1** and **AV2**
- **EXT1** and **EXT2**
- The different source volume level can be set between **iPod** and **USB**.
- When [**Flat**] is selected, no supplement or correction is made to the sound. This is useful to check the effect of the equalizer curves by switching alternatively between [**Flat**] and a set equalizer curve.

Adjustable parameters

You can adjust the center frequency, level and Q factor (curve characteristics) of each currently selected curve band (**Low/Mid/High**).



- **Band:**
You can select the equalizer band.
- **Frequency:**
You can select which frequency to set as the center frequency.
- **Level:**
You can select the decibel (dB) level of the selected EQ.
- **Q:**
You can select the details of the curve characteristics. (The following figure shows the characteristic image.)

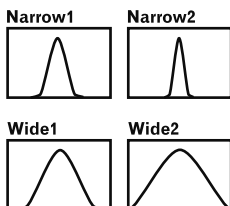

1 Touch [EQ] on the “AV Sound Settings” menu.

- ☉ For details, refer to *Displaying the “AV Sound Settings” menu* on page 159.

2 Touch the one of keys to select a curve that you want to use as the basis of customizing.

3 Touch [Customize].

4 Touch [◀] or [▶] to select the equalizer band to adjust.

Each time you touch [◀] or [▶] selects equalizer bands in the following order:

Low — Mid — High

5 Touch [◀] or [▶] to select the desired frequency.

Touch [◀] or [▶] until the desired frequency appears in the display.

Low: 40 Hz — 80 Hz — 100 Hz — 160 Hz

Mid: 200 Hz — 500 Hz — 1 kHz — 2 kHz

High: 3.15 kHz — 8 kHz — 10 kHz — 12.5 kHz

6 Touch [◀] or [▶] to adjust the level of the equalizer band.

Each time you touch [◀] or [▶], the level of the equalization band increases or decreases. **+6** to **-6** is displayed as the level is increased or decreased.

7 Touch [◀] or [▶] to select the desired Q factor.

Touch [◀] or [▶] until the desired Q factor appears in the display.

Wide2 — Wide1 — Narrow1 — Narrow2

Adjusting loudness

Loudness compensates for deficiencies in the low- and high-sound ranges at low volume.

1 Touch [Loudness] on the “AV Sound Settings” menu.

- ☉ For details, refer to *Displaying the “AV Sound Settings” menu* on page 159.

2 Touch [Loudness] to select the level you want.

Each time you touch [Loudness], the level is selected in the following order:

Off — Low — Mid — High

Using subwoofer output

The navigation system is equipped with a subwoofer output mechanism, which can be turned on or off.

- Only when “Sub Woofer” is [On], you can adjust “Phase”, “Level” and “Frequency”.

1 Touch [Sub Woofer] on the “AV Sound Settings” menu.

- For details, refer to *Displaying the “AV Sound Settings” menu* on page 159.

2 Touch [On] to turn subwoofer output on.

To turn subwoofer output off, touch [Off].



3 Touch [Reverse] or [Normal] to select the phase of subwoofer output.

4 Touch [+] or [-] next to “Level” to adjust the output level.

+6 to -24 is displayed as the level is increased or decreased.

5 Touch [+] or [-] next to “Frequency” to select cut-off frequency.

Each time you touch [+] or [-], cut-off frequencies are selected in the following order:

50 Hz — 63 Hz — 80 Hz — 100 Hz — 125 Hz

Only frequencies lower than those in the selected range are output from the subwoofer.

Using the high pass filter

When you do not want low sounds from the subwoofer output frequency range to play from the front or rear speakers, activate **HPF** (high pass filter). Only frequencies higher than those in the selected range are output from the front or rear speakers.

1 Touch [HPF] on the “AV Sound Settings” menu.

- For details, refer to *Displaying the “AV Sound Settings” menu* on page 159.

2 Touch [HPF] to select cut-off frequency.

Each time you touch [HPF] selects cut-off frequencies in the following order:

Off — 50 Hz — 63 Hz — 80 Hz — 100 Hz — 125 Hz

Adjusting source levels

SLA (source level adjustment) lets you adjust the volume level of each source to prevent radical changes in volume when switching between sources.

- Settings are based on the FM tuner volume level, which remains unchanged.

1 Compare the FM tuner volume level with the level of the source you wish to adjust.

2 Touch [SLA] on the “AV Sound Settings” menu.

- For details, refer to *Displaying the “AV Sound Settings” menu* on page 159.

3 Touch [+] or [-] to adjust the source volume.

+4 to -4 is displayed as the source volume is increased or decreased.

The following AV sources are set to the same source level adjustment volume automatically.

- **CD, ROM, DivX** (for AVIC-X910BT)
- **CD, ROM** (for AVIC-X710BT)
- **XM** and **SIRIUS**
- **AV1** and **AV2**
- **EXT1** and **EXT2**

Customizing preferences

- ❑ The different source volume level can be set between **iPod** and **USB**.
- ❑ For AVIC-X910BT, the source volume level can be set to **DVD-V** and **DVD-VR** respectively as well as differently from the other sources of the built-in DVD drive previously mentioned.

Enhancing bass (Bass Booster)

The “**Bass Booster**” enhances bass sounds, which can be muted by driving noise.

1 Touch [Bass Booster] on the “AV Sound Settings” menu.

- For details, refer to *Displaying the “AV Sound Settings” menu* on page 159.

2 Touch [+] or [-] to adjust the range from 0 to 6.

Options on the “AV System Settings” menu

Displaying the “AV System Settings” menu

1 Press the MENU button to display the “Top Menu”, and then touch [Settings].

2 Touch [AV Settings].

The “**AV System Settings**” menu appears.

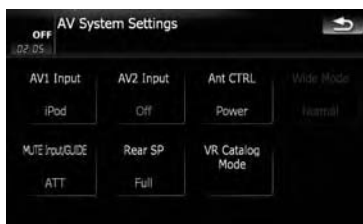

- ❑ You can only adjust [**Wide Mode**] when selecting an AV source with video.
- ❑ Only when the AV source is “**OFF**”, the following items can be adjusted; [**MUTE Input/GUIDE**] and [**Rear SP**]

Setting video input 1 (AV1)

You can switch this setting according to the connected component.

- ❑ This setting applies to RCA inputs (AUDIO INPUT and VIDEO INPUT) on the back of the system.

● Touch [AV1 Input] on the “AV System Settings” menu.

- For details, refer to *Displaying the “AV System Settings” menu* on this page.

Each touch of [**AV1 Input**] changes the setting as follows:

- **iPod** — iPod connected with the USB Interface cable for iPod (CD-IU230V)
- **Video** — External video component
- **EXT** — Pioneer external unit connected with the RCA video cable
- **Off** — No video component is connected

Setting video input 2 (AV2)

You can switch this setting according to the connected component.

- ❑ This setting applies to mini-jack input on the front panel.

● Touch [AV2 Input] on the “AV System Settings” menu.

- For details, refer to *Displaying the “AV System Settings” menu* on this page.

Each touch of **[AV2 Input]** changes the setting as follows:

- **Off** — No video component is connected
- **Video** — External video component
- Use **AV2 Input** when connecting CD-RM10 (sold separately) through the external video component.

Switching the auto antenna setting

If the blue lead of the navigation system is connected to the antenna control terminal of the vehicle, select either of the following settings.

- **Radio** — The antenna extends or turns on only when the audio source is **FM** or **AM**. The antenna is stored or turned off when the AV source is switched to another source.
- **Power** — The antenna extends or turns on when the ignition switch is turned on. The antenna is stored or turned off when the ignition switch is turned off.

● Touch **[Ant CTRL]** on the “AV System Settings” menu.

- ➔ For details, refer to *Displaying the “AV System Settings” menu* on the previous page.

Touching **[Ant CTRL]** switches between **[Radio]** and **[Power]**.

- Regardless of whether **[Radio]** or **[Power]** is selected, turning off the ignition switch will cause the antenna to automatically retract or turn off.

Changing the wide screen mode

● Touch **[Wide Mode]** on the “AV System Settings” menu.

- ➔ For details, refer to *Displaying the “AV System Settings” menu* on the previous page.

Each touch of **[Wide Mode]** changes the setting as follows:

Full — **Normal**
Full (full)

A 4:3 picture is enlarged in the horizontal direction only, enabling you to enjoy a 4:3 TV picture (normal picture) without any omissions.

Normal (normal)

A 4:3 picture is displayed normally, giving you no sense of disparity since its proportions are the same as that of the normal picture.

- Different settings can be stored for each video source.
- The same setting is automatically applied for the following grouping.
 - **SD, USB, iPod**
 - **AV1 and AV2**
 - **EXT1 and EXT2**
- When video is viewed in a wide screen mode that does not match its original aspect ratio, it may look strange.
- Remember that use of this system for commercial or public viewing purposes may constitute an infringement on the author's rights protected by the Copyright Law.
- The navigation map and the rear view camera picture is always viewed at **Full**.

Switching the sound muting/attenuation

You can select the muting method when the navigation guidance is output. This setting is also effective for a mute signal that has been received from the MUTE lead connected to the navigation system.

- When you use a cellular phone connected with Bluetooth technology (dialing, talking, incoming call), the AV source volume is always muted independently of this setting.
- When the voice recognition mode is activated, the AV source volume is always muted independently of this setting.

● Touch **[MUTE Input/GUIDE]** on the “AV System Settings” menu.

- ➔ For details, refer to *Displaying the “AV System Settings” menu* on the previous page.

Each touch of **[MUTE Input/GUIDE]** changes the setting as follows:

- **MUTE** — Muting

Customizing preferences

- **ATT** — Attenuation
- **Normal** — Volume does not change
- Operation returns to normal when the correspond action is ended.
- When "**SD**" or "**USB**" selected as the AV source, the sounds are not muted or attenuated even when the navigation guidance and beep outputs.
- When "**SD**" or "**USB**" is selected as the AV source, the AV sounds, the navigation guidance and beep sounds are mixed and the volume can be adjusted simultaneously.

Important Notice regarding Volume of Navigation Voice Guidance when Playing Audio Files from USB or SD

If music files stored on an external storage device (USB, SD) are played when the system guides the route (i.e., a destination has been selected and the system is routing you to a destination), the volume of the navigation guidance voice will be the same as the volume of the music files being played, even if a different volume level has been selected on "**Master**" or "**Voice**" or "**Dynamic Volume**" in the "**Sound settings**" menu.

Setting the rear output

The navigation system's rear output can be used for a full-range speaker or subwoofer connection. If you switch **Rear SP** to **Sub W**, you can connect a rear speaker lead directly to a subwoofer without using an auxiliary amp. Initially, the navigation system is set for a rear full-range speaker connection (**Full**).

1 Touch [Rear SP] on the "AV System Settings" menu.

- ➔ For details, refer to *Displaying the "AV System Settings" menu* on page 163.

2 Touch [Rear SP] to switch the rear output setting.

When no subwoofer is connected to the rear output, select **Full**.

When a subwoofer is connected to the rear output, select **Sub W**.

- Both rear speaker leads output and RCA rear output are switched simultaneously in this setting. (When you use the product without RCA rear output, this setting only applies to the rear speaker leads.)

Acquiring/Cataloging iPod music information

If you always set the language other than "**English**" on "**Program language:**", this setting is unnecessary.

Unless [VR Catalog Mode] is turned off, this navigation system tries to acquire the information needed to operate iPod with voice commands. It may take a short period of time to transfer the information. Change the setting according to your usage.

The navigation system starts acquiring/cataloging music information (1) when the iPod is connected or when the system boots up while the iPod is connected and (2) when iPod is the selected and displayed AV Source, unless [VR Catalog Mode] is turned off.

- If you do not use iPod, this setting is unnecessary.
- During transfer, iPod operations (such as [Shuffle], [Menu], or [Video]) are not available.
- Once the cataloging is completed, you can deactivate [VR Catalog Mode] until you update the content/data on iPod. If you update the iPod data, activate [VR Catalog Mode] again to transfer the music information and synchronize the music information for voice commands with the data on iPod.
- After you select "**Off**" in [VR Catalog Mode], the system doesn't catalog the data on the iPod. In such case, the previously cataloged data are available as voice commands.

- ❑ Once you start the cataloging process, only a few basic voice commands can be used for iPod until the process has completely finished.
- ❑ If unreadable characters are included in the data on your iPod, names or types may not be available as voice commands.

Important Notice regarding Voice Control for iPods

Voice Control for iPods may be limited if cataloging of iPod content is not completed. Cataloging of iPod content only occurs when the system is in “**AV Source**” mode and the “**iPod**” is the selected and displayed “**AV Source**” screen. Cataloging of iPod content will not occur if the system is off, if any other “**AV Source**” is selected (aside from iPod), or if the system is in any other mode (aside from “**AV Source**” mode) such as “**Destination Menu**”, “**Contacts**”, “**Settings Menu**”, “**Phone Menu**” or the map screen. If you wish to use Voice Control for all iPod content, it is recommended that you first connect your iPod, select “**iPod**” as the AV source, and keep the iPod screen displayed until cataloging is completed — cataloging of iPod content should only take a few minutes, and will depend on the size of the content stored on your iPod. A message will be displayed when cataloging is completed.

1 Touch [VR Catalog Mode] on the “AV System Settings” menu.

- ➔ For details, refer to *Displaying the “AV System Settings” menu* on page 163.

2 Touch [On] or [Off] to activate or deactivate “VR Catalog Mode”.

Operating Your Navigation System with Voice

To Ensure Safe Driving

Some functions of the navigation system supports voice operation.

- ❑ The navigation function is not available using voice operation.



CAUTION

For your safety, avoid viewing the screen in the voice operation as much as possible while driving.

If you use voice operation, select **[English]** in **[Program language:]** of **"Language"**. If you select other languages, voice operation will not be available.



Basics of Voice Operation

Your Pioneer navigation system uses the latest in voice recognition technology. You can use voice commands to operate many of its functions. This chapter describes where you can use voice commands, and also what commands the system accepts.

Flow of voice operation

You can start voice operation any time even when the map screen is displayed or audio is operating. (Some operations are not available.) The basic steps of voice operations are as follows.

1 Switch the screen to map screen or AV operation screen.

- For details concerning operations, refer to *Screen switching overview* on page 34.



2 Press MULTI-CONTROL to activate voice operations.



3 Speak a command into the microphone after the beep.



4 When the command is recognized, the navigation system displays next options on the screen, and pronounces it in some cases.



5 Repeat previous step as necessary.



6 The requested operation will be carried out.

- ❑ The voice operation may not be operable for a minute after the navigation system has booted up.

Starting voice operation

- Press **MULTI-CONTROL** on map screen or the AV operation screen.

The voice operation screen appears.

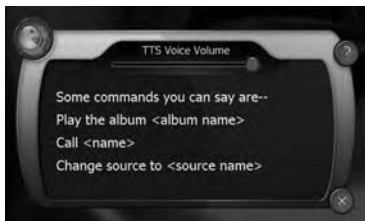

If you lose your way...

You can listen to the brief operating instruction by touching ●.

To cancel voice operation

You can cancel the voice operation feature at any time by saying “**Cancel**”. After you cancel voice operations, the display returns to the screen displayed before the voice operation screen appeared.

- You can also cancel voice operation if you touch ● on the voice operation screen, or press **MENU** button or **MAP** button. □

Operating iPod by voice

You can play music using voice operation from the iPod connected to the navigation system.

- Playback of iPod movies is not available using voice commands.
- To use the content/data on the iPod for voice operation, transfer the data to this system first.
 - ➔ For details, refer to *Acquiring/Cataloging iPod music information* on page 165.

Examples of voice operation of the iPod are shown below. (A method for playing the album title named “Pioneer” is described here, along with an operational example.)

- 1 Press **MULTI-CONTROL** to start voice operation.

- 2 Say “**Change Source**” to display the AV source selection screen.

- 3 Say “**iPod**” on the selection screen to switch the AV source to iPod.

- Touching the item on the screen also enables you to select the desired AV source.

- 4 Press **MULTI-CONTROL** to start voice operation.

- 5 Say “**Play the album Pioneer**” to playback the album name “Pioneer”.

If the command is recognized properly, playback starts from the first song of “Pioneer”. □

Calling the entry on “Contacts”

A method for dialing the entry named “Nancy” is described here along with an operational example.

- 1 Press **MULTI-CONTROL** to start voice operation.

- 2 Say “**Call Nancy**” to make a call.

Dialing starts. □

Operating Your Navigation System with Voice

Available Basic Voice Commands

The navigation system can also recognize the words in the following list.

Basic commands

Voice commands and operations

Back → Returns the previous screen.

Cancel → Cancels the voice operation.

Help → Outputs the brief operating instruction by voice.

Voice operation for the iPod

For <Artist name>, <Album name>, <Playlist name>, <Genre name> shown on the following chart, say the name their name in the iPod.

- ❑ Playback of iPod movies is not available using voice commands.

Voice commands and operations

Shuffle play → Plays all songs randomly.

Pause the music, Stop the music → Pauses the song currently playing .

Resume the music → Resumes the song currently playing .

Next song → Plays the next song.

Previous song → Plays the previous song or return to the beginning of the song currently playing.

Play songs → Start playback from the top of "**Songs**".

Play artists → Start playback from the top of "**Artists**".

Play the artist <Artist name> → Start playback from the top of the selected artist.

Play albums → Start playback from the top of "**Albums**".

Play the album <Album name> → Start playback from the top of the selected album.

Play playlists → Start playback from the top of "**Playlists**".

Play the playlist <Playlist name> → Start playback from the top of the selected playlist.

Play genres → Start playback from the top of "**Genres**".

Play the genre <Genre name> → Start playback from the top of the selected genre.

Show artists → Displays the artist list together with sub-screen to continue the voice operation. → Touch the desired item on the list or say the desired voice commands.

Show the artist <Artist name> → Displays the album list of the selected artist together with sub-screen to continue the voice operation. → Touch the desired item on the list or say the desired voice commands.

Show albums → Displays the album list together with sub-screen to continue the voice operation. → Touch the desired item on the list or say the desired voice commands.

Show the album <Album name> → Displays the song list of the selected album together with sub-screen to continue the voice operation. → Touch the desired item on the list or say the desired voice commands.

Show playlists → Displays the playlist together with sub-screen to continue the voice operation. → Touch the desired item on the list or say the desired voice commands.

Show the playlist <Playlist name> → Displays the song list of the selected playlist together with sub-screen to continue the voice operation. → Touch the desired item on the list or say the desired voice commands.

Show genre → Displays the genre list together with sub-screen to continue the voice operation. → Touch the desired item on the list or say the desired voice commands.

Show the genre <Genre name> → Displays the song list of the selected genre list together with sub-screen to continue the voice operation. → Touch the desired item on the list or say the desired voice commands.

Show songs → Displays the song list together with sub-screen to continue the voice operation. → Touch the desired item on the list or say the desired voice commands.

Page down, Page up → Displays the previous or next page of the selection list. (Note 1)

(Note 1) The voice commands is available only when the selection list is displayed.

Voice operation for AV source (other than iPod)

AV source selection

Voice commands and operations

Change Source to DISC → Switch the AV source to **DISC**.

Change Source to FM → Switch the AV source to **FM**.

Change Source to AM → Switch the AV source to **AM**.

Change Source to XM Satellite Radio → Switch the AV source to **XM**.

Change Source to SIRIUS Satellite Radio → Switch the AV source to **SIRIUS**.

Change Source to HD Radio → Switch the AV source to **Digital Radio**.

Change Source to SD Media → Switch the AV source to **SD**.

Change Source to USB → Switch the AV source to **USB**.

Change Source to iPod → Switch the AV source to **iPod**.

Change Source → Switch to the AV source selection screen. → Touch the desired AV source or say the desired AV source name.

External storage device (USB, SD)

Voice commands and operations

Shuffle play → Plays all songs randomly.

Pause the music, Stop the music → Pauses the song currently playing .

Resume the music → Resumes the song currently playing .

Next song → Plays the next song.

Previous song → Plays the previous song or return to the beginning of the song currently playing.

Operating Your Navigation System with Voice

Voice commands related to hands-free phoning

- ❑ You can make a phone call by voice dialing if the cellular phone featuring Bluetooth wireless technology is being paired with the navigation system.
- ❑ For <entry's name> shown on the following chart, say the name of the entry stored in "**Contacts**".
- ❑ For <phone number> shown on the following chart, say the desired phone number.

Voice commands and operations

Call <entry's name> → Make a call to the entry (Note2).

Call <entry's name> mobile → Dial the cellular phone number of the entry (Note3).

Call <entry's name> home → Dial the home phone number of the entry (Note3).

Call <entry's name> office → Dial the office phone number of the entry (Note3).

Call <phone number> → Dial the phone number.

Make a call → Say the phone number you want to call → The system starts dialing to the number.

Make a call → Say the name of entry stored on "**Contacts**" you want to call → The system starts dialing to the number (Note2).

List outgoing calls → Display the list of recent outgoing calls ("**Dialed Numbers**") to select the number and call.

List recent calls → *Incoming calls* (Note4) → Display the list of recently received calls ("**Received Calls**") to select the number and call.

List recent calls → *Outgoing calls* (Note4) → Display the list of recent outgoing calls ("**Dialed Numbers**") to select the number and call.

List recent incoming calls → Display the list of recently received calls ("**Received Calls**") to select the number and call.

(Note2) If the entry has multiple phone number data, selection list may appear. In such case, say the type of phone number or touch the one of listed item that you want to dial.

(Note3) If there is no corresponding type on the entry, the system may suggest you other phone numbers of the entry. In such case, say the type of phone number or touch the one of listed item that you want to dial.

(Note4) Touching the item on the screen also enables you to select the desired list.



Tips for Voice Operation

For your voice commands to be correctly recognized and interpreted, ensure that conditions are suitable for recognition.

Close the vehicle windows

Please note that wind through the vehicle window or miscellaneous noise from outside the vehicle can interfere with voice operation.

Position the microphone carefully

For optimum pick-up, the microphone should be fixed at a suitable distance directly in front of the driver.

Pause before giving a command

Speaking too soon may cause the recognition to fail.

Pronounce your commands carefully

Speak slowly, deliberately, and clearly. 

Other functions

Setting the anti-theft function

You can set a password for the navigation system. If the back-up lead is cut or the **RESET** button is pressed after the password is set, the navigation system prompts for the password at the time of next boot up.

Setting the password

- 1 With the map displayed, press the **MENU** button.
- 2 Touch **[Settings]** on the "Top Menu".
- 3 Touch **Area1**, followed by **Area2**, and then touch and hold **Area3**.

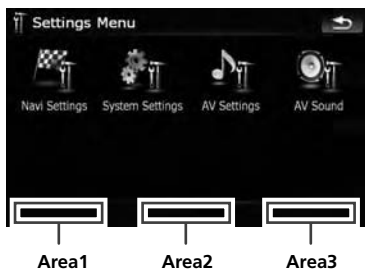

- 4 Touch **[Set Password]**.
The password setting screen appears.
- 5 Enter the password you want to set.
 - 5 to 16 characters can be entered for a password.
- 6 Touch **[Done]**.
- 7 Reenter the password to confirm the setting.
- 8 Touch **[Done]**.
Password protection is applied.
 - If you want to change the password currently set, enter the current password and then enter the new one.

Entering the password

On the password input screen, you must enter the current password. If you enter an incorrect password three times, the screen is locked and operations using touch panel keys are disabled.

- 1 Enter the password.
- 2 Touch **[Done]**.
The message "Antitheft is being unlocked. Do not switch off during the process." appears if you entered the correct password and the navigation system is unlocking.

Deleting the password

The current password can be deleted.

- 1 With the map displayed, press the **MENU** button.
- 2 Touch **[Settings]** on the "Top Menu".
- 3 Touch **Area1**, followed by **Area2**, and then touch and hold **Area3**.
- 4 Touch **[Clear password]**.
The password setting screen appears.
- 5 Enter the current password.
- 6 Touch **[Done]**.
- 7 Touch **[Yes]**.
The message for deletion appears and then the current password is deleted.

Forgotten passwords

Contact the nearest authorized Pioneer Service Station. 

Returning the navigation system to the default or factory settings

You can return settings or recorded content to the default or factory settings. There are three methods to clear user data, and the situations and the cleared content are different for each method. For information regarding the content that is cleared by each method, see the list presented later.

Method 1: Press the RESET button

Pressing the **RESET** button clears almost all settings of the audio function.

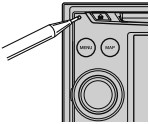

This transforms the system into the same state as when the battery of the vehicle is removed or the yellow lead of the navigation system is disconnected.

➔ For details concerning operations, refer to *Resetting the microprocessor* on page 26.

Method 2: Restore Factory Settings

This clears some items in the “**Navi Settings**” menu.

➔ For details, refer to **Restore Factory Settings** on page 158.

Method 3: Delete user information

Clears almost all settings and user data of the navigation function, the audio function and the phone function.

➔ For details, refer to **Restore Factory Settings** on page 158.

Other functions

Setting items to be deleted

The items to be deleted vary depending on the reset method. The items listed in the following table return to the default or factory settings.

- Almost all items not listed below will be retained. However, some of the items to be returned to their default values are not listed if the setting value can be easily recovered by user, such as the last map scale, the last status of AV operation screen, etc.

— : The setting will be retained.

✓ : The setting will be cleared and returned to the default or factory settings.

Navigation functions		Method 1	Method 2	Method 3
	All settings on "MSN Direct" (*)	—	✓	✓
	"History" on "Address"	—	—	✓
Destination Menu	[History]	—	—	✓
	[Favorites]	—	—	✓
	"Saved Criteria" on "POI"	—	—	✓
	[Set Home]	—	—	✓
	[GPS & Time Settings], [Map Visual], [Route], [Warnings], [Regional Settings]	—	✓	✓
Navi Settings	[Sound settings] "Voice", "Keys", "Dynamic Volume (On/Off)"	—	✓	✓
	[Sound settings] "Master", "Dynamic Volume (Maximum speed:, Minimum speed:)"	—	—	✓
System Settings	[Language]	—	✓	✓
	Other settings	—	—	✓
Others	Pin icon data	—	—	✓
	Anti-theft password	—	—	✓

(*) This function is available for AVIC-X910BT.

Audio functions		Method 1	Method 2	Method 3
AV Settings	[Wide Mode], [VR Catalog Mode]	—	—	✓
	Other settings	✓	—	—
AV Sound	All settings	✓	—	—
CD, ROM, DivX, FM, AM	All settings (*1)	✓	—	—
DVD-V, DVD-VR	All settings	✓	—	—

SD, USB	All settings (*1)	✓	—	✓
	Volume setting for AV sources	✓	—	—

(*1) All settings including the setting on the "Function" menu are to be deleted.

Phone functions		Method 1	Method 2	Method 3
	[Phone Volume]	—	—	✓
	[Received Calls]	—	—	✓
Phone Menu (*2)	[Dialed Numbers]	—	—	✓
	[Missed Calls]	—	—	✓
	[Phone Settings]	—	—	✓
Contacts (*2)	All entries	—	—	✓

(*2) All stored data of 3 users is deleted.



Appendix

Troubleshooting

If you have problems operating your navigation system, refer to this section. The most common problems are listed below, along with likely causes and solutions. While this list is not comprehensive, it should answer your most common problems. If a solution to your problem cannot be found here, contact your dealer or the nearest authorized Pioneer service facility.

Problems with the navigation screen

Symptom	Cause	Action (Reference)
The power doesn't turn on. The navigation system doesn't operate.	Leads and connectors are incorrectly connected.	Confirm once more that all connections are correct.
	The fuse is blown.	Rectify the reason for the fuse blowing, then replace the fuse. Be very sure to install a correct fuse with the same rating.
	Noise and other factors are causing the built-in microprocessor to operate incorrectly.	Press the RESET button. (Page 26)
You cannot position your vehicle on the map without a significant positioning error.	The quality of signals from the GPS satellites is poor, causing reduced positioning accuracy. Such a loss of signal quality may occur for the following reasons: —The GPS antenna is in an unsuitable location. —Obstacles are blocking signals from the satellites. —The position of satellites relative to your vehicle is inadequate. —Signals from the GPS satellites have been modified to reduce accuracy. (GPS satellites are operated by the US Department of Defense, and the US government reserves the right to distort positioning data for military reasons. This may lead to greater positioning errors.) —If a vehicle phone or cellular phone is used near the GPS antenna, GPS reception may be lost temporarily.	Check the GPS signal reception and the position of the GPS antenna if necessary, or continue driving until reception improves. Keep the antenna clear.
	Something covers the GPS antenna.	Do not cover the GPS antenna with spray paint or vehicle wax, because this may block the reception of GPS signals. Snow buildup can also degrade the signals.
	Signals from the vehicle's speed pulse are not being picked up properly. (This information is intended for AVIC-X910BT only.)	Check that the cables are properly connected. If necessary, consult the dealer that installed the system.

Appendix

You cannot position your vehicle on the map without a significant positioning error.	The navigation system may not be mounted securely in your vehicle.	Check that the navigation system is securely mounted and, if necessary, consult the dealer that installed the system.
	The navigation system is installed with an extreme angle exceeding the installation angle limitations.	Confirm the installation angle. (The navigation system must be installed within the allowed installation angle. For details, refer to "Installation Manual".)
	Indication of the position of your vehicle is misaligned after a U-turn or reversing.	Check whether or not the reverse gear signal input lead (violet) is connected properly. (The navigation system works properly without the lead connected, but positioning accuracy will be adversely affected.)
The map color does not switch automatically between daytime and nighttime.	[Night mode] is set to [Day].	Check [Night mode] setting and make sure [Automatic] is selected. (Page 145)
	The orange/white lead is not connected.	Check the connection.
The screen is too bright.	An improper value has been set on " Brightness ".	Check the settings.
The display is very dim.	[Night] is selected in " Night mode ".	Check the setting of [Night mode] and select [Automatic] or [Day]. (Page 145)
	An improper value has been set on " Brightness ".	Check the settings.
No sounds of AV source are produced. The volume level will not rise.	The volume level is low.	Adjust the volume level.
	The attenuator or mute is on.	Turn the attenuator or mute off.
	A speaker lead is disconnected.	Check the connection.
The volume of navigation guidance and beeps cannot be adjusted.	Try to adjust them with MULTI-CONTROL .	Turn the volume up or down using [Sound settings] on the " Navi Settings " menu. (Page 149)
The person on the other end of the phone call cannot hear the conversation due to an echo.	The voice from the person on the other end of the phone call is output from the speakers and then picked up by the microphone again, creating an echo.	Use the following methods to reduce the echo: —Lower the volume on the receiver —Have both parties pause slightly before speaking
There's no picture.	The parking brake cord is not connected.	Connect the parking brake cord, and apply the parking brake.
	The parking brake is not applied.	Connect the parking brake cord, and apply the parking brake.
	The backlight of the LCD panel is turned off.	Turn on the backlight. (Page 159)
"Rear display" picture disappears. (This information is intended for AVIC-X910BT only.)	The source disc being listened to in the navigation system has been ejected.	Before ejecting the disc, switch the source. This problem may occur when certain connection methods are used.
	There is a problem with the "Rear display", for example a faulty wiring connection.	Check the "Rear display" and its connection.
	An AV source that cannot output to the rear display is selected.	Select an appropriate AV source.



Appendix

Nothing is displayed and the touch panel keys cannot be used.	The setting for the rear view camera is incorrect. The shift lever was placed in [R] when the rear view camera was not connected.	Select the appropriate setting for the rear view camera. Press the MAP button, and then press the MENU button to return to the "Top Menu" and then select the correct polarity setting for [Back Camera] . (Page 156)
There is no response when the touch panel key are touched, or a different key responds.	The touch panel keys deviate from the actual positions that respond to your touch for some reason.	Perform touch panel calibration. (Page 157)
The external storage device (USB, SD) cannot be used.	The USB storage device has been removed immediately after plugging it.	Park your vehicle in a safe place, and turn off the engine. Turn the ignition key back to "Acc off". Then start the engine again, and turn the power to the navigation system back on.

Problems in the AV screen

Symptom	Cause	Action (Reference)
CD or DVD playback is not possible.	The disc is inserted upside down.	Insert the disc with the label upward.
	The disc is dirty.	Clean the disc.
	The disc is cracked or otherwise damaged.	Insert a normal, round disc.
	The files on the disc are an irregular file format.	Check the file format.
	The disc format cannot be played back.	Replace the disc.
The screen is covered by a caution message and the video cannot be shown.	The loaded disc is a type this system cannot play.	Check what type of disc it is. (For more cautions about handling each type of media, refer to Page 193.)
	The parking brake lead is not connected or applied. The parking brake interlock is activated.	Connect the parking brake lead correctly, and apply the parking brake. Park your vehicle in a safe place and apply the parking brake.
No video output from connected equipments. No video output from connected iPod.	[AV1 Input] or [AV2 Input] setting is incorrect.	Please read the following page and establish the setting correctly. (Page 140)
	The connection of the USB interface cable for iPod is incorrect.	Connect both the USB plug and the RCA cable side. (If only one of these connection has been made, the iPod will not work properly.) (Page 31)
The audio or video skips.	The navigation system is not firmly secured.	Secure the navigation system firmly.
No sounds are produced. The volume level will not rise.	Cables are not connected correctly.	Connect the cables correctly.
	The system is performing still, slow motion, or frame-by-frame playback with DVD-Video.	There is no sound during still, slow motion, or frame-by-frame playback with DVD-Video.
	The system is paused or performing, fast reverse or forward during the disc playback.	For the media other than music CD (CD-DA), there is no sound on fast reverse or forward.

Appendix

The icon  is displayed, and operation is not possible.	The operation is not compatible with the video configuration.	This operation is not possible. (For example, the DVD playing does not feature that angle, audio system, subtitle language, etc.)
The picture stops (pauses) and the navigation system cannot be operated.	The reading of data is impossible during disc playback.	After touching  once, start playback once more.
The picture is stretched, with incorrect aspect ratio.	The aspect setting is incorrect for the display.	Select the appropriate setting for that image. (Page 164, Page 104)
A parental lock message is displayed and DVD playback is not possible.	Parental lock is on.	Turn parental lock off or change the level. (Page 104)
Parental lock for DVD playback cannot be canceled.	The code number is incorrect.	Input the correct code number. (Page 104)
Playback is not with the audio language and subtitle language settings selected in [DVD Setup].	The DVD playing does not feature dialog or subtitles in the language selected in [DVD Setup].	Switching to a selected language is not possible if the language selected in [DVD Setup] is not recorded on the disc.
The picture is extremely unclear/distorted and dark during playback.	The disc features a signal to prohibit copying. (Some discs may have this.)	Since the navigation system is compatible with the copy guard analogue copy protect system, the picture may suffer from horizontal stripes or other imperfections when a disc with that kind of protection signal is viewed on some displays. This does not mean the navigation system is malfunctioning.
Cannot be operated.	The iPod is frozen.	<ul style="list-style-type: none"> • Reconnect the iPod with the USB interface cable for iPod. • Update the iPod software version.
	An error has occurred.	<ul style="list-style-type: none"> • Reconnect the iPod with the USB interface cable for iPod. • Park your vehicle in a safe place, and turn off the engine. Turn the ignition key back to "Acc off". Then start the engine again, and turn the power to the navigation system back on. If this does not solve the problem, press the RESET button on the navigation system. • Update the iPod software version.
Songs on iPod connected with this system cannot be available as voice commands or different song or title from the one that you said is recognized.	iPod content/data has been updated, but the data on this system's memory has not been updated yet. (i.e., system has not cataloged new iPod content), or cataloging was not completed)	If you update the iPod data, activate [VR Catalog Mode] to catalog/transfer the music information to this system and synchronize the music information for voice commands with the data on iPod. (Page 165)

Problems with the phone screen

Symptom	Cause	Action (Reference)
Dialing is not possible because the touch panel keys for dialing are inactive.	Your phone is out of range for service.	Retry after re-entering the range for service.
	The connection between the cellular phone and the navigation system cannot be established now.	Perform the connection process.

Appendix

If the screen becomes frozen...

Park your vehicle in a safe place, and turn off the engine. Turn the ignition key back to "Acc off". Then start the engine again, and turn the power to the navigation system back on. If this does not solve the problem, press the **RESET** button on the navigation system.



Appendix

Messages and how to react to them

The following messages may be displayed by your navigation system. Refer to the table below to identify the problem, then take the suggested corrective action.

There are occasions when you may see error messages other than those shown here. In such a case, follow the instructions given on the display.

Messages for navigation functions

Message	When	What to do (Reference)
There is no "Pictures" folder. Please create /Pictures/ folder and store the appropriate file images to be uploaded in that Folder.	Cannot load the image because "Pictures" folder is not found in the inserted external storage device.	Use appropriate data and store it correctly. (Page 155)
	"Pictures" folder exists on the external storage device (USB, SD) but there is no loadable data in the folder.	Use appropriate data and store it correctly. (Page 155)
Data Read error.	Failed to read the data for some reason.	Use appropriate data and store it correctly. (Page 155)
The file is corrupt	The data is damaged or an attempt was made to set an image file that was not made to specifications as the splash screen.	Use appropriate data and store it correctly. (Page 155)
Connection failed.	The cellular phone's Bluetooth wireless technology is turned off.	Activate the target phone's Bluetooth wireless technology.
	The cellular phone is paired (connected) with another device.	Cancel the pairing (connection) and retry.
	Rejection has been received from the cellular phone.	Operate the target phone and accept the connection request from the navigation system. (Furthermore, check the connection settings on your cellular phone.)
	The target cellular phone cannot be found.	Check whether your cellular phone is activated and, whether the distance to your cellular phone is not too far.
Could not find any available phone.	No available phone exists in the surroundings when the system searches for connectable cellular phones featuring Bluetooth wireless technology.	<ul style="list-style-type: none"> • Activate the target phone's Bluetooth wireless technology. • Check whether your cellular phone is activated and, whether the distance to your cellular phone is not too far.
Dataloading failed.	You may have transferred the data from your cellular phone in a format cannot be received by the navigation system.	<ul style="list-style-type: none"> • Select a suitable item and format, then retry. (Page 84) • Connect your cellular phone with another method again and retry. (Page 73)
Your mobile phone can not support this feature.	The connected cellular phone has no compatibility with the phone book transfer function of this navigation system.	Depending on the cellular phone, phone book transfer may not be available.



Appendix

Messages for audio functions

When problems occur with AV source playback, an error message appears on the display. Refer to the table below to identify the problem, then take the suggested corrective action. If the error persists, record the error message and contact your dealer or your nearest Pioneer service center. The messages in “()” will appear on the “Rear display”.

Built-in DVD drive (AVIC-X910BT)

Message	Cause	Action (Reference)
Reading error (ERROR-02-XX)	Dirty	Clean the disc.
	Scratched disc	Replace the disc.
	The disc is loaded upside down	Check that the disc is loaded correctly.
Mechanism error	Electrical or mechanical	Press the RESET button. (Page 26)
Region code error (DIFFERENT REGION DISC)	The disc does not have the same region number as the navigation system.	Replace the DVD-Video with one bearing the correct region number.
UNPLAYABLE DISC	This type of disc cannot be played by the navigation system	Replace the disc with one the navigation system can play.
Thermal error (THERMAL PROTECTION IN MOTION)	The temperature of the navigation system is outside of the normal operating range	Wait until the unit's temperature returns to within normal operating limits.
Error not defined (ERROR-FF-FF)	Undefined error	Press the RESET button. (Page 26)
Non-playable tracks are skipped. (FILE SKIPPED)	Files that are protected by digital rights management.	The protected files are skipped.
Impossible to play all tracks. (PROTECTED DISC)	All the files on the inserted disc are secured by DRM.	Replace the disc.
Flash writing error. Impossible to write on the flash. (CAN NOT SAVE DATA)	The playback history for VOD contents cannot be saved for some reason.	<ul style="list-style-type: none"> • Retry. • If the message appears frequently, consult your dealer.
Authorization Error (AUTHORIZATION ERROR)	The device does not match the device registered with the VOD provider. VOD content cannot be played back.	Check whether this device has been registered with the VOD provider.
Press track list to play and title will appear.	The disc has too many files for all titles to be displayed at once.	Touch the one of listed items to play.
File Not Playable-High Definition (FILE NOT PLAYABLE-HIGH DEF)	High definition (HD) DivX video cannot play.	Create playable one and retry.

Built-in CD drive (AVIC-X710BT)

Message	Cause	Action (Reference)
Reading error (ERROR-11, 12, 17, 30)	Dirty	Clean the disc.
	Scratched disc	Replace the disc.
Reading error (ERROR-10, 11, 12, 15, 17, 30, A0)	Electrical or mechanical	Turn the ignition switch OFF and back ON, or switch to a different source, then back to the CD player.

Appendix

Reading error (ERROR-15)	The inserted disc does not contain any data.	Replace the disc.
Reading error (ERROR-23)	The CD format cannot be played back.	Replace the disc.
Reading error (ERROR-22)	The inserted disc does not contain any files that can be played back	Replace the disc.
Non-playable tracks are skipped.	The inserted disc contains files that are protected by DRM	Replace the disc.
Impossible to play all tracks.	All the files on the inserted disc are secured by DRM.	Replace the disc.

SD/USB/iPod

Message	Cause	Action (Reference)
Non-playable tracks are skipped.	Files that are protected by digital rights management.	The protected files are skipped.
Impossible to play all tracks.	All the files on the inserted external storage device are secured by DRM.	Store playable files.
An error occurred on USB connection. USB devices are not available to use and iPod power supply is also unavailable.	The USB connector or USB cable is short-circuited.	Confirm that the USB connector or USB cable is not caught in something or damaged.
	The connected USB storage device consumes more than 500 mA (maximum allowable current).	Disconnect the USB storage device and do not use it. Turn the ignition switch to OFF, then to ACC or ON and then connect the compliant USB storage device.
	The USB interface cable for iPod is short-circuited.	Confirm that USB interface cable for iPod or USB cable is not caught in something or damaged.
Connected iPod is not supported. Please check instruction manual.	The iPod is not compatible with this navigation system.	Use an iPod of a compatible version.
iPod connection failed. Please reconnect.	Communication failure	<ul style="list-style-type: none"> • Disconnect the cable from iPod. Once iPod main menu is displayed, connect the cable again. • If the message appears frequently, consult your dealer.
Updating VR dictionary. Please wait.	iPod function is restricted because the navigation system is trying to acquire the information needed to operate iPod with voice commands from the iPod currently connected.	<ul style="list-style-type: none"> • Wait on the iPod basic screen (Music) until "iPod VR activation process complete." appears. • Switch the screen to another screen to cancel the acquiring process. (In such case, the acquiring process will resume when the iPod basic screen (Music) is displayed.) (Page 165)
Voice Synching... My voice system will be busy until I'm finished, but you can use the touch interface	Voice operation is restricted because the navigation system is trying to acquire the information needed to operate iPod with voice commands from the iPod currently connected.	<ul style="list-style-type: none"> • Wait on the iPod basic screen (Music) until "iPod VR activation process complete." appears. • Switch the screen to another screen to cancel the acquiring process. (In such case, the acquiring process will resume when the iPod basic screen (Music) is displayed.) (Page 165)

Appendix

Other sources

Message	Cause	Action (Reference)
System detected improper connection of Parking Brake lead. Please check your configuration for safety. Please see Operation Manual for more information regarding safe operation.	Parking brake lead is incorrectly connected.	Confirm once more that their connections are correct.
UPDATING	The selected channel is not included in your subscription.	Select another channel.
	Radio is being updated with the latest encryption code.	Wait until the encryption code is fully updated.



Appendix

Positioning technology

AVIC-X910BT accurately measures your current location by combining the positioning by GPS and by “Dead Reckoning”.

AVIC-X710BT accurately measures your current location by the GPS positioning.

Positioning by GPS

The Global Positioning System (GPS) uses a network of satellites orbiting the Earth. Each of the satellites, which orbit at a height of 21 000 km, continually broadcasts radio signals giving time and position information. This ensures that signals from at least three can be picked up from any open area on the earth's surface.

The accuracy of the GPS information depends on how good the reception is. When the signals are strong and reception is good, GPS can determine latitude, longitude and altitude for accurate positioning in three dimensions. But if signal quality is poor, only two dimensions, latitude and longitude, can be obtained and positioning errors are somewhat greater.

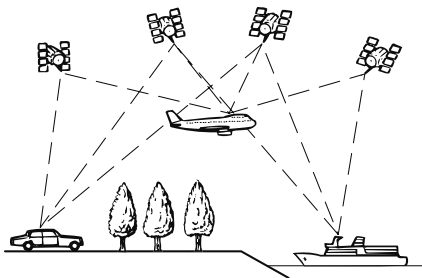

Positioning by “Dead Reckoning”

The built-in sensor in the navigation system also calculates your position. The current location is measured by detecting driving distance with the speed pulse, the turning direction with the “Gyrosensor” and inclination of the road with the “G sensor”.

The built-in sensor can even calculate changes of altitude, and corrects for discre-

pancies in the distance traveled caused by driving along winding roads or up slopes. If you use AVIC-X910BT with connecting the speed pulse, the system will become more accurate than no connection of speed pulse. So be sure to connect the speed pulse to get full positioning accuracy.

- ❑ The position of the speed detection circuit vary depending on the vehicle model. For details, consult your authorized Pioneer dealer or an installation professional.
- ❑ Some types of vehicles may not output a speed signal while driving at just a few kilometers per hour. In such a case, the current location of your vehicle may not be displayed correctly while in traffic congestion or in a parking lot.

How do GPS and “Dead Reckoning” work together?

For maximum accuracy, your navigation system continually compares GPS data with your estimated position as calculated from the data of built-in sensor. However, if only the data from the built-in sensor is available for a long period, positioning errors are gradually compounded until the estimated position becomes unreliable. For this reason, whenever GPS signals are available, they are matched with the data of the built-in sensor and used to correct it for improved accuracy.

- ❑ If you use chains on your wheels for winter driving or put on the spare wheel, errors may suddenly increase because of difference in wheel diameter. In such case, pressing the **RESET** button initialize the sensor status and it may recover the accuracy to normal condition.

Appendix

Map matching

As mentioned, the positioning systems used by this navigation system are susceptible to certain errors. Their calculations may, on occasion, place you in a location on the map where no road exists. In this situation, the processing system understands that vehicles travel only on roads, and can correct your position by adjusting it to a nearby road. This is called map matching.

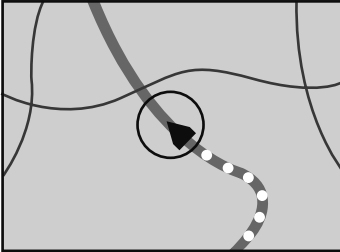

With map matching

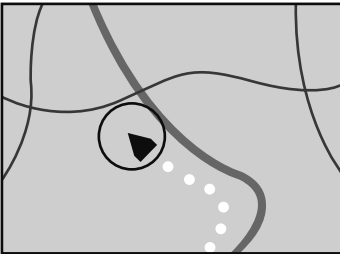

Without map matching



Handling large errors

Positioning errors are kept to a minimum by combining GPS, "Dead Reckoning" and map matching. However, in some situations, these functions may not work properly, and the error may become bigger.

When positioning by GPS is impossible

- GPS positioning is disabled if signals cannot be received from more than two GPS satellites.
- In some driving conditions, signals from GPS satellites may not reach your vehicle. In this case, it is impossible for the system to use GPS positioning.

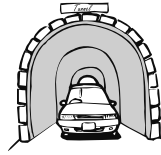

In tunnels or enclosed parking garages

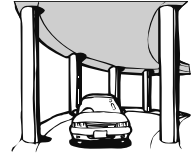

Under elevated roads or similar structures



When driving among high buildings



When driving through a dense forest or tall trees

- If a car phone or cellular phone is used near the GPS antenna, GPS reception may be lost temporarily.
- Do not cover the GPS antenna with spray paint or car wax, because this may block the reception of GPS signals. Snow buildup can also degrade the signals, so keep the antenna clear.
- ❑ If a GPS signal have not been received for a long time, your vehicle's actual position and the current position mark on the map may diverge considerably or may not be updated. In such case, once GPS reception is restored, accuracy will be recovered.

Appendix

Conditions likely to cause noticeable positioning errors

For various reasons, such as the state of the road you are traveling on and the reception status of the GPS signal, the actual position of your vehicle may differ from the position displayed on the map screen.

- If you make a shallow turn.

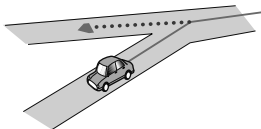

- If there is a parallel road.

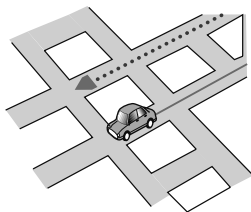

- If there is another road very nearby, such as in the case of an elevated freeway.

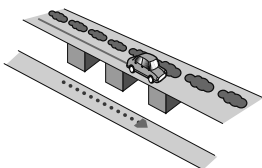

- If you take a recently opened road that is not on the map.

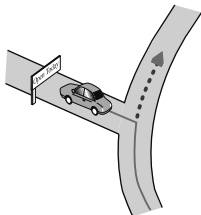

- If you drive in zigzags.

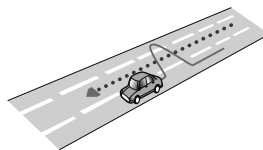

- If the road has a series of hairpin bends.

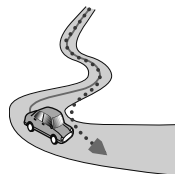

- If there is a loop or similar road configuration.

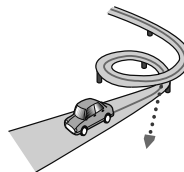

- If you take a ferry.

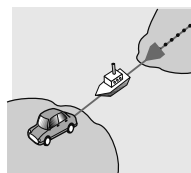

- If you are driving on a long, straight road or a gently curving road.

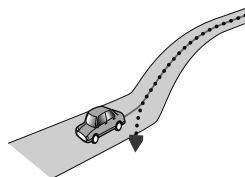

Appendix

- If you are on a steep mountain road with many height changes.

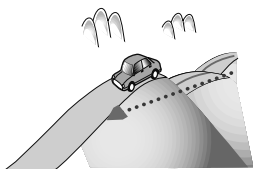

- If you enter or exit a multi-storey parking lot or similar structure using a spiral ramp.

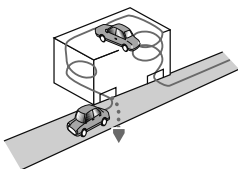

- If your vehicle is turned on a turntable or similar structure.

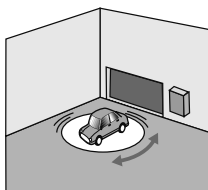

- If your vehicle's wheels spin, such as on a gravel road or in snow.



- If you put on chains, or change your tires for ones with a different size.

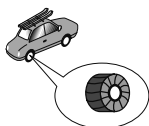

- If trees or other obstacles block the GPS signals for a considerable period.

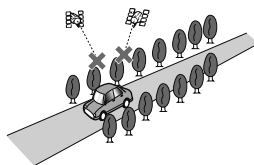

- If you drive very slowly, or in a start-and-stop manner, as in a traffic congestion.

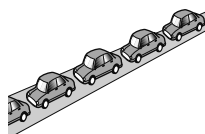

- If you join the road after driving around a large parking lot.

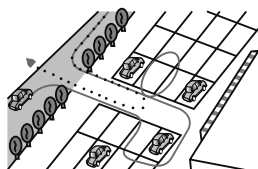

- When you drive around a traffic circle.

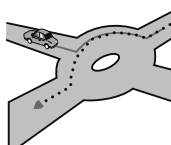

- When starting driving immediately after starting the engine.

Route setting information

Route search specifications

Your navigation system sets a route to your destination by applying certain built-in rules to the map data. This section provides some useful information about how a route is set.

Appendix

CAUTION

When a route is calculated, the route and voice guidance for the route are automatically set. Also, for day or time traffic regulations, only information about traffic regulations applicable at the time when the route was calculated is shown. One-way streets and street closures may not be taken into consideration. For example, if a street is open during the morning only, but you arrive later, it would be against the traffic regulations so you cannot drive along the set route. When driving, please follow the actual traffic signs. Also, the system may not know some traffic regulations.

- The calculated route is one example of the route to your destination decided by the navigation system while taking the type of streets or traffic regulations into account. It is not necessarily an optimum route. (In some cases, you may not be able to set the streets you want to take. If you need to take a certain street, set a waypoint on that street.)
- If the destination is too far, there may be instances where the route cannot be set. (If you want to set a long-distance route going across several areas, set waypoints along the way.)
- During voice guidance, turns and intersections from the freeway are announced. However, if you pass intersections, turns, and other guidance points in rapid succession, some may delay or not be announced.
- It is possible that guidance may direct you off a freeway and then back on again.
- In some cases, the route may require you to travel in the opposite direction to your current heading. In such cases, you are instructed to turn around, so please turn around safely by following the actual traffic rules.
- In some cases, a route may begin on the opposite side of a railway or river from your actual current location. If this happens,

drive towards your destination for a while, and try route calculation again.

- When there is a traffic congestion ahead, a detour route may not be suggested if driving through the traffic congestion would still be better than taking the detour.
- There may be instances when the starting point, the waypoint and the destination point are not on the highlighted route.
- The number of traffic circle exits displayed on the screen may differ from the actual number of roads.





Route highlighting

- Once set, the route is highlighted in bright color on the map.
- The immediate vicinity of your starting point and destination may not be highlighted, and neither will areas with particularly complex road layouts. Consequently, the route may appear to be cut off on the display, but voice guidance will continue.

Auto reroute function

- If you deviate from the set route, the system will re-calculate the route from that point so that you remain on track to the destination.
- This function may not work under certain conditions.

Supplemental information about directions

Symbol	Meanings
	Highway
	Freeway exit left/right
	Traffic circle (clockwise and anti-clockwise)
	Ferry landings (port of departure or arrival)
	Car only road (start and end)

Appendix



Car train (start and end)



Other information

Supplemental information about traffic icon

Icon	Meanings
	Stop-and-go traffic
	Stopped traffic
	Closed/blocked roads
	Accidents, constructions, etc.
	Road works
	Road narrows, lane closures
	Warnings, other dangers
	Bad weather conditions
	Police ahead



Handling and care of discs

Some basic precautions are necessary when handling your discs.

Built-in drive and care

- Use only conventional, fully circular discs. Do not use shaped discs.

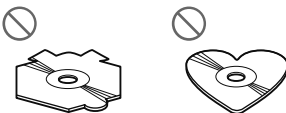

- Do not use cracked, chipped, warped, or otherwise damaged discs as they may damage the built-in drive.

- Do not touch the recorded surface of the discs.
- Store discs in their cases when not in use.
- Avoid leaving discs in excessively hot environments including under direct sunlight.
- Do not attach labels, write on or apply chemicals to the surface of the discs.
- To clean a disc, wipe it with a soft cloth, moving outward from the center.



- Condensation may temporarily impair the built-in drive's performance. Leave it to adjust to the warmer temperature for about one hour. Also, wipe any damp discs with a soft cloth.
- Playback of discs may not be possible because of disc characteristics, disc format, recorded application, playback environment, storage conditions and so on.
- Road shocks may interrupt disc playback.
- Read the precautions for discs before using them.

Ambient conditions for playing a disc

- At extremely high temperatures, a temperature cutout protects this product by switching it off automatically.
- Despite our careful design of the product, small scratches that do not affect actual operation may appear on the disc surface as a result of mechanical wear, ambient conditions for use or handling of the disc. This is not a sign of the malfunction of this product. Consider it to be normal wear and tear. ■

Appendix

Playable discs

DVD-Video and CD

DVD and CD discs that display the logos shown below generally can be played on this built-in DVD drive.

DVD-Video



CD



- DVD** is a trademark of DVD Format/Logo Licensing Corporation.
- It is not possible to play DVD-Audio discs. This DVD drive may not be able to play all discs bearing the marks shown above.

AVCHD recorded discs

This unit is not compatible with discs recorded in AVCHD (Advanced Video Codec High Definition) format. Do not insert AVCHD discs. If inserted, the disc may not be ejected.

Playing DualDisc

- DualDiscs are two-sided discs that have a recordable CD for audio on one side and a recordable DVD for video on the other.
- Playback of the DVD side is possible with this navigation system. However, since the CD side of DualDiscs is not physically compatible with the general CD standard, it may not be possible to play the CD side with this navigation system.
- Frequent loading and ejecting of a Dual-Disc may result in scratches to the disc.

- Serious scratches can lead to playback problems on this navigation system. In some cases, a DualDisc may become stuck in the disc loading slot and will not eject. To prevent this, we recommend you refrain from using DualDisc with this navigation system.
- Please refer to the manufacturer for more detailed information about DualDiscs.

Dolby Digital

AVIC-X910BT will down-mix Dolby Digital signals internally and the sound will be output in stereo.

- Manufactured under license from Dolby Laboratories. "Dolby" and the double-D symbol are trademarks of Dolby Laboratories.



DTS sound

DTS audio cannot be output, so select an audio setting other than DTS.

"DTS" is registered trademarks of DTS, Inc.

Appendix

Detailed information for playable media

Compatibility

Common notes about disc compatibility

- Certain functions of this product may not be available for some discs.
- Compatibility with all discs is not guaranteed.
- It is not possible to play back DVD-ROM/ DVD-RAM discs.
- Playback of discs may become impossible with direct exposure to sunlight, high temperatures, or depending on the storage conditions in the vehicle.

DVD-Video discs

- DVD-Video discs that have incompatible region numbers cannot be played on this DVD drive. The region number of the player can be found on this product's chassis.

DVD-R/DVD-RW/DVD-R DL (Dual Layer) discs

- Unfinalized discs which have been recorded with the Video format (video mode) cannot be played back.
- Discs which have been recorded with the Video Recording format (VR mode) can be played back. However, unfinalized discs may not be played back. Unplayable discs should be finalized.
- DVD-R DL (Dual Layer) discs which have been recorded with Layer Jump recording cannot be played back.
- For more information about recording mode, please contact the manufacturer of media, recorders, or writing software.
- The following logo indicates that this unit is compatible with DVD-RW discs which have been recorded with the Video Recording format (VR mode).



CD-R/CD-RW discs

- Unfinalized discs cannot be played back.
- It may not be possible to play back CD-R/ CD-RW discs recorded on a music CD recorder or a personal computer because of disc characteristics, scratches or dirt on the disc, or dirt, scratches or condensation on the lens of the built-in drive.
- Playback of discs recorded on a personal computer may not be possible, depending on the recording device, writing software, their settings, and other environmental factors.
- Please record with the correct format. (For more details, please contact manufacturer of media, recorders, or writing software.)
- Titles and other text information recorded on a CD-R/CD-RW disc may not be displayed by this product (in the case of audio data (CD-DA)).
- Read the precautions with CD-R/CD-RW discs before using them.

Common notes about the external storage device (USB, SD)

- Depending on the kind of the external storage device (USB, SD) you use, this navigation system may not recognize the storage device or files may not be played back properly.
- Do not leave the external storage device (USB, SD) in any location with high temperatures.
- The text information of some audio and video files may not be correctly displayed.
- File extensions must be used properly.

Appendix

- There may be a slight delay when starting playback of files on an external storage device (USB, SD) with complex folder hierarchies.
- Operations may vary depending on the kind of an external storage device (USB, SD).
- It may not be possible to play some music files from SD or USB because of file characteristics, file format, recorded application, playback environment, storage conditions, and so on.
- Video playback from SD or USB will be paused when the navigation is displayed.

USB storage device compatibility

➔ For more details about USB storage device compatibility with this navigation system, refer to *Specifications* on page 212.

Protocol: bulk

Subclass: SCSI (06h)

- You cannot connect a USB storage device to this navigation system via a USB hub.
- Partitioned USB memory is not compatible with this navigation system.
- Firmly secure the USB storage device when driving. Do not let the USB storage device fall onto the floor, where it may become jammed under the brake or gas pedal.
- There may be a slight delay when starting playback of audio files encoded with image data.
- Some USB storage devices connected to this navigation system may generate noise on the radio.
- Do not connect anything other than the USB memory device.

The sequence of audio files on USB memory

For USB memory, the sequence is different from that of USB memory device.

SD memory card and SDHC memory card

- For more details about SD memory card compatibility with this navigation system, refer to *Specifications* on page 212.

Handling guidelines and supplemental information

- This system is not compatible with Multi Media Card (MMC).
- Copyright protected files cannot be played back.

Notes specific to DivX files

- Only DivX files downloaded from DivX partner sites are guarantee for proper operation. Unauthorized DivX files may not operate properly.
- DRM rental files cannot be operated until playing back is started.
- The navigation system corresponds to a DivX file display of up to 1 590 minutes 43 seconds. Search operations beyond this time limit are prohibited.
- DivX VOD file playback requires supplying the ID code of this navigation system to the DivX VOD provider. Regarding the ID code, refer to *Displaying your DivX VOD registration code* on page 105.
- Plays all versions of DivX video (including DivX 6) with standard playback of DivX media files.
- For more details about DivX, visit the following site:
<http://www.divx.com/>

DivX subtitle files

- Srt format subtitle files with the extension “.srt” can be used.
- Only one subtitle file can be used for each DivX file. Multiple subtitle files cannot be associated.

Appendix

- Subtitle files that are named with the same character string as the DivX file before the extension are associated with the DivX file. The character strings before the extension must be exactly the same. However, if there is only one DivX file and one subtitle file in a single folder, the files are associated even if the file names are not the same.
- The subtitle file must be stored in the same folder as the DivX file.
- Up to 255 subtitle files may be used. Any more subtitle files will not be recognized.
- Up to 64 characters can be used for the name of the subtitle file, including the extension. If more than 64 characters are used for the file name, the subtitle file may not be recognized.
- The character code for the subtitle file should comply with ISO-8859-1. Using characters other than ISO-8859-1 may cause the characters to be displayed incorrectly.
- The subtitles may not be displayed correctly if the displayed characters in the subtitle file include control code.
- For materials that use a high transfer rate, the subtitles and video may not be completely synchronized.
- If multiple subtitles are programmed to display within a very short time frame, such as 0.1 seconds, the subtitles may not be displayed at the correct time.

Appendix

Media compatibility chart

General

Media	CD-R/-RW AVIC-X710BT	CD-R/-RW AVIC-X910BT	DVD-R/-RW/- R DL AVIC-X910BT	USB storage device (All models)	SD memory card (All models)
File system	ISO9660 level 1, ISO9660 level 2, Romeo and Joliet		ISO9660 level 1, ISO9660 level 2, Romeo, Joliet and UDF 1.02	FAT16/FAT32	
Maximum number of folders	99	700		FAT32: No limit. FAT16: 512 (including files)	
Maximum number of files	999		3 500	FAT32: No limit. FAT16: 512 (including folders)	
Playable file types	MP3, WMA, AAC, WAV	MP3, WMA, AAC, DivX		MP3, WMA, AAC, WAV, AVI, MPEG-4	

MP3 compatibility

Media	CD-R/-RW AVIC-X710BT	CD-R/-RW AVIC-X910BT	DVD-R/-RW/- R DL AVIC-X910BT	USB storage device (All models)	SD memory card (All models)
File extension	.mp3				
Bit rate	8 kbps to 320 kbps (CBR), VBR				
Sampling frequency	16 kHz to 48 kHz (32 kHz, 44.1 kHz, 48 kHz for emphasis)			16 kHz to 48 kHz	
ID3 tag	ID3 Tag Ver. 1.0, 1.1, 2.2, 2.3			ID3 Tag Ver. 1.0, 1.1, 2.3	
Notes:					
<ul style="list-style-type: none"> Ver. 2.x of ID3 Tag is given priority when both Ver. 1.x and Ver. 2.x exist. The navigation system is not compatible with the following: MP3i (MP3 interactive), mp3 PRO, m3u playlist 					

Appendix

WMA compatibility

Media	CD-R/-RW AVIC-X710BT	CD-R/-RW AVIC-X910BT	DVD-R/-RW/- R DL AVIC-X910BT	USB storage device (All models)	SD memory card (All models)
File extension	.wma				
Bit rate	48 kbps to 320 kbps (CBR), VBR	5 kbps to 320 kbps (CBR), VBR		Ver. 9: 5 kbps to 320 kbps (CBR), VBR Ver. 7 or 8: 128 kbps to 192 kbps (CBR), VBR	
Sampling frequency	32 kHz to 48 kHz	8 kHz to 48 kHz			
Note:					
<ul style="list-style-type: none"> The navigation system is not compatible with the following: Windows Media Audio 9 Professional, Lossless, Voice 					

WAV compatibility

Media	CD-R/-RW AVIC-X710BT	CD-R/-RW AVIC-X910BT	DVD-R/-RW/- R DL AVIC-X910BT	USB storage device (All models)	SD memory card (All models)	
File extension	.wav		AVIC-X910BT cannot play WAV files on the built-in DVD drive.	.wav		
Format	Linear PCM (LPCM), MS ADPCM	Linear PCM (LPCM), IMA-ADPCM				
Sampling frequency	LPCM: 16 kHz to 48 kHz MS ADPCM: 22.05 kHz and 44.1 kHz	LPCM: 16 kHz to 48 kHz IMA-ADPCM: 22.05 kHz and 44.1 kHz				
Quantization bits	LPCM: 8 bits and 16 bits MS ADPCM: 4 bits	LPCM: 8 bits and 16 bits IMA-ADPCM: 3 bits and 4 bits				
Note:						
The sampling frequency shown in the display may be rounded.						

Appendix

AAC compatibility

Media	CD-R/-RW AVIC-X710BT	CD-R/-RW AVIC-X910BT	DVD-R/-RW/- R DL AVIC-X910BT	USB storage device (All models)	SD memory card (All models)
File extension	.m4a				
Bit rate	16 kbps to 320 kbps (CBR)			8 kbps to 320 kbps (CBR)	
Sampling frequency	11 kHz to 44.1 kHz	8 kHz to 44.1 kHz			
Notes:					
<ul style="list-style-type: none"> The navigation system plays back AAC files encoded by iTunes. The navigation system is not compatible with the following: Apple Lossless, files encoded with VBR 					

DivX compatibility

Media	CD-R/-RW AVIC-X710BT	CD-R/-RW AVIC-X910BT	DVD-R/-RW/- R DL AVIC-X910BT	USB storage device (All models)	SD memory card (All models)
File extension	AVIC-X710BT cannot play DivX files.	.avi/.divx		DivX files on the external storage device (USB, SD) cannot be played.	
Profile (DivX version)		Home Theater Ver. 3.11/Ver. 4.x/ Ver. 5.x/Ver. 6.x			
Compatible audio codec		MP3, Dolby Digital			
Bit rate (MP3)		8 kbps to 320 kbps (CBR), VBR			
Sampling frequency (MP3)		16 kHz to 48 kHz (32 kHz, 44.1 kHz, 48 kHz for emphasis)			
Maximum image size		720 pixels × 576 pixels			
Maximum file size		4 GB			
Notes:					
<ul style="list-style-type: none"> The navigation system is not compatible with the following: DivX Ultra format, DivX files without video data, DivX files encoded with LPCM (Linear PCM) audio codec Depending on the file information composition, such as the number of audio streams, there may be a slight delay in the start of playback on discs. If a file contains more than 4 GB, playback stops before the end. Some special operations may be prohibited because of the composition of DivX files. Files with high transfer rates may not be played back correctly. The standard transfer rate is 4 Mbps for CDs and 10.08 Mbps for DVDs. 					

Appendix

AVI compatibility

Media	CD-R/-RW AVIC-X710BT	CD-R/-RW AVIC-X910BT	DVD-R/-RW/- R DL AVIC-X910BT	USB storage device (All models)	SD memory card (All models)
File extension	AVI files cannot be played on the built-in drive.			.avi	
Compatible video codec				MPEG-4	
Compatible audio codec				ADPCM	
Recommended video specifications				Image size: VGA (640 pixels x 480 pixels) Bit rate: 480 kbps Frame rate: 24 fps	

MPEG-4 compatibility

Media	CD-R/-RW AVIC-X710BT	CD-R/-RW AVIC-X910BT	DVD-R/-RW/- R DL AVIC-X910BT	USB storage device (All models)	SD memory card (All models)
File extension	MPEG-4 files cannot be played on the built-in drive.			.mp4	
Compatible video codec				MPEG-4	
Compatible audio codec				AAC	
Recommended video specifications				Image size: VGA (640 pixels x 480 pixels) Bit rate: 480 kbps Frame rate: 24 fps	

Common notes

- The navigation system may not operate correctly, depending on the application used to encode WMA files.
- Depending on the version of Windows Media Player used to encode WMA files, album names and other text information may not be correctly displayed.
- There may be a slight delay when starting playback of audio files encoded with image data.
- The navigation system is not compatible with packet write data transfer.
- This navigation system can recognize up to 32 characters, beginning with the first character, including extension for the file and folder name. Depending on the display area, the navigation system may try to display them with a reduced font size. However, the maximum number of the characters that you can display varies according to the width of each character, and of the display area.
- Folder selection sequence or other operations may be altered, depending on the encoding or writing software.
- Regardless of the length of blank section between the songs of original recording, compressed audio discs play with a short pause between songs.

Appendix

Example of a hierarchy

The following figure is an example of the tier structure in the disc. The numbers in the figure indicate the order in which folder numbers are assigned and the order to be played back.

📁: Folder

🎵: File

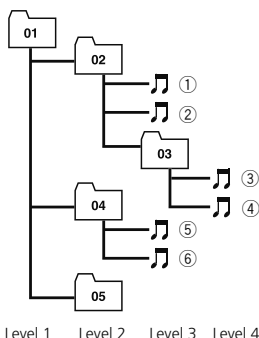

Notes

- This product assigns folder numbers. The user cannot assign folder numbers.
- If there is a folder that does not contain any playable file, the folder itself will display in the folder list but you cannot check any files in the folder. (A blank list will appear.) Also, these folders will be skipped without displaying the folder number. ▣

Bluetooth



Bluetooth is a short-range wireless radio connectivity technology that is developed as a cable replacement for cellular phones, handheld PCs and other devices. Bluetooth operates in 2.4 GHz frequency range and transmits voice and data at speeds up to 1 megabit per

second. Bluetooth was launched by a special interest group (SIG) comprising Ericsson Inc., Intel Corp., Nokia Corp., Toshiba and IBM in 1998, and it is currently developed by nearly 2 000 companies worldwide.

- The *Bluetooth*® word mark and logos are registered trademarks owned by Bluetooth SIG, Inc. and any use of such marks by Pioneer Corporation is under license. Other trademarks and trade names are those of their respective owners. ▣

About the SAT RADIO READY Logo



The SAT RADIO READY logo indicates that the Satellite Radio Tuner for Pioneer (i. e., XM tuner and Sirius satellite tuner which are sold separately) can be controlled by this navigation system. Please inquire with your dealer or nearest authorized Pioneer service station regarding the satellite radio tuner that can be connected to this navigation system.

Note:

The system will use direct satellite-to-receiver broadcasting technology to provide listeners in their cars and at home with crystal-clear sound seamlessly from coast to coast. Satellite radio will create and package over 100 channels of digital- quality music, news, sports, talk and children's programming. "SAT Radio", the SAT Radio logo and all related marks are trademarks of Sirius Satellite Radio inc., and XM Satellite Radio Inc. ▣

HD Radio Technology

The HD Radio Ready logo is a proprietary trademark of iBiquity Digital Corp. ▣

Appendix

SD and SDHC logo



SD Logo is a trademark.



SDHC Logo is a trademark.

WMA



The Windows Media™ logo printed on the box indicates that this unit can play back WMA data.

WMA is short for Windows Media Audio and refers to an audio compression technology that is developed by Microsoft Corporation. WMA data can be encoded by using Windows Media Player version 7 or later.

Windows Media and the Windows logo are trademarks or registered trademarks of Microsoft Corporation in the United States and/or other countries.

DivX



DivX is a compressed digital video format created by the DivX video codec from DivX, Inc. This unit can play DivX video files recorded on CD-R/RW/ROM and DVD-R/RW/ROM discs. Keeping the same terminology as DVD video, individual DivX video files are called "Titles". When naming files/titles on a CD-R/RW or a DVD-R/RW disc prior to burning, keep in mind that by default they will be played in alphabetical order.

Plays DivX® video.

DivX® is a registered trademark of DivX, Inc., and is used under license.

AAC

AAC is short for Advanced Audio Coding and refers to an audio compression technology standard used with MPEG-2 and MPEG-4. Several applications can be used to encode AAC files, but file formats and extensions differ depending on the application which is used to encode. This unit plays back AAC files encoded by iTunes version 4.6.

Detailed information regarding connectable iPods

CAUTION

- Pioneer accepts no responsibility for data lost from an iPod, even if that data is lost while using the navigation system.

Appendix

- Do not leave the iPod in direct sunlight for extended amounts of time. Extended exposure to direct sunlight can result in iPod malfunction due to the resulting high temperature.
- Do not leave the iPod in any location with high temperatures.
- Firmly secure the iPod when driving. Do not let the iPod fall onto the floor, where it may become jammed under the brake or gas pedal.

For details, refer to the iPod's manuals.

iPod



"Made for iPod" means that an electronic accessory has been designed to connect specifically to iPod and has been certified by the developer to meet Apple performance standards.

Apple is not responsible for the operation of this device or its compliance with safety and regulatory standards.

iPod is a trademark of Apple Inc., registered in the U.S. and other countries.

iPhone



"Works with iPhone" means that an electronic accessory has been designed to connect specifically to iPhone and has been certified by the developer to meet Apple performance standards.

Apple is not responsible for the operation of this device or its compliance with safety and regulatory standards.

iPhone is a trademark of Apple Inc.

iTunes

iTunes is a trademark of Apple Inc., registered in the U.S. and other countries. 

Using the LCD screen correctly

Handling the LCD screen

- When the LCD screen is subjected to direct sunlight for a long period of time, it will become very hot, resulting in possible damage to the LCD screen. When not using this navigation system, avoid exposing it to direct sunlight as much as possible.
- The LCD screen should be used within the temperature ranges shown in "*Specifications*".
- Do not use the LCD screen at temperatures higher or lower than the operating temperature range, because the LCD screen may not operate normally and could be damaged.
- The LCD screen is exposed in order to increase its visibility within the vehicle. Please do not press strongly on it as this may damage it.
- Do not push the LCD screen with excessive force as this may scratch it.
- Never touch the LCD screen with anything besides your finger when operating the Touch panel functions. The LCD screen can scratch easily.

Appendix

Liquid crystal display (LCD) screen

- If the LCD screen is near the vent of an air conditioner, make sure that air from the air conditioner is not blowing on it. Heat from the heater may break the LCD screen, and cool air from the cooler may cause moisture to form inside the navigation unit, resulting in possible damage.
- Small black dots or white dots (bright dots) may appear on the LCD screen. These are due to the characteristics of the LCD screen and do not indicate a malfunction.
- The LCD screen will be difficult to see if it is exposed to direct sunlight.
- When using a cellular phone, keep the antenna of the cellular phone away from the LCD screen to prevent disruption of the video in the form of disturbances such as spots or colored stripes.

dealer or the nearest authorized PIONEER Service Station. 

Maintaining the LCD screen

- When removing dust from the LCD screen or cleaning it, first turn the system power off, then wipe with a soft dry cloth.
- When wiping the LCD screen, take care not to scratch the surface. Do not use harsh or abrasive chemical cleaners.

LED (light-emitting diode) backlight

A light emitting diode is used inside the display to illuminate the LCD screen.

- At low temperatures, using the LED backlight may increase image lag and degrade the image quality because of the characteristics of the LCD screen. Image quality will improve with an increase in temperature.
- The product lifetime of the LED backlight is more than 10 000 hours. However, it may decrease if used in high temperatures.
- If the LED backlight reaches the end of its product lifetime, the screen will become dimmer and the image will no longer be visible. In that case, please consult your

Appendix

Display information

Destination Menu



	Page
[Address]	42
[POI]	
[Around Current GPS Location]	45
[Around Destination]	45
[Around Cursor]	44
[Along Route]	45
[Around entered address]	45
[Saved Criteria]	47
[Register Search Criteria]	46
[Favorites]	50
[History]	50
[USB/SD]	48
[Return Home]	51
[Delete Route]	63
[Saved Routes]	51
[Route Function]	
[Route info]	59
[Itinerary]	60
[Edit Route]	62
[Save Route]	62
[Coordinate]	49
[MSN Direct]	64

Phone Menu



	Page
[Dial Pad]	78
[Call Home]	79
[GOOG-411]	80
[Phone Volume]	82
[Received Calls]	78
[Dialed Numbers]	78
[Missed Calls]	78
[Phone Book Transfer]	80
[Phone Settings]	
[Connection]	76
[Bluetooth On/Off]	82
[Auto Answer Preference]	82
[Refuse All Calls]	83
[Echo Cancel]	83
[Auto Connect]	83
[Edit Name]	83
[Clear Memory]	81
[Bluetooth Software Update]	85

Appendix

Settings Menu

Navi Settings

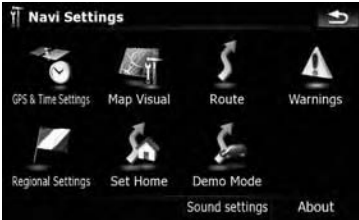

	Page
[GPS & Time Settings]	143
[Time Settings]	144
[Map Visual]	
[POI Settings]	150
[3D Settings]	145
[Map Settings]	145
[Displayed Info]	146
[Smart Zoom]	146
[Overview Mode]	147
[Manage Track Logs]	152
[Route]	
[Method:]	147
[U-turn penalty:]	148
[Unpaved Roads]	148
[Highways]	148
[Ferries]	148
[U-turns]	148
[Permit Needed]	148
[Toll Roads]	148
[Warnings]	
[Warn When Speeding]	148
[Regional Settings]	149
[Set Home]	154
[Demo Mode]	149

[Sound settings]	149
[About]	150

Appendix

System Settings menu

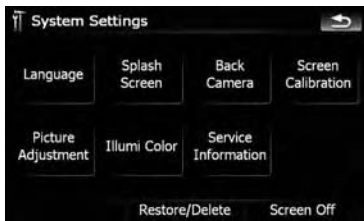

	Page
[Language]	155
[Splash Screen]	155
[Back Camera]	156
[Screen Calibration]	157
[Picture Adjustment]	157
[Illumi Color]	157
[Service Information]	158
[Restore/Delete]	
[Restore Factory Settings]	158
[Delete user information]	158
[Screen Off]	159

AV System Settings menu

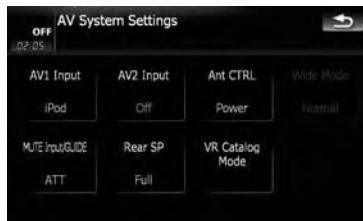

	Page
[AV1 Input]	163
[AV2 Input]	163
[Ant CTRL]	164
[Wide Mode]	164
[MUTE Input/GUIDE]	164
[Rear SP]	165
[VR Catalog Mode]	165

Appendix

AV Sound Settings menu



	Page
[FAD/BAL] ([Balance])	159
[EQ]	160
[Loudness]	161
[Sub Woofer]	162
[HPF]	162
[SLA]	162
[Bass Booster]	163

Shortcut menu

Map Confirmation Screen



	Page
[Map]	52
[Save as...]	55
[Add Pin]	56
[Add POI]	57
[Add Favorite]	58
[Route...]	54
[Go Here Now]	55
[Add Via]	55
[Continue]	55
[Starting Point]	55
[Info]	56
[Call]	79

Appendix

DVD Setup



	Page
[Language]	103
[Multi Angle]	103
[TV Aspect]	104
[Parental]	104
[DivX VOD]	105
[Auto Play]	105
[Subtitle File]	105



Appendix

Glossary

AAC

AAC is short for Advanced Audio Coding and refers to an audio compression technology standard used with MPEG-2 and MPEG-4.

Aspect ratio

This is the width-to-height ratio of a TV screen. A regular display has an aspect ratio of 4:3. Wide screen displays have an aspect ratio of 16:9, providing a bigger picture for exceptional presence and atmosphere.

Bit rate

This expresses data volume per second, or bps units (bits per second). The higher the rate, the more information is available to reproduce the sound. Using the same encoding method (such as MP3), the higher the rate, the better the sound.

Built-in sensor

The built-in sensor that enables the system to estimate your vehicle's position.

CD-DA

This stands for a general music CD (commercial-release audio CD). In this manual, this word is sometime used for a distinction between data CDs (which include compressed audio files) and general music CDs.

Chapter

Titles of DVD-Video or DVD-VR are in turn divided into chapters which are numbered in the same way as the chapters of a book. With discs featuring chapters, you can quickly find a desired scene with chapter search.

Current location

The present location of your vehicle; your current location is shown on the map by a red triangle mark.

Destination

A location you choose as the end point of your journey.

DivX

DivX is a popular media technology created by DivX, Inc. DivX media files contain highly compressed video with high visual quality that maintains a relatively small file size. DivX files can also include advanced media features like menus, subtitles, and alternate audio tracks. Many DivX media files are available for download online, and you can create your own using your personal content and easy-to-use tools from DivX.com.

DivX Certified

DivX Certified products are officially tested by the creators of DivX and guaranteed to play all versions of DivX video, including DivX 6.

Favorites

A frequently visited location (such as your workplace or a relative's home) that you can register to allow easy routing.

GPS

Global Positioning System. A network of satellites that provides navigation signals for a variety of purposes.

Guidance mode

The mode in which guidance is given as you drive to your destination; the system automatically switches to this mode as soon as a route has been set.

Guidance point

These are important landmarks along your route, generally intersections. The next guidance point along your route is indicated on the map by the yellow flag icon.

Home location

Your registered home location.

Appendix

ID3 tag

This is a method of embedding track-related information in an MP3 file. This embedded information can include the track title, the artist's name, the album title, the music genre, the year of production, comments and other data. The contents can be freely edited using software with ID3 Tag editing functions.

Although the tags are restricted by the number of characters, the information can be viewed when the track is played back.

ISO9660 format

This is the international standard for the format logic of DVD/CD-ROM folders and files. For the ISO9660 format, there are regulations for the following two levels:

Level 1:

The file name is in 8.3 format (the name consists of up to 8 characters, half-byte English capital letters, half-byte numerals and the “_” sign, with a file-extension of three characters).

Level 2:

The file name can have up to 31 characters (including the separation mark “.” and a file extension). Each folder contains less than 8 hierarchies.

Extended formats

Joliet:

File names can have up to 64 characters.

Romeo:

File names can have up to 128 characters.

- **Level 1:**

The file name is in 8.3 format (the name consists of up to 8 characters, half-byte English capital letters, half-byte numerals and the “_” sign, with a file-extension of three characters).

- **Level 2:**

The file name can have up to 31 characters (including the separation mark “.” and a file extension). Each folder contains less than 8 hierarchies.

- **Extended formats**

Joliet:

File names can have up to 64 characters.

Romeo:

File names can have up to 128 characters.

JPEG

This stands for Joint Photographic Experts Group, and is an international still image compression standard.

MP3

MP3 is short for MPEG Audio Layer 3. It is an audio compression standard established by a working group (MPEG) of the ISO (International Standards Organization). MP3 is able to compress audio data to about 1/10th the size of a conventional disc.

MPEG

This stands for Moving Pictures Experts Group, and is an international video image compression standard.

Multi-angle

With regular TV programs, although multiple cameras are used to simultaneously shoot scenes, only images from one camera at a time are transmitted to your TV. Some DVDs feature scenes shot from multiple angles, letting you choose your viewing angle as desired.

Multi-audio (Multilingual dialog)

Some videos feature dialog recorded in multiple languages or audio recorded in multiple tracks. For example, dialog in up to 8 languages can be recorded on a single DVD-Video, letting you choose the language as desired.

Multi-session

Multi-session is a recording method that allows additional data to be recorded later. When recording data on a CD-ROM, CD-R or CD-RW, etc., all data from beginning to end is treated as a single unit or session. Multi-session is a method of recording more than 2 sessions in one disc.

Multi-subtitle

For example, subtitles in up to 32 languages can be recorded on a single DVD-Video, letting you choose as desired.

Appendix

Packet write

This is a general term for a method of writing individual files to a CD-R, etc. whenever required, just as is done with files on floppy or hard disks.

Parental lock

Some DVD-Video discs with violent or adult-oriented scenes feature parental lock which prevents children from viewing such scenes. With this kind of disc, if you set the unit's parental lock level, playback of scenes inappropriate for children will be disabled, or these scenes will be skipped.

Phone book

An address book on user's phone is collectively referred to as "Phone book". Depending on the cellular phone, the "Phone book" may be called a name such as "Contacts", "Business card" or something else.

Point of Interest (POI)

Point Of Interest; any of a range of locations stored in the data, such as railway stations, shops, restaurants, and amusement parks.

Region number

DVD players and DVD discs feature region numbers indicating the area in which they were purchased. Playback of a DVD is not possible unless it features the same region number as the DVD player.

Route setting

The process of determining the ideal route to a specific location; route setting is done automatically by the system when you specify a destination.

Set route

The route marked out by the system to your destination. It is highlighted in bright color on the map.

Title

DVD-Video or DVD-VR discs have a high data capacity, enabling recording of multiple videos on a single disc. If, for example, one disc con-

tains three separate videos, they are divided into title 1, title 2 and title 3. This lets you enjoy the convenience of title search and other functions.

Track log

Your navigation system logs routes that you already passed through if the track logger is activated. This recorded route is called a "track log". It is handy when you want to check a route traveled or if returning along a complex route.

VBR

VBR is short for variable bit rate. Generally speaking, CBR (constant bit rate) is more widely used. But by flexibly adjusting the bit rate according to the needs of audio compression, it is possible to achieve compression-priority sound quality.

Voice guidance

The giving of directions by navigation voice while in guidance.

Waypoint

A location that you choose to visit before your destination; a journey can be built up from multiple waypoints and the destination.

WMA

WMA is short for Windows Media™ Audio and refers to an audio compression technology that is developed by Microsoft Corporation. ■

Appendix

Specifications

General

Rated power source	14.4 V DC (allowable voltage range: 10.8 V to 15.1 V DC)
Grounding system	Negative type
Maximum current consumption	10.0 A
Dimensions (W × H × D):	
Chassis	178 mm × 100 mm × 157 mm (7 in. × 3-7/8 in. × 6-1/8 in.)
Nose	171 mm × 97 mm × 8 mm (6-3/4 in. × 3-7/8 in. × 3/8 in.)
Weight:	
AVIC-X910BT	2.1 kg
AVIC-X710BT	2.1 kg
NAND flash memory	2 GB

Navigation

GPS Receiver:	
System	L1, C/Acode GPS SPS (Standard Positioning Service)
Reception system	30-channel multi-channel reception system
Reception frequency ...	1 575.42 MHz
Sensitivity	-140 dBm (typ)
Position update frequency	Approx. once per second
GPS antenna:	
Antenna	Micro strip flat antenna/ right-handed helical polarization
Antenna cable	5.0 m (16 ft. 5 in.)
Dimensions (W × H × D)	33 mm × 15 mm × 36 mm (1-1/4 in. × 5/8 in. × 1-3/8 in.)
Weight	96 g (0.2 lbs)

Display

Screen size/aspect ratio	5.8 inch wide/16:9 (effective display area: 128 mm × 72 mm)
Pixels	384 000 (800 × 480)
Display method	TFT Active matrix driving
Backlight	LED
Color system	NTSC compatible
Tolerable temperature range:	
Power on	+14°F to +140°F
Power off	-4°F to +176°F

Audio

Maximum power output	50 W × 4 50 W × 2 ch/4Ω + 70 W × 1 ch/2Ω (for subwoofer)
Continuous power output ...	22 W × 4 (50 Hz to 15 kHz, 5%THD, 4Ω LOAD, Both Channels Driven)
Load impedance	4Ω (4Ω to 8Ω [2Ω for 1 ch] allowable)
Preout output level (max) ...	2.2 V
Preout impedance	1 kohm
Equalizer (3-Band Parametric Equalizer):	
Low	
Frequency	40 Hz/80 Hz/100 Hz/160 Hz
Q Factor	0.35/0.59/0.95/1.15 (+6 dB when boosted)
Gain	±12 dB
Mid	
Frequency	200 Hz/500 Hz/1 kHz/2 kHz
Q Factor	0.35/0.59/0.95/1.15 (+6 dB when boosted)
Gain	±12 dB
High	
Frequency	3.15 kHz/8 kHz/10 kHz/ 12.5 kHz
Q Factor	0.35/0.59/0.95/1.15 (+6 dB when boosted)
Gain	±12 dB
Loudness contour:	
Low	+3.5 dB (100 Hz), +3 dB (10 kHz)
Mid	+10 dB (100 Hz), +6.5 dB (10 kHz)
High	+11 dB (100 Hz), +11 dB (10 kHz) (volume: -30 dB)
HPF:	
Frequency	50 Hz/63 Hz/80 Hz/100 Hz/ 125 Hz
Slope	-12 dB/oct
Subwoofer:	
Frequency	50 Hz/63 Hz/80 Hz/100 Hz/ 125 Hz
Slope	-18 dB/oct
Gain	-24/+6 dB
Phase	Normal/Reverse
Bass boost:	
Gain	0 dB to +12 dB

DVD drive (AVIC-X910BT)

System	DVD-Video, CD, MP3, WMA, AAC, DivX system
Usable discs	DVD-Video, CD, MP3, WMA, AAC, DivX

Appendix

Region number	1
Signal format:	
Sampling frequency	44.1 kHz/48 kHz/96 kHz
Number of quantization bits	16 bit/20 bit/24 bit; linear
Frequency response	5 Hz to 44 000 Hz (with DVD, at sampling frequency 96 kHz)
Signal-to-noise ratio	97 dB (1 kHz) (IHF-A network) (CD: 96 dB (1 kHz) (IHF-A network))
Dynamic range	95 dB (1 kHz) (CD: 94 dB (1 kHz))
Distortion	0.008 % (1 kHz)
Output level:	
Video	1.0 Vp-p/75 Ω (± 0.2 V)
Audio	1.0 V (1 kHz, 0 dB)
Number of channels	2 (stereo)
MP3 decoding format	MPEG-1 & 2 Audio Layer 3
WMA decoding format	Ver.9.0 L3
AAC decoding format	MPEG-4 AAC (only encoded by iTunes): .m4a
DivX decoding format	Home Theater Ver.3.11, Ver.4.X, Ver.5.X, Ver.6.X: .avi, .divx

CD drive (AVIC-X710BT)

System	CD, MP3, WMA, AAC system
Usable discs	CD, MP3, WMA, AAC
Signal-to-noise ratio	94 dB (1 kHz) (IHF-A network)
MP3 decoding format	MPEG-1 & 2 Audio Layer 3
WMA decoding format	Ver.7,7.1,8,9,10 (2 ch audio) (Windows Media Player)
AAC decoding format	MPEG-4 AAC (iTunes encoded only)
WAVE SIGNAL FORMAT	Linear-PCM, MS ADPCM (Non Compressed)

USB

USB standard spec.	USB 2.0 High Speed
Max current supply	500 mA
Max memory capacity	8 GB
File system	FAT16, FAT32
USB class	Mass storage class
Decoding format	MP3/WMA/AAC/WAVE/MPEG4

SD

Compatible physical format	Version 2.00
----------------------------------	--------------

Max memory capacity	8 GB
File system	FAT16, FAT32
Decoding format	MP3/WMA/AAC/WAVE/MPEG4

Bluetooth

Version	Bluetooth 1.2 certified
Output power	+4 dBm Max. (Power class 2)

FM tuner

Frequency range	87.9 MHz to 107.9 MHz
Usable sensitivity	8 dBf (0.7 μ V/75 Ω mono, S/N: 30 dB)
Signal-to-noise ratio	75 dB (IHF-A network)
Distortion	0.3 % (at 65 dBf, 1 kHz, stereo) 0.1 % (at 65 dBf, 1 kHz, mono)
Frequency response	30 Hz to 15 000 Hz (± 3 dB)
Stereo separation	45 dB (at 65 dBf, 1 kHz)

AM tuner

Frequency range	530 kHz to 1 710 kHz (10 kHz)
Usable sensitivity	18 μ V (S/N: 20 dB)
Signal-to-noise ratio	65 dB (IHF-A network)

CEA2006 Specifications



Power output	14 W RMS \times 4 Channels (4 Ω and \leq 1 % THD+N)
S/N ratio	91 dBA (reference: 1 W into 4 Ω)



Note

Specifications and design are subject to possible modifications without notice due to improvements. \square

Register your product at

<http://www.pioneerelectronics.com>

in Canada **<http://www.pioneerelectronics.ca>**

See "Visit our website" page

PIONEER CORPORATION

4-1, MEGURO 1-CHOME, MEGURO-KU
TOKYO 153-8654, JAPAN

PIONEER ELECTRONICS (USA) INC.

P.O. Box 1540, Long Beach, California 90801-1540, U.S.A.
TEL: (800) 421-1404

PIONEER EUROPE NV

Haven 1087, Keetberglaan 1, B-9120 Melsele, Belgium/Belgique
TEL: (0) 3/570.05.11

PIONEER ELECTRONICS ASIACENTRE PTE. LTD.

253 Alexandra Road, #04-01, Singapore 159936
TEL: 65-6472-7555

PIONEER ELECTRONICS AUSTRALIA PTY. LTD.

178-184 Boundary Road, Braeside, Victoria 3195, Australia
TEL: (03) 9586-6300

PIONEER ELECTRONICS OF CANADA, INC.

300 Allstate Parkway, Markham, Ontario L3R 0P2, Canada
TEL: 1-877-283-5901
TEL: 905-479-4411

PIONEER ELECTRONICS DE MEXICO, S.A. de C.V.

Bldv.Manuel Avila Camacho 138 10 piso
Col.Lomas de Chapultepec, Mexico, D.F. 11000
TEL: 55-9178-4270

先鋒股份有限公司

總公司：台北市中山北路二段44號13樓
電話：(02) 2521-3588

先鋒電子（香港）有限公司

香港九龍尖沙咀海港城世界商業中心9樓901-6室
電話：(0852) 2848-6488

Published by Pioneer Corporation.

Copyright © 2009 by Pioneer Corporation.
All rights reserved.

Printed in China

<CRB2985-A/S> UC

<KKYZX> <09D00000>