

Service Manual

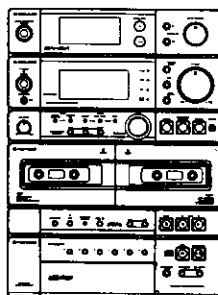

ORDER NO.
RRV1023

STEREO MULTI-PLAY CD CASSETTE DECK RECEIVER

XR-P740M

XR-P640M

XR-P340M

STEREO CD CASSETTE DECK RECEIVER

XR-P740

XR-P640

XR-P340

THIS MANUAL IS APPLICABLE TO THE FOLLOWING MODEL(S) AND TYPE(S).

Type	Model						Power Requirement	The voltage can be converted by the following method.
	XR-P740M	XR-P740	XR-P640M	XR-P640	XR-P340M	XR-P340		
SD	○	○	○	○	○	○	AC110V/120-127V/ 220V/240V	With the voltage selector
YPW	○	—	○	—	○	○	AC240V	—
KU	—	—	—	—	○	—	AC120V	—
KC	—	—	—	—	○	—	AC120V	—

CONTENTS

CHAPTER 1

1.1 SAFETY INFORMATION	1-2
1.2 SPECIFICATIONS	1-4
1.3 PANEL FACILITIES	1-5
1.4 DISASSEMBLY	1-8
1.5 BLOCK DIAGRAM	1-9
1.6 IC INFORMATION	1-11
1.7 ADJUSTMENTS	1-20

1.8 PARTS LIST FOR PACKING AND EXPLODED VIEWS	1-38
1.9 PCB PARTS LIST	1-47

CHAPTER 2

2.1 PACKING AND EXPLODED VIEWS ...	2-2
2.2 SCHEMATIC AND PCB CONNECTION DIAGRAMS	2-16

CHAPTER 1

1.1 SAFETY INFORMATION

This service manual is intended for qualified service technicians; it is not meant for the casual do-it-yourselfer. Qualified technicians have the necessary test equipment and tools, and have been trained to properly and safely repair complex products such as those covered by this manual.

Improperly performed repairs can adversely affect the safety and reliability of the product and may void the warranty. If you are not qualified to perform the repair of this product properly and safely, you should not risk trying to do so and refer the repair to a qualified service technician.



WARNING

Lead in solder used in this product is listed by the California Health and Welfare agency as a known reproductive toxicant which may cause birth defects or other reproductive harm (California Health & Safety Code, Section 25249.5).

When servicing or handling circuit boards and other components which contain lead in solder, avoid unprotected skin contact with the solder. Also, when soldering do not inhale any smoke or fumes produced.



NOTICE

(FOR CANADIAN MODEL ONLY)

Fuse symbols  (fast operating fuse) and/or  (slow operating fuse) on PCB indicate that replacement parts must be of identical designation.

REMARQUE

(POUR MODÈLE CANADIEN SEULEMENT)

Les symboles de fusible  (fusible de type rapide) et/ou  (fusible de type lent) sur CCI indiquent que les pièces de remplacement doivent avoir la même désignation.

(FOR USA MODEL ONLY)

1. SAFETY PRECAUTIONS

The following check should be performed for the continued protection of the customer and service technician.

LEAKAGE CURRENT CHECK

Measure leakage current to a known earth ground (water pipe, conduit, etc.) by connecting a leakage current tester such as Simpson Model 229-2 or equivalent between the earth ground and all exposed metal parts of the appliance (input/output terminals, screwheads, metal overlays, control shaft, etc.). Plug the AC line cord of the appliance directly into a 120V AC 60Hz outlet and turn the AC power switch on. Any current measured must not exceed 0.5mA.

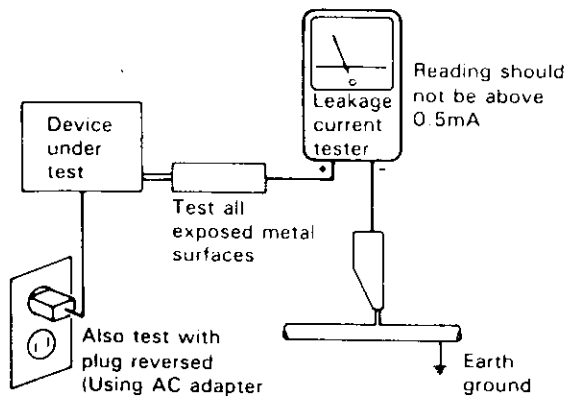

AC Leakage Test

ANY MEASUREMENTS NOT WITHIN THE LIMITS OUTLINED ABOVE ARE INDICATIVE OF A POTENTIAL SHOCK HAZARD AND MUST BE CORRECTED BEFORE RETURNING THE APPLIANCE TO THE CUSTOMER.

2. PRODUCT SAFETY NOTICE

Many electrical and mechanical parts in the appliance have special safety related characteristics. These are often not evident from visual inspection nor the protection afforded by them necessarily can be obtained by using replacement components rated for voltage, wattage, etc. Replacement parts which have these special safety characteristics are identified in this Service Manual.

Electrical components having such features are identified by marking with a Δ on the schematics and on the parts list in this Service Manual.

The use of a substitute replacement component which does not have the same safety characteristics as the PIONEER recommended replacement one, shown in the parts list in this Service Manual, may create shock, fire, or other hazards.

Product Safety is continuously under review and new instructions are issued from time to time. For the latest information, always consult the current PIONEER Service Manual. A subscription to, or additional copies of, PIONEER Service Manual may be obtained at a nominal charge from PIONEER.

(FOR EUROPEAN MODEL ONLY)

VARO!
AVATTAESSA JA SUOJALUKITUS
OHITETTAESSA OLET ALTTIINA
NÄKYMÄTTÖMÄLLE LASERSÄTEILYLLE.
ÄLÄ KATSO SÄTEESEEN.

ADVERSEL:
USYNLIG LASERSTRÅLING VED ÅBNING
NÅR SIKKERHEDSAFBRYDERE ER UDE AF
FUNKTION UNDGÅ UDSÆTTELSE FOR
STRÅLING.

VARNING!
OSYNLIG LASERSTRÅLNING NÅR DENNA
DEL ÄR ÖPPNAD OCH SPÄRREN
ÄR URKOPPLAD. BETRAKTA EJ STRÅLEN.



LASER
Kuva 1
Lasersäteilyn
varoituserkki

WARNING!
DEVICE INCLUDES LASER DIODE WHICH
EMITS INVISIBLE INFRARED RADIATION
WHICH IS DANGEROUS TO EYES. THERE IS
A WARNING SIGN ACCORDING TO PICTURE
1 INSIDE THE DEVICE CLOSE TO THE LASER
DIODE.



LASER
Picture 1
Warning sign for
laser radiation

IMPORTANT
THIS PIONEER APPARATUS CONTAINS
LASER OF CLASS 1.
SERVICING OPERATION OF THE APPARATUS
SHOULD BE DONE BY A SPECIALLY
INSTRUCTED PERSON.

LASER DIODE CHARACTERISTICS
MAXIMUM OUTPUT POWER: 5 mw
WAVELENGTH: 780-785 nm

LABEL CHECK

YPW type



VRW-329

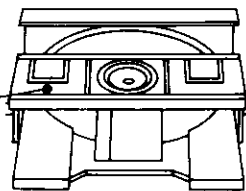

CD Single

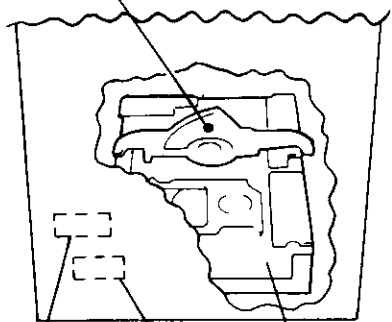

CD Multi

YPW type

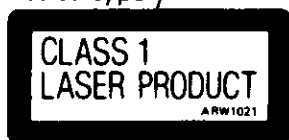

ARW1021

YPW type

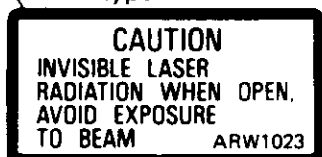

ARW1023

FOR CD MULTI

Additional Laser Caution

- Laser Interlock Mechanism**
The ON/OFF (ON : low level, OFF : high level) status of S601 (LPS1) and S602 (LPS2) switches for detecting the loading state is detected by the system microprocessor, and the design prevents laser diode oscillation except when both switches (LPS1 and LPS2) are ON (low level or clamped state). Thus, interlock will no longer function if switches S601 (LPS1) and S602 (LPS2) are deliberately shorted. The interlock also does not operate in the test mode*. Laser diode oscillation will continue, if pin 1 of M51593FP (IC101) on the PRE-AMP BOARD assembly loaded on pickup assembly are connected to GND, or pin 19 is connected to low level (ON), or else the terminals of Q101 are shorted to each other (fault condition).
- When the cover is opened with the servo mechanism block removed and turned over, close viewing of the objective lens with the naked eye will cause exposure to a Class 1 laser beam.

92M1A

* Refer to page 1-29.

FOR CD SINGLE

Additional Laser Caution

- Laser Interlock Mechanism**
The position of the switch (S601) for detecting loading state is detected by the system microprocessor, and the design prevents laser diode oscillation when the switch (S601) is not on CLMP terminal side (CLMP signal is OFF or high level). Thus, the interlock will no longer function if the switch (S601) is deliberately set to CLMP terminal side. (low level). The interlock also does not function in the test mode*. Laser diode oscillation will continue, if pin 1 of M51593FP (IC101) on the PRE-AMP BOARD ASSY mounted on the pickup assembly is connected to GND, or pin 19 is connected to low level (ON), or else the terminals of Q101 are shorted to each other (fault condition).
- When the cover is opened, close viewing of the objective lens with the naked eye will cause exposure to a Class 1 laser beam.

* Refer to page 1-29.

1.2 SPECIFICATIONS

**STEREO CD CASSETTE DECK RECEIVER/STEREO
MULTI-PLAY CD CASSETTE DECK RECEIVER: XR-
P740/XR-P740M/XR-P640/XR-P640M/XR-P340/XR-
P340M**

Amplifier section

<XR-P740/XR-P740M>

FRONT

Continuous Average Power Output is 70 Watts* per channel, min., at 8 ohms from 50 Hertz with no more than 1 % total harmonic distortion.**

Continuous Power Output (RMS) 100 W + 100 W
(1 kHz, T.H.D. 10%, 8 Ω)

Peak Music Power 1050 W

REAR

Continuous Power Output (RMS) 15 W
(1 kHz, T.H.D. 10%, 16 Ω x 2)

CENTER

Continuous Power Output (RMS) 15 W
(1 kHz, T.H.D. 10%, 16 Ω x 2)

<XR-P640/XR-P640M>

FRONT

Continuous Average Power Output is 70 Watt* per channel, min., at 8 ohms from 50 Hertz with no more than 1 % total harmonic distortion.**

Continuous Power Output (RMS) 100 W + 100 W
(1 kHz, T.H.D. 10%, 8 Ω)

Peak Music Power 950 W

REAR

Continuous Power Output (RMS) 15 W
(1 kHz, T.H.D. 10%, 16 Ω x 2)

<XR-P340/XR-P340M>

FRONT

Continuous Average Power Output is 33 Watts* per channel, min., at 8 ohms from 50 Hertz with no more than 1 % total harmonic distortion.**

Continuous Power Output (RMS) 50 W + 50 W
(1 kHz, T.H.D. 10%, 8 Ω)

Peak Music Power 500 W

FM/AM tuner section

FM Tuner Section

Frequency Range

(9 kHz/10 kHz step) 7.5 MHz to 108 MHz

Antenna Input 75 ohms unbalanced

AM Tuner Section

Frequency Range

With 10 kHz step 530 kHz to 1,700 kHz

With 9 kHz step 531 kHz to 1,602 kHz

Antenna Loop Antenna

Miscellaneous

Power Requirements

Singapore model 220-230/240 V, 50/60 Hz

Other model 110/120-127/220/240 V, 50/60 Hz

Power Consumption

(XR-P740/XR-P740M) 444 W

(XR-P640/XR-P640M) 432 W

(XR-P340/XR-P340M) 276 W

Dimensions 260 (W) x 371.5 (H) x 295 (D) mm

(XR-P740/XR-P740M/XR-P640/XR-P640M)

260 (W) x 310 (H) x 295 (D) mm

(XR-P340/XR-P340M)

Weight (without package)

(XR-P740M/XR-P640M) 9.5 kg

(XR-P740/XR-P640) 8.8 kg

(XR-P340M) 7.4 kg

(XR-P340) 6.7 kg

CD Section

Type Compact disc digital audio system

Wow and Flutter Limit of measurement
(±0.001% W.PEAK) or less (EIAJ)

Cassette deck section

Systems 4 track, 2-channel stereo

Heads Recording/playback head x 1

Playback head x 1

Erasing head x 1

Motor DC servo motor x 1

Tape type TYPE I (Normal) tape/TYPE II (CrO₂) tape

1.3 PANEL FACILITIES

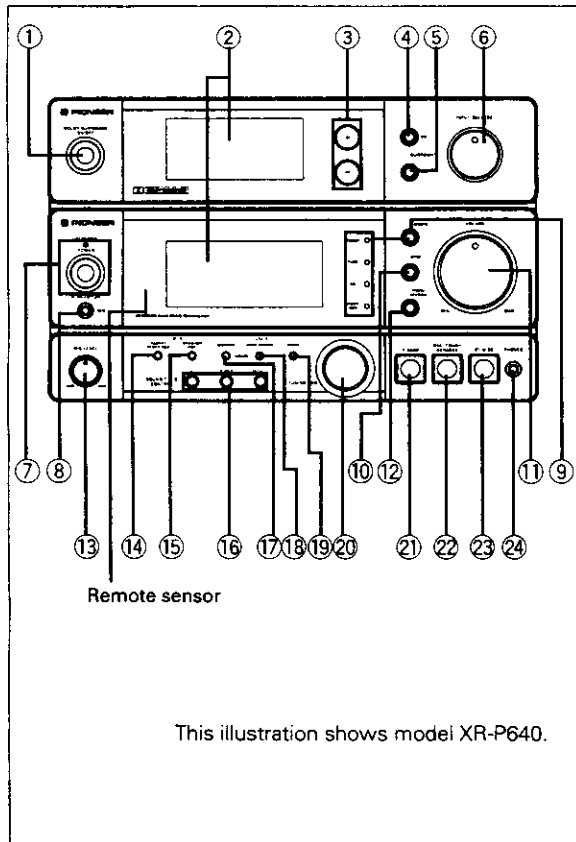

RECEIVER

The XR-P340/XR-P340M is not equipped with the buttons ①-

- ① DOLBY SURROUND ON/OFF button (XR-P640/XR-P640M only)
- ①* CENTER/REAR button (XR-P740/XR-P740M only)
- ② Display
- ③ REAR LEVEL (+, -) buttons (XR-P640/XR-P640M only)
- ③* CENTER/REAR LEVEL (+, -) buttons (XR-P740/XR-P740M only)
- ④ SURROUND ON button (XR-P640/XR-P640M only)
- ④* CENTER MODE button (XR-P740/XR-P740M only)
- ⑤ SURROUND OFF button (XR-P640/XR-P640M only)
- ⑤* MODE button (XR-P740/XR-P740M only)
- ⑥ INPUT BALANCE control (XR-P640/XR-P640M only)
- ⑥* BALANCE (L,R) control (XR-P740/XR-P740M only)
- ⑦ POWER STANDBY/ON switch and STANDBY indicator

This is the switch for electric power.

ON: When set to the ON position, power is supplied and the unit becomes operational.

STANDBY: When set to the STANDBY position, the main power flow is cut and the unit is no longer fully operational. A minute flow of power feeds the unit to maintain operation readiness. (The STANDBY indicator lights.)

- ⑧ Microphone jack (MIC)
- ⑨ FUNCTION (*DEMO) button and indicators

Each time this button is pressed, the function changes in the following sequence (The selected function is displayed in the display window and indicator.):

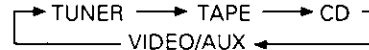

- ⑩ BAND button
- ⑪ VOLUME control
- ⑫ FREQ/STATION button
- ⑬ MIC LEVEL control
- ⑭ CLOCK/CLOCK ADJ button
- ⑮ WAKE-UP/REC button
- ⑯ SOUND FIELD CONTROL buttons (HALL, DISCO, MOVIE)
- ⑰ MEMORY button
- ⑱ AUTO TUNING button
- ⑲ MONO button
- ⑳ TUNING JOG knob
- ㉑ P. BASS button
- ㉒ ONE-TOUCH KARAOKE button
- ㉓ ST WIDE button (XR-P740/XR-P740M/XR-P640/XR-P640M)
- ㉓* SURROUND & ST WIDE button (XR-P340/XR-P340M)
- ㉔ Headphones jack (PHONES)

Manufactured under license from Dolby Laboratories Licensing Corporation.

DOLBY and the double-D symbol are trademarks of Dolby Laboratories Licensing Corporation.

TAPE DECK

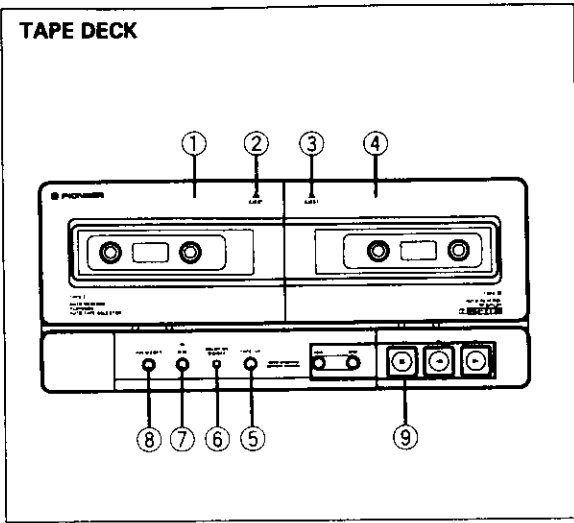

TAPE DECK

- ① **TAPE I cassette door**
- ② **TAPE I EJECT section (▲)**
- ③ **TAPE II EJECT section (▲)**
- ④ **TAPE II cassette door**
- ⑤ **TAPE 1/2 selector button**
- ⑥ **DOLBY* NR B/C OFF button (XR-P740/XR-P740M and XR-P640/XR-P640M)**
Each time this button is pressed, DOLBY NR setting changes B → C → OFF.
- ⑥' **DOLBY* NR ON/OFF button (XR-P340/XR-P340M only)**
Each time this button is pressed, DOLBY NR system turns ON and OFF.
- ⑦ **Rec pause button (● II)**
- ⑧ **ASES (Auto Synchro Editing System)/COPY button**
- ⑨ **TAPE operation buttons (PLAY ◀▶, STOP ■, Fast ◀◀▶▶)**

■ Auto Function

This model is equipped with "Auto Function" operation, so when the switch for PLAY/PAUSE, DISC SELECTOR 1-6, RND, TAPE 1/2, PLAY (tape), or BAND is pressed, the function switches automatically. Use the FUNCTION button to select the component connected to the VIDEO/AUX IN jacks, since Auto Function is not effective for this.

NOTE:

The function cannot be switched during recording and tape copying.

MULTI-PLAY CD PLAYER

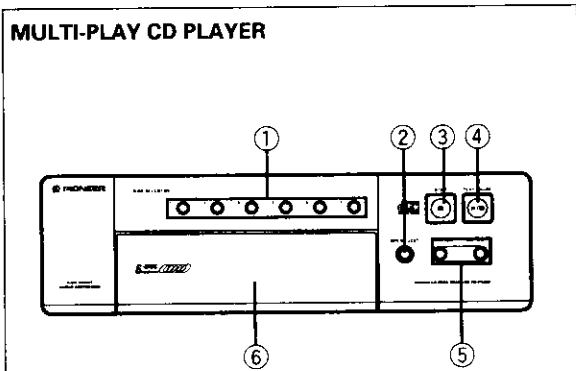

CD PLAYER

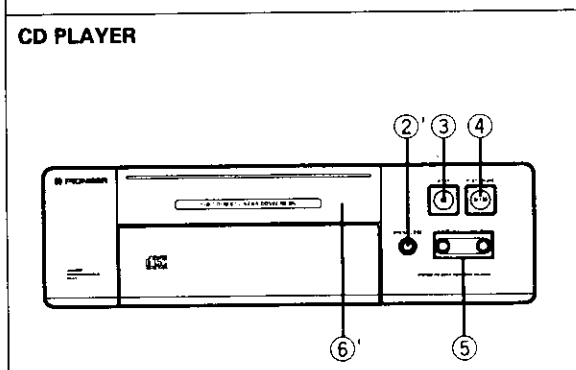

CD PLAYERS

- ① **DISC SELECTOR buttons (1-6)**
- ② **OPEN/EJECT button**
- ②' **OPEN/CLOSE button**
- ③ **STOP button (■)**
- ④ **PLAY/PAUSE button (▶/II)**
- ⑤ **Manual/Track search buttons (◀◀ • ◀◀, ▶▶ • ▶▶)**
- ⑥ **Magazine slot door**
- ⑥' **Disc tray**

- *Dolby noise reduction manufactured under license from Dolby Laboratories Licensing Corporation.*
- *"DOLBY" and the double-D symbol are trademarks of Dolby Laboratories Licensing Corporation.*

REMOTE CONTROL UNIT

<XR-P740/
XR-P740M>

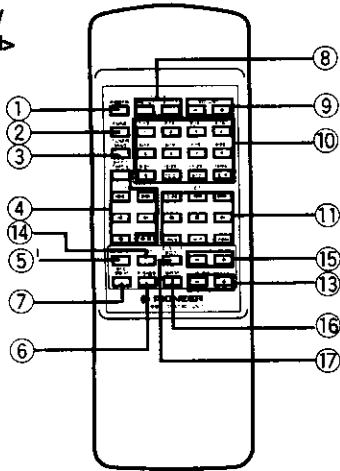

<XR-P640/
XR-P640M>

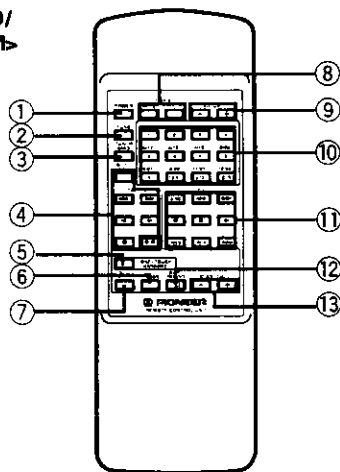

<XR-P340/
XR-P340M>

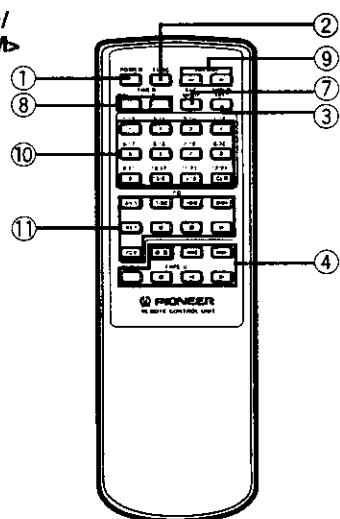

REMOTE CONTROL UNIT

- ① **POWER button**
- ② **Function button (FUNC)**
Each time this button is pressed, the function changes in the following sequence:

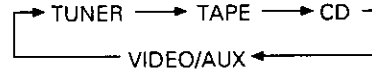

- ③ **TUNER BAND button**
- ④ **TAPE operation buttons**
(SHIFT TAPE I, Fast ◀◀▶▶, Play ▶▶, Stop ■, Rec pause ● ||)
To operate TAPE I, press the desired deck operation button while pressing SHIFT TAPE I. (Except for the Rec pause ● || button)
- ⑤ **ONE-TOUCH KARAOKE button**
(XR-P640/XR-P640M only)
- ⑤ **KARAOKE button** (XR-P740/XR-P740M only)
- ⑥ **P. BASS button** (Except for XR-P340/XR-P340M)
- ⑦ **SFC MODE button**
- ⑧ **TIMER control buttons (WAKE-UP, SLEEP)**
- ⑨ **VOLUME (-/+) buttons**
- ⑩ **Number buttons**
These buttons are used for selecting track numbers of a CD and scanning preset stations.
- ⑪ **CD operation buttons**
(DISC, Track search ◀◀▶▶, Pause ||, Stop ■, Play ▶▶, RND (Random), REP (Repeat), PGM (Program))
- ⑫ **SURROUND button**
(XR-P640/XR-640M only)
- ⑬ **REAR LEVEL (-/+) buttons**
(Except for XR-P340/XR-P340M)
- ⑭ **Test tone button (TEST)**
(XR-P740/XR-P740M only)
- ⑮ **CENTER LEVEL (-/+) buttons**
(XR-P740/XR-P740M only)
- ⑯ **MODE button**
(XR-P740/XR-P740M only)
- ⑰ **CENTER MODE button**
(XR-P740/XR-P740M only)

1.4 DISASSEMBLY

■ CD MECHA ASSY DIAGNOSIS AND REPLACEMENT

1. Remove the cover.
2. OPEN the tray and lift the tray cap, pulling the bottom of the tray cap toward you. After removing the tray cap, CLOSE the tray.
3. Remove the VOL knob and 2 screws (BBZ30P080FZK) holding the VR Assy in place.
4. Remove the 3 screws between the front panel and the chassis.
L/R sides: CBZ30P080FMC × 2
Bottom side: BBZ30P080FZK × 1
5. Remove the lead wire from the cassette mecha Assy from the chassis.
Screw: BBZ30P080FZK × 1
6. Remove the front panel from the chassis (watching out for the claw on the left and right), and open the side of the AF CD Assy. (Refer to Fig. 1)

NOTE:

Do not remove the rear panel and AF CD Assy at this time.

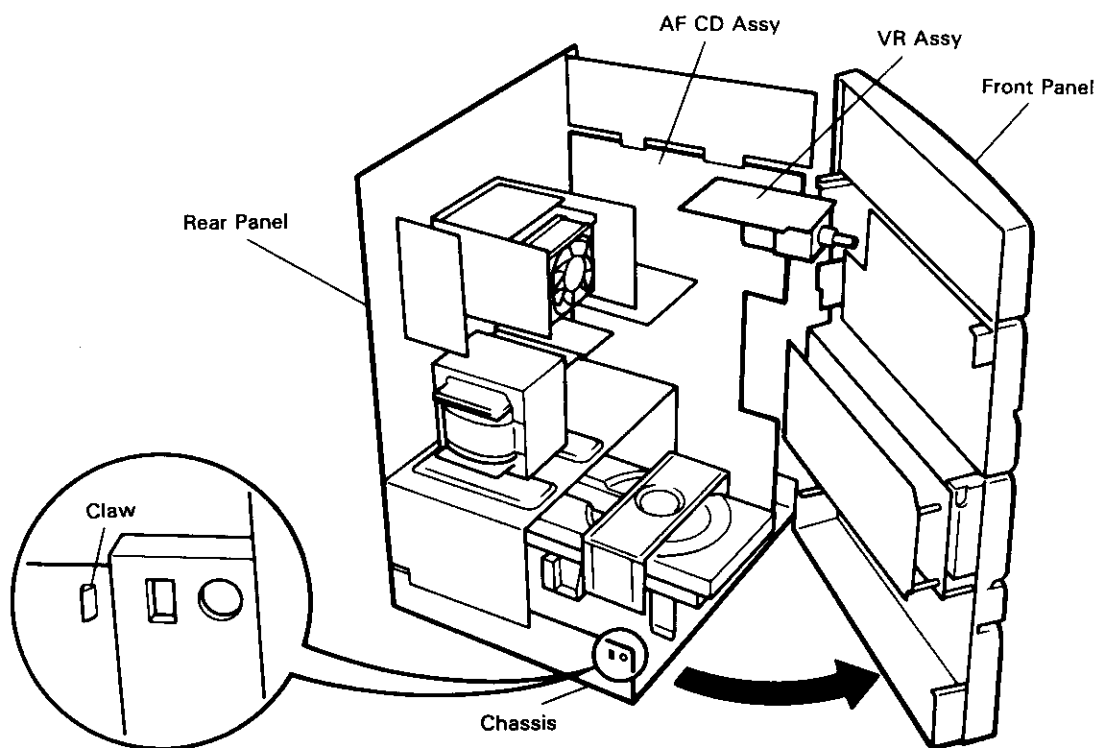

Fig. 1

Under these conditions most of the PCB diagnosis and parts replacement can be performed.

■ REMOVAL OF AF CD ASSY

1. Under the conditions of the previous paragraph, remove the rear panel and AF CD Assy.
(Do not separate the rear panel and AF CD Assy.)

XR-P340M (except KU type) and XR-P340 ... Between rear panel and chassis.

Screw: BBZ30P080FZK × 2

XR-P740M, 740, 640M, 640 and XR-P340M/KU ... Between rear panel and trans frame.

Screw: BBZ30P080FZK × 3

1.5 BLOCK DIAGRAM

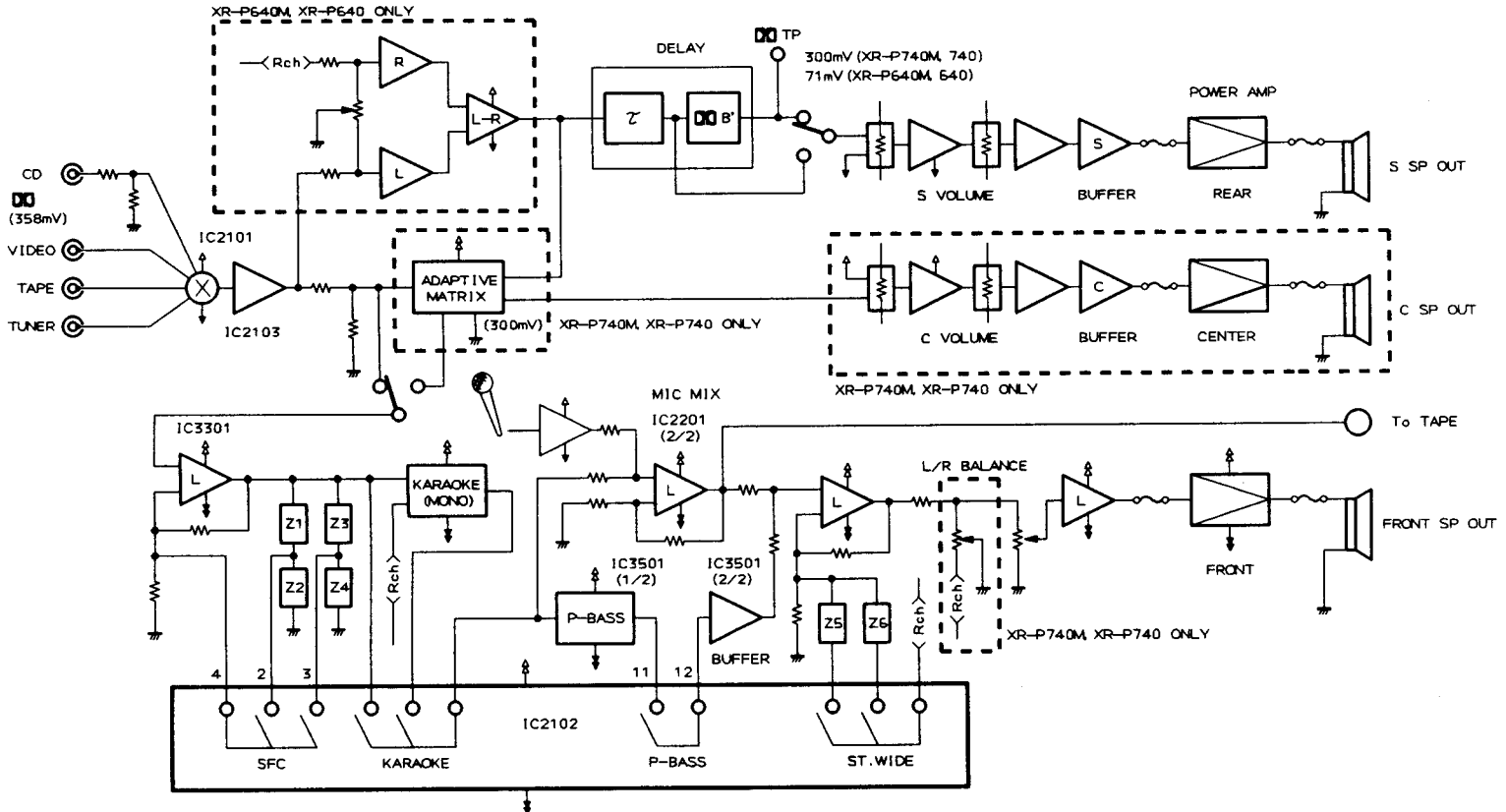

POWER AMP MODULE SECTION

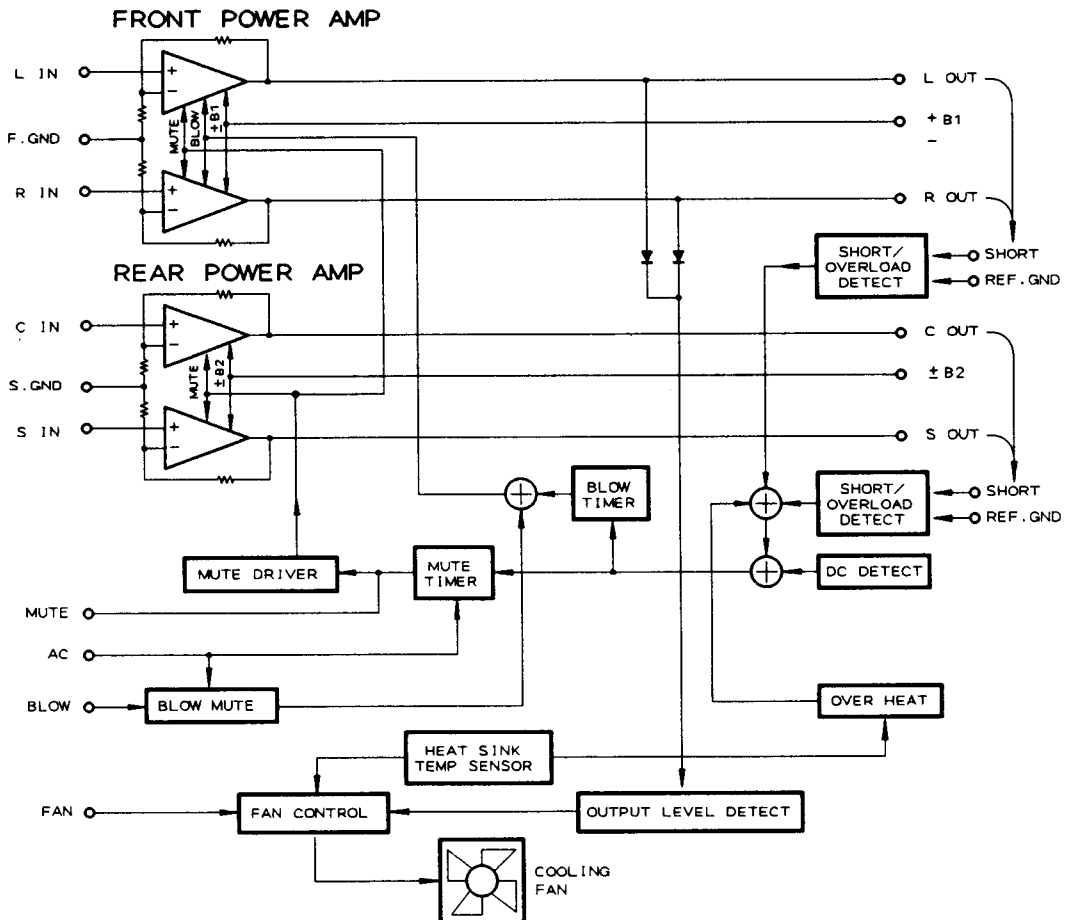

● Pin Function of Power Amp Module

Connector	No.	Name	I/O	Description
CN7101	1	+12V. M	O	+12V separate system stabilized output
	2	UNREG -12	I	Unstabilized power input for -12V
	3	AC	I	AC detection input; for power ON/OFF and MUTE.
	4	-12V	O	Stabilized power output for -12V
	5	MUTE	I/O	Mute external input; outputs internal mute conditions; cancels forced mute.
	6	REF. GND	I	GND for protective circuit; reference GND for short detection
	7	BLOW	I	BLOW circuit external output; ON at ±0.5V or more.
	8	REG. GND	I	Reference GND for stabilized power source
	9	UNREG +5	I	Unstabilized power input for +5.6V
	10	UNREG +12	I	Unstabilized power input for +12V and +12V. M
	11	+5.6V	O	+5.6V stabilized output
	12	+12V	O	+12V stabilized output
CN7102	1	C IN	I	Center signal input
	2	S. GND	I	Signal input GND; floating interior type
	3	S IN	I	Surround signal input
	4	OVERLOAD	I	Short detection input for Surround and Center channels
	5	+B2	I	Power supply (+) for Surround and Center channels
	6	-B2	I	Power supply (-) for Surround and Center channels
	7	C OUT	O	Center speaker output
	8	S OUT	O	Surround speaker output
CN7502	1	REF. GND	I	Reference GND for short detection
	2	L OUT	O	Left speaker output
	3	R OUT	O	Right speaker output
	4	FAN	I	Forced fan circuit input (LOW speed)
	5	+B1	I	Power supply (+) for L/R channels
	6	-B1	I	Power supply (-) for L/R channels
	7	SHORT	I	Short detection input for L/R channels
	8	L IN	I	Left signal input
	9	F. GND	I	Signal input GND; floating interior type
	10	R IN	I	Right signal input

1.6 IC INFORMATION

- The information shown in the list is basic information and may not correspond exactly to that shown in the schematic diagrams.

■ TC9268F (IC8401 : AF CD ASSY)

- Σ - Δ Modulation-Type DA Converter with Built-in 8-fold Oversampling Digital Filter

- Pin Assignment (Top View)

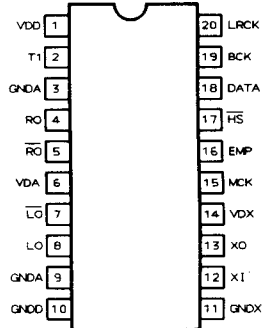

- Block Diagram

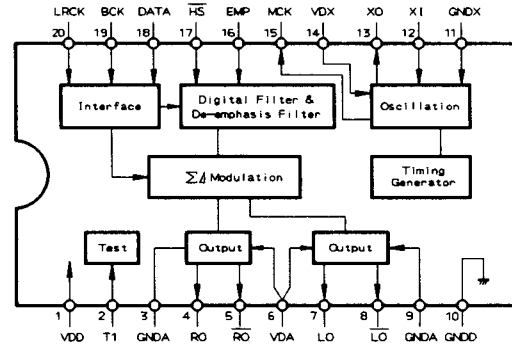

- Pin Function

No.	Symbol	I/O	Description	Remarks
1	VDD	—	Digital part power supply terminal	
2	T1	I	Test terminal; normally used on "L"	
3	GNDA	—	Analog part ground terminal for R channel	
4	RO	O	R channel data right output terminal	
5	RO-bar	O	R channel data inverse output terminal	
6	VDA	—	Analog part power supply terminal	
7	LO-bar	O	L channel data inverse output terminal	
8	LO	O	L channel data right output terminal	
9	GNDA	—	Analog part ground terminal for L channel	
10	GNDD	—	Digital part ground terminal	
11	GNDX	—	Crystal-oscillating part ground terminal	
12	XI	I	Crystal oscillator connection terminal; oscillates clock needed by system	
13	XO	O		
14	VDX	—	Crystal-oscillating part power terminal	
15	MCK	O	System clock output terminal	
16	EMP	I	De-emphasis filter control terminal; "H": de-emphasis filter ON, "L": de-emphasis filter OFF	
17	HS	I	Standard/double-speed operating mode changeover terminal; "H": standard operation, "L": double-speed operation	
18	DATA	I	Data input terminal	
19	BCK	I	Bit clock input terminal	
20	LRCK	I	LR clock input terminal	

XR-P740M, XR-P640M, XR-P340M XR-P740, XR-P640, XR-P340

PD4493A (IC1901 : DISPLAY ASSY for MULTI CD)

● System Control Micro-computer

● Pin Assignment (Top View)

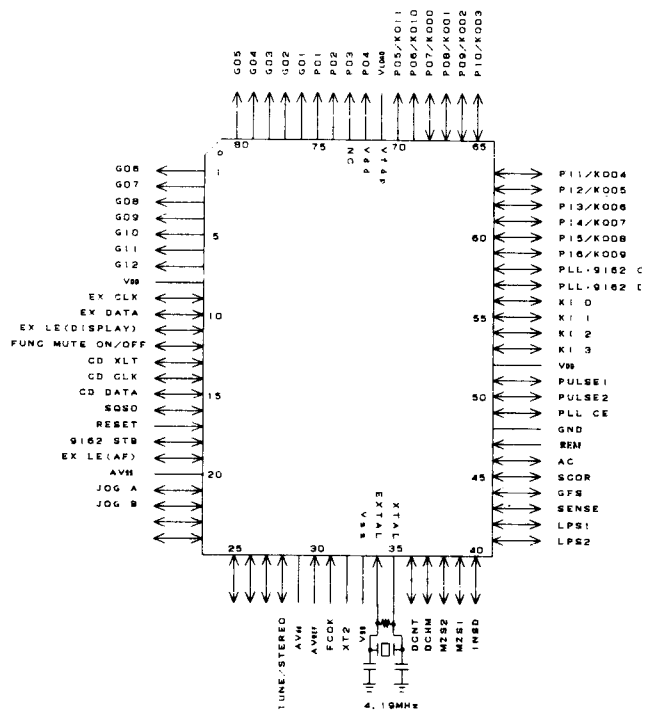

No.	Name	Function	I/O	Description
15	SO1	CD DATA	C	LSI control data serial output
16	SI1	SQSO	I	Subcode Q data serial input
17	RESET	-	-	Reset input
18	P74	9162 STB	N	9162 strobe output
19	P73	EX LE (AF)	N	Extension port (AF system) latch pulse
20	AVss	AVss	-	Connected to GND.
21	ANI7	JOG A	I	JOG Input
22	ANI6	JOG B		
23	ANI5	-	A/D	Spectrum analyzer input
24	ANI4	-		
25	ANI3	-		
26	ANI2	-		
27	P11	-		
28	P10	TUNE/STEREO	A/D	TUNE/STEREO status discrimination input
29	AVDD	AVDD	-	Connected to +5V.
30	AVREF	AVREF	-	
31	P04	FCOK	I	Focus OK input
32	XT2	-	O	Open
33	Vss	-	-	Connected to GND.
34	X1	-	I	Connected to Oscillator (4.19MHz).
35	X2	-	O	
36	P37	DCNT	I	Disc count pulse input
37	P36	DCHM	I	Disc selector home SW
38	P35	MZS2	I	Magazine discrimination SW input
39	P34	MZS1		
40	P33	INSD	I	Slider inside SW input
41	P32	LPS2	I	Load position discrimination input
42	P31	LPS1		

● Pin Function

No.	Name	Function	I/O	Description
1	FIP6	6G	P	FL grid
2	FIP5	7G		
3	FIP4	8G		
4	FIP3	9G		
5	FIP2	10G		
6	FIP1	11G		
7	FIP0	12G		
8	VDD	VDD	-	Connected to +5V.
9	SCK0	EX CLK	N	Extension port serial clock output
10	SO0	EX DATA	N	Extension port serial data output
11	P25	EX LE (DISPLAY)	C	Extension port (display system) latch pulse
12	P24	POWER ON/OFF	C	POWER ON/OFF
13	P23	CD XLT	C	LSI control data latch pulse
14	SCK1	CD CLK	C	LSI control data serial clock

No.	Name	Function	I/O	Description
43	P30	SENS	I	LSI operating status multi-mode input
44	P03	GFS	I	Frame/synch/lock input
45	INTP2	SCOR	I	Subcode synch SO + SI input
46	INTP1	AC	I	AC input
47	INTP0	REM	I	Remote control signal input
48	IC	—	—	Connected to GND.
49	P72	PLL CE	N	PLL latch pulse
50	P71	PULSE2	I	Tape 2 reel pulse input
51	P70	PULSE1	I	Tape 1 reel pulse input
52	V _{DD}	—	—	Connected to +5V.
53	P127	—	I	Key scan input
54	P126	—		
55	P125	—		
56	P124	—		
57	P123	PLL 9162 DATA/ KO11	P	PLL and 9162 serial data
58	P122	PLL 9162 CLK/ KO10	P	PLL and 9162 clock
59	FIP27	P16/KO9	P	FL segment and key scan output
60	FIP26	P15/KO8	P	
61	FIP25	P14/KO7	P	
62	FIP24	P13/KO6	P	
63	FIP23	P12/KO5	P	
64	FIP22	P11/KO4	P	
65	FIP21	P10/KO3	P	
66	FIP20	P9/KO2	P	
67	FIP19	P8/KO1	P	
68	FIP18	P7/KO0	P	

No.	Name	Function	I/O	Description
69	FIP17	P6	P	FL segment
70	FIP16	P5	P	
71	V _{LOAD}	—	—	Connected to -30V.
72	FIP15	P4	P	FL segment
73	FIP14	P3	P	
74	FIP13	P2	P	
75	FIP12	P1	P	
76	FIP11	1G	P	FL grid
77	FIP10	2G	P	
78	FIP9	3G	P	
79	FIP8	4G	P	
80	FIP7	5G	P	

Note)

I : Input

A/D : Analog Input

O : Cmos Output

N : Nch Open Drain Output

P : Pch Open Drain Output

No.	Name	Function	I/O	Description
43	P30	SENS	I	LSI operating status multi-mode input
44	P03	GFS	I	Frame/synch/lock input
45	INTP2	SCOR	I	Subcode synch SO + SI input
46	INTP1	AC	I	AC input
47	INTP0	REM	I	Remote control signal input
48	IC	—	—	Connected to GND.
49	P72	PLL CE	N	PLL latch pulse
50	P71	PULSE2	I	Tape 2 reel pulse input
51	P70	PULSE1	I	Tape 1 reel pulse input
52	V _{DD}	—	—	Connected to +5V.
53	P127	—	I	Key scan input
54	P126	—		
55	P125	—		
56	P124	—		
57	P123	PLL 9162 DATA/ KO11	P	PLL and 9162 serial data
58	P122	PLL 9162 CLK/ KO10	P	PLL and 9162 clock
59	FIP27	P16/KO9	P	FL segment and key scan output
60	FIP26	P15/KO8	P	
61	FIP25	P14/KO7	P	
62	FIP24	P13/KO6	P	
63	FIP23	P12/KO5	P	
64	FIP22	P11/KO4	P	
65	FIP21	P10/KO3	P	
66	FIP20	P9/KO2	P	
67	FIP19	P8/KO1	P	
68	FIP18	P7/KO0	P	

No.	Name	Function	I/O	Description
69	FIP17	P6	P	FL segment
70	FIP16	P5	P	
71	V _{LOAD}	—	—	Connected to -30V.
72	FIP15	P4	P	FL segment
73	FIP14	P3	P	
74	FIP13	P2	P	
75	FIP12	P1	P	
76	FIP11	1G	P	FL grid
77	FIP10	2G	P	
78	FIP9	3G	P	
79	FIP8	4G	P	
80	FIP7	5G	P	

Note)

I : Input

A/D : Analog Input

O : Cmos Output

N : Nch Open Drain Output

P : Pch Open Drain Output

**XR-P740M, XR-P640M, XR-P340M
XR-P740, XR-P640, XR-P340**

**■ PDG108A (IC3951 : ADDON DISPLAY ASSY)
(Except XR-P340M and XR-P340)**

● System Control Micro-computer

● Pin Function

No.	Name	Function	I/O	Description
1	PE3/INT3	NO USE	-	
2	PE4/RMC	RMC IN	I	Remote control signal input
3	PE5	NO USE	-	
4	PE6	PRO. LOGI	O	Pro-logic ON output
5	PE7/T0	NO USE	-	
6	PB0			
7	PB1/CS0			
8	PB2/SCK0			
9	PB3/SI0			
10	PB4/SO0	9154 CLK	O	9154 CLK output
11	PB5/SCK1	9154 STB	O	9154 STB output
12	PB6/SI1	9154 DATA	O	9154 DATA output
13	PB7/SO1	NO USE	-	
14	PC0/KR0	KEY IN0	I	Key scan, Key return signal input
15	PC1/KR1	KEY IN1		
16	PC2/KR2	NO USE	-	
17	PC3/KR3			
18	PC4/KR4			
19	PC5/KR5			
20	PC6/KR6			
21	PC7/KR7			
22	PA0/AN0	LEVEL L IN	I	A/D input for level meter (Lch)
23	PA1/AN1	LEVEL R IN	I	A/D input for level meter (Rch)
24	PA2/AN2	Destination	I	Prologic/Dolby surround changeover
25	PA3/AN3	SURROUND SEL	O	DOLBY/THROUGH changeover output for FRONT & REAR signals.
26	PA4/AN4	F MUTE	O	Front mute output

No.	Name	Function	I/O	Description
27	PA5/AN5	NO USE	-	
28	PA6/AN6			
29	PA7/AN7			
30	RST	-	-	Reset signal input
31	EXTAL		-	Connected to ceramic oscillator (8MHz).
32	XTAL			
33	VSS	VSS	-	GND
34	PD0/S0	S MUTE	O	Surround mute output
35	PD1/S1	C MUTE	O	Center mute output
36	PD2/S2	C MODE2	O	Center mode 2 output
37	PD3/S3	C MODE1	O	Center mode 1 output
38	PD4/S4	N MODE2	O	Noise mode 2 output
39	PD5/S5	N MODE1	O	Noise mode 1 output
40	PD6/S6	N CH SEL2	O	Noise channel select 2 output
41	PD7/S7	N CH SEL1	O	Noise channel select 1 output
42	PF0/S8	FL ON	O	FL ON output
43	PF1/S9	NO USE	-	
44	PF2/S10			
45	PF3/S11			
46	PF4/S12			
47	PF5/S13	S1	O	FL control segment output
48	PF6/S14	S2		
49	PF7/S15	S3		
50	S16	S4		
51	S17	S5		
52	S18	S6/KO2	O	FL control segment/Key scan strobe output
53	S19	S7/KO1		
54	S20	S8/KO0		

■ **TC7S04F (IC8402 : AF CD ASSY)**

● **Inverter**

● **Pin Assignment (Top View)**

No.	Name	Function	I/O	Description
55	T15/S21	S9	O	FL control segment output
56	T14/S22	S10		
57	T13/S23	S11		
58	T12/S24	S12		
59	T11/S25	S13		
60	T10/S26	S14		
61	T9/S27	S15		
62	T8/S28	S16		
63	T7	NO USE	-	
64	T6			
65	T5			
66	T4			
67	T3			
68	T2	G3	O	FL control timing output
69	T1	G2		
70	T0	G1		
71	VFDP	VFDP	-	Offset voltage (-30V) for FL control.
72	VDD	VDD	-	+5V Power Supply
73	NC	VDD	-	Connected to VDD.
74	PG0	DOLBY OFF	I	DOLBY NR OFF input
75	PG1	NO USE	-	
76	PG2			
77	PG3			
78	PE0/INT0	POWER ON	I	Power ON input
79	PE1/INT1	Destination	P	Domestic/foreign changeover
80	PE2/INT2	NO USE	-	

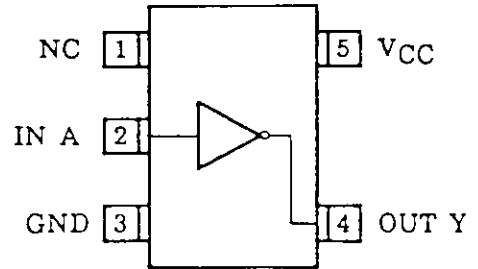

**AAV7001 (V3951 : ADDON DISPLAY ASSY)
(Except XR-P340M and XR-P340)**

- FL Tube
- Grid Assignment

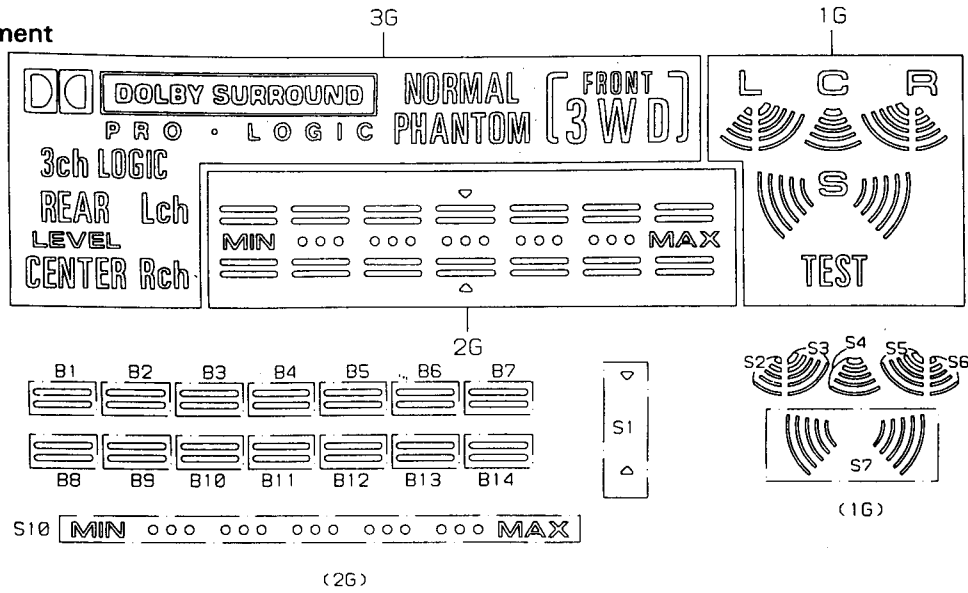

● Pin Assignment

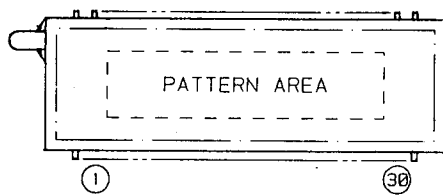

● Pin Connection

PIN NO.	1	2	3	4	5	6	7	8	9	10	11	12	13	14	15	16	17	18	19	20	21	22	23	24	25	26	27	28	29	30	
CONNECTION	F	F	N		P	P	P	P	P	P	P	P	P	P	P	P	P	P	P	P	N	N	N	N	N	N	N	N	N	F	F
	1	1	P	G	G	G	6	5	4	3	2	1	0	9	8	7	6	5	4	3	2	1	X	X	X	X	X	P	2	2	

- NOTE
- 1) F1, F2 --- Filament
 - 2) NP ----- No pin
 - 3) NX ----- No extend pin
 - 4) DL ----- Datum Line
 - 5) 1G - 3G - Grid

● Anode Connection

	3G	2G	1G
P1	DOLBY SURROUND	S10	L R
P2	PRO LOGIC	B1	C
P3	3ch LOGIC	B2	S
P4	REAR	B3	TEST
P5	LEVEL	B4	S2
P6	CENTER	B5	S3
P7	Lch Rch	B6	S4
P8	NORMAL	B7	S5
P9	PHANTOM	B8	S6
P10	FRONT (3WD)	B9	S7
P11	-	B10	-
P12	-	B11	-
P13	-	B12	-
P14	-	B13	-
P15	-	B14	-
P16	-	S1	-

1.7 ADJUSTMENTS

1. TUNER SECTION

■ FM Tuner Section

- Set the mode selector to FM BAND.
- Connect the wiring as shown in Fig. 1-1.

Step No.	Adjustment Title	FM SG (1kHz, ± 75 kHz dev.)		Reception Frequency Display	Adjustment Location	Specifications
		Frequency (MHz)	Level (dB μ V)			
1	Center Adjustment	98 Non modulation	80 or more	—	L6207	Adjust so that the DC voltage between Pin 4 and Pin 28 of IC6201 becomes $0V \pm 50mV$.
2	Front End Sencitivity	98	10-30	98MHz	L6102 T6101	Adjust so that the DC voltage of the Pin12 of IC6201 (S-meter) becomes at maximum level.
3	TUNED IND. Lighting Level	98	15 ± 2	98MHz	VR6201	Adjust so that the indicators of TUNED IND. start to light up.

Notes:

- Before adjusting, make sure there is no gap between L6101 and L6102. If there is a gap between them, bring them into contact with each other first, and then make adjustments.
- Make indicator adjustments in order of AM \rightarrow FM.

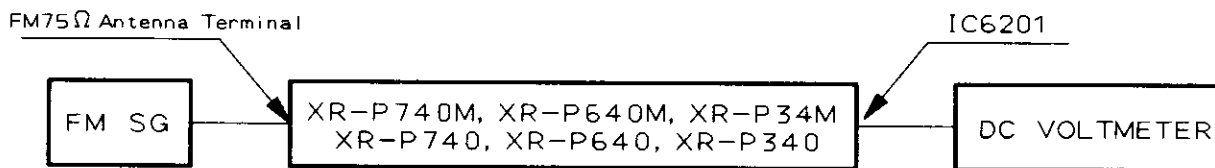

Fig. 1-1 FM Adjustment Connection Diagram

■ AM Tuner Section

- Set the mode selector to AM BAND.
- Connect the wiring as shown in Fig. 1-2.

Step No.	Adjustment Title	AM SG (400Hz, 30% Mod.)		Reception Frequency Display	Adjustment Location	Specifications
		Frequency (kHz)	Level (dB μ V/m)			
1	TUNED IND. Lighting Level	999	47 ± 2	999kHz	VR6202	Adjust so that the indicators of TUNED IND. start to light up.

Note:

- When SD and YPW type is used, set the AM frequency step to 10kHz.

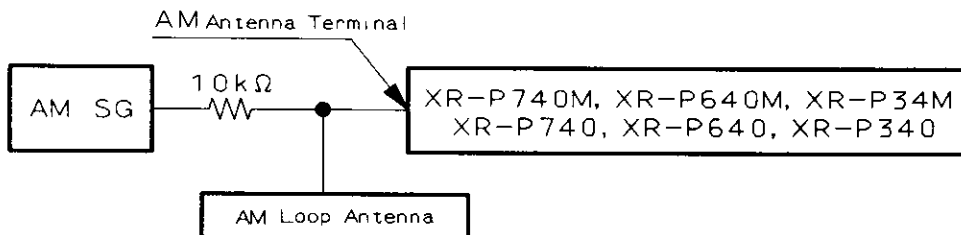

Fig. 1-2 AM (MW) Adjustment Connection Diagram

FM/AM TUNER MODULE

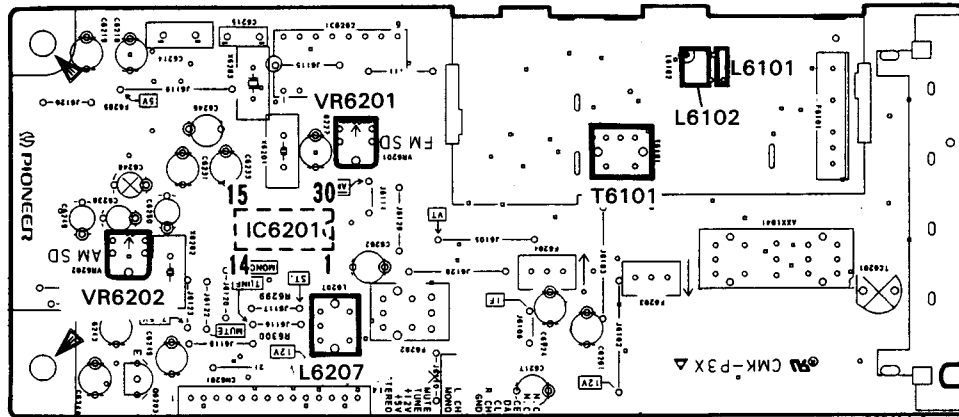

Fig. 1-3 Adjustment Points

2. POWER AMP MODULE SECTION (Refer to Fig. 2-1.)

1. Handling Precautions

- Since the heat sink and transistor metallic parts are connected to the Front Amp output, make sure they do not contact the GND (chassis) or other circuits.
- Since there is residual high voltage in the Power Amp Module Assy ±B1 (FRONT ASSY FOR 100W) and ±B2 (REAR, PWR, PRTEC ASSY) even when the power is OFF, caution should be exercised. (If necessary, the voltage should be discharged).
- When handling the Power Amp Module Assy, make sure you do not touch the fan motor blade.

2. Adjustment and Confirmation of Idle Current

- Basically, the idle current needs to be confirmed when replacing a power transistor, driver transistor, or bias transistor, or when the entire split board Assy of the Power Amp Module Assy has been replaced.
- Make sure the heat sink has cooled sufficiently before measuring the idle current. (Temperature should be the same as room temperature; 25°C is ideal, if possible.)
- Idle current stipulated value: 3-50mA.

■ **Front Amp Side (FRONT ASSY FOR 100W)**

Step	Measurement	Item	Remarks
1	Lch side	Short both sides of C7123 and C7124 on the Rear Amp side.	Do not operate the Rear Amp side.
2		Insert a resistor (0.22Ω, 3W or more) in series in the connector CN7502 +B1 (or -B1) line (terminal No. 5 or 6). (Refer to Fig. 2-2.)	For measuring voltage at both sides of resistor
3		Short both sides of C7524.	Do not operate Rch side.
4		Turn the power ON, wait 6 seconds, and then measure the resistance voltage in Step 2.	Lch Idle current $I = V / 0.22 (\Omega)$
5	Rch side	<ul style="list-style-type: none"> ● Same as Steps 1 and 2 above. ● Short both sides of C7523. 	Do not operate Lch side.
6		Turn the power ON under the above conditions, and after 6 seconds measure the resistance voltage in Step 2.	
7	—	If the measured idle current is greater than 50mA, perform the following procedure.	
8	Lch side	Short between the Point A pattern in Fig. 2-3 using solder.	Connect R7517 to R7515 in a parallel circuit.
9	Rch side	Short between the Point B pattern in Fig. 2-3 using solder.	Connect R7518 to R7516 in a parallel circuit.
10	—	After performing Steps 8 and 9, remeasure the idle current and confirm that it is below 50mA.	

NOTE:

If the idle current is below 3mA, support a resistor (33kΩ) between the emitter and the Q7501 (Lch) and Q7502 (Rch) bias transistor base, and confirm that the idle current is within 3-50mA.

■ Rear Amp Side (REAR, PWR, PRTEC ASSY)

Step	Measurement	Item	Remarks
1	Center amp side	Short both sides of C7523 and C7524 on the Front Amp side.	Do not operate the Front Amp side.
2		Insert a resistor (0.22Ω, 2W or more) in series in the connector CN7102 +B2 (or -B2) line (terminal No. 5 or 6). (Refer to Fig. 2-4.)	For measuring voltage at both sides of resistor
3		Short both sides of C7124 on the Surround Amp side.	Do not operate the Surround Amp.
4		Turn the power ON, wait 6 seconds, and then measure the resistance voltage in Step 2.	Idle current: $I = V/0.22 (\Omega)$
5	Surround amp side	<ul style="list-style-type: none"> ● Same as Steps 1 and 2 above. ● Short both sides of C7123 on Surround Amp side. 	Do not operate Surround Amp.
6		Turn the power ON under the conditions in Steps 1 and 2, and after 6 seconds measure the resistance voltage in Step 2.	
7	—	If the measured idle current is greater than 50mA, perform the following procedure.	
8	Center amp side	Short between the Point C pattern in Fig. 2-5 using solder.	Connect R7117 to R7115 in a parallel circuit.
9	Surround amp side	Short between the Point D pattern in Fig. 2-5 using solder.	Connect R7118 to R7116 in a parallel circuit.
10	—	After performing Steps 8 and 9, remeasure the idle current and confirm that it is below 50mA.	

NOTE:

If the idle current is below 3mA, support a resistor (15kΩ) between the emitter and the Q7101 (Center-ch) and Q7102 (Surround-ch) base, and confirm that the idle current is within 3-50mA.

3. Adjusting the Operating Temperature Setting of the Fan Motor (VR7701)

This adjustment is necessary when IC7403 (+12V regulator), Q7301 and Q7302 (temperature sensors), or VR7701 has been replaced, or when the entire split board Assy of the Power Amp Module Assy has been replaced.

■ Adjustment-Related Cautions

- Make sure the heat sink has sufficiently cooled (is the same as room temperature Ta.)
- Once the power has been turned ON, make measurements and adjustments as quickly as possible. (If too much time is taken, the heat sink temperature will rise, and the measurements will deviate from the Ta measurement point.)

■ Adjustment

1. Connect a voltmeter between TEMP and TP (or between IC7702 terminals No.3 and 2). (Refer to Figs. 2-3 and 2-6.)
2. Determine the fan motor operating temperature setting by means of the following formula. (Tolerance is within ±30mV.)
Formula: $(85^{\circ}\text{C} - \text{Ta}) \times 19 (\text{mV})$
Ta: ambient temperature (°C)
3. Adjust VR7701 so that the voltage between TEMP and TP is the value obtained from the above formula.

For example:

when the room temperature is 25°C,
set value = $(85 - 25) \times 19 (\text{mV})$
= 1140mV (tolerance within ±30mV).

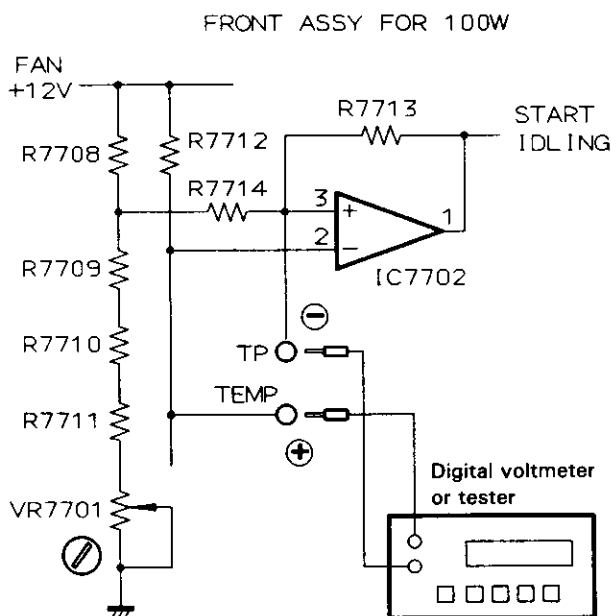
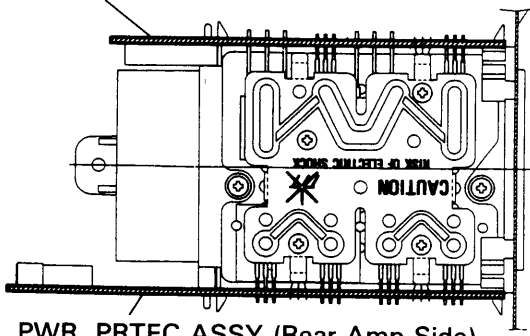

Fig. 2-6 Adjustment of Operating Temperature Setting of Fan Motor

XR-P740M, XR-P640M, XR-P340M XR-P740, XR-P640, XR-P340

FRONT ASSY FOR 100W (Front Amp Side)



REAR, PWR, PRTEC ASSY (Rear Amp Side)

Fig. 2-1 Power Amp Module
(POWER MOD. F100+R20)

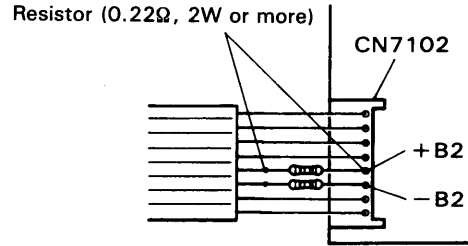

Fig. 2-4 REAR, PWR, PRTEC ASSY

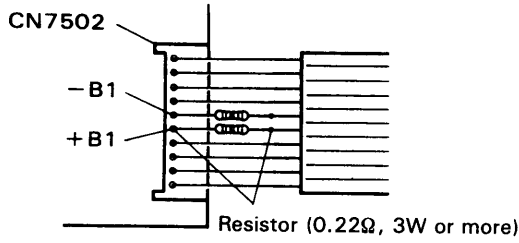

Fig. 2-2 FRONT ASSY FOR 100W

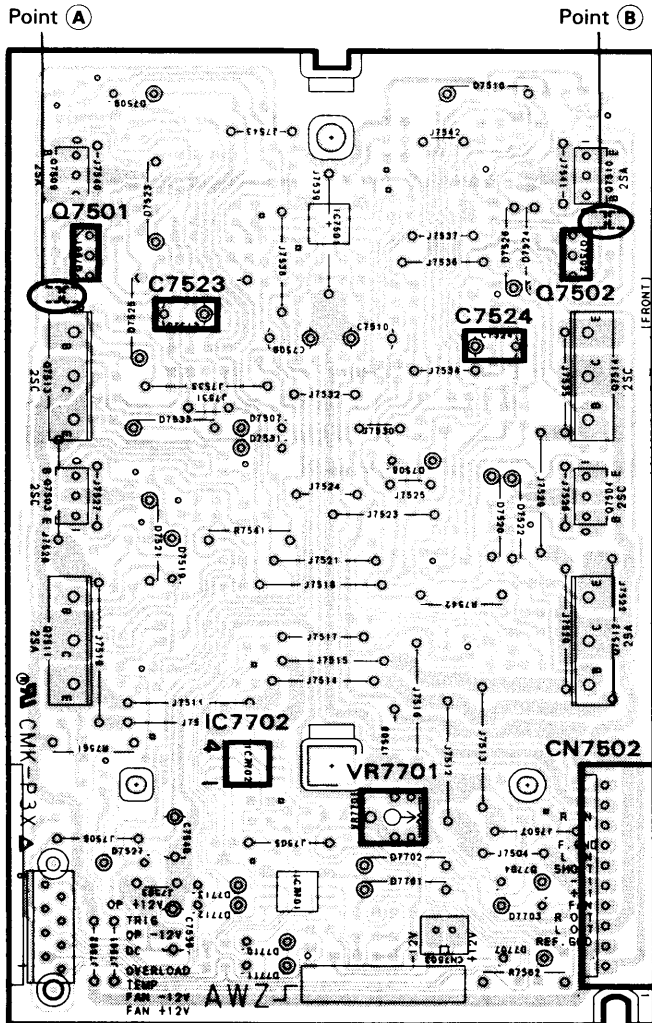

Fig. 2-3 FRONT ASSY FOR 100W
(This diagram is viewed from the foil side)

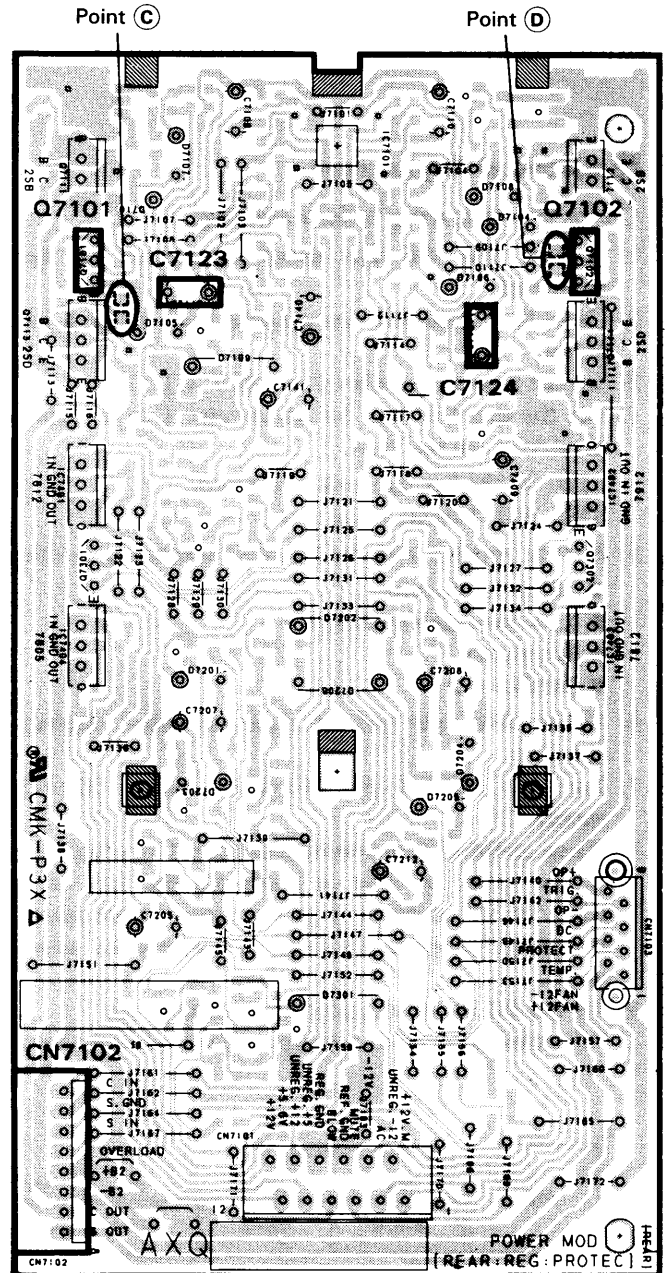

Fig. 2-5 REAR, PWR, PRTEC ASSY
(This diagram is viewed from the foil side)

3. CASSETTE DECK SECTION

● Adjustment points and test points are shown in Fig. 3-2 and Fig. 3-4.

■ Mechanical Adjustment

- Set the TAPE function.
- Test tape: STD-301 (3kHz, 30min).

1. Tape Speed Adjustment

No.	Mode	Test Tape	Adjusting Points	Measurement Points	Adjustment Procedure	Remarks
1	PLAY	STD-301 (Playback: 3kHz)	DECK Unit VR4111	TAPE TEST POINT (Rch) (AF CD Assy)	Press the PLAY SW and adjust so that the reading becomes 3010Hz ± 10Hz. Confirm that wow & flutter level is below 0.2% (in the reverse direction, confirm that the reading is within 3010Hz ± 60Hz).	

■ Electrical Adjustment

Check the following before starting.

1. Confirm that the tape speed adjustment has been completed.
2. Clean the heads and demagnetize them using a head eraser.
3. Set the measurement level to 0 dBV = 1 Vrms.
4. Use the specified tape for adjustment. Use the labeled (A) side of the test tape.
STD-331E: For playback adjustment
STD-631: Normal blank tape
5. Provide yourself with the following measuring devices:
 - AC millivoltmeter
 - Low-frequency oscillator
 - Attenuator
 - Oscilloscope
6. Adjust both right and left channels unless otherwise specified.
7. Turn the DOLBY NR switch off unless otherwise specified.
8. Warm up the unit for several minutes before adjustment. In particular, be sure to warm up the unit in the REC/PLAY mode for 3 to 5 minutes before starting recording/playback frequency characteristics adjustment.
9. Always follow the indicated adjustment order. Otherwise, a complete adjustment may not be achieved.

Playback Adjustment (Decks I and II)

1. Head Azimuth Adjustment
2. Playback Level Adjustment

Recording Adjustment (Deck II)

1. Bias Oscillation Frequency Adjustment
2. Recording Level Adjustment.
3. Recording/playback Frequency Characteristics Adjustment
4. ALC Operation Check

**As the reference recording level is 250nwb/m for STD-331E, the recording level will be higher by 4 dB for STD-331B (160nwb/m). When adjusting, pay carefull attention to the type of tape used.*

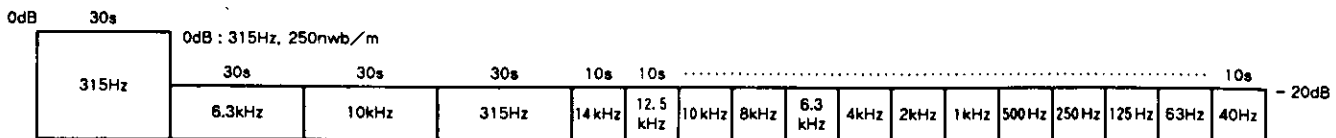



Fig. 3-1 STD-331E Test Tape

Dolby noise reduction manufactured under license from Dolby Laboratories Licensing Corporation.
"DOLBY" and the double-D symbol  are trademarks of Dolby Laboratories Licensing Corporation.

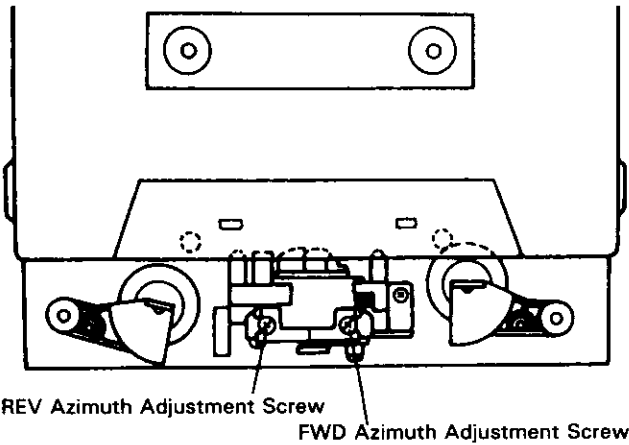
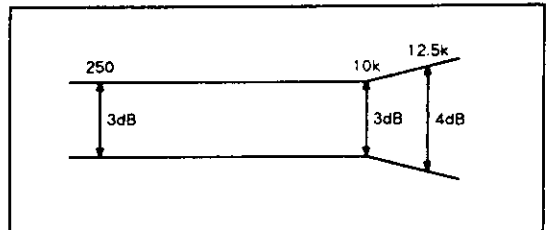

Fig. 3-2 Head Azimuth Adjustment

PLAY BACK



RECORDING

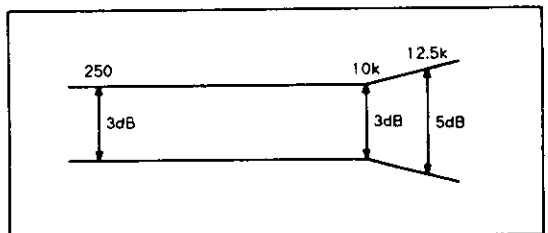

Fig. 3-3 Frequency Characteristics

● **Playback Adjustment**

1. Head Azimuth Adjustment

- This unit is equipped with auto tape selector.
- Do not switch between forward and reverse operation with the screwdriver inserted.

Step	Tape Selector (AUTO)	Mode	Input Signal/ Test Tape	Adjusting Points		Measurement Points	Adjustment Value	Remarks
1	NORMAL	PLAY	STD-331E test tape (Playback: 10kHz, -10dB)	Deck I	Head azimuth adjustment screw (Fig. 3-2)	TAPE TEST POINT (L, Rch) (AF CD Assy)	Max. playback signal level	After adjustment, apply lock paint to the head azimuth adjustment screw.
				Deck II				

2. Playback Level Adjustment

- Since this adjustment determines playback Dolby NR level, perform it carefully.

Step	Tape Selector (AUTO)	Mode	Input Signal/ Test Tape	Adjusting Points		Measurement Points	Adjustment Value	Remarks
1	NORMAL	PLAY	STD-331E test tape (Playback: 315Hz, 0dB)	Deck I	VR4201 (Lch) VR4202 (Rch)	TAPE TEST POINT (L, Rch) (AF CD Assy)	-1.2 dBV	
				Deck II	VR4203 (Lch) VR4204 (Rch)			

● **Recording Adjustment**

1. Bias Oscillation Frequency Adjustment

Step	Tape Selector (AUTO)	Mode	Input Signal/ Test Tape	Adjusting Points		Measurement Points	Adjustment Value	Remarks
				Deck I	Deck II			
1	NORMAL	REC	Load the STD-631 test tape and set the recording mode.	Deck I	—	Between ① point in Fig. 3-4 and GND.	Oscillation frequency to be 105.0kHz ±2kHz.	When the power is turned ON while the BAND button is depressed, the frequency will decrease 2-3 kHz.
				Deck II	—			

2. Recording Level Adjustment

Step	Tape Selector (AUTO)	Mode	Input Signal/Test Tape	Adjusting Points		Measurement Points	Adjustment Value	Remarks
				Deck I	Deck II			
1	NORMAL	REC	Input a 315Hz signal to the VIDEO/AUX IN terminal and set the input selector to VIDEO.	Deck I	Input signal level	TAPE TEST POINT (L, Rch) (AF CD Assy)	-5.2 dBV	
				Deck II				
2	NORMAL	REC/ PLAY	STD-631 test tape and record, playback the 315Hz signal.	Deck I	—	TAPE TEST POINT (L, Rch) (AF CD Assy)	Repeat recording, playback and adjustment until playback level of the 315Hz signal becomes -5.2dBV.	
				Deck II	VR4301 (Lch) VR4302 (Rch)			

● Since this adjustment affects recording bias, prevent distortion from increasing due to underbias.

3. Recording/playback Frequency Characteristics Adjustment

Step	Tape Selector (AUTO)	Mode	Input Signal/Test Tape	Adjusting Points		Measurement Points	Adjustment Value	Remarks
				Deck I	Deck II			
1	NORMAL	REC	Input a 315Hz signal to the VIDEO/AUX IN terminal and set the input selector to VIDEO.	Deck I	—	TAPE TEST POINT (L, Rch) (AF CD Assy)	-25.2 dBV	
				Deck II	Input signal level			
2	NORMAL	REC/ PLAY	Load the STD-631 test tape and record/playback the 315Hz and 10kHz signals. (see the Note below)	Deck I	—	TAPE TEST POINT (L, Rch) (AF CD Assy)	Repeat adjustment until playback level of the 10kHz signal is within 0±0.5dB from that of the 315Hz signal.	
				Deck II	VR4351 (Lch) VR4352 (Rch)			

Note: Set to the same level used for the 315Hz input signal at step 1.

4. ALC Operation Check

Step	Tape Selector (AUTO)	Mode	Input Signal/Test Tape	Adjusting Points		Measurement Points	Adjustment Value	Remarks
				Deck I	Deck II			
1	NORMAL	REC • PAUSE	Input a 315Hz signal to the VIDEO/AUX IN terminal and set the input selector to VIDEO.	Input signal level		TAPE TEST POINT (L, Rch) (AF CD Assy)	-5.2 dBV	
2				Set to a level +10dB above the input level at step 1.				

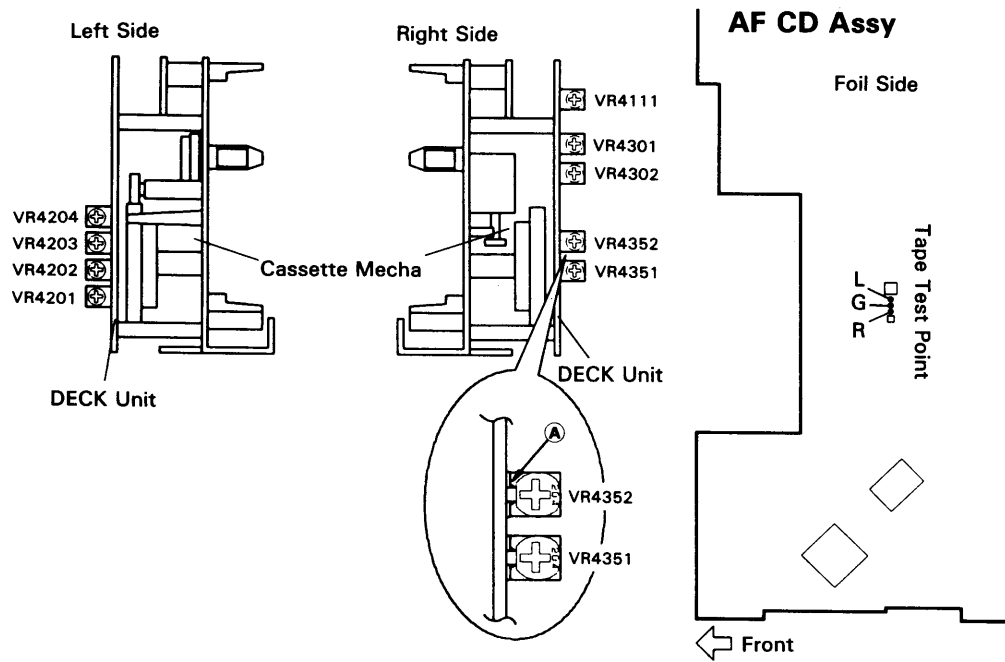

Fig. 3-4 Adjusting Points and Measurement Points

4. DOLBY PRO-LOGIC ADJUSTMENT

1. Turn FUNCTION to VIDEO, MODE to PRO-LOGIC, and CENTER MODE to NORMAL.
2. Input a 1kHz sine wave (253mVrms) to the Video Terminal (L/R). (But the input signal for R should be 180° inverse of the input signal for L.)
3. Adjust VR3401 so that the Dolby Test Point (CN3402) is 300mVrms.

NOTE:

Wait at least 2 minutes after the power has been turned ON before making adjustments.

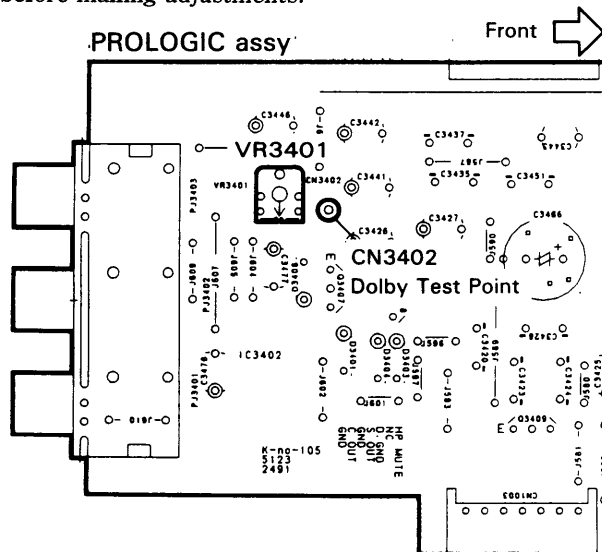

Dolby noise reduction manufactured under license from Dolby Laboratories Licensing Corporation.
"DOLBY" and the double-D symbol  are trademarks of Dolby Laboratories Licensing Corporation.

5. DOLBY SURROUND ADJUSTMENT

1. Turn FUNCTION to VIDEO and SURROUND to ON.
2. Input a 1kHz sine wave (260mVrms) to the Video Terminal (L/R). (But the input signal for R should be 180° inverse of the input signal for L.)
3. Adjust VR3401 so that the Dolby Test Point (R3440) is 71mVrms.

NOTE:

Wait at least 2 minutes after the power has been turned ON before making adjustments.

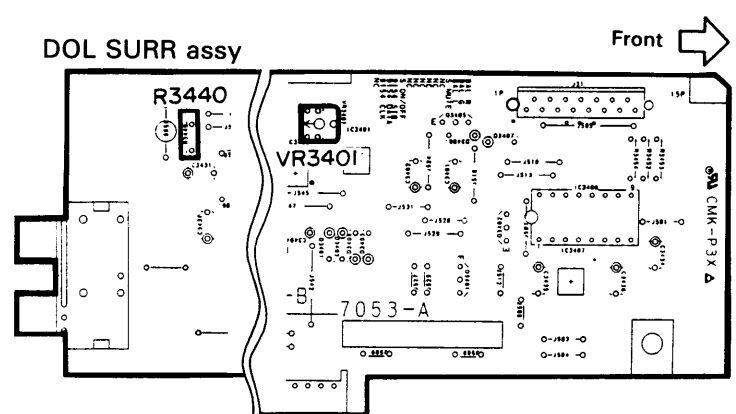

Manufactured under license from Dolby Laboratories Licensing Corporation.
DOLBY and the double-D symbol  are trademarks of Dolby Laboratories Licensing Corporation.

6. CD SECTION (FOR CD MULTI AND CD SINGLE)

■ Adjustment Methods

If a disc player is adjusted incorrectly or inadequately, it may malfunction or not work at all even though there is nothing at all wrong with the pickup or the circuitry. Adjust correctly following the adjustment procedure.

● Adjustment Items/Verification Items and Order

If the specified values cannot be obtained or no adjustment is possible by performing the verifications or adjustments described in steps 1–4, the pickup block may be defective.

Step	Item	Test Point	Adjustment Location
1	Focus offset verification	TP1, Pin6 (FOER)	None
2	Tracking error balance verification	TP1, Pin2 (TRER)	None
3	Pickup radial/tangential direction tilt adjustment	TP1, Pin1 (RF)	Radial tilt adjustment screw, Tangential tilt adjustment screw
4	RF level verification	TP1, Pin1 (RF)	None
5	Focus servo loop gain adjustment	TP1, Pin5 (FOIN) TP1, Pin6 (FOER)	VR8152 (FCS GAN)
6	Tracking servo loop gain adjustment	TP1, Pin3 (TRIN) TP1, Pin2 (TRER)	VR8151 (TRK GAN)

● Abbreviation Table

FOER	: Focus Error
TRER	: Tracking Error
FCS GAN	: Focus Gain
TRK GAN	: Tracking Gain
FOIN	: Focus In
TRIN	: Tracking In

● Measuring Instruments and Tools

1. Dual trace oscilloscope (10 : 1 probe)
2. Low-frequency oscillator
3. Test disc (YEDS-7)
4. Low pass filter (39kΩ + 0.001μF)
5. Resistor (100kΩ)
6. 8cm disc (With at least about 20 minutes of recording)
7. Ball point hexagon wrench (GGK1002)
8. Standard tools

● **Test Point and Adjustment Variable Resistor Positions**

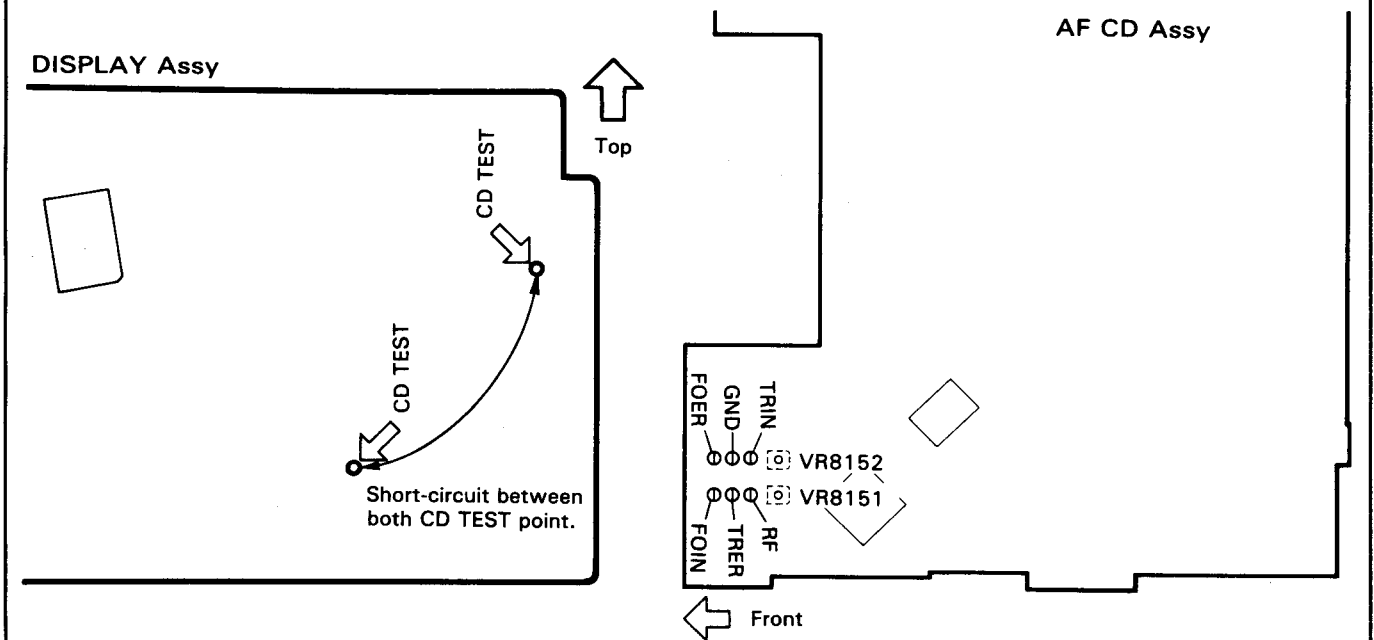

Fig. 1 Adjustment Location

● **Notes**

1. Use a 10 : 1 probe for the oscilloscope.
2. All the knob positions (settings) for the oscilloscope in the adjustment procedures are for when a 10 : 1 probe is used.

● **Test Mode**

These models have a test mode so that the adjustment and checks required for service can be carried out easily. When these models are in test mode, the keys on the front panel work differently from normal. Adjustments and checks can be carried out by operating these keys with the correct procedure. For these models, all adjustments are carried out in test mode.

[Setting these models to test mode]

How to set this model into test mode.

1. When the Power switch is activated, set the FUNCTION button to CD.
2. Short-circuit between both CD TEST points. (See Fig. 1)

When the test mode is set correctly, the display is different from what it usually is when the power is turned on. If the display is still the same as usual, test mode has not been set correctly, so repeat Steps 1–2.





[Release from test mode]

Here is the procedure for releasing the test mode:

1. Press the STOP key and stop all operations.
2. Turn off the power switch on the front panel.

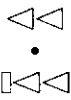
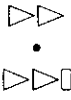
[Operations of the keys in test mode]

Code	Key Name	Function in Test Mode	Explanation
	DOLBY NR	Focus servo close	<p>The laser diode is lit up and the focus actuator is lifted up, then lowered slowly and the focus servo is closed at the point where the objective lens is focused on the disc.</p> <p>With the player in this state, if you lightly rotate the stopped disc by hand, you can hear the sound the focus servo.</p> <p>If you can hear this sound, the focus servo is operating correctly. If you press this key with no disc mounted, the laser diode lights up, the focus actuator is pulled up, then the actuator is lowered and raised three times and returned to its original position.</p>
▷/⏸	PLAY/PAUSE	Spindle servo ON	<p>Starts the spindle motor in the clockwise direction and when the disc rotation reaches the prescribed speed (about 500rpm at the inner periphery), sets the spindle servo in a closed loop.</p> <p>Be careful. Pressing this key when there is no disc mounted makes the spindle motor run at the maximum speed.</p> <p>If the focus servo does not go correctly into a closed loop or the laser light shines on the mirror section at the outermost periphery of the disc, the same symptom is occurred.</p>
		Tracking servo close/open	<p>Pressing this key when the focus servo and spindle servo are operating correctly in closed loops puts the tracking servo into a closed loop, displays the track number being played back and the elapsed time on the front panel, and outputs the playback signal.</p> <p>If the elapsed time is not displayed or not counted correctly or the audio is not played back correctly, it may be that the laser is shining on the section with no sound recorded at the outer edge of the disc, that something is out of adjustment, or that there is some other problem.</p> <p>This key is a toggle key and open/close the tracking servo alternately. This key has no effect if no disc is mounted.</p>

Code	Key Name	Function in Test Mode	Explanation
	MANUAL/ TRACK SEARCH REV	Carriage reverse (inwards)	Moves the pickup position toward the inner diameter of the disc. When this key is pressed with the tracking servo in a closed loop, the tracking servo automatically goes into an open loop. Since the motor does not automatically stop at the mechanical end point in test mode, be careful with this operation.
	MANUAL/ TRACK SEARCH FWD	Carriage forward (outwards)	Moves the pickup position toward the outer diameter of the disc. When this key is pressed with the tracking servo in a closed loop, the tracking servo automatically goes into an open loop. Since the motor does not automatically stop at the mechanical end point in test mode, be careful with this operation.
	STOP	Stop	Initializes and the disc rotation stops. The pickup and disc remain where they are when this key is pressed.
	EJECT	CD magazine eject (For CD Multi)	Stores Disc 1 in the CD magazine, then ejects the CD magazine. However, even though the CD magazine is ejected, the pickup does not return to the park position. Even if the CD magazine is mounted again, the pickup remains where it is.
	OPEN/CLOSE	Disc tray open/close (For CD Single)	Open/close the disc tray. This key is a toggle key and open/close tray alternately. Pressing this key when the disc is turning stops the disc, then opens the tray. This key operation does not affect the position of the pickup.

Note: When inserting the magazine, disc 1 of the magazine is loaded automatically.

[How to playback a disc in test mode]

In test mode, since the servos operate independently, playing back a disc requires that you operate the keys in the correct order to close the servos.

Here is the key operation sequence for playing back a disc in test mode.

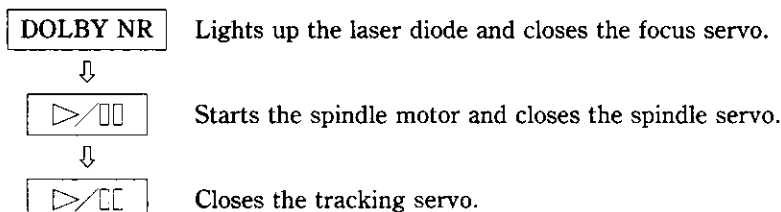

Wait at least 2–3 seconds between each of these operations.

Focus Offset Verification

● Objective	Verify the DC offset for the focus error amp.		
● Symptom when out of adjustment	The model does not focus in and the RF signal is dirty.		
● Measurement Instrument Connections	Connect the oscilloscope to TP1, Pin6 (FOER) [Settings] 5mV/division 10ms/division DC mode	● Player State ● Adjustment Location ● Disc	Test mode, stopped (just the Power switch on) None None needed
[Procedure] Verify the DC voltage at TP1, Pin6 (FOER) is $0 \pm 50\text{mV}$.			

Note: If the specified values cannot be obtained or no adjustment is possible by performing the verifications or adjustments described in adjustment items 1–4, the pickup block may be defective.

Tracking Error Balance Verification

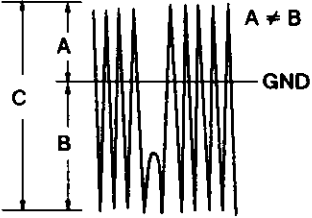
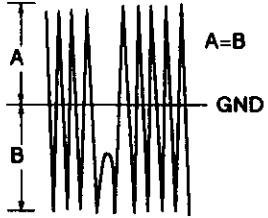
● Objective	To verify that there is no variation in the sensitivity of the tracking photo diode.		
● Symptom when out of adjustment	Play does not start or track search is impossible.		
● Measurement Instrument Connections	Connect the oscilloscope to TP1, Pin2 (TRER). This connection may be via a low pass filter. [Settings] 50mV/division 5ms/division DC mode	● Player State ● Adjustment Location ● Disc	Test mode, focus and spindle servos closed and tracking servo open. None YEDS-7
[Procedure] <ol style="list-style-type: none"> 1. Move the pickup to midway across the disc (R=35mm) with the MANUAL/TRACK SEARCH FWD $\triangleright \triangleright \bullet \triangleright \triangleright \triangleright$ key or REV $\triangleleft \triangleleft \bullet \triangleleft \triangleleft \triangleleft$ key. 2. Press the DOLBY NR key, then the PLAY/PAUSE \triangleright / \square key in that order to close the focus servo then the spindle servo. 3. Line up the bright line (ground) at the center of the oscilloscope screen and put the oscilloscope into DC mode. 4. Supposing that the positive amplitude of the tracking error signal at TP1, pin2 (TRER) is (A) and the negative amplitude is (B), the following expression is satisfied. 			
When $A \geq B$, $\frac{A-B}{C} \times \frac{1}{2} \leq 0.1$			
When $A < B$, $\frac{B-A}{C} \times \frac{1}{2} \leq 0.1$	When there is a DC component		When there is no DC component

■ Pickup Radial/Tangential Tilt Adjustment (For CD Multi)

● Objective	To adjust the angle of the pickup relative to the disc so that the laser beams are shone straight down into the disc for the best read out of the RF signals.		
● Symptom when out of adjustment	Sound broken; some discs can be played but not others.		
● Measurement Instrument Connections	Connect the oscilloscope to TP1, Pin1 (RF). [Settings] 20mV/division 200ns/division AC mode	● Player State ● Adjustment Location ● Disc	Test mode, play Pickup radial tilt adjustment screw and tangential tilt adjustment screw YEDS-7

[Procedure]

1. Press the **MANUAL/TRACK SEARCH FWD** $\triangleright\triangleright \cdot \triangleright\triangleright$ key or **REV** $\triangleleft\triangleleft \cdot \triangleleft\triangleleft$ key to move the pickup to halfway across the disc (R=35mm). Press the **DOLBY NR** key, the **PLAY/PAUSE** \triangleright/\square key twice in that order to close the respective servos and put the player into play mode.
2. First, adjust the radial tilt adjustment screw with a Phillips screwdriver so that the eye pattern (the diamond shape at the center of the RF signal) can be seen the most clearly.
3. Next, adjust the tangential tilt adjustment screw with a Phillips screwdriver so that the eye pattern (the diamond shape at the center of the RF signal) can be seen the most clearly (Fig. 3).
4. Adjust the radial tilt adjustment screw and the tangential tilt adjustment screw again so that the eye pattern can be seen the most clearly. As necessary, adjust the two screws alternately so that the eye pattern can be seen the most clearly.
5. When the adjustment is completed, lock the radial and tangential adjustment screw.

Note: Radial and tangential mean the directions relative to the disc shown in Fig. 2.

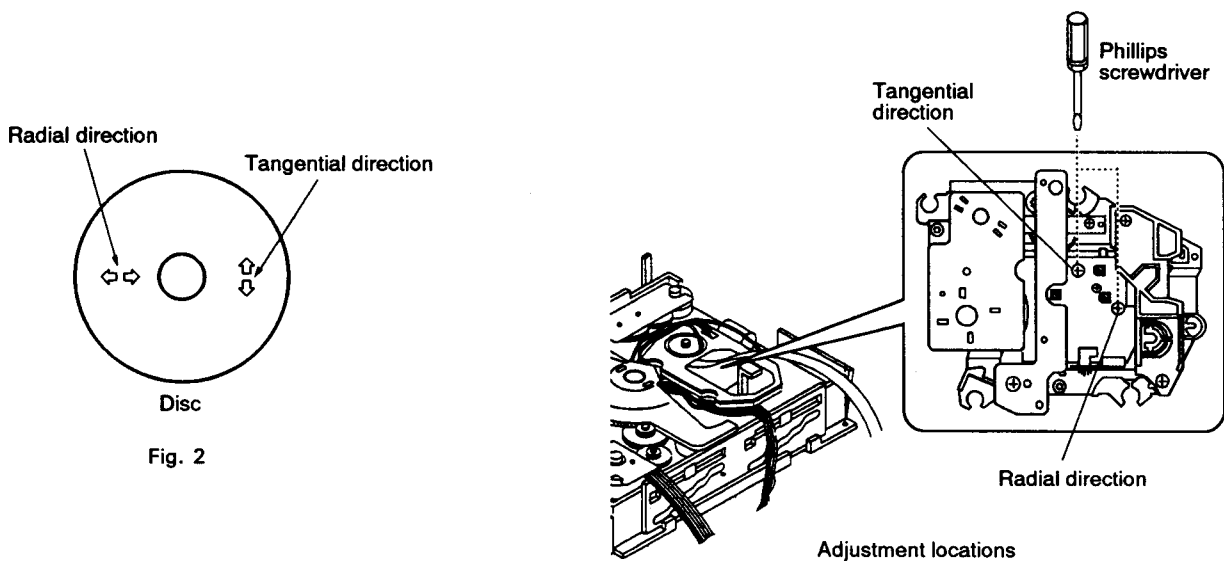

■ Pickup Radial/Tangential Tilt Adjustment (For CD Single)

● Objective	To adjust the angle of the pickup relative to the disc so that the laser beams are shone straight down into the disc for the best read out of the RF signals.		
● Symptom when out of adjustment	Sound broken; some discs can be played but not others.		
● Measurement Instrument Connections	Connect the oscilloscope to TP1, Pin1 (RF). [Settings] 20mV/division 200ns/division AC mode	● Player State ● Adjustment Location ● Disc	Test mode, play Pickup radial tilt adjustment screw and tangential tilt adjustment screw 8 cm disc [However, those with approx. 20 min of audio signal (music).]

[Procedure]

1. Press the **MANUAL/TRACK SEARCH FWD** $\triangleright\triangleright \cdot \triangleright\triangleright$ key or **REV** $\triangleleft\triangleleft \cdot \triangleleft\triangleleft$ key to move the pickup to the external circumference of the disc.
Press the **DOLBY NR** key, the **PLAY/PAUSE** \triangleright/\square key twice in that order to close the respective servos and put the player into play mode.
2. First, adjust the radial tilt adjustment screw with the hexagon wrench (GGK1002) so that the eye pattern (the diamond shape at the center of the RF signal) can be seen the most clearly.
3. Next, adjust the tangential tilt adjustment screw with the hexagon wrench (GGK1002) so that the eye pattern (the diamond shape at the center of the RF signal) can be seen the most clearly (Fig. 3).
※ The ball-point type hexagonal wrench is used because the disc will get in the way if a normal hexagonal wrench is used.
4. Adjust the radial tilt adjustment screw and the tangential tilt adjustment screw again so that the eye pattern can be seen the most clearly. As necessary, adjust the two screws alternately so that the eye pattern can be seen the most clearly.
5. When the adjustment is completed, lock the radial and tangential adjustment screw.

Note: Radial and tangential mean the directions relative to the disc shown in Fig. 2.

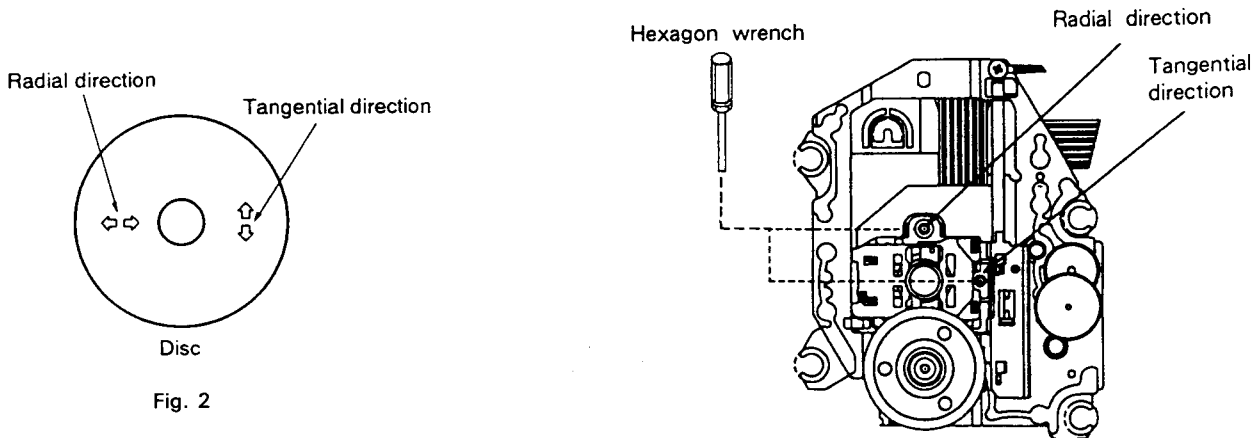

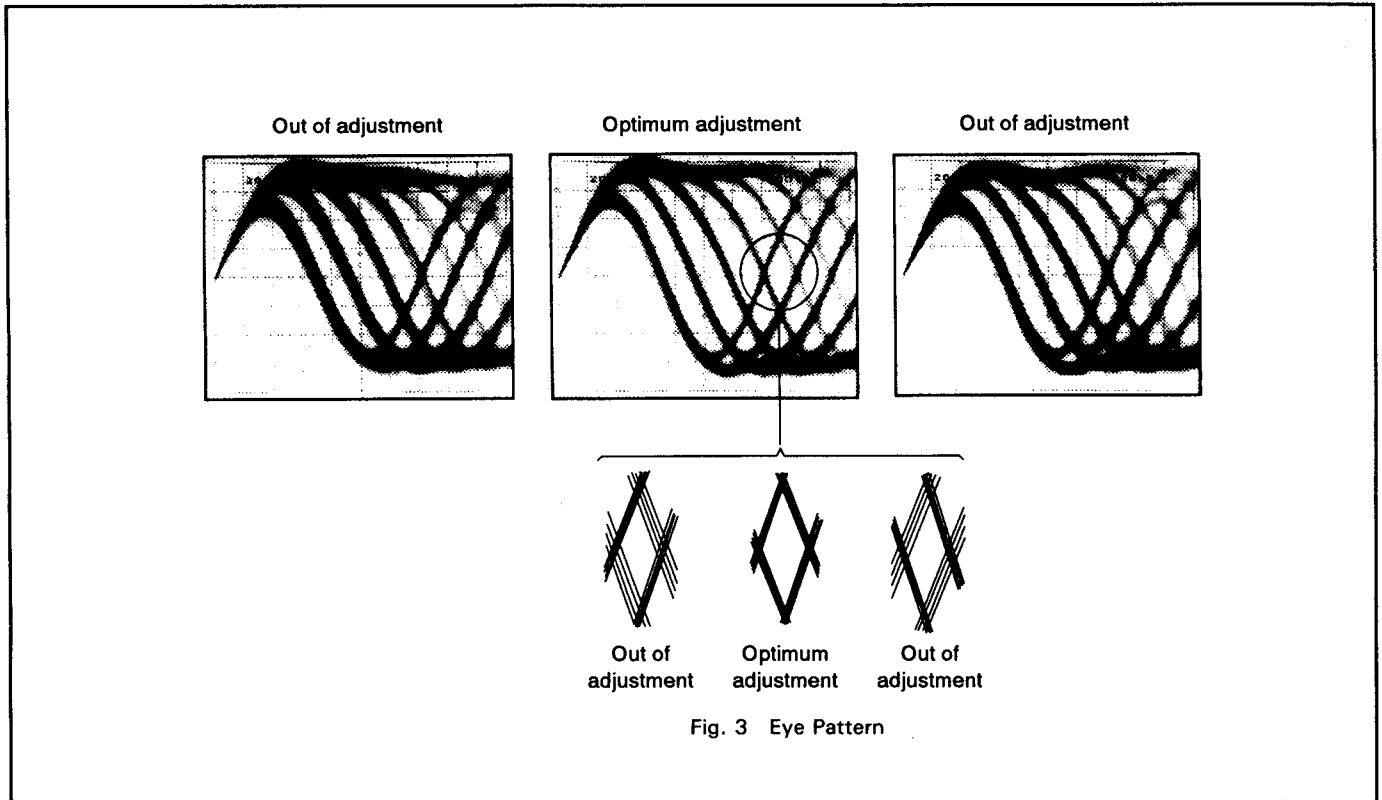

RF Level Verification

● Objective	To verify the playback RF signal amplitude.		
● Symptom when out of adjustment	No play or no search		
● Measurement Instrument Connections	Connect the oscilloscope to TP1, Pin1 (RF). [Settings] 50mV/division 10ms/division AC mode	● Player State ● Adjustment Location ● Disc	Test mode, play None YEDS-7
[Procedure]			
<p>1. Move the pickup to midway across the disc (R=35mm) with the MANUAL/TRACK SEARCH FWD ▷▷ • ▷▷◻ key or REV ◻◁◁ • ◻◁◁ key, then press the DOLBY NR key, the PLAY/PAUSE ▷/◻ key twice in that order to close the respective servos and put the player into play mode.</p> <p>2. Verify the RF signal amplitude is 1.2V_{p-p} ± 0.2V.</p>			

Focus Servo Loop Gain Adjustment

<ul style="list-style-type: none"> ● Objective 	To optimize the focus servo loop gain.		
<ul style="list-style-type: none"> ● Symptom when out of adjustment 	Playback does not start or focus actuator noisy.		
<ul style="list-style-type: none"> ● Measurement Instrument Connections 	See Fig. 4. [Settings] CH1 20mV/division X-Y mode CH2 5mV/division	<ul style="list-style-type: none"> ● Player State ● Adjustment Location ● Disc 	Test mode, play VR8152 (FCS GAN) YEDS-7

[Procedure]

1. Set the AF generator output to 1.2kHz and 1Vp-p.
2. Press the MANUAL/TRACK SEARCH FWD $\triangleright \triangleright \cdot \triangleright \triangleright$ key or REV $\triangleleft \triangleleft \cdot \triangleleft \triangleleft$ key to move the pickup to halfway across the disc (R=35mm), then press the DOLBY NR key, the PLAY/PAUSE \triangleright / \square key twice in that order to close the corresponding servos and put the player into play mode.
3. Adjust VR8152 (FCS GAN) so that the Lissajous waveform is symmetrical about the X axis and the Y axis.

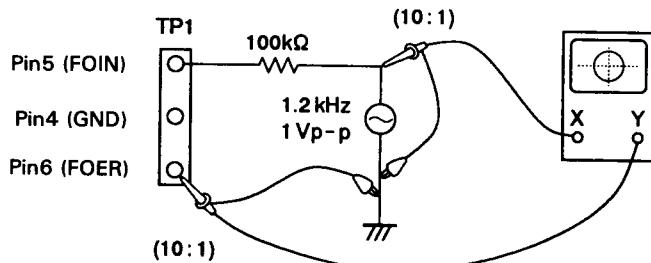
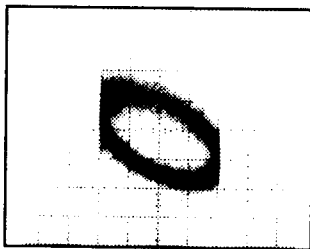
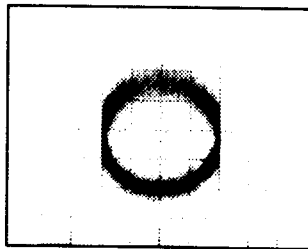

Fig. 4

Focus Gain Adjustment



Higher gain



Optimum gain

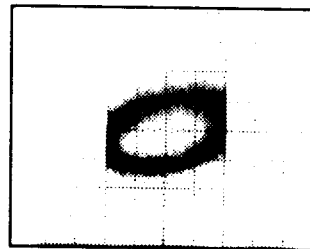

Lower gain

Tracking Servo Loop Gain Adjustment

● Objective	To optimize the tracking servo loop gain.		
● Symptom when out of adjustment	Playback does not start, during searches the actuator is noisy, or tracks are skipped.		
● Measurement Instrument Connections	See Fig. 5. [Settings] CH1 50mV/division X-Y mode CH2 20mV/division	● Player State ● Adjustment Location ● Disc	Test mode, play VR8151 (TRK GAN) YEDS-7

[Procedure]

1. Set the AF generator output to 1.2kHz and 2Vp-p.
2. Press the MANUAL/TRACK SEARCH FWD $\triangleright\triangleright$ • $\triangleright\triangleright$ key or REV $\triangleleft\triangleleft$ • $\triangleleft\triangleleft$ key to move the pickup to halfway across the disc (R=35mm), then press the DOLBY NR key, the PLAY/PAUSE \triangleright/\square key twice in that order to close the corresponding servos and put the player into play mode.
3. Adjust VR8151 (TRK GAN) so that the Lissajous waveform is symmetrical about the X axis and the Y axis.

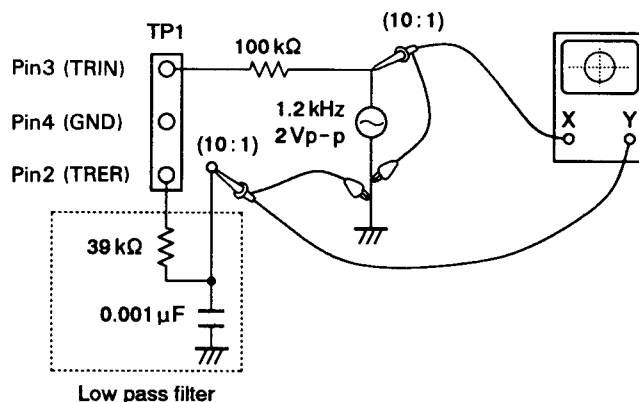
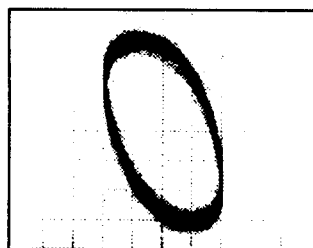
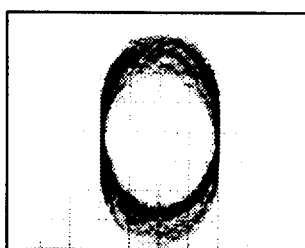

Fig. 5

Tracking Gain Adjustment



Higher gain



Optimum gain

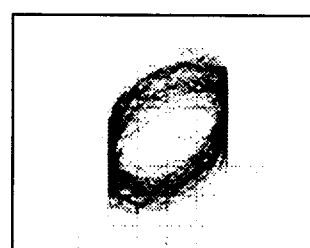

Lower gain

1.8 PARTS LIST FOR PACKING AND EXPLODED VIEWS

NOTES :

- Parts marked by "NSP" are generally unavailable because they are not in our Master Spare Parts List.
- The Δ mark found on some component parts indicates the importance of the safety factor of the part. Therefore, when replacing, be sure to use parts of identical designation.
- Parts marked by "☉" are not always kept in stock. Their delivery time may be longer than usual or they may be unavailable.

(1) PACKING

(1) - 1. FOR XR - P740M, XR - P740, XR - P640M AND XR - P640

■ For XR - P740M/SD

Mark	No.	Description	Parts No.
	1	MAGAZINE ASSY	PXA1549
	2	OPERATING INSTRUCTIONS (ECS-1,2,3/S/M)	ARC7006
	3	REMOTE CONTROL UNIT (CU-XR012)	AXD7007
	4	BATTERY COVER	AZA7032
	5	FM ANTENNA	ADH1016
	6	
	7	LOOP ANTENNA (L8043)	ATB1012
	8	FRONT PAD LR	AHA7004
	9	REAR PAD LR	AHA7005
	10	PACKING CASE	AHD7039
	11	SHEET	AHG7004

■ For XR - P740M/YPW, XR - P740/SD, XR - P640M/SD, YPW and XR - P640/SD

Part number differs between XR - P740M/YPW, XR - P740/SD, XR - P640M/SD, YPW, XR - P640/SD and XR - P740M/SD

Mark	No.	Symbol & Description	Part No.						Remarks
			XR - P740M		XR - P740	XR - P640M		XR - P640	
			SD	YPW	SD	SD	YPW	SD	
	2	Operating instructions (English/Spanish/Chinese)	ARC7006	ARC7006	ARC7006	ARC7006	
	2	Operating instructions (English)	ARB7006	ARB7006	
	10	Packing case	AHD7039	AHD7039	AHD7038	AHD7037	AHD7037	AHD7036	
	3	Remote control unit (CU-XR012)	AXD7007	AXD7007	AXD7007	
	3	Remote control unit (CU-XR010)	AXD7002	AXD7002	AXD7002	
	1	Magazine assy	PXA1549	PXA1549	PXA1549	PXA1549	

(1)-2. FOR XR-P340M AND XR-P340

■ For XR-P340M/KU

Mark	No.	Description	Parts No.
	1	MAGAZINE ASSY	PXA1549
	2	OPERATING INSTRUCTIONS (E-1, 2, 3/S/M)	ARB7006
	3	REMOTE CONTROL UNIT (CU-XR009)	AXD7001
	4	BATTERY COVER	AZA7031
	5	FM ANTENNA	ADH1016
	6	
	7	LOOP ANTENNA (L8043)	ATB1012
	8	FRONT PAD LR	AHA7002
	9	REAR PAD LR	AHA7003
	10	PACKING CASE	AHD7035
	11	SHEET	AHG7003

■ For XR-P340M/KC, SD, YPW, XR-P340/SD and YPW

Part number differs between XR-P340M/KC, SD, YPW, XR-P340/SD, YPW and XR-P340M/KU

Mark	No.	Symbol & Description	Part No.						Remarks
			XR-P340M				XR-P340		
			KU	KC	SD	YPW	SD	YPW	
	2	Operating instructions (English)	ARB7006	ARB7006	ARB7006	ARB7006	
	2	Operating instructions (English/Spanish/Chinese)	ARC7006	ARC7006	
	2	Operating instructions (French)	ARC7007	
	10	Packing case	AHD7035	AHD7035	AHD7034	AHD7034	AHD7033	AHD7033	
	1	Magazine assy	PXA1549	PXA1549	PXA1549	PXA1549	

**XR-P740M, XR-P640M, XR-P340M
XR-P740, XR-P640, XR-P340**

(2) EXPLODED VIEWS

(2) - 1. EXTERIOR

■ For XR-P740M, XR-P740, XR-P640M and XR-P640

● For XR-P740M/SD

Mark	No.	Description	Parts No.	Mark	No.	Description	Parts No.
△	1	POWER TRANSFORMER (T8005)	ATS7015	46	SCREW	VPZ30P080FZK	
△	2	FUSE (T2.5A/250V, FU1)	AEK-512	47	FRONT PANEL A	AMB7059	
△	3	AC POWER CORD	ADG1051	48	LENS	AAK7021	
	4	STRAIN RELIEF	AEC-882	49	AMP. TUNER BUTTON	AAD7048	
NSP	5	GROUND LEAD	ADB1001	50	DOOR-L	AAN7016	
	6	FLEXIBLE CABLE (J1)	ADD1127	51	DOOR-R	AAN7020	
	7	MULTI MECHA ASSY	AXA7006	52	CATCHER	AEC7001	
	8	CASSETTE MOD. BC	EXK2420	53	DOOR SPRING (L)	ABH7001	
NSP	9	CHASSIS	ANA7001	54	DOOR SPRING (R)	ABH7002	
	10	REAR PANEL	ANC7036	55	DECK. CD BUTTON	AAD7049	
	11	RUBBER SHEET	AEB1111	56	M-CD PANEL	AAK7016	
	12	TRANS FRAME	ANA7002	57	DAMPER ASSY	AXA7001	
	13	BRACKET	ANG7002	58	KEEP PLATE	ABK1017	
	14	NYLON BINDER	AEC-093	59	FRONT PANEL B	AMB7067	
	15	PCB SPACER (3×12)	AEC1372	60	DOLBY BUTTON	AAD7007	
	16	PCB CONNECTOR (PVC)	AEC1500	61	LEVEL BUTTON	AAD7012	
	17	FRONT PANEL ASSY	AMB7084	62	DOOR SHAFT	AXA7003	
	18	TUNER PLATE	AAK7012	63	DAMPER	PXA1484	
	19	DOLBY PLATE	AAK7013	64	DOOR SPRING	ABH7003	
	20	DECK PLATE LR	AAK7018	65	MULTI BUTTON	AAD7009	
	21		66	MULTI DOOR	AAK7017	
	22		67	LOCK LEVER SPRING	ABH7004	
	23	JOG KNOB	AAB7006	68	SCREW	BPZ20P080FMC	
	24	VOL KNOB	AAB7021	△	69	VOLTAGE SELECTOR (S8001)	AKX-507
	25	BALANCE KNOB	AAB7008	△	70	FUSE (T2.5A/250V, FU2)	AEK-512
	26	P. BASS KNOB	AAB7013		71	GROUND LEAD	ADB1005
	27	BONNET	ANE7005	NSP	72	PARALLEL WIRE (J2)	D20PYY0615E
	28	AF CD ASSY	AWZ7095				
	29	VR ASSY	AWZ7282				
	30	H. P ASSY	AWZ7105				
	31	SECONDRY TRANS ASSY	AWZ7211				
	32	DISPLAY ASSY	AWZ7215				
	33	CD DECK SW ASSY	AWZ7125				
	34	TRANS PRIMARY ASSY	AWZ7130				
	35	PROLOGIC ASSY	AWZ7138				
	36	ADDON DISPLAY ASSY	AWZ7141				
	37	FM/AM TUNER MODULE	AXQ1012				
	38	POWER MOD. F100+R20	AXQ1019				
	39	SCREW (P2.6×8)	ABA1095				
	40	SCREW	ASZ40P060FMC				
	41	SCREW	BBZ30P060FMC				
	42	SCREW	BBZ30P080FZK				
	43					
	44	SCREW	BPZ26P080FMC				
	45	SCREW	CBZ30P080FMC				

**XR-P740M, XR-P640M, XR-P340M
XR-P740, XR-P640, XR-P340**

● For XR-P740M/YPW, XR-P740/SD, XR-P640M/SD, YPW and XR-P640/SD

Part number differs between XR-P740M/YPW, XR-P740/SD, XR-P640M/SD, YPW, XR-P640/SD and XR-P740M/SD

Mark	No.	Symbol & Description	Part No.						Remarks
			XR-P740M		XR-P740	XR-P640M		XR-P640	
			SD	YPW	SD	SD	YPW	SD	
	28	AF CD assy	AWZ7095	AWZ7095	AWZ7281	AWZ7091	AWZ7091	AWZ7089	
	29	VR assy	AWZ7282	AWZ7282	AWZ7282	AWZ7099	AWZ7099	AWZ7099	
	32	DISPLAY assy	AWZ7215	AWZ7215	AWZ7214	AWZ7118	AWZ7118	AWZ7116	
	33	CD DECK SW assy	AWZ7125	AWZ7125	AWZ7124	AWZ7125	AWZ7125	AWZ7124	
	34	TRANS PRIMARY assy	AWZ7130	AWZ7127	AWZ7130	AWZ7130	AWZ7127	AWZ7130	
	35	PROLOGIC assy	AWZ7138	AWZ7138	AWZ7138	
	35	DOL SURR assy	AWZ7137	AWZ7137	AWZ7137	
	36	ADDON DISPLAY assy	AWZ7141	AWZ7141	AWZ7141	AWZ7139	AWZ7139	AWZ7139	
	7	MULTI MECHA assy	AXA7006	AXA7006	AXA7006	AXA7006	
	7	SINGLE MECHA assy	AXA7004	AXA7004	
△	69	S8001 Voltage selector	AKX-507	AKX-507	AKX-507	AKX-507	
△	1	T8005 Power transformer	ATS7015	ATS7015	ATS7015	ATS7013	ATS7013	ATS7013	
△	3	AC power cord	ADG1051	ADG1123	ADG1051	ADG1051	ADG1123	ADG1051	
△	70	FU2 Fuse (T2.5A/250V)	AEK-512	AEK-512	AEK-512	AEK-512	
	17	Front panel assy	AMB7084	AMB7084	AMB7083	AMB7082	AMB7082	AMB7081	
	47	— Front panel A	AMB7059	AMB7059	AMB7058	AMB7056	AMB7056	AMB7055	
	59	— Front panel B	AMB7067	AMB7067	AMB7067	AMB7065	AMB7065	AMB7065	
	64	— Door spring	ABH7003	ABH7003	ABH7003	ABH7003	
	62	— Door shaft	AXA7003	AXA7003	AXA7003	AXA7003	
	63	— Damper	PXA1484	PXA1484	PXA1484	PXA1484	
	68	— Screw	BPZ20P080FMC	BPZ20P080FMC	BPZ20P080FMC	BPZ20P080FMC	
	56	— M-CD panel	AAK7016	AAK7016	AAK7016	AAK7016	
	56	— S-CD panel	AAK7053	AAK7053	
	66	— Multi door	AAK7017	AAK7017	AAK7017	AAK7017	
	10	Rear panel	ANC7036	ANC7040	ANC7035	ANC7029	ANC7033	ANC7028	
	65	Multi button	AAD7009	AAD7009	AAD7009	AAD7009	
	67	Lock lever spring	ABH7004	ABH7004	ABH7004	ABH7004	
	71	Ground lead	ADB1005	ADB1005	ADB1005	ADB1005	
	19	Dolby plate	AAK7013	AAK7013	AAK7013	AAK7014	AAK7014	AAK7014	
	21	Tray cap	AAK7020	AAK7020	
	42	Screw (for CD MECHA assy)	BBZ30P080FZK	BBZ30P080FZK	BBZ30P180FMC	BBZ30P080FZK	BBZ30P080FZK	BBZ30P180FMC	※
	73	Caution label	VRW-329	VRW-329	

※ : Refer to page 2-3 (*3).

**XR-P740M, XR-P640M, XR-P340M
XR-P740, XR-P640, XR-P340**

■ For XR-P340M and XR-P340

● For XR-P340M/KU

Mark	No.	Description	Parts No.	Mark	No.	Description	Parts No.
△	1	POWER TRANSFORMER (T8005)	ATS7009	51	M-CD PANEL	AAK7016	
△	2	FUSE (4A/125V, FU1)	AEK-125	52	DAMPER ASSY	AXA7001	
△	3	AC POWER CORD	ADG1146	53	KEEP PLATE	ABK1017	
	4	CORD STOPPER	AEP-113	54	TRANS FRAME	ANA7002	
NSP	5	GROUND LEAD	ADB1001	55	65 LABEL	ORW1069	
	6	FLEXIBLE CABLE (J1)	ADD1127	56	DOOR SHAFT	AXA7003	
	7	MULTI MECHA ASSY	AXA7006	57	DOOR SPRING	ABH7003	
	8	CASSETTE MOD. B	EXK2430	58	MULTI BUTTON	AAD7009	
NSP	9	CHASSIS	ANA7001	59	MULTI DOOR	AAK7017	
	10	REAR PANEL	ANC7026	60	LOCK LEVER SPRING	ABH7004	
	11	RUBBER SHEET	AEB1111	61	DAMPER	PXA1484	
	12	BRACKET	ANG7002	62	SCREW	BPZ20P080FMC	
	13	NYLON BINDER	AEC-093	63	GROUND LEAD	ADB1005	
	14	PCB SPACER (3×12)	AEC1372	NSP 64	PARALLEL WIRE (J2)	D20PYY0615E	
	15	PCB CONNECTOR (PVC)	AEC1500				
	16	FRONT PANEL ASSY	AMB7075				
	17	TUNER PLATE	AAK7012				
	18	DECK PLATE LR	AAK7018				
	19					
	20					
	21	JOG KNOB	AAB7006				
	22	VOL KNOB	AAB7021				
	23	P. BASS KNOB	AAB7013				
	24	BONNET	ANE7003				
	25	AF CD ASSY	AWZ7088				
	26	VR ASSY	AWZ7270				
	27	H. P ASSY	AWZ7103				
	28	SECONDRY TRANS ASSY	AWZ7107				
	29	DISPLAY ASSY	AWZ7113				
	30	CD DECK SW ASSY	AWZ7125				
	31	TRANS PRIMARY ASSY	AWZ7131				
	32	FM/AM TUNER MODULE	AXQ1012				
	33	POWER MOD. F50	AXQ1018				
	34	SCREW (P2.6×8)	ABA1095				
	35	SCREW	ASZ40P060FMC				
	36	SCREW	BBZ30P060FMC				
	37	SCREW	BBZ30P080FZK				
	38					
	39	SCREW	BPZ26P080FMC				
	40	SCREW	CBZ30P080FMC				
	41	SCREW	VPZ30P080FZK				
	42	FRONT PANEL A	AMB7054				
	43	LENS	AAK7021				
	44	AMP. TUNER BUTTON	AAD7048				
	45	DOOR-L	AAN7016				
	46	DOOR-R	AAN7019				
	47	CATCHER	AEC7001				
	48	DOOR SPRING (L)	ABH7001				
	49	DOOR SPRING (R)	ABH7002				
	50	DECK. CD BUTTON	AAD7049				

**XR-P740M, XR-P640M, XR-P340M
XR-P740, XR-P640, XR-P340**

● For XR-P340M/KC, SD, YPW, XR-P340/SD and YPW

Part number differs between XR-P340M/KC, SD, YPW, XR-P340/SD, YPW and XR-P340M/KU

Mark	No.	Symbol & Description	Part No.						Remarks
			XR-P340M				XR-P340		
			KU	KC	SD	YPW	SD	YPW	
	25	AF CD assy	AWZ7088	AWZ7088	AWZ7086	AWZ7086	AWZ7084	AWZ7084	
	26	VR assy	AWZ7270	AWZ7270	AWZ7280	AWZ7080	AWZ7080	AWZ7080	
	29	DISPLAY assy	AWZ7113	AWZ7113	AWZ7114	AWZ7114	AWZ7110	AWZ7110	
	30	CD DECK SW assy	AWZ7125	AWZ7125	AWZ7125	AWZ7125	AWZ7124	AWZ7124	
	31	TRANS PRIMARY assy	AWZ7131	AWZ7131	AWZ7130	AWZ7127	AWZ7130	AWZ7127	
	8	CASSETTE MOD. B	EXK2430	EXK2410	EXK2410	EXK2410	EXK2410	EXK2410	
	7	MULTI MECHA assy	AXA7006	AXA7006	AXA7006	AXA7006	
	7	SINGLE MECHA assy	AXA7004	AXA7004	
△	66	S8001 Voltage selector	AKX-507	AKX-507	
△	1	T8005 Power transformer	ATS7009	ATS7009	ATS7010	ATS7010	ATS7010	ATS7010	
△	3	AC power cord	ADG1146	ADG1146	ADG1051	ADG1123	ADG1051	ADG1123	
△	65	FU2 Fuse (T1A/250V)	AEK-508	AEK-508	
	16	Front panel assy	AMB7075	AMB7075	AMB7075	AMB7075	AMB7074	AMB7074	
	42	└ Front panel A	AMB7054	AMB7054	AMB7054	AMB7054	AMB7053	AMB7053	
	57	└ Door spring	ABH7003	ABH7003	ABH7003	ABH7003	
	56	└ Door shaft	AXA7003	AXA7003	AXA7003	AXA7003	
	61	└ Damper	PXA1484	PXA1484	PXA1484	PXA1484	
	62	└ Screw	BPZ20P080FMC	BPZ20P080FMC	BPZ20P080FMC	BPZ20P080FMC	
	51	└ M-CD panel	AAK7016	AAK7016	AAK7016	AAK7016	
		└ S-CD panel	AAK7053	AAK7053	
	59	└ Multi door	AAK7017	AAK7017	AAK7017	AAK7017	
	10	Rear panel	ANC7026	ANC7027	ANC7021	ANC7025	ANC7020	ANC7024	
	58	Multi button	AAD7009	AAD7009	AAD7009	AAD7009	
	60	Lock lever spring	ABH7004	ABH7004	ABH7004	ABH7004	
	63	Ground lead	ADB1005	ADB1005	ADB1005	ADB1005	
	4	Cord stopper	AEP-113	AEP-113	AEC-882	AEC-882	AEC-882	AEC-882	
	54	Trans frame	ANA7002	ANA7002	
	20	Tray cap	AAK7020	AAK7020	
	35	Screw	ASZ40P060FMC	ASZ40P060FMC	ASZ30P060FZK	ASZ30P060FZK	ASZ30P060FZK	ASZ30P060FZK	
	37	Screw (for CD MECHA assy)	BBZ30P080FZK	BBZ30P080FZK	BBZ30P080FZK	BBZ30P080FZK	BBZ30P180FMC	BBZ30P180FMC	※
	55	65 level	ORW1069	
	67	Caution label	VRW-329	VRW-329	

※ : Refer to page 2-6 (*3).

(2) - 2. CASSETTE MECHA SECTION (FOR ALL MODELS)

Mark	No.	Description	Parts No.	Mark	No.	Description	Parts No.
	1	SPRING	EBH1467	51	SWITCH (AR - F)	ESN1009	
	2	SPRING	EBH1475	52	SWITCH (CrO2)	ESN1009	
	3	SPRING	EBL1021	53	SWITCH (HALF)	ESG1002	
	4	SPRING	EBH1478	54	CONNECTOR	EKS1012	
	5	SPRING	EBH1483	55	CONNECTOR	EKS1017	
	6	SPRING	EBH1472	56	PHOTO INTERRUPTER	ON1004	
	7	SPRING	EBH1496	57	LEAD WIRE	EDE1012	
	8	SPRING	EBH1495	58	RESISTOR	ERD25T561S	
	9	ARM	ENV1431	59	SCREW (For AZIMUTH)	EBA1034	
	10	BRAKE	ENV1395	60	CASSETTE MECHA UNIT (For EXK2420 and EXK2410)	EXA1347	
	11	ARM	ENV1394	60	CASSETTE MECHA UNIT (For EXK2430)	EXA1362	
	12	GEAR	ENV1393				
	13	PULLEY	ENV1291				
	14	REEL	ENV1385	61	SPRING	EBL1019	
	15	GEAR	ENV1383	62	HEAD UNIT	EXA1316	
	16	REEL	ENV1384	63	HEAD UNIT	EXA1317	
	17	ARM	ENV1400	64	SPRING	EBL1473	
	18	BUSH	ENV1386	65	SPRING	EBL1474	
	19	ARM	ENV1403				
	20	LIMITER UNIT	EXA1349	66	SPRING	EBL1476	
	21	FLYWHEEL UNIT	EXA1330	67	SPRING	EBL1479	
	22	FLYWHEEL UNIT	EXA1329	68	LEVER	ENC1349	
	23	ROLLER UNIT	EXA1352	69	SCREW	EBA1035	
	24	ROLLER UNIT	EXA1353				
	25	FLYWHEEL UNIT	EXA1322				
	26	FLYWHEEL UNIT	EXA1321				
	27	SHAFT	ELA1332				
	28	SPRING	EBH1468				
	29	SOLENOID	EXP1011				
	30	ARM	ENC1359				
	31	ARM	ENC1358				
	32	BRACKET	ENC1357				
	33	BRACKET	AZN7094				
	34	BELT	ENT1033				
	35	BELT	ENT1032				
	36	CHASSIS UNIT	EXA1348				
	37	HEAD BASE ASSY	EXX1031				
	38	MOTOR ASSY	EXX1030				
	39	HEAD BASE ASSEMBLY	EXX1029				
	40	SUB COMPLEX PCB	ENX1026				
	41	SUB COMPLEX PCB	ENX1022				
	42	DECK UNIT (For EXK2420)	EWM1002				
	42	DECK UNIT (For EXK2410 and EXK2430)	EWM1001				
	43	SCREW	BSZ20P035FMC				
	44	SCREW	PMS26P025FUC				
	45	SCREW	BSZ20P030FMC				
	46	SCREW	ATZ26P080FMC				
	47	WASHER	EBF1028				
	48	WASHER	EBF1027				
	49	SWITCH (AR - R)	ESN1009				
	50	SWITCH (CrO2)	ESN1009				

**(2) - 3. CD MULTI MECHA ASSY
(FOR XR - P740M, XR - P640M AND XR - P340M)**

Mark	No.	Description	Parts No.	Mark	No.	Description	Parts No.
	1	MOTOR PULLEY	PNW1634		51	GEAR 1	PNW2052
	2	GEAR HOLDER	PNW1929		52	GEAR 2	PNW2053
	3	PU FLEXIBLE CABLE	PNP1343		53	GEAR 3	PNW2054
	4	CAM GEAR	PNW1923		54	PINION GEAR	PNW2055
	5	BELT	PEB1138		55	PWB HOLDER	PNW2057
	6	TOP GUIDE N	PNW2441	NSP	56	CARRIAGE DC MOTOR/0.3W	PXM1027
	7	GEAR PULLEY	PNW1918		57	D.C. MOTOR ASSY (SPINDLE, with OIL)	PEA1235
	8	GEAR S	PNW1919		58	PICKUP ASSY	PEA1179
	9	GEAR L	PNW1920		59	DISC TABLE ASSY	PEA1035
	10	EJECT SPRING	PBH1107		60	SCREW	BBZ26P060FMC
	11	SWITCH LEVER	PNW1927		61	SCREW	BPZ20P060FMC
	12	SEVEN BAR	PNW1931		62	SCREW	BPZ26P100FMC
	13	SUB ROTARY LEVER	PNW1933		63	SCREW	JFZ17P025FZK
	14	SUB ROTARY LEVER SPRING	PBH1111		64	SCREW	JFZ20P040FMC
	15	ROTARY LEVER	PNW1932		65	WASHER	WT12D032D025
	16	DRIVE PLATE	PNW1930		66	
	17	MOTOR SCREW	PBA - 112		67	STOP SPRING	PBH1131
	18	HOLDER LEVER SPRING	PBH1110		68	STOPPER	PNW2069
	19	DISC HOLDER	PNW1924		69	CARRIAGE DC MOTOR ASSY	PEA1246
	20	CUSHION A	PED1001				
	21	HOLDER LEVER	PNW1925				
	22	FLOAT RUBBER	PEB1014				
	23	FLOAT RUBBER	PEB1132	NSP	101	MOTOR	VXM1033
	24	FLOAT SCREW	PBA1073	NSP	102	EJECT LEVER	PNB1306
	25	RELEASE LEVER	PNW1934		103	UPPER CHASSIS N	PNB1267
	26	RELEASE SPRING	PBH1106	NSP	104	SERVO MECHANISM ASSY M	PXA1537
	27	CLAMPER CAM	PNW1922	NSP	105	LOADING BOARD ASSY	AWZ7207
	28	CLAMPER HOLDER	PNW1921		106	SUB CHASSIS N	PNW2440
	29	CLAMPER SPRING	PBH1109		107	
	30	CLAMPER	PNW1857	NSP	108	MAIN CHASSIS	PNW2074
	31	LOCK LEVER	PNW1917	NSP	109	SELECT BOARD ASSY	AWZ7209
	32	LOCK SPRING	PBH1108	NSP	110	MOTOR BOARD ASSY	AWZ7208
	33	STAIR NL	PNW2443	NSP	111	MECHANISM BOARD ASSY	PWX1192
	34	STAIR NR	PNW2444	NSP	112	EARTH LEAD UNIT	PDF1074
	35	SYNCHRONIZE LEVER	PNW1926	NSP	113	CLAMP MAGNET	PMF1014
	36	MOTOR ASSY (LOADING, DISC SELECT)	PEA1130	NSP	114	GEAR STOPPER	PNB1303
	37	SCREW	PMZ26P040FMC	NSP	115	YOKE M	PNB1312
	38	SCREW	PPZ30P080FMC	NSP	116	AV ANGLE	PNB1405
	39	SCREW	BBZ30P060FMC		117	CARRIAGE BASE	PNW2445
	40	WASHER	WT26D047D025				
	41	WASHER	WA31D054D025				
	42	E RING	Z39 - 010				
	43	SCREW	IPZ30P080FMC				
	44	RUBBER SPACER	PEB1238				
	45	RUBBER SPACER	PEB1179				
	46	SILENT RING	PBK1093				
	47	WASHER	WA62D130D025				
	48	EARTH SPRING	PBH1132				
	49	GUIDE BAR	PLA1094				
	50	DISC TABLE	PNW1067				

**XR-P740M, XR-P640M, XR-P340M
XR-P740, XR-P640, XR-P340**

(2)–4. CD SINGLE MECHA ASSY (FOR XR–P740, XR–P640 AND XR–P340)

Mark	No.	Description	Parts No.	Mark	No.	Description	Parts No.
	1	LEVER SWITCH (CLAMP, S8001)	DSK1003		26	WASHER	WT12D032D025
	2	FLOAT SCREW	PBA1048		27	PICKUP ASSY	PEA1179
	3	RUBBER BELT	PEB1193		28	GUIDE BAR	PLA1094
	4	MOTOR PULLEY	PNW1634		29	GEAR 1	PNW2052
	5	TRAY	PNW2265	NSP	30	GEAR STOPPER	PNB1303
	6	FLOAT BASE	PNW2032		31	SCREW	BPZ20P060FMC
	7	DRIVE GEAR 2	PNW2369		32	PWB HOLDER	PNW2057
	8	GEAR PULLEY	PNW2034		33	SCREW	BPZ26P100FMC
	9	CLAMPER BASE	PNW2375	NSP	34	EARTH LEAD UNIT	PDF1104
	10	CLAMP CAM	PNW2364		35	SCREW	BBZ26P060FMC
	11	DC MOTOR/0.75W (LOADING)	PXM1010	NSP	36	MECHANISM BOARD ASSY	PWX1192
	12	FLOAT RUBBER	PEB1014	NSP	37	CLAMP MAGNET	PMF1014
	13	FLOAT RUBBER	PEB1132	NSP	38	YOKE	PNB1216
	14	SCREW	BPZ26P080FMC	NSP	39	H RUBBER	PEB1249
	15	SCREW	Z39–018	NSP	40	CLAMPER S	PNW1609
	16	SCREW	PMZ26P040FMC	NSP	41	LOADING BASE	PNW2376
	17	PINION GEAR	PNW2055		42	DC MOTOR ASSY (CARRIAGE)	PEA1246
NSP	18	DC MOTOR (CARRIAGE)	PXM1027	NSP	43	SERVO MECHANISM ASSY	PXA1536
	19	DC MOTOR ASSY (SPINDLE)	PEA1235		44	SCREW	BBZ30P080FZK
	20	CARRIAGE BASE	PNW2058	NSP	45	CONNECTOR ASSY (4P)	PDE1238
	21	DISC TABLE	PNW1608	NSP	46	CONNECTOR ASSY (5P)	PDE1239
	22	SCREW	JFZ20P030FNI				
	23	SCREW	JFZ17P025FZK				
	24	GEAR 3	PNW2054				
	25	GEAR 2	PNW2053				

(2)–5. POWER AMP MODULE SECTION (FOR ALL MODELS)

Mark	No.	Description	Parts No.	Mark	No.	Description	Parts No.
	1	FRONT ASSY FOR 100W (For AXQ1019)	AWZ5389	△	18	TRANSISTOR (Q7113) (AXQ1019 only)	2SD1913
	1	FRONT ASSY FOR 50W (For AXQ1018)	AWZ5390	△	19	TRANSISTOR (Q7114) (AXQ1019 only)	2SD1913
	2	REAR, PWR, PRTEC ASSY (For AXQ1019)	AWZ5391		20	TRANSISTOR (Q7503) (AXQ1019 only)	2SC4793
	2	PWR, PRTEC ASSY (For AXQ1018)	AWZ5392		21	TRANSISTOR (Q7504) (AXQ1019 only)	2SC4793
	3	HEAT SINK (AL)	ANH1446		22	TRANSISTOR (Q7509) (AXQ1019 only)	2SA1837
	4	BRACKET	ANG1868		23	TRANSISTOR (Q7510) (AXQ1019 only)	2SA1837
	5	SHEET	AEB1256		24	TRANSISTOR (Q7511) (For AXQ1019)	2SA1264N
	6	MOLD A	AMR2594	△	24	TRANSISTOR (Q7511) (For AXQ1018)	2SA1263N
	7	MOLD B	AMR2595	△	25	TRANSISTOR (Q7512) (For AXQ1019)	2SA1264N
	8	SCREW (3×10)	ABA1021	△	25	TRANSISTOR (Q7512) (For AXQ1018)	2SA1263N
	9	SCREW	BBZ30P140FZK	△	26	TRANSISTOR (Q7513) (For AXQ1019)	2SC3181N
	10	SCREW	BPZ30P350FZK	△	26	TRANSISTOR (Q7513) (For AXQ1018)	2SC3180N
	11	FAN MOTOR	AXM1019	△	27	TRANSISTOR (Q7514) (For AXQ1019)	2SC3181N
	12	REGULATOR IC (IC7401)	MC7812CT	△	27	TRANSISTOR (Q7514) (For AXQ1018)	2SC3180N
	13	REGULATOR IC (IC7402)	NJM7912A				
	14	REGULATOR IC (IC7403)	MC7812CT				
	15	REGULATOR IC (IC7404)	MC7805CT				
△	16	TRANSISTOR (Q7111) (AXQ1019 only)	2SB1274	△	27	TRANSISTOR (Q7514) (For AXQ1019)	2SC3180N
△	17	TRANSISTOR (Q7112) (AXQ1019 only)	2SB1274	△	27	TRANSISTOR (Q7514) (For AXQ1018)	2SC3180N

1.9 PCB PARTS LIST

NOTES :

- Parts marked by "NSP" are generally unavailable because they are not in our Master Spare Parts List.
- The Δ mark found on some component parts indicates the importance of the safety factor of the part. Therefore, when replacing, be sure to use parts of identical designation.
- Parts marked by "●" are not always kept in stock. Their delivery time may be longer than usual or they may be unavailable.
- When ordering resistors, first convert resistance values into code form as shown in the following examples.

Ex. 1 When there are 2 effective digits (any digit apart from 0), such as 560 ohm and 47k ohm (tolerance is shown by J = 5%, and K = 10%).

560 Ω \rightarrow 56 \times 10¹ \rightarrow 561 RD1/8PM $\begin{matrix} 5 & 6 & 1 \\ \hline & & J \end{matrix}$

47k Ω \rightarrow 47 \times 10³ \rightarrow 473 RD1/4PS $\begin{matrix} 4 & 7 & 3 \\ \hline & & J \end{matrix}$

0.5 Ω \rightarrow 0R5 RN2H $\begin{matrix} 0 & R & 5 \\ \hline & & K \end{matrix}$

1 Ω \rightarrow 010 RS1P $\begin{matrix} 0 & 1 & 0 \\ \hline & & K \end{matrix}$

Ex. 2 When there are 3 effective digits (such as in high precision metal film resistors).

5.62k Ω \rightarrow 562 \times 10¹ \rightarrow 5621 RM1/4PC $\begin{matrix} 5 & 6 & 2 & 1 \\ \hline & & & F \end{matrix}$

(1) FOR XR-P740M, XR-P740, XR-P640M AND XR-P640

(1)-1. LIST OF WHOLE PCB ASSEMBLIES

Mark	Symbol & Description	Part No.						Remarks
		XR-P740M		XR-P740	XR-P640M		XR-P640	
		SD	YPW	SD	SD	YPW	SD	
	MAIN assy	AWK7041	AWK7041	AWK7080	AWK7037	AWK7037	AWK7035	
	└ AF CD assy	AWZ7095	AWZ7095	AWZ7281	AWZ7091	AWZ7091	AWZ7089	
	└ H. P assy	AWZ7105	AWZ7105	AWZ7105	AWZ7105	AWZ7105	AWZ7105	
	└ SECONDRY TRANS assy	AWZ7211	AWZ7211	AWZ7211	AWZ7211	AWZ7211	AWZ7211	
	└ VR assy	AWZ7282	AWZ7282	AWZ7282	AWZ7099	AWZ7099	AWZ7099	
	COMPLEX assy	AWM7050	AWM7051	AWM7081	AWM7040	AWM7041	AWM7034	
	└ CD DECK SW assy	AWZ7125	AWZ7125	AWZ7124	AWZ7125	AWZ7125	AWZ7124	
	└ TRANS PRIMARY assy	AWZ7130	AWZ7127	AWZ7130	AWZ7130	AWZ7127	AWZ7130	
	└ DISPLAY assy	AWZ7215	AWZ7215	AWZ7214	AWZ7118	AWZ7118	AWZ7116	
	PRO LOGIC assy	AWM7054	AWM7054	AWM7054	
	└ PROLOGIC assy	AWZ7138	AWZ7138	AWZ7138	
	└ ADDON DISPLAY assy	AWZ7141	AWZ7141	AWZ7141	
	DOLBY SURROUND assy	AWM7053	AWM7053	AWM7053	
	└ DOL SURR assy	AWZ7137	AWZ7137	AWZ7137	
	└ ADDON DISPLAY assy	AWZ7139	AWZ7139	AWZ7139	
	MULTI MECHA assy	AXA7006	AXA7006	AXA7006	AXA7006	
NSP	└ LOADING BOARD assy	AWZ7207	AWZ7207	AWZ7207	AWZ7207	
NSP	└ MOTOR BOARD assy	AWZ7208	AWZ7208	AWZ7208	AWZ7208	
NSP	└ SELECT BOARD assy	AWZ7209	AWZ7209	AWZ7209	AWZ7209	
NSP	└ MECHANISM BOARD assy	PWX1192	PWX1192	PWX1192	PWX1192	
	SINGLE MECHA assy	AXA7004	AXA7004	
NSP	└ MECHANISM BOARD assy	PWX1192	PWX1192	
	FM/AM TUNER MODULE	AXQ1012	AXQ1012	AXQ1012	AXQ1012	AXQ1012	AXQ1012	
	POWER MOD. F100+R20	AXQ1019	AXQ1019	AXQ1019	AXQ1019	AXQ1019	AXQ1019	
	└ FRONT ASSY FOR 100W	AWZ5389	AWZ5389	AWZ5389	AWZ5389	AWZ5389	AWZ5389	
	└ REAR, PWR, PRTEC ASSY	AWZ5391	AWZ5391	AWZ5391	AWZ5391	AWZ5391	AWZ5391	
	CASSETTE MECHA MOD. BC	EXK2420	EXK2420	EXK2420	EXK2420	EXK2420	EXK2420	
	└ DECK unit	EWM1002	EWM1002	EWM1002	EWM1002	EWM1002	EWM1002	

XR-P740M, XR-P640M, XR-P340M XR-P740, XR-P640, XR-P340

(1) - 2. FOR XR - P740M/SD

Mark	No.	Description	Parts No.	Mark	No.	Description	Parts No.
AF CD ASSY							
SEMICONDUCTORS							
	IC8151		CXA1372Q		C1013, C1014		CEAS470M16
	IC8301		CXD2517Q		C2251, C2252		CEAS470M50
	IC1001		ICP - N70		C3301, C3302, C3501, C8160, C8162		CEAS4R7M50
	IC8201, IC8202	LA6520			C2503, C2504		CEASR15M50
	IC2104		M66311FP		C3502, C3601, C8309		CEASR47M50
	IC2101		MC14052BF		C8164, C8167, C8169, C8212		CKSQYB103K50
	IC2103, IC2201 - IC2203, IC3301, IC3501		NJM4558M - D		C8306, C8441, C8442		CKSQYB152K50
	IC3601, IC8405		NJM4558M - D		C3309, C3310, C8155		CKSQYB182K50
	IC8402		TC7S04F		C3503		CKSQYB223K50
	IC2102		TC9162N		C3305, C3306		CKSQYB273K50
	IC8401		TC9268F		C3307, C3308, C8170		CKSQYB332K50
	Q1051, Q1053		2SA1048		C8156, C8168		CKSQYB333K50
	Q1002, Q1006, Q1040		2SA1515		C2201 - C2203		CKSQYB471K50
	Q1005, Q106		2SB560		C8171, C8172		CKSQYB472K50
	Q1052, Q1403, Q9001 - Q9003, Q9005		2SC2458		C8307		CKSQYB473K50
	Q1003		2SC3377		C3311, C3312, C8157, C8202, C8203		CKSQYF103Z50
	Q105		2SD438		C8205 - C8207		CKSQYF103Z50
	Q8401		2SK246		C1301 - C1304, C2253, C2257		CKSQYF104Z50
	Q1001, Q1007, Q1041		RN1201		C8158, C8159, C8161, C8163, C8301		CKSQYF104Z50
	Q1004, Q9004		RN2201		C8304, C8308, C8361, C8414, C8415		CKSQYF104Z50
	Q8402		RN2203	RESISTORS			
	D1001		D5SB20F		VR8151, VR8152 (22kΩ)		ACP1057
	D1021, D1022, D1027, D1031		HSS104 - 02		R2125		RA11T103J
	D1153, D1154, D6901, D8301, D8401		HSS104 - 02		R1159, R1160		RD1/2PM151J
	D9001		HSS104 - 02		R1064, R1153, R1157		RD1/4PM102J
	D2201, D8211		HZS6CL		R1041		RD1/4PM222J
	D1010		HZS7BL		R1002		RD1/4PM272J
	D1002, D1003		RB152		R1020		RD1/4PM432J
	D1023		RD30ESB4		R1003		RD1/4PM472J
	D1151, D1152		RD5.1ESB		R1019		RD1/4PM511J
	D1011, D1012		RD5.6ESB2		R1301, R1302		RD1/4PMF6R8J
	D1007, D1008, D1013 - D1020		S5688G		R1031, R2101, R2102, R2105 - R2107		RD1/8PM102J
	D1024, D1025, D1041 - D1043, D1996 - D1999		S5688G		R2111 - R2113, R2117, R2129, R9007		RD1/8PM102J
					R1040, R1063, R1154, R1158		RD1/8PM103J
					R8368		RD1/8PM105J
					R1026		RD1/8PM114J
					R1015		RD1/8PM223J
					R1051		RD1/8PM331J
					R3502		RD1/8PM433J
					R1052		RD1/8PM471J
					R1151, R2136, R9001, R9002		RD1/8PM472J
					R2114		RD1/8PM473J
					R1013		RD1/8PM562J
					R2121, R2122		RD1/8PM912J
					R1006, R1016		RS1LMFR22J
					R1001		RS2LMF151J
					R1998		RS2LMF220J
					R1007, R1017		RS2LMFR22J
					R1999		RS3LMF3R9J
					Other Resistors		RS1/10S□□□J
				OTHERS			
					CN8131 CONNECTOR		12FMZ - ABT
					CN8204 6P JUMPER CONNECTOR		52147 - 0610
					CN2101 PIN JACK 2P (VIDEO/AUX)		AKB1171
					SPEAKER TERMINAL 4 - P		AKE1026
					CN1 36P SOCKET		AKP1105
	C2501, C2502		CEAS2R2M50				
	C8216, C8217, C8302		CEAS330M16				
	C8175, C8176		CEAS331M16				
	C1003		CEAS332M35				
	C1224		CEAS3R3M50				

Mark	No.	Description	Parts No.	Mark	No.	Description	Parts No.
	CN10	JUMPER CONNECTOR	KPC6	DISPLAY ASSY			
	X8401	XTAL RES (OSC)	PSS1008	SEMICONDUCTORS			
		PCB BINDER	VEF1008	IC1951			M66311FP
	CN8202	CONNECTER	VKN1051	IC2501, IC3701 - IC3703			NJM4558M - D
	CN8203	CONNECTOR 4P	4 - 173981 - 4	IC1901			PD4493A
				Q1801			2SA1048
				Q1901			2SC2458
				Q1902			RN1201
H.P ASSY				Q1707			RN2201
RESISTORS	R1201, R1202		RS3LMF331J	D1701 - D1705			AEL1118
	Other Resistors		RS1/10S□□□J	D1801 - D1817, D1819, D1901, D1903			HSS104 - 02
OTHERS				D1905, D1906, D3701 - D3705			HSS104 - 02
	CN1201	JACK	AKN1029				
				D1951, D1953			HZS6CL
SECONDRY TRANS ASSY				D1904			HZS7AL
SEMICONDUCTORS	IC1002 - IC1005		ICP - N70	COIL			
				L1901			LAU220J
VR ASSY				SWITCHES			
SEMICONDUCTORS	IC1501, IC1502 NJM4558M - D		TA8409S	S1801 - S1815			ASG1034
	IC1551			S1901			ASX1021
CAPACITORS	C1517, C1518		CCSQCH470J50	CAPACITORS			
	C1554		CEAS101M16	C1903			ACH1246
	C1503, C1504, C1511 - C1514		CEAS2R2M50	C1952			CCSQCH101J50
	C1501, C1502		CEYA2R2M50	C2504			CCSQCH221J50
	C1557, C1558		CKSQYB273K50	C1907			CEJA010M50
				C1910, C2503, C2505			CEJA100M50
	C1509, C1510, C1519, C1520		CKSQYB473K50	C1905			CEJA221M10
	C1555, C1556		CKSQYB473K50	C1902			CEJA470M16
	C1551 - C1553		CKSQYF104Z50	C2502			CEJA4R7M50
RESISTORS	VR301 (100K - 3B*4)		ACX1088	C1908			CFTYA224J50
	Other Resistors		RS1/10S□□□J	C1915, C1916			CKSQYB102K50
CD DECK SW ASSY				C1954			CKSQYB103K50
SEMICONDUCTORS	Q1701 - Q1706		2SA1048	C2501			CKSQYB122K50
	D1708		AEL1131	C3710, C3711			CKSQYB152K50
	D1706, D1707, D1709 - D1714		AEL1132	C3704, C3705			CKSQYB153K50
SWITCHES	S1816 - S1835		ASG1034	C3713, C3714			CKSQYB471K50
RESISTORS	R1703		RD1/8PM201J	C3707, C3708			CKSQYB472K50
	R1704		RD1/8PM241J	C2507, C3701, C3702			CKSQYB473K50
	Other Resistors		RS1/10S□□□J	C2506			CKSQYB682K50
TRANS PRIMARY ASSY				C1909			CKSQYF102Z50
COILS AND FILTERS	L1101		ATF - 151	C1955			CKSQYF103Z50
CAPACITORS	C1102 (0.01/400)		ACG1003	C1901, C1904, C1906, C1911 - C1914			CKSQYF473Z50
RESISTORS	Other Resistors		RS1/10S□□□J	C2508, C2509, C3703, C3706, C3709			CKSQYF473Z50
				C3712, C3715			CKSQYF473Z50
				RESISTORS			
				VR2501 (10K - B)			ACS1104
				R1701			RD1/8PM181J
				R1801 - R1804			RD1/8PM223J
				R1941			RD1/8PM472J
				R1919			RD1/8PM473J
				R1935, R1938, R1939			RD1/8PM561J
				Other Resistors			RS1/10S□□□J
				OTHERS			
				V1701			AAV7002
				JACK			AKN1030
				CN1001 36P SOCKET			AKP1105
				X1901			ASS1018
				REMOTE RECEIVER UNIT			AXX1023

XR-P740M, XR-P640M, XR-P340M XR-P740, XR-P640, XR-P340

Mark	No.	Description	Parts No.
PROLOGIC ASSY			
SEMICONDUCTORS			
	IC3406		LA2780N
	IC3410		LM3364K-15
	IC3408		LV1001M-A
	IC3402		MC14053BF
	IC3403-IC3405, IC3409		NJM4558M-D
	IC3401		TC9154AP
	Q3401, Q3402, Q3407, Q3408		2SC1740S
	Q3409		2SC2458
	Q3405		2SD438
	Q3403, Q3404, Q3406		RN2203
	D3401, D3403, D3404, D3406-D3410		HSS104-02
	D3412		RD5.1ESB
CAPACITORS			
	C3403, C3404, C3407, C3408		CCSQCH101J50
	C3460, C3469		CCSQCH102J50
	C3455, C3470		CCSQCH151J50
	C3484		CCSQCH331J50
	C3410, C3430, C3440		CCSQCH681J50
	C3444, C3445, C3449, C3450		CEANL4R7M50
	C3429		CEANP100M35
	C3443		CEANPR33M50
	C3427		CEAS010M50
	C3416, C3419, C3421, C3422, C3426		CEAS100M50
	C3441, C3442, C3446		CEAS100M50
	C3417		CEAS101M16
	C3474		CEAS221M10
	C3464, C3471		CEAS221M16
	C3472		CEAS221M25
	C3413, C3414, C3476, C3477		CEAS2R2M50
	C3415		CEAS470M25
	C3466		CEAS471M16
	C3463, C3467		CEAS4R7M50
	C3452, C3453		CEASR15M50
	C3425		CEASR22M50
	C3457, C3458		CEYA3R3M50
	C3431, C3432		CEYAR33M50
	C3411		CFTYA103J50
	C3409, C3433, C3436, C3438, C3439		CFTYA104J50
	C3456		CFTYA104J50
	C3412		CFTYA153J50
	C3451, C3461, C3462		CFTYA154J50
	C3459, C3468		CFTYA223J50
	C3428		CFTYA333J50
	C3447		CFTYA334J50
	C3454		CFTYA473J50
	C3424		CFTYA683J50
	C3475		CKSQYB103K50
	C3434		CKSQYB471K50
	C3478, C3483		CKSQYB473K50
	C3418		CKSQYB562K50
	C3448		CKSQYB681K50
	C3465, C3473, C3479-C3482		CKSQYF104Z50
	C3423		CQMA392J50
	C3420		CQMA472J50
	C3435		CQMA562J50
	C3437		CQMA682J50

Mark	No.	Description	Parts No.
RESISTORS			
	VR3401 (22k Ω)		ACP1044
	R3472		RD1/2PM561J
	R3473-R3475		RD1/8PM222J
	Other Resistors		RS1/10S□□□J
OTHERS			
	CN3401 PIN JACK 3P (CENTER, REAR)		AKB1215
	X3401 CRYSTAL RESONATOR		ASS1015
ADDON DISPLAY			
SEMICONDUCTORS			
	IC3952		NJM4558M-D
	IC3951		PDG108A
	Q3951		2SA1515
	Q3952		RN2201
	D3951-D3954, D3956-D3960		HSS104-02
	D3955		HZS6C1L
COILS AND FILTERS			
	L3951		LAU220K
SWITCHES			
	S3951-S3955		ASG1034
CAPACITORS			
	C3953, C3954		CEJA100M16
	C3951		CEJA100M50
	C3956		CEJA101M10
	C3952		CKSQYF102Z50
	C3961		CKSQYF104Z50
	C3957-C3960		CKSQYF473Z50
RESISTORS			
	VR3951 (10K-B)		ACS1103
	R4029-R4032, R4034		RD1/8PM102J
	Other Resistors		RS1/10S□□□J
OTHERS			
	V3951 FL TUBE		AAV7001
	X3951 CRYSTAL RESONATOR		ASS1015
	CN20 CONNECTOR (13P)		KPE13
LOADING BOARD ASSY			
SWITCHES			
	S601, S602		DSG1016
MOTOR BOARD ASSY			
OTHERS			
	CN602 6PJUMPER CONNECTOR		52151-0610
SELECT BOARD ASSY			
SWITCHES			
	S604-S606		DSG1016
	S603		PSG1010
MECHANISM BOARD ASSY			
SWITCHES			
	S610		DSG1016

XR-P740M, XR-P640M, XR-P340M XR-P740, XR-P640, XR-P340

Mark	No.	Description	Parts No.	Mark	No.	Description	Parts No.
FM/AM TUNER MODULE							
SEMICONDUCTORS							
	IC6201		LA1836M		C6225, C6241, C6266		CKSQYF473Z50
	IC6202		LM7001J		C6232		CKSYB333K50
	Q6102		2SC2223		C6251		CKSYB472K50
	Q6203		2SC2235		C6223		CKSYF103Z50
	Q6202		2SC2712		C6263		CKSYF473Z50
	Q6103, Q6214		2SC2714	RESISTORS			
	Q6201		2SK208		VR6201 (10kΩ)		ACP1043
	Q6104		2SK302		VR6202		VRTB6VS223
	Q6101		3SK194		R6299, R6300		RD1/8PM102J
	Q6204		XDA124EK		R6113, R6116, R6118, R6268 - R6271		RS1/8S000J
	Q6217		XDC124EK		R6275, R6276, R6278, R6283, R6284		RS1/8S000J
	D6101, D6102		1T33		R6290, R6293, R6294, R6297		RS1/8S000J
COILS AND FILTERS					R6243, R6244		RS1/8S101J
	L6104		ATC1003		R6211		RS1/8S103J
	L6101		ATC1020		R6237		RS1/8S182J
	L6102		ATC1021		R6209		RS1/8S221J
	T6101		ATE - 063		R6239		RS1/8S332J
	L6207 (10.7MHZ)		ATE1013		R6101		RS1/8S470J
	F6204 (SFE10.7MA8)		ATF - 107	OTHERS			
	F6203 (SFE10.7MS3G)		ATF - 119		BN6201 TERMINAL 4 - P		AKA1016
	F6101		ATF - 155		X6203 CRYSTAL RESONATOR		ASS1042
	F6202 (450KHZ)		ATF1145		X6201 CRYSTAL RESONATOR		ASS1066
	L6103		ATH1043		X6202 CERAMIC RESONATOR		ATF1027
	L6202, L6203, L6208		LCTA2R2J3225		AM RF TUNING BLOCK		AXX1041
CAPACITORS				FRONT ASSY FOR 100W			
	C6202, C6234, C6236 (1μ/16V)		ACG1051	SEMICONDUCTORS			
	C6235 (0.47/25V)		ACG1052		IC7501		UPC4570G2
	C6107		CCSCH010C50		IC7701, IC7702		XRA4558F - P
	C6229		CCSCH821J50		Q7507, Q7508		2SA1182
	C6110		CCSQCH020C50		Q7601		2SA1255
	C6101		CCSQCH050C50		Q7501, Q7502		2SC2240
	C6108, C6203, C6268		CCSQCH101J50		Q7605, Q7606, Q7703		2SC2712
	C6111, C6116, C6208, C6221, C6222		CCSQCH150J50		Q7505, Q7506		2SC2859
	C6115		CCSQCH330J50		Q7603		2SC3138
	C6114		CCSQRH080D50		Q7704		XDC143EK
	C6113		CCSQRH180J50		D7505, D7506, D7517, D7518		1SS181
	C6105		CCSQTH150J50		D7503, D7504, D7516		1SS184
	C6261		CEAS010M50		D7521 - D7524		1SS244
	C6224, C6231, C6233, C6246, C6262		CEAS100M50		D7519, D7520, D7525, D7526, D7531		HSS104 - 02
	C6216, C6217		CEAS330M16		D7533, D7701 - D7704, D7707		HSS104 - 02
	C6219		CEAS470M10		D7710 - D7713		HSS104 - 02
	C6243 - C6245		CEAS470M16		D7507 - D7510		RD3.3ESB2
	C6227		CEAS470M25	CAPACITORS			
	C6238		CEJA100M16		C7703 (1/16V)		ACG1051
	C6249, C6250		CEJA4R7M35		C7523, C7524 (10/35V)		ACH1150
	C6215		CFTXA103J50		C7509, C7510 (47/16V)		ACH1151
	C6214		CFTXA224J50		C7539, C7540 (22/16V)		ACH1248
	C6103, C6106, C6112, C6204		CKSQYB102K50		C7519 - C7522, C7545 - C7552		CCSQCH101J50
	C6102, C6109, C6117, C6210, C6264		CKSQYB103K50		C7525 - C7528		CCSQCH271J50
	C6213		CKSQYB223K50		C7503, C7504		CCSQCH331J50
	C6230		CKSQYB333K50		C7541, C7542		CCSQCH470J50
	C6228, C6252		CKSQYB472K50		C7529 - C7532		CKSQYB333K50
	C6209, C6237, C6265, C6267		CKSQYB473K50		C7543, C7544		CKSQYB472K50
	C6212, C6218		CKSQYF103Z50		C7602		CKSQYF103Z50
	C6220, C6226, C6239, C6242, C6255		CKSQYF223Z50		C7601, C7603, C7702		CKSQYF104Z50
					C7537		CKSQYF473Z50

**XR-P740M, XR-P640M, XR-P340M
XR-P740, XR-P640, XR-P340**

Mark	No.	Description	Parts No.
RESISTORS			
	VR7701 (1kΩ)		ACPI076
	R7519, R7520 (630kΩ)		ACN1106
	R7515, R7516 (1.8kΩ)		ACN1107
	R7541, R7542		RD1/4PMF100J
	R7547-R7550		RS1/10S2200F
	R7709		RS1/10S39R0F
	R7710		RS1/10S56R0F
	R7708		RS1/10S7500F
	R7753		RS1/8S000J
	R7537-R7540		RS1/8S100J
	R7551, R7552		RD1/8PM333J
	R7553		RS1/8S101J
	R7543, R7544		RS1/8S7R5J
	Other Resistors		RS1/10S□□□J

REAR, PWR, PRTEC ASSY

SEMICONDUCTORS

IC7101	UPC4570G2
Q7107, Q7108, Q7208, Q7215, Q7219	2SA1162
Q7213	2SA1182
Q7109, Q7110	2SB1115
Q7301, Q7302	2SC1815
Q7101, Q7102	2SC2240
Q7105, Q7106, Q7205-Q7207, Q7209	2SC2712
Q7212, Q7214, Q7218, Q7220, Q7221	2SC2712
Q7216	2SC2859
Q7211, Q7217	2SC3138
Q7103, Q7104	2SD1615
Q7210, Q7222	XDA124EK
D7113, D7114	1SS181
D7111, D7112	1SS184
D7103-D7106, D7201, D7205	HSS104-02
D7204, D7206	HZS6C3L
D7203	HZS9A2L
D7107-D7110	RD2.2ESB2

CAPACITORS

C7402, C7406, C7408 (0.082/25V)	ACG1050
C7401, C7405, C7407 (0.33/50V)	ACG1053
C7123, C7124, C7212 (1/50V)	ACH1056
C7409 (10/35V)	ACH1150
C7109, C7110, C7205, C7207, C7208 (47/16V)	ACH1151
C7140, C7141	ACH1248
C7119-C7122	CCSQCH101J50
C7133-C7136	CCSQCH221J50
C7125-C7128	CCSQCH271J50
C7103, C7104	CCSQCH331J50
C7142, C7143	CCSQCH470J50
C7301	CKSQYB332K50
C7129-C7132	CKSQYB333K50
C7213, C7214	CKSQYF103Z50
C7206, C7404	CKSQYF104Z50
C7137, C7138	CKSQYF472Z50
C7139	CKSQYF473Z50

RESISTORS

R7403, R7404 (1.0Ω)	ACN1104
R7119, R7120	ACN1105
R7115, R7116 (1.8kΩ)	ACN1107

Mark	No.	Description	Parts No.
	R7137-R7140		RS1/10S0100F
	R7303		RS1/10S1002F
	R7151, R7152		RS1/10S333J
	R7147-R7150		RS1/10S2200F
	R7304		RS1/10S8200F
	R7141-R7144		RS1/8S100J
	R7153		RS1/8S101J
	Other Resistors		RS1/10S□□□J

OTHERS

CN7101 CONNECTOR (12P)	KPE12
------------------------	-------

OTHER ELECTRICAL PARTS

FRONT ASSY FOR 100W

SEMICONDUCTORS

IC7404	MC7805CT
IC7401, IC7403	MC7812CT
IC7402	NJM7912A
△ Q7111, Q7112	2SB1274
△ Q7113, Q7114	2SD1913

REAR, PWR, PRTEC ASSY

SEMICONDUCTORS

△ Q7511, Q7512	2SA1264N
Q7509, Q7510	2SA1837
△ Q7513, Q7514	2SC3181N
Q7503, Q7504	2SC4793

OTHERS

POWER MOD. PCB	ANP1708
FAN MOTOR	AXM1019

DECK UNIT

SEMICONDUCTORS

IC4431	CXA1330S
IC4901	M66320FP
IC4202	MC14066BF
IC4101, IC4151, IC4301	NJM4558M-D
Q4111, Q4113, Q4161, Q4352	2SA1515
Q4356	2SC2240
Q4101, Q4102, Q4151, Q4152,	2SC2458
Q4203-Q4206, Q4301, Q4302, Q4305,	
Q4306, Q4451-Q4454	
Q4355	2SC2712
Q4353, Q4354	2SC3377
Q4307, Q4308	2SK373
Q4303, Q4432, Q4901	XDA124ES
Q4208	XDA143ES
Q4112, Q4114, Q4155, Q4162, Q4357,	XDC124ES
Q4431, Q4433, Q4434	
Q4207, Q4351	XDC143ES
D4111, D4161, D4201, D4202,	HSS104-02
D4301-D4306, D4451, D4452,	
D4901-D4906	

COILS AND FILTERS

F4431, F4432	ATF1064
T4351	ATX-043
L4301, L4302	LTA272J
L4303, L4304	LTA822J

**XR-P740M, XR-P640M, XR-P340M
XR-P740, XR-P640, XR-P340**

Mark	No.	Description	Parts No.	Mark	No.	Description	Parts No.
CAPACITORS							
	C4361 (2000p/630V)		ACE1020		C4358		CQMA123K250
	C4319, C4320		CCDSL271K500		C4356		CQMA153J50
	C4323, C4324		CCSQCH100D50		C4433 - C4436		CQMA222J50
	C4902		CCSQCH101J50		C4362		CQMA562K400
	C4353		CCSQCH221J50		C4105, C4106, C4155, C4156		CQMA682J50
	C4109, C4110, C4159, C4160		CCSQCH471J50		C4311, C4312		CQMA823J50
	C4151, C4152		CCSQCH561J50		C4998, C4999		CQMA104J50
	C4101, C4102, C4321, C4322, C4355		CCSQCH681J50	RESISTORS			
	C4303, C4304, C4451, C4452		CEAS010M50		VR4111		VRTP6HS103
	C4359, C4360, C4364, C4403, C4404, C4443 - C4446, C4454		CEAS100M50		VR4201 - VR4204		VRTP6HS203
	C4365, C4366, C4453		CEAS220M16		VR4351, VR4352		VRTP6HS204
	C4301, C4302, C4315, C4316		CEAS2R2M50		VR4301, VR4302		VRTP6HS502
	C4103, C4104, C4153, C4154, C4309, C4310, C4317, C4318		CEAS330M16		R4353		RD1/2PM560J
	C4357		CEAS3R3M50		R4444		RD1/8PM103J
	C4107, C4108, C4157, C4158		CEAS470M10		R4121		RD1/8PM153J
	C4351		CEAS470M16		R4361, R4362		RD1/8PM333J
	C4207, C4208		CEAS4R7M50		R4401, R4402		RD1/8PM473J
	C4437, C4438		CEASR22M50		R4357		RD1/8PM6R8J
	C4439 - C4442		CEASR33M50		R4113, R4114, R4163, R4164, R4323, R4324		RD1/8PM820J
	C4363		CKCYB222K500		Other Resistors		RS1/10S□□□J
	C4352, C4354		CKSQYB103K50	OTHERS			
	C4313, C4314		CKSQYB222K50		CN24 3P SOCKET		EKS1018
	C4307, C4308		CKSQYB273K50		CN25 5P SOCKET		EKS1019
	C4305, C4306		CKSQYB473K50		CN16 12P JUMPER CONNECTOR		KPE12
	C4901		CKSQYF473Z50		CN3002 13P JUMPER CONNECTOR		KPE13

**(1) - 3. FOR XR - P740M/YPW, XR - P740/SD, XR - P640M/SD, YPW AND XR - P640/SD
AF CD ASSY**

AWZ7281, AWZ7091, AWZ7089 and AWZ7095 have the same construction except for the following :

Mark	Symbol & Description	Part No.				Remarks
		AWZ7095	AWZ7281	AWZ7091	AWZ7089	
	IC2203	NJM4558M - D	NJM4558M - D	
	D1010	HZS7BL	RD7.5ESB	HZS7BL	HZS7BL	
	R2217, R2218, R3469, R3470	RS1/10S472J	RS1/10S472J	
	R2219, R2220	RS1/10S104J	RS1/10S104J	
	R3411, R3412	RS1/10S911J	RS1/10S911J	
	R5003, R5009	RS1/10S223J	RS1/10S223J	
	R5011, R5012	RS1/10S000J	RS1/10S000J	
	CN8203	4 - 173981 - 4	4 - 173981 - 4	
	CN8203	VKN1052	VKN1052	
	CN8204	52147 - 0610	52147 - 0610	
	PCB binder	VEF1008	VEF1008	

**XR-P740M, XR-P640M, XR-P340M
XR-P740, XR-P640, XR-P340**

VR ASSY

AWZ7099 and AWZ7282 have the same construction except for the following :

Mark	Symbol & Description	Part No.		Remarks
		AWZ7282	AWZ7099	
	C1501, C1502	CEYA2R2M50	CEAS2R2M50	
	VR301	ACX1088	ACX1092	

CD DECK SW ASSY

AWZ7124 and AWZ7125 have the same construction except for the following :

Mark	Symbol & Description	Part No.		Remarks
		AWZ7125	AWZ7124	
	Q1701-Q1706	2SA1048	
	D1709-D1714	AEL1132	
	S1828, S1830-S1835	ASG1034	
	S1836	ASG1034	
	R1705-R1710, R1729-R1734	RS1/10S301J	
	R1711-R1716	RS1/10S273J	
	R1717-R1722	RS1/10S272J	

TRANS PRIMARY ASSY

AWZ7127 and AWZ7130 have the same construction except for the following :

Mark	Symbol & Description	Part No.		Remarks
		AWZ7130	AWZ7127	
	L1101	ATF-151	
	C1102 (0.01/400)	ACG1003	

DISPLAY ASSY

AWZ7214, AWZ7118, AWZ7116 and AWZ7215 have the same construction except for the following :

Mark	Symbol & Description	Part No.				Remarks
		AWZ7215	AWZ7214	AWZ7118	AWZ7116	
	IC1901	PD4493A	PD4492A	PD4493A	PD4492A	
	R1723-R1728	RS1/10S562J	RS1/10S562J	

ADDON DISPLAY ASSY

AWZ7139 and AWZ7141 have the same construction except for the following :

Mark	Symbol & Description	Part No.		Remarks
		AWZ7141	AWZ7139	
	R3968	RS1/10S473J	
	R3969	RS1/10S473J	
	R4030-R4034	RD1/8PM102J	

DOL SURR ASSY

Mark	No.	Description	Parts No.	Mark	No.	Description	Parts No.
SEMICONDUCTORS				RESISTORS			
	IC3404		LA2730		VR3401		ACP1044
	IC3403		M50198P		R3451		RD1/2PM271J
	IC3405		MC14066BF		R3422		RD1/4PM390J
	IC3401, IC3402, IC3407		NJM4558M-D		R3440		RD1/8PM102J
	IC3406		TC9154AP		R3452-R3454		RD1/8PM222J
	Q3402		2SC1740S		Other Resistors		RS1/10S□□□J
	Q3405		2SC2458	OTHERS			
	Q3404		RN1201		PIN JACK (2P)		AKB1164
	Q3403		RN2201		X3401 CERAMIC OSCILLATOR		ASS1016
	Q3401		RN2203				
	D3410		1SS226				
	D3401-D3404, D3406-D3408		HSS104-02				
	D3409		RD5.1ESB				
COILS AND FILTERS							
	L3401		LAU5R6K				
CAPACITORS							
	C3414		CEANP100M35				
	C3421		CEAS010M50				
	C3404, C3417, C3424, C3427, C3431		CEAS100M50				
	C3426		CEAS101M10				
	C3425		CEAS220M16				
	C3401, C3402, C3430, C3432		CEAS2R2M50				
	C3434-C3436		CEAS2R2M50				
	C3405, C3409		CEAS470M16				
	C3418		CEAS470M25				
	C3419		CEASR33M50				
	C3416		CFTYA103J50				
	C3408, C3413, C3420		CFTYA104J50				
	C3422, C3429		CFTYA333J50				
	C3410, C3411		CFTYA474J50				
	C3437		CKSQYB471K50				
	C3440, C3441		CKSQYF104Z50				
	C3403, C3442		CKSQYF473Z50				
	C3423		CQMA153J50				
	C3428		CQMA472J50				
	C3407, C3415		CQMA561J50				
	C3406, C3412		CQMA562J50				

XR-P740M, XR-P640M, XR-P340M
XR-P740, XR-P640, XR-P340

(2) FOR XR-P340M AND XR-P340
(2)-1. LIST OF WHOLE PCB ASSEMBLIES

Mark	Symbol & Description	Part No.						Remarks
		XR-P340M				XR-P340		
		KU	KC	SD	YPW	SD	YPW	
	MAIN assy	AWK7034	AWK7034	AWK7082	AWK7082	AWK7081	AWK7081	
	└ AF CD assy	AWZ7088	AWZ7088	AWZ7287	AWZ7287	AWZ7286	AWZ7286	
	└ H. P assy	AWZ7103	AWZ7103	AWZ7103	AWZ7103	AWZ7103	AWZ7103	
	└ SECONDRY TRANS assy	AWZ7107	AWZ7107	AWZ7107	AWZ7107	AWZ7107	AWZ7107	
	└ VR assy	AWZ7270	AWZ7270	AWZ7280	AWZ7280	AWZ7280	AWZ7280	
	COMPLEX assy	AWM7027	AWM7027	AWM7028	AWM7029	AWM7020	AWM7021	
	└ CD DECK SW assy	AWZ7125	AWZ7125	AWZ7125	AWZ7125	AWZ7124	AWZ7124	
	└ TRANS PRIMARY assy	AWZ7131	AWZ7131	AWZ7130	AWZ7127	AWZ7130	AWZ7127	
	└ DISPLAY assy	AWZ7113	AWZ7113	AWZ7114	AWZ7114	AWZ7110	AWZ7110	
	MULTI MECHA assy	AXA7006	AXA7006	AXA7006	AXA7006	
NSP	└ LOADING BOARD assy	AWZ7207	AWZ7207	AWZ7207	AWZ7207	
NSP	└ MOTOR BOARD assy	AWZ7208	AWZ7208	AWZ7208	AWZ7208	
NSP	└ SELECT BOARD assy	AWZ7209	AWZ7209	AWZ7209	AWZ7209	
NSP	└ MECHANISM BOARD assy	PWX1192	PWX1192	PWX1192	PWX1192	
	SINGLE MECHA assy	AXA7004	AXA7004	
NSP	└ MECHANISM BOARD assy	PWX1192	PWX1192	
	FM/AM TUNER MODULE	AXQ1012	AXQ1012	AXQ1012	AXQ1012	AXQ1012	AXQ1012	
	POWER MOD. F50	AXQ1018	AXQ1018	AXQ1018	AXQ1018	AXQ1018	AXQ1018	
	└ FRONT ASSY FOR 50W	AWZ5390	AWZ5390	AWZ5390	AWZ5390	AWZ5390	AWZ5390	
	└ REAR, PRTEC ASSY	AWZ5392	AWZ5392	AWZ5392	AWZ5392	AWZ5392	AWZ5392	
	CASSETTE MECHA MOD. B	EXK2430	EXK2410	EXK2410	EXK2410	EXK2410	EXK2410	
	└ DECK unit	EWM1001	EWM1001	EWM1001	EWM1001	EWM1001	EWM1001	

(2)-2. FOR XR-P340M/KU

Mark	No.	Description	Parts No.	Mark	No.	Description	Parts No.
		AF CD ASSY					
		SEMICONDUCTORS					
		IC8151	CXA1372Q			Q1051, Q1053	2SA1048
		IC8301	CXD2517Q			Q1002, Q1006, Q1040	2SA1515
		IC1001	ICP-N70			Q1005, Q106	2SB560
		IC8201, IC8202 LA6520				Q1052, Q1403, Q9001, Q9002	2SC2458
		IC2104	M66311FP				
		IC2101	MC14052BF			Q1003	2SC3377
		IC2201, IC2202, IC3301, IC3501, IC3601	NJM4558M-D			Q105	2SD438
		IC8405	NJM4558M-D			Q8401	2SK246
		IC8402	TC7S04F			Q1001, Q1007, Q1041	RN1201
		IC2102	TC9162N			Q1004, Q9004	RN2201
		IC8401	TC9268F			Q8402	RN2203
						D1001	D3SBA20 (A)
						D1021, D1022, D1027, D1031	HSS104-02
						D1153, D1154, D6901, D8301, D8401	HSS104-02
						D9001	HSS104-02

**XR-P740M, XR-P640M, XR-P340M
XR-P740, XR-P640, XR-P340**

Mark	No.	Description	Parts No.	Mark	No.	Description	Parts No.
	D2201, D8211 D1010 D1002 D1023 D1151, D1152		HZS6CL HZS7BL RB152 RD30ESB4 RD5.1ESB		R1019 R1301, R1302		RD1/4PM511J RD1/4PMF6R8J
	D1011, D1012 D1007, D1008, D1013-D1020 D1024, D1025, D1041-D1043		RD5.6ESB2 S5688G S5688G		R1031, R2101, R2102, R2105-R2107 R2111-R2113, R2117, R2129, R9007 R1040, R1063, R1154, R1158 R8368 R1032		RD1/8PM102J RD1/8PM102J RD1/8PM103J RD1/8PM105J RD1/8PM152J
CAPACITORS					R1051 R3502 R1052 R1151, R2136 R2114		RD1/8PM331J RD1/8PM433J RD1/8PM471J RD1/8PM472J RD1/8PM473J
	C1009 (0.01/150V) C1001, C1002 (5600/56V) C2255, C8173, C8174 C8403, C8404 C3303, C3304		ACG1005 ACH1211 CCSQCH101J50 CCSQCH150J50 CCSQCH220J50		R1013 R1026 R2121, R2122 R1007, R1017 Other Resistors		RD1/8PM562J RD1/8PM823J RD1/8PM912J RS2LMFR22J RS1/10S□□□J
	C2204 C8435-C8438 C8429, C8430 C8433, C8434 C1019		CCSQCH331J50 CCSQCH390J50 CCSQCH560J50 CEANP2R2M50 CEAS010M50				
	C1016 C1011, C1012 C1018 C1007, C1225 C1017		CEAS101M10 CEAS101M16 CEAS101M63 CEAS220M50 CEAS221M35	OTHERS	CN8131 CONNECTOR CN8204 6P JUMPER CONNECTOR CN2102 PIN JACK 2P (SP OUT) CN2101 PIN JACK 2P (VIDEO/AUX) SPEAKER TERMINAL 4-P		12FMZ-ABT 52147-0610 AKB1146 AKB1171 AKE1026
	C1004 C8216, C8217, C8302 C8175, C8176 C1003 C1224		CEAS222M35 CEAS330M16 CEAS331M16 CEAS332M35 CEAS3R3M50		CN1 36P SOCKET CN10 JUMPER CONNECTOR X8401 XTAL RES (OSC) PCB BINDER CN8202 CONNECTER CN8203 CONNECTOR 4P		AKP1105 KPC6 PSS1008 VEF1008 VKN1051 4-173981-4
	C1013, C1014 C2251, C2252 C3301, C3302, C3501, C8160, C8162 C2503, C2504 C3502, C3601, C8309		CEAS470M16 CEAS470M50 CEAS4R7M50 CEASR15M50 CEASR47M50	H. P ASSY			
	C8164, C8167, C8169, C8212 C8306, C8441, C8442 C3309, C3310, C8155 C3503 C3305, C3306		CKSQYB103K50 CKSQYB152K50 CKSQYB182K50 CKSQYB223K50 CKSQYB273K50	RESISTORS	R1201, R1202 Other Resistors		RS2LMF331J RS1/10S□□□J
	C3307, C3308, C8170 C8156, C8168 C2201-C2203 C8171, C8172 C8307		CKSQYB332K50 CKSQYB333K50 CKSQYB471K50 CKSQYB472K50 CKSQYB473K50	OTHERS			AKN1029
	C3311, C3312, C8157, C8202, C8203 C8205-C8207 C1301-C1304, C2253, C2257 C8158, C8159, C8161, C8163, C8301 C8304, C8308, C8361, C8414, C8415		CKSQYF103Z50 CKSQYF103Z50 CKSQYF104Z50 CKSQYF104Z50 CKSQYF104Z50	SECONDRY TRANS ASSY			ICP-N70
	C8431, C8432, C8461, C8462		CKSQYF104Z50	SEMICONDUCTORS	IC1006-IC1009		
RESISTORS	VR8151, VR8152 (22kΩ) R2125 R1159, R1160 R1064, R1153, R1157 R1041		ACP1057 RA11T103J RD1/2PM151J RD1/4PM102J RD1/4PM222J	VR ASSY			
	R1002 R1020 R1003		RD1/4PM272J RD1/4PM432J RD1/4PM472J	SEMICONDUCTORS	IC1501 IC1551		NJM4558M-D TA8409S
				CAPACITORS	C1554 C1501-C1504 C1557, C1558 C1509, C1510, C1555, C1556 C1551-C1553		CEAS101M16 CEAS2R2M50 CKSQYB273K50 CKSQYB473K50 CKSQYF104Z50
				RESISTORS	VR301 (100K-3B*2) Other Resistors		ACX1089 RS1/10S□□□J

**XR-P740M, XR-P640M, XR-P340M
XR-P740, XR-P640, XR-P340**

Mark	No.	Description	Parts No.
DISPLAY ASSY			
SEMICONDUCTORS			
	IC1951		M66311FP
	IC2501, IC3701-IC3703		NJM4558M-D
	IC1901		PD4493A
	Q1901		2SC2458
	Q1902		RN1201
	Q1707		RN2201
	D1701-D1705		AEL1118
	D1801-D1815, D1819, D1820, D1901		HSS104-02
	D1903, D1905, D1906, D3701-D3705		HSS104-02
	D1951, D1953		HZS6CL
	D1904		HZS7AL
COILS AND FILTERS			
	L1901		LAU220J
SWITCHES			
	S1801-S1815		ASG1034
	S1901		ASX1021
CAPACITORS			
	C1903		ACH1246
	C1952		CCSQCH101J50
	C2504		CCSQCH221J50
	C1907		CEJA010M50
	C1910, C2503, C2505		CEJA100M50
	C1905		CEJA221M10
	C1902		CEJA470M16
	C2502		CEJA4R7M50
	C1908		CFTYA224J50
	C1915, C1916		CKSQYB102K50
	C1954		CKSQYB103K50
	C2501		CKSQYB122K50
	C3710, C3711		CKSQYB152K50
	C3704, C3705		CKSQYB153K50
	C3713, C3714		CKSQYB471K50
	C3707, C3708		CKSQYB472K50
	C2507, C3701, C3702		CKSQYB473K50
	C2506		CKSQYB682K50
	C1909		CKSQYF102Z50
	C1955		CKSQYF103Z50
	C1901, C1904, C1906, C1911-C1914		CKSQYF473Z50
	C2508, C2509, C3703, C3706, C3709		CKSQYF473Z50
	C3712, C3715		CKSQYF473Z50
RESISTORS			
	VR2501 (10K-B)		ACS1104
	R1701		RD1/8PM181J
	R1801-R1804		RD1/8PM223J
	R1941		RD1/8PM472J
	R1919		RD1/8PM473J
	R1935, R1938, R1939		RD1/8PM561J
	Other Resistors		RS1/10S□□□J
OTHERS			
	V1701 FL TUBE		AAV7002
	JACK		AKN1030
	CN1001 36P SOCKET		AKP1105
	X1901 CERAMIC RESONATOR		ASS1018
	REMOTE RECEIVER UNIT		AXX1023

Mark	No.	Description	Parts No.
CD DECK SW ASSY			
CD DECK SW assy of XR-P340M/KU is the same as that of XR-P740M/SD.			
Refer to "(1)-2. FOR XR-P740M/SD".			
TRANS PRIMARY ASSY			
CAPACITORS			
	C1102 (0.01/400)		ACG1003
RESISTORS			
	R1101 (2.2M, 1/2W)		ACN-208
	Other Resistors		RS1/10S□□□J
LOADING BOARD ASSY			
LOADING BOARD assy of XR-P340M/KU is the same as that of XR-P740M/SD.			
Refer to "(1)-2. FOR XR-P740M/SD".			
MOTOR BOARD ASSY			
MOTOR BOARD assy of XR-P340M/KU is the same as that of XR-P740M/SD.			
Refer to "(1)-2. FOR XR-P740M/SD".			
SELECT BOARD ASSY			
SELECT BOARD assy of XR-P340M/KU is the same as that of XR-P740M/SD.			
Refer to "(1)-2. FOR XR-P740M/SD".			
MECHANISM BOARD ASSY			
MECHANISM BOARD assy of XR-P340M/KU is the same as that of XR-P740M/SD.			
Refer to "(1)-2. FOR XR-P740M/SD".			
FM/AM TUNER MODULE			
FM/AM TUNER MODULE of XR-P340M/KU is the same as that of XR-P740M/SD.			
Refer to "(1)-2. FOR XR-P740M/SD".			
FRONT ASSY FOR 50W			
SEMICONDUCTORS			
	IC7501		UPC4570G2
	IC7701, IC7702 XRA4558F-P		
	Q7507, Q7508		2SA1182
	Q7601		2SA1255
	Q7517, Q7518		2SB1115
	Q7501, Q7502		2SC2240
	Q7605, Q7606, Q7703		2SC2712
	Q7505, Q7506		2SC2859
	Q7603		2SC3138
	Q7515, Q7516		2SD1615
	Q7704		XDC143EK
	D7505, D7506, D7517, D7518		1SS181
	D7503, D7504, D7516		1SS184
	D7521-D7524		1SS244
	D7519, D7520, D7525, D7526, D7531		HSS104-02

Mark	No.	Description	Parts No.	Mark	No.	Description	Parts No.
	D2201, D8211 D1010 D1002 D1023 D1151, D1152		HZS6CL HZS7BL RB152 RD30ESB4 RD5.1ESB		R1019 R1301, R1302		RD1/4PM511J RD1/4PMF6R8J
	D1011, D1012 D1007, D1008, D1013-D1020 D1024, D1025, D1041-D1043		RD5.6ESB2 S5688G S5688G		R1031, R2101, R2102, R2105-R2107 R2111-R2113, R2117, R2129, R9007 R1040, R1063, R1154, R1158 R8368 R1032		RD1/8PM102J RD1/8PM102J RD1/8PM103J RD1/8PM105J RD1/8PM152J
CAPACITORS					R1051 R3502 R1052 R1151, R2136 R2114		RD1/8PM331J RD1/8PM433J RD1/8PM471J RD1/8PM472J RD1/8PM473J
	C1009 (0.01/150V) C1001, C1002 (5600/56V) C2255, C8173, C8174 C8403, C8404 C3303, C3304		ACG1005 ACH1211 CCSQCH101J50 CCSQCH150J50 CCSQCH220J50		R1013 R1026 R2121, R2122 R1007, R1017 Other Resistors		RD1/8PM562J RD1/8PM823J RD1/8PM912J RS2LMFR22J RS1/10S□□□J
	C2204 C8435-C8438 C8429, C8430 C8433, C8434 C1019		CCSQCH331J50 CCSQCH390J50 CCSQCH560J50 CEANP2R2M50 CEAS010M50	OTHERS			
	C1016 C1011, C1012 C1018 C1007, C1225 C1017		CEAS101M10 CEAS101M16 CEAS101M63 CEAS220M50 CEAS221M35		CN8131 CONNECTOR CN8204 6P JUMPER CONNECTOR CN2102 PIN JACK 2P (SP OUT) CN2101 PIN JACK 2P (VIDEO/AUX) SPEAKER TERMINAL 4-P		12FMZ-ABT 52147-0610 AKB1146 AKB1171 AKE1026
	C1004 C8216, C8217, C8302 C8175, C8176 C1003 C1224		CEAS222M35 CEAS330M16 CEAS331M16 CEAS332M35 CEAS3R3M50		CN1 36P SOCKET CN10 JUMPER CONNECTOR X8401 XTAL RES (OSC) PCB BINDER CN8202 CONNECTER CN8203 CONNECTOR 4P		AKP1105 KPC6 PSS1008 VEF1008 VKN1051 4-173981-4
	C1013, C1014 C2251, C2252 C3301, C3302, C3501, C8160, C8162 C2503, C2504 C3502, C3601, C8309		CEAS470M16 CEAS470M50 CEAS4R7M50 CEASR15M50 CEASR47M50	H. P ASSY			
	C8164, C8167, C8169, C8212 C8306, C8441, C8442 C3309, C3310, C8155 C3503 C3305, C3306		CKSQYB103K50 CKSQYB152K50 CKSQYB182K50 CKSQYB223K50 CKSQYB273K50	RESISTORS			
	C3307, C3308, C8170 C8156, C8168 C2201-C2203 C8171, C8172 C8307		CKSQYB332K50 CKSQYB333K50 CKSQYB471K50 CKSQYB472K50 CKSQYB473K50		R1201, R1202 Other Resistors		RS2LMF331J RS1/10S□□□J
	C3311, C3312, C8157, C8202, C8203 C8205-C8207 C1301-C1304, C2253, C2257 C8158, C8159, C8161, C8163, C8301 C8304, C8308, C8361, C8414, C8415		CKSQYF103Z50 CKSQYF103Z50 CKSQYF104Z50 CKSQYF104Z50 CKSQYF104Z50	OTHERS			
	C8431, C8432, C8461, C8462		CKSQYF104Z50		CN1201 JACK		AKN1029
RESISTORS				SECONDRY TRANS ASSY			
	VR8151, VR8152 (22kΩ) R2125 R1159, R1160 R1064, R1153, R1157 R1041		ACP1057 RA11T103J RD1/2PM151J RD1/4PM102J RD1/4PM222J	SEMICONDUCTORS			
	R1002 R1020 R1003		RD1/4PM272J RD1/4PM432J RD1/4PM472J	IC1006-IC1009			
				VR ASSY			
				SEMICONDUCTORS			
				IC1501 IC1551			
				CAPACITORS			
				C1554 C1501-C1504 C1557, C1558 C1509, C1510, C1555, C1556 C1551-C1553			
				CEAS101M16 CEAS2R2M50 CKSQYB273K50 CKSQYB473K50 CKSQYF104Z50			
				RESISTORS			
				VR301 (100K-3B*2) Other Resistors			
				ACX1089 RS1/10S□□□J			

**XR-P740M, XR-P640M, XR-P340M
XR-P740, XR-P640, XR-P340**

Mark	No.	Description	Parts No.
DISPLAY ASSY			
SEMICONDUCTORS			
	IC1951		M66311FP
	IC2501, IC3701-IC3703		NJM4558M-D
	IC1901		PD4493A
	Q1901		2SC2458
	Q1902		RN1201
	Q1707		RN2201
	D1701-D1705		AEL1118
	D1801-D1815, D1819, D1820, D1901		HSS104-02
	D1903, D1905, D1906, D3701-D3705		HSS104-02
	D1951, D1953		HZS6CL
	D1904		HZS7AL
COILS AND FILTERS			
	L1901		LAU220J
SWITCHES			
	S1801-S1815		ASG1034
	S1901		ASX1021
CAPACITORS			
	C1903		ACH1246
	C1952		CCSQCH101J50
	C2504		CCSQCH221J50
	C1907		CEJA010M50
	C1910, C2503, C2505		CEJA100M50
	C1905		CEJA221M10
	C1902		CEJA470M16
	C2502		CEJA4R7M50
	C1908		CFTYA224J50
	C1915, C1916		CKSQYB102K50
	C1954		CKSQYB103K50
	C2501		CKSQYB122K50
	C3710, C3711		CKSQYB152K50
	C3704, C3705		CKSQYB153K50
	C3713, C3714		CKSQYB471K50
	C3707, C3708		CKSQYB472K50
	C2507, C3701, C3702		CKSQYB473K50
	C2506		CKSQYB682K50
	C1909		CKSQYF102Z50
	C1955		CKSQYF103Z50
	C1901, C1904, C1906, C1911-C1914		CKSQYF473Z50
	C2508, C2509, C3703, C3706, C3709		CKSQYF473Z50
	C3712, C3715		CKSQYF473Z50
RESISTORS			
	VR2501 (10K-B)		ACS1104
	R1701		RD1/8PM181J
	R1801-R1804		RD1/8PM223J
	R1941		RD1/8PM472J
	R1919		RD1/8PM473J
	R1935, R1938, R1939		RD1/8PM561J
	Other Resistors		RS1/10S□□□□
OTHERS			
	V1701 FL TUBE		AAV7002
	JACK		AKN1030
	CN1001 36P SOCKET		AKP1105
	X1901 CERAMIC RESONATOR		ASS1018
	REMOTE RECEIVER UNIT		AXX1023

Mark	No.	Description	Parts No.
CD DECK SW ASSY			
CD DECK SW assy of XR-P340M/KU is the same as that of XR-P740M/SD.			
Refer to "(1)-2. FOR XR-P740M/SD".			
TRANS PRIMARY ASSY			
CAPACITORS			
	C1102 (0.01/400)		ACG1003
RESISTORS			
	R1101 (2.2M, 1/2W)		ACN-208
	Other Resistors		RS1/10S□□□□
LOADING BOARD ASSY			
LOADING BOARD assy of XR-P340M/KU is the same as that of XR-P740M/SD.			
Refer to "(1)-2. FOR XR-P740M/SD".			
MOTOR BOARD ASSY			
MOTOR BOARD assy of XR-P340M/KU is the same as that of XR-P740M/SD.			
Refer to "(1)-2. FOR XR-P740M/SD".			
SELECT BOARD ASSY			
SELECT BOARD assy of XR-P340M/KU is the same as that of XR-P740M/SD.			
Refer to "(1)-2. FOR XR-P740M/SD".			
MECHANISM BOARD ASSY			
MECHANISM BOARD assy of XR-P340M/KU is the same as that of XR-P740M/SD.			
Refer to "(1)-2. FOR XR-P740M/SD".			
FM/AM TUNER MODULE			
FM/AM TUNER MODULE of XR-P340M/KU is the same as that of XR-P740M/SD.			
Refer to "(1)-2. FOR XR-P740M/SD".			
FRONT ASSY FOR 50W			
SEMICONDUCTORS			
	IC7501		UPC4570G2
	IC7701, IC7702 XRA4558F-P		
	Q7507, Q7508		2SA1182
	Q7601		2SA1255
	Q7517, Q7518		2SB1115
	Q7501, Q7502		2SC2240
	Q7605, Q7606, Q7703		2SC2712
	Q7505, Q7506		2SC2859
	Q7603		2SC3138
	Q7515, Q7516		2SD1615
	Q7704		XDC143EK
	D7505, D7506, D7517, D7518		1SS181
	D7503, D7504, D7516		1SS184
	D7521-D7524		1SS244
	D7519, D7520, D7525, D7526, D7531		HSS104-02

**XR-P740M, XR-P640M, XR-P340M
XR-P740, XR-P640, XR-P340**

Mark	No. •	Description	Parts No.	Mark	No.	Description	Parts No.	
	D7533, D7701-D7704, D7707 D7710-D7713 D7507-D7510		HSS104-02 HSS104-02 RD3.3ESB2	RESISTORS				
CAPACITORS					R7403, R7404 (1Ω) R7303 R7304 Other Resistors		ACN1104 RS1/10S1002F RS1/10S8200F RS1/10S□□□□	
	C7703 (1/16V) C7523, C7524 (10/35V) C7509, C7510 (47/16V) C7539, C7540 (22/16V) C7519-C7522, C7545-C7552		ACG1051 ACH1150 ACH1151 ACH1248 CCSQCH101J50	OTHERS				
	C7525-C7528 C7503, C7504 C7541, C7542 C7529-C7532 C7543, C7544		CCSQCH271J50 CCSQCH331J50 CCSQCH470J50 CKSQYB333K50 CKSQYB472K50	OTHER ELECTRICAL PARTS				
	C7602 C7601, C7603, C7702 C7537		CKSQYF103Z50 CKSQYF104Z50 CKSQYF473Z50	FRONT ASSY FOR 50W SEMICONDUCTORS				
RESISTORS					IC7404 IC7401, IC7403 IC7402		MC7805CT MC7812CT NJM7912A	
	VR7701 (1kΩ) R7519, R7520 (630kΩ) R7515, R7516 (1.8kΩ) R7541, R7542 R7547-R7550		ACP1076 ACN1106 ACN1107 RD1/4PMF100J RS1/10S2200F	PWR, PRTEC ASSY SEMICONDUCTORS				
	R7709 R7710 R7708 R7753 R7537-R7540		RS1/10S39R0F RS1/10S56R0F RS1/10S7500F RS1/8S000J RS1/8S100J		Q7511, Q7512 Q7513, Q7514		2SA1264N 2SC3181N	
	R7551, R7552 R7553 R7543, R7544 Other Resistors		RD1/8PM333J RS1/8S101J RS1/8S7R5J RS1/10S□□□□	OTHERS				
PWR, PRTEC ASSY SEMICONDUCTORS					POWER MOD. PCB FAN MOTOR		ANP1708 AXM1019	
	Q7208, Q7215, Q7219 Q7213 Q7301, Q7302 Q7207, Q7209, Q7212, Q7214, Q7218 2SC2712 Q7220, Q7221		2SA1162 2SA1182 2SC1815	DECK UNIT SEMICONDUCTORS				
	Q7216 Q7211, Q7217 Q7210, Q7222 D7201, D7205 D7204, D7206		2SC2712 2SC2859 2SC3138 XDA124EK HSS104-02 HZS6C3L		IC4421 IC4901 IC4202 IC4101, IC4151, IC4301 Q4111, Q4113, Q4161, Q4352		CXA1100P M66320FP MC14066BF NJM4558M-D 2SA1515	
	D7203		HZS9A2L		Q4356 Q4101, Q4102, Q4151, Q4152, Q4203-Q4206, Q4301, Q4302, Q4305, Q4306, Q4451-Q4454 Q4355 Q4353, Q4354		2SC2240 2SC2458	
CAPACITORS					Q4307, Q4308 Q4303, Q4901 Q4208 Q4112, Q4114, Q4155, Q4162, Q4357 Q4207, Q4351		2SC2712 2SC377	
	C7402, C7406, C7408 (0.082/25V) C7401, C7405, C7407 (0.33/50V) C7212 (1/50V) C7409 (10/35V) C7205, C7207, C7208 (47/16V)		ACG1050 ACG1053 ACH1056 ACH1150 ACH1151		D4111, D4161, D4201, D4202, D4301-D4306, D4451, D4452, D4901-D4906		2SK373 XDA124ES XDA143ES XDC124ES XDC143ES	
	C7301 C7213, C7214 C7206, C7404		CKSQYB332K50 CKSQYF103Z50 CKSQYF104Z50	COILS AND FILTERS				
					F4401, F4402 T4351 L4301, L4302 L4303, L4304		HSS104-02	
CAPACITORS					C4361 (2000P/630V) C4319, C4320 C4323, C4324 C4902 C4353		ATF1064 ATX-043 LTA272J LTA822J	

**XR-P740M, XR-P640M, XR-P340M
XR-P740, XR-P640, XR-P340**

Mark	No.	Description	Parts No.	Mark	No.	Description	Parts No.
	C4109, C4110, C4159, C4160 C4151, C4152 C4101, C4102, C4321, C4322, C4355 C4303, C4304, C4451, C4452 C4359, C4360, C4364, C4403 - C4405, C4407, C4454		CCSQCH471J50 CCSQCH561J50 CCSQCH681J50 CEAS010M50 CEAS100M50		C4105, C4106 C4155, C4156 C4311, C4312		CQMA682J50 CQMA682J50 CQMA823J50
	C4401, C4408 C4365, C4366, C4453 C4301, C4302, C4315, C4316 C4103, C4104, C4153, C4154, C4309, C4310, C4317, C4318 C4357		CEAS101M16 CEAS220M16 CEAS2R2M50 CEAS330M16 CEAS3R3M50	RESISTORS	VR4111 VR4201 - VR4204 VR4351, VR4352 VR4301, VR4302 R4353 R4121 R4401, R4402 R4361, R4362 R4357 R4113, R4114, R4163, R4164, R4323, R4324		VRTP6HS103 VRTP6HS203 VRTP6HS204 VRTP6HS502 RD1/2PM560J RD1/8PM153J RD1/8PM242J RD1/8PM333J RD1/8PM6R8J RD1/8PM820J
	C4107, C4108, C4157, C4158 C4351 C4207, C4208 C4402, C4406 C4363		CEAS470M10 CEAS470M16 CEAS4R7M50 CEASR22M50 CKCYB222K500	Other Resistors			RS1/10S□□□J
	C4352, C4354 C4313, C4314 C4307, C4308 C4305, C4306 C4901		CKSQYB103K50 CKSQYB222K50 CKSQYB273K50 CKSQYB473K50 CKSQYF473Z50	OTHERS	CN24 3P SOCKET CN25 5P SOCKET CN16 12P JUMPER CONNECTOR CN3002 13P JUMPER CONNECTOR		EKS1018 EKS1019 KPE12 KPE13
	C4358 C4356 C4362		CQMA123K250 CQMA153J50 CQMA562K400				

(2) - 3. FOR XR - P340M/KC, SD, YPW, XR - P340/SD AND YPW

AF CD ASSY

AWZ7287, AWZ7286 and AWZ7088 have the same construction except for the following :

Mark	Symbol & Description	Part No.			Remarks
		AWZ7088	AWZ7287	AWZ7286	
	D1010 D1032, D1033 D2201, D8211 D1996, D1997	HZS7BL HZS6CL	RD7.5ESB HSS104-02 RD6.2ESB S5688G	RD7.5ESB HSS104-02 RD6.2ESB S5688G	
	C1001, C1002 (5600/56) C1001, C1002 (3300/50) C1010 (0.01/150)	ACH1211 ACH1066 ACG1005 ACH1066 ACG1005	
	R1223 R1997 R1998 R1999 R3503	RS1/10S303J RS1/10S272J	RS1/10S333J RD1/8PM100J RS1LMF220J RS3LMF6R8J	RS1/10S333J RD1/8PM100J RS1LMF220J RS3LMF6R8J RS1/10S272J	
	CN8203 CN8203 CN8204 PCB binder	4-173981-4 52147-0610 VEF1008	4-173981-4 52147-0610 VEF1008 VKN1052	

VR ASSY

AWZ7280 and AWZ7270 have the same construction except for the following :

Mark	Symbol & Description	Part No.		Remarks
		AWZ7270	AWZ7280	
	C1501, C1502 C1557, C1558 R1555-R1558	CEAS2R2M50 CKSQYB273K50 RS1/10S823J	CEYA2R2M50 CKSQYB393K50 RS1/10S104J	

CD DECK SW ASSY

CD DECK SW assemblies of XR-P340M and XR-P340 are the same as those of XR-P740M and XR-P740. Refer to "(1)-2. FOR XR-P740M/SD".

TRANS PRIMARY ASSY

AWZ7130, AWZ7127 and AWZ7131 have the same construction except for the following :

Mark	Symbol & Description	Part No.			Remarks
		AWZ7131	AWZ7130	AWZ7127	
	L1101 C1102 (0.01/400) R1101 (2.2M, 1/2W) ACG1003 ACN-208	ATF-151 ACG1003 	

DISPLAY ASSY

AWZ7114, AWZ7110 and AWZ7113 have the same construction except for the following :

Mark	Symbol & Description	Part No.			Remarks
		AWZ7113	AWZ7114	AWZ7110	
	IC1901 D1820 R1723-R1728	PD4493A HSS104-02 RS1/10S562J	PD4493A RS1/10S562J	PD4492A	