

**Pioneer** *sound.vision.soul*

**AUDIO/VIDEO MULTI-CHANNEL  
RECEIVER**

**VSX-C100**

**VSX-C100-S**

Operating Instructions

# IMPORTANT



The lightning flash with arrowhead symbol, within an equilateral triangle, is intended to alert the user to the presence of uninsulated "dangerous voltage" within the product's enclosure that may be of sufficient magnitude to constitute a risk of electric shock to persons.

## CAUTION

**RISK OF ELECTRIC SHOCK  
DO NOT OPEN**

**CAUTION:**  
TO PREVENT THE RISK OF ELECTRIC SHOCK, DO NOT REMOVE COVER (OR BACK). NO USER-SERVICEABLE PARTS INSIDE. REFER SERVICING TO QUALIFIED SERVICE PERSONNEL.



The exclamation point within an equilateral triangle is intended to alert the user to the presence of important operating and maintenance (servicing) instructions in the literature accompanying the appliance. **H002\_En**

**NOTE:** THE NO USER-SERVICEABLE PARTS COMPARTMENT WARNING IS LOCATED ON THE APPLIANCE BONNET

Thank you for buying this Pioneer product. Please read through these operating instructions so you will know how to operate your model properly. After you have finished reading the instructions, put them away in a safe place for future reference.

## [For U.S. model] IMPORTANT NOTICE

The serial number for this equipment is located on the bottom plate of the unit. Please write this serial number on your enclosed warranty card and keep it in a secure area. This is for your security.

**WARNING:** THE APPARATUS IS NOT WATERPROOF, TO PREVENT FIRE OR SHOCK HAZARD, DO NOT EXPOSE THIS APPLIANCE TO RAIN OR MOISTURE AND DO NOT PUT ANY WATER SOURCE NEAR THIS APPARATUS, SUCH AS VASE, FLOWER POT, COSMETICS CONTAINER AND MEDICINE BOTTLE ETC. **H001AEn**

### CAUTION:

THE STANDBY/ON BUTTON IS SECONDARY CONNECTED AND THEREFORE DOES NOT SEPARATE THE UNIT FROM MAINS POWER IN STANDBY POSITION. THEREFORE INSTALL THE UNIT SUITABLE PLACES EASY TO DISCONNECT THE MAINS PLUG IN CASE OF THE ACCIDENT. THE MAINS PLUG OF UNIT SHOULD BE UNPLUGGED FROM THE WALL SOCKET WHEN LEFT UNUSED FOR A LONG PERIOD OF TIME. **H017BEn**

**NOTE:** This equipment has been tested and found to comply with the limits for a Class B digital device, pursuant to Part 15 of the FCC Rules. These limits are designed to provide reasonable protection against harmful interference in a residential installation. This equipment generates, uses, and can radiate radio frequency energy and, if not installed and used in accordance with the instructions, may cause harmful interference to radio communications. However, there is no guarantee that interference will not occur in a particular installation. If this equipment does cause harmful interference to radio or television reception, which can be determined by turning the equipment off and on, the user is encouraged to try to correct the interference by one or more of the following measures:

- Reorient or relocate the receiving antenna.
  - Increase the separation between the equipment and receiver.
  - Connect the equipment into an outlet on a circuit different from that to which the receiver is connected.
  - Consult the dealer or an experienced radio/TV technician for help.
- H010**

## Information to User

Alteration or modifications carried out without appropriate authorization may invalidate the user's right to operate the equipment.

### [For Canadian model]

This Class B digital apparatus complies with Canadian ICES-003.

### [Pour le modèle Canadien]

Cet appareil numérique de la classe B est conforme à la norme NMB-003 du Canada.

**ATTENTION:** AFIN DE PREVENIR TOUS RISQUES DE CHOC ELECTRIQUE OU DE DEBUT D'ENCENDIE, NE PAS EXPOSER CET APPAREIL A L'HUMIDITE OU A LA PLUIE. **H001 Fr**

### ATTENTION:

L'INTERRUPTEUR STANDBY/ON EST RACCORDE SECONDAIREMENT ET PAR CONSEQUENT NE SEPARA PAS L'APPAREIL DE L'ALIMENTATION SECTEUR SUR LA POSITION D'ATTENTE. INSTALLER L'APPAREIL DANS UN ENDROIT ADAPTE DE FACON A CE QU'IL SOIT FACILE DE DEBRANCHER LA FICHE D'ALIMENTATION EN CAS D'INCIDENT. LA FICHE D'ALIMENTATION DE L'APPAREIL DEVRAIT ETRE DEBRANCHEE DE LA PRISE MURALE LORSQUE QUE L'APPAREIL N'EST PAS UTILISE PENDANT UN CERTAIN TEMPS. **H017BFr**

## [For Canadian model]

**CAUTION:** TO PREVENT ELECTRIC SHOCK, DO NOT USE THIS (POLARIZED) PLUG WITH AN EXTENSION CORD, RECEPTACLE OR OTHER OUTLET UNLESS THE BLADES CAN BE FULLY INSERTED TO PREVENT BLADE EXPOSURE.

**ATTENTION:** POUR PREVENIR LES CHOCS ELECTRIQUES NE PAS UTILISER CETTE FICHE POLARISEE AVEC UN PROLONGATEUR, UNE PRISE DE COURANT OU UNE AUTRE SORTIE DE COURANT, SAUF SI LES LAMES PEUVENT ETRE INSERES A FOND SANS EN LAISSER AUCUNE PARTIE A DECOUVERT.

[For U.S. model]



ENERGY STAR® and the ENERGY STAR certification mark are registered US marks. **K001A\_En**

# IMPORTANT SAFETY INSTRUCTIONS

**READ INSTRUCTIONS** — All the safety and operating instructions should be read before the product is operated.

**RETAIN INSTRUCTIONS** — The safety and operating instructions should be retained for future reference.

**HEED WARNINGS** — All warnings on the product and in the operating instructions should be adhered to.

**FOLLOW INSTRUCTIONS** — All operating and use instructions should be followed.

**CLEANING** — Unplug this product from the wall outlet before cleaning. The product should be cleaned only with a polishing cloth or a soft dry cloth. Never clean with furniture wax, benzene, insecticides or other volatile liquids since they may corrode the cabinet.

**ATTACHMENTS** — Do not use attachments not recommended by the product manufacturer as they may cause hazards.

**WATER AND MOISTURE** — Do not use this product near water — for example, near a bathtub, wash bowl, kitchen sink, or laundry tub; in a wet basement; or near a swimming pool; and the like.

**ACCESSORIES** — Do not place this product on an unstable cart, stand, tripod, bracket, or table. The product may fall, causing serious injury to a child or adult, and serious damage to the product. Use only with a cart, stand, tripod, bracket, or table recommended by the manufacturer, or sold with the product. Any mounting of the product should follow the manufacturer's instructions, and should use a mounting accessory recommended by the manufacturer.

**CART** — A product and cart combination should be moved with care. Quick stops, excessive force, and uneven surfaces may cause the product and cart combination to overturn.



**VENTILATION** — Slots and openings in the cabinet are provided for ventilation and to ensure reliable operation of the product and to protect it from overheating, and these openings must not be blocked or covered. The openings should never be blocked by placing the product on a bed, sofa, rug, or other similar surface. This product should not be placed in a built-in installation such as a bookcase or rack unless proper ventilation is provided or the manufacturer's instructions have been adhered to.

**POWER SOURCES** — This product should be operated only from the type of power source indicated on the marking label. If you are not sure of the type of power supply to your home, consult your product dealer or local power company.

**LOCATION** — The appliance should be installed in a stable location.

**NONUSE PERIODS** — The power cord of the appliance should be unplugged from the outlet when left un-used for a long period of time.

## GROUNDING OR POLARIZATION

- If this product is equipped with a polarized alternating current line plug (a plug having one blade wider than the other), it will fit into the outlet only one way. This is a safety feature. If you are unable to insert the plug fully into the outlet, try reversing the plug. If the plug should still fail to fit, contact your electrician to replace your obsolete outlet. Do not defeat the safety purpose of the polarized plug.

- If this product is equipped with a three-wire grounding type plug, a plug having a third (grounding) pin, it will only fit into a grounding type power outlet. This is a safety feature. If you are unable to insert the plug into the outlet, contact your electrician to replace your obsolete outlet. Do not defeat the safety purpose of the grounding type plug.

**POWER-CORD PROTECTION** — Power-supply cords should be routed so that they are not likely to be walked on or pinched by items placed upon or against them, paying particular attention to cords at plugs, convenience receptacles, and the point where they exit from the product.

**OUTDOOR ANTENNA GROUNDING** — If an outside antenna or cable system is connected to the product, be sure the antenna or cable system is grounded so as to provide some protection against voltage surges and built-up static charges. Article 810 of the National Electrical Code, ANSI/NFPA 70, provides information with regard to proper grounding of the mast and supporting structure, grounding of the lead-in wire to an antenna discharge unit, size of grounding conductors, location of antenna-discharge unit, connection to grounding electrodes, and requirements for the grounding electrode. See Figure A.

**LIGHTNING** — For added protection for this product during a lightning storm, or when it is left unattended and unused for long periods of time, unplug it from the wall outlet and disconnect the antenna or cable system. This will prevent damage to the product due to lightning and power-line surges.

**POWER LINES** — An outside antenna system should not be located in the vicinity of overhead power lines or other electric light or power circuits, or where it can fall into such power lines or circuits. When installing an outside antenna system, extreme care should be taken to keep from touching such power lines or circuits as contact with them might be fatal.

**OVERLOADING** — Do not overload wall outlets, extension cords, or integral convenience receptacles as this can result in a risk of fire or electric shock.

**OBJECT AND LIQUID ENTRY** — Never push objects of any kind into this product through openings as they may touch dangerous voltage points or short-out parts that could result in a fire or electric shock. Never spill liquid of any kind on the product.

**SERVICING** — Do not attempt to service this product yourself as opening or removing covers may expose you to dangerous voltage or other hazards. Refer all servicing to qualified service personnel.

**DAMAGE REQUIRING SERVICE** — Unplug this product from the wall outlet and refer servicing to qualified service personnel under the following conditions:

- When the power-supply cord or plug is damaged.
- If liquid has been spilled, or objects have fallen into the product.
- If the product has been exposed to rain or water.
- If the product does not operate normally by following the operating instructions. Adjust only those controls that are covered by the operating instructions as an improper adjustment of other controls may result in damage and will often require extensive work by a qualified technician to restore the product to its normal operation.
- If the product has been dropped or damaged in any way.
- When the product exhibits a distinct change in performance — this indicates a need for service.

**REPLACEMENT PARTS** — When replacement parts are required, be sure the service technician has used replacement parts specified by the manufacturer or have the same characteristics as the original part. Unauthorized substitutions may result in fire, electric shock, or other hazards.

**SAFETY CHECK** — Upon completion of any service or repairs to this product, ask the service technician to perform safety checks to determine that the product is in proper operating condition.

**WALL OR CEILING MOUNTING** — The product should not be mounted to a wall or ceiling.

**HEAT** — The product should be situated away from heat sources such as radiators, heat registers, stoves, or other products (including amplifiers) that produce heat.

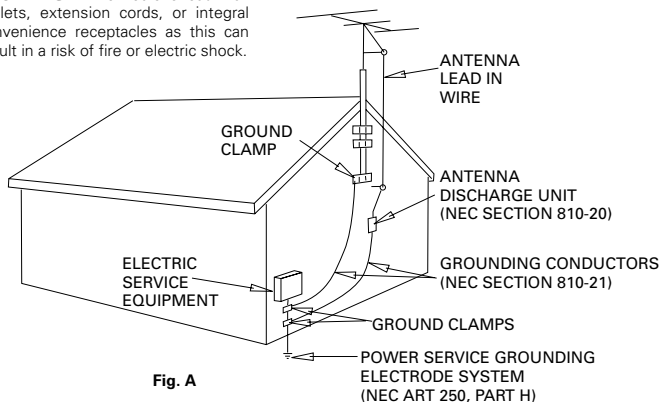

Fig. A

When using this product follow the instructions written on the underside of the unit, which concern rated voltage, etc.

**WARNING:** BEFORE PLUGGING IN THE UNIT FOR THE FIRST TIME, READ THE FOLLOWING SECTION CAREFULLY. THE VOLTAGE OF THE AVAILABLE POWER SUPPLY DIFFERS ACCORDING TO COUNTRY OR REGION, BE SURE THAT THE POWER SUPPLY VOLTAGE OF THE AREA WHERE THIS UNIT WILL BE USED MEETS THE REQUIRED VOLTAGE (E.G., 230V OR 120V) WRITTEN ON THE REAR PANEL. H041 En

**WARNING:** NO NAKED FLAME SOURCES, SUCH AS LIGHTED CANDLE, SHOULD BE PLACED ON THE APPARATUS. IF NAKED FLAME SOURCES ACCIDENTALLY FALL DOWN, FIRE SPREAD OVER THE APPARATUS THEN MAY CAUSE FIRE. H044 En

**CAUTION:** The POWER switch does not completely separates the unit from the MAINS in off position, therefore install the unit suitable places easy to disconnect the MAINS plug in case of the accident. The MAINS plug of unit should be unplugged from the wall socket when left unused for a long period of time. H046 En

## Operating Environment H045 En

Operating environment temperature and humidity: +5°C – +35°C (+41°F – +95°F); less than 85%RH (cooling vents not blocked)

Do not install in the following locations

- Location exposed to direct sunlight or strong artificial light
- Location exposed to high humidity, or poorly ventilated location

**VENTILATION:** When installing this unit, make sure to leave space around the unit for ventilation to improve heat radiation (at least 20 cm at top, 50 cm at rear, and 10 cm at each side).

**WARNING:** Slot and openings in the cabinet are provided for ventilation and to ensure reliable operation of the product and to protect it from overheating, to prevent fire hazard, the openings should never be blocked and covered with items, such as newspapers, tablecloths, curtains, etc. Also do not put the apparatus on the thick carpet, bed, sofa, or fabric having a thick pile. H040 En

### CAUTION:

This product satisfies FCC regulations when shielded cables and connectors are used to connect the unit to other equipment. To prevent electromagnetic interference with electric appliances such as radios and televisions, use shielded cables and connectors for connections. H012 En

This product is for general household purposes. Any failure due to use for other than household purposes (such as long-term use for business purposes in a restaurant or use in a car or ship) and which requires repair will be charged for even during the warranty period. K041\_En

## TWO VOLTAGE SELECTOR SWITCHES (multi-voltage model only)

Only multi-voltage model is provided with these switches. Mains voltages in Saudi Arabia are 127 V and 220 V only. Never use this model with the 110 V setting in Saudi Arabia.

Only multi-voltage model is provided with this(these) switch(es).

U.S. and Canadian models are not provided with these switches. H014 En

The line voltage selector switches are on the rear panel. Check that they are set properly before plugging the power cord into the household wall socket. If the voltage is not properly set or if you move to an area where the voltage requirements differ, adjust the selector switches as follows.

1. Use a medium-size screwdriver.
2. First, insert the screwdriver in the groove of the voltage selector at the right, and adjust so that the tip of the groove points to the voltage value of your area.
3. Next, insert the screwdriver in the groove of the voltage selector at the left and adjust until the voltage is the same as at the right.

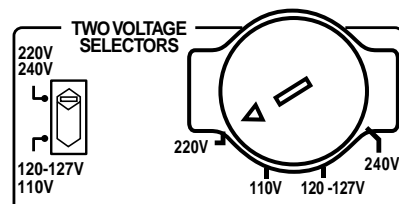

### CAUTION 220 V

Power source voltage is factory adjusted 220 volts. If your area is different, change voltage selectors settings.

# Features

## Compatibility with the Home Theater Formats

### Dolby Digital, DTS Sound Decoders

These highly evolved multichannel sound formats are the heart of home theater. They deliver realistic multichannel sound that can turn any living room into a theater, reproducing all the sound effects of the original movie. The VSX-C100/C100-S has the flexibility to decode all these formats.

### Dolby Pro Logic II Decoder

The VSX-C100/C100-S reproduces this industry-leading format with excellent clarity. With it you can get multichannel surround sound even from two channel and Dolby Surround sources.

## Home Theater Listening Modes

### Custom Designed Listening Modes (p.35)

These modes enhance the sound of sources from movies and music to TV and video games for a more dramatic effect. These are each designed to accentuate specific sound qualities, giving the listener a wide range of possibilities.

### VIRTUAL Mode (p.35)

This especially designed listening mode uses only two channels but through sound imaging imitates a full surround sound. It allows you to experience surround sound with only two speakers.

### PHONES SURROUND Mode (p.35)

This new headphone mode allows the user to get a surround-like sound while listening on headphones designed to accommodate this technology.

### Sound Modes (p.37)

This unit also has especially created Sound Modes that can enhance your listening experience and bring out the best in each soundtrack. Each mode is designed to bring out a specific quality of the soundtrack or balance the sound. The NATURAL corrects the frequencies for small speakers to achieve better theater-like surround sound. The MIDNIGHT listening mode allows you to obtain excellent surround sound effects even when listening at low volumes, something that was previously impossible. The QUIET mode provides good sound by smoothing out harsh noises in the soundtrack. This is achieved by reducing the bass and treble. The BRIGHT mode flattens out the total frequency output to match the characteristics of the front speakers. The S.BASS mode gives you added bass for that driving punch that really livens up your music or makes a film more realistic.

## Easy-to-use Remote Control

This new remote control is extremely convenient to use. One button is dedicated to one task in the control of the receiver, eliminating confusing buttons whose purpose are unclear. In addition, this remote can be used to operate a variety of other components simply by recalling the appropriate setup codes.

## Easy Setup for Quick Home Use

This receiver features an automatic setup function that senses which speakers you have hooked up and automatically sets the receiver for proper surround sound. Thus, you can start enjoying home theater immediately after hooking up your speakers and components, without worrying about difficult setup procedures.

## The Energy-saving Design

This unit is designed to use less than 1 W of energy when the receiver is in standby mode.

*Manufactured under license from Dolby Laboratories. "Dolby", "Pro Logic", and the double-D symbol are trademarks of Dolby Laboratories.*

*"DTS" and "DTS Digital Surround" are trademarks of Digital Theater Systems, Inc.*

*TruSurround and the  symbol are trademarks of SRS Labs, Inc. TruSurround technology is incorporated under license from SRS Labs, Inc.*

# Contents

---

Congratulations on buying this fine Pioneer product.

Please read through these operating instructions so you will know how to operate your model properly. After you have finished reading the instructions, put them away in a safe place for future reference.

<b>Contents</b>	<b>6</b>	<b>06 Playback Modes</b>	<b>35</b>
<b>Quick Start Guide</b>	<b>7</b>	Listening Modes	35
<b>01 Introductory Information</b>	<b>11</b>	Selecting a Listening Mode	36
Checking the Supplied Accessories	11	Sound Modes	37
Installing the Receiver	11	Selecting a Sound Mode	37
Ventilation	11	<b>07 Using the Tuner</b>	<b>38</b>
When Making Cable Connections	11	Finding a Station	38
Loading the Batteries	12	Channel Step Setting (multi-voltage model only)	38
Operating Range of Remote Control Unit	12	Tuning Directly to a Station	39
Maintenance of External Surfaces	12	Memorizing Stations	39
<b>02 Connecting Your Equipment</b>	<b>13</b>	Naming Memorized Stations	40
Audio/Video Cords	13	Recalling Memorized Stations	40
Coaxial Cords/Optical Cables	13	<b>08 Using Other Functions</b>	<b>41</b>
Connecting a DVD Player & TV	14	Muting the Sound	41
Connecting a Digital Tuner/Set Top Box	15	Using the Headphones	41
Connecting a TV with an Internal Digital Tuner	16	Changing the Display Brightness (DIMMER button)	41
Connecting Video Components	16	Input Signal Select	42
Connecting Speakers	18	The SLEEP Function	42
Hints on Speaker Placement	19	Resetting the System	42
Connecting Antennas	20	Default Settings for the Receiver	43
Using External Antennas	20	<b>09 Controlling the Rest of Your System</b>	<b>44</b>
Operating other Pioneer Components with this Unit's Sensor	21	Changing the Remote Control Mode	44
Plugging in the Receiver	21	Recalling Preset Codes	45
<b>03 Displays &amp; Controls</b>	<b>22</b>	Clearing the Preset Codes	46
Front Panel	22	CD/MD/CD-R/VCR/DVD/LD/DVD recorder/ Cassette Deck Controls	47
Rear Panel	23	Cable TV/Satellite TV/Digital TV/TV Controls	48
Remote Control	24	Preset Code List	49
<b>04 Basic Playback</b>	<b>26</b>	<b>10 Additional Information</b>	<b>50</b>
Checking the Settings on Your DVD (or other) Player	26	Troubleshooting	50
Program Format/Speaker Channel Indicators	26	<b>11 Techno Know How</b>	<b>53</b>
Playing a Source	27	Understanding DVD Packaging	53
<b>05 Fine Tuning Your Surround Sound</b>	<b>28</b>	Digital Audio Formats	53
Room Setup	28	Recording Formats	54
Personalizing Your Surround Sound	29	Playback Formats	54
Setting the Volume Level of Each Channel	34	Specifications (U.S. model)	56
		Specifications (Multi voltage model and Singaporean model)	57

## Home Theater: The Basics

Most consumers are used to using stereo equipment to listen to music but many people are not used to home theater systems that give you many more options when listening to soundtracks. In fact, home theater is not really complicated and this little guide should give you an understanding of basics.

The main reasons why it seems so difficult is that there are three different factors involved in home theater and each will contribute to what kind of sound you get.

These factors are:

- 1) The equipment you are using for your home theater set up. Particularly important is the number of speakers you are using. We call this your speaker configuration. The default settings should be fine in most cases.
  - 2) The 'source' material you are using. This is the actual product (like a DVD) or broadcast (like cable TV) you are listening to/watching. We call this the source.
  - 3) The last factor is the listening mode you choose on the VSX-C100/C100-S receiver. These are explained below and in subsequent chapters but most likely the default setting will be fine.
- Let's start with the home theater set up you have in your home.

## Your Home System

The heart of your system is the VSX-C100/C100-S receiver and it is very flexible in getting you theater-like surround sound. You can use this receiver with anywhere from two to five speakers (front left, front right, center, surround left and right) and a subwoofer to get home theater surround sound. However we recommend you use five speakers. If you only have two speakers choose the Listening mode that offers surround sound for your home setup. Also, a DVD player is essential for home theater and you can also hook up satellite or cable TV tuner to this receiver and get a more home theater like sound from those programs.

## The Source Material

DVDs have become the basic source material for home theater because they offer excellent sound and picture quality, allow users to choose the movies they want, and are easy to store, etc. You can also enjoy home theater with other sources, such as digital satellite TV, cable TV and VHS videotapes. The important part here is all these sources have soundtracks recorded on them with various kinds of technology (this is called the sound encoding). Home theater sources are recorded (encoded) with multiple sound channels, that is discrete parts of the overall sound. CDs (which are stereo sources) work the same way but they only have two sound channels, the left channel and the right channel. These two channels carry different parts of the soundtrack and mix together when you hear it to make an enjoyable, stereo sound. The same idea applies to home theater sources except home theater sources are recorded with multichannels, that is, more than two channels. For example, Dolby Pro Logic encoding has four channels (front left, front right, center and a single channel for both surround speakers), Dolby Pro Logic II, Dolby Digital and DTS encoding usually have six channels (front left, front right, center, surround left and right and a channel that powers the subwoofer). Since the subwoofer channel is only for bass sounds this multichannel set up has been named 5.1 channel sound. These multiple channels are what create a surround sound effect and give you a similar experience of that of a movie theater. It is important you consult the manual that came with your DVD player as well to make sure the player is outputting a surround soundtrack and all the other settings are appropriate for home theater.

## The Listening Modes

This receiver has many different listening modes and they are designed to cover all the speaker configurations and types of sources you might be using. In general, if you follow the recommend advice and have five speakers hooked up in most cases the AUTO listening mode is the easiest way to get realistic home theater sound. This is the default setting so you don't have to do anything. Other possibilities (like listening to a stereo CD with all five speakers or, conversely taking a stereo source and it getting multichannel home theater-like sound) are explained in Listening modes (page 35).

These are the three basic factors that contribute to your home theater sound. The easiest thing is to hook up five speakers and simply play your DVDs with AUTO mode. This will give you realistic and enjoyable home theater sound.

# Quick Start Guide

## No Frills Setup

This receiver was designed with the easiest possible setup in mind so if you just want to hook up your equipment and start enjoying quality home theater movies follow the four steps below and use these easy settings on the VSX-C100/ C100-S. In most cases you can leave the receiver in the default settings.

### Default Settings:

- Speaker Setting: Automatically sensed by the receiver
- Input Setting: DVD
- Signal Select: AUTO
- Listening Mode: AUTO
- Sound Mode: NATURAL

## 1) Hook up your DVD player, speakers, subwoofer and TV.

Connect your DVD player to this unit using either the coaxial digital terminal or the optical digital terminals, depending on which type of digital terminal your DVD has. The quality of these two types of connection is the same so it's simply a matter of matching like with like, and you don't need to do both. It is easiest, however, if you follow this receiver's default settings and connect your DVD player to coaxial terminal. If your DVD player does not have an coaxial terminal, use one of the optical terminal to hook it up to this receiver. (In this case you need to assign the DVD function to that terminal. See p.33 in order to do this.) Follow the diagram below to hook up your DVD player to either the coaxial or optical terminal(s). Then, hook up the speakers you want to use with this receiver. This receiver can be used with just two speakers but it's better to have five speakers to get accurate surround sound. See pages 18-19 for more details on connecting your speakers. Next, hook up your powered subwoofer, if you have one. For all speakers make sure to connect the positive (+) and negative (-) terminals on the receiver and speakers with the same wire (positive to positive, negative to negative).

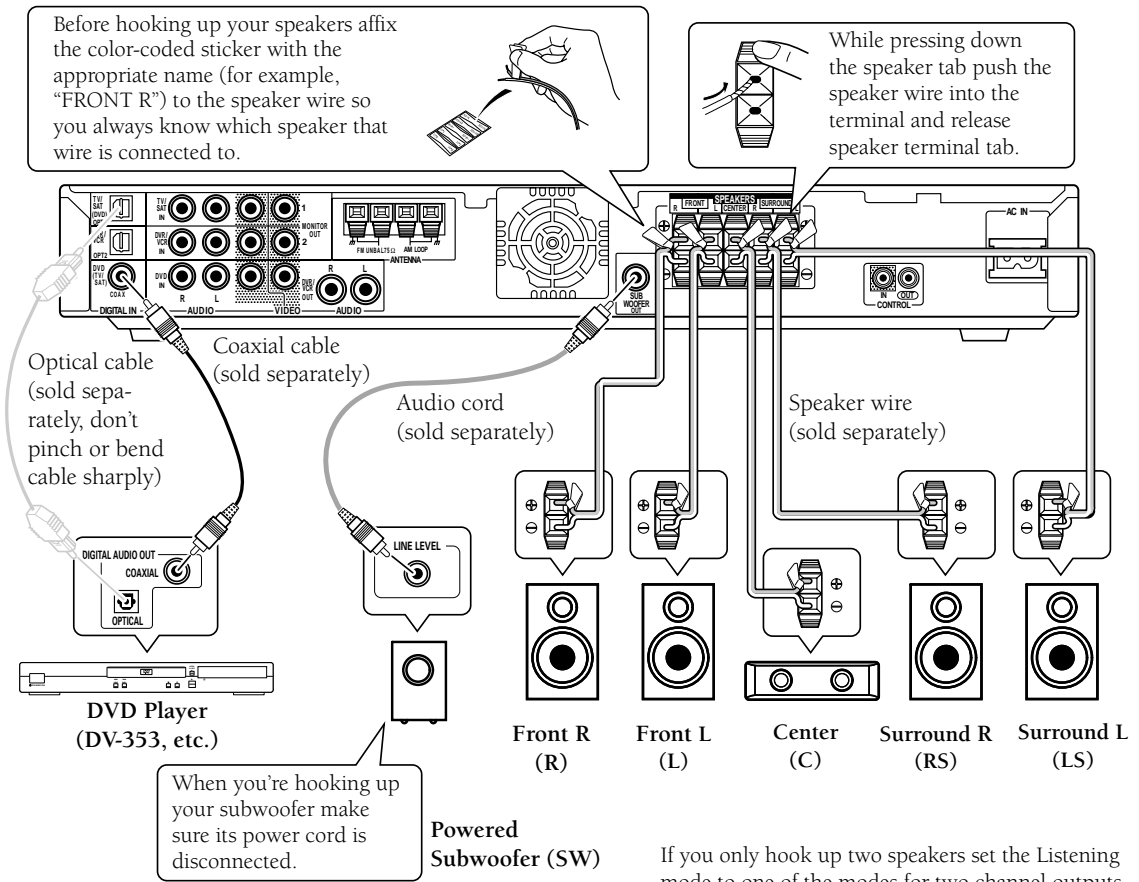



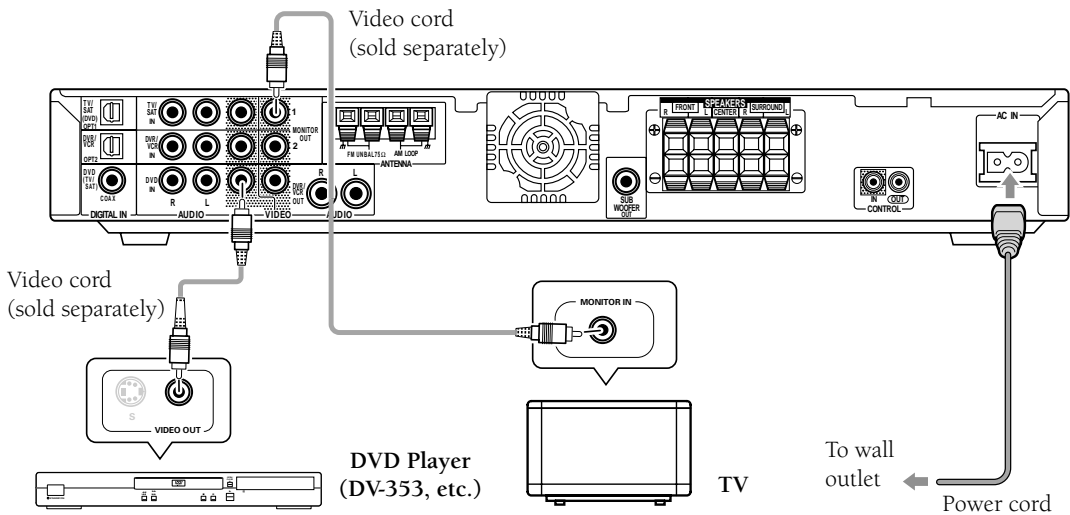

Lastly, hook up your DVD player to the DVD IN VIDEO and your TV to the MONITOR OUT VIDEO terminals as shown above and plug in the receiver's power cord to a power outlet.

**Automatic speaker setup** (receiver automatically configures Front, Center, Surround speakers and Subwoofer) Once you have completed the above tasks, the receiver will automatically detect which speakers you have connected and configure your speaker settings according to that. You don't have to do anything. This setup establishes the size and configuration of the speaker system you have connected and is the easy way to setup your speakers for surround sound. If you don't have surround speakers or want to make more exact speaker settings, go to page 29.

The Automatic speaker setup will give you acceptable surround sound.

## 2) Turn on the power on the receiver, your DVD player, your powered subwoofer and TV.

- Make sure your TV is set to the receiver. If it is not, check the input jack this receiver is hooked up to on your TV and consult the manual that came with the TV to figure out the proper TV setting.
- Confirm that **DVD** appears in the receiver's display, indicating that the receiver is set to the DVD input. If it does not, press the DVD button to set the receiver to DVD input.

## 3) Confirm the settings on your DVD player are correct for the source you want to play.

Make sure your DVD player is outputting a digital signal and choose the soundtrack (Dolby Digital, DTS, etc.) that you want to hear. If you are unsure about your DVD player's settings, see page 26 for more information and/or consult the manual that came with your DVD player.

## 4) Play a source (like a DVD) and adjust the volume to your liking.

You are now ready to experience home theater with your new surround sound system.

## Advanced/Customized Settings

If you want to customize your home theater to your environment, equipment or personal tastes, many settings are available. One of the most important advanced settings, called Room Setup, establishes the distances between your speakers and your normal listening position (as well as volume levels, etc.). Making this setting should improve your surround sound. Room Setup is explained on page 28. After that you could go on to fine tune your surround sound for maximum sound quality. These settings start on page 29.

The VSX-C100/C100-S has many different listening modes to accommodate many different kinds of sources, speaker configurations and sound reproduction. Experiment with these features to figure out what suits your tastes. The listening mode explanations and settings start on page 35.

The above is a quick guide to getting you started with your home theater system and a few setup suggestions. It is a good idea, however, to read this manual in its entirety so you understand what you can do with the VSX-C100/C100-S and the possibilities of home theater in general. You may find many hints in these explanations that help you get better sound and let you operate all your equipment more effectively.

## Checking the Supplied Accessories

Please check that you've received the following supplied accessories:

- AM loop antenna
- FM wire antenna
- Power cord
- Dry cell batteries (AA Size / IEC R6P) x2
- Remote control unit
- Operating instructions
- Speaker cord labels
- Cord with plug (for U.S model)
- Warranty card (for U.S model)
- Caution 220V label (for Multi voltage model)
- Power plug adapter (for Multi voltage model)

## Installing the Receiver

- When installing this unit, make sure to put it on a secure and level plane that is stable.
- Don't place it on the following places:
  - on a color TV (the screen may distort)
  - near a cassette deck (or close to a device that gives off a magnetic field) This may interfere with the sound.
  - in direct sunlight
  - in damp or wet areas
  - in extremely hot or cold areas
  - in places where there is a vibration or other movement
  - in places that are very dusty
  - in places that have hot fumes or oils (such as a kitchen)

## Ventilation

- When installing this unit, make sure to leave space around the unit for ventilation to improve heat dispersal (at least 20 cm at the top, 50 cm at the rear, and 10 cm at each side). If not enough space is provided between the unit and walls or other equipment, heat will build up inside, interfering with performance and/or causing malfunctions. See below for exceptions to this.
- If using a rack to hold the receiver make sure the back of the rack and the left side are open.
- Also, if you're using a case with glass doors, leave the glass doors open when using the receiver.
- Do not place on a thick carpet, bed, sofa or fabric having a thick pile. Do not cover the receiver with fabric or other covering. Anything that blocks ventilation will cause the internal temperature to rise, which may lead to breakdown or fire hazard.

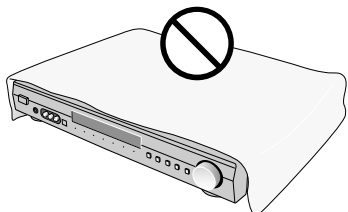

- Don't place anything on top of the receiver except for a Pioneer DV-353/355/251/250/444/533-K/3310/5310KD DVD player. If you do place one of these pieces of equipment on top of the receiver be sure to leave the ventilation space over it as prescribed above.
- The receiver may become hot while in use, please take care around it.

## When Making Cable Connections

Be careful not to arrange cables in a manner that bends the cables over the top of this unit. If the cables are laid on top of the unit, the magnetic field produced by the transformers in this unit may cause a humming noise to come from the speakers.

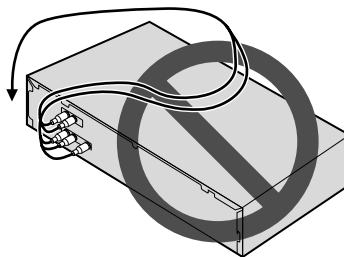

### Cassette deck placement

Depending on where the cassette deck is placed, noise may occur during playback of your cassette deck which is caused by leakage flux from the transformer in the receiver. If you experience noise, move the cassette deck farther away from the receiver.

## Storing optical cable

When storing optical cable, coil loosely as shown below. The cable may be damaged if bent around sharp corners.

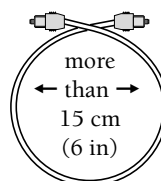

# Introductory Information

## Loading the Batteries

The remote control operates on two AA batteries (supplied).

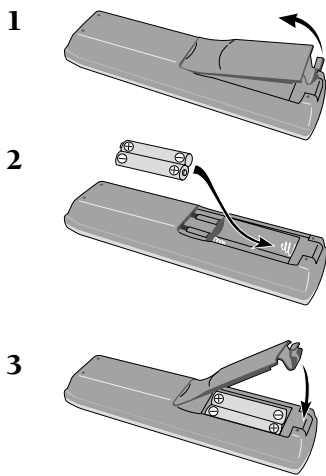

### CAUTION:

Incorrect use of batteries may result in such hazards as leakage and bursting. Observe the following precautions:

- Never use new and old batteries together.
- Insert the plus and minus sides of the batteries properly according to the marks in the battery case.
- Batteries of the same shape may have different voltages. Do not use different batteries together.
- When disposing of used batteries, please comply with governmental regulations or environmental public institution's rules that apply in your country or area.

## Operating Range of the Remote Control Unit

The remote control may not work properly if:

- There are obstacles between the remote control and the receiver's remote sensor.
- Direct sunlight or fluorescent light is shining onto the remote sensor.
- The receiver is located near a device that is emitting infrared rays.
- The receiver is operated simultaneously with another infrared remote control unit.

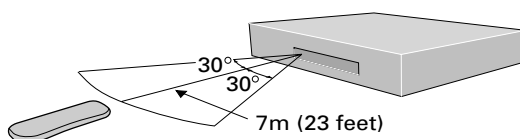

## Maintenance of External Surfaces

- Use a polishing cloth or dry cloth to wipe off dust and dirt.
- When the surfaces are dirty, wipe with a soft cloth dipped in some neutral cleanser diluted five or six times with water, and wrung out well, and then wipe again with a dry cloth. Do not use furniture wax or cleansers.
- Never use thinners, benzene, insecticide sprays or other chemicals on or near this unit, since these will corrode the surfaces.

## Audio/Video Cords

Use audio/video cords (not supplied) to make analog audio and video connections. Connect red plugs to R (right), white plugs to L (left), and the yellow plugs to VIDEO. Be sure to insert completely.

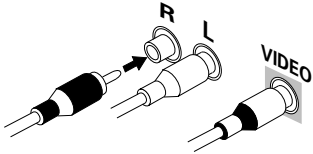

## Coaxial Cords/Optical Cables

Commercially available digital audio coaxial cords (standard video cords can also be used) or optical cables (not supplied) are used to connect digital components to this receiver.

Be sure to insert completely and in the case of the optical cable, right-side up. If it is inserted improperly it can break the shutter on the optical terminal (this won't, however, affect the connection or insertion of an optical cable).

**Coaxial cord  
(or standard composite  
video cord)**

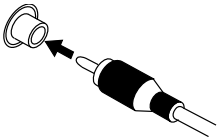

**Optical cable**

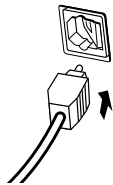

## Connecting Your Equipment

Before making or changing the connections, switch off the power and disconnect the power cord from the AC wall outlet.

### Connecting a DVD Player & TV

In order to play PCM/Dolby Digital/DTS multichannel soundtracks, you need to make digital audio connections. Connect your DVD player to this unit using either the coaxial digital terminal or the optical digital terminals, depending on which type of terminal your DVD has. The quality of these two types of connection is the same so it's simply a matter of matching like with like. It is easiest, however, if you follow this receiver's default settings and connect your DVD player to coaxial terminal. If your DVD player does not have an coaxial terminal, use the optical terminal to hook it up to this receiver. In this case you need to assign the DVD function to that terminal. See p.33 in order to do this. Follow the diagram below to hook up your DVD player to either the coaxial or optical terminal(s). Also, connect your TV to this receiver as shown below.

#### Note

The basic default settings for the DIGITAL IN terminals are as follows: COAX: DVD; OPT. 1: TV/SAT; OPT. 2: DVR. If you need to use an optical terminal for your DVD use OPT.1. In this case, assign your coaxial terminal to TV/SAT (see p.33) and the optical default settings change to: OPT. 1: DVD; OPT. 2: DVR.

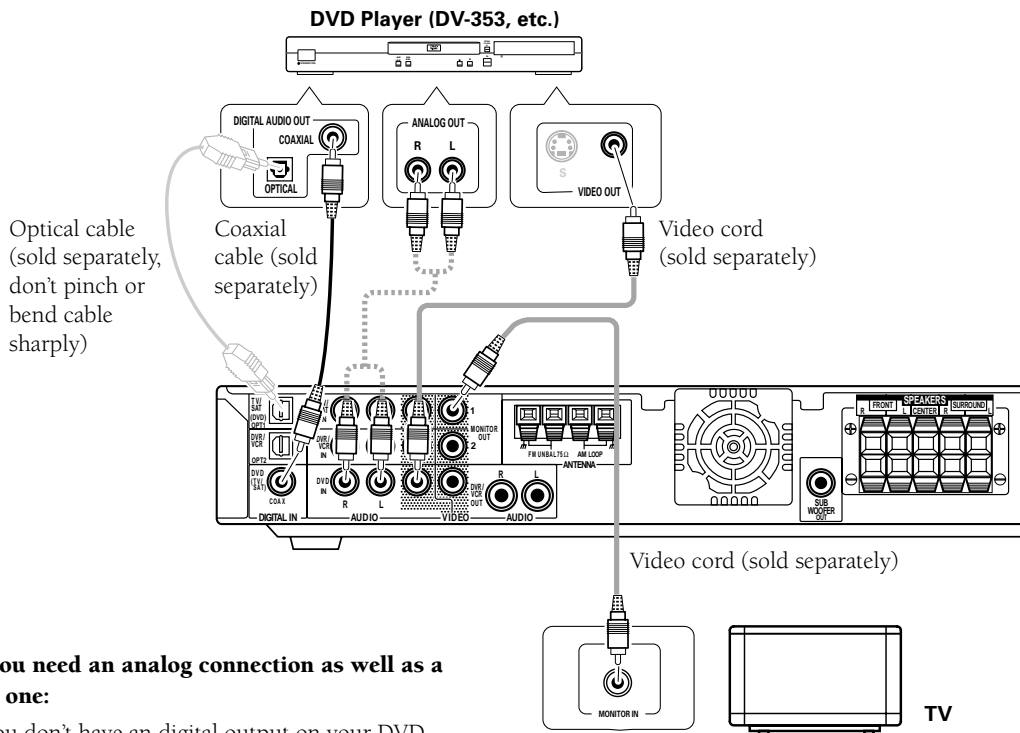

#### Why you need an analog connection as well as a digital one:

- If you don't have a digital output on your DVD player you will need to use the analog connection shown here.
- If you want to get an audio signal from the VCR out you need an analog connection.
- If you want to use your DVD player for karaoke you need an analog connection.

Before making or changing the connections, switch off the power and disconnect the power cord from the AC wall outlet.

## Connecting a Digital Tuner/Set Top Box

If you have an external digital tuner (like a set top box for satellite or cable TV) you need to connect it to either the optical digital terminals or the coaxial digital terminal in order to play digital cable/satellite broadcasting. The quality of these two types of connection is the same so it's simply a matter of matching like with like. It is easiest, however, if you follow this receiver's default settings and connect your cable/satellite tuner (or TV/SAT as it's called on the remote control) to optical terminal 1. If your TV/SAT does not have an optical terminal, use the coaxial terminal to hook it up (consult the DVD hook up information on the previous page). In this case you need to assign the TV/SAT function to that terminal. See p.33 in order to do this. Follow the diagram below to hook up your TV/SAT to either the optical or coaxial terminal.

Make sure you use a digital connection as well as an analog one for the audio on the cable/satellite tuner, as pictured below.

 **Note**

The basic default settings for the DIGITAL IN terminals are as follows: COAX: DVD; OPT. 1: TV/SAT; OPT. 2: DVR. If you need to use the coaxial terminal for your TV/SAT, then assign the coaxial terminal to TV/SAT. The digital terminals settings change to: COAX: TV/SAT; OPT. 1: DVD; OPT. 2: DVR. (see p.33)

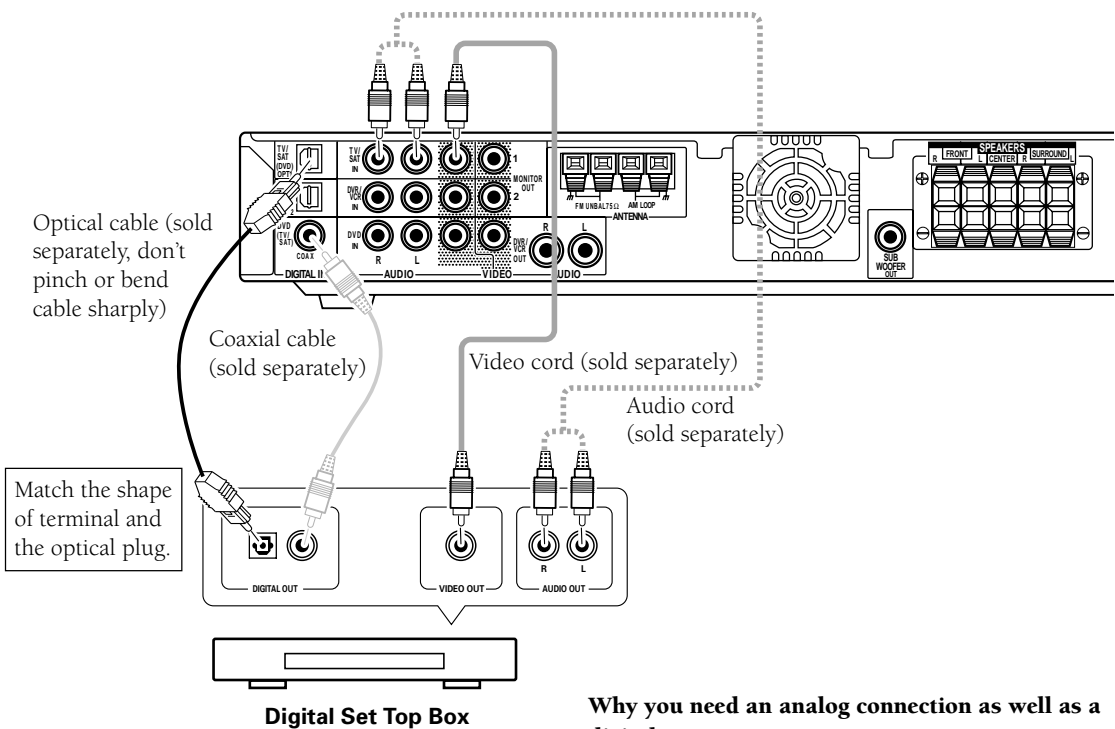

**Why you need an analog connection as well as a digital one:**

- If you don't have an digital output on your TV tuner you will need to use an analog connection.
- If the program you want to watch isn't output from the digital terminals you need an analog connection.
- If you want to get a signal from a video deck instead of a TV tuner you need an analog connection.

## Connecting Your Equipment

Before making or changing the connections, switch off the power and disconnect the power cord from the AC wall outlet.

### Connecting a TV with an Internal Digital Tuner

If you have a TV with an internal digital tuner follow the directions above for an external digital tuner and in addition hook up your TV, if you have not already done so when you hooked up your DVD player (see the previous page). Make sure you use a digital connection as well as an analog one for the audio, as pictured below.

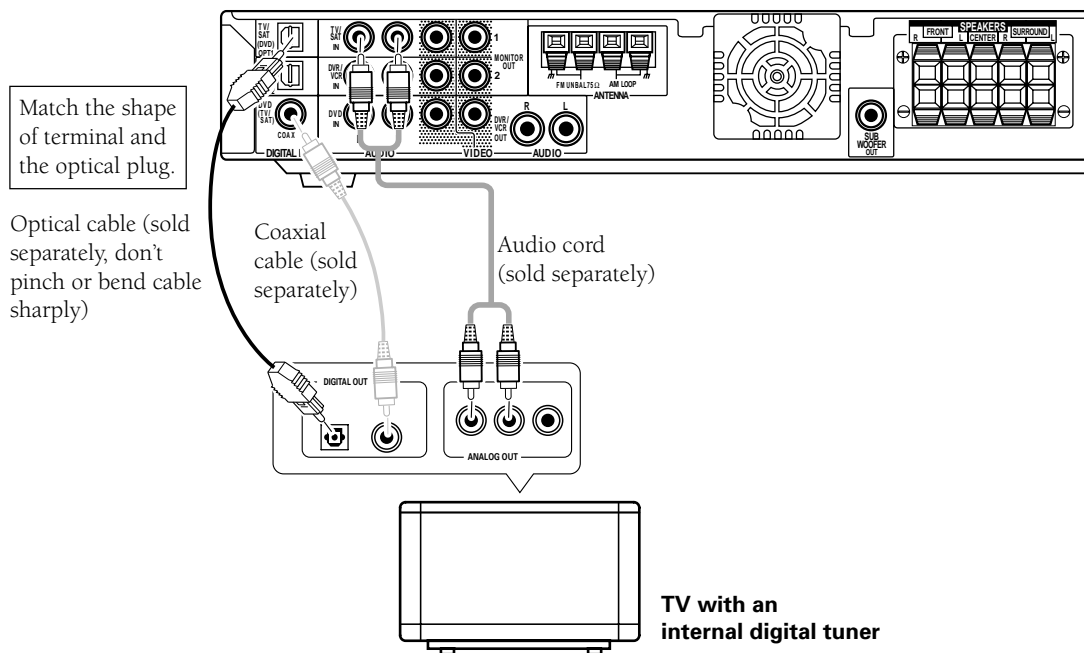

### Connecting Video Components

Connect your video components to the terminals as shown next page.

If you have a Digital Video Recorder (a DVR) you need to connect it digitally to either the optical digital terminals or the coaxial digital terminal in order to play and/or record multichannel sound. The quality of these two types of connection is the same so it's simply a matter of matching like with like and using the available terminal(s) after you've hooked up your DVD player and cable/satellite/TV tuner.

Basically the easiest way to connect a DVR is to follow this receiver's default settings and connect your cable/satellite tuner (or TV/SAT as it's called on the remote control) and DVR to optical terminals 1 and 2 respectively, and connect the DVD to the coaxial terminal.

If this isn't possible due to the types of terminals each component is equipped with, then you need to figure out which component will be used for the coaxial terminal and assign it properly (see p. 33). After that follow the optical terminal defaults (as below).

If you connected the coaxial terminal to DVD and thus left it on the default DVD setting the optical terminals default settings are:

OPT. 1: TV/SAT

OPT. 2: DVR

If you assigned the coaxial terminal to TV/SAT the optical terminals default settings are:

OPT. 1: DVD

OPT. 2: DVR

All video decks (both DVRs and VCRs) should be hooked up with analog connections as well. If you want to record programs it is necessary to connect to the DVR/VCR IN AUDIO terminals as shown next page.



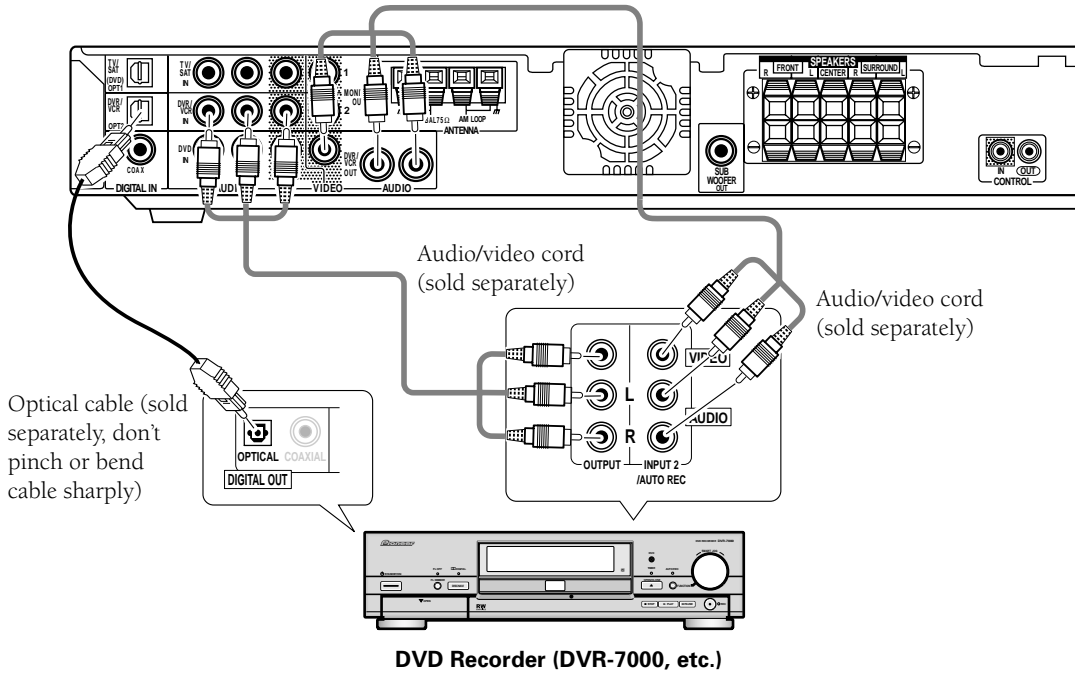

**You can only record audio signals from video components hooked up with analog connections.**

If the input component and the receiver are only connected with an digital cable (coaxial or optical), which is for audio, you need to connect analog video and audio cables in order to be able to record video programs with soundtracks.

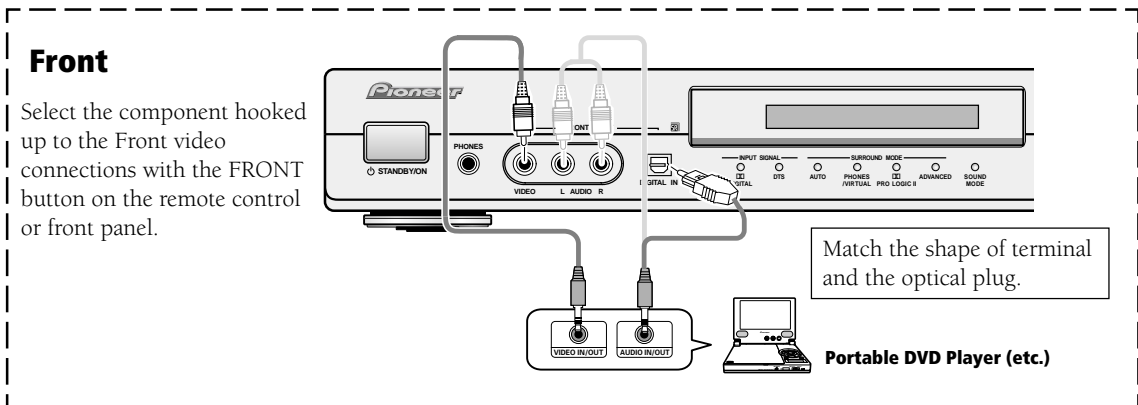

# Connecting Your Equipment

Before making or changing the connections, switch off the power and disconnect the power cord from the AC wall outlet.

## Connecting Speakers

A full complement of five speakers is shown here but, naturally, everyone's home setup will vary. Simply connect the speakers you have in the manner described below. The receiver will sense which speakers you have hooked up. The receiver will work with just two stereo speakers (called "Front" speakers in the diagram) but we recommend you use five speakers. If you don't hook up surround speakers you need to adjust the Listening mode settings (see p. 35). Make sure you connect the speaker on the right to the right terminal and the speaker on the left to the left terminal. Also make sure the positive and negative (+/-) terminals on the receiver match those on the speakers.

### Note

- Use speakers with a nominal impedance of 6 Ω to 16 Ω.

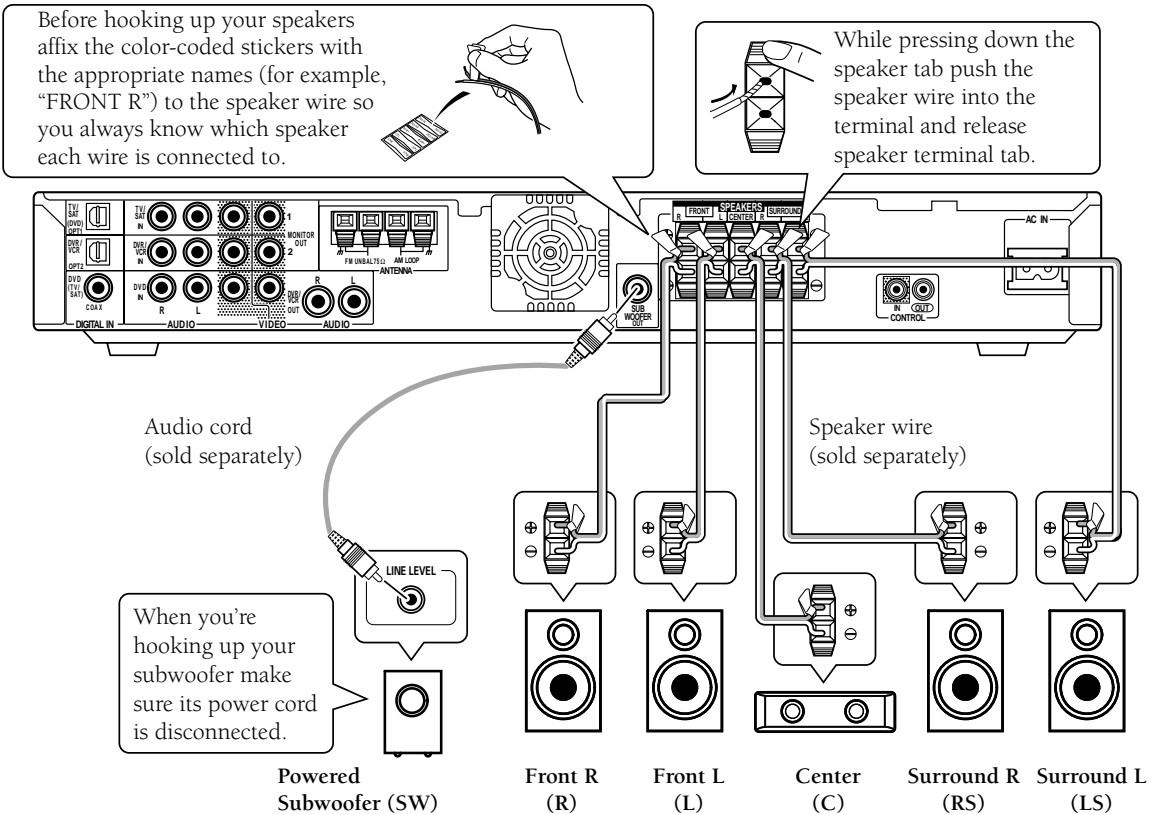

## Speaker terminals

Use good quality speaker wire to connect the speakers to the receiver.

- 1 Twist about 10 mm (3/8 in) of bare wire strands together.
- 2 Push in the speaker terminal tab and insert the wire.
- 3 Release speaker terminal tab, it should snugly grip the speaker wire.



10 mm (3/8 in)

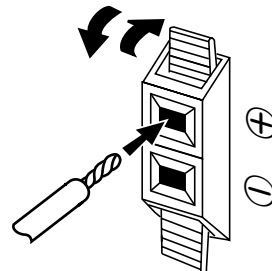

### Caution:

Make sure that all the bare speaker wire is twisted together and inserted fully into the speaker terminal. If any of the bare speaker wire touches the back panel it may cause the power to cut off as a safety measure.

## Hints on Speaker Placement

Speakers are usually designed with a particular placement in mind. Some are designed to be floor standing, while others should be placed on stands to sound their best. Some should be placed near a wall; others should be placed away from walls. Follow the guidelines on placement that the speaker manufacturer provided with your particular speakers to get the most out of them.

- Place the front left and right speakers at equal distances from the TV.
- When placing speakers near the TV, we recommend using magnetically shielded speakers to prevent possible interference, such as discoloration of the picture when the TV is switched on. If you do not have magnetically shielded speakers and notice discoloration of the TV picture, move the speakers farther away from the TV.
- Install the center speaker above or below the TV so that the sound of the center channel is localized at the TV screen.

### CAUTION!

If you choose to install the center speaker on top of the TV, be sure to secure it by suitable means to reduce the risk of damage or injury resulting from the speaker falling from the TV in the event of external shocks such as earthquakes.

- If possible, install the surround speakers slightly above ear level.
- Try not to install the surround speakers farther away from the listening position than the front and center speakers. Doing so can weaken the surround sound effect.
- Install the subwoofer on the same plane as the front speakers.

To achieve the best possible surround sound, install your speakers as shown on the right. Be sure all speakers are installed securely to prevent accidents and improve sound quality.

Overhead view of speaker set up

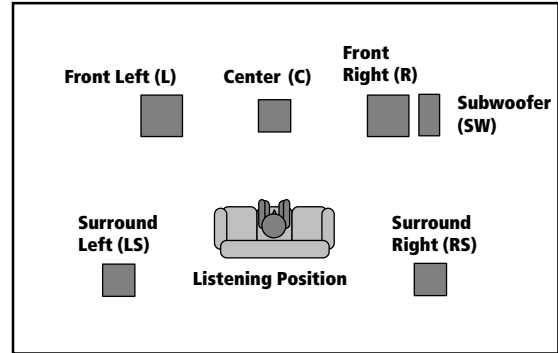

3-D view of speaker set up

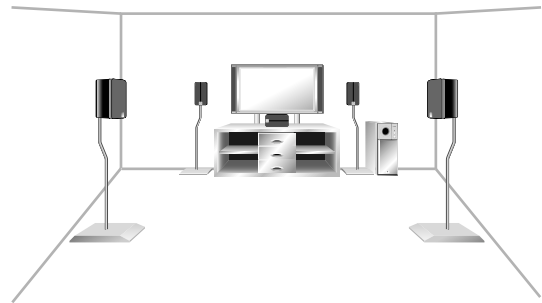

# Connecting Your Equipment

Before making or changing the connections, switch off the power and disconnect the power cord from the AC wall outlet.

## Connecting Antennas

Connect the AM loop antenna and the FM wire antenna as shown below. To improve reception and sound quality, connect external antennas (see Using External Antennas, below).

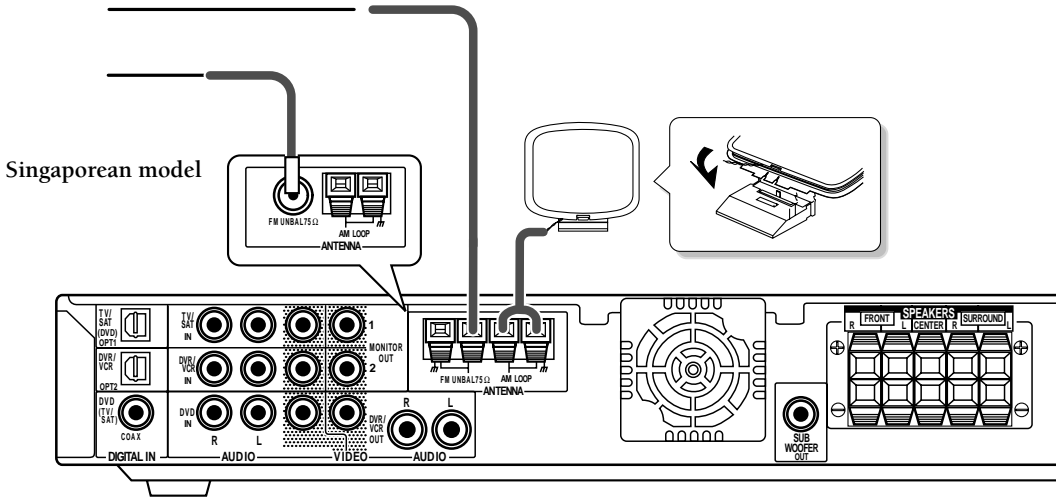

### AM loop antenna

Assemble the antenna and connect to the receiver. Attach to a wall, etc. (if desired) and face in the direction that gives the best reception.

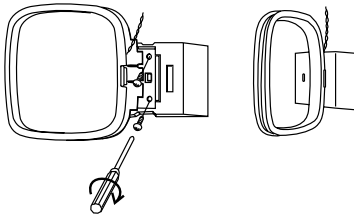

### AM Antenna connectors

Twist the exposed wire strands together push the tab back, insert into the hole and release connector.

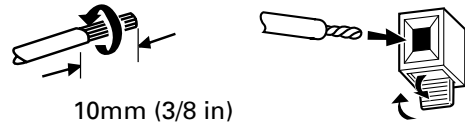

### FM wire antenna

Connect the FM wire antenna and fully extend vertically along a window frame or other suitable area.

## Using External Antennas

### To improve FM reception

Connect an external FM antenna.

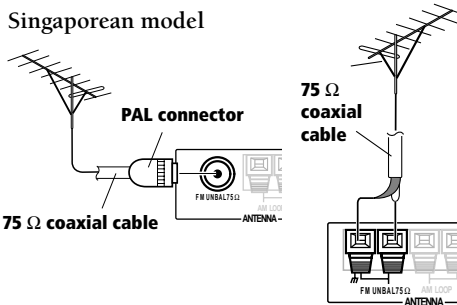

### To improve AM reception

Connect a 5-6 m (15-18 feet) length of vinyl-coated wire to the AM antenna terminal without disconnecting the supplied AM loop antenna.

For the best possible reception, suspend horizontally outdoors.

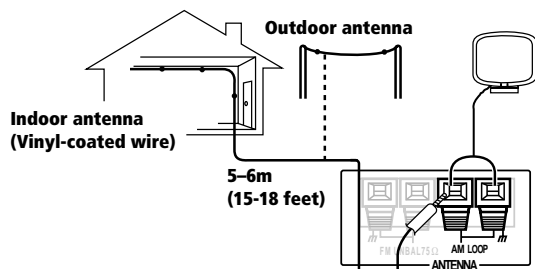

## Operating other Pioneer Components with this Unit's Sensor

By connecting a control cord to the CONTROL terminals of the respective equipment, you can control several Pioneer components using one remote sensor. Following the diagram below you will see that one component feeds the CONTROL OUT terminal and on the other end another component is connected to the CONTROL IN terminal. The component that is the end point (the one that has a cord hooked up to its CONTROL OUT only) it is the component whose sensor you will use. Point the remote control at that sensor when you want to operate the any of the equipment connected by this system. In the example below you would point the remote control unit towards the remote sensor of the equipment on the left.

**Note**

- You can also control Pioneer components by pointing the receiver's remote control directly at the component. This type of operation does not require control cords. See page 44 for more information.
- To use this kind of remote control you have to hook up a control cord AND the have the component and receiver hooked up with analog RCA audio/video cords as well (see pages 14–17).

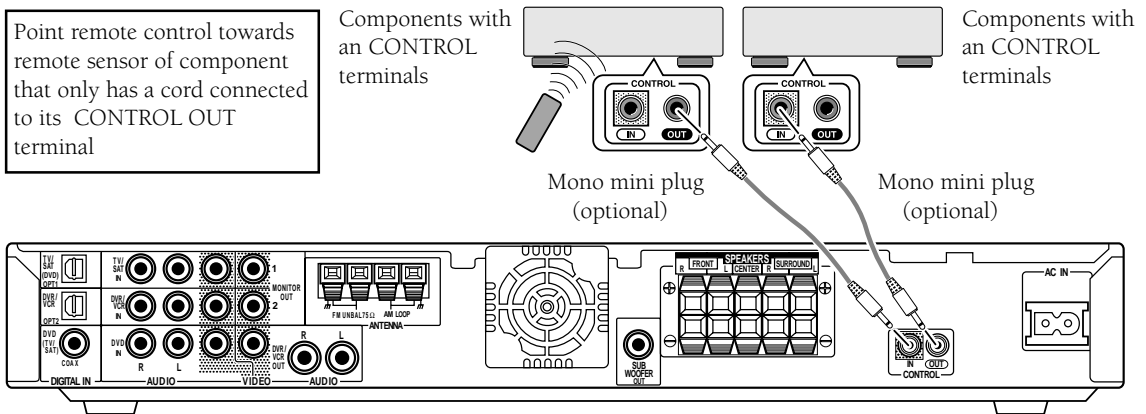

## Plugging in the Receiver

After you have connected all your components, including the speakers, plug the receiver into a wall outlet.

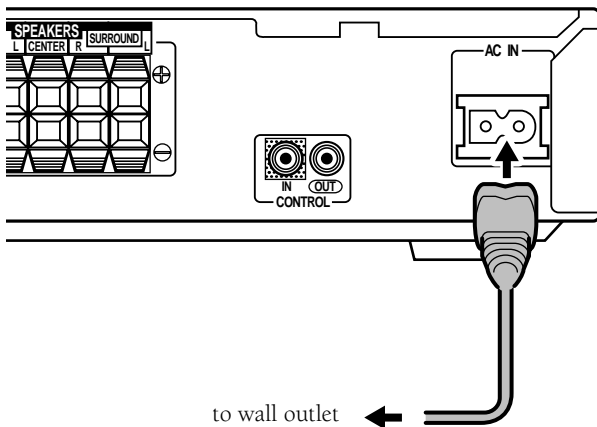

**Note**

- The power cord is removable from main unit for storage.

### Power cord CAUTION!

Handle the power cord by the plug. Do not pull out the plug by tugging the cord and never touch the power cord when your hands are wet as this could cause a short circuit or electric shock. Do not place the unit or a piece of furniture, etc., on the power cord, or pinch the cord. Never make a knot in the cord or tie it with other cords. The power cords should be routed such that they are not likely to be stepped on. A damaged power cord can cause a fire or give you an electrical shock. Check the power cord once in a while. When you find it damaged, ask your nearest PIONEER authorized service center or your dealer for a replacement.

## Front Panel

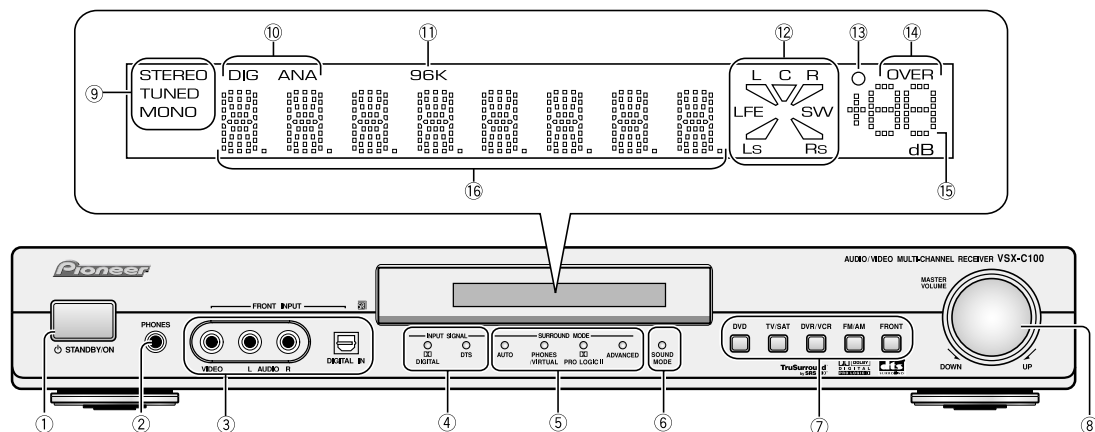
① **STANDBY/ON (Main power) button**

Pressing this button switches the receiver ON from STANDBY mode.

RECEIVER button on the remote control also toggles between ON and STANDBY mode.

The receiver uses a small amount of electricity (less than 1W) in STANDBY mode.

② **PHONES jack**

Use to connect headphones (this switches the speakers off).

③ **FRONT INPUT**

You can connect a portable DVD player, video camera, video game system, or whatever equipment you would like to have handy, to the FRONT INPUT (refer to page 17).

④ **INPUT SIGNAL indicators**

Indicates the kind of input signal.

**DIG** DIGITAL:

When a **DIG** DIGITAL source is input this indicator will light.

**DTS**:

When a DTS source is input this indicator will light.

⑤ **SURROUND MODE indicators**

Indicates the SURROUND mode of input signal.

**AUTO**:

Lights when the AUTO mode is selected. This mode automatically selects which kind of signal is being input and plays back in the appropriate mode.

**PHONES/VIRTUAL**:

Lights when the VIRTUAL or PHONES SURROUND mode is selected. The VIRTUAL mode simulates surround sound for two speakers (when headphones are not plugged in, see p.35). The PHONES SURROUND mode simulates surround sound for headphones, when they are plugged in.

**PRO LOGIC II**:

Lights when the **PRO LOGIC II** mode is selected. This mode automatically plays back in **PRO LOGIC II** (see p.35).

**ADVANCED**:

Lights when an ADVANCED mode is selected. These modes playback emphasizing certain characteristics of the sound (see p.35–36).

⑥ **SOUND MODE**

Lights when you have chosen one of the sound modes to be applied to playback (see p.37).

⑦ **Input buttons**

Use to select the playback source: the possibilities are DVD, TV/SAT, DVR/VCR, FM/AM and FRONT.

⑧ **MASTER VOLUME**

Use to set the overall listening volume.

## DISPLAY

⑨ **TUNER indicators**

**STEREO**: Lights when a stereo FM broadcast is being received in auto stereo mode.

**TUNED**: Lights when a broadcast is being received.

**MONO**: Lights when the mono mode is set using MPX (on the remote control).

⑩ **Digital (DIG) & Analog (ANA) indicators**

Light according to the kind of signal, digital or analog, received (see p.42).

⑪ **96kHz playback indicator**

Lights when a 96 kHz source is being played.

⑫ **Format indicator**

Shows which speakers are currently in use based on the listening mode chosen, the source material and the type of decoding being used (see p.26).

⑬ **SLEEP indicator**

Lights when the SLEEP function is set or active (see p.42).

⑭ **OVER indicator**

Lights when the analog signal is too powerful, causing possible distortion (see p.33).

⑮ **Volume level indicator**⑯ **Character display**

Shows the current input (DVD, TV/SAT, etc.), listening mode, radio frequency, etc.

Rear Panel

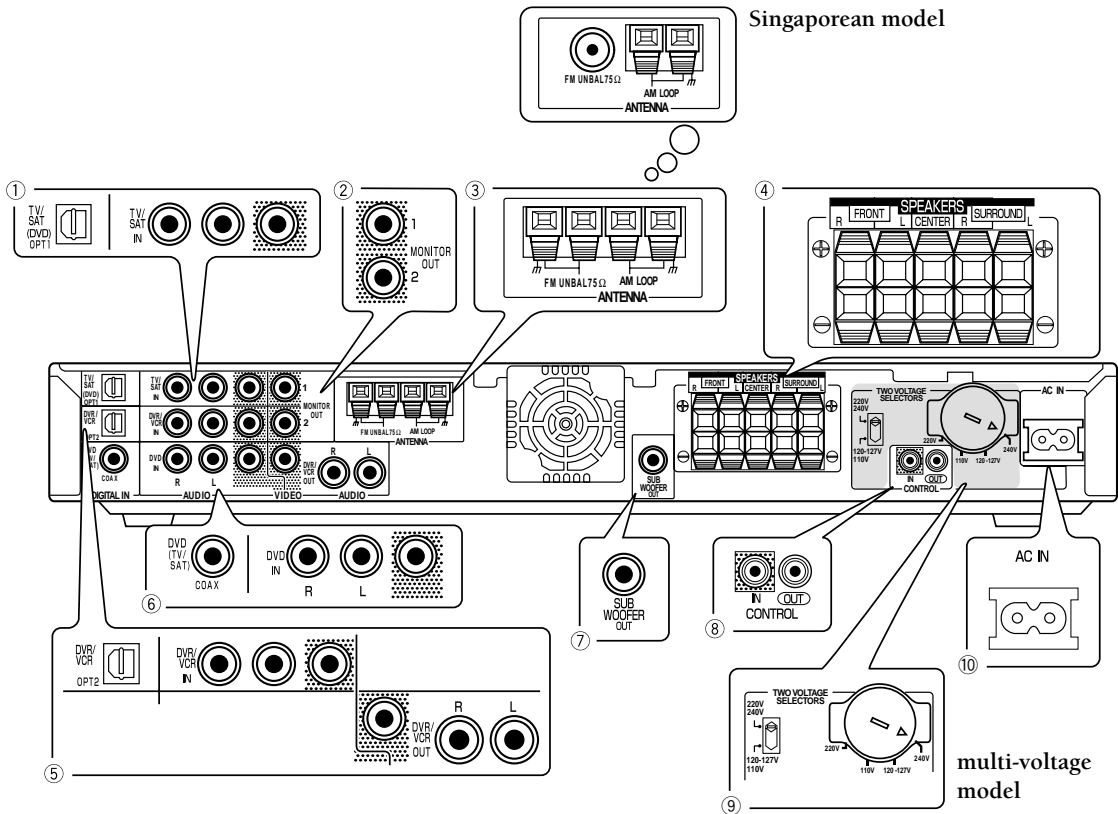



- ① **TV/SAT IN terminals (connect a TV/SAT set top box here, see page 15)**  
Use these terminals to input a TV/SAT signal (or from another kind of source, if you choose). Make sure to connect to the video terminals and both the analog and optical digital terminals for audio. To be able to play digital surround soundtracks you need to make digital connections. To do this it's best to use the optical digital terminal here but you can use the coaxial digital terminal if necessary (in this case you need to assign the terminal to the TV/SAT function. See page 33 in order to do this).
- ② **MONITOR OUT terminals (connect a TV or monitor here, see pages 14)**  
Use these terminals to output the signal from the above terminals ①, ⑤ or ⑥ and FRONT INPUT. These are video jacks. MONITOR 2 outputs the same signal as MONITOR 1.
- ③ **ANTENNA terminals**  
Connect AM or FM antennas here (see page 20).
- ④ **SPEAKERS terminals**  
Use these terminals to connect speakers to the receiver (see page 18).
- ⑤ **DVR/VCR IN/OUT terminals (connect a DVR or VCR here, see page 16–17)**  
Use the optical digital terminal to connect a DVR out digitally to this receiver. There are also analog terminals to input and output the audio and video signal from a DVR, VCR (or a video camera, etc.).

- ⑥ **DVD IN terminals (connect a DVD player here, see page 14)**  
Use these terminals to input the signal from a DVD player. Make sure to connect to the video terminals and both the analog and coaxial digital terminals for audio. To be able to play Dolby Digital and other surround soundtracks you need to make digital connections. To do this it's best to use the coaxial digital terminal but you can use the OPT 1 digital terminal if necessary (in this case you need to assign the coaxial digital terminal to the TV/SAT function. See page 33 in order to do this).
- ⑦ **SUBWOOFER OUT terminals**  
Use this terminal to connect a powered subwoofer to the receiver (see page 18).
- ⑧ **CONTROL IN/OUT terminal**  
You can use this jack to hook up other PIONEER equipment, that bears the CONTROL terminal, so that you can control them all with the remote control for this receiver (see page 21).
- ⑨ **Voltage Selector (multi-voltage model only)**  
Use to match the voltage coming into the receiver with the voltage in your country or region (see page 4).
- ⑩ **AC IN (Power In)**  
Hook up the power cord to this terminal.



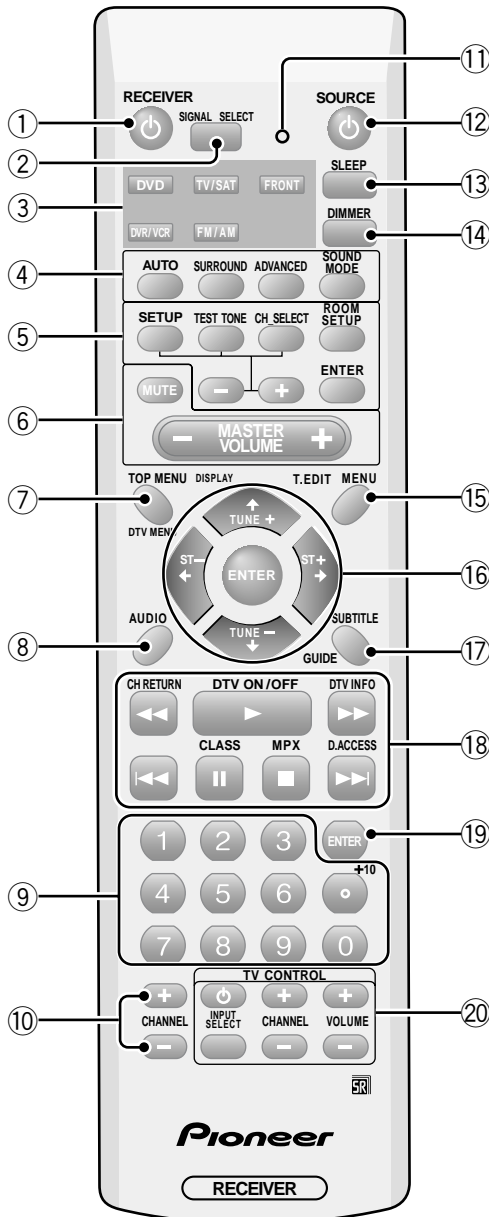



## Remote Control

All the buttons on the remote control are explained here. See pages 47 & 48 for details relating to using the remote control with other components (like your DVD player or TV/SAT tuner).



- ① **RECEIVER  (Power) button:**  
This switches between STANDBY mode and power ON for this receiver.
- ② **SIGNAL SELECT button (See p.42):**  
Press SIGNAL SELECT repeatedly to select one of the following:  
ANALOG: To select an analog signal.  
DIGITAL: To select a digital signal.  
AUTO: This is the default. If there are analog and digital signals input, the receiver automatically selects digital. If only analog is input the receiver will select analog.
- ③ **Input/Control Mode Select buttons:**  
Use to put the receiver/remote control in the input mode stated on the button. The FM/AM button puts the receiver in tuner mode if it was in another mode and switches between the FM and the AM band if the receiver was already in tuner mode.
- ④ **Listening Mode buttons:**  
**AUTO button:**  
Use this button for direct decoding of the input signal with no added sound effects. The receiver will automatically detect what kind of signal (stereo, multichannel, etc.) is being input and play accordingly.  
**SURROUND button (see page 35):**  
Use this button to choose one of the surround listening modes this receiver is equipped with.  
**ADVANCED button (see page 35):**  
Use this button to choose one of the advanced listening modes this receiver is equipped with.  
**SOUND MODE button (see page 37):**  
Use this button to choose one of the sound modes this receiver is equipped with.
- ⑤ **System setup buttons:**  
**SETUP button (see page 29):**  
Use this button to start the receiver setup process which adjusts the settings to your particular system.  
**TEST TONE button (see page 34):**  
Use to sound the TEST TONE when setting the volume level of each channel.  
**CH SELECT button (see page 34, note):**  
Use to select a speaker when setting the volume level of each channel.  
**ROOM SETUP button (see page 28):**  
Use to set the distance from your speakers to your normal listening position.  
**+/- buttons (see pages 29-34):**  
Use these buttons when making adjustments to the SETUP, TEST TONE, or CH.SELECT features.



- ENTER button:**  
Use this button to enter Room Setup commands. You can also use this button to exit a SETUP mode.
- ⑥ **Volume buttons:**  
**MASTER VOLUME +/- buttons:**  
Use to set the overall listening volume.  
**MUTE button (see page 41):**  
Use to mute the sound or restore the sound if it has been muted.
- ⑦ **TOP MENU button:**  
Use to return to the most basic menu on a DVD player or disc. Also used for tuner commands and finding stations or menus on a digital TV tuner.
- ⑧ **AUDIO button:**  
Use to switch the audio tracks of a DVD when in DVD mode or to access the EON function when in tuner mode.
- ⑨ **Number buttons:**  
Use to enter track number on discs or radio frequencies.
- ⑩ **CHANNEL +/- buttons:**  
Use to select channels on other components such as a DVR or satellite tuner.
- ⑪ **LED indicator:**  
This indicator flashes when a command is sent from the remote control to the receiver. It also flashes at when teaching the receiver preset codes.
- ⑫ **SOURCE  (Power) button:**  
Use this button to turn on and off the power of other components.
- ⑬ **SLEEP button (see page 42):**  
Use to put the receiver in sleep mode and select the amount of time before the receiver turns off.
- ⑭ **DIMMER button (see page 41):**  
Press to change the display brightness. The DIMMER button allows you to cycle through the four different brightness strengths for the display.
- ⑮ **MENU button:**  
Use to return to the most basic menu on a DVD player or disc. Also used for some tuner commands.
- ⑯ **    & ENTER buttons**  
Use these arrow buttons when adjusting the tuner or navigating TV or DVD menus. See these respective sections for more information.
- ⑰ **SUBTITLE button:**  
Use to switch the subtitles on a DVD player or disc.
- ⑱ **Component/Tuner/Satellite Tuner/CATV control buttons:**  
The main function of these buttons (, , etc.) is to control a component (CD, for example) after you have selected it using the Input/Control Mode Select buttons. The tuner/satellite tuner controls above these buttons can be accessed after you have selected the corresponding Input/Control Mode Select buttons (TUNER or SAT, etc.). In this case the buttons marked with letters (A, etc.) or EXIT will access preset channels or functions, depending on your particular satellite/cable TV system.  
**CH RETURN button:**  
Returns to the last channel selected when using a digital TV tuner.  
**DTV ON/OFF button:**  
Switches between on or off of DTV mode.  
**DTV INFO button:**  
You can access the DTV information with this button.  
**CLASS button (page 39–40):**  
Switches between the three banks (classes) of radio station presets.  
**MPX button (page 38):**  
Switches between stereo and mono reception of FM broadcasts. If the signal is weak then switching to mono will improve the sound quality.  
**D. ACCESS button (page 39):**  
After pressing, you can access a radio station directly using the number buttons.
- ⑲ **ENTER button (page 47–48):**  
It can be used to enter commands for TV, CATV and TUNER.
- ⑳ **TV CONTROL buttons:**  
These controls are for your TV. They are dedicated TV controls and will work no matter what mode the remote control is in. They can, however, be set for different TVs. By default they will control the TV. Thus if you only have one TV, assign it to the TV/SAT button (see page 45).

## Checking the Settings on Your DVD (or other) Player

If you don't set the following two features correctly you may experience problems with your surround sound (for example: no sound whatsoever; the sound is unidimensional or lacks punch; or other problems).

### 1 Digital output from your DVD player or other component outputting a digital source

Set the DVD player so the signals below are output from the optical terminal (if you are unsure how to do this check the manual that came with your DVD player). It may or may not be necessary to set the digital output on other components, like a satellite tuner. Check the manual that came with the component.

- Dolby Digital
- DTS
- 96 kHz PCM (2 channel stereo)

### 2 Checking the soundtrack on your disc

Choose the surround sound signal (for example, Dolby Digital 5.1 ch or Dolby Surround) that you want to hear from the disc. Check the manual that came with your DVD player for more information.



#### Note

- Depending on your DVD player or source discs you may not be able to output sound from other than digital 2 channel stereo and analog. In this case you need to change the listening mode to SURROUND if you want multichannel surround sound.

## Program Format/Speaker Channel Indicators

One very useful feature of this receiver is the Program Format/Speaker Channel Indicators. This indicator looks something like this:

The letters  
(Input indicator)

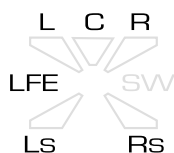

The triangular segments and SW  
(Output indicator)

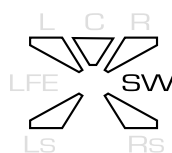

With this indicator you can determine which channels are present in a Dolby Digital or DTS source as well as the speakers that are currently being used. The letters L, C, R, LFE, LS & RS represent the signal being input for each channel respectively, with LFE being the Low Frequency Effects channel which feeds your subwoofer. These letters will only appear if the input is a Dolby Digital or DTS signal.

The triangular segments and SW represent the output from the receiver. The upper segments represent the front left, center, and front right speakers while the bottom segments represent the surround left and surround right channels. SW represents the subwoofer channel. If you have all of these speakers connected and are using either a multichannel signal (for example, Dolby Digital 5.1 ch or Dolby Surround), or a listening mode to get five channels sound, all five of the segments will light. For stereo signals only the front left, center, and front right speakers segments will light.

In some cases, depending on the source and listening mode, the output channels may not light up.

## Playing a Source

Here are the basic instructions for playing a disc or videotape (or any other source) with your home theater system. The following pages will tell you about refinements you can make to the sound but the below procedure (with the settings you have already made) should allow you to get enjoyable home theater.

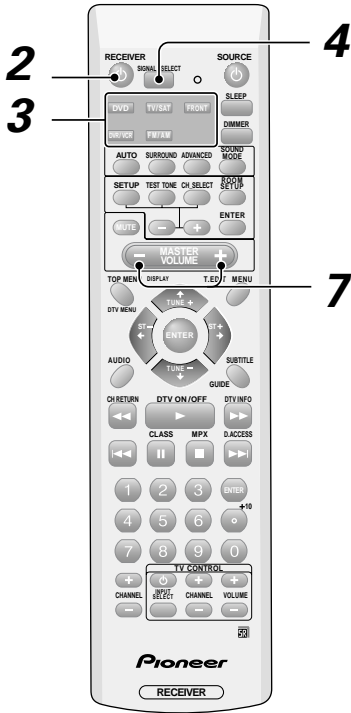

- 1 Turn on the power of the playback component (for example a DVD player), your TV and subwoofer (if you have one).
- 2 Press **RECEIVER** to turn the power on.
- 3 Select the source (like a DVD player) you want to playback using the individual Input buttons on the remote control.
- 4 Set the signal select to AUTO (if necessary).
- 5 Make sure the TV is set to this receiver.  
If you're not sure which input on your TV this receiver is hooked up to confirm the input jack on the back of the TV and consult the manual that came with your TV to figure out the proper setting.
- 6 Start playback of the component you selected in step 3.
- 7 Press **MASTER VOLUME (+/-)** to adjust the volume level.

**Note**

- If you want to use analog sources choose analog with the SIGNAL SELECT button (see page 42).
- When you're using your TV's internal tuner the TV shouldn't be set to this receiver (step 5 above).
- For Karaoke make sure the equipment is hooked up with analog connections and choose analog with the SIGNAL SELECT button (see page 42).

**2** **STANDBY/ON button**

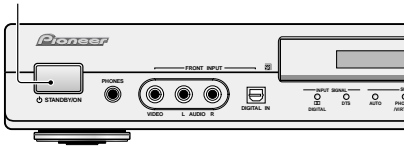

**3** **Input buttons**      **7** **MASTER VOLUME**

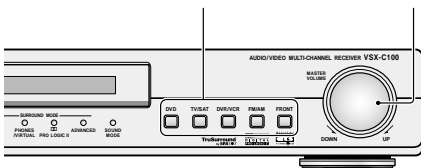

## Room Setup

This setup establishes the distances from your speakers to your normal listening position. It is important for the receiver to know these distances so it can output proper surround sound. Alternatively, you can make more precise speaker distance settings on page 29-31. You don't have to do both, however.

There are three choices for speaker distances here. They are marked 'S', 'M' and 'L' but they represent the relationship between how far your front speakers and your surround speakers are from your normal listening position, i.e. the relationship in distance between the speakers and your listening position. 'S' should be used when your surround speakers are nearer your main listening position than your front speakers. 'M' should be used when all your speakers are equidistant from your main listening position. 'L' should be used when your surround speakers are farther from your main listening position than your front speakers.

Follow the instructions below to set the room type.

**S** (surround speakers closer to listening position)

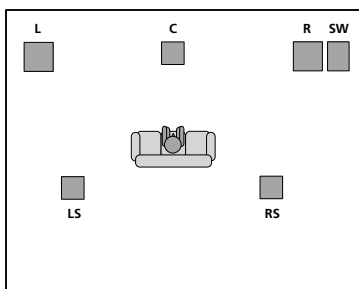

**M** (speakers are equidistant to listening position)

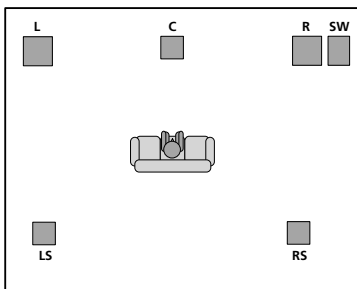

**L** (front speakers are closer to listening position)

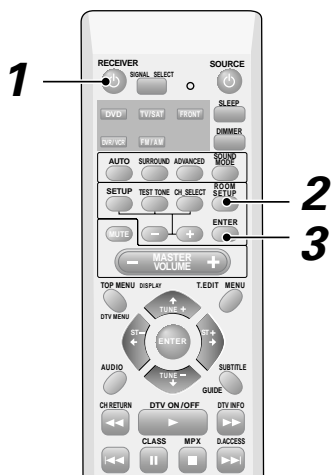
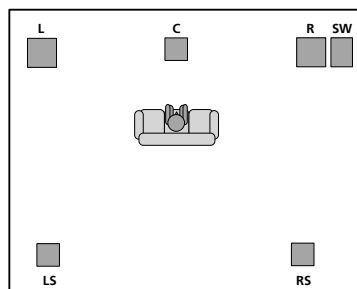

1 Press **RECEIVER** to turn the power on.

2 Press **ROOM SETUP**.

Cycle through the 'S', 'M', or 'L' settings using the ROOM SETUP button and choose the one that best represents the placement of your speakers around the room. The setting will blink for five seconds.

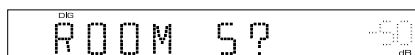

3 While the display is blinking press **ENTER**.

The setting is input into the system and the display shows ENTERED.



1 **STANDBY/ON** button

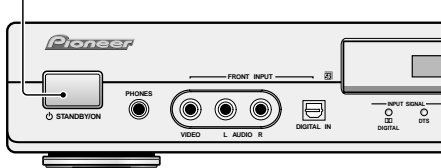

### Note

- These speaker settings will automatically adjust the distance between your listening position and the speakers as well as the output level from each speaker. It is also possible to select these functions manually. To do so see below. For the distance between the listening position and the speakers see pages 29-31; For the output level of each speaker see page 34.
- The settings made most recently, whether here or manually, on the pages mentioned directly above, will supercede any previous settings.
- The default setting is 'M'.

## Personalizing Your Surround Sound

This receiver will make the necessary speakers settings automatically so you can use it to get enjoyable surround sound without doing anything, but making more exact settings here will give you finer surround sound.

For better surround sound complete the instructions that follow the speaker settings. Use the first two steps on this page and continue on page 30. In this way you can get maximum performance out of the receiver.

You only need to do these settings once (unless you change the placement of your current speaker system or add new speakers, etc.). The following pages offer a more detailed description of the settings available for each mode. The default setting is also shown on each page.

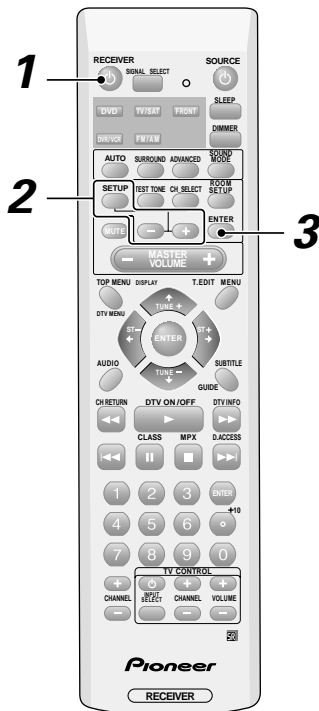

- 1 Press **RECEIVER** to turn the power on.
- 2 Press **SETUP**.

Make the adjustments that match your home setup using the **+/-** buttons. When finished with one setting continue to cycle through the setting modes using the **SETUP** button and make adjustments in the same way.

For best results, start with Front speakers setting mode and make your initial adjustments in the order described below.

The current settings are displayed automatically.

- **Front speakers setting mode (page 30)**  
Use to specify the size and configuration of the FRONT speakers you have connected.
  - **Center speaker setting mode (page 30)**  
Use to specify the size and configuration of the CENTER speaker you have connected.
  - **Surround speaker setting mode (page 30)**  
Use to specify the size and configuration of the SURROUND speakers you have connected.
  - **Subwoofer setting mode (page 30)**  
Use to set the subwoofer output and determine at which frequency the bass tones will be sent to the subwoofer (if it is on).
  - **LFE (Low Frequency Effects) attenuator setting mode (page 31)**  
Use to lower the level for the LFE channel (a special bass channel) when the LFE level is so high as to distort.
  - **Front speakers distance setting mode (page 31)**  
Use to specify the distance from your listening position to your front speaker.
  - **Center speakers distance setting mode (page 31)**  
Use to specify the distance from your listening position to your center speaker.
  - **Surround speakers distance setting mode (page 32)**  
Use to specify the distance from your listening position to your surround speakers.
  - **Dynamic range control setting mode (page 32)**  
Use to compress the dynamic range of a Dolby Digital soundtrack with this feature (for non-Dolby Digital soundtracks use the MIDNIGHT mode for the same effect).
  - **Dual mono setting (page 32)**  
Use with soundtracks that have dual mono encoding if you want to isolate one channel to a particular speaker.
  - **Input attenuator setting (page 33)**  
Use to reduce the analog input level coming into the receiver when it is so loud as to make it distort.
  - **Coaxial connection setting (page 33)**  
Use to tell the receiver (assign) which component is hooked up the other coaxial digital terminal.
- 3 Press **ENTER** to exit the setting mode.

**Note**

The setting mode is automatically exited if no operation is performed within 20 seconds.

### Front speakers setting

This settings establishes the size and configuration of the front speakers you have connected more exactly than the automatic setup. Select either Large (**L**) or Small (**S**). This will determine if bass sounds are sent by the receiver to the speakers being set.

Large: If the cone size (diameter) of your speaker(s) is larger than 12 centimeters (4 12/16 in.), set to Large.

Small: If the cone size (diameter) of your speaker(s) is 12 centimeters (4 12/16 in.) or smaller, set to Small.

**Follow steps 1&2 on page 29 (if necessary).**

**Use the +/- buttons to choose a speaker setting according to the speakers you hooked up.**

Press **SETUP** to advance to the next receiver setting mode.

**Press ENTER if you want to exit the setting mode.**

### Center speaker setting

This settings establishes the size and configuration of the center speaker you have connected more exactly than the automatic setup. Select either Large (**L**) or Small (**S**).

This will determine if bass sounds are sent by the receiver to the speaker being set. If no speakers are connected choose “-”.

Large: If the cone size (diameter) of your speaker(s) is larger than 12 centimeters (4 12/16 in.), set to Large.

Small: If the cone size (diameter) of your speaker(s) is 12 centimeters (4 12/16 in.) or smaller, set to Small.

None (-): Choose this setting if you have no speaker(s) hooked up to this terminal. Sound coming from this channel in the original source will be down-mixed to one of the active speakers.

**Follow steps 1&2 on page 29 (if necessary).**

**Use the +/- buttons to choose a speaker setting according to the speakers you hooked up.**

Press **SETUP** to advance to the next receiver setting mode.

**Press ENTER if you want to exit the setting mode.**



#### Note

- If the front speakers are set to Small (**S**) you can't choose Large (**L**) for the center speaker.
- If the center and surround speakers are set to None (-) the listening modes for all the inputs will automatically go into AUTO mode.

### Surround speakers setting

This settings establishes the size and configuration of the surround speaker you have connected more exactly than the automatic setup. Select either Large (**L**) or Small (**S**). This will determine if bass sounds are sent by the receiver to the speaker being set. If no speakers are connected choose “-”.

Large: If the cone size (diameter) of your speaker(s) is larger than 12 centimeters (4 12/16 in.), set to Large.

Small: If the cone size (diameter) of your speaker(s) is 12 centimeters (4 12/16 in.) or smaller, set to Small.

None (-): Choose this setting if you have no speaker(s) hooked up to this terminal. Sound coming from this channel in the original source will be down-mixed to one of the active speakers.

**Follow steps 1&2 on page 29 (if necessary).**

**Use the +/- buttons to choose a speaker setting according to the speakers you hooked up.**

Press **SETUP** to advance to the next receiver setting mode.

**Press ENTER if you want to exit the setting mode.**



#### Note

- If the front speakers are set to Small (**S**) you can't choose Large (**L**) for the surround speakers.
- If the center and surround speakers are set to None (-) the listening modes for all the inputs will automatically go into AUTO mode.

### Subwoofer setting

The Subwoofer setting divides the high and low sounds (frequencies) between the speakers. Since most smaller speakers can't handle deep bass tones, this setting allows you to send those sounds to the subwoofer instead of the speakers set to Small (**S**) in your system. Choose the point at which you want the frequency routed to the subwoofer. We recommend setting this to 200 Hz if smaller bookshelf-type speakers are used for your “Small” speakers. Also, when a subwoofer is used, you have the option of selecting the PLS setting, which adds extra bass.

**Follow steps 1&2 on page 29 (if necessary).**

**Use the +/- buttons to choose subwoofer setting 100 Hz, 150 Hz, 200 Hz, PLS (plus) or --- (off).**

**SUBWF 200 Hz**

Sends bass frequencies below 200 Hz to the subwoofer.

**SUBWF 150 Hz**

Sends bass frequencies below 150 Hz to the subwoofer.

**SUBWF 100 Hz**

Sends bass frequencies below 100 Hz to the subwoofer.

**SUBWF PLS**

Adds extra bass to the soundtrack.

**SUBWF ---**

Select if you didn't connect a subwoofer.

Press **SETUP** to advance to the next receiver setting mode.

Press **ENTER** if you want to exit the setting mode.

 **Note**

- The Subwoofer setting will appear automatically, depending on whether you have connected a subwoofer or not.
- The default setting is "200 Hz".
- You can only select PLS when the front speakers are set to Large (L).
- If the all the speakers are set to Large (L) you can only select 100 kHz, PLS or off (---) for the Subwoofer.
- Setting the front speakers to Small (S) means you will use a subwoofer, thus its setting cannot be turned off. In this case make sure you set the subwoofer and choose its cutoff frequency.
- There are some cases where no sound will come from the subwoofer even if it is (this depends on the speaker setting, the listening mode and/or the kind of source material).

**LFE attenuator setting**

Dolby Digital and DTS audio sources include ultra-low bass tones. Set the LFE attenuator as needed to prevent the ultra-low bass tones from distorting the sound from all the active speakers.

Follow steps 1&2 on page 29 (if necessary).

Use the +/- buttons to choose the attenuation level 0 dB, 10 dB or LFE OFF.

**0 dB**

No attenuation.

**10 dB**

LFE volume is reduced.

**LFE OFF**

LFE channel is off.

Press **SETUP** to advance to the next receiver setting mode.

Press **ENTER** if you want to exit the setting mode.

 **Note**

- The default setting is "0 dB".

**Front speakers distance setting**

Set the distance from the front speakers to the listening position.

Follow steps 1&2 on page 29 (if necessary).

Use the +/- buttons to choose the distance of the front speakers from the main listening position (within a range from 1 foot [0.3m] to 30 feet [9m]).

Press **SETUP** to advance to the next receiver setting mode.

Press **ENTER** if you want to exit the setting mode.

 **Note**

- The default setting is "6 feet (1.8m)".
- One step equals about 1 foot (0.3m).
- If you do the Room Setup (see page 28) after the settings here, those will take precedence.

**Center speaker distance setting**

Set the distance from the center speakers to the listening position.

Follow steps 1&2 on page 29 (if necessary).

Use the +/- buttons to choose the distance of the center speaker from the main listening position (within a range from 1 foot [0.3m] to 30 feet [9m]).

Press **SETUP** to advance to the next receiver setting mode.

Press **ENTER** if you want to exit the setting mode.

 **Note**

- The default setting is "5 feet (1.5m)".
- One step equals about 1 foot (0.3m).
- When "CENTER -" is selected in Center speaker setting, the Center speaker distance cannot be set.
- If you do the Room Setup (see page 28) after making the settings here, those will take precedence.

### Surround speakers distance setting

Set the distance from the surround speakers to the listening position.

Follow steps 1&2 on page 29 (if necessary).

Use the +/- buttons to choose the surround speakers from the main listening position (within a range from 1 foot [0.3m] to 30 feet [9m]).

Press SETUP to advance to the next receiver setting mode.

Press ENTER if you want to exit the setting mode.

#### Note

- The default setting is “6 feet (1.8m)”.
- One step equals about 1 foot (0.3m).
- When “SURR. –” is selected in Surround speakers setting, the Surround speakers distance cannot be set.
- If you do the Room Setup (see page 28) after the settings here, those will take precedence.

### Dynamic range control setting

Dynamic range is the difference between the loudest and softest sounds in any given signal. The dynamic range control helps you playback sounds so the quieter sounds are audible yet the louder sounds don't get distorted. It does this by compressing the dynamic range. When watching a movie at low volume, setting this function enables low level sounds to be heard more easily but you won't be jolted by louder sounds.

Follow steps 1&2 on page 29 (if necessary).

Use the +/- buttons to choose the dynamic range control (OFF, MAX, or MID).

Dynamic range control is operative only when a Dolby Digital soundtracks with this feature encoded into it is being played back. For other sources use the MIDNIGHT mode (see page 37) to achieve the same effect.

Press SETUP to advance to the next receiver setting mode.

Press ENTER if you want to exit the setting mode.

#### Note

- The default setting is “OFF”.
- When listening at high volume, set to OFF.
- For best results at low volumes, set to “MAX” for maximum dynamic range compression.
- Dynamic range control is expressed as DRC in the display.

### Dual mono setting

Dual mono has two different audio channels in it. You can use it to listen to soundtracks that have one language on one channel and a different language on the other.

The dual mono setting can only be used when listening to discs that have dual mono software encoded in them, for example some Dolby Digital discs. As of now these are not that widely used.

The **ch1** setting plays channel 1 through your center speaker. If you have selected no Center speaker in the speakers setting (or are in a 2 ch listening mode) then you will hear ch1 out of both front speakers. The **ch2** setting plays channel 2 through your center speaker. If you have selected no Center speaker in the speakers setting (or are in a 2 ch listening mode) then you will hear channel 2 out of both front speakers. In the **L. c1 R. c2** setting the speakers will play the soundtrack independently of each other. The left front speaker will play channel 1 and the right front speaker will play channel 2.

Follow steps 1&2 on page 29 (if necessary).

Use the +/- buttons to choose the Dual mono setting (ch1, ch2 or L. c1 R. c2).

Press SETUP to advance to the next receiver setting mode.

Press ENTER if you want to exit the setting mode.

#### Note

- The default setting of this feature is “ch1”.



## Input attenuator setting

You can set the input signal to be lowered if it is distorting. This is only possible for analog signals, digital signals can't be attenuated.

**Follow steps 1&2 on page 29 (if necessary).**

**Use the +/- buttons to set the input attenuator ON or OFF.**

Press **SETUP** to advance to the next receiver setting mode.

**Press ENTER if you want to exit the setting mode.**



### Note

- The default setting is "OFF".
- When the OVER indicator light please put the input attenuator ON.
- The Input Attenuator is expressed as IN.ATT in the display.

## Coaxial connection setting (assigning the coaxial terminal)

This receiver has two different ways you can connect your digital video components (like a DVD player, satellite tuner, or DVR). You can connect them with an optical or coaxial cords (see p.13). The easiest way to hook your equipment is using the default settings of this receiver. In this case, use a coaxial cord to connect your DVD player. If you use the coaxial terminal for your satellite or TV tuner (called TV/SAT on the receiver) you need to assign that component to the remote (that is, tell the remote that you used the coaxial terminal for your TV/SAT). The optical terminals' default settings will change in accordance with how you assign the coaxial terminal here. See the next heading for more information.

**Follow steps 1&2 on page 29 (if necessary).**

**Use the +/- buttons to choose the component that you hooked up with coaxial cords.**

Press **SETUP** to advance to the next receiver setting mode.

**Press ENTER if you want to exit the setting mode.**

## Optical connection default settings

You can connect your digital video components (like a DVD player, satellite tuner, or DVR) with optical or coaxial cords, as explained directly above and on page 13. However, the optical terminals cannot be assigned, you must follow their default settings in order to match your equipment to the remote control buttons (and display names, etc.) of this receiver. Thus if you followed the default setting for the coaxial terminal and hooked a DVD up to that terminal the optical terminal default settings are:

OPT. 1: TV/SAT

OPT. 2: DVR

If you assigned your TV/SAT (displayed as SAT) to the coaxial terminal (see "Coaxial connection setting" above and "Connecting Your Equipment" page 14–16) then the defaults for the optical terminals will change (because you cannot have one component assigned to two different places). Thus they become:

OPT. 1: DVD

OPT. 2: DVR

Follow the default settings when hooking up equipment to the optical terminals.

## Setting the Volume Level of Each Channel (adjusting the speaker volume balance)

Use to set the relative volume of each channel as you find necessary.

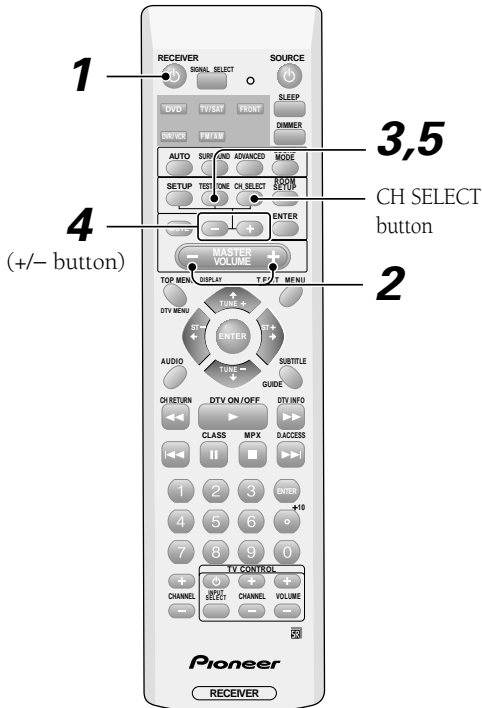

- 4 Use the + or – buttons to adjust speaker levels so that you hear the test tone at the same volume from each speaker when seated in your main listening position.
- If a speaker is deselected in the center, surround speaker or subwoofer setting mode (see page 30) then no test tone will be output for that speaker.
- The channel level range is  $\pm 10$  dB.
- Levels can be set for each surround mode.
- 5 Press **TEST TONE** to turn off the test tone.

### Note

- Since the subwoofer transmits an ultra-low frequency its sound may seem quieter than it actually is. Be careful not to turn up your subwoofer too much and check the volume with an actual source.
- The subwoofer volume is best controlled with the volume control on the powered subwoofer.
- The speaker volume can be adjusted without outputting the test tone by pressing CH SELECT and +/- button.
- The default setting is 0 dB for all channels.
- If you have adjusted the channel level using the + button, even if the master volume is all the way up you'll never actually get a volume level that is 0 dB (full volume).

- 1 Press **RECEIVER** to turn the power on.
- 2 Press **MASTER VOLUME +** or – to adjust the volume to an appropriate level.
- 3 Press **TEST TONE** to output the test tone.

The test tone is output in the following order.

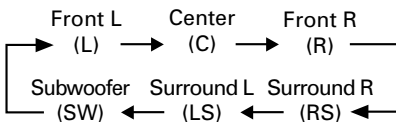

The test tone sequence corresponds to the speaker settings.

## Listening Modes

Intrinsic to home theater, surround sound delivers a realistic and powerful soundtrack that recreates the movie theater experience. You may need to experiment with these different modes to see which suit your home system and personal tastes, but in general you should listen to movie sources (like DVDs) in one of the listening modes for multichannel outputs.

### AUTO

This mode automatically detects what kind of signal is being input and employs the proper listening mode of the receiver. If you don't know what kind of signal (stereo, multichannel, etc.) you are using or don't want to bother with switching listening modes, use this feature. This is the basic home theater decoding mode.

### SURROUND

These modes are generally used for two channel sound sources though you can use multichannel sources like Dolby Digital. If you use multichannel sources with these modes you won't be able to select the first three. Try the modes with sources that seem to match the description of the mode below and decide if you like the results. What modes you are able to access in any given situation will depend on the source you are using, the surround settings and other receiver factors (for example, you won't be able to access PHONES SURROUND mode unless you have the headphones plugged). Also, according to the speaker settings you have made and the signal input you may or may not be output from a subwoofer in these modes.

#### PRO LOGIC

This mode gives 4.1 channel surround sound. It is less sensitive to the quality of the source material so it may be useful when PRO LOGIC II MOVIE/MUSIC do not give good results.

#### PRO LOGIC II MOVIE (MOVIE)

This mode gives 5.1 channel surround sound. It is suitable for movies, especially those recorded in Dolby Surround. The channel separation and movement of surround effects is comparable to Dolby Digital 5.1.

#### PRO LOGIC II MUSIC (MUSIC)

This mode gives 5.1 channel surround sound and is suitable for music. The surround effect is more enveloping than PRO LOGIC II MOVIE.

#### VIRTUAL (TRUSURROUND VIRTUAL)

This mode imitates surround sound with two speakers. The sound will only be heard from two speakers in this mode but the feeling of an all-encompassing surround sound is reproduced.

#### PHONES SURROUND

When listening with headphones the above mode becomes PHONES SURROUND. Here the effect of overall surround sound is reproduced for headphone listening.

#### STEREO

Use this mode to listen to conventional stereo sources and retain a stereo sound. Even if a multichannel source is input when you are using this listening mode, you will only hear two channel sound.

### ADVANCED

These modes are used to decode all sound sources but each mode emphasizes certain characteristics of the sound. Experiment with the modes and different sound sources to get an effect that suits you. You cannot choose ADVANCED modes when inputting 96 kHz signals.

#### MOVIE

This mode simulates the relaxed environment of a medium size movie theater, and is suitable for watching drama.

#### MUSIC

This mode simulates the acoustics of a large concert hall and is suitable for music or musical sources.

## Playback Modes

### TV SURROUND

This mode produces surround sound even for mono or stereo TV sources. It is useful for old movies. A mono TV signal will be able to approximate the effect of overall surround sound.

### GAME

Use this mode when playing a video game. It works especially well with sound moving from left to right in such software as racing games, shooting games, and those kind of games with movement in them.

### VIRTUAL Surround Back (VIRT SB)

This mode is especially designed to simulate surround back channels for sources that don't have them. It emulates the effect of surround back speakers in your listening space.

### EXPANDED

This mode is especially designed to give sound depth to Dolby Surround sources. The overall effect expands the sound, giving a dynamic and broad sound to these sources while allowing a faithful reproduction of five speaker sound.

### 5-CH STEREO (5 STEREO)

This mode is especially designed to give sound depth to Stereo sources. The overall effect builds a dynamic and broad sound space, allowing a reproduction with five speakers.

## Selecting a Listening Mode

Choose a listening mode that suits the soundtrack you are listening to or achieves the effect you want, as explained on the previous page. It will probably be necessary for you to experiment with different modes until you find ones which suit your tastes.



1-2

- 1 Press **AUTO**, **SURROUND** or **ADVANCED**.
- 2 If you choose one of the latter two, cycle through the modes using the **SURROUND** or the **ADVANCED** button and select the one suits the soundtrack you're listening to.

Refer to page 35 for more details about each listening mode.

### Note

- The default setting is AUTO. With headphones the default setting is STEREO.
- You can only select the STEREO or PHONES SURROUND mode when headphones are plugged into the headphone jack.
- The listening mode you choose with headphones is fully independent of the listening mode with speakers.
- If you disconnect the headphones while in PHONES SURROUND mode the receiver will return to the listening mode it was in before you selected PHONES SURROUND.
- When inputting a 96 kHz PCM signal you can only use STEREO listening modes.
- If you are in a different mode than STEREO and then input a 96 kHz PCM signal the receiver will automatically switch to AUTO.
- Each playback component can be set independently and retains its sound mode when another component is being used.
- If you did not connect center and surround speakers you can only choose VIRTUAL or STEREO in SURROUND mode.

## Sound Modes

The Sound Modes allow you to add certain sound elements when playing all kinds of sources (two-channel/stereo sources, Dolby Surround sources, Dolby Digital or DTS sources). They can be used in conjunction with the listening modes explained on the previous page.

### NATURAL

This mode flattens the total frequency output to make it match the characteristics of the small speakers. When playing a multichannel source using the small speakers this setting corrects the frequency to achieve better theater-like surround sound.

### MIDNIGHT

This mode makes the softer sounds more audible and the louder sounds a bit softer so you can hear the entire soundtrack, especially quiet sounds and dialog, with a good surround sound feeling when listening at low volumes.

### QUIET

This mode reduces the bass and treble in the signal. It is best used when you feel sounds are too harsh or sharp and would like to smooth them out.

### BRIGHT

This mode is used for 2ch Stereo, and is only audible from the front speakers. It flattens the total frequency output to make it match the characteristics of the front speakers. When playing two channel sources the bass trim often becomes muddy and this mode offers clear, true sound in low and high frequencies.

### S.BASS

This mode increases the bass in the signal and puts the beat of the music or soundtrack in the forefront.

### OFF

No sound mode is applied.

## Selecting a Sound Mode

The receiver has three tone effect types that you can add to the Listening mode you are using.

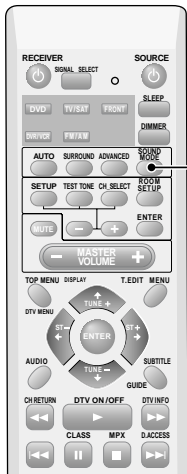

1-2

### 1 Press **SOUND MODE**.

### 2 Cycle through the different possibilities using the **SOUND MODE** button and select the one you want.

Refer to above for more details about each sound mode.



### Note

- The default setting is NATURAL.
- Each playback component can be set independently and retains its sound mode when another component is being used.
- When you choose VIRTUAL mode (page 35) you can't select a Sound mode.
- When inputting a 96 kHz PCM signal you can't select a Sound mode.

## Finding a Station

The following steps show you how to tune in to FM and AM radio broadcasts using the automatic (search) and manual (step) tuning functions. If you already know the exact frequency of the station you want to listen to, see “Tuning Directly to a Station” on page 39. Once you are tuned to a station you can memorize the frequency for recall later—see “Memorizing Stations” on page 39 for more on how to do this.

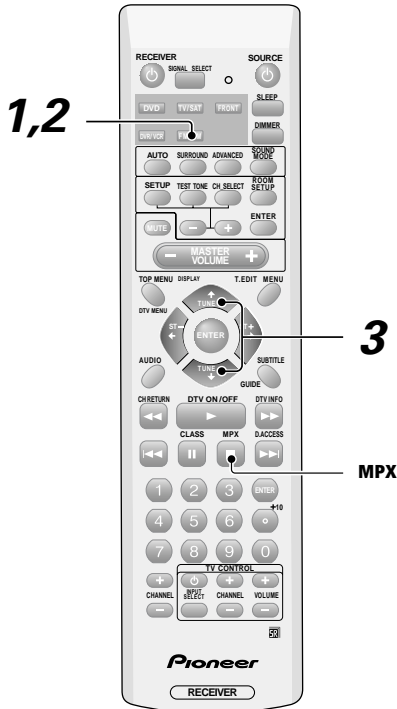

- 1 Press the **FM/AM** button on the remote control to put it in tuner mode.
- 2 Press the **FM/AM** button again to change the band (FM or AM), if necessary.  
Each press switches the band between FM and AM.
- 3 Tune to a station using the **TUNE +** or **TUNE –** buttons.

### Automatic tuning

To search for stations in the currently selected band, press and hold either the **TUNE +** or **TUNE –** buttons for about a second. The receiver will start searching for the next station, stopping when it has found one. Repeat this step to search for other stations.

### Manual tuning

To change the frequency one step at a time, press the **TUNE +** or **TUNE –** buttons.

### High speed tuning

Press and hold the **TUNE +** or **TUNE –** buttons for high speed tuning, releasing the button once the desired frequency is reached.

## MPX mode

If there is interference or noise during a FM radio broadcast, or the radio reception is weak, press the **MPX** button to switch the receiver into mono reception mode. This should improve the sound quality and allow you to enjoy the broadcast.

## Channel Step Setting (multi-voltage model only)

The unit has been factory preset to the channel allocation value for the area in which it is to be sold. If this value is set incorrectly, the tunes in frequency may be wrong, or sound may be distorted, resulting in an inability to reproduce reception signals at their proper sound quality. For this reason, be sure to confirm that the values are set correctly before first using the unit.

### FM 100 kHz, AM 10 kHz:

Set to this position for areas with an FM reception step of 100 kHz and AM 10 kHz.

### FM 50 kHz, AM 9 kHz:

Set to this position, for areas with an FM reception step of 50 kHz and AM 9 kHz.



### Note

When unsure about the channel allocation for your area, consult your dealer for correct information.

## To Change Channel Steps (multi-voltage model only)

With the power turned on, press the **FM/AM** button and the **DVR/VCR** button on front panel at the same time for five seconds to change the kHz setting.

- Each time the above operation is performed, the channel tuning step will alternate between **10K STEP**, and **9K STEP**.

## Tuning Directly to a Station

Sometimes, you'll already know the frequency of the station you want to listen to. In this case, you can simply enter the frequency directly using the number buttons on the remote control.

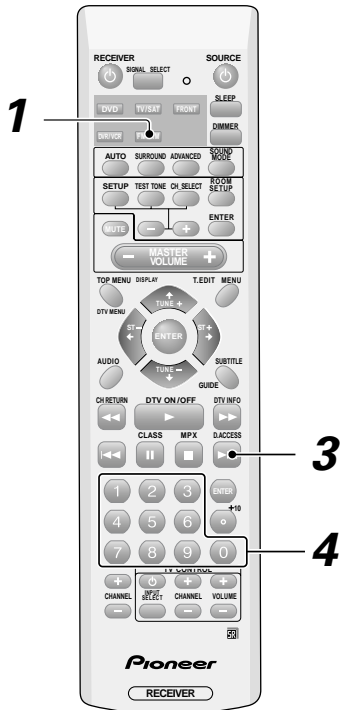

- 1 Press the **FM/AM** button on the remote control to put it in tuner mode.
- 2 Press the **FM/AM** button again to change the band (FM or AM), if necessary.  
Each press switches the band between FM and AM.
- 3 Press **D.ACCESS** (Direct access).
- 4 Use the number buttons to enter the frequency of the radio station.  
Example: To tune to 106.00 (FM), press **1 - 0 - 6 - 0 - 0**



### Note

- If you make a mistake while inputting the frequency, press the **D.ACCESS** button twice to cancel the frequency and start again.

## Memorizing Stations

If you often listen to a particular radio station, it's convenient to have the receiver store the frequency for easy recall whenever you want to listen to that station. This saves the effort of manually tuning in each time. The receiver can memorize up to 30 stations, stored in three banks, or classes, (A, B and C) of 10 stations each. When memorizing FM frequencies, the receiver also stores the MPX setting (auto stereo or mono, see page 38).

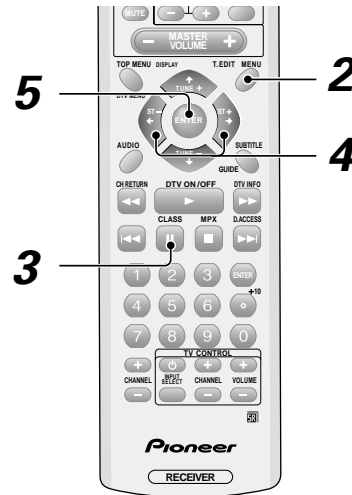

- 1 Tune to a station you want to memorize.

See "Finding a Station" on page 38 and "Tuning Directly to a Station" on this page for more detail on how to do this.

- 2 Press **T.EDIT**.

The display shows a blinking memory class.



- 3 Press **CLASS** to select one of the three classes.

Repeatedly pressing this button cycles through the three available classes, A, B and C.

- 4 Press the **ST +** or **ST -** buttons (or the number buttons) to select the station memory number you want.

Pressing these buttons repeatedly cycles through the 10 available station memories in each class.

After choosing the location you want, the preset class and number blink.

- 5 Press **ENTER** while the display is blinking to input your choice.

- 6 Repeat steps 1 to 4 to memorize up to 30 stations.

### Naming Memorized Stations

You can input a name of up to four characters for each preset station in the receiver's memory (see the previous page). This name can be anything you choose. For example, you could input "BBC1" for that station and when you listen to it the name, rather than the frequency number, will appear on your display.

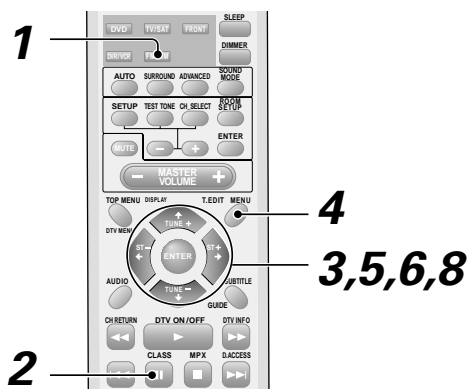

- 1 Press the **FM/AM** button on the remote control.
- 2 Press **CLASS** repeatedly to select the class. Repeatedly pressing this button cycles through the three available classes, A, B and C.
- 3 Press **ST +** or **ST -** to select the FM preset channel.
- 4 Press **T.EDIT** twice to select the station name mode.



- 5 Press **ST +** (or **ST -**) to choose the first character. Scroll through the letters, numbers and symbols you can input. Stop on the one you want.



- 6 Press **ENTER** to input the first of the four characters. That character lights steadily in the display and the cursor automatically moves to the next space.
- 7 Enter up to three more characters in the same way.



Any time you want to exit the process you can press the T.EDIT button.

- 8 Press **ENTER** when you have got the characters you want to enter.
- 9 Repeat steps 2 to 6 to memorize up to 30 preset broadcast station names.

#### To erase or change the station name

Perform the procedures of "Naming Memorized Stations" and enter four spaces to erase the memorized station name.

When you want to change a memorized station name, input the new station name using the same procedure.

### Recalling Memorized Stations

Having memorized up to 30 stations (see the previous explanation for how to do this), preset stations can be easily recalled.

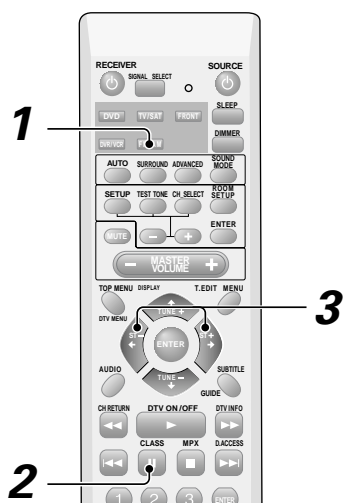

- 1 Press the **FM/AM** button on the remote control.
- 2 Press **CLASS** to select the class in which the station is stored. Repeatedly pressing this button cycles through the three available classes, A, B and C.
- 3 Use the **ST +** or **ST -** buttons (or the number buttons) to select the station memory in which the station is stored. Alternatively, recall the station memory using the number buttons on the remote control.



#### Note

- If the receiver is left disconnected from the AC power outlet or the power is turned off for more than one month, the station memories will be lost and will have to be reprogrammed.



## Muting the Sound

Use this feature to mute the volume.

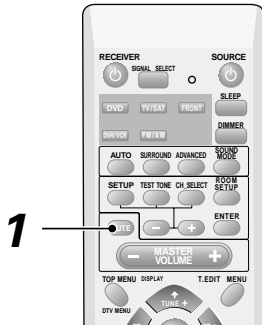

- 1 Press the **MUTE** button on the remote control.

No sound will be audible until the MUTE button is pressed again to cancel the muting. Alternatively, you can press the MASTER VOLUME +/- buttons to cancel the muting.

## Using the Headphones

The headphone features are explained here.

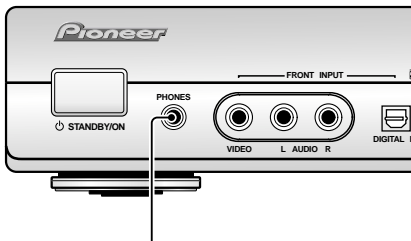

PHONES jack

Plug headphones into the PHONES jack on the front of the receiver.

No sound will be audible from the speakers when headphones are plugged in.

**Note**

- When using the headphones you can only select STEREO or PHONES SURROUND listening modes.

## Changing the Display Brightness (DIMMER button)

The display on the receiver has four brightness settings. Use the instructions below to adjust the brightness of the display.



- 1 Use the **DIMMER** button to cycle through the different display brightness settings.

There are four brightness settings, including display off.

**Note**

- In the off mode all the lights in the display are off except for the master volume indicator, which appears very dimly.
- If you operate the receiver when the display is in the off or dimmed modes the display will light for about two seconds and then go off again.

## Using Other Functions

### Input Signal Select

This button selects the type of input signal, ANALOG, DIGITAL or AUTO, sent to the receiver. You need to take special care to switch to the appropriate input when necessary. For example, the switch would have to be on DIGITAL to hear Dolby Digital or DTS surround sound material but it would have to be on analog to record from the ANALOG out jacks on the receiver. The default setting is AUTO which chooses digital over analog when both are available but goes with whatever is available if it is the only choice.

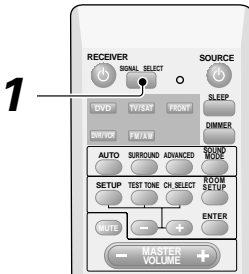

- 1 Use the **SIGNAL SELECT** button to cycle through the three input modes.

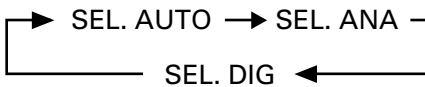

#### Note

- If there are no digital inputs (see p.14–17), the SIGNAL SELECT will default to AUTO.
- Set the SIGNAL SELECT to ANALOG if you want to use the receiver for karaoke.

### The SLEEP Function

Use this function to listen to the receiver and have it turn off at a specified time without you having to do anything. As is clear from the title this function is useful for drifting off to sleep while listening to music.

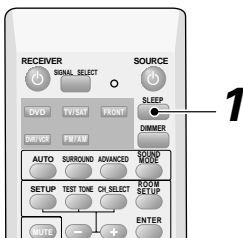

- 1 Use the **SLEEP** button to cycle through the three sleep time lengths (90 min., 60 min., and 30 min.) and set the sleep timer.

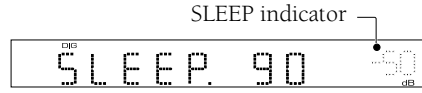

#### Note

- When the SLEEP timer has been set, or is active, a dot indicator will appear in the display (to the left of the volume indicator).
- Press the SLEEP button once to view how much time is left on the timer before shutdown. Each press after that will cycle through the possible SLEEP time lengths.

### Resetting the System

Use this feature to reset the system to its factory default settings.

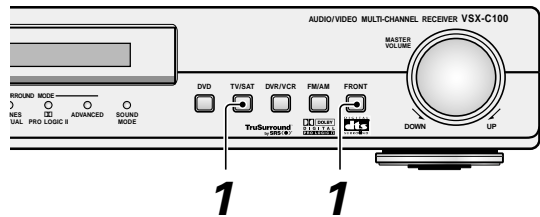

- 1 Press the **TV/SAT** button and the **FRONT** button at the same time for five seconds to return all of the settings to their default mode.

#### Note

- If the receiver is disconnected from a power source for more than a month, or the main power is turned off, it will reset to the default settings.
- The above reset doesn't affect the presets that you have programmed into the remote control (see page 45).
- The receiver resets to STANDBY.

## Default Settings for the Receiver

All the settings that return to their defaults when you reset the system are listed here (see the previous page “Resetting the System”).

Setting Type		Default Settings	Page
Input		DVD	page 27
MASTER VOLUME		— — — dB (no sound)	page 27
Listening mode		AUTO (all inputs)	page 35
Listening mode (with headphones)		STEREO (all inputs)	page 35
Sound mode		NATURAL	page 37
Input signal select		AUTO	page 42
Speakers (Front, Center, Surround) setting		automatically sensed	page 30
Subwoofer setting		200 kHz	page 30
LFE attenuator		0 dB	page 31
Front speakers distance		6 ft (1.8 m)	page 31
Center speakers distance		5 ft (1.5 m)	page 31
Surround speakers distance		6 ft (1.8 m)	page 32
Dynamic range control		OFF	page 32
Dual mono		ch1	page 32
Input attenuator		OFF	page 33
Coaxial connect setting		DVD (OPT1 TV/SAT)	page 33
Setting the volume level of each channel		Front “0 dB”, Center “0 dB”, Surround “0 dB”, Subwoofer “0 dB”	page 34
Frequency step	Singapore, multi-voltage model	AM: 9kHz FM: 50kHz	page 38
	U.S. model	AM: 10kHz FM: 100kHz	page 38



### Note

- The default settings for the remote control to control other components are listed on page 46.

## Changing the Remote Control Mode

The remote control that comes with this receiver is very flexible and can be switched from controlling this receiver to controlling other components, even components not made by Pioneer. You can set up the remote to control so it will be able to control everything in your system and thus you'll only need to use this remote when operating your home theater system.

The settings to control other components on this remote control are for Pioneer equipment but you can include most other brand makers. You do this by inputting preset codes that have been decided for each brand maker into the remote (see the next page). After these codes are input you'll be able to operate the equipment.

For this remote, when you press an input button (like DVD) it also changes the remote control from controlling the receiver to controlling DVD functions as well as switching the input to the receiver.

## Switching the Operation Mode of the Remote

Press the button for the piece of equipment you want to control with this remote (for example DVD). Since the buttons have different functions when operating different equipment pages 44 & 45 will give you detailed information on what each button does in each operation mode.

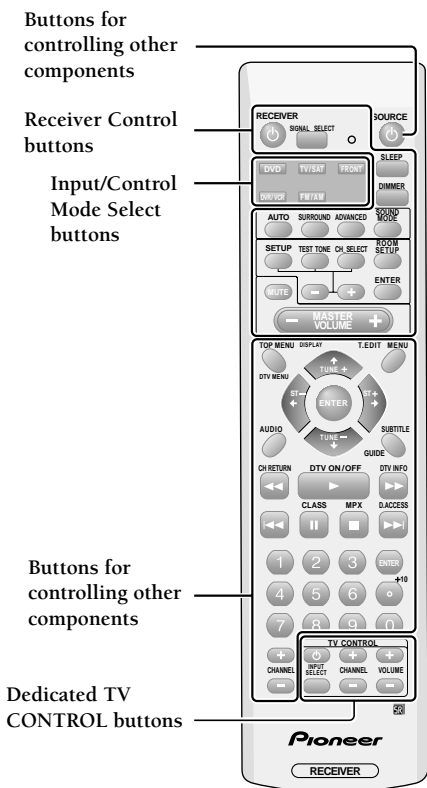

Press the button of the component you want to use this remote to operate. This will both change the input into the receiver and the remote control operation mode.

The factory settings for all Input/Control Mode Select buttons are explained here. All the settings are all for Pioneer components but you can change this.

- DVD: DVD player
  - TV/SAT: TV
  - DVR/VCR: DVD recorder
  - FM/AM: the built-in radio tuner
  - FRONT: VCR
  - TV: TV
- (For a detailed chart of the factory settings see “Clearing the Preset Codes” on page 46)

**Note**

- The TV CONTROL buttons are dedicated to controlling the TV. They will always control the TV no matter what operation mode the remote is in. Of course, you need to input the preset code for your TV (if it is not Pioneer-made) in order to control it with this remote. If, however, you input the code for a similar component (like a satellite TV tuner) for a different button (like the TV/SAT button) the TV CONTROL buttons may take on the controls of that component when in that mode (i.e. when you press the TV/SAT button the TV CONTROL buttons might control your satellite TV tuner, not your TV).

## Recalling Preset Codes

The following steps show you how to recall preset codes for each Input/Control Mode Select button or the TV CONTROL buttons. In the former case, once the preset code is assigned, pressing the button will automatically set the remote to operate the respective component.

 **Note**

- Refer to “Preset Code List” on pages 49 for the components and manufacturers available. You should have no problem controlling a component if you find the manufacturer in this list, but you can only set these codes for the button that is assigned to that component. So, for example, the TV codes can only be set to the TV/SAT button.  
Please note that there are cases where only certain functions may be controllable after assigning the proper preset code, or the codes for the manufacturer in the list will not work for the model that you are using.
- Refer to “Controlling the Rest of Your System” on pages 47 & 48 for detailed explanations on how to operate your other components.

- 1 While pressing the **ENTER** button press the **Input/Control Mode Select** button you want to preset. For the **TV CONTROL** buttons press the **TV CONTROL**  (Power) button while pressing the **ENTER** button.

The LED lights.

To cancel the preset mode at any time

Press **ENTER**.

The remote control will also return to the previous mode after thirty seconds of inactivity.

- 2 Use the **number buttons** to enter the **3 digit setup code** (see pages 49 for “Preset Code List”).

The LED turns off.

After a code has been input the power of the component being input will turn on or off.

The remote will return to the previous mode after thirty seconds of inactivity.

The power of the component being input will only turn on or off if that component is able to be turned on directly by remote control.

- 3 Repeat process to assign preset codes for as many components as you want.

 **Note**

- You can only input a code for the component type written on each Input/Control Mode Select button.
- Even if you don't input a preset code for the TV (TV/ SAT Input/Control Mode Select button) you will be able to control your TV using the dedicated TV CONTROL on the remote.

**CAUTION:**

- You may not be able to use a particular code even if it is listed on pages 49.
- The remote control buttons will not be able operate other equipment unless preset with the method above.

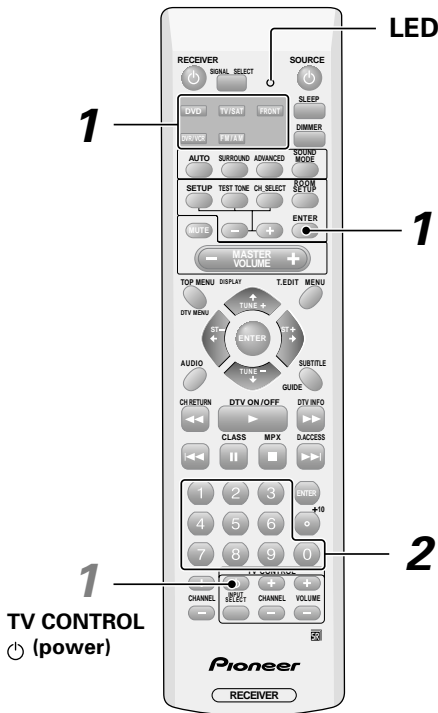

## Clearing the Preset Codes

Clears all presets, all learned functions and restores the factory presets.

- 1 While pressing the **ENTER** button press and hold the **0** button for three seconds.

The LED on the remote control blinks three times indicating all the preset codes have been cleared. The remote control will reset as described in the box below.













Input/Control Mode Select button	Preset Code	Component (Manufacturer)
DVD	000	DVD (PIONEER)
TV/SAT	600	TV (PIONEER)
DVR/VCR	456	DVD Recorder (PIONEER)
FRONT	400	VCR (PIONEER)
TV CONTROL	600	TV (PIONEER)

## CD/MD/CD-R/VCR/DVD/LD/DVD recorder/Cassette Deck Controls

This remote control can control these components after entering the proper codes or teaching the receiver the commands (see page 45).

Use **Input/Control Mode Select** buttons to put the remote control in the stated mode.

Button(s)	Function	Components
SOURCE 	Press to switch the components between <b>STANDBY</b> and <b>ON</b> .	CD/MD/CD-R/VCR/DVD/LD/ DVD recorder/Cassette deck
	Press to return to the start of the current track or chapter. Repeated presses skips to the start of previous tracks or chapter. Play the reverse side of the tape on a reversible deck.	CD/MD/CD-R/DVD/LD/ DVD recorder Cassette deck
	Press to advance to the start of the next track or chapter. Repeated presses skips to the start of following tracks or chapter. Play the forward side of the tape on a reversible deck.	CD/MD/CD-R/DVD/LD/ DVD recorder Cassette deck
	Pause playback or recording.	CD/MD/CD-R/VCR/DVD/LD/ DVD recorder/Cassette deck
	Hold down for fast forward playback.	CD/MD/CD-R/VCR/DVD/LD/ DVD recorder/Cassette deck
	Hold down for fast reverse playback.	CD/MD/CD-R/VCR/DVD/LD/ DVD recorder/Cassette deck
	Start playback.	CD/MD/CD-R/VCR/DVD/LD/ DVD recorder/Cassette deck
	Stop playback (on some models, pressing this when the disc is already stopped will cause the disc tray to open).	CD/MD/CD-R/VCR/DVD/LD/ DVD recorder/Cassette deck
Number	Directly access tracks on a program source.	CD/MD/CD-R/LD
Buttons	Directly access chapter on a program source. Directly select a channel.	DVD/DVD recorder VCR
+10 Button	Select tracks or chapter higher than 10. Press this button and the remaining number to get the track or chapter (+10 Button + 3= track or chapter 13). Switches subtitles for DVD or video game control pad.	CD/MD/CD-R/VCR/ DVD/LD/DVD recorder Video game
	Start recording. To prevent accidental recording, these buttons must be pressed together.	VCR/DVD recorder/ MD/CD-R/Cassette deck
MENU	Displays menus concerning the current DVD or DVR you are using.	DVD/DVD recorder
TOP MENU	Displays the top menu of the current DVD or DVR you are using.	DVD/LD/DVD recorder
AUDIO	Changes the audio track of discs with more than one audio track.	DVD/LD/DVD recorder
SUBTITLE	Displays/changes the subtitles on multilingual DVDs	DVD/DVD recorder
  & ENTER	Navigate DVD menus/options.	DVD/DVD recorder

### Note











- Depending on the maker and individual model, there are some buttons that may not be able operate some equipment or may operate it in a different way.

## Controlling the Rest of Your System

### Cable TV/Satellite TV/Digital TV/TV Controls

This remote control can control these components after entering the proper codes or teaching the receiver the commands (see page 45).

Use **Input/Control Mode Select** buttons to put the remote control in the stated mode.

Button(s)	Function	Components
TV 	Press to switch the TV or CATV between <b>STANDBY</b> and <b>ON</b> .	Cable TV/ Satellite TV/ TV
INPUT SELECT	Press to switch the TV input.	Cable TV/ Satellite TV/ TV
CHANNEL +/-	Select channels.	Cable TV/ Satellite TV/ TV
VOLUME +/-	Adjust the TV volume.	Cable TV/ Satellite TV/ TV
MENU	Takes you to the TV menu of that system.	Cable TV/ Satellite TV/ TV/ Digital TV
TOP MENU	Takes you to the guide menu of that system.	Cable TV/ Satellite TV/ TV/ Digital TV
DISPLAY	Takes you to the previous channel	TV
	Use to show the DTV menu.	Digital TV
	Use to return to a previous channel.	Cable TV/ Satellite TV/ Digital TV
	Use to move back a page in the menu.	Cable TV
	BLUE	Satellite TV/ Digital TV
	Use to move forward a page in the menu.	Cable TV
	YELLOW	Satellite TV/ Digital TV
	GREEN	Satellite TV/ Digital TV
	RED	Satellite TV/ Digital TV
+10 Button	Select channel higher than 10. Press this button and the remaining number to get the track or chapter (+10 Button + 3= track or chapter 13).	TV
Number Buttons	Use to select a specific TV channel.	Cable TV/ Satellite TV/ TV
    & ENTER	Press to select or adjust and navigate items on the menu screen.	Cable TV/ Satellite TV/ TV



#### Note

- Depending on the maker and individual model, there are some buttons that may not be able operate some equipment or may operate it in a different way.



Preset Code List

DVD

Manufacturer	Code
TOSHIBA	001
SONY	002
PANASONIC	003
JVC	004
SAMSUNG	005
SHARP	006
AKAI	007
RCA	009, 011
DENON	003, 010
HITACHI	012
PHILIPS	013
ZENITH	014
SONY	
(video game)	016
LOEWE	013
GOLDSTAR	014
MICROSOFT	017 (Video game)
PIONEER	000, 003, 008, 111

LD

Manufacturer	Code
SONY	101
PANASONIC	105, 106
PHILIPS	104
KENWOOD	103
MITSUBISHI	100
RCA	107
PIONEER	100, 111(DVD/LD)

TV

Manufacturer	Code
RCA	601, 610, 615, 616 617, 618, 661, 662 609
ZENITH	603, 620
MAGNAVOX	607, 610, 603, 612 629
GE	601, 608, 607, 610 617, 602, 628, 618
PHILIPS	607
SONY	604
PANASONIC	607, 608, 622
TOSHIBA	605, 602, 626, 621
SHARP	602, 619, 627
HITACHI	606, 610, 624, 625 618
SANYO	621, 614
MITSUBISHI	609, 610, 602, 621
GOLDSTAR	610, 623, 621, 602
JVC	613, 623
RADIOSHACK	610, 623, 621, 602
FUNAI	658
GRANDIENTE	630
LOEWE	607
PIONEER	600

STB (SATELLITE/CATV)

Manufacturer	Code
JERROLD	711, 701, 702, 712 704, 713, 703, 714 716, 715
S.ATLANTA	705, 706, 708, 709
ZENITH	707, 717, 710
PIONEER	700

On digital STB

Manufacturer	Code
RCA	201, 203
SONY	202
ECHOSTAR	205
PRIMESTAR	206
BELL	208
PIONEER	200, 207, 231

DTV

Manufacturer	Code
PIONEER	229, 207
PANASONIC	230

TUNER

Manufacturer	Code
PIONEER	500

VCR

Manufacturer	Code
ORION	445, 446, 424
FUNAI	441
RCA	401, 406, 408, 414 405, 413, 411, 415 460, 461, 462, 463 435
ZENITH	403, 404, 417
MAGNAVOX	414, 408, 426, 403
FISHER	410, 426, 412, 427 425, 420
PANASONIC	408, 432, 433
TOSHIBA	405, 409, 426
JVC	428, 430, 429, 408 414, 431, 407
HITACHI	408, 401, 406, 436 434
SONY	416, 417, 404, 408 457, 458, 459
MITSUBISHI	409, 420, 421, 422 423, 424, 408, 407 456
SANYO	410, 412, 425, 435
SHARP	402, 418, 419, 456
GOLDSTAR	411, 409
OPTIMUS	408, 432, 433, 402 418, 419
GRADIENTE	441
LOEWE	414, 432
KENWOOD	456
PIONEER	400

DVD Recorder

Manufacturer	Code
PIONEER	456

TAPE

Manufacturer	Code
DENON	810
FISHER	813
JVC	802
KENWOOD	804, 807
MARANTZ	821
ONKYO	808, 809
OPTIMUS	800
SONY	801, 806
TEAC	805
TECHNICS	803
YAMAHA	811, 812
PIONEER	800

CD

Manufacturer	Code
DENON	309, 346
JVC	303
KENWOOD	310, 311, 321
MARANTZ	323, 312, 324, 346
ONKYO	320, 308, 307
OPTIMUS	300
PHILIPS	312, 322, 346
RCA	302, 319, 313
SANYO	313
SONY	301, 316, 317, 318
TEAC	305, 306, 327, 324 325
TECHNICS	304, 326
YAMAHA	315, 314, 328, 347
PIONEER	300, 345

MD

Manufacturer	Code
SONY	901
KENWOOD	903
SHARP	902
TEAC	904
ONKYO	905
DENON	906
PIONEER	900, 902, 907

## Troubleshooting

Incorrect operations are often mistaken for trouble and malfunctions. If you think that there is something wrong with this component, check the points below. Sometimes the trouble may lie in another component. Investigate the other components and electrical appliances being used. If the trouble cannot be rectified even after exercising the checks listed below, ask your nearest PIONEER authorized service center or your dealer to carry out repair work.

Symptom	Cause	Remedy
The power does not turn on.	<ul style="list-style-type: none"> <li>The power plug is disconnected.</li> <li>The protection circuit may have been activated.</li> <li>Speaker wire may be touching the rear panel.</li> <li>Static electricity caused by dry air.</li> </ul>	<ul style="list-style-type: none"> <li>Connect the power plug to the wall outlet.</li> <li>Disconnect the power plug from the outlet, and insert again.</li> <li>Make sure there are no loose strands of speaker wire touching the rear panel. This could cause the receiver to shut off automatically.</li> <li>Disconnect the power plug from the outlet, and insert again.</li> </ul>
AMP ERR blinks in the display and the unit turns off.	<ul style="list-style-type: none"> <li>The receiver has a serious problem.</li> </ul>	<ul style="list-style-type: none"> <li>Unplug the receiver from the wall and call a Pioneer-accredited repair center.</li> </ul>
HEAT UP blinks in the display.	<ul style="list-style-type: none"> <li>The receiver has gotten too hot.</li> </ul>	<ul style="list-style-type: none"> <li>Allow the receiver to cool down with good ventilation. If problem persists turn off receiver, unplug from wall and allow it to cool down.</li> </ul>
OVERHEAT blinks in the display and no sound is output.	<ul style="list-style-type: none"> <li>The receiver has gotten too hot.</li> </ul>	<ul style="list-style-type: none"> <li>Turn the receiver off and allow it to cool down with good ventilation. If problem persists turn the volume down.</li> </ul>
THDCT NG blinks in the display and no sound is output.	<ul style="list-style-type: none"> <li>The thermistor (temperature sensor) is out of order.</li> </ul>	<ul style="list-style-type: none"> <li>Turn the receiver off, unplug from wall and call a Pioneer-accredited repair center.</li> </ul>
The unit does not respond when the buttons are pressed.	<ul style="list-style-type: none"> <li>Improper connections.</li> <li>Sound is muted.</li> <li>The volume is turned down.</li> </ul>	<ul style="list-style-type: none"> <li>Make sure the component is connected correctly (refer to pages 14–17).</li> <li>Press MUTE on the remote control.</li> <li>Adjust the MASTER VOLUME.</li> </ul>
No sound is output when the AM/FM is selected.	<ul style="list-style-type: none"> <li>Incorrect frequency.</li> <li>The antenna is not connected.</li> </ul>	<ul style="list-style-type: none"> <li>Tune in the correct frequency.</li> <li>Connect the antenna (refer to page 20).</li> </ul>
Considerable noise in radio broadcasts.	FM broadcasts <ul style="list-style-type: none"> <li>The FM antenna is not fully extended or is poorly positioned.</li> <li>Weak radio signals.</li> </ul>	<ul style="list-style-type: none"> <li>Fully extend the FM wire antenna, position for best reception, and secure to a wall.</li> <li>Connect an outdoor FM antenna (refer to page 20).</li> </ul>
	AM broadcasts <ul style="list-style-type: none"> <li>The AM antenna is poorly positioned.</li> <li>Weak radio signals.</li> <li>Interference caused by other equipment (fluorescent lamp, motor, etc.).</li> </ul>	
Broadcast stations cannot be selected automatically.	<ul style="list-style-type: none"> <li>The radio signal is too weak.</li> </ul>	<ul style="list-style-type: none"> <li>Connect an outdoor antenna (refer to page 20).</li> </ul>

Symptom	Cause	Remedy
No sound from surround or center speakers.	<ul style="list-style-type: none"> <li>• Surround or center speaker settings are incorrect.</li> <li>• The surround and/or center levels are turned down.</li> <li>• The surround and/or center speakers are disconnected.</li> </ul>	<ul style="list-style-type: none"> <li>• Refer to speakers setting mode on page 30 to check the speaker settings.</li> <li>• Turn levels up. Refer to “Setting the Volume Level of Each Channel” on page 34 to check the speaker levels.</li> <li>• Connect the speakers (refer to page 18).</li> </ul>
No sound from subwoofer	<ul style="list-style-type: none"> <li>• The subwoofer is disconnected.</li> <li>• The subwoofer's settings are incorrect.</li> <li>• The subwoofer's levels are too low.</li> <li>• The LFE Attenuator is set to OFF.</li> </ul>	<ul style="list-style-type: none"> <li>• Connect the subwoofer (refer to page 18).</li> <li>• Set the subwoofer (refer to page 30).</li> <li>• Set the front speakers to Small (<b>S</b>) (refer to page 30).</li> <li>• Refer to “Setting the Volume Level of Each Channel” on page 34 to check the speaker levels.</li> <li>• Set the LFE Attenuator to either 0 dB or 10 dB (refer to page 31).</li> </ul>
Sound is produced from analog components, but not from digital ones (DVD, LD, CD-ROM etc.).	<ul style="list-style-type: none"> <li>• Digital connections are incorrect.</li> <li>• The digital output of the player is turned off.</li> <li>• The CD-ROM player is outputting a data stream (not an audio signal) which is incompatible with this receiver.</li> <li>• Digital connections are incorrect.</li> <li>• Analog input has been selected.</li> <li>• The digital input assignment is wrong.</li> </ul>	<ul style="list-style-type: none"> <li>• Make digital connections (refer to page 13–16)</li> <li>• Turn on the digital output of the player on (consult the manual that came with the player, if necessary).</li> <li>• Use a player that is compatible with this receiver.</li> <li>• Make digital connections (refer to page 13–16).</li> <li>• Select digital input (refer to page 42).</li> <li>• Assign the digital input (refer to page 33).</li> </ul>
No sound is output or a noise is output when Dolby Digital/DTS software is played back.	<ul style="list-style-type: none"> <li>• A DVD player not compatible with Dolby Digital/DTS is being used.</li> <li>• The settings on the DVD player are incorrect and/or the DTS signal output is turned off.</li> <li>• The digital output level is turned down on a CD player or other component equipped with digital output level adjustment capability. (The DTS signal has been altered by the player, and cannot be read.)</li> </ul>	<ul style="list-style-type: none"> <li>• Make sure your DVD player is compatible with Dolby Digital/DTS.</li> <li>• Make sure the player's settings are correct and/or the DTS signal out is on. Refer to the instruction manual supplied with the DVD player.</li> <li>• Set the digital volume level of the player to full, or to the neutral position.</li> </ul>
When a search is performed by a DTS compatible CD player during playback, noise is output.	<ul style="list-style-type: none"> <li>• The search function performed by the player slightly alters the digital information, making it unreadable.</li> </ul>	<ul style="list-style-type: none"> <li>• This is not a malfunction, but be sure to turn the volume down to prevent the output of loud noise from your speakers.</li> </ul>
The Dolby/DTS indicator doesn't light when playing Dolby/DTS software.	<ul style="list-style-type: none"> <li>• The player is paused.</li> <li>• The player's sound output settings are wrong.</li> </ul>	<ul style="list-style-type: none"> <li>• Press play.</li> <li>• Set the player correctly (consult the manual that came with the player, if necessary).</li> </ul>
When playing a 96 kHz/24bit disc the sound is too loud.	<ul style="list-style-type: none"> <li>• Different discs have different recording levels so some may be louder than others.</li> </ul>	<ul style="list-style-type: none"> <li>• Turn the volume down.</li> </ul>





## Additional Information

Symptom	Cause	Remedy
The sound distorts.	<ul style="list-style-type: none"> <li>The analog signal is too strong.</li> <li>Master volume is too loud.</li> </ul>	<ul style="list-style-type: none"> <li>Turn on input attenuator (see page 33).</li> <li>Turn the volume down.</li> </ul>
You can only hear treble from speakers.	<ul style="list-style-type: none"> <li>The front speakers are set to small.</li> </ul>	<ul style="list-style-type: none"> <li>Set the front speakers to large (refer to page 30).</li> </ul>
No image is output when an input is selected.	<ul style="list-style-type: none"> <li>The video connections are incorrect.</li> <li>The input source is not properly selected.</li> <li>The DVD/video player settings are incorrect.</li> </ul>	<ul style="list-style-type: none"> <li>Make sure the video component is connected correctly (refer to pages 13 to 16).</li> <li>Make sure the proper component is selected by pressing the correct function button (see page 22).</li> <li>Set correctly. Refer to the instruction manual supplied with the DVD/video player.</li> </ul>
The settings have all been cleared.	<ul style="list-style-type: none"> <li>The receiver has been unplugged or the main power turned off for more than a month.</li> </ul>	<ul style="list-style-type: none"> <li>Set the receiver again (refer to page 28-32).</li> </ul>
OVERLOAD blinks in the display and the power turns off automatically.	<ul style="list-style-type: none"> <li>There is a short in your speaker cable.</li> <li>The output is too high.</li> </ul>	<ul style="list-style-type: none"> <li>Fix the short or get new speaker cable.</li> <li>Turn the volume down.</li> </ul>
You can't set the subwoofer frequency route.	<ul style="list-style-type: none"> <li>All the speakers are set to either large or NO (i.e. no speakers are set to small).</li> </ul>	<ul style="list-style-type: none"> <li>Change the speaker settings (refer to page 29-31).</li> </ul>
The display is dark or off.	<ul style="list-style-type: none"> <li>The DIMMER feature is set to dark or off.</li> </ul>	<ul style="list-style-type: none"> <li>Press DIMMER on the remote control repeatedly to select a different brightness.</li> </ul>
After making an adjustment the display goes off.	<ul style="list-style-type: none"> <li>The DIMMER feature is set to off.</li> </ul>	<ul style="list-style-type: none"> <li>Press DIMMER on the remote control repeatedly to select a different brightness.</li> </ul>
The receiver cannot be remote controlled.	<ul style="list-style-type: none"> <li>The remote control batteries have worn out.</li> <li>You are too far away or at a bad angle for operation.</li> <li>There is an obstacle between the receiver and the remote control.</li> <li>Strong light such as fluorescent light.</li> <li>The CONTROL terminal has been hooked up.</li> </ul>	<ul style="list-style-type: none"> <li>Replace the batteries (refer to page 12).</li> <li>Operate within 7 m (23 feet), 30° of the remote sensor on the front panel (refer to page 12).</li> <li>Remove the obstacle or operate from another angle of position.</li> <li>Avoid exposing the remote sensor on the front panel to direct light.</li> <li>Disconnect the CONTROL terminal.</li> </ul>
Other components cannot be remote controlled.	<ul style="list-style-type: none"> <li>The proper code hasn't been input into the remote control to control that component.</li> <li>The remote control is in a mode to make some setting or control something on the receiver.</li> <li>Something is plugged into the "CONTROL IN Terminal" (see page 21).</li> </ul>	<ul style="list-style-type: none"> <li>Input the proper code into the remote control (see page 45).</li> <li>Press the button of the component you want to control.</li> <li>Either point remote at the remote sensor of the unit that is plugged into the "Control Terminal in" or unplug the cable from the "CONTROL IN Terminal" and use remote normally.</li> </ul>
The shutter of the optical terminal doesn't close after removing plug.	<ul style="list-style-type: none"> <li>The plug was inserted improperly.</li> </ul>	<ul style="list-style-type: none"> <li>The terminal is fine but the shutter won't close.</li> </ul>

If the unit does not operate normally due to external effects such as static electricity. Disconnect the power plug from the outlet and insert again to return to normal operating conditions.

## Understanding DVD Packaging

DVD packaging usually states what sound formats are included on the DVD. The diagram here shows what you might see on a typical DVD box. The terms used (Dolby Digital, etc.) are explained in the following sections.

LANGUAGE	English
 DOLBY DIGITAL	 5.1 SURROUND
 dts	 5.1 SURROUND
CAPTIONS SUBTITLES	Captioned

## Digital Audio Formats

Home theater uses various types of methods to encode the sound on to the digital sources and these are known as digital formats. The most common digital formats are explained below.

### Dolby Digital and Dolby Surround

Dolby Digital is the most widely used system to record soundtracks on DVDs and other media. It's a sound compression format which records the sound of 6 channels of the theater surround system (Dolby Digital) on a movie film digital track. Of the 6 channels, the subwoofer channel is intended for bass only, and because the frequency range is smaller than a main channel, the overall soundtrack is called 5.1 channels.

Dolby Digital is the name of the Dolby surround multichannel digital system that was developed after the Dolby Surround System and Dolby Pro Logic Surround System.

Dolby Digital is also known as the 5.1 channel system. It is equipped with 5 channels (front left, front right, center, surround left, surround right) in the frequency range from 20 Hz to 20 kHz and an independent Low Frequency Effect (LFE) channel. The subwoofer channel is also called Low Frequency Effect (LFE).

This channel can be used with a powered subwoofer to get strong bass sounds.

### DTS

DTS is another widely used system to record soundtracks on DVDs and other media. It has been adopted as a sound recording format in the latest movie theaters since the release of "JURASSIC PARK" in 1993, and has a good reputation for high quality sound and dynamic surround effects.

In this system, 6 channels of digital sound are recorded on CD-ROM, rather than on the film. DTS adopts a simultaneous playback format. With a low rate of compression of sound signals and a high rate of transmittance, a higher sound quality format is produced. Also, unlike the process of recording digital sounds on film directly, the only components required are a CD-ROM player as might be used with a personal computer and a DTS processor, and therefore less investment is required than with other formats. For this reason, the format is being introduced in more and more movie theaters, and is being adopted in home movie software (DVD, LD) and music software (5.1 channel CD).

### PCM (Pulse Code Modulation)

This is an uncompressed 2 channel stereo format found on most CDs and DATs. PCM can be used as one of the audio recording formats for DVD but as it's only 2 channel stereo. It is sometimes used for DVD audio discs (or DVD-A).

### Recording Formats

These are the recording formats. Determining what kind of playback format is being employed with any particular recording format depends on three things: 1) how the signal is encoded and transmitted; 2) how the signal is decoded; and 3) how the sound is actually heard through the speakers (where your speaker configuration and the sound mode you choose have a big effect).

All the possibilities are listed below.

#### 2 Channel Stereo

In this format the signal is recorded on two channels (i.e. stereo), left and right. Most music CDs use this format.

#### 2 Channel Surround (Dolby Surround)

Used mainly for videotape, this is one of the original home theater formats and can be decoded by this receiver. Because it developed over a time it is the most complicated system explained here. The developers had to solve the problem of how to offer surround sound to the people who had the proper decoder but at the same time deliver 2 channel sound to those without the proper decoder. Thus the Dolby Surround format encodes four channels (left, right, center, surround) into two channels for storage and transmission.

#### 5.1 Channel Surround

This is a format with five channels (front left & right, center, surround left & right) and a channel for bass. (This is called the LFE channel and is usually output from a subwoofer. Since it is only for bass sounds it is thus expressed as .1 of a channel.) With this format you can get movie theater-like, powerful surround sound.

### Playback Formats

This receiver is equipped with many different playback formats and this flexibility should allow you to get stereo or surround sound playback (depending on the kind of source you're using) with all speaker configurations.

#### 2 Channel Stereo Playback

This is conventional stereo playback from the left and right speakers (called "front" speakers on this receiver).

#### Virtual Surround Playback (PHONES/VIRTUAL indicator lights)

With this playback method you can get multichannel-like surround sound even when using just two speakers. This is achieved by the Virtual surround listening mode which uses SRS Tru Surround technology.

#### Headphone Surround Playback (PHONES/VIRTUAL indicator lights)

With this playback method you can get multichannel-like surround sound like effects even when listening on headphones. This new technology is useful for getting a surround sound feeling even when listening with the privacy of headphones.

#### Dolby Pro Logic II Playback (PRO LOGIC II indicator lights)

##### Dolby Pro Logic II

Dolby Pro Logic II is an improved version of Dolby Pro Logic technology with extended matrix decoding technology that can create 5.1 channel sound playback from two channel sources. Dolby Pro Logic II creates basic 5 channel sound by using the innovative "steering logic" circuit. Therefore when listening to typical two-channel sources like CD, the listener can enjoy a richer spatial effect. When using software encoded with Dolby Surround, this decoding system affords the listener an improved surround experience with greater sound detail.

This unit has a three Dolby Pro Logic II functions. The first is "MOVIE" (suitable for film soundtracks); "MUSIC" (suitable for music); "Pro Logic Mode" (this mode is less sensitive to the quality of the source material, so may be useful when Movie Mode or Music Mode do not give good results). One can select one of them for playback depending on your soundtrack of choice.

#### Multichannel Surround Playback (ADVANCED indicator lights)

These are different multichannel playback methods which are each suited to various sources. These modes will give you realistic and powerful surround sound playback for five speakers.



*Dear Customer:*

Selecting fine audio equipment such as the unit you've just purchased is only the start of your musical enjoyment. Now it's time to consider how you can maximize the fun and excitement your equipment offers. This manufacturer and the Electronic Industries Association's Consumer Electronics Group want you to get the most out of your equipment by playing it at a safe level. One that lets the sound come through loud and clear without annoying blaring or distortion-and, most importantly, without affecting your sensitive hearing.

Sound can be deceiving. Over time your hearing "comfort level" adapts to higher volumes of sound. So what sounds "normal" can actually be loud and harmful to your hearing. Guard against this by setting your equipment at a safe level BEFORE your hearing adapts.

**To establish a safe level:**

- Start your volume control at a low setting.
- Slowly increase the sound until you can hear it comfortably and clearly, and without distortion.

**Once you have established a comfortable sound level:**

- Set the dial and leave it there.

Taking a minute to do this now will help to prevent hearing damage or loss in the future. After all, we want you listening for a lifetime.

**We Want You Listening For A Lifetime**

Used wisely, your new sound equipment will provide a lifetime of fun and enjoyment. Since hearing damage from loud noise is often undetectable until it is too late, this manufacturer and the Electronic Industries Association's Consumer Electronics Group recommend you avoid prolonged exposure to excessive noise. This list of sound levels is included for your protection.

**Decibel**

**Level Example**

30	Quiet library, soft whispers
40	Living room, refrigerator, bedroom away from traffic
50	Light traffic, normal conversation, quiet office
60	Air conditioner at 20 feet, sewing machine
70	Vacuum cleaner, hair dryer, noisy restaurant
80	Average city traffic, garbage disposals, alarm clock at two feet.

**THE FOLLOWING NOISES CAN BE DANGEROUS UNDER CONSTANT EXPOSURE**

90	Subway, motorcycle, truck traffic, lawn mower
100	Garbage truck, chain saw, pneumatic drill
120	Rock band concert in front of speakers, thunderclap
140	Gunshot blast, jet plane
180	Rocket launching pad

Information courtesy of the Deafness Research Foundation.



S001 En

## Specifications (U.S. model)

### Amplifier Section

**Continuous average power output of 21 watts\* per channel, min., at 6 ohms, from 20 Hz to 20,000 Hz with no more than 0.9 %\*\* total harmonic distortion (front).**

Continuous Power Output (SURROUND MODE)  
FRONT ..... 33 W / ch (1 kHz, THD 1 %, 6 Ω)  
CENTER ..... 33 W (1 kHz, THD 1 %, 6 Ω)  
SURROUND ..... 33 W / ch (1 kHz, THD 1 %, 6 Ω)

RMS Power Output (SURROUND MODE)  
FRONT ..... 41 W / ch (1 kHz, THD 10 %, 6 Ω)  
CENTER ..... 41 W (1 kHz, THD 10 %, 6 Ω)  
SURROUND ..... 41 W / ch (1 kHz, THD 10 %, 6 Ω)

Input (Sensitivity/Impedance)  
DVD, TV/SAT, DVR/VCR, FRONT ..... 200 mV/47 kΩ  
Frequency Response  
DVD, TV/SAT, DVR/VCR, FRONT

..... 5 Hz to 100,000 Hz  $\pm 3$  dB  
Output (Level/Impedance)  
DVR/VCR OUT ..... 200 mV/2.2 kΩ

Signal-to-Noise Ratio (IHF, short circuited, A network)  
DVD, TV/SAT, DVR/VCR, FRONT ..... 97 dB  
Signal-to Noise Ratio [EIA, at 1 W (1 kHz)]  
DVD, TV/SAT, DVR/VCR, FRONT ..... 79 dB

\* Measured pursuant to the Federal Trade Commission's Trade Regulation rule on Power Output Claims for Amplifiers.

\*\* Measured by Audio Spectrum Analyzer.

### VIDEO Section

Input (Sensitivity/Impedance)  
DVD, TV/SAT, DVR/VCR, FRONT ..... 1 Vp-p/75 Ω  
Output (Level/Impedance)  
DVR/VCR, MONITOR ..... 1 Vp-p/75 Ω  
Frequency Response  
DVD, TV/SAT, DVR/VCR, FRONT → MONITOR  
..... 5 Hz to 7 MHz  $\pm 3$  dB  
Signal-to-Noise Ratio ..... 55 dB

### FM Tuner Section

Frequency Range ..... 87.5 MHz to 108 MHz  
Usable Sensitivity ... Mono:13.2 dBf, IHF (1.3 μV/ 75 Ω)  
50 dB Quieting Sensitivity ..... Mono: 20.2 dBf  
..... Stereo: 38.6 dBf  
Signal-to-Noise Ratio ..... Mono: 73 dB (at 85 dBf)  
..... Stereo: 70 dB (at 85 dBf)  
Distortion ..... Stereo: 0.5 % (1 kHz)  
Alternate Channel Selectivity ..... 60 dB (400 kHz)  
Stereo Separation ..... 40 dB (1 kHz)  
Frequency Response ..... 30 Hz to 15 kHz (±1dB)  
Antenna Input (DIN) ..... 75 Ω unbalanced

### AM Tuner Section

Frequency Range ..... 530 kHz to 1,700 kHz (10 kHz)  
Sensitivity (IHF, Loop antenna) ..... 350 μV/m  
Selectivity ..... 25 dB  
Signal-to-Noise Ratio ..... 50 dB  
Antenna ..... Loop antenna

### Miscellaneous

Power Requirements ..... AC 120 V, 60 Hz  
Power Consumption ..... 120 W  
In Standby ..... 0.8 W  
Dimensions ..... 420 (W) x 65 (H) x 319(D) mm  
..... 16 9/16 (W) x 2 9/16 (H) x 12 9/16(D) in.  
Weight (without package) ..... 4.8 kg (10 lb 10 oz)

### Furnished Parts

AM loop antenna ..... 1  
FM wire antenna ..... 1  
Dry cell batteries (AA size IEC R6P) ..... 2  
Remote control unit ..... 1  
Power cord ..... 1  
Speaker cord labels ..... 1  
Cord with plug ..... 1  
Warranty card ..... 1  
Operating instructions ..... 1



### Note

- Specifications and the design are subject to possible modifications without notice, due to improvements.



## Specifications (Multi voltage model and Singaporean model)

### Amplifier Section

Maximum Output Power  
..... 41 W / ch (1 kHz, THD 10 %, 8  $\Omega$ )

Continuous Power Output (STEREO MODE)  
FRONT ..... 25 W+25W (DIN 1 kHz, THD 1 %, 8  $\Omega$ )

Continuous Power Output (SURROUND MODE)  
FRONT ..... 30 W / ch (DIN 1 kHz, THD 1 %, 8  $\Omega$ )  
CENTER ..... 30 W (DIN 1 kHz, THD 1 %, 8  $\Omega$ )  
SURROUND .... 30 W / ch (DIN 1 kHz, THD 1 %, 8  $\Omega$ )

Input (Sensitivity/Impedance)  
DVD, TV/SAT, DVR/VCR, FRONT ..... 200 mV/47 k $\Omega$   
Frequency Response  
DVD, TV/SAT, DVR/VCR, FRONT  
..... 5 Hz to 100,000 Hz  $\pm 3$  dB  
Output (Level/Impedance)  
DVR/VCR OUT ..... 200 mV/2.2 k $\Omega$

Signal-to-Noise Ratio (IHF, short circuited, A network)  
DVD, TV/SAT, DVR/VCR, FRONT ..... 97 dB

#### Singaporean model

Signal-to-Noise Ratio [DIN (Continuous rated power output/50 mW) ]  
DVD, TV/SAT, DVR/VCR, FRONT ..... 88 dB/64 dB

#### Multi voltage model

Signal-to Noise Ratio [EIA, at 1 W (1 kHz)]  
DVD, TV/SAT, DVR/VCR, FRONT ..... 79 dB

### VIDEO Section

Input (Sensitivity/Impedance)  
DVD, TV/SAT, DVR/VCR, FRONT ..... 1 Vp-p/75  $\Omega$   
Output (Level/Impedance)  
DVR/VCR, MONITOR ..... 1 Vp-p/75  $\Omega$   
Frequency Response  
DVD, TV/SAT, DVR/VCR, FRONT  $\rightarrow$  MONITOR  
..... 5 Hz to 7 MHz  $\pm 3$  dB  
Signal-to-Noise Ratio ..... 55 dB

### FM Tuner Section

Frequency Range ..... 87.5 MHz to 108 MHz  
Usable Sensitivity  
Singaporean model ..... Mono:15.2 dBf, IHF (1.6  $\mu$ V/ 75  $\Omega$ )  
Multi voltage model ..... Mono:13.2 dBf, IHF (1.3  $\mu$ V/ 75  $\Omega$ )  
50 dB Quieting Sensitivity  
Singaporean model ..... Mono: 20.2 dBf  
..... Stereo: 41.2 dBf  
Multi voltage model ..... Mono: 20.2 dBf  
..... Stereo: 38.6 dBf

Signal-to-Noise Ratio  
Singaporean model ..... Mono: 76 dB (at 85 dBf)  
..... Stereo: 72 dB (at 85 dBf)  
Multi voltage model ..... Mono: 73 dB (at 85 dBf)  
..... Stereo: 70 dB (at 85 dBf)

Distortion  
Singaporean model ..... Stereo: 0.6 % (1 kHz)  
Multi voltage model ..... Stereo: 0.5 % (1 kHz)

Alternate Channel Selectivity  
Singaporean model ..... 70 dB (400 kHz)  
Multi voltage model ..... 60 dB (400 kHz)  
Stereo Separation ..... 40 dB (1 kHz)  
Frequency Response ..... 30 Hz to 15 kHz ( $\pm 1$ dB)  
Antenna Input ..... 75  $\Omega$  unbalanced

### AM Tuner Section

Frequency Range  
Singaporean model ..... 531 kHz to 1,602 kHz (9 kHz step)  
Multi voltage model .... 531 kHz to 1,602 kHz (9 kHz step)  
..... 530 kHz to 1,700 kHz (10 kHz step)  
Sensitivity (IHF, Loop antenna) ..... 350  $\mu$ V/m  
Selectivity  
Singaporean model ..... 30 dB  
Multi voltage model ..... 20 dB  
Signal-to-Noise Ratio ..... 50 dB  
Antenna ..... Loop antenna

### Miscellaneous

Power Requirements  
Singaporean model ..... AC 220 - 230 V, 50/60 Hz  
Multi voltage model .. AC 110/120-127/220/240 V, 50/60 Hz  
Power Consumption  
Singaporean model ..... 120 W  
Multi voltage model ..... 320 W  
In Standby ..... 0.9 W  
Dimensions ..... 420 (W) x 65 (H) x 319(D) mm  
Weight (without package) ..... 4.8 kg

### Furnished Parts

AM loop antenna ..... 1  
FM wire antenna ..... 1  
Dry cell batteries (AA size IEC R6P) ..... 2  
Remote control unit ..... 1  
Power cord ..... 1  
Speaker cord labels ..... 1  
Caution 220V label (for Multi voltage model) ..... 1  
Power plug adapter (for Multi voltage model) ..... 1  
Operating instructions ..... 1

### NOTE:

- Specifications and the design are subject to possible modifications without notice, due to improvements.





## AFTER-SALES SERVICE FOR PIONEER PRODUCTS

Please contact the dealer or distributor from where you purchased the product for its after-sales service (including warranty conditions) or any other information. In case the necessary information is not available, please contact the Pioneer's subsidiaries (regional service headquarters) listed below:

PLEASE DO NOT SHIP YOUR PRODUCT TO THE COMPANIES at the addresses listed below for repair without advance contact, for these companies are not repair locations.

### AMERICA

PIONEER ELECTRONICS (USA) INC.  
CUSTOMER SUPPORT DIVISION  
P.O. BOX 1760, LONG BEACH, CA 90801-1760, U.S.A.  
CUSTOMER SERVICE HOTLINE : (800) 421-1404

### EUROPE

PIONEER EUROPE NV  
EUROPEAN SERVICE DIVISION  
HAVEN 1087, KEETBERGLAAN 1, B-9120 MELSELE, BELGIUM

### ASEAN

PIONEER ELECTRONICS ASIACENTRE PTE. LTD.  
SERVICE DEPARTMENT  
253, ALEXANDRA ROAD #04-01 SINGAPORE 159936

### JAPAN AND OTHERS

PIONEER CORPORATION (HEAD OFFICE)  
CUSTOMER SUPPORT CENTER  
4-1, MEGURO 1-CHOME, MEGURO-KU, TOKYO 153-8654 JAPAN

S016D\_en

Published by Pioneer Corporation.  
Copyright © 2002 Pioneer Corporation.  
All rights reserved.

---

**PIONEER CORPORATION** 4-1, Meguro 1-Chome, Meguro-ku, Tokyo 153-8654, Japan  
**PIONEER ELECTRONICS [USA] INC.** P.O. BOX 1540, Long Beach, California 90801-1540, U.S.A.  
**PIONEER ELECTRONICS OF CANADA, INC.** 300 Allstate Parkway, Markham, Ontario L3R 0P2, Canada  
**PIONEER EUROPE NV** Haven 1087, Keetberglaan 1, B-9120 Melsele, Belgium TEL: 03/570.05.11  
**PIONEER ELECTRONICS AUSTRALIA PTY. LTD.** 178-184 Boundary Road, Braeside, Victoria 3195, Australia, TEL: [03] 9586-6300  
**PIONEER ELECTRONICS DE MEXICO S.A. DE C.V.** San Lorenzo 1009 3er Piso Desp. 302 Col. Del Valle Mexico D.F. C.P. 03100  
TEL: 55-5688-5290